

# SFB CAMPAIGN DESIGNER'S HANDBOOK

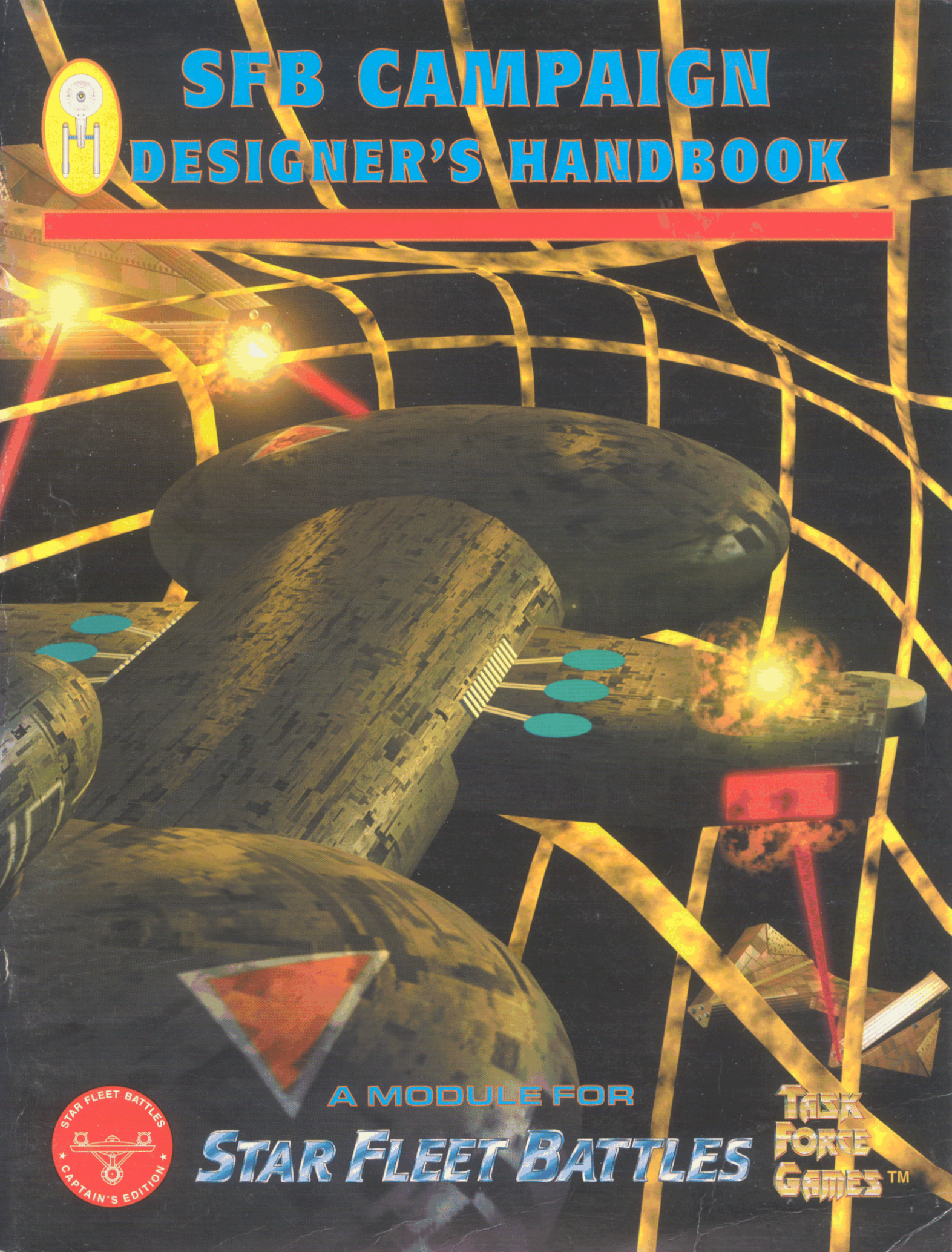

A MODULE FOR

# STAR FLEET BATTLES

TASK  
FORCE  
GAMES™

# STAR FLEET BATTLES

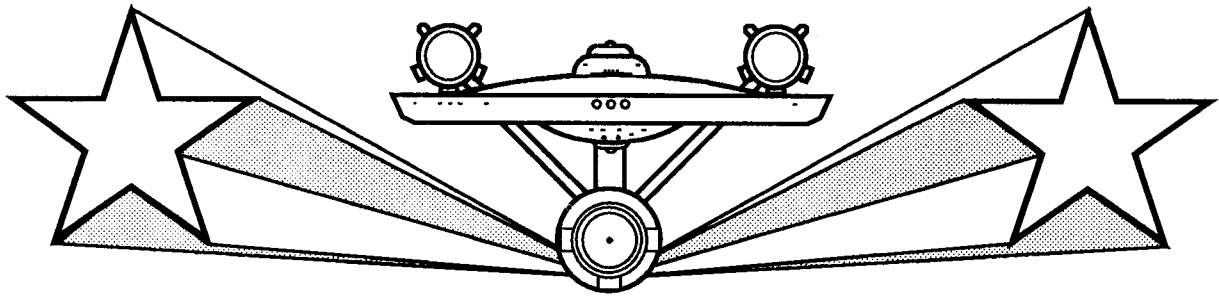

## THE CAMPAIGN DESIGNER'S HANDBOOK

### TABLE OF CONTENTS

INTRODUCTION TO CAMPAIGNS .....	2
THE STRATEGIC ARENA .....	7
ECONOMICS .....	13
LOGISTICS .....	16
CONSTRUCTION .....	19
SCENARIOS.....	25
COMMAND LIMITS .....	30
TECHNOLOGY .....	37
THE TECHBLOCK TECHNOLOGY SYSTEM .....	39
RACES .....	64
OTHER CAMPAIGN CONSIDERATIONS .....	70
REPAIRS .....	70
REFITS AND UPGRADES .....	72
THE STRATEGIC SEQUENCE OF PLAY .....	74
LEGENDARY OFFICERS .....	75
STARSHIP CREWS .....	79
ESPIONAGE AND SABOTAGE .....	82
MINOR SHIP IMPROVEMENTS .....	84
RANDOM EVENTS .....	85
DESIGNER'S NOTES AND PUBLISHER'S INFORMATION .....	87
SUPPLEMENTARY MATERIAL	
PSEUDO-HISTORICAL CAMPAIGN MAP (4 SECTIONS) .....	88
CAMPAIGN STARSHIP RECORD FORM .....	92
SSDS FOR CONSTRUCTION DOCKS AND WARP GATE .....	93

## INTRODUCTION TO CAMPAIGNS

What is a campaign? A campaign is an entire war or portion of a war, told through a series of battles, each leading to the other in an orderly sequence. A campaign is *strategic*—the individual tactical battles (scenarios) have importance, but only as a means to achieve the greater strategic goal. As the saying goes, it is possible to win a battle but lose the war (and, naturally, the reverse holds true as well).

The *strategic goal* is the overall objective—be it political, territorial, or whatever. In contrast, a tactical battle involves a local conflict between units or elements. Think of battles (which we will term “scenarios” from this point onward) as a stepping-stone to the campaign objective, a subset of a greater macrocosm of combat.

### WHY HAVE A CAMPAIGN?

Campaigns have much to offer, but their best feature is adding a sense of overall purpose to your SFB-playing. Many SFBers enjoy individual scenarios, and are content to fight a simulated historical battle or work their way out of an intricate situation. They then leave the gaming table after the scenario has reached a satisfactory conclusion. After a while, however, this can lose its interest—especially when players are part of a group of more than three or four gamers.

At this point the free-for-alls (and their innumerable derivatives) begin, but even these lose their flavor after a time. What's the point of getting together to face Joe and Mike and Bob yet again? If I get destroyed, what's the difference? Why should I bother trying to disengage? Why shouldn't I self-destruct even though I'm barely crippled?

Campaigns answer these questions—they add a sense of *meaning* to your gaming. Suddenly, you *care* if your Federation CA gets the saucer away safely, or if your Legendary Navigator can beam over to a friendly ship in time to avoid perishing with the rest of his ship's crew. Rules for tracking crew losses, fighter pilot quality, split economic/combat BPV, and so on suddenly have meaning. What happens in one game now affects what will happen in future games, so you now have a reason to come back!

There are other reasons to have a campaign, too:

*Campaigns keep gaming groups together, and keep interest in SFB high.* Since the typical campaign takes months or years to complete, joining one is a long-term commitment. A player who truly gets involved in the campaign is not likely to leave the group, even if his position is overwhelmed by an opponent (he will just join forces with an ally). Friendships grow between all players, ally and enemy alike, as they brag, taunt, and discuss strategies among each other.

*Campaigns give you something to think about during the days between gaming meetings.* If your group meets twice a month, you'll rarely think about SFB between sessions, but a campaign changes all that. You'll find yourself discussing options, making decisions, and working out details whenever you have free time. Campaigns offer a wealth of alternatives and choices which only the individual players can make, and these will really get your mind working.

*Finally, campaigns explore a hidden side of SFB.* On the surface, you see only tactics, but in a campaign you enter the strategic level. Your empire has three DNs—where do they need to go? Should you attack another player or guard important worlds? What about economies, production, overall force structure, and so forth? These are things the SFB rules touch on only briefly.

## CAMPAIGN ELEMENTS

Designing a campaign involves the construction of a set of rules wherein each player will build and move his forces in an attempt to accomplish the overall strategic objective (i.e., win the campaign). As the campaign designer, you will write these rules however you like, but before writing anything specific, you should familiarize yourself with the building blocks of a campaign—in other words, the campaign elements.

The following list includes many of the elements of a good SFB campaign. Not every campaign needs to have all of these elements, and some have just one or two. It's up to you, and your gaming group, to decide which of these you wish to use. Once you've decided, then you get down to writing actual rules.

### CENTRAL CONTROL

There are two ways to control a campaign—with a GM or without. A GM is a “Gamemaster,” or game controller, who oversees the physical operation of the campaign. The GM is responsible for writing the rules, maintaining the map (if any), controlling any tactical scenarios, making impartial judgments when required, and so on.

If a GM is used, he normally does not participate in the actual campaign itself (other than as its overseer), unless the rules are written so specifically that they cannot be open to interpretation. (Alternately, you could use a democratic process to solve rules disputes.) Otherwise, the GM cannot remain impartial whenever a decision is called for. Impartiality is an absolute requirement in a GM! Many campaigns have fallen apart because a GM makes a judgment viewed by others as fair only to himself or his best friend. Would *you* continue to play in a game when you knew that if you attacked the GM's buddy, every ruling would go against you?

If a GM is not used, then the rules must be written so that the campaign operates autonomously, without requiring direct control. The movement of units, for example, will usually be visible to all players (otherwise accusations of cheating will arise). GM-less campaigns can also be computerized, with data stored in a computer database and processed by a custom-written program. To prevent cheating, the database can be encrypted, or stored on disk in a sealed envelope. Of course, if your group is lucky enough to include a very trustworthy player, these precautions will not be necessary.



## SCENARIO GENERATION

Most campaigns are designed so they will generate SFB scenarios. In other words, whenever the strategic forces of two or more players interact, a battle will be fought as an SFB scenario. This can create an infinite number of variations and unknowns as the forces come together to fight. What kind of cruiser is that? Is it carrying any T-bombs or swordfish drones? The owning player can't just arbitrarily pay "Commander's Options" to purchase them, either—he must have put them on the ship when it was built, or when it was resupplied, in order for them to be present. *It's a drone cruiser?? I wish I'd bought four T-bombs instead of just one!* And so on. This is not to say that every campaign must carefully track these kinds of details—the rules for such things are, as always, up to you and your gaming group.

Not every campaign needs to create scenarios. It is possible to design a set of rules where exploration and diplomacy are the primary objectives, and whenever conflict occurs, it is resolved with a set of die rolls (which, naturally, depend on the forces present) or by some agreed-upon result. Federation and Empire handles combat with die rolls, and these rules (or something similar) could certainly be used.

In practice, it's been noted that actual campaign battles are rare unless the rules of the campaign force a fight. If Joe and Mike encounter each other and Joe has an obviously more powerful force, Mike will almost certainly just turn around and disengage. Many players become very attached to their ships, especially the ones they have spent a lot of time building up with refits, optional items and other enhancements, and are loath to risk them in combat. If they do fight, and the battle goes poorly, such ships will often disengage rather than risk destruction. The only time true "to-the-death" battles occur is during base assaults, where the base cannot leave and the defenders are forced to do as much damage as they can to the attacker before being destroyed.

There are a number of good ways to avoid this problem. One way is to put penalties on those who disengage and reward those who fight. In one campaign, players earned economic points for fighting, even if they lost the battle! In other campaigns, ships gain or lose crew points or officer points depending on whether they win or lose—this encourages disadvantaged players to remain and try to score damage before disengaging.

In both of these cases, however, actual to-the-death battles are still rare. Players are very canny, and will often fight just long enough to score any "combat benefits" before leaving the scenario. Therefore, if your goal is to create complex battles, you will need to write more strict rules regarding disengagement. Forcing a battle to be fought on a tournament map, with a tournament barrier, is one possibility, but leaves the disadvantaged player no alternatives. Another possibility is to force the defender to begin at speed zero, but now you have to decide how to determine which player is the defender!

As you can see, this is not an easy issue to tackle. Everything depends on your gaming group. If you want to see to-the-death battles, you will have to come up with rules to force their occurrence. If you are more interested in the overall planning and don't mind seeing lots of long-range "smile-and-wave" encounters, then your rules can be much more open.

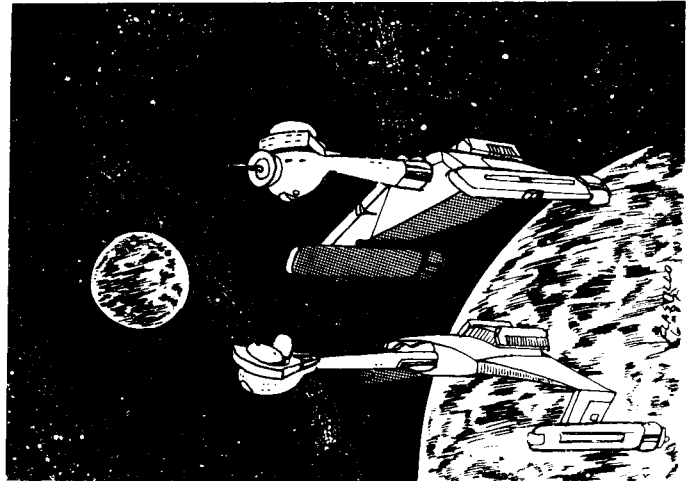

## TERRITORY EXPLORATION/CONQUEST

Campaigns usually have some kind of territory that needs to be explored and controlled. In Federation and Empire, for example, each player has a home area, with provinces and worlds that make up their race's holdings and neutral zones which are available for conquest.

In F&E, the map is known and visible to all players, but this does not have to be the case. Maps with vast areas of unexplored territory are some of the most intriguing. What will be in that star system? A useful planet? An Andromedan satellite base? A Jindarian caravan in an asteroid field? Another player waiting to ambush you? The only way to find out is to investigate!

The size and construction of any map is dependent on many factors, and cannot be easily defined here. You will want to make it large enough that it can be fully explored, but not so large that players never meet.

In at least one past campaign, ships moved on a Cartesian plane in two dimensions, giving as their destination a point in (X,Y) coordinates, and getting there in a certain number of turns based on their speed. The unit of distance was called a "parsec," and each was equal to 30 hexes on an SFB tactical map, so whenever ships got sufficiently close to each other, a scenario could be played out. The point is, a strategic map made up of hexes is not the *only* solution. In addition to the Cartesian system described above, you could use squares (sectors), 3-D vector geometry, "stargates," warp points *a la* Starfire, or something else entirely.

Finally, it is also possible to not use a map at all, but design the campaign solely for the generation of scenarios. In such a campaign, players would participate in free-for-alls or other similar games during each gaming session, but would be limited in their choices of units and options based on what they have in their Order of Battle. It is assumed that there is some kind of "neutral zone" where these conflicts are taking place, or simply that the Masters are putting together another game for their amusement. This is a very simple campaign, and is perhaps the easiest to design and organize. It is effective in getting people to care more about what happens in each gaming session, but the rules should be short and sweet, and care must be taken to avoid turning the game into little more than an exercise in bookkeeping.

## SHIP SPEEDS

When you generate a strategic map, be it hexes or parsecs or whatever, you have to decide how fast a ship can move. Some campaigns use a calculation based on the ship's maximum SFB speed using warp engines only, and assuming no speed-30 restrictions. In one campaign, ships divided their maximum tactical speed by 6, dropping fractions, to yield the number of hexes they could move on the strategic map per turn. Thus, a CA with 30 warp could move 5 hexes per turn, while a CW or DW (which could move 36 hexes if not for the speed-30 limit in SFB) could move 6, a War Eagle could only move 3, and FRDs could not move at all unless towed (and then you would determine the speed of the ship/FRD combination and divide by 6). (Note: Some other units, like monitors, fighters and PFs, used other, more limited movement rules.) This had the side effect of encouraging the use of war cruisers and war destroyers (to say the least)!

You do not have to use this exact system to determine speeds, of course. Campaigns have been run in which all ships moved a single set speed. In other campaigns, frigates were faster than cruisers, which were in turn faster than dreadnoughts. Some basic rules of thumb should be followed. First, PFs and fighters should be allowed to move only one strategic hex or parsec, or perhaps two at most, or these units will become far too powerful (and PFTs/carriers will probably disappear). Second, FRDs and other sublight ships should either not be able to move at all or move at most one hex/parsec per turn. Monitors should also be limited in speed, perhaps to speed-1 or speed-2, lest they become part of attack fleets. On the flip side, X-ships should receive a strategic speed benefit!

Another thing to consider is the strategic intelligence rules (D17.4). Read these carefully and use them in your rules on information gathering. This will encourage players to move their ships to avoid giving other players as little information as possible—if you know there is a base nearby, you'll move your force around its sphere of vision. You could also play tricks on your opponent by flitting around on the edges of his range, making him wonder what you're up to. If you don't want or need this kind of complexity, simply elect not to use the strategic intelligence rules.

## ECONOMICS

Most campaigns will have a way for new units to be built or purchased. To do this, an economic system will need to be devised. In most cases, resources are produced by worlds or other income-producing locations/items, and can be used by shipyards (or the equivalent) to construct new units. Often, these resources are not produced at the shipyard(s), but must be shipped there (see Logistics, below). This creates the opportunity for convoy raids and similar scenarios.

Resources are usually defined in terms of Economic Points, or EPs, which are used to create EPV points on a one-for-one basis. (EPV points define the economic costs of building ships and other units in SFB.) For example, a planet may be defined as producing 50 EPs per campaign turn, which would allow that world to construct (if it had the appropriate facilities) a leader PF, for example. This is the simplest means by which economics are handled in a campaign.

In more complex campaigns, different kinds of resources are produced. For example, habitable worlds might produce population, which can be used to make starship crews. An empire with a low population would have trouble crewing its ships, resulting in potential problems (and requiring careful efforts to rescue crews from doomed ships whenever possible). Other resources include, but are not limited to: ores, dilithium, food, goods, repair parts, plastics, weapons, fuel, luxuries, etc.

In some campaigns, the combinations of certain resources creates other resources. In the Star Fleet Warlord play-by-mail game, for example, one unit of each of people, food, dilithium and ores produces one economic point, which can then be used to build units. However, the individual resources can also be used for special purposes: people for training, dilithium for speed refits, ores for repairs, and food for ship support. This is not the only possibility. In your campaign, for example, you might make ores into EPs using ore mining stations, or a world's agriculture into food using small agro bases. It all depends on how complex you want to design your system. The more complicated, the more bookkeeping will be required by the players and GM—but some players thrive on bookkeeping, so be sure to tailor your campaign to your players' wishes.

It is possible to design campaigns with no economic system at all. In such a campaign, new units simply "arrive" at various times and places (specified by either the campaign rules or by the individual players). You might also simplify economics by saying that each campaign turn, some quantity of EPV value of ships and units arrives at a player's home world, and players are free to select in what form that EPV arrives (as ships, fighters, PFs, optional items, and so on).

## LOGISTICS

Campaigns with an economic system require a way to get resources from one place to another, as it should not be economical to build a shipyard on every world you own. The movement of resources for strategic purposes is called *logistics*.

If logistics are an important part of your campaign, you will need some facility for moving resources from world to world. This requires an appropriate cargo ship, usually a freighter, depending on the rules you define. There is nothing in SFB that tells you how many EPs can be carried in a cargo box, so you are free to decide this for yourself. The obvious choice is one EP per box, which means a small freighter will carry 25 EPs, large freighters 50, and so on. Other units, such as tugs, will also have cargo boxes (note, however, that Orions and a few others have a smaller capacity and should be penalized appropriately). Cargo boxes could be defined as capable of carrying 2 EPs per box, 1/2 an EP per box, or whatever else you deem appropriate.

You will want to review the cargo rules before making this decision. For example, a drone takes up one cargo space (and most cargo boxes have 50 such spaces), but would cost you one EP to build, so it would be *much* more efficient for a player to build 50 EPs of drones and move them in just one cargo box. You will have to take these sorts of things into account when designing your logistics system!

If logistics are important in your campaign, most players will choose to use freighters for shipping. Small freighters are the most economical means of moving EPs from point to point. This will cause the inevitable scenarios to arise where one player raids another's convoy. You will need to devise a campaign rule dealing with this possibility, and specify that freighters carrying EPs cannot be self-destructed, nor can EPs be dumped overboard to avoid capture. Otherwise, most players would simply choose to destroy their EPs rather than have them captured by an opponent. As the campaign progresses, many players who suffer from frequent losses will choose to use armed freighters, Q-ships, or tugs to transport their valuable EPs. If your players do not want to mess with these details, keep your logistics rules simple. Many players, however, find that raids involving these units are some of the campaign's best scenarios!

## SHIPYARDS AND CONSTRUCTION FACILITIES

Most campaigns start players off with a shipyard on their home planet or starting point. The term "shipyard" is somewhat arbitrary since no unit exists in Star Fleet Battles to define it. We've provided SSDs for three "Naval Construction Docks" and one "Warp Gate" with this product, which can be used to simulate a shipyard. See *Ship Construction* for more information on these units.

Basically, a shipyard (for purposes of this discussion) is any unit or location capable of constructing starships. Sometimes campaigns use starbases or some other combination of expensive ground bases, or even FRDs, to build ships or other units. Other campaigns don't allow ship construction at all, having ships arrive on a set schedule or via transit systems such as Warp Gates.

A shipyard's cost and production ability will directly affect the amount of logistics each player will need. If shipyards cost a lot of money to create (as with the Naval Construction Docks provided in this product), most players will choose to have few of them, and ship all resources to their location. On the other hand, if shipyards are cheap, players will be tempted to buy them on all their worlds with significant resource values.

A shipyard production simply indicates the quantity of resources the shipyard can transform into starships each turn. If a shipyard can only use a limited number of EPs, such as 100 EPs per turn, then building larger ships will take longer. This may be a desired effect (but be sure to devise rules for scenarios involving partially-built ships). If the limitations are severe, players will want to build more shipyards (despite the cost) so they can roll more units off the lines and into battle.

In some campaigns, you do not need a shipyard to construct simple items like T-bombs, drones, shuttles, and so on. It is up to you to decide what can be produced where. You might define, for example, that a base station (or larger) can construct these sorts of items on its own, or that certain ground bases can build them. As another example, you might state that small fighter ground bases can be used to actually build fighters if the EPs are present at the world. This allows players to use these bases to pick up replacement fighters. Again, you are free to define these sorts of rules for your campaign as you see fit.

## BASES

Construction of bases is a vital part of any campaign. Bases, especially the larger ones, are the ultimate defensive units in SFB. Getting one in place can be made to be difficult or easy depending on how you want to go about it.

Many campaigns require a multiple-step process in getting a base in operation. Often this involves first creating a mobile base, towing its parts to a world and setting them up, and then upgrading the base first to base station level, then to battle station, and finally to starbase size. Usually materials need to be "shipped in" using the logistics system (see above) to make this possible, and the presence of certain units (repair ships, tugs, etc.) might be required to make the upgrade.

In a simpler system, bases can be constructed at any world using EPs produced there or brought in from the outside. No shipyard would be required in this case. While simplistic, this can be disruptive if it is too easy, as players will build battle stations at every world, turning every scenario into a redundant base assault. Many players find base assaults so monotonous that they design their campaigns to make base construction extremely difficult, or impossible altogether!

## RACES

In most campaigns, players choose one race and buy ships only from that race, while other players use different races. In a campaign with a historical flavor, players will then be placed on the map near their race's historical neighbors. More free-formed campaigns will not have this limitation, with players adjacent to any other race at random. This could result in very interesting tactical matchups, such as Rom vs. Hydran or Gorn vs. Lyran.

If players don't wish to be limited only to one race, you can write rules for "primary" and "secondary" races (for example, the secondary race might be available at a 10% cost penalty). Other alternatives also exist—you could say that players can buy from any race, or can buy from only a select list of races. There has even been at least one campaign where players "bid" for the right to use each race's ships!

Whenever races are used, players will eventually want to transfer ships, units or technology (usually as part of some kind of deal). How this is handled is up to you. Do you want to see mixed racial fleets? Have you considered the deadly combination of ISC PPDs followed up by hellbores from Hydrans? Or Tholian ships trapping enemies in webs just before hitting them with plasma torpedoes from a purchased Killerhawk? Players are very crafty and will come up with these sorts of things, if your rules allow it.

What about rules for utilizing captured ships? What about "boxes" of technology being sold for installation on another player's units (and how would this work)? Will you allow Orions to buy phaser-4s to put in their bases? Can the Romulans create cloaking devices to sell to other players? If so, how much does this cost? These are the sort of questions which will come up during play if you don't decide the answer beforehand.

## TECHNOLOGY

This is an aspect of a campaign that can be one of the most interesting. Simply start your campaign in a certain year, such as Y165 or Y168, with only the ships and technology available in that year available for purchase. Then, as each turn of the campaign progresses, the clock advances—sometimes on year per turn, sometimes six months, or possibly other amounts. The exact amount of time you set should be dependent on the number of players, the size of the map (and how often you expect players to meet), and other factors.

Choose your starting date carefully. Some of the most important dates are Y168 (the year medium-speed drones become available for general purchase), Y178 (the first year for PFs), Y181 (X-ships), and so on. The best choices are during the General War era when most of the best new ship designs and technologies become available in rapid succession.

If you don't care for this sort of detail, simply state that your campaign allows players to buy any units they want, regardless of their year of availability. Note, however, that this will result in players always buying the "best" ships available to them (as they see things), and the actual number of different ships you'll see in the game will be very small. If there is no year restriction, and assuming no other restrictive rules, what LDR player wouldn't buy a CWL whenever he could? What WYN player wouldn't have a PBB? And so on.

You could also design or use a more detailed technology system. Campaigns have been run where it costs some amount of EPs (allocated to research and development) to advance the player's race one "year" in time. Other alternatives also exist; later in this product we'll present a detailed technology system in which players begin with very limited abilities and must research nearly every facet of SFB! This leads to intriguing scenarios where neither side knows what abilities the other has researched, and what they can or can't do in the battle.

## BACKGROUND

This is usually very simple, and depends very much on the type of campaign you are designing. A background can be historical (perhaps one of the Federation & Empire scenarios being played out using SFB battles), pseudo-historical (using the F&E map and races, but allowing players to design their own Order of Battle and move ships using a set of custom rules), generic (a hex map of some predefined size which players will explore and conquer), or something else.

Many campaigns involve "the Masters," a race of ultra-powerful beings who kidnap ships for their games. In one campaign, it was theorized that the Masters were so upset at the Organians for stopping the General War that the Masters decided to recreate the War from the beginning. They transported a subset of the races, gave them some worlds and let them go at it, even going so far as to simulate the march of technology, starting the "game" in Y165 and moving up one year per turn. This is a good example of a pseudo-historical campaign.

You should keep the background simple, as simple as possible. For the most part, it will be the least important element of your campaign, once it has gotten under way.

## VICTORY CONDITIONS

This may sound obvious, but a campaign needs to have an end point. It is theoretically possible to run an "open-ended" game, where play continues as long as the people involved enjoy it, but interest in such campaigns dwindles quickly.

You can set victory conditions to be whatever you like—total victory over all enemy forces, conquering a set number of worlds, accumulating a certain amount of economic points, etc. You should use common sense when doing this. If victory can only be achieved by actually conquering all opponents, then it will never happen, because the disadvantaged players will quickly lose interest and quit. It might be more sensible to say that a player would win when they control 50% of all worlds on the map, or something similar. Just make sure the victory conditions are achievable by all players—for example, the WYN or LDR could not be expected to conquer half the planets on the F&E map!

## ONE LAST THING

Let's not forget to have a few *players* for your campaign! All the best rules in the world won't help if no one wants to play.

Everyone has a different idea about what a campaign is, how much time it will take, and why you would even want to have one. Talk to your players and see what they want. You don't have to get specifics, just a general idea. It doesn't do you any good to put together a historical campaign starting in Y165, when your players are more interested in exploring a random universe with whatever ships they want.

Another thing you must be concerned with is a commitment from your player group. They must *want* to play. Never force a player to accept a position against their will, or if they aren't really interested. It's better to add them into the campaign later (when they see how much fun everyone else is having) than to put them in and have them drag the campaign down by not participating.

And, of course, *you* have to make a commitment too! Designing a campaign is not a simple thing (as you can tell from the sheer size of this Handbook). You'll write rules, solve disputes, handle movement and encounters, answer questions, and so on—in other words, you'll pretty much manage the entire campaign process. If you don't think this will take a good deal of time and effort, think again! If you run a good campaign, though, it'll be well worth it.

## A FEW NOTES AND DISCLAIMERS

A campaign system for the Star Fleet Universe already exists, of course. It's called FEDERATION & EMPIRE. We'll assume for the moment that if you were totally satisfied with F&E you would not have bought this Handbook. Even so, it must be noted that many of F&E's rules could be used in your campaign; those rules are often the simplest alternative for any given subject. It is, of course, also possible to create your own campaign by starting with F&E and adding some of the various rules from this Handbook to replace or expand the F&E-based rules.

It must be noted that the CAMPAIGN DESIGNER'S HANDBOOK is a book for the *PLAYERS* of SFB who want to build a campaign. As such, it provides many alternative rules in many areas. Not all of those rules are consistent with the historical background and rules of SFB (or other games of the Star Fleet Universe). There is nothing wrong with this; in your campaign you can create any map, rule, concept, or system that makes it something you want to play. However, because of this aspect, nothing in the Campaign Designer's Handbook should or can be used to create, define, explain, or change any rules in SFB (or any other game of the Star Fleet Universe) in so far as they relate to gaming *OUTSIDE* of your own campaign. If you try to convince an F&E player that you can build PFs in Y168 because the Techblock system in this Handbook could theoretically allow it, you're likely to find out what "8,000-counter pickup" means.

Players should be warned that (despite their self-denial) even the most ardent SFB player has an upper limit to the amount of paperwork he or she will put up with to create SFB battles. If you use the most complicated option in every category, you will create a campaign that is probably too paperwork-laden to maintain interest. Carefully select from the options in each category, spending your future effort in accounting wisely in the areas that are of special interest and getting along with simpler rules in areas that are less important to you.

## IN THESE PAGES...

We'll touch on each of the above subjects throughout this Handbook, providing a more detailed discussion of each, along with many rules and alternatives for you to choose from. Where possible, the consequences of each set of rules (or the lack thereof) will be explained, backed by experience drawn from many past campaigns—some successful, and many less so. By avoiding these pitfalls, and understanding campaign structure and design before you start one, your game will be exciting, challenging, and best of all, fun!

## THE STRATEGIC ARENA

Nothing is more important to the campaign than the setting—the arena where all the action takes place. There are a number of possibilities depending on the kind of campaign you want to have.

### HISTORICAL SETTING

If you want your campaign to have a historical flavor, with each race bordered by its traditional neighbors, use the Federation & Empire map (or something very much like it).

The F&E map has wide areas for each race, and very small neutral zones. Each border has pre-set bases placed along it, which (depending on your campaign) may or may not be present. This sort of setting is ideal for large campaigns with many fleets, although battles will likely be too huge to fight (but see *Command Ratings* later in this Handbook for rules on how to control this).

You could also use a map similar to, but not as large as, the F&E map. One problem the F&E map has is that if one race throws their entire fleet at another, and the target has most of their forces on a different border, then the unfortunate victim will not have enough time to react and defend his home system. This is true for most of the homeworlds, which are generally in the middle of each race's territory. If the territory were smaller, with each race no more than 8 or so hexes across, then this difficulty would be reduced. (You could also raise the strategic speed of ships to help counter this, although you don't want them so fast that they can invade deep into enemy territory in a single turn. As an alternative, you could make movement in friendly space faster than in neutral zones or within enemy borders.)

Another map design possibility is to keep the races in the historical positions, but with their territory smaller and the neutral zones much larger. With bases on the borders (as on the F&E map), most combat will generally take place in the neutral zones. If you provide for neutral worlds or other economic benefits from these zones, then the winner of the campaign will not be the one who destroys the other players, but the one who conquers and controls the neutral zones and the resources they provide.

A pseudo-historical map is provided with this product. This map offers large starting areas for the Federation, Klingons, Romulans, Kzintis, Gorns, Hydrans, Lyrans, and ISC, with smaller spaces available for the Tholians, WYN and LDR. The neutral zones are larger than the F&E map, in most cases three hexes across instead of one.

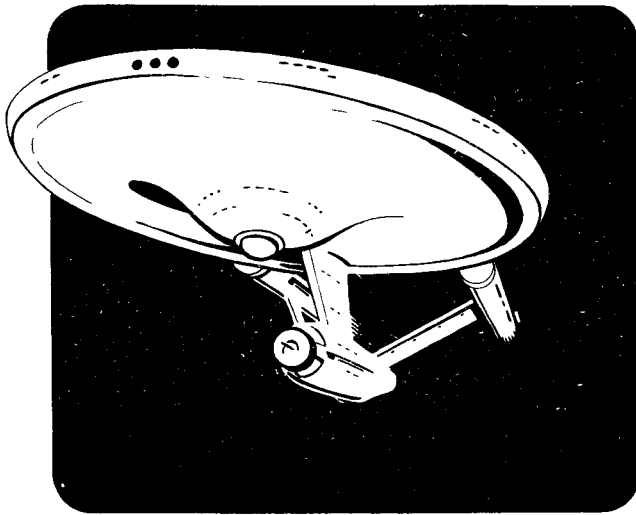

### RANDOM MAPS

One problem with the historical map is that it requires a certain minimum number of players. One player is almost certainly needed for each of the classic races: Federation, Klingon, Romulan, Gorn, Kzinti, Hydran and Lyran (with extras playing ISC, Tholian, Orion, and so on). Your group might not have seven players, which would leave out one or more of these positions, and would make a historical game less interesting.

A random map can solve this problem. In such a game, the GM would randomly generate a map using a set of predefined possibility charts. The dimensions of the map would be set before the campaign, but what is actually *in* each hex (or other division) of the map would be randomly determined.

The contents of each hex (or whatever) could be either visible to all players or secret, known only to the GM. Visible terrain is definitely easier (and is the only method realistically available in a no-GM campaign), but is not as interesting as a secret map.

With hidden terrain, there needs to be a set of rules for exploration and surveying. Some possibilities will be listed later in this section.

Here is a sample map which could be used for a small campaign using random terrain:

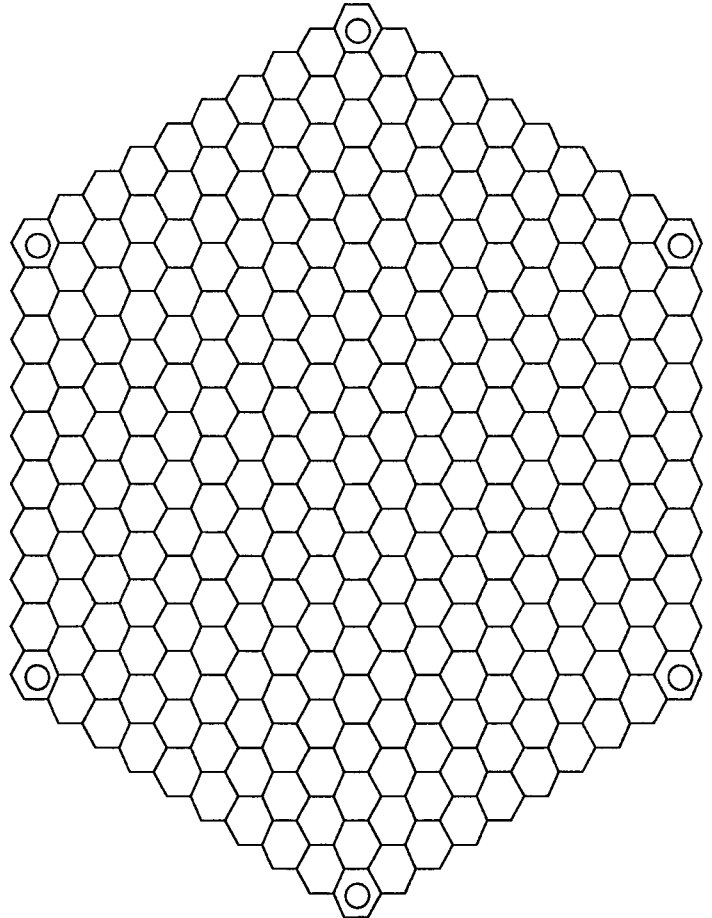

This map is designed for six players, each of whom starts in one of the hexes containing a circle. This places each player nine hexes from each other, which may be too close for some tastes. To force engagements in the center, rather than encouraging the "blow to the head" homeworld attack, the GM should consider making some of the hexes between players "unenterable," perhaps containing supernovas or some other terrain which ships cannot pass through.



**WARP POINTS**

In Starfire, another game by TFG, ships never achieved faster-than-light travel. Instead, they discovered that “warp points” existed in each star system which led to other systems elsewhere in the galaxy. These warp points allowed virtually instantaneous travel from one system to another, providing one knew of their existence and wanted to risk entering this potentially dangerous space.

If you wish to experiment with this concept, you don't need a map at all! Instead, start by generating a certain quantity of systems (at least 25 for every player), then generating a random number of warp points in each system (minimum 1). Each warp point will lead to a random system (except the system it starts in), creating a movement path which ships can use to get around in the galaxy.

Care must be taken when generating such a map. If you allow true and total randomness, you are virtually guaranteed to have a “pocket” somewhere—an area where no warp points lead, from which any player unfortunate enough to begin the game can never escape. There are several ways to avoid this problem. One is to have so many warp points in every system (say, 5 or more) that the likelihood of a pocket universe is reduced to virtually nil. Another is to write system numbers on a certain number of cards (e.g., write each system number on 3 cards and put them all in a box), drawing one card each time the destination of a warp point needs to be determined. Then, if a pocket is discovered, simply pick a system at random and add a new warp point, repeating as necessary until a way out of the pocket has been found.

Computer programs can also be written to generate warp points, creating a data structure known as a *graph*. Code for such a program is beyond the scope of this product, but would provide an interesting programming challenge to the software enthusiast.

Here is a sample to help you visualize the idea of warp points:

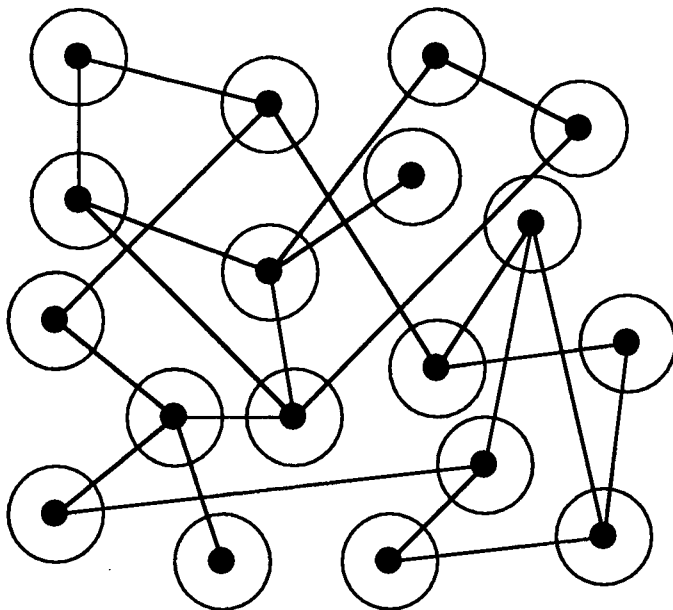

Each of the large circles indicates a star system, and each line is a path between two warp points (one in each of the systems on each end). Note that there are no “pocket universes,” as it is possible to trace a path to any of these systems from any other system (although it may take many “jumps” to actually reach the destination system). Note also that

two systems are cul-de-sacs with only one way in or out; these are the most easily defended systems in such a campaign.

Depending on how complex you wish to get, you can also add one-way warp points that can only be passed through in one direction. You can also use “closed” warp points, which are invisible on the “closed” side but visible on the other. They can be passed through in both directions, but only if you already know the warp point is there by having come through it from the “open” side. Other warp point variants are also available.

**HEX, SQUARE AND OCTAGONAL MAPS**

All maps need some sort of grid to divide the strategic arena into staging areas. Normally, battles will take place when the forces of one player meet those of another player within one of these divisions.

Hex grids are the most common choice for several reasons, the most obvious being that Star Fleet Battles scenarios are played on hex maps and players are already familiar with them. Federation & Empire, Star Fleet Warlord, and countless other campaigns have used hex grids in the past, with great success. Hexes interlock perfectly, unlike squares or octagons, and with six possible destinations when leaving any given hex, movement strategies can become quite intricate. Note the comparison of hex, square and octagonal layouts shown below (and the number of possible moves from any given position):

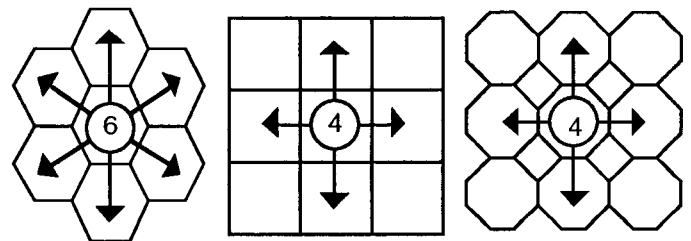

With a hex grid, units can move to any of six adjacent locations. Squares and octagons provide only four. You could, of course, allow units to move diagonally on the square map, providing eight possible moves, but this is not very realistic—a ship in the upper left corner of the map could reach the upper right corner at the same speed as any square on the right side of the map, which makes diagonal movement way too fast. You could solve this by making diagonal movement cost 1.5 “movement points” to accomplish.

The octagonal map allows for better control of this and a visual reminder of the extra cost of “diagonal” movement. You might allow ships to pass through (but not stop in) one of the small diamond-shaped areas, costing half a “movement point” for each such area entered. For a more complex movement system, ships could actually be allowed to stop in these “transit areas,” which might represent the deep space between systems or important territory. There should not be terrain in these zones, but they might make ideal ambush spots or observation posts for scouts.

**CARTESIAN MAPS**

Cartesian planes are an alternate map design method. On a Cartesian map, each location has an (X,Y) coordinate on a two-dimensional grid. [For simplicity, the lower left corner of the map is normally defined as (0,0), so that no negative X and Y locations can appear in the game.] A working knowledge of simple grade-school geometry is needed to play in such a campaign, but players do *not* need to be geometry experts!

When the map is generated, each star system (or other object) should be given a positive integer value for its X and Y locations (to keep things simple). This can be random—often determined by a simple computer program—or placed directly by the GM to ensure balance. Each player's starting point will be in one of these systems, at some minimum distance from the other players.

Here's an illustration of how part of the map might appear, with three systems shown:

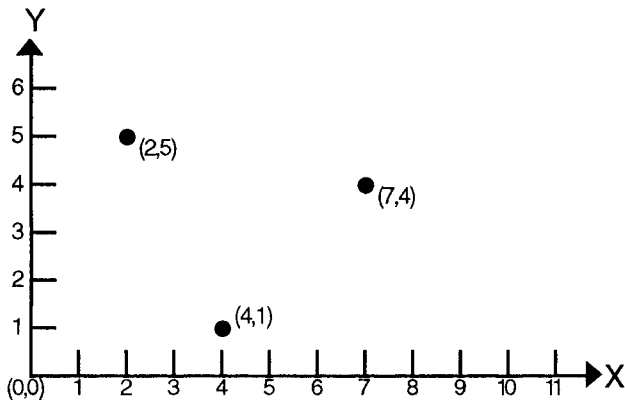

When a ship moves, it can go to any (X,Y) coordinate which it can reach in a single turn, based on its campaign speed. As mentioned in the *Introduction*, campaign rules will need to specify the maximum speed of ships, depending on the average distance between systems. As a rule of thumb, a typical cruiser should be able to move from one system to the nearest system in a single campaign turn. For example, if the average distance between one system to its nearest system is 5, then cruisers should be able to move at least speed 5, if not faster.

To determine the distance between any two points on the grid, use the distance formula:

$$\sqrt{(X_2-X_1)^2 + (Y_2-Y_1)^2}$$

Subtract one X-coordinate from the other and square the result. Do the same for the Y-coordinates and add the two squares together. Take the square root of this sum and you have the distance between two points. If your ship can move at least this distance, then it can move between those two points in a single campaign turn. For fast ships, multiple moves or patrols might be possible.

For example, on the map above, the distance between (2,5) and (7,4) is calculated as follows:

$$\sqrt{(7-2)^2 + (4-5)^2} = 5.099$$

Thus, a ship would have to be capable of speed-6 to be able to move between these two systems in a single campaign turn.

Instead of using the distance formula for every calculation, it's easier to use a ruler or other straightedge with speeds marked on it (or use a compass opened to the exact range of your ship). If your movement path fits within this area, you can

make the movement; otherwise you must move to a nearer point. (For simplicity, movement only between integer points on the plane is recommended, although players who don't mind decimal places can certainly use them.)

Encounters are more difficult to manage in a Cartesian plane. If encounters are to happen in open space, then you need a knowledge of vector mathematics to find out whether two ships on the move have their paths intersect (something too complicated to go into here). Instead of this, it is recommended that encounters happen only in systems, with ships elsewhere considered "in warp transit" and ineligible for battle (but possibly still detectable by nearby units or bases). If you use this system, then nothing stops a player from simply putting together a fleet and flying straight across the map to another player's home planet. Some restriction should prevent this—perhaps a range limit from the nearest supply base, or possibly allowing ships only to warp between systems, never into open space. The former allows great flexibility; the latter limits the campaign to movement along preset lines instead of truly two-dimensional space.

The most challenging campaign would be a three-dimensional X-Y-Z universe, with ships moving between points in three-space. Such a campaign would be mathematically intense, thought-provoking, and not for the simple-minded. If you choose to try such a campaign, you're moving into uncharted waters. Good luck, and let us know how it works out!

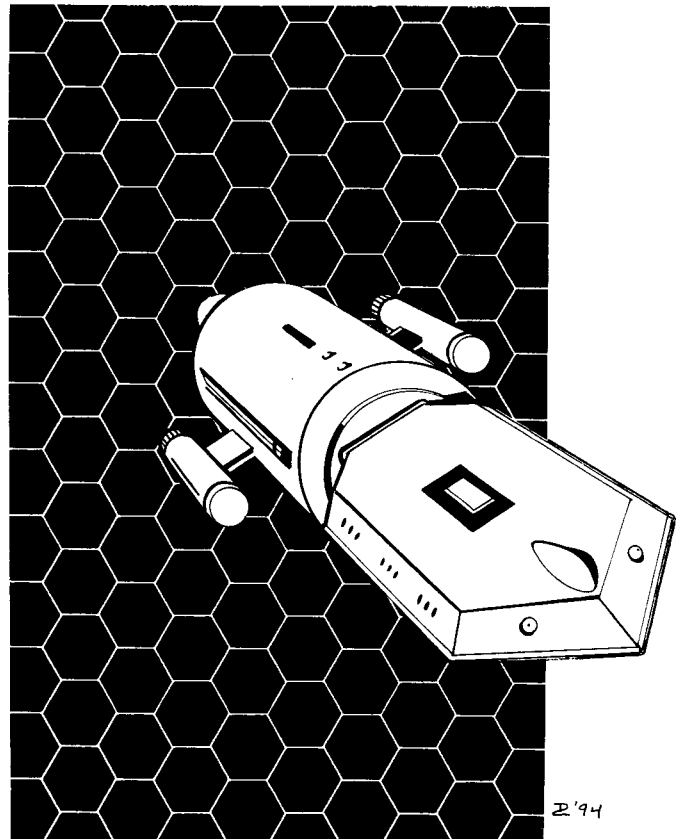

**TERRAIN GENERATION**

Once you have determined what kind of map you're going to use, the next step is to place the terrain. This can be done either by hand or randomly, depending on your preferences and whether or not the GM is actually participating in the campaign as a player.

If terrain is hand-placed, the main advantage is balance. The GM can see just by looking whether or not all players have a fairly equal distribution of systems and resources, and can correct any inconsistencies immediately. In addition, weaker players can be compensated by providing them with slightly more planets and income opportunities. However, if the map is very large, this may be more trouble than it's worth. The GM might also be accused of playing favorites, unless player trust in his impartiality is complete.

With random placement, the possibility for unbalanced areas arises. The GM will probably want to take a close look at the map once it's finished to see if any part of it is resource-light or resource-heavy, correcting the problem if it is outside the bounds of fairness. Areas likely to be contested by two or more players need not be adjusted if resource levels are high, as this will actually encourage combat and interesting scenarios.

Campaign designers should feel free to put together their own charts for random terrain. Below is one possible set of charts, suitable for use in any campaign.

**RANDOM TERRAIN CHARTS**

**TERRAIN OCCURRENCE CHART**

Die Roll	General Type
2-4	No Terrain
5-6	Area Terrain Only
7-11	Star System Only
12	Both Area and System Terrain

**AREA TERRAIN CHART**

Die Roll	Area Terrain Type
2	Supernova
3	Nebula
4	Sunspot Zone
5-6	Heat Zone
7	Dust Cloud
8-9	Radiation Zone
10	Ion Storm
11	Gravity Waves
12	Roll Twice

**STAR TYPE CHART**

Die Roll	Star Type
2	Black Hole
3	Neutron Star
4	White Dwarf
5-10	Normal Star
11	Variable Pulsar
12	Roll Twice

**NORMAL STAR CHART**

Die Roll	Inner Worlds	Biozone Worlds	Gas Giants	Outer Worlds
2-3	1	0	1-3	1
4-5	1-2	0-1	1-3	1-2
6-8	1-3	1	1-4	1-3
9-11	1-4	1-2	1-4	1-4
12	1-5	1-3	1-5	1-5

**USING THESE CHARTS**

For every map region (hex, square, octagon, etc.) roll two dice on the TERRAIN OCCURRENCE CHART. Statistically, there is a 5 in 6 chance that at least some sort of terrain will appear in that location (there are only 6 out of 36 possible die rolls which result in "no terrain"). Terrain can be either "area" (a cloud, field or zone), "star" (some kind of central star or starlike object), or both.

If area terrain is indicated, roll two dice on the AREA TERRAIN CHART, and place that type of terrain on the map. Most of these terrains are obvious and match the appropriate SFB rules, with a couple of exceptions. "Sunspot Zones" are regions where sunspot activity is considered always in effect, even though no sun may be present. "Ion Storms" are permanently located in the hex, not temporary as might be expected. Finally, "Gravity Waves" are also permanent, the strength of which can be determined by rolling three dice at the start of any scenario. One wave will enter the map every three turns, starting on one side of the map at random and proceeding until it is off the board.

If a star system is indicated, roll two dice on the STAR TYPE CHART and mark the star type on the map. Pulsars, black holes, etc. will not have planets, only "normal stars" will have them. (You may, alternately, generate star systems for white dwarfs, but no such system will have any world in the biozone regardless of the die roll.)

After generating the star type, roll two dice on the NORMAL STAR CHART and see how many worlds of each type are present. (Note: For SFB purposes, the actual star type is unimportant, just that it is a "normal" star.) Additional die rolls are required for most of the world types shown, which are:

**Inner world:** Hot or molten planets with no life-sustaining capability, but possible ore resources. The innermost planet in this zone should have the effect of a heat zone on any battle in its area. Inner worlds do not have moons.

**Biozone:** Any world here is capable of supporting life, and therefore colonies. They could produce many kinds of resources, as well as support a population. Roll one six-sided die and subtract three, treating any result less than zero as zero; this is the number of moons present.

**Gas giant:** These worlds are, like Jupiter and Saturn, huge balls of gas surrounding a small rocky or icy core. They cannot support life but might have any of several types of resources (gaseous in nature, obviously). Roll three dice to determine the number of moons at such a world; there is also a 1 in 6 chance that any gas giant will have rings.

**Outer worlds:** Rocky iceballs with weak or nonexistent resources, these are pretty close to useless. The outermost such world is a good location for a ground warning station, alerting bases in the system to the approach of enemy forces. Roll one die and subtract four, treating any number less than zero as zero; this is the number of moons present.

When any standard system is generated, there is a chance that one or more special terrains might also appear:

**Asteroid belt:** Roll one die. A result of 1, 2 or 3 indicates the presence of an asteroid field. Asteroids might contain minerals, Jindarians, or both.

**Comet:** Roll one die, with a result of 1 indicating the presence of a large comet. Comets might contain rare minerals or readily available water. Note: The rules for comets appear in SFB Module P6.

**Active sun:** Roll one die, with a 1 indicating an active sun. In any given campaign turn, there is then a 1 in 6 chance that solar turbulence will create an ion storm in the system. Any such storm will last the entire campaign turn.

### ADDITIONAL NOTES ON TERRAIN

The charts and rules above generate a moderately complex campaign setting with plenty of terrain (some may argue that it generates *too much* terrain). Players should, of course, feel free to modify these charts or design their own. Some players may choose to ignore the star system generation process entirely (merely noting whether or not a habitable world is present), while other players will need even more complexity, going so far as to generate orbital widths, planetary diameters, and the like.

Most of these details will not matter until an actual scenario is to be played. The question then comes up as to where (on the tactical map) a world should be placed, where its moons are in relation to it, how far away an asteroid belt is, and so on. The GM can gloss over these details by simply setting things up in a way that looks good (and leaving faraway terrains like asteroids and such out of the battle entirely), or specify them with charts and tables of his own design.

For worlds, moons, large asteroids, etc., players are going to need to know some general information about them for the purposes of fortifications. The GM will need to decide before the campaign begins just how many bases can be placed on a planet (if he wants to limit them), how far away moons will be from a planet (in case players put ground defense bases on them), and similar details.

Tholian players will want to know about towing asteroids from a nearby field to their planets for use as web anchors. This should be allowed, but the player should still be forced to pay 25 points per asteroid for the privilege. In systems without asteroid belts, it might still be possible to locate suitable rocks or meteoroids here and there; perhaps a survey ship or scout is required to find them, or a higher price need be paid for this ability. It's up to you.

Players are also going to want to know about hiding their ships within terrain or on the surface of worlds. The ability to do this is an important one, as it can be used to gather information or avoid attack by superior forces. (A ship hiding in an asteroid field would be almost impossible to discover, considering the sheer volume of space which would need to be scanned.) Read the hidden deployment rules carefully, and decide for yourself how easy (or hard) you want to make this procedure.

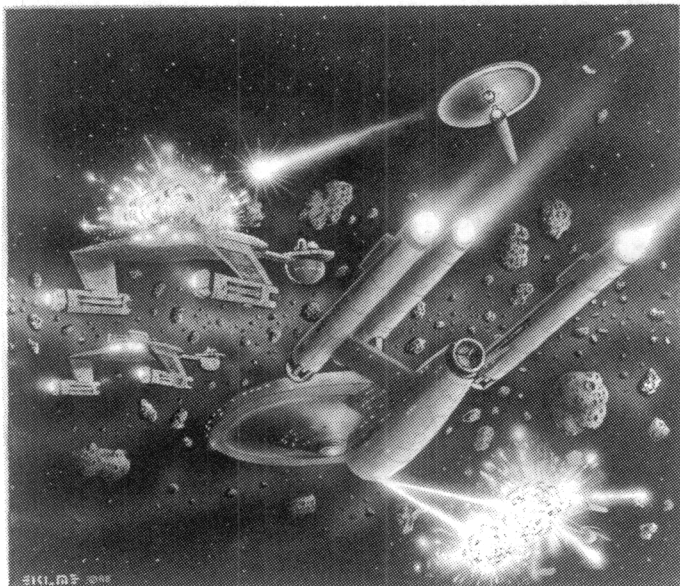

### EXPLORATION & SURVEYING

If your campaign uses a random map and/or hidden terrain, you will need to include rules for exploration and surveying. These are, respectively, the processes used to locate terrain and examine new worlds once you've found them.

#### EXPLORATION

This is generally accomplished with scouts, usually survey ships or true scouts. (You may wish to require that only a true scout or true survey ship be allowed to do this. Otherwise, alternative ships will almost always be used—PF tenders, drone ships, and so forth, and not all races possess equivalent units in these categories.) Alternatively, you could allow any ship to accomplish exploration.

The simplest way to handle this is that whenever a ship enters an unexplored hex (or whatever division your map uses), exploration happens automatically. The GM tells the player what is located in the hex (perhaps making a die roll to determine what information is discovered) and that's that. This method has the advantage of simplicity, and is ideal on small maps with few areas to move to.

For campaigns with lots of territory and few ships to perform exploration, you can consider some of these alternatives:

**Short-range scans.** Scouts can scan the hexes immediately adjacent to their current location. This kind of scan should be able to detect general terrain types in all adjacent hexes, but not details such as the value of worlds, or the locations of ships or bases. Small or damaged scouts should be limited to only a few hexes, while cruiser-sized scouts can scan all six adjacent hexes.

**Long-range scans.** Large scouts or scouts with Legendary Science Officers might be allowed to scan more than one hex away from their current location. To handle this, require the player to trace a line from the ship's current location to the target hex. Then, reveal the terrain in each of the hexes the line passes through. (The range should be two, three or possibly even four hexes, if the map is very large.) Hexes which contain terrain which (in a tactical battle) affect scout channels should "block" such a scan, stopping its progress. Terrains of this type include nebulae, ion storms, sunspot zones (assume no shadows are possible, and that the sunspot zone affects the entire map), and supernovas.

**Ship scans.** To simulate the ability of scouts to make prolonged strategic observation, you might allow a scout to be placed on "watchdog" duty. Depending on the size of your map, any scout doing this should be able to detect enemy movement in nearby hexes. Information gained on enemy ships will, of course, be limited to Strategic levels only. Note that bases, which are also scouts, will probably wind up doing ship scans every turn, which will give players one more reason to build them.

**Passive scans.** Making any of the scans listed above can be detected by scouts making *passive scans*. Generally, the scout making passive scans will be hidden or on the surface of a planet so it cannot be detected by ship scans, and it cannot itself make any other scans that turn. In a region where borders are uncertain and exploration important, this can be used to detect an opponent's advance scouts without being yourself detected. Note that an impartial GM is required for this (and he must keep *very good* records).

All of the above should be limited strictly to true scouts or survey ships, and should work only after movement and combat is over. (The scout should be in a controlled area and not contested by other ships. If it had to disengage from a battle earlier in the turn and is still in the same area, it's too busy

hiding to make a scan.) Depending on the abilities of the scout, you might provide benefits to encourage the use of heavier or better scout designs. For example, you might limit smaller scouts to only a few hexes of scanning while heavy scouts (or those with more scout channels) can see more hexes or hexes further away. Note that some races have better scouts than others (particularly the Federation) so don't let these abilities unbalance your campaign.

The above suggestions are written with hexes in mind, so you'll have to adjust them if using another type of territory. On a Cartesian map, for example, scouts should have a scanning range based on their size and/or total number of scout channels, allowing them to see things within a certain distance on the map. In a campaign which uses warp point travel, scouts might be able to see through a warp point to find out what's on the other side, avoiding a potential ambush.

## SURVEYING

Survey ships exist for a reason, and that's to explore newly discovered star systems. Your campaign should include rules to handle this type of mission.

The simplest way to handle surveying is to say that any ship can accomplish it. When a ship enters a new system, it spends a set amount of time checking out each world or other terrain feature, and this act provides the owning player with a report on such details as colonization potential, economic value, resource availability, and the presence (or lack thereof) of enemy forces. However, allowing just any ship to do this is not realistic, as most vessels don't have the capability to learn such details (although some things will still be obvious, like the total number of planets in the system). To gather such information, you should require a survey ship.

Some possibilities for survey ships are:

**Determining values.** While any ship can count worlds, moons, etc., only a survey ship can find out how much they are worth. A world might appear at first to be valuable, but have some hidden flaw or lack valuable resources. The reverse might also be true—it might be extraordinarily fertile or have a large supply of dilithium, for example. It would be nice to know about such things before deciding where to put your colonies, wouldn't it?

**Activating production.** In campaigns with a simple economic system (without colonies, population, etc.) you might require a visit by a survey ship to "activate" world production. As soon as the survey ship has visited the world (perhaps remaining there for a certain amount of time), the world begins to produce economic points or other resources, which are then added to the world's economy or become available for shipping.

**Terraforming.** Not all worlds are likely to be 100% habitable when first encountered, but survey ships might be able to do something about that (given time). For example, a world with a high concentration of carbon dioxide would not support animal life, but a survey ship could be able to bring in enough algae or other plants to begin converting all that CO<sub>2</sub> to oxygen. Then, after a few campaign turns, the world could be transformed into a colony. Some campaigns might require air, water or other resources to be brought to the world in order to aid in this effort.

**Repairing world damage.** If a world has been devastated (P2.311) or has suffered damage by enemy ships attempting to do so, a survey ship might be required to repair this effect. The exact cost of this procedure and the amount of time required is up to you, and depends on how easy you make it to devastate worlds (or whether it is even allowed at all).

**Starting colonies.** Survey ships might be used in a colonization role. To count as a colony ship, they should visit an established world and collect colonists (drawing them from the

world population, if your campaign tracks such things), which could require an economic fee or other expenditures depending on your campaign. The survey ship then moves to the desired world and "activates" the colony, which can then begin building ground bases, producing resources, or whatever. (Note: If you choose to use this campaign option, civilian small exploration freighters will become very common.)

**Finding enemy forces.** Survey ships performing detailed studies of a system should have a chance to detect hidden enemy units, such as: ships concealed on planetary surfaces or large asteroids; cloaked ships; ground bases such as small warning stations; Jindarian caravans in asteroid fields; Andromedan satellite bases; etc. Depending on the perceived difficulty of detection, the chance of finding these things should not necessarily be automatic. You'll have to determine the odds yourself, based on the size of your map, the number of survey ships you expect to have in play, and the ability of players to hide forces for observation purposes.

**Finding warp points.** If your campaign uses a warp point system adapted from Starfire, you might consider requiring a survey ship to find these warp points. For example, a normal ship might have a chance to find them (say, a 25% chance), while survey ships do it automatically whenever they survey a system. If using closed warp points, *only* a survey ship can have any chance of finding one from the "closed" side, although this chance should be very low.

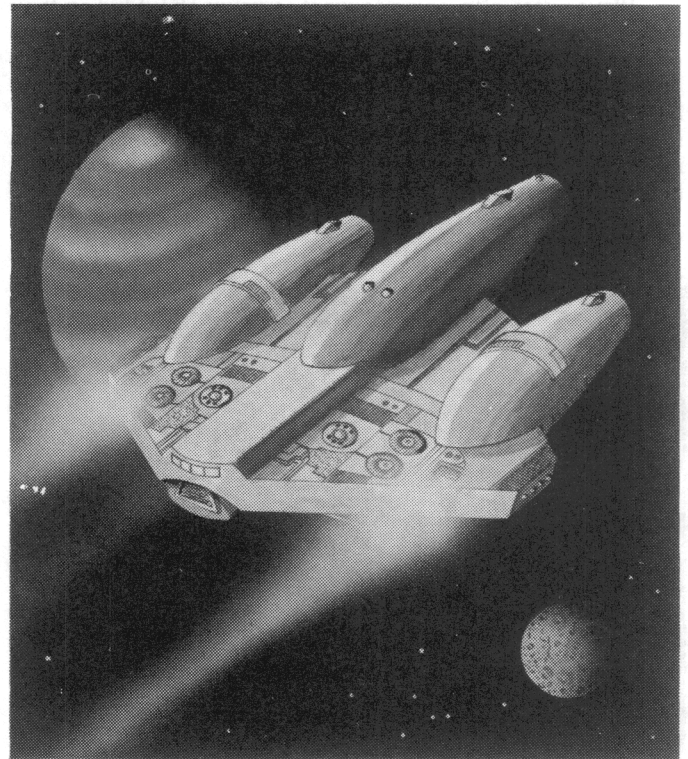

# ECONOMICS

Only a very simple campaign (one which provides for automatic arrival of reinforcements and supplies) will not have an economic system of some sort. Economics allow players to decide for themselves what units and defenses they want, and the generation of resources to use to buy such items is part of the strategic overlay of the campaign.

Economics are very closely tied to logistics (the means to get your resources where you need them) and construction (using resources to build things). These are the subjects of the next two chapters.

## ECONOMIC SYSTEMS

The economic system you use for your campaign can be very simple or very complex. For the most part it is a question of bookkeeping—the more complicated the economics, the more numbers will need to be shuffled by your players. (Many players prefer complexity, of course; you'll want to poll your group to see how much time and effort they're willing to spend on the game.)

Here are a few possible systems you might use.

### SIMPLE ECONOMICS

In this system there are only Economic Points (EPs), which are used to purchase items at their EPV cost. In a simple economy, anything that produces resources—such as a colony world or asteroid belts—generates it in the form of EPs. (Note that EPV is normally equal to BPV, unless there are two numbers separated by a slash, in which case the first number is the EPV.)

Under this system, worlds will typically produce some set amount of EPs. Controlling a world militarily will allow you to collect these EPs each campaign turn, to be shipped or spent depending on your campaign's logistical or construction rules. Terran or other habitable worlds should produce the most EPs; ice worlds, gas giants, moons, etc. would have little or no production value.

Note that this is the system used in *Federation & Empire*, although F&E simplifies things even more by consolidating all of those minor planets and asteroid belts into provincial income.

### COMBINED RESOURCE ECONOMY

Under this system, worlds or other sites produce certain resources (ores, food, etc.) which are collected and combined into EPs for use in ships; some resources might also have other uses on their own. A system like this is used in the *Star Fleet Warlord* play-by-mail game and serves as an excellent example of this concept. In SFW, there are four resources: people (used for crew training), ores (repairs), dilithium (ship speed), and food (ship support). One point of each of these four resources combine to make one EP, or can be spent on their own for the purposes listed.

A campaign with a reasonably detailed terrain generation system could use this sort of economy. The chart below lists some possible resources and the places they would be likely to be found. Note that major planets would be able to provide any of these resources.

Resource	Possible Uses	Potential Sources
People	Crew training; crew replacements; legendary officers	Inhabited worlds, colonies, etc.
Ores	Building starships; repair points	Asteroids, rocky planets, mining stations
Dilithium	Warp engines; strategic speed; repairs to engines	Certain rare planets or asteroids; comets; mining stations
Food	Keeping ships in supply; allowing ships to range farther	Colonies, agro stations
Uranium	Building drones, mines, other explosive things	Very rare asteroids, mining stations
Fuel	Ship range; ability to disengage by acceleration	Certain planets, gas giants
Technology	Advancement of years; research points (see <i>Technology</i> )	Colonies, scientific outposts
Water	Supporting colonies on hostile worlds; terraforming	Terran or ice planets
Air	Supporting colonies on hostile worlds; terraforming	Planets within a biozone

Your campaign doesn't need to use all of these resources; in fact, if it does, combining them to form EPs will prove difficult. If a large number of resources exist and need to be combined, then some places should produce several different resources, and major worlds or homeworlds should produce some of *each* of them.

### TRADING ECONOMY

In this interesting system, worlds do not produce EPs at all—only trading does! Each world or colony produces one or more commodities which must be shipped to other worlds that need them. The stimulation of these markets provides EPs to the player.

This type of campaign makes more sense in a galaxy where worlds are already populated, and creation of new colonies is a secondary aspect. Pre-populated worlds already have an infrastructure, cities, etc., which provide goods and have wants or needs. Bringing in things they need generates tribute and work from the indigenous population.

Commodities can be just about anything, limited only to your imagination. Examples include all of the resources listed in the previous section, plus things like clothing, glass, electronics, computers, lumber, vehicles, processed metals, luxury goods, wiring, small arms, rare elements, artwork, tourists, etc.

At the start of the campaign, each world should have the following information generated for it:

**Exports:** The type(s) of export commodities the world produces on a regular basis, and the amount it will generate each campaign turn.

**Imports:** The type(s) of imports the world will pay for and the amount its population wants/needs each campaign turn.

**Market:** The amount of money the world will pay for each import you bring in. You might also require players to pay for exports they pick up, depending on how complicated you want things to get.

**Storage:** The amount of unused exports the world can store before excess spoils and is lost. This might depend on the export—some, like wine, might actually improve with age!

For example, the world Syxar might produce 20 units of Livestock each turn, with a maximum storage capacity of 40; it will pay 3 EPs/unit for Plastics or 5 EPs/unit for Gems (maximum of 30 units of trade per turn). If a player brought a freighter carrying 20 Plastics and 10 Silicon to this world, he would earn  $(20 \times 3) + (10 \times 5) = 110$  EPs.

Generally, what will happen in this kind of campaign is this: A player will move a freighter or other trade ship to a world, drop off any resources it has aboard (earning EPs), pick up (or buy) new commodities, and move off to satisfy another market. The path such a ship takes is called a *trade route*. Players will try to seek worlds that work together; i.e., each one produces what the other needs. These make the ideal trade routes. You should keep this in mind when generating the galaxy, making sure that a player doesn't have too many of these "perfect routes" available compared to other players, or that one player doesn't start in an area where few imports and exports match.

To make this sort of campaign even more interesting, give players an economic bonus to any trade related to the distance they brought the commodities. This is more realistic in terms of things like art or luxury goods, which will be rarer (and thus more valuable) the farther away they come from. In the example of the planet Syxar above, you might say that for every 5 strategic hexes away the Gems are brought from, one additional EP per unit is earned. (Note: Calculate this based on the most direct route available. It won't do to allow players to pick up a commodity, fly 10 hexes away, then come all the way back to a world nearly adjacent to the original source, earning the bonus for 20 or more hexes of movement!)

A final possibility is to give a similar economic bonus if trade is accomplished between worlds of different empires. This would give players a reason to ally, but might do too much to discourage fighting. Another possibility is to provide these bonuses only for worlds conquered from an opponent—which will have the opposite effect!

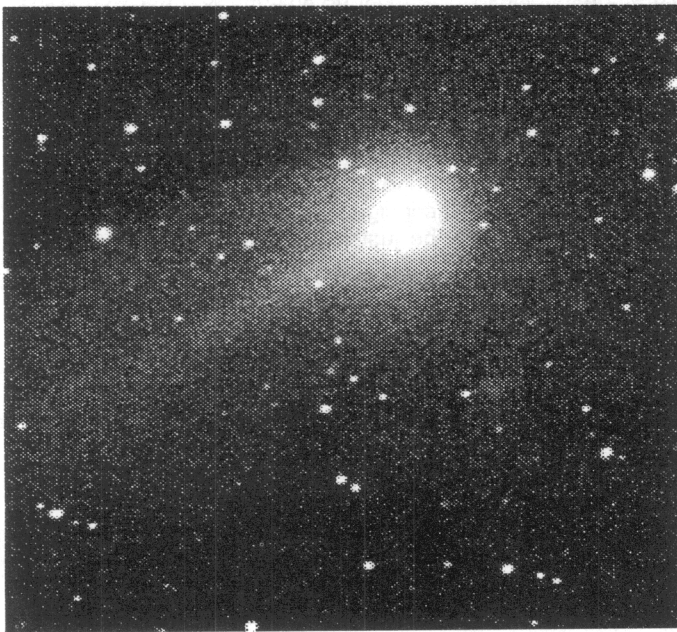

## POPULATION-BASED ECONOMY

In this intriguing system, all economic points are generated by population, based on the amount of population on a given world. Each point of population, also referred to as a PopPoint or PP, represents around 1,000-10,000 people (or more depending on your campaign), all of whom operate various industries and thereby produce EPs.

As an added twist, population is often used to crew starships. Each PP is worth some number of crew units, such as 10 or 5 or, in the most extreme case, 1. For example, in a campaign where each PP equals 10 crew units, a player would need to take 3-5 population off a world to operate a typical cruiser. (Note: Don't allow players to build ships with less than a full complement of crew!)

Each world should have a maximum number of PopPoints it can hold at any time (typically around 50-200, depending on your campaign, for Terran worlds within a system's biozone), and a population growth factor. Population will grow based on this factor each turn. For example, a world with 50 PP and a growth factor of 20% would increase by 10 to 60 population. The campaign's sequence of play will need to specify when growth occurs, either before or after EPs are generated and either before or after population is transferred between worlds. Any population growth in excess of the world's maximum limit is lost.

In a campaign of this sort, players are going to want to move PopPoints between planets (this system is most often used in a campaign where a player begins with one fully populated world and embarks on a mission of colonization). Your campaign rules will need to identify how this is done. The normal method is to use cargo boxes to haul PopPoints, the typical amount being one PP per box. (This may seem unrealistic considering each PP is supposed to be about 1,000 people; assume they are frozen in cryo-tubes or some other facility which stack and store easily in cargo holds.) It is recommended that whenever population is being moved in this way, the campaign's sequence of play restricts it from providing production or growth (for obvious reasons). Some campaigns require freighters to be specifically outfitted for this process, and prohibit cargo boxes on non-freighters from moving cargo (chiefly because some races have cargo on their warships—such as drone bombardment ships—while other races lack this capability).

Campaigns using population force players to guard every colony, because losing one takes away not only that world but future growth (and thus future colonies). You'll need to consider rules for planetary bombardment and devastation, which could kill all population on a world—or else simply outlaw these kinds of atrocities. Players might also want to capture a world (using ground combat), taking control of the surviving population, so you'll need to consider rules for this as well; some of the population might be available as world militia to help fight off the invasion.

If you set your colony growth rates too high—20% or more—the inevitable effect will be that player colonies max out after a fairly short period of time and keeping track of population becomes tedious and pointless. One way to control this is to reduce growth after a certain number of campaign turns (10 or 15 turns, for example). If this is done, players will often spend the first few turns of the campaign building few or no ships (assuming population is used to crew them) and concentrate on shipping PopPoints to fertile worlds. Once growth exceeds population requirements elsewhere, and economic production has increased, then they'll build ships. This is not necessarily a bad thing, as it gives players an different kind of strategic alternative (and is not without its obvious risks).

Ground bases can be used to enhance population-based economies. Scientific outposts, for example, might improve the maximum population of a world over time through research. Small mining stations might provide a production bonus, perhaps increasing the world's EP generation by 5% each (to some stated maximum, say 25% or 50%). Agro stations could increase population growth, especially on less hospitable worlds. Finally, small military garrisons would allow worlds to defend themselves against ground assaults. These bases provide infrastructure to a colony, and become excellent strategic targets.

**PROSPECTING ECONOMY**

This system can be combined with any of the economies above as an added feature, or can operate on its own.

Prospecting economies depend not on colonies or population, but on basic raw materials, which are mined from asteroids, rocky worlds, and the like. (The term "prospected" is generally used instead of "mined" to avoid confusion with defensive mines of the type normally found in minefields.) Perhaps EPs are generated by selling these materials to needy worlds, or these resources are simply converted directly into EPs when collected; it all depends on the campaign.

The typical means to collect EPs from prospecting is to use a prospecting freighter, a unit first seen in Module F1. If you don't have that module, freighters could be used in this role by simply paying the difference in price between an F-S and an F-PS (the prospecting variant), or between an F-L and an F-PL, and calling the result a "prospecting freighter." In any case, the freighter normally must spend an entire turn prospecting an asteroid (or whatever), filling its cargo bays with EPs; it then moves to a nearby world or construction facility to deposit these EPs for building purposes. (Other possibilities might exist depending on the logistics system your campaign uses.) Using prospecting freighters is just one method; requiring a mining station or other base is another, as is requiring a tug or similar unit. Note that Module F1 also provides several other prospecting units, such as the Free Prospector and Prospecting Platform, which could also be very useful.

In some campaigns, worlds or asteroids might have a limited amount of EPs available, and once they've been completely "prospected out," they are worthless thereafter. Other campaigns might allow asteroid fields to be prospected for the length of the game, but provide only a certain maximum number of EPs in any given turn no matter how many freighters are used. In any case, a survey ship doing a detailed survey of the system can find out these values, but no other type of unit (even a prospecting ship) can do so.

Prospecting can lead to some interesting scenarios, in which a unit collecting EPs comes under enemy fire. (Prospecting ships cannot begin a scenario "hidden," as they are too busy with mining activities not to be noticed.) It is suggested that any prospecting ship which disengages from a scenario should lose some of its prospecting for the campaign turn; it could return after the battle, but the interruption would cost it at least some fraction of its work. Ships engaged in prospecting should begin any scenario at speed-0 and at a low weapons status, their whole effort being put into prospecting. (Ships guarding the area might not suffer these penalties.)

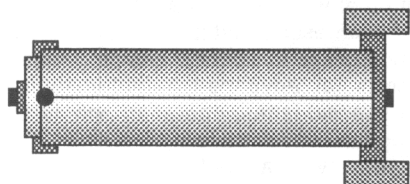

SMALL PROSPECTING FREIGHTER

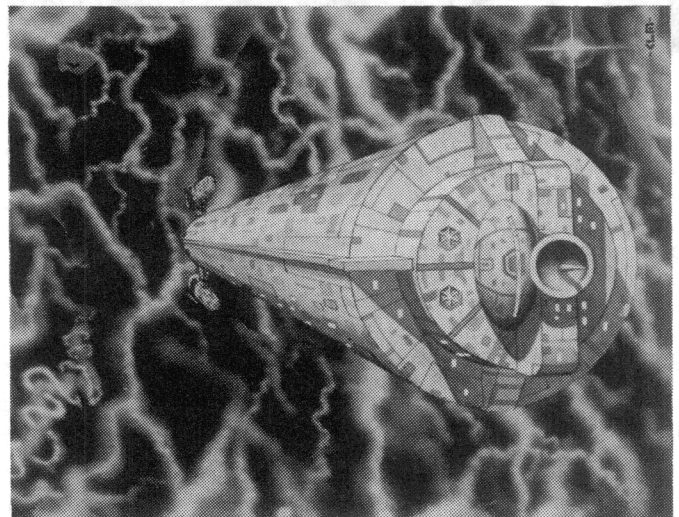

**ECONOMIC BONUSES**

Some campaigns might wish to experiment with economic bonuses, which provide added income for owning areas on the map or groups of worlds. Two examples: Federation & Empire provides provincial bonuses to anyone who controls all the territory in a given province; Star Fleet Warlord gives a sector bonus to players who own every site in any one of the 101 sectors in the game.

On a fixed, predesigned map, regions which provide bonuses should be clearly delineated. Players may not need to have a ship in each and every hex of an area to "control" it, but should own each of the worlds found therein; construction of at least one base in the area could also be required.

If the map is random, then regional bonuses should be laid out in an obvious grid or pattern to keep things fair to all players. Grid-based Cartesian maps are idea for this, although it can also be done for hex and square maps. Campaigns using the warp point mapping system will find region bonuses extremely difficult to handle.

Players who participate in a campaign with regional bonuses will always seek to capture the region nearest to them (usually the one with their home planet in it) as quickly as possible. Each player should have an equal chance or opportunity to do this, or else the campaign may not be viewed as fair to all. If players are near each other, then they will be sure to launch attacks on worlds within their opponents' regions to try to disrupt their bonuses, especially if the amount available from such a bonus is considerable. They may strike without any attempt to capture or control a world, only to disrupt the bonus—in other words, this sort of campaign encourages hit-and-run attacks and recon-in-force maneuvers, which might be something you want to see. The side effect, however, is that players will try to heavily fortify worlds within their regions, possibly leading to more attacks against fixed defenses than most players would really prefer.

**OTHER ECONOMIC SYSTEMS**

There are, of course, other economic possibilities available, or combinations of the above. A trading economy with a supply and demand variation, causing import and export costs to rise and fall based on how much trade is being conducted in particular commodities, would be quite intriguing. A system in which economic points are not collected but are earned or paid as wages is another, simpler possibility. If none of the above economic systems interests you, create your own!



## LOGISTICS

"Logistics" is the means to get money, resources, supplies, and equipment from one place to another—from where they are now to where they are most needed. Most campaigns need some system to handle shipping, often breaking logistics down into two forms: economics and supply.

Some campaigns avoid the logistical question entirely, choosing simplicity over the required bookkeeping; unfortunately, this also removes the possibility of intriguing scenarios involving convoy raids and the like. Also, many players find the logistical element a fascinating aspect of the game, one not seen in everyday tactical scenarios.

### ECONOMIC LOGISTICS

Most campaigns involve numerous worlds, all of which produce some kinds of resources, chiefly EPs. All of these need to be brought to production facilities to be turned into useful goods. Here are some ways this can be done:

**No effort.** Assume that all resources are moved automatically to their destinations. This is the simplest (and most boring) method and is the same used in F&E. (While it *is* boring, using a simpler system here might let you spend the effort adding detail to other areas, such as ship construction, while keeping the total effort below the level of complexity your players don't want to exceed.) It is recommended that even with this simplistic system, resources cannot be used on the same turn they are shipped, though this might depend on the campaign's sequence of play.

**Shipping by freighter.** Require players to maintain a fleet of cargo ships, chiefly freighters, to move resources around. Since the SFB rules do not define how many "resource points" (usually EPs) fit in a cargo box, you'll need to decide this for your campaign. One EP per cargo box will require lots of freighters; ten per box means no more than one freighter will be needed for any shipping route. Recommended amounts are somewhere between 2 and 5 EPs per cargo box, inclusive. Note that under this system, any ship with a cargo box can carry EPs (not just freighters), but freighters will be the most efficient due to their low price.

**Automatic shipping network.** This system allows players to create a network or grid in which all shipping is handled by automatic rules. In order to be part of such a network, a world should be required to have some sort of base in orbit, even one as small as a commercial platform. Once such a base is in place, shipping takes place between worlds in the network automatically; a series of freighters are assumed to be taking care of this outside the player's control. Note that if this system is used, players may still wish to ship EPs around to worlds without connections in the network; if so, allow no more than one EP per cargo box, or players will be tempted to not use the network at all, avoiding the trouble of placing bases in every system.

**Shipping lanes.** Under this system, which is applicable in a campaign where worlds are sparsely spread out across the map, you might allow players to create a "shipping lane." This would be a type of automatic shipping in which the player pays for each leg of the network. For example, to connect the homeworld with a nearby colony with a shipping lane might require an expenditure of EPs based on the production level of the colony and the distance from the homeworld. Thereafter, that colony would ship resources to the homeworld automatically. This avoids the need for tracking individual freighters, but is not as broad as the automatic network described previously; it forces players to decide for themselves

which worlds are important enough to have shipping lanes, and how to organize the most efficient shipping network. (One might liken it to a "space railroad.")

**Shipping for hire.** Don't allow players to build their own freighters or cargo ships, but provide a "merchant marine" service that handles shipping for a fee (usually a percentage of the resources being shipped, such as 10% or 20%). Non-player Orions may also be hired for this role, though they may not be as trustworthy. If this system is used, players will be more likely to build extra construction facilities at high-production worlds, avoiding the added cost of hiring shipping services.

**Combinations.** Naturally, you could allow combinations of the above. For example, a campaign might provide a shipping network and shipping for hire, letting players choose which one they feel is best for their needs—possibly even using both systems in different parts of their empire.

Note: If you allow EPs to be shipped in cargo boxes, there is a potential loophole if your rules aren't careful to prohibit it—be sure to include a rule that once an item is bought, it cannot be turned back into EPs! For example, if a player buys a drone for 1 EP, it cannot be sold back for that same value later. Why, you ask? Because drones and other small items can be packed into a cargo box at much higher rates than EPs will. For example, most cargo boxes hold 50 space points, and a drone is just a 1-space item! If you let players buy drones, pack them in a cargo box, and "liquidate" them at their destination, then a smart player will buy expensive drones for this purpose—and a single small freighter will be able to carry 5,000 EPs or more! Needless to say, this will make a mockery of your campaign's carefully structured logistics system.

### RAIDING SUPPLY LANES

If your campaign has lines of supply or some other kind of shipping rule, it should be possible to raid these areas. Attacking a nation's supply lines has a proven effect on their ability to make war, as proven time and time again throughout the history of our planet.

The simplest way to allow for raiding is to require an enemy force to penetrate the border, move near a world in the shipping network (or between worlds believed to be involved in such activities), and try to intercept a convoy. Naturally, this works best in campaigns where players can't see each other's ships and a non-player GM tracks ship movements.

If the campaign requires the specific use of freighters for shipping, then raiding is simple to resolve: If the raiding ship encounters a freighter, it can raid it; otherwise there can be no success. Campaigns with automated networks or established shipping lanes are another matter, however. If you wish to allow raiding, your campaign rules will have to enable a player to move into a supply zone and engage in a raiding mission. Then, a die roll will be made to see if a convoy has been encountered.

Since any convoy a raider encounters will probably be destroyed or decimated, the logical question for the defender will be, "How do I guard my convoys?" Your campaign rules will need to allow them to upgrade the freighters or add escorts to their convoys. This depends on the type of network you're using, of course. A fully automated, global system could require that escorts be paid for and then "dropped" into the network, whereupon they disappear from the player's force list and are unavailable for other work. Then, if a raid attempt is made, there is a chance for each escort that it will be with the convoy being attacked. Campaigns with specific shipping lanes will require that such escorts (or advanced freighters and Q-ships) be "dropped" into specific lanes, operating only in that lane (and always escorting the convoy traveling therein).

Setting up a convoy raid battle is discussed in more detail in the *Scenarios* section.

## STORAGE OF EXCESS RESOURCES

If a situation arises where EPs or some other commodity can't be shipped (perhaps the world is out of the supply grid or no freighters are available), then some storage facility may be needed to hold onto these resources. The ideal location is any cargo box on a ground base or other facility. You might also give worlds a built-in "bank" of a certain size, but allow this bank to be captured if the world itself is captured by an enemy. In complex economies, storage might also be determined by the type of resource involved—any Terran planet should be able to store air or water in unlimited quantities, for example, but food could spoil, ores might corrode, and so on. Any resources or EPs above the world's maximum storage capacity should be lost, encouraging the player to improve his logistical network as soon as possible to avoid future losses.

## SUPPLY LOGISTICS

Once you've got your ships built, you'll have to keep them supplied out there in the field. There are a few ways to do this, too:

**Automatic resupply.** This simple system avoids resupply considerations entirely. Each ship is automatically refilled with consumables at the end of each campaign turn, at no cost. While simple, this system may allow ships too much flexibility, enabling them to go anywhere they want without fear of the consequences.

**Resupply by range.** This is similar to automatic resupply, but works only so long as the ship is within range of a base. A network of fast resupply ships is assumed to be in operation within that range (these ships can't be attacked). This is the system used in F&E. Note that larger bases might provide a greater range benefit. If this system is used, then base-building becomes much more important, and long-range sustained attacks within enemy space become much less likely.

**Resupply from bases.** To get resupplied, a ship must travel to a base (usually a base station or larger, though MBs might also be allowed). This makes bases even more critical, especially to drone-using races, and might turn the campaign into a series of raids instead of a war (though this might be what you want, of course).

**Resupply from ships.** The new class of Fast Resupply Ships from Module R6 would be ideal for this purpose; a Gorn FCR is shown below. Basically, in order to be resupplied, a ship or fleet must be visited by FCRs (or other ships, possibly auxiliaries or tugs), which would distribute spare items like shuttles or drones from their cargo boxes. Note that if this system is used, the FCR should be given a very high strategic speed, at least as long as it is in friendly territory. After resupplying a ship or fleet, an FCR would have to return somewhere for more supplies, probably the nearest base or world.

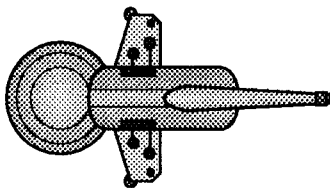

GORN FCR

**Combinations.** Obviously, you could combine two or more of the above possibilities, or create a customized resupply system if your campaign needs one.

## COST OF SUPPLIES

Depending on the type of item, supplies might cost the listed price, some other cost, or be free entirely. Here are some suggestions for how your campaign should handle various supplies and equipment:

**Fuel.** It is assumed that ships carry some quantity of fuel, be it antimatter, dilithium, or some other element or combination (the exact details don't matter). A ship performing normal non-combat duties, such as guarding an area or a passive patrol, would not use fuel at any noteworthy rate. Traveling at high speeds, engaging in combat, remaining on alert at a high weapons status, or disengaging by acceleration are all things that could require considerable quantities of fuel. Your campaign may wish to keep track of fuel usage, perhaps requiring a cost in EPs to maintain a ship's stock; recommended values are 1-3% of the ship's combat BPV (don't include any optional items in this calculation, except fighters and PFs). If the ship uses more than the standard fuel amounts (perhaps by disengaging by acceleration during a scenario), then the regular fuel cost could increase by some factor—possibly even double. If any ship isn't refueled, then any number of bad effects could happen (its strategic speed could be reduced, it might be prohibited from disengaging by acceleration, its weapons status in all scenarios could be penalized, or some other effect).

**Food.** Keeping the crew stocked with food could also require some kind of maintenance cost, possibly lumped together with the fuel support cost. Another alternative is to charge by the crew unit, such as 1 EP per turn for every 10 crew units in a player's fleets.

**Shuttles and fighters.** Just about every campaign requires payment for fighter replacements; otherwise, players will concentrate exclusively on carriers, and often won't even bother to recover fighters during a battle. The same should go for special shuttles, like MRS, GAS, HTS, etc. Administrative shuttles are another matter, however. To keep your campaign simple, any ship which returns to a supply point or is in the proper supply range should receive replacement admins at no cost.

**T-bombs and mines.** Mines in minefields should always be paid for. If such a mine is swept or destroyed during a scenario, replacing it should require the appropriate payment. (If much of the field was lost, the player may choose to simply lay another entire minefield.) Transporter bombs and Romulan NSMs are different, because they can be used in any scenario, and are quite expensive. The typical way to handle this is to require the ship's owner to pay the cost once (except for first-generation Rom NSMs, which are free), and then all replacements come at no cost whenever the ship is in supply. Note that this does not apply to mines in mine racks, such as those on minesweepers or Romulan Q-ships; these must always be paid for.

**Drones.** Like T-bombs, drones are an item often only paid for once, with all campaign replacements being free. The reason for this is fairness to the drone-using races. If a ship has to pay 16 points to buy fast type-I drones for four drone racks, and uses those drones in every scenario, the cost of replacements will be prohibitive over the course of a campaign. Note that players will need to keep careful records of what kinds of drones they've bought for their ships. If a ship changes its drone loadout, it will have to pay full cost for the new drone types, receiving nothing in exchange for drone types that were replaced.

**Crew and boarding parties.** This depends much on the economic system your campaign uses. If you track population and draw ship crews from that base, then crew replacements should be free, but must come directly from the population available. If some other system is in use, then crew units will be either free (in a simple campaign) or cost some small amount

(like 0.5 EPs per crew unit, 1.0 for a boarding party). Outstanding crews should cost more, if allowed to be replaced at all (see *Starship Crews*). Note that special ground forces, commandoes, and so forth should probably require full price to replace if lost, owing to the special training and equipment these items require.

**Pseudo-plasma torpedoes.** There is some debate over what a pseudo-plasma really is and whether it should be a supplied item or something the ship just creates for itself at the end of a scenario. You'll need to decide this for yourself in your own campaign rules. Many campaigns choose to force a ship to be in supply to pick up PPTs, as a compensation to the drone-using races, which need supplies more than anyone else in a campaign. However, the question of whether PPTs actually cost anything is a matter of some debate. If they do cost EPs, then plasma-users will argue that drones must also cost EPs to replace. If not, then plasma races will try tricks like buying a transport shuttle or cargo PF and claiming its cargo boxes are filled to overflowing with free PPTs. Obviously, you'll need to consider these kinds of things when deciding whether or not a PPT is a supplied item and how much to charge for one.

**Other items.** There are plenty of other items that supply rules should consider, such as warp booster packs, fighter pods, chaff packs, and so forth. The cost for these will depend greatly on the price (if any) charged for other replacement items. Very large objects, like PFs, base modules, pods, and so forth should always require full payment for replacements.

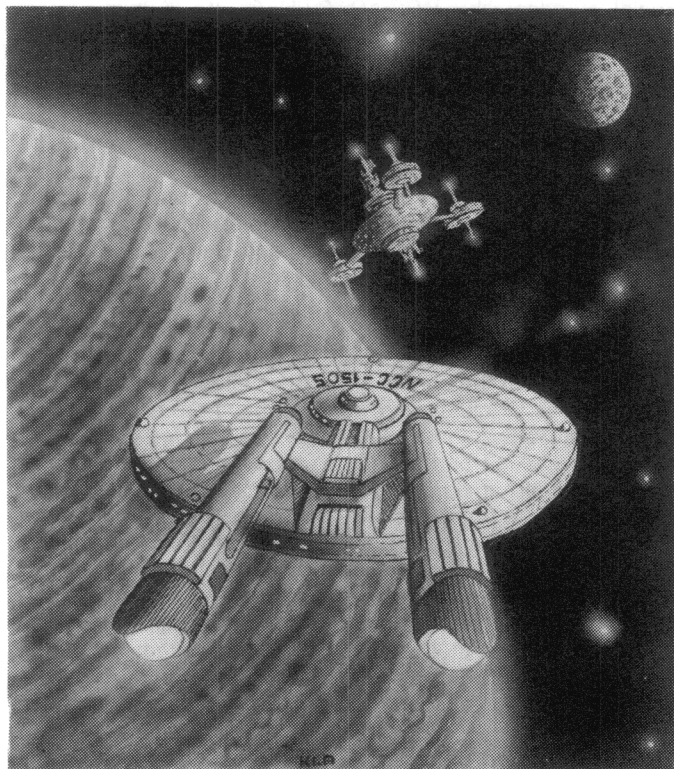

## SHIP MAINTENANCE

Some campaigns require a ship maintenance fee to reflect the cost of automatic supplies, such as fuel. (This was touched on briefly above. Note that your campaign doesn't have to use these rules at all if you wish to avoid the added complexity.) A cost of 5% or more of a ship's EPV (or BPV) is not unreasonable, and will help to keep player forces from growing too large and exceeding their economy's ability to support. If the campaign uses complex economics (tracking production and use of food, fuel, air, etc.), then the maintenance fee may be paid in these resources; otherwise it will be paid in general EPs from the player's treasury. Units which should require maintenance include ships, fighters, PFs, and bases, plus possibly minefields, defats, ground bases, colony populations, FRDs, independently active pods, ground troops, and so on.

In some cases, the cost of maintenance might be increased or decreased. For example, if a ship is to be held at a high state of readiness (such as weapons status-I or -II), it might cost double the normal maintenance fee. Keeping a ship at WS-III might also be allowed at a much higher cost, or not allowed at all. Other things that might change the maintenance fee include: maintaining units under cloak, giving a fleet an active patrol or reactionary mission, forcing a unit to move farther than its normal limits (if allowed by your campaign rules), supporting an outstanding or poor crew, and so forth.

If using maintenance fees, paying the maintenance should be sufficient to consider the ship "in supply." Note that the ship may need to meet other requirements, such as being within an appropriate range from a friendly base, in order to gain this benefit. If the cost isn't paid, then various penalties could apply to the ship—its speed could be reduced, its crew could act as one level lower in quality (outstanding as average, average as poor, and poor crews could mutiny and cause the ship to up and disappear), or it could be confined to drydock while waiting for supplies. Note that maintenance fees should take precedence over all other expenditures, such as construction of other units.

## MOTHBALLED SHIPS

Under some circumstances, players may wish to "mothball" a ship. The ship is essentially removed from play, hidden near a base or on a planet somewhere (out of sight and out of mind). While mothballed, a ship cannot participate in any scenario, and reactivating it will take a minimum of one full campaign turn (preventing mothballed ships from being used as a reserve or reactionary fleet).

The primary reason to mothball a ship would be to avoid high maintenance costs, using such ships as replacements for battle losses. It might also be done in a campaign where crews are carefully managed or drawn from a limited world population (while mothballed, a ship requires no crew). Finally, a ship that is heavily damaged or crippled and awaiting repairs might be mothballed to keep this otherwise useless unit from costing maintenance fees or supply resources.

Mothballing or un-mothballing a ship will cost nothing in most campaigns (unless population must be taken from a world to re-crew the ship), except for the time factor. The location of the unit must be recorded, though this could be a general statement of the form "somewhere on the planet" or "in the asteroid field." Locating a mothballed ship would be virtually impossible for any enemy, except perhaps a survey ship doing a detailed search, but if the world (or system) containing a mothballed ship is captured, then any ships left there would be considered destroyed. You can justify this by saying that anyone who mothballs a ship would be foolish not to pre-place a couple of antimatter bombs on board to vaporize the ship and prevent its capture in the event of discovery.

## CONSTRUCTION

One factor present in all campaigns is the ability to construct new units. There are several aspects to this, each of which is described in the following sections.

### THE NATURE OF CONSTRUCTION

Depending on your campaign, construction can come in various forms:

**Automatic deployment.** This is not really construction, but simply the arrival of reinforcements based on a set schedule. In such a campaign, each player receives ships depending on some predefined set of rules; logistics, facilities, and even economics may not even come into play. Alternatively, ships might be paid for using the player's economy, and then "arrive" at the homeworld (or other possible locations) without the use of actual construction facilities.

**Fixed purchase menu.** This is the system used in F&E. Players have a set number of ships which are available for purchase each turn, certain units become available only at certain points in the game, and certain units can be produced only in limited numbers. Surplus money can be spent buying additional ships at a premium. If the mechanics of construction are not a major interest to you, your campaign could just "borrow" the F&E production rules (or some version of them) and use them as written.

**Purchase from elsewhere.** This is the method used most often in Masters campaigns. Quite simply, the players hand over the required amount of economic points or resources to the Masters, and they provide the ship automatically. This is a simple method, requiring no facilities, no delay time, and quite possibly no logistics at all. Ships usually arrive at the player's homeworld; another alternative (the Warp Gate) is provided later in this section.

**Assembly line production.** In this unusual campaign scheme, ships are built using assembly lines of materials, not all of which might be located in the same place. In order to build a ship, for example, you would need to bring in enough tractors, transporters, warp, impulse, etc., to put all the required boxes onto the SSD. Under this system, the main element is logistics—you have to get these "boxes" to the place where the ship is being built. (Of course, if any player has a choice they'll put all their assembly lines in the same system to make this easier, so your rules should make this difficult or impossible.)

**Actual building.** This is the most commonly seen construction method, in which ships are actually built from the ground up using resources (money, ores, etc.) gathered during the campaign. This involves getting the resources to the right place (logistics), paying the cost, spending the required time, and using the appropriate facilities, each of which is discussed in more detail hereafter.

### CONSTRUCTION LOGISTICS

Logistical matters are dealt with in greater detail elsewhere in this Handbook, but some discussion of them needs to be made with respect to construction.

In order to build a ship, you need to have the required materials in the same location as the construction facility. This requires logistics. The simplest way to handle this is to allow freighters to carry some quantity of funds, ores, etc. in their cargo boxes. If your campaign does not track individual resources but uses economic points (EPs) only, then your only real decision is to decide how many EPs fit in a cargo box. One EP per box is too small unless you want to see *lots* of freighters; 10 EPs is probably too high. 3-5 EPs per cargo box is recommended. (Remember that Orion boxes will usually carry only half this amount due to their smaller size.) If your campaign also tracks ores and other resources, you'll need to make a similar decision regarding each of these commodities.

### ASSEMBLY LINES

If you wish to experiment with a more complex construction scheme, use assembly lines. As mentioned above, this requires various facilities to make each type of system box that appears on an SSD (control, warp, impulse, tractor, drone rack, etc.). Each type of power system requires its own construction facility, as does each type of weapon (although sub-types can still be built at the same facility—you don't need to separate different phaser, plasma, or drone rack types, for example). Some boxes should be able to be constructed anywhere—hull, cargo, shields, tracks, etc.

In such a campaign, players will try to put all of their box construction in the same system. This should be restricted or made impossible in some way (otherwise you might as well not bother with assembly lines in the first place). Your star system generation process should "rate" each world on its capability to produce certain boxes, based on available local resources and manpower. For example, one world might be able to construct tractor beams, while another might not (or might pay extra to do so).

Once boxes are built, they need to be moved to the construction site. The recommended method for this is one system box per cargo box (note that some system boxes are double-sized, such as SFGs, plasma-S, etc.) or of other varying sizes. Also note that most Orion cargo boxes will carry only half the stated amounts, requiring two cargo boxes for each single system box. Boxes should be loaded or unloaded using the standard cargo transfer rules, and are too large to be moved via transporter. Also, they cannot be activated, installed, etc. during a scenario.

There are no SSDs or other descriptions available for box construction facilities. You can feel free to design your own, or simply state that any world capable of producing a box already has the facilities present to construct that box type.

This rule can also be used for constructing various optional items, such as shuttles, T-bombs, drones, and so on. Getting these to your ships is also a matter of logistics.

## CONSTRUCTION COSTS

How much does it cost to build a ship? Usually, the economic point cost (EPV) of the ship/unit is used. On the Master Ship Chart, the EPV cost is the number in the BPV column before the slash (if one is present) or equal to the BPV (if not). For example, the Federation GSC (Galactic Survey Cruiser) shows a 142/122 in the BPV column, making its economic cost 142.

Some alternatives are available. One possibility is to charge the BPV and ignore the EPV entirely. This is not recommended, as it doesn't accurately reflect the difficulty of putting certain strategically valuable units (like the FRD) into the field. However, if you are concerned with balancing your battles to the ultimate degree, you might charge BPV instead of EPV. A good example of such a campaign might be one in which players are restricted to bringing a certain amount of BPV into any battle.

Another possibility is to charge whichever amount is higher (in the case of a split EPV/BPV). This can avoid certain problems, such as the cheap cost of the monitor, a popular defensive unit, but can make other units (e.g., some battle tugs) too expensive to use. Consider the effects on each race carefully if you choose to use this option.

## PROTOTYPES

One intriguing campaign option is to require players to pay extra for prototyping a new design. At the start of the campaign (which might begin in a certain year, or use another technology rule—see *Technology*), only a small subset of ship designs are available. In order to create a new one, a prototype cost (perhaps 50% of the ship's basic BPV) might be required. For added interest, there might be a possibility that the prototype will blow up or meet with some other accident during field testing, setting back production of that ship type by several turns.

If prototyping is required, players will generally pick one or two designs, prototype them, and build strictly those hulls from there on out. Unless you also include rules encouraging a number of different ship types, your battles might become stale and repetitious, with the same hull types in every scenario, time and time again.



## OTHER ITEM COSTS

**Fighters.** The economic cost of any shuttle or fighter is equal to one-half the listed combat BPV (J1.85); exception: SWACs. This rule is often overlooked by campaigners; make sure your players know about it before the campaign starts. Because of this, campaign players will likely concentrate on fighters and carriers as much as they can, because this is an inexpensive way to maximize firepower. If you don't want your battles to become endless carrier duels, consider putting limits on fighter production, or charge command rating points for them (see *Command Ratings*). You'll also want to require the historical listed escorts in order to operate a carrier (and these escorts can *only* be used for this role). Note: While fighter economic costs are half their BPV, this does not include the cost of options for them, such as drone speeds, warp booster packs, fighter pods, and so forth. Don't bend on this, either, because it's a built-in balance factor for drone-using fighters (when they get speed-32 drones, they are truly obnoxious if not limited by high drone costs).

**PFs.** The economic cost of fast patrol ships is very low—about half their BPV, except for leaders and scouts. As they will with fighters, players will try to build PFs as much as they can, using the mech link refit (R1.R1) to make every ship into a casual PF tender. You can and should limit this, using any of several methods—command rating limitations, flotilla requirements (all PFs must be organized into formal flotillas with leaders and scouts required), elimination of the mech link refit, and so on.

**Minefields.** As listed in (M6.32), the cost of a standard minefield is 100 EPV, which is halved if the mines are deployed around bases (M6.33). Owing to the incredible defensive potential of a minefield, this will encourage players to deploy at least one around every base or planet (depending, of course, on the availability of minelayers). If you had 50 EPV to guard a base, would you rather have a POL, 2 1/2 defstats, or 64 mines? Anyone who's ever played a minefield assault knows the answer. GMs would be wise to place limits on minefields, perhaps raising the cost or reducing the number of such fields that can be placed around any given world.

**Other items.** The BPV of most other items, such as T-bombs, drone speeds, etc., is listed in the SFB rules. These costs should be identical in EPV unless stated otherwise.

**CONSTRUCTION TIME**

Ships can take varying lengths of time to construct based on their size and complexity. There are several ways to handle this.

**Quick completion.** Any ship, unit, etc. can be built in a single turn. This is quick and easy and uncomplicated. It also encourages players to build nothing but large ships (especially if other rules, such as command ratings, don't counter this natural tendency). Depending on the sequence of play in the campaign, quick completion can still take the duration of a single turn (i.e., pay for it at the start of the turn and it's done at the end of the turn) or can be instantaneous (pay for it and it's there, available for use immediately).

**Staggered completion.** This is a frequently seen completion strategy: size class-4 units take one turn, size-3 take two turns, size-2 take three turns, and size-1 (starbases) take four turns. It looks simple, but adds new questions: What percentage of a ship must be built during each turn, and can construction be extended if necessary? If you don't put any restrictions on these, you'll find players putting 1 economic point into each of dozens of ships, then spending the remaining 99% of the cost on the final turn so the ship is ready at the drop of a hat. To prevent this, use limited production facilities, or require that an appropriate percentage be spent on each turn—e.g., if it takes two turns to build a 150-EP cruiser, then 50% (75 EPs) must be spent on both turns in order to complete the ship. You'll also need to prohibit extending the completion time to avoid similar loophole abuses.

**Random completion.** This is an unusual campaign option but can be quite interesting. When a ship is paid for, it takes a random number of turns before it is finished or delivered. To handle this, each player tells the GM when a ship is finished, the GM records the turn it will arrive, and announces the arrival when it occurs. Careful paperwork by the GM is required, as is absolute trust in his impartiality. The recommended time delay is 1-6 turns (one die roll), although other values are possible.

**Experienced completion.** This is best combined with the prototype cost rules described previously. As any ship is built multiple times, the builders become more efficient at putting them together. At the start of the campaign, for example, it might take three turns to build a particular type of frigate, but after the initial prototype is completed and functional this might drop to two turns, and after the next three (or other quantity) have been built it could go to one turn. As with the prototype rule, this can have the side effect of causing people to specialize in only one or two specific favorite ships, unless other rules prevent or restrict this.

**CONSTRUCTION TIME FOR BASES**

Building a base can use any of the above possibilities or can be a separate activity.

The most common way to handle base construction is to have the player drop a mobile base (MB) on one turn, upgrade it to a base station on the next turn, then upgrade it to a battle station, and finally to a starbase—a total of four turns. You could also allow bases to be constructed from the ground up, at the same speed as a ship of their size class.

Note that mobile bases are technically size class 3 units, so if using the standard staggered completion rules, they would take two turns to construct. Adding to this the time required to transport the MB to the desired system, the length of time to get a base fully upgraded is quite considerable. If your campaign uses a complex logistics system or requires resupply from bases, then you might want to consider allowing MBs to be built or upgraded faster than normal.

**OTHER ITEMS**

Most other items (fighters, PFs, T-bombs, etc.) should take no more than one turn to produce, although you might want to place a limit on the quantity that can be put together in any particular location.

**CONSTRUCTION FACILITIES**

If your campaign uses actual construction or assembly line construction (as opposed to automatic arrival or purchase from an outside source), there needs to be some kind of facility where units are put together. The simplest way to handle this is to allow the homeworld, and possibly certain other major planets, to construct ships, saying they have some kind of "shipyard" present which can do this. Capture of the world, or devastation of its surface, would destroy this shipyard. An alternative is to allow another unit, such as a starbase or FRD, to construct ships (or parts of ships).

Included with this Handbook are several units which can construct (or receive) other starships: Naval Construction Docks and Warp Gates. The use of these units is optional, and they can be used in any of dozens of ways, depending on your campaign's rules. Suggestions for campaign uses are provided hereafter.

**FACILITIES FOR OTHER ITEMS**

Items smaller than size class 4 starships can be built at various locations; your campaign rules will need to specify what sort of production facilities are required to build these items. For example:

**Small ground bases and defsats:** Any colony should be able to build these on its own, perhaps after a certain time period has elapsed or after a certain population level has been reached. You might require an initial ground base (such as an agricultural station) to be dropped by a tug or other unit as part of the colony initialization procedure; after this the colony could be said to be self-sufficient and capable of building its own small ground bases.

**Base modules:** Any base should be able to build its own modules. Otherwise, tugs will be too busy transporting modules around, when they should be busy placing new bases.

**Commander's Option items (T-bombs, etc.):** Any well-populated world should be allowed to build these, but not brand-new colonies. If a facility is capable of building a ship, it can probably also build optional items for it (unless you are using the assembly line concept described previously).

**Fighters and PFs:** At a minimum, a base station should be present before these can be built, and only well-populated worlds should be able to construct them. You might wish to specify that at least one ground fighter or ground PF base be present and unoccupied (for field testing).

**Bases:** Upgrading a base from one size to the next (e.g., mobile base to base station) should require more than just an economic point payment. Repair ships (or tugs with repair pods) are good choices for this role, as are FRDs.

If you wish to keep your campaign's construction rules as simple as possible, simply state that the above items can only be built at facilities which can build starships. However, while this will simplify construction, it will tend to make logistics more complicated than it needs to be.

**NAVAL CONSTRUCTION DOCKS**

Star Fleet Battles players have long wanted an SSD for a "shipyard" to use in scenarios which involve ship construction facilities. Unfortunately, it is not possible to provide one single SSD for a shipyard, because shipyards are more than just any one unit! Anything properly called a "shipyard" will include satellite facilities, engine production shops, worker quarters, material storage, pre-fabrication, and so on, all of which would be separate units (just a small shipyard would probably include the equivalent of four SAMS/ComPlats, eight cargo pods and a mobile base). Many of these facilities, quarters, and so forth are found on the planet where the shipyard is located (due to the vast number of personnel involved in building a ship, the construction facilities are never found in open space or away from population centers).

Despite this, there is one definite "construction dock" unit wherein the ship's keel, framework and superstructure is housed while the ship itself is assembled. SSDs are provided for these units, which come in three sizes: small (for production of size class 4 ships), medium (for size class 3) and large (for size class 2). Larger docks can produce units smaller than their maximum limit (e.g., a large construction dock could produce size class 3 or 4 units in addition to size class 2), but not at increased rates.

Construction docks have small impulse engines, allowing them to maintain an orbit without positional stabilizers (which they do not possess). However, these engines are very limited in usefulness. They cannot be used to disengage by sublight evasion (the dock is just too large to be missed) and cannot move the dock strategically. Naval construction docks may never leave the system in which they are assembled.

**CONSTRUCTION RATES**

Naval Construction Docks are designed to build ships, but can also build certain other items at the rates shown on the following chart (shown on a per-turn basis):

Unit Type	Sm. Dock	Med. Dock	Lg. Dock
Size class 2	N/A	N/A	1
Size class 3	N/A	1	1
Size class 4	1	1	1
PF/INT	3	6	12
Fighter	6	12	24
Defsat	2	5	10
Minefield	1	3	6
Mobile base	1/2	1	2
SAM/CPL	1	2	4
Ground base	1	2	4
Base module	1	3	6
Pod*	2	4	8
SP module	1	2	4
SK/SE module	2	4	8

\*The rate shown for pods is for single-weight pods. Double-weight pods count as two pods for this purpose.

Note that the above rates can be modified to suit your campaign. If you want a medium dock to be able to build one frigate and one destroyer per turn, and a large dock one heavy cruiser and one light or war cruiser per turn, feel free to specify this in your campaign rules.

**BUILDING CONSTRUCTION DOCKS**

Your campaign rules will need to specify how construction docks themselves are built. For this purpose, you can pay the economic cost of the dock (shown on the SSD) and the rest of the shipyard (production shops, quarters, storage, etc.) are assumed to be built at the same time, either on the surface of the world or in orbit as appropriate. These items can safely be left out of a scenario for ease of play, as they cannot be used for any purpose other than in support of the construction dock they were built with. (This is the simplest method, designed to avoid undue complications. A more detailed campaign might specify which additional facilities—ComPlats, cargo pods, mobile bases, etc.—need to be built along with the construction dock.)

Naval construction docks should be allowed only at major worlds, depending on the scope of your campaign. An F&E-like historical game should allow them only at capitals or certain major planets, whereas a small empire-building colonization game should allow them only at fully colonized planets where the population could be large enough to support them.

Building a shipyard should be a tedious procedure which takes many campaign turns (depending, of course, on the relative speed of your campaign). It is recommended that at least one tug and one repair ship/base (or another tug operating in that role) be present at the site while the dock and other facilities are built.

Many ships are built on planetary surfaces; examples include most Orion ships and police corvettes, Romulan "Eagle" hulls, and just about any ship capable of taking off or landing on planets. Construction docks cannot land, and if one is built on a planetary surface, it is there permanently (change the impulse to APR with no adjustment in BPV).

**SHIPYARD SPECIALIZATION**

In larger campaigns, players may wish to experiment with *shipyard specialization*. Under this alternative rule, each individual naval construction dock must "specialize" in a specific class of ship. For example, a Federation player might have three medium docks, one of which is specialized in CAs, one in NCLs and one in CLs. Note that any such campaign must be careful to define exactly what specialization is needed (e.g., you might say BCHs can be built in CA docks or require a specific BCH dock).

At the start of any such campaign, players would possess only a few construction docks; for example, each player might have three small (specializing in POLs, FFs, and DDs) and one medium (for CLs). In this game players will have to decide for themselves whether to spend their valuable funds on ships or to build a dock to specialize in another type of ship. In campaigns where economic points are plentiful, this will promote diversity in ship designs, but in smaller games, players will tend to build only at the shipyards that produce their favorite ships, while the others sit idle or work only in emergencies.

**SHIPS IN DRYDOCK**

While a ship is being constructed, it cannot function in any capacity. If a construction dock is attacked while a ship is being built, then the partially built ship is destroyed when the dock is destroyed. It can be damaged, using the following procedure.

Each campaign will include a sequence of play in which economic points are allocated for ship building, and then, after a certain amount of time has elapsed (often one or more campaign turns), the ship is completed. When an attack occurs, determine how much time is still required to complete the ship, and express this as a percentage. Then, figure how many internal boxes are unfinished using this same percentage. For example, if your campaign allows a cruiser to be built in a single turn, and a player attacks a dock halfway through the turn, then the ship is 50% incomplete. If it has 120 internals (including all tracks), then roll 60 omnidirectional internals, marking each box as not only destroyed but unavailable (i.e., they cannot be repaired). Note: If your campaign does not allow for a precise determination of a completion percentage, then use a completely random die roll, such as three dice multiplied by 5.

When the construction dock takes a "cargo" hit, the owning player can choose to take one hit on the partially built ship instead of on the dock (unless there are no cargo hits remaining, in which case the hit must be scored on the ship within). Keep track of how many such hits are transferred to the partially built ship in any volley. After the volley against the dock is finished, roll a new volley of internals on the partially built ship. Example: A player takes 10 cargo hits on his dock and decides to allocate 5 of them on the cruiser within (the remaining ones being scored on the dock itself). After the volley against the dock is complete, 5 random internals are rolled against the cruiser as a single, omnidirectional volley (they are not rolled as 5 separate one-hit volleys).

If an incomplete ship is destroyed within a dock, it does not explode unless it is at least 81% complete, in which case use the full listed explosion strength (destroying the dock in the process; its explosion strength is added to the resulting blast).

Any internals suffered by a partially built ship will be automatically repaired when the construction process is done. The player will need to pay any repair costs associated with this repair (if any, depending on campaign repair rules) or else the damage will remain on the completed ship.

**CONSTRUCTION DOCK DESCRIPTIONS**

Weapons on all naval construction docks are as shown on the following chart:

RACE	W1	W2	W3
Federation	Ph-1	Ph-3	Drn-G
Klingon	Ph-2	Ph-3	Drn-B
Romulan	Ph-1	Ph-3	Plas-D
Kzinti	Ph-1	Ph-3	Drn-B
Gorn	Ph-1	Ph-3	Plas-D
Tholian	Ph-1	Ph-3	Web
Orion	Ph-1	Ph-3	Drn-B
Hydran	Ph-2	Ph-G	Void
Lyran/LDR	Ph-2	Ph-3	ESG
WYN	Ph-1	Ph-3	Drn-B
ISC	Ph-1	Ph-3	Plas-D
Seltorian	Ph-1	Ph-3	WB

Plasma cartel Orions replace Drn-B with Plas-D at no additional cost. Andromedans and Jindarians do not operate construction docks; your campaign rules will have to specify how their ships are built or arrive in the Galaxy. Jindarians, in particular, have other units (shipyard cruisers) which can be used to construct certain ships.

**(R1.C1) SMALL NAVAL CONSTRUCTION DOCK (SCD):** This dock is capable of constructing any size class 4 ship appropriate to the owning race (or a civilian ship). It does not possess positional stabilizers, and normally uses its rudimentary impulse engine to maintain a standard orbit; it cannot disengage by sublight evasion. The large number of shuttles and transporters are used to bring in materials used in ship construction. Two shuttles are HTSs as shown on the SSD.

These docks can hold two type-B base augmentation modules. Normally these would be one hospital module for emergency use, and one VIP module for the bridge officers as they awaited the completion of their new ship.

Klingon SCDs add two security stations; boxes for these are provided to the left of the main SSD.

Other data from the Master Ship Chart: Spare shuttles 0; year in service Y0; docking points NA (cannot dock internally to anything); explosion 10; command rating 3.

**(R1.C2) MEDIUM NAVAL CONSTRUCTION DOCK (MCD):** This dock can construct any size class 3 or smaller ship appropriate to the owning race (or a civilian ship). Like the small dock, it does not have positional stabilizers, and cannot disengage by sublight evasion.

Up to four type-B augmentation modules can be docked to the exterior of this unit. Hospital and VIP modules were often used, though players may use any type-B modules they wish.

Klingon MCDs add four security stations as shown.

Other data from the Master Ship Chart: Spare shuttles 0; year in service Y0; docking points NA (cannot dock internally to anything); explosion 15; command rating 3.



**(R1.C3) LARGE NAVAL CONSTRUCTION DOCK (LCD):** This dock can construct size class 2 or smaller ships as appropriate to the owning race (or a civilian ship). As with the other two docks, positional stabilizers are not available, and it cannot disengage by sublight evasion. Large docks can build battleships, but usually only in sections, extending the time required; this should be reflected in your campaign rules.

LCDs can use up to six type-B base augmentation modules of any type, two of which were usually hospital modules and one a VIP module; the other three varied widely.

Klingon LCDs add six security stations as shown.

Other data from the Master Ship Chart: Spare shuttles 0; year in service Y165?; docking points NA (cannot dock internally to anything); explosion 21; command rating 3.

## WARP GATES

Warp Gates, or WGs, are an alternative to shipyards: Instead of creating ships, they act as an "arrival point" for ships purchased from elsewhere. Warp Gates are used in Star Fleet Warlord, a SFB play-by-mail game, and similar concepts have occurred in other free-form campaigns throughout the years. Warp Gates are not "real" SFB units and appear only in Star Fleet Warlord or as an optional campaign enhancement.

In a campaign which uses Warp Gates, players do not actually construct their own ships. Instead, ships are built (or leased, or whatever) from another source which does not itself enter into campaign play. In Star Fleet Warlord, it is a hypothetical "Galactic Council" which provides Corporations (players) with "obsolete" General War ships, delivering them to the Warp Gate of the purchaser's choice.

WGs might also be used by the Masters. A campaign might be the Masters' idea of a high-stakes contest, and instead of just sending ships anywhere in the campaign arena, they might use Warp Gates instead. Other concepts for the use of WGs could certainly be used; these are merely examples.

The Warp Gate SSD provided is usable as a ship delivery point. Your campaign will need to specify exactly how this is done and when (in the strategic sequence of play) ships actually arrive. Typically, ships are paid for at the start of the strategic turn and arrive at the end of the strategic turn, after movement and combat is complete. This is perhaps the fairest method, and might provide an interesting strategic impact—if a WG is destroyed while ships are en route to it, those ships are lost! This will make Warp Gates critical targets, especially in hotly contested areas. Alternatively, you might have ships arrive the moment they are purchased (either at the end of the turn, meaning they cannot be used that turn, or at the beginning, allowing them to be used the same turn they are bought).

## SHIPS APPEARING DURING SCENARIOS

It is also possible to set up rules in which ships arrive *during* the strategic turn, possibly setting up scenarios in which a ship appears at a Warp Gate *during a battle*. The following scenario rules are recommended. Note that your campaign's strategic rules will need to specify exactly when a purchased ship will appear in any scenario (possibly a random turn number rolled before the scenario begins, adding a nail-biting element to the battle).

The major crucial element which needs to be addressed first is whether the Warp Gate can be in motion during the strategic turn in which it is receiving ships. This depends in part on your campaign's sequence of play. If it is possible for a WG to be moving strategically when ships arrive, then you need to specify if it can be moving *tactically* as well. It is highly recommended that a WG be forced to stop for at least the

arrival turn during any scenario and the guidelines below reflect this.

The following is a suggested set of procedures for Warp Gate use during scenarios. Feel free to modify any part of it you wish or invent your own ship-arrival rules.

If ships are arriving at a Warp Gate during a scenario, the WG must pay 2 points of power to maintain the "portal" each turn (paid during Energy Allocation, not from reserve power) until the last ship has arrived on the map. Ships can arrive no faster than one every third turn and will arrive in the order sent (which will depend on your campaign's purchase and delivery rules).

At the start of any tactical turn in which a ship is to arrive via Warp Gate, the WG must activate the "portal" for 4 points of energy (instead of, not in addition to, the normal maintenance cost). Activation is announced at the start of the turn to all ships within tactical intelligence level A. The announcement is merely that something is coming through; no other information (like hull type, etc.) is available. The WG cannot move under warp power (even for tactical maneuvers) during the turn in which the portal is active; it could be moved by tractor beam or terrain effects, such as black hole movement.

At the end of the turn, after Impulse #32 is complete, the ship appears, in the same hex as and with the same facing as the Warp Gate itself. Only the complete destruction of the WG can prevent a ship's arrival; if the WG is destroyed, any ship in transit is destroyed with no hope of rescue, and no unit within can escape (including booms, saucers, etc.).

When the ship arrives, it is at weapons status-0 (regardless of the weapons status of the owning player's forces, and no bonuses from any source are applicable). It can have shields fully up at the start of Impulse #1, and its maximum speed is limited to no more than 10. It is treated as having exited the WYN Radiation Zone (P7.0) for all purposes, with Turn #1 of the post-zone effects beginning the turn after arrival. It can take no actions on Impulse #32 of the turn of arrival, and can have no units (shuttles, PFs, etc.) previously launched.

Only starships can transit a Warp Gate. Shuttles, PFs, etc. cannot do so alone.

If ships are coming through a Warp Gate, the player must allocate room for them in the command rating limits (if your campaign uses command limit rules), as though the ship(s) were actually in the battle (even though they won't arrive for one or more turns).

## WARP GATE SHIP DESCRIPTION

**(R1.C4) WARP GATE:** This is a unit which can operate as a mobile ship arrival point (as described above). Unlike construction docks, it is very well armed, as it is designed to operate in front-line areas and expects to see combat. Since it has warp drive, it is capable of strategic movement, although this should be limited to very slow speeds (no more than half of that allowed for normal ships in a campaign).

The Warp Gate is a conjectural unit; nothing like it exists in Star Fleet Battles. It is provided for campaign use only. It is assumed that the Warp Gate provided for players is identical regardless of race, as the Masters (or whoever makes the Warp Gate available) uses a single generic design (except for Klingon WGs, which have security stations).

Other data from the Master Ship Chart: Spare shuttles 0; year in service CJ; docking points NA (cannot dock internally to anything); explosion 17; command rating 3.

## SCENARIOS

With all the discussion so far about logistics, economics, and so forth, the basic element of the campaign might have been forgotten—tactical battles. Since the purpose of most campaigns is to generate interesting scenarios which have purpose and meaning, then some means needs to be provided for setting up such battles.

### SETTING UP SCENARIOS

Scenarios have several elements in common, no matter where or how they are fought.

**Number of players:** Normally this is two, although it's possible for more to participate. Sometimes, in an ambush situation, one or more players may be involved but not visible when the scenario begins. While this is not difficult to set up on the map, players may have a tough time getting the extra player(s) over to the host's house to play, or might have difficulty explaining why their presence is required without giving away the ambush.

**Terrain:** This depends, of course, on where the battle is taking place on the strategic map. Normally the terrain will be obvious to everyone. Not so obvious might be encounters in a star system which has several worlds or other features. What if one player wants to fight near the gas giant so it can use the moons to disrupt the opponent's drone lock-ons? The drone-using player won't like that and will want to engage in open space. This could result in encounters wherein neither player will engage on the other's turf. This could be handled by simply saying no encounter occurred, and both ships could go their separate ways. (Of course, if one ship is defending the system from the other, it will have to move to block any attacks on worlds or facilities, resulting in a scenario.)

**Initial setup:** Ships will come onto the tactical map from any of a number of possible directions. If the encounter occurs because one or another force arrived in the strategic hex (or whatever) at that moment, then the direction of arrival should be based on the direction of the strategic movement. For example, a Tholian ship crossing the Federation neutral zone on an F&E-like campaign map would enter the tactical board from direction D. If the direction of movement cannot be determined (e.g., a random raid on a supply lane) or does not apply (such as a survey ship surprised by an ambush while checking out a star system), then the direction of setup and initial placement of forces should be effectively random.

**Range of encounter.** This will depend greatly on the type of encounter, naturally, and might be based on the type of detection units or facilities present, as well as the presence of any terrain. A scenario involving a base (which has excellent scanning abilities) would begin with the opposing forces some distance away, perhaps as far as 100 hexes. Scenarios between two exploring forces might start anywhere from 30-50 hexes. Ambushes and such could be as close as 6-15 hexes—anything closer than this would be unlikely, as even a hidden ship would be detected at 5 hexes from an enemy unit.

**Known information.** Players will want to know what they can tell about the opposing forces before working on their first turn's energy allocation. You can do this by determining the range of the encounter and then checking the tactical intelligence ranges in (D17.3). Assume that no ship is using EW and any scout is using a channel for tactical intelligence, and give out information based on the resulting range.

**Cloak status.** Ships with the cloaking device may wish to begin the scenario cloaked. If the cloak-capable ship was moving strategically when the encounter occurred, this should not be allowed (unless your campaign provides for a system of strategic cloaked movement). Ships which were already in a system or area and were relatively stationary could begin the scenario cloaked if they could reasonably be able to detect the opponent coming, or if they were lying in ambush. Campaign rules will need to allow for this.

### REACTIONARY FORCES

Some campaigns may wish to provide rules for reactionary (or patrol) forces. These ships are given a "patrol" or "sentry" order and cover an area on the map, waiting for a call for help. If an enemy unit is detected in the area or if an attack occurs within a certain range of the patrolling fleet, then the reaction force rushes to the scene. This is normally reflected in the scenario as arrival after a certain number of turns have passed. The most obvious example of this sort of maneuver is found in the reaction rules in Federation and Empire.

This sort of rule is ideal for campaigns wherein the defending player controls a very large area of space or shares a very long border with an opponent. In this case, reaction fleets are usually set up between bases on the border, covering the space between those bases. If the area is too wide for one fleet to patrol, another fleet is added or another base is built in the opening. The patrol fleet will want to be close enough to these bases to be able to help them if they come under assault, just as they will wish to prevent an enemy from slipping through the lines.

This makes for some interesting strategic maneuvers. In order to attack a base in force, the invader will have to do more than just throw a big fleet at it—he'll also have to make feints at other points along the border to draw off the reserves. Similar moves could be made in order to enable a recon-in-force or raiding fleet to penetrate to the interior of enemy territory. (Of course, care must be taken to avoid having them trapped inside, out of supply and unable to escape without meeting more and larger patrols.)

When setting up a scenario in which a reserve fleet will arrive, the defender will have to begin by making a call for help, which will be picked up by the invader. (He may not be able to break the code and hear exactly what was said, but he'll know that some kind of call was sent. The call could also be a fake or bluff, for all he knows.) The GM then evaluates the player's reserve fleet movement and orders and determines when they will arrive and from what direction. He does this in secret (perhaps with a bit of randomness involved) and doesn't tell either the attacker or the defender. Only when the ships actually show up will either side know their arrival time. They should appear on the map no closer than 30 hexes from the battle site, perhaps closer if the fighting is spread out or has moved towards the approaching reserves.

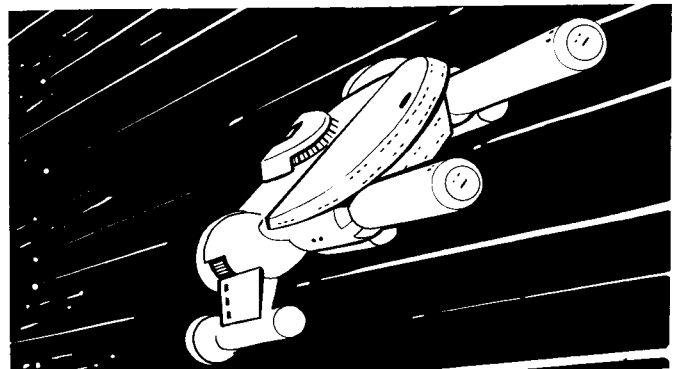

## TYPES OF SCENARIOS

The number of possible scenarios is limitless, and the setup parameters can only be discussed in the most general of terms. Some guidelines you can use for different scenario types are listed in the paragraphs which follow.

### OPEN SPACE ENCOUNTER

This is the simplest and most common campaign scenario, usually resulting when the paths of two fleets intersect. More often than not, one fleet will be much larger than the other, and the smaller will attempt to evade once the size of the opposing force is determined. You'll want to go through the initial setup procedures (determining the range and initial known information), announce this to the players involved, and see if one side will avoid contact. In many cases a weaker side might decide to engage, if only to see what the other player has in the strategic theater.

Open space encounters should set up with about 50 hexes between fleets, each of which can be moving at any desired speed. One good idea is to place one fleet on one side of the standard SFB tactical map and the other fleet on the opposite (long) side. This puts them at a range of 41 when the scenario begins.

### IN-SYSTEM ENCOUNTER

Another common campaign scenario, this one involves one fleet entering a system and finding an opposing force already present. This should be set up much like the open space encounter (above) except that the defending fleet will begin play at a point on the map, usually near a populated world or other facility, with a speed on the previous turn no more than 10. The encroaching fleet then has the option of retreating out of the system or some other nearby location before the defender can react to stop them. If the attacking force chooses to remain in the system, the defender can attempt to pursue and engage them if they wish, which should then be set up like the open space encounter (above).

### ATTACKING A BASE

Base assaults (that is, when the attacker already knows the base is present, as opposed to discovering one upon arrival in a previously unexplored system) are usually major operations. The attacker will have planned ahead, so his fleet's weapons status will be at maximum, as will his speed. The defender, on the other hand, will detect the opponent's approach due to the base's superior scanning abilities. While this may not be enough to increase the defense force's weapons status, it should at least force the attacker to come onto the tactical stage at a greater range, perhaps 75-100 hexes away. You could simulate this by laying two maps side by side, starting the attacker on one side and putting the base on the opposite side of the other map.

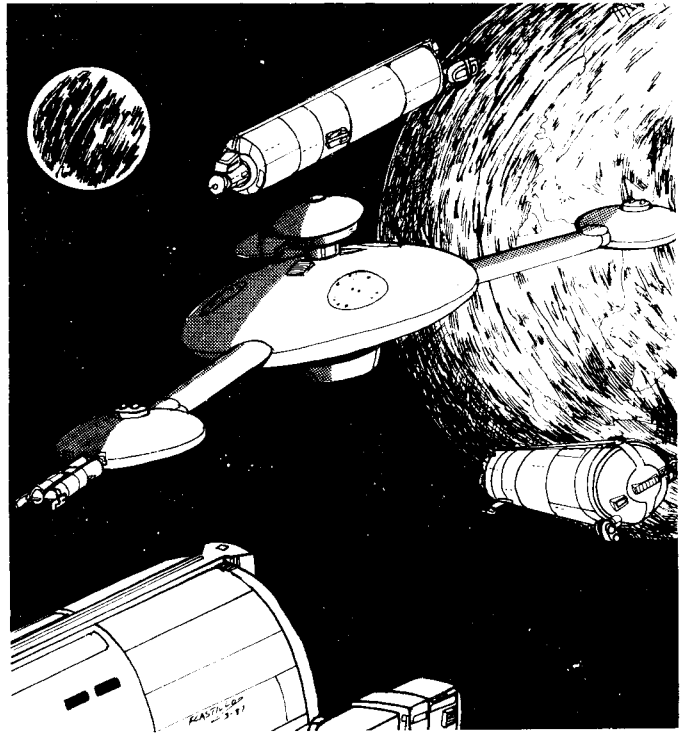

### CONVOY RAIDS

What comprises a "convoy" will be determined in part by your campaign's logistics rules. If you must track each freighter individually, then raiding a convoy will involve whatever freighters and escorts the player has bought for it. If the campaign has an automated logistics network, the content of the convoy will be based on the amount of resources being shipped, the amount of resources that fit into a single cargo box, and what additional defenses or upgrades the player has purchased for his logistics network or shipping lane.

Setup of a convoy scenario should have the convoy in the center of the map, each ship within a few hexes of each other, and at a very slow speed (usually 4). The attacking force then comes onto the map along one of the sides and attacks. Depending on the campaign and the location of the raid, the attacker may wish to destroy the freighters or attempt to capture them (a force deep in enemy territory will probably not bother with a capture attempt unless the attacking fleet has its own cargo capability).

In many encounters of this sort, the outcome is so obvious that the battle doesn't even need to be played. An attacking ship of even frigate size will always capture a single unescorted small freighter, for example. The decision of whether or not the battle should be played out will always be up to the defender, however. A force of three freighters will not be likely to escape destruction, but the player may feel he has a chance to save one of them if he scatters them in all directions and tries to disengage by separation.

Note: It should be specifically prohibited in the campaign rules for freighters to self-destruct or otherwise dump cargo to prevent its capture. You can justify this by stating that there would always be a chance to recapture the resources later, and trying to get them away will only slow down the raiders. (Or you could simply say that freighter captains lose their insurance if they dump a load!) Freighters should also not be allowed to disengage by sub-light evasion; otherwise this will be the first thing the raided player will try, and raids will become little more than rolls for successful disengagement.

## AMBUSHES

Setting up a good ambush is something every SFB campaigner dreams about. Hiding a fleet in asteroids and drawing an enemy in to be destroyed is an excellent idea. The trouble is setting up such a thing. If your rules makes it too easy, then a couple of good ambushes could ruin the whole campaign. Ambushes should be difficult to arrange, and will generally involve an exploring or prospecting ship. Fleets in friendly space will rarely be exposed to ambushes.

If a player has a ship hidden in terrain, he can choose when to reveal himself and attack, though he will be discovered by an enemy unit reaching five hexes of his position. The battle should begin at the moment the defender reveals his presence (or has it revealed for him); setting up a scenario where only one player is on the map is a dead giveaway that an ambush is coming! The ambushing ship will have weapons status-III but will be at speed zero on the previous turn; the other ship(s) will be at a low weapons status and speed-10 (unless they already knew the ship was present and were actively searching for it). The ambushed ship will have full shields and active fire control unless it was on silent running or otherwise trying to sneak up on an opponent's position.

A more common ambush scenario might arise if a ship arrives in a system, hides there, and watches enemy ship movements in the area, choosing the right time to attack. In this case the engagement will take place at a greater range, giving the "surprised" ship a chance to detect the approaching ship and turn to run. This might turn into a pursuit scenario, beginning with the ambusher on one side of the map at speed-30 and the defender in the middle of the board at speed-0 or speed-10. This type of ambush is more useful against units which find it hard to escape, such as freighters, FRDs, tugs setting up bases, repair ships conducting repairs, and so on.

## GROUND ASSAULTS

Captain's Module M provides a host of rules for ground combat, which is the only way one player should be able to take a world away from another player. (Starships can secure the system itself, but the world will remain under the original owner's control until conquered by ground attack.)

Typically, the ground assault will take place after the ship-to-ship combat is over. The attacker almost always secures space superiority first, then brings in the more vulnerable troop ships to overwhelm the world's defenses. The only exception might be a world with a very large base in orbit (like a starbase); if the attacker has only a few ships, he may hide on the opposite side of the planet, conquering it one hex side at a time and keeping the base on the other side. Such a battle might have the base itself recapturing these hex sides as it passes over them.

The trouble with the Module M rules is that it doesn't handle the campaign situation. Module M assumes that all scenarios will specify what defensive forces are present, but doesn't say anything about campaigns! Thus, you'll need to provide for this in your rules. (One alternative is to not use the complex Module M rules at all, but state that ownership of a planet is determined by who has control of the system itself. This is simple but unrealistic.)

The easiest way to decide what ground forces are on a planet is to force a player to buy them. A ground military garrison will provide the initial ground troops, plus extras could be purchased at the costs shown in Module M. Naturally, the first thing an attacker will do is blast the garrison base from orbit, but troops therein will simply spread out onto the planet to defend it. If enough ground troops are there, the attacking ground assault may fail, forcing another try in later campaign turns (and allowing more defenses to be constructed by the

planet under siege, or possibly a relief force to arrive and drive off the attack force).

If you don't have Module M, ground assaults can be accomplished by using simple boarding parties, as though the planet were a ship. The attacking force beams down BPs or lands them by shuttle or ship, and casualties are then rolled using the procedure in (D7.4). Militia aboard ships may not be used in such attacks.

If your campaign tracks world population, you might allow some amount of militia to be drawn from the population base, allowing a planet to defend itself even if no boarding parties have been purchased for it. (At least this would defend against a couple of small ships and their standard boarding parties, but it wouldn't stand against a concentrated effort by ground assault ships.)

## SHIPS UNDERGOING REPAIRS OR REFITS

One interesting type of scenario occurs when a fleet surprises a base, FRD or repair ship in the process of fixing damage or upgrading another vessel. Needless to say, the units involved in this process will be at speed-0 and probably a very low weapons status. The real question is what the ship being repaired or refitted can do during the scenario.

One option is to make it completely inactive for the entire battle. While simple, this leaves it as nothing more than a target that will be easily destroyed. The attacking fleet might even ignore it, knowing it can't fight, and concentrate on other ships. The useless ship then becomes "capture bait."

Another possibility is to have it start the scenario inactive, using the rules of (D18.0). If it reactivates, any systems which were being added as a result of repairs or refits will not be available.

If repairs are involved (not refits), then you might have the ship active when the scenario starts, and allow its damage to be repaired during the battle using the normal repair procedures. The ship could, of course, choose not to do this and undock, fighting in its current damaged state.

If the repair ship or facility is destroyed, crippled, or disengages, or the damaged ship is destroyed or disengages, then the repairs or refits should be considered disrupted, and would have to be accomplished on the next strategic turn. (The EPs paid may also be lost, depending on campaign rules.)



## WARP POINT DEFENSES

In campaigns which use warp points a la Starfire, the question of defending a warp point will inevitably come up. If given the chance, players will choose to park a fleet, base, minefield, and anything else they can on a warp point leading to known enemy space. While this is a great idea, it makes assaulting the warp point all but impossible—the fleet will arrive and immediately die horribly under the base's phaser-4s and the holocaust of a half-dozen exploding captor mines. Warp point assaults in Starfire are easily handled under that game system's rules, but SFB has nothing to deal with them. Therefore, you should put some restrictions on warp point guarding.

One possibility is to say that warp points meander about randomly through the system, or orbit the star that creates them. This prevents a base, minefield, or other fixed fortification from being used as a defense, and is highly recommended. However, fleets can and will be used as guards, especially ships armed with gatling phasers and stasis field generators. To prevent fleets from doing this and gaining a massive advantage on the invader, set up your campaign rules to keep them at some kind of minimum distance. The recommended rule is to say that the warp point discharges energy when a fleet comes through, sufficient to cripple or destroy ships within a set range, say 10-20 hexes or fewer from the warp point.

Note that in any case the defender should still have the advantage. The attacker will arrive at a minimum with disrupted fire control, and probably at a low weapons status (unless entering known enemy space, or if a higher maintenance fee is paid for each attacking ship). The defender will also know the attacker is coming through due to energy discharges from the warp point, so they will likely already be on the move and at a higher weapons status. This will allow the defending fleet to set up on the map however they wish (no closer than the minimum range set by the campaign rules). For added intrigue, have the attacking fleet arrive with each ship at a random facing and within 1-6 random hexes of the warp point itself. While the attacker then forms up into a fleet, the defender can assay the situation and choose to attack or run.

## SOME RULES NOTES

### WEAPONS STATUS

In the notes above on scenario types, some comments have been made about weapons status in scenarios. A simple campaign might avoid the issue and allow all fleets to be at weapons status-III at all times, making things fair for everyone. Others, however, could create a specific chart for the weapons status of a fleet depending on circumstances, or else require a die roll for weapons status.

As a general rule, logic will determine where to set the range of weapons status. A fleet attacking a known base, for example, will always be at WS-III. However, this is about the only situation wherein WS-III will be guaranteed. Even a recon-in-force fleet marauding through enemy space will not remain at that high level of readiness for days or weeks on end as it looks for something to attack. WS-I might be appropriate for such a fleet.

If a fleet has observed an enemy force in the area and has had plenty of time to prepare for its arrival, then it could be argued that the observing fleet would be at WS-III regardless of any die rolls. For example, a fleet hiding behind a moon as a survey ship approaches to scan the planet would probably be at WS-III. The survey ship, however, would likely be at WS-0 unless it had already detected some sort of enemy presence in the system.

Some players might even be allowed to set up their forces at a weapons status even higher than WS-III in some cases.

This would be determined by the campaign rules and on a case-by-case basis. For example, if a fleet arrives in a system and attacks an outlying world, then turns to approach and attack an inner planet, then the forces defending the second world would have more than enough time to deploy a fighter squadron, pre-place a few T-bombs, and basically take any action that could be done during the course of a scenario (e.g., a transporter bomb could be laid and active, but not a captor mine). Tholians would be able to lay web in just about any pattern and strength that they wished, so taking your time attacking a Tholian system is a very bad idea.

Except for scenarios involving ships being built, repaired or upgraded, there should be no chance (in a campaign environment) for ships to be "surprised" and caught in an inactive state. Being inactive is tantamount to certain destruction, so leaving the determination of this status up to any kind of die roll is simply not fair to the players.

### FLOATING OR FIXED MAP?

A critical question in a campaign is whether or not maps are fixed or floating. Since campaigns are fought in virtually limitless regions of space, it seems unrealistic to require a fixed map in any situation. However, floating maps have several disadvantages, the major one being that scenarios can last virtually forever. They also tend to favor certain races, especially direct-fire races which engage in retrograde defenses.

If scenarios are played on floating maps, then plasma races will have a difficult time engaging a competent direct-fire force, especially one with expanded heavy weapon arcs like the Klingons, Kzintis or Lyrans. Such races will simply run away from any approaching ships, forcing them to bolt (and bolted plasmas do less damage statistically than just about any other direct-fire weapon). Therefore, smart plasma players will simply avoid engagements in open space and limit their attacks on fixed or slow-moving targets. Unfortunately, this can turn the campaign into an endless series of base assaults.

The apparent solution, using a fixed map (perhaps one larger than a standard 42x30 SFB map), may not be appropriate because now the plasma races may be perceived as having the advantage. No matter where the direct-fire ships go, they can't escape being trapped in a corner and eventually killed by plasmas (or forced to disengage). It also may be hard to justify. In open space, why should crossing an arbitrary line somewhere in space cause the scenario to end? The edge of the board might also be used as a convenient escape for ships that would otherwise be destroyed, something many players may not find fair.

Obviously, the decision of whether to use a floating or fixed map is one you can't take lightly. Consult your players, consider their answers and reasoning, and make the decision. Whichever way you go, it should always affect all players and all scenarios throughout the campaign.

### WORLD FORTIFICATIONS

You may wish to place campaign limits on how many defsts, bases, and mines can be stationed at any given planet (or whatever). If you don't limit them in some way, you're guaranteed to have players with ridiculous and unassailable fortifications, especially if planets are few and very valuable. Have you ever tried to attack a world with a battle station, 6 standard minefields and 20 phaser-4 ground bases? That's less than 800 EPV, but even a full-sized F&E command rating fleet will have a tough time facing this kind of defenses. Our recommendations:

- No more than one base (base station, battle station, or starbase) in any system. An exception could be made in worlds

with more than one colony planet (assuming they are in separate orbits, not a “dual planet”).

- No more than 5 defense satellites around any world and none at all around moons.
- No more than one defensive ground base (fighter or PF base, ground missile base, ground phaser base, etc.) on any hex side of any world, and no more than one (or two) on any moon.
- No more than two fighter squadrons and one PF flotilla stationed as a fixed defense in the system, i.e., on ground bases or base modules.
- No more than two standard minefields around any colony, four around a major world, or six around the homeworld. Each standard minefield can have no more than 10 points spent on additional mine enhancements (command control, etc.).

In the case of minefields, the player must provide a complete map of any minefield and all enhancements thereof to the campaign GM (or, if there is no GM, it must be drawn up and sealed in an envelope) at the time it is laid. This prevents players from redesigning their minefields on the fly to react to certain attacking forces (or possibly an assault by a race other than the one it was originally designed to defend against). Bases and planets protected by minefields need to be near the center of any scenario map so that players are forced to arrange for 360° coverage—otherwise, the mines will tend to be too thick in the direction from which any attack must come.

### FIGHTER AND PF STRIKES

Though your campaign rules may prohibit fighters and PFs from moving strategically, you might experiment with the “strike” concept. In this attack, the carrier or tender moves into a hex next to the target location (or within some other stated range), launches the attack, and waits for the attrition units to return. It could move during the interim, rendezvousing in another location within the fighters’ or PFs’ range, or they might be picked up by another carrier/tender elsewhere.

The strike would be resolved as a scenario, with the squadron or flotilla entering the system and attacking whatever they find. They won’t have much time due to fuel and range limitations, so using this sort of move for exploration, surveying, or cargo transfer simply isn’t possible. If the target runs away, the attacking units will have to break off pursuit and return to the rendezvous point or risk destruction when their engines burn out.

Generally, this sort of attack would take place only when the carrier or tender needs to keep from ranging too far from a base or patrol route, or is too valuable to risk in battle. It could also be used if the carrier or tender is immobile (e.g., a base or monitor) or heavily damaged. Rarely, it could be used strictly as a transfer maneuver, such as to move replacement attrition units from an auxiliary (which doesn’t want to go too far from its base) to a carrier or tender on the front lines.

An interesting scenario could occur in the case of a counterattack, where the enemy follows the fighters or PFs back to the mother ship, or another ship blunders into the empty carrier/tender while it waits for the strike’s return. In such cases, campaign rules will need to cover the effects on the fighters and PFs. For example, fighters may be required to immediately land for a full turn while their overworked engines cool off, and PFs may be specified as having a number of engine degradation points already accumulated, forcing them to dock or lose their engines entirely.

### OFF-MAP DRONE BOMBARDMENT

This is an ability alluded to in the SFB rules, but for which no specific rules exist within the game system. Some published scenarios specify drones already on the board, or which arrive at various times and under listed circumstances, but this has never before been up to the player’s control. If you choose to allow off-map bombardment, you’ll basically be writing the rules for it by yourself, from scratch. We can give you some guidelines, but for the most part your rules will have to match your campaign.

Typically, only ships specifically listed or described as “drone bombardment ships” can make such an attack, and they can only do so by using type-III-XX “long-lance” drones. The bombardment ships move to a hex near the target (within a set range, usually one hex on most maps), launch all their long-lance drones, and then leave the area. (Sometimes the attack will accompany an invasion by a fleet from the same or a different location.)

The amount of drones which can be launched is limited only by the number of drone racks and bombardment ships present. However, while realistic, this disrupts the balance of the campaign. If you don’t put an upper limit on the number of off-map drones in any scenario, then it’s very likely that at some point drone ships will be used to fire so many drones that no base could possibly survive (even if it uses all its wild weasels).

One thing to consider is the cost associated with making this kind of attack. Even if your campaign’s logistics system allows for free replacement drones, you might make an exception in the case of type-III-XXs. This is probably the best solution, as it makes players think twice about throwing drones away for potentially no gain. Instead, drone assaults will be limited strictly to support of well-planned assaults (which is perhaps as it should be).

The attacking player should be able to have some control over how the drones arrive on the tactical map, at least being able to specify the map edge (within a few hexes’ distance of a given point) and the impulses of arrival (possibly including some kind of random factor) for each drone. However, this must be recorded in advance, before any battles take place during the campaign turn. Do not allow players to define their drone arrival schedule after learning what defenses are present at the target location.

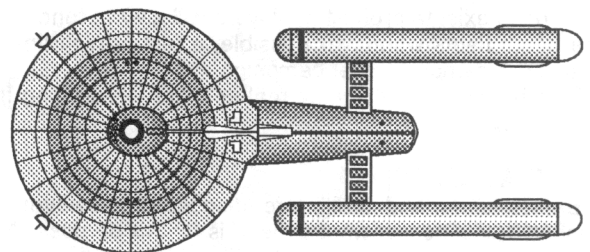

FEDERATION HEAVY DRONE CRUISER

## COMMAND LIMITS

One of the problems many campaigners quickly discover is that players tend to gather their ships together into large fleets, and the resulting scenarios become impossible to fight using Star Fleet Battles. Consider a campaign in which each player is allowed to start with 3,000 EPV points to buy units. On the first turn of this hypothetical campaign, what would happen if the Kzinti player put 2,000 BPV together into a fleet and attacked a well-defended Klingon battle station on the border? This is not all that hypothetical—it actually happened in one campaign, and in the resulting battle, the first *turn* took over 4 hours as the 15-ship Kzinti fleet launched at least 100 drones at the 10 defending ships and the BATS! A single impulse near the end of the turn took almost 15 minutes to resolve. Clearly, there are very few players who will have the patience for this sort of scenario.

There are basically three ways to resolve this problem: (1) don't fight battles out using SFB, (2) don't give the players very many points with which to buy ships, or (3) create a rule which forces fleets to be kept smaller (while not reducing the number of actual ships in the strategic arena).

The first option, using a system other than SFB to handle battles, will not be discussed in this section because it is contrary to one established purpose of the campaign: promoting the play of SFB in your group! "Quick combat" systems which allow some battles to be fought with a series of simple die rolls (like the systems used in F&E or Star Fleet Warlord) might be allowed as an optional rule; however, they should not be the *only* way to resolve scenarios, or else the campaign will lose the critical SFB flavor.

The trouble with the second option (keeping the economic system small) is that it sounds good on paper but doesn't really work in practice. Early in the campaign it might seem to work, as players move about using single ships (or possibly frigate or destroyer squadrons), but as the game progresses and players gain more ships (through whatever income or shipbuilding system the campaign uses), they will naturally form fleets—fleets which will grow ever larger in order to counter those of their enemies. A very large fleet allows a player to project an irresistible force wherever he needs to, and to know that he will defeat any potential opponent except another "death fleet." Unless rules exist to prohibit it, players will always tend to form these death fleets whenever possible, a fact proven time and time again in campaign after campaign.

This brings us to the only real solution for keeping fleets small: command limits.

### WHAT'S A FLEET?

Before command limits are discussed, however, it is necessary to define just what a "fleet" is for this purpose. A fleet is simply the maximum number of ships which can be in a battle (on one side) at a time.

Note that in many cases it will be possible for more ships to be in a campaign hex (or whatever territorial divisions your map uses) than could possibly be involved in battle due to command limit restrictions. Your campaign can deal with this in a number of ways, which are discussed later in this chapter under the heading Exceeding the Command Limit (page 34).

## THE SFB COMMAND LIMIT RULE (S8.0)

Rule (S8.0) provides a system for controlling fleets, both in size and in what they can contain. This rule was written for "patrol" scenarios (i.e., pick-up battles in which players have a certain amount of BPV to buy whatever ships they choose) but can be made to work in campaigns, albeit with certain limitations. Federation & Empire uses a system similar to this one to control fleet sizes.

Some of the rules listed in (S8.0) might not apply well, and others may simply be unusable. For example, (S8.45) states that minesweepers cannot appear in scenarios unless pre-established minefields are present, but if the minesweeper is intercepted in open space while moving from one base to another, then the scenario will still have to be fought, and this rule simply doesn't apply.

In a nutshell, (S8.2) gives the fleet flagship a command rating, which is listed on the Master Ship Chart. This number, which does not exceed 10 for any unit on the MSC, indicates how many additional ships may appear under the flagship's command. There are some additional units which may also appear: the first scout does not count, fighters and PFs do not count if their carrier or tender is in the battle, and of course the flagship itself does not count. With this in mind, the maximum number of ships which could be present in a scenario is 12 (a dreadnought with a 10 command limit and one scout), and at most 36 fighters or 18 PFs can appear in most fleets due to (S8.32) (some Hydran hybrid ships could bring a few more fighters).

The trouble with this system is that fleets can still be too large to effectively play in a scenario, especially since most players will choose to maximize their command rating by using the largest possible ships, the maximum possible attrition units, and every potential exception they can find. Campaigners are very good at this sort of thing—it's not a loophole they're finding, it's simply the best possible use of all available points. Players call this *maximization of force*—and if they don't do it, their opponents will!

To illustrate this concept, consider this example. Assuming that the economic cost is not a factor, a Federation player could theoretically put together a fleet consisting of the following units: one fully loaded CVA+ (the flagship, with a "10" command rating), one loaded CVB (this makes a total of 36 fighters in the fleet), one GSC+ (the scout, which doesn't count against the command limit), and 9 CBs. Just the ships (not counting fighters, drone speeds, etc.) have a total BPV in excess of 1,900 points! A battle involving this force and a similar fleet of another race could take days to play, and would require more patience than even the most stalwart SFBer possesses. Thus, while (S8.0) is a good guideline for patrol battles, it does not work well in campaigns. Alternative rules are needed.

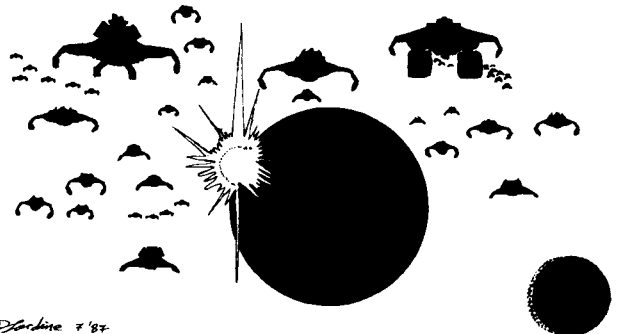

D. Gardine '87

**REDUCING THE COMMAND RATING**

The easiest and simplest way to lower fleet sizes is to reduce the command ratings shown on the Master Ship Chart—possibly by dividing it in half, or subtracting some value, possibly 3-5 points (with a minimum result of 2 or 3). The rest of the rules of (S8.0) are then used where applicable to the campaign. This would limit the number of ships in any potential scenario to the maximum possible command rating plus two; e.g., if you halve the ratings, a DN could command 5 ships and the free scout, for a total of 7 ships including itself.

If you do this, you will want to modify certain other rules as well. You might, for example, limit the number of “free” fighters/PFs (S8.32) to one squadron/floatilla, and make players pay a command point for each additional squadron/floatilla. This will certainly lower the number of attrition units in the scenario (and thereby speed up the game). Drone bombardment ships (S8.47) might also be limited to one per fleet, and other restrictions (one mauler per fleet, etc.) can be added to cover potential excesses.

**A NOTE ON LEADERS**

Leaders (CWLs, DDLs, CCs, etc.) are especially ruinous to campaigns if not controlled using a rule such as (S8.36), which restricts them to one of any given type per fleet. In addition to this rule, it is also recommended that no leader ship can be built or employed unless it is with its squadron (the rule as listed allows a leader to operate alone).

Leaders are an oft-abused ship type in campaigns. If not restricted by (S8.36) or some other rule, players will build nothing but leaders in order to maximize firepower, and battles quickly become stale and boring (“My leaders versus your leaders again—sigh...”). Plus, in a campaign without such controls, races without leaders will not be able to compete.

The following suggested limits will help keep these problems from cropping up in your campaign. Use some or all of them, but use at least one.

- Maximum of one leader of any given type per fleet. This is the (S8.36) rule and should be your minimum consideration.
- No leaders allowed unless they have a non-leader of the same type to lead. If you have a DDL you must have a regular DD or variant; CCs need a CA to command; etc. This prevents leaders from appearing alone. However, it can be hard to enforce—what happens if everything in a fleet is destroyed except one DDL?
- Only one leader type can be constructed for every two normal types of the same class. This is a construction limit, not a fleet limit.
- Require a certain *in-service* ratio of standard variants to leaders before a new leader can be built. For example, you might require two standard types for every leader, or some other ratio. Thus, for example, if a player had 5 leaders and 10 standard variants and then lost a standard ship (or converted it to a non-standard variant), he would have to build another “normal” ship before another leader could be constructed.
- If used to lead a squadron (three-ship grouping), leaders provide a bonus to the command rating. This depends on the command rating system you choose. In the discussions which follow, suggested benefits are given for the proper use of leaders.

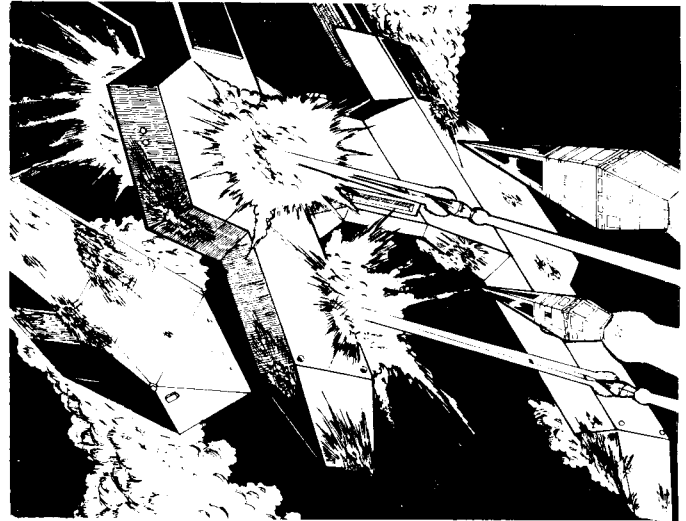

**KEEPING FLEETS BALANCED**

One problem with the (S8.0) rules (or any variants thereof) is—assuming for the moment that economics are not a factor—there is no reason for players to buy or employ small ships! Instead, the ideal fleet will consist of the command ship and as many cruisers as possible. This is unrealistic historically, and yet the nature of (S8.0) makes this strategy the only viable option for campaigners.

Forcing players to balance fleets is tricky. Keep in mind that no matter what you do, players are still going to maximize their forces by building the largest possible ships in each category, unless you somehow make it undesirable to do so. A few possible methods for balancing a force are listed below.

**Method 1.** Reduce the command rating cost of smaller ships to make them useful by quantity. The recommended values are listed below:

Heavy War Destroyer .....	0.8 points
War Destroyer .....	0.7 points or 3 for 2 points
Destroyer .....	0.6 points or 3 for 1.5 points
Frigate/Police Flagship .....	0.4 points or 3 for 1 point
Police Cutter .....	0.3 points
..... or 1 Police Flagship and 3 Police Cutters for 1 point	

Using this chart, you could use one destroyer and one frigate in place of a cruiser, a war destroyer squadron in place of two cruisers, or employ similar combinations. This system is simple and works well with (S8.0), especially when the command ratings are cut in half (remember to retain fractions since this chart allows them to become meaningful).

Here’s another good possibility:

- Reduce all published command ratings by 3 to a minimum of 2.
- Size class 4 units cost a number of command rating points equal to their movement cost (i.e., 0.33 for most frigates, 0.5 for DDs, etc.).

This simplistic alternative encourages the use of small ships and in fact most fleets will contain plenty of frigates and destroyers to keep a good balance. In fact, move cost 0.67 war destroyers will be uncommon in such a campaign!



**Method 2.** Require that for any ship type to be present, one of the next smaller class must also be present. Classes are: frigate (which includes POLs), destroyer (including war destroyers), light cruiser (including war cruisers), heavy cruiser (including heavy battlecruisers), and dreadnoughts. For example, in order for a fleet to have a dreadnought, it must have at least one CA/BCH, one CW/CL, one DD/DW, and one FF/POL.

If a second ship of the same class is to be present, it must have another set of prerequisites; in the example above, a second CA could not be added without first adding another CW/CL, DD/DW and FF/POL.

This method will not work well if the command rating has been reduced at all, unless you want fleets to consist of mostly small ships and only the occasional heavy cruiser or dreadnought. If your gamers prefer scenarios like this (i.e., varying sizes of ships with smaller ships being more common), then this might be the best method for your campaign.

Note that under this method, these restrictions would only need to be in effect at the beginning of any scenario. If players run on the ragged edge of these limits, they will find that their opponents can severely restrict their fleet sizes in future battles by targeting and destroying smaller ships.

**Method 3.** Simply limit the number of ships of each size class which can be present. For example, try this:

No fleet can contain more than the following:

- One size class 2 unit
- Three size class 3 units (max one BCH or CC)
- At most six size class 4 units with a combined movement cost not to exceed 2.5 (no more than one leader per ship class and at least one standard ship of that class must be present to be "led")

- One scout of size class 3 or smaller

All sorts of alternatives exist for this method. You might reduce the number of cruisers, or put a movement cost limit on the fleet as a whole (e.g., fleets can consist of any number of or quantity of units but cannot exceed a combined movement cost of 7.0). Note that rules limiting the number of specialty ships like BCHs, leaders, etc. should still be included in the campaign design.

**Method 4.** Restrict the type of ships which can be bought/constructed in any campaign turn. The primary way to do this is to make building dreadnoughts and cruisers take longer or to require construction facilities which are limited in availability.

Making cruisers and dreadnoughts take longer to build is a good way to make them rare in the campaign. The simplest way to do this is make cruisers take 2 turns to construct and dreadnoughts 3 turns, with players paying the appropriate portion of the price each turn (i.e., 50% each turn for cruisers, 33% each turn for DNs). This forces players to "think ahead" before building these units. You might also strongly consider some limit in the number of such ships that can be under construction at a time—otherwise players will simply build as many as they can, and accept the extra turn or two delay. Forcing them to be built at limited construction facilities, or no more than one or two in progress at any time, will suffice.

Another alternative is to force players to build two size class four units for every size class three unit, and two size class threes for every size class four (or a similar variation of this). This is known as the "pyramid" concept. You could combine pyramidal building limitations with the time delay described in the preceding paragraph for even greater complexity. Note that players will tend to buy nothing but DWs as their size class four units, maximizing their firepower as much as possible

(assuming they have the economic points available to do so). To prevent this you could make sub-pyramids, requiring (for example) one DD for every DW, and one or two FFs for every DD, but avoid going overboard!

This product includes three shipyard SSDs—small, medium and large—for possible use in campaigns. The small shipyard is for building frigates and destroyers, the medium one is for cruisers, and the large version is for dreadnoughts. If you choose to utilize these in your campaign, the high economic cost of the medium shipyard (and the ridiculous price of the large one) will keep the number of such shipyards down, thus reducing the amount of cruiser and dreadnought production available. Thus, players will tend to crank out frigates and destroyers while building cruisers and dreadnoughts only rarely, and fleets are more likely to contain a good mix of ship types.

This fleet-balancing method has one problem, and that is that players can still collect all their cruisers into a single "killer fleet" if they wish (putting the destroyers and smaller ships into other, lesser forces). With all the cruisers in a single fleet and all other fleets small, players using this strategy will suffer catastrophically if that all-cruiser fleet meets with a sudden end; however, most players will choose to accept the risk considering the sheer power of the killer fleet over its potential destroyer- and frigate-comprised opposition. Thus, you may wish to close this loophole using all or part of one of the preceding three fleet-balancing methods.

**Method 5.** Use a predefined Order of Battle or specified list of reinforcements for each player. Under this system each player receives a certain list of ships every turn (presumably balanced with those of the other players), of which most will be frigates and destroyers, several might be cruisers, and perhaps one will be a dreadnought. Additional campaign rules might then be included defining how these reinforcements may be deployed, in order to prevent the "all-cruiser" killer fleet from appearing.

This will not be a popular alternative for most campaigns because players tend to prefer to make their own choices. However, it needs to be mentioned because it is a viable option. Such a system would also largely eliminate the need for campaign economics, since players will receive these reinforcements without having to pay for them. This sort of campaign would provide simple bookkeeping while sacrificing flexibility.

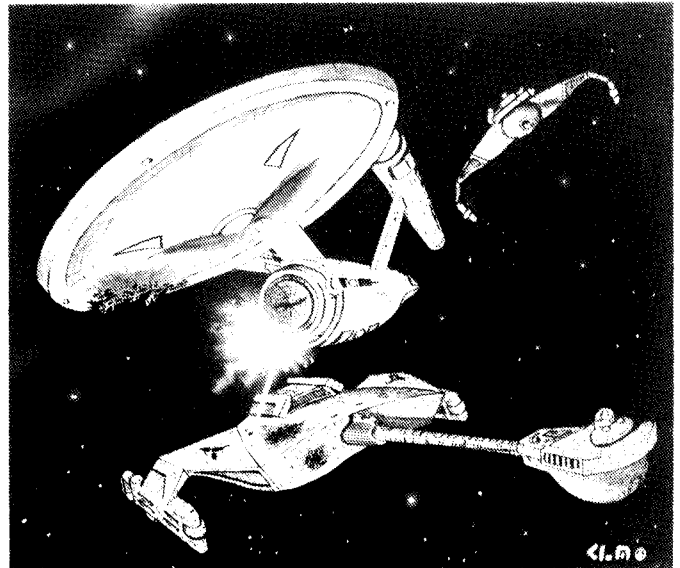

**THE FLEXIBLE COMMAND SYSTEM**

This system (and at least one variant) has already been used in a campaign, with excellent results. The Flexible Command System encourages the use of smaller ships by giving them a small point cost, includes a penalty for using multiple similar ships without leaders, and keeps fleets small and manageable.

This is a replacement for (S8.0) and its related rules; if using this system, do not use (S8.0).

**BASIC RULES**

Choose a flagship for your fleet. To figure this ship's Flexible Command Rating (FCR), multiply the command rating shown on the Master Ship Chart by 5 (or some other value if you wish to have smaller or larger battles). The resulting FCR is subject to the following modifiers:

Each flag bridge* box .....	+1
Legendary Captain present on ship .....	+3
Ship has an outstanding crew .....	+2
Ship has a poor crew .....	-5

\*For Klingon ships without flag bridges, use the number of flag bridge boxes on the nearest Federation equivalent ship; e.g., the C8 or C9 dreadnoughts would use the flag bridge count from the Federation DN.

The final FCR value determines the maximum amount of Flexible Command Points (FCPs) which can be present in the scenario. The flagship itself does not cost any FCPs (exception: battleships cost 4), but all other ships, fighters, PFs, ground bases, minefields, and defense satellites have an FCP value as shown on the chart below.

BB, SB, DN .....	N/A
Super-Heavy Cruiser .....	15
BCH .....	14
CC, CCH, BATS .....	12
CA, NCA, CWH, CF, MON .....	10
CW, CWL .....	9
CL, CLC, BS .....	8
DW, DWL, HDW, MB, F-OL .....	7
DD, DDL, F-L, SAM .....	6
FF, FFL, FH, FLG, CPL .....	5
POL, F-S .....	4
Each 6 PFs/INTs .....	1 each
Each 12 fighters (each 18 for Hydrans) .....	1/2 each
Each 5 defense satellites .....	1 each
Standard minefield .....	2
Small or medium ground base .....	1
Large ground base .....	2

No more than one BB/SB/DN can be in a fleet, and because no FCP cost is given above, any such ship must by definition be the flagship. Note: It is recommended that production of battleships be severely limited in your campaign, otherwise players will want to use one for every fleet they have. One battleship per player (period) is a good rule; one per frontier might also suffice.

Freighters include all naval auxiliaries of the given size; e.g., a small auxiliary PFT is considered a small freighter. (Note that freighters are counted only when being used in a military action, not if transporting cargo in a convoy. The reason they are given a command point cost is to prevent a player from building a force of several cruisers and 50 or more freighters—a loophole just waiting to be exploited!)

**DUPLICATE CLASSES**

If more than one unit from any given row is present, except freighters (but not excepting auxiliaries), add 1 to the cost of each additional unit after the first (exception: fighters add 1/2). For example, if you have one CA, one NCA and one CWH in your fleet, the first costs 10 FCPs, the second 11 and the third 12. As another example, if you have 10 PFs in your fleet, the first six cost 1 each and the other four cost 2 each for a total of 14 FCPs.

For ships, this penalty is lifted if a leader is present. One leader can be designated being "in command" of two other ships of its size, the resulting trio termed a "squadron." Leaders cannot be used in any fleet unless they have a two-ship squadron to command; if they appear without a squadron or with a partial one, they pay a penalty of 2 additional FCPs for the first such leader, 4 for the second, 6 for the third, and so on.

Some races do not possess leaders for their frigate, destroyer, war destroyer, light cruiser, or war cruiser classes. This puts any such race at a disadvantage when fighting races which have such leaders. As an optional rule, you might allow races without a leader to "refit" one ship to leader status. This refit adds nothing to the SSD but costs 3 EPV for frigates, 4 for destroyers and war destroyers, and 5 for light cruisers or war cruisers. This refit is not available for heavy cruisers. Any such ship is identifiable as a leader when an enemy unit achieves tactical intelligence level H. Leader status cannot be deactivated once bought to avoid the "lack-of-squadron" penalties listed in the preceding paragraph, and once any ship is refitted to "leader" status, it is subject to all other rules pertaining to leaders. Once so refitted, the ship must be tracked carefully; you cannot suddenly confer the leader status you have paid for to another ship.

**CARRIERS**

Carriers pay for every fighter in the scenario, but pay only 1/2 for each of the first 12 fighters, 1 for each of the next 12, 1+1/2 for each of the next 12, and so on. Hydrans use groups of 18, not groups of 12.

Fighters can be voluntarily left out of a battle in order to keep a fleet under the FCR limit. This can be done in two ways: leaving the fighters off the map to be picked up later, or putting them in storage crates aboard ship. In either case the fighters will not be available for any purpose in the battle.

If left off the map, fighters can be recovered later if the carrier survives (or by other ships in the scenario) but are considered destroyed otherwise. If aboard ship, they cannot be activated in the middle of the fight, and will not explode in chain reactions; however, they are still destroyed if their box on the SSD is destroyed (so their location must be recorded and tracked). This prevents a player from using inactive fighters as readily available reinforcements, something they would surely use as a tactic if not prohibited.

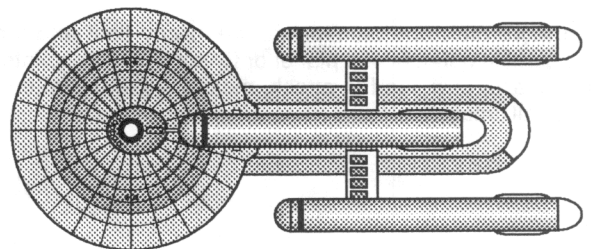

FEDERATION HEAVY CARRIER

### PF TENDERS

PFTs (or any unit with casual PFs) pay for every PF in the scenario, regardless of whether they are used or not. They can be voluntarily left out of a battle, as with carriers (above); however, they must be off the map entirely. You cannot carry inactive PFs (and thus use them for damage padding) without paying their FCP cost.

If a leader PF is present and on a true PF tender (not a casual tender), along with at least 5 other PFs (3 for Lyrans), the leader's FCP cost is zero. (A scout PF is not required, although if one is used, no more than one can be present in that flotilla.) Note that no more than one leader can be used with any flotilla.

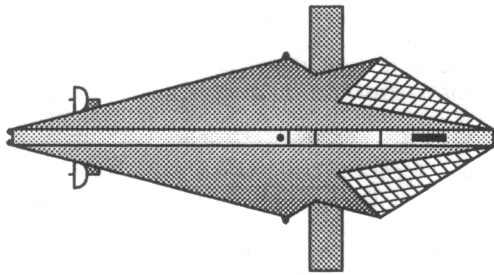

THOLIAN WAR PF TENDER

### FORTIFICATIONS

Fortifications (defats, minefields, and bases) are listed in the above chart, but their use in the command rating is optional and depends on your campaign. Many SFB players feel that defenses are "too powerful" and should be limited; if this is the case with your group, then use the FCP values shown above for the various fortifications. However, if you want to make strategic targets difficult to attack, then don't charge any FCPs for fortifications at all. An additional discussion of possible limits is found in the *Scenarios* section of this Handbook.

### OTHER FLEET RESTRICTIONS

No more than one SFG and/or mauler ship can be present in any fleet. [Under (S8.42) a penalty can be imposed for doing this; in a campaign this is not feasible.]

Minesweepers can only be used to assault minefields, unless caught unawares in open space; they are not normal fleet elements. If caught in open space, they cannot lay mines other than their standard complement of T-bombs. (Note: See the section on minelaying elsewhere in these rules for more information on minelayers and minesweepers.)

Tugs: Use (S8.46).

No more than one drone bombardment ship (defined as any ship with a "DB" note on the Master Ship Chart, or any ship which replaces heavy weapons with drone racks) can be in any fleet.

No more than one monitor can be in any fleet and it can only be used in defense of a planet or fixed base. If encountered in open space, or if used to attack, monitors use disrupted fire control at all times.

## EXCEEDING THE COMMAND LIMIT

Regardless of the command rules used, the scope of the limitation needs to be considered. Space itself is tremendously huge, so to some players it makes little sense to limit the number of ships that can fit within a given strategic area. Limiting the number of ships in a battle is one thing; what about ships which exceed this limit? This is a question that needs to be dealt with, and here are a few solutions:

### STACKING LIMITS

Under this system, the number of ships which can be "stacked" in a strategic area cannot exceed the command rating at all! It simply isn't possible to put more ships into a single spot on the strategic map.

This method ignores the "voluminousness" of space entirely, and is not very realistic, but keeps things simple, since you don't have to worry about whether "extra" ships in excess of the command limit can join a battle in progress.

### CLEANUP SQUADS

With this method, the player designates a "cleanup squad" (not to exceed the command limitations) to enter an area and secure it. Any amount of ships can follow up this force later in the campaign turn, but only if the cleanup squad defeats any and all enemy forces beforehand. Of course, if the area is already secure (controlled by friendly forces with at least one friendly unit present) no cleanup squad is required.

This is also a simple system, but works only for players on the attack. Defending players (who, having secured the system on previous turns, can have any amount of forces there) will only be able to use a portion of their ships, and campaign rules will need to specify how these are selected.

### UNLIMITED FLEET SIZES

This is the most realistic solution, not restricting the size of any fleet in any way. However, if a battle occurs, some portion of the fleet will "break off" to fight while other ships remain behind, unable to help.

One interesting side effect of this method is that a single encounter could result in several battles between "pieces" of very large fleets. For example, a player with 20 ships might break them up into a fleet of 7, a fleet of 8 and a fleet of 5 ships. Seeing this, a defender with 15 ships and a base might allocate 4 ships to engage the 5-ship force, 6 ships to fight the 7-ship fleet and leave the remaining 5 ships at the base to defend against the 8-ship force. Use this sequence of play:

(1) Attacker breaks up his force into one or more fleets, designating (secretly and in writing) which units are in which fleet. Once decided, this cannot be changed.

(2) Defender does the same for his forces, but before doing so, he can ask the number of fleets and the number of ships in each fleet. If the defender has a scout, he can also determine the size classes of ships in each fleet unless they are cloaked or using silent running (if allowed in the campaign).

(3) Defender announces which of his fleets will engage which of the attacking fleets (no more than one fleet on each). It is not necessary to engage every attacking fleet; often, one or more fleets will be left behind to guard strategic targets like bases or planets.

(4) Any attacking fleet not engaged by a defending fleet can then attack any defending fleet or base which is left over.

(5) Battles are resolved. (If an attacking fleet engages a defending force so small that it is no threat—less than 1/5th the BPV of the attacking force, or one which is defeated in less than 4 tactical turns of battle—the attacker can "blow through" this picket force and attack any strategic target in the system. This

prevents the defender from putting just one ship in the path of every attacking force except one, driving away the one exception without risking any other significant ships.)

(6) Repeat steps 1-5 as necessary. Victorious forces can regroup and attack (or defend); units which disengaged are "dispersed" and unavailable. Depending on campaign rules, some amount of repairs and/or resupply may be available before the next round of battles occurs.

### JOINING A BATTLE IN PROGRESS

If campaign rules allow more ships in a strategic area than a command rating will support, then players will eventually want to know if ships left out of the battle (due to command limits) can join that battle in progress. It is strongly recommended that this NOT be allowed, and here's why:

The overall purpose to the command rating rules is to keep battles as small and short as possible to maintain playability (if you don't care about these things, then you won't use a command rating rule in the first place). If you allow "reinforcements" to fleets in combat, then the only effect of the command rating is to put a cap on the number of units in the scenario at any given moment. Any time a ship is crippled it will simply disengage and be replaced by a fresh ship, and battles will actually last *longer*!

Determining when a ship can enter the board (and where on the map it is allowed to arrive), and determining when a ship is considered "out of play" (and therefore out of the command rating) is an issue so complex that it defies resolution by all but the most detailed rules. In fact, you'll have players deliberately NOT destroy enemy ships, preferring to leave them damaged so much that they are out of power so they can't disengage and be replaced by fresh forces—a situation which just isn't realistic at all.

### REDUCTION OF THE COMMAND RATING

If, during a battle, the fleet flagship is destroyed or severely damaged, the ability to command the fleet can be disrupted. The following section explains one way to deal with this situation. However, readers are warned that this can be a tricky area which defies easy definition. In fact, rules to handle every possibility simply cannot be written. An impartial GM (or very understanding group of players) is required if these guidelines are to be used.

[Note: You could, of course, choose to ignore this section entirely, although it does provide for some interesting tactical possibilities. If so, simply state in your campaign rules that command limits apply only at the start of combat, and destruction of the flagship has no effect on what other ships can or cannot do. This is the (S8.0) system, and reflects the idea that once the captain of a frigate can actually see the enemy ships, he doesn't need a whole lot of specific instructions.]

When the last control space on the flagship is destroyed (or the ship itself is destroyed/captured, whichever comes first), the "flag" will be transferred to another ship. This is assumed to take place automatically and immediately (and must be announced). When this is done, the command rating needs to be recalculated with respect to the new flagship, and the new rating might suddenly be too low to support all the units on the map.

If this is the case, then some units must disengage, attempting to do so by whatever means is convenient, and doing so with the utmost haste. The player owning the fleet is free to choose which unit(s) will do this; he does not have to announce it, but must record it secretly and in writing. (Note that this is one of those "gray areas" that an impartial GM is probably needed for. Exactly how the units are to disengage, and what constitutes "utmost haste," depends almost entirely on the

tactical situation, which is why actual rules cannot be written to handle these questions.)

Fighters may disengage or can land in any eligible shuttle/fighter box, but if the latter option is used, the fighters can never launch again or be used for any other purpose during the scenario (their weapons could be unloaded, but not reused by other units). PFs must actually disengage; landing on a tender (where they could then be used for damage padding) is not sufficient.

Units which are disengaging may not fire offensively, but can fire in defense of their ship only, as if they were using disrupted fire control (D6.68). Obviously, an enemy who realizes that a particular ship is disengaging due to lack of command will probably target that ship if possible, knowing it will be unable to make a counterstrike.

If units are disengaging (but have not finished the process) and the command rating suddenly increases (perhaps one of the control boxes on the original flagship is repaired, allowing it to resume command of the fleet) then the unit(s) may return to the fray as long as they have not yet finished disengaging. Their disrupted fire control restrictions are lifted immediately; there is no four-impulse delay (unless they are suffering from disrupted fire control for another reason).

Since bases or other fixed defenses cannot disengage, they cannot be selected by a player as a unit which must exit a battle when a command ship is damaged or destroyed. However, the owning player can shut them down voluntarily in times of desperation. If this is done, the unit is "shut down" and cannot be reactivated during the scenario. Boarding parties on the base could be used to defend it from capture, but not for any other purpose.

As a simpler alternative, use the above rules but do not force units in excess of the (now reduced) command rating to disengage. However, they should be prohibited from firing a weapon (or launching or controlling a seeking weapon) at any target more than four hexes away. The designation of which ships are "excess" ships could be changed at the start of any turn (at the same time the command ratings are recalculated).

### MULTI-PLAYER FORCES

In any of the command rating systems listed previously, it has been assumed that two players are involved, each with a separate command rating. However, as is frequently the case in free-form campaigns, players tend to form alliances and join together for combined attacks. This can be difficult to moderate, as any two players who join together can create a fleet of twice the normal command limit in size—a force no single player could hope to defeat.

The obvious response is to prohibit players from working together in this way, but the trouble arises when two players ally but don't bother to make this fact public knowledge. Then, when the battle occurs, they simply don't fire on each other but work together to destroy the common (third-party) enemy. Sometimes cagey players will make a show of forming a "temporary" alliance to deal with the "greater threat" and then, citing any of a number of reasons, choose not to fight each other after the main foe is defeated. This hides their allied status from everyone in the campaign, including the Gamemaster (if any).

This kind of secret diplomacy should not be stifled, but rather applauded; it is one of the things that make campaigns fun and worth playing! Be that as it may, however, the problem has not been solved: How do you go about controlling multi-player fleets?

**Method 1.** Don't allow scenarios involving more than two players at a time. This is simple and easy to accomplish—when three or more fleets arrive on the scene, force them to fight each other in random order. Allies who meet will simply not fight, and then one of them at random will be selected to fight the third player while the other disengages from the area.

Unfortunately, this seemingly elegant solution may not sit well with players, as it removes two of the possible intrigues of a campaign—the unusual combinations of players and races which might meet in a three-player scenario, and the frightening potential for a “backstab” attack!

**Method 2.** Force any multi-player fleet to “integrate” into a single combined force under one flagship, with any extra units disengaged and unavailable for battle. This is perhaps the best solution, as it keeps things fair for all sides, while still allowing for the possibility of betrayal in the midst of scenario.

Note that the two players who are combining forces will have a significant advantage if allowed to see any or all of the opposing forces before choosing what (if anything) must disengage due to command rating limits. Thus, you may want to limit this ability or even force the fleet structure to be defined before strategic movement is resolved on that campaign turn.

Depending on how much you expect this feature to be abused, you might impose on the integrated fleet one or more of the restrictions found in the next section.

**Method 3.** Allow multiple allied players to bring separate fleets into the scenario, but place them under certain restrictions preventing overt cooperation. Any or all of the following are recommended. (Note that some of these are not “realistic”—they are not intended to be such, but are included only to keep the game fair and balanced.)

**No fleet integration.** Fleets must remain at least 9 or more hexes apart at all times unless movement restrictions prohibit it; this reflects the inherent distrust between the two players' ship crews (the players themselves may trust each other fully, but the crews may not be so easily convinced). If ships get too close, they must turn and sideslip as soon as possible to get out of range. (You might choose a number other than 9 hexes—smaller numbers allow overload attacks, while larger ones make maneuvering difficult.) An impartial GM is probably required to enforce this restriction and prevent abuse (and to make sure the spirit, if not the letter, of the rule is being followed).

**No private chats.** Allied players operating under two command ratings cannot discuss battle plans in the midst of battle, because things are happening too fast. During Energy Allocation, the players may discuss what to do on the next turn, but must do so openly, in front of the opposing player(s). Secret signals, like firing one phaser-3 into open space to indicate a coming alpha strike, can be set up in advance but must be accomplished via the game—hand signals or pantomime is not allowed, nor is note-passing or similar tricks.

**No EW support.** Scouts cannot loan EW to units in another command rating (except offensive EW). ECM drones cannot be launched from a unit in one command rating to aid a unit in another.

**No friendly boarding parties.** Boarding parties transported to a unit in another command rating will fight that unit's boarding parties (and vice versa); they cannot be told or ordered not to do so. Note that “rescued” boarding parties (if rescued from a ship employing catastrophic damage) are still under the provisions of this rule, and cannot be used to attack another enemy. Therefore, rescued boarding parties are counted as “rescued crew” but are accounted for as “rescued marines” when returned to their own side.

**No revealing of secret information.** If a drone is launched by one player, his ally will not know its target or type without identifying it, and this information cannot be given out (even during the Energy Allocation discussions). The same goes for other secret information, like plasma torpedo targets (and pseudo-torpedo status), mine settings/locations, shuttle armament (or lack thereof), and so forth.

**No tractor help.** Ships of one command rating may not tractor those of another, even with their permission, except as part of an offensive attack. This is largely a judgment call by the players involved or the Gamemaster, and is intended to prevent such things as slowing both units down to improve turn modes (or avoid/cause movement on a coming impulse), dragging units out of webs, and the like.

**No direct aid.** Again, this is a judgment call and will likely require a Gamemaster to properly officiate. Basically, a fleet is not allowed to directly aid another fleet not in the same command rating. For example, beaming a T-bomb into the path of a drone swarm about to reach another player's ship would be considered direct aid unless there was a reasonable chance that the drones were targeted on the T-bomb owner's units. Examples of direct aid include, but are not limited to, the following: Firing at seeking weapons which are obviously not targeted on your own units; using transporters to move another player's units around (except to rescue them from an exploding ship); giving shuttles, T-bombs or other items to an ally for use during the scenario; using T-bombs to defend another player while not directly benefiting yourself; casting web to help another player while not directly benefiting yourself; placing an ally's unit(s) in stasis so they avoid damage from seeking weapons or approaching ships; loaning offensive EW to a ship about to overrun an ally; docking to an ally's ship and cloaking or launching a WW to defend that ship; and so forth.

**Allowed actions** include the following: rescuing crew from destroyed or soon-to-be-destroyed units; firing at (or tractoring, or stasising, or otherwise affecting) enemy (non-allied) units; firing at seeking weapons which might reasonably be targeted on your own units; using web in your own defense; and so on.

Using these guidelines, two-on-one battles will still be possible but not quite as deadly. Such battles can be quite interesting as the lone player will inevitably attempt to engage one opponent and elude the other. He will still be disadvantaged, but victory will still be possible.

# TECHNOLOGY

One of the staples of campaigns is technology advancement. The campaign typically begins at a low level of technology (often abbreviated "tech") which then grows as the campaign progresses. There are two ways to accomplish this: use SFB's built-in system, or design your own. We'll go over the former (the most commonly seen system) and then provide a complex example of an alternative.

You could, of course, use no technology system at all, allowing players to use whichever ships and tech they wish from day one. This will keep things simple, but you'll likely see only the "best" units (heavy battlecruisers, war cruiser leaders, etc.) unless other, more complicated rules are written to control this.

## HISTORICAL TECHNOLOGY ADVANCEMENT

Star Fleet Battles provides a built-in means to accomplish tech advancement, the Year of Availability system. Every technological development as a year associated with it, showing the historical year in which that tech first appeared in the Galaxy. Starships, too, have a year listed in the Master Ship Chart, defining when they became available to their race.

The obvious and most frequently seen tech system is to start your campaign in a particular year, and advance the year by one per turn, one year every other turn, or some other increment. This system is simple, and it *works*, as proven by zillions of campaigns throughout the years. It works because great pains have been taken to ensure that in any given historical period, no one race has a major advantage over another. There are some years in which one race might briefly step forward, but within at most a few years the other races have caught up with their own parallel advancements (often leaving the original designer behind in the process). A good example of this is the Lyran PF, the first such unit to be developed. Within a few years after the Lyrans deployed PFs, all races were operating them, and the Lyran version is generally considered inferior in comparison.

## CHOOSING A STARTING YEAR

When using historical advancement, your first choice is to determine the starting year of the campaign. The starting year defines what initial forces can be purchased by players, and because of this, care needs to be taken to ensure that the year doesn't allow one player to build large numbers of one particularly crucial unit. As mentioned above, Lyrans are the first to develop PFs (in Y178), so if Y178 were the campaign's starting year, the Lyran player would likely build tons of PFs (which no one else can have for at least another year).

The chart which follows lists some of the advantages and disadvantages of various starting years, showing the techs which first become available and, therefore, which of the races would benefit over others.

YEAR	NEW TECH
Y130	Q-ships first available
Y133	Hydrans begin using gatling phasers
Y134	Hydrans begin using Stinger-I fighters
Y135	Kzintis field first battle tug
Y150	Type-II and -V speed-12 drones developed ECM drones developed MRS shuttles first deployed
Y152	Probe drones first developed
Y154	LDR declares independence
Y156	Hydrans begin using hellbore ships
Y158	Federation deploys first full-sized minesweeper (MS)
Y160	Romulans begin using second-generation ships ISC fields first PPD-armed ship (CA) Tholian web 1.5x-strength improvement (G10.321)
Y161	Kzintis begin using AS fighters LDR begins using gatling phasers
Y162	Enveloping plasma torpedoes first available
Y164	Romulans deploy full-sized minesweeper (PEL) Romulans deploy first mauler (FAL)
Y165	Medium-speed drones become Limited Availability Lyran have CW and DW base hulls Klingons deploy first SFG ship (D7A) Klingons begin using UIM and DERFACS WYNs deploy minesweeper (AxMS) Tholians and Romulans begin using fighters Plasma-D torpedoes and racks available ISC begins rear phaser-3 refits Fighter jammer, cargo, sensor pods available
Y166	Medium-speed drones become Restricted Availability First Andromedan ships appear Lyran begin using UIM and DERFACS
Y167	Medium-speed drones become General Availability Fed, Klingon, Kzinti, Tholian deploy first DNs Feds and Klingons begin using fighters Lyran develop ESG capacitor
Y168	CWs and DWs become available for most races Romulans deploy third-generation ships Minesweepers see general deployment All disruptor ships have DERFACS available Hydrans begin using fusion holding Lyran first apply power pack refits Plasma shotguns first available to Gorns Chaff packs and EW pods become available Fighter ground attack pods available Stingray drones first available ISC first deploy PPDs (use PL-G before this year)
Y169	Plasma shotguns become available to all other races
Y170	Plasma-S torpedoes first available Bases receive first shield refit and limited aegis Multi-warhead drones first used Chaff pods become available Tholian photon refits available
Y171	More Andromedan advanced ships appear ISC begins rear plasma torpedo refits SWAC shuttles available to Federation RALADs become available
Y172	Starfish drones become available Fighter phaser pods available EW fighters first deployed
Y173	Tholians develop web anchor buoy
Y174	Swordfish drones become available

YEAR	NEW TECH
Y175	Full aegis available Bases receive second shield refit and full aegis "Y175 refits" available for appropriate races WYN produce first "fish" hull (FF) Heavy fighters first used (by Kzintis) Spearfish drones become available Fighter seeking weapon control pods available Tholian web 2x-strength improvement (G10.322)
Y176	Lyrans deploy first interceptors
Y178	Lyrans deploy first PFs Tholian web caster & Neo-Tholians first available Fast drones are Limited Availability Romulans first use cloaked decoy
Y179	Interceptors now available for all races Fast drones are Restricted Availability Death-Rider PFs first used
Y180	Fast drones are General Availability Warp booster packs for fighters and shuttles appear
Y181	Feds & Klingons deploy 1st-gen X-ships (CX, DX)
Y182	PFs now available for all races PF shield refits available Seltorians arrive in Galaxy
Y183	Snare refits available for Tholians C-refits available for fighters
Y184	Arrival of Andromedan Dominators Energy modules available to Andromedans

Note that more technology is out there than is shown above. Only major milestones have been listed. For example, during the Early Years period many of the technologies normally taken for granted (such as tractor beams, transporters, etc.) were unavailable or operated at reduced effectiveness. However, this discussion has been limited to the years surrounding the General War, as this is the timeframe with the most changes and improvements (and which is therefore the most interesting).

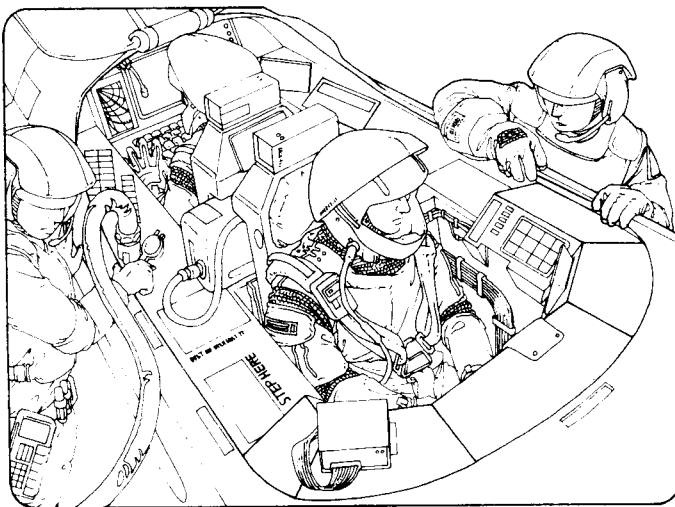

### SUGGESTED CAMPAIGN STARTING TIMES

**Y150 (Prelude to the General War):** This is a good date if your campaign will involve many turns of setup and colonization before open warfare is expected. During these years, players will have access to only the simplest ship designs—basic hulls (POL, FF, DD, CL, CA, CC), tugs, troop transports, scouts and survey ships. Battles will tend to be simple and quick, as drones are slow or moderate speed and fighters are unavailable to anyone but the Hydrans. If your campaign operates in a one-year-per-turn increment, the arrival of General War technology will be most welcome, and many players will actually hold off engaging in full-scale conflicts until then!

Note that some races (Romulans and ISC, for example) have either no ships available in this year or just a couple of potential designs. If you wish to include these races, you will need to make exceptions for their basic ships, allowing them to be built earlier than shown on the Master Ship Chart. No player will select Romulans if they can only have sublight ships!

**Y165 (The Dawn of the General War):** This is an excellent starting point, as all of the basic SFB races have a full complement of ships, and some of the first General War technologies have already appeared. Medium speed drones have become available for the first time (as Limited Availability items) and drone-using races will spend the first few turns of the campaign upgrading their drones to this speed. Note that some races have minor advantages in this timeframe (Romulans, Tholians, Hydrans and Kzintis are the only ones with fighters, Klingons have SFGs, Lyrans have war cruisers and war destroyers, Romulans have maulers, and only the WYN, Romulans and Federation have minesweepers).

**Y170 (The Heart of the General War):** This starting year could also be titled "Carriers Rule!" All races are now using fighters and carriers, and many players will be tempted to build carriers for maximum firepower (unless restricted by other campaign rules). This year is also good because the "war" hull types are available, the Hydrans have virtually all their fighter classes, and the plasma races have "caught up" by deploying the plasma-S, plasma shotguns and enveloping torps. In the first few years of the campaign, the last and best of the fighter designs will arrive, such as the Federation gatling-armed fighters, and (a bit later) heavy fighters. Plus, PFs are just around the corner. Y170 is a good starting year for campaigns with a turn increment of less than one turn per year.

**Y182 (The General War Winds Down):** At this point virtually all General War technology has arrived, and players will be able to build basically anything except the most advanced starships (SCSs, super-heavy cruisers, etc.). All races have PFs (with shield refits), warp booster packs are available for fighters, fast drones are in play, and some races already have their first X-ships. This is also the first year in which the Seltorians are available for campaign use.

Y182 is about the latest you would want to start a campaign without just foregoing the technology system altogether. This year or any of several years beforehand would be a good starting point for a campaign with a turn increment of three months per turn or less. Note, however, that if you choose any of the few years which precede this one, some races will have PFs while others do not (and your players will not appreciate this fact unless they are one of the ones who have PFs!).

## BUYING YEARS

In most campaigns which use historical technology, the campaign timeline advances one year per turn automatically, at an equal speed for all players. As mentioned previously, you could adjust this by making turns six months long, two years long, or other values.

An interesting variation of this is to require players to "research" each year of advanced technology. Research would require either economic points, research infrastructure (science bases, population, colonies, etc.), or some combination of these. The precise quantity of these cannot be listed, as they depend greatly on the economic level of your campaign, the amount of worlds and EPs available, and similar details. However, some suggestions can be made.

If EPs are to be the only means to advance in years, you should set the required amount to something affordable but still high enough to make a player worry about whether he should buy ships or technology. For example, if your players receive an average of 500 EPs per turn as income, then requiring 100 EPs to move up a year is probably not enough as everyone will just pay the cost and buy 400 EPs worth of ships. However, a cost of 300 or more would make them think twice, and 500 would mean an entire turn's build just to move up a year!

If infrastructure is needed, there are three basic ways to collect research: bases, colonies, and scouting. The obvious base would be the ground scientific outpost (GSO), a 10-EP base which would provide some quantity of research (which should be expressed as "research points"). Base stations and larger which have science modules should also provide research.

Colonies can also be used to provide research, either with or without ground base support. You might simply state that after a colony has been operational for a while, or after its population has grown above a certain limit, it begins to provide research points.

Finally, survey ships might be able to collect research points. As each survey ship explores a new system or area of space, it is doing research and can learn new things. One way to accomplish this is to deposit some quantity of research points in every uncontrolled system at the start of the campaign, with a survey ship needed to collect them.

If your campaign combines these "research points" and an economic payment to advance one year, then simulate this by allowing the research points to be "cashed in" as EPs for technological purposes. In the example above, we considered a player with an income of 500 EPs. If the economic cost of going up a year was 500 EPs, they would think twice before spending an entire turn's income to improve their technology. However, if they also had the ability to cash in research points, say for 50 EPs per point, then when they had collected several, they would be more likely to buy a year's improvement. Cashing in 6 research points would earn them 300 EPs worth of technology, and the remaining 200 would not be as economically painful.

The overall effect of "buying years" will be this: Players will buy up to their favorite year, then sit there for a while as they construct warships. Then, perhaps in response to more advanced ships fielded by other players, they will be forced to upgrade, ultimately up to PFs and X-ships. Most importantly, however, this system forces a player to balance his technology with ship-building, an interesting strategic choice.

## THE TECHBLOCK TECHNOLOGY SYSTEM

This is an alternative to the Historical Technology System described previously. To begin with, all years of availability are thrown out the proverbial window—you could, if you wished, develop PFs very quickly at the expense of other technologies. It would be possible, under this system, to operate a flotilla of PFs but not possess (for example) the ability to build dreadnoughts!

In this system, all technological advancements are condensed into individual segments known as TechBlocks. These blocks are then arranged into categories such as starship types, static defenses, maneuvering, and so forth. In each category there is a "starting block" which all players in the campaign possess automatically at the beginning of the game, whereas additional blocks must be purchased with "research points."

### RESEARCH POINTS

For a campaign to use the TechBlock system, Research Points (RPs) need to be integrated into the economic structure. RPs are a simulation of technology research produced by various laboratories, academies, and the like on worlds controlled by an player's empire (or whatever). It is suggested that populated worlds produce one or more RPs per turn (possibly augmented with ground research facilities), which go into a central pool to be spent on TechBlocks; see the next section for other suggestions.

Each campaign turn, research points can be spent to buy TechBlocks. A "TechBlock" is a facet of technology which allows a player to do something, or purchase something, not available without that block. To avoid confusion, ALL CAPS is used to refer to TechBlocks within these rules. The price of any given TechBlock is shown within that block on the flowcharts provided.

Some TechBlocks provide nothing more than an opening to purchase further TechBlocks, and most have prerequisites (other blocks which must be acquired before further research into other areas is possible). Blocks related to each other are grouped together on the flowcharts provided, with arrows used to show which blocks lead to another. Thus, for example, on the Starship TechBlocks page, an arrow leads from the block of DESTROYERS (DDs) to the LIGHT CRUISERS (CLs) block, indicating that the player must research the DDs block before CLs can be researched.

For a more detailed example, consider the Starship TechBlocks page once again. As can be seen on this page, players start the game with the FFs block. In order to buy DDs, the DESTROYERS TechBlock must first be purchased with the appropriate number of Research Points (in this case 1). On the next campaign turn, the player might then wish to buy a small Q-ship, but in consulting the required prerequisites, he discovers that the SMALL Q-SHIPS TechBlock requires both the DESTROYERS block (which he has) and the FREIGHTERS block (which he doesn't). Therefore, he would have to purchase the FREIGHTERS block on the next campaign turn, and then SMALL Q-SHIPS on the following turn. With both these prerequisites covered, he could then buy as many small Q-ships as he wishes. (Note that large Q-ships have their own TechBlock, which requires LIGHT CRUISERS.)

It is not possible to purchase a TechBlock in any campaign turn unless that player *already has all prerequisite blocks completely researched*. Continuing the example above, if the player had DESTROYERS but not FREIGHTERS, he could not choose to buy FREIGHTERS and SMALL Q-SHIPS in the same turn. He would have to buy FREIGHTERS in the coming turn and wait until the following turn for SMALL Q-SHIPS. Note also that small Q-ships could not be built until *after* the tech has been



acquired; you cannot build a ship which requires technology you are researching on the same turn!

Some TechBlocks require other blocks not on the same flowchart. These special prerequisites are shown without a box around them. For example, on the Starships flowchart, TROOP TRANSPORTS requires GROUND COMBAT, which is found on the Marines tech flowchart.

### RESEARCH POINT PRODUCTION

Here are some suggested ways for making RPs available:

**One per planet:** If your colonization rules are simple, and worlds generally alike, use this easy rule: Once a planet is a colony, it produces one research point per turn. This is about as uncomplicated as it gets.

**Based on population:** Some campaigns have been known to use population, which must be moved from world to world as colonies are formed. On fertile worlds, the population then grows as the campaign progresses, providing more economic production and (if appropriate) research points. Because every campaign is different, it is impossible to state the exact levels to set, but some guidelines are needed. As a general rule, it should take at least a couple of turns of growth (beyond the initial investment) before worlds begin to produce research points. Set the first RP at about one-third to one-fourth of the colonial pop maximum, the second at one-half to two-thirds, and the third at maximum population level only. You want it to be difficult to earn research points, taking many turns for maximum RP production, but not so great that it is unachievable.

**Based on facilities:** SFB provides an SSD for a ground scientific outpost (GSO) under rule (R1.28D) in Module R1. This 10-point base is ideal for the research point system. Simply state that each GSO provides one RP if located on a colony (above some population minimum, if your campaign tracks population), with a maximum of one GSO per world. This actually promotes the use of a non-defensive base on a planet, and provides a valuable target in a scenario (especially if your rules make ground base placement difficult).

**Available for purchase:** It might also be possible to spend economic points (up to some limit) to purchase RPs, hastening tech research. However, this should be strictly controlled using an arithmetic progression. For example, you might have the first RP cost 5 EPs, the second 10, the third 15, and so on. This will force players to balance starship production with technology research. Some players might choose to spend an entire turn's income on research alone, especially in the early game—you might want to install limitations or maximums, or use a higher degree of arithmetic progression.

**Combinations:** You might require ground bases in addition to population limits, or allow a world to produce one RP on its own plus additional RPs through population or GSO enhancements. If combining automatic RP production with EP purchasing using economic points, make sure the RP cost is prohibitive and allows only a few RPs to be bought per turn—for example, make the first cost 10 EPs, the second 30, the third 50, and so forth.

If you use RP production instead of purchasing, another possibility is to allow the first few colonies to produce more RPs than others—for example, you might state that the first couple of colonies with GSOs produce 3 RPs per turn, the next couple produce 2, and anything beyond that produce only 1 RP. This will help keep the campaign research levels somewhat balanced, as otherwise players who find more worlds than others might gain too great a technology advantage.

### TRADING/STEALING TECHBLOCKS

This should not be allowed! If trading of TechBlocks is part of your campaign, it will force "tech alliances" to form in which teams of players work together to cover the chart. Anyone left out of a tech group would then have no chance to keep up in the campaign. Unless your campaign is a team-based one, with alliances already formed and set at the start, you should not allow tech trading.

Likewise, stealing blocks (by capturing ships or worlds owned by an enemy, or with "spies") should not be allowed, because it is too difficult to control. Unscrupulous players often "arrange" to "lose" a world here or there, then "take it back" the next turn, thus accomplishing tech-trading through dubious means.

### ADDITIONAL NOTES ON TECHBLOCKS

At the start of the campaign, each player starts with the starting blocks on each of the tech flowcharts. Some flowcharts are meant for specific races only; however, any player can research them, if he wishes to pay the points. The only reason to do this is if rules exist in your campaign for capturing or trading ships. (For example, a Romulan player who buys a drone-armed ship might want to purchase a few drone TechBlocks, or else drones on the ship will be speed-8 type-I drones with no possibility of upgrades.) Similarly, Orion players often find themselves researching the blocks for many different weapons and systems, in case they ever choose to arm their ships with these weapons (plus, Orions also have their own flowchart, making them a very research-intensive race to play).

Players are not required to use every flowchart in their campaign. The Officers & Crew flowchart is a good example of one which could be ignored if desired. For a less complex campaign, consider deleting the Maneuver, EW, Marines, Officers & Crew, and individual weapon flowcharts, assuming that all blocks on those charts are automatically available. (Any blocks which are listed as having a prerequisite on one of those flowcharts can be safely assumed to already have that prerequisite.)

Some TechBlocks provide an ability to refit or modify a ship to utilize the newly researched technology. If this is the case, players who research such blocks will have to actually refit their ships (using the campaign's refit rules) to benefit from the block. Ships built after the tech is researched can be built with the refit in place if they wish (and if they pay the extra cost). If a TechBlock is of this type, it will be listed in the descriptions which follow with a "refit required" notice. If such a notice is not present, then the new technology is automatically available to all ships as soon as it is acquired. Example: SNARES is listed as a "refit required" TechBlock, so a player who acquires this block would have to refit his ships to use snare generators. RANGE-30 DISRUPTORS, however, is not listed as "refit required," so upon acquiring this block, disruptors possessing that range would immediately be able to fire out to 30 hexes (whereas before they could not).

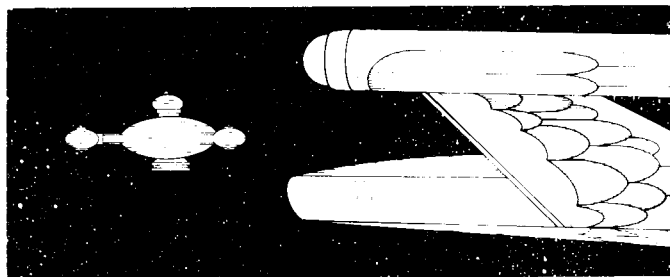

## CAMPAIGN DESIGN NOTES

Keep in mind that it will take a good deal of research to get most technologies up to the General War level. Players will probably want to concurrently research many blocks. If you make the number of RPs available per turn low, your campaign will remain primitively low-tech for many turns. Campaigns with larger amounts of RP production (or easier methods to purchase them) will advance faster. You will want to find the balance that fits the mindset of your players.

One alternative is to begin players with a set amount of RPs, say 20-50 points depending on their race, which they can spend on pre-campaign research. This will allow players to begin with some, but not all, of the technology they are used to. A plasma-user, for example, could spend 20 RPs to work up into the advanced plasma enhancements (plasma bolts, envelopers, etc.) but might not be able to afford swivel mounts or D-racks.

Note also that some races are going to have tougher times getting their technology fully advanced. Weaponwise, the Gorns (for example) only have to work on plasma technology, while the Federation must work on photons, drones and drone racks ... and plasma tech, too, if they want to use their plasma ships! The Orions are perhaps the worst off, having not only their own racial blocks, but also every different weapon type they choose to use during the campaign. If you give everyone some amount of starting RPs, you should consider adjusting this amount accordingly depending on race.

## RACIAL STARTING TECHBLOCKS

As an optional rule, you might allow each different race to start with one or more TechBlocks appropriate to their race. Here are the recommended starting blocks. Note: Some blocks normally require prerequisites, but any such prerequisite blocks are *not* automatically provided; they will still need to be researched. For example, the Klingons have DERFACS and UIM listed, which normally require RANGE-22 and RANGE-30 DISRUPTORS, but those blocks are *not* included in the Klingon's starting list and will still need to be researched.

**Federation:** PROXIMITY FUZE, TYPE-G DRONE RACKS.

**Klingon:** DERFACS, UIM.

**Romulan:** CRUISER CLOAKS, EXTENDED DURATION CLOAK.

**Kzinti:** SPEED-12 DRONES, ADD RACKS.

**Gorn:** GAS SHUTTLES.

**Tholian:** GLOBULAR WEB, PHASER PENETRATION.

**Orion:** STEALTH BONUS, IMPULSE DOUBLING.

**Hydran:** FIGHTERS, FIGHTER ENHANCEMENTS.

**Andromedan:** TRLs, PA DISSIPATION.

**Lyran/LDR:** DERFACS, RADIUS 2 ESG.

**WYN:** DOUBLE DRONE WARHEADS, TYPE-B RACKS.

**ISC:** PPDs.

**Seltorian:** WEB BREAKER.

**Jindarian:** LIGHT RAIL GUNS, FULL ARMOR.

Other races not listed above, such as simulator races from Module C4, will need their own starting blocks based on your campaign rules.

## TECHBLOCK DESCRIPTIONS

For each TechBlock on the flowcharts provided, a description can be found below, elaborating on the rules and procedures which apply to that block. Note that many rules depend on your campaign; if a question comes up which is not handled in these rules (e.g., how to define a certain ship type for purposes of which block it falls under), your campaign's GM will have to be consulted. If there is no GM, a consensus of players will be required.

Some blocks modify the "normal" rules of Star Fleet Battles, simulating a hypothetical "pre-development" state of a system or weapon. For example, if you have purchased no extra TechBlocks to enhance cloaking devices, cloaks have many limitations not found in the standard rules—they can only be used for a limited period of time, and the fade-in and fade-out periods are extended in duration. These extra restrictions are explained in the descriptions which follow. Note that no SFB systems are actually improved (beyond the existing rules) by any TechBlock. Thus, no additional SFB rules are needed.

## OTHER TECHBLOCKS

No TechBlocks are defined for simulator races, Early Years technology, and the like; players can feel free to design their own. TechBlock arrangements for these elements of SFB and additional rules, such as tactical intelligence, scout functions, detailed ground combat, and so forth, could also be designed for additional complexity. Some such designs may be published in a future product.

## HINTS ON TECHBLOCKS

Players new to the TechBlock system should first read through the rules carefully. Then, consider how many research points you begin the game with and how many you expect to generate each turn. This will give you some idea of how to proceed, depending on your race.

Drone-using races, especially the Kzintis and Klingons, will need to concentrate on drone tech early. At a minimum, you can expect to spend 35 research points to work up to fast (speed-32) drones, the most useful kind. If the GM designs the research system correctly, this will occupy a good deal of your research for the first several turns of the game (probably five turns or more), assuming you concentrate specifically on this goal. This may be too research-intensive for most players, so get medium-speed drones and worry about other considerations for a while.

Plasma-using races can get by with just a couple of blocks early on: plasma-S and minor plasma enhancements, for example. Still, getting those two, plasma-Rs and plasma-D racks will cost 19 RPs, and finishing off the rest of the more useful plasma enhancements (the ones everyone usually counts on having) takes another 11. Decide which of these are most important to you and save the others for later.

Every race has their own direct-fire weapon table (phasers included). As a general rule, buy the first block on the flowchart appropriate to you, as it's going to be the most useful. Photon users will definitely want to hold photons; disruptors need to have a range higher than 15; and so on.

Of the other charts, the maneuver flowchart is probably the most important. You can probably get by without most of the items on the chart, but if you do, keep a close eye on what you can and can't do in combat. If you don't research HETs, then whatever you do, don't get yourself into a situation where only an HET can save you!

STARSHIP TECHBLOCKS

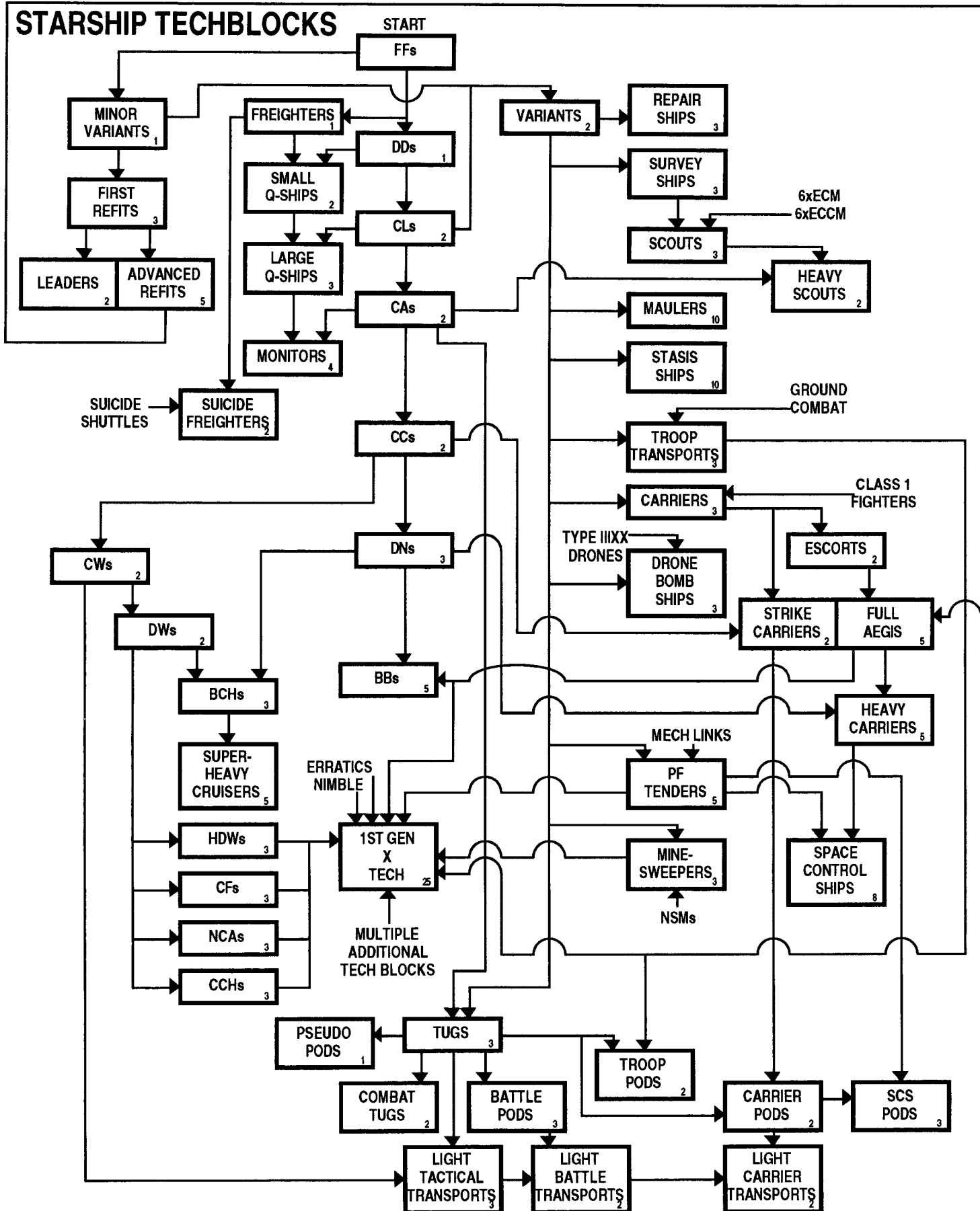

**STARSHIP TECHBLOCKS**

**FRIGATES:** Allows construction of basic, unmodified POL and FF ships for the player's race. Romulans can build only first-generation ships until they purchase VARIANTS. Gorn DDs are considered FFs for this purpose. Tholians cannot build command modules until they have acquired WEB CASTERS. Andromedans can build only VIPs and BULs.

**DESTROYERS:** Allows construction of DDs, but not DWs or MPs. Gorn BDDs are NOT considered DDs for this purpose (they are DWs). Andromedans can build COBs and KSSs.

**LIGHT CRUISERS:** Allows construction of CLs. Andromedans can build COqs.

**HEAVY CRUISERS:** Allows construction of CAs. Andromedans can build INTs.

**COMMAND CRUISERS:** Allows construction of CCs. Andromedans gain no additional new ships.

**DREADNOUGHTS:** Allows construction of DNs. Andromedans can build DOMs, although this should be strictly controlled by the campaign rules—e.g., no more than one per turn or every other turn.

**BATTLESHIPS:** Allows construction of BBs (including conjectural BBs if allowed by the campaign rules). This should be limited, perhaps to one BB per player or per frontier.

**WAR CRUISERS:** Allows construction of CWs, which includes Gorn HDDs, Romulan SPHs, etc. Romulans can purchase third-generation ships (of any type) only after acquiring this block.

**WAR DESTROYERS:** Allows construction of DWs, which includes battle frigates like the Fed FFB or Klingon F6, the Gorn BDD, etc.

**HEAVY BATTLECRUISERS:** Allows construction of BCHs. The Tholian D-hull is a DN, not a BCH.

**SUPER-HEAVY CRUISERS:** Allows construction of super-heavy cruisers, such as the Romulan Killerhawk. At the time these rules were written, the KH is the only super-heavy cruiser in SFB, though more could be added at a later time; these would fall under this block.

**HEAVY WAR DESTROYERS:** Allows construction of HDWs. Note that these ships have certain optional systems which may require other TechBlocks before they can be used; for example, you could not put fighters in the non-weapon options unless you first had the CARRIERS TechBlock.

**FAST CRUISERS:** Allows construction of CFs.

**NEW HEAVY CRUISERS:** Allows construction of NCAs.

**HEAVY COMMAND CRUISERS:** Allows construction of CCHs.

**MINOR VARIANTS:** Allows construction of simple variants, such as VIP transports, and any other minor variant that doesn't have its own TechBlock below. Alternate border ships like the Federation FFR require VARIANTS. This block also allows players to purchase extra crew units at the cost shown under the Commander's Options.

**FIRST REFITS:** Allows use of the first standard refit on any ship class. Note that some refits (mech links, ESG capacitors, etc.) require separate TechBlocks before they can be used. Purchasing this block does not automatically refit any existing ships; these must return to a base and use the campaign's refit rules. The refits which fall under this block are: Federation "+" refit, Klingon B-refit, Romulan "+" refit, Kzinti "C" refits (C-8, C-10, C-12, etc.), Gorn "+" refit, Tholian photon refit, Orion "+" refit, Hydran "+" refit, Lyran/LDR "+" (but not phaser) refit, ISC phaser-3 refit, and the early Y170 shield refits for bases.

**ADVANCED REFITS:** Allows use of all other refits (Federation AWR refits, Klingon "K" refits, Gorn "F" refits, ISC rear-firing plasma-F refit, base Y175 shield refits, etc.). Note that these refits may require their own TechBlock, such as the full aegis refit, snare refit, ESG capacitor refit, and so on; any such

refit also requires ADVANCED REFITS before it can be purchased.

**LEADERS:** Allows purchase of leader variants for ships classes, such as FFLs, DDLs, police flagships, etc. Note that command cruisers have their own separate block, and that police flagships require many other blocks (REPAIR SHIPS, TROOP TRANSPORTS, etc.) before they can be purchased.

**FREIGHTERS:** Allows purchasing of any freighter (including APTs, FTs, etc.) or civilian ship not listed as requiring any other TechBlock. Armed freighters require MINOR VARIANTS. Large freighters require LIGHT CRUISERS. Large ore carriers require DREADNOUGHTS. Auxiliaries, such as auxiliary carriers, would also require the appropriate specific TechBlock (CARRIERS, PF TENDERS, SPACE CONTROL SHIPS, etc.).

**SUICIDE FREIGHTERS:** Allows the use of freighters as suicide freighters.

**SMALL Q-SHIPS:** Allows purchase of small Q-ships. Note that some Q-ships might need other blocks (Kzinti and Hydran will need FIGHTERS; Romulan will need NSMs) to work at peak efficiency, but they can still be bought without these blocks (and without these items, naturally).

**LARGE Q-SHIPS:** Allows purchase of large Q-ships.

**MONITORS:** Allows purchase of monitors. Monitor pallets are treated as tug pods for TechBlock purposes.

**VARIANTS:** Allows purchase of additional TechBlocks which allow specific variants. With this block, Romulans can purchase second-generation Klingon hulls (but not third-generation hulls unless WAR CRUISERS have been acquired). ISC cannot purchase the CS without this block. Alternate border ships like the Federation FFR require this block.

**REPAIR SHIPS:** Allows purchase of repair ships. Police Flagships require this block.

**SURVEY SHIPS:** Allows purchase of survey or exploration ships, such as exploration freighters, Fed GSCs, Klingon D6Es, etc. Special sensors on such ships cannot loan EW at all, regardless of any EW TechBlocks acquired, unless SCOUTS have been researched.

**MAULERS:** Allows purchase of maulers, including Alliance conjectural maulers if conjectural ships are allowed in the campaign.

**STASIS FIELD SHIPS:** Allows purchase of SFG ships (Klingons only). Orion players may also be allowed to purchase this block if campaign rules allow SFGs in option mounts. Orions may be allowed to purchase SFGs from Klingon players (but cannot build their own); if so, any SFGs so purchased cannot be used until this block is researched.

**SCOUTS:** Allows purchase of fleet scouts (any scout which is not a survey ship or heavy scout). Upon acquiring this block, all special sensors gain the ability to loan EW (no refit required).

**HEAVY SCOUTS:** Allows purchase of heavy scouts. For this purpose, heavy scouts are considered to be any scout constructed on a war cruiser or larger hull.

**TROOP TRANSPORTS:** Allows purchase of troop transport class ships. This basically includes any unit, including Police Flagships, which possesses barracks. Option mount-equipped ships may not place barracks in their options unless they first purchase this block.

**CARRIERS:** Allows purchase of carriers. Hydran ships which are not "true carriers" are exempted from this block, but can use no better than Stinger-1 fighters without it. A Hydran player must still purchase this block in order to buy variants of such ships or to research any other block which requires this one. This block allows a player to purchase extra deck crews at the cost shown under the Commander's Options.

**STRIKE CARRIERS:** Allows purchase of strike carriers like those operated by the Federation, Kzintis, ISC, Orions, etc.

**ESCORTS:** Allows purchase of carrier escort ships excepting those with full aegis. No ship which possesses limited aegis (including the D5) can utilize that system until its owner has researched this block. Bases which have paid the cost of the Y170 shield refit automatically receive limited aegis when this block is acquired.

**FULL AEGIS:** Allows purchase of aegis carrier escorts. Existing escorts which have an aegis improvement (such as the Federation NEC, which becomes the NAC) can be refitted to the improved version (refit required). Bases which have purchased the Y175 shield refit automatically receive full aegis when this block is acquired.

**HEAVY CARRIERS:** Allows construction of CVAs. Note that some CVAs, such as the Tholian CVA, are not built on DN hulls, but the DN block is still required.

**PF TENDERS:** Allows purchase of PF tenders (and, for the Federation, the NVH). Special sensors on PFTs cannot be used to loan EW (even to the flotilla) unless the SCOUTS block has been researched.

**SPACE CONTROL SHIPS:** Allows construction of SCSs. Some SCSs, such as the Romulan TH and various other BCS-class ships, are not built on dreadnought hulls, but still require the DN and CVA blocks.

**MINESWEEPERS:** Allows purchase of minesweeper class ships including minesweeping and minelaying freighters. Option mount-equipped ships cannot put mine racks in option mounts until this block has been researched.

**DRONE BOMBARDMENT SHIPS:** Allows the use of the D% drone percentage benefits of drone bombardment ships or tug pods (i.e., any unit with a "D%" on the Master Ship Chart). You do NOT need this block to buy such units, but they will not have the D% benefit (and cannot use drone bombardment, if allowed in your campaign) until this block is acquired. Special sensors on such ships cannot be used to loan EW until the SCOUTS block has been researched.

**TUGS:** Allows purchase of light fleet tugs such as the Lyran TGP. Races which have only one fleet tug can purchase that tug with this block. Tugs can have only cargo pods with this block; if REPAIR SHIPS has also been researched, the tug can have repair pods as well. The Tholian CPC is considered a tug; other Tholian ships cannot carry packs until this TechBlock has been researched (and then only the cargo pack until other pod types are researched).

**COMBAT TUGS:** Allows purchase of combat variant tugs. Races which do not have combat tugs do not need this block at all, and can safely ignore it as it is not a prerequisite for any other block.

**LIGHT TACTICAL TRANSPORTS:** Allows purchase of LTTs. Races without LTTs do not need this block or any which follow it. LTTs are defined as any pod-carrying unit on a CW-class hull (most are already called LTTs, but others, like the Romulan SPH, are not so obvious). Tholians may not purchase the LTT without this block, but can carry cargo packs on other CWs without it.

**PSEUDO PODS:** Allows use of pseudo pods.

**TROOP PODS:** Allows use of troop pods.

**CARRIER PODS:** Allows use of carrier pods.

**SCS PODS:** Allows use of SCS pods.

**BATTLE PODS:** Allows use of battle pods and any similar combat-oriented or defense-oriented pod, like the Hydran fire support pallet or the Tholian phaser pack. Note that some pods may have other requirements; the Klingon drone pod requires DRONE BOMBARDMENT SHIPS, for example.

**LIGHT BATTLE TRANSPORTS:** Allows purchase of LBTs (i.e., the use of battle pods on LTTs).

**LIGHT CARRIER TRANSPORTS:** Allows purchase of LTVs (i.e., the use of carrier pods on LTTs).

**X-SHIPS:** Allows construction of first-generation X-ships. Note that some other categories will also have requirements for X-ships which are based on race only; you cannot build X-ships without all such blocks which apply to your race. For example, plasma-users cannot construct plasma-armed X-ships until they have the PLASMA X-SHIPS block. See the descriptions of these individual blocks for more information.

**SPECIAL NOTE:** The TechBlock chart on page 42 (the first and largest in the TechBlock system) is quite complex, and many of the technological dependencies are intricate. The chart given is designed to force players to produce the various types of ships in the approximate historical order of their appearance in the Star Fleet Universe. It is not the only possible system, and players may wish to devise their own alternative chart for their own campaign.

Some examples of possible changes include:

- Make CCHs an intermediate step between CCs and BCHs.
- Do not require DNs as a prerequisite to building BCHs.
- Make DWs a prerequisite to CWs, or make both of them (and the CF) derivatives of a new "fast warp" TechBlock.
- NCAs might be a derivative of CWs.
- CWs might be made a derivative of CLs rather than CAs, but in that case, the CF and CCH blocks will have to move.
- Players might be allowed to build LTTs based on CWs, and use that technology (along with CAs) to produce TUGs instead of the other way around.

One possibility is to create an "either/or" dependency line. For example, DWs might be listed as requiring EITHER the CW or the DD block, but not both. Any number of extremely complex relationships could be created in this way.

Another possibility is to allow players to have more than one race to select ships from, BUT require them to buy the TechBlock charts for both races *separately*. Within four campaign turns, one player might go from FF to DD to CL to CA and then to CC with one race, while another might reach CA with one race but only DD with their second one. Needless to say, such an option would require careful recordkeeping.

Innovative GMs are encouraged to experiment with any or all of these ideas, and to create their own concepts. You are encouraged to submit such ideas for consideration in future expansions of the Campaign Designer's Handbook.

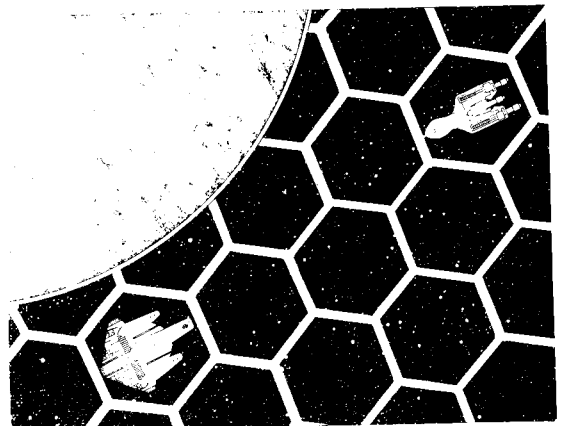

# STATIC DEFENSE TECHBLOCKS

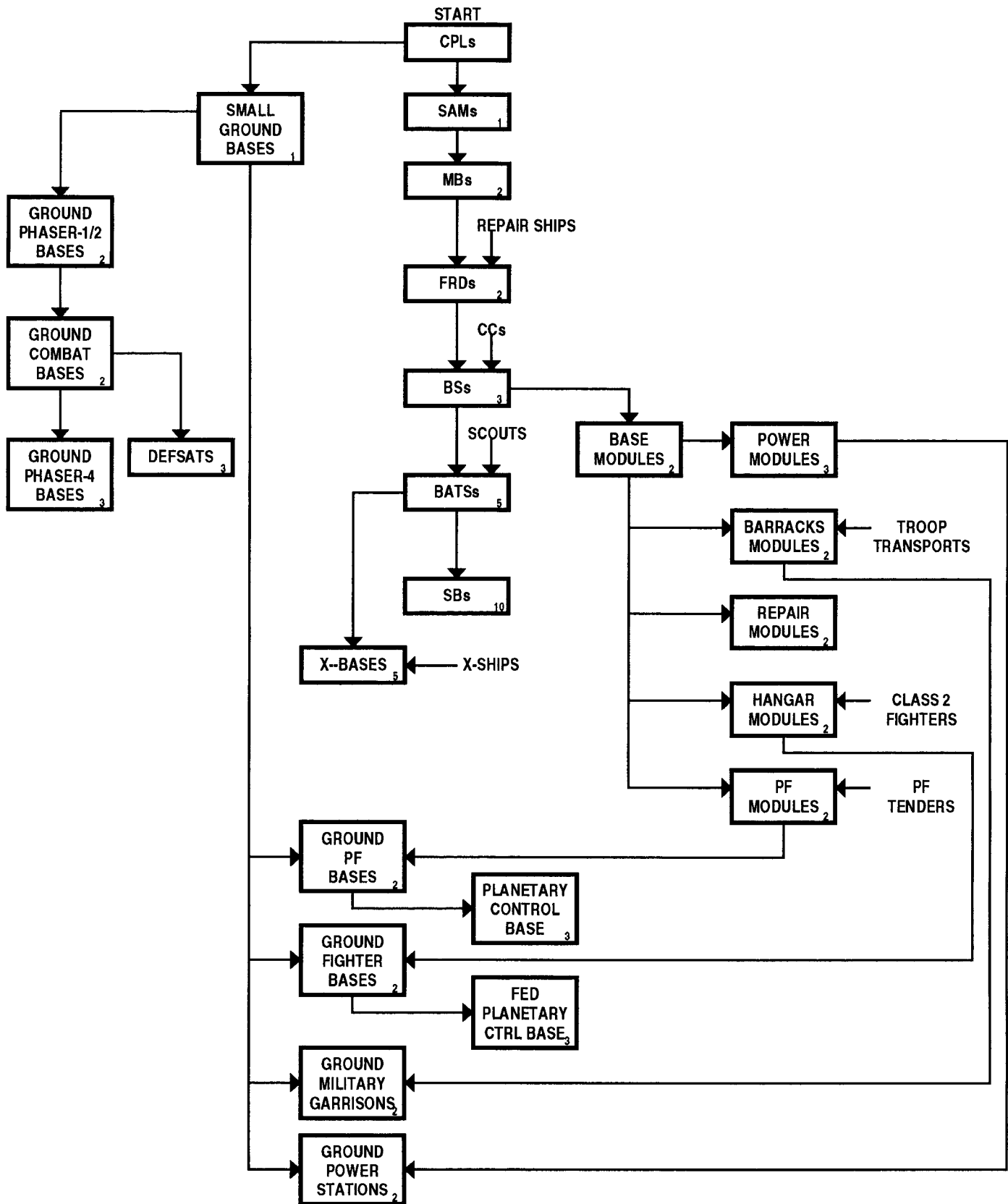

**STATIC DEFENSE TECHBLOCKS**

**COMMERCIAL PLATFORMS:** Allows construction of commercial platforms and cargo modules for bases.

**SAMS:** Allows construction of System Activity Maintenance Stations.

**MOBILE BASES:** Allows construction of MBs. Andromedans can purchase Satellite Bases.

**FLEET REPAIR DOCKS:** Allows construction of FRDs, if allowed for your race. If not allowed for your race, you must still research this block before you can continue down the chart.

**BASE STATIONS:** Allows construction of BSs. Base refits are governed by the FIRST REFITS and ADVANCED REFITS blocks. Andromedans can purchase core modules and assemble base (but not battle) stations with this block.

**BATTLE STATIONS:** Allows construction of battle stations.

**STARBASES:** Allows construction of starbases (but not by Orions or WYN). Andromedans can build the Desecrator starbase, but can build only one, and only at their homeworld (however this is defined by the campaign rules).

**BASE MODULES:** Allows construction of any class-B base augmentation module which does not require its own block elsewhere on the chart.

**BARRACKS MODULES:** Allows use of barracks modules.

**REPAIR MODULES:** Allows use of repair modules.

**HANGAR MODULES:** Allows use of hangar modules.

**PF MODULES:** Allows use of PF tender modules.

**POWER MODULES:** Allows use of power modules.

**SMALL GROUND BASES:** Allows construction of simple small ground bases (those not requiring other blocks below), such as ground agro stations and the like. Note: If your campaign uses ground scientific outposts (GSOs) for research

point generation, these should not require this block but should be part of COMMERCIAL PLATFORMS, the starting block on this flowchart.

**GROUND POWER STATIONS:** Allows construction of ground power stations.

**GROUND MILITARY GARRISONS:** Allows construction of ground military garrisons.

**GROUND FIGHTER BASES:** Allows construction of small and medium fighter bases.

**FEDERATION PLANETARY CONTROL BASE:** Allows Fed players to utilize their special planetary control base, though it is recommended it be allowed in the campaign only after PFs have been deployed by at least one other race. Note: In a free-form campaign where players use just one race, this unit requires special considerations for balance purposes, lest the Federation be able to deply twice as many fighters on their planets as anyone else. The recommended solution is to allow any race (not just Feds) to build this base at any time simply by researching this block.

**GROUND PF BASES:** Allows use of ground PF bases.

**PLANETARY CONTROL BASE:** Allows use of planetary control bases for non-Federation races.

**GROUND PHASER-1/2 BASES:** Allows use of ground-based phaser-1 and ground-based phaser-2 bases.

**GROUND COMBAT BASES:** Allows use of all other ground combat bases except the GBDP.

**GROUND PHASER-4 BASES:** Allows use of ground-based phaser-4 stations. (Of course, Orions cannot use these.)

**DEFSATS:** Allows use of defense satellites.

**X-BASES:** Allows construction of X-bases. To purchase X-Starbases, STARBASES must also be researched.

**PHASER TECHBLOCKS**

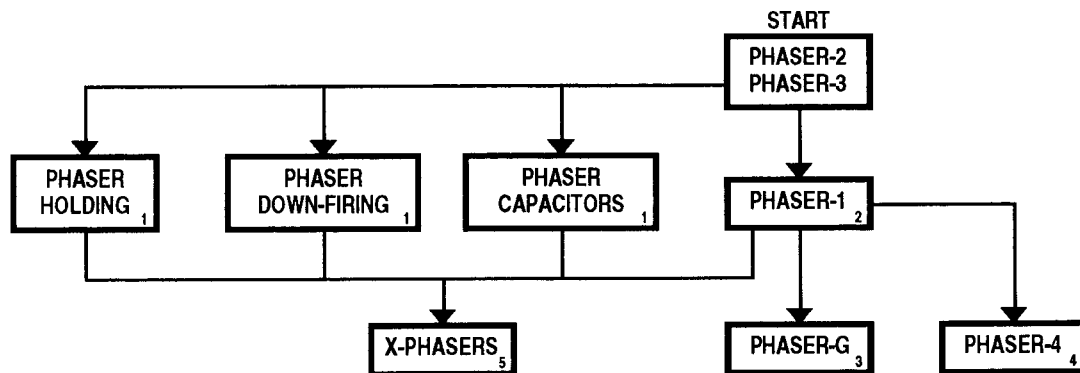

**PHASER TECHBLOCKS**

**PHASER-2/PHASER-3:** All units have no better than phaser-2s and phaser-3s. Ships with phaser-1s or phaser-4s use ph-2s instead; ships with ph-Gs use ph-3s in their place. There is no phaser capacitor system (energy must be allocated to phasers individually), energy in phasers cannot be held, and phasers cannot be down-fired as weaker phasers to save energy. Do not reduce the cost of ships for these changes.

**PHASER-1:** Units with phaser-1s on the SSD can now use them as ph-1s instead of ph-2s (no refit required). (This does NOT allow ships with ph-2s to upgrade them to ph-1s, nor does it allow Klingon ships to earn K-refits without ADVANCED REFITS.) Ships with phaser-4s treat them as phaser-1s until PHASER-4s is researched. Phaser-1s cannot be down-fired unless PHASER DOWN-FIRING has been acquired.

**PHASER-G:** Units with phaser-Gs on the SSD can now use them as phaser-Gs instead of phaser-3s (no refit required). This does NOT allow ships to upgrade phaser-3s to phaser-Gs.

**PHASER-4:** Ships with phaser-4s on the SSD can now use them as phaser-4s instead of weaker phasers. They cannot down-fire them as phaser-1, phaser-2 or phaser-3 unless PHASER DOWN-FIRING has been researched.

**PHASER CAPACITORS:** Ships have phaser capacitors (no refit required). Without this block, energy must be allocated to phasers on an individual basis. The ship must still "warm" the phasers first with (E2.3), however; this energizes all phasers on the ship simultaneously.

**PHASER HOLDING:** Phaser energy can be held from turn to turn, in the capacitors (if PHASER CAPACITORS has been researched) or in the individual phasers (if not).

**PHASER DOWN-FIRING:** Phasers can be fired as a weaker type to save energy: phaser-1 or phaser-2 as phaser3s; phaser-4s as phaser-1, phaser-2 or phaser-3s.

**X-PHASERS:** X-ships gain the ability to overload phasers and use other X-phaser rules. X-ships can be built without this block; if so, no X-phaser abilities can be used.

# SHIELD TECHBLOCKS

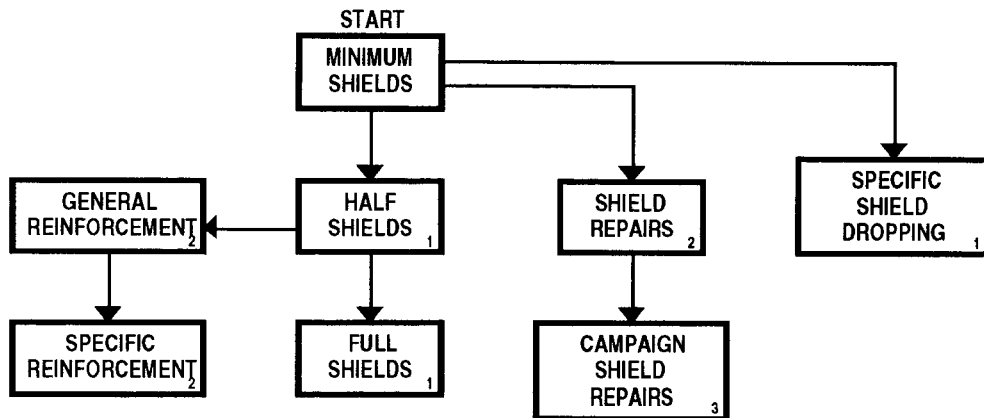

## SHIELD TECHBLOCKS

*Note: Andromedans cannot use these TechBlocks.*

**MINIMUM SHIELDS:** Ships can use only minimum shields, cannot drop individual shields, cannot repair shields during battle, and cannot reinforce shields. Ships can repair shields between scenarios at the rate of 25% of the ship's original boxes per campaign turn, rounding fractions up (e.g., if a ship has a 20-point #1 shield, it could repair 5 boxes on that shield per campaign turn).

**HALF SHIELDS:** Ships can use one-half (50%) of the boxes on any shield (minimum 5 boxes); any boxes over this limit are considered unavailable. If a refit is applied which increases the amount of boxes, take 50% of the total boxes after the refit. E.g., if a ship has 20 boxes on its #1 shield, it could use 10 of them with this block. If it added a refit that increased the front shield to 24 boxes, it could use 12 of them.

**FULL SHIELDS:** Ships can use the full amount of shields shown on the SSD.

**GENERAL REINFORCEMENT:** Ships can use general reinforcement.

**SPECIFIC REINFORCEMENT:** Ships can use specific reinforcement.

**SPECIFIC SHIELD DROPPING:** Ships can drop shields individually. Without this block, in order to drop one shield, a ship must drop them all.

**SHIELD REPAIRS:** Ships can use the shield repair procedures (D9.2) during scenarios.

**CAMPAIGN SHIELD REPAIRS:** Ships can use the campaign repairs rule (D9.41) to repair all shields between campaign turns. Note that campaign rules will specify when this is actually done. It might be possible, if the sequence of play allows it, for a ship to suffer shield damage in one scenario and fight another battle (on the same campaign turn) in which its shields may not yet be repaired.

# ELECTRONIC WARFARE TECHBLOCKS

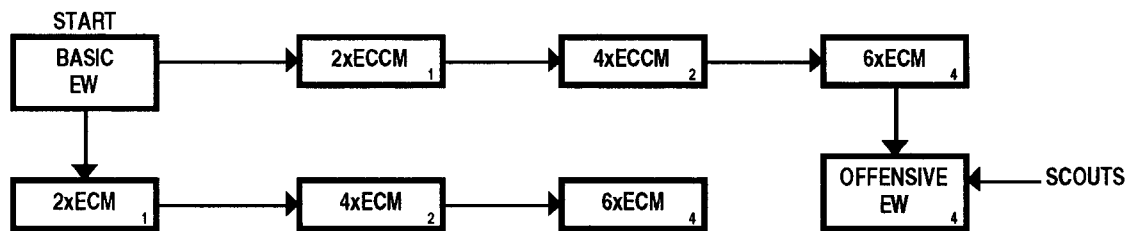

## ELECTRONIC WARFARE TECHBLOCKS

**BASIC EW:** Ships have no facility for use of EW, although units can benefit from natural sources and small target modifiers; drones still possess the (FD1.52) penalty, and cloaking devices still provide their EW benefits. At this level no unit has self-generated EW. Note: Even if the blocks which follow are acquired, scout channels cannot loan EW (including offensive EW) until SCOUTS has been researched.

**2xECCM:** Allows use of up to 2 points of ship-generated ECCM and any self-generated ECCM up to 2 points.

**4xECCM:** Allows use of up to 4 points of ECCM as above.

**6xECCM:** Allows use of maximum ECCM levels.

**2xECCM:** Allows use of up to 2 points of ship-generated ECM and any self-generated ECM up to 2 points. Small target modifiers of up to a +1 shift can be used.

**4xECCM:** Allows use of up to 4 points of ECM as above. All small target modifiers apply.

**6xECCM:** Allows use of maximum ECM levels.

**OFFENSIVE EW:** Allows loaning of offensive EW to enemy units.



# MANEUVERING TECHBLOCKS

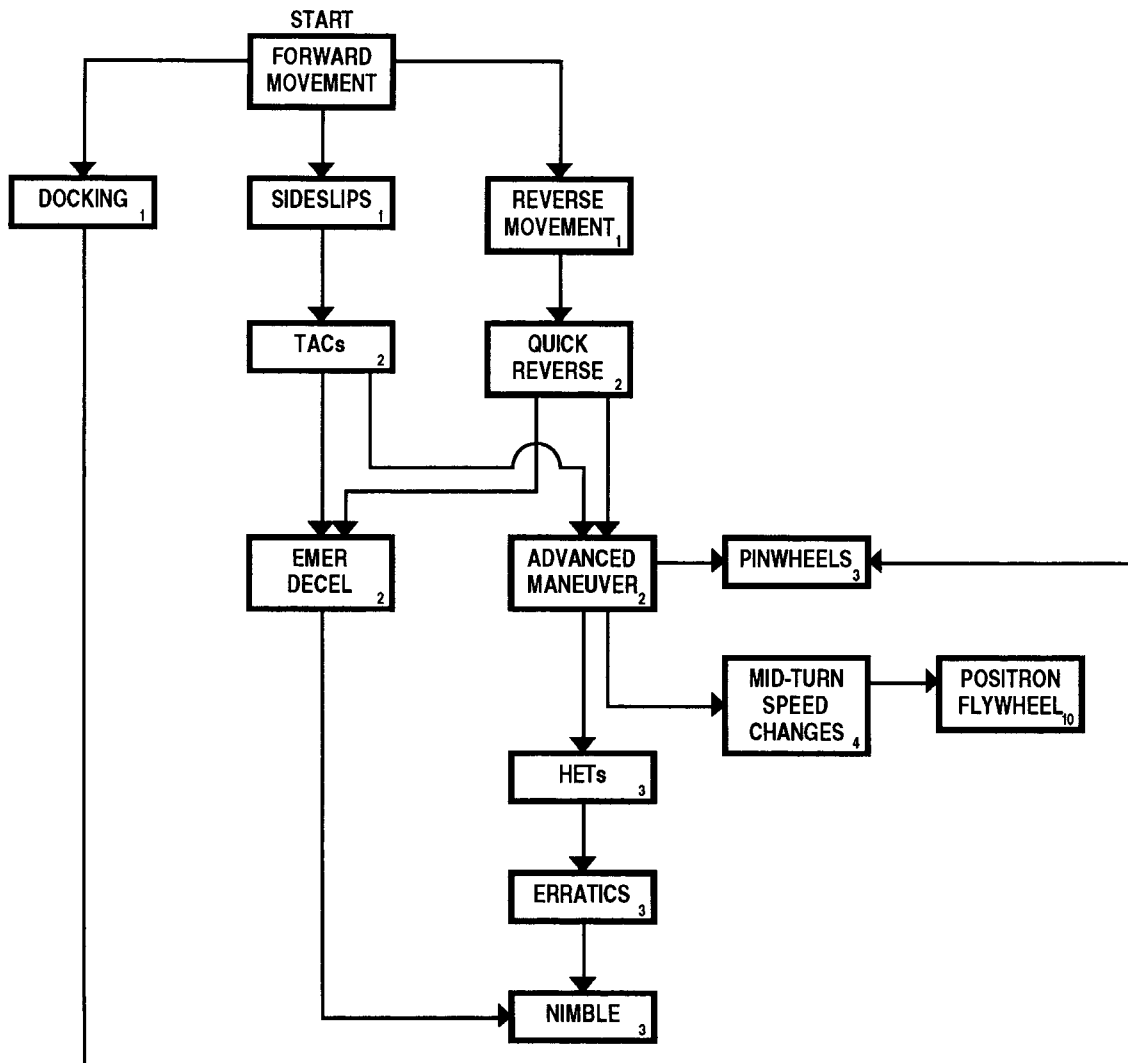

## MANEUVERING TECHBLOCKS

**FORWARD MOVEMENT:** Allows units to move in a forward direction or turn using standard turn mode rules. Sideslips, HETs and the like are not allowed until further research is performed. Ships can make zero energy turns but no other tactical maneuvers. Nimble ships are treated as normal ships for all purposes.

**SIDESLIPS:** Allows sideslips.

**TACTICAL MANEUVERS:** Allows warp and impulse tactical maneuvers.

**DOCKING:** Allows docking. Without this block, units which require docking to perform certain actions cannot perform them: tugs cannot reattach pods, ships may not dock to bases, repairs which require docking to a repair-capable ship cannot be performed, PFs cannot be landed on mech links, etc. Shuttles can be landed normally without this block (this is not considered docking).

**REVERSE MOVEMENT:** Allows ships to move in reverse and/or use braking energy.

**QUICK REVERSE:** Allows quick reverses.

**EMERGENCY DECELERATION:** Allows use of emergency deceleration.

**ADVANCED MANEUVERS:** Allows access to advanced maneuver TechBlocks.

**PINWHEELS:** Allows use of pinwheels.

**HIGH ENERGY TURNS:** Allows use of HETs. Until this block is acquired, ships do not have their "first-use" breakdown bonus, which may be important if the ship attempts a quick reverse, becomes trapped in web, or performs another action which requires a breakdown roll.

**MID-TURN SPEED CHANGES:** Allows use of mid-turn speed changes.

**ERRATIC MANEUVERS:** Allows use of erratic maneuvers. Note that EM provides only as much ECM as the player has researched; for example, if the player has only 2xECM, then EM would provide only 2 points of ECM, not 4.

**NIMBLE:** Allows use of nimble benefits (if present on ship). No refit is required.

**POSITRON FLYWHEEL:** Allows use of positron flywheel (if allowed in the campaign). Refit required (and an expensive one at that).

# SHUTTLE AND FIGHTER TECHBLOCKS

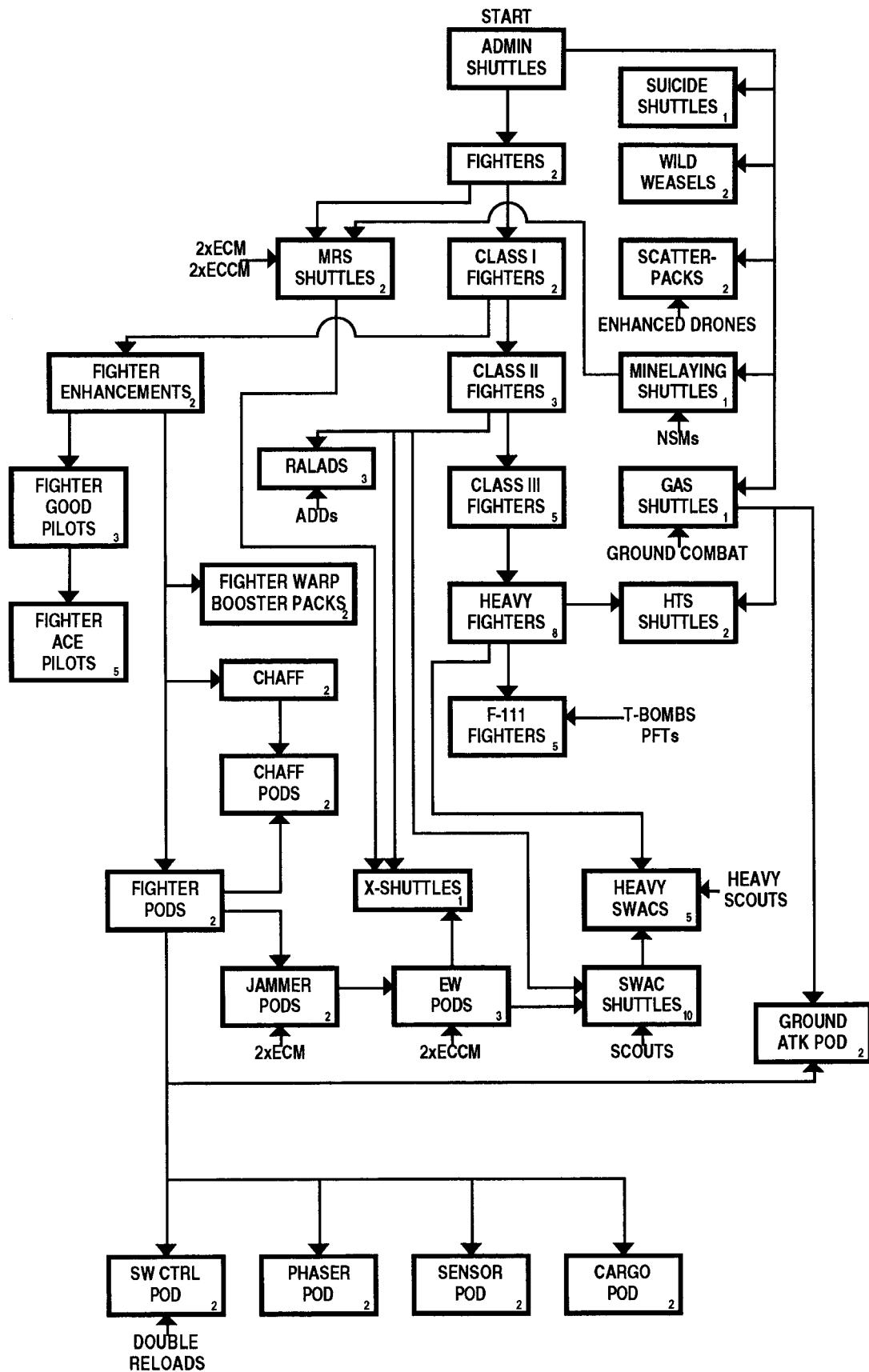

**SHUTTLE AND FIGHTER TECHBLOCKS**

**ADMIN SHUTTLES:** Allows use of standard admin shuttles with no enhancements. Sublight shuttles are also available, but are not required, except on sublight Romulan ships not yet upgraded to first-generation warp technology.

**MINELAYING SHUTTLES:** Allows MLS and MSS class shuttles.

**GROUND ASSAULT SHUTTLES:** Allows use of GAS shuttles. If an empire has Gorns or TROOP TRANSPORTS but does not possess this block, all GAS shuttles listed as such are admin shuttles until this block is bought, at which time they "become" GAS shuttles automatically at no cost.

**SCATTER-PACKS:** Allows use of scatter-packs.

**SUICIDE SHUTTLES:** Allows use of suicide shuttles.

**WILD WEASELS:** Allows use of wild weasels. Note that wild weasels cannot provide more ECM than your current ECM tech level; e.g., if you have 2xECM, a WW would only provide 2 ECM. As soon as you researched 4xECM, weasels would provide 4, and so on.

**FIGHTERS:** Allows use of the first available fighter class for the player's race (Gladiator-1s, Z-1s, Stinger-1s, etc.). All pilots are considered "green."

**MULTI-ROLE SHUTTLES:** Allows use of multi-role shuttles by qualified ships.

**CLASS 1 FIGHTERS:** Allows use of any class-1 fighter (0-7 BPV).

**CLASS 2 FIGHTERS:** Allows use of any class-2 fighter (8-10 BPV).

**CLASS 3 FIGHTERS:** Allows use of any class-3 fighter (11-15 BPV).

**HEAVY FIGHTERS:** Allows use of any heavy fighter.

**HEAVY TRANSPORT SHUTTLE:** Allows use of HTSs.

**FIGHTER ENHANCEMENTS:** Allows access to various fighter enhancement blocks.

**CHAFF:** Allows use of chaff. Until this block is acquired, chaff shown on the fighter display is simply not present; as soon as this block is researched, it appears automatically with no refit or resupply required (including carrier spares).

**FIGHTER WARP BOOSTER PACKS:** Allows use of WBPs on fighters or shuttles, although such WBPs must still be purchased before they can be used.

**FIGHTER GOOD PILOTS:** All new fighters coming on line have good pilots instead of green. Existing green pilots remain green and must advance through combat experience.

**FIGHTER ACE PILOTS:** Every 12th fighter bought has an ace pilot automatically at no cost (maximum one ace per squadron in play). Roll for legendary status at creation time.

**FIGHTER PODS:** Allows use of fighter cargo and sensor pods, and access to additional pod blocks.

**JAMMER PODS, EW PODS, GROUND ATTACK PODS, PHASER PODS, SEEKING WEAPON PODS, CHAFF PODS:** Allows use of the appropriate pod as described in Module J.

**RALADS:** Allows use of Rail-Launched Anti-Drones.

**SWACS:** Allows use of SWAC shuttles by Federation players.

**HEAVY SWACS:** Allows use of heavy SWACS.

**F-111 FIGHTERS:** Allows use of F-111s by Federation players.

**X-SHUTTLES:** Allows use of X-shuttles on X-ships only. Without this block, X-ships use normal admin shuttles.

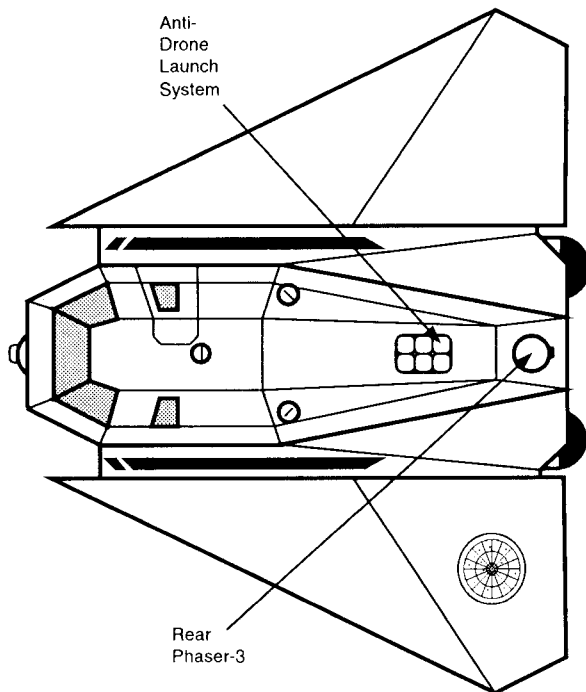

FEDERATION A-20 FIGHTER (John R Wagner)

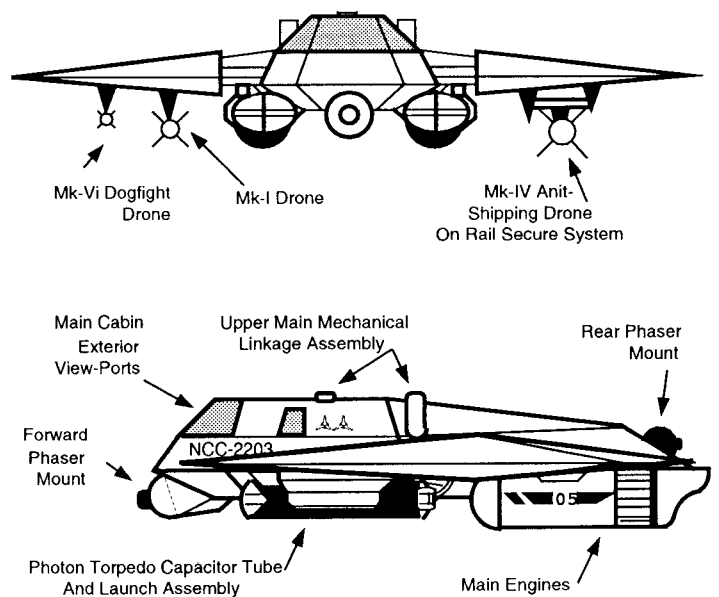

# FAST PATROL SHIP TECHBLOCKS

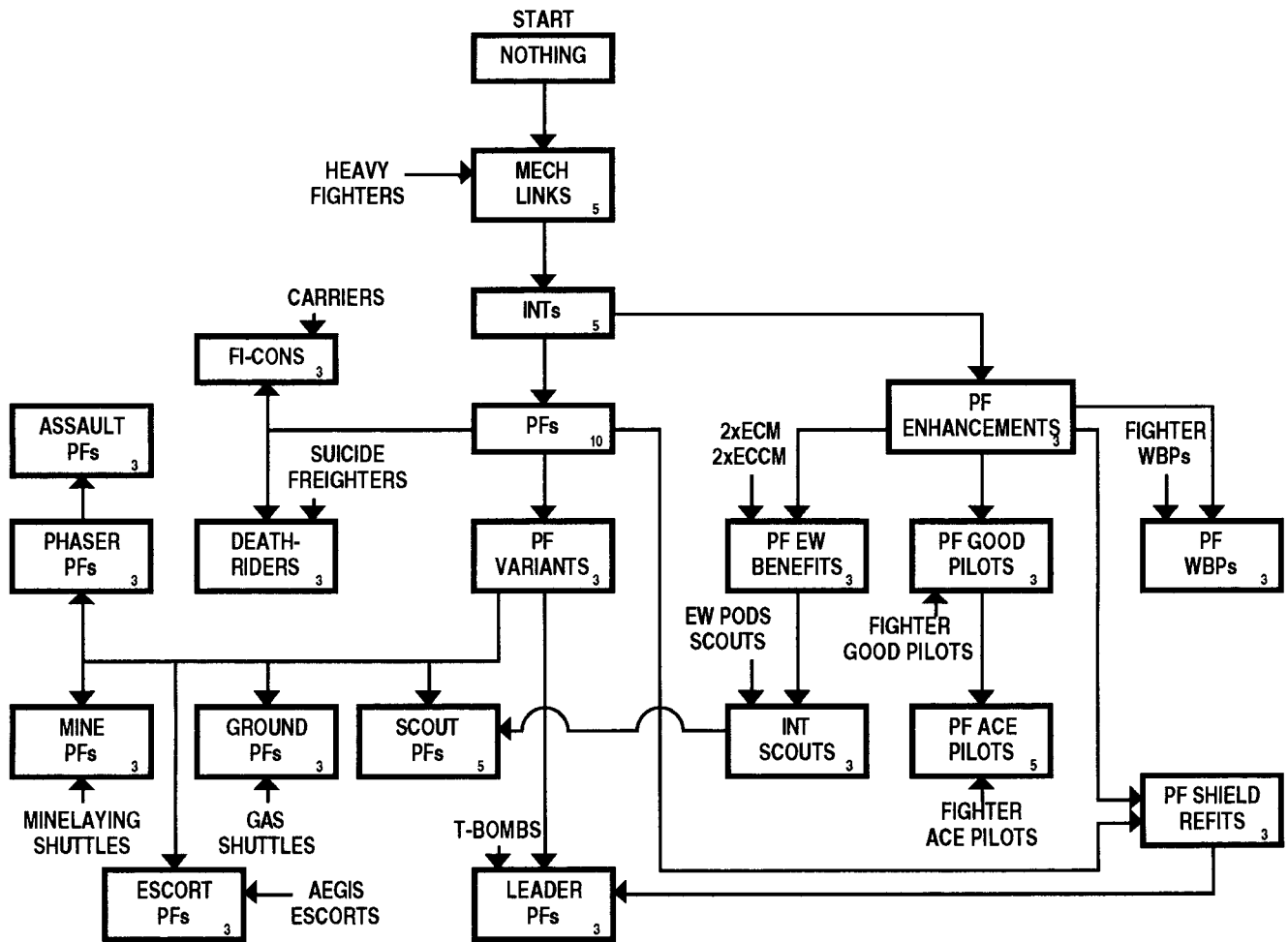

## FAST PATROL SHIP TECHBLOCKS

*Note: There is no starting block for this tech.*

**MECH LINKS:** Allows addition of mech links to ships as casual PF tenders. Note: If you do not have this block, ships with mech links on the SSD (such as most BBs) must be built without them, and adding them after construction is considered a refit.

**INTERCEPTORS:** Allows construction of basic interceptor designs. All such interceptors have no booster packs, no available variants, and green crews.

**FAST PATROL SHIPS:** Allows construction of basic PF designs.

**PF ENHANCEMENTS:** Allows access to certain PF and interceptor enhancement blocks. Note that PFs have nimble benefits only if the NIMBLE block has been acquired. None of these enhancements require refits unless otherwise noted.

**PF GOOD PILOTS:** All new PFs coming on line have good pilots instead of green. Existing green pilots remain green and must advance through combat experience.

**PF ACE PILOTS:** For every full flotilla (6 PFs, including leader and scout), one of the non-leader, non-scout PFs will be an ace pilot at no cost (maximum one ace per flotilla). Roll for legendary status at creation time.

**EW BENEFITS:** Allows PFs to utilize their special EW benefits (they can receive loaned EW from their tender without this block, but only if the player has researched SCOUTS).

**PF WARP BOOSTER PACKS:** Allows PFs to use warp booster packs. If PFs or INTs are built without this block, they cannot use WBPs, but as soon as this block is researched, they receive one set (and their PFTs receive the listed quantity of sets) automatically at no cost (no refit required).

**INTERCEPTOR SCOUTS:** Allows construction of interceptor scouts.

**SHIELD REFITS:** Allows PFs to purchase shield refits (refit required).

**FI-CONS:** Allows fighter-conveyors to be constructed.

**LEADER PFs:** Allows construction of leader PFs.

**DEATH-RIDERS:** Allows use of Death-Rider PFs and interceptors.

**PF VARIANTS:** Allows use of cargo PFs and access to certain additional PF variant TechBlocks.

**SCOUT PFs:** Allows construction of scout PFs.

**GROUND ASSAULT PFs:** Allows use of ground assault variant PFs.

**MINE WARFARE PFs:** Allows use of mine warfare PFs.

**PHASER PFs:** Allows use of phaser-variant PFs if any exist for the race in question.

**ESCORT PFs:** Allows use of escort (plasma-D) PFs.

**ASSAULT PFs:** Allows use of assault PFs such as the Klingon G-1B.

## MINE WARFARE TECHBLOCKS

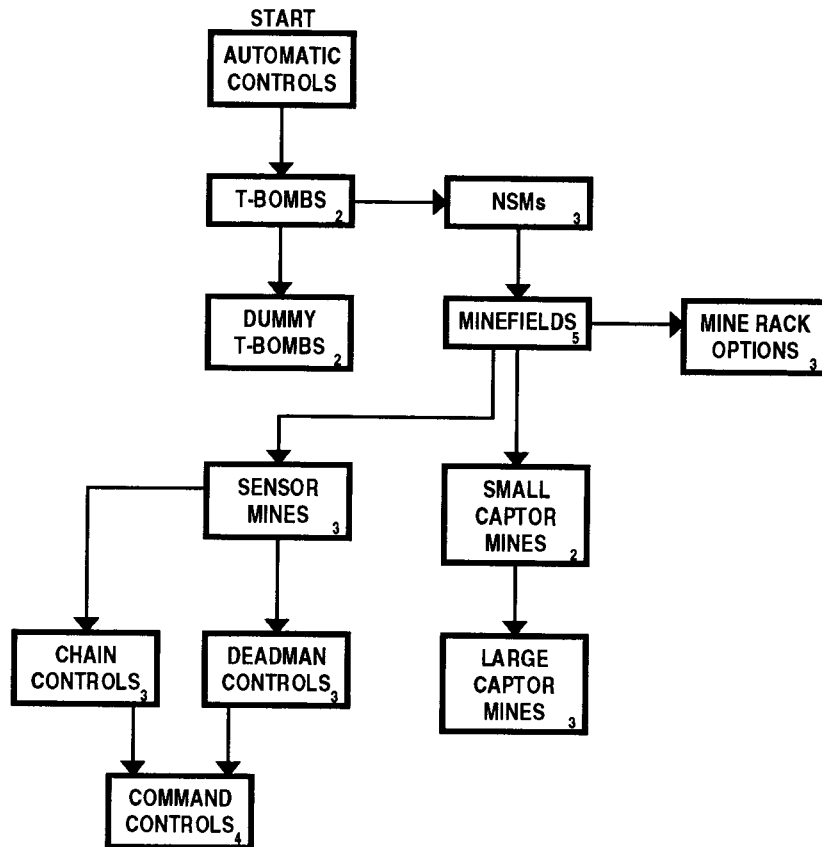

## MINE WARFARE TECHBLOCKS

**AUTOMATIC CONTROLS:** Allows use of automatic control systems for mines.

**TRANSPORTER BOMBS:** Allows purchase and use of transporter bombs during scenarios.

**DUMMY T-BOMBS:** Allows use of dummy T-bombs. When this block is acquired, all existing T-bombs gain one dummy T-bomb automatically, at no cost.

**NUCLEAR SPACE MINES:** Allows purchase and use of nuclear space mines in units which can utilize them (and, for the Andromedans, power absorber mines). Old Romulans which have NSMs in their ship description cannot utilize them without this block, but they are still present, and do not need to be bought when this block is required. Second- and third-generation Romulans cannot buy NSMs until this block is researched.

**MINEFIELDS:** Allows players to lay minefields.

**MINE RACK OPTION MOUNTS:** Allows mine racks to be placed in option mounts.

**SMALL CAPTOR MINES:** Allows purchase of small captor mines as appropriate to your race (Andros use trans-captor mines). Note that any such mines will also be limited to other tech you may or may not have purchased; e.g., drone captors can only use drone enhancements you have paid to research, and plasma-D captors can only be used if you have PLASMA-D TORPEDOES.

**LARGE CAPTOR MINES:** Allows purchase of large captor mines.

**SENSOR MINES:** Allows purchase of sensor mines.

**CHAIN CONTROLS:** Allows purchase of chain control systems for mines.

**DEADMAN CONTROLS:** Allows purchase of deadman control systems for mines.

**COMMAND CONTROLS:** Allows purchase of command control systems for mines.

## OFFICER AND CREW TECHBLOCKS

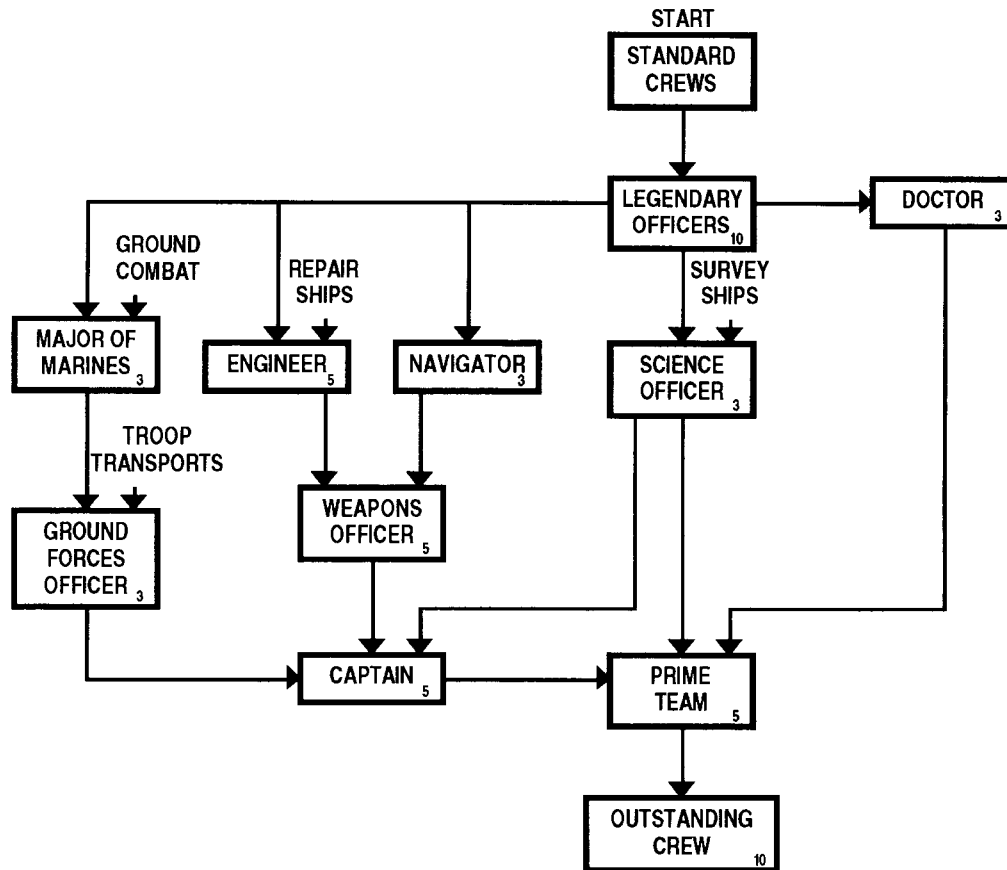

## OFFICER AND CREW TECHBLOCKS

*Note: This tech flowchart is optional and should only be used if players wish to buy their own officers and crews for their ships. It is recommended that such purchases be limited; otherwise, most direct-fire races will buy weapons officers for their heavy firepower ships, and most everyone will want legendary engineers and navigators. By limiting officers, you avoid this "officer escalation" and the resulting disruption of your campaign.*

**STANDARD CREWS:** Ships begin the game with standard crews and officers.

**LEGENDARY OFFICERS:** Ships can purchase or acquire legendary officers (by whatever means are provided in the campaign rules), but only those for which the appropriate blocks (below) have been researched. If an officer is present on a ship but the appropriate block has not been acquired, the officer is

considered non-legendary, but must still be tracked (as he might still be killed or wounded in battle).

**DOCTOR:** Legendary Doctors are available.

**SCIENCE OFFICER:** Legendary Science Officers are available.

**NAVIGATOR:** Legendary Navigators are available.

**MAJOR OF MARINES:** Legendary Majors of Marines are available.

**GROUND FORCES OFFICER:** Legendary Ground Forces Officers are available, and other officers capable of using this function have access to it.

**ENGINEER:** Legendary Engineers are available.

**WEAPONS OFFICER:** Legendary Weapons Officers are available.

**CAPTAIN:** Legendary Captains are available.

**PRIME TEAMS:** Prime Teams are available.

**OUTSTANDING CREW:** Outstanding Crews are available.

# DRONE TECHBLOCKS

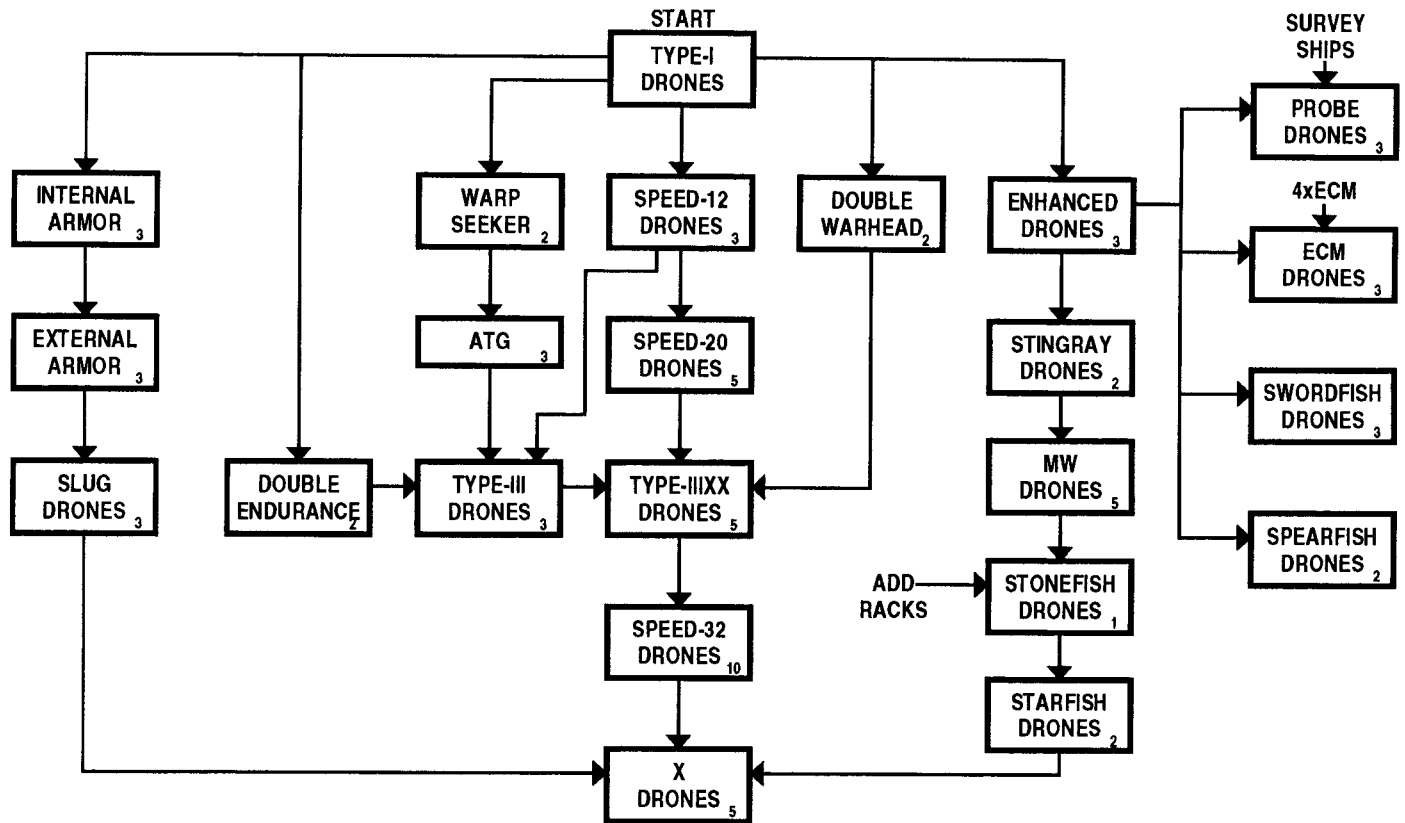

## DRONE TECHBLOCKS

**TYPE-I DRONES:** All drones are type-I slow. When a faster speed or improved drone is acquired, drones do not instantly become faster/better; the appropriate cost must be paid, and the ship must move to a supply point (usually a base) or be visited by a resupply ship to replace its drones with the improved versions. This does not, however, require a refit.

**SPEED-12:** Moderate (speed-12) drones are available. This includes type-II drones.

**SPEED-20:** Medium-speed drones are available.

**SPEED-32:** Fast drones are available.

**DOUBLE WARHEAD:** Type-IV double-warhead drones are available. If SPEED-12 is also purchased, type-V drones are available at no additional research cost.

**DOUBLE ENDURANCE:** Extra endurance can be purchased for drones.

**WARP SEEKER:** Type-VI dogfight drones are available.

**ACTIVE TERMINAL GUIDANCE (ATG):** Allows purchase of ATG for drones.

**TYPE-III DRONES:** Allows purchase of type-III drones.

**TYPE-IIIXX DRONES:** Allows purchase of type-IIIXX long-range drones and use of wild-boar and/or tame-boar targeting. Ships cannot make long-range drone bombardment attacks without this block.

**INTERNAL ARMOR:** Allows use of internal drone armor.

**EXTERNAL ARMOR:** Allows use of external drone armor.

**SLUG DRONES:** Allows use of slug drones.

**ENHANCED DRONES:** Allows access to various enhanced drone blocks.

**PROBE DRONES, ECM DRONES, SWORDFISH DRONES, SPEARFISH DRONES, STINGRAY DRONES, MULTI-WARHEAD DRONES, STONEFISH DRONES, STARFISH DRONES:** Allows use of these special drones. (Note: Stonefish drones first appeared in Module P6.)

**X-DRONES:** Allows use of X-drones on X-ships. Without this block, all drones on X-ships remain at current technological levels.

# DRONE RACK TECHBLOCKS

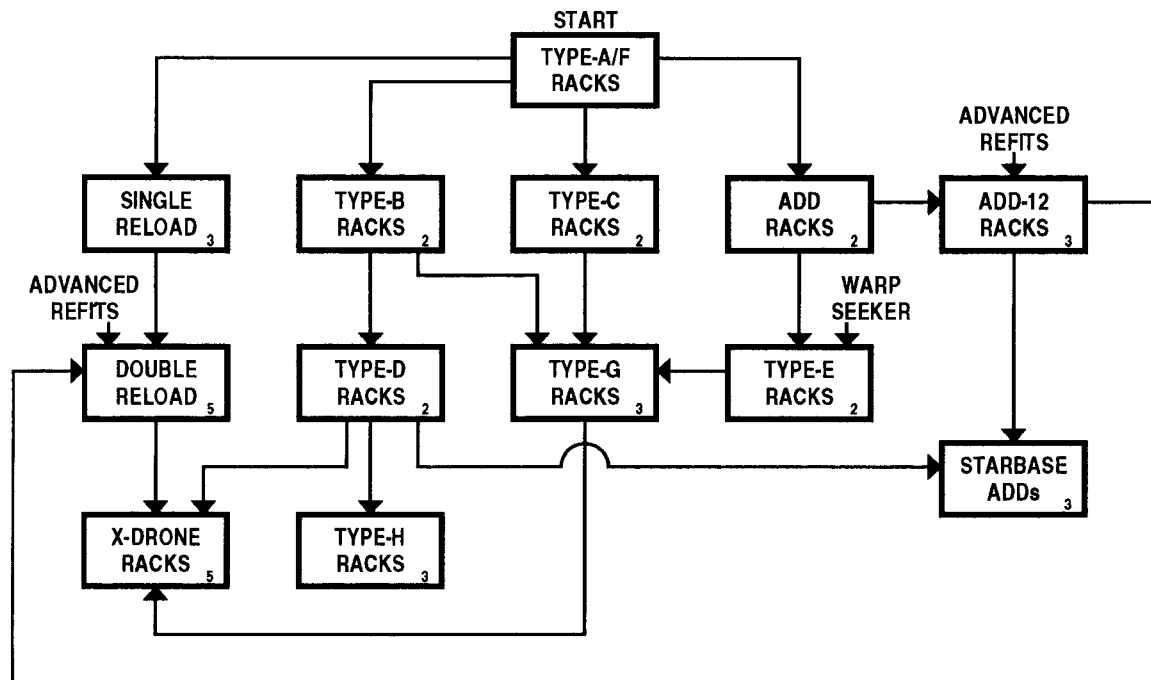

## DRONE RACK TECHBLOCKS

**A/F-RACKS:** Ships have type-A racks (type-F in the case of certain Klingon ships). If ships are built which have other rack types shown on the SSD, these are treated as A-racks until the appropriate blocks are obtained, at which time the racks can be upgraded by using the campaign refit procedures.

**B-RACKS:** Ships can utilize B-racks.

**C-RACKS:** Ships can utilize C-racks.

**D-RACKS:** Bases and certain tugs/pods can utilize D-racks.

**H-RACKS:** Starbases can utilize H-racks.

**ANTI-DRONE RACKS:** Ships can utilize ADD-racks. ADD racks on ships without this block cannot be used (even to launch dogfight drones) until this block is acquired (ADD racks are still present, and can be damaged, repaired, etc.). No refit is required to activate them when this block is acquired.

**ADD-12:** Ships with ADD-12s can use the extra ADDs; if this block is not researched, any ADD-12s on SSDs are treated as ADD-6s for all purposes (e.g., they have only enough reloads for a standard ADD-6).

**STARBASE ADD:** Allows starbases to utilize their special ADD racks; until this block is researched, starbases have "normal" ADD racks.

**E-RACKS:** Ships can utilize E-racks.

**G-RACKS:** Ships can utilize G-racks.

**SINGLE RELOAD:** Drone/plasma racks acquire a single reload (if this block is not purchased, racks have no reloads at all). Plasma racks cannot purchase this block without the PLASMA-D RACK block as a prerequisite.

**DOUBLE RELOAD:** Allows ships to utilize the "Y175 refit" which doubles their reload capacity for drone and plasma-D racks. Refit required.

**X-DRONE RACKS:** Allows construction of drone-armed X-ships. Without this block, drone-armed X-ships cannot be built. You cannot elect to build X-ships without this block.

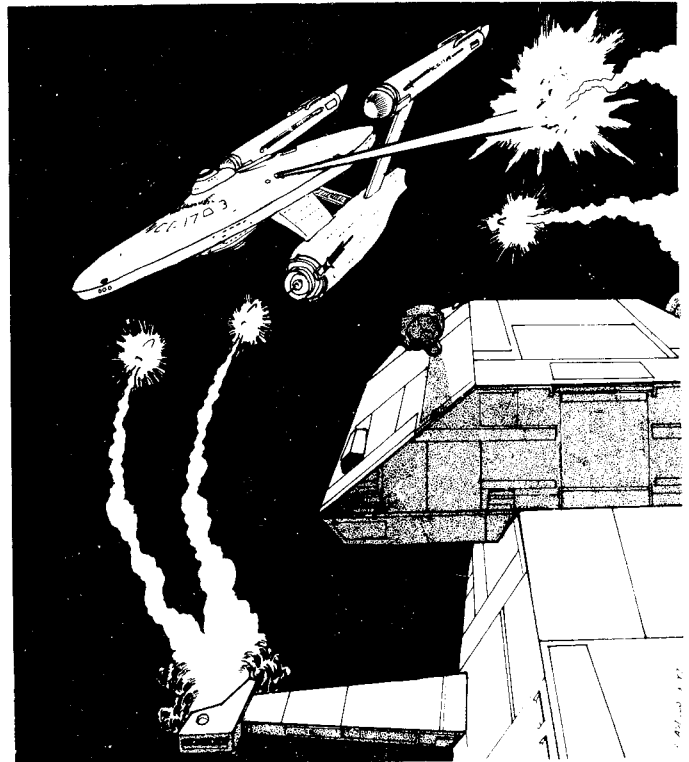



# PLASMA TORPEDO TECHBLOCKS

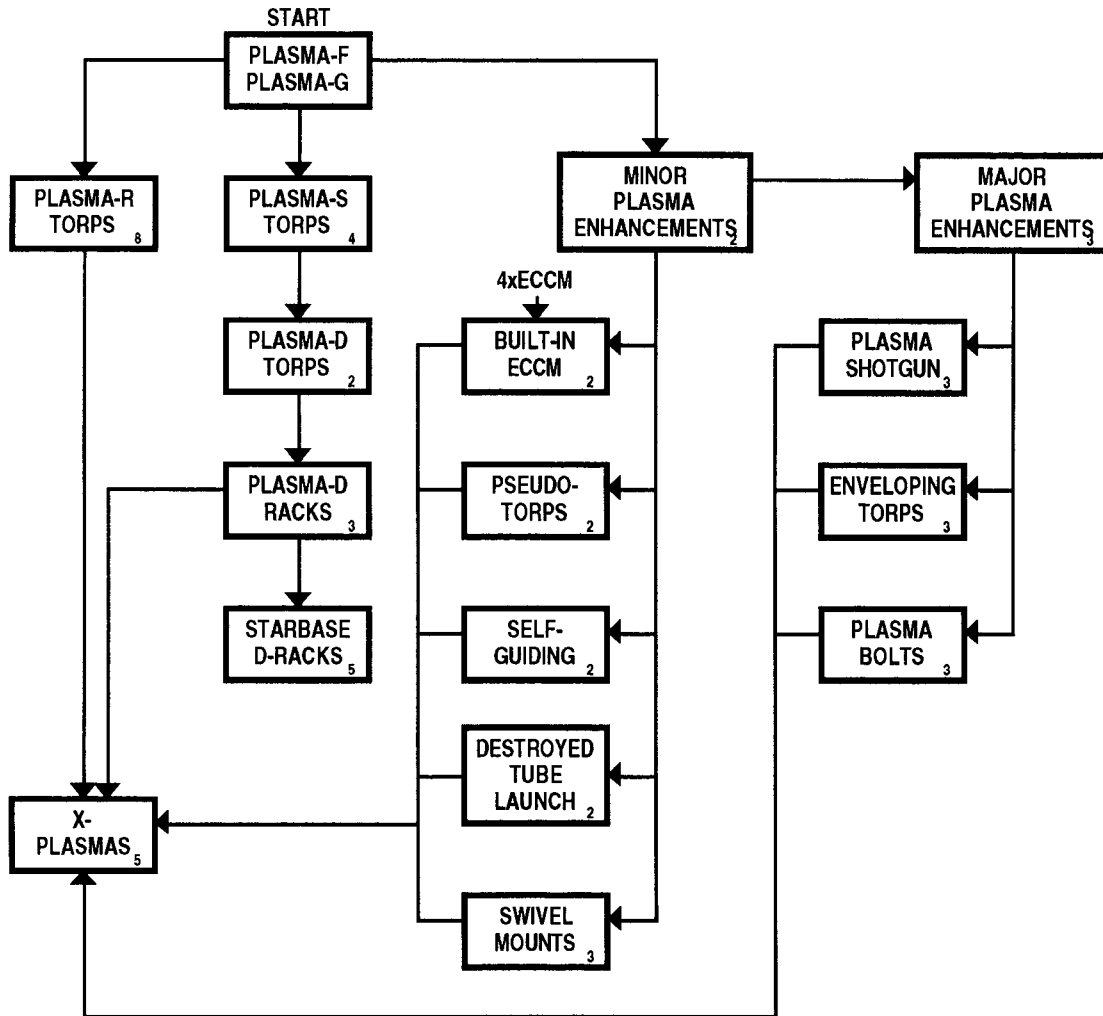

## PLASMA TORPEDO TECHBLOCKS

**PLASMA-G:** Ships can have plasma-F or plasma-G torpedoes, but these cannot be held. Plasma-F torpedoes do not have stasis boxes. Ships with larger torpedoes cannot be built; refits which add larger plasmas cannot be received. No launchers have swivels. Torpedoes lack most of their special features.

**PLASMA-S:** Plasma-S-equipped ships may be built, and refits upgrading plasma-G to plasma-S can be utilized (refit required) if FIRST REFITS is also purchased.

**PLASMA-R:** Plasma-R-equipped ships may be built.

**PLASMA-D:** Plasma-D torpedoes are available. Fighters using this weapon can be purchased and reloaded.

**PLASMA-D RACK:** D-racks become available, but have no reloads until SINGLE RELOAD (found on the Drone Rack tech flowchart) is researched.

**STARBASE PLASMA RACK:** Starbases can utilize their special plasma-D racks. Without this block, starbases have standard plasma-D racks; these are upgraded automatically (no refit required) to starbase types when this block is researched.

**MINOR PLASMA ENHANCEMENTS:** Plasma-F torpedoes have stasis boxes and plasma torpedoes can be held. Also

allows access to various plasma torpedo enhancement blocks; except as noted, none of these enhancements require refits.

**BUILT-IN ECCM:** Allows plasmas to use their ECCM.

**PSEUDO-TORPEDOES:** Plasma launchers gain the ability to use their pseudo-torpedoes.

**SELF-GUIDING TORPEDOES:** Plasmas can now be self-guiding.

**DESTROYED TUBE LAUNCH:** Torpedoes can be launched from destroyed launchers.

**SWIVEL MOUNTS:** Plasma launchers can utilize swivel mounts, and refits which make these mounts available can now be purchased (refit required).

**MAJOR PLASMA ENHANCEMENTS:** Allows access to several useful plasma blocks; none of these abilities require refits.

**PLASMA SHOTGUNS:** Allows use of plasma shotguns.

**ENVELOPING TORPEDOES:** Allows use of enveloping plasma torpedoes.

**PLASMA BOLTS:** Allows use of plasma bolts.

**X-PLASMAS:** Allows X-ships armed with plasmas to be purchased. Plasma-armed X-ships cannot elect to not have this block; they cannot be purchased without it.

# MARINE TECHBLOCKS

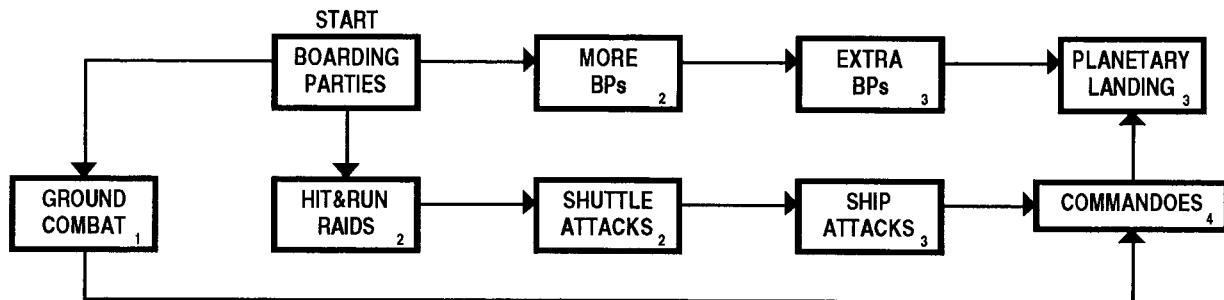

## MARINE TECHBLOCKS

**BOARDING PARTIES:** Ships possess the basic number of marines shown on their SSDs, but these marines can only defend their ship from capture; they cannot do anything else (including prevent self-destruction).

**GROUND COMBAT:** The player can make ground assaults and use any of the special items or units in Module M which does not need another TechBlock (e.g., ground combat vehicles, engineers, or transporter artillery could be used, but HTS shuttles or commandoes require their own block). In complex campaigns, a block of this sort may be required for several different planetary types (airless, ice, molten, etc.).

**MORE BOARDING PARTIES:** Ships may buy an additional number of boarding parties, up to 25% of the ship's original complement, maximum of 5 added.

**EXTRA BOARDING PARTIES:** As above but ships can buy up to 50% of their complement, maximum of 10 added.

**HIT AND RUN RAIDS:** Ships can make hit-and-run raids and can assign boarding parties as guards.

**SHUTTLE ATTACKS:** Boarding parties can attack shuttles.

**SHIP ATTACKS:** Boarding parties can attempt to capture enemy ships, prevent self-destruction, etc.

**COMMANDOES:** Ships can buy commandoes.

**PLANETARY LANDING:** Ships which are capable of landing on planets (by whatever means) may do so. Without this block, any attempt to land automatically results in a crash landing. Note that shuttles and PFs do not require this block to make landings.

# ORION TECHBLOCKS

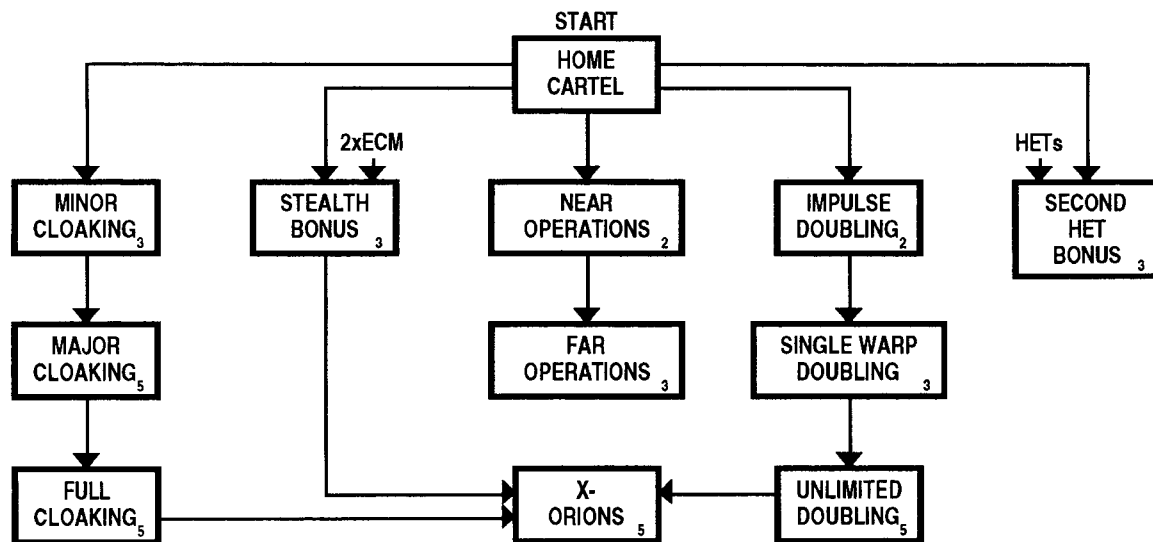

## ORION TECHBLOCKS

**HOME CARTEL:** Orions can buy only optional weapons from their home cartel's race. They do not have stealth, cloaks, engine doubling, or a second HET bonus.

**STEALTH:** Orions gain their stealth bonus.

**NEAR OPERATIONS:** Up to 10% of option mounts (fleetwide) can come from the home cartel's operating zone; the rest must come from the cartel's home race.

**FAR OPERATIONS:** Up to 20% of options can come from the operating zone, while 10% can come from any zone.

**IMPULSE DOUBLING:** Allows impulse engine doubling.

**SINGLE WARP DOUBLING:** Allows Orions to double at most one warp engine per turn (even on size class 4 ships).

**UNLIMITED DOUBLING:** Allows doubling of any warp engines as per the normal rules.

**SECOND HET BONUS:** Allows use of a second high energy turn. If NIMBLE is acquired but this block has not been researched, nimble Orions still have a second HET bonus (provided by the nimble benefit).

**MINOR CLOAKING:** 10% of non-X-Orion ships may purchase the cloaking device.

**MAJOR CLOAKING:** 25% of non-X-Orion ships may purchase the cloaking device.

**FULL CLOAKING:** 50% of non-X-Orion ships may purchase the cloaking device.

**X-ORIONS:** Allows construction of Orion X-ships. Without this block, Orion X-ships cannot be built. Note that all X-Orions possess the cloak, though it will not function without X-CLOAKS.

# CLOAKING DEVICE TECHBLOCKS

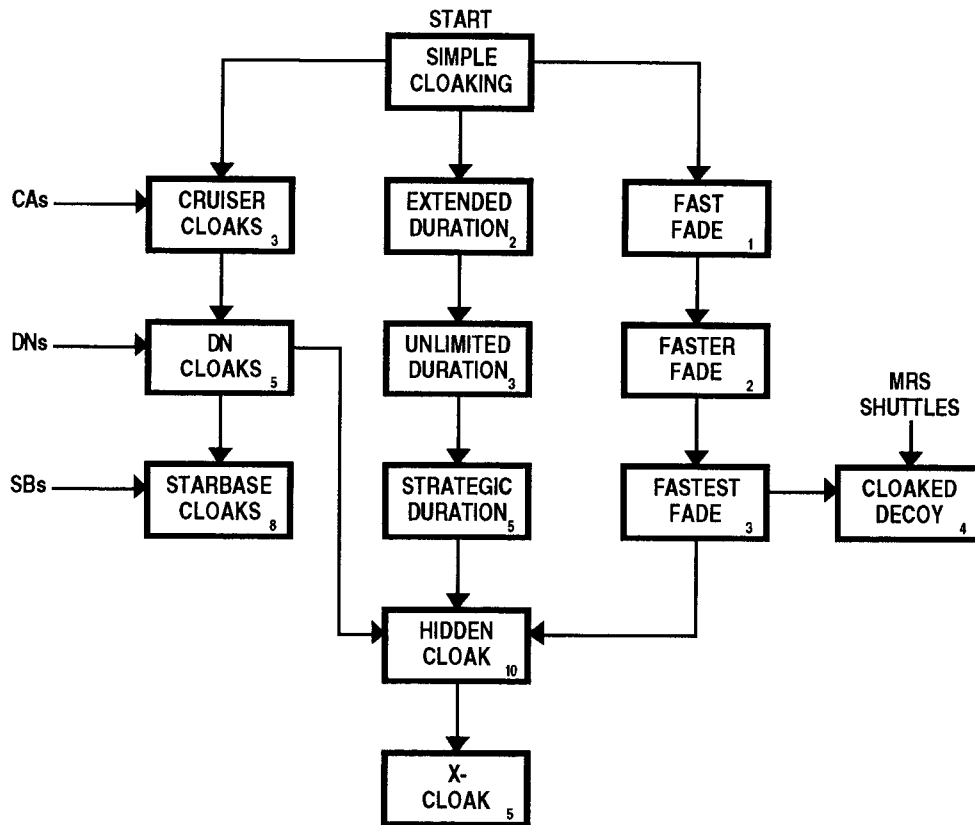

## CLOAKING DEVICE TECHBLOCKS

**SIMPLE CLOAKING:** Only size class 4 and smaller ships can use cloaks. Cloaks can be active for at most 32 consecutive impulses and have an 8-impulse fade-in/out period. These factors are improved by various blocks below; except as noted, no refit is required with these upgrades.

**EXTENDED DURATION:** Cloaks can be active for up to 96 consecutive impulses.

**UNLIMITED DURATION:** Cloaks can be active indefinitely.

**STRATEGIC DURATION:** Cloaks can be used for strategic movement to keep the fleet concealed while moving (subject to local campaign rules). It is recommended that any fleet allowed to do this be required to move very slowly or suffer other penalties as appropriate to your campaign.

**CRUISER CLOAKS:** Cloaks now work on size class 3 units.

**DREADNOUGHT CLOAKS:** Cloaks now work on size class 2 units.

**STARBASE CLOAKS:** Cloaks now work on size class 1 units.

**FAST FADE:** Cloak fade-in/out time is reduced to 7 impulses.

**FASTER FADE:** Fade-in/out reduced to 6 impulses.

**FASTEST FADE:** Fade-in/out reduced to 5 impulses (the standard level).

**CLOAKED DECOY:** Allows purchase and use of cloaked decoy units.

**HIDDEN CLOAK:** Allows purchase of hidden cloak (if allowed by campaign rules). Installation of hidden cloak on existing units is treated as a refit.

**X-CLOAKS:** Allows Romulan and Orion X-ships to use the cloak. X-ships CAN be built without this block; if so, the cloak is present on the ship but cannot be used (even using non-X rules) until this block is acquired.

# WEB TECHBLOCKS

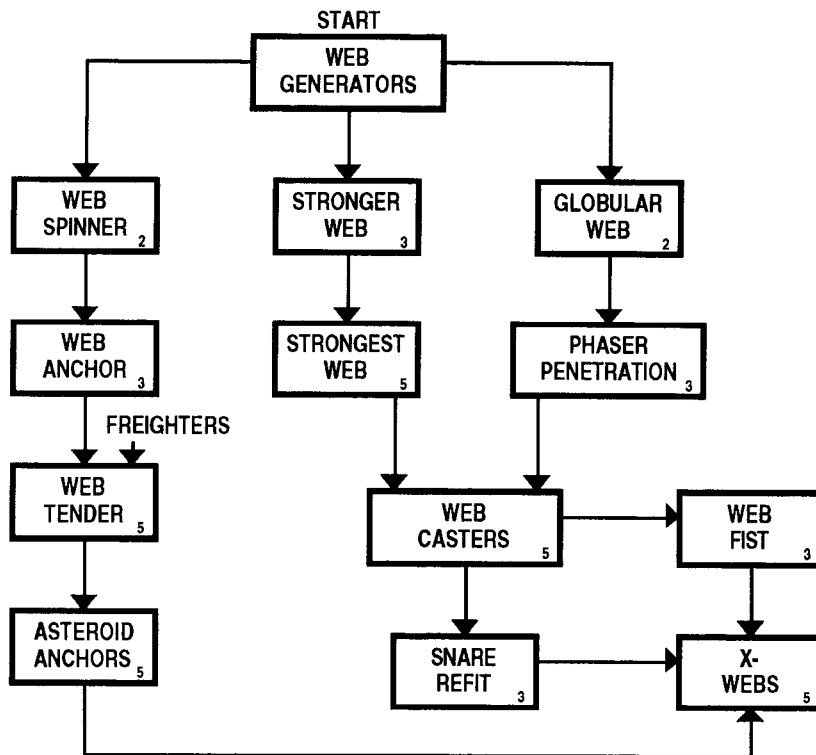

## WEB TECHBLOCKS

**WEB GENERATOR:** Tholian ships can use their web generators, but only to lay linear web. Web strength is 1xNormal strength. Note: Non-Tholian players may not purchase any of these TechBlocks, even if they purchase a ship from a Tholian player.

**STRONGER WEB:** Web strength is 1.5xNormal.

**STRONGEST WEB:** Web strength is 2xNormal.

**WEB SPINNER:** Web spinner units can be constructed.

**WEB ANCHOR:** Web anchors can be constructed.

**WEB TENDER:** Web tenders can be constructed.

**ASTEROID ANCHORS:** The player can purchase asteroids for use as permanent web anchor points. It is assumed that these are found somewhere in space near the world where the base is located. An actual asteroid belt or field in the system is not required as long as there is some sort of stellar body there (i.e., a star or remnant thereof), because all star systems

contain some quantity of otherwise worthless rocks waiting to be found. A base being placed in a system containing open space or located far from a stellar body would not have asteroids available.

**GLOBULAR WEB:** Globular webs can be laid.

**PHASER PENETRATION:** Tholian phasers can fire through web. Until this block is purchased, they cannot do so.

**WEB CASTER:** Web caster-equipped ships (such as Neo-Tholians) can be purchased, and web caster refits become available (if **ADVANCED REFITS** have been researched); refit required. Note that campaign rules may limit the number of web casters which can be produced in any given campaign turn.

**WEB FIST:** The web caster can be fired as a web fist.

**SNARE REFIT:** Snare refits are available; refit required.

**X-WEBS:** Allows web-equipped X-ships to be built. Without this block, such ships may not be purchased. You cannot elect to build X-Tholians without this block.

# PARTICLE CANNON TECHBLOCKS

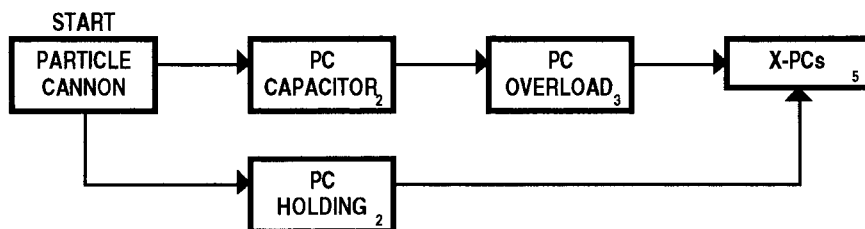

## PARTICLE CANNON TECHBLOCKS

**PARTICLE CANNON:** Starting PCs have a capacitor with a maximum capacitor size of 3.

**PC CAPACITOR:** PC capacitors can hold 5 points of energy.

**PC HOLDING:** PCs can be held.

**PC OVERLOAD:** PCs can be overloaded.

**X-PC:** PC-armed X-ships (if published) can be built.

# SHIELD CRACKER TECHBLOCKS



## SHIELD CRACKER TECHBLOCKS

**SHIELD CRACKER:** Standard SC.  
**WEB BREAKER:** Web Breaker function becomes available.

**X-SHIELD CRACKER:** SC-armed X-ships (if published) can be built.

# ESG TECHBLOCKS

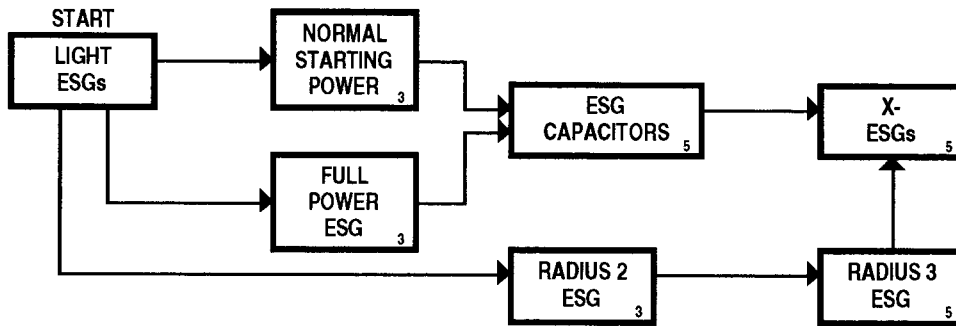

## ESG TECHBLOCKS

**LIGHT ESG:** ESGs can hold at most 3 points of power, have a maximum radius of 1, and have no energy in them at the start of any scenario, even at weapons status-III. They do not have capacitors. Except as noted below, blocks which improve these factors do not require a refit.

**FULL POWER ESG:** ESGs can hold 5 points of power.

**NORMAL STARTING POWER:** ESGs have the normal amount of energy at the start of the scenario as determined by weapons status.

**RADIUS 2 ESG:** ESGs can have radius 2.

**RADIUS 3 ESG:** ESGs can have radius 3.

**ESG CAPACITORS:** ESGs can have capacitors. Existing ships without them must put in for a refit and pay the additional cost for this improvement.

**X-ESGs:** Allows ESG-equipped ships to be built. Without this block, such ships may not be purchased. You cannot elect to build ESG X-ships without this block.

# PHOTON TORPEDO TECHBLOCKS

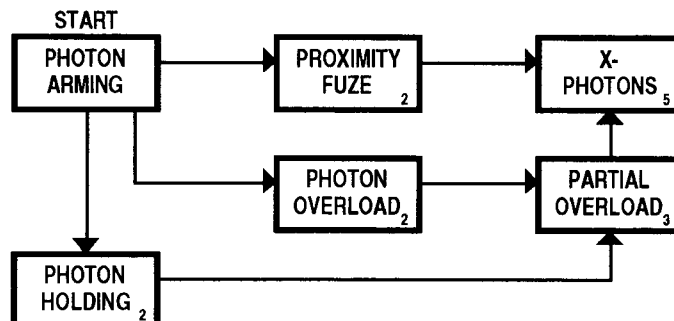

## PHOTON TORPEDO TECHBLOCKS

**PHOTONS:** Standard photons can be armed/fired. Photons cannot be held, but must use rolling delay.

**PHOTON HOLDING:** Photons can be held.

**PROXIMITY FUZE:** Proximity fuze torpedoes can be used.

**PHOTON OVERLOAD:** Photons can be overloaded, but only to full levels.

**PARTIAL OVERLOAD:** Photons can be partially overloaded.

**X-PHOTONS:** Photon-armed X-ships can be built.

# DISRUPTOR TECHBLOCKS

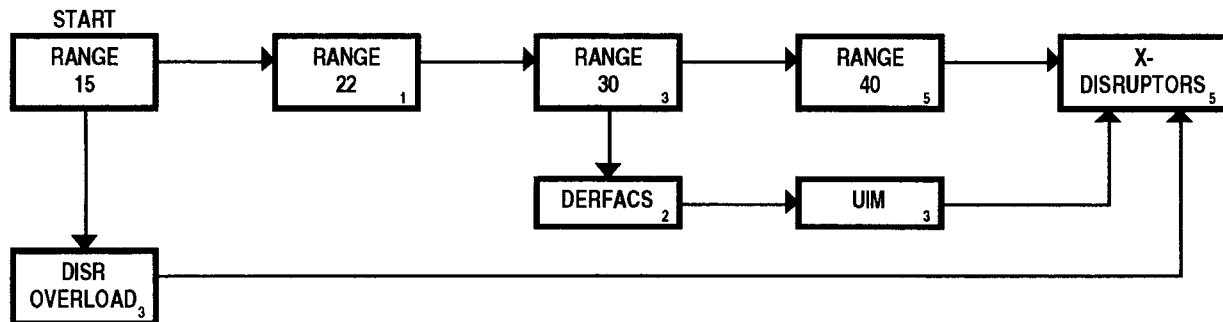

## DISRUPTOR TECHBLOCKS

**DISRUPTORS:** Standard disruptors can be armed/fired. All disruptors have a max range of 15; on ships with longer ranges, they can only fire to this range until the appropriate blocks are researched (no refit is required, however).

**RANGE-22:** Maximum range increased to 22.

**RANGE-30:** Maximum range increased to 30.

**RANGE-40:** Maximum range increased to 40.

**DERFACS:** DERFACS is automatically installed in all ships at no cost.

**UIM:** UIM is available to those races which can use it. Ships with some quantity of UIM included in their cost can now utilize their UIMs. Ships without UIMs can purchase them (as a refit) if allowed to do so by campaign rules (normally only certain races can purchase UIM; in free-form campaigns this restriction is often lifted as a balance factor).

**DISRUPTOR OVERLOAD:** Disruptors can be overloaded.

**X-DISRUPTORS:** Disruptor-armed X-ships can be built.

# FUSION & HELLBORE TECHBLOCKS

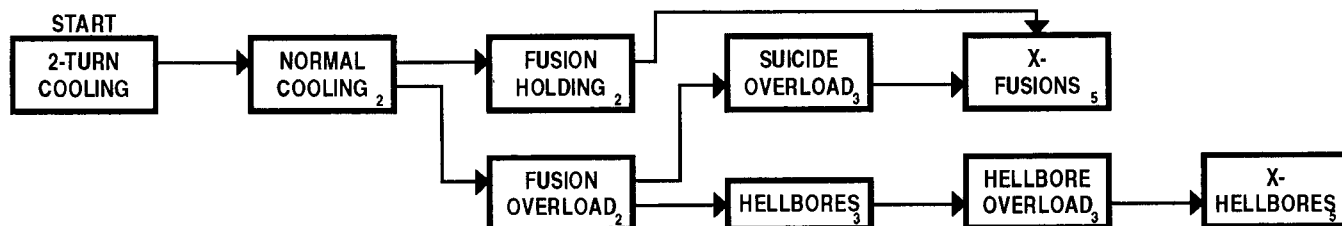

## FUSION & HELLBORE TECHBLOCKS

**2-TURN COOLING:** Fusion beams require two turns of cooling before they can be fired again (fusions on fighters are rearmed normally). Fusions cannot be held or overloaded until additional blocks are acquired.

**NORMAL COOLING:** Fusions require only the normal one turn of cooling.

**FUSION HOLDING:** Fusions can be held.

**FUSION OVERLOAD:** Fusions can be overloaded.

**SUICIDE OVERLOAD:** Fusions can be suicide overloaded.

**X-FUSIONS:** Fusion-armed X-ships can be built.

**HELLBORES:** Hellbore-equipped ships can be built.

**HELLBORE OVERLOAD:** Hellbores can be overloaded.

**X-HELLBORES:** Hellbore-armed X-ships can be built.

# PPD TECHBLOCKS

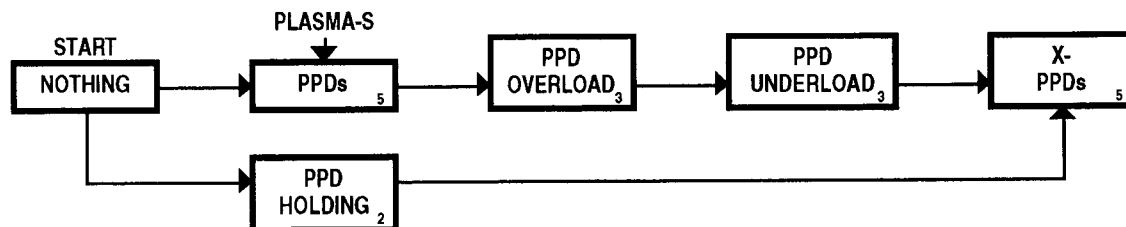

## PPD TECHBLOCKS

*Note: No starting block is available for PPDs. Also, PPD HOLDING is available without PPDs so it can be concurrently researched if desired.*

**PPD:** PPD-armed ships can be built. PPDs cannot be held, but must use rolling delay.

**PPD HOLDING:** PPDs can be held.

**PPD OVERLOAD:** PPDs can be overloaded.

**PPD UNDERLOAD:** PPDs can be underloaded.

**X-PPD:** PPD-armed X-ships can be built.

# ANDROMEDAN TECHBLOCKS

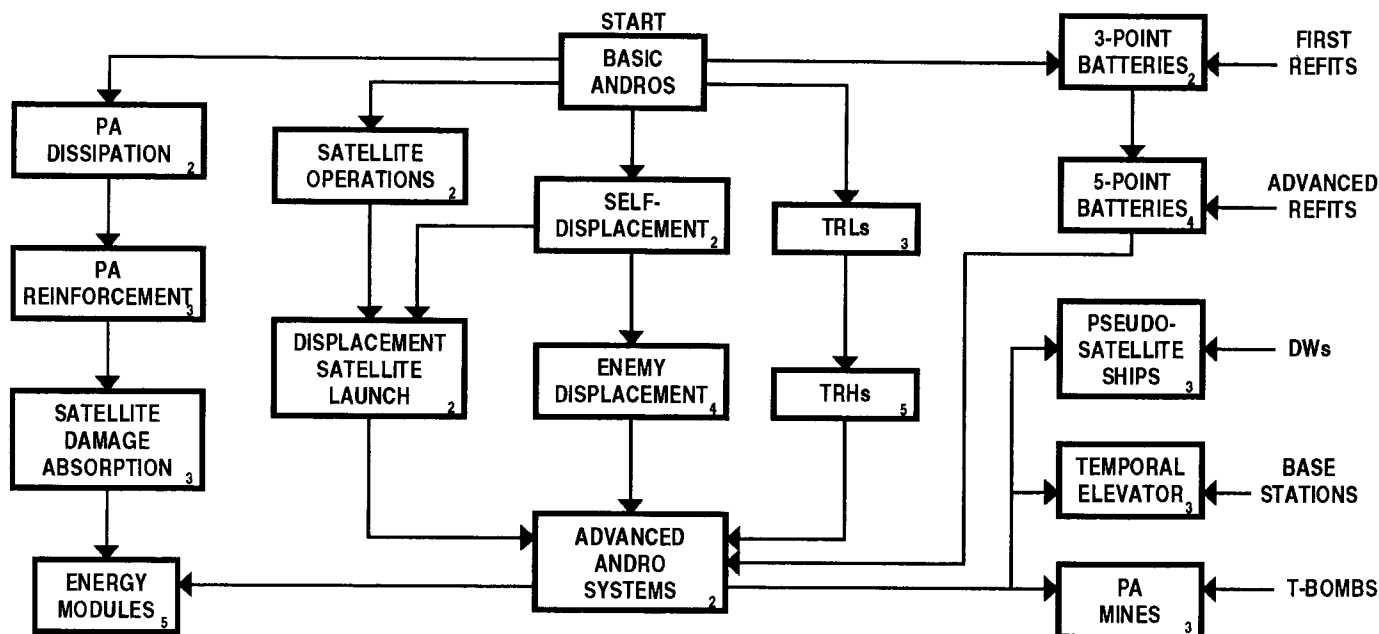

## ANDROMEDAN TECHBLOCKS

*These blocks are appropriate if Andromedans are used by a player in your campaign. If used by the GM as random menaces or as mercenaries, ignore these blocks (or use a portion of them relative to the amount of research available to players).*

**BASIC ANDROS:** Andromedans have no heavy weapons, one-point batteries, no PA panel dissipation abilities, and no advanced technologies. Satellite ships can only be beamed out at speed zero. Displacement can only be used for strategic movement (if used in the campaign), not during scenarios. PA panels cannot be raised to reinforced levels. Damage allocated to "hangar" hits cannot be absorbed by units in the hangar; any such hits go to the next line on the DAC.

**3-POINT BATTERIES:** Andromedan batteries can hold three points of power.

**5-POINT BATTERIES:** Andromedan batteries can hold five points of power.

**TRIs:** Without this block, all TR boxes on SSDs are simply tractor beams, with no offensive capabilities. When TRIs are researched, these become TRIs (no refit required). Note that only boxes shown on the SSD as TRs actually become TRIs (regular tractor beams do not).

**TRHs:** Any TRHs shown on the SSD now become TRHs (no refit required) instead of TRIs (see previous block description).

**SELF-DISPLACEMENT:** Andros can use displacement devices for self-displacement.

**ENEMY DISPLACEMENT:** Andros can use DisDevs offensively against enemy units.

**SATELLITE OPERATIONS:** Without this block, satellite ships can be carried but can only be launched by transporter at speed-0. When SATELLITE OPERATIONS is acquired, these restrictions are lifted, except that satellites still cannot be launched by displacement device.

**DISPLACEMENT SATELLITE LAUNCH:** Satellites can be launched by displacement device.

**PA DISSIPATION:** Allows PA panels to dissipate energy into space (at the standard rate of 1 point per panel per turn). Note that energy can always be absorbed into batteries (no block is required for that).

**PA REINFORCEMENT:** PA panels can be raised to reinforced levels.

**SATELLITE DAMAGE ABSORPTION:** Satellite ships in the hangar can now be used to absorb damage allocated to "hangar" hits.

**ADVANCED ANDRO SYSTEMS:** Allows access to several advanced system blocks.

**ENERGY MODULES:** Allows purchase and use of energy modules of all sizes.

**PSEUDO-SATELLITE SHIPS:** Allows purchase of pseudo-satellite ships.

**TEMPORAL ELEVATOR:** Allows use of temporal elevators.

**PA MINES:** Allows use of power absorber mines. Note that trans-captor mines are controlled with the CAPTOR MINES TechBlock, but such mines can deploy only standard transporter bombs without this block.

# JINDARIAN TECHBLOCKS

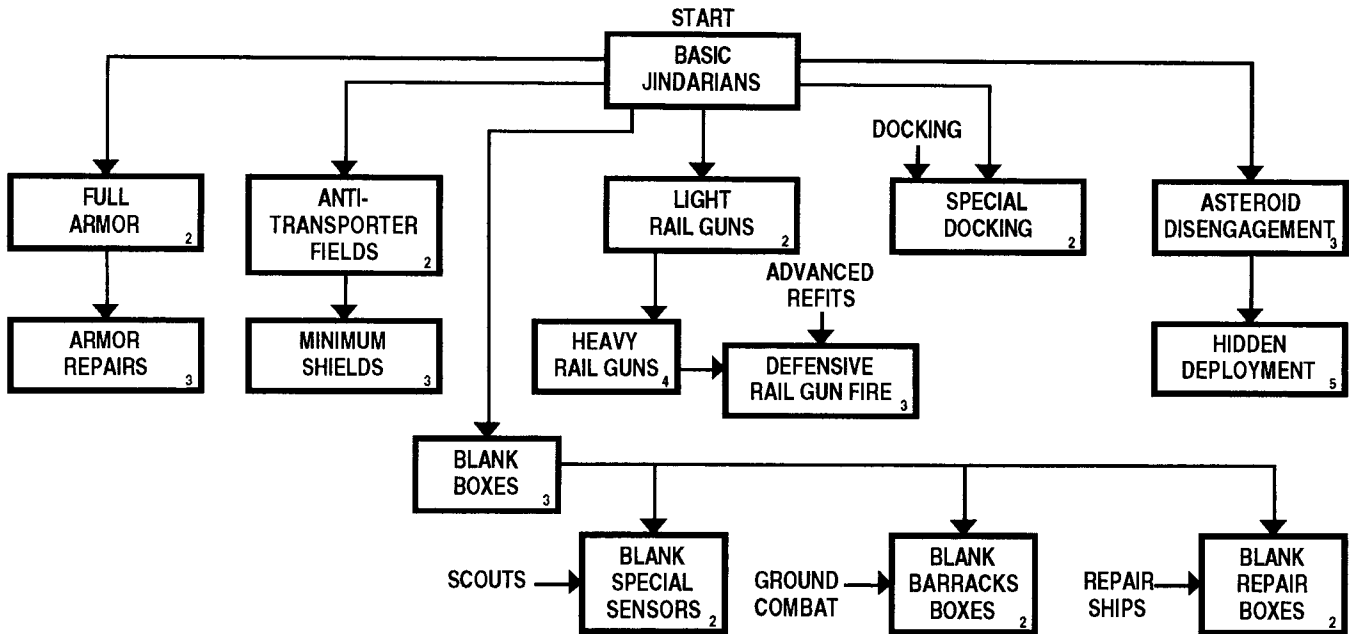

## JINDARIAN TECHBLOCKS

*These blocks are appropriate if Jindarians are used by a player in your campaign. If used by the GM as random menaces or as mercenaries, ignore these blocks (or use a portion of them relative to the amount of research available to players).*

**BASIC JINDARIANS:** Jindarians have no ATFs, no rail guns, no shields and only half the armor shown on the SSDs.

**LIGHT RAIL GUNS:** Without this block, all rail guns on Jindarian SSDs are not present. When this block is acquired, these boxes become LRGs (no refit required).

**HEAVY RAIL GUNS:** When this block is acquired, all WRGs previously limited to LRG status are upgraded to full WRGs (no refit required).

**DEFENSIVE RAIL GUN FIRE:** WRGs gain the ability to fire in defensive mode.

**ANTI-TRANSPORTER FIELDS:** Without this block, ATF boxes on the SSD are not present; when this block is acquired, ATFs appear automatically (no refit required).

**MINIMUM SHIELDS:** Jindarians gain the ability to use minimum shields (without this block they cannot use shields at all).

**FULL ARMOR:** Without this block Jindarians have only half the armor shown on their SSD, but this is upgraded to full levels automatically (no refit required) when this block is acquired.

**ARMOR REPAIRS:** Jindarian asteroid ships can repair their armor during scenarios using (D25.2).

**SPECIAL DOCKING:** Jindarians can use the special asteroid docking rules in (R16.1E).

**ASTEROID DISENGAGEMENT:** Jindarian asteroid ships can use the special disengagement procedures in (R16.1D).

**HIDDEN DEPLOYMENT:** Jindarian asteroid ships can begin scenarios hidden using (R16.1C6), if allowed by your campaign rules. Note that an actual asteroid field is required in the system.

**BLANK BOXES:** Without this block the blank "non-standard" boxes (R16.1C1) on Jindarian ships must be empty. When this block is acquired, they can hold Forward Hull, Aft

Hull, Cargo, Lab, Tractor, Transporter, Bridge, Emergency Bridge, Aux Con, Fabrication, or Works. Replacing blank boxes with any system requires a refit with the cost shown in Annex #8B. Once a system has been added it cannot be later removed.

**BLANK SPECIAL SENSORS:** This block allows blank boxes to also hold special sensors.

**BLANK BARRACKS BOXES:** This block allows blank boxes to also hold barracks.

**BLANK REPAIR BOXES:** This block allows blank boxes to also hold repair.





## RACES

In many campaigns, players will play just one race, buying all their ships from that race's list in the Master Ship Chart. Of course, civilian units will also be available in most cases. Other campaigns allow players to buy whatever ships they like regardless of race, although this is not recommended due to certain nasty combinations that can be put together. In such a campaign, you might allow players to buy whatever they like, but not mix multiple races in the same fleet.

### RACE SELECTION

One of your first campaign considerations will be what races to allow and how to let players pick their choices.

Most of the time, SFB players have preferences and racial favorites, plus a few races they just can't stand or don't like to play. You should try to let your players choose their favorite race if at all possible, as it will keep them interested in the game longer. (If a player has to fly a race they hate, he'll be less likely to participate, even less so as time goes on.)

In some cases, one player may want to play the same race as someone else. If this happens, you have two basic choices: Let players draw straws to see who gets first choice, or allow the same race to be played by multiple players. Obviously, this latter choice will not work well in pseudo-historical campaigns where only one of each race can possibly exist. More free-form campaigns could handle this situation, but some care must be taken: you don't want half the players using one race, and you want to avoid having too many scenarios involving the same race on both sides. Set up your campaign to avoid this situation if at all possible, because battles of this type can be boring and tedious.

Perhaps the best solution is to have players roll dice, with the highest roll getting first pick of race. After all picks are made, players would be allowed a chance to trade races with another player if they wish. After this stage, races are "locked in" and the campaign can begin.

An alternative is to allow a primary race and a secondary race. Players are expected to buy most of their ships from the primary race, but can (subject to the appropriate production facilities) construct a few ships from the secondary race. The cost for such buys might be increased, reflecting the economic limitations involved, perhaps by raising ship prices 10% or more.

In any campaign that allows multiple races to be used by the same player, you have to watch out for certain tremendously powerful weapon combinations. Examples of these are PPDs and hellbores, photons and hellbores, web casters and any seeking weapon, and SFGs and plasma torpedoes. You should take steps to avoid these combinations. Web casters (or webs in general), for example, should be outlawed in anything but a Tholian fleet.

### A NOTE ON SPECIALTY SHIPS

Some races have special ships (maulers, SFG ships, etc.) which may prove disruptive to campaigns if allowed without restrictions. The descriptions which follow will point out these ships where applicable. If you choose to restrict them, you can use the simple (but unrealistic) way of limiting them to one per fleet (or other grouping), or the more realistic method of limiting production to one or two per strategic turn. In the latter case, you might see a fleet with a concentration of specialty ships, but if a player chooses to put "all his hammers in one toolbelt," as it were, he will not have them available in other areas.

### NOTES ON RACES

Each race has some advantages and disadvantages, as well as abilities which might disrupt your campaign if you aren't careful. A general discussion of each race follows.

#### FEDERATION



The Feds have a large list of ships, and just about every class (frigate, destroyer, war destroyer, etc.) is represented. Their primary advantage is their excellent fighters once the midpoint of the General War era has been reached. Somewhat countering this advantage, they have no "real" PFs, using F-111s in their place, but conjectural PFs are provided in Module K for use if you wish. Your campaign will need to specify whether the Federation player(s) can build PFs, and if so, whether the F-111 will be available at the same time. It is recommended that Fed players get one or the other of these units but not both.

The Federation also has one other particularly disruptive piece of technology, the SWAC shuttle. The rules for this weapon prohibit its use except on certain specific ship types, restrict its sale or transfer to other races, and limit its production to only one or two per campaign turn. You would be well advised to observe these rules carefully, because SWACs in unlimited production or distribution can ruin a campaign.

#### KLINGONS

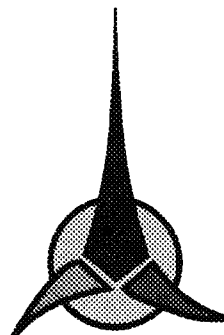

The Klingons also have a lot of ships, plus (arguably) the best war cruiser in the game. Their maneuverability and flexible weaponry make them a popular choice. Some players, however, feel they lack "punch" in a fleet setting, more because of their general lack of phaser-1s than for any other reason.

The Klingons have two special technologies, one shared by several races and one they have sole ownership of. These are, respectively, the mauler and the stasis field generator.

Maulers are not particularly disruptive to a campaign; in fact, many campaigns will allow all races to use maulers. Conjectural versions for the Alliance were released in several SFB newsletters to date, and are scheduled for formal publication in Module R7. If used in mass quantities, however,

maulers can be very powerful against fixed defenses. A fleet of several maulers can close to range 10 on a base and deliver volley after volley of damage that rarely misses, even against very powerful electronic warfare. Therefore, you should consider restricting mauler ships using your campaign's specialty ship limitations as described earlier in this chapter.

SFG ships are another specialty ship you should consider limiting. If not, you are virtually guaranteed to see just about every possible SFG variant in the game, including some fleets comprised of nothing but stasis cruisers. Therefore, at a minimum you should allow no more than one SFG ship per fleet, or else restrict production to one such ship per campaign turn.

## ROMULANS

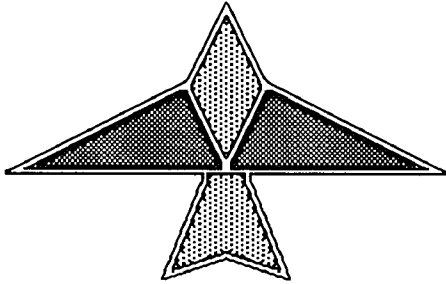

The Romulans are a dangerous race because of their cloaking device. In tactical scenarios its utility is obvious, but in the strategic arena, Romulan players will want to use it for sneak attacks and ambushes that no one else could possibly pull off. You are cautioned to put strict controls on how this is done.

Romulans will want to be able to move strategically while cloaked, so their movements can't be seen. If you allow this, the strategic speed of the Romulan ships will be affected, perhaps even cut in half. There will also be a fuel requirement (if your campaign tracks such things; see *Logistics*). There should also be at least some chance that the cloaked ships will be detected, in order to keep things fair.

The cloak will also be used to ambush other players. Non-cloaking ships need terrain to hide in, while cloaked ships could be allowed to hide anywhere. The cost of doing this should be high, however, and in order to keep the ship cloaked for long periods, there might be a requirement to leave the ship undermanned to reduce life support needs.

Romulans also have maulers (especially the cheap Falcon mauler) which should be limited in the same way as Klingon maulers (above).

## KZINTIS

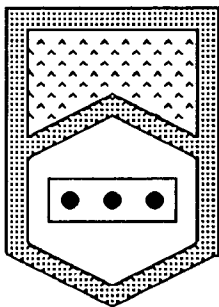

The main advantage of the Kzintis is their drones, which they can spew forth in tremendous quantities. In fact, most Kzinti players will choose to buy drone frigates and similar ships over "normal" units, in order to maximize the number of drones they can put in play. Unfortunately, this can make fleet-vs.-fleet scenarios extremely long and tedious to play. Use the command rating rules (see *Command Ratings*) to keep the number of ships small and reduce this risk. You should also consider limiting the number of drone bombardment ships that can participate in any scenario, perhaps to a maximum of one drone cruiser or two drone frigates in any battle. An alternative is to put a limit on the number of drone racks in any scenario (in much the same way as PPDs and web casters have a fleet limit), although this is not recommended. If you choose to set such a limit, then all races should be forced to obey it, not just the Kzintis.

## GORNS

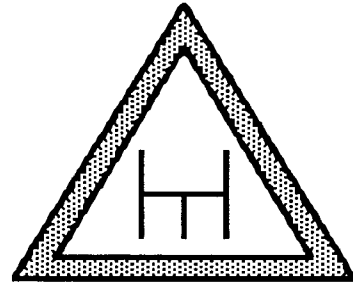

The Gorns have just one advantage in a campaign, that being in ground combat. Most of their ships have GAS shuttles (which have no benefit except in a ground assault) and a few extra boarding parties compared to similar ships of other races. If your campaign does not have ground combat, or uses it only rarely, then Gorns will probably not be a very popular race. In this case you may wish to give the Gorns some other benefit, perhaps allowing them to have commandoes at no cost (perhaps one on size class 4 ships and two on larger vessels).

## THOLIANS

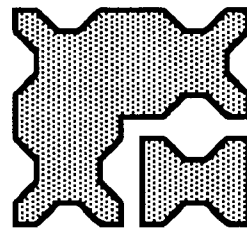

Webs are perhaps the single greatest defensive system in Star Fleet Battles, and this gives Tholians an incredible ability to destroy a campaign. While they are not particularly powerful as an invasion force (at least not without web casters), once they have secured a planet, they will defend it by surrounding it with webs and making it all but unassailable.

If your campaign allows Tholians as a player race, there should be some limitations on this. First and foremost, Tholian players should be forced to pay to maintain web structures. The SFB rules provide for a cost of pre-laid web hexes, and the cost of such webs can be tremendous. Unfortunately, there is a loophole in that webs with zero strength have a cost of zero. Thus, Tholian players could argue that they have a three-layer wedding cake or large web spiral in place at every single world at no cost—then, the moment the location comes under attack,

they begin powering it up with whatever ships or bases are stationed at the site. This clearly isn't fair. Thus, there should be some minimum economic cost for each web hex; the recommended amount is 5 EPs per hex, plus any web strength charges. This will force Tholian players to think twice before putting up a web around everything they own.

Another disruptive item the Tholians possess is the web caster. Fortunately, it does not come out until late in the General War time period, and when it does, its production is severely limited by various rules. Be sure to obey these restrictions or the Tholians can ruin your campaign.

## ORIONS



The Orions are a questionable race for most campaigns, since they do not have a real governmental structure. At best they should appear as a minor race.

Any Orion player should be forced to choose a cartel from the standard list; this will limit what they can put in their option mounts. It is vital that Orions not be allowed to buy whatever weapons they want—anyone who has ever faced an Orion cruiser armed with photons and hellbores can tell you why. Cartel weapon restrictions should cover both the Orion player's Order of Battle as a whole *and* each individual fleet, in order to keep them from putting all their hellbores in one place (for example).

Orion ships can also use certain special technologies normally available to only certain races, like the cloak, fighters, and SFGs. Your campaign rules may require the Orions to actually acquire such items before they can be used. Orions of a cartel that operates in a race's area might be allowed to have these items (perhaps with some limits). For example, a cartel operating in Federation and Romulan space could use Fed or Rom fighters at will, and might be allowed to have some cloaking devices. SFB rules suggest that no more than 10% of all Orion ships should have cloaks—this is an excellent suggestion. Orions should not be allowed to have SFGs in unlimited numbers, if at all.

Note that Orion bases have an extremely high economic cost, which will make them difficult to build. This is an intrinsic Orion disadvantage and should not be relaxed. These bases do not have phaser-4s, since the Orions do not have access to that technology. If you choose to allow Orions to purchase ph-4s from other races, then they will do everything they can to do so, and you should be prepared to face the consequences.

One final option you might consider for semi-historical campaigns (or any campaign in which a player has only one race) is to allow players the ability to "buy" Orion ships of one cartel, using the weapons of their primary race as "home" weapons and those of neighboring races as "area" weapons. These ships could then be used as raiders or mercenaries or by any other means your campaign allows. Be careful, though, to restrict or limit Orion-hiring, or players will end up with entire fleets of pirate ships and none of their own race! A limit of 5% of total racial production per turn would be appropriate (and treat these as specialty ships, with the same campaign fleet restrictions as maulers or stasis ships).

## HYDRANS

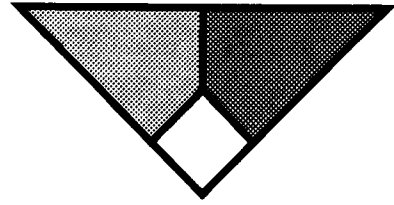

The Hydrans have two things that make them unique: hellbores and gatling phasers. Fortunately, they do not have so many of either that their race is overly powerful. There is no need to limit these weapons in any way—unless the Hydrans are allowed to team up with other races, in which case the hellbore can become a very rude weapon. Perhaps the worst combination imaginable is hellbores and PPDs.

Hydrans also use fighters, and lots of them. However, their fighters are usually seen only on fusion ships, not hellbore ships. Therefore, the Hydran player will need to decide whether he prefers fighters or hellbores, or some combination of both. Note that Hydran fighter squadrons should be organized as shown on the SSDs of their carriers—in particular, no more Stinger-Hs should be allowed than the listed percentages. Hydrans cannot put all their Stinger-H fighters into one squadron, for example.

Note that Hydran PF flotillas have certain restrictions regarding their organization; see (K0.322). The use of Howler PFs should be restricted to perhaps no more than one or two in any flotilla, and never alone or as casual PFs.

## ANDROMEDANS

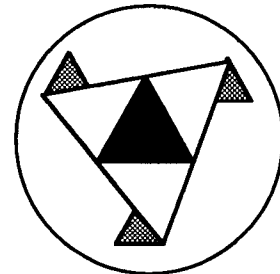

Unless the campaign is specifically devoted to the Andromedan threat, Andromedans should *not* be allowed as a player race. Their ships are so radically different from everyone else's ships that they just don't work well in campaigns. What's more, some races (notably plasma-users, especially on a floating map) have a very difficult time fighting Andros.

Under no circumstances should Andromedan technology every be allowed to be transferred to another race. This is not just because the SFB rules say so—it's a simple matter of game balance. TR beams and displacement devices are just too powerful on the ships of other races.

LYRANS

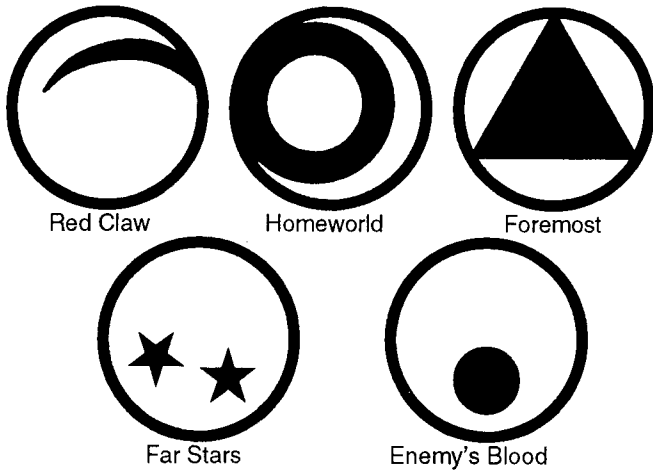

Lyrans have no real advantage in the campaign until PFs become available. They are the first to develop PFs and have mech links on most of their ships, enabling them to carry more PFs than anyone else. (Note that these mech links cannot be installed until they become available technologically, so a refit may still be required. The Lyran player can't just choose to build his ships with the mech links before PFs are available.)

Because of the sheer number of PFs a Lyran force could amass, it is recommended that the maximum number of PFs in a scenario be limited in some way, probably with the scenario command rating. Fortunately for game balance, the Lyran PF is not tremendously powerful.

WYN

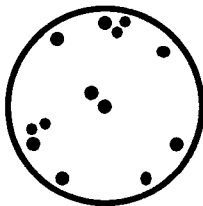

The WYN should be a minor race at best. Most of their ships are too powerful for a campaign in which they may be used in an offensive role. If the WYN exist, they should be a defensive force only and should stay in their cluster where they belong.

If you choose to ignore the above recommendation and allow WYN to operate as a normal race, then the first step is to restrict the auxiliary fleet in some way (probably by giving them a range limit or a subtraction in strategic speed). Also, the "captured" designs should be limited to very slow production rates, or might require purchase of the basic hull from another player in the campaign. Perhaps the only ship class the WYN could be allowed to build in unlimited quantities would be the "fish ships," which are the closest thing the WYN have to a regular war fleet.

Note that the WYN radiation zone is even more obnoxious to attack through than a three-layer Tholian "web cake." If the WYN are a major race like any other (in a non-historical free-form campaign), the radiation zone should not be included or the WYN will basically be invulnerable.

ISC

1	2	3	4	5	6	7	8	9	0
DN	CA	CL	DD	FF	Tg	St	Ldr	PF	SR
Ex: Celestra, CLS-05	CV	MS	Sc						

The primary advantage of the ISC is the size of their ships. Command point for command point, the ISC can field a larger force than anyone else in the game. Their light cruiser is really a war cruiser, for example, and their command cruiser is really a heavy battlecruiser. No race has a larger destroyer than the ISC DDL, and none has a larger dreadnought than the ISC DN. However, this is not a problem your campaign should seek to correct, but rather an advantage the ISC should be allowed to benefit from.

The ISC also have PPDs, which are very powerful long-range weapons. There is a PPD limit listed in (E11.17) which should be followed; otherwise, the ISC could put together some truly frightening fleets.

LDR

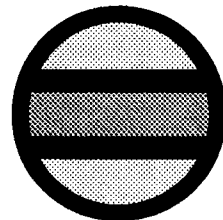

The LDR should not be allowed as anything other than a minor race in any campaign. The reason is simple: Given the choice between Lyrans and LDR, who wouldn't choose the LDR? The extra cost for their ships is well worth the price.

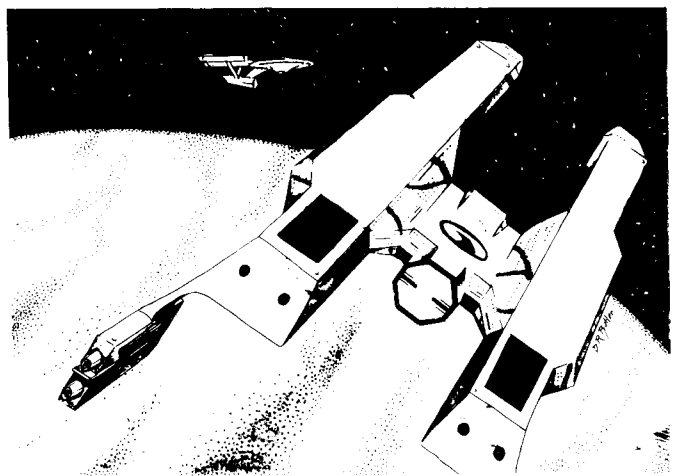

## SELTORIANS

The Seltorians will not normally be an appropriate race for a pseudo-historical campaign, because in that setting they will seek only the destruction of the Tholians. Unless this is the entire focus of the campaign (perhaps you are running an "Operation Nutcracker"-like mini-campaign), then the Seltorians aren't really needed. One thing you might do is give the Tholians the 312th Battle Squadron as reinforcements in Y178, then bring the Seltorians in a few years later to counter this addition.

In a free-form campaign, there's no reason the Seltorians can't be used as a player race. They have a small fleet, but they possess most of the required variants (except perhaps survey ships and the like). Since their year of availability is very high, you might need to adjust these dates to make them viable in a campaign that uses years for technological advancement.

The Seltorians do have one particular unit which needs to be restricted in such a campaign: the Hive Ship. The best method is to just outlaw the production of these massive units. If you do allow them, their strategic speed should be very low, and certainly no more than one of them should be allowed in any strategic theater.

## JINDARIANS

The Jindarians are not well suited for a campaign because their ships are not designed to support an empire. They don't have a lot of the ships needed for various roles (in particular, they have no bases), so your campaign would have to make exceptions for Jindarians in these areas. Instead, Jindarians should be used as minor nuisances and surprises for prospecting and survey ships.

Any of the special technologies used by Jindarians, such as rail guns and anti-transporter fields, should not be allowed outside the Jindarian race under any circumstances. The only exception would be prospecting charges, though these make very poor weapons.

## FRAX

Of the simulator races in existence when this Handbook was written, the Frax are the only one with enough ships and variants to be *fully* viable in a campaign setting. There is no reason they should not be allowed in a free-form campaign (although they would never appear in one with a historical bent, since they are not "real"). Frax ships can be difficult to fight, especially on a floating map, but the new tactics they require (for both player and opponent) could be very refreshing.

The Frax have several technological items which might need to be controlled in a campaign. The obvious examples are submarines, the only ships in SFB outside of the Romulans (and limited numbers of Orions) which can cloak. Any restrictions on cloaking devices for the Romulans should apply equally to the Frax. To avoid all-submarine scenarios where the Frax ships stay cloaked for the entire battle, you might limit subs to no more than a few per fleet or one for every two or three other ships in a force.

The Frax also use the axion torpedo, a weapon which can fire from under cloak. This need not be limited within the Frax race, but should never be transferable to another race. Your campaign may allow Orions to acquire the weapon, but it would never be something they could build in unlimited numbers (in fact, you should probably require them to buy and track each such item individually).

Finally, the Frax have the AFD, which is God's gift to drone defense. If you don't restrict the purchase of this item (the restrictions listed in Module C4 are recommended), then every Frax ship will have it and no drone will ever touch them. You'll want to be very sure that this technology cannot be transferred to other races or used by Orions!

## SIMULATOR RACES

The races in Module C4 vary considerably in their suitability for use as campaign races, based mostly on the available ship types. The absolute minimum for a campaign would include the major combat classes (FF through DN), plus a scout, carrier, escort, tug, PFT, fighter, PF, and perhaps a commando ship. To be fully operational, several different ships of each specialist type are needed. A race with relatively few choices in ship types will be at a painful disadvantage to one such as the Klingons which have many choices for each mission and can usually convert the nearest standard warship into a variant for that mission. Module C4R (C4-Reinforcements) will provide ships for most of the C4 races to fill such gaps and make the simulator races more capable for campaign use. A few of these ships have already been published in the Star Fleet Times, the official newsletter of the Star Fleet Universe.

Module C4 provided capable simulator races for the Federation (Qari), Klingons (Frax), Romulans (Sharkhunters), Gorns (Triaxians), and ISC (Barbarians). In a campaign which uses only these races, a rule *might* be written to allow players to build a very limited number of ships of those races as specialty ships or prototypes of failed designs. (The Kzintis might be allowed to use Frax as well, or possibly Flivvers; Lyrans might be permitted to build Canadi'ens or Britanians.)

## QARIS

Next to the Frax, the Qaris have the most ship designs in Module C4, including carriers, PF tenders, scouts, and the like (although the more specialized logistical units, like tugs and repair ships, are lacking). As the Qaris are a Federation simulator race, players might consider allowing non-combat Fed units (such as non-battle tugs, FCRs, etc.) to fill these voids until Module C4R is published.

The Qaris use trans-mortars and Scud missiles, both of which might require specific logistical rules in your campaign. In particular, you might consider limiting production of Scud missiles to a certain quantity per campaign turn (or, if using assembly line production, requiring a special facility to build them or possibly convert normal drones into Scuds). Scud missile ships might also be considered "specialty ships" and limited to certain quantities in fleets or with limited production rates.

## SHARKHUNTERS

The Sharkhunters are an excellent race as a nemesis for the Romulans (or a cloak-happy Orion) in a non-historical campaign. They have fewer ship designs than the Qaris, but do possess a scout and carrier type. No PF Tender is available, though this will be remedied in Module C4R. They also have no logistical support units, but might be allowed to use Romulan non-combat hulls, such as the KRT or a non-modular SPH, in these roles.

It should be noted that since the Sharkhunters are optimized for defeating the cloak, they will not be desirable in a campaign without a nearby cloaking race. Bombthrowers and flashbombs will, obviously, be useless in such a case. A friendly GM might be persuaded to allow these to be converted to another system (perhaps phaser-3s) or deleted for a return in BPV.

Sharkhunters use heloshuttles, a particularly useful type of shuttle which can move however it wishes. Rules should be written to restrict transfer of this technology between the Shark player and other races. GMs might also consider logistically tracking flashbombs as cargo, requiring replacements using the supply rules, but this is completely optional.

**BARBARIANS**

Barbarians possess all the ship sizes needed for campaign use, but lack specific scout, carrier and PFT designs. Some of this can be simulated using the optional boxes on the SSD (scouts using weapon options and carriers/PFTs using non-weapon options). As the Barbarians do not have fighters or PFs, you will have to allow them to use the designs of another race for this purpose.

**TRIAXIANS**

The Triaxians have the bare minimum needed to be usable in a campaign, including one carrier, PFT and scout. This would make them useful as a "pocket race" like the WYN or LDR, but certainly not a major power.

**FLIVVERS, DELTANS, CANADI'ENS, BRITANIANS**

These are simply not campaign-capable at this time. Their best use would be as random encounters, one-time or limited-run production as specialty items, or something similar.

**MINOR RACES**

Some campaigns may experiment with minor races, often controlled by the GM using a set of predetermined movement or defensive rules. The following races are often used in this way.

**THOLIANS**

Non-player Tholians are never allowed to attack. They generally patrol their own space along their borders, possibly extending into the neutral zones around them. Any attack on their space will be repulsed with all available force, but no counterattack will be mounted. They just want to be left alone.

Typically, the campaign rules will specify what fortifications are present at Tholian worlds, including the presence of webs and the strength thereof. Alternately, tables could be devised to determine what type of web and other fortifications are present in any given battle.

**ORIONS**

The Orions are perhaps the ideal minor race, since that is what they were designed to be. They should not have any kind of "homeworld" in the campaign, though individual cartels might have a central hidden base which could come under attack. Campaign rules should specify the defensive forces present at such a base, though discovering it should be a difficult operation.

Orions could be used for shipping, trading or mercenaries for hire. They could offer goods or resources for sale which the player might need for some purpose or other; for example, if the player needs ores (in a complex economy), Orions might be able to provide them, for a price. Orions might also be willing to ship priority cargo from one place to another quickly, again at a price. Finally, they could be available for hire as mercenaries to augment an assault fleet (or to make random convoy raids on an opponent). As with everything else, this would come with a price, and Orion loyalty to the player's cause will be nonexistent. If their ship came under heavy fire in a battle, they would be likely to turn and run rather than stick it out.

In some campaigns Orions might take on other missions, as determined by your specific rules. For example, a campaign with espionage might provide for the use of Orion ships for spy placement. Even without espionage rules, Orions may be allowed to spy on one's enemies and pass along what they learn, for a fee (but, of course, the other player may be paying them even more to feed you lies, so take any such information with a grain of salt).

Under no circumstances should you allow Orion non-player cartels to sell technology to players (though they could ship an item from one player to another), or to sell ships to a player as a permanent transfer.

**ANDROMEDANS**

Andros make a good random nuisance; they have little else to offer a campaign. One way to use them is to pre-place a few satellite bases and use random Andromedan forces to make raids every now and then on nearby worlds or convoys. If the base is discovered (which would be very difficult unless it can be triangulated upon), an interesting scenario could result as the player seeks to eradicate this trouble spot—and if it is destroyed, then no future raids will happen in that area.

If the campaign progresses for a while and everything appears stalemated, the Andromedans might be used to keep things interesting, but this will turn the game from a face-off between players to a big game hunt. After a while, battles against Andromedans will become stale. Thus, this sort of thing should be avoided unless killing Andros is the primary goal of your campaign in the first place.

**WYN**

The WYN will usually occupy only a single hex on any campaign map, and will never leave that hex if run in non-player mode. A campaign's rules will specify the WYN order of battle, all of which will be able to respond to any incursion. To defeat them, multiple attacks will be needed, all of which will probably be ruinous to the invader (and giving nearby races a strategic edge in the area). This is how the WYN survive in the Galaxy, by the way.

The primary use of the WYN in a campaign would be as a trading port. The WYN might be said to have a market for certain resources, and a player with good relations to the WYN could earn money supplying this need. The WYN fish ships (only) might also be available as a mercenary force, albeit at a high cost.

**LDR**

Treat the LDR in much the same way as you would the Tholians: They maintain fiercely guarded fortifications, patrol their space, and keep an eye on the neutral zones, but do little else. The only exception might be if the LDR is attacked by a player. Unlike the WYN, who rely on their radiation zone for protection, and the Tholians, who have webs, the LDR have no such defenses. Thus, if they are attacked, they might well ally with another player, using the "enemy of my enemy is my friend" theory. Your campaign might provide rules to allow this.

LDR might also be used for trade, but would be unlikely to work as mercenaries, fearing that while they are away, their home territory might come under a sneak attack.

**OTHER RACES AND MONSTERS**

Free-form campaigns which have large amounts of unexplored territory might use single-system minor races to occupy some of these systems. The campaign's terrain generation rules would provide random tables to determine the defenses of such a minor race. Seltorians, Frax, Britanians, and the other races of Module C4 would be perfect choices to occupy such systems.

These races might also be used as random events, attacking or raiding in some random fashion. Jindarians, for example, make excellent random events—especially if the campaign involves prospecting of asteroid fields for extra income. Monsters are also good random events, though their use will probably require special care and be handled on a case-by-case basis.

## OTHER CAMPAIGN CONSIDERATIONS

This section deals with campaign concepts which don't easily fit into any of the above sections.

### REPAIRS

In any campaign that involves combat (and most campaigns will), ships will become damaged and need repairs. This involves timing (when the repairs occur), cost, and facilities.

#### WHEN DO REPAIRS OCCUR?

In many battles, ships will suffer a light smattering of internals, perhaps taking one or two small volleys of no more than 10 hits, plus the inevitable shield damage. Some amount of this damage can be repaired by the ship's own damage control systems, usually by continuous or emergency damage repair. These repairs should take little or no strategic time to accomplish; after the scenario is over, the ship simply exhausts the limits of its own self-repair capability (in effect extending the scenario out a few extra turns, even though it may not have actually lasted that long). Shield repairs, which take only power and not damage control systems, would also be performed during this period.

Damage beyond this minimal "light damage" level is more complicated to resolve. If a repair ship is present, it will probably be able to perform an incredible number of repairs (limited to no more than 100 repair points per repair box), also without taking too much strategic time. (If a campaign turn represents a year, six months, or even six weeks, the time to repair 500 repair points of damage using SFB rules will still not come close to this duration.) However, these "quick repairs" will not stand up well during combat if performed rapidly; the ship will need considerable time (perhaps even a full strategic turn) to make them stick. Moreover, after using these repair points, the repair ship will need to return to a base or other supply points to pick up more, restocking its storage of spare parts and other consumables.

In many campaigns, repair ships can perform the above spot-fixes, but the damage they repair is only temporary. If the ship does not return to a base immediately, the jury-rigged systems will break down and the ship will revert to its heavily damaged state. Returning to a base allows the player to pay the EPs and spend the time required to get everything fully functional again. An entire campaign turn is often required; some campaigns base the amount of time on the level of damage sustained, requiring the ship to sit idle for a number of movement phases until it is fully operational again.

More serious is the loss of a ship section, such as the rear hull of a separable ship or a set of dropped warp engines. Repair ships cannot fix these; in fact, constructing replacements will require the services of at least a base or FRD, or perhaps even a shipyard.

#### ECONOMIC COST OF REPAIRS

Since time, manpower and materials are needed to fix damage, it is only logical that some sort of economic cost be involved to pay for repairs. There is no specific rule in SFB stating how much any given system costs to build, so the economic cost of repairs is up to you to decide, depending on your campaign and the level of intensity you expect combat to reach. Here are a few suggestions:

**Charge for repair points.** Allow repair ships to make repairs any time or anywhere, but make them buy their repair points in advance, perhaps for 1 EP for every 5 repair points. At this ratio, a repair ship that had 8 repair boxes (each of which hold 100 repair points of capacity) would cost 160 EPs to fully stock. Thus, most players will not run around with completely loaded repair ships! You'll also need to specify how many repair points a newly build repair ship arrives with—if a ship or base is fully stocked, it will be cheaper to buy a new repair ship than to restock an existing one! You'll want to be sure to avoid this pitfall.

**Charge by the box.** Any time a ship repairs one box (other than a shield box), charge a flat amount—perhaps 1/2 an EP for every box you fix—after simple self-repairs are exhausted. This might encourage some players to leave a few "unimportant" boxes, such as hull or armor, unrepaired in order to save EPs. To avoid allowing this, you might require total repairs at all times (no partial repairs at all).

**Charge by box cost.** When a ship puts in for repairs (whatever the source), charge EPs based on some arbitrary box cost. You might make up your own costs, or use the prices found in the Ship Construction Manual (when published). You could also charge based on repair points, similar to charging for repair points (above), but without requiring repair ships to effectively pay in advance. Choose your box costs carefully—if repairs cost too much, players may leave them unrepaired and spend the money on new ships instead.

**Charge for an "overhaul."** (D9.4) includes rules for a campaign repair procedure, which assumes that some kind of base or repair ship is present. You might charge a flat fee, perhaps 10% or 15% of the EPV of the ship, for each such overhaul, allowing at most one such overhaul per campaign turn. (Some ships might need two overhauls for full repairs; it is extremely unlikely that a ship would need three of them.) If this is done, and no other repair procedure is available, you might see some players leaving ships with partial damage rather than pay the cost (and time in a repair facility) to fix a few internals.

**Combinations.** You could also combine the above procedures, e.g., charge a reasonably high "by-the-box" cost and a flat overhaul fee, allowing players to choose the repair procedure that works best for their individual case.

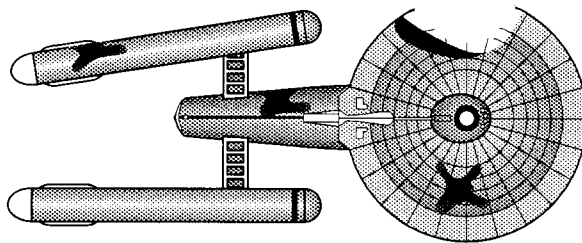

## REPAIR FACILITIES

There are basically two kinds of these: repair ships and bases. Any ship with a repair box (other than PF tenders, whose repair boxes service their PFs only) is a repair ship; any base of base station size or larger with at least one repair module can be considered a repair base. In addition to this, any facility capable of constructing a starship would also be quite capable of performing repairs as well.

One obvious requirement of repairs is that the damaged ship be in the same location as the repair unit. (It can't just ship the parts via the campaign's logistics network.) This requires either the damaged ship move to the facility, or vice versa. Since bases can't move, and damaged ships are often slowed down to a near crawl, this gives repair ships the advantage. However, repair ships don't have as many repair boxes as most bases, and have an unusually high economic cost to boot.

If repairs take part or all of a strategic campaign turn to accomplish, then a repair ship should only be allowed to work on one ship at a time during that period. Bases, on the other hand, can work on as many ships as they have external docking positions for (thus, a base station could work on three ships at once, each one docked near one of the blocks of repair boxes on the SSD.) If the number of repair boxes on the base impacts in the speed or cost of repairs, then if multiple ships are using the same base, the player will need to specify how many boxes are working on each damaged ship.

## ALTERNATIVE REPAIR METHODS

The above are merely guidelines, of course, and many other means exist for players to repair their ships. A few examples:

**No repairs.** A campaign might not allow ship repairs at all, other than ship self-repair capabilities. A campaign involving the Masters might work this way, as would any campaign in which bases and/or repair ships can't be built. Simply state that ships can make only their self-capable repairs (shields, continuous damage control, and emergency damage control) each campaign turn, restoring their DamCon rating to its full level just after all repairs are completed. (If some or all of these repairs are used during a scenario, they will not be available during the campaign's Repair Phase.) In a campaign like this, damage to a ship will be much more important, and bookkeeping will need to track it carefully. Replacing a separated section or dropped warp engines will be difficult or impossible, making such maneuvers unlikely.

**Automatic Repairs.** A simple campaign might require no effort at all for repairs. The campaign system would simply include a rule that at the end of a certain period of time (perhaps one or more campaign turns) all damage on ships is instantly fixed. Alternatively, you might require players to bring their ships to a repair facility and dock them there for a full strategic turn, after which they are fully repaired (at no cost).

**Campaign Overhauls.** This simple system provides each ship with the capability of making one (D9.4) repair on its own at any time, at no cost and without requiring a repair facility. A check-box should be added to each ship record indicating whether the ship has used this overhaul yet. Once the overhaul has been used, the ship must return to a base (not repair ship) to collect enough supplies to make another overhaul later; the overhaul box can then be erased. You might want to charge some amount of EPs or time to gather these supplies. Even if this system is in use, you should also provide rules for repair of individual boxes (if nothing else so repair ships can be useful). This should be expensive, however—perhaps one EP for every two repair points needed, or maybe even a one-for-one fee.

## EMERGENCY DAMAGE REPAIRS

Emergency Damage Repairs (EDR) should be dealt with cautiously in a campaign where repairs must be paid for. According to the Cost of Repair Chart (Annex #9), damage control boxes cost 3 repair points for every point of DamCon fixed. Thus, repairing a "6" box on the DamCon track will cost 18 repair points. However, using EDR to fix six systems (using that "6" box) is much more efficient, because (on the average) it will repair five boxes in a typical turn, and the sum of the repair points required for those boxes can greatly exceed 18. Five warp boxes, for example, cost 50 repair points; large weapons like heavy plasmas, PPDs, etc. will be even higher. An intelligent player will therefore always choose to utilize EDR to its fullest extent before paying a single EP for your campaign's repair procedures. Even if the highest DamCon box is a "2," a player will gladly use EDR on the chance he can fix one of those high-priced systems (typically large weapons, warp boxes, and sensor/scanner track hits).

If you don't want players doing this, there are a few ways it can be controlled. One is to use the "temporary repairs" rule to state that any such fixes work only for the duration of the campaign turn and then collapse, necessitating a return to base for retooling. (Of course, if you do this you'll want to be sure to let damage to the DamCon track disappear automatically at the same time, otherwise players will never use EDR.) This is the recommended rule. Another possibility is to require EDR repairs to be paid for with EPs just like any other campaign repairs, but this might not sit well with players who feel a particular EDR action is required during a scenario but they don't have the money to pay for it. If you choose this alternative, a rule allowing players to go temporarily in debt (in this case only) is highly recommended.

Of course, you could completely ignore this "loophole" and allow players the ability to use it at will. There are a couple of disadvantages, of course. Ships can't repair their own DamCon, so if this technique is used, they're stuck with the lower track until it can be fixed at a base or repair ship. And, of course, there's the chance they will roll their EDR rolls very poorly and waste the attempt.

## REPLACING MISSING SECTIONS

If a ship separates sections or drops its warp engines and needs to replace the missing parts, the campaign procedure for this will probably not be the same as the standard repair procedure. As a general rule, you should require the ship to put in to a construction facility to replace missing parts.

Replacing a missing rear section (or saucer, boom, etc.) is a simple calculation, usually made by looking up the price of the saucer/boom/whatever on the Master Ship Chart, or (if no price is available) using a simple price differential between what you have and the price of the original ship. In the case of warp engines, however, this is not so easily done, because no price is given for individual engines. Your campaign will need to specify how much is paid for a warp box. Good values are 3, 4, or 5 EPs per box on each engine. Note that engines can only be built to replace missing ones on a damaged ship; players cannot build warp engines and leave them lying around for future use (or attach them to other ships for additional power).

As a final consideration, you might make replacing a missing section a refit instead of a repair operation. If that is the case, then rules to handle such things will fall under the next heading.





### SCRAPPING SHIPS

In some situations a ship may be so badly crippled or so anachronistic that repairing it or keeping it around is a waste of resources. (This will depend on how much your campaign charges for repairs and ship maintenance.) If this is the case, players may want to scrap ships.

The simplest way to handle this is to just destroy the ship and be done with it, gaining nothing whatsoever from the debris. However, this is unrealistic; even scrap metal will have some value, as will surviving electronics, wiring, computer parts, and so on. Even if these materials can't be used again as they are, they could still be recycled.

To simulate this, a scrapped ship should provide some percentage of its original BPV as a refund to the player's economy. This will be provided as EPs in most cases, unless your campaign tracks individual resources like ores, wiring, hardware, and the like. Note that any returned resources will be present at the location of the ship when it was scrapped, and unless a production facility is present at that spot, the recovered EPs (or whatever) will have to be shipped elsewhere using cargo boxes or the campaign logistics system.

The value of a scrapped ship should be no higher than 25% of the ship's basic EPV, though this may be too high; 10-20% is recommended. Figure the return based on the ship's EPV including the cost of any refits, modules, pods, etc. which are present and scrapped at the same time the ship is (if they escaped or were destroyed, then they aren't there and can't provide a return). Optional items, crew, drone upgrades, T-bombs, legendary officers, and the like don't provide any kind of refund, although if they are still on the ship, they could probably be transferred elsewhere for re-use.

### REFITS AND UPGRADES

In campaigns with a technological system, such as those which begin in one year and advance steadily through the General War, certain refits and upgrades will become available to ships which weren't there when the ship was first constructed. Your campaign will need some system for handling these refits.

The recommended way is to require the ship to return to a base (at least of base station size) and remain there for a full campaign turn. Naturally, any cost for the refit must be paid for by funds present at the base (so some logistics may come into play). Some refits, such as some of the Y175 drone rack refits on various ships, have no cost but should still require the stated amount of time at a base. The actual facility used required can vary; some campaigns allow FRDs or repair ships to perform refits in addition to bases.

Another possibility is to allow ships to perform their own refits, as long as the proper cost is paid. This is useful for simple campaigns or campaigns which don't use bases (e.g., those with an emphasis on ship-to-ship combat). A related alternative is to have the player pay the full cost of a ship (including the maximum possible refits) when it is built, but until the campaign reaches the appropriate year for a given refit, those systems can't be used. This system keeps things simple, but players may not like the idea of paying the extra price for something they can't use. (Some refits, such as many of those available for plasma ships, are rather expensive.)

### WHAT REQUIRES REFITS?

For some ship upgrades, it might not be immediately obvious if a campaign's refit rules can be used. Here are some examples of things which should be considered refits:

- Anything described anywhere in the rules as a "refit," e.g., adding mech links, Lyran power packs, ESG capacitors, Hydran fusion holding, ISC rear-firing plasma torpedoes, Tholian snare generators, APR to AWR upgrades, adding gatlings to LDR ships, limited aegis to full aegis conversions, etc.
- Changing fighter boxes to handle a different fighter type (ready rack conversions and everything else that comes with such a change).
- Changing from a base hull type to a variant, if your campaign allows it; e.g., changing a D7 to a D7A when SFGs become available, or converting a survey ship to a survey carrier during wartime.
- Changing Orion option mounts (or option mounts on ships of other races, such as those found on heavy war destroyers); note that you might want to put other controls on this to keep it from being abused. Generally, this sort of thing should only be allowed if the Orion (or whoever) comes into the possession of some new type of option mount that he wants to install on an existing ship. For example, an Orion who "acquires" a stasis field generator might want to put it on a particular cruiser rather than build a whole new one (especially if he has to pay what he should have to pay for the SFG). Heavy war destroyers, even with their "optional" APR and NWO boxes, generally stay in one configuration once built—they are not technically modular ships.
- Changing the modules of a modular ship, such as the Romulan Sparrowhawk. Note that this should be faster than most refits due to the modular design.
- Adding a cloaking device, fake weapon, blow-away panel, DERFACS, UIM, positron flywheel, or super-intelligent computer. Note that once a ship has a UIM, replacing a burned-out module should not require a refit or repair operation; the crew fixes the burned-out systems after the scenario. (SFB rules do not specify how to handle this, so you're free to set your own procedure if you wish.)

- Changing a drone rack from one type to another (some campaigns may allow this as a customization option), upgrading a plasma-G to plasma-S (if allowed for a given ship—size class 4 ships cannot have plasma-S torpedoes, for example), adding plasma swivels to a torpedo, upgrading shield crackers to web breakers, or basically anything that changes the name, position or arc of any box on the SSD.

As a general rule of thumb, if the rules say that a new *ability* appears in a particular year, that doesn't need a refit unless some piece of physical equipment is needed to make it work. For example, plasma shotguns first became available (to the Gorns) in Y168 (other races in Y169). This is just an ability, however, and does not require any actual hardware, so no refit is needed to use it. Other examples of abilities that don't need refits include Tholian web strength improvements, the ability to carry an MRS shuttle, upgrades to a ship's optional items (like improving a boarding party to a commando), and so on.

In some campaigns, doing some of the changes that are considered "refits" (such as changing option mounts or Sparrowhawk modules) might be specified in your campaign rules as taking less time than others. For example, you might say that changing Hawk modules takes just one movement phase (the same amount of time it would take a ship to move one hex on the map) as long as the ship and the new modules are at the proper facilities and the replacement modules are already built. Such decisions will, naturally, be based on the nature of your campaign and are up to you.

Some conversions may result in a system, box, or module being left behind and reusable. For example, if a WYN ship converts a disruptor in an option mount to a recently acquired hellbore (perhaps as a trade from a friendly Hydran player), then the disruptor is not lost in the conversion. It's still around and should be noted as such. Another WYN ship built at the same facility could use that disruptor during construction, possibly saving the player a couple of EPs (if the disruptor has a very high range). Even one or two EPs may be important, especially in a tight economy!

### BUILDING SHIPS WITH REFITS INSTALLED

Once a refit has become generally available, ships can be built with it already in place by simply paying the higher ship cost. To be realistic, you may require at least one ship already in existence to be refitted to the new design before new production can be updated. Campaigns with smaller numbers of ships should probably ignore this suggestion.

### MULTIPLE SIMULTANEOUS REFITS

When a player wants to refit a ship and another refit is just a year or two away, some players may choose to keep the ship in the field and then install both refits simultaneously (as soon as the new one is ready). Unless your campaign rules specifically state that players can't do this, then simultaneous refits are allowed. It takes no additional space or time in the refit facility, although there will likely be an added cost.

### CHANGING FROM ONE VARIANT TO ANOTHER

There are many ships in the game which are merely a variant or conversion of some other basic hull. As a general rule, it should be possible to upgrade a basic ship to any variant listed for that class using the campaign's refit rules.

There needs to be some control over this, however, or every ship in the game will become a modular ship, able to change to another variant at will. The recommended restriction is to allow a change *to* a variant, but not back to the original or to any other variant. In other words, once a ship has become a variant or converted ship, it can't be modified again, except to install a future published refit that particular variant can use.

Some ships are capable of massive conversions from much smaller ship types. The best example of this is the Romulan Warbird, which begins life as a sublight cruiser but can be massively improved twice, once to the War Eagle and then to the King Eagle. Other examples include new heavy cruisers, heavy command cruisers, certain Lyran trimarans, and so on. WYN captured ships also fall into this category. Your campaign might consider such upgrades to be refits, or require a more complex or time-consuming procedure. (Considering that the cost to bring a Warbird to King Eagle status is as much as many destroyers, you can certainly see the logic in this.) The exact procedure used is up to your campaign.

### UPGRADING A BASE

Enlarging a base will likely be a separate type of upgrade, chiefly because most improvements require a base and in this case it's the base being upgraded! Repair ships, tugs, FRDs, or a combination of these are some possibilities.

Usually a base begins play as an MB, which is dropped in the desired spot by a tug, and upgraded from that point. An alternative is to allow the base to be constructed directly in place, though this might be difficult if campaign construction rules require specific facilities to build large units.

The cost to upgrade a base will, naturally, equal the difference in price between the new base and the old one. It is specifically prohibited to "downgrade" a base (ostensibly to earn economic points as a refund). Also, if a base has one of the shield refits (or another refit), the upgraded version must also have the same refit(s). Finally, you should require that bases be built in steps: MB to BS, BS to BATS, and BATS to SB, taking one campaign turn for each. This helps make base-building a difficult task, requiring a considerable amount of time and effort. Once you have a base in place, you'll be more than likely to keep it well defended.

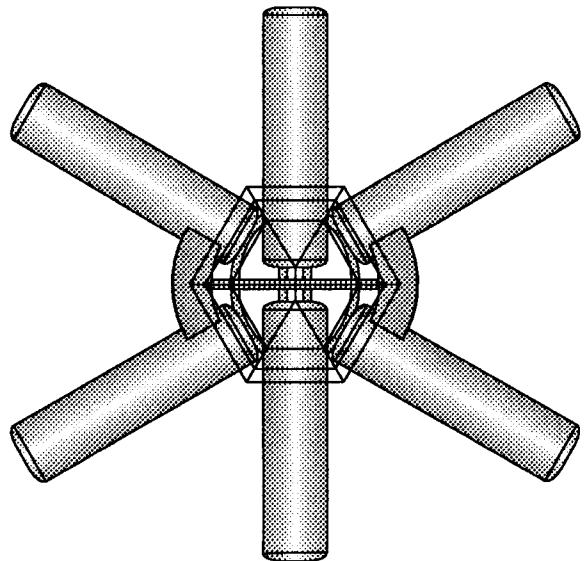

**THE STRATEGIC SEQUENCE OF PLAY**

The importance of the strategic sequence of play is subtle—it's something you're not likely to think much about until it's needed for the first time. The sequence of play in a tactical SFB scenario is similar. When you first learned how to play SFB, you probably weren't taught the sequence of play initially, but discovered the order in which things worked only when any given action interacted with something else you or an opponent wanted to do. For example, if your friend taught you how to arm and launch plasma torpedoes, it probably didn't occur to him to mention that shuttles (and thus wild weasels) can be launched immediately afterwards—even on the same impulse.

A similar effect can be seen in a campaign if you fail to consider the sequence of play and make it known to all players. As an example, if you don't tell players that their worlds generate income *after* ship construction, then you can be sure that some or all of them will be building ships with EPs earned on the same turn they're built.

**PRIMARY SEQUENCE ELEMENTS**

As the campaign GM, you are free to set up the sequence of play however you like. In any campaign, however, there are several distinct actions which take place in any strategic turn. These are: *Income* (collection of EPs or other resources); *Construction* (building of new units or items); and *Movement* (strategic movement of ships and other units). Just about every other campaign action will fall under one of these three headings. You can organize these in any order, and here are some of the possible results of different combinations:

**Income First:** When income is generated before anything else happens, then you can use that income for construction or shipping purposes in that same campaign turn. EPs or other resources which are shipped elsewhere will not be available for construction if Movement is before Construction; otherwise it might be (if shipping routes are short enough to get EPs to their destinations quickly enough). Another factor to be aware of is that if a world is captured on one turn, it will produce EPs again at the start of the following turn; for this reason Movement is usually before Construction (to keep players from building a bunch of fortifications at a captured world before the other player has a chance to recapture it). The typical sequence of play is Income-Movement-Construction.

**Construction First:** In this type of campaign, players will construct units using income generated on the *preceding* campaign turn. Units built will be able to move immediately (since movement follows construction), providing an amazing ability to respond to attacks on shipyards and other construction facilities. Some campaigns require building to *begin* at the start of the turn, but not finish until the *end*, putting Movement and Income between the two actions—this keeps players from building “instant reinforcements” and provides for interesting scenarios involving attacks on partially complete units.

Construction First is particularly interesting if your campaign has a lot of little things to spend money on during the turn, such as repairs. Players will have to withhold some of their funds to pay for the unexpected, or use deficit spending (if allowed).

**Movement First:** This allows campaigns to have, among other things, instantaneous logistics. All shipping will take place in movement phase, which happens right away; money delivered to a facility can be used for construction immediately. This could cause a potential problem if, for example, a player writes construction orders assuming a certain amount of EPs will arrive, but the freighter bringing those EPs is ambushed and captured by a pirate. GMs might want to write rules for conditional builds, or provide some ability to adjust construction if income is reduced.

These three activities (Movement, Construction and Income) are usually referred to as “phases” of the strategic turn. Depending on your campaign, you might add other phases, or subdivide these or any other phases into sub-phases.

**SUBDIVIDING MOVEMENT**

Movement is an area which can become very complicated due to the possible interactions between players. It is highly recommended that Movement Phase be subdivided in some way, to make sure encounters can be properly resolved.

Ships in a campaign normally have a strategic speed, allowing them to move some maximum distance during the turn. Thus, it is logical to subdivide Movement Phase into a number of sub-phases equal to the maximum speed of the fastest ship your campaign can have. Then, you need to define some method of determining which sub-phases (often called “pulses”) any given ship moves in. Here are three possibilities:

**As early as possible.** Ships move in the earliest pulses available. For example, if your campaign's Movement Phase has six pulses, a speed-3 ship would move in pulses 1, 2 and 3, remaining idle in pulses 4-6. (Alternatively, you could reverse this, using the last pulses instead of the first.)

**When the player chooses.** Just let players decide which pulses each ship should move in. This gives them some flexibility, and another interesting strategic choice to make.

**Like an impulse chart.** Design a chart similar to SFB's impulse chart, but with a number of rows equal to the number of pulses in your campaign's Movement Phase. Here's an example of a twelve-phase movement chart:

Ph	12	11	10	9	8	7	6	5	4	3	2	1
1	1	-	-	-	-	-	-	-	-	-	-	-
2	2	1	1	1	1	1	1	-	-	-	-	-
3	3	2	2	2	2	-	-	1	1	-	-	-
4	4	3	3	3	-	2	2	-	-	1	-	-
5	5	4	4	-	3	-	-	2	-	-	-	-
6	6	5	5	4	4	3	3	-	2	-	1	-
7	7	6	-	5	-	4	-	-	-	-	-	-
8	8	7	6	6	5	-	4	3	-	2	-	-
9	9	8	7	-	6	5	-	-	3	-	-	-
10	10	9	8	7	-	-	5	4	-	-	-	-
11	11	10	9	8	7	6	-	-	-	-	-	-
12	12	11	10	9	8	7	6	5	4	3	2	1

If a ship was moving at a speed of three in a campaign that used the above chart, it would take its moves on phases 4, 8 and 12. Note that this type of system makes it more desirable to buy ships of a like speed, or else it will be difficult to concentrate an attack (except on the last pulse of the turn). You could, of course, voluntarily move a ship at a slower speed than its maximum to keep it with a slower fleet, but this should be for the entire turn; “mid-turn speed changes” should not be allowed strategically.

**A NOTE ON SIMULTANEOUS MOVEMENT**

Most campaigns use “simultaneous movement,” the most realistic type, in which each player's ships move at the same time as everyone else's. If your campaign uses “individual movement,” in which one player moves while others sit idle (and on the defensive), then subdividing the Movement Phase (or any other phases) is not needed. In fact, in such a campaign, the sequence of play will be greatly simplified, since it will apply only to players on an individual basis, never to interactions between players.

**OTHER ACTIONS TO BE SEQUENCED**

In addition to Movement, Construction, and Income, there are a number of other minor considerations that need to be added to any sequence of play. Here are some examples, along with suggestions for where they should appear in the sequence:

**Combat:** Battles will occur during the Movement Phase only depending on your encounter rules (see *Scenarios*). Normally they are a result of movement; it might also be possible to discover hidden ships in any movement pulse, generating a new scenario at that point.

**Repairs:** Ships which suffer more damage than they can repair during a scenario will have to use the campaign's strategic repair procedures at some point in the turn. Often, this is accomplished at the end of Movement Phase after all movement and combat is complete.

**Refits and Upgrades:** These normally occur during Construction Phase, depending on your campaign's refit rules. Often they take an entire turn to complete, creating the opportunity for scenarios involving ships in drydock undergoing upgrades.

**Scans and Surveying:** Active scanning should always occur after Movement Phase, giving players a chance to see where other players have moved (if that kind of scan is used in your campaign) and prepare their next turn with that in mind. Surveying also usually occurs after Movement Phase, and if surveys can activate colonies or similar actions, they usually come after Income and Construction Phase as well (to prevent players from immediately building at worlds they just found).

**Placing Bases:** Mobile bases can be dropped by tugs at any time during Movement Phase, but should not become active until their positional stabilizers have activated (which can't happen during a scenario). We recommend at least one movement pulse before this occurs.

**Laying Minefields:** This should take a great deal of time, at least several movement pulses and possibly an entire turn. You might say that it takes one or two pulses to get the initial mines laid, and the rest of the turn to activate any special mine control systems, captor mines, etc. This could create a scenario in which a minefield is partially laid but not fully active.

**Population Growth:** If your campaign uses population, you need to decide when growth occurs. The main decision is whether it happens before or after Income Phase (to determine if new population affects income or not), but Movement Phase also has an impact—if movement is first, players can pick up newly generated population and move it on the same turn; otherwise they have to wait. One possibility is to have growth occur at the end of the turn, but specify that population that has been moved from one world to another not be eligible for growth.

**Other:** Depending on your campaign, you may have other considerations to keep in mind, such as espionage, arrival of new ships at warp gates, detecting new warp points, etc. Be sure to consider your campaign's specific rules when putting together your sequence of play.

**LEGENDARY OFFICERS**

Legendary officers are one of those optional rules that many players love to hate, and often ban from pickup games or patrol battles. However, in a campaign they can be more effective and provide added interest and scenario objectives. Entire battles can be fought with the single goal of "Kill the Legendary Captain!"

However, if not controlled properly, legendary officers can ruin a campaign. A squadron of war cruisers with Legendary Weapons Officers and Legendary Engineers on each ship are extremely deadly and difficult to deal with, even with a sizable opposing force. You don't want officers to become common in your campaign, or situations like this may develop. Instead, keep them rare, and players will treat them with the respect they deserve. A few guidelines:

**BUYING OFFICERS**

Don't let your players purchase legendary officers with standard campaign resources. This is the sort of thing that leads to entire fleets optimized with every officer imaginable. Just about any warship—even plasma ships—would much rather have a Legendary Weapons Officer than any other optional items of comparable BPV (even PFs), because the potential for additional damage and the extended range benefits that officer provides. A similar argument can be made for the Legendary Engineer, for what ship in SFB couldn't benefit from four extra points of power? If you let players buy officers at will, you virtually guarantee that every warship will have at least one, and probably both, of these officers—and every dreadnought will have a Navigator, every scout a Science Officer, every troop ship a Marine Major, and so on.

Still, depending on your feelings on officers, you still might want to let your players purchase or create them in some fashion. There are several alternatives to this:

**Legendary Officer Points (LOPs).** This is effectively a new kind of resource which a player's infrastructure would produce automatically. LOPs would be spent on legendary officers on a point for point basis, so if you wanted to buy a Legendary Engineer, the cost would be 15 LOPs. Generation of LOPs might be one per colony per turn, or some flat amount per turn. You might also require some sort of facility (such as a starbase) to earn LOPs. Linking these points to planets or bases gives you another good reason to capture or destroy such things in order to reduce the number of these special resources your enemy can acquire.

The exact amount of LOPs per turn will vary per campaign, depending on how many ships each player is expected to have, and how many officers you want roaming the universe.

**Battle Points.** Whenever a ship fights in a battle, it earns some amount of "battle points" (related to LOPs, above), which can later be spent to add a legendary officer to that ship. (You could also have battle points go into a central experience pool which any ship could draw from, but be careful with this, as it will result in only the best ships possessing officers, even if your POLs earned most of the points.) The LOP system has the interesting effect of encouraging fighting between players, especially if the amount of battle points earned is based in some way on the victory level in the scenario—players which are disadvantaged might be convinced to stay and fight, trying to cause at least some damage and disengage with a victory. As the GM, though, you must be very careful to avoid allowing "mock battles," in which players engage, damage each other very slightly, and then retreat in order to score battle points without any detrimental effects. Make it clear that this sort of thing is CHEATING, and then treat it as such, severely penalizing any players caught doing it.

**EPs with limits.** If neither of the above options appeal to you, you can try allowing players to use EPs for officers, but with extreme limitations. For example, you could limit officer expenditures to 5% of a player's total revenue. You might also state that the *economic* cost of an officer is equal to double the price shown in the Commander's Options (Annex #6). Other alternatives are limited only to your imagination.

**No purchasing.** The final option, of course, is to simply not allow officers to be purchased in any way. The appearance of an officer could be a random event, or could be rolled on the (G22.111) table for each ship as it is built. You might also devise a legendary officer arrival table of your own for each player (not each ship), giving each player a roll on each campaign turn. Here is an example using the Legendary Officer Point concept explained earlier. Each player rolls two dice on this chart at the start of each turn:

Die Roll	LOPs Gained	Die Roll	LOPs Gained
2	3	7-8	12
3	5	9	15
4	6	10	18
5	8	11	21
6	10	12	25

This chart is just an example, and may provide too much of a variance for your tastes. (A player who rolls poorly several turns in a row might become very discouraged.) Feel free to adjust these numbers or design your own charts.

For another possibility, you could use a subjective determination similar to that discussed in (U7.84) in *Advanced Missions*. This requires careful note-taking by the campaign GM (and his presence at every battle as an observer). The GM should watch for exceptional actions, such as an incredible series of die rolls, which might indicate a legendary officer. Some guidelines to follow:

**Weapons Officer:** Hitting with every weapon in a salvo; direct hits from very long range; maximum damage from a volley of phasers; etc.

**Navigator:** Several HETs in a row without breaking down; surviving a scenario after breaking down; intricate maneuvers to avoid seeking weapons and mines; etc.

**Engineer:** Incredible emergency damage repair rolls; using all damage repair capacity available in the scenario; surviving with a heavily crippled ship.

**Marine Major:** Multiple successful hit-and-run raids; capturing an enemy ship in a close fight; suppressing enemy hit-and-run and capture attempts.

**Science Officer:** Successfully identifying most or all enemy seeking weapons; earning a spectacularly high amount of lab information on opponents; breaking an unusually large number of drone lock-ons; etc.

**Doctor:** Surviving a battle after unusually high crew losses aboard ship; having a large number of wounded crew units (or legendary officers) survive a scenario.

**Captain:** Multiple occurrences of the above; lopsided victory against difficult odds; unusual tactics which (to everyone's surprise) succeeded; escaping from a destroyed ship after a noble sacrifice that saves the day; and so on.

Again, you should be warned—as mentioned in (U7.84) itself—that this should be taken in the spirit of fair play, and the GM's total objectivity is needed. Just because one ship fired four photons and hit with all four does not mean the weapons officer is necessarily legendary! The GM must exercise caution to avoid giving away too many officers or bending under pressure from whiny players to award them one because they think you should. Award a couple of officers per turn, no more than one or two per player; do so in secret; and don't try to

explain your reasoning for or against giving out any particular officer. This will save you a lot of headaches.

## LIMITING OFFICERS

Even if very few officers appear, players will still try to abuse them as much as possible. Here are some restrictions to consider.

**One officer per ship.** While this is not realistic, it prevents the "all-legendary" bridge crew from appearing, or (if nothing else) the synergistic effect of a Legendary Weapons Officer and a Legendary Engineer. This rule is ideal in campaigns where players can buy officers for any ship they choose; it doesn't work so well if using a battle experience system in which only the ship earning battle points can benefit—unless you allow officers to be upgraded later.

**One of each type of officer per fleet.** This is another guideline you might consider, in order to prevent the "Weapons Officer Squadron" concept from becoming widespread in your campaign. Again, it is not realistic, but is fair and encouraged distribution of officers.

**No officer transfers.** See (U7.8) in *Advanced Missions*, which is an excellent rule regarding the transfer of officers to another ship. Basically, it states that only Doctors, Ground Forces Officers, and Marine Majors can transfer to other ships and still use their abilities; other officers cannot. If the original ship is destroyed, they can move to another identical ship (or a variant, if you choose to allow this). Officers might also be promoted (U7.83) in an attempt to move up to the next larger ship type, but according to this rule, they have only a 33% chance of success. Feel free to alter these probabilities to suit your campaign.

**Ship upgrades.** If your campaign allows ships to be upgraded, refitted or converted (and most campaigns will do so), and your campaign allows officers to be paid for with some amount of funds related to the ship's cost or size, then a significant loophole exists that you need to be aware of. Having considered these conditions, you have probably already figured out this loophole: players could pay for an officer on a cheap basic ship, then upgrade it to a significantly larger ship and improved the officer's capabilities dramatically. Consider the Legendary Weapons Officer, which costs 15% of the ship's BPV (minimum 15 points). A canny Romulan player might purchase a War Eagle for 100 EPV, and the appropriate campaign cost of 15 for the officer. Then the player upgrades the WE to a KE, adding 40 points to the ship's value! Unless your campaign also forces players to cover the increased price of the officer at the same time, expect to see this loophole exploited time and time again. If a player can't afford to improve the officer at the same time the ship is improved, then the officer should be lost!

**No bluffing/limited bluffing.** The Captain's ability to "bluff" opposing forces is incredibly powerful in a campaign. In a patrol-style battle it is merely annoying, but when you're trying to fight an enemy in a campaign, it's downright frustrating. One way to stop this is to simply disallow the "bluff" ability of Legendary Captains, although this is the extreme solution. Another possibility is to give some sort of penalty or cost, or a possibility that the Captain will be lost (fired from his post) due to some unforeseen conflict with the Admiralty for not actually fighting—perhaps the Admirals are concerned that the enemy fleet will now penetrate the lines or destroy some other strategic target, while they were counting on the Captain's fleet to slow them down or damage them somehow.

### OFFICER STRATEGIC ABILITIES

With a campaign, you discover a strategic aspect of legendary officers not found in simple scenarios. In other words, over the long term of month- or year-long campaigns, any given officer might have additional abilities you won't see in battle. What follows are suggestions for some of these abilities if you should choose to use them. (Note: If using these options, increase the cost of legendary officers. Making the economic cost double the Commander's Option cost is an excellent idea.)

**Weapons Officer:** Can repair ship's weapons given time. After a scenario is over, any weapons left unrepaired can be fixed by a Weapons Officer, up to a limit of 10% of the ship's BPV in repair points. (For example, a Weapons Officer could repair up to 20 repair points after a scenario on a ship with a BPV of 200.) This only works for weapons; he cannot fix anything else.

**Navigator:** Can increase the ship's strategic speed by one per campaign turn. (This may be too powerful for some campaigns. You might instead allow a die roll to possibly earn an extra movement point, or allow 1/2 of an extra movement point in campaigns where partial movement or movement carryover is allowed.)

**Engineer:** His campaign repair abilities are defined in his specific rules (G22.414).

**Marine Major:** At the end of any campaign turn, Marine Majors can train regular crew units to become replacement boarding parties (if the ship is unable to get more on its own). This is not required, but works only if the owning player so chooses. Simply change the required number of crew units into boarding parties on the SSD. (Note that this cannot be used to acquire extra BPs, only replacements.) Marine Majors may also be allowed to train normal boarding parties up to commando level (remaining within the normal commando deployment limits of two per ship, of course).

**Science Officer:** Increases the scanning abilities of his ship depending on which exploration and survey rules your campaign uses. At a minimum, he should improve the amount of strategic Tac Intel gained by his ship by one level. If using scout channels for short-range or long-range scans, he increases their range or quantity by one as appropriate.

**Doctor:** At the end of any campaign turn, one-third (round fractions up) of all crew units lost during that turn (for whatever reason) are "cured" by the Doctor. Any crew units cured during scenarios using (G22.61) count against this amount.

**Captain:** Can choose one of the above abilities (except that provided by the Doctor) to utilize each turn; this decision must be made before the campaign turn begins. If not using one of these choices, he has another ability: If his ship is on patrol or defending an area and a battle takes place within one hex of his location, he somehow manages to be there to join in the fighting. Note that he cannot use this ability to attack, although he could act as a Navigator and simulate it (if that ability is allowed in the campaign).

### NEW CAMPAIGN OFFICERS

With a campaign, you might consider allowing some or all of the following strategic officers. Most have no effect in a scenario, although their location must still be tracked; they could still be killed or wounded in combat. Note that if you add any of these officers, you'll need to provide some means to actually get them in the campaign; e.g., if you use the random legendary officer table, you'll need to add an entry for each of the new officers, probably by creating an entirely new table to feature them.

### Legendary Admiral

The Admiral has several abilities, all of which function only if he is on the flagship of a multi-ship fleet. Generally he is found on dreadnoughts and command cruisers only.

**Command Rating:** The Legendary Admiral adds one to the command rating of whatever ship he is on, so long as that ship has at least one undestroyed flag bridge box (bridge box on Klingon ships without flag bridge). This can exceed the normal maximum command rating but to a maximum of 1. Two Legendary Admirals cannot combine; only one will function in any fleet at a time.

**Legendary Captain:** While providing the above benefit, Legendary Admirals can perform as a Legendary Captain, using all the abilities Legendary Captains can, including strategic benefits (if used). If they change jobs (G22.23), the one-turn delay (G22.231) does not apply; they do not actually move, but work by "inspiring" another officer to act in the "legendary" role. Note that this does not cause them to lose the flag command benefit.

**Bluff:** Legendary Admirals may also bluff using (G22.21), but have a base 60% chance of success, with a maximum of 75% and minimum of 33%. If the Captain's bluff is not allowed in your campaign, the Admiral cannot use this ability.

**Transfer:** Legendary Admirals can "transfer their flag" during a scenario to another ship with undestroyed flag bridge boxes without losing the above abilities, but ONLY if the original flagship is destroyed during the battle. On a ship without undestroyed flag bridge boxes, they are treated as a Legendary Captain in all respects.

**Cost:** 40% of the ship's BPV, minimum 40 points. Note that this officer functions *only* if on the fleet flagship, so putting him on a small ship is not a good idea.

(Note: This is, without a doubt, the most commonly suggested "new" legendary officer for Star Fleet Battles. Many players proposed this one, too many to list here.)

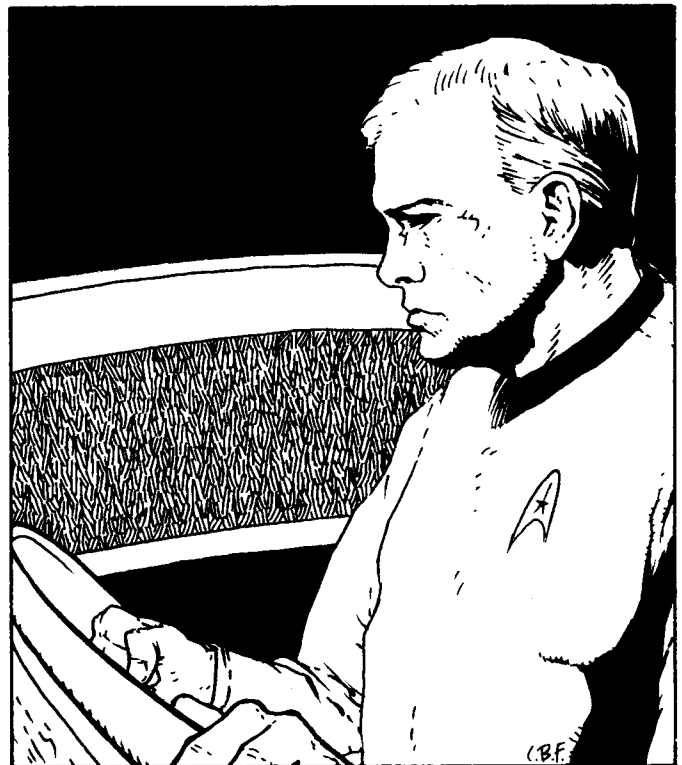

**Legendary Professor**

This officer has several abilities, many of which will vary depending on the campaign.

**Legendary Officers:** If assigned to a construction facility, the Professor allows all legendary officer rolls (G22.111) to be shifted by 1 in either direction. Before rolling, the player owning the Professor announces which direction he wishes to shift the roll (by -1 or +1) and then makes the roll. This ability can be used only once per campaign turn and on only one ship. (If your campaign uses different officer acquisition rules, this ability will need to be modified accordingly.)

**Fighter/PF Training:** If assigned to a base or other facility where fighter or PF crews can be sent for training, their training rolls are increased by +2. This applies to (J6.341) and (K8.34) only.

**Crew Experience:** If assigned to a base, any ships visiting that base within one campaign turn of a battle receive a bonus of 25% to any crew experience they gained during that battle due to intensive debriefing and battle reviews. Round fractions of 50% or more up, others down. Fighter pilots and PF crews can also benefit from this instruction.

**Cross-Training:** If assigned to a ship, the personnel aboard that ship become involved in intensive cross-training during their next campaign turn (only). This provides the following benefits:

- Boarding parties and deck crews are increased in number by 50% (drop fractions). No new crew units are added; this represents existing crew trained in additional duties.

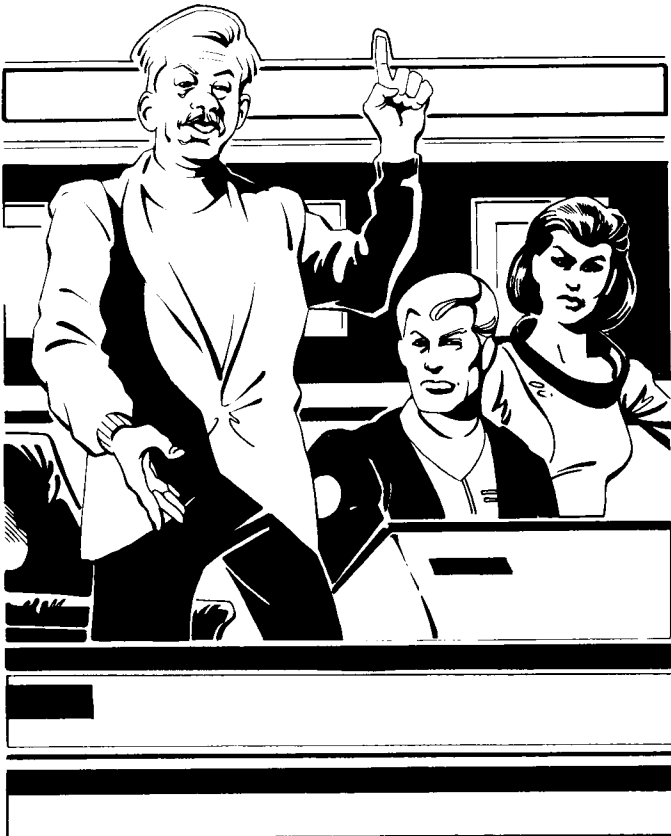

- Weapons status is increased by 1 level for that ship only due to heightened readiness.

- Legendary officers might appear in this intense training environment. Roll once on the (G22.111) chart with no modifiers. If one or more officers appear, they can be used during that campaign turn only, and revert to normal status thereafter.

- During any turn of battle (in a scenario) it is possible that the crew might "click" and operate as an outstanding crew for that scenario turn only. Roll two dice at the start of each turn, before Energy Allocation. If the total is "2," the crew is treated as outstanding for the coming turn only. (No roll is allowed at the start of the following turn; the crew reverts automatically.)

The Professor does not need to be in any particular location on the ship to provide any of the above benefits, and what happens to him during the scenario does not impact any of the above abilities in that battle (though if he is killed, he will not affect any future scenarios on that same or a later campaign turn).

**Cost:** If used in a scenario only (for the cross-training benefit), the Professor has a BPV cost of 10% of the ship's BPV, minimum 10 points, and any officers gained must be paid for in BPV. If used in a campaign, the cost will have to be determined based on your campaign's rules and setup. Campaigns with many ships or infrequent battles would find the Professor less useful and would charge less than a campaign with many ships or constant fighting. Alternatively, a campaign might provide each empire (or whatever) with one Legendary Professor at the start of the campaign, with no additional ones available.

This officer was suggested by James Pack.

**Legendary Mine Control Officer**

This officer is also generally found only on bases, though he also appears on minesweepers and minelayers. He has different abilities depending on where he is located.

**Mine Control (base only):** When a command controlled mine is activated by the base during a scenario, it counts against the base's control limit for that impulse and only three subsequent impulses, not the next seven impulses as stated under (M5.26). This is identical to the Legendary Base Commander ability above and is not cumulative with that ability.

**Automatic Controls (base only):** After the base assault scenario is set up, the Mine Control Officer can change the automatic control designations—but not the locations—of up to six mines in each standard minefield around the base.

**Minfield Controls (base only):** Each standard minefield around the base gains an additional two command controls (placed on mines already in the minefield) at no cost.

**Mine Detection Range:** Increases the range at which a minefield can be detected by two hexes.

**Mine Location Range:** Increases the range at which individual mines can be located by one hex.

**Minelaying:** 25% (drop fractions) of the mine racks on the ship can lay two mines per turn instead of one. Example: A ship with 8 mine racks could lay 10 mines in a given turn, laying two from each of two racks of the player's choice. On the following turn, two different racks (if desired) can be selected for double duty.

**Cost:** The cost of Mine Control Officer is 10 points if used only on ships. If placed on a base, his cost is 8 points for each standard minefield around the base; each time a new minefield is laid the extra cost must be paid or the officer will lose his abilities.

### Legendary Base Commander

This officer functions only if located on a base. Generally he is found on a base station or larger; he might rarely appear on an MB or SAM. He has several strategic abilities and several tactical ones, all of which work simultaneously. If used during a scenario, he must be located in a control box.

**Detection:** His base gains one strategic Tac Intel level of information on nearby enemy forces than a base of its size or capabilities normally would. If using special sensors to make long-range or other types of scans, the base adds one to its scanning range or quantity of scans, depending on campaign rules. This is essentially identical to the Legendary Science Officer strategic abilities described previously, and is not cumulative with that officer if one is present.

**Base Modules:** The base can use one of its position-B augmentation module mounting positions for a class-A augmentation module (if desired); if on a starbase, two such positions can hold class-A modules. This increases the amount of class-A modules available to the base by 33%. Bases smaller than base stations cannot use this ability. The BPV cost of this added class-A module (or modules) is/are doubled, in addition to the cost of this officer.

**Minefield Sizes:** Any minefields deployed around the base include an extra three small explosive mines, one large explosive mine, and one small captor mine, all provided at no additional cost.

**Mine Control:** When a command controlled mine is activated by the base during a scenario, it counts against the base's control limit for that impulse and only three subsequent impulses, not the next seven impulses as stated under (M5.26).

**Repairs:** Each repair box on the base (or any attached repair modules) can generate up to 110 repair points during a scenario, not 100 as listed in (G17.26).

**Cost:** The cost of a Legendary Base Commander is 15% of the BPV of the base itself. If the base is refitted or enlarged to the next size level, 15% of the upgrade cost must be paid in order to maintain the Base Commander as well.

The concept of this officer was suggested by Steven P. Petrick.

### Legendary Cargo Officer

This is a civilian officer normally found on freighters, tugs or other cargo ships. He has several abilities which operate simultaneously. This officer can transfer freely between ships at will, but will provide his benefits on only one ship per campaign turn.

**Capacity:** The cargo capacity of each cargo box on the ship is increased by 20% (i.e., 10 spaces on normal size-50 cargo boxes, 5 on most size-25 Orion boxes). If cargo boxes can be used to transfer economic points, population, or other resources, these capacities should be increased by a like amount. This represents the efficient packing ability provided by the Cargo Officer, who does not need to be in any particular location on the ship to provide this benefit.

**Transfer:** When using direct cargo transfer (G25.23), increase the transfer rates by 25% (retain fractions) except for explosive ordnance (G25.3), which does not benefit. No benefit is provided for transporter or shuttlecraft transfer. The Cargo Officer must be located in a cargo box for this ability to function.

**Shuttlecraft:** If placed aboard a shuttlecraft as part of the flight crew, the shuttle can carry 20 spaces of cargo (10 spaces if carrying a crew unit and 0 if overcrowded). This is an increase over the amounts listed in (G25.131). MRS shuttles can carry 25 spaces (10 if carrying a crew unit and 0 if overcrowded). HTS shuttles can carry 60 spaces (less 20 for every crew unit carried or 0 if overcrowded). Other restrictions, such as minelaying, remain as described in (G25.131). Once the shuttle has been

packed in this way, the officer can transfer off the shuttle to another location without harming the extra cargo.

**Cost:** The cost of a Cargo Officer is 15/10 (i.e., 15 EPV and 10 BPV), reflecting his enhanced strategic usefulness. Cargo Officers are normally found on large armed freighters, cargo tugs, or large ore carriers.

## STARSHIP CREWS

Crew units are found on every ship SSD (even Andromedans, although we don't even know what their crew looks like). One crew unit is killed by every 10 internals, and according to (G9.16), every dead unit is worth 1/4 BPV point to the opponent. Most players, however, don't bother keeping track of these because they aren't worth the trouble to calculate.

In a campaign, however, crew units become much more important. If a ship loses a great deal of crew in combat and doesn't replace it, there is the danger of becoming undermanned (G9.41). Boarding parties and deck crews are also considered part of the crew (G9.31) and should be tracked, because they also need to be replaced individually. A ship which loses most or all of its boarding parties in one battle might find itself in danger of being captured in a subsequent battle!

In addition to these concerns, there are "poor" and "outstanding" crews which can be found on certain ships. In a one-shot, patrol-style scenario these are little trouble, but in a campaign, the management of poor and outstanding crews can become troublesome.

The following sections provide suggestions for dealing with these sorts of issues. You can use some, all, or none of them as your campaign requires.

### CREW LOSSES

As mentioned previously, crew units are lost for every 10 internals (all fractions are dropped). These need to be replaced in some way.

Crew can be "created" on any world your race/empire owns by purchasing them for 1 economic point. (This is the price found in Annex #6. You may choose another cost, such as 0.5, if the campaign will involve large numbers of ships.) Crew for new ships does not need to be bought; it is assumed to come with the ship. You can transfer crew from one ship to another, or from ships to bases, at will whenever the two units are in the same location.

Worlds must be populated in order to create crew (the people have to come from somewhere). Underpopulated colonies or hostile (captured) planets should not be allowed to do this. If your campaign uses or tracks population and draws from that base to crew ships, then replacing lost crew (and boarding parties or deck crews) should also draw from planetary populations.

Another way to handle replacements is to simply make them automatic, as long as the ship is "in supply." A visit by a fast resupply ship (from Module R6) might also be required.



### REPLACING OUTSTANDING CREWS

(U9.0) includes a detailed rule for tracking crew experience. As a ship's crew gains experience, it earns an overall total crew level score (which starts at 500 for average crews, rising as the ship wins battles and performs various other actions). When crew units need to be replaced, they come in as 500-point crew units which are then averaged into the rest of the crew, lowering the experience total. Veterans of this procedure know that keeping a crew at outstanding level (1500 points or above) is very difficult, especially considering that any such ship is going to be a primary target of enemy fire.

An alternative to this is to allow players to actually purchase outstanding crew units to replace losses. Consider the cost of one average crew unit to be 1 EPV (as shown in the previous section). Then charge a cost relative to the extra experience of the crew unit being replaced. For example, a crew unit with 600 experience has a 20% improvement over the average of 500, so the cost of a crew unit of this level would be 1.2 EPV. From this you can see that a 1500-point outstanding crew unit would cost 3 EPV, which can get expensive!

**Note:** You cannot make a crew outstanding by simply replacing its crew units with outstanding ones! You can only pay for higher-experience crew if you are actually replacing a crew unit of that level. This reflects the ability of the remaining crew to train the new unit and pass along their experience and insight.

As for poor crew, make sure that poor crew units cost the same as standard crew units. Don't give players a price break for creating them—this creates a game loophole in campaigns where battles are scarce and quantity is more important over quality. You'll find your players frequently use poor crews to save on points. Needless to say, you can't replace a normal or outstanding crew unit with a poor one (the better crew would have nothing to do with them).

### LOW CREW PENALTIES

If replacing crew requires EPV the player doesn't have, or a visit to a supply point that is out of range, the ship may be left without a full complement of crew units for a period of time. If this happens, it can suffer some debilitating campaign-related effects. Here are some suggestions on what to do in this case:

If a ship is missing more than 33% (one-third) of its crew, it loses one point of strategic speed (e.g., if the ship could move four hexes per campaign turn, this speed is reduced to three). Its strategic intelligence detection abilities become one level worse (this depends on the campaign rules). Subtract one from each type of system repaired under (D9.4)—so, for example, the amount of weapons which can be repaired is equal to two times the damage control rating minus one. Reduce the ship's weapons armed status by one level (III to II, II to I, or I to 0; WS-0 cannot be reduced further). The time required for all refits, module changes, cargo transfers, repairs, overhauls, etc. is increased by 50%, unless the lost crew is being replaced simultaneously. The time required to perform special ship actions such as surveys, minelaying, prospecting, scanning, setting up colonies, etc. is doubled.

If a ship is missing more than 67% (two-thirds) of its crew, double the above effects (strategic speed reduced by two, strategic intelligence shifted by two levels, -2 to all (D9.4) repairs, weapons status reduced by two levels, time factors for repairs, refits, etc. increased by 100%, time required for special ship abilities is quadrupled).

Note that ships which have lost over 50% of their crew also suffer from (G9.452), which causes their maximum damage rating to be considered a "2" under this rule.



### OUTSTANDING CREWS

If using crew experience (U7.9), it takes a *loooooong* time to get a ship to fully outstanding levels. In a typical battle, no more than 50-100 crew points will be awarded, so it will take at minimum of 10 battles (on the average) to work up to an outstanding crew. Since the average length of the typical campaign is around 10 turns, you probably won't see an outstanding crew at all. Here are some alternate possibilities:

**Increased experience points.** You might increase the crew experience points in some fashion, perhaps increasing the (U7.9511) participation benefit from 2 to some larger value, such as 25 or 50 points. This should relate directly to the size of your campaign and its expected length. You don't want to make outstanding crews too common, but you don't want them to be unachievable either. Watch out for "mock battles" or other abuses of this system!

**Outstanding Crew Points (OCPs).** Another possibility is to provide Outstanding Crew Points, which are similar to the Legendary Officer Points described earlier. Each OCP can be used to change one crew unit from average to outstanding (or can be treated as 1,000 experience points for a single crew unit). OCPs could be produced by worlds or earned at a flat or random rate, just like LOPs could.

If you don't use the experience system at all, use OCPs as BPV points for purchasing outstanding crews. For example, 50 OCPs could purchase an outstanding crew for a 100-BPV ship.

**Partially outstanding crews.** A final possibility is to use this concept, in which a ship which has earned some of the required experience points is rewarded with a few, but not all, of the outstanding crew benefits.

To handle this, there are ten categories of outstanding abilities. For every 100 points over the average level of 500, the player can choose from any of the first nine. The final category, considered the "best" ability, can only be earned if the ship is fully outstanding. The categories are:

Category	Abilities
1	<b>Maneuver-I:</b> Extra HET bonus; HET cost reduced by 20%
2	<b>Maneuver-II:</b> Ship can make six tactical warp maneuvers per turn; +1 to quick reverse rolls; certain terrain rolls improved by one, see (G21.228)
3	<b>Shuttles:</b> Ship may have an MRS regardless of type; can prepare a spare shuttle during the scenario
4	<b>Weapons:</b> UIM breaks down on a "1" only; can use probes as weapons; shock die roll modifier in (D23.51)
5	<b>Scouting:</b> Subtract one from scout function die rolls; collect tactical intelligence at the next better level; scenario event rolls increased by "1" in most favorable direction
6	<b>Crew:</b> Various boarding party benefits (G21.241); add one when rolling for fighter/PF crew quality; increase deck crews by 33%; mutiny put down on a 1-4
7	<b>EW:</b> First point of EW produces two EW points
8	<b>Repair:</b> Subtract one from the die roll for repair in (D8.31) and (D14.13); the total number of systems that can be repaired is one more than shown in (D9.76)
9	<b>Other:</b> EM produces 5 ECM for enemy and 3 for the ship's own weapons; effective mine detection range increased by 2; escape die rolls are increased by 2; nimble ships do not lose the benefit of (C11.33)
10	<b>Direct-Fire Weapons:</b> Ship has 3 ECCM, which can produce a -1 shift for weapons fire (this is widely considered the best outstanding crew ability and must be the last one chosen)

Since many of the abilities above do not apply to certain ships (e.g., scout abilities to non-scouts), the groupings above are designed to give at least something to any ship. Letting the player choose his category allows him to not only pick his favorites but to avoid categories with abilities that don't apply. Alternatively, you could roll a die to determine the category (but re-roll any result of "10").

**CAMPAIGN OUTSTANDING CREW ABILITIES**

In addition to the (G21.2) abilities, which cover only tactical scenarios, we offer the following possibilities for campaign use. A crew should be fully outstanding to utilize any of these; alternatively, you could add them to the categories for partially outstanding crews listed in the previous section, using the category numbers shown.

**1. Weapons Status:** The ship has a weapons status one level higher than it normally would in any scenario. Even at weapons status-I, it always has phaser capacitors charged by 50% (retain fractions).

**2. Weapon Replacements:** After a scenario, all burned-out UIMs are replaced and all shock points are repaired at no cost. One set of drone reloads is replaced at no cost (but no fighter drone supplies are replaced). If your campaign rules require PPTs to be resupplied, then they are automatically resupplied after any campaign turn (not scenario).

**3. Resupply:** Ships are more efficient at getting replacement supplies. Instead of having to actually visit a base for resupply, the ship only has to come near it (1 hex away is recommended). If your supply system requires replacements to be paid for, then the ship pays 25% less for each replacement item.

**4. Deception Weapons:** The ship has two dummy weapons (D17.73) at no cost, determined when the ship gains this ability; these are in excess of the limits in (D17.731). Similarly, the ship gains two concealment panels (D17.74) at no cost.

**5. Strategic Intelligence:** Collect strategic intelligence at one level better than another ship of the same class.

**6. Crew:** Ships lose crew, boarding parties, etc. only on every 12th internal, not every 10th. Replacement crew units can be picked up at any colony, not just resupply points (if your campaign rules require)

**7. Silent Running:** If the ship uses silent running (D17.75), the effective information-gathering range for purposes of (D17.3) is doubled under (D17.751) and tripled under (D17.752).

**8. Repairs:** If using the (D9.4) campaign repairs, the ship earns an additional one box for each of the listed categories, i.e., (D9.41), (D9.42), (D9.43), and (D9.44). If not using this system, then the ship has 100 repair points available which it can use after any scenario (but not during one). After these points are used up, they cannot be restored until the ship has been resupplied.

**9. Cargo:** Increase the cargo capacity of the ship by 50% over its current level. If it cannot carry cargo, then it gains a special cargo-carrying capacity based on its size class: 2 cargo boxes for size class 4 ships, 4 on size-3, and 6 on size-2 or larger units. No boxes are actually added to the ship; the cargo is distributed through the hull. No single item larger than 20 cargo spaces can be carried because of this. Each "box" holds 50 space points (25 on Orion ships).

**10. Speed:** Increase the strategic speed of the ship by one per campaign turn.

Other similar abilities are also possible, and are limited only by your imagination!



## ESPIONAGE AND SABOTAGE

These features are highly optional, and are provided only for experimentation. There is nothing in Star Fleet Battles that simulates these concepts, although some abilities of Prime Teams may seem similar.

### CREATING SPIES

Spies are the basic unit of espionage—secret agents, or a group/corps of them, who gather information and pass it along to the nation, race or empire to which they have sworn their allegiance. Under some conditions they may perform more detailed activities, such as assassination, subversion, sabotage, and wreaking havoc in whatever way they can.

In order to use spies, your campaign should provide some sort of training or indoctrination facility so they can be created. Since nothing like this exists in SFB, you'll need to invent a facility to handle this operation, or simply state that any player's homeworld is capable of training spies (but no other location can do so).

Once this facility is defined, you need to specify exactly what a spy is and how much they cost. A spy could be a single individual (perhaps treated as a legendary officer), a small group (the size of a boarding party), or an entire cadre of people (numbering several crew units). There are many types of spy: highly trained members of your own race/empire; dissatisfied members of another empire working for pay or other reasons; enemy agents "turned" to your own purposes by counter-intelligence; and so on. For construction purposes these possibilities are effectively one and the same, unless your campaign tracks population and draws crew units from the population base. The only real difference may arise if a scenario requires delivery of a spy (surreptitiously, of course).

Spy costs vary, and depend on the abilities a spy will have in your campaign (the more abilities, the higher the cost). One possibility is to charge a set price for each of the abilities a player wants to give a spy, allowing for customization. As an example, a spy might have a base cost of 50 EPs (providing it with information-gathering abilities). Adding the ability to perform sabotage and more detailed actions could cost another 25 EPs or more for each such ability.

### DELIVERY OF SPIES

Spies can do their work in basically two places: on a planet or on a ship. Some campaigns, such as those with an automated logistics network, might allow a spy to be infiltrated into such a network; other possibilities also exist.

Getting a spy onto an enemy ship is a difficult process, and generally a passive one. To get there, a spy is often left on a world or in a facility that you expect to have captured, and then slips aboard in the cargo hold of a shuttle or by taking the place of one of the members of a boarding party. Spies which are members of the race being spied upon (such as double agents) might have an easier time of it; a human spying on Hydrans would have to remain hidden all the time, whereas a Hydran dissident could move about more freely. Normally the exact means of insertion can be left to the imagination; the point is that if a spy is left somewhere and an enemy ship visits that world, there should be a chance the spy can gain access to the ship.

Another way to get aboard could be during a scenario, but this usually requires that a spy be a single individual or perhaps no larger than a boarding party. Naturally, if a player beams a boarding party to an enemy unit and that BP disappears or does nothing, this will be like attaching a sign saying SPY ON BOARD! Instead, allow the spy to travel with a regular boarding party during a hit-and-run raid or capture attempt, slipping away

from the action and into the shadows. The GM might provide a roll to locate the spy during post-battle security checks (though this would be secret, of course), but the defender simply saying "By the way, I'm looking for spies because Joe used a hit-and-run raid on my cruiser" shouldn't be sufficient to find a spy.

Getting a spy onto a planet can be a much simpler procedure. A ship can just fly up to the world, beam the spy down, and leave. Unfortunately, if that world is controlled by someone, you might as well just tell him there's a spy there, or why else would you have done that? Instead, you should provide some ability to deploy a spy surreptitiously, perhaps by moving close to the system (one hex away, for example), launching the spy in a shuttle, and then retreating the ship. The spy then proceeds to the world at sublight speeds, arriving on the following campaign turn and landing on some remote part of the planet and traveling overland to the population centers or other facilities. There will probably be some chance of detecting the shuttle as it silently approaches, and this chance should be based in some part on the world's size and the forces present. Note also that terrain in the target system, such as a nebula or other feature deadly to shuttles, will prevent this kind of spy delivery system from working.

Once a spy is on a world or planet owned by the enemy, he should be able to move around fairly easily, skulking around in shadows and the like. Getting off the ship (or onto another), however, can be tricky and should require a success roll based on the spy's skill.



**SPY MISSIONS ON WORLDS**

A spy can perform various activities once he has reached an enemy planet. Here are some possibilities. Your campaign does not have to allow all of them, and could include others not listed here.

**Gathering information.** This is the most basic spy mission and is the one thing every good spy should be able to do. The kinds of information vary: value of the planet, total population present, defenses present or under construction, ships in orbit, strength of ground defenses, and so on are all good possibilities. The chance of getting caught while gathering information should be very small.

**Sabotaging facilities.** Any ground base present on the planet can be a target for sabotage, once the spy has discovered their presence. No more than one sabotage operation should be allowed per turn, and each attempt should have both a roll for success and a roll for capture. Note that once sabotage has occurred, the world's owner is going to KNOW a spy is present, and will do whatever he can to deal with the infiltration. Therefore, at a minimum, future sabotage operations should have an increased chance of failure.

**Killing population.** Spies can release poisons or biological agents into the air or water supply of colony worlds, causing a degradation in population levels and overall morale. If your campaign tracks population, just reduce its level by some random amount if this mission is successful. If population is not a world statistic, then it can be affected by lowering its production values for the next few campaign turns. Again, with this mission the presence of the spy is probably going to be revealed, unless plagues are provided for as random events in the campaign.

**Subverting world leadership.** This should be very difficult and time-consuming, and is nothing less than an attempt to overthrow a world's government and cause its loyalty to change to that of the spy. On a major planet or well-established colony it is not likely to meet with much success, but on a fringe world that's poorly defended he might be able to do this (especially if the spy's player has won a few battles in the general area, as the news of these victories will fuel the fires of rebellion). The sudden arrival of a large fleet of the spy's empire would also do wonders to incite a revolt, and might save the attacking player a long ground battle.

**Counterespionage.** This is the only action a spy can take on a friendly planet. If a world's owner suspects that an enemy spy might be present, he can bring in one or more counterspies to try to find them. Once they've been located, he could kill them outright, or (more interestingly) feed them false information. If the spy attempts any mission more complex than information-gathering, counterspies could intercept him if they wished or let him succeed, in order to continue passing false information. A good example of this sort of thing happened in World War II when the British broke the German codes and knew about a bombing attack on a city. If they warned the populace, it would tip the Germans that their code had been broken, so the town was sacrificed—a painful decision. Counterspies might have to do the same sort of thing: let a valuable ground base be destroyed in order to continue passing false information to a known spy.

**SPIES ON SHIPS**

This is a very controversial subject, mostly because no rules exist in SFB to handle the effect of a spy on a ship. There are some scenarios in which spies have caused some kind of sabotage, but these are very specific to those individual scenarios, and really can't be duplicated as a general ability. The best we can do is give a few suggestions.

**Note:** None of these abilities can be performed on the same strategic turn the spy is placed on the enemy ship. You must wait until the next turn to use them.

**Information-gathering.** A spy could pass the enemy ship's location back to its owner, as well as any refits installed, optional items aboard, and possibly even the presence of other ships nearby.

**Sabotage.** During the scenario, a spy might be allowed to attempt sabotage. This should be limited to at most a few boxes or one group of boxes (most likely a warp engine), although any sabotaged boxes would only be deactivated, not actually destroyed. Another possibility is to allow the spy to attempt to cause a critical hit, rolling once on that chart and living with the results. After any battle in which sabotage is attempted and the spy is not rescued, the spy will automatically be caught and killed (the ship's security personnel will scour the ship for days or weeks if necessary until the spy is found).

**Assassination.** A spy could attempt to kill a legendary officer, if one is present on the ship. (Of course, the spy might not know that one is there, but could suspect it.) The chance of success should be no more than 50%, and even less if the officer is a Major of Marines, the ship has an outstanding crew, or the ship is a troop carrier. The assassination attempt could come at any time, during a scenario or at some other point in the strategic turn (more likely the latter). Once assassination is attempted, the spy will likely be found and terminated unless rescued during a scenario, but this is not always the case. A smart spy (and you can assume your spies are rather intelligent) will try to make an assassination look like an accident. The exact means of this are left to the imagination.

**Counter-espionage.** A spy might be placed on a friendly ship to search for enemy spies, in much the same way that counterspies are used on planets. Again, a discovered spy could be left in place and fed with false information. Depending on your preferences, you might allow a Prime Team or Legendary Major of Marines to attempt counter-espionage activities.

**NOTES ON SPIES**

Spies add another level of intrigue to the campaign, definitely enhancing the interest of players. However, if abused or made too easy to acquire, they could prove troublesome. You might find that only one or two players in the campaign actually use spies, the others either forgetting about them or choosing to ignore this extra level of play. In this case, the players who actually use spies will gain a significant advantage; others will only get into the espionage game when they've seen others already participating. Thus, as a general rule, you should use spies in your campaign only if most of the players agree they should be present as a game option. Most of the time, spies will only be useful in a larger campaign with many worlds, lots of ships, and plenty of EPs to spend on spy training.

**MINOR SHIP IMPROVEMENTS**

This is an interesting rule suggested by Garth Getgen. When a ship is created, there is a chance that some minor difference or improvement might creep into the design. This could be the result of an effort by the designers to enlarge or improve one of the ship systems, an attempt to use some kind of prototype technology, or any of a number of other factors.

When a ship is built (or delivered, depending on the campaign rules), roll two dice and consult the following chart. Do not use this chart for PFs, fighters, or bases smaller than a base station.

**IMPROVEMENT OCCURRENCE TABLE**

Die Roll	Result
2	Two successful improvements
3-5	One successful improvement
6-10	No improvement
11-12	One unsuccessful improvement

There are 36 possible improvements listed in the chart which follows. Roll one die, subtract one, and multiply the result by six. Then roll another die and add it to the result. (This generates a number from 1 to 36 with no bell curve distribution.) Example: A roll of 4 on the first die and 3 on the second is a total of 21.

If the improvement was "successful," then use the listed effect on the ship in question (the improvement is permanent). If not applicable, roll again on the Improvement Table. Any added boxes must be added to existing box groups already on the SSD (e.g., you cannot create a whole new shuttle bay if you gain one shuttle box).

If the improvement was "unsuccessful," then use the reverse effect (e.g., if the chart says to add a tractor box, subtract one instead). If not applicable, roll again on the Improvement Table (of course, it will still be an "unsuccessful" improvement). No subtraction can remove the last box of the given type from a ship; if this would be the case, then roll again.

You cannot choose to ignore an improvement (whether it was successful or not). If something happens, you're stuck with it!

These improvements may not be made to the modules of a modular ship, pods on a tug, or modules/pods on a base. If the improvement requires a change to such a system because no other alternatives exist on the ship, then roll again.

If a ship undergoes a refit or upgrade which changes it to another variant and deletes the group of boxes to which an improvement was made, then the improvement is lost (but returns if the ship is converted back to the original form). Any other refits/upgrades do not affect improvements.

Note that random ship improvements affect only the individual ship for which the die roll is made. Other ships of the same class, whether already in existence or future construction, will not necessarily have the same improvement.

**IMPROVEMENT TABLE**

Roll	Improvement
1	Add one box to the damage control track (box value is equal to the highest box already on the track)
2	Add one "6" to the sensor track
3	Add one "0" to the scanner track
4	Add one box to the excess damage track if a size class 4 ship, two boxes to a size class 3 ship, and four boxes to a size class 2 ship
5	Add one box to each shield if a size class 4 ship, two to size class 3, three to SC 2; Andros reroll
6	Add one APR box (Orions roll again)
7	Add one impulse box
8	Add one shuttle box (Andros roll again)
9	Add one tractor box
10	Add one transporter box
11	Add one battery
12	Add one control space other than flag or security
13	Add one phaser-3
14	Add one phaser-1 or phaser-2
15	Add one probe box
16	Add one lab box
17	Add one fighter box
18	Add one launch tube (if a carrier; if not roll again)
19	Add one additional HET bonus
20	Add the ability to carry one additional T-bomb
21	Add two boarding parties
22	Reduce the cost of an HET by one point of speed (i.e., the ship needs to pay for only four hexes of movement in order to HET)
23	Reduce the cost of erratics by one point of speed (i.e., the ship needs to pay for 5 hexes of movement to perform erratics, 2 hexes if a nimble ship)
24	Reduce the breakdown rating by 1 (e.g., 3-6 goes to 4-6); if already a 6, roll again
25	Reduce the cost of life support by 1/2 point
26	Reduce the shield cost to 1/2+0 for size class four ships, 1+1/2 for size class three, and 1+2 for size class 2; Andros reduce panel cost by 1
27	Decrease the shield cost by 1/2 point of energy (1 point for size class 2 ships); Andros see #26
28	Replace one admin shuttle with a GAS shuttle (if no admins exist, roll again)
29	Add two deck crews; Andros roll again
30	Add 3 boxes to the front shield if a size class 4 ship, six boxes if size-3, ten if size-2; Andros add one PA panel to the forward or aft panel bank at their option
31	Increase the phaser capacitor size by 20%, i.e., each phaser-1 or phaser-2 provides 1.2 points of capacitor space, not 1 point
32	Add one barracks box (boarding parties, commandoes, etc. must be paid for)
33	Add two hull boxes if size class 4, four if size-3, and six if size-2
34	Add two cargo boxes if size class 4, four if size-3, and six if size-2
35	Add one legendary officer, determined by random roll under (G22.111) re-rolling any result of "2" or "no officer" (or use your campaign's alternate officer procedure, if any)
36	Decrease the turn mode by one level, e.g., C to B or B to A; if already A, roll again



**RANDOM EVENTS**

For an added twist, add random events to your campaign. A random event is a minor happening beyond a player's control. Each player should get one once per campaign turn, at a point specified in the sequence of play (although some effects might not actually happen until another step of the campaign sequence or on the following turn).

Because there are so many potential random events, we have listed them in terms of playing cards. Each player draws one card from the deck and consults the chart to see what his random event is. Red cards are "good" (the higher the card, the better, with aces representing the best possible effect). Black cards are bad, although as a general rule, not *that* bad.

If you wish, add the Jokers (the standard one and the one with the trademark, indicated by an "\*" in the list which follows). Jokers are optional; if you don't want to use them, leave them out of the deck.

As with any "random" feature, there will be players who have extraordinarily bad luck and those with unusually good luck, drawing either black or red cards each turn, respectively. One way to counter this is to say that no player can draw more than two cards of any given color more than two turns in a row, allowing them to redraw if they draw a third consecutive card of the same color.

If an event says to choose a ship at random, then the player should list out his ships, assigning a number to each one, and roll at random to pick one. Don't include fighters, PFs, bases, monitors, freighters, etc.; use warships of size class 4 or larger only.

Here is a sample list of random events. Feel free to create your own!

**"GOOD" EVENTS LIST**

Card	Effect
2♦	Gain 1-6 transporter bombs
3♦	Gain a Legendary Doctor on a random ship
4♦	Gain a Legendary Science Officer on a random ship
5♦	Gain a Legendary Major of Marines on a random ship
6♦	Gain a Legendary Navigator on a random ship
7♦	Gain a Legendary Engineer on a random ship
8♦	Homeworld produces 50% more economic points this turn
9♦	Receive one squadron of class-1 or class-2 fighters at your homeworld, if available; if not, redraw another red card
10♦	All strategic intelligence efforts have +1 to their range for the next turn
J♦	All ships entering battle this turn do so at +1 to their weapons status
Q♦	Gain a Legendary Weapons Officer on a random ship
K♦	Homeworld produces double the normal economic points this turn
A♦	All ships gain a +1 strategic speed bonus on the next campaign turn
2♥	Gain 1-3 multi-role shuttles; Andros draw another red card
3♥	Gain 3-18 extra boarding parties to assign to ships as extras (no more than 4 can be added to any one ship); for every four BPs, also receive one commando; these cannot exceed the normal commando limits on ships
4♥	Receive one small ground base on a random world; it can be of any type available to the player except planetary control bases (bases with fighters or PFs do not come with these items)
5♥	Gain 21-40 economic points
6♥	One random ship gains the effect of an outstanding crew in the first battle it fights next turn (but no strategic effects); if the crew is already outstanding, draw another red card
7♥	Gain an Ace Pilot (not legendary) on one fighter on a random carrier; if not applicable, draw another red card
8♥	One random ship receives 250 crew experience points (or an equivalent benefit if using a different crew experience rule)
9♥	Receive three PFs (standard types) at your homeworld if PFs are available; if not, redraw another red card
10♥	Gain 51-100 economic points
J♥	Receive the services of an Orion mercenary ship for the next campaign turn, not to exceed 125 BPV; this ship will fight in any battle you choose, but counts against your command rating; if crippled, the ship disengages immediately and automatically
Q♥	Receive a free police ship (including any refits appropriate to the year or technology except the mech link refit) at your homeworld
K♥	Homeworld produces 10 extra economic points for the remainder of the campaign
A♥	Gain 101-200 economic points

## "BAD" EVENTS LIST

- |     |  |     |  |
|-----|--|-----|--|
| 2♣  | One random ship loses all its T-bombs; if no ships carry T-bombs, draw another black card  | 2♠  | No effect (no random event)  |
| 3♣  | One random ship loses its MRS shuttle; if no ships have MRS shuttles, draw another black card  | 3♠  | No effect (no random event)  |
| 4♣  | One random ship loses 2 fighters (or 1 heavy fighter); if no ships have fighters, draw another black card  | 4♠  | No event this turn, but next turn draw one black card (even if this would be your third in a row)  |
| 5♣  | One random ship loses a standard PF; if no ships have standard PFs, draw another black card  | 5♠  | One random ship loses 20% of its crew to an unexplained radiation leak   |
| 6♣  | One random ship loses 50% of its boarding parties and ground forces due to a freak training accident   | 6♠  | One random ship suffers an explosion in one shuttle bay; all but one shuttle box (and the shuttles in those boxes) is destroyed; fighter boxes are unaffected; Andros draw another black card              |
| 7♣  | One random ship loses 200 crew experience points (or a similar effect if a different experience system is in use)  | 7♠  | Lose 26-50 economic points   |
| 8♣  | One random ship under construction and slated for completion in the next campaign is delayed by one additional turn due to materiel shortages; if no ships meet this criteria, draw another black card                                     | 8♠  | All strategic intelligence levels are reduced by one level for the next strategic turn   |
| 9♣  | A random moon around a random planet explodes and becomes a "ring" (P2.223); any ground bases on the moon are destroyed, though units on the moon escape automatically   | 9♠  | One random ship with a legendary officer loses that officer to retirement; if multiple officers are on the selected ship, choose a random one; if no officers exist in your fleet, draw another black card |
| 10♣ | A random small ground base on a random planet blows up, obviously the victim of sabotage; any fighters or PFs aboard may attempt to escape   | 10♠ | The production level of your homeworld is reduced by 10 EPs permanently  |
| J♣  | An Orion cruiser of up to 125 BPV raids one of your convoys this turn, dragging away one large or two small freighters if possible; this is automatically successful if the convoy is not escorted, otherwise fight this out as a scenario | J♠  | One random ship has an unexplained explosion aboard; roll 3-18 (three dice) omnidirectional internals which cannot be repaired until the next campaign turn is over  |
| Q♣  | All your ships have -1 to their weapons status level in all battles next turn  | Q♠  | One random ship suffers a communications failure and cannot move or be given orders on the current campaign turn; if attacked it will be able to defend itself normally                                    |
| K♣  | One random ship suffers the effect of a poor crew for the duration of the campaign turn  | K♠  | Lose 76-125 economic points  |
| A♣  | Homeworld produces no economic points on the next campaign turn  | A♠  | All ships, except those with outstanding crews, suffer -1 to their strategic speed next turn   |

## "SPECIAL" EVENTS LIST

- |        |  |
|--------|--|
| Joker  | Draw two more random event cards; if the player is required to draw a specific color card this turn, both must be of that same color   |
| Joker* | (Joker with Trademark) Draw another random event card; ALL players in the campaign receive that random event in addition to any other events they may receive from their own draws |

Naturally, there are many other random event possibilities and players should feel free to design their own charts. More detailed or specialized charts may be presented in a future product.

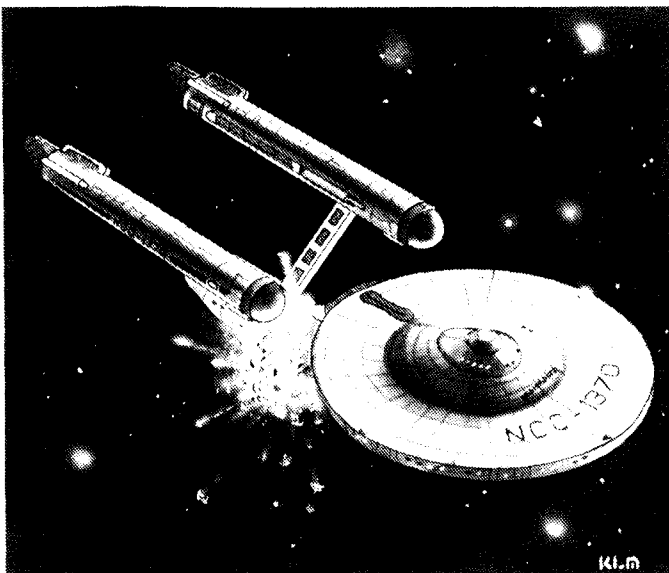

**DESIGNER'S NOTES AND PUBLISHER'S INFORMATION**

This product grew out of a short series of articles presented in the now defunct Star Fleet Times, the official newsletter of the Star Fleet Universe, during its first year as an official SFB product. As editor of SFT, I (Bruce Graw) put out a call for campaign ideas and concepts for a semi-regular column, and was (to my surprise) inundated with campaign rules from readers. Having either run or participated in a number of campaigns myself, I knew there was a lot of interest in them, yet most of the submissions I'd seen — and comments from their authors — told me that just about every campaign seemed to encounter the same old problems, misconceptions and difficulties. Thus the idea for this product was born.

You won't find very many specific, numbered rules in their Campaign Designer's Handbook. It is meant as a set of guidelines and a discussion of campaign structure, not as any kind of official declaration of how you should run your campaign. Campaigns can be likened to role-playing games of a sort, with each player taking on the persona of a leader (President, Emperor, or whatever). Just as no role-playing game can survive with inalterable, carved-in-stone rules, no product that deals with campaigns can exist without giving the individual game designer the flexibility to give his players what they want (and what he wants to give them).

As large as this product is, there is a lot more that could be written, because the precise elements of a campaign are limited only to each designer's imagination. Perhaps additional suggestions, guidelines, maps, player aids, and the like will appear in future products. If you would like to see these, or have any submissions, send them to Amarillo Design Bureau, Inc. just as you would any other submission.

The designer of this product would like to thank the following people: Todd Warnken, who ran my first campaign; Kevin Stringer, Bill Seall, Tom Gondolfi, and Rob Glass, other campaign designers I've had the pleasure of having as a campaign GM; and countless players in my own campaign too numerous to list here (but you know who you are).

The following SFB players submitted additional material used in this product or as references: Steve Kay, Eugene Tramaglino, Michael Calhoon, Richard Eitzen, and John Berg (who runs the longest-running play-by-mail SFB campaign in existence—send Email to jkerg11@aol.com for information).

**CAMPAIGN DESIGNER'S HANDBOOK STAFF**

- Written by..... Bruce H Graw
- SFB Designer ..... Stephen V. Cole, PE
- SFB Executive Developer.... Steven P. Petrick
- Star Fleet Staff..... Scott Moellmer, chuck Strong,  
Sewart Frazier, Tony Zbaraschuk, Joe Butler, Cliff  
Yahnke, Ken Burnside, Mike Filsinger, Jon Cleaves,  
Bruce Graw, Mike Calhoon, Richard Eitzen.
- Editor Star Fleet Times ..... Bruce H Graw
- Publisher ..... Amarillo Design Bureau, Inc.
- Cover Art ..... Robert Glass
- Internal Computer Art ..... Stephen V Cole
- Internal Art ..... Jonathan R Wagner, Reynold  
Wong, Dan Carroll, Gregg Breault, Frank Castillo,  
Ken Mayfield, Duncan Jardine, Brent Ferguson, and  
others.
- Printing ..... Automated Graphics Systems
- Cover ..... Trafton Printing, Amarillo
- Co-Chiefs of ADB Security... Ramses, Isis

Elements of the Star Fleet Universe are the property of Paramount Pictures Corporation and are used with their permission.

**PUBLISHER'S INFORMATION**

The Campaign Designer's Handbook was created by Agents of Gaming under an arrangement with Amarillo Design. It is published by:

**AMARILO DESIGN BUREAU, Inc.**  
POST OFFICE BOX 8759  
AMARILLO, TEXAS 79109

You may contact ADB Inc. by any of these means:  
Phone: 806-351-1950  
Fax: 806-351-2585  
Email: sales@starfleetgames.com  
Web Site: www.starfleetgames.com  
BBS: www.starfleetgames.com/discus

**DESIGNER'S INFORMATION**

Questions, comments, suggestions, and any expansion material for the STAR FLEET UNIVERSE should be sent to Amarillo Design Bureau Inc., Post Office Box 8759, Amarillo, TX 79114. All correspondence must include a stamped self-addressed envelope if you wish to receive an answer or evaluation of your submission. Foreign customers should enclose three International Reply Coupon. It is imperative that you place your name and address on EVERY page of your correspondence. Please do not put questions and expansion material on the same sheet.

When sending questions, phrase each one so that it can be answered with a yes or no, a brief answer, or by circling one of several choices. Please attempt to look up the answer yourself first. We will cheerfully answer questions about how the rules work, but cannot answer questions as to "WHY?" various things work the way that they do. Such "WHY?" questions are sometimes printed (with answers) in Captain's Log. All future products for the STAR FLEET UNIVERSE will be prepared by ADB; all questions relating to existing products will be answered by ADB.

Players can contact the design staff by email at either:  
rules@starfleetgames.com (questions)  
design@starfleegames.com (submissions)

Email questions are answered as above. Contact the design office before Emailing any attached-file submissions.

**SUBMISSIONS OF NEW MATERIAL:** ADB welcomes the submission of new SFB material for possible publication. See details in Advanced Missions.

**COPYRIGHT AND LICENSING**

STAR FLEET BATTLES — CAMPAIGN DESIGNER'S HANDBOOK and all contents thereof are copyright © 1996 by Amarillo Design Bureau, Inc. All rights are reserved under the Pan-American, Berne, and International Copyright Conventions. No material which is based on, for use with, incorporates elements of Star Fleet Battles, F&E, or the Star Fleet Universe background, can be published by any party without advanced written permission of ADB Inc. See our web site for our policy on internet publishing and SFB-related sites. This handbook is produced by special arrangement with Franz Joseph Designs, authors of the STAR TREK: STAR FLEET TECHNICAL MANUAL.

**WEB SITE AND SERVICES**

See our web site at www.starfleetgames.com for answers to questions, playtest material, secure shopping cart, retailer information, discussions of products in development, links to on-line real-time gaming forums, links to play-by-Email forums, proposals by other players (or yourself) under furious debate, special announcements, short-term offers and promotions, and links to dozens of authorized SFB sites.



PSEUDO-HISTORICAL CAMPAIGN MAP

Section 1 of 4

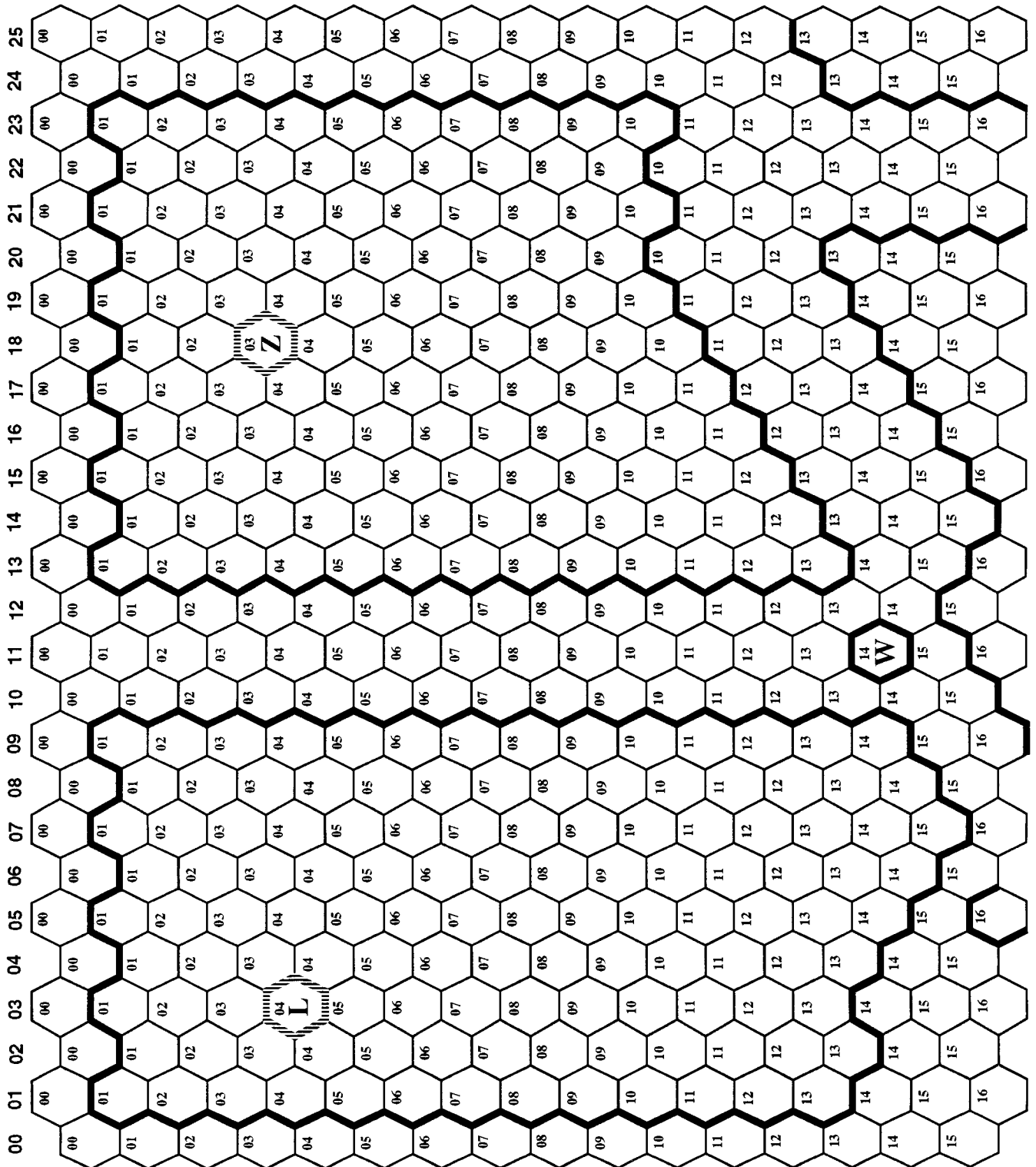

PSEUDO-HISTORICAL CAMPAIGN MAP

Section 2 of 4

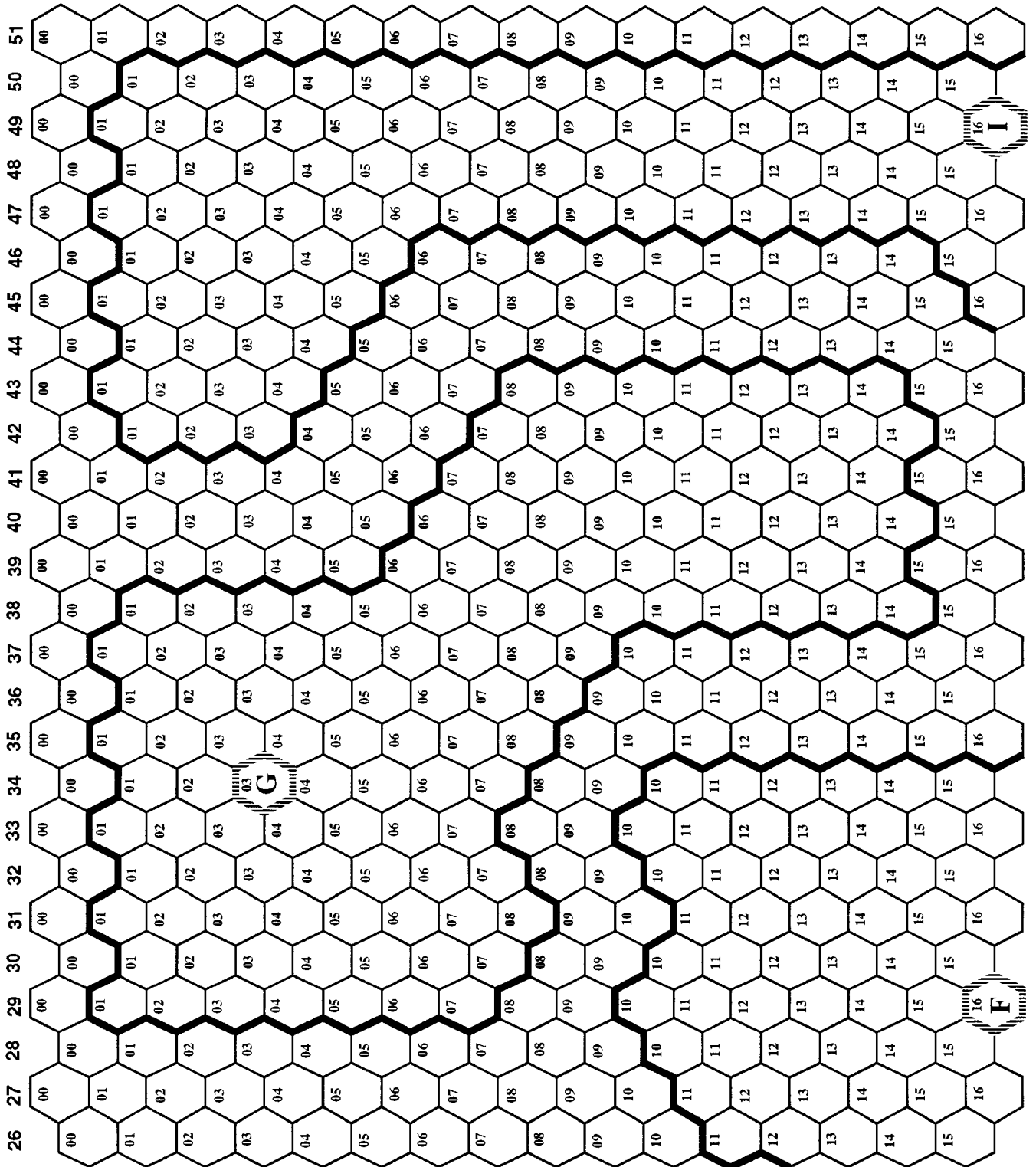

PSEUDO-HISTORICAL CAMPAIGN MAP

Section 3 of 4

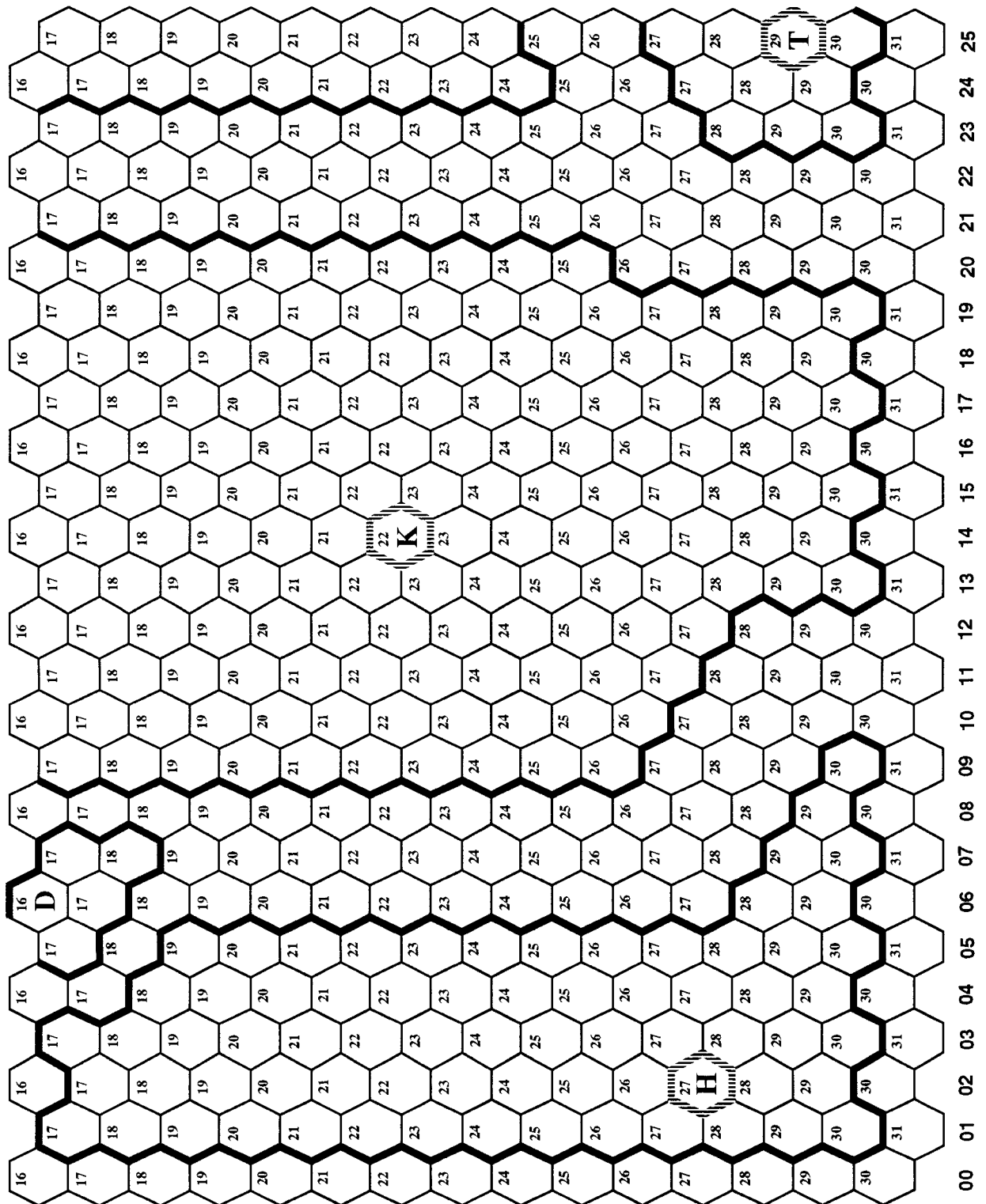

PSEUDO-HISTORICAL CAMPAIGN MAP

Section 4 of 4

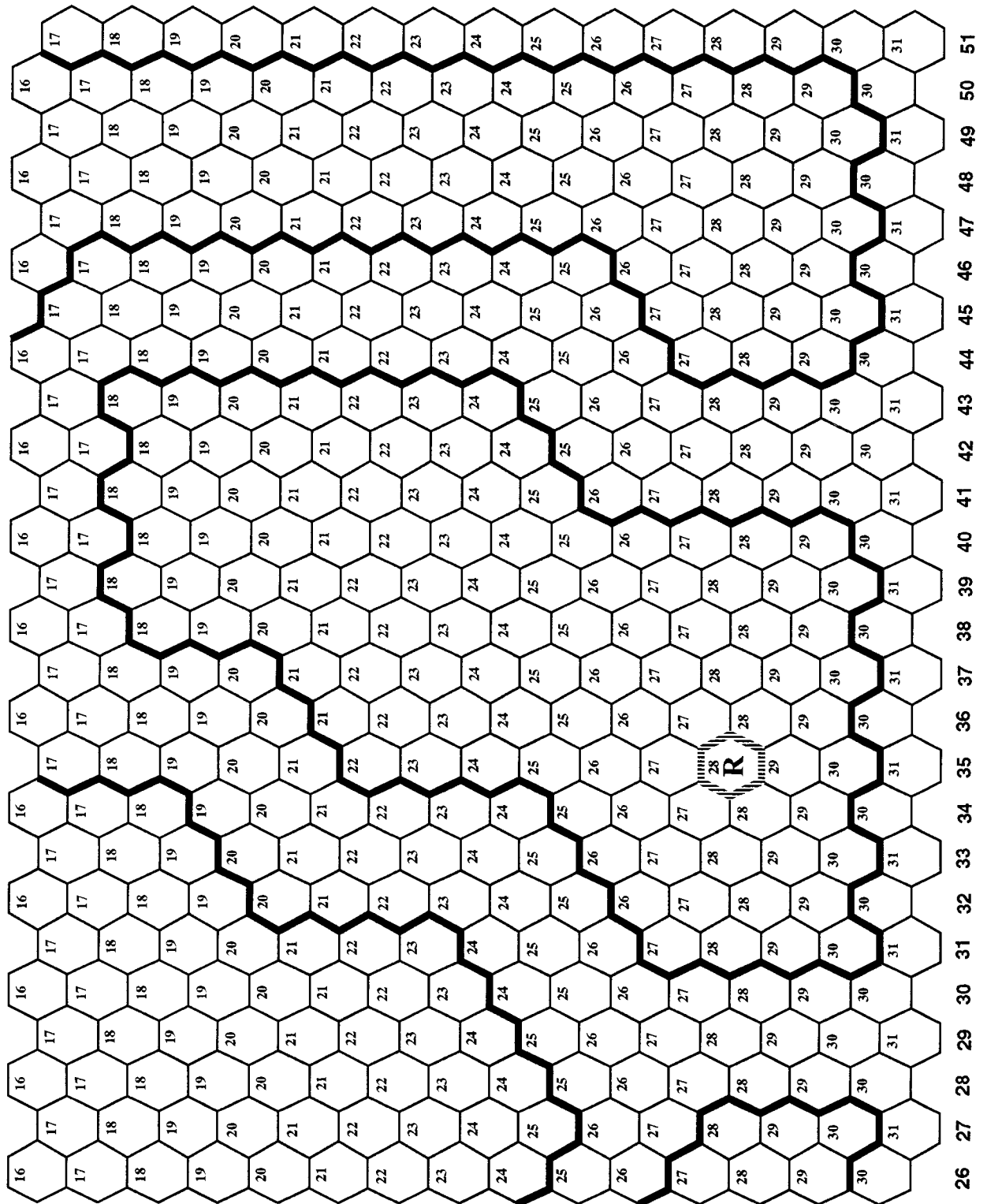

CLASS	#	NAME	BUILT ON TURN #
COST	REFIT #1	TURN#	REFIT #2
			TURN#

**OPTIONAL ITEMS IN STOCK**

T-BOMBS	ROM NSM	EXTRA CREW	EXTRA BPs	EXTRA COMMANDOES
DRONE LOADOUT				
CREW EXPERIENCE	LEG. OFFICERS			
SPARE SHUTTLES	SHUTTLE WBPs	SHUTTLE TYPES		
EXTRA UIM	DUMMY WEAPONS, PANELS, ETC			
OTHER EXTRA ITEMS				

**FIGHTER/CARRIER ITEMS**

FTR TYPES	
PILOT QUALITY	
WBPs	CHAFF
PODS	EXTRA DCs
OTHER ITEMS	

**GROUND COMBAT ITEMS**

COMMANDOES	HW SQUADS
ENGINEERS	GCVs
T-HOWITZERS	TANKS
GASs	HTSs
OTHER ITEMS	

**FAST PATROL SHIPS**

TYPE	#1	#2	#3	#4	#5	#6
REFITS						
WBPs						
QUALITY						
OTHER INFO						

**TUG INFO**

PODS CARRIED
TRANSFERS

**BATTLE HISTORY**

--

**CARGO BOX CONTENTS**

GENERAL					
1	2	3	4	5	6
7	8	9	10	11	12
13	14	15	16	17	18
19	20	21	22	23	24
25	26	27	28	29	30
31	32	33	34	35	36
37	38	39	40	41	42

**STANDARD GUARD LOCATIONS**

**NOTES**

--

LARGE NAVAL CONSTRUCTION DOCK

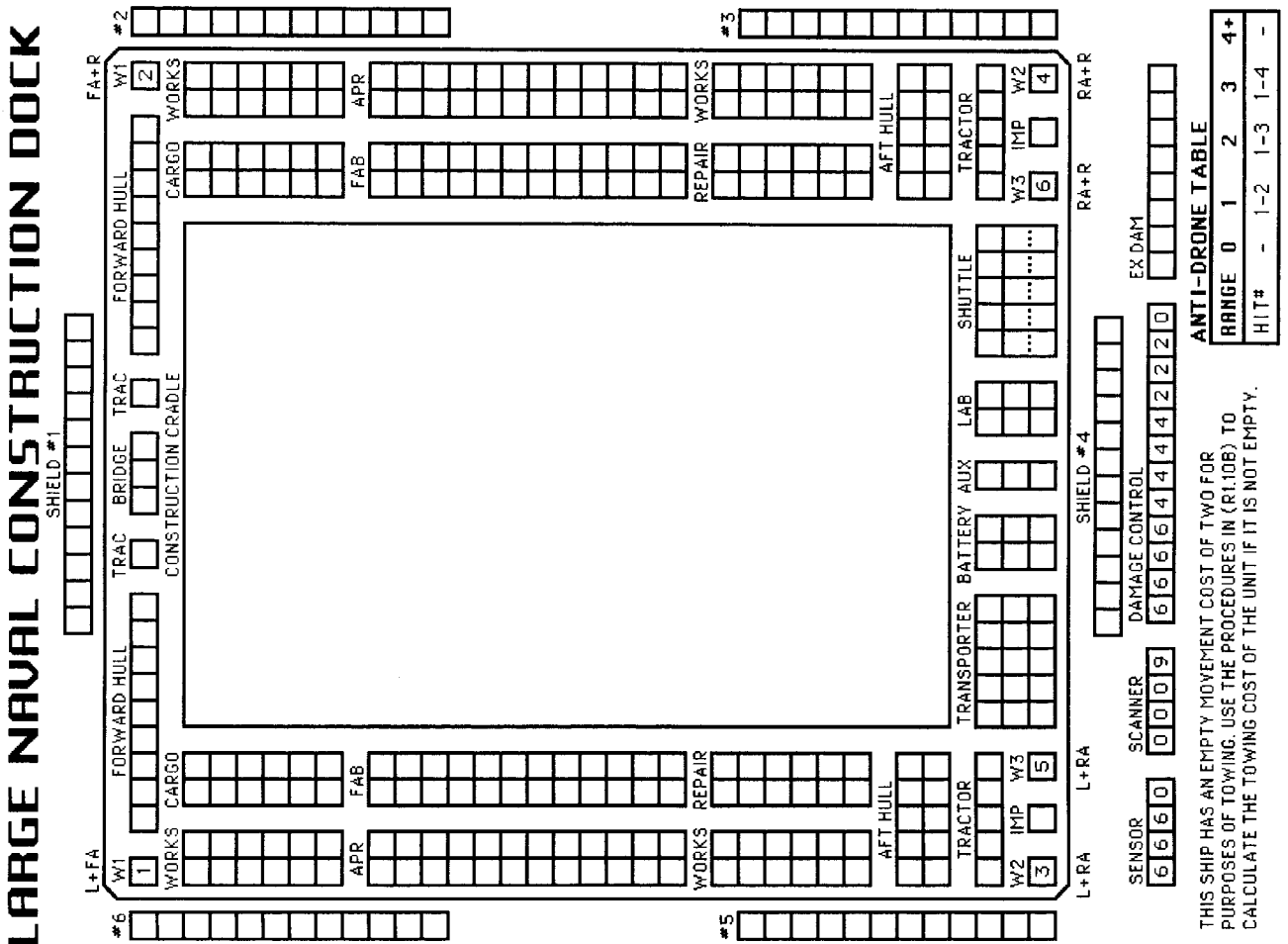

CREW UNITS		ADMINISTRATIVE SHUTTLES	
* IDENT	HIT POINTS	IDENT	NOTES
	10		
	20		
	30		
	40		
	50		
	60		
	70		
	80		
	90		
	100		
	110		
	120		

BOARDING PARTIES	
IDENT	HIT POINTS
	10
	20
	30
	40
	50
	60
	70
	80
	90
	100
	110
	120

SEE (R1.10C) FOR WEAPONS.  
THIS SHIP HAS NO T-BOMBS.

TYPE I OFFENSIVE PHASER TABLE

DIE RANGE	4-9	16-26	51-75
ROLL 0	1	2	3
1	9	8	7
2	8	7	6
3	7	5	4
4	6	4	4
5	5	4	4
6	4	3	2

TYPE II PHASER TABLE

DIE RANGE	4-9	16-31
ROLL 0	1	2
1	6	5
2	5	4
3	4	4
4	3	3
5	2	2
6	1	1

TYPE III DEFENSE PHASER

DIE RANGE	4-9	15
ROLL 0	1	2
1	4	4
2	4	4
3	4	4
4	4	4
5	4	3
6	3	2

FA = LF + RF  
LS = LF + L + LR  
RS = RF + R + RR  
RA = LR + RR

KLINGON SCTY SCTY

CLINGON SCTY SCTY

DRONE RACKS

DRONE RACKS	DRONE RACKS
5	5
6	6

Y175 REFIT ADDED THE SECOND RELOAD.

RACKS HAD TWO RELOADS PRIOR TO Y175, THREE THEREAFTER.  
ONE RELOAD IS ENTIRELY ADDS.

PLASMA-D RACKS

PLASMA TORPEDO WARHEAD TABLE					
RANGE	0-5	6-10	11-12	13-14	15
TYPE 0	10	8	5	2	1
BOLT	1-4	1-3	1-2		

SHIP DATA TABLE

TYPE	=	LCD
POINT VALUE	=	450/200
SHIELD COST	=	1+3
LIFE SUPPORT	=	1+1/2
SIZE CLASS	=	2
REFERENCE	=	R1.C3
Y175 REFIT	=	+0

ANTI-DRONE TABLE

RANGE	0	1	2	3	4+
HIT#	-	1-2	1-3	1-4	-

THIS SHIP HAS AN EMPTY MOVEMENT COST OF TWO FOR PURPOSES OF TOWING. USE THE PROCEDURES IN (R1.10B) TO CALCULATE THE TOWING COST OF THE UNIT IF IT IS NOT EMPTY.



# SMALL NAVAL CONSTRUCTION DOCK

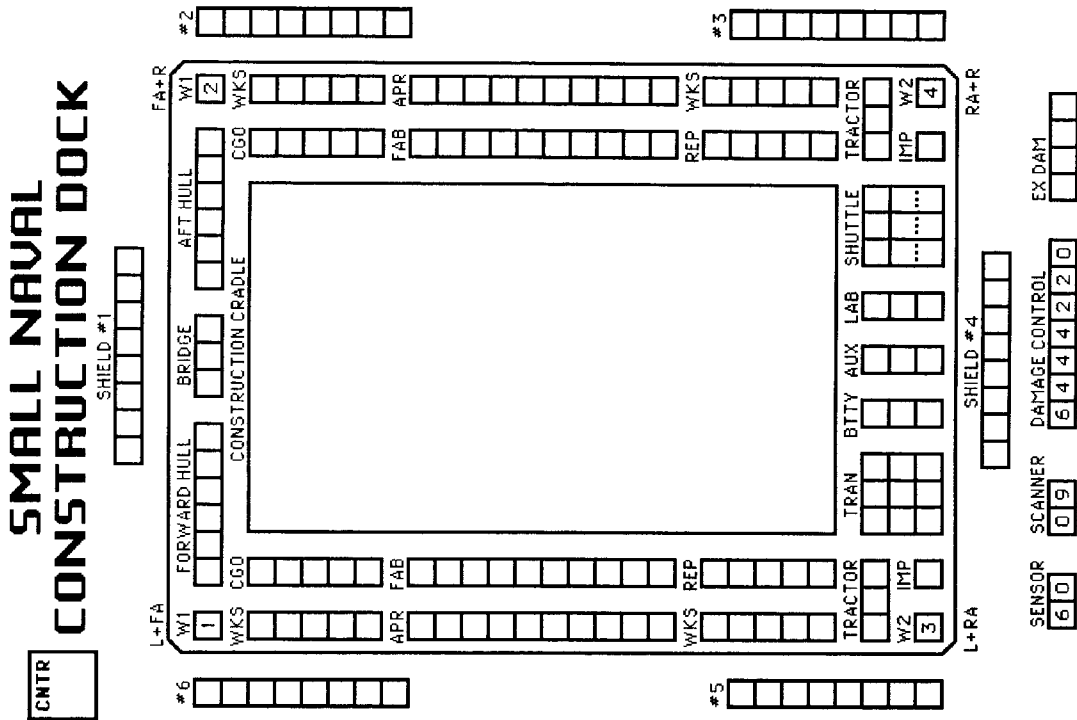

**SHIP DATA TABLE**

TYPE = SCD  
 POINT VALUE = 200/75  
 SHIELD COST = 1+3  
 LIFE SUPPORT = 1+1/2  
 SIZE CLASS = 2  
 REFERENCE = R1.C1

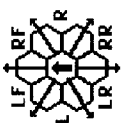

FA = LF + RF  
 RA = LR + RR

KLINGON SCTY SCTY

**ADMINISTRATIVE SHUTTLES**

IDENT	HIT POINTS	NOTES
		HTS
		HTS
		HTS

**CREW UNITS**

10									
20									
30									
40									
50									

**BOARDING PARTIES**

4

THIS SHIP HAS NO T-BOMBS.

**TYPE I OFFENSIVE PHASER TABLE**

DIE RANGE	6-8		9-15		16-25		26-50		51-75	
	1	2	3	4	5	6	7	8	9	10
1	9	8	7	6	5	4	3	2	1	1
2	8	7	6	5	4	3	2	1	1	0
3	7	5	4	4	4	3	1	0	0	0
4	6	4	4	4	4	3	2	0	0	0
5	5	4	4	4	3	3	1	0	0	0
6	4	4	3	3	2	2	0	0	0	0

**TYPE II PHASER TABLE**

DIE RANGE	4-6		7-15		16-30		31-50	
	1	2	3	4	5	6	7	8
1	6	5	5	4	3	2	1	1
2	6	5	4	4	2	1	1	0
3	6	4	4	4	1	1	0	0
4	5	4	4	3	1	0	0	0
5	5	4	3	3	0	0	0	0
6	5	3	3	3	0	0	0	0

**TYPE III DEFENSE PHASER**

DIE RANGE	4-6		7-15	
	1	2	3	4
1	4	4	3	1
2	4	4	2	1
3	4	4	1	0
4	4	4	3	0
5	4	3	2	0
6	3	3	1	0

SEE (R1.10C) FOR WEAPONS.

THIS SHIP HAS AN EMPTY MOVEMENT COST OF 1+1/2 FOR PURPOSES OF TOWING. USE THE PROCEDURES IN (R1.10B) TO CALCULATE THE TOWING COST OF THE UNIT IF IT IS NOT EMPTY.





# BUILD YOUR OWN GALAXY!



Everything you need to design and run your own Star Fleet Universe campaign!

**CAMPAIGNS** are the ultimate expression of Star Fleet Battles. Only in a campaign setting does everything — cost, fleets, technology, availability, movement, economics, deployments — come together into a complete picture of war in space!

The **CAMPAIGN DESIGNER'S HANDBOOK** provides options allowing you to create a campaign that suits your own tastes and interests.

**STRATEGIC ARENA:** Maps and ideas on how to lay out your universe for conquest! Historical, hexagonal, octagonal, large, or small, it's up to you!



**ECONOMICS:** How to buy, build, and supply your massive space fleet, while keeping the amount of paperwork under control so you can focus on the battle. New SSDs are provided for Naval Construction Docks and Warp Gates. The innovative TechBlock system provides players with the opportunity to buy the technologies that will win battles, or gamble on the technology to win wars! Everything is covered, including repairs, refits, upgrades, plus new improvements and variants. Wars are fought for money — design yours so you can play to win!



**SCENARIOS** are the whole point of a campaign; everything else is designed to deliver your ships to the battle. This handbook includes several options and concepts for generating, setting up, and controlling the size of scenarios.

**RACES:** How to fit them into your campaign so that each can strive to fulfill its destiny.

**AND MORE:** Strategic Sequence of Play, legendary officers (including several new types), outstanding and poor crews, and entirely new rules on espionage, sabotage, and random events!



This product adds new strategic game play situations, ships, and concepts for Star Fleet Battles. You must have at least the SFB Basic Set to use this material. Campaign options are discussed for all of the advanced and supplementary products in the game system; using those options will require those products.

Task  
Force  
Games™



STOCK#5715

Written by Bruce H. Graw

Made in USA

ISBN 0-922335-74-5 \$14.95