

STARSHIP DESIGN



INTERSTELLAR FORUM FOR NAVAL POWER
20 CREDITS

**SPECIAL
ISSUE:**
STAR FLEET'S
SHIPBUILDING
SCHEDULE

VOLUME XXXIV
NUMBER ONE
MARCH 2280
TERRANGLO EDITION

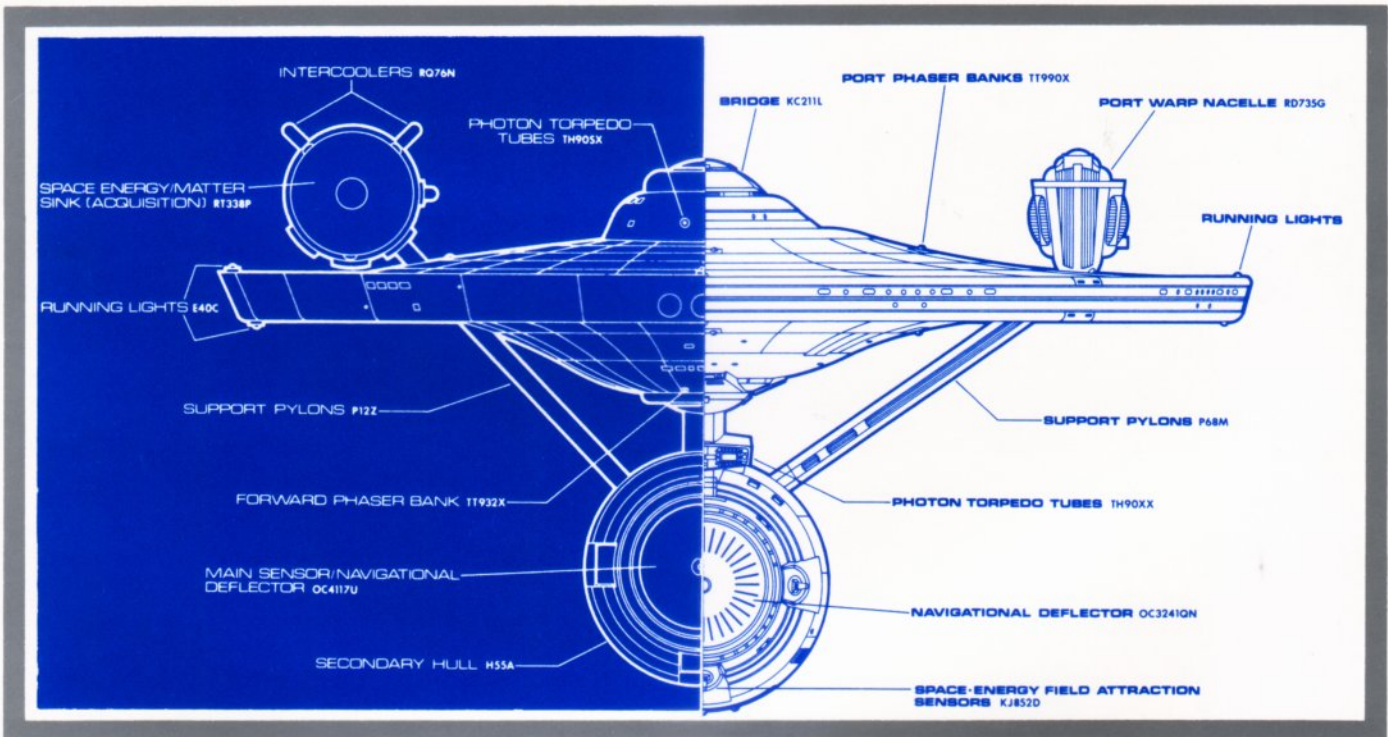

K'teremny: EXAMINATION OF A NEW DESTROYER RECENTLY PUT TO SPACE BY THE KLINGON IMPERIAL FLEET.

THE MK-20 PROGRAM. A CRUISER CLASS STARSHIP DESIGNED TO BECOME THE WORKHORSE OF THE FLEET.

U.S.S. Menahga. CAN THIS SHIP, AND HER PROPOSED SISTERS, FILL THE BATTLECRUISER ROLE?

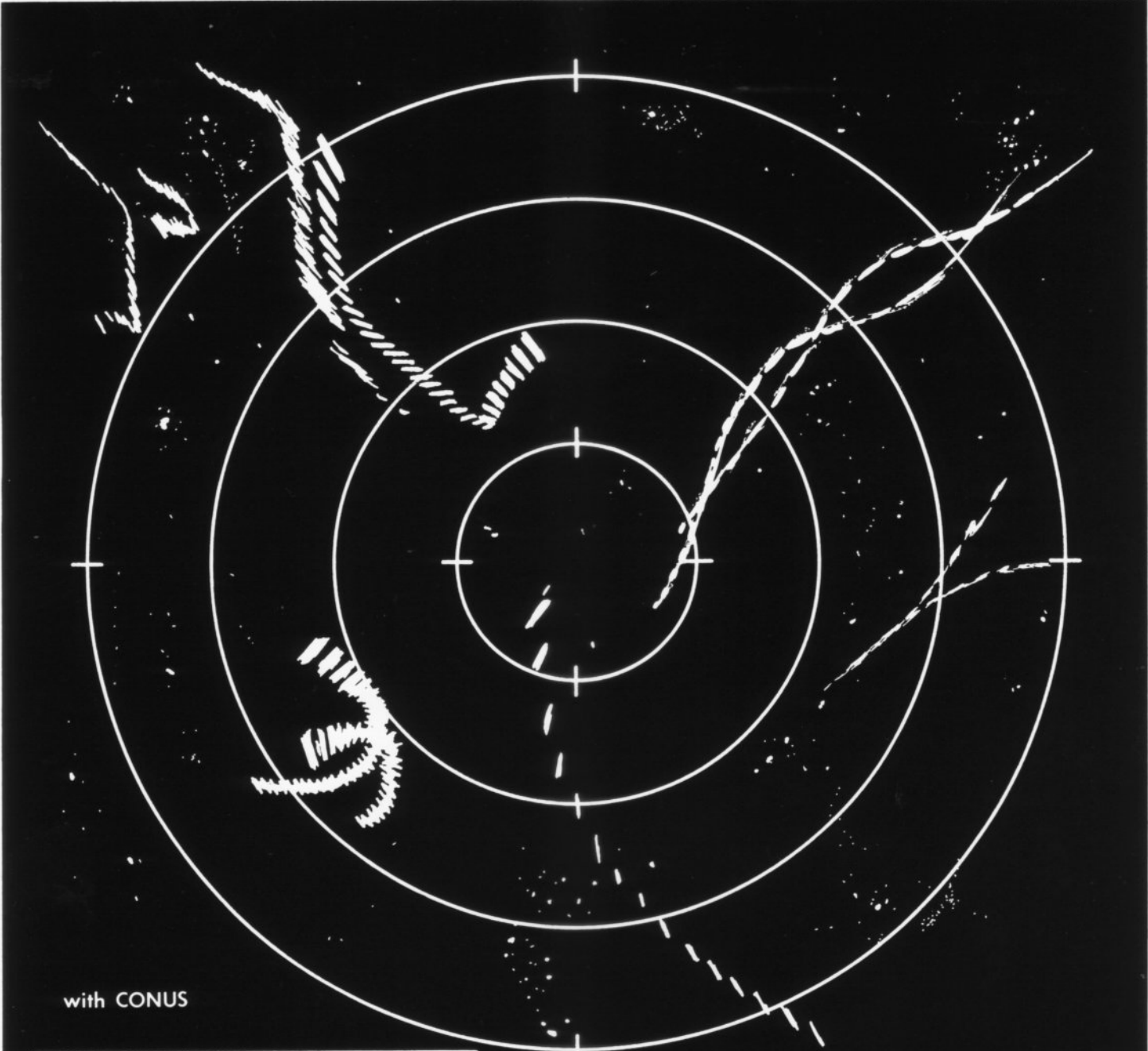

with CONUS

TRACKING: POSITIVE
COORDINATES: DISPLAY
NUMBER: 7 UNITS
IDENTITY: KLINGON



without CONUS

CONUS from
RAAKUV
SENSOR & FIRE CONTROL SYSTEMS



After the successful conversion of the CONSTITUTION class heavy cruisers to new technology standards, Star Fleet headed full steam into a similar program with the dreadnought fleet. After several years of operation, the gamble appears to have paid off. Update File begins on printout 1013.

AUTHOR	TITLE	PRINTOUT
	Comment	1002
Captain E.S. Ishan	The MK-20 Program: A Shipbuilding Status Report	1003
Compiled by C. Roster	Dreadnought Update	1013-19
Commander D.C. Costin	The New Klingon Destroyer	1020
Compiled by Lia Xiacha	Star Fleet's Shipbuilding Status (as of January 2280)	1027
Fshynda Fa'a'Aren	Star Fleet's... Battlecruiser?	1028

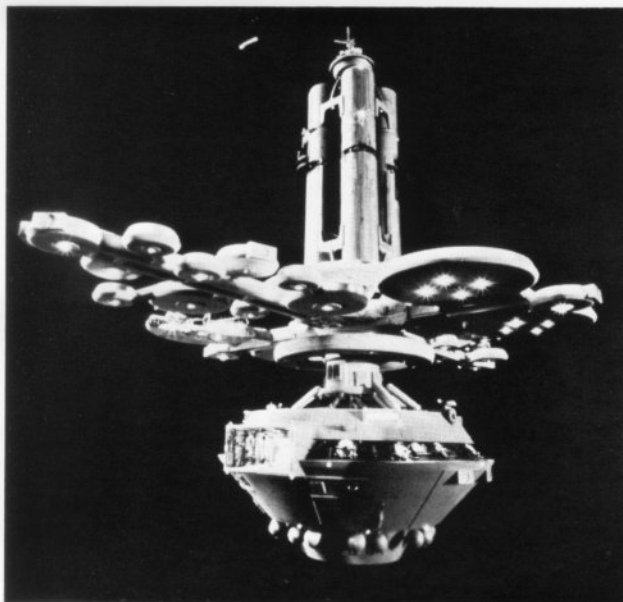

Uncovering the facts about Star Fleet Command's latest battlecruiser design.

ENTER THE FORUM

We welcome brief comments on material published in Starship Design and also brief discussion items on topics of naval, maritime, or Star Fleet interest for possible publication on the "Comment" pages. A primary purpose of Starship Design is to provide a place where ideas of importance to the space services can be exchanged. All comment or discussion items which are submitted for possible publication must be signed by the author. No remuneration is offered.

	Recognition Silhouettes Scale representations of the Class 1 starships discussed in this issue.	1035-36
Compiled by S. Carre	Observer	1037
	Reunions	1037

The opinions or assertions in the articles presented here are the personal ones of the authors and are not to be construed as official. They do not necessarily reflect the views of either Star Fleet Command or the publishers of *Starship Design*.

STARSHIP DESIGN

MARCH 2280

HARD COPY PRINTOUT

PUBLISHING GROUP
HEADQUARTERS

DEVON-AURORA CENTER
FLORIDA MOUNTAIN SOUTHERN COMPLEX
BERKSHIRE PROVINCE
MASSACHUSETTS
TERRA

COORDINATOR
DUSTIN HENRI

TECHNICAL STAFF
PI JHASSAR
DANA KRIS PALLEY
KEIA FILLIAN
SERENA CARRE

SUPPORT STAFF
JAMESON KINN
LE ANN PATRIC
HARRISON MARST
SANDER REIGHT DUNN
BRISTA KAAHL



DEVON-AURORA PUBLICATIONS CENTER

MASSACHUSETTS, TERRA • 2280

ALL RIGHTS RESERVED. NO PART OF THIS PUBLICATION MAY BE TRANSMITTED, STORED IN A RETRIEVAL SYSTEM, OR REPRODUCED IN ANY FORM OR BY ANY MEANS — ELECTRONIC, MECHANICAL, PHOTOCOPYING, RECORDING, OR BY ANY PROCESS NOW KNOWN OR TO BE INVENTED — WITHOUT WRITTEN PERMISSION FROM THE PUBLISHER.

TEXT AND ARTWORK COPYRIGHT © 1984, 1987 TODD GUENTHER.

PUBLISHED BY DEVON-AURORA PUBLICATIONS & STAR STATION AURORA, POST OFFICE BOX 4990, HOLYOKE, MASSACHUSETTS, 01041-4990.

REQUESTS FOR ADDITIONAL COPIES OF THIS PERIODICAL SHOULD BE FORWARDED TO STAR STATION AURORA AT THE ABOVE ADDRESS.

PRINTED IN THE UNITED STATES OF AMERICA

AVALON-DOWNE RECORDS GROUP — FILE SERIES 8064

Comment

Shuttlecarrier Issues

(see "Shuttlecarriers: Do We Really Need Them?" by S. Sauter, January 2280 *Starship Design*)

Fleet Captain Josephs Pendle, StarFleet Command, retired

One of the major StarFleet issues that the Federation Council and the Military Staff Committee must address is the fleet's shuttlecarriers. The carrier issue is one of the most controversial because of the ships' cost, differing views on what size they should be and what type of craft they should carry, and their survivability factor.

Additional shuttlecarrier construction has been continually voted down by the Council. The reasons cited are basically those mentioned above, but the primary reason seems to be the lack of a definitive role for the ships. Without this, there can be no agreement on what size they should be, which in turn leads to disagreement on the embarked craft (i.e. shuttles, fighters, probes, etc.) they should operate, as well as what type of fixed armament they should mount, etc. A recent suggestion by retired admiral Nan'k Tasschat'n that 3 ships of various sizes be constructed (one in a military scheme, one with a purely scientific makeup and the third a middle-of-the-road design) seemed to be a likely candidate for approval when it was first tabled by the Council, but two standard years have passed and there is still no decision. The official reason for the rejection of Tasschat'n's proposal was that it ignored the fact that Star Fleet Division's San Francisco facility is the only shipyard that can even consider building ships of such immense size (all of the current Ariel class shuttlecarriers were built by SFD), and the design and construction of components for three different carrier types would have ended up costing more than building three ships with the same specs.

The construction of smaller, perhaps less-versatile carriers would have less impact on a given year's budget, would be easier to crew and could be constructed in any of several shipyards (though too small to assume the same tasks as the Ariel shuttlecarriers, the six Coronado class through-deck cruisers are prime examples of versatile, multi-purpose ships that are constantly in demand). Over the past 5 years, a number of "small" carrier designs have been suggested, from the space control ship (SCS) of 350,000 tons to the 500,000-ton Henna proposal. Much larger carrier concepts, such as the gargantuan Golian design, have never been seriously considered by Star Fleet's leadership.

Of the two other proposals, the SCS seemingly holds the most promise. The design has been called a "floating landing bay" by some, due to the fact that there

is no primary hull as such, but instead one large secondary hull with dimensions that are somewhat similar to the secondary hull of the Ariel class. A small, raised section is mated into the hull at the forward end to provide a command platform, while the RaaR/STAK-designed warp engines are mated directly into the hull at the rear. SCS has two landing bays at the aft location as opposed to Ariel's six, but the SCS bays are approximately 1.6 times larger than those on the Ariel class.

It has become obvious that additional Ariel-type shuttlecarriers cannot be produced in large numbers (nor is it necessary) without major realignment of current shipyard activity. For this reason as well as the others mentioned, it seems apparent that finding an agreeable mid-point between the Ariel and Coronado designs is the most logical course to take.

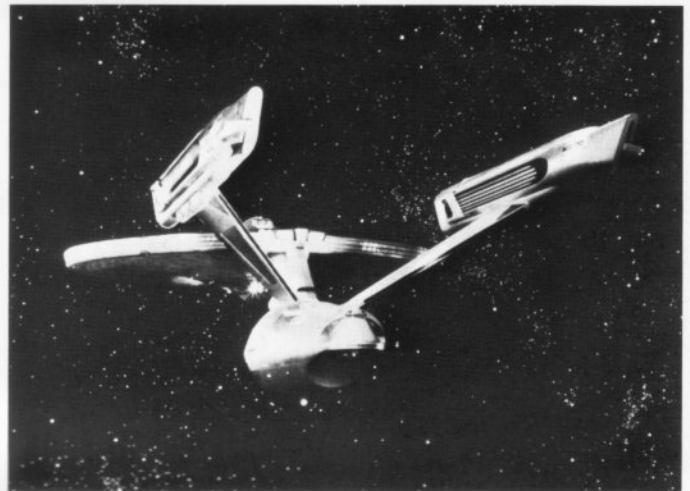

AN ENTERPRISE CLASS HEAVY CRUISER ON PATROL. (Courtesy StarFleet)

Cruiser Crisis

(see "We Need More Cruisers" by Commander Calo Ambergris, December 2279 *Starship Design*)

Captain D.G. Tov, StarFleet Operating Forces

I must disagree with Commander Ambergris' comments regarding the Constitution II, Iikopai and Enterprise class heavy cruisers. To say that they are all gloss and no substance is completely irresponsible. Though their basic designs are similar, Mr. Ambergris would have found almost completely different vessels had he bothered to look past the surface "gloss." Internal arrangement, armament and scientific capacity of the three classes are quite different, and their value as high-priority starships should not be overlooked. The inference that the "more versatile" Belknaps should be considered for front-line scientific duty is absurd, since this is more of a "military" class. I rather think that Cmdr. Ambergris needs more time at Academy.

The MK-20 Program: A Shipbuilding Status Report

By Captain E. Sandes Ishan, SFOF (Ret.)

Since the commissioning five and one-half Earth years ago of the U.S.S. Belknap (NCC-2501), lead ship of Star Fleet's current cruiser shipbuilding program, Star Fleet Division (Deneb V) and Cosmadyne Shipyards, Incorporated (Earth) have delivered a total of 7 ships of the class to Star Fleet Operating Forces, and Cosmadyne is expected to turn over two more MK-20s in the next few months. Eventually, the total number of ships in the class will be twenty or more.

Delivery dates for the first four ships built by Star Fleet Division's Cameron Naval Facility on Deneb V averaged 2 local weeks early, and SFD estimates that the remaining vessels will be at least 3 weeks ahead of schedule. Meanwhile, Cosmadyne, utilizing its vast Boston Shipyard & Design complex, launched NCC-2503, -2505 and -2507 when they were 77%, 82% and 83% complete, respectively. All three ships were delivered to Star Fleet early, with NCC-2505 arriving 13 weeks ahead of schedule, 94% complete and with a very low, 4% (C³) "growth margin"*. Cosmadyne recently reactivated an extensive pre-outfitting facility at its Shipyards complex and the company attributes its ahead-of-schedule delivery rate to this modification in the overall construction process. The early deliveries have saved Star Fleet millions of credits in vessel expenditures, and Cosmadyne has enjoyed an acceleration incentive of 25% of the construction cost savings.

TRIALS, SHAKEDOWNS AND POST-SHAKEDOWN AVAILABILITIES

Before delivery to Star Fleet, all MK-20s undergo builder's trials. The purpose of these trials is to test all aspects of the starship's design, from structural integrity to equipment performance and reliability.

Upon completion (about 12 weeks later) the ships go through acceptance trials presided over by the president of Star Fleet's Board of Inspection and Survey. (Star Fleet is presently considering Cosmadyne's suggestion to combine both trials into one for later ships). Final contract trials are scheduled after 6 - 8 months of fleet operations. Since the program began, Star Fleet acceptance trial deficiencies have decreased from 572 on NCC-2501 to 107 on NCC-2508. Approximately 10 months after delivery, the MK-20s return to the shipyard for a 3 - 4 month post-shakedown availability (PSA).

An extensive 10-month PSA was required for the Decatur (NCC-2500), due to the fact that she was the prototype test vessel for the class and was constructed largely from uncompleted, old-technology components (her primary hull was "borrowed" from the never-finished MK-VIB Transport U.S.S. Swift). Decatur was the first ship in the fleet to test the linear warp engines (which were first installed in final form on Enterprise) and these are the only entirely new-tech units that she has retained since her upgrading to operational readiness. After her testing and evaluation as a prototype was completed, she was returned to drydock for systems analysis while work on the U.S.S. Belknap was begun. Major modifications were required on Decatur's primary bridge, command hull (O2 level) and secondary hull which included the installation of "A" level equipment fits (primary and backup C³ systems), sensor modifications, a new navigational deflector and the installation of photon torpedo tubes at the base of her interconnecting dorsal. Decatur is currently serving as the active line training vessel for the MK-20 class.

CRUISER

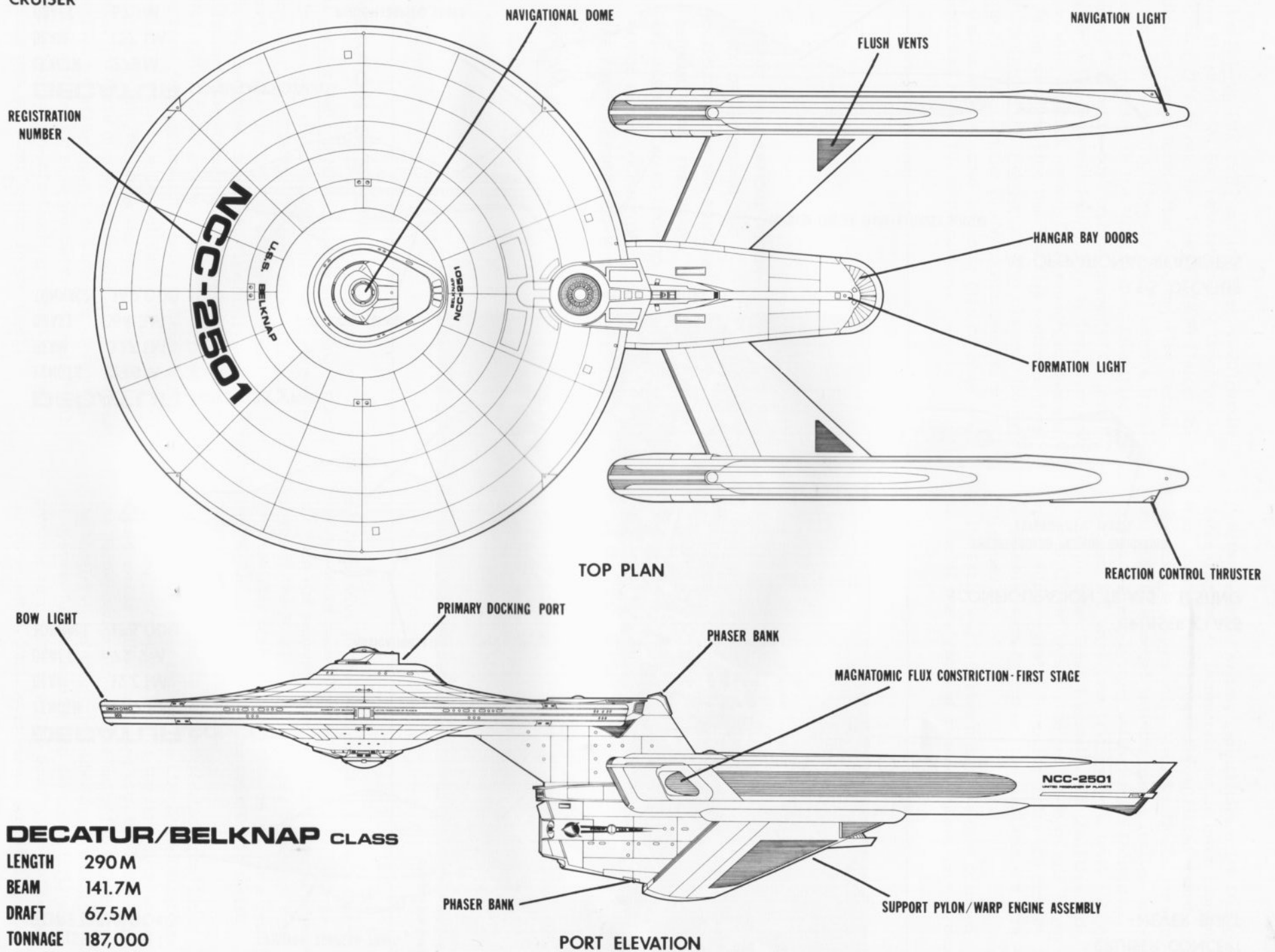

DECATUR/BELKNAP CLASS

LENGTH 290 M
BEAM 141.7M
DRAFT 67.5M
TONNAGE 187,000

CRUISER
PORT ELEVATIONS

PHOTON TORPEDO TUBES

IMPULSE ENGINES

CRUISER CONCEPT
- NEVER BUILT

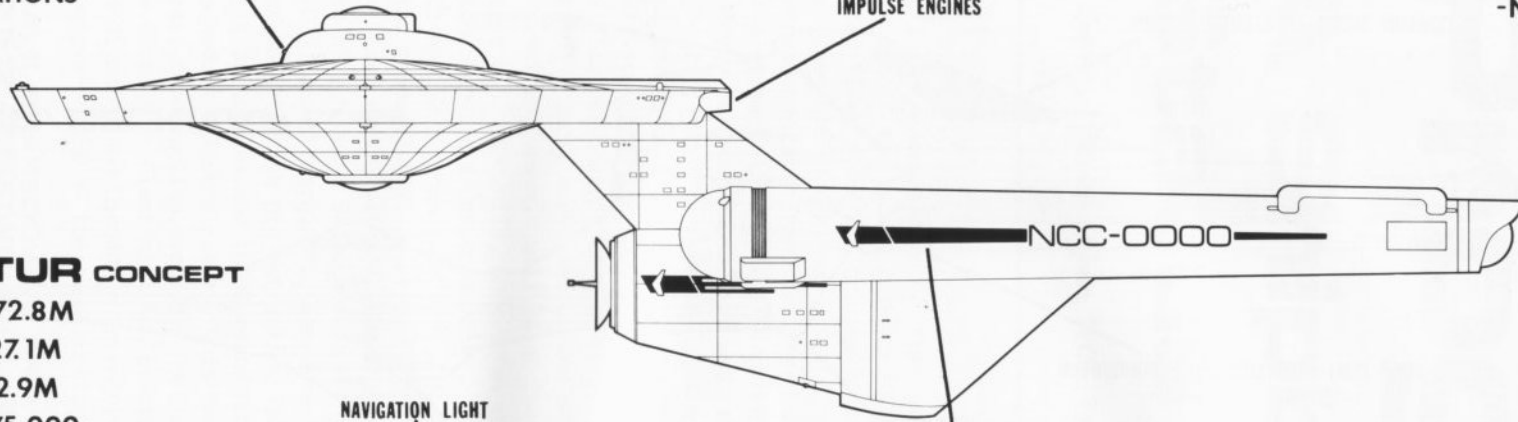

DECATUR CONCEPT

LENGTH 272.8M
BEAM 127.1M
DRAFT 72.9M
TONNAGE 175,000

NAVIGATION LIGHT

STAR FLEET PENNANT

CRUISER CLASS
- CONFIGURATION TRIALS & TESTING

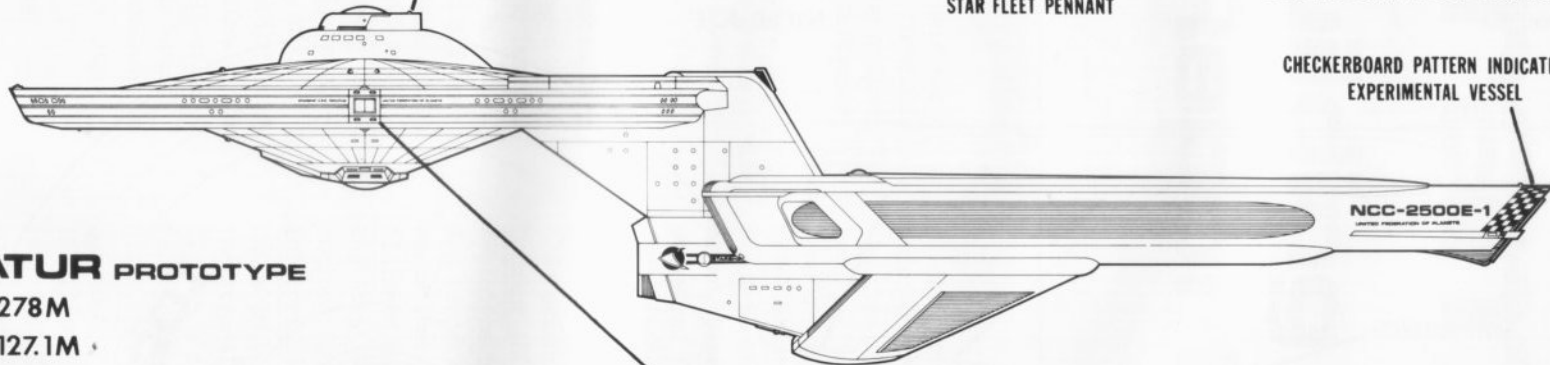

CHECKERBOARD PATTERN INDICATING
EXPERIMENTAL VESSEL

DECATUR PROTOTYPE

LENGTH 278M
BEAM 127.1M
DRAFT 64.3M
TONNAGE 169,000

OFFICERS' LOUNGE

REACTION CONTROL THRUSTERS

U.S.S. DECATUR
- AT OPERATIONAL READINESS

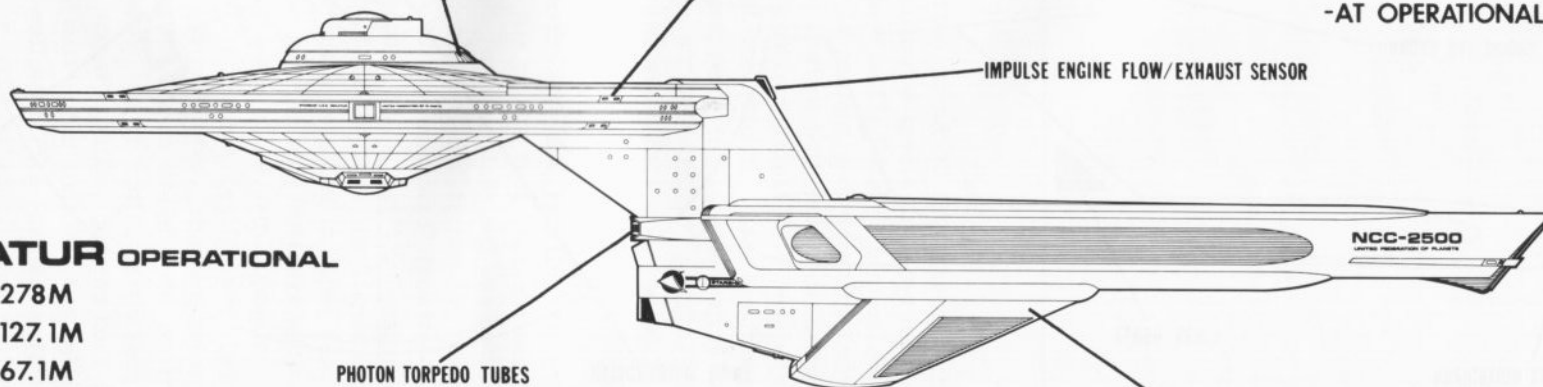

IMPULSE ENGINE FLOW/EXHAUST SENSOR

DECATUR OPERATIONAL

LENGTH 278M
BEAM 127.1M
DRAFT 67.1M
TONNAGE 171,000

PHOTON TORPEDO TUBES

WARP ENGINE/SUPPORT PYLON ASSEMBLY

The Belknap (NCC-2501) was the first MK-20 to undergo a standard PSA. She reported back to Cosmadyne in December 2274 to have her Type 217 TACAR (Target Acquisition Center Accelerated Response) Fire Control System and Type 2016L ("Sneaky Pete") sensors installed. Deficiencies in the TACAR system, identified during "fly-before-buy" testing, prevented its installation prior to commissioning. This system, in conjunction with the 2016L sensor fit, has a longer range and a faster response time than the fire control systems in the Enterprise, Avenger and Knox classes. The Belknap also received the 25/ADA countermeasures support system as well as added deflector grid coverage and additional hangar bay modifications.

With the Cetus system, capabilities exist through later upgrades to incorporate battle group coordination schemes (BCACS) presently outfitted aboard dreadnought designs only. Also, the MK-20s are equipped with an embedded training system (called Cetus Combat Training System) which permits individual, subteam, and total team training on a level not possible in other Class 1 vessels. The qualities and flexibility of this system are not available in any other ship's combat information center and provide a valuable means to ensure crew readiness and effectiveness.

The Cetus weapon system proper has been designed to resist the effects of countermeasures interference

DESPITE THEIR "OFFICIAL" ASSIGNMENT OF PROTECTING THE OUTPOSTS ALONG THE ROMULAN NEUTRAL ZONE, THE MK-20s MAY ALSO BE CALLED UPON TO PATROL IN THE VICINITY OF THE EPSILON SERIES OUTPOSTS (right) ALONG THE DISPUTED KLINGON-FEDERATION BORDER.

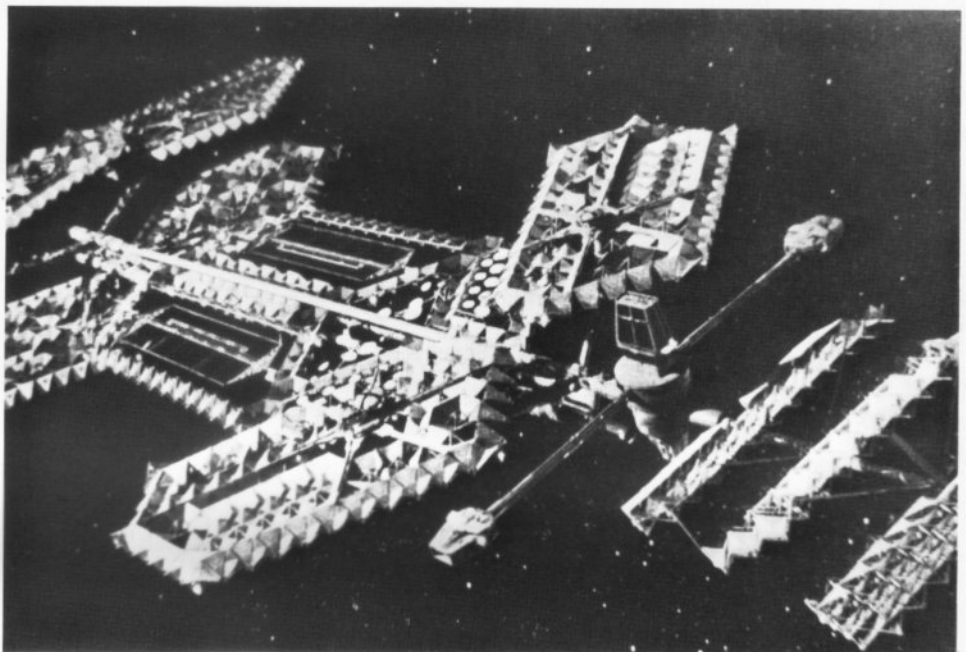

Courtesy Star Fleet

WEAPON SYSTEM

All Decatur/Belknap class cruisers are being fitted with the Cetus weapon system. This system, in conjunction with the TACAR fire control unit, will significantly enhance the MK-20s' offensive capability. The reaction time, data base, flexibility, availability and countermeasures resistance of the entire Cetus system surpasses any other weapon system in the fleet today, or presently being contemplated. Similarly, there is a vast difference in the capabilities of FSTR/TAC ships and those fitted with Cetus. The Cetus display system with its large screen displays and status boards provides the commanding officer and command crew greater real-time tactical information for own-ship fighting or battle group warfare than any other system in the fleet.

and to survive in the environment which such interference would cause. Many other features, such as the main and secondary damage control console arrangements of the MK-20s, were developed to support their survivability posture should they be hit. As a result, the MK-20s have a much greater capacity to resist damage and continue fighting.

Systems scheduled to be incorporated into later ships of the class include the Link 22 communications core, beginning with NCC-2512; the close-in deflector shield system (CIDSS) beginning with NCC-2515; and the Navtac navigation guidance suite for NCC-2518. The accelerated shipbuilding schedules and testing of systems for reliability and maintainability will continue to require scheduled backfitting to be done during selected, restricted vessel availability.

Decatur/Belknap cruiser class

NAME	HULL NUMBER	BUILDERS	LAID DOWN	LAUNCHED	COMMISSIONED
<i>Decatur</i>	NCC-2500	Cosmadyne, Earth	02 DEC 2265	17 FEB 2267	12 MAY 2270
<i>Belknap</i>	NCC-2501	Cosmadyne, Earth	21 OCT 2271	09 JAN 2273	07 FEB 2274
<i>Bradley</i>	NCC-2502	Cosmadyne, Earth	14 AUG 2274	18 SEP 2275	28 JUNE 2276
<i>Khirirat</i>	NCC-2503	Cosmadyne, Earth	23 MAR 2275	27 FEB 2276	06 NOV 2276
<i>Haversham</i>	NCC-2504	StarFleet Division, Deneb	SD 7154.22	SD 7298.35	SD 7402.51
<i>Sovereign</i>	NCC-2505	Cosmadyne, Earth	17 NOV 2276	04 DEC 2277	29 JULY 2278
<i>Concord</i>	NCC-2506	StarFleet Division, Deneb	SD 7565.43	SD 7593.26	SD 7732.53
<i>Rishiri</i>	NCC-2507	Cosmadyne, Earth	03 JULY 2278	14 JULY 2279	-----
<i>Essahir</i>	NCC-2508	StarFleet Division, Deneb	SD 7982.36	SD 8011.14	-----
<i>Jarrett</i>	NCC-2509	StarFleet Division, Deneb	SD 8003.36	SD 8212.57	-----
<i>Fahrion</i>	NCC-2510	Cosmadyne, Earth	15 OCT 2278	05 NOV 2279	-----
<i>Estocin</i>	NCC-2511	Cosmadyne, Earth	06 MAR 2279	-----	-----
<i>Matsurra</i>	NCC-2512	Cosmadyne, Earth	17 DEC 2279	-----	-----
<i>Baikal</i>	NCC-2513	StarFleet Division, Deneb	SD 8200.34	-----	-----
<i>Haven</i>	NCC-2514	Cosmadyne, Earth	-----	-----	-----
<i>Briza (ex-Belknap)</i>	NCC-2515	Cosmadyne, Earth	-----	-----	-----
<i>Mikuma</i>	NCC-2516	StarFleet Division, Deneb	-----	-----	-----
<i>Shangri-La</i>	NCC-2517	StarFleet Division, Deneb	-----	-----	-----
<i>Hai Din (ex-Bon Homme Richard)</i>	NCC-2518	Cosmadyne, Earth	-----	-----	-----
<i>Raan</i>	NCC-2519	StarFleet Division, Deneb	-----	-----	-----
<i>Delphin</i>	NCC-2537*	StarFleet Division, Deneb	-----	-----	-----
<i>Seneca</i>	NCC-2538	StarFleet Division, Deneb	-----	-----	-----
<i>Ki Rin</i>	NCC-2539	Cosmadyne, Earth	-----	-----	-----
<i>Cicala</i>	NCC-2540	StarFleet Division, Deneb	-----	-----	-----
<i>Sur Cha</i>	NCC-2541	StarFleet Division, Deneb	-----	-----	-----
<i>Mira</i>	NCC-2542	StarFleet Division, Deneb	-----	-----	-----
<i>Aveley</i>	NCC-2543	StarFleet Division, Deneb	-----	-----	-----
<i>Alor</i>	NCC-2544	Cosmadyne, Earth	-----	-----	-----

*HULL NUMBERS 2520 THROUGH 2536 ARE ASSIGNED TO THE Ascension CLASS DREADNOUGHTS.

HEAVY CRUISER

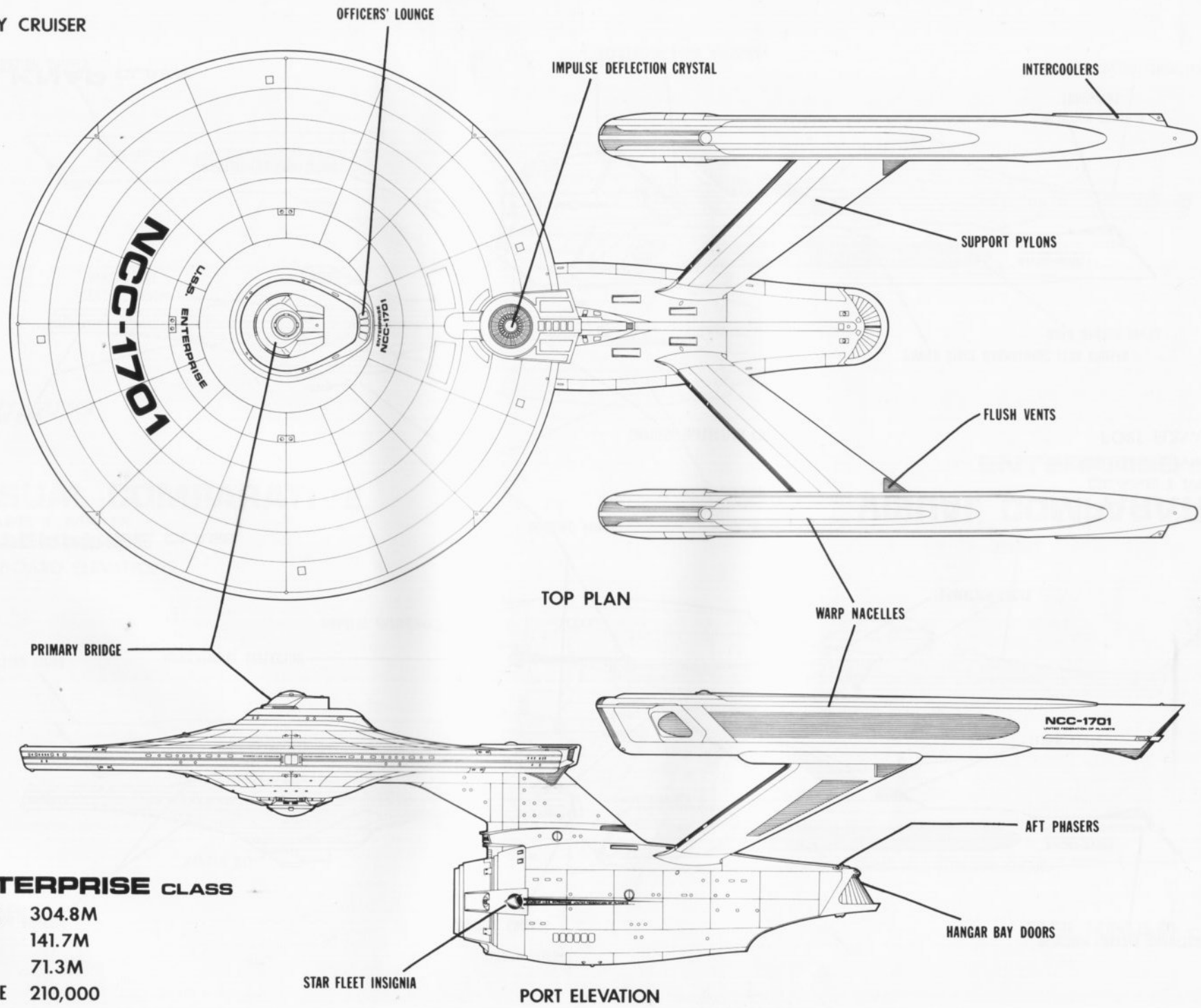

ENTERPRISE CLASS

LENGTH 304.8M
BEAM 141.7M
DRAFT 71.3M
TONNAGE 210,000

STAR FLEET INSIGNIA

PORT ELEVATION

FORWARD PHASERS

IMPULSE ENGINES

REACTION CONTROL THRUSTER

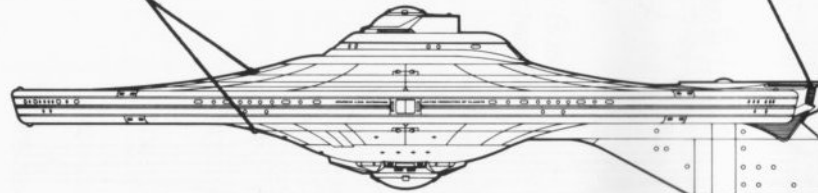

FLUSH VENTS

NAVIGATIONAL DEFLECTOR

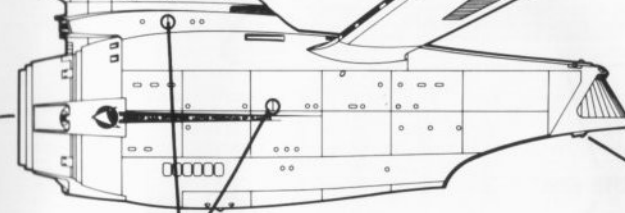

FORMATION LIGHT

ENTERPRISE CLASS

DOCKING PORTS

VISUAL COMPARATIVE

CLASS 1 MK-IX

CLASS 1 MK-XX

PORT ELEVATIONS

DEFLECTOR GRID

IMPULSE DEFLECTION CRYSTAL

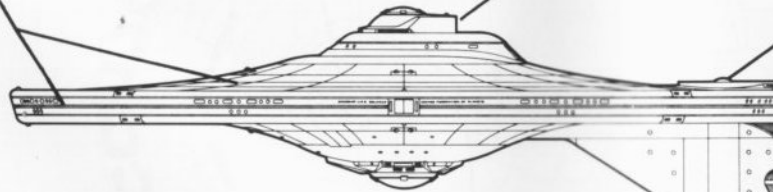

POWER STAGE MAGNATOMIC FLUX CHILLER

PHOTON TORPEDO TUBES

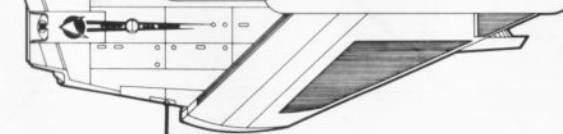

REACTION CONTROL THRUSTERS

BELKNAP CLASS

PHASERS

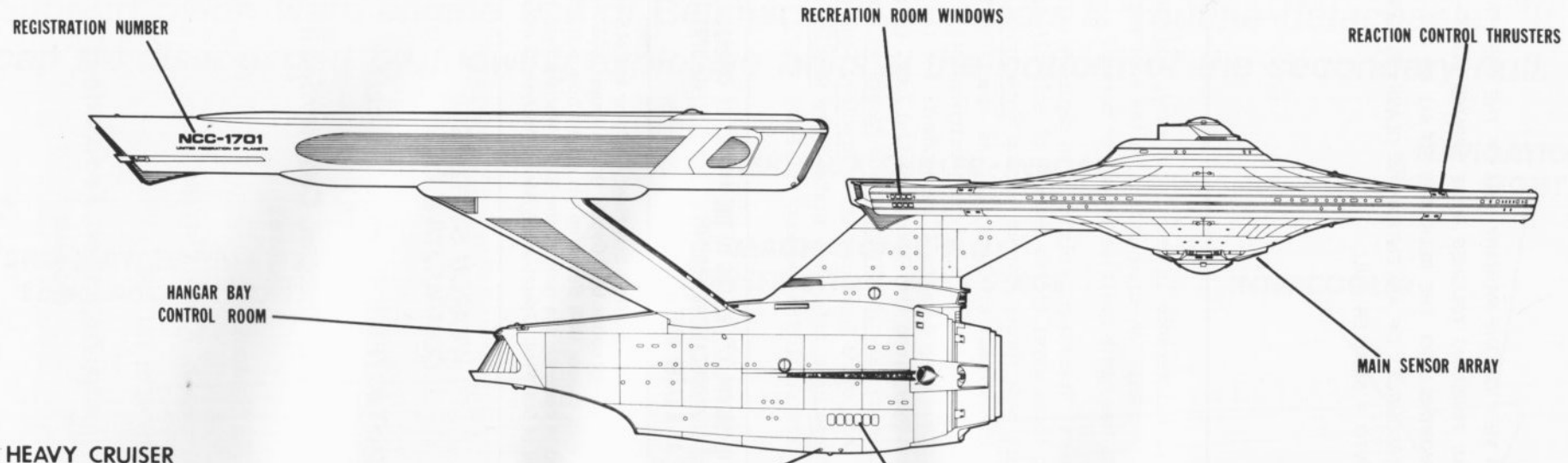

HEAVY CRUISER

ENTERPRISE CLASS

VISUAL COMPARATIVE

CLASS 1 MK-IX
 CLASS 1 MK-XX
 STARBOARD ELEVATIONS

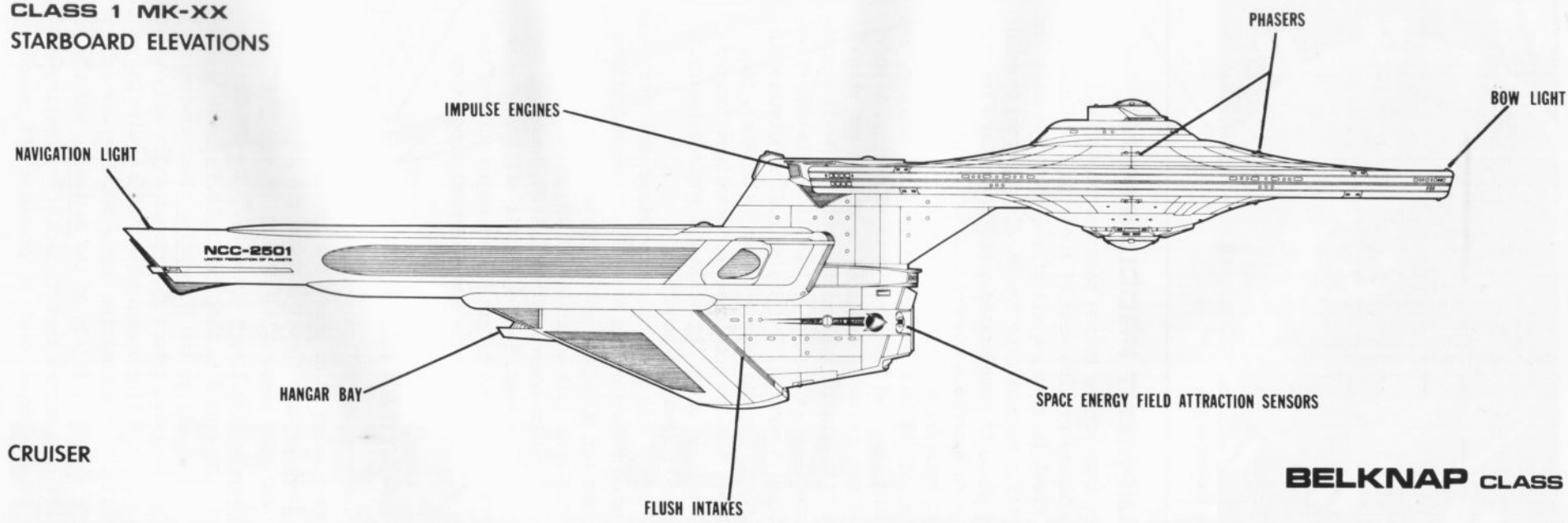

CRUISER

BELKNAP CLASS



Courtesy Star Fleet Division

A VIEW OF THE PRIMARY HULL OF THE ESSAHIR AS FINISHING TOUCHES WERE APPLIED FOUR MONTHS AGO. THE BELKNAPS FIT ALL OF THE RESOURCES OF AN ENTERPRISE CLASS CRUISER INTO A SMALLER HULL.

EQUIPMENT PROCUREMENT

Rather than adhere to the past practice of having the shipbuilders provide most of the vessel equipment, Star Fleet is ordering all of the combat systems and scientific hardware for the MK-20s. In order to equip these ships on accelerated schedules, Star Fleet has had to do extensive advance planning. Orders for the ships' warp drive systems are now being placed six months earlier than at the start of the program, increasing the lead time from 9 to 15 months. An additional two months is required to obtain the ships' TACAR fire control systems (3 months), Mk-3A computer interfaces (4 months), linear intermix warp drive chambers (9 months), and Sty'sz coil regulators for the photon torpedo launch system (4 months). Star Fleet has applied acceleration incentives "across-the-board" in order to obtain all engineering/drive system components on schedule.

The early ship deliveries surprised some shore establishments and caused Star Fleet some outfitting problems for NCC-2504, which had to leave Star Fleet Division with just under 90% of the necessary C³ systems support on board. With NCC-2508, however, the level has increased to 95%, but it still may be another 6 - 8 months before MK-20s begin joining the fleet with full systems and equipment support on board.

OPERATING REPORTS

MK-20 commanding officers report that their vessels are performing at or above the levels they expected, and they indicate that the ships are extremely reliable and very responsive. The CO of NCC-2502 says, "Bradley handles like a corvette." The MK-20s can accelerate from 0 to Warp One in 19.5 seconds and are as warp dynamic as the Enterprise class cruisers.

MK-20 COs also report experiencing virtually no problems with the linear warp drive shafts or with the antimatter containment bottles (minor buckling was evident during the early trials of the Belknap), and the junior officers report that the lack of engineering problems takes a great deal of pressure off everyone.

Equipment maintenance is relatively easy, and the increased emphasis on crew safety in the engineering sections has had a positive effect on morale.

At present, Star Fleet is planning to deploy MK-20 vessels in three ways: (1) As members of scientific/exploratory task forces formed around Enterprise and Tikopai class heavy cruisers; (2) As special units reserved for military or defense assignments; (3) and as guardians of and "on-call" respondents for the outpost stations along the Romulan Neutral Zone. Currently, starships Belknap, Khiriirrat and Haversham are assigned this third function, while Bradley, Sovereign and Concord have defensive status. The Rishiri and Essahir are still on shakedown trials ■

***GROWTH MARGIN (C³), REFERS TO THE AMOUNT OF COMMAND, CONTROL AND COMMUNICATIONS EQUIPMENT AND SYSTEMS UPDATING TO BE DONE AT A LATER DATE.**

Captain Ishan graduated from Star Fleet Academy in 2245. He commanded the patrol cutter USS Gynda, the destroyer USS Rahman and the light cruiser USS Seasprite. He retired from active duty in 2272 and is currently the head of the Strike Warfare Branch for the Chief of Star Fleet Operations' Systems Analysis Division.

WEAPON SYSTEMS COMPARATIVE DATA

**FSTR/TAC (Fleet Strategic/Tactical
Data System)**

***Enterprise, Tikopai, Constitution II
classes***

CETIS System

Avenger, Knox classes

CETIS with TACAR

***Belknap, Ascension, Federation II
classes***

Support pylon/warp engine unit of Belknap class cruisers is "routine-detachable." It can be disengaged by blowing explosive bolts at the bottom of the secondary hull.

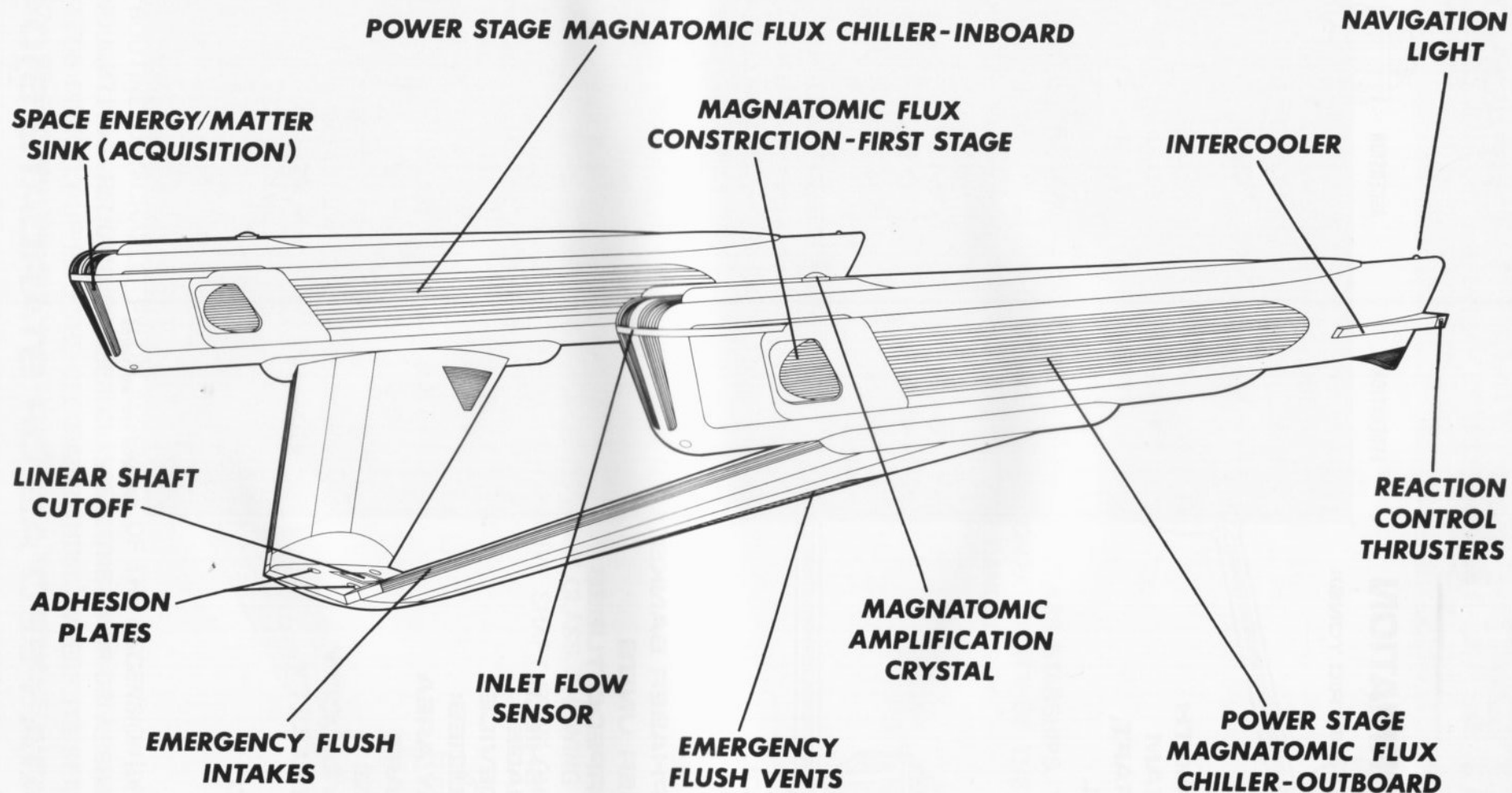

PERSPECTIVE VISUAL

BELKNAP CLASS WARP ENGINE/SUPPORT PYLON ASSEMBLY

UPDATE FILE

DREADNOUGHTS

CLASS INFORMATION

DISPLACEMENT (METRIC TONS):

LIGHT

STANDARD

FULL LOAD

DIMENSIONS:

OVERALL LENGTH

OVERALL BEAM

OVERALL DRAFT

PRIMARY HULL

LENGTH

BEAM

DRAFT

NACELLES

LENGTH

BEAM

DRAFT

SYSTEMS:

NAVIGATION

DEFENSE

FIRE CONTROL

COMPUTERS

ARMAMENT:

STANDARD PHASER BANKS

MEGA-PHASER UNITS

PHOTON TORPEDO TUBES

DEFENSE:

DEFLECTOR SHIELD

GRID COVERAGE

CLOAKING DEVICE

HANGAR FACILITIES:

HANGAR BAY AREA

SHUTTLECRAFT

PERFORMANCE:

MAXIMUM VELOCITY

CRUISING VELOCITY

RANGE

COMPLEMENT:

OFFICERS

CREW

FEDERATION

ASCENSION

KOMSOMOLSK*

272,000

241,000

339,000

275,000

245,000

345,000

276,500

247,000

352,000

307.6M

289.8M

350M

141.7M

141.7M

185M

83.7M

77.8M

80M

146.3M

146.3M

160M

141.7M

141.7M

151M

32.9M

32.9M

39M

154.8M

154.8M

172.5M

12.6M

12.6M

15M

18.3M

18.3M

20M

WARP CELESTIAL GUIDANCE

CETIS WEAPON SYSTEM

TACAR (TARGET ACQUISITION CENTER ACCELERATED RESPONSE)

DUOTRONIC II

13 BANKS [20]

11 BANKS [18]

10 BANKS [18]

NONE

NONE

2 [4 CANNONS]

4

2

4

90%

92%

87%

YES

YES

YES

745 SQ.M.

590 SQ.M.

1400 SQ.M.

2-3

2

8

W15[3375C]

W15[3375C]

W14[2744C]

W11[1331C]

W11[1331C]

W11[1331C]

24 YRS.

24 YRS.

19 YRS.

70

65

60

430

420

525

*Figures are estimates

DATA FEED AS OF STARDATE 8104

WARP ENGINE/PYLON ASSEMBLIES

FEDERATION, ASCENSION & BELKNAP CLASSES - FRONT VIEW

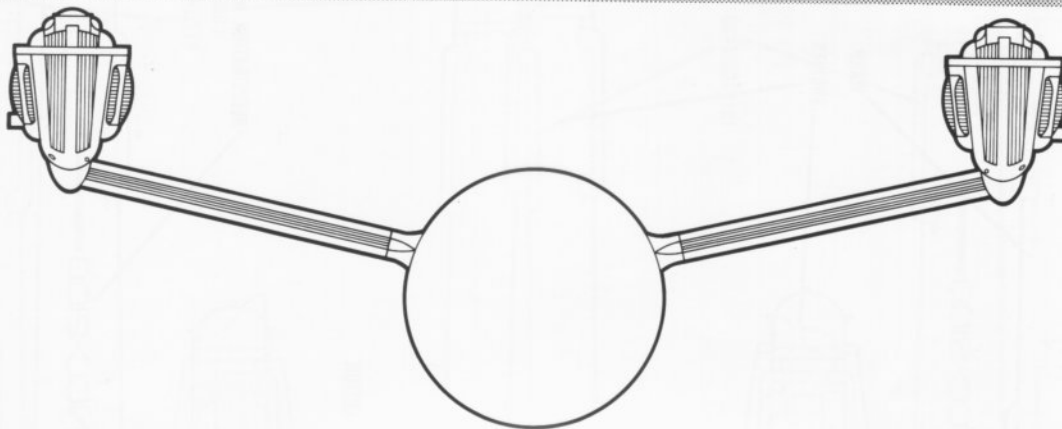

ORIGINAL DESIGN OF UPDATED *FEDERATION* CLASS STARSHIPS. THIS VERSION WAS SCRAPPED DUE TO THE INCOMPATIBILITY OF THE ENGINE SHAFT DESIGN AND ITS PROXIMITY TO THE HANGAR BAY.

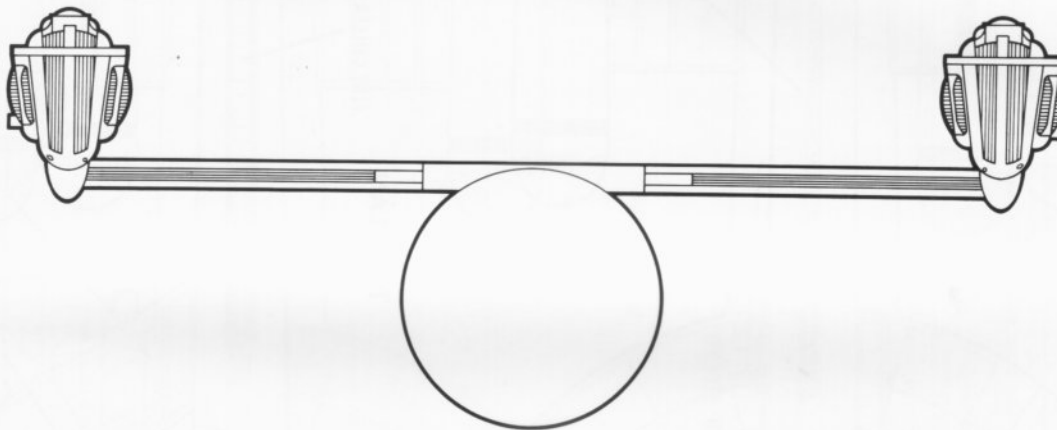

MODIFIED, FINAL DESIGN FOR THE *FEDERATION* CLASS, SHOWING THE DIRECT HORIZONTAL FEED OF THE WARP DRIVE SHAFT FROM ONE NACELLE TO THE OTHER.



"ROUTINE-DETACHABLE" PYLON ASSEMBLY OF THE *ASCENSION* (DREADNOUGHT) AND *BELKNAP* (CRUISER) CLASSES. THE WARP DRIVE SHAFT FEEDS DIRECTLY UP INTO THE SECONDARY HULL, WHERE ITS SEALS CAN BE BROKEN AND THE PYLON/NACELLE UNIT DETACHED.

DREADNOUGHT

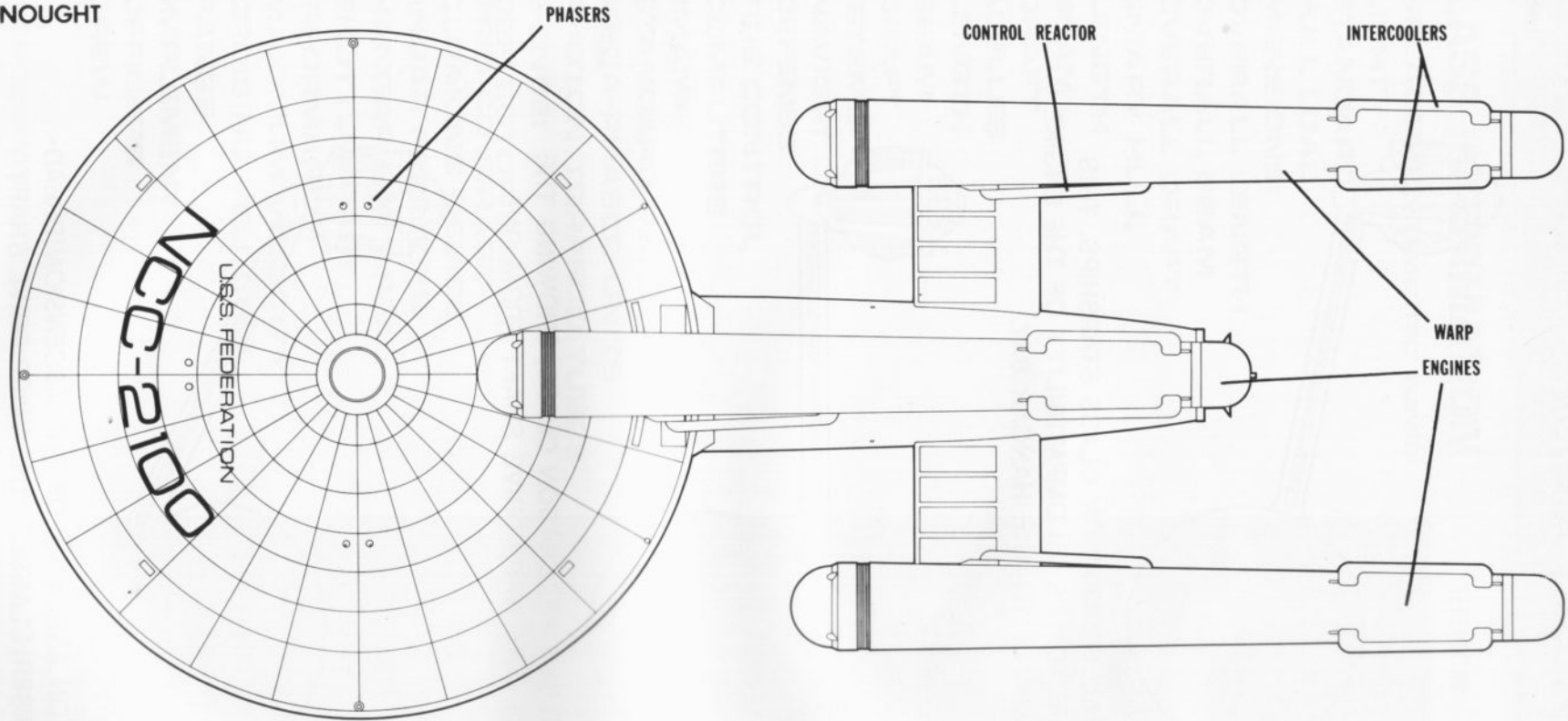

Configuration as proposed

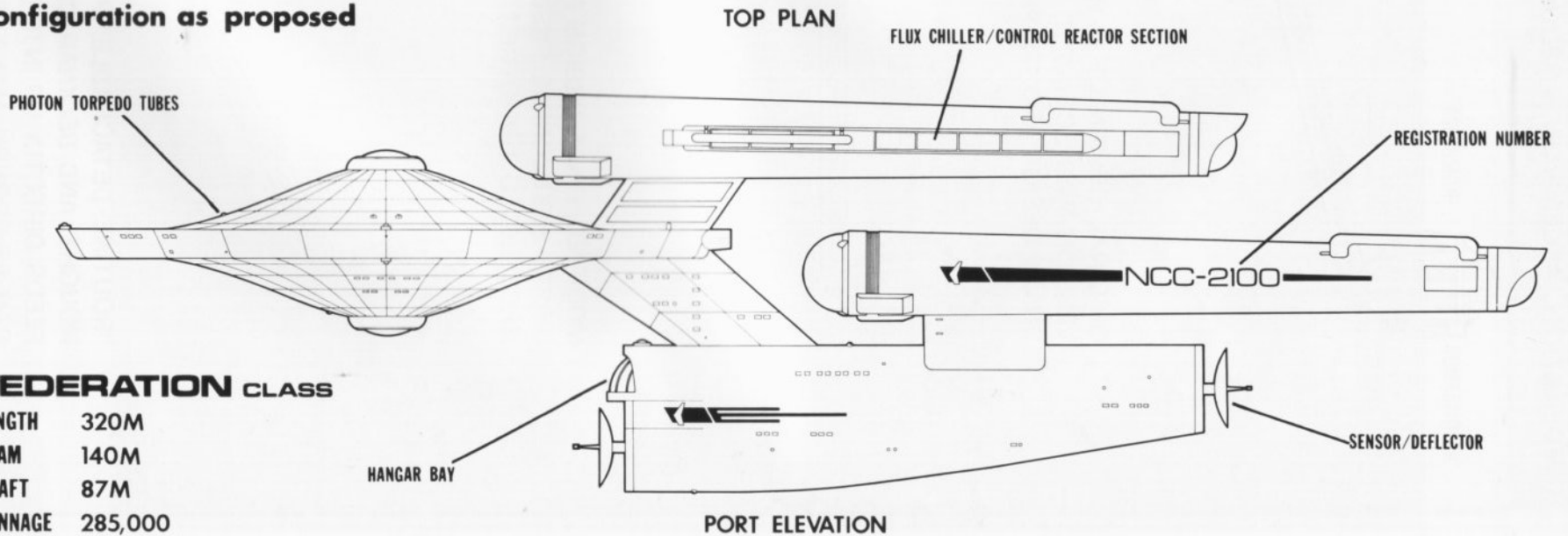

FEDERATION CLASS

LENGTH 320M
BEAM 140M
DRAFT 87M
TONNAGE 285,000

DREADNOUGHT

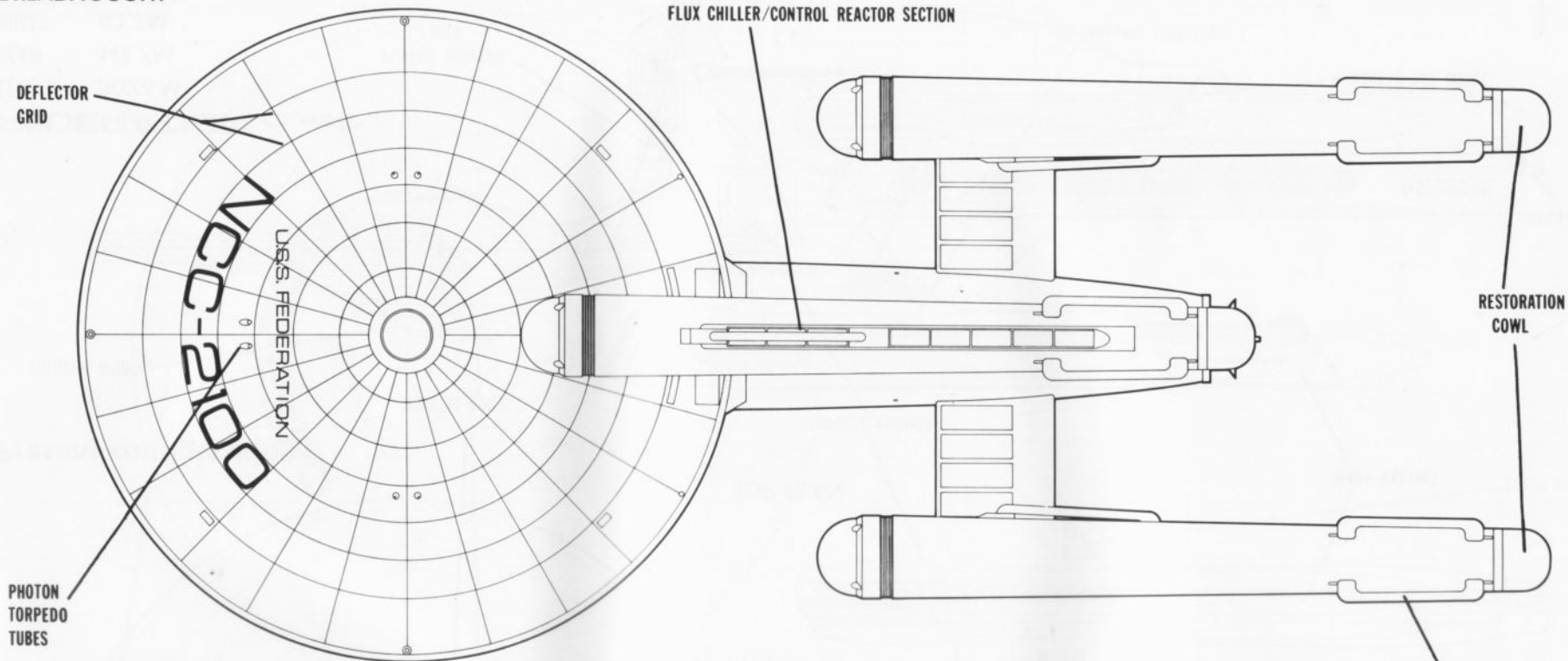

Configuration as built

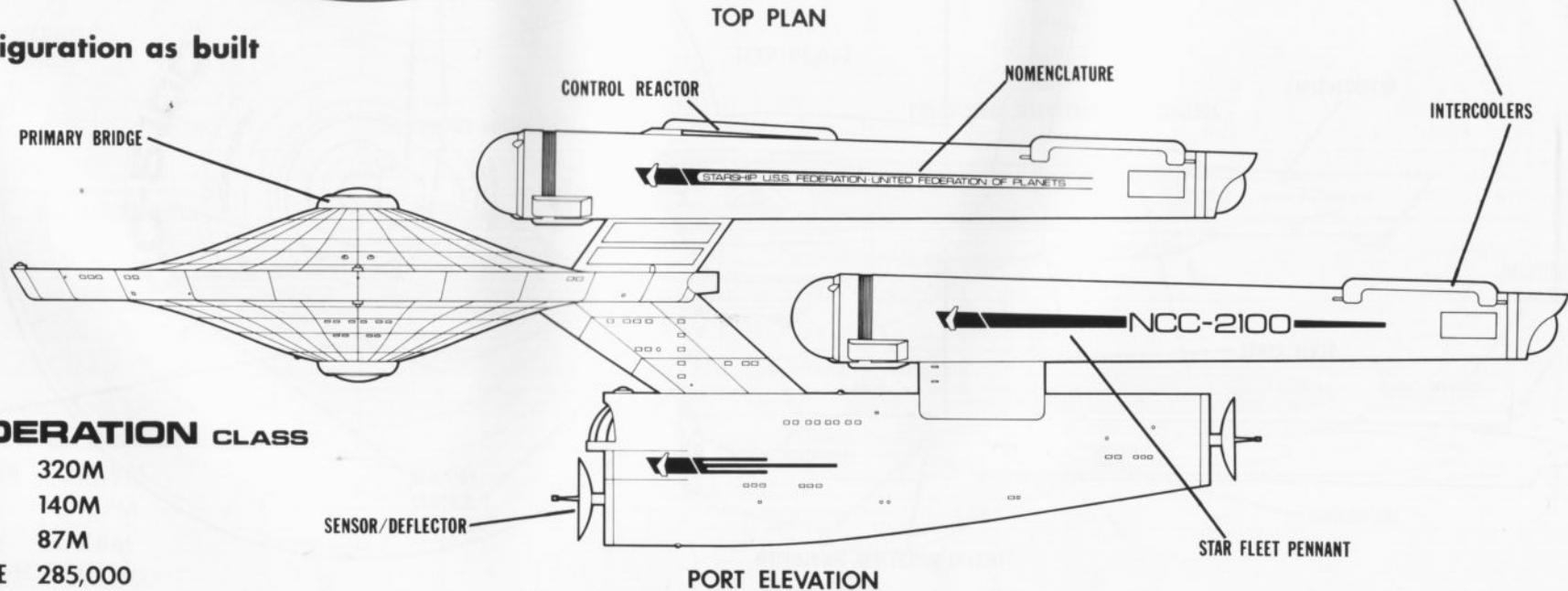

FEDERATION CLASS

LENGTH 320M
 BEAM 140M
 DRAFT 87M
 TONNAGE 285,000

DREADNOUGHT

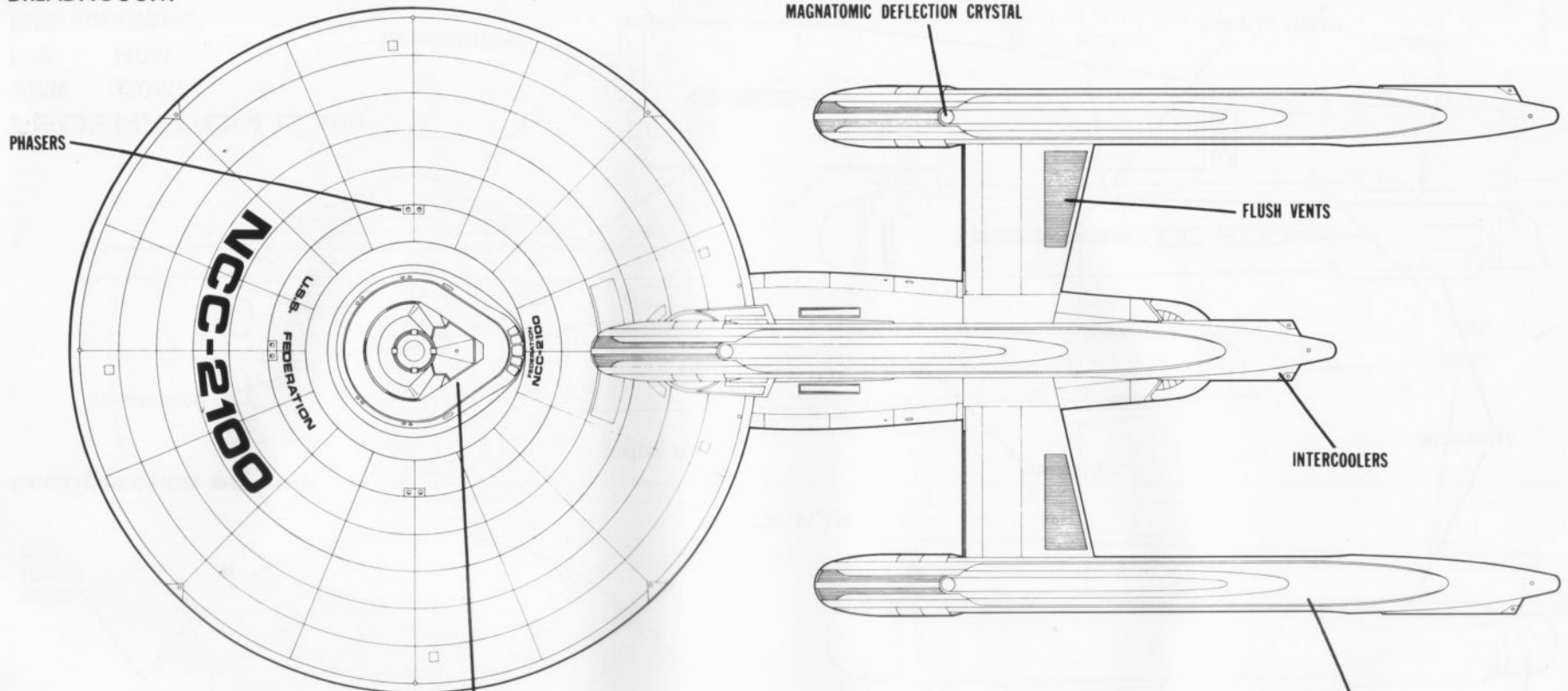

Present configuration

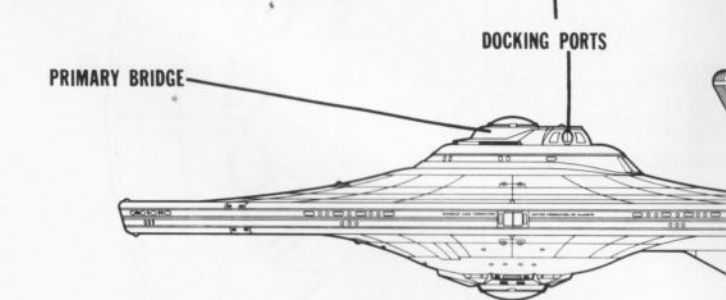

TOP PLAN

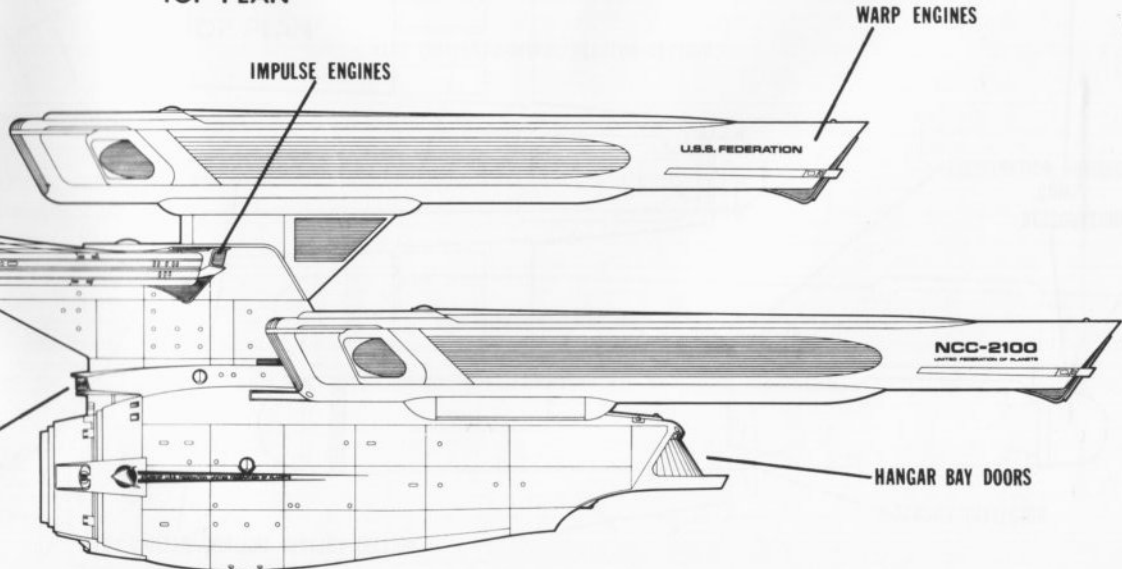

FEDERATION CLASS

LENGTH	307.6M
BEAM	141.7M
DRAFT	83.7M
TONNAGE	275,000

PHOTON TORPEDO TUBES

PORT ELEVATION

HANGAR BAY DOORS

DREADNOUGHT

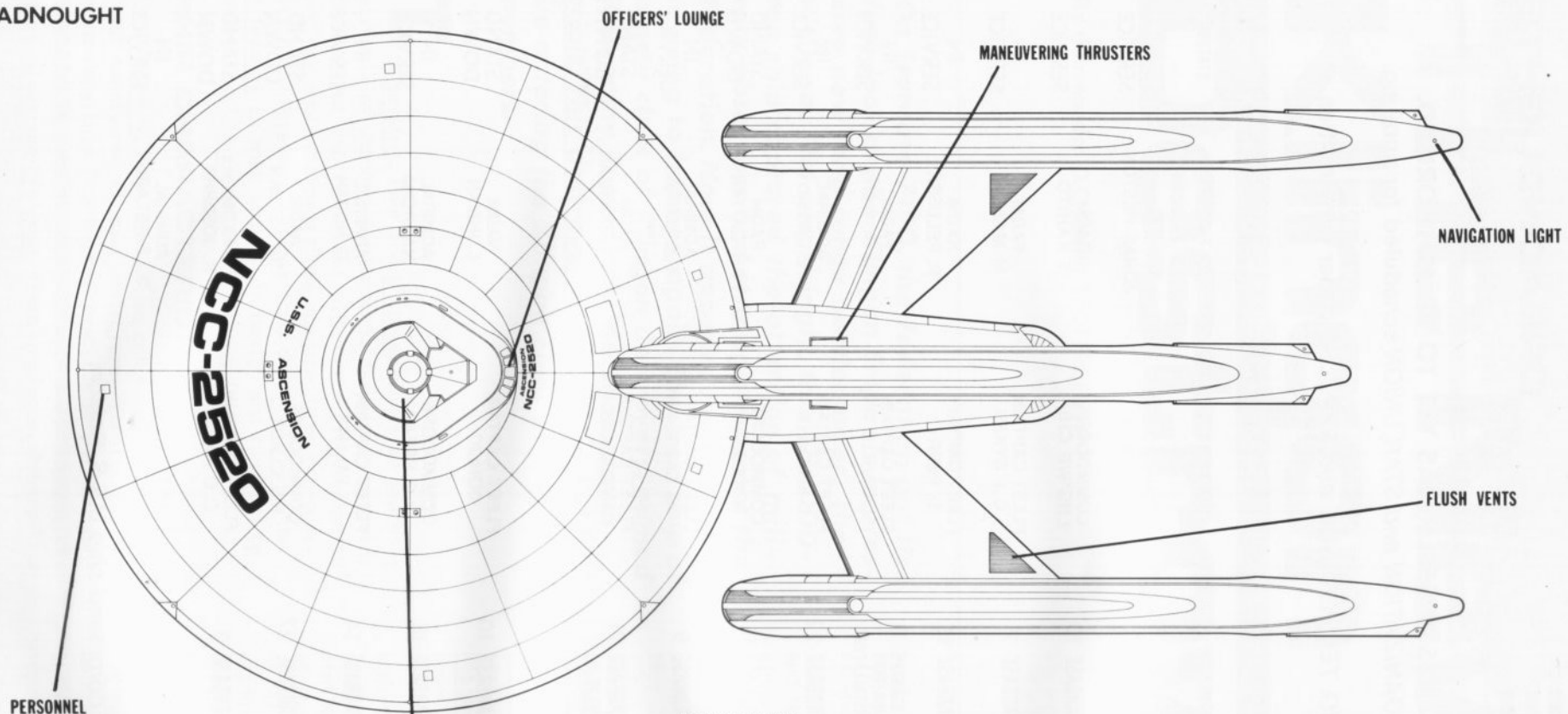

TOP PLAN

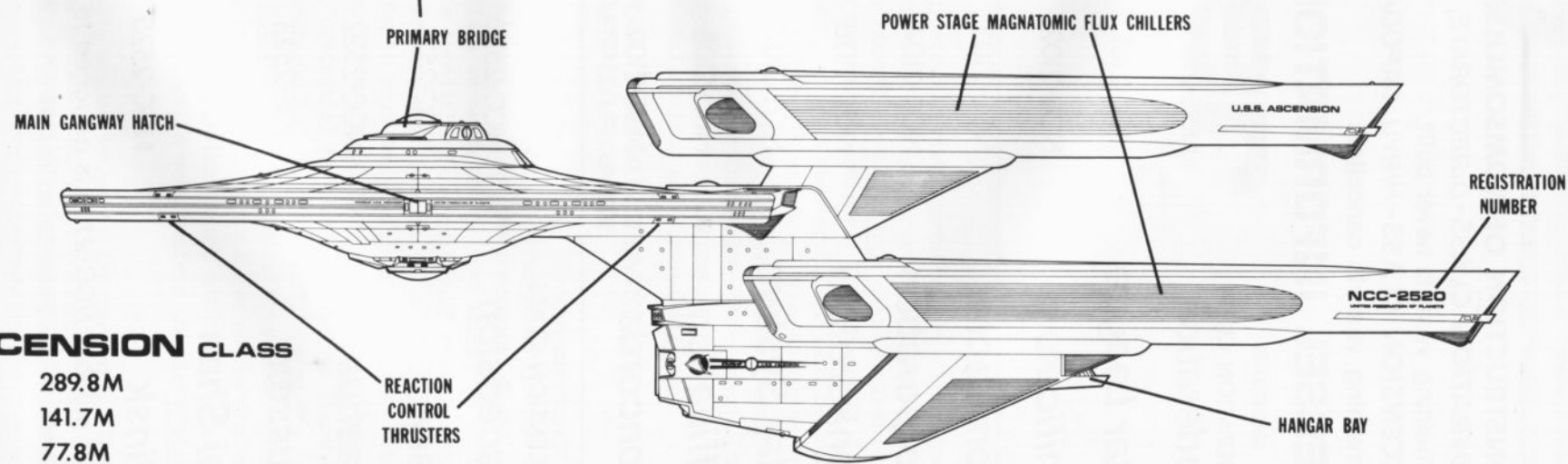

PORT ELEVATION

ASCENSION CLASS

LENGTH	289.8M
BEAM	141.7M
DRAFT	77.8M
TONNAGE	245,000

CONSTRUCTION OF KOMSOMOLSK CLASS VESSELS HAS YET TO BE AUTHORIZED.

FEDERATION CLASS-DIRECTORATE, ORGANIZATION and STAR UNION scheduled for uprating.

Remaining vessels never built.

ASCENSION CLASS-HIRYU, CAPODANNO, TEMPERANCE and REPULSE under construction.

Remaining vessels cancelled.

VESSEL INFORMATION

NOMENCLATURE	HULL NUMBER	HOMEPORT	COMMAND	FLAG	STATUS
FEDERATION CLASS					
<i>Federation</i>	NCC-2100	STARBASE 4	COMMODORE J.T.L. SUNN	RADM JONAS RESTON	IN SERVICE
<i>Star League</i>	NCC-2101	STARBASE 10	COMMODORE LNG'WE CHI	RADM T. KAHITO	IN SERVICE
<i>Unificatum</i>	NCC-2102	STARBASE 7	FLEET CAPTAIN C.J. SYKES	FADM M. MASSA	IN SERVICE
<i>Compactat</i>	NCC-2103	STARBASE 15	FLEET CAPTAIN D. PERRY	RADM R. PELUSSA	IN SERVICE
<i>Corporation</i>	NCC-2104	BEKKAAS MILITARY INSTALLATION	FLEET CAPTAIN S. NEVILLE III	FADM TIM POWERS	IN SERVICE
<i>Konkordium</i>	NCC-2106*	STARBASE 22	FLEET CAPTAIN D.S. ROANE	ADMIRAL E. CASSIDY	IN SERVICE
<i>Star System</i>	NCC-2107	STARBASE 16	COMMODORE H. RAMSAY	RADM EN GA'TAN	STAND DOWN
<i>Affiliation</i>	NCC-2108	STARBASE 9	FLEET CAPTAIN O. CATOLA	ADMIRAL R.L. CARIUS	IN SERVICE
<i>Concordat</i>	NCC-2109	STARBASE 21	FLEET CAPTAIN N. CULLINS	RADM I.H. BAUGHMAN	STAND DOWN
ASCENSION CLASS					
<i>Ascension</i>	NCC-2520	STARBASE 10	FLEET CAPTAIN DOHIJO	VADM L. INMAN	STAND DOWN
<i>Leander</i>	NCC-2521	STARBASE 18	COMMODORE K.C. SPEAR	ADMIRAL NAARCHA	IN SERVICE
<i>Nashua</i>	NCC-2522	STARBASE 14	FLEET CAPTAIN D. PALMER	ADMIRAL G. NORTH	IN SERVICE
<i>Sussex</i>	NCC-2523	STARBASE 27	COMMODORE R.S. CLARK	RADM SA PETSAN	STAND DOWN
<i>Tai Shan</i>	NCC-2524	STARBASE 3	FLEET CAPTAIN C. O'HARA	FADM K. JOSEPHS	STAND DOWN
<i>Minsk</i>	NCC-2525	STARBASE 6	FLEET CAPTAIN T.L. WARD	ADMIRAL J. I.S. KELARRU	IN SERVICE

*Hull number NCC-2105 is assigned to the command ship U.S.S. Balson.

The New Klingon Destroyer

By Commander D.C. Costin, SFOF(TacFleet)

On Stardate 7190, the Federation got its first look at the Klingon Empire's impressive new long-range battlecruiser, the K't'inga. Not surprisingly, this 120,000-ton ship captured the attention of military observers and strategists across the Federation. Now it appears the same thing is going to happen again. The lead ship of a new class of Klingon destroyers, named K'teremny, is currently on shakedown trials. This destroyer class will probably be entering the Klingon Fleet in large numbers.

The K'teremny, like the K't'inga, mounts an impressive mix of weapons and sensors. When first observed, she was not yet outfitted with her disruptor mounts and her photon torpedo tubes appeared to be non-operational. More warp-dynamic than the K't'ingas, the K'teremny is most similar in design and function to Star Fleet's Knox (NCC-1940) class frigates.

SHIP CHARACTERISTICS

The K'teremny, the first of an estimated fleet of at least twenty new Klingon destroyers, constitutes a major departure from the past practice of the Klingon Fleet. She is unquestionably a further development of the Klolode and K't'inga class cruisers. Apparently realizing the vast benefits of similar-hull vessel design (with regard to parts manufacturing, layover time,

outfitting, etc.), Intelligence reports that the Klingon Imperial Fleet is proceeding with construction of what is essentially a K't'inga class cruiser redesigned for the role of destroyer. The Klolode/K't'inga and this new destroyer have strikingly similar dimensions and identical propulsion systems. Noting the sophistication of the K't'ingas, the appearance of the K'teremny indicates an increasing emphasis on high-value, technologically sophisticated warships with improved sustainability and survivability.

GENERAL ARRANGEMENTS AND APPEARANCE

As is the case with most other Klingon warships, the K'teremny is a well-armed, ominous-looking ship. She possesses virtually all of the components found on K't'inga class vessels, though some appear to be improved, more sophisticated versions of the same equipment. The primary hull is particularly antagonizing, and it seems to have been designed as much for its look as for its practicality. The multi-level command platform (forecastle) is recessed into the front end of the primary hull (instead of sitting atop the hull as on the K't'ingas) while the life support/engineering deck is positioned both above and behind the forecastle. Also, the design and exterior layout of the engineering deck is more austere than its K't'inga counterpart.

K'teremny's bridge is one of the largest ever seen on a vessel of her size, while the sensor tower, positioned directly behind, is somewhat compact. Of particular interest is the lack of any apparent provisions for an officers' lounge with a direct external view, though this is undoubtedly the result of



K'TEREMNY

CLASS DESTROYERS
OUTBOARD TOP PLAN

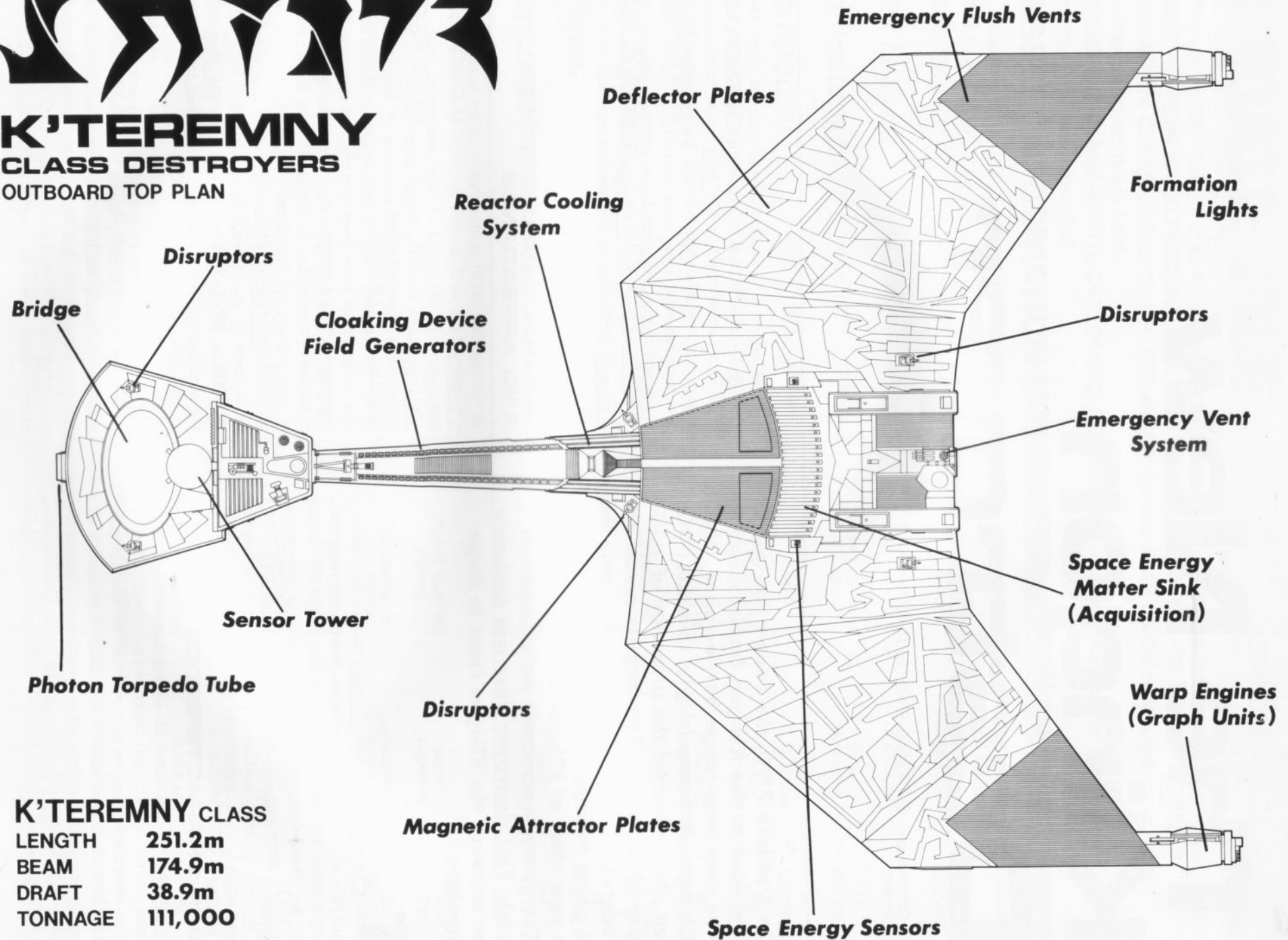

K'TEREMNY CLASS	
LENGTH	251.2m
BEAM	174.9m
DRAFT	38.9m
TONNAGE	111,000

K'teremny's role as a destroyer. The access boom section is slightly shorter than K't'inga's, but the navigation beacon tower and boom disruptor emplacements are still readily apparent.

K'teremny's secondary/warp engineering hull is basically a modified K't'inga battlecruiser hull. Cargo space appears to have been cut back, with a single, large hatch at the forward port location as opposed to K't'inga's three hatches. The area allocated for the space energy/matter sink (acquisition) intakes is slightly larger on K'teremny, indicating increased engine power and/or efficiency. However, the two small space energy sensors are apparently of the same type.

The "power-plate packs" are no longer attached to the hull at a diagonal slant but are instead perpendicular to the horizontal axis of the ship and are mated directly into the intake deck, apparently without the ability to be blown away in case of emergency. This entire section does seem to be slightly improved, but it is not known if existing K't'ingas will be backfitted with this configuration.

The hydrogen intake and by-pass vents are of the same configuration, as are the hydrogen sensors. The area allotted to the emergency flush vents for the warp engines is much larger. The reason for their size is unknown (one would think these units would become smaller, not larger, if improved); the only explanation is that K'teremny's designers wanted a faster venting time in case of an emergency.

WEAPONRY & DEFENSE

K'teremny is literally bristling with disruptor weapons - 10 individual mounts as opposed to 8 on the K't'ingas (K'teremny's two additional mounts are located on the upper forecastle). These appear to be the standard model first used on the K't'inga class and now employed on all Klingon ships. Secondary hull de-

sign and proximity to their power source (warp engines) would easily allow for several more emplacements, but it is not known if K'teremny's sister ships will be more heavily armed in this area.

K'teremny is fitted with two photon torpedo tubes - one fore and one aft. This design is identical to that of K't'inga, with one exception: K't'inga's forward tube-to-exhaust feed passes along the very bottom of her primary hull, well below and away from any areas occupied by her crew. K'teremny's torpedo tube is positioned directly at the center of her primary hull, with her exhaust at the rear. This would indicate that her exhaust feed travels through the middle of the hull (with inhabited areas 360° around, this is a seemingly dangerous design flaw) or along the bottom of the hull to its aft position. The latter would be more consistent with the design of previous Klingon ships and would make more sense from a safety standpoint.

K'teremny's deflector plating is situated on her hull in an unusually random pattern. It is not known if this is due to a new manufacturing/application process or if it simply provides more protection for the hull. The underside of the access boom appears to have slightly more deflector protection than does the same location on K't'inga. Field generators for the Romulan-designed cloaking device are located on the upper section of the access boom.

Interesting to note is the large bridge mentioned earlier. This is somewhat expected of a destroyer in the Klingon Fleet since additional stations would be required for a weapons officer, gunners, gunnery mates and tactical personnel as well as added space for auxiliary fire control computers. The sensor tower contains the standard long- and short-range sensors and scanning devices in addition to the usual assortment of warfare countermeasures and jamming equipment found in most Klingon warships.

Klingon Imperial Fleet (KIF) and StarFleet Comparisons

	STAR FLEET SUPERIOR		PARITY	KIF SUPERIOR	
	SOLID LEAD	KLINGONS CLOSING GAP		SOLID LEAD	FEDERATION CLOSING GAP
INTERNAL FACTORS					
ORGANIZATION	X				
WEAPONS/EQUIPMENT		X			
TRAINING			X		
DOCTRINE		X			
SUSTAINABILITY	X				
EXPERIENCE			X		
EXTERNAL FACTORS					
SHORE-BASED RESPONSE				X	
PATROL COMBATANTS			X		
CARRIER-BASED RESPONSE		X			
MERCHANT FLEET	X				
STRATEGIC REACH		X			

K'TEREMNY
CLASS DESTROYERS
 PORT ELEVATION

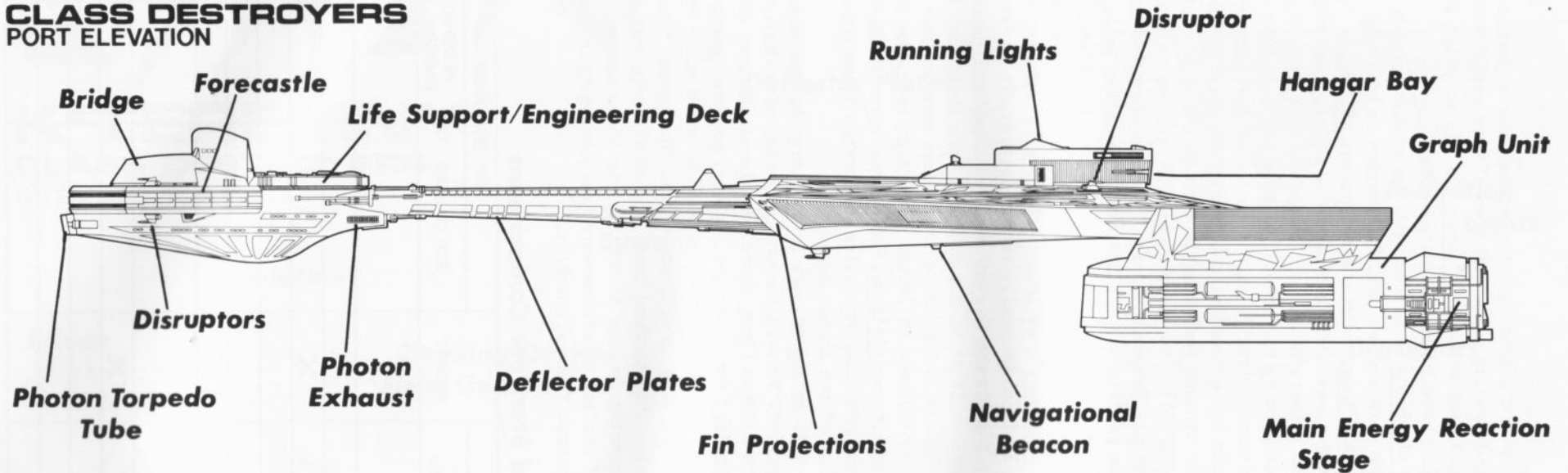

K'T'INGA
CLASS BATTLECRUISERS
 PORT ELEVATION

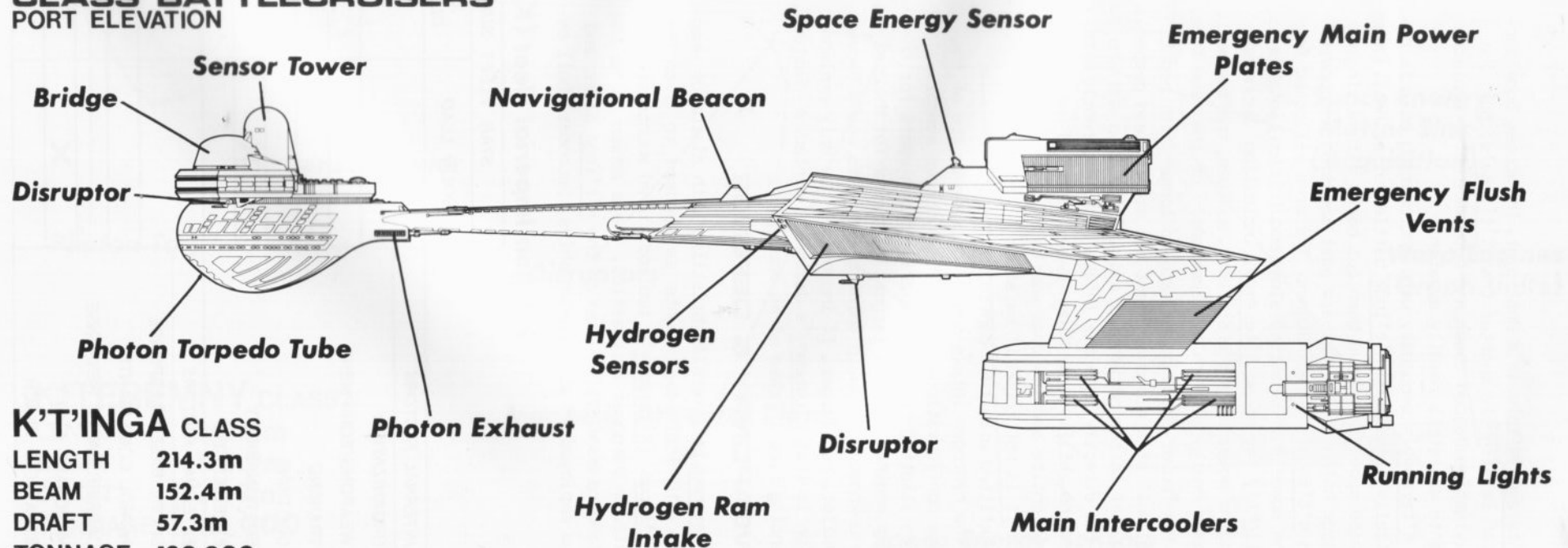

K'T'INGA CLASS
 LENGTH 214.3m
 BEAM 152.4m
 DRAFT 57.3m
 TONNAGE 120,000

K'TEREMNY CLASS DESTROYERS - BOW ELEVATION

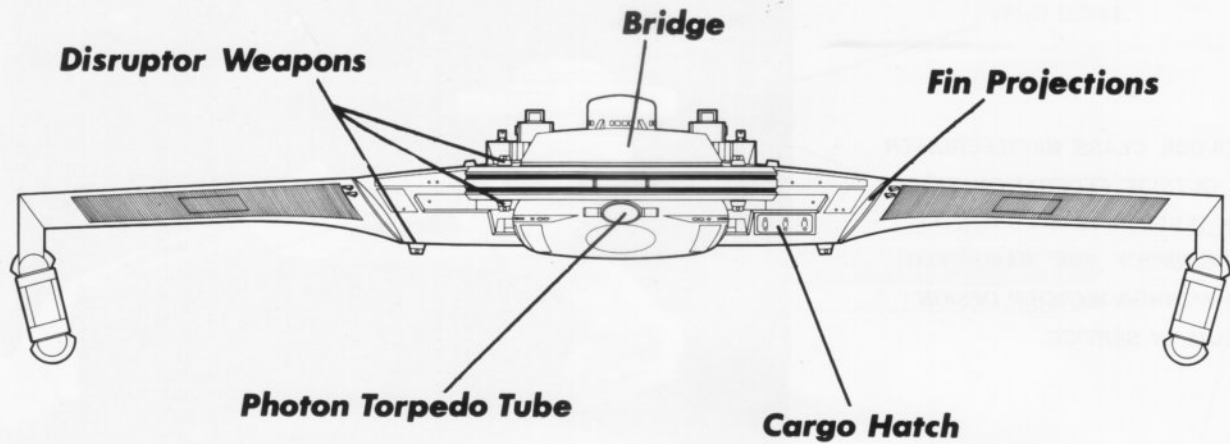

PERCENTAGE OF TOTAL MILITARY EXPENDITURE	U.F.P.	KLINGON EMPIRE
MILITARY PERSONNEL COSTS	25	11
OPERATIONS & MAINTENANCE	43	29
EQUIPMENT PROCUREMENT	20	37
RESEARCH AND DEVELOPMENT	10	20
CONSTRUCTION OF MILITARY FACILITIES	2	3

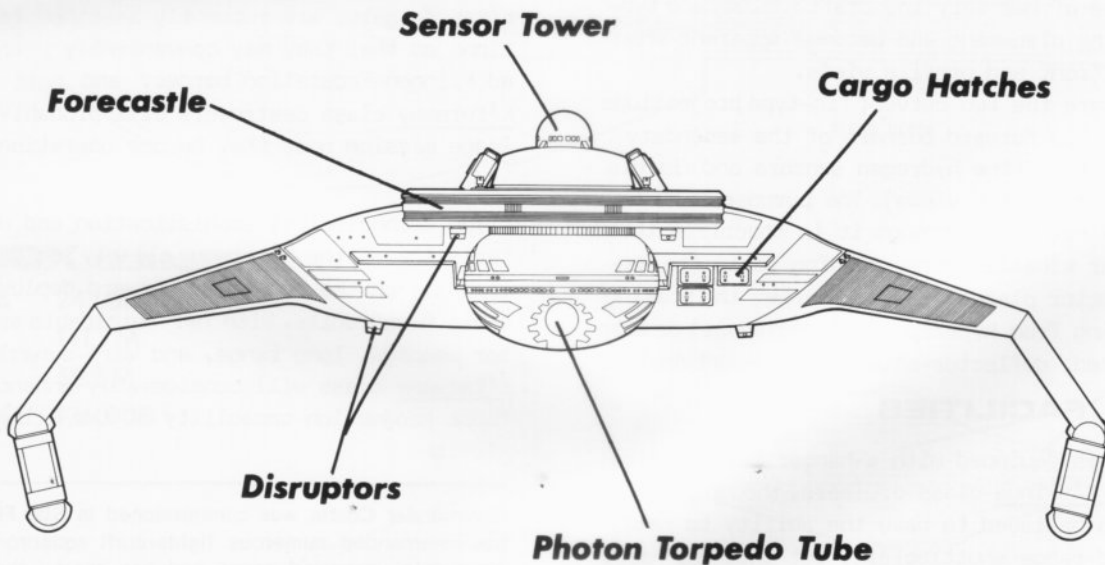

K'T'INGA CLASS BATTLECRUISERS - BOW ELEVATION

A KLOLODE CLASS BATTLECRUISER
JUST OUTSIDE FEDERATION SPACE.
THE K'TEREMNY IS A FURTHER
EXTENSION OF THE RAXOR/KLO-
LODE/K'T'INGA WARSHIP DESIGN.
ALL ARE IN SERVICE.

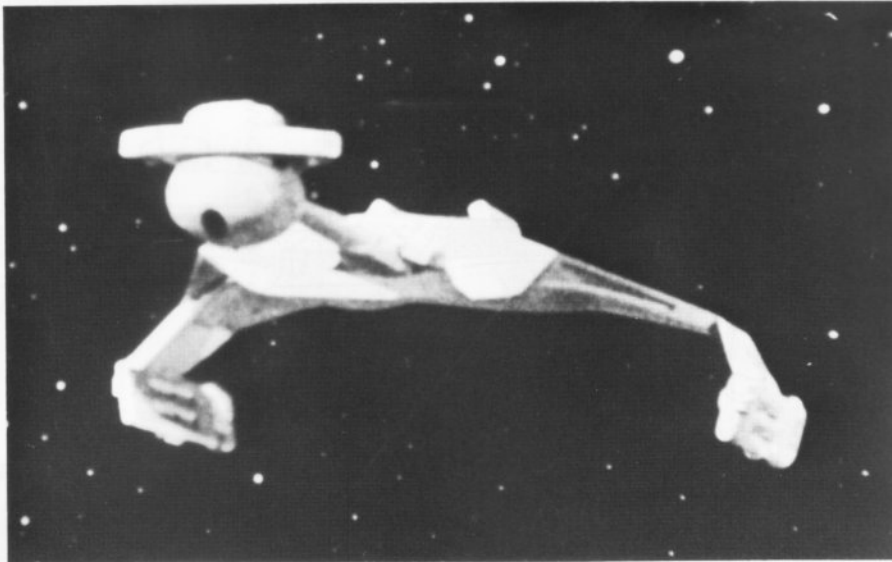

Courtesy Star Fleet Intelligence

PROPULSION, HULL FORM AND WARP ABILITY

K'teremny's propulsion package is identical to that of the K't'inga class, consisting of hydrogen energy impulse engines and K'tchar STN5 Graph units (warp engines), producing warp power via dilithium conversion. Her impulse engines are located in the same position as those of K't'inga, at the very bottom rear of the secondary hull.

K'teremny's overall shape makes her an extremely warp-dynamic vessel. The warp bubble she creates while in warp has the effect of efficiently "piercing" the hyperspace in front of her along her horizontal axis. This is because of her very low draft (38.9m) and typical wide engine placement and becomes apparent when observing her front and profile views.

Of interest are the two curved, fin-type projections located at the two forward corners of the secondary hull (just forward of the hydrogen sensors and visible on the front and profile views). The purpose of these projections is not known, though it is theorized that they are either kinetic energy dumping vanes (to assist the deflector plates and thus shorten the braking time when moving from hyperspace to realspace) or some form of directed, deflector-shield enhancement device.

HANGAR FACILITIES

The K'teremny is equipped with a hangar bay identical to the bay on K't'inga class cruisers, though slightly larger. She is believed to have the ability to carry 2 or 3 limited-range shuttlecraft, but that is all. These craft are armed with small disruptor emplacements but are designed for planetfall missions only. K'teremny class destroyers do not carry Klingon attack shuttlecraft.

If the K'teremny has a counterpart in Star Fleet it is almost certainly the Knox (NCC-1940) class frigates. Not only is their basic design similar (i.e. tonnage, armament, etc.) but their operational role in their respective fleets will be the same as well.

The Knox class currently consists of 26 (NCC-1940 through NCC-1965) front-line vessels. These ships are armed with two of the large megaphaser emplacements in addition to 12 standard phasers (6 banks, two each) and are essentially scaled-down versions of Avenger class heavy frigates (NCC-1860 through NCC-1881). They are not equipped with photon torpedo tubes, but the megaphasers more than make up for their absence. Knox class frigates are currently assigned forward positions so that they may conveniently patrol the disputed Klingon-Federation border, and most of the K'teremny class destroyers will probably have a mirror-image mission once they become operational.

The technological sophistication and design characteristics of the K'teremny clearly indicate the Klingon emphasis on the continued forward deployment role of their fleet units. With her formidable array of disruptor weapons, long range, and warp-dynamic design, the K'teremny class will considerably enhance the growing force projection capability of the Klingon Imperial Fleet ■

Commander Costin was commissioned in Star Fleet in 2255. He has commanded numerous fightercraft squadrons on escort missions into uncharted space and has served three tours ashore in weaponry and defensive R&D billets with Terrier, Scrimshaw and Point Defense systems. He has served aboard the cruiser USS Skatepack and the command ship USS Stenn and is presently assigned to the Special Operations Division of TacFleet.

FRIGATE

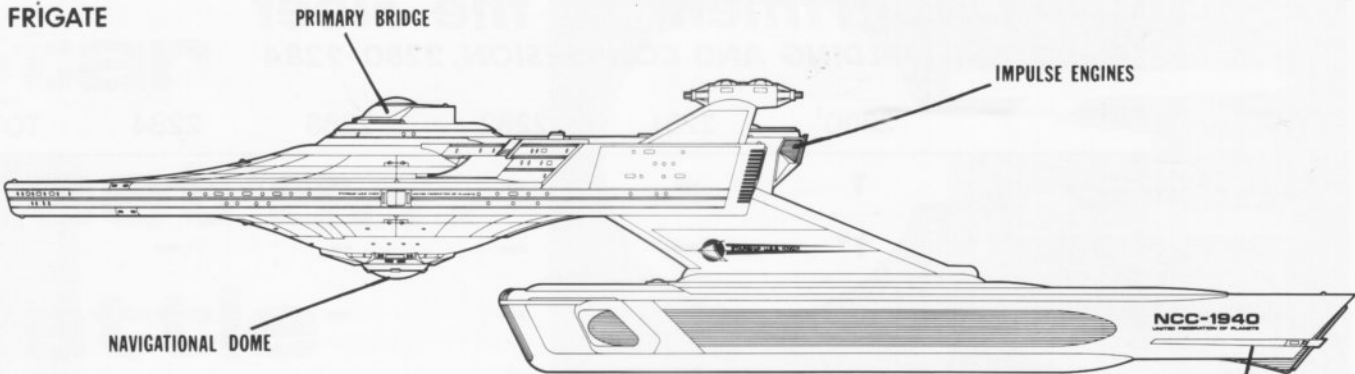

PORT ELEVATION

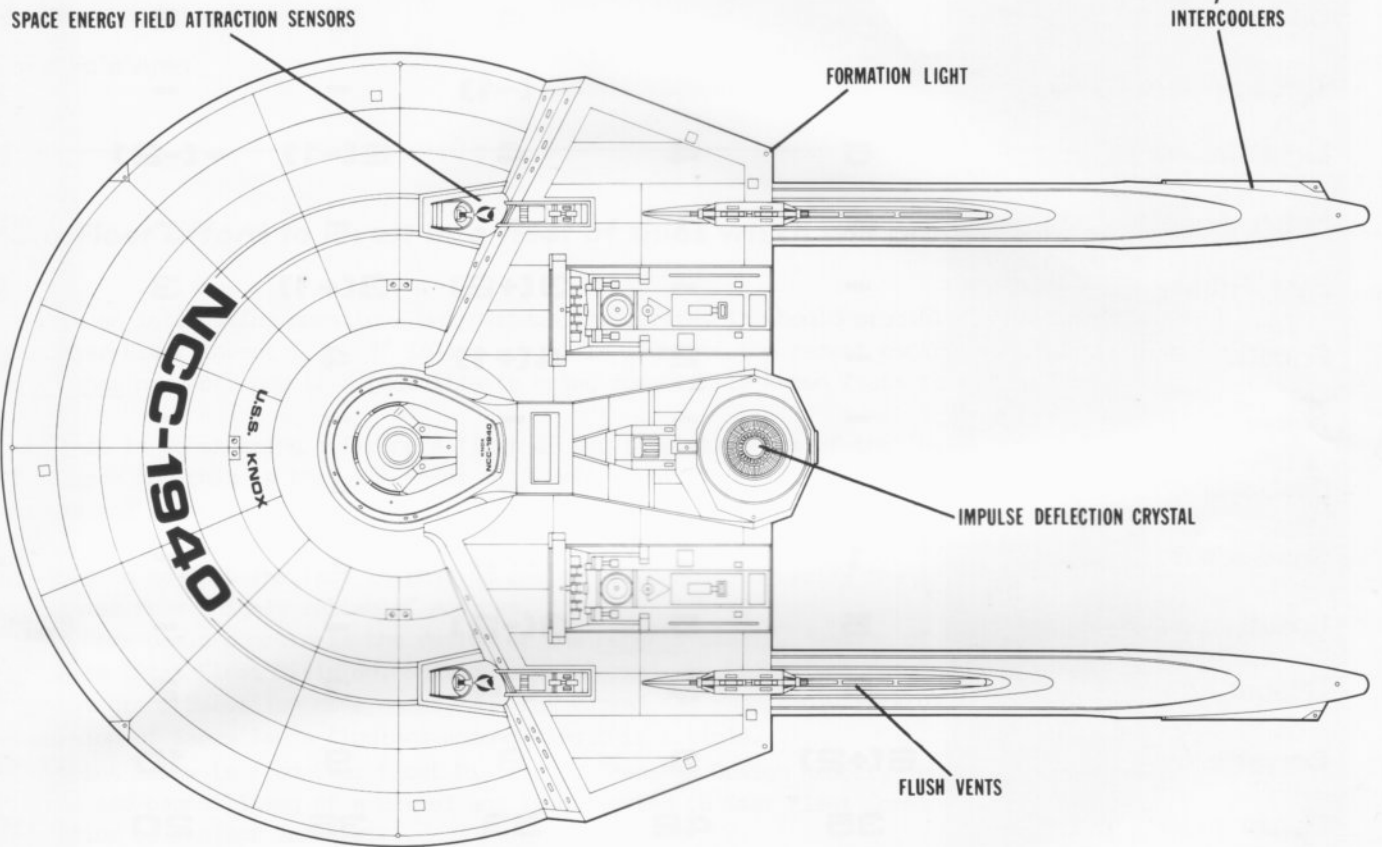

TOP PLAN

KNOX CLASS

LENGTH	243.3M
BEAM	141.7M
DRAFT	52.8M
TONNAGE	136,000

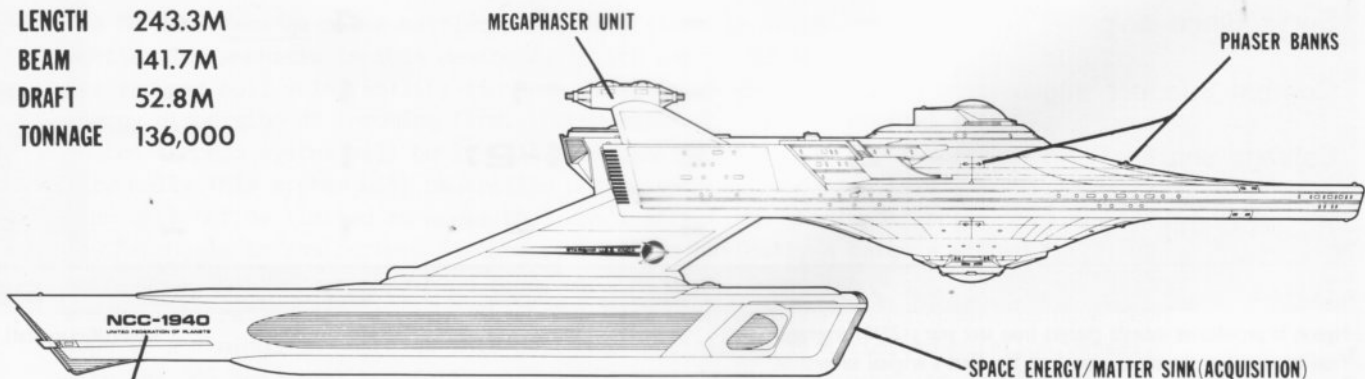

REGISTRATION NUMBER

STARBOARD ELEVATION

Department of the Fleet

SHIPBUILDING AND CONVERSION, 2280-2284

TYPE	2280 ¹	2281	2282	2283	2284	TOTAL
Shuttlecarrier	1	-	-	-	-	1
Battlecruiser	1 ²	-	-	-	-	1
Dreadnought	2	1(-1)	-	-	-	3
Heavy Cruiser	3	1(-1)	1	-	-	5
Strike Cruiser	-(-1)	-	1	-	-	1
Cruiser	4	4	4	3	3	18
Through-deck Cruiser	1	1	-(-1)	-	-	2
Light Cruiser	5	4	4	2(-1)	-(-2)	15
Heavy Frigate	2	1	-	-	-	3
Fast Frigate	-	-	3(+2)	3(+1)	3	9
Frigate	-	2	4(+1)	4	-	10
Heavy Destroyer	-	-	-	-	-	-
Destroyer	1(-1)	-	-	-	-	1
Superscout	1	1	1(+1)	1	-	4
Scout	5	5	3(-2)	-	-	13
Clipper	9	9	7(-4)	3	2	30
Corvette	6(+2)	9	9	9	10	43
Lesser craft ³	35	42	53	35	20	185
Conversion/Acquisition						
Surveillance ship	-	-	-	4	4	8
Combat Support ship	-	-	1	1	-	2
Salvage ship	2	2	1(-2)	1	-	6
Hospital ship	1	-	-	1	-	2
TOTAL	79	82	92	67	42	362

Figures in parentheses indicate changes from last year's (2279) program.

¹Final appropriation showing changes from Star Fleet's original submission.

²Indicates completion of test vehicle U.S.S. MENANCA.

³Includes Corsairs, Scoops, Long-range shuttles, etc. Figures do not include fightercraft.

Source: Military Staff Committee

Star Fleet's... Battle Cruiser?

By Fshynda Fa'a'Aren

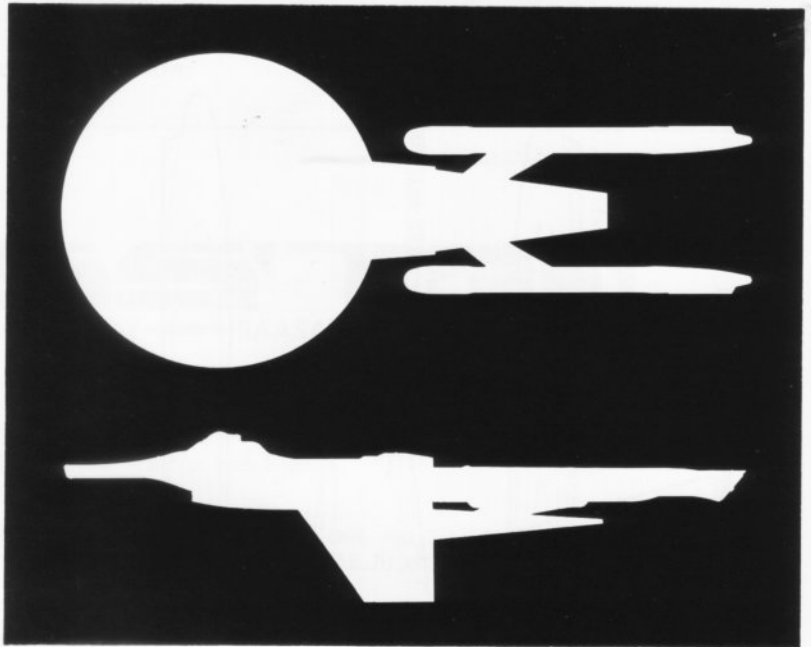

Can StarFleet afford to invest in a fleet of ships which will probably sit around unused?

That is an interesting question, but perhaps inaccurate. It should probably begin with the words "Should Star Fleet invest . . . ?" In any event, in light of the recent controversy surrounding the proposed Menahga project, now is a good time to bring some little known facts to the surface.

Star Fleet is considering building a fleet of ten (10) starships of the 'battlecruiser' class. The official reason for this is that the ships will help counter what intelligence sources call "a large, widespread and potentially far-reaching increase in construction activity at numerous Klingon dockyard facilities." The vagaries of that statement, which was quoted from an official Star Fleet press release, are obvious to anyone. The fact is that no one has been able to verify the information which Star Fleet insists comes from "highly reliable" sources.

An even more basic concern is the design of the Menahga itself. Testing of the Menahga-prototype by its builders (Star Fleet Division, Baltic Yards, Terra), by Star Fleet Command, and by the independent development group Saess'Tan have ended, and the vessel has reportedly received mixed reviews. A summarized version of Saess'Tan's findings accompanies this article.

The excerpt below is from Star Fleet Division's "Menahga Design Report," which is a summary of the expectations and capabilities of a vessel and is presented to Star Fleet Command by the contracted ship-builder prior to project approval.

SECURITY DOCKET NO. 2155, "MENA HGA DESIGN REPORT"

The MK-XIII Menahga class battlecruiser is a starship designed almost exclusively for battle. The emphasis in this design is in its battle durability. Extensive shielding has reduced hull vulnerability (in some areas by as much as 27%) by allowing greater energy dispersion of incoming fire. Though still in the experimental stage, an improved photon torpedo system will be installed on centerline at the lower section of the primary hull. This system will neutralize photon exhaust, and as a result, its installation will not be limited to areas that don't affect the ship's deflector grid system*. The Menahga's infrastructure (secondary hull) is basically a cargo and warp drive support hull. This section has been especially designed to accept repeated hull violations while still retaining a fully functioning crew complement. Personal comforts have been kept to a minimum on board as this design is envisioned as a limited-duration vessel, with her 305 personnel hopefully not manning her for any extended length of time.

*AS OF STARDATE 8455.8, ALL EXPERIMENTS WITH THE PHOTON NEUTRALIZATION SYSTEM FOR Menahga's TORPEDO EXHAUST HAVE PROVEN UNSUCCESSFUL.

BATTLECRUISER

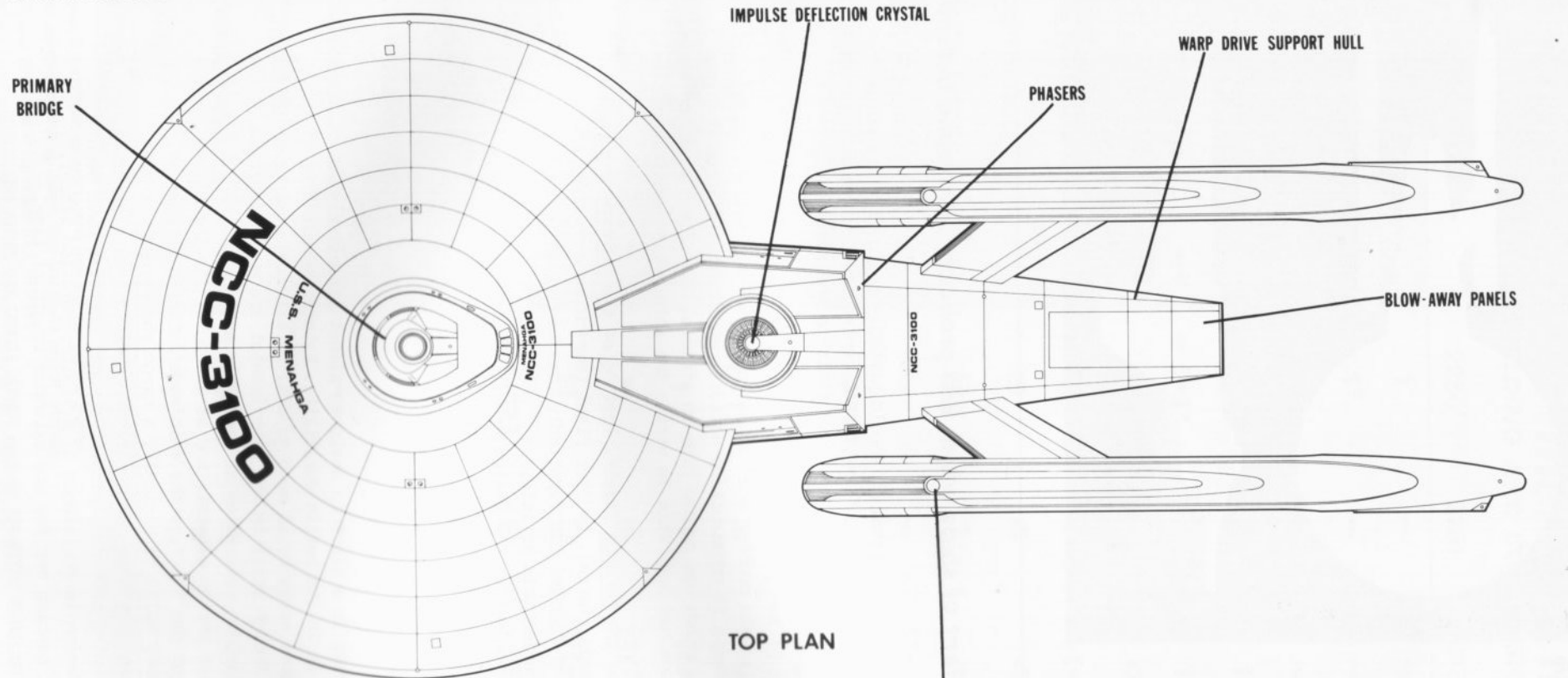

TOP PLAN

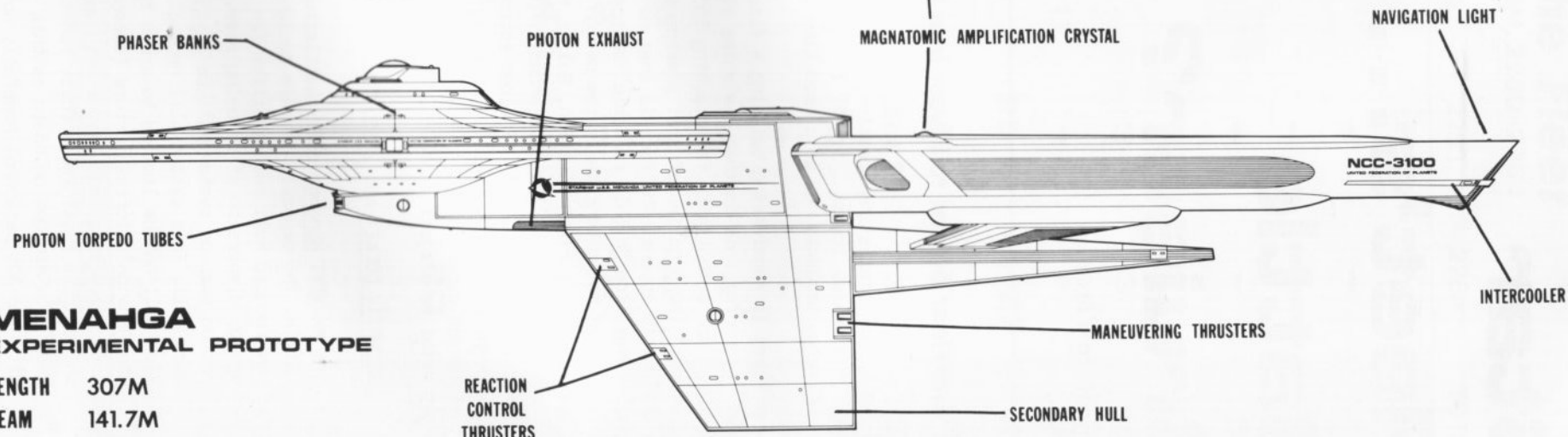

PORT ELEVATION

**MENAHGA
EXPERIMENTAL PROTOTYPE**

LENGTH	307M
BEAM	141.7M
DRAFT	78M
TONNAGE	173,000

SAESS'TAN

WORKING FOR A BETTER TOMORROW...TODAY — RAASAH AT BENECIA/DULJOV

MEMORANDUM TO: MILITARY STAFF COMMITTEE, StarFleet Command
FROM: JHYSHYK FHYDHAHFHYDEES, Prime Coordinator, saess'TAN-Rhkk Testing Facility
SUBJECT: RST3V597-jA MENA 3100 (1100) Battlecruiser Prototype Trials & Testing
STARDATE: STDRD 8007.503

DATAFILE FOLLOWING CONTAINS FINDINGS PURSUANT TO STRUCTURAL, OPERATIONAL AND SYSTEMS TESTING OF 3100 SERIES "MENAHA" STARSHIP CLASS. FOR ADDITIONAL RESPONSE, REFER TO VIS/SEQ 2175A FOR ENHANCED VISUAL REVIEW.

597-06...DEGREE OF SLOPE OF WARP ENGINE SUPPORT PYLONS RESULTS IN PLACEMENT OF WARP NACELLES WHICH IS UNNECESSARILY ELEVATED. ACQUISITION VANES (SPACE ENERGY/MATTER SINK) AND IN-LET FLOW SENSOR ARE EITHER PARTIALLY OR WHOLLY OBSCURED BY PRIMARY HULL. THIS COULD AFFECT WARP FIELD FORMATION AND/OR BALANCE. RECOMMEND RELOCATION (LOWERING) OF WARP NACELLES. SPECIFICS FOLLOW: **DELETED**

597-11...PROPOSED LOCATION OF PHOTON TORPEDO SYSTEM (DECK) IS INADEQUATE. ITS POSITIONING PROHIBITS INSTALLATION OF STANDARD SENSOR FIT AT ITS MOST EFFECTIVE LOCATION. RECOMMEND RELOCATION. SPECIFICS FOLLOW: **DELETED**

597-12...EXPERIMENTS WITH EXHAUST PURIFICATION SYSTEM HAVE PROVED INEFFECTIVE. RELOCATION OF PHOTON TORPEDO SYSTEM (DECK) NECESSARY FOR THIS REASON. (ALSO, SEE IMMEDIATE ABOVE). SPECIFICS FOLLOW: **DELETED**

597-23...LOCATION OF HANGAR BAY AT FORWARD END OF SECONDARY HULL NOT DESIRABLE. REASON: (A) VULNERABILITY DURING BATTLE SITUATIONS (B) PROXIMITY OF PHOTON EXHAUST TO HANGAR BAY COULD PROVE DANGEROUS AND/OR DETRIMENTAL TO HANGAR AND FLIGHT CREWS DEPENDING ON OPERATING CONDITIONS. RECOMMEND RELOCATION. SPECIFICS FOLLOW: **DELETED**

597-27...LOCATION AND HULL-MATING OF SPACE-ENERGY FIELD ATTRACTION SENSORS INADEQUATE. RECOMMEND REDESIGN AND/OR RELOCATION. SPECIFICS FOLLOW: **DELETED**

597-30...LOCATION OF AFT PHASER BANKS (TWO) IS INADEQUATE. PHASER FIRE ARC PRESENTS HAZARD TO WARP NACELLES REGARDLESS OF COMPUTER FIRE CONTROL. RECOMMEND RELOCATION. SPECIFICS FOLLOW: **DELETED**

597-31...GENERAL DESIGN OF "WARP ENGINE SUPPORT HULL" INEFFECTUAL. DEFLECTOR PROTECTION AND WARP STABILITY INSUFFICIENT; ANTI-MATTER CONTAINMENT BOTTLE LOCATION AND SECURABILITY INADEQUATE. RECOMMENDATIONS NUMEROUS. SPECIFICS FOLLOW: **DELETED**

597-32...RECOMMEND RELOCATION OF "REACTION CONTROL THRUSTER" PACKAGES TO CORNER POSITIONS OF SECONDARY HULL. ALSO, MANEUVERING THRUSTERS SHOULD BE MOVED TO ANGLED SURFACES (GC-21M, GC-27M THROUGH GR-15M HULL PLOTS) OF WARP ENGINE SUPPORT HULL FOR INCREASED EFFECTIVENESS AND SPACE EFFICIENCY. SPECIFICS FOLLOW: **DELETED**

597-41...LOCATION OF VERTICAL WARP DRIVE SHAFT INEFFECTUAL. RECOMMEND MOVING SHAFT FURTHER AFT TO ALLOW FOR ADDITIONAL CARGO SPACE IN SECONDARY HULL AND IMPROVED SHAFT EJECTION CAPABILITY IN CASE OF EMERGENCY. SPECIFICS FOLLOW: **DELETED**

BELIEVE ADDED WARP MANEUVERING ABILITY INSUFFICIENT TO JUSTIFY INCREASED SIZE AND VULNERABILITY OF SECONDARY HULL; SELF-PROTECTIVE CAPABILITIES ALONE (I.E. EXTENSIVE DEFLECTOR SHIELDING) DO NOT WARRANT 'BATTLECRUISER' CLASSIFICATION. ARMAMENT (PHASER EMPLACEMENTS) ALSO INSUFFICIENT. RECOMMENDATIONS NUMEROUS.

Criticism of the Menahga project hails from many quarters, from those who are screaming "warmonger" at Star Fleet Command to the perimeter base and outpost commanders who simply don't ever want to see the ships in their sectors for fear the antagonists they are adjacent to (primarily the Romulans and the Klingons) would take some provocative action. The Menahga's supporters consist mainly of those firms which have so far been given tentative subcontractor status on the project, and with roughly one-third of the contracts still to be awarded, support from this faction will undoubtedly increase.

The paragraph below was authored by one of the most respected supporters of the Menahga project, Vice Admiral Jahn Coe, and is excerpted from his recent article in "Interstellar Defense Review."

"THE CURRENT OPERATIONAL CONCEPT OF STAR FLEET SINGLE-PURPOSE STARSHIPS IS TO HOLD THEM IN 'RETAINER' AT CERTAIN PRESELECTED MILITARY INSTALLATIONS (E.G. STARBASES) UNTIL SUCH TIME AS THEIR OPERATION AND SUBSEQUENT DEPLOYMENT IS REQUIRED. IN THE CASE OF THE MENAHGAS, A LARGE (25 TO 30 VESSEL) FLEET HELD IN A STATE OF CONSTANT STANDBY WOULD BE LUDICROUS. HOWEVER, IN VIEW OF THEIR SIMPLER DESIGN (WHEN COMPARED TO THE DREADNOUGHT VARIATIONS), A SMALL (5 OR 6 VESSEL) TASK FORCE DISPERSED EQUITABLY THROUGHOUT FEDERATION SPACE IS SOMETHING TO SERIOUSLY CONSIDER. WITH THEIR EXTENSIVE SHIELDING (WHICH HAS HELPED REDUCE HULL VULNERABILITY BY ALLOWING GREATER ENERGY DISPERSION) AND AN IMPROVED (THOUGH EXPERIMENTAL) PHOTON TORPEDO SYSTEM, THE MENAHGAS WOULD COMBINE FORMIDABLE FIREPOWER WITH THE SPEED AND MANEUVERABILITY OF A CLASS 1 STARSHIP-OF-THE-LINE."

EXCERPTED FROM INTERSTELLAR DEFENSE REVIEW, VOL. XXVII, NO. 7, "TRENDS IN FLEET DEPLOYMENT"
VADM JAHN T.L. COE (RET), VICE CHIEF OF STAR FLEET OPERATIONS (PLANS, POLICY & OPERATIONS)

The following excerpt is from Rear Admiral Dys Sy Sejkh's article in the same periodical, and is indicative of the position held by many of those opposed to the Menahga project.

"THE MENAHGA CLASS BATTLECRUISER, ON THE OTHER HAND, IS A MYSTERY. WHY, IN A FLEET DESIGNED PRIMARILY FOR DEFENSE AND EXPLORATION, IS THE [MILITARY STAFF] COMMITTEE CONSIDERING PROVIDING FUNDS FOR WHAT EVEN THEY HAVE TERMED A 'BATTLECRUISER?' THE DESIGN, ON THE SURFACE ANYWAY, IS MOST SIMILAR IN COMPOSITION TO THE CURRENT DREADNOUGHT DESIGNS (RE: ASCENSION, FEDERATION & KOMSOMOLSK DREADNOUGHT VARIATIONS), AN OBVIOUS FLAW SINCE THE SERVICES OF THOSE VESSELS HAVE BEEN OPENLY SCORNEED BY ALL BUT THE MOST OUTLYING MILITARY COMMANDERS. AS FAR AS COST IS CONCERNED, BEST ESTIMATES PLACE THE MENAHGA PROJECT AT ONLY SLIGHTLY LESS EXPENSIVE THAN ANY OF THE DREADNOUGHT PROJECTS (167 BILLION CREDITS AS OPPOSED TO 173, 198 AND 214 BILLION, RESPECTIVELY). INDEED, THE ONLY THING THE MENAHGA APPEARS TO HAVE GOING FOR IT IS ITS 'WARP DYNAMIC' DESIGN. HOWEVER, EVEN THAT CLAIM IS COMING UNDER FIRE FROM SOME RESPECTED SPECIALISTS."

EXCERPTED FROM INTERSTELLAR DEFENSE REVIEW, VOL. XXVI, NO. 3, "ADVANCED STARSHIP DEVELOPMENT"
RADM DYS SY SEJKH, STAR FLEET SYSTEMS COMMAND, OFFICE OF THE CHIEF OF STAR FLEET OPERATIONS

Sejkh's reference to the "outlying military commanders" and their propensity for requesting the services of the dreadnoughts is somewhat exaggerated, and refers mainly to the few incidents of armed incursion which have occurred in recent years. His statements about the Menahga, however, are completely accurate.

Alternatives to the Menahga design are numerous, but the only one which seems to be receiving any serious consideration is a concept called Project ADREFT. This plan would utilize the basic characteristics and dimensional ratios of Avenger class heavy frigates (ADREFT is an acronym for Avenger Design Refit) to form a somewhat larger vessel with greater firepower, equally impressive warp geometries, and definitive 'battlecruiser' capabilities (i.e. the ability to move quickly to a battle situation, engage enemy units without the assistance of support vessels, and remain on station for an extended length of time). The possible addition of a third warp nacelle between the two primary units has also been considered (see Avenger class drawings for reference)■

Fshynda Fa'a'Aren is a native of the Sardat Tar outpost of Andor (Epsilon Indi). She served in Star Fleet for six standard years before entering the Rischet Sodoa of the Andorian space forces. She is currently a senior member at the Marararet Futurist tank.

HEAVY FRIGATE

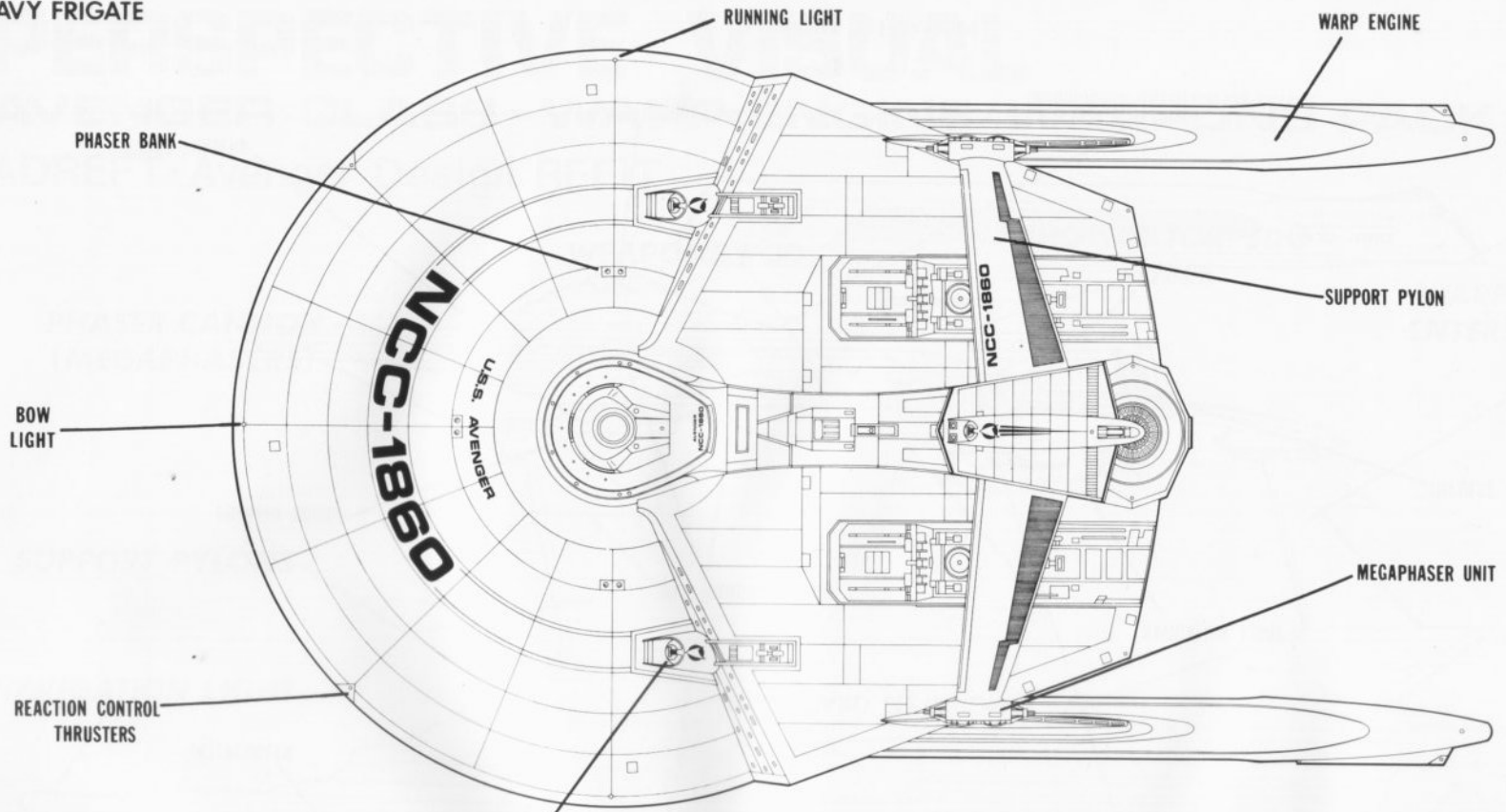

TOP PLAN

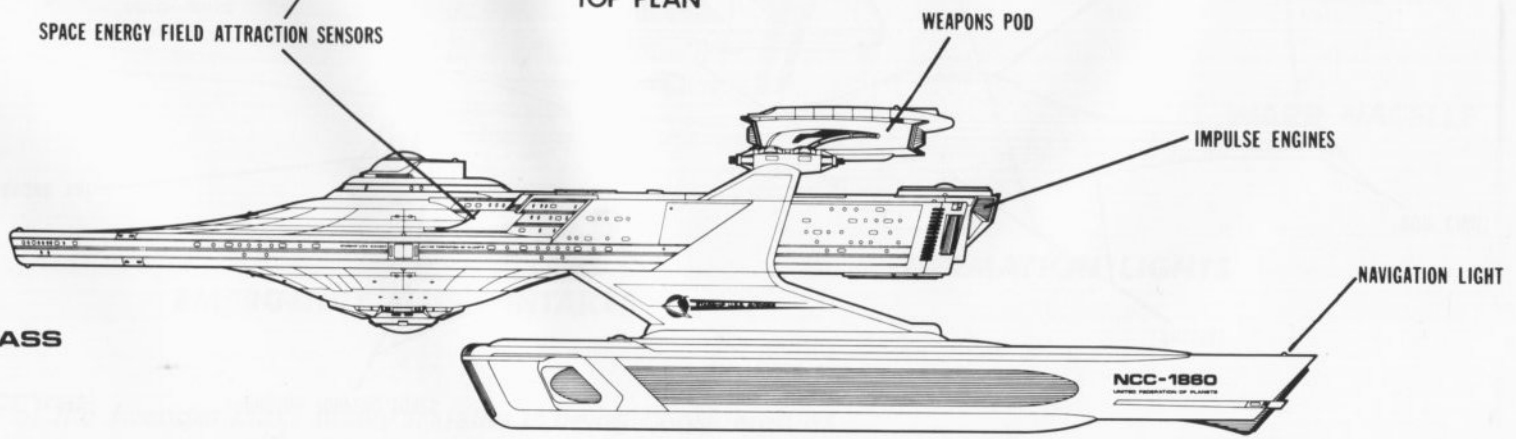

PORT ELEVATION

AVENGER CLASS

LENGTH	234.9M
BEAM	141.7M
DRAFT	58.2M
TONNAGE	150,000

AVENGER CLASS
HEAVY FRIGATE

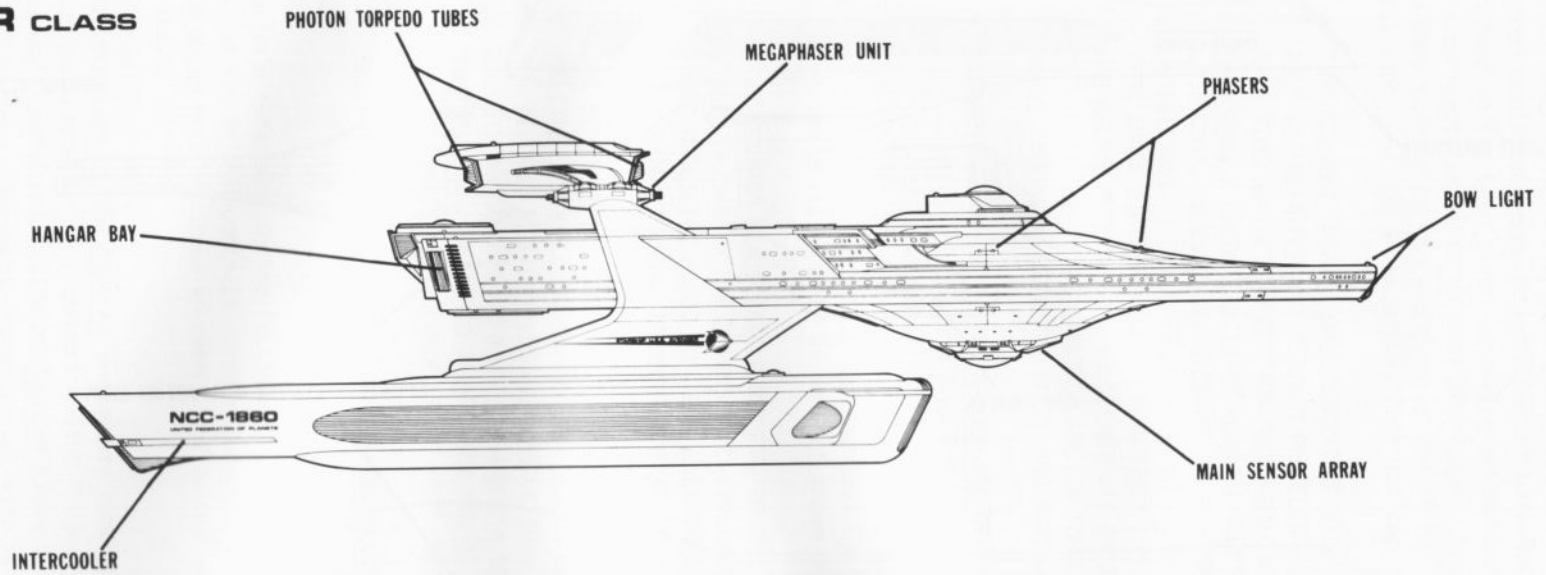

STARBOARD ELEVATION

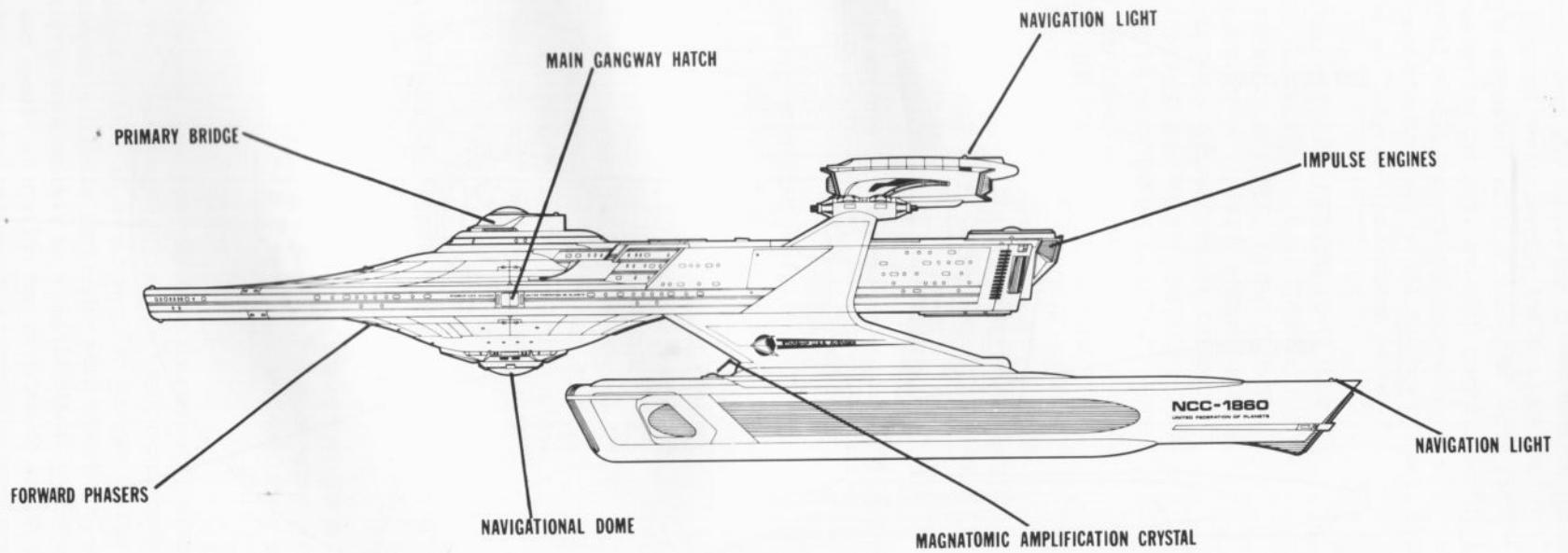

PORT ELEVATION

PERSPECTIVE VISUAL

AVENGER CLASS - WARP ENGINE/WEAPONS PACKAGE

ADREFT-Avenger Design REFiT

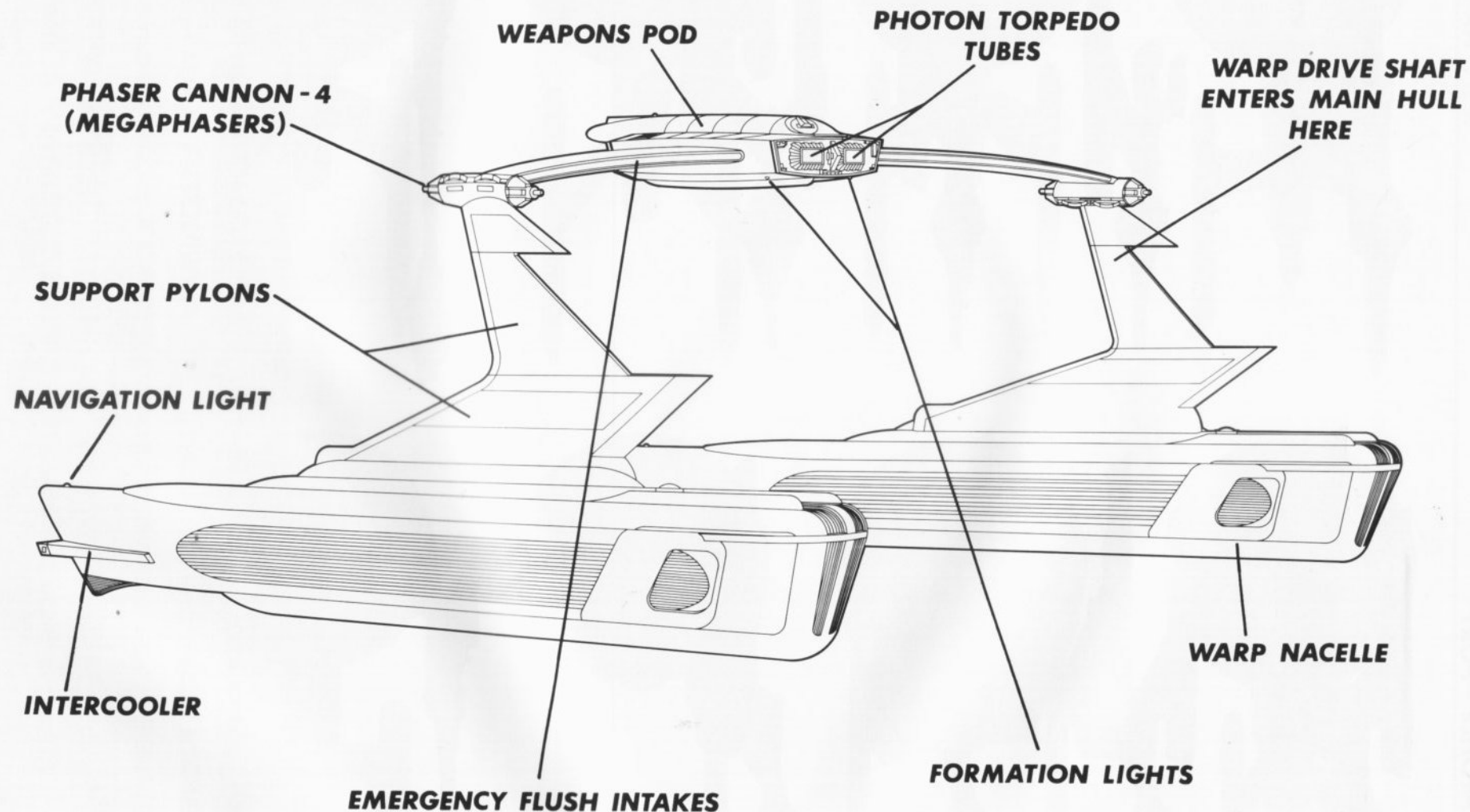

This configuration of the Avenger class heavy frigates is being considered as the basis for the larger, more sophisticated Project ADREFT. It is shown here without the main hull for reasons of clarity.

Avenger class
NCC-1860-1881 FG

RECOGNITION SILHOUETTES

OUTBOARD PROFILE - PORT



Klingon Fleet units



FEDERATION CLASS DREADNOUGHTS

ASCENSION CLASS DREADNOUGHTS

ENTERPRISE CLASS HEAVY CRUISERS

BELKNAP CLASS CRUISERS

K'T'INGA CLASS BATTLECRUISERS

MENAHGA TEST VEHICLE

AVENGER CLASS HEAVY FRIGATES

KNOX CLASS FRIGATES

FEDERATION (PRIOR TO UPRATING)

K'TEREMNY CLASS DESTROYERS

RECOGNITION SILHOUETTES

OUTBOARD PLAN VIEW

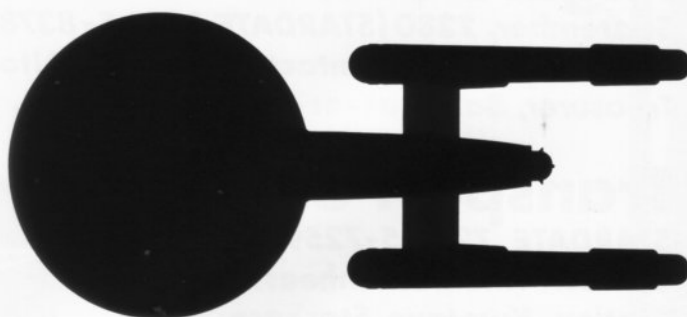
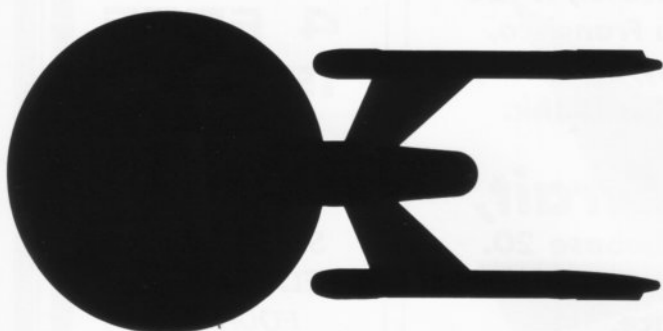
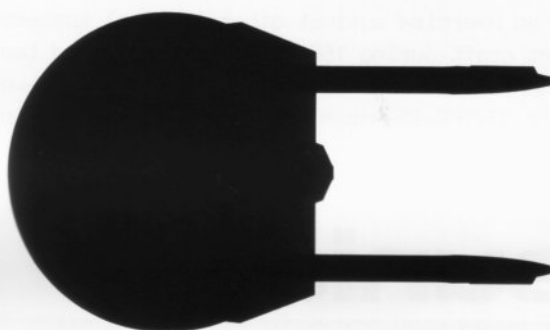
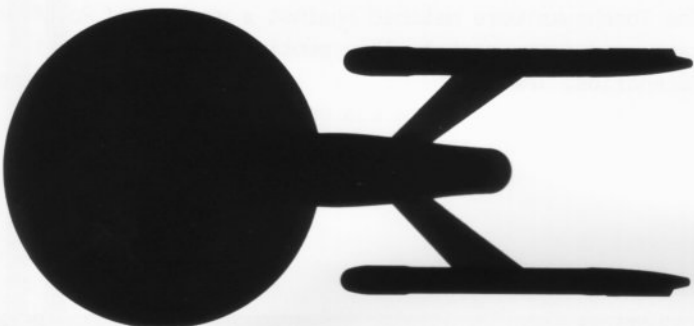
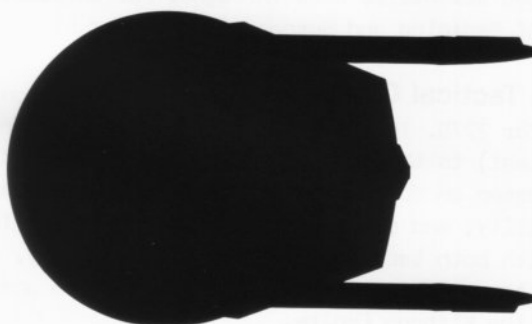
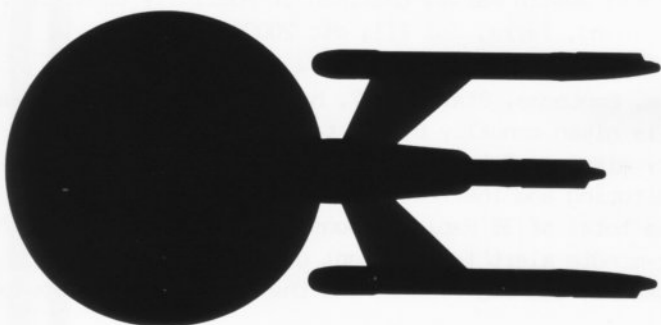
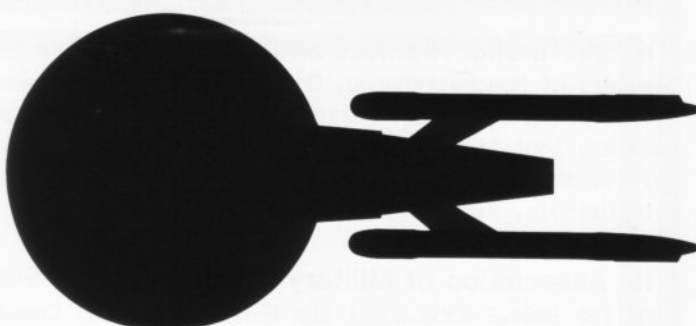
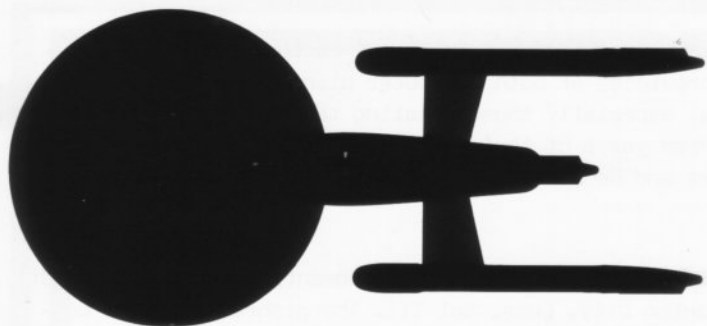

FEDERATION CLASS DREADNOUGHTS
ASCENSION CLASS DREADNOUGHTS
ENTERPRISE CLASS HEAVY CRUISERS
BELKNAP CLASS CRUISERS

MENAHGA TEST VEHICLE
AVENGER CLASS HEAVY FRIGATES
KNOX CLASS FRIGATES
FEDERATION (PRIOR TO UPRATING)

Observer

The Interstellar Archives and Records Service is seeking "ancient-" and "historic-categorized" data files on the wars of Maachatrehannu, Dngbaatannu and Ksalalawataak provinces of both the outer planet Yshnn and the inner planet Dstenna of the Dstennata star system. Any data files, especially those relating to psychological operations, tactics, logistics, third party observation and the last three years of their interplanetary war are requested. Parties should contact: Dr. Gan Retah, Interstellar Archives and Records Service (IARS), Ishm Historical krenn, Beta Orionis, Rigel IV, dtc 21867554gde.

The Association of Military Surgeons of the Star Fleet will hold its biennial convention from 7-15 August 2280 (SD 8354.2-8358.5) at the Peleidiades Planet Complex, Canton City, Luna, Sol III. The program includes continuing offerings in education for physicians, nurses, etc., research presentations, seminars on non-humanoid medical techniques, alien on-planet procedures, a Combat Medical Readiness Course, and numerous seminars on medically-related scientific breakthroughs. For information, contact: Justin Marss, Chairman of Publicity Committee, Department of Medicine and Surgery (A27), Star Fleet Systems Command, Terra, Sol III, dtc 20000503aa.

The 124th Tactical Combat Squadron of Station Rotterdam, Bentocha, Starbase 27, has won the Parten Achievement Award for 2279. The award, also known as the Partenplas, is given annually by the tactical division of Star Fleet (TacFleet) to the outstanding squadron assigned a primary mission of territorial and/or sectorial defense. Judging is based on operational performance (both computer monitoring and ineffective weapons scenarios), readiness capability, and other achievements. The 124th TCS keeps a total of 35 Rapid Response spacecraft (RRS), which are armed with both tactical and strategic weaponry, on a four-minute alert to intercept unidentified spacecraft penetrating the borders of Federation space. Such spacecraft usually emanate from behind the Federation's disputed border with the Klingon Empire.

Superior scanning and weapon systems capability assured dominance for eight F/C-10J Tomahawk fightercraft engaged in an exercise against other tactical spacecraft. The Tomahawks were matched against a variety of Pokofian and TacFleet craft during 1500 hours of simulated tactical and near-space combat. They routinely outmaneuvered their opponents, scoring heavily in numerous "dead-weapon" scenarios. The Tomahawks were successful in large part due to their TS/TEC-25 scanning systems, which gave pilots excellent spatial awareness upon entering engagements and helped them quickly acquire their targets. Rapier Dynamics Group builds the system for Star Fleet under contract to Lockheed Corp., Earth.

Reunions

Frigate USS Dun Tak (ASSOCIATION), 17-20 September, 2280 (STARDATE 8375.5-8378.4) San Francisco, California, Earth. Contact: Division A-Alton Pinley, Secretary-Treasurer, Bahmras-at-Stinn, New Paris, dtc 31446153hk.

Transport USS Makassar Strait, STARDATE 7255.5-7259.1, Pearrian Province, Starbase 20. Contact: Khahranamhees, Quartermaster Corps, Pennsylla Station, Kwotauc, Starbase 20, dtc 43000760mce.

Destroyer USS Patrekov, STARDATE 8381.4-8383.7, Starbase 14. Contact: D.S. Simpson, Vejarru City, Metroway, Texas, Earth, Sol III, dtc 76000413gg.

4 FREE ISSUES
ALL NEWLY
COMMISSIONED
OFFICERS IN
STAR FLEET ARE
ELIGIBLE FOR
FOUR FREE
ISSUES OF
STARSHIP
DESIGN

CONTACT: MEMBERSHIP SERVICES

HEADLIGHTS • LINTAS • ASCENSON • FREIGHT

WASAR • DROVER • CARRALLI • FROSTENT • DUMAY
BYME • SELWANE • EDENTAY • AGU • HELEA • SHU
BRILLANT • KANARO • DEBATION • KESLA • BOXER • WIL
KEESE • RAMSAY • VERTI • DESTROYERS • MINIO • AIA
MIRAMON • REBOUTON • NELSON • PEFELIS • LYANDE
BRAKE • DE PLUYER • ADARFALO • TAY • APES • SHATA
LIMAN • TAMERLANE • CESTEV • SEMVES • MOFL
ARON • DALLAS • FLAT • ROUSE • UNALI • KAPSAF
BECUTS • NAEVIN • MONACHON • BADER • COLN • ARE
HAY • CLAP • DIANA • APHILS • TRANSPORTS • VOTE
LANTA • REYAL • BELSHATTAR • SATLRA • MATHIA
KOHAMBEAU • MEROS • BLOPPY • DAMONIK • ROY
RIS • FREYER • TOWEALSH • BEFFA • CLIPPER • PE
TROVA • HERPES • WELCH • EIKENH • MAMATI
THE 97 AIRCRAFT VESSELS AND FOR LIBERTY SHIPS

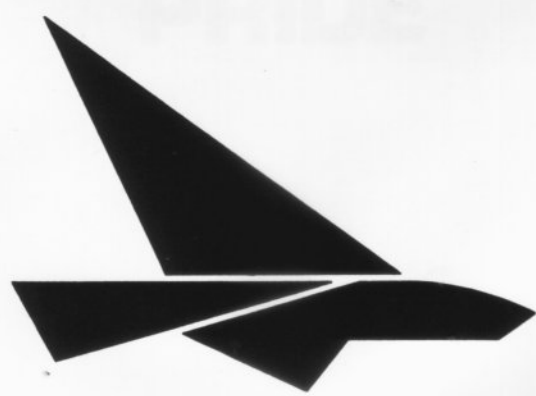

DEVON-AURORA
PUBLISHING CONSORTIUM

Observer

*Mama always told me not to look
into the eyes of the sun,*

But mama . . . that's where the fun is.

DREADNOUGHTS ▪ UNIFICATUM ▪ ASCENSION ▪ FEDERATION
THROUGH-DECK CRUISERS ▪ CLEMENCEAU ▪ DEVONSHIRE
KIEV ▪ BENNINGTON ▪ ORISKANY ▪ CORONADO ▪ **FRIGATES**
POLONIUS ▪ HIPPOLYTA ▪ DARDANIUS ▪ ANTIPHOLUS ▪ AMIENS
BALTHASAR ▪ DROMIO ▪ CARRIACOU ▪ RESURGENT ▪ CONSTANT
JEN MIRI ▪ ASSURANCE ▪ COVENTRY ▪ NIOVI ▪ REGENT ▪ SHIVA
BRILLIANT ▪ KANARIS ▪ DURMITOV ▪ KESSLA ▪ BOXER ▪ RI SHIK
BREESE ▪ RAMSAY ▪ WAPITI ▪ **DESTROYERS** ▪ NIANTIC ▪ AJAX
MIRAMAR ▪ RESOLUTION ▪ NELSON ▪ PERSEUS ▪ LYSANDER
DRAKE ▪ DE RUYTER ▪ ALVARADO ▪ TYR ▪ ARES ▪ SHAITAN
AHRIMAN ▪ TAMERLANE ▪ DESTEFV ▪ SEMMES ▪ MORIUAI
LAPON ▪ DALLAS ▪ HUNT ▪ SEN SEN ▪ LINAEU ▪ KEARSARGE
SCOUTS ▪ NAISMIN ▪ MONAGHAN ▪ BADGER ▪ COLIN ▪ ARIES
LEWIS & CLARK ▪ DIANA ▪ AEOLUS ▪ **TRANSPORTS** ▪ VOGEL
CUANZA ▪ BENGAL ▪ BELSHAZZAR ▪ SATPURA ▪ MARTABAN
ROCHAMBEAU ▪ IMBROS ▪ RUDOLPH ▪ CHAMONIX ▪ HOYLE
ROSS ▪ DREYER ▪ TOMBAUGH ▪ REBER ▪ **CLIPPERS** ▪ FARS
TACOMA ▪ HERCULES ▪ WELCH ▪ ESKISEHIR ▪ MANHATTANET
PLUS 97 SUPPORT VESSELS AND 756 LIBERTY SHIPS.

**ALL BUILT WITH
PRIDE**

VICKERS SHIPBUILDING LIMITED
Spacecraft Division - Earth
DTC21799

SENSORS

SENSOR CONTACT 15 mark. 107.4
RANGE 1 727 320 KM
DESCRIPTION SPACE VESSEL

RESEARCH, DEVELOPMENT AND PRODUCTION
CAPABILITY BASED ON 130 YEARS OF EXPERIENCE

ERISTAFFE-ZYNN
DEFENSE & SPACE SYSTEMS DIVISION
SEBALDHASTA SENNIS 251 - DATATIC D 3870 GDH