

UNDERSTANDING

WARP DRIVE

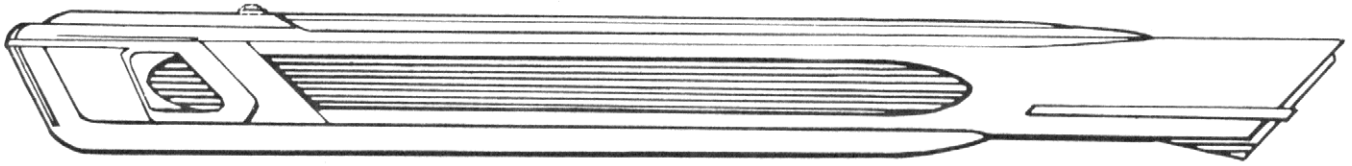

by Pete Rogan

Everybody knows how warp drive works. The Captain says, "Warp 3," the helmsman repeats it, and the ship slides up to 27 times the speed of light, the cube of the warp number.

But a *STAR TREK* gamemaster has to know more for a campaign. A gamemaster has to know (or seem to know) more about such details as how a starship moves from one place to another. For the dedicated gamemaster, here is a look at warp engineering, the construction of a warp engine, and some details on their little troubles.

The Basics

Warp drive evolved from a breakthrough in physics made at the beginning of the 21st century: the discovery of Artificial Gravity, or Magnatomics. The ability to manipulate gravity and create antigravity led Zefram Cochrane to discover the warp drive principle.

All objects with mass distort space via gravity. In a gravitational field objects in motion change their paths, light bends, and time slows down. Cochrane found the same holds true of 'synthetic mass' created by a strong artificial gravity field. Experimenting with antigravity to observe the effects of a synthetic antimass, he discovered that when a strong gravity field was generated in the same location as a strong antigravity field, they produced a unique distortion in space/time: a warp. A warp can travel through space faster than light, and when the antigravity field reduced the mass of the generator to about 0.001% of its original value, the warp could carry the generator and a good deal more with it.

When the first Cochrane warp drives were built, some basic elements were found to be true of all of them:

The energy needed to power a warp generator capable of carrying a starship is so great that only matter-antimatter annihilation, a tempermental and dangerous power source, can provide it.

A ship with warp drive 'bypasses' the speed of light by riding the warp at the edge of subspace, a hypothetical region just beyond normal space. The effect is characterized by some California warp engineers as 'star surfing'.

When a warp drive is engaged, it **immediately** propels a ship to the speed of light. A ship must be very close to this speed at the time of warp initiation in order to prevent tearing the vessel apart. Magnatomic fields were found to be necessary in warp driven ships to cushion the crew against this acceleration.

The smaller the remaining percentage of a ship's mass left by the drive, the faster the ship will go, to a theoretical limit of zero mass at Warp 15, 3375 times the speed of light.

The large gravity generators needed to balance against the antigravity generators make a warp-driven ship fantastically heavy with synthetic mass. The larger the mass that needs to be removed, however, the finer the control over speed.

The ship, even though moving faster than light itself, can still receive normal light and radio waves—very badly distorted, of course. Computer rectification cures this effect, and allows crews to see outside their ships at warp speeds.

The major problem with early warp drives was sublight propulsion. Years passed before reliable impulse engines could get a ship up to and back down from warp speed in less than many hours. But warp drive had many advantages. It could collect matter and antimatter from space via magnatomic fields, literally never running out of fuel once engaged. Warp engines were also simple to build, easy to navigate and steer, and most importantly, they opened the stars to the people of Earth.

Over the years several advances were made to improve on the warp drive:

A warp was created to carry a message, as opposed to a ship, at Warp 15. Subspace radio was thus created to link worlds together more efficiently than by ship-borne mail.

Dilithium crystals, not found on Earth, act as natural lasers in the presence of great energy, making splendid conduits for the power needed to run warp drives, thus superceding the old-style magnatomic fields. Larger and faster ships were now possible.

More precise controls, and a better theoretical understanding of the warp principle, reduced the dangers from uncertainties in design and the weirdly distorted environment of warp flight.

Some drawbacks were also discovered. In regions of space poor in interstellar gas and dust, warp engines cannot maintain high speeds. Large scale gravity events, such as gravity waves from the galactic core or a more localized disturbance, can also prevent the drive from functioning; or even cause a catastrophic accident. If two engines are in close proximity to each other, as in the case of a dual-drive ship, one engine may tend to produce irregularities in the warp of the other. Multi-engine ships thus have to be carefully tended, tuned, and balanced.

But in spite of technical difficulties, the warp drive became a popular instrument of interstellar travel, and nearly every race encountered by the Federation has used or adapted it to their own purposes.

Inside A Warp Engine

A warp engine, whatever its external appearance, always has six main parts:

- A. **The collector** projects a magnatomic field ahead and on all sides of a ship's course, drawing matter and scarcer antimatter, usually hydrogen, towards the engine.
- B. **The matter-antimatter seperator** sorts out the two kinds of matter and begins to heat them to plasma temperatures, the better to make them react.
- C. **The intermix chamber** where annihilation of matter

and antimatter produces energy, heat, and radiation. A lot of energy, heat, and radiation.

D. **The energy ducting system** uses dilithium and backup magnetic fields to channel energy from the intermix chamber.

E. **The warp generators** create the huge gravity and antigravity fields that cause the warp around the ship.

F. **The cooling system/matter dump** vents waste heat and surplus matter from the engine back into space.

Originally warp engines used a great deal more matter than antimatter for power, with ratios as high as 50 to one. They produced a great deal of heat which was difficult to dispose of. Current warp engines use a one-to-one matter/antimatter ratio, venting 90% of the matter collected through the cooling system. A warp engine leaves behind it a stream of highly ionized hydrogen, which cools rapidly but leaves a tell-tale trail that sensors can trace. Such a trail becomes too faint to detect after about 24 hours.

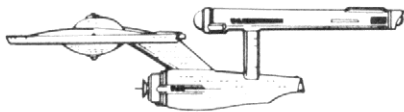

Normally, automatic controls monitor an engine's performance, but for each of the six main components the Engineering deck has readouts and manual controls. If, say, the engine were running a little hot, the collector's field could be expanded to channel more matter through the cooling system to dump more heat. Engineering also monitors and controls two other important warp engine features:

The secondary engine power source provides the energy needed to heat an engine from cold shutdown to normal 'hot' operating status. This is usually a 30 to 60 minute operation, and engines are only put on cold shutdown for extended port calls or emergencies.

The warp engine automatic monitoring system itself. If an engine says it is running hot when actually and it is not, the engineer had better know about it before something unfortunate happens. The monitors on the automatic controls say if they are working correctly or not, giving backup readings on all the engine functions. If the automatic controls fail, the engineer may have to handle their functions manually until repaired.

A vessel with two engines has the additional task of keeping them balanced. Because warp drive depends on very precise control of a ship's mass, an error, no matter how slight, can possibly cause one engine to go several times the speed of light faster than the other. This can be very messy. **The warp balancing controls** permit fine-tuning

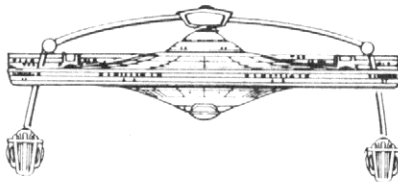

the engines to keep them rock-steady.

The problem of balancing three or more engines is too complex to resolve with present 23rd Century technology. Adjusting one engine usually causes at least one of the other two to go out of synchronization. Another breakthrough in design is needed before triple engine ships become practical.

The Engineering deck also contains the impulse engines and the auxiliary reactor for ship power. Many Star Fleet vessels also have batteries as a third power source. In warp flight power may be tapped from the warp engines, but it is easier and safer to use other sources.

More modern ships, such as the updated *Enterprise* (and the new *Excelsior*) have a more sophisticated energy ducting system that leads from the warp engines to the impulse engines and ship's phasers. This ducting system uses much more dilithium, but provides enormous power to weapons and sublight propulsion units. It also makes all of these systems dependent on how the warp engines are functioning; if they go out, so do the other systems. Impulse engines will still function, but at a much reduced efficiency level. In such a drastic situation it makes little difference that the other systems quit: without warp drive a ship cannot run very far very fast anyway. Starfleet believes the extra power made available under normal operating circumstances make this vulnerability an acceptable tradeoff.

Warp Engine Problems

No known warp drive can exceed Warp 15. At that speed the ship's mass, 190,000 (mostly synthetic) tons for the *Enterprise*, is reduced to zero. Warp theory states that a ship above Warp 15 either travels infinitely fast, or is destroyed: it leaves space completely, perhaps to be lost in subspace. Yet alien vessels have been reported with higher speeds, and the Medusans are sup-

posedly working on a means of navigating beyond Warp 15 (purely as a theoretical thing, of course).

Warp drives are subject to a lot of phenomena invisible to human senses, such as gravity waves and energy fluxes, strong magnetic fields, and even the warp created by other engines. Anywhere mass is changing or energy flowing, a drive will react poorly to it. These events are, fortunately, rare and easily detected by sensors. A more common and maddening problem occurs with tidal forces. If a ship, especially if it has two engines, is too close to a too-massive object, it may not be able to initiate warp. The problem has been noted between two close planets, moons, or other large bodies. If a ship is between two or more gravity-producing objects the difference in gravitational pull can be sufficient to unbalance even the most carefully tuned engine.

Warp engines, even in cold shutdown, often store enough antimatter (a tenth of a gram or so) to initiate warp. Once at warp speed the collector keeps replenishing the supply. A warp engine is built with safeguard upon safeguard to make sure that antimatter never gets away and causes a disaster. Even if an engine is destroyed, the antimatter capsule will slowly bleed off its contents into space, producing a flare but not a blast. Many spaceports that allow warp-driven vessels to land have laws regarding the tampering with antimatter on a planetary surface. Unless licenced and bonded to do warp engineering, such individuals may be subject to stiff fines or imprisonment. No one wants to be the neighbor of a cosmic catastrophe.

Most warp problems happen in the engines themselves, from damage suffered or parts simply wearing out. For the gamemaster who wishes to make the engineers life a little more hectic, roll 1D10 and consult the following table for a random breakdown:

Run-of-the-mill Warp Engine Malfunction Table

1. **Collector Failure:** The engine is not getting enough matter and antimatter, or it may be getting too much and fouling the cooling system. Sometimes the field just sticks at a particular setting and will not expand or contract. Once in a while they pull larger objects toward the engine: asteroids, debris, people in spacesuits, or even shuttlecraft.
2. **Matter-antimatter separator failure:** The drive becomes erratic and suffers surges or sudden lulls. In 90% of these incidents, automatic overrides shut the engine down completely, causing

dropout (see below). The drive may also dump all the plasma fuel it contains in a brilliant and dangerous flare. Less frequently it suffers a 'clog,' causing an explosive blowout in 1% of all separator failures. If this happens, the engine is inoperable until repaired at a base or shipyard.

3. **Intermix chamber failure:** This is the worst possible malfunction because the chamber is the heart of the warp engine. Ninety percent of the time the safety overrides will shut the engine down, once again causing dropout. If it does not, things get nasty. The chamber could rupture, spilling hot, radioactive matter into space or the interior of the ship. It could also explode. Fortunately, only one in a thousand chamber failures result in a ship-destroying blast.

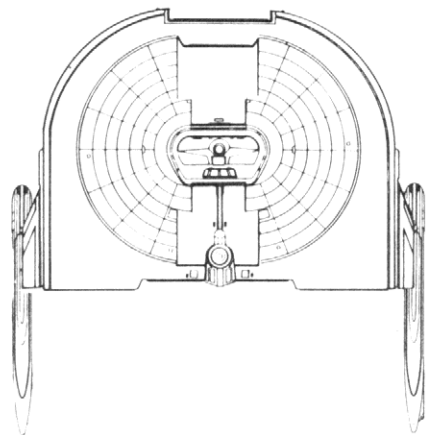

4. **Energy ducting system failure:** The famous dilithium crystal burnout. The ship slows, though energy output remains high and may even suddenly increase. Usually ducting failure is just a misalignment or minor component failure, but if large degrees of speed or power have been recently demanded of the engine, it could be the dilithium. Roll 1D10; a result of 2 or less means at least one dilithium crystal has burned out. If so, roll 1D10 again; a result of 10 means two crystals have blown. For each crystal lost, the engine's power drops by 10% until a base or shipyard can replace them. Ships rarely carry spares, due to the expense.
5. **Warp generator failure:** The ship's speed may reduce suddenly. Oscillation may begin, or the ship may drift sideways. Once in a great while a generator may suddenly switch gravitic

polarities, resulting in a warp hop or dropout (see below). A ship can still maintain warp speed with a generator or two out, but engine efficiency is severely reduced. In a dual-drive vessel, generator failure will necessitate the undamaged engine to be throttled back in order to match the weakened power output of the damaged drive. Engine power is reduced 2D10% per failure.

6. **Cooling system/matter dump failure:** This is the most spectacular malfunction of a warp engine. Internal temperatures may rise sharply, causing the entire engine to shut down. There may be a massive flare of hot gas from the drive exhaust, or worse, from one of the intercoolers on the external side hull. If the system clogs entirely, the engine will have to be shut down and flushed, either in space or in dock. A cooling system flareout has been described as looking "like a star trying to crawl into the nacelle." People not prepared for the sight can be scared out of their wits; the flare is very bright and often miles in length, though not as dangerous as a separator or intermix chamber flare.

7. **Secondary engine power source failure:** A minor but irritating problem. A warp engine cannot be started until the secondary source is fixed. If the ship is in warp flight nothing happens, but as soon as the ship drops out of warp it will not reheat until repaired. (Note: Starfleet vessels can use impulse engine power or auxiliary reactors in such a situation, but only by shutting down nearly all other power use.)

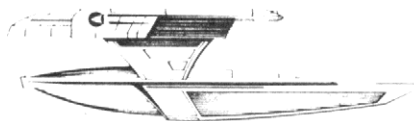

8. **Warp engine monitoring system failure:** Under this condition the Engineering readouts indicate everything is normal, but the automatic systems are reacting to a problem. The engineer will have to manually take over until the fault is traced. Reroll on this table for the false failure; ignore a roll of 8 or 9.

9. **Engineering readout failure:** The automatic controls are working normally but the Engineering indicators say something is wrong. Same effects as above.

10. **No bloody reason failure:** The ship rocks, the power drops, the control board goes crazy, but no cause can be found. Eventually it goes away by itself. Nobody understands **everything** about warp drive. Reroll on this table for a specific component to blame.

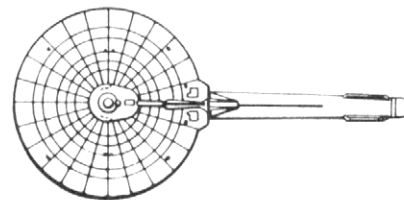

Repairing Failures

Roll 2D10 for the number of hours it will take for repairs. If a 20 is rolled, roll 4D10 instead. The engineer can roll on Warp Drive Technology skill to attempt to reduce the time. A successful roll shortens repair time by 1D10 hours, to a minimum of 1 hour. A roll of 05 or less, regardless of skill level, repairs the engine in less than one hour. ("Just a loose wire, Cap'n!")

These are the most common warp engine problems. Sometimes the trouble is much more spectacular and frightening. For gamemasters who wish to plague crews with major warp engine problems, roll 1D10 and consult the following table:

Major Warp Engine Malfunction Table

1. **Warp non-initiation:** Near unstable planetary or stellar bodies, too close to too massive an object, in the grip of an artificial gravity or antigravity field, or as a result of tidal stress, a ship's engines may just refuse to come on. The usual solution is to move farther away from the disturbance. If the impulse engines are working, and if the ship can move against the gravity pull, and if there is time to get away at sublight speed, this situation is nothing more than an annoyance.
2. **System superclog:** Warp engines will accept nearly any kind of gaseous matter in space for fuel. In regions of extremely

thick gas and dust, such as nebulae or planetary atmospheres, so great a volume of material can be received that the engine simply clogs everywhere at once, in the collector, separator, and cooling systems particularly. Unless an engineer is very sharp or warned ahead of time to cut back the collector fields, the engines will superclog and shut down. 4D10 hours will be required to flush the engines before they will work again.

3. **Contamination:** A ship that remains too long in too low an orbit or on a planetary surface, or fails to completely flush a clogged engine, may suffer degraded performance from contamination. Roll percentiles for the amount of power lost from a contaminated engine. Repair as any other malfunction.
4. **Warp lock:** The ship begins to accelerate, sometimes by itself, and will not stop. Cold shutdown of the engines will stop warp lock in 1D10 minutes, but the ship may suffer a malfunction due to stress before the lock is corrected. Roll 1D10 again, if the second roll is smaller than the first, then in that many minutes something else blows, stopping the warp lock. Repair the breakage as for any other malfunction.
5. **Wormhole:** The ship cannot turn, cannot decelerate, and anti-surge fields squeeze the crew, reducing their DEX and movement rates by half. The ship seems to be accelerating down a ribbed shaft (hence the name), and anything moving within the ship shows the same effect, distorting vision. Only total cold shutdown will stop the wormhole, taking 1D10 minutes. Repair afterwards as for any other malfunction.
6. **Dropout:** A sudden failure in the engine causes the ship to *immediately* drop out of warp flight, to a speed of about 99% the speed of light. Depending on how fast the ship was going, the deceleration could be merely uncomfortable, to damaging, to crushing. Above Warp 6 a ship that drops out will be lucky to make it in one piece. Roll 1D10; if the number rolled is equal to or less than the warp number, the ship suffers engine stress equal to the roll of the die. Repeat for superstructure stress. It will take 1 hour for each point of

damage to be repaired, unless the damage exceeds the number of points the ship has to lose. If the engine stress points are exceeded, the engines are unusable until repaired at a base or shipyard. Lastly, if the superstructure stress points are exceeded, the ship is a crumpled ruin when it goes sublight.

7. **Warp hop:** Also known as warp skip and warp jump. At Warp 15, or very high emergency speeds, a ship's mass may momentarily flicker below zero. The ship makes a sudden translation to somewhere else in space, usually on its line of flight but a great and unknown distance away. The ship lurches, the stars go out, and strange, different stars reappear. Some ships have journeyed far beyond the Federation by accidentally warp-hopping, and then returned. Sometimes it has taken them years.
8. **Time disparity:** The ship suddenly gains or loses several minutes, hours, or even days, and the crew may not even notice it. Not actually time travel, the ship simply becomes 'dislocated' in time as a result of high speed, radiation, gravitational effects or space time discontinuity (see below). No one has yet run into themselves going into the past, but no one knows why not. Some ship disappearances may be as a result of large time displacements.

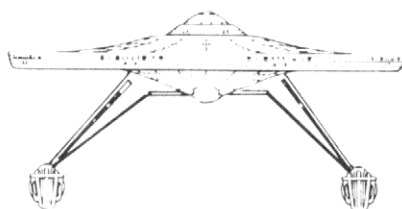

9. **Space/time discontinuity:** At times and in places, completely at random, the fabric of space begins to unravel. Distortion of natural laws take place, throwing objects into subspace, changing chemical reactions in the brain, accelerating the decay of the ship as if from extreme age, almost anything. These phenomena are not well understood, but they usually cause warp engines to act quite strangely. This may produce instantaneous movement from or

to the discontinuity, time disparities, or even dimensional projection (see below). Occasionally ships have been found stranded in such discontinuities, and have been known to reappear at intervals in widely-separated places, similar to the *USS Hood*.

10. **Dimensional projection:** A sudden power surge or gravity event can cause a warp-driven ship to leave this universe and arrive in some other one. Dimensional projection is the most fantastic and rare of warp engine accidents. By amazing luck and intelligence, some ships or individuals have been known to return from such different universes. The effect does not seem to be controllable, and virtually nothing is known of it.

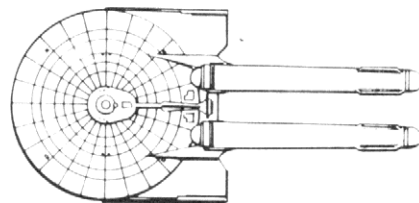

Warning: These severe events can radically change the flow of a campaign and could put the crew and your game under severe stress. Use them sparingly. Besides, too many breakdowns get very boring. Save them for a surprise.

Successful and interesting games rest on the detail and knowledge a gamemaster can draw upon to make a game intriguing, challenging and enjoyable. Hopefully, this primer on warp drive will help bring *STAR TREK* gamers a little more challenge and fun. Enjoy it, that's what it's for!

