

A supplement for use with
STAR TREK[®]
THE F.A.S.A. PLAYING GAME

FEDERATION

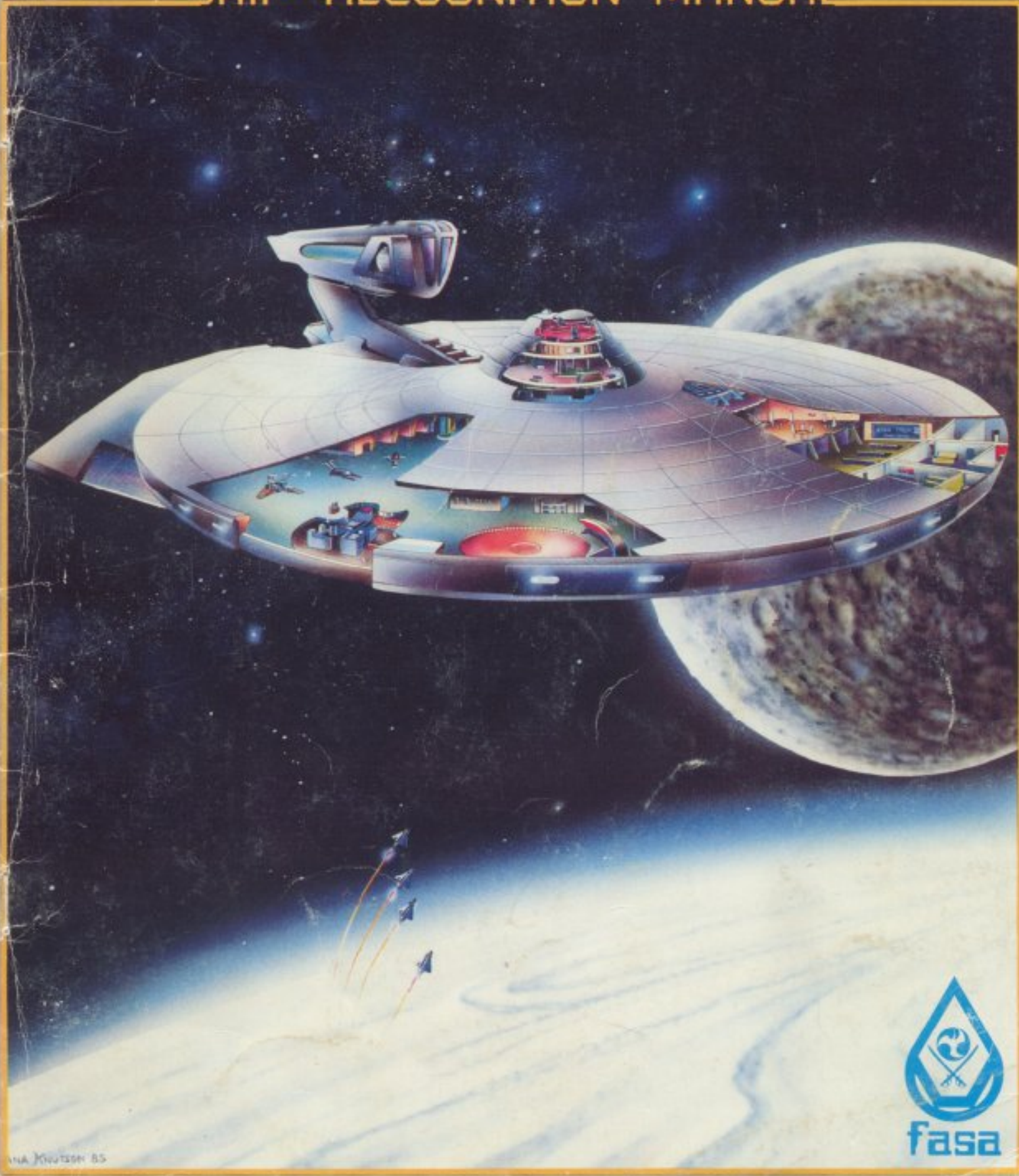

SHIP RECOGNITION MANUAL



Time Line Of Activ

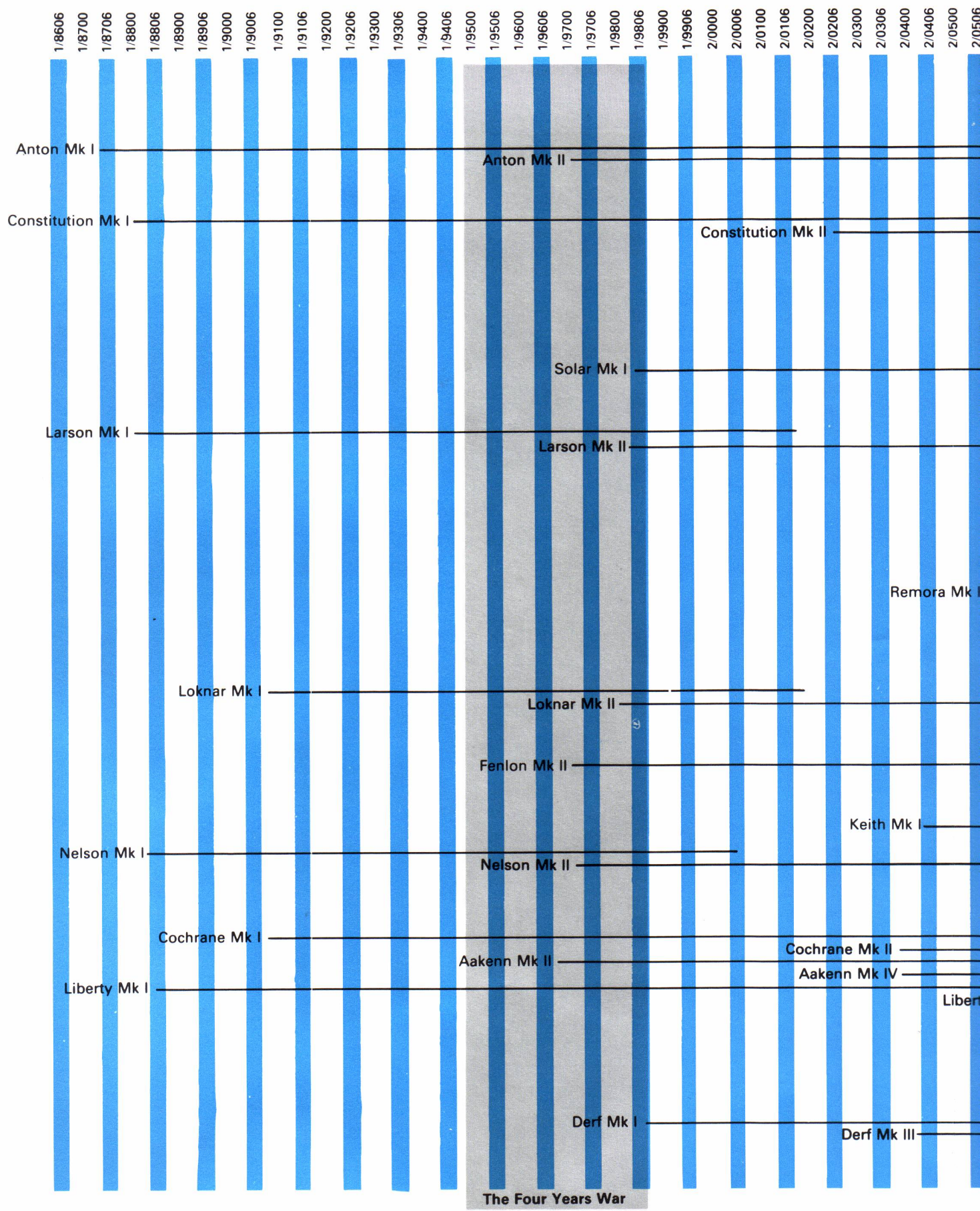

The Four Years War

Active Service Duty

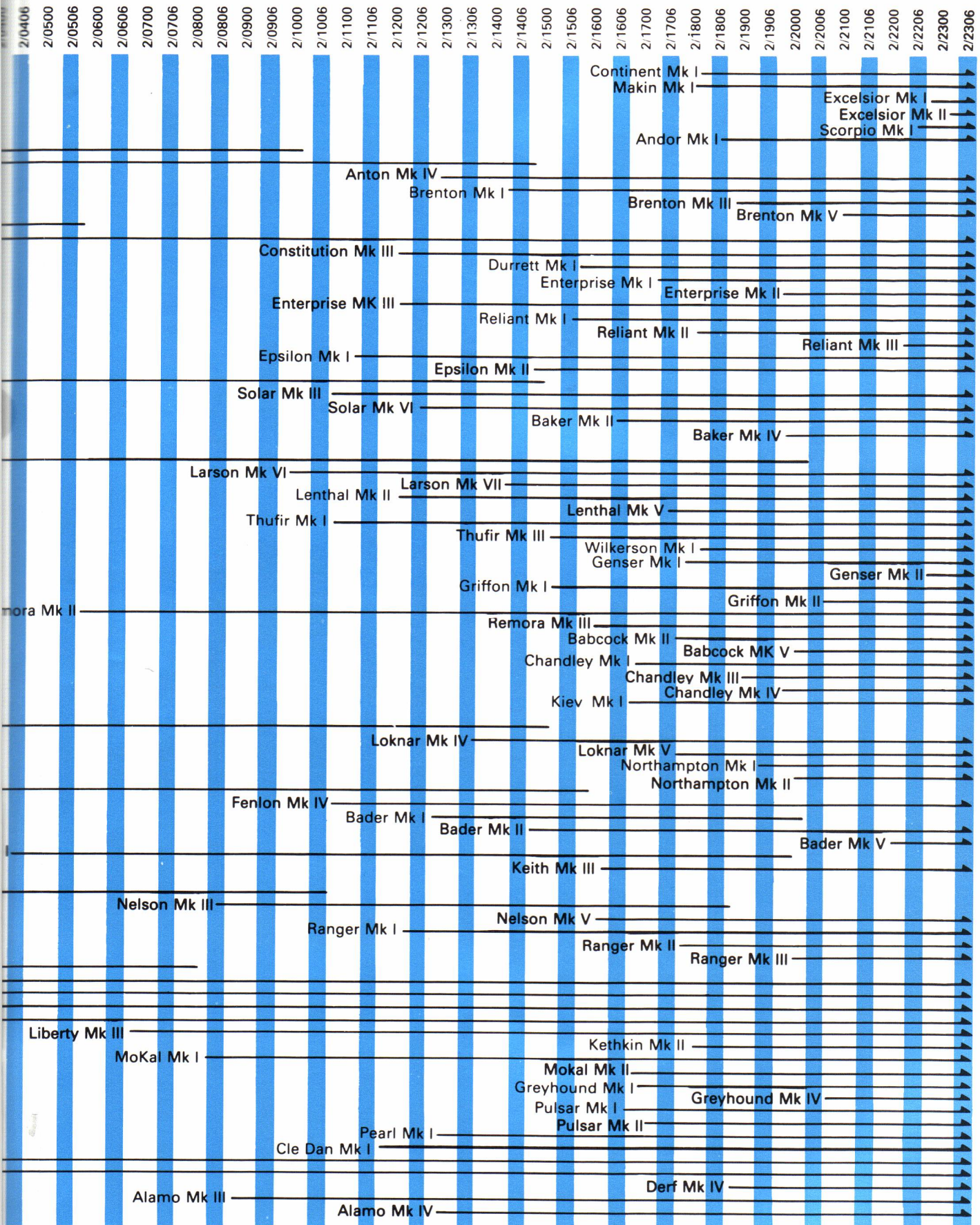

Federation Recog

**Constitution
Class XI Cruiser**

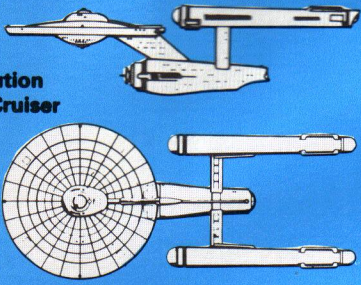

**Mo'at
Class X Transport**

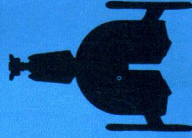

**Excelsior
Class XIII-XIV Battleship**

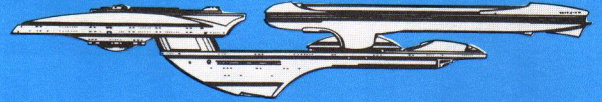

**Cle Dan
Class VI Repair Tender**



**Baker
Class IX Destroyer**

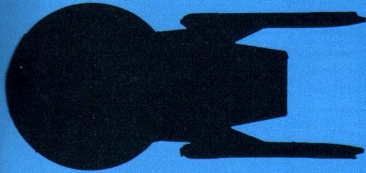

**Reliant
Class XI Cruiser**

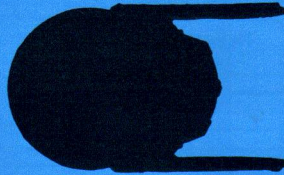

**Anton
Class X Cruiser**

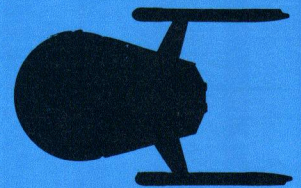

**Larson
Class VII Destroyer**

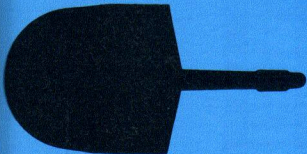

**Liberty
Class VII Freighter**

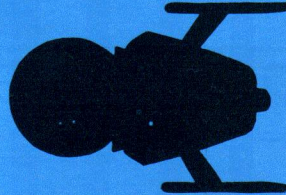

**Derf
Class Mk IX Buoy Tender**

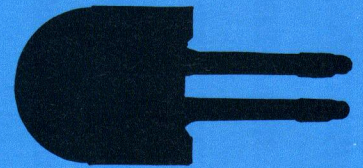

**Lenthal
Class IX Destroyer**

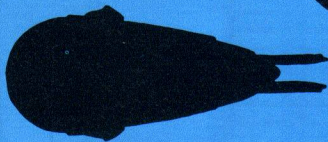

**Greyhound
Class I Warpshuttle/Courier**



**Babcock
Class XI Frigate**

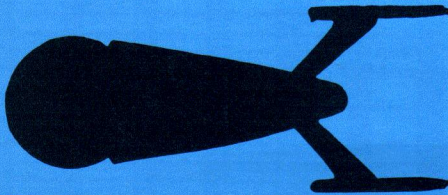

**Thufir
Class VIII-IX Destroyer**

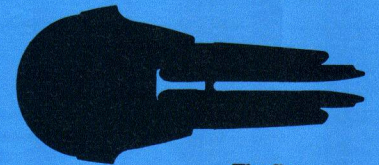

**Andor
Class IX Cruiser**

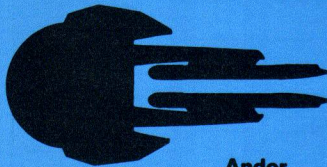

**Griffon
Class VIII Escort**



**Continent
Class IX Assault Ship**

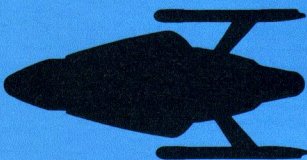

**Pearl
Class VII Mobile Repair Facility**

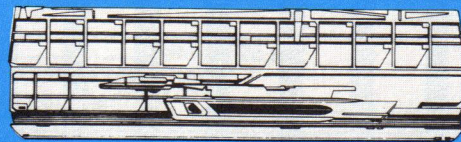

**Northampton
Class X Frigate**

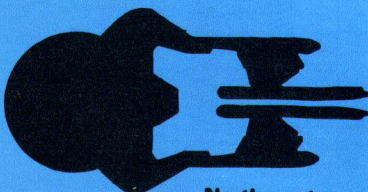

**Durrett
Class VIII Cruiser**

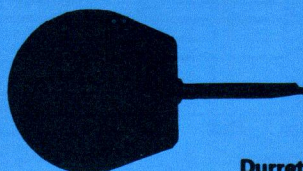

**Chandley
Class XI Frigate**

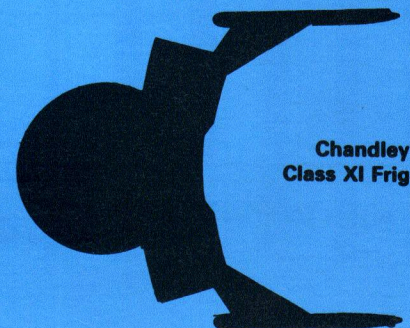

Cognition Silhouettes

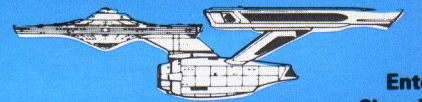

Enterprise
Class XI Cruiser



Solar
Class III Cutter

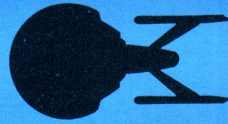

Makin
Class VII Assault Ship

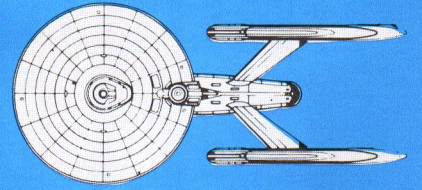

Epsilon
Class III-IV Cutter

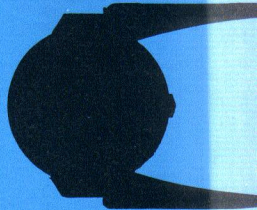

Bader
Class VIII Scout

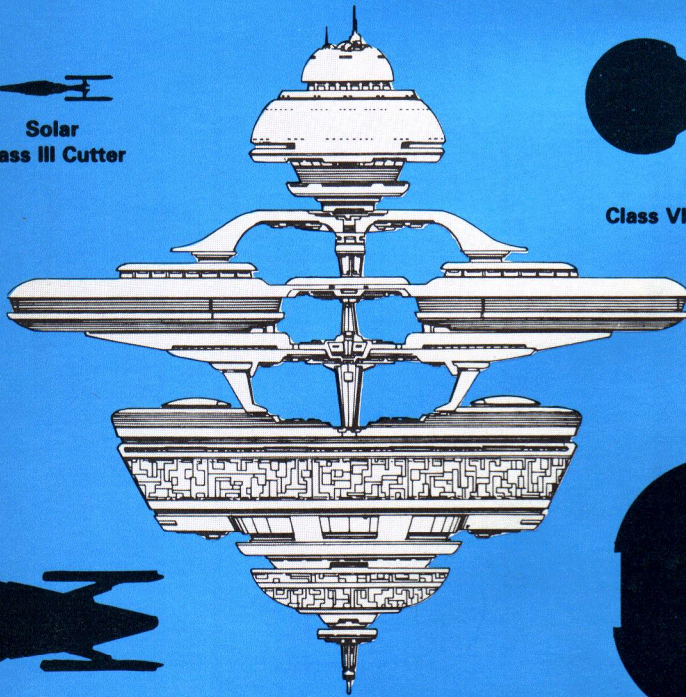

Keith
Class VI Scout

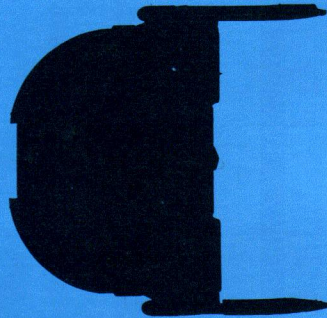

Brenton
Class XI Cruiser

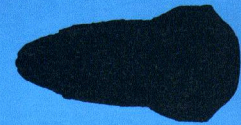

Aakenn
Class VI Freighter



Pulsar
Class II Warpshuttle

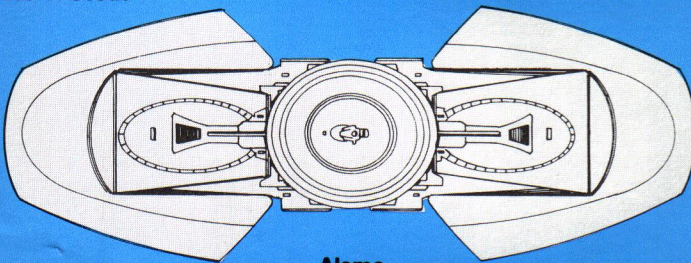

Alamo
Class Defense Outpost



Scorpio
Class II Corvette

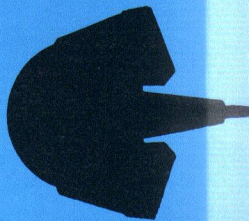

Remora
Class VI-VII Escort



Ranger
Class V-VI Scout

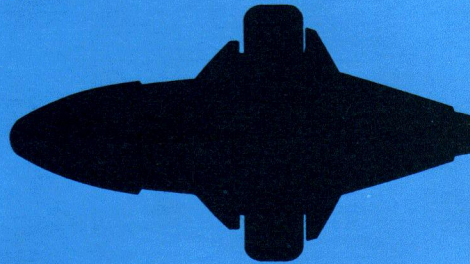

Cochrane
Class VI Colonial Transport

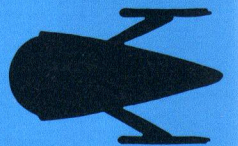

Genser
Class IV Escort

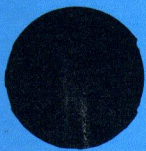

Fenlon
Class V Monitor

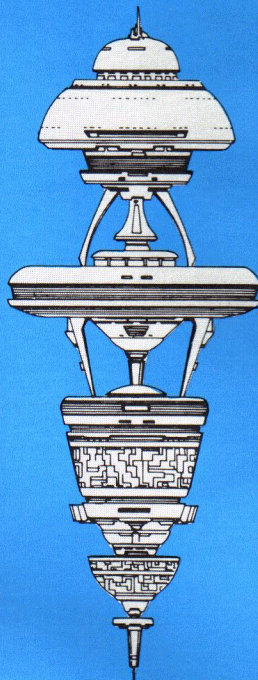

Kethkin
Class IX Transport

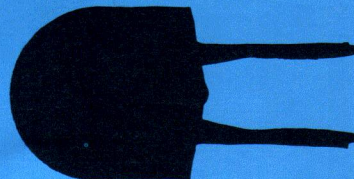

Kiev
Class XI Frigate

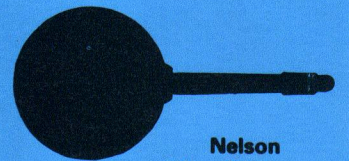

Nelson
Class VII Scout

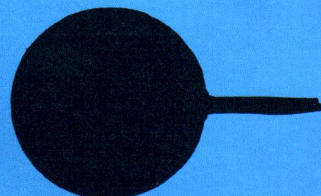

Wilkerson
Class IX Destroyer

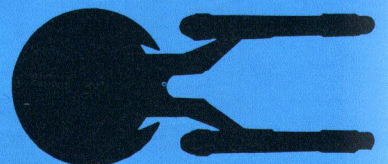

Loknar
Class VIII-X Frigate



CHANGES TO THIS MANUAL

Users of this manual are required to submit changes in the information in this publication pursuant to SFOPS. MAN. 307/A45T. Such changes or other comments regarding this publication must be keyed to the specific page, paragraph, and line of text in which the change is recommended. Reasons should be provided for each comment to insure understanding and complete evaluation.

Comments should be prepared using SFRD Form 2028 (*Recommended Changes to Publication*) and forwarded directly to:

STAR FLEET INTELLIGENCE COMMAND

Assistant Chief of Staff,
Military History Division
Austin, Tx, Terra 01.3

Unauthorized use, possession, or disclosure of the contents of this manual is strictly prohibited. All violations are treasonous acts against the United Federation of Planets. Failure to comply with directives regarding the use of this manual will result in life imprisonment, death or both.

Classified Documents Directive 998.21C

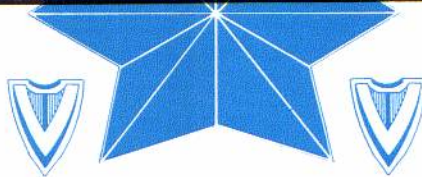

Introduction

THE ROLE OF STAR FLEET

Since its austere beginnings on Stardate 0/8910, Star Fleet has grown into the most powerful military, colonial, and exploratory force in known space. Its purpose is to defend the United Federation of Planets from its known enemies or any would-be invaders, to keep open all trade routes by enforcing the laws governing their use, and to explore, colonize, and develop frontier areas for the betterment of all. To this end, Star Fleet maintains a large and modern navy capable of meeting any challenge.

The following excerpt, from Adm. Josef Cookston's address to the Military Appropriations Committee, Stardate 2/2104, gives a portent of the future:

For more than 130 years, Star Fleet has been tested, re-tested, and never found wanting, but its supreme challenge lies ahead. With the quantitative military balance decidedly adverse and with the former qualitative edge increasingly in doubt, we can assume a favorable outcome in the event of war only by superior concepts, tactics, and leadership. We are desperately in need of a strategy not only for waging war, but for winning without war.

SCOPE OF THIS MANUAL

This manual describes the major ships of Star Fleet on a classified basis, providing an overview to authorized personnel and line officers. An effort has been made to provide a comprehensive and objective presentation despite the limitations of space. It is designed for general reading and quick reference.

A historical background of Star Fleet starships from the period of "The Great Awakening" to the present is provided. Discussions of all major ships include observations on their weaknesses and strengths, and complete combat data is provided for evaluation. The overall reliability of the data provided is subject to the level of classification authorized by Star Fleet Command. More detailed information on the performance characteristics of each vessel may be found in the operations manuals of those particular vessels.

FEDERATION SHIP RECOGNITION MANUAL

INTRODUCTION

The Role Of Star Fleet	1
Scope Of This Manual	1

COMBAT VESSELS

Assault Ships

<i>Makin</i>	3
<i>Continent</i>	3

Battleships

<i>Excelsior</i>	4
------------------------	---

Corvettes

<i>Scorpio</i>	5
----------------------	---

Cruisers

<i>Andor</i>	6
<i>Anton</i>	7
<i>Constitution</i>	8
<i>Enterprise</i>	10
<i>Reliant</i>	12
<i>Brenton</i>	14
<i>Durrett</i>	14

Cutters

<i>Epsilon</i>	15
<i>Solar</i>	15

Destroyers

<i>Baker</i>	16
<i>Wilkerson</i>	17
<i>Larson</i>	18
<i>Lenthal</i>	20
<i>Thufir</i>	20

Escort

<i>Genser</i>	21
<i>Griffon</i>	22
<i>Remora</i>	22

Frigate

<i>Northampton</i>	23
<i>Chandley</i>	24
<i>Loknar</i>	26
<i>Babcock</i>	28
<i>Kiev</i>	28

Monitors

<i>Fenlon</i>	29
---------------------	----

Scouts

<i>Nelson</i>	30
<i>Bader</i>	31
<i>Keith</i>	32
<i>Ranger</i>	32

SUPPORT VESSELS

Transports

<i>Cochrane</i>	33
<i>Kethkin</i>	34
<i>MoKal</i>	35

Freighters

<i>Aakenn</i>	36
<i>Liberty</i>	37

Warpshuttles

<i>Greyhound</i>	38
<i>Pulsar</i>	38

REPAIR VESSELS AND FACILITIES

Tenders

<i>Derf</i>	39
<i>Cle Dan</i>	40

Repair Facilities

<i>Pearl</i>	41
--------------------	----

Defense Outposts

<i>Alamo</i>	42
--------------------	----

RECOGNITION SILHOUETTES

Pull-out	43
----------------	----

TIME LINES

Pull-out	45
----------------	----



CREDITS

Design

Forest G. Brown

Writing

Forest G. Brown

Historical Consultant

Commander Hikaru Sulu

Editorial Staff

Editor-In-Chief

L. Ross Babcock III

Editing And Additional Writing

Wm. John Wheeler

Proofreading

Donna Ippolito

Illustration

Dana Knutson

Robert Oswald

Cover Art

Dana Knutson

Production Staff

Layout And Pasteup

Dana Knutson

Todd F. Marsh

Jane Bigos

Typesetting

Karen Vander Mey



[\(Click to enlarge back cover\)](#)

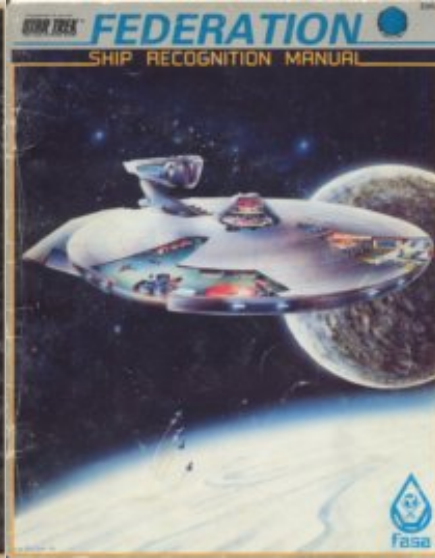

[\(Click to enlarge front cover\)](#)

CREDITS

Design: Forest G. Brown

Writing: Forest G. Brown

Historical Consultant: Hikaru Sulu

Editor-in-Chief: L. Ross Babcock III

Editing & Additional Writing: Wm. John Wheeler

Proofreading: Donna Ippolito

Illustration & Cover Art: Dana Knutson

Typesetting: Karen Vander May

Layout & Pasteup:

Dana Knutson

Todd F. Marsh

Jane Bigos

BRAD'S COMMENTS: The United Federation Of Planets and its Starfleet possess the most high-tech and powerful ships among all of the three major 'superpowers' in the old FASA game universe. Strangely, I don't think the FEDERATION SHIP RECOGNITION MANUAL is as well written as the KLINGON manual, and I also don't think the ship designs are quite as good. Mostly because the scaling seems all wrong to me. Very often it seems the illustrators just photocopied the saucer section and warp nacelles from a refit Constitution class (Enterprise class in the old FASA books) and then slapped a bunch of other hardware around that saucer & nacelles, and called it a ship, regardless of size or mission.

There are destroyers like the [Lenthal](#) or the [Baker](#) which ought to mass more than the [Enterprise cruisers](#), if the identical saucer and nacelles are supposed to be to scale. But too often the saucer and nacelles are *not* to scale, and I think it was dumb on the part of the designers to slap an Enterprise saucer and nacelles on a scout or an escort or a destroyer when these ships are clearly much smaller than the heavy cruiser that is the Enterprise. Another beef of mine is that the written text describes a total Starfleet that is horribly small compared to, say, the Klingons. Yes, the UFP does have better technology, and yes Starfleet's primary mission is still one of exploration, but the Klingon forces number into the tens of thousands of ships, while if you added up the entire Federation manual you'd get a Starfleet that amasses only a few thousand ships, at the most. This to me is not very believable, especially since we've seen Starfleet ship registry numbers in the tens of thousands. Where are all the rest of the ships?

Like all the old FASA manuals, this one was made thoroughly outdated by the TNG universe, as well as movies like **Star Trek VI** and **Star Trek Generations**. There was an effort to bring the UFP up to date with the introduction of the STAR TREK THE NEXT GENERATION OFFICERS MANUAL, but as with the older UFP recognition manual, just about every design in the TNG Officer's Manual is apocryphal, having little or no basis in the actual television program. I have included the TNG Officer's Manual ships in this section, however, since I consider those few ship designs to be an extension of the original UFP recognition manual.

Ships are listed below by their ship class. Click on the link to each ship and a window will appear giving a full graphic of the vessel, plus history and game stats. Vessel names that are *not linked* are vessels that I have not yet scanned in, but will be coming in the future. Enjoy.

P.S: I tried to scan each ship at as high a quality as I could, but the original format of the drawings in the manual makes this VERY difficult. The designers at FASA used an old b/w layout trick where the "gray" color that shades the ships is not gray at all, but thousands of tiny black dots on a field of white. The net effect viewed from afar by the human eye is that of 'grayness' but the scanner picks up every last dot and it takes a lot of softening/blurring and reduction via Paintshop to get the ships to look halfway decent. Even then, the images sometimes don't come out crisp. So if things seem a teeny bit fuzzy around the edges, or if the graphics don't look exactly as they did on paper, please understand that I did what I could with what I've got. In some lucky cases I have been able to find large-scale graphics from other sources for canon ships (like the [Constitution Refit/Enterprise](#) & [Reliant/Miranda](#)). These graphics produce superior scans when compared to the Ship Recognition Manuals, and I have necessarily replaced the poor FASA graphics with crisp, better looking images that have been cropped, resized, and shaded manually.

Cheers!



ASSAULT SHIPS



[Makin](#)

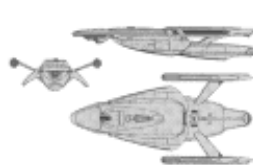

[Continent](#)



[Kolm-An](#)

[Jump to top of page](#)

BATTLESHIPS



[Excelsior](#)



[Excelsior Refit](#) *



[Federation](#) ***



[Royal Sovereign](#) (TNG)



[Sovereign](#) (TNG) *

[Jump to top of page](#)

CRUISERS

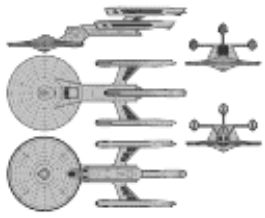

[Triton](#) **



[Andor](#)



[Anton](#)



[Constitution](#)

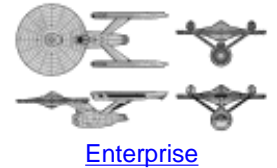

[Enterprise](#)
(Constitution Refit)



[Reliant](#)
(Miranda/Soyuz)

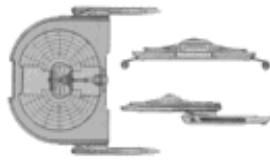

[Brenton](#)

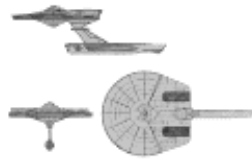

[Durrett](#)

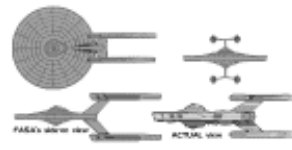

[Constellation](#) (TNG)



[Wellington](#) (TNG)



[FASA Ambassador](#) (TNG)



[Galaxy](#) (TNG)

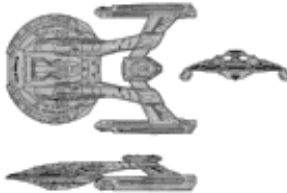

[Akira](#) (TNG) *



[Intrepid](#) (TNG) *



[Ambassador](#) (TNG) *



[Nebula](#) (TNG) *

[Jump to top of page](#)

DESTROYERS



[Firestorm](#) **



[Baker](#)



[Wilkerson](#)

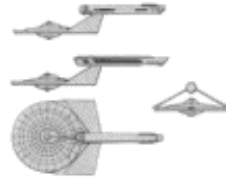

[Larson](#)



[Lenthal](#)



[Thufir](#)



[Decker](#) (TNG)



[Saladin](#) ***



[Defiant](#) (TNG) *

[Jump to top of page](#)

ESCORTS



[Genser](#)



[Griffon](#)



[Remora](#)

[Jump to top of page](#)

FRIGATES



[Cygnus](#) (TNG) **



[Thoth](#) **



[Northampton](#)



[Chandley](#)

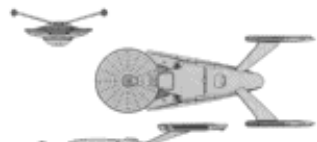

[Babcock](#)



[Kiev](#)



[Paine \(TNG\)](#)



[Loknar](#)

[Jump to top of page](#)

CUTTERS AND CORVETTES



[Scorpio](#)



[Epsilon](#)



[Solar](#)



[Danube \(TNG\) *](#)

[Jump to top of page](#)

SCOUTS



[Gagarin/Sagan \(Oberth\)](#)



[Nelson](#)



[Bader](#)



[Keith](#)



[Moscow \(TNG\)](#)

coming soon?

Hermes ***



[Clark **](#)

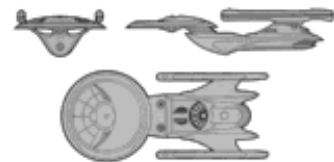

[Scylla](#)



[Ranger](#)

[Jump to top of page](#)

MONITORS



[Fenlon](#)

[Jump to top of page](#)

SPACE STATIONS



[Alamo Defense Outpost](#)

[Earth Spacedock](#)

[R1 Orbital Station](#)

[Jump to top of page](#)

SHUTTLES

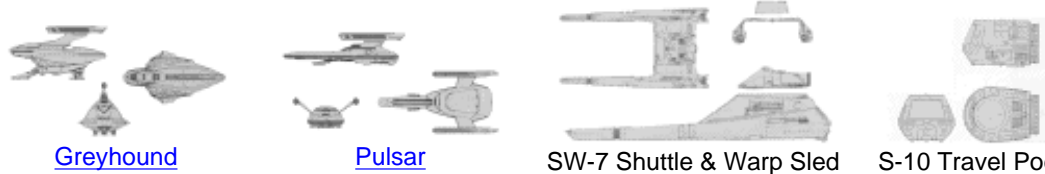

[Greyhound](#)

[Pulsar](#)

SW-7 Shuttle & Warp Sled

S-10 Travel Pod

comings soon?

S-20 Shuttle (TNG)

comings soon?

Sphinx Shuttle (TNG)

[SW-21 Shuttle](#) (TNG)

[Jump to top of page](#)

MISCELLANEOUS



[Illustrious](#) carrier **

[Cochrane](#) transport

[Aakenn](#) freighter

[Mokai](#) transport

comings soon?

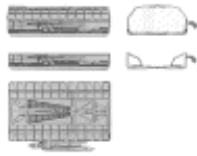

[Pearl mobile repair facility](#)



[Kethkin transport](#)



[Liberty freighter](#)

Ptolemy freighter ***

comings soon?

Cle Dan tender

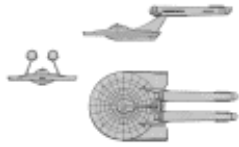

[Derf tender](#)



[Samson tug / tender](#)



[M'Benga medical ship \(TNG\)](#)

[Jump to top of page](#)

(TNG) Denotes a ship class that is specifically from the era of *Star Trek: The Next Generation*, and periods shortly afterward, including ST:DS9 and ST:VOY. The design may or may not be part of official Trek canon, and may or may not have been included in the FASA-produced **TNG Officers Manual**.

* Denotes a ship class NOT included with the original FASA version of the STSSTCS. The ship class itself **is** official and part of movie and television lore, but the stats are *not* necessarily official and have been written by Brad R. Torgersen as part of the continuing update.

** Denotes a ship class that is neither officially part of the FASA version of the STSSTCS, nor is it part of official Trek canon. Usually a fanship design. Gamers may choose to ignore any and all fanships, as they are completely apocryphal.

*** Denotes a ship class that was not part of the original FASA version of the STSSTCS. The ship class was taken from the **Star Trek Star Fleet Technical Manual**, originally compiled by Franz Joseph in 1975. I have always loved these ST:TOS era designs, especially the Federation Class, and happily include them here. I hope you fans have as much fun using them in the game as I did building them into this site!



IMPORTANT NOTE:

It is entirely possible that you have surfed to this page from an internet portal and are now viewing this page without frames. **The STSSTCSMU&A is best viewed from within its own set of frames**, so [click here to jump to the main STSSTCSMU&A web page](#) and then [see the site as it was meant to be seen!](#)

LENTHAL CLASS DESTROYER

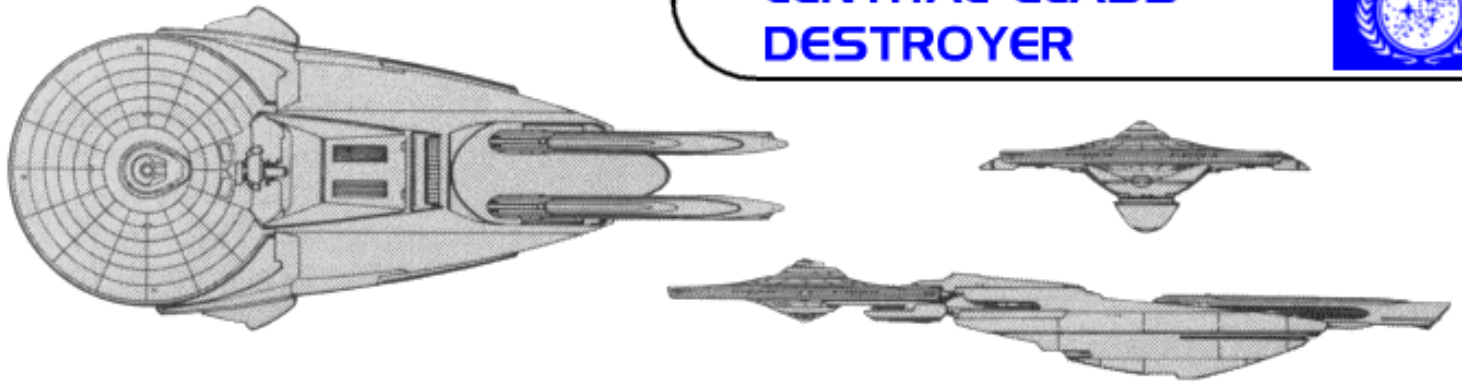

[Click here if you want to view this ship in its own window](#)

BRAD'S COMMENTS: If the scale of the saucer section and the warp nacelles is to be believed, then the Lenthal class is both wider and longer than even an [Enterprise class](#) cruiser!! Naturally, it's not, so I don't like the looks of this ship very much. And I've already covered the fact that I never really understood the close-together nature of the warp nacelles, something we see a lot of in the UFP Ship Recognition Manual. So I won't repeat that material here. Things would be better if the Lenthal class had some teeth, but without torpedoes this ship is pretty much going to get mauled in any kind of fight with an advanced Klingon or Romulan opponent. Best player advice: safety in numbers.



From the **FASA Star Trek FEDERATION SHIP RECOGNITION MANUAL**, circa 1985

Lenthal Class IX Destroyer

NOTES: Of the 311 Lenthals built, 161 Mk IIs and 98 Mk Vs remain in active service, with 10 Mk IIs in reserve fleets; 2 Mk IIs are used by Star Fleet Training Command; 22 Mk IIs and 10 Mk Vs have been destroyed; 2 Mk IIs are listed as missing; 2 Mk IIs and 2 Mk Vs have been scrapped; and 2 Mk IIs have been sold to civilian commercial concerns. The Lenthal, an Andorian design, is manufactured at Salazaar at a rate of 18 per year.

Construction Data:

Model Numbers-	MK II	MK V
Ship Class-	IX	IX
Date Entering Service-	2/1202	2/1708
Number Constructed	201	110

Hull Data:

Superstructure Points-	18	19
Damage Chart-	C	C
Size		
Length-	260 meters	260 meters
Width-	110 meters	110 meters
Height-	40 meters	40 meters
Weight-	133,700 tons	135,300 tons
Cargo		
Cargo Units-	100 units	100 units
Cargo Capacity-	5,000 tons	5,000 tons
Landing Capability-	None	None

Equipment Data:

Control Computer Type-	M-2	M-2
Transporters-		
Standard 6-person-	4	4
Combat 20-person-	None	None
Emergency 22-person-	2	2
cargo-	1	1

Other Data:

Crew-	160	165
Passengers-	10	10
Shuttlecraft-	2	2

Engines and Power Data:

Total Power Units Available-	36	40
Movement Point Ratio-	3/1	3/1
Warp Engine Type-	FWD-1	FWD-1
Number-	2	2
Power Units Available-	12	12
Stress Charts-	L/G	L/G
Maximum Safe Cruising Speed-	Warp 7	Warp 7
Emergency Speed-	Warp 9	Warp 9
Impulse Engine Type-	FIF-1	FIF-2
Power Units Available-	12	16

Weapons and Firing Data:

Beam Weapon Type-	FH-12	FH-13
Number-	6 in two banks	6 in two banks
Firing Arcs-	3f/p/a, 3f/s/a	3f/p/a, 3f/s/a
Firing Chart-	R	T
Maximum Power-	6	8
Damage Modifiers		
+3		(1 - 5)
+2	(1 - 9)	(6 - 12)
+1	(10 - 16)	(13 - 18)

Shields Data:

Deflector Shield Type-	FSH	FSH
Shield Point Ratio-	1/2	1/2
Maximum Shield Power-	12	12

Defense Factor-	77.7	82.1
Weapon Damage Factor-	29.4	39

[<<<< GO BACK](#)

IMPORTANT NOTE:

It is entirely possible that you have surfed to this page from an internet portal and are now viewing this page without frames. **The STSSTCSMU&A is best viewed from within its own set of frames**, so [click here to jump to the main STSSTCSMU&A web page](#) and then [see the site as it was meant to be seen!](#)

LENTHAL CLASS DESTROYER

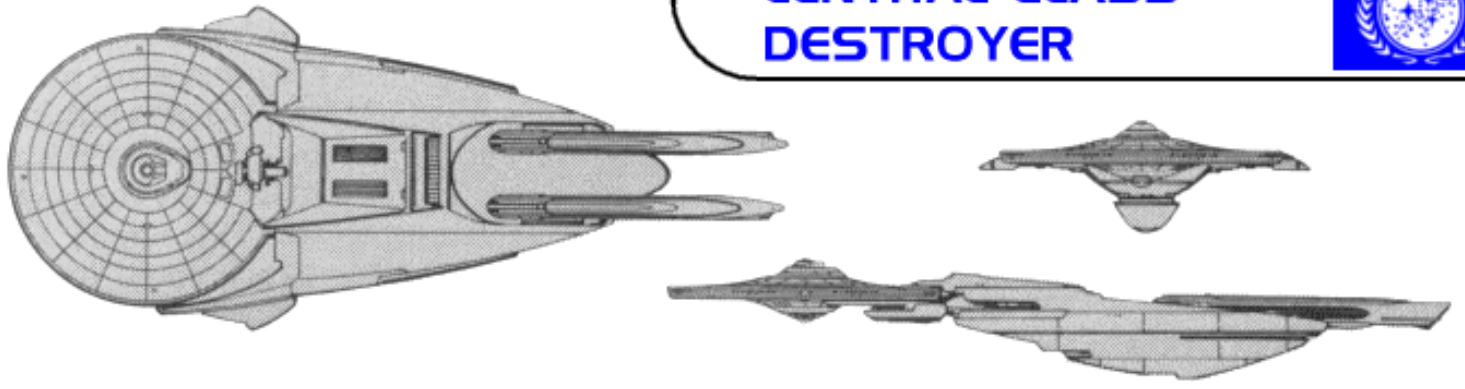

ENTERPRISE CLASS (aka: Constitution Refit)

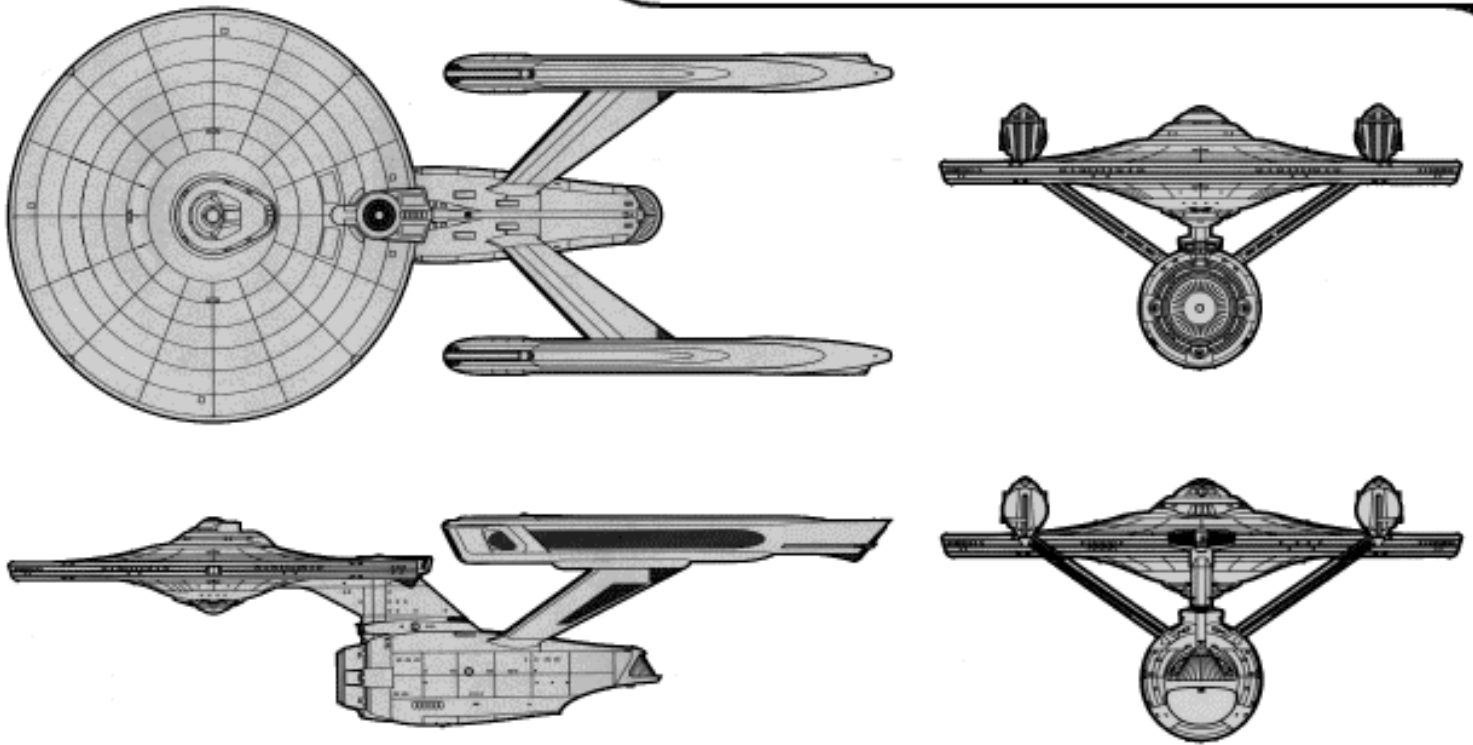

[Click here if you want to view this ship in its own window](#)

BRAD'S COMMENTS: This has got to be my #1 all-time favorite Star Trek ship design!! To me, this ship takes the rudimentary lines of the [Constitution](#)--first laid down for **ST:TOS** by Matt Jeffries and built by Greg Jein--and maximizes all the best features while minimizing or eliminating all the dumb features. Planned for a second, never-to-be-seen Star Trek Kirk-era television series called **Star Trek 2**, the revamped design would eventually be pressed into service for **Star Trek: The Motion Picture**. Seen in all six of the Kirk-era motion pictures as both the NCC-1701 and the NCC-1701-A, this design, to me, is simply gorgeous. Matt Jeffries's TOS-era ship has been expounded upon by Mike Minor, Joe Jennings, Andrew Probert, Douglas Trumbull, and Harold Michelson, with a streamlined look that definitely brought Star Trek into the 1980's. The saucer looks better, the nacelles and their pylons look better, the secondary hull looks better, what else is there to say? A fantastic looking spaceship that would take Star Trek off the small screen and stick it up there on the big screen to compete with the likes of the Death Star and Luke Skywalker's X-Wing fighter.



It was not until ST:TNG came along that most of us realized that this design was not indeed the "Enterprise class"! Instead, we find out its still the old "Constitution" class, and then later the "Constitution Refit" as dictated by info coming from studio sources like M. Okuda. Pretty dumb in my opinion since this ship does look so much different (and better) than the original from TOS. Oh well, at least in the FASA game we get to pretend.

Like its progenitor, the misnamed Enterprise class is a very powerful Kirk-era cruiser, second only to the [Excelsior class](#) in terms of raw muscle. Fans and gamers will find it natural to include this class in numerous different scenarios, usually battling off a numerically superior

foe using inferior ships, or taking on a superior ship like the [L-24](#) or the [Z-1 Nova](#) escorted by a gaggle of smaller ships. I'd dare say at least half of *all* the scenarios I have ever gamed over the last 14 years have included at least one Enterprise class ship, and in almost all cases the Enterprise class never failed me, even during losing efforts. If I could not beat my opponent, my Enterprise class sure smacked the crap out of my opponent before it was all through. And rightly so. The Enterprise class has a very strong superstructure and great power thanks to its warp engines. Shields are high with a very nice 1/4 ratio, and let's not forget the almighty torpedoes, which inflict 20 damage points at a pop and can sometimes wipe

out many smaller enemy designs in a single blow.

Experienced gamers will notice that I have four model types below, where there were only 3 in the original UFP Recognition Manual. This is because the fourth model was included in the TNG Officer's Manual and it seemed dumb to create a whole new page for what is essentially the same ship class, only a different model. Like the Excelsior class, the [Gagarin/Oberth class](#), and the [Reliant/Miranda-Soyuz](#) classes, this is one of those Kirk-era ships we will see making cameos throughout the **ST:TNG** series, though seldom in glamour shots. Usually its in the background as part of a larger fleet, like during the battle at Wold 359.

[Click here to see my cardboard & paper model of this class!](#)



From the FASA Star Trek FEDERATION SHIP RECOGNITION MANUAL, circa 1985

Constitution Class XI - XII Cruiser

NOTES: On Stardate 2/1204, the Constitution Class cruiser *USS Enterprise* returned from its last 5-year mission, the only one of the original 13 remaining in service, all others having been lost or destroyed. She was publicly hailed as the 'Champion Of The Federation', and, on Stardate 2/1302, the vessel began a scheduled overhaul that would lead to one of the most interesting conversion/modifications in recent history. What began as a scheduled overhaul of a Constitution Class cruiser turned into the Enterprise Class cruiser.

While in drydock for upgrade to the Mk IV version of the Constitution Class, the Chief of Engineering, Commander Montgomery Scott, proposed that the vessel be fitted with FWG-1 warp engines, which would give the ship 33% more operating power and would increase its range. The proposal was endorsed, and the vessel was fitted with the newer engines. Once the engines were tested, it was found that the mounts would not withstand the forces exerted by the higher speeds, and so new pylon assemblies were required. A new lower or secondary hull assembly was designed that not only supported the new engines but also incorporated several major changes in appearance.

The secondary hull was enlarged, giving room for larger shuttle bays, larger and more efficiently arranged engineering compartments and work stations, enlarged and improved research facilities, and an enclosed sensor array instead of the older-style extended dish. Furthermore, the photon torpedo bay was placed in the upper forward area. These changes also meant that the primary hull had to be replaced with a larger dish able to house the new fire-control, life-support, and computer systems. The vessel's final appearance was so drastically changed that Star Fleet Command decided to make it a new class entirely.

The Enterprise Class ships are the most powerful in known space. Since their introduction on Stardate 2/1704, they have been the UFP's most effective deterrent to aggression. Their combat abilities are equaled by their capability to perform extensive research duties, and this makes them the most versatile of all vessels in service. Despite the dual capabilities, however, the class is being used more and more in its combat role due to the increased border activities of both the Klingon and Romulan Empires.

Like many ships, the Enterprise Class has been modified. The first modification was made to house the FIF-1 impulse drive system, giving the Mk II 7% more operating power. The Mk III, likely to replace both the Mk I and II, mounts the FIF-2 impulse drive system, giving 15% more power than the Mk I and 6% more power than the Mk II. Also incorporated into this design is an additional bank of FH-11 phasers and an additional FP-4 torpedo bay, both systems firing aft, giving the class much needed protection there. These modifications have been ordered on several existing Mk Is and Mk IIs, and they may be required on all vessels of this class in the near future. Only two Mk Is are under construction; both are believed to be undergoing the modifications to Mk III.

The Enterprise Class cruisers are produced at the Sol III and Salazaar shipyards at a rate of 4 per year. The number under production varies and should only be used for reference.

Construction Data:

	MK I	MK II	MK III	MK IV (TNG)
Model Numbers-	XI	XI	XI	XII
Ship Class-				
Date Entering Service-	2/1704	2/1910	2/2102	2/2802
Number Constructed	26	19	10	50

Hull Data:

Superstructure Points-	26	27	28	32
Damage Chart-	C	C	C	C
Size				
Length-	302 meters	302 meters	302 meters	322 meters
Width-	131 meters	131 meters	131 meters	131 meters
Height-	74 meters	74 meters	74 meters	78 meters
Weight-	150,275 tons	153,275 tons	161,008 tons	197,543 tons
Cargo				
Cargo Units-	450 units	450 units	450 units	450 units
Cargo Capacity-	22,500 tons	22,500 tons	22,500 tons	22,500 tons
Landing Capability-	None	None	None	None

Equipment Data:

Control Computer Type-	M-6	M-6	M-6A	M-7A
Transporters-				
Standard 6-person-	4	4	4	4
Combat 20-person-	None	None	None	4
Emergency 22-person-	4	4	4	4
cargo large-	2	2	2	2
cargo small-	None	None	None	2

Other Data:

Crew-	412	416	416	422
Passengers-	60	60	60	50
Shuttlecraft-	12	12	12	10

Engines and Power Data:

Total Power Units Available-	60	64	68	66
Movement Point Ratio-	4/1	4/1	4/1	4/1
Warp Engine Type-	FWG-1	FWG-1	FWG-1	FTWC-2
Number-	2	2	2	2
Power Units Available-	26	26	26	25
Stress Charts-	D/F	D/F	D/F	D/E
Maximum Safe Cruising Speed-	Warp 8	Warp 8	Warp 8	Warp 8
Emergency Speed-	Warp 9.9	Warp 9.9	Warp 9.9	Warp 9.9
Impulse Engine Type-	FIE-2	FIF-1	FIF-2	FIF-2
Power Units Available-	8	12	16	16

Weapons and Firing Data:

Beam Weapon Type-	FH-11	FH-11	FH-11	FH-11
Number-	6 in three banks	6 in three banks	8 in four banks	8 in four banks
Firing Arcs-	2f/p, 2f, 2f/s	2f/p, 2f, 2f/s	2f/p, 2f, 2f/s, 2a	2f/p, 2f, 2f/s, 2a
Firing Chart-	Y	Y	Y	Y
Maximum Power-	10	10	10	10
Damage Modifiers				
+3	(1 - 10)	(1 - 10)	(1 - 10)	(1 - 10)
+2	(11 - 17)	(11 - 17)	(11 - 17)	(11 - 17)
+1	(18 - 24)	(18 - 24)	(18 - 24)	(18 - 24)
Missile Weapon Type-	FP-4	FP-4	FP-4	FP-4
Number-	2	2	3	4
Firing Arcs-	F	F	2f, 1a	2f, 2a
Firing Chart-	S	S	S	S
Power To Arm-	1	1	1	1
Damage-	20	20	20	20

Shields Data:

Deflector Shield Type-	FSP	FSP	FSP	FSP
Shield Point Ratio-	1/4	1/4	1/4	1/4
Maximum Shield Power-	16	16	16	16

Defense Factor-	145.2	152.0	162.8	195.76
Weapon Damage Factor-	89.2	89.2	123.1	135.60

[<<<< GO BACK](#)

IMPORTANT NOTE:

It is entirely possible that you have surfed to this page from an internet portal and are now viewing this page without frames. **The STSSTCSMU&A is best viewed from within its own set of frames**, so [click here to jump to the main STSSTCSMU&A web page](#) and then [see the site as it was meant to be seen!](#)

BAKER CLASS DESTROYER

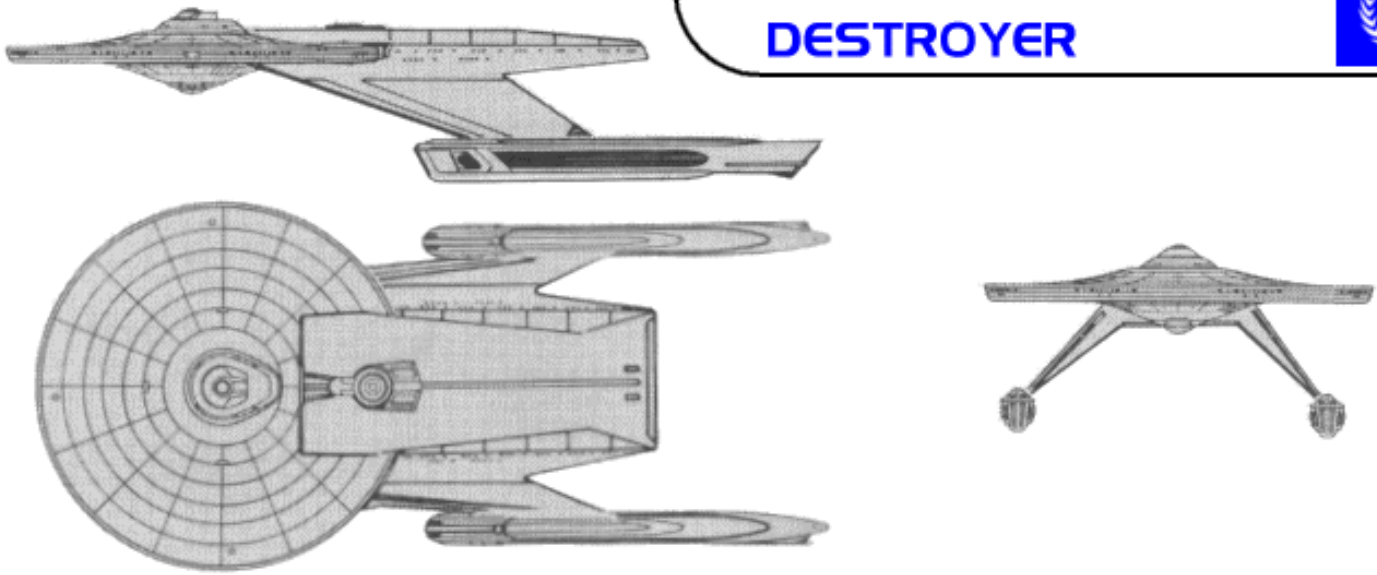

[Click here if you want to view this ship in its own window](#)

BRAD'S COMMENTS: I actually like how the Baker looks; a very solid design... for a cruiser! Again, the size comparison problem with the other ships comes into play, because the Baker uses the saucer off the [Constitution Refit](#), hence the boxy secondary hull looks HUGE compared to the relatively small and tubular Enterprise secondary hull. And this ship is a destroyer, yet it should be bigger than a cruiser? Go figure!

The Baker is a nice little TMP-era destroyer that plays well and packs a good punch. It can handle itself against many older Romulan and Klingon cruisers, and can be effective in numbers against most contemporary enemy vessels. A good mixed-bag combination for game play is usually two Bakers escorting a [Reliant class](#) cruiser or an Enterprise class cruiser, versus a [V-30](#) and some [T-10's](#) or perhaps a late-model [D-7](#) or [D-10](#) and several [D-2 destroyers](#).



From the FASA Star Trek FEDERATION SHIP RECOGNITION MANUAL, circa 1985

Baker Class IX Destroyer

Notes: The Baker Class destroyer has a unique development history. When the original contracts were let out, they called for a research vessel with limited combat capabilities. The designs for the ship were accepted by Star Fleet Procurement, and, on Stardate 2/1403, the actual construction of the Baker Class research cruiser began.

As the main hull neared completion, Star Fleet decided that a destroyer was needed to supplement the Larson Class. At this same time, the Admiralty was of the opinion that fewer research cruisers would be needed on the frontiers. The Baker class was then dropped as a research cruiser and re-designated a destroyer.

In order to accomplish its mission as a destroyer, the Baker's design underwent several changes. The laboratory facilities were removed and crew quarters and recreation areas were expanded. The Baker class vessels are well known for these spacious quarters and crew comforts. Another change came in the weaponry. The original design had only four phasers, and as can be seen, the finished design, known as the Mk II, was fitted with six phasers and two torpedoes.

On Stardate 2/1606 the Baker Class destroyer was brought into service with the commissioning of the USS Baker, USS Stafford, and USS Peterson. Since that time, 224 ships of this class have been commissioned. As was intended, these vessels are being used to replace the aging Larson Class destroyers in more hostile areas, the latter being used more and more along trailing and rimward frontiers.

The Baker Class has a compartmented dual-wall internal structure to give additional protection from explosive decompression during battle. Earlier designs with single-wall protection often ruptured when one compartment decompressed, victims of a domino effect that would eventually render the entire vessel incapable of sustaining itself. Although compartmentalization is not new in ship design, double walls separated by a pressurized dead space was. Such a dead space counteracts the forces on the outer wall surfaces by means of sensors that detect any changes in pressure and trigger units that regulate the pressure inside the dead space. This system has become a standard feature on all Federation warships. The Baker Class destroyer is the first vessel in Star Fleet to be designed with the newer style nacelle; previous uses were all refits. The FWE-2 warp drive system was installed to give a cruising speed of Warp 7 and temporary speeds of Warp 8, as well as great maneuverability, making it more efficient in battle, than many of its counterparts. The weapons arrangement of the Baker Class is unusual by Star Fleet standards. Two of the phaser banks are capable of firing in all quadrants except directly to the rear, unlike most other Federation vessels on which they are usually positioned to fire in only two quadrants.

The Baker Class remained unchanged until an experimental model, the *USS Knutson*, completed its testing of an impulse drive system that would increase the total power output of the vessel by 25%. The Mk III went into production on Stardate 2/1804, but was

quickly replaced by the Mk IV with upgraded FP-1 photon torpedoes. All Mk III's have been refitted to this design.

Construction Data:

Model Numbers-	MK II	MK IV
Ship Class-	IX	IX
Date Entering Service-	2/1606	2/1912
Number Constructed	162	62

Hull Data:

Superstructure Points-	15	17
Damage Chart-	C	C
Size		
Length-	301 meters	301 meters
Width-	148 meters	148 meters
Height-	77 meters	77 meters
Weight-	121,300 tons	125,600 tons
Cargo		
Cargo Units-	110 units	110 units
Cargo Capacity-	5,500 tons	5,500 tons
Landing Capability-	none	none

Equipment Data:

Control Computer Type-	M-3	M-4
Transporters-		
Standard 6-person-	4	4
Emergency 22-person-	2	2
cargo small -	none	none
cargo large -	1	1

Other Data:

Crew-	265	273
Troops-	none	none
Passengers-	15	15
Shuttlecraft-	2	2

Engines and Power Data:

Total Power Units Available-	30	38
Movement Point Ratio-	3/1	3/1
Warp Engine Type-	FWE-2	FWE-2
Number-	2	2
Power Units Available-	13	13
Stress Charts-	G/K	G/K
Maximum Safe Cruising Speed-	Warp 7	Warp 7
Emergency Speed-	Warp 9	Warp 9
Impulse Engine Type-	FID-2	FIF-1
Power Units Available-	4	12

Weapons and Firing Data:

Beam Weapon Type-	FH-8	FH-8
Number-	6, in three banks	6, in three banks
Firing Arcs-	4f/p/s, 2f	4f/p/s, 2f
Firing Chart-	T	T
Maximum Power-	5	5
Damage Modifiers		
+3		
+2	(1 - 10)	(1 - 10)
+1	(11 - 18)	(11 - 18)
Missile Weapon Type-	FP-2	FP-1
Number-	2	2
Firing Arcs-	F	F
Firing Chart-	H	L
Power To Arm-	1	1
Damage-	6	10

Shields Data:

Deflector Shield Type-	FSI	FSI
Shield Point Ratio-	1/3	1/3
Maximum Shield Power-	12	12
Defense Factor-	81.5	96.3
Weapon Damage Factor-	27.6	34.8

[<<<< GO BACK](#)

IMPORTANT NOTE:

It is entirely possible that you have surfed to this page from an internet portal and are now viewing this page without frames. **The STSSTCSMU&A is best viewed from within its own set of frames**, so [click here to jump to the main STSSTCSMU&A web page](#) and then [see the site as it was meant to be seen!](#)

RELIANT CLASS (aka: Miranda/Soyuz)

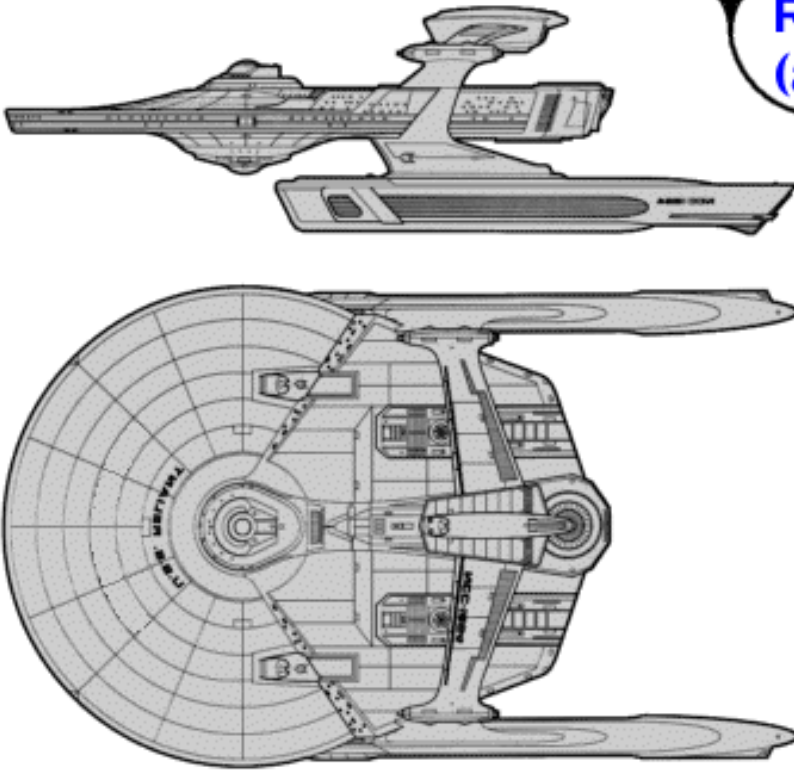

[Click here if you want to view this ship in its own window](#)

BRAD'S COMMENTS: This is maybe my second all-time most favorite ship design, but in official Trek canon there is no such thing as the "Reliant class". We find out in **ST:TNG** that these ships are known as the Miranda class, as well as a mildly modified sub-class w/o the 'roll bar' called the Soyuz. I never liked the removal of the roll bar, personally, especially since it made perfect sense that this is where the all-important torpedo bay would be located along with the two phaser banks that fired forward/port and forward/starboard.



This class is, of course, most famous as the ship that Khan uses to attack Kirk and the [Enterprise](#) in **Star Trek II**. The *USS Reliant*, NCC-1864, is the only ship on which we ever see Pavel Chekov approach command rank--as first officer. And the *USS Reliant* kicks the crud out of the *USS Enterprise* throughout Star Trek II and the famous Mutara Nebula 'submarine combat' sequence, before ultimately being dealt several gosh-wow special effects blows by the *Enterprise's* phasers and torpedoes. The *Enterprise* versus *Reliant* ship battle sequences have got to be the most breathtaking and involved ship-to-ship battles we've ever seen in Star Trek's big-screen history. The only thing that comes close is probably in **Star Trek VI** when *Enterprise* and *Excelsior* take on a [Klingon Bird of Prey](#), but even then, the Star Trek II battles set the standard.



Which probably means that more STSSTCS scenarios have been carried out re-enacting this screen battle than any other scenario possible in the game. I would defy any experienced STSSTCS gamer to prove me wrong. The *Reliant* versus *Enterprise* fight is really irresistible in gamers terms, not only because of its on-screen analog, but because the Reliant class is almost a match for the Enterprise class in terms of firepower, superstructure, shields, and engines. A skillful gamer can defeat an Enterprise class with a Reliant

class, given a lucky roll or two during firing phases. Especially if you match a later-model Reliant against an earlier model Enterprise. The matchup is *that* close.

In aesthetic terms, compared to the [Anton](#), I kind of don't understand what FASA was thinking because the Anton looks *bigger* than the Reliant in many ways. And the Reliant is supposed to have 'evolved' from the Anton?? The warp pylons on the Anton are longer, the secondary structure behind the saucer seems to be larger and longer, etc. The basic shape is sort of there for both ships, but looking at the two designs side by side the supposed 'evolution' from Anton to Reliant does not seem as obvious as the Constitution to Enterprise classes. But hey, even though it is not part of official Trek canon, I always loved the FASA backstory of the Reliant having come out of the Anton in the same fashion the apocryphal Enterprise class

came out of the Constitution.

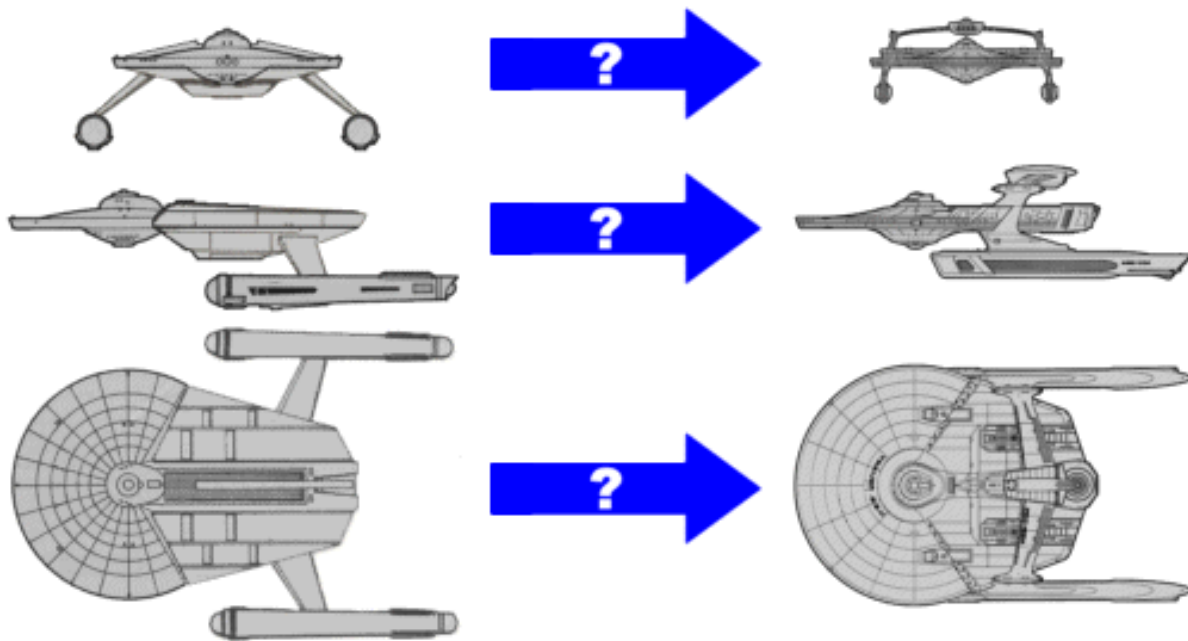

From the FASA Star Trek FEDERATION SHIP RECOGNITION MANUAL, circa 1985

Reliant Class XI Cruiser

NOTES: The Reliant Class cruiser evolved from the Anton Class research cruiser in much the same manner as the Enterprise Class cruiser evolved from the Constitution Class. On Stardate 2/1410, the *USS Reliant*, an Anton Class research cruiser, was brought into the shipyards of Morena for a refit to the Mk IV. As the ship was being dismantled for an engine refit, Star Fleet Command decided to mount the FWF-1 and FIE-2 engine systems instead of the FWC-2 and FIC-3 systems normally used on the Mk IV. This change in both the warp and impulse drive systems created several exterior design changes that prompted Star Fleet to christen this a new class.

During this time, the *Reliant* was further fitted with the 'roll bar' weapons pod, which gave a better field of fire and allowed the addition of photon torpedoes. The Anton Class had suffered from lack of intense firepower during the Four Years War, in which 16 Antons were destroyed due to their inability to deliver massive blows to their targets. After the war, when public feeling was to disarm instead of rearming, no consideration was given to rearm research ships, but after the Klingon attempt to take Organia, public opinion changed and the problem of the undergunned Anton Class resurfaced. In considering the refit and upgrade to more firepower with the emerging Reliant Class, the problem of preserving the massive onboard research facilities prompted the 'roll bar' weapons pod. This pod contains the phaser banks mounted on the outer edges, and the fore and aft torpedoes mounted centrally. The major components of the fire control system are also located in the pod, thus giving additional room for personnel and work stations.

The *USS Reliant*, being the first of this type, was made the class vessel. It retained its original hull number, as have all converted models, but newly constructed ships have been given a different series of numbers. Once the decision was made, production of new ships and modifications of existing models was then ordered.

Since they entered service, Reliant Class vessels have undergone two changes. The first, upgrading to the Mk II, saw an improved impulse drive system and the changing of the phasers to the FH-11. The second and most recent change, refitting to the Mk III, includes a more powerful set of warp drive engines, which are actually lighter than several of the older styles still in use. All production of Mk I and II models will be halted with the completion of the ships that are already in production, and new Reliants will be of the Mk III type.

The Reliant Class cruisers are produced at the Morena, Sol IV, and Salazaar shipyards. The rate of production is currently 10 per year.

Construction Data:

Model Numbers-	MK I	MK II	MK III
Ship Class-	XI	XI	XI
Date Entering Service-	2/1507	2/1802	2/2204
Number Constructed	52	46	5

Hull Data:

Superstructure Points-	22	24	24
Damage Chart-	C	C	C
Size			
Length-	233 meters	233 meters	233 meters
Width-	140 meters	140 meters	140 meters
Height-	64 meters	64 meters	64 meters
Weight-	165,800 tons	169,600 tons	161,600 tons
Cargo			
Cargo Units-	400 units	400 units	400 units
Cargo Capacity-	20,000 tons	20,000 tons	20,000 tons
Landing Capability-	None	None	None

Equipment Data:

Control Computer Type-	M-4	M-4	M-4
Transporters-			
Standard 6-person-	4	4	4
Combat 20-person-	None	None	None
Emergency 22-person-	3	3	3
cargo large-	2	2	2
cargo small-	None	None	None

Other Data:

Crew-	336	346	352
Passengers-	75	75	75
Shuttlecraft-	4	4	4

Engines and Power Data:

Total Power Units Available-	48	52	56
Movement Point Ratio-	4/1	4/1	4/1
Warp Engine Type-	FWF-1	FWF-1	FWG-1
Number-	2	2	2
Power Units Available-	20	20	22
Stress Charts-	G/L	G/L	H/K
Maximum Safe Cruising Speed-	Warp 6	Warp 6	Warp 8
Emergency Speed-	Warp 8	Warp 8	Warp 9
Impulse Engine Type-	FIE-2	FIF-1	FIF-1
Power Units Available-	8	12	12

Weapons and Firing Data:

Beam Weapon Type-	FH-10	FH-11	FH-11
Number-	4 in two banks	4 in two banks	4 in two banks
Firing Arcs-	2f/p, 2f/s	2f/p, 2f/s	2f/p, 2f/s
Firing Chart-	W	Y	Y
Maximum Power-	7	10	10
Damage Modifiers			
+3	(1 - 10)	(1 - 10)	(1 - 10)
+2	(11 - 17)	(11 - 17)	(11 - 17)
+1	(18 - 20)	(18 - 24)	(18 - 24)
Missile Weapon Type-	FP-4	FP-4	FP-4
Number-	2	2	2
Firing Arcs-	1f, 1a	1f, 1a	1f, 1a
Firing Chart-	S	S	S
Power To Arm-	1	1	1
Damage-	20	20	20

Shields Data:

Deflector Shield Type-	FSL	FSL	FSL
Shield Point Ratio-	1/3	1/3	1/3
Maximum Shield Power-	14	14	14

Defense Factor-	105.0	110.8	113.8
Weapon Damage Factor-	63.8	67.8	67.8

[<<<< GO BACK](#)

IMPORTANT NOTE:

It is entirely possible that you have surfed to this page from an internet portal and are now viewing this page without frames. **The STSSTCSMU&A is best viewed from within its own set of frames**, so [click here to jump to the main STSSTCSMU&A web page](#) and then [see the site as it was meant to be seen!](#)

CONSTITUTION CLASS CRUISER

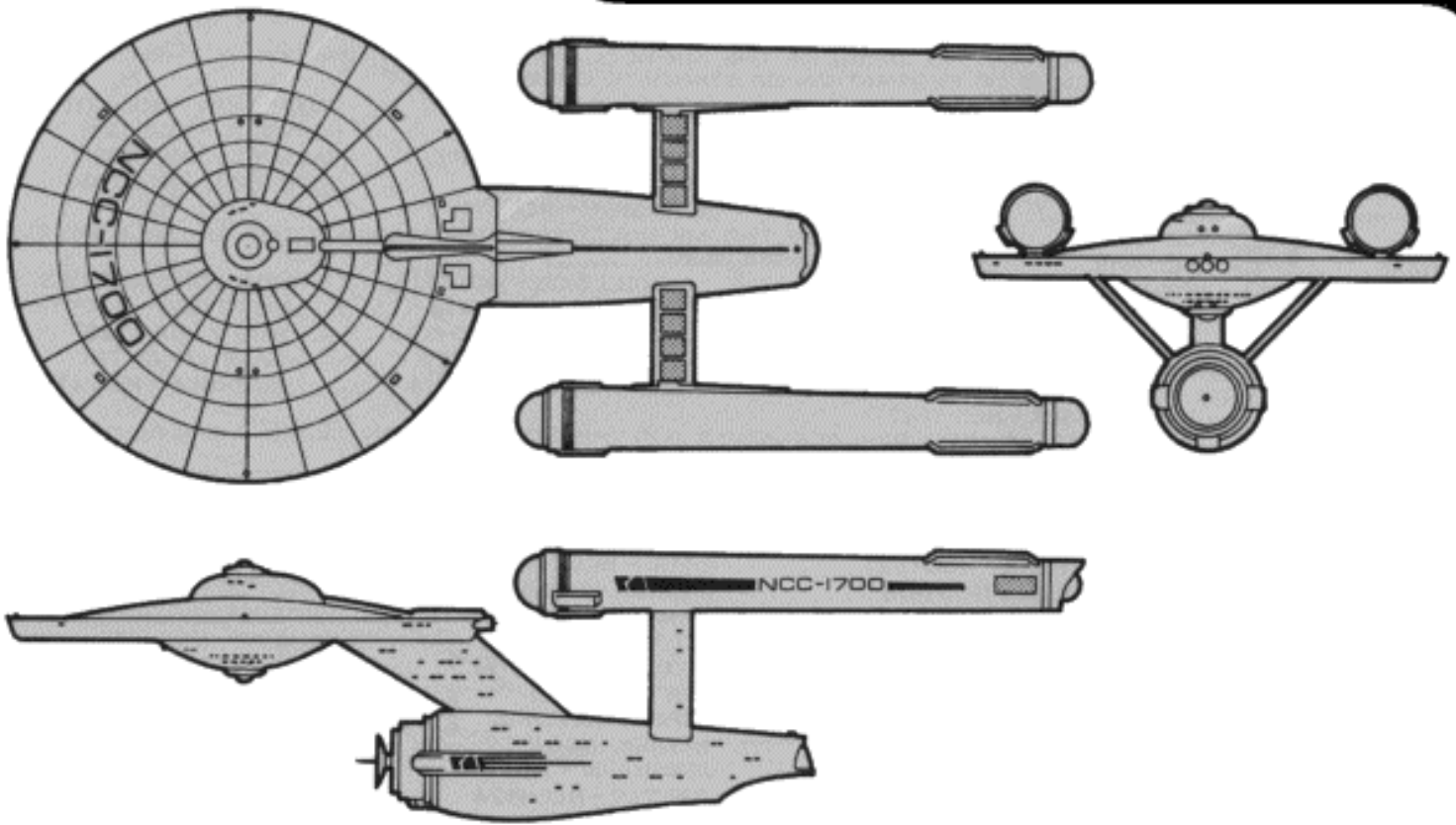

[Click here if you want to view this ship in its own window](#)



BRAD'S COMMENTS: This is it! The great granddaddy of all Star Trek ships, and all Star Trek PERIOD!! The Constitution class ship is the *creme de la creme* of Trek ships, the beginning and the end, the origin and the definition! Well, okay, I admit I am spouting off, but come on! This design, originally put together to satisfy the requirement that the TOS-era *Enterprise* look like both a flying saucer and a rocket ship, is probably the most widely-recognized vessel in all of television science fiction history! Matt Jeffries, the original model maker, probably had no idea when he built the thing that this ship would launch an entire design philosophy that would

resonate down through ten feature films and five different television series. Next to the Star Wars ships like the X-Wing fighter and the Imperial Star Destroyer, the Constitution class and the [Constitution Refit](#) are far and away the definitive sci-fi ships of the modern screen age. Models of this ship are currently perched on countless desks around the world, hang from countless ceilings in children's bedrooms, and graphics of the ship(s) adorn countless Windows computer desktops.

I was born in the early 1970's and grew up with this ship, but I will admit I do not like it as much as the Constitution Refit. Maybe that's because the special effects of the 1960's just were not up to the task of making the old Constitution seem realistic. Even as a small child I could tell the ship swooshing across the screen every Saturday evening was a model. Maybe it's because I have heard quotes that Gene wanted the original Constitution to look like the Refit to begin with, but simply lacked the funds to



make it happen in 1965. Or maybe it's just the fact that the pylons for the warp nacelles on the TOS design seemed too flimsy, and at odds with the otherwise angular dorsal pylon. In any case, this ship is not necessarily my favorite design, at least from an aesthetic viewpoint, but its place in Trek canon and science fiction lore cannot be denied.



In game play, the ship lives up to her heritage as the backbone of the TOS-era Starfleet. No other TOS-era Federation ship can match her, and it's probably safe to say no other TOS-era Klingon or Romulan ship can match her either. Combining a good balance of offensive weaponry, including torpedoes, and defensive shielding and superstructure, this vessel can easily dominate any TOS-era battle scenario unless faced with multiple, sufficiently armed opponent vessels. Even entering the Motion Picture-era time, the original Constitution class can hold her own against all but the most modern enemy ships, and therefore this class makes a nice playing piece in any scenario that does not significantly

approach the overly powerful ships of the TNG-era.

Some of the scenarios I have used, as either the Federation player, the Klingon Player, or the Romulan player, are as follows: 1 Constitution versus 3 Klingon [D-7 cruisers](#), 1 Constitution versus 2 Romulan [V-8 cruisers](#), 1 Constitution class and [2 Anton class cruisers](#) versus 6 Klingon D-7 cruisers, etc. etc. No matter what, the Constitution class is going to be the focus both offensive and defensive activity in just about any scenario. With skillful play this class can sometimes win whole battles all by itself, even in the face of enormous enemy numeric superiority.



From the FASA Star Trek FEDERATION SHIP RECOGNITION MANUAL, circa 1985

Constitution Class XI Cruiser

NOTES: The Constitution Class cruisers are the most renowned vessels of their time. Serving as both a research vessel and a cruiser, these ships have performed their duties to perfection for the last 35 years. The Constitution Class ships were an integral part of the buildup during "The Great Awakening," from the outset the most versatile of all ships built for the expansion efforts.

The original construction contract called for 13 vessels to be built that would serve as cruisers, have complete research facilities, and be capable of operating on 5-year research and exploration missions. On Stardate 1/8801, the first of these vessels, the *USS Constitution*, was commissioned, followed by one more each month for five months. As soon as these vessels were completed and commissioned, they were sent on 2-year shakedown cruises. Over the next five years, the remaining 7 cruisers were built. The construction program came to a halt with the commissioning of the *USS Defiant*.

When the Four Years War broke out, Star Fleet decided to produce warships instead of the dual-purpose cruisers that devoted large areas of their space to research and laboratories. Even though the Constitution Class was not put into production for the war effort, four of the ships saw action. Each distinguished itself in battle time and again, soon gaining the nickname "The Queens Of Star Fleet". After-action reports continued to show the combat ability of this ship to be superior to any other ship in the fleets, and so the decision to produce more of them was finally issued on Stardate 1/9611.

The ship that would be produced was the Mk II version, mounting the new phaser weaponry and newer, more powerful shields. Because of these modifications to the original design, construction did not begin until Stardate 1/9709, and the first ship did not come off the line until 1/9901, 7 months after the end of the war. Star Fleet decided to continue the production of the Constitution Class cruisers and expanded the total number to 42 vessels.

On Stardate 2/0104, the FWF-1 warp drive engine was brought into the inventory, and all Constitution Class ships were recalled to be refit as Mk IIIs. By Stardate 2/0510, the refitting was complete and the Constitution Class remained the most advanced starship of its time. One Mk III, the *USS Ark Royal*, still serves in Star Fleet, exploring the rimward areas and acting as ongoing proof of this class' successful record.

After the first successful test firing of the FP-5 photon torpedo, Star Fleet ordered that 12 Constitution Class ships be modified to fire it. On Stardate 2/1202, the *USS Discovery*, *USS Saratoga*, *USS El Dorado*, and *USS Kitty Hawk* were sent into service as Mk IVs, mounting not only the new torpedo system, but also more powerful impulse engine and shield generators.

The Mk IV was the last version of the Constitution Class to be built, but not the last to use that particular hull style. The Enterprise Class cruiser was originally built from older Constitution hulls and retains its general appearance. Constitution Class ships were constructed at the Sol IV shipyards.

Construction Data:

Model Numbers-	MK I	MK II	MK III
Ship Class-	XI	XI	XI
Date Entering Service-	1/8801-2/1210	2/0206	2/1202
Number Constructed	13	28	6

Hull Data:

Superstructure Points-	20	20	22
Damage Chart-	C	C	C
Size			
Length-	290 meters	290 meters	295 meters
Width-	127 meters	127 meters	127 meters
Height-	73 meters	73 meters	73 meters
Weight-	162,425 tons	164,600 tons	167,900 tons
Cargo			
Cargo Units-	380 units	390 units	390 units
Cargo Capacity-	19,000 tons	19,500 tons	19,500 tons
Landing Capability-	None	None	None

Equipment Data:

Control Computer Type-	M-3	M-4	M-4
Transporters-			
Standard 6-person-	4	4	4
Combat 20-person-	None	None	None
Emergency 22-person-	5	5	5
cargo-	2	2	2

Other Data:

Crew-	410	430	430
Passengers-	80	60	60
Shuttlecraft-	10	12	12

Engines and Power Data:

Total Power Units Available-	36	44	48
Movement Point Ratio-	4/1	4/1	4/1
Warp Engine Type-	FWC-1	FWF-1	FWF-1
Number-	2	2	2
Power Units Available-	16	20	20
Stress Charts-	O/M	G/L	G/L
Maximum Safe Cruising Speed-	Warp 6	Warp 6	Warp 6
Emergency Speed-	Warp 8	Warp 8	Warp 8
Impulse Engine Type-	FIB-2	FID-2	FIE-2
Power Units Available-	4	4	8

Weapons and Firing Data:

Beam Weapon Type-	FL-6	FH-3	FH-3
Number-	6 in three banks	6 in three banks	6 in three banks
Firing Arcs-	2f/p, 2f, 2f/s	2f/p, 2f, 2f/s	2f/p, 2f, 2f/s
Firing Chart-	H	W	W
Maximum Power-	3	5	5
Damage Modifiers			
+3		(1 - 10)	(1 - 10)
+2	(1 - 4)	(11 - 17)	(11 - 17)
+1	(5 - 7)	(18 - 20)	(18 - 20)
Missile Weapon Type-	FAC-3	FP-1	FP-5
Number-	2	2	2
Firing Arcs-	F	F	F
Firing Chart-	H	L	R
Power To Arm-	4	1	1

Damage-	12	10	16
Shields Data:			
Deflector Shield Type-	FSG	FSN	FSO
Shield Point Ratio-	1/1	1/2	1/3
Maximum Shield Power-	9	16	16
Defense Factor-	64.6	83.6	97.5
Weapon Damage Factor-	12.4	43.6	53.8

[<<<< GO BACK](#)

IMPORTANT NOTE:

It is entirely possible that you have surfed to this page from an internet portal and are now viewing this page without frames. **The STSSTCSMU&A is best viewed from within its own set of frames**, so [click here to jump to the main STSSTCSMU&A web page](#) and then [see the site as it was meant to be seen!](#)

EXCELSIOR CLASS BATTLESHIP

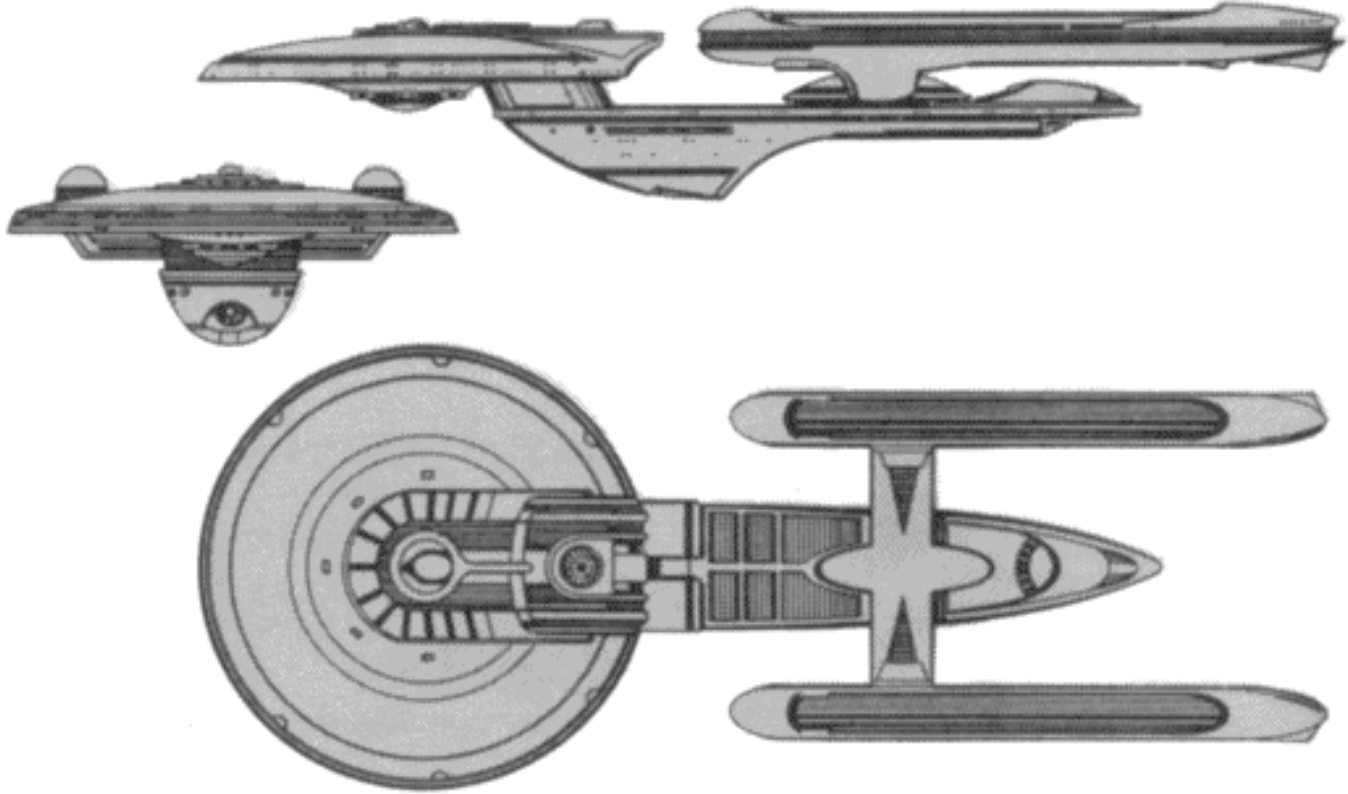

[Click here if you want to view this ship in its own window](#)

BRAD'S COMMENTS: One of the biggest goofs that the old FASA writers made was to include Transwarp Drive in their work. Any half-decent Trek fan knows that Transwarp was considered a failure in the canon of the show, and all of the Excelsior ships built---including the NCC-2000, to be famously captained by USS Enterprise alumnus Hikaru Sulu---used conventional warp engines. The FASA description of the Excelsior is almost comical when you realize how truly far from official Trek lore it is. Nevertheless, in FASA terms, the Excelsior design would become the backbone of the 'Transwarp fleet' and go on to become one of the most famous lines in all of Starfleet. In reality, the former is completely false, even if the latter is true in terms of the films and the television programs which have shown countless Excelsior ships in action.



There has also been a great deal of fan dispute over the FASA [ship type designation](#) system, particularly where ships like the Excelsior and the [Galaxy Class](#) are concerned. Purists rail that Roddenberry is rolling in his grave over the "militarization" of Starfleet, and that there should be no such thing as a Starfleet "battleship" since even the largest Starfleet vessels are almost always primarily exploration

ships, not gunboats. For the sake of maintaining some continuity, though, I have chosen--where it seems reasonable--to adhere to FASA's designation system, so the Excelsior is a "battleship". And Gene can keep on rolling.

Besides, the Excelsior is the undisputed queen of the battlefield in the old FASA Trek game system. Only the super-heavy ships from the TNG Officer's Manual have a chance against the Excelsior, but if we exclude TNG-era vessels it is almost impossible for any single Klingon or Romulan ship to tackle the Excelsior one-on-one. Even the impressive [Klingon L-24 battleship](#) is not quite up to par, and only once or twice have I ever managed to beat an Excelsior with an L-24, and then it took a lot of lucky shots. Otherwise, the Excelsior is the Karl Malone

or the Shaq O'Neil of Starfleet: massive, huge, awesome, powerful, capable of clobbering multiple smaller opponents at will.

Artistically, I must admit, it took years for the Excelsior design to grow on me. When I first saw **Star Trek III** I was horrified by the lines of the Excelsior when compared to the [Enterprise](#). Yeah, there was the standard saucer-and-dorsal thing with the secondary hull and the warp nacelles, but everything was so *curvy*. Curves everywhere. Curved everything. I don't think it was until **Star Trek VI** came out and the true apparent size of the ship became apparent that I started to get turned on to the design. Now I love it, and consider it to be a very classy looking thing. So much so that I built my own paper-and-glue model of it in 1995, which was a pretty massive project in itself.

I have listed three different versions of the Excelsior below, the first two being from the UFP Ship Recognition Manual and the third being from the TNG Officer's Manual.

What never made sense to me about the Mark III model is how it's not too much better than the Mark II. Indeed, in some ways it is *worse* off than the Mark II. The only thing better about the Mark III is it has more power, while the downside is that it actually has less superstructure than the Mark II. Also, if the two manuals are right, only 40 of the Excelsior ships were ever built! This clearly makes no sense at all when we consider how ubiquitous these ships have become by the time of **Star Trek The Next Generation**. By my reckoning there ought to be several *hundred* of these ships in service by the time of Picard and the Enterprise-D, if not many more.

Getting back to game play, different scenarios may be appropriate depending on which era the melee is going to take place in. A scenario in the time of Kirk and Spock would certainly only involve one Excelsior vessel at the most, since these ships are exceedingly rare and exceedingly powerful. For limited play I suggest pitting one Excelsior against three later-model [Klingon D-7 ships](#), or against a Klingon L-24 and an older-model D-7. The [Romulan Nova](#) ship is even less of a match, so you could try one Excelsior versus a Z-1 Nova and two or three smaller Romulan ships. Any way you slice it, for a player to beat the Excelsior it's going to take numbers. If you expand the melee to fleet-level proportions, I have always found it fun to build a 'carrier group' of ships comprised of an Excelsior accompanied by two cruisers, two frigates, and four destroyers. Face this bunch off against a numerically-superior fleet of Klingon or Romulan ships, numbering 3 cruisers, 3 frigates, 3 destroyers, and 3 escorts. The Romulans and Klingons have numbers, but the Federation has firepower, and it all comes down to which player can use his or her advantage to the best effect. Such a massive fleet-level engagement takes days to complete, but can be a hell of a lot of fun.

For TNG-era scenarios the Excelsior has ceased to become such an advanced brute and is now more of a aged workhorse. The advanced Klingon, Ferengi, and Romulan designs of the TNG-era kick butt on the old outdated Excelsior, so now it is time to reverse things: pit two or three Excelsiors against a single [Ferengi Marauder](#) or [Klingon KFD-2](#) or [Romulan D'Daridex](#). It is now the Excelsior that needs numbers to match the advanced firepower and heavy armor of the TNG-era enemy, making for interesting game play.



From the **FASA Star Trek FEDERATION SHIP RECOGNITION MANUAL**, circa 1985

Excelsior Class XIII - XIV Battleship

Notes: On Stardate 2/2210, the first of the new battleships, the USS Excelsior, was commissioned. This vessel is the newest in Starfleet, and it incorporates many experimental operating systems. Since that time, Starfleet has announced that another Mk I has been built, the USS Proxima, which is expected to finish its trials sometime in early 2/2400, and will be commissioned immediately thereafter.

Starfleet Command has contracted for two Mk II versions to be built. The first of those, the USS Columbia, will be completed and ready for trials in early 2/2400 while the second, the USS Galacta, is expected to begin its trials sometime in the latter part of the year.

All the battleships are being constructed at the Sol III and Sol IV shipyards.

Technical data regarding the TransWarp engines used on these ships is classified and is not available for publication at this time. These engines operate by capturing the warp envelope in a transporter field and beaming it ahead of the ship to attain the reported warp speeds.

The weapons arrangement of the Mk I consists of 16 phasers and 4 photon torpedoes. Mounting 8 FH-11s and 8 FH-5s, the Mk I's originally were designed to cover all fields of fire with both long and short-range phasers. The evaluation teams felt this arrangement could be improved by removing the FH-5s and replacing them with two

additional FH-11s. This meant that the ship would carry only 10 of the long-range phasers, but the fields of fire overlap more effectively. An improvement in torpedo launcher technology allowed two more torpedo bays to be added. The torpedo tubes of the Mk I bear only to the fore and aft, but those of the Mk II are arranged to cover all firing arcs.

The shield system of the Excelsior Class vessels is reportedly an improved version of the quadri-transducer that delivers more deflector power. Like the engines, the technical data regarding the shield system is classified.

The Excelsior has been called "The Great Experiment" by many in influential circles. These ships are the newest of any in Star Fleet and incorporate experimental technology in most of the components required to operate a warship. With so many new systems aboard these vessels, the process of testing them has been slow. Prior to being installed, each component was tested and re-tested until it met standards. Nevertheless, when the USS Excelsior was taken out for trials, the evaluation teams were constantly faced with primary system malfunctions that would not allow any of the secondary or back-up systems to be tested. This caused the evaluators to deal with these new components on a one-at-a-time basis, and thus creating time delays in the commissioning of the class.

Construction Data:

Model Numbers-	MK I	MK II	MK III (TNG)
Ship Class-	XIII	XIV	XIII
Date Entering Service-	2/2210	2/2210	2/2303
Number Constructed	1	1	38

Hull Data:

Superstructure Points-	38	42	37
Damage Chart-	C	C	C
Size			
Length-	467 meters	467 meters	467 meters
Width-	186 meters	186 meters	186 meters
Height-	78 meters	78 meters	78 meters
Weight-	239,930 tons	243,610 tons	239,645 tons
Cargo			
Cargo Units-	550 units	550 units	100 units
Cargo Capacity-	27,500 tons	27,500 tons	5,000 tons
Landing Capability-	None	None	None

Equipment Data:

Control Computer Type-	M-8	M-8	M-8
Transporters-			
Standard 6-person-	6	6	6
Emergency 22-person-	6	6	6
cargo-	3	3	3

Other Data:

Crew-	810	802	802
Troops-	40	40	40
Shuttlecraft-	20	20	20

Engines and Power Data:

Total Power Units Available-	108	116	128
Movement Point Ratio-	6/1	6/1	6/1
Warp Engine Type-	FTWA	FTWA	FTWAI
Number-	2	2	2
Power Units Available-	38	38	48
Stress Charts-	D/F	D/F	D/F
Maximum Safe Cruising Speed-	Warp 12	Warp 12	Warp 12
Emergency Speed-	Warp 14	Warp 14	Warp 14
Impulse Engine Type-	FIG-2	FIG-3	FIG-2
Power Units Available-	32	40	32

Weapons and Firing Data:

Beam Weapon Type-	FH-11	FH-11	FH-11
Number-	8	10	8
Firing Arcs-	2p, 2f, 2s, 2a	2f/p, 2f, 2f/s, 2p/a, 2s/a	1f/p, 2f, 1f/s, 2p/a, 2s/a
Firing Chart-	Y	Y	Y
Maximum Power-	10	10	10
Damage Modifiers			
+3	(1 - 10)	(1 - 10)	(1 - 10)
+2	(11 - 17)	(11 - 17)	(11 - 17)
+1	(18 - 24)	(18 - 24)	(18 - 24)
Beam Weapon Type-	FH-5		
Number-	8		
Firing Arcs-	4p, 4s		
Firing Chart-	R		
Maximum Power-	4		
Damage Modifiers			
+3			
+2	(1 - 8)		
+1	(9 - 16)		
Missile Weapon Type-	FP-4	FP-4	FP-4
Number-	4	6	6
Firing Arcs-	2f, 2a	1f, 2f/p, 2f/s, 1a	1f, 2f/p, 2f/s, 1a
Firing Chart-	S	S	S
Power To Arm-	1	1	1
Damage-	20	20	20

Shields Data:

Deflector Shield Type-	FSS	FSS	FSS
Shield Point Ratio-	1/4	1/4	1/4
Maximum Shield Power-	20	20	20

Defense Factor-	184.3	198	174.91
Weapon Damage Factor-	160.4	182	160.60

[<<<< GO BACK](#)

IMPORTANT NOTE:

It is entirely possible that you have surfed to this page from an internet portal and are now viewing this page without frames. **The STSSTCSMU&A is best viewed from within its own set of frames**, so [click here to jump to the main STSSTCSMU&A web page](#) and then [see the site as it was meant to be seen!](#)

GAGARIN CLASS SCIENCE VESSEL

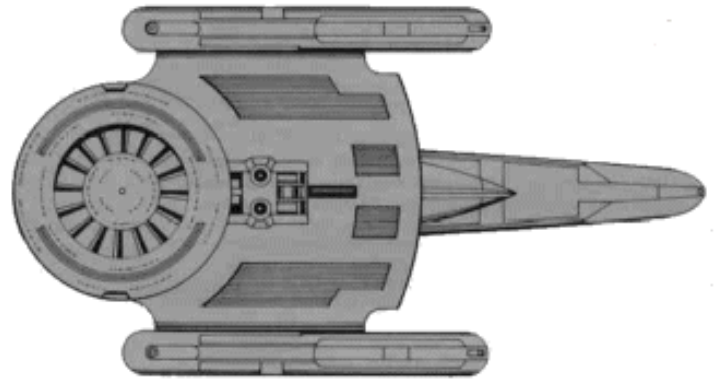
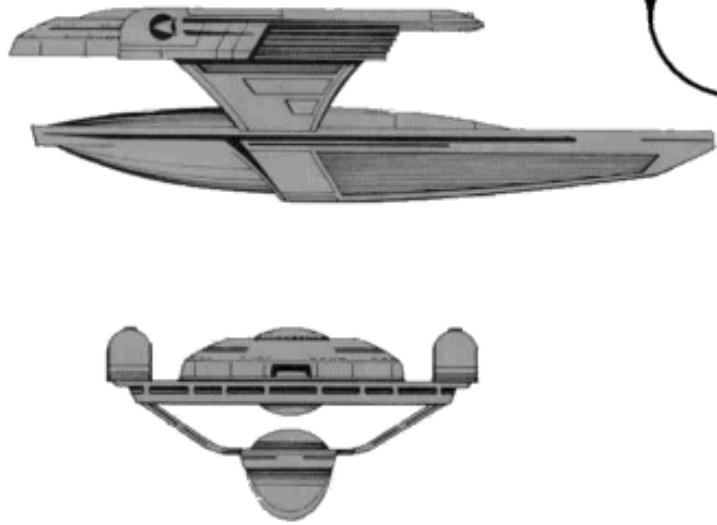

[Click here if you want to view this ship in its own window](#)



BRAD'S COMMENTS: Oddly, this is one of the two Federation designs that appears in the STSSTCS primary game manual and not in the UFP Ship Recognition Manual. It would later appear in the TNG Officers Manual as the Sagan class research vessel. I have listed it with the other Scouts even though the manuals never place it under that header, mainly because it serves little or no other use during game play. It lacks torpedoes, has almost no offensive capability, and is only good in game



play as a complimentary piece. Naturally, it is fun to use this piece in a re-play of the events of **Star Trek III** wherein a helpless Gagarin class comes under attack by Klingon forces, only to be rescued(?) by the *USS Enterprise*. Sure, sure, in the movie *USS Grissom* gets taken out long before Kirk ever gets there, but imagine if Kirk shows up at the same time? Anyway, that is just one scenario. But there can be many others, usually with the crux of the game revolving around protecting the Gagarin class from destruction or capture at enemy hands.

In official Trek canon this design is listed as the Oberth class, and makes its first appearance in **Star Trek III**, though it would make many appearances in **Star Trek: The Next Generation**. In all cases it seems to function as a smallish, lightly armed (unarmed?) science vessel that has a knack for getting into harm's way.

P.S: Thanks to [Bernard Guignard](#) for his scans of the ship and information from a previous edition of the game!



From the FASA Star Trek Starship Tactical Combat Simulator, circa 1983 - 1986

Gagarin Class V Science Vessel

Notes: The Gagarin class ships were designed for low-risk, intensive surveys of new worlds. Advances in warp drive shielding made it unnecessary for their low-yield warp nacelles to be mounted at an extended distance from the main hull. The engines remain detachable in case of emergency overload. Too undergunned to be used in frontier areas, the Gagarin class vessels only work deep in Federation-protected territory. Though they fulfilled their intended function, only 10 were constructed, as it was discovered that few surveys can truly be called 'low risk'. The *USS Grissom* was utterly destroyed with ease by an attacking Klingon K-22 'Bird of Prey' scout.

Construction Data:

Model Numbers-	MK I	Sagan Class (refit?)
Ship Class-	V	V
Date Entering Service-	2/1912	2/8502
Number Constructed	10	17

Hull Data:

Superstructure Points-	9	9
Damage Chart-	C	A
Size		
Length-	148 meters	180 meters
Width-	103 meters	105 meters
Height-	59 meters	62 meters
Weight-	41,000 tons	59,335 tons
Cargo		
Cargo Units-	100 unit	100 unit
Cargo Capacity-	5,000 tons	5,000 tons
Landing Capability-	none	none

Equipment Data:

Control Computer Type-	M-1	M-1
Transporters-		
Standard 6-person-	2	2
Combat 20-person-	none	none
Emergency 22-person-	1	5
cargo small-	1	2
cargo large-	none	2

Other Data:

Crew-	78	80
Passengers-	10	10
Shuttlecraft-	3	4

Engines and Power Data:

Total Power Units Available-	22	30
Movement Point Ratio-	2/1	2/1
Warp Engine Type-	FWB-1	FWB-2
Number-	2	2
Power Units Available-	9	12
Stress Charts-	M/O	M/O
Maximum Safe Cruising Speed-	Warp 7	Warp 8
Emergency Speed-	Warp 8	Warp 9
Impulse Engine Type-	FIB-2	FIB-3
Power Units Available-	4	6

Weapons and Firing Data:

Beam Weapon Type-	FH-1	FH-8
Number-	1	3 in two banks
Firing Arcs-	F	2f/p/s, 1a
Firing Chart-	F	T
Maximum Power-	2	5
Damage Modifiers	none	
+3		
+2		(1 - 10)
+1		(11 - 18)

Shields Data:

Deflector Shield Type-	FSB	FSF
Shield Point Ratio-	1/2	1/2
Maximum Shield Power-	6	10

Defense Factor-	53.8	92.87
Weapon Damage Factor-	0.5	12.90

[<<<< GO BACK](#)

IMPORTANT NOTE:

It is entirely possible that you have surfed to this page from an internet portal and are now viewing this page without frames. **The STSSTCSMU&A is best viewed from within its own set of frames**, so [click here to jump to the main STSSTCSMU&A web page](#) and then [see the site as it was meant to be seen!](#)

ANTON CLASS CRUISER

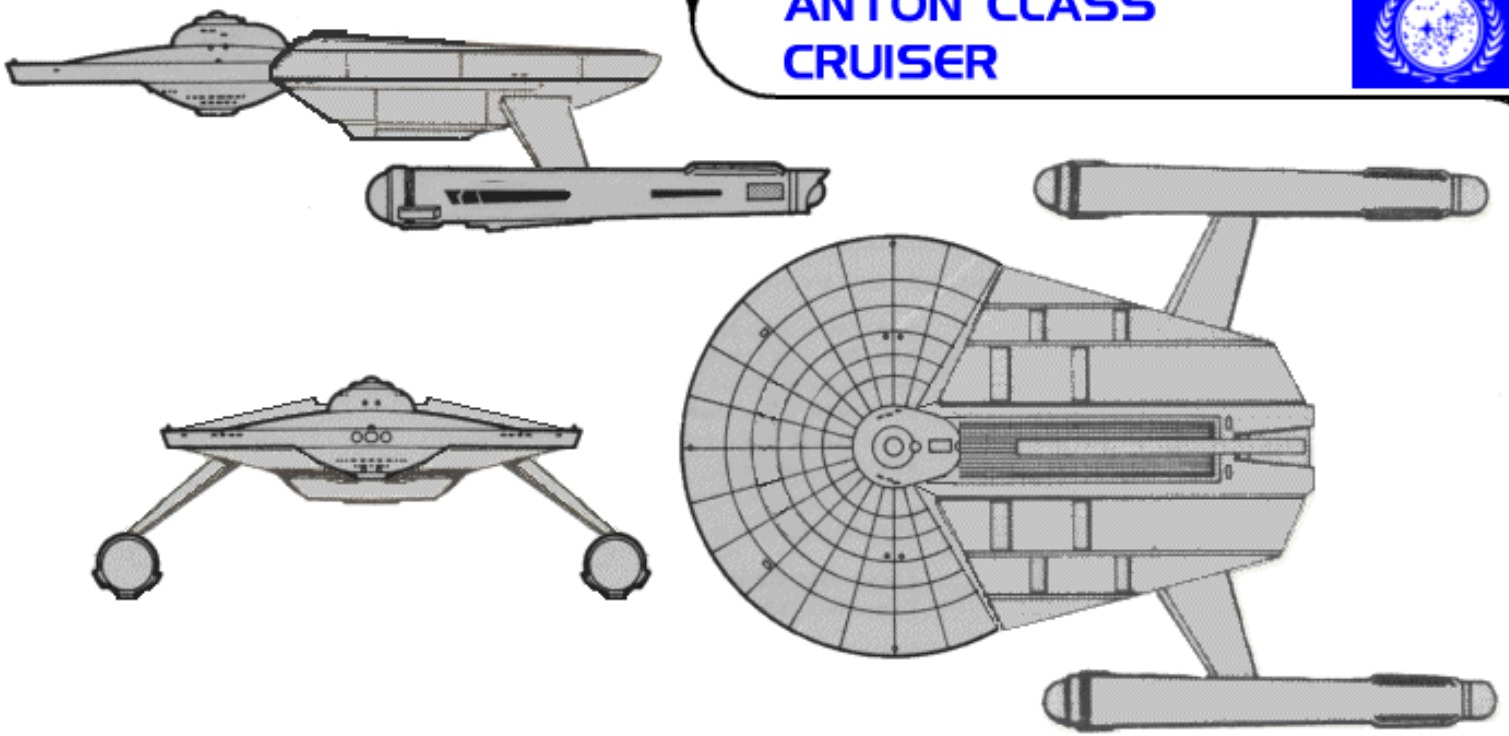

[Click here if you want to view this ship in its own window](#)

BRAD'S COMMENTS: The original concept for the Anton is pretty cool in my opinion; that being a TOS-era model of ship along the lines of the [USS Reliant](#) (first seen in **Star Trek II**) and which would be "refitted" in the same fashion as the [USS Enterprise](#) to become a whole new ship, known as the [Reliant class](#). This was back when FASA did not know that there would be no such thing as the [Enterprise class](#) cruiser or Reliant class cruiser, merely a Constitution Refit model and the Miranda/Soyuz models. My only major beef about the Anton's design as it appears in the book is the fact that the saucer dish is yet another carbon-copy off the Constitution Refit, but the nacelles are clearly TOS-era nacelles! They should have made the dish a TOS-era looking dish and kept the design aesthetics in line with all TOS-era Federation vessels from that time. For some weird reason they did not, either forgetting or just not caring. Humph!

Since this web site is my pet project, I decided I would make the extra effort that was not made at FASA, and re-do the Anton cruiser so that it looks like it *should* have looked originally. I cut and cropped pieces off of the [Constitution class](#) that I scanned in from the old Star Fleet Technical Manual and pasted them over the original ship as scanned in from the FASA manual. A little cleaning up, and voila, the Anton as she was supposed to look, right down to the TOS-era saucer and everything. (see my rendition of the Anton above.)

At right you can see a smaller scan of the Anton as she *originally* looked in the book. The saucer is all wrong, the lower secondary hull has no symmetry, and so forth. They even have the warp nacelles *upside down* in the FASA book when those warp nacelles should clearly be *right-side-up*!

In game play, the Anton does okay so long as the ship is not faced with torpedo-armed opponents. Square this ship off against opponents from a similar era, lacking beam weapons, and the Anton performs pretty well, mainly thanks to the strong superstructure and decent engines. The older-model [Klingon D-7 cruisers](#) make very good opponents for the Anton, since each class is using only beam weapons and each class has a similar amount of superstructure and power output. The Anton also does well against older Romulan cruisers. The shields could really use some help, but other than that there is not much to whine about.

I have enjoyed using this vessel as a companion to the sister Constitution class, with one Constitution entering a hostile area accompanied by one or two Antons. The Constitution has the torpedoes to do the lion's share of the damage, while the Antons can act as distractions, zooming in to deliver phaser blows and absorbing enemy fire while the Constitution can chuck torpedoes into the fray. You'll probably lose at least one Anton, but the ship is sturdy enough to act as a buffer between the Constitution and the enemy, allowing the Federation player to (usually) win the day.

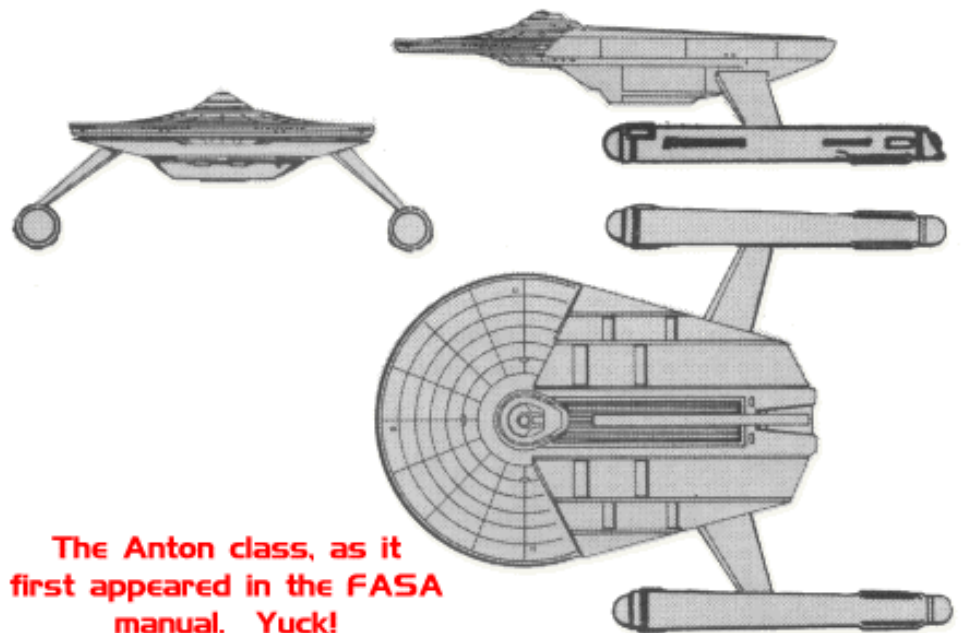

From the FASA Star Trek FEDERATION SHIP RECOGNITION MANUAL, circa 1985

Anton Class X Science Cruiser

Notes: First commissioned on Stardate 1/8704 during the period known as "The Great Awakening", the Anton Class cruiser was in the forefront of that expansion effort. At the time, Star Fleet itself was expanding in response to the changing and expanding economic and political goals of the UFP. To meet the demand of a larger navy, the Military Appropriations Committee authorized the development and testing of hundreds of vessel types, the Anton among them.

During this same period, the concepts of ship design were rapidly evolving and becoming more sophisticated, and the technology to build and operate starships was going through an industrial revolution. Advances in all facets of the technology required to construct, maintain, and operate a starship was changing so rapidly that some ships were obsolete before they were completed. The Anton design was changed no fewer than 12 times before the tooling and machining was begun. Even so, the ship required some alterations during its trials and was to see many more changes after its commissioning, the last of which was the refitting to the Reliant Class.

When these new cruisers were launched, they were only capable of performing 3-year missions with re-supply at 1-year intervals. This made their dual-purpose role of research cruiser harder to perform. With the great distances that had to be traveled, they could not get more than 6-months travel time from a friendly outpost. This meant they could only advance as fast as the frontier was expanding.

Construction Data:

Model Numbers-	MK I	MK II	MK IV
Ship Class-	X	X	X
Date Entering Service-	1/8704-2/1002	1/9702-2/1410	2/1210
Number Constructed	68	56	12

Hull Data:

Superstructure Points-	16	18	18
Damage Chart-	C	C	C
Size			
Length-	224 meters	226 meters	226 meters
Width-	145 meters	145 meters	145 meters
Height-	51 meters	51 meters	51 meters
Weight-	147,800 tons	150,000 tons	149,200 tons
Cargo			
Cargo Units-	300 units	300 units	300 units
Cargo Capacity-	15,000 tons	15,000 tons	15,000 tons
Landing Capability-	None	None	None

Equipment Data:

Control Computer Type-	M-3	M-4	M-4
Transporters-			
Standard 6-person-	4	4	4
Combat 20-person-	None	None	None
Emergency 22-person-	2	3	3
cargo-	2	2	2

Other Data:

Crew-	290	295	306
Passengers-	40	40	40
Shuttlecraft-	4	4	4

Engines and Power Data:

Total Power Units Available-	35	38	46
Movement Point Ratio-	3/1	3/1	4/1
Warp Engine Type-	FWC-1	FWC-1	FWC-2
Number-	2	2	2
Power Units Available-	16	16	20
Stress Charts-	O/M	O/M	N/M
Maximum Safe Cruising Speed-	Warp 7	Warp 7	Warp 6
Emergency Speed-	Warp 9	Warp 9	Warp 8
Impulse Engine Type-	FIC-2	FIC-3	FIC-3
Power Units Available-	3	6	6

Weapons and Firing Data:

Beam Weapon Type-	FL-5	FH-3	FH-10
Number-	4 in two banks	4 in two banks	4 in two banks
Firing Arcs-	2f/p, 2f/s	2f/p, 2f/s	2f/p, 2f/s
Firing Chart-	H	W	W
Maximum Power-	2	5	7
Damage Modifiers			
+3		(1 - 10)	(1 - 10)
+2	(1 - 4)	(11 - 17)	(11 - 17)
+1	(5 - 7)	(18 - 20)	(18 - 20)

Shields Data:

Deflector Shield Type-	FSG	FSH	FSH
Shield Point Ratio-	1/1	1/2	1/2
Maximum Shield Power-	9	11	11

Defense Factor-	52.9	78.7	76.7
Weapon Damage Factor-	4.4	23.2	38.8

[<<<< GO BACK](#)

IMPORTANT NOTE:

It is entirely possible that you have surfed to this page from an internet portal and are now viewing this page without frames. **The STSSTCSMU&A is best viewed from within its own set of frames**, so [click here to jump to the main STSSTCSMU&A web page](#) and then [see the site as it was meant to be seen!](#)

MAKIN CLASS ASSAULT SHIP

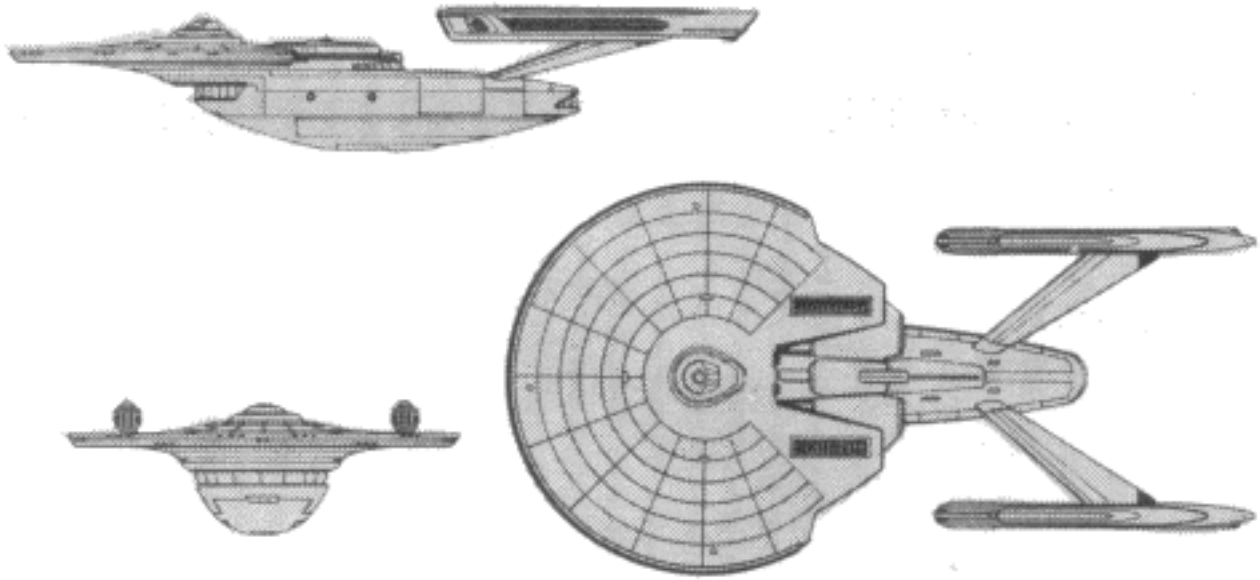

[Click here if you want to view this ship in its own window](#)

BRAD'S COMMENTS: Like the majority of the ships in the UFP recognition manual, this one borrows much from the [Enterprise Class](#) cruiser design, both in terms of the saucer section and in terms of the warp nacelles, as well as the overall primary/secondary hull configuration. Like many assault ships, the Makin doesn't have much to offer a gamer in the way of firepower, nor can it stand up to much punishment. A relatively weak superstructure and low-power shields make it vulnerable to all but the lightest of enemy vessels. But you don't want to include this ship in a game scenario unless you're trying to take a planet, in which case I suggest burying it as far behind a defensive screen of frigates, cruisers, and destroyers as you possibly can. Once the shooting starts the Makin's phaser-only weaponry isn't good for much more than half-hearted self defense. But if it comes down to Makins being forced to defend themselves, it's probably too late. The only exception might be if you pit the Makin against other weak assault ship(s), in which case the matches are fairly even and, if played well, fairly interesting.



From the FASA Star Trek FEDERATION SHIP RECOGNITION MANUAL, circa 1985

Makin Class VII Assault Ship

Notes: The Makin Class assault ship can beam down its compliment of 1,800 marines, 9 heavy tanks and 32 light support vehicles in 25 minutes, slightly less rapidly than the Continent Class vessel. The Makin is produced at the Tellar and Salazaar shipyards, with a combined annual production rate of 14 per year. Of the 68 Makin Class ships built, 64 remain in active service, 1 is used by Star Fleet Training Command, 1 has been destroyed, and 1 has been scrapped.

Construction Data:

Model Numbers-	MK II
Ship Class-	VII
Date Entering Service-	2/1712
Number Constructed	68

Hull Data:

Superstructure Points-	11
Damage Chart-	C
Size	
Length-	180 meters
Width-	95 meters
Height-	35 meters
Weight-	102,200 tons
Cargo	
Cargo Units-	600 units
Cargo Capacity-	30,000 tons
Landing Capability-	None

Equipment Data:

Control Computer Type-	M-2
Transporters-	
Standard 6-person-	4
Combat 20-person-	6
Emergency 22-person-	2
cargo small-	4
cargo large-	2

Other Data:

Crew-	38
Troops-	1,800
Shuttlecraft-	2

Engines and Power Data:

Total Power Units Available-	20
Movement Point Ratio-	3/1
Warp Engine Type-	FWE-1
Number-	2
Power Units Available-	8
Stress Charts-	G/K
Maximum Safe Cruising Speed-	Warp 7
Emergency Speed-	Warp 9
Impulse Engine Type-	FIB-2
Power Units Available-	4

Weapons and Firing Data:

Beam Weapon Type-	FH-2
Number-	4
Firing Arcs-	2f/p, 2f/s
Firing Chart-	H
Maximum Power-	3
Damage Modifiers	
+3	
+2	
+1	(1 - 10)

Shields Data:

Deflector Shield Type-	FSD
Shield Point Ratio-	1/2
Maximum Shield Power-	7

Defense Factor-	44.7
------------------------	------

Weapon Damage Factor-	5.2
------------------------------	-----

[<<<< GO BACK](#)

IMPORTANT NOTE:

It is entirely possible that you have surfed to this page from an internet portal and are now viewing this page without frames. **The STSSTCSMU&A is best viewed from within its own set of frames**, so [click here to jump to the main STSSTCSMU&A web page](#) and then [see the site as it was meant to be seen!](#)

CONTINENT CLASS ASSAULT SHIP

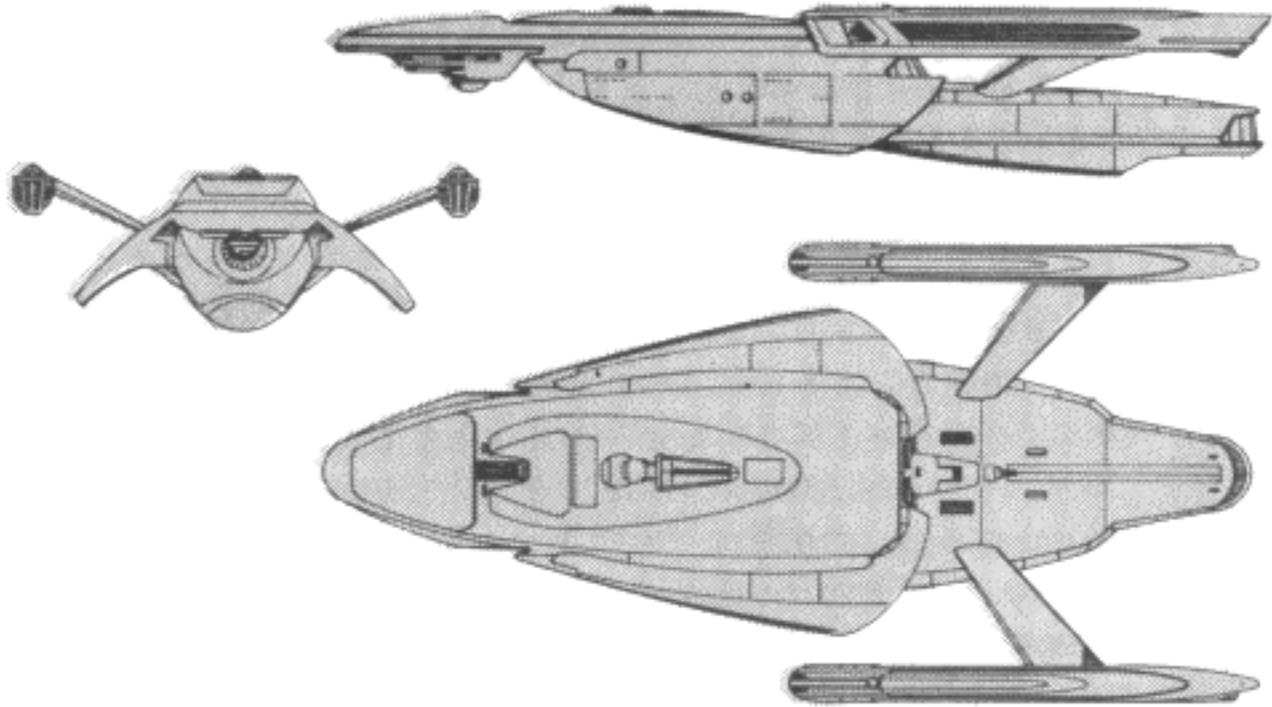

[Click here if you want to view this ship in its own window](#)

BRAD'S COMMENTS: I've always liked the look of the Continent assault ship, if only because it departs markedly from the typical saucer-shaped hull design. With an almost predatory appearance, the Continent is a better fighting ship than its lighter cousin, the [Makin](#). The Continent doesn't pack more firepower necessarily, but it has better superstructure and twice as much power available for weapons and movement. In game play the Continent is at least twice as mobile as the Makin, often able to avoid ship-to-ship melees with speed instead of always having to hide behind a flotilla of friendly vessels. When it comes time to take a planet, the Continent also has a lot more troops, making it more effective in numbers.



From the FASA Star Trek FEDERATION SHIP RECOGNITION MANUAL, circa 1985

Continent Class IX Assault Ship

Notes: A typical Continent Class assault ship can beam down its contingent of 3,200 marines, 16 heavy tanks, and 50 light support vehicles in 30 minutes, insuring fast response when arriving at a planetary trouble-spot. The Continent is produced at Sol II at a rate of 12 per year. Of the 60 Continent Class ships built, 58 remain in active service, 1 is used by Star Fleet Training Command, and 1 has been scrapped.

Construction Data:

Model Numbers-	MK I
Ship Class-	IX
Date Entering Service-	2/1801
Number Constructed	60

Hull Data:

Superstructure Points-	15
Damage Chart-	C
Size	
Length-	245 meters
Width-	175 meters
Height-	45 meters
Weight-	129,900 tons
Cargo	
Cargo Units-	1,000 units
Cargo Capacity-	50,000 tons
Landing Capability-	None

Equipment Data:

Control Computer Type-	M-3
Transporters-	
Standard 6-person-	6
Combat 20-person-	8
Emergency 22-person-	4
cargo small-	6
cargo large-	2

Other Data:

Crew-	62
Troops-	3,200
Shuttlecraft-	6

Engines and Power Data:

Total Power Units Available-	40
Movement Point Ratio-	3/1
Warp Engine Type-	FWD-2
Number-	2
Power Units Available-	18
Stress Charts-	M/G
Maximum Safe Cruising Speed-	Warp 5
Emergency Speed-	Warp 7
Impulse Engine Type-	FID-2
Power Units Available-	4

Weapons and Firing Data:

Beam Weapon Type-	FH-2
Number-	6
Firing Arcs-	2f/p, 2f, 2f/s
Firing Chart-	H
Maximum Power-	3
Damage Modifiers	
+3	
+2	
+1	(1 - 10)

Shields Data:

Deflector Shield Type-	FSD
Shield Point Ratio-	1/2
Maximum Shield Power-	7

Defense Factor-
Weapon Damage Factor-

68.5
7.8

[<<<< GO BACK](#)

IMPORTANT NOTE:

It is entirely possible that you have surfed to this page from an internet portal and are now viewing this page without frames. **The STSSTCSMU&A is best viewed from within its own set of frames**, so [click here to jump to the main STSSTCSMU&A web page](#) and then [see the site as it was meant to be seen!](#)

KOLM-AN CLASS ASSAULT SHIP

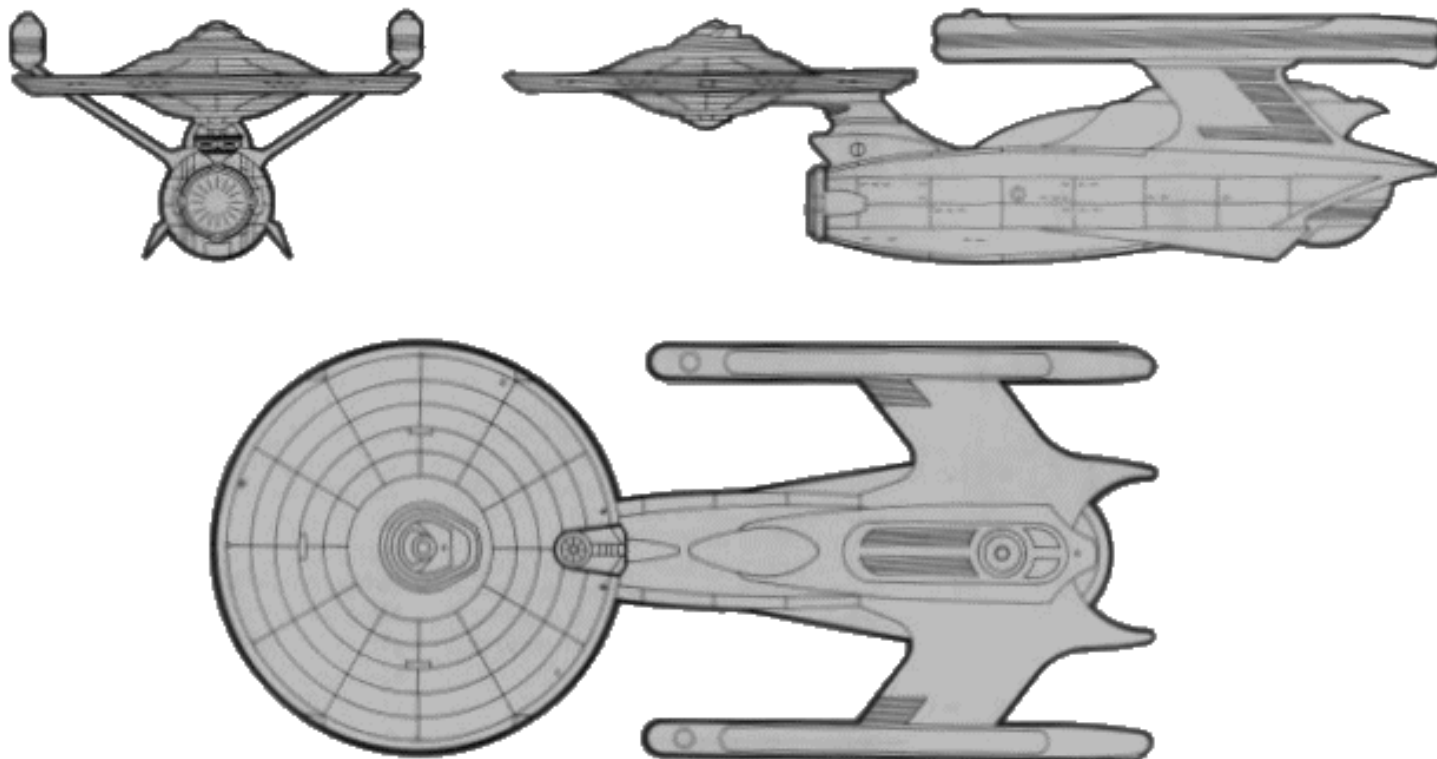

[Click here if you want to view this ship in its own window](#)

BRAD'S COMMENTS: This is a rare class that was not included in the FASA Ship Recognition Manuals. Many thanks to [Gary Perry](#) for digging it up out of the old, now-defunct Star Trek Stardate Magazine (once officially endorsed by FASA). This class is but one of several such ships that Gary has kindly submitted to the MU&A, almost all of which came under the Stardate Magazine header "Jaynz Ships of the Galaxy", an obvious nod to the real [Janes](#) military hardware information service.



From **STARDATE MAGAZINE**, courtesy of contributor [Gary Perry](#)

Class design by J.M. Kuzee and Pete Rogan

Kolm-An Class VIII Assault Ship

NOTES: "Muscular" is the word used to describe the formidable Kolm-An assault ship. The Makin and Continent classes carry more men and equipment, but the Kolm-An carries a heftier load of shipboard weaponry, the better to provide its landed troops with fire support from orbit.

The Kolm-An class was designed to transport up to a company of Federation marines, their vehicles and equipment, to land them on a hostile world via transporters and/or assault shuttlecraft; to provide all their support needs for up to 30 standard solar days without re-supply, and to hold off minor counterattacks, all of this without aid or support from accompanying Star Fleet vessels.

Star Fleet felt it necessary to have such ships as the Kolm-An class to provide swift deployment of needed defensive forces at short notice along the Klingon and Romulan Neutral Zones. Unlike the larger assault ships, Kolm-An need not be based or restricted to limited patrol routes, or provided with extensive escort and support ships, all of which increase response time. To deal with the threat of deliberate invasion or even sudden raids on Federation or neutral worlds on the frontier, the best course was to place single companies of Marines on constant combat patrol, and the best way to do that was to build a

ship capable of holding its own with a minimum of external aid.

The Kolm-An can land its troops combat-ready, in approximately ten minutes from 'go'. Its dual-purpose Combat Information Center on the bridge coordinates reports from the ground and monitors the space situation. The ground commander can order phaser or photon torpedo bombardment with pin-point accuracy in less than thirty seconds from the receipt of the fire order, evaluate the overall terrain with spaceborne sensors to determine the local threat, and ensure backup communications control with the aid of the Kolm-An's sophisticated track-and-comm station.

For quick insertions and rapid extractions, the Kolm-An has no equal on either side of the frontier. But its mission profile demands that the local threat be conclusively dealt with in thirty minutes before the ship's orbit carries it beyond the battle zone. Some Marine commanders have extended their combat ability by landing as much as an orbit ahead of time, and attacking the objective only as the Kolm-An arrives above the Horizon (ATH). Time and circumstances do not always permit this, though standard orders always explicitly grant Marine commanders the option to retreat from too large a threat. Only once has a Kolm-An retreated before landing its forces. Apparently the Marines can adapt to fighting for extended period with only sporadic orbital support.

Kolm-An are being built at the rate of 16 per year at the Salazaar, Sol II and Star Base 12 shipyards. Of the 39 Kolm-An class vessels built, 34 remain in active service. of the remainder, 2 are used by Star Fleet Training Command, 2 have been scrapped, and 1 has been destroyed.

Construction Data:

Model Numbers-	MK I
Ship Class-	VIII
Date Entering Service-	2/2003
Number Constructed	39

Hull Data:

Superstructure Points-	19
Damage Chart-	C
Size	
Length-	212 meters
Width-	93 meters
Height-	54 meters
Weight-	117,838 tons
Cargo	
Cargo Units-	350 units
Cargo Capacity-	17,500 tons
Landing Capability-	None

Equipment Data:

Control Computer Type-	M-3
Transporters-	
Standard 6-person-	4
Combat 20-person-	4
Emergency 22-person-	2
cargo large-	4
cargo small-	2

Other Data:

Crew-	30
Troops-	350
Passengers-	none
Shuttlecraft-	4

Engines and Power Data:

Total Power Units Available-	36
Movement Point Ratio-	3/1
Warp Engine Type-	FWE-2
Number-	2
Power Units Available-	12
Stress Charts-	G/K
Maximum Safe Cruising Speed-	Warp 7
Emergency Speed-	Warp 9
Impulse Engine Type-	FIF-1
Power Units Available-	12

Weapons and Firing Data:

Beam Weapon Type-	FH-12
Number-	6 in three banks
Firing Arcs-	2f, 2f/p, 2f/s
Firing Chart-	R
Maximum Power-	6
Damage Modifiers	
+3	
+2	(1 - 9)
+1	(10 - 16)
Missile Weapon Type-	FP-7
Number-	4 in one bay
Firing Arcs-	4f
Firing Chart-	R
Power To Arm-	1
Damage-	8

Shields Data:

Deflector Shield Type-	FSI
Shield Point Ratio-	1/2
Maximum Shield Power-	13

Defense Factor- 86.4

Weapon Damage Factor- 67.8

[<<<< GO BACK](#)

IMPORTANT NOTE:

It is entirely possible that you have surfed to this page from an internet portal and are now viewing this page without frames. **The STSSTCSMU&A is best viewed from within its own set of frames**, so [click here to jump to the main STSSTCSMU&A web page](#) and then [see the site as it was meant to be seen!](#)

GALAXY CLASS HEAVY CRUISER

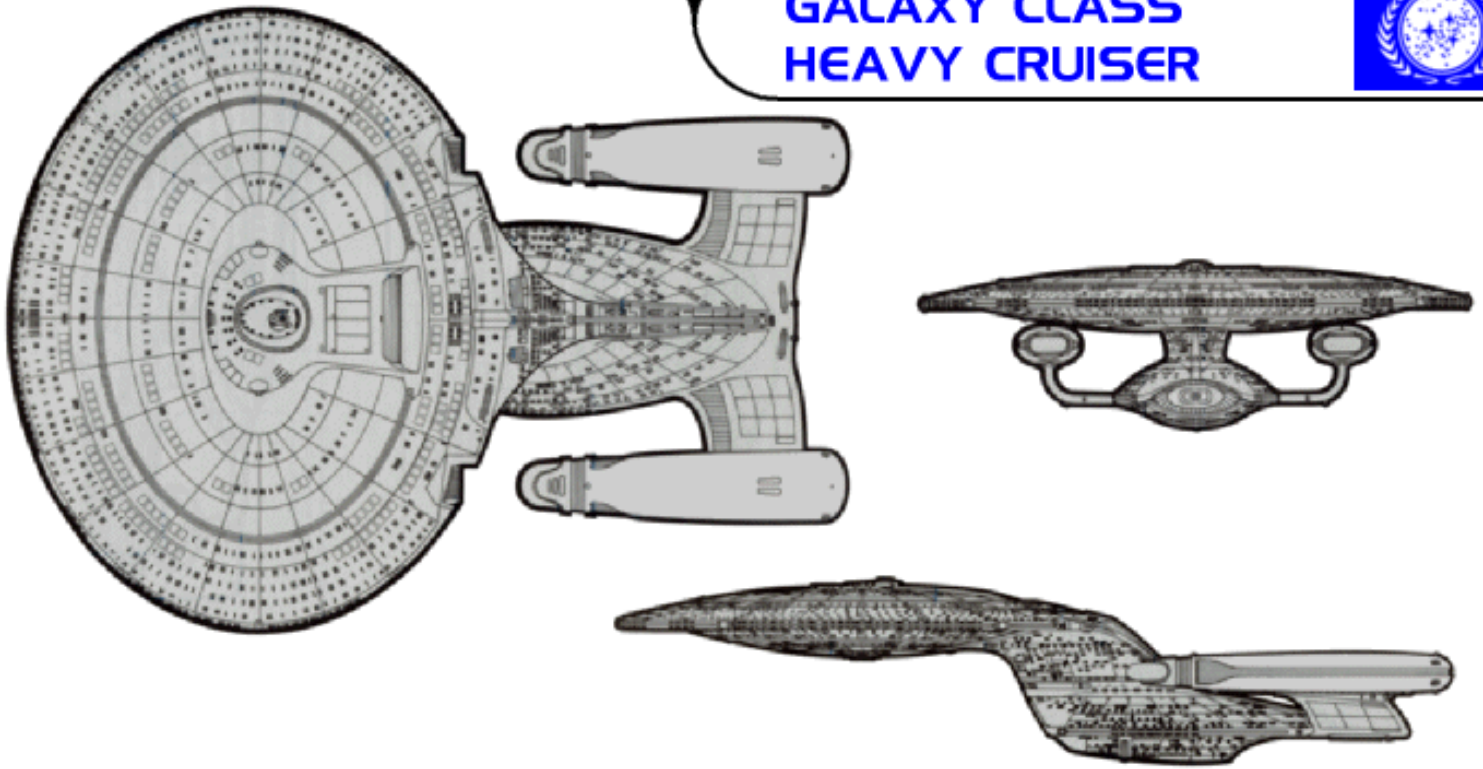

[Click here if you want to view this ship in its own window](#)

BRAD'S COMMENTS: I'll be honest, I totally hated the look of the NCC-1701-D when it first debuted during the first season of **ST:TNG**. I mean, I really, really, really HATED this design. It seemed to violate ALL of the neat industrial design aesthetic set down with the [Constitution Refit](#). The saucer of the Galaxy was not circular, was completely too large for the secondary hull, the warp engines were in the wrong place, shaped wrong in the first place, the secondary hull was smushed and the deflector not circular, and so on and so forth. The whole thing... Blech! I detested it. I mean, I really struggle to make it clear to you guys how much I *barfed* at the Galaxy class design. It took me YEARS to get over it! As much as I recoiled over the initial [Excelsior design](#), the Galaxy design rubbed me wrong a hundred times worse. Really.

Having said all this, the Galaxy class and its new-agey organic design aesthetic have grown on me over the last 15 years. Grudgingly, haltingly, I have come to recognize this design as being perhaps one of the most beautiful among all Enterprise designs. Perhaps the most beautiful of all? Like any acquired taste, it took me awhile to come around to seeing this class with some fresh eyes. Not exactly a fan of the [TOS-era Enterprise](#), the TMP-era Refit design was, for me, the ultimate Star Trek ship in the 1980's. In fact, I still have to rank the Constitution Refit as my all-time favorite, though I readily acknowledge that the Galaxy class probably surpasses the Constitution in not just complexity, but artistry. The Galaxy also provides us with a template for the Starfleet ships of the 24th century, replicated and imitated again and again from the [Nebula class](#) to the [Intrepid](#), and beyond. Just like the TMP-era Enterprise, and the TOS-era Enterprise before that.



In the STSSTCS the Galaxy class is the king of all the original FASA Federation ships. More superstructure, more energy, more weapons. The ship is truly a cut above all the rest, especially offensively, which both does and does NOT make sense considering that this ship carries civilian families onboard and is designated as an explorer, not a fighter. I have often thought that, in the real world, if a ship like the Galaxy were ever built she would not rely on a tremendous amount of onboard weaponry, but rather would save such energy and space for science equipment and bunking for personnel, leaving the brunt of offense and defense to a companion fleet of frigates and destroyers. Indeed, from a realistic point of view, the NCC-1701-D should have NEVER gone into the great unknown unaccompanied! It should have its own small fleet of support ships. When the United States Navy sends an Iowa-class battleship to sea, does the battleship go all by itself? How about a carrier?? See what I mean???

Anyway, what's done is done. The Galaxy class, as built by FASA, is a super-tough hombre of a ship. I have created a new mark, improving on the original Mark I model, which makes the ship even more tough, approaching the toughness of the ultra-recent [Sovereign class heavy cruisers](#) that picked up where the Galaxy and Nebula classes left off. Like most of the Enterprise designs, the Galaxy gets a huge amount of screen time and, for this reason alone, is more likely to be involved in fan scenarios than most other ships. The most obvious being pitting a Galaxy versus a [D'Daridex](#), or a Galaxy versus the [Klingon Vor'cha](#) or the [KDF-2](#). Maybe the [Ferengi Marauder](#)?



One odd thing to note is that the Star Trek TNG Technical Manual by Rick Sternbach indicates that the stardrive and saucer have consolidated torpedo launchers that are "rapid fire" in operation. Instead of multiple torpedo banks being spread across the ship, the stardrive mounts a single torpedo bay forward and a single bay aft, and each bay is capable of delivering multiple-shot volleys in a single stroke thanks to rapid-fire automation built into the launchers themselves. This

is certainly an advancement over Kirk-era manual and semi-automatic torpedo loading, as seen in **Star Trek II** and **Star Trek VI**. But for game coherency I have continued to rely upon the old FASA system wherein torpedoes are listed individually. Same goes for the phasers, which are technically no longer mounted in banks but are instead mounted into the hull in long, thin collimating "strips" that have fields of fire on the order of 180 degrees to 360 degrees. The TNG Tech Manual states that these collimated strips are actually made up of hundreds of small phaser points set side by side, but it's ridiculous to assume that the Galaxy actually has hundreds of phasers at its command. Easier to just write out the stats in practical game terms, defining firing arcs in degrees if necessary.

Finally, doing the stats for the Galaxy was tricky because the Galaxy is essentially two complete starships in one package. The stardrive and saucer sections are fully equipped and capable of operating independently of one another, even at warp. Each has independent weaponry, power, superstructure, and so forth. Yet 99.7% of the time the two ships are joined as ONE SHIP. So, below, things look a little weird. I have posted stats for the stardrive, the saucer, and then combined stats for the entire ship taken as a single whole. I hope nobody gets too confused.



Construction Data:

Model Numbers-	MK I	MK II *
Ship Class-	XVI	XVII
Date Entering Service-	3/0301	2372 A.D.
Number Constructed	7	32

Hull Data:

Superstructure Points-	saucer 38, stardrive 60, total 98	saucer 42, stardrive 64, total 106
Damage Chart-	C	C
Size		
Length-	642.5 meters	642.5 meters
Width-	467 meters	467 meters
Height-	137.5 meters	137.5 meters
Weight-	397,805 tons	417,000 tons
Cargo		
Cargo Units-	500 units	500 units
Cargo Capacity-	25,000 tons	25,000 tons
Landing Capability-	None	None

Equipment Data:

Control Computer Type-	M-8A Duotronics AICS	MBT-12
Transporters-		
Standard 6-person-	20	20
Emergency 22-person-	?	16
cargo large-	3	3
cargo small-	5	5

Other Data:

Crew-	900+	850
Troops-	none	none
Passengers/Civilians-	800 max, 300 standard	800 max, 300 standard
Shuttlecraft-	44	44

Engines and Power Data:

Total Power Units Available-	saucer 32, stardrive 120, total 152	saucer 41, stardrive 132, total 173
Movement Point Ratio-	saucer 4/1, stardrive 7/1, total 7/1	saucer 4/1, stardrive 6/1, total 8/1
Warp Engine Type-	saucer FWH-1B, stardrive FVWA-1	saucer FNWD-2A, stardrive FNWD-4B
Number-	saucer 1, stardrive 2	saucer 1, stardrive 2
Power Units Available-	saucer 16, stardrive 40 each	saucer 23, stardrive 44 each, total 111
Stress Charts-	saucer L/F, stardrive E/F	saucer L/M, stardrive K/F
Maximum Safe Cruising Speed-	saucer 5, stardrive 8	saucer 5, stardrive 8
Emergency Speed-	saucer 7, stardrive 9.9	saucer 7, stardrive 9.9
Impulse Engine Type-	saucer FIF-2, stardrive FIG-3	saucer FNIS-110, stardrive FNIS-400
Power Units Available-	saucer 16, stardrive 40, total 56	saucer 18, stardrive 44, total 62

Weapons and Firing Data:

Beam Weapon Type-	FH-15, saucer	FAHW-24, saucer
Number-	8, spread across collimated 'strip'	8, spread across collimated 'strip'
Firing Arcs-	300+ degrees, all arcs at all times	300+ degrees, all arcs at all times
Firing Chart-	Y	V
Maximum Power-	12	16
Damage Modifiers		
+3	(1 - 11)	(1 - 8)
+2	(12 - 20)	(9 - 15)
+1	(21 - 24)	(16 - 21)
Beam Weapon Type-	FH-10, stardrive	FAHW-28, stardrive
Number-	16 in 4 banks	8 in 4 banks
Firing Arcs-	4f, 4f/p, 4f/s, 4a	2f/s, 2f/p, 2a/s, 2a/p
Firing Chart-	W	X
Maximum Power-	7	20
Damage Modifiers		
+3	(1 - 10)	(1 - 10)
+2	(11 - 17)	(10 - 16)
+1	(18 - 20)	(17 - 22)
Missile Weapon Type-	FP-10, saucer	FP-15, saucer
Number-	4	3
Firing Arcs-	4f/p/s	3f/p/s
Firing Chart-	S	W
Power To Arm-	1	3
Damage-	20	25
Missile Weapon Type-	FP-10, stardrive	FQT-7, stardrive
Number-	16	7
Firing Arcs-	4f/p/s, 4p, 4s, 4a	3f, 1f/p, 1f/s, 2a
Firing Chart-	S	Y
Power To Arm-	1	5
Damage-	20	34
Shields Data:		
Deflector Shield Type-	FSQ, saucer	NGSS-ON, saucer
Shield Point Ratio-	1/4	1/5
Maximum Shield Power-	16	25
Deflector Shield Type-	FSQ, stardrive	NGSS-O, stardrive
Shield Point Ratio-	1/4	1/5
Maximum Shield Power-	16	30
Defense Factor-	300+ (est)	Holy Cow!!
Weapon Damage Factor-	200+ (est)	Kaboom!!!

* Denotes completely hypothetical model number and stats, devised by Brad R. Torgersen.

[<<<< GO BACK](#)

IMPORTANT NOTE:

It is entirely possible that you have surfed to this page from an internet portal and are now viewing this page without frames. **The STSSTCSMU&A is best viewed from within its own set of frames**, so [click here to jump to the main STSSTCSMU&A web page](#) and then [see the site as it was meant to be seen!](#)

EXCELSIOR (refit) BATTLECRUISER

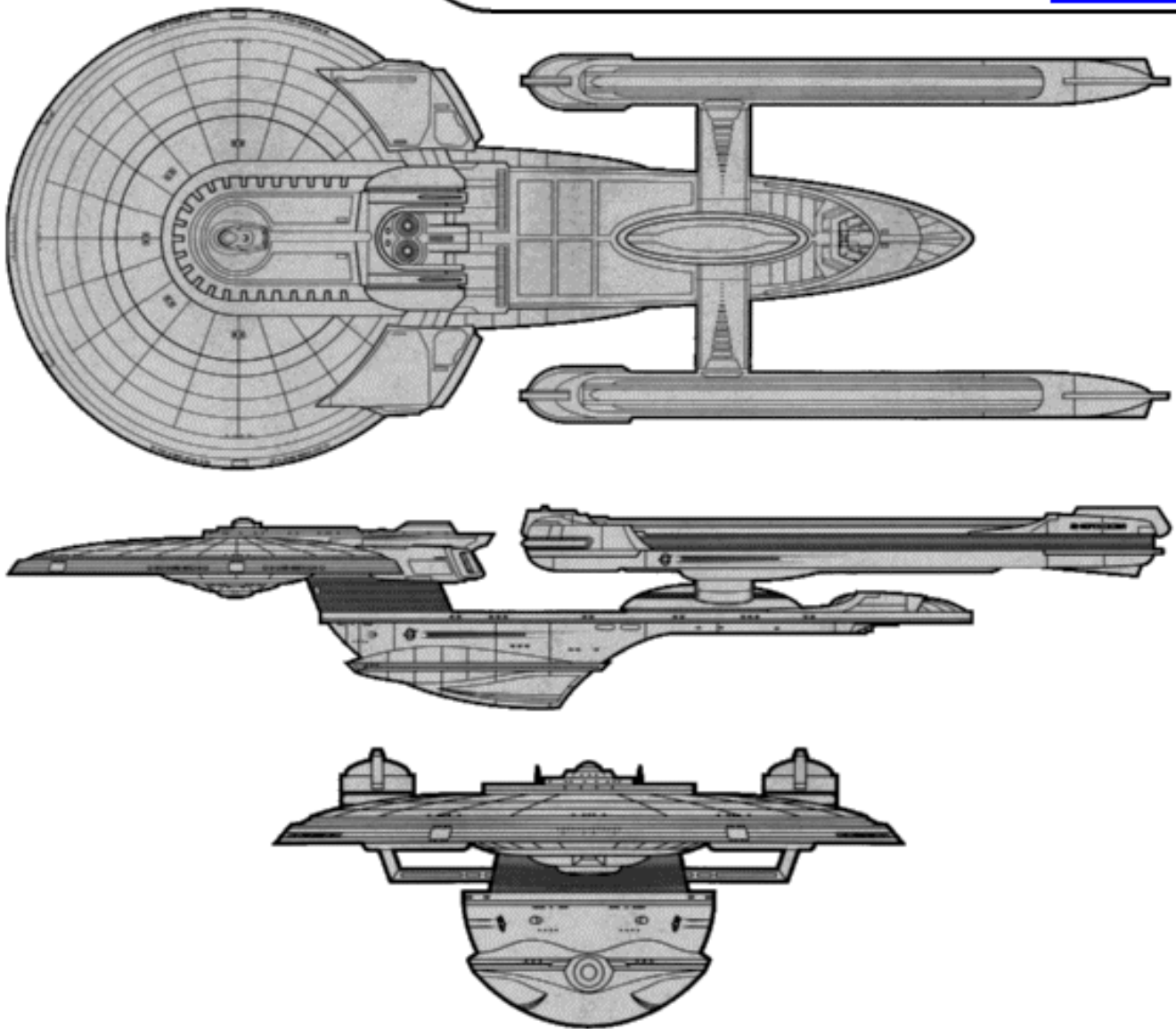

[Click here if you want to view this ship in its own window](#)

BRAD'S COMMENTS: This is one of those designs that the original writers at FASA never imagined. It was fairly safe to assume that the NCC-1701-B Enterprise was going to be an Excelsior model, especially after it was made apparent in the first season of TNG that the Excelsior class had a very long life in Starfleet. But in retrospect it seems silly to think the Excelsior class would go 75 years without a significant refit. Even the Constitution class did not last that long without a major overhaul.

The stats listed below for the Excelsior Refit are of my own devising, and I've tried to base them as much as I can on what little I know about official Trek canon regarding this design. I've also tried to limit the firepower and structural strength of the older models so that, yes, they are improved over the original Excelsior, but still modest enough to reflect their aged nature by the time of ships like the [Galaxy](#) and [Sovereign](#) class. Conversely the later models are almost as potent as the Galaxy class, and allow the Excelsior Refit to retain its role as a front-line cruiser in Starfleet, taking part in all the heavy action, as is often seen in **ST:TNG** and **ST:DS9**.



Construction Data:

Model Numbers-	MK IV *	MK V *	MK VI *	MK VII *
Ship Class-	XIV	XIV	XIV	XIV
Date Entering Service-	2293 A.D.	2315 A.D.	2332 A.D.	2357 A.D.
Number Constructed	N/A	N/A	N/A	N/A

Hull Data:

Superstructure Points-	45	48	51	56
Damage Chart-	C	C	C	C
Size				
Length-	470 meters	472 meters	472 meters	474 meters
Width-	188 meters	188 meters	188 meters	190 meters
Height-	81 meters	81 meters	84 meters	84 meters
Weight-	244,310 tons	250,100 tons	253,200 tons	262,400 tons
Cargo				
Cargo Units-	200 units	200 units	200 units	250 units
Cargo Capacity-	10,000 tons	10,000 tons	10,000 tons	12,500 tons
Landing Capability-	None	None	None	None

Equipment Data:

Control Computer Type-	M-9A	MBT-08	MBT-09	MBT-10
Transporters-				
Standard 6-person-	7	7	7	7
Emergency 22-person-	6	6	6	6
cargo-	4	4	4	5

Other Data:

Crew-	780	760	720	695
Troops-	50	50	50	50
Shuttlecraft-	20	20	20	20

Engines and Power Data:

Total Power Units Available-	145	155	158	160
Movement Point Ratio-	6/1	7/1	7/1	6/1
Warp Engine Type-	FESW-2	FESW-3	FESW-3	FNWD-5B
Number-	2	2	2	2
Power Units Available-	55	60	60	60
Stress Charts-	D/F	D/F	D/F	F/K
Maximum Safe Cruising Speed-	Warp 7	Warp 7	Warp 7	Warp 8
Emergency Speed-	Warp 9.9	Warp 9.9	Warp 9.9	Warp 9.9
Impulse Engine Type-	FNIS-300	FNIS-300	FNIS-320	FNIS-330
Power Units Available-	35	35	38	40

Weapons and Firing Data:

Beam Weapon Type-	FH-11	FH-11	FAHW-22	FAHW-22
Number-	6	6	8	8
Firing Arcs-	2p, 2f, 2s	2p, 2f, 2s	2p, 2f, 2s, 2p/s/a	2p, 2f, 2s, 2p/s/a
Firing Chart-	Y	Y	U	U
Maximum Power-	10	10	14	14
Damage Modifiers				
+3	(1 - 10)	(1 - 10)	(1 - 7)	(1 - 7)
+2	(11 - 17)	(11 - 17)	(8 - 14)	(8 - 14)
+1	(18 - 24)	(18 - 24)	(15 - 20)	(15 - 20)
Beam Weapon Type-	FAHW-20	FAHW-20		
Number-	6	6		
Firing Arcs-	2f/p, 2f/s, 2a	2f/p, 2f/s, 2a		
Firing Chart-	T	T		
Maximum Power-	12	12		
Damage Modifiers				
+3	(1 - 6)	(1 - 6)		
+2	(7 - 14)	(7 - 14)		
+1	(15 - 18)	(15 - 18)		

Missile Weapon Type-	FP-4	FP-11	FP-13	FP-15
Number-	6	6	6	6
Firing Arcs-	2f, 1f/p, 1f/s, 2a	2f/s, 2f/p, 1a/s, 1a/p	2f/s, 2f/p, 1a/s, 1a/p	2f/s, 2f/p, 1a/s, 1a/p
Firing Chart-	S	U	V	T
Power To Arm-	1	1	3	3
Damage-	20	21	23	25
Shields Data:				
Deflector Shield Type-	NGSS-F	NGSS-G	NGSS-G	NGSS-H
Shield Point Ratio-	1/3	1/3	1/3	1/3
Maximum Shield Power-	21	24	24	27
Defense Factor-	unknown	unknown	unknown	unknown
Weapon Damage Factor-	unknown	unknown	unknown	unknown

* Denotes completely hypothetical model number and stats, devised by Brad R. Torgersen.

[<<<< GO BACK](#)

IMPORTANT NOTE:

It is entirely possible that you have surfed to this page from an internet portal and are now viewing this page without frames. **The STSSTCSMU&A is best viewed from within its own set of frames**, so [click here to jump to the main STSSTCSMU&A web page](#) and then [see the site as it was meant to be seen!](#)

SOVEREIGN CLASS BATTLESHIP

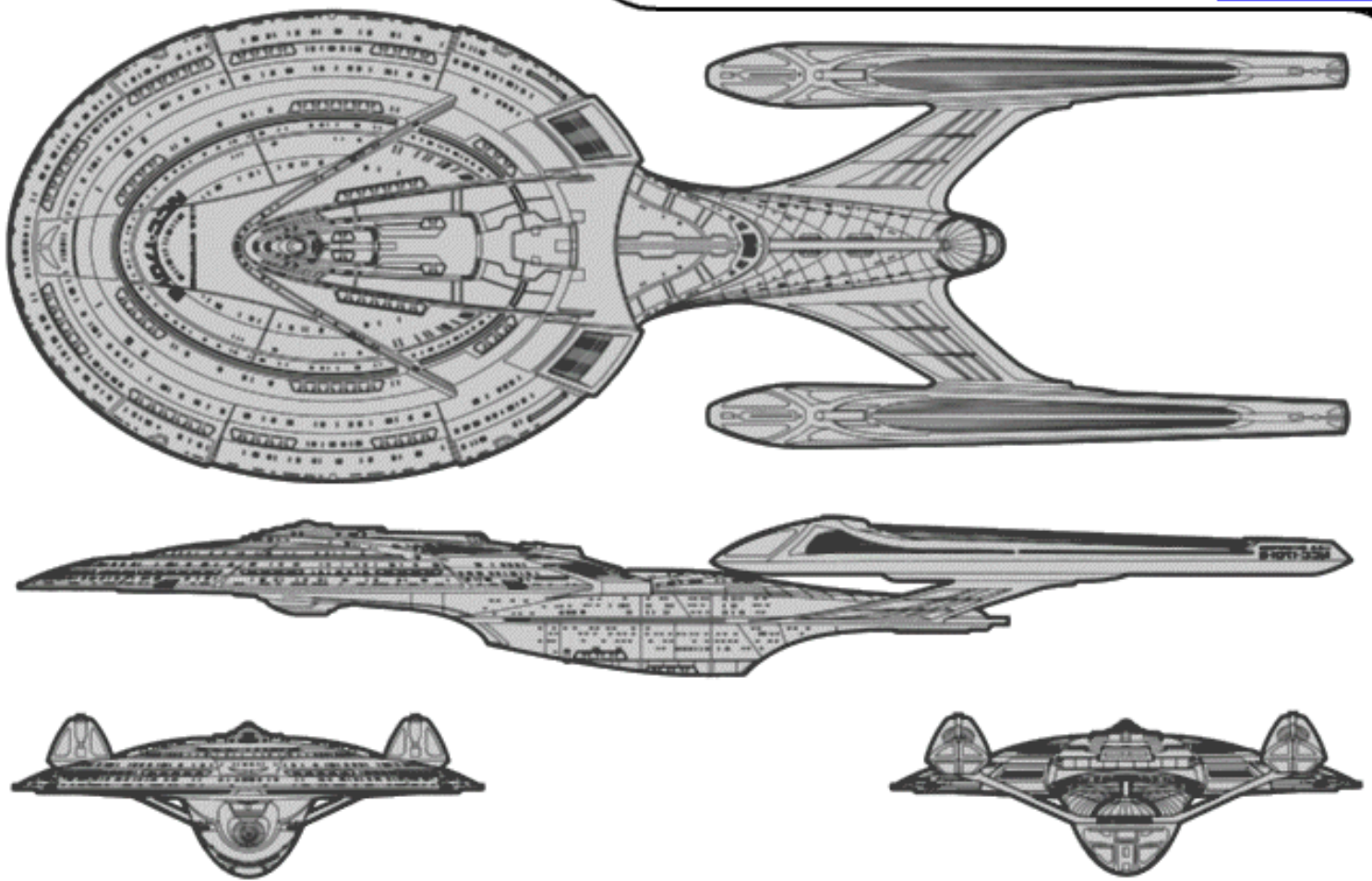

[Click here if you want to view this ship in its own window](#)

BRAD'S COMMENTS: Doing the stats for this ship was a worrisome affair. There are no game stats in FASA for this latest Enterprise design, and although I was tempted to borrow stats from the [Royal Sovereign](#) (a design of FASA origin not connected to the *real* Sovereign class in any way) I quickly realized that the Royal Sovereign is not as powerful as the [Galaxy class](#). And it seems quite evident from the movies that the actual Sovereign class is superior to the Galaxy class, even if the Sovereign is smaller than the Galaxy in both dimensions and mass.

So, I looked long and hard at the Galaxy class stats from the TNG Officers Manual, and then took them one step further. The results are a ship that is fantastically, ridiculously powerful. This violates all my own rules of ship design! But I am not sure what else to do? This is a class designed to take on the Jem'Hadar, the Borg, the Cardassians, Romulan [warbirds](#), et al. And it is the successor class to the uber-powerful Galaxy class. By definition it is going to be one whale of a ship! So you will pardon me if the stats below seem not just a little outrageous.

Aesthetically, I think the Sovereign looks a lot better than the Galaxy class, almost a fusion between the organic of TNG-era and the industrial of Kirk-era. When **ST:TNG** debuted in the late 1980's I recall being shocked and very put off by the overly rounded shape of the Galaxy class, and other similar TNG classes like the [Nebula](#). It took forever for that design aesthetic to grow on me, and once the Sovereign class was unveiled in **ST:FC** I found myself much better prepared to embrace the new design, especially since it seemed to incorporate the best aspects of both the Kirk-era aesthetic and the Picard-era aesthetic.

I'm also glad that they are not making each new Enterprise bigger than the one before it. Past a certain point, increasing the size truly does seem like a futile effort. Bigger is not always better, and how much bigger does the Federation need to go? The Romulans can have their whopper [D'Daridex](#). So long as the *USS Enterprise* can dish out as much damage as it can take, size truly does not matter. And, from my point of view, I would think size on a warship would be a severe disadvantage. Size almost always means less maneuverability, and it makes you a bigger target and therefore easier for the bad guys to hit when they shoot at you.

I have not actually play-tested this ship yet. I imagine it would take either a ship of equally fell potential to combat the Sovereign, or a legion of smaller ships able to bring down the mighty ship in the same manner a pack of wolves might bring down a grizzly bear. Those poor wolves will get the crap knocked out of them, but by numbers alone they might accomplish what each cannot hope to do individually.

Construction Data:

Model Numbers-	MK I *	MK II *
Ship Class-	XV	XV
Date Entering Service-	2372 A.D.	2377 A.D.
Number Constructed	(classified)	(classified)

Hull Data:

Superstructure Points-	122	138
Damage Chart-	C	C
Size		
Length-	685 meters	685 meters
Width-	242 meters	242 meters
Height-	82 meters	82 meters
Weight-	385,000 tons	397,000 tons
Cargo		
Cargo Units-	600 units	600 units
Cargo Capacity-	30,000 tons	30,000 tons
Landing Capability-	None	None

Equipment Data:

Control Computer Type-	MBT-11	MBT-12
Transporters-		
Standard 6-person-	18	18
Emergency 22-person-	10	10
cargo-	10	10

Other Data:

Crew-	965	952
Troops-	none	none
Passengers/Civilians-	(classified)	(classified)
Shuttlecraft-	30	30

Engines and Power Data:

Total Power Units Available-	215	238
Movement Point Ratio-	7/1	7/1
Warp Engine Type-	FNWD-6B	FNWD-6C
Number-	2	2
Power Units Available-	80	90
Stress Charts-	D/E	D/E
Maximum Safe Cruising Speed-	Warp 8	Warp 8
Emergency Speed-	Warp 9.9	Warp 9.9
Impulse Engine Type-	FNIS-430	FNIS-500
Power Units Available-	55	58

Weapons and Firing Data:

Beam Weapon Type-	FAHW-30	FAHW-32
Number-	16	16
Firing Arcs-	4f, 4f/p, 4f/s, 2a/s, 2a/p	4f, 4f/p, 4f/s, 2a/s, 2a/p
Firing Chart-	Y	Y
Maximum Power-	22	24
Damage Modifiers		
+3	(1 - 11)	(1 - 11)
+2	(12 - 18)	(12 - 18)
+1	(19 - 24)	(19 - 24)
Missile Weapon Type-	FQT-6	FQT-7
Number-	10 in 4 banks	10 in 4 banks
Firing Arcs-	3f/s, 3f/p, 2a/s, 2a/p	3f/s, 3f/p, 2a/s, 2a/p
Firing Chart-	Y	Y
Power To Arm-	5	5
Damage-	30	34

Shields Data:

Deflector Shield Type-	NGSS-P	NGSS-PQ
Shield Point Ratio-	1/5	1/5
Maximum Shield Power-	35	40

Defense Factor-

Whoa man!

Damn!

Weapon Damage Factor-

Oh wow!!

Holy shit!

* Denotes completely hypothetical model number and stats, devised by Brad R. Torgersen.

[<<<< GO BACK](#)

IMPORTANT NOTE:

It is entirely possible that you have surfed to this page from an internet portal and are now viewing this page without frames. **The STSSTCSMU&A is best viewed from within its own set of frames**, so [click here to jump to the main STSSTCSMU&A web page](#) and then [see the site as it was meant to be seen!](#)

FEDERATION CLASS BATTLESHIP

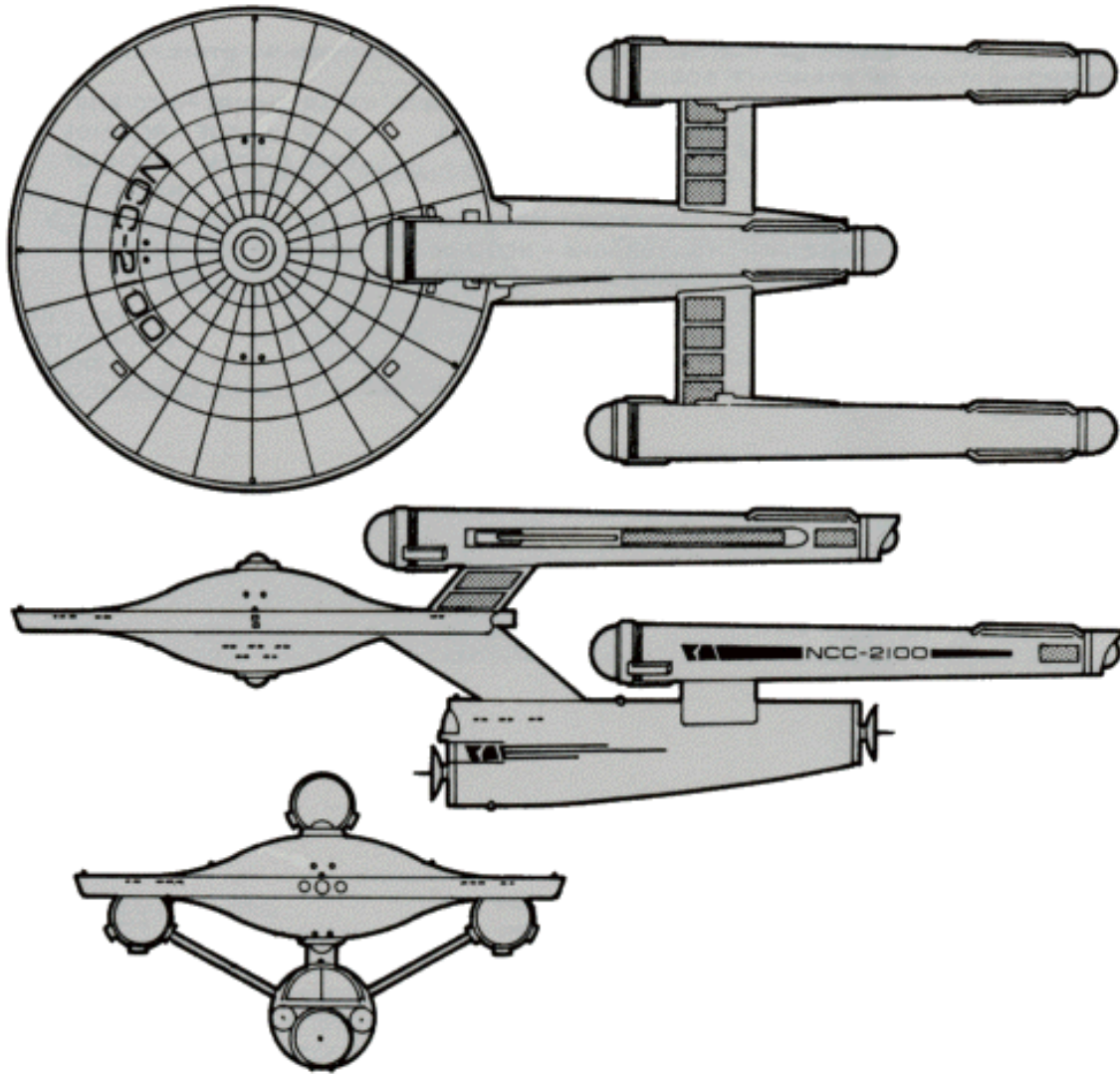

[Click here if you want to view this ship in its own window](#)

BRAD'S COMMENTS: Let me state now that I *cherish* this design. It was part of the old Star Trek Star Fleet Technical Manual first put out by Franz Joseph in 1975. My copy from Pocketbooks sits proudly on the shelf alongside other similar manuals, like Mister Scott's Guide to the Enterprise and Rick Sternbach's Star Trek The Next Generation Technical Manual. I think Franz Joseph's work shares a hell of a lot in common with FASA's STSSTCS. Both were way ahead of their time, extrapolating wildly from what information was available at the time of publication. And both have been soundly ignored by the powers-that-be who decide what is and is not "official" Trek canon.

I've stated many times that my largest and most bitter beef with the entire Star Trek franchise is the policy that film and television producers have taken towards the majority of all printed Trek material. Basically, to them, it doesn't matter who prints what, or in what form. Unless the words come from the word processor of an established fixture in the Trek production office, like M. Okuda, then it's treated with extreme prejudice. All the hundreds of Star Trek novels written by good authors, all the countless pages of technical and behind-the-scenes data in various 'technical manuals'. In the eyes of the current Trek powers, none of this work is worth anything. With a twinkle in their eyes they remind us time and again that what we're often reading is not to be taken seriously. And I believe this greatly damages the franchise as a whole.

As a long-time science fiction fan, what I expect most out of my favorite authors is consistency within the work itself. Authors like Larry Niven take huge pains to ensure that their various universe(s) remain internally consistent. Look at Larry's KNOWN SPACE saga. That damn thing is at *least* as snarled and complex as the Star Trek universe! But it is consistent within itself, and I know of no Larry Niven stories in KNOWN SPACE that are considered apocryphal. Even more importantly, Larry has allowed other writers to come onto his "playground" and build onto the established---and accepted---framework. Witness the successful Man-Kzin wars books. 90% written by other authors, 90% wildly extrapolative where KNOWN SPACE and the races within it are concerned. Yet it is ALL 100% reliable and 100% adopted and accepted by both Larry himself, and the fans as a whole. Larry does not smirk and, with a wink, tell us that the Man-Kzin tales never happened, nor that the stories in the series cannot be relied

upon. This makes KNOWN SPACE a hundred times more fascinating in some respects when compared to Star Trek. And as a Niven reader I don't feel betrayed.

I think that's where my emotional anger really lies. When the television and film producers ignore and disregard the novels and the manuals, they are in a certain sense betraying the fans. Investing time and energy in paying attention to a science fiction saga is a major effort for most fans. We're not like soap opera people who swallow whatever is offered to us. We have certain demands and standards that we expect to be met. We hate it when there is no internal consistency, and if any auxiliary materials are produced around a television or motion picture series, we appreciate it when those materials are embraced as part and parcel of the media venture that spawned them. Not shunned and cut off, as in the case of Star Trek's auxiliary material.

So I offer you the Federation class dreadnought, from the mind of Franz Joseph. This is my way of embracing all that is Trek, regardless of what the Trek producers may say. Maybe they ignore books like Franz's, but I don't. To me, that book, and indeed the Federation class, are just as "real" as anything written in Okuda's Star Trek Encyclopedia. My hat is off, Franz. Here is to your work.

Besides, the Federation class just *looks so damn cool!!* A great evolution on the old [Constitution Class](#), into a vessel that still retains all the old lines but is markedly different in just the right ways. In a certain sense, this class does live on in official Trek lore, if for no other reason than the neat-looking refit Galaxy design that we see in in the final episode of **ST:TNG**. Nobody can tell me that the tri-engined Enterprise of that final episode wasn't influence by the Federation class!! Likewise, I have seen various model makers who have produced works that borrow an awful lot from the Federation class. Too much so for it to be a coincidence.

I tried to be as careful as I could with the stats. I quoted the [Star Fleet Technical Manual](#) verbatim where applicable. I didn't want to make this class unrealistic, especially since it is a **ST:TOS** era design. But I did want it to be better than an ordinary **ST:TOS** era Constitution class, since this design was clearly intended to be a battleship. I hope I was successful.



Construction Data:

	MK X *	MK XI *	MK XII *	MK XIII *
Model Numbers-	XIV	XIV	XV	XV
Ship Class-	2248 A.D.	2253 A.D.	2259 A.D.	2265 A.D.
Date Entering Service-	(classified)	(classified)	(classified)	(classified)
Number Constructed				

Hull Data:

Superstructure Points-	27	30	33	35
Damage Chart-	C	C	C	C
Size				
Length-	320 meters	320 meters	320 meters	320 meters
Width-	140 meters	140 meters	140 meters	140 meters
Height-	87 meters	87 meters	87 meters	87 meters
Weight-	285,000 tons	295,000 tons	310,000 tons	315,000 tons
Cargo				
Cargo Units-	500 units	500 units	500 units	500 units
Cargo Capacity-	25,000 tons	25,000 tons	25,000 tons	25,000 tons
Landing Capability-	None	None	None	None

Equipment Data:

Control Computer Type-	M-4	M-4	M-4	M-4
Transporters-				
Standard 6-person-	5	5	5	5
Emergency 22-person-	6	6	6	6
cargo-	3	3	3	3

Other Data:

Crew-	500	500	480	470
Troops-	70	70	70	70
Shuttlecraft-	14	14	14	14

Engines and Power Data:

Total Power Units Available-	64	72	84	88
Movement Point Ratio-	5/1	5/1	5/1	5/1
Warp Engine Type-	FWF-1	FWF-1	FWF-2	FWF-2
Number-	3	3	3	3
Power Units Available-	20	20	24	24
Stress Charts-	G/L	G/L	G/L	G/L
Maximum Safe Cruising Speed-	Warp 7	Warp 7	Warp 7	Warp 7
Emergency Speed-	Warp 8.5	Warp 8.5	Warp 9.9	Warp 9.9
Impulse Engine Type-	FID-2	FIF-1	FIF-1	FIF-2
Power Units Available-	4	12	12	16

Weapons and Firing Data:

Beam Weapon Type-	FH-3	FH-3	FH-3	FHX-3A
Number-	10, in 5 banks	10, in 5 banks	10, in 5 banks	10, in 5 banks
Firing Arcs-	2f, 2f/p/s, 2p, 2s, 2a	2f, 2f/p/s, 2p, 2s, 2a	2f, 2f/p/s, 2p, 2s, 2a	2f, 2f/p/s, 2p, 2s, 2a
Firing Chart-	W	W	W	W
Maximum Power-	5	5	5	7
Damage Modifiers				
+3	(1 - 10)	(1 - 10)	(1 - 10)	(1 - 10)
+2	(11 - 17)	(11 - 17)	(11 - 17)	(11 - 17)
+1	(18 - 20)	(18 - 20)	(18 - 20)	(18 - 20)
Missile Weapon Type-	FP-1	FP-1	FP-6	FP-5
Number-	4, in 2 bays	4, in 2 bays	4, in 2 bays	4, in 2 bays
Firing Arcs-	2f, 2a	2f, 2a	2f, 2a	2f, 2a
Firing Chart-	L	L	O	R
Power To Arm-	1	1	1	1
Damage-	10	10	12	16

Shields Data:

Deflector Shield Type-	FSN-X1	FSN-X1	FSN-X2	FSN-X2
Shield Point Ratio-	1/2	1/2	1/3	1/3
Maximum Shield Power-	16	16	18	18

Defense Factor-	(classified)	(classified)	(classified)	(classified)
Weapon Damage Factor-	(classified)	(classified)	(classified)	(classified)

* Denotes completely hypothetical model number, with stats provided by Brad R. Torgersen.

[<<<< GO BACK](#)

IMPORTANT NOTE:

It is entirely possible that you have surfed to this page from an internet portal and are now viewing this page without frames. **The STSSTCSMU&A is best viewed from within its own set of frames**, so [click here to jump to the main STSSTCSMU&A web page](#) and then [see the site as it was meant to be seen!](#)

ROYAL SOVEREIGN CLASS BATTLESHIP

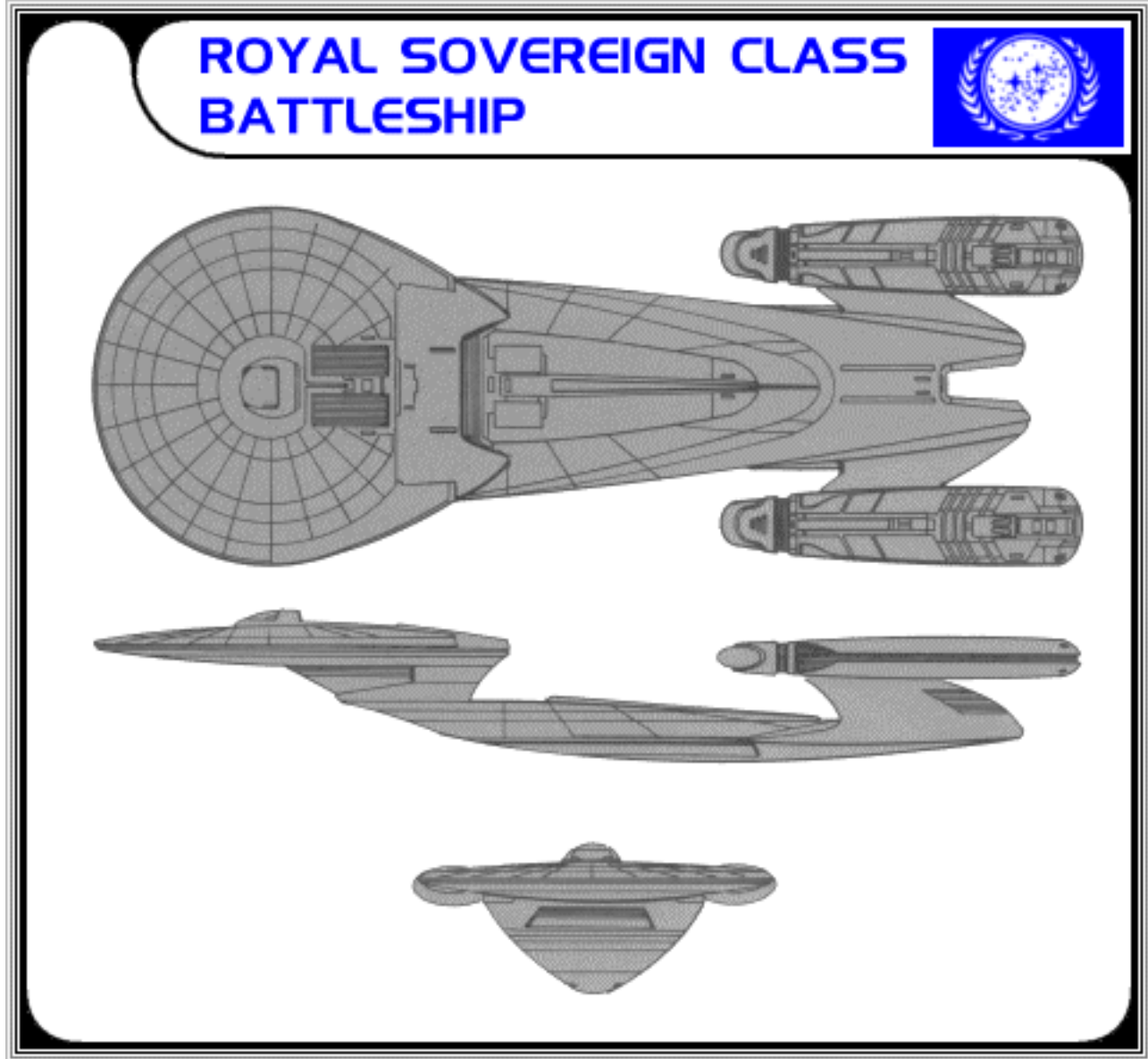

[Click here if you want to view this ship in its own window](#)

BRAD'S COMMENTS: Weird looking, eh? In some ways the FASA designers who worked on the the FASA TNG Officers Manual took the whole 'organic' aesthetic too far. The Galaxy class is graceful, yes, but ships like the Royal Sovereign just don't work for me at all. They seem to curve in the wrong places, the front-on and side-on views don't jive with each other or the top-down view, and besides which they look nothing like the **DS9** or **VOY** ships that seem to be taking the Federation away from circular saucers and Enterprise-D nacelles towards irregular elliptical saucers and a variety of new nacelle shapes, like the [Intrepid class](#) and the canon-official [Sovereign class](#).

Speaking of the Sovereign class, it's funny that the old FASA guys would name one of their big capital ships so close to an actual capital ship to be named and designed twelve years later. Frankly the actual Sovereign class looks a hell of a lot better than the Royal Sovereign, and I was tempted to just replace the Royal Sovereign graphic with a self-modified Sovereign graphic, and leave the stats. Only, I didn't want to confuse gamers any more than necessary, and I think it is worth noting that the Royal Sovereign and the Sovereign are two distinct classes, one non-official and the other completely official, sharing nothing in common in either design or period.

Gamers should love the Royal Sovereign's heavy hand during scenarios. Along with the [Galaxy](#) class, the Royal Sovereign can stand up to a world of hurt and pay back in kind, making it a better match for opponents like the [D'Daridex](#) and the [KDF-2](#) than other TNG Officers Manual Federation ships. Power output is superb, as is the weaponry spread. 70 superstructure points and a max shield power approaching 20 points means this class can soak up deadly blow after deadly blow and not blink twice.

Construction Data:

Model Numbers-	I
Ship Class-	XV
Date Entering Service-	2/7701
Number Constructed	12

Hull Data:

Superstructure Points-	70
Damage Chart-	C
Size	
Length-	625 meters
Width-	224 meters
Height-	100 meters
Weight-	334,825 tons
Cargo	
Cargo Units-	600 units
Cargo Capacity-	30,000 tons
Landing Capability-	None

Equipment Data:

Control Computer Type-	M-9A
Transporters-	
Standard 6-person-	6
Combat 12-person-	4
Emergency 22-person-	none
cargo large-	2
cargo small-	4

Other Data:

Crew-	850
Passengers-	none
Troops-	125
Shuttlecraft-	8

Engines and Power Data:

Total Power Units Available-	136
Movement Point Ratio-	6/1
Warp Engine Type-	FTWA-2
Number-	2
Power Units Available-	52
Stress Charts-	E/G
Maximum Safe Cruising Speed-	Warp 8
Emergency Speed-	Warp 9.9
Impulse Engine Type-	FIG-2
Power Units Available-	32

Weapons and Firing Data:

Beam Weapon Type-	FH-11A
Number-	10, in 4 banks
Firing Arcs-	4f, 2s, 2p, 2a
Firing Chart-	W
Maximum Power-	7
Damage Modifiers	
+3	(1 - 10)
+2	(11 - 17)
+1	(18 - 24)
Missile Weapon Type-	FP-4
Number-	8
Firing Arcs-	2f, 2p, 2s, 2a
Firing Chart-	S
Power To Arm-	1
Damage-	20

Shields Data:

Deflector Shield Type-	FSS
Shield Point Ratio-	1/4
Maximum Shield Power-	19

Defense Factor- 157.25

Weapon Damage Factor- 207.0

[<<<< GO BACK](#)

IMPORTANT NOTE:

It is entirely possible that you have surfed to this page from an internet portal and are now viewing this page without frames. **The STSSTCSMU&A is best viewed from within its own set of frames**, so [click here to jump to the main STSSTCSMU&A web page](#) and then [see the site as it was meant to be seen!](#)

INTREPID CLASS SCIENCE CRUISER

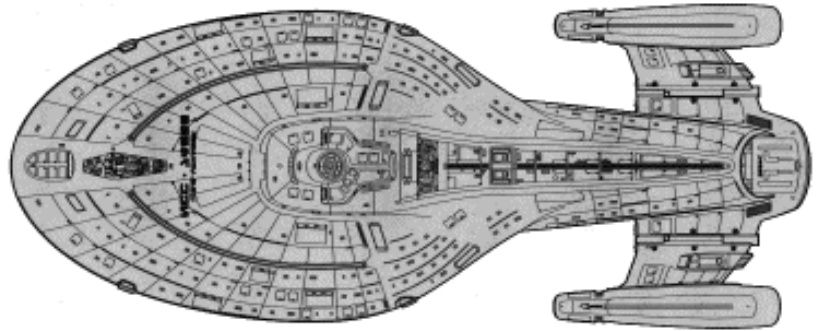

[Click here if you want to view this ship in its own window](#)

BRAD'S COMMENTS: As much as the [Galaxy Class](#) was a departure from the linear, industrial shaped [Constitution Refit](#) that dominated the Star Trek films from 1979 until 1987, the Intrepid Class was an even more radical departure. Debuting in 1995 with the fourth Star Trek television series (the often-maligned **Star Trek: Voyager**) the Intrepid shares little in common with its progenitor the [Constitution](#). The "saucer" has ceased to be a saucer altogether and the engineering hull has been greatly merged with the elliptical primary hull. The warp engines are stubby and diminutive compared to those of the Constitution, especially when one considers the fact that the Constitution and the Intrepid are of similar size. And the Intrepid is also the first featured ship in a series that has not been larger than the ship featured in the series before it: the Intrepid is about half the length of the Galaxy Class and possesses about a quarter of the apparent mass of the Galaxy Class.

Even though the Intrepid does pack some state-of-the-art TNG-era weaponry, such as the rarely-mentioned Tricobalt Devices, the ship is essentially a science vessel designed for long-range missions beyond the safety of the Federation frontier. I like to think of it as the 24th century answer to the [Anton Class](#), which was also primarily a science vessel. For this reason I have limited the offensive stats of the Intrepid (relative, of course, to other TNG-era ships--which are already massively powerful in comparison to TMP-era vessels!) and focused more on defensive capabilities. Superior speed, in the form of a generous movement point ratio, and superior shielding are the primary traits of this class. I seem to recall not just a few episodes where it was the *USS Voyager's* ability to depart the scene quickly which saved the day, so I have tweaked the stats to reflect this. I know some fans may disagree, but I do not believe this ship's primary goal is combat. If you want a gunboat, take a look at the [Akira Class](#), which seems specifically design to slug it out with either Borg or Dominion. The Intrepid on the other hand seems more like the Galaxy Class in that it is primarily a ship of exploration equipped secondarily for defense.

CONSTITUTION and INTREPID



An approximate scale comparison

Construction Data:

Model Numbers-	MK I *	MK II *
Ship Class-	XIII	XIII
Date Entering Service-	2371 A.D.	2377 A.D.
Number Constructed	classified	classified

Hull Data:		
Superstructure Points-	44	51
Damage Chart-	C	C
Size		
Length-	344 meters	346 meters
Width-	130 meters	130 meters
Height-	63 meters	65 meters
Weight-	234,500 tons	247,200 tons
Cargo		
Cargo Units-	75 units	75 units
Cargo Capacity-	3,750 tons	3,750 tons
Landing Capability-	Yes!	Yes!

Equipment Data:		
Control Computer Type-	MBT-07	MBT-07
Transporters-		
Standard 6-person-	4	4
Emergency 22-person-	4	4
cargo-	1	1

Other Data:		
Crew-	200	185
Passengers-	5	10
Shuttlecraft-	4	4

Engines and Power Data:		
Total Power Units Available-	75	93
Movement Point Ratio-	2/1	2/1
Warp Engine Type-	FNWD-3A	FNWD-3B
Number-	2	2
Power Units Available-	30	34
Stress Charts-	M/K	M/K
Maximum Safe Cruising Speed-	Warp 8	Warp 8
Emergency Speed-	Warp 9.9	Warp 9.9
Impulse Engine Type-	FNIS-100	FNIS-200
Power Units Available-	15	25

Weapons and Firing Data:		
Beam Weapon Type-	FAHW-20	FAHW-23
Number-	8 in four banks	8 in four banks
Firing Arcs-	2f/p, 2f/s, 2a/p, 2a/s	2f/p, 2f/s, 2a/p, 2a/s
Firing Chart-	T	U
Maximum Power-	12	15
Damage Modifiers		
+3	(1 - 6)	(1 - 7)
+2	(7 - 14)	(8 - 14)
+1	(15 - 18)	(15 - 20)
Missile Weapon Type-	FP-9	FP-9
Number-	4 in two bays	4 in two bays
Firing Arcs-	2f, 2a	2f, 2a
Firing Chart-	T	T
Power To Arm-	1	1
Damage-	18	18
Missile Weapon Type-	Tricobalt Devices	Tricobalt Devices
Number-	2	2
Firing Arcs-	F	F
Firing Chart-	M	M
Power To Arm-	5	5
Damage-	30	30

Shields Data:		
Deflector Shield Type-	NGSS-IG	NGSS-IJ
Shield Point Ratio-	1/3	1/3
Maximum Shield Power-	24	33

Defense Factor-	257.9 **	318.9 **
Weapon Damage Factor-	149 **	167.4 **

* Denotes completely hypothetical model number and stats, devised by Brad R. Torgersen.

** D and WDF numbers provided by [Bryan Jecko](#). Thanks Bryan!

[<<<< GO BACK](#)

IMPORTANT NOTE:

It is entirely possible that you have surfed to this page from an internet portal and are now viewing this page without frames. **The STSSTCSMU&A is best viewed from within its own set of frames**, so [click here to jump to the main STSSTCSMU&A web page](#) and then [see the site as it was meant to be seen!](#)

NEBULA CLASS MULTI-ROLE CRUISER

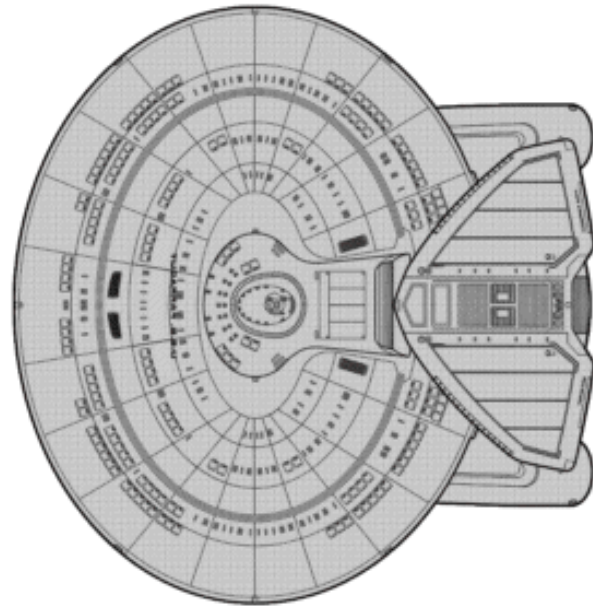
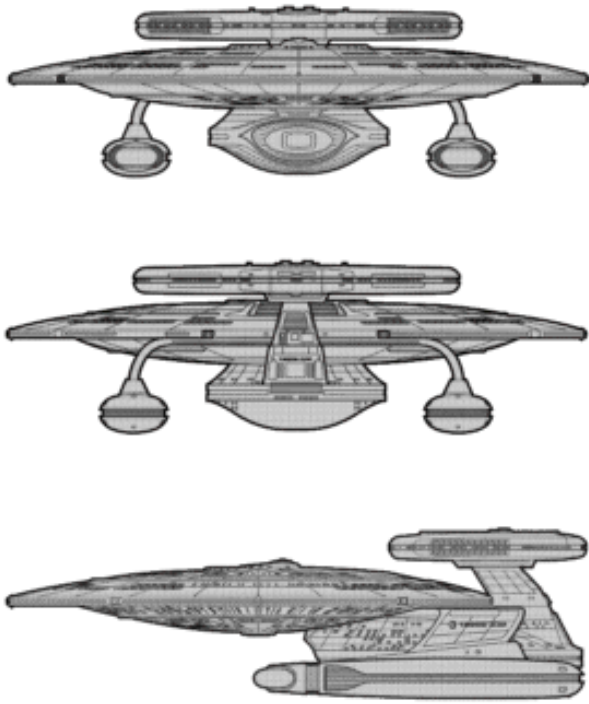

[Click here if you want to view this ship in its own window](#)

BRAD'S COMMENTS: The Nebula Class cruiser is to the [Galaxy](#) Class as the [Miranda/Soyuz/Reliant](#) was to the [Constitution Refit/Enterprise](#). Employing an almost identical saucer section and warp nacelles as the Galaxy, the Nebula also uses a similar design philosophy as the Miranda/Soyuz in that the warp nacelles are slung underneath the saucer on downward-sloping pylons, and there is a weapon/sensor structure projecting above the saucer behind the bridge. One of several new designs that would be created for ST:TNG, the Nebula Class seems to be broken down into two distinct types, distinguishable by the style of pod that they sport above the ventral surface of the saucer.

The first type, known on this site as the Mark I model, features a thin, oval-shaped structure that rides on two support structures attached to the warp pylons. This oval rides fairly high above and behind the bridge, and looks not just a little like the radomes on American AWACS planes of the 20th century. Whether or not the oval structure on the Mark I is indeed some kind of advanced sensor unit or other kind of detection device is a matter of some debate among fans, but for the purposes of the STSSTCS I have treated the oval as a benign, non-weaponry related structure, thus making the Mark I a science cruiser.

The second type, known on this site as the Mark II model, features a triangular, and much thicker structure that is supported by a single heavy-duty pylon that projects out of the spine of the engineering hull. Based on footage from numerous ST:TNG and ST:DS9 episodes, this triangular projection very often functions as a weaponry platform, much like the "roll bar" of the Soyuz/Miranda. Official text from the creators of the ship indicates that the pod of the Mark II Nebula is a multi-role structure capable of taking interchangeable equipment, either sensory or weaponry. For the sake of simplicity in the STSSTCS system, I have treated the Mark II's dorsal pod as a weaponry platform, making the Mark II something of a combat cruiser, very different in mission from the Mark I.

Also of some debate is whether or not the Nebula Class saucer section can detach from the rest of the ship, like the Galaxy's saucer, and whether or not the Nebula has a civilian population in addition to its Starfleet crew compliment. Based on the research I have done, it would seem that the Nebula does not have a civilian compliment aboard, and I have never seen any writing or television footage indicating that the Nebula's saucer can fully detach from the rest of the ship. This makes my life easier only in that I don't have to fudge full blown stats for saucer/stardrive as I did with the Galaxy.

In terms of game stats, I have treated the Nebula as being slightly less massive than the Galaxy, with the Mark I having much less combat weaponry than the Galaxy, and the Mark II having somewhat more combat weaponry than the Nebula. Realistically, the Nebula would make a superior fighting ship as its compact size compared to the Galaxy makes it a smaller target, not to mention affording improved maneuverability. But since the Nebula is a design of roughly the same age as the Galaxy, I have limited to the Mark II model so as to not be more powerful than the super-advanced [Sovereign Class](#).

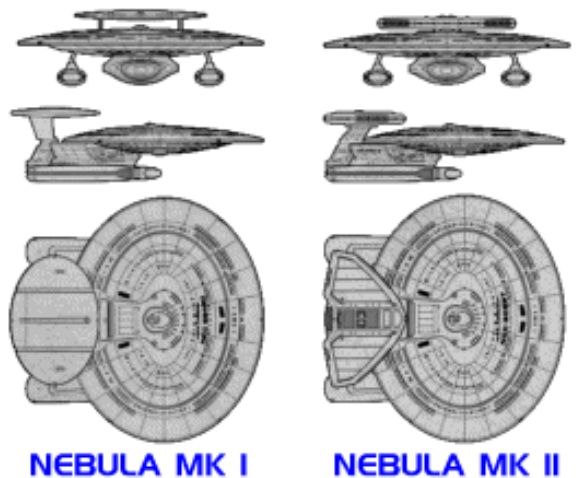

NEBULA MK I

NEBULA MK II

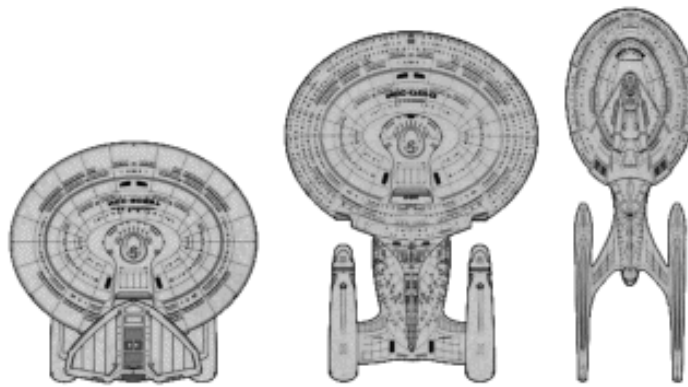

NEBULA CLASS compared with GALAXY and SOVEREIGN

Construction Data:

	MK I *	MK II *
Model Numbers-	XVI	XVI
Ship Class-	classified	classified
Date Entering Service-	classified	classified
Number Constructed	classified	classified

Hull Data:

	MK I *	MK II *
Superstructure Points-	92	100
Damage Chart-	C	C
Size		
Length-	440 meters	465 meters
Width-	467 meters	467 meters
Height-	130 meters	130 meters
Weight-	361,400 tons	377,000 tons
Cargo		
Cargo Units-	400 units	400 units
Cargo Capacity-	20,000 tons	20,000 tons
Landing Capability-	None	None

Equipment Data:

	MK I *	MK II *
Control Computer Type-	MBT-10	MBT-10
Transporters-		
Standard 6-person-	16	16
Combat 20-person-	none	none
Emergency 22-person-	10	12
cargo large-	2	2
cargo small-	2	2

Other Data:

	MK I *	MK II *
Crew-	750	775
Passengers-	45	20
Shuttlecraft-	18	16

Engines and Power Data:

	MK I *	MK II *
Total Power Units Available-	136	149
Movement Point Ratio-	5/1	5/1
Warp Engine Type-	FNWD-4B	FNWD-4C
Number-	2	2
Power Units Available-	44	47
Stress Charts-	K/F	K/F
Maximum Safe Cruising Speed-	Warp 8	Warp 8
Emergency Speed-	Warp 9.9	Warp 9.9
Impulse Engine Type-	FNIS-420	FNIS-430
Power Units Available-	48	55

Weapons and Firing Data:

Beam Weapon Type-	FH-15	FAHW-24
Number-	8 in collimated 'strips'	14 in collimated 'strips'
Firing Arcs-	300+ degrees, all arcs at all times	300+ degrees, all arcs at all times
Firing Chart-	Y	V
Maximum Power-	12	16
Damage Modifiers		
+3	(1 - 11)	(1 - 8)
+2	(12 - 20)	(9 - 15)
+1	(21 - 24)	(16 - 21)
Missile Weapon Type-	FP-4	FP-4
Number-	10	8
Firing Arcs-	3f/p, 3f/s, 4a	3f/p, 3f/s, 2a
Firing Chart-	S	S
Power To Arm-	1	1
Damage-	20	20
Missile Weapon Type-		FP-17 (weapons pod)
Number-		10
Firing Arcs-		4f/p, 4f/s, 2a
Firing Chart-		X
Power To Arm-		3
Damage-		27

Shields Data:

Deflector Shield Type-	NGSS-G	NGSS-I
Shield Point Ratio-	1/3	1/3
Maximum Shield Power-	24	30

Defense Factor-	281.6 **	314 **
Weapon Damage Factor-	226.6 **	486.2 **

* Denotes completely hypothetical model number and stats, devised by Brad R. Torgersen.

** D and WDF numbers provided by [Bryan Jecko](#). Thanks Bryan!

[<<<< GO BACK](#)

IMPORTANT NOTE:

It is entirely possible that you have surfed to this page from an internet portal and are now viewing this page without frames. **The STSSTCSMU&A is best viewed from within its own set of frames**, so [click here to jump to the main STSSTCSMU&A web page](#) and then [see the site as it was meant to be seen!](#)

TRITON CLASS CRUISER

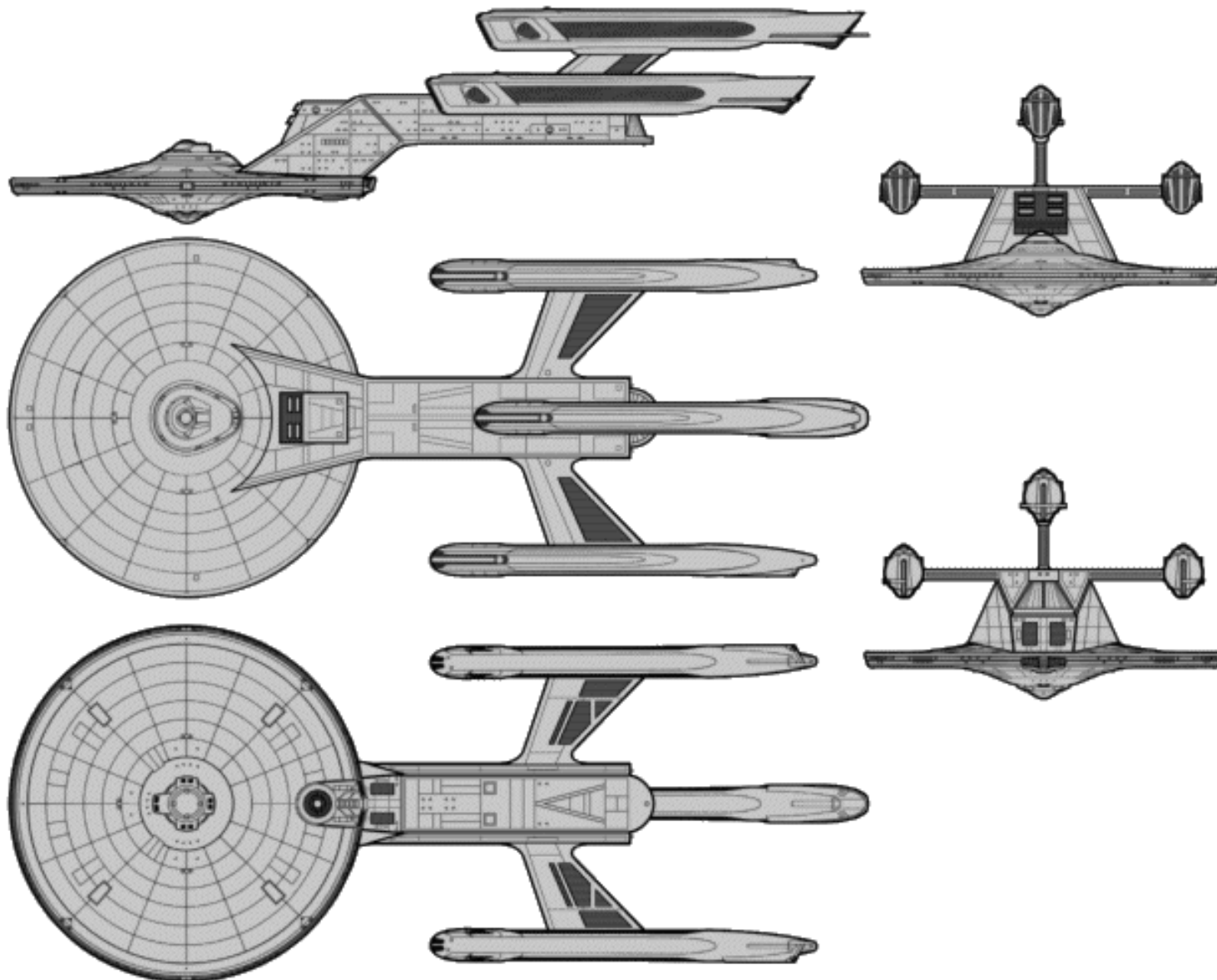

[Click here if you want to view this ship in its own window](#)

CLICK BELOW TO SEE LARGER VIEWS!

[Port view](#) [Dorsal view](#) [Ventral view](#) [Bow view](#) [Stern view](#)

FANSHIP DESIGN & STATS: Brad R. Torgersen, 1989 - 2002

Triton Class XIII Heavy Cruiser

NOTES: The Triton class emerged shortly after the signing of the famous Khitomer Accords in 2293 A.D.--a treaty which ceased decades of official hostility between the Klingon Empire and the United Federation of planets. Not all Klingons were embracing the new alliance, however, and cross-border conflicts with terrorist Klingons attempting to break away from their "traitor" Empire and attack the Federation were becoming a persistent problem for Starfleet.

The aged detachment of [Federation class battleships](#) were pressed into service once again to patrol the former Klingon Neutral Zone and maintain the sovereignty of Federation space against rogues. A newer ship should have been used, but the [Excelsior class](#) cruisers were still too few in number at that stage to be massed effectively. Besides which, the Excelsiors were needed far more on the frontier where their advanced sensors, speed, and laboratory facilities made them invaluable. Older cruiser designs such as the [Miranda \(Reliant\)](#) and [Constitution \(Enterprise\)](#) were proving to be somewhat outgunned by more recently designed Klingon ships in the hands of renegade commanders, and there was an immediate need for a fast warship that could take over where the venerable Federation class ships left off. In order to minimize the time it would take to go from the drawing board to the construction yards, Starfleet contractors opted to implement a design that would use as many off-the-shelf components as possible, while still filling the requirements handed down from Starfleet Command.

The result was the Triton class.

The Mark I Triton began trials in late 2294 and was officially commissioned in 2295 when the *USS Triton* left Earth Spacedock for her first tour of duty along the boundary between Federation and Klingon space. Like the old Federation class, the Triton class bore a novel-looking set of three warp nacelles, all off-the-rack FWG type. Early tests during trials indicated that the warp geometry created by the three FWG nacelles was overly complex and yielded too little speed for too much power expended, so the engineers opted instead to use the third warp nacelle much like the third engine was once used on 20th century Earth DC-10 jetliners. The warp field itself would be maintained by just the two primary nacelles at any given moment, while the dorsal nacelle would act as a backup in case any one of the active two became damaged or destroyed in combat. Meanwhile, that third engine could pour its entire power production into phasers and shields, giving the Triton a good deal of defensive capacity when under heavy attack.

The main offensive weapon of the Triton is its impressive forward-facing multi-tube torpedo bay. A specially designed superstructure juts from the sloping secondary hull to reveal apertures for four FP-5 model torpedo launchers. This bay assembly allows the Triton to concentrate a hail of heavy fire on its forward arc when attacking hostile starships. The effect is similar to that seen with the [Andor class](#) missile cruisers, which also mass torpedoes in the forward arc, delivering potentially crippling blows to even the largest enemy battleships.

Finally, the Triton class is unusual for a cruiser in that a contingent of Starfleet Marines is aboard for police actions and hostile ship boarding duty. In another time the Triton might have been classified a heavy frigate, but her sensors and long-range capability necessitated her classification as a cruiser, in spite of the onboard marines.

It did not take long for the Triton class to bloody its blade. Five months after beginning patrol duty at the border, the *USS Triton* was set upon by a trio of hostile Klingon [D-32 class cruisers](#) under the command of a breakaway Klingon commander. The captain of the *Triton* reacted quickly and was able to pour all of the power from the dorsal nacelle into her shields, absorbing the initial Klingon barrage while remaining warp power was channeled to phaser banks and, most importantly, the torpedoes.

With one of the three D-32 cruisers swinging around for a second strike, the *Triton* locked all four of her FP-5 tubes onto the Klingon ship and fired. Surprised by the overwhelming concentration of torpedo fire issuing from the fore of the *Triton*, the D-32 had only a second or two for futile evasive maneuvers before two torpedoes struck and destroyed the left wing, tossing the cruiser backwards and exposing its belly to the remaining two torpedoes which penetrated shields and armor and reduced the Klingon aggressor to a cloud of flaming debris.

Klingons being Klingons, the other D-32 cruisers regrouped and attacked again, battering through the *Triton's* semi-depleted shields and mangling the starboard warp nacelle before the *Triton* could return phaser fire and force the Klingons to break off their second strike. With the starboard nacelle reading as hopelessly damaged, the backup power routines programmed into the M-6B computer flawlessly shunted warp field geometry to asymmetric mode, thus using the dorsal and port nacelles exclusively while the wreckage of the starboard nacelle was ejected from the end of its pylon.

Running at two-thirds normal power, the ship swung about and the captain loaded up the torpedo assembly for another volley. As the Klingons dropped their wingtips to deliver some disruptor fire, the *Triton* cut loose with a second deadly hail of torpedoes, again smashing through the shields of a D-32 and severing the command pod from the rest of the craft in a horrific explosion. As the wreckage of the second D-32 pinwheeled away into the void, the *Triton* went nose to nose with her remaining enemy, which blasted the *Triton* with deadly green arcs of disruptor energy. Phaser fire was returned while the *Triton's* engineer fought to keep the shields from utterly collapsing, and several solid strikes sent the D-32 reeling.

At this stage the Klingons decided that the day was not theirs for the taking, and began a retreat towards the border. Thanks to its asymmetric warp field programming and two operational nacelles, the *Triton* gave pursuit at medium to high warp for several tens of minutes, until a volley of torpedoes dropped the remaining D-32 from warp. Disabled, the Klingon D-32 drifted with shields down, and the captain of the *Triton* quickly marshaled her marines. Combat transporters hummed to life, and within half an hour the renegade Klingons had been captured along with their ship, to be delivered into the angry hands of official Imperial forces which arrived two days later. The renegades were all given life imprisonment at Rura Kathol penal colony, while the *Triton* was actually able to resume patrol duties for two weeks until the *USS T'Nir*, a Miranda (Reliant) class cruiser, was able to relieve the damaged *Triton* and allow her to reach a Starbase for repair.

When the after-action reports of the incident reached San Francisco, Starfleet Command was very pleased with the



[Click here to see a size comparison chart!](#)

performance of their three-engined "off the shelf" ship, and a production run of over 80 vessels was ordered through 2305 A.D. At least eight Mark I ships were built every year until 2306, at which point the Mark II model became the focus of production.

The Mark II model was identical to the Mark I in appearance, but a much more powerful impulse deck was mounted to give the class extra maneuvering ability at sub-warp while yielding still more energy for shields and phasers. More superstructure was added to handle the new deck, and an extra bank of phasers was mounted in the aft arc in order to make up for the fact that the design did not mount torpedoes capable of firing to stern. Of the 62 Mark I ships that remained in active service by 2309, all were eventually upgraded to Mark II refit specs by 2315 A.D.

By 2327 the Triton class was starting to show its age. With next generation vessels like the [Excelsior Refit class](#), [Constellation class](#), and other ships taking over patrol duties, and with the danger along the Klingon border largely reduced, the Triton was given a final upgrade before being reassigned to a variety of alternative duties in other areas. Never intended as an exploration vessel, several Mark III Triton class ships did prove noteworthy in their exploration of the Beta Quadrant. And even though hostile ship-to-ship boarding action was almost never seen by the Mark III, the contingent of marines left aboard still proved quite valuable, as either peacekeepers or as a tactical assault force on frontier worlds across the Federation rim.

By 2345 the Triton class began to near the end of its effective lifespan. 109 of the original combined production run of 181 vessels had survived and were still in service as Mark III's, either with Starfleet Reserve, as training ships with the Starfleet Academy, or occasionally as mainline units still on active duty.

According to Starfleet protocol, in 2346 the Triton ships began to be slowly culled from the fleet and occasionally mothballed or, as was more often the case, scrapped. The last mainline operational Triton was decommissioned in 2360, some 65 years after the original conception of the class.

By 2365 only five Triton class ships remained in existence, three of which were in museums across the Federation and two of which were in mothballs, one stored at the Oort Twelve facility in Sol System. This particular Triton, the *USS Hillside*, saw action one last time in 2367 after being revived on emergency call-up to fight off the Borg invasion of Federation space. Crewed by a hastily assembled mix of Academy cadets and Starfleet reservists, the *USS Hillside* was part of the 39 ship fleet that took on a Borg cube at Wolf 359. Little data survived the battle to indicate how the aged *Hillside* fared against the Borg. Nevertheless, the valiant death of the *Hillside* serves as an appropriate capper to the noteworthy career of the Triton design.



Construction Data:

Model Numbers-	MK I	MK II	MK III
Ship Class-	XIII	XIII	XIII
Date Entering Service-	2295 A.D.	2309 A.D.	2327 A.D.
Number Constructed	85	96	(refit only)

Hull Data:

Superstructure Points-	29	33	36
Damage Chart-	C	C	C
Size			
Length-	381 meters	381 meters	381 meters
Width-	132 meters	132 meters	132 meters
Height-	93 meters	93 meters	93 meters
Weight-	212,300 tons	218,100 tons	222,600 tons
Cargo			
Cargo Units-	600 units	600 units	600 units
Cargo Capacity-	30,000 tons	30,000 tons	30,000 tons
Landing Capability-	None	None	None

Equipment Data:

Control Computer Type-	M-6B	M-6B	M-6C
Transporters-			
Standard 6-person-	5	5	5
Combat 20-person-	4	4	4
Emergency 22-person-	4	4	4
cargo large-	3	3	3
cargo small-	2	2	2

Other Data:

Crew-	400	390	375
Marines-	120	120	120
Passengers-	40	40	40
Shuttlecraft-	12	12	12

Engines and Power Data:

Total Power Units Available-	86	94	100
Movement Point Ratio-	5/1	5/1	5/1
Warp Engine Type-	FWG-3	FWG-3	FWG-4
Number-	3	3	3
Power Units Available-	26	26	28
Stress Charts-	D/F	D/F	D/F
Maximum Safe Cruising Speed-	Warp 8	Warp 8	Warp 8
Emergency Speed-	Warp 9.9	Warp 9.9	Warp 9.9
Impulse Engine Type-	FIE-2	FIE-3	FIE-3
Power Units Available-	8	16	16

Weapons and Firing Data:

Beam Weapon Type-	FH-11	FH-11	FH-11
Number-	8 in four banks	10 in five banks	10 in five banks
Firing Arcs-	2f/p, 2f, 2f/s, 2a	2f/p, 2f, 2f/s, 2a/s, 2a/p	2f/p, 2f, 2f/s, 2a/s, 2a/p
Firing Chart-	Y	Y	Y
Maximum Power-	10	10	10
Damage Modifiers			
+3	(1 - 10)	(1 - 10)	(1 - 10)
+2	(11 - 17)	(11 - 17)	(11 - 17)
+1	(18 - 24)	(18 - 24)	(18 - 24)
Missile Weapon Type-	FP-5	FP-5	FP-4
Number-	4	4	4
Firing Arcs-	F	F	F
Firing Chart-	R	R	S
Power To Arm-	1	1	1
Damage-	16	16	20

Shields Data:

Deflector Shield Type-	FSP	FSP	FSN-X3
Shield Point Ratio-	1/4	1/4	1/3
Maximum Shield Power-	16	16	18

*Defense Factor-	159.47	175.19	162.48
*Weapon Damage Factor-	123.6	123.6	135.6

* Special thanks to [Bryan](#) for figuring out the D and WDF for this fanship!

[<<<< GO BACK](#)

IMPORTANT NOTE:

It is entirely possible that you have surfed to this page from an internet portal and are now viewing this page without frames. **The STSSTCSMU&A is best viewed from within its own set of frames**, so [click here to jump to the main STSSTCSMU&A web page](#) and then [see the site as it was meant to be seen!](#)

ANDOR CLASS CRUISER

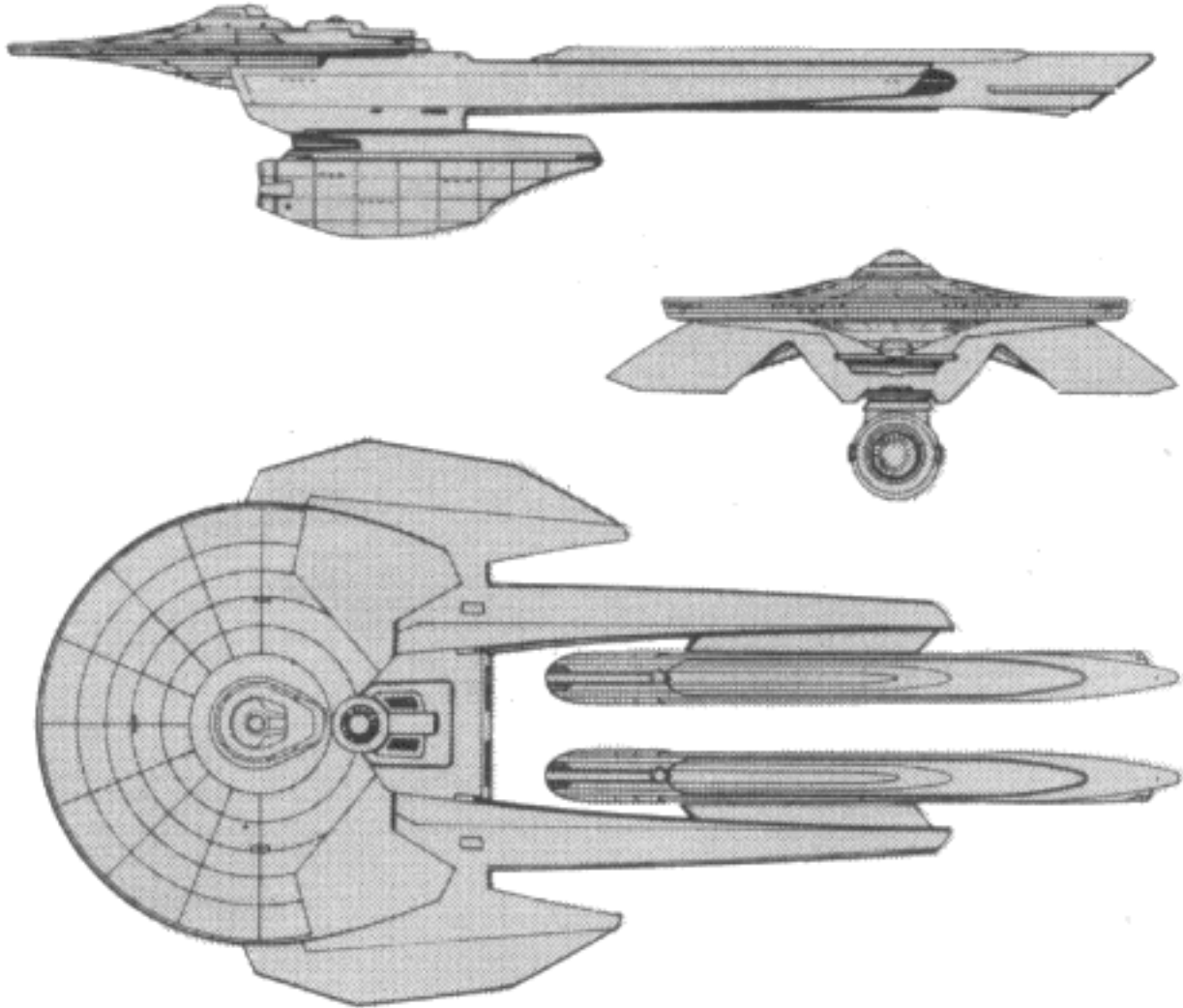

[Click here if you want to view this ship in its own window](#)

BRAD'S COMMENTS: The Andor is the first ship in the UFP Recognition Manual that uses a style that makes no sense at all to me: the warp nacelles are positioned *inboard* of their pylons, close together. Now, I'm not the most fanatical Trek fan of all time, but even I know the logic behind the original placement of the engines on the [Constitution class](#). In case of an anti-matter imbalance or overload of energy in the nacelles themselves, they were positioned on pylons *well clear* of the ship for rapid and safe jettison in the event of an emergency. Given this simple theory, the design of the Andor (and several other Federation classes) just irritates me all to hell. Those nacelles should be facing *out and away* from the ship, not inward, and certainly not side-by-side with each other. Did the artists and designers bother to check up on their Trek lore before they started with these kinds of designs? One wonders.

The backstory for this ship is also contradictory in that it states the engines are positioned as they are for their "protection" and yet can be "jettisoned" anyway. Based on their positions, it seems to me a jettison would have to entail detaching the entire nacelle boom assembly, from the saucer back. If the engines eject from their inward-facing pylons, they will crash into each other and explode, defeating the whole purpose! Ugh.

Otherwise, the Andor is an obvious Federation ship, as indicated by its saucer section (which, like so many Federation designs, is a direct copy of the [Enterprise class](#) or "[Constitution Refit](#)" saucer, especially looking top-down!) There is a secondary hull, too, and forward-facing navigational deflection dish, both borrowing much from the Constitution and Enterprise cruisers.

During game play, the Andor has a lot of offensive punch thanks to its spread of torpedoes. Each single

torp does not do much damage, but there are four tubes facing forward and one to both port and starboard. At any given moment, the ship can fire at least five tubes on an opponent in three different arcs (save for aft) and that can add up to a heck of a lot of damage. Assuming hits from all five tubes, that is a total of 40 points, a fell blow that even some of the largest battleships not might recover from, assuming all the damage is done directly to a vital area like engines or superstructure. The single forward phaser bank is almost an afterthought, useful for finishing off an opponent once the torpedoes have done their work.

Defensively, the Andor is not bad off, with an adequate shield system and decent amount of superstructure. Combined with its offensive abilities, the Andor is a great cruiser for use in one-on-one melees with Klingons or Romulans, and can also be used in the heavy frigate role, escorting other ships in multi-ship scenarios. Never intended to be primarily an exploratory vessel, the Andor plays much like a heavy frigate, sans a complement of marines.

A side note on the "blue fleet" idea that is used in the backstory for this class, and a few others. The Andorians were barely ever seen the Trek films, and only featured once (that I can recall) in **ST:TOS**. Only now with **ST:ENT** are we seeing the Andorians a lot, and it's almost believable that the Andorians in the time of the Federation would still be war-like enough to warrant an offensive-minded fleet, and ships, of their own. But this is pure invention on the part of the FASA writers and seems to have no basis at all in official canon. There is no "blue fleet", though the idea is sort of interesting, given how the Andorian species is being developed in the new TV show. And of course, the best thing about the new Andorians that are showing up on **ST:ENT** is their articulated antennae!



From the FASA Star Trek FEDERATION SHIP RECOGNITION MANUAL, circa 1985

Andor Class IX Cruiser

Notes: The Andor Class is the only operational missile cruiser in Star Fleet. These unique vessels have gained the respect and admiration of their crews because of their handling characteristics and offensive capabilities. The overall design came from Andorian design teams contracted to create a cruiser with photon torpedoes as its main weapons. These ships have so captured the heart and spirit of the Andorians that the majority are crewed solely by them. All have been named for Andorian military leaders. The Andor Class forms the core of all squadrons in the famed 'Blue Fleet', and is an integral part of front line forces for Star Fleet.

Like the Thufir Class destroyer, the warp engines are mounted close together and center aft of the main hull. This affords the engines more protection during battle because of the partial cover provided by the secondary hull. As with all Star Fleet vessels, the engines can be jettisoned in case of an overload in the matter/anti-matter chamber.

The most unusual feature of this vessel is the weapons array. Mounting two FH-13 phasers and 8 FP-7 photon torpedoes, it well deserves its informal name of 'missile boat'. Andor Class vessels are capable of engaging the enemy at 80,000 km with their phasers, and 160,000 km with their torpedoes. Due to the number of torpedoes and the ranges at which they are most effective, these vessels normally operate in combat at 120,000 km. The Andor Class has been encountered and engaged by both Romulan and Klingon forces, which were taken by surprise when the Star Fleet vessel fired a spread of torpedoes whose number was unexpected. In each case, the enemy withdrew from the field of battle before the cruiser could be fully put to the test.

The Andor Class cruiser is manufactured at the Andor and Salazaar shipyards at a combined rate of 28 per year. Of the 140 Andors built, 138 remain in active service. Two have been scrapped after a high-speed collision that resulted in irreparable damage.

Construction Data:

Model Numbers-	MK II
Ship Class-	IX
Date Entering Service-	2/1806
Number Constructed	140

Hull Data:

Superstructure Points-	22
Damage Chart-	C
Size	
Length-	260 meters
Width-	130 meters
Height-	60 meters
Weight-	121,600 tons
Cargo	
Cargo Units-	300 units
Cargo Capacity-	15,000 tons
Landing Capability-	None

Equipment Data:

Control Computer Type-	M-3
Transporters-	
Standard 6-person-	6
Emergency 22-person-	3
cargo small -	2
cargo large -	1

Other Data:

Crew-	240
Troops-	40
Shuttlecraft-	6

Engines and Power Data:

Total Power Units Available-	42
Movement Point Ratio-	3/1
Warp Engine Type-	FWE-2
Number-	2
Power Units Available-	13
Stress Charts-	G/K
Maximum Safe Cruising Speed-	Warp 7
Emergency Speed-	Warp 9
Impulse Engine Type-	FIF-2
Power Units Available-	16

Weapons and Firing Data:

Beam Weapon Type-	FH-3
Number-	2, in one bank
Firing Arcs-	F
Firing Chart-	T
Maximum Power-	8
Damage Modifiers	
+3	(1 - 5)
+2	(6 - 12)
+1	(13 - 18)
Missile Weapon Type-	FP-7
Number-	8
Firing Arcs-	4f, 1p, 1s, 2a
Firing Chart-	R
Power To Arm-	1
Damage-	8

Shields Data:

Deflector Shield Type-	FSL
Shield Point Ratio-	1/3
Maximum Shield Power-	15

Defense Factor-	112.5
------------------------	-------

Weapon Damage Factor-	51.4
------------------------------	------

[<<<< GO BACK](#)

IMPORTANT NOTE:

It is entirely possible that you have surfed to this page from an internet portal and are now viewing this page without frames. **The STSSTCSMU&A is best viewed from within its own set of frames**, so [click here to jump to the main STSSTCSMU&A web page](#) and then [see the site as it was meant to be seen!](#)

CONSTELLATION CLASS CRUISER

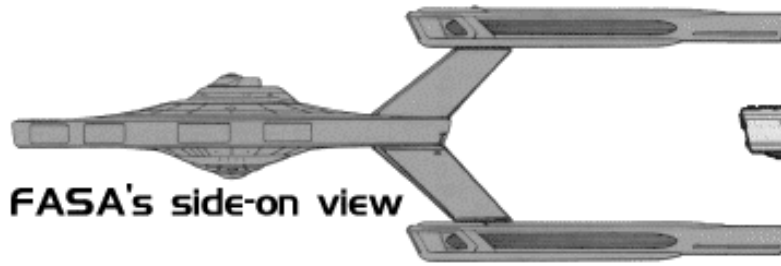
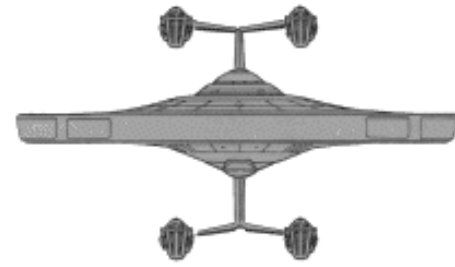
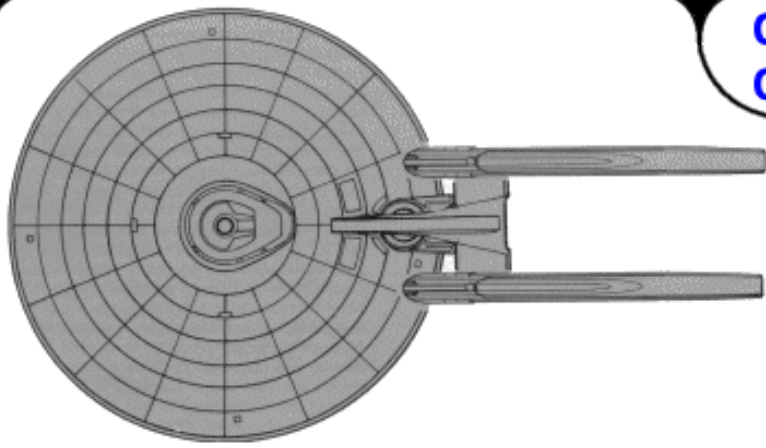

FASA's side-on view

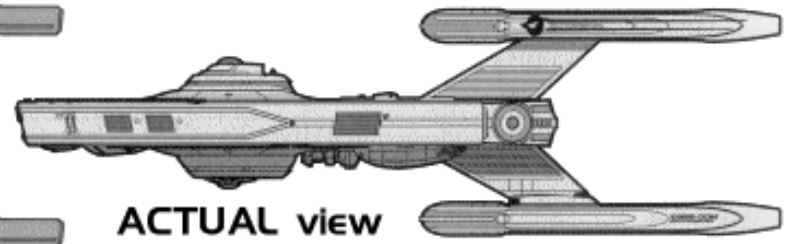

ACTUAL view

[Click here if you want to view this ship in its own window](#)

BRAD'S COMMENTS: Talk about getting it *wrong!* The FASA TNG Officers Manual is loaded with information that would turn out to be false after publication. But the schematic of the Constellation class amuses me most. Above we can see the class as rendered by the FASA artists, and I have placed beneath it a side-on view of the *real* Constellation as seen in the Star Trek Encyclopedia. Even with a minimal side-on shot comparison we can see that the ship as FASA saw it, and the ship as we actually see it in film, are quite different!

To be fair, it is hard to fault the FASA artists when all they had to go on was **ST:TNG** Season One, during which the Constellation appears ever so briefly, and even then not in tremendous detail. I don't think I noticed something was wrong until Season Two or Three when Riker takes on Picard with the *USS Hathaway* during wargame exercises. It is during this episode that the class gets all kinds of glamour shots, and the details become more apparent. Such as the fact that the saucer section is much *thicker* than FASA guessed, and shaped like a truncated teardrop *ala* the [Miranda class](#) or [Soyuz class](#), instead of a perfect circle. The warp nacelles are the right size, but FASA has them vertically aligned when they ought to be horizontally aligned. The impulse deck(s) are also clearly horizontally actuated instead of vertically actuated, and there is a tremendous amount of "bumpy" superstructure slung on the ventral surface of the real Constellation, while FASA's version is overly clean in that regard.



It helps if one sees the FASA version as an educated guess, constructed along the same lines as a police sketch, using all too familiar components like the warp nacelles and the saucer from the [Enterprise \(Constitution Refit\)](#) class to fill in the blanks. Naturally, after we get closer looks at the 'suspect' in later seasons of TNG we can better define what the ship actually looks like. But in Season One, there really weren't any great shots that revealed the detail necessary to come up with a more 'anatomically correct' Constellation design. They did what they could with the information available to them.



The Constellation is an impressive cruiser by Kirk-era standards. Factoids revealed in various TNG episodes suggest that the Constellation class is indeed a Kirk-era design, arising at roughly the same time as the [Excelsior class](#). Played in Kirk's time, circa **ST:TMP** through **Star Trek VI** and after, the Constellation is a top-rate ship capable of clubbing it out with even the largest Romulan and Klingon cruisers. It even fairs half decent against the big enemy battleships, thanks to a potent spread of weapons and a good amount of power generated by four warp engines. In Kirk's time the class would certainly be considered advanced, and somewhat rare, occupying a special place within the fleet alongside similarly potent ships of the day.

By Picard's era however, the Constellation is run-of-the-mill, at best. The Constellation is badly outmatched by the [Klingon KDF-2](#), [Romulan D'Daridex](#), and [Ferengi Marauder](#). You may have some success against these bigger ships using the Constellation in numbers, but still the ship is out of its league, and fairs better against older opponents from a different time. If only FASA had kept the license and provided us with all those dreamt of Klingon and Romulan ships that emerged between roughly 2290 and 2365 A.D! Maybe then it would be easier to place this class in its proper historical perspective.

Without these missing and imagined opponents, though, the Constellation is kind of a ship out of time: a little too advanced for

general Kirk-era scenarios, a little too ancient for general Picard-era scenarios.
Gamers, play at your discretion.



Construction Data:

Model Numbers-	MK I
Ship Class-	XI
Date Entering Service-	2/5403
Number Constructed	126

Hull Data:

Superstructure Points-	32
Damage Chart-	C
Size	
Length-	310 meters
Width-	140 meters
Height-	94 meters
Weight-	208,743 tons
Cargo	
Cargo Units-	150 units
Cargo Capacity-	12,500 tons
Landing Capability-	none

Equipment Data:

Control Computer Type-	M-6A
Transporters-	
Standard 6-person-	4
Combat 12-person-	4
Emergency 22-person-	none
cargo large-	2
cargo small-	none

Other Data:

Crew-	350
Passengers-	20
Shuttlecraft-	8

Engines and Power Data:

Total Power Units Available-	92
Movement Point Ratio-	4/1
Warp Engine Type-	FTWD-2
Number-	4
Power Units Available-	20 each
Stress Charts-	E/F
Maximum Safe Cruising Speed-	Warp 8
Emergency Speed-	Warp 9.9
Impulse Engine Type-	FIF-1
Power Units Available-	12

Weapons and Firing Data:

Beam Weapon Type-	FH-14
Number-	6 in three banks
Firing Arcs-	2f/p, 2a, 2f/s
Firing Chart-	T
Maximum Power-	12
Damage Modifiers	
+3	(1 - 5)
+2	(6 - 12)
+1	(13 - 18)
Missile Weapon Type-	FP-4
Number-	4
Firing Arcs-	2f/p/s, 2a/p/s
Firing Chart-	S
Power To Arm-	1

Damage- 20

Shields Data:

Deflector Shield Type-	FSQ
Shield Point Ratio-	1/4
Maximum Shield Power-	18

Defense Factor-	193.76
Weapon Damage Factor-	104.60

[<<<< GO BACK](#)

IMPORTANT NOTE:

It is entirely possible that you have surfed to this page from an internet portal and are now viewing this page without frames. **The STSSTCSMU&A is best viewed from within its own set of frames**, so [click here to jump to the main STSSTCSMU&A web page](#) and then [see the site as it was meant to be seen!](#)

BRENTON CLASS CRUISER

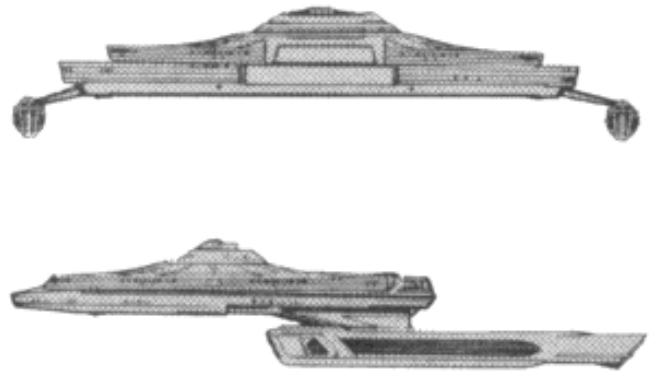
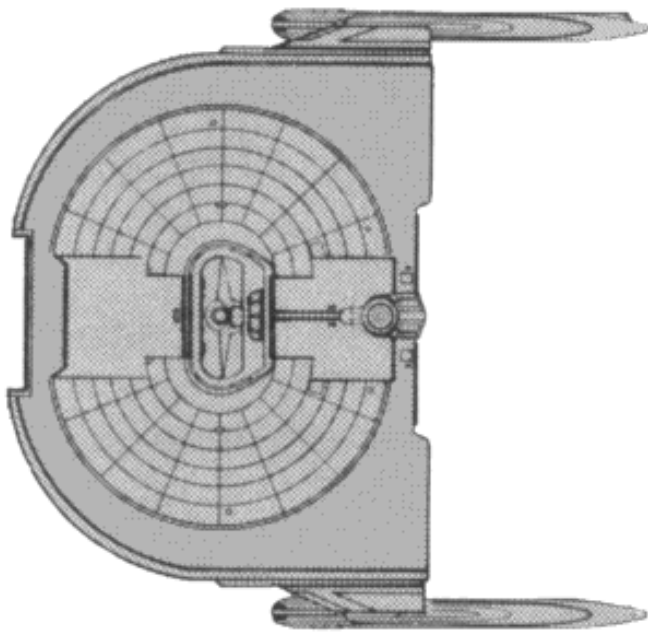

[Click here if you want to view this ship in its own window](#)

BRAD'S COMMENTS: Ugh! An ugly design that never made any aesthetic sense to me! It's almost like they took a saucer off a [Constellation class](#) vessel, chopped it in half and stretched it out like the leaves in a dining room table, and then stuck two warp engines on it. I've hated the looks of this class since the first day I read the UFP Recognition Manual.

Luckily, the class plays a lot better than it looks. The Mark V Brenton is about as potent as a [Reliant \(Miranda\)](#) class cruiser, and it has been my experience that the Brenton is a little better off than the Reliant as an offensive weapon, mainly because the Brenton has more torpedo tubes and phaser banks. Superstructure is very good, and the shielding system is also good. Along with the [Enterprise](#) and Reliant classes, the Brenton is actually one of the most playable cruisers in the FASA Federation inventory.



From the FASA Star Trek FEDERATION SHIP RECOGNITION MANUAL, circa 1985

Brenton Class XI Cruiser

NOTES: Of the 185 Brentons built, 28 Mk Is, 57 Mk IIIs, and 18 Mk Vs remain in active service, with 12 Mk Is in reserve fleets; 1 Mk I is used by Star Fleet Training Command, 6 Mk Is have been destroyed, 1 Mk I has been captured by the Klingons, 1 Mk I and 1 Mk III are listed as missing, 2 Mk Is and 1 Mk III have been scrapped, and 2 Mk Is have been disarmed and sold to private commercial concerns. The Brenton is produced at the Sol IV, Cait, and Morena shipyards at a combined rate of 12 per year.

Construction Data:

	MK I	MK III	MK V
Model Numbers-			
Ship Class-	XI	XI	XI
Date Entering Service-	2/1404	2/1810	2/2101
Number Constructed	108	59	18

Hull Data:

	MK I	MK III	MK V
Superstructure Points-	21	26	28
Damage Chart-	C	C	C
Size			
Length-	260 meters	260 meters	275 meters
Width-	254 meters	254 meters	258 meters
Height-	55 meters	55 meters	57 meters
Weight-	162,200 tons	173,100 tons	177,300 tons
Cargo			
Cargo Units-	450 units	450 units	400 units
Cargo Capacity-	22,500 tons	22,500 tons	20,000 tons
Landing Capability-	None	None	None

Equipment Data:

Control Computer Type-	M-4	M-4	M-4
Transporters-			
Standard 6-person-	4	4	4
Combat 20-person-	None	None	None
Emergency 22-person-	3	3	3
cargo large-	2	2	2
cargo small-	None	None	None

Other Data:

Crew-	378	386	395
Passengers-	60	60	60
Shuttlecraft-	4	4	4

Engines and Power Data:

Total Power Units Available-	44	44	48
Movement Point Ratio-	4/1	4/1	4/1
Warp Engine Type-	FWF-1	FWF-1	FWF-1
Number-	2	2	2
Power Units Available-	20	20	20
Stress Charts-	G/L	G/L	G/L
Maximum Safe Cruising Speed-	Warp 6	Warp 6	Warp 6
Emergency Speed-	Warp 8	Warp 8	Warp 8
Impulse Engine Type-	FID-2	FID-2	FIE-2
Power Units Available-	4	4	8

Weapons and Firing Data:

Beam Weapon Type-	FH-5	FH-8	FH-8
Number-	6 in three banks	6 in three banks	8 in 3 banks
Firing Arcs-	2f/p, 2f/s, 2f	2f/p, 2f/s, 2f	2f/p, 2f/s, 4f
Firing Chart-	R	T	T
Maximum Power-	4	5	5
Damage Modifiers			
+3			
+2	(1 - 8)	(1 - 10)	(1 - 10)
+1	(9 - 16)	(11 - 18)	(11 - 18)
Missile Weapon Type-	FP-3	FP-6	FP-5
Number-	3	3	3
Firing Arcs-	2f, 1a	2f, 1a	2f, 1a
Firing Chart-	D	O	R
Power To Arm-	1	1	1
Damage-	6	12	16

Shields Data:

Deflector Shield Type-	FSK	FSL	FSL
Shield Point Ratio-	1/2	1/3	1/3
Maximum Shield Power-	14	14	14

Defense Factor-	82	106	113.5
------------------------	----	-----	-------

Weapon Damage Factor-	22.2	45.9	62.9
------------------------------	------	------	------

[<<<< GO BACK](#)

IMPORTANT NOTE:

It is entirely possible that you have surfed to this page from an internet portal and are now viewing this page without frames. **The STSSTCSMU&A is best viewed from within its own set of frames**, so [click here to jump to the main STSSTCSMU&A web page](#) and then [see the site as it was meant to be seen!](#)

DURRETT CLASS CRUISER

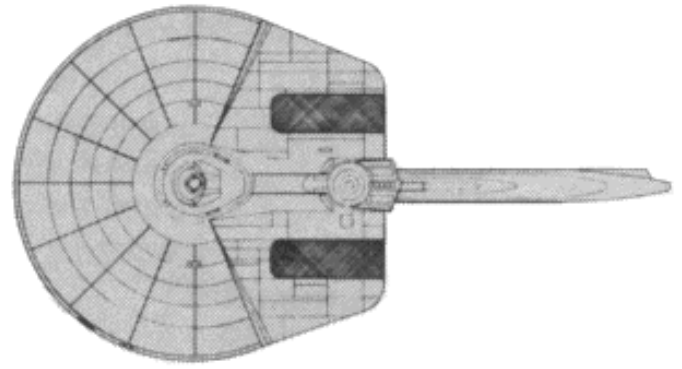
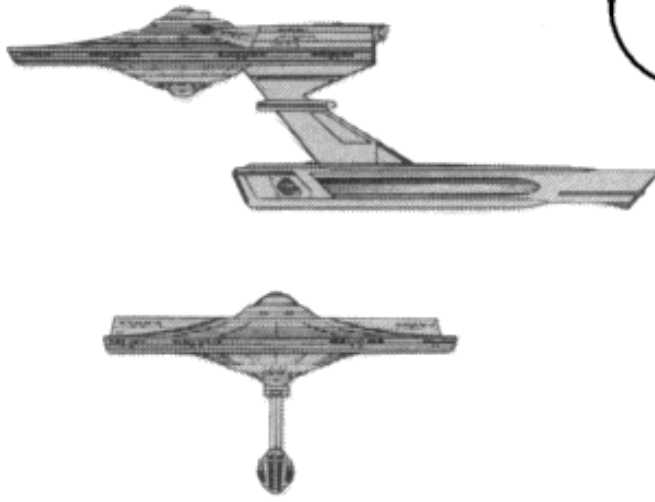

[Click here if you want to view this ship in its own window](#)

BRAD'S COMMENTS: The saucer and hull on this light cruiser are similar to the [Reliant \(Miranda\)](#) class, with the difference being that the single warp engine is mounted on a pylon that extends well beneath the ship in a direct line with the impulse deck. When I first saw this ship I viewed it as a somewhat veiled ripoff of the [Saladin destroyer](#) from the old Star Fleet Technical Manual! As a matter of fact, I have always been tempted to write up a whole new page for a TMP-era "refit" of the Saladin class, and just use this graphic as the image for the "refit" model since the Saladin and the Durrett are so damned similar looking

Game-wise, the Durrett is a very light cruiser, and might qualify as a destroyer if it had more weaponry. Shields are good, but the single warp engine does not give a player a lot of juice to work with. If you try and power up phasers you invariably don't have much to spare for the shields, and vice versa, which limits this craft in extended battles with similarly-sized opponents. On a scale of 1 to 10, with 10 being whoopass and 1 being limp-wristed, I'd give this cruiser design a 5.



From the FASA Star Trek FEDERATION SHIP RECOGNITION MANUAL, circa 1985

Durrett Class VIII Cruiser

NOTES: Of the 108 Durrett's built, 102 remain in active service, 1 is used in Star Fleet Training Command, 2 have been destroyed, 2 are listed as missing, and 1 has been scrapped. The Durrett is produced at the Sol II facility at a rate of 14 per year.

Construction Data:

Model Numbers-	MK I
Ship Class-	VIII
Date Entering Service-	2/1509
Number Constructed	108

Hull Data:

Superstructure Points-	22
Damage Chart-	C
Size	
Length-	240 meters
Width-	131 meters
Height-	75 meters
Weight-	101,400 tons
Cargo	
Cargo Units-	200 units
Cargo Capacity-	10,000 tons
Landing Capability-	None

Equipment Data:

Control Computer Type-	M-3
Transporters-	
Standard 6-person-	4
Combat 20-person-	None
Emergency 22-person-	2
cargo large-	2
cargo small-	None

Other Data:

Crew-	320
Passengers-	10
Shuttlecraft-	4

Engines and Power Data:

Total Power Units Available-	32
Movement Point Ratio-	3/1
Warp Engine Type-	FWC-2
Number-	1
Power Units Available-	20
Stress Charts-	M/K
Maximum Safe Cruising Speed-	Warp 6
Emergency Speed-	Warp 8
Impulse Engine Type-	FIF-1
Power Units Available-	12

Weapons and Firing Data:

Beam Weapon Type-	FH-9
Number-	4 in two banks
Firing Arcs-	2f/p, 2f/s
Firing Chart-	X
Maximum Power-	6
Damage Modifiers	
+3	
+2	(1 - 12)
+1	(13 - 22)
Missile Weapon Type-	FP-6
Number-	2
Firing Arcs-	1f, 1a
Firing Chart-	O
Power To Arm-	1
Damage-	12

Shields Data:

Deflector Shield Type-	FSL
Shield Point Ratio-	1/3
Maximum Shield Power-	16

Defense Factor- 100.5

Weapon Damage Factor- 37.4

[<<<< GO BACK](#)

IMPORTANT NOTE:

It is entirely possible that you have surfed to this page from an internet portal and are now viewing this page without frames. **The STSSTCSMU&A is best viewed from within its own set of frames**, so [click here to jump to the main STSSTCSMU&A web page](#) and then [see the site as it was meant to be seen!](#)

SALADIN CLASS DESTROYER

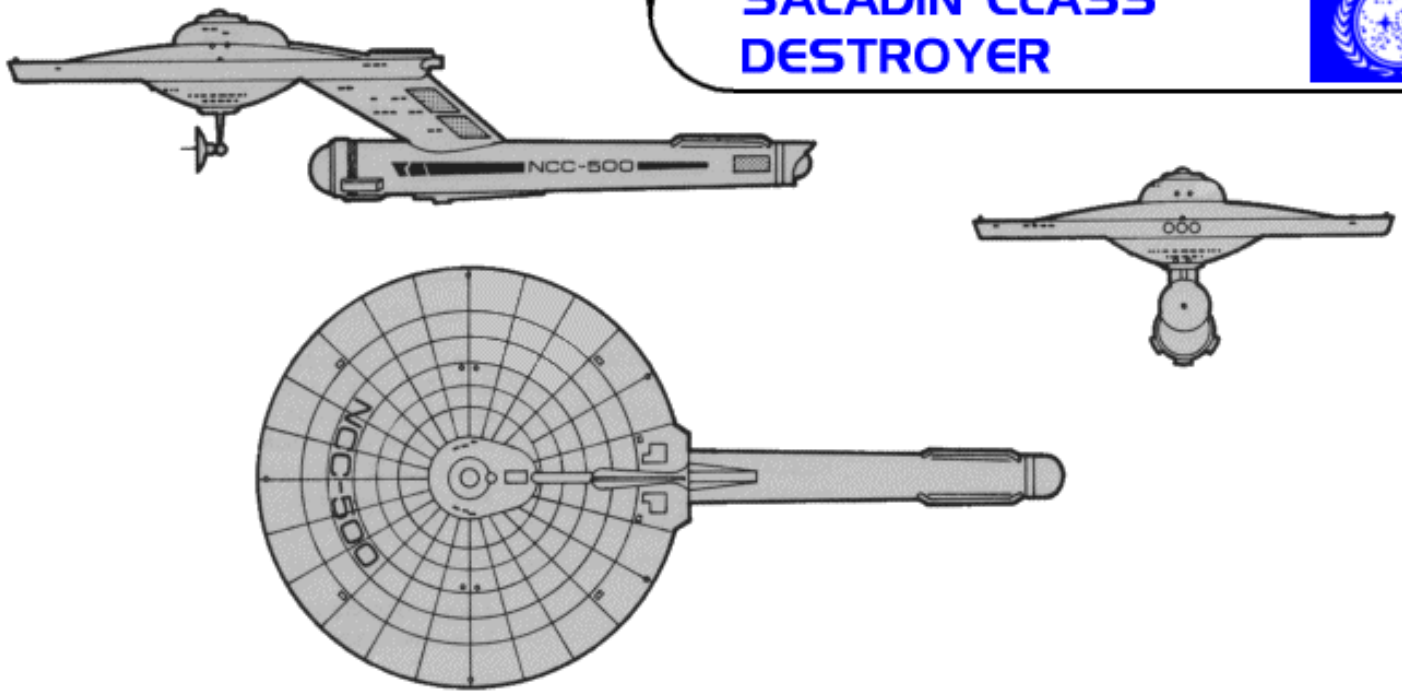

[Click here if you want to view this ship in its own window](#)

BRAD'S COMMENTS: Like the [Federation class battleship](#), this is a design resurrected from the beloved [Star Trek Star Fleet Technical Manual](#) by Franz Joseph. I used a new Excel spreadsheet--aid I built to help me with the old STSSTCS Ship Construction Manual tables--to create the stats for this ship, so there are accurate WDF and D numbers. I didn't look at the [Larson](#) class destroyer from the UFP Recognition Manual, but invariably because of the restrictions of the old design system, I came up with something that was similar. Ascending through the Mark III model, I have made the Saladin more potent offensively than the Larson, especially where torpedoes are concerned. I was tempted to write backstory for this class too, but since the Technical Manual has no backstory for the Saladin, I have chosen to leave this info up to the reader's imagination. I have yet to play this class in a game so if you guys use it and find it successful, let me know.

Construction Data:

	MK I	MK II	MK III
Model Numbers-	VII	VII	VII
Ship Class-	1/8903	1/9421	1/9903
Date Entering Service-	120	74	50
Number Constructed			

Hull Data:

	MK I	MK II	MK III
Superstructure Points-	19	19	21
Damage Chart-	C	C	C
Size			
Length-	242 meters	242 meters	243 meters
Width-	127 meters	127 meters	130 meters
Height-	60 meters	60 meters	60 meters
Weight-	95,540 tons	95,540 tons	99,490 tons
Cargo			
Cargo Units-	150 units	150 units	150 units
Cargo Capacity-	7,500 tons	7,500 tons	7,500 tons
Landing Capability-	None	None	None

Equipment Data:

Control Computer Type-	M-2C	M-2C	M-2C
Transporters-			
Standard 6-person-	4	4	4
Combat 20-person-	None	None	None
Emergency 22-person-	4	4	4
cargo large-	None	None	None
cargo small-	1	1	1

Other Data:

Crew-	200	200	190
Passengers-	10	10	10
Shuttlecraft-	4	4	4

Engines and Power Data:

Total Power Units Available-	26	26	26
Movement Point Ratio-	2/1	2/1	2/1
Warp Engine Type-	FWC-2	FWC-2	FWC-2
Number-	1	1	1
Power Units Available-	20	20	20
Stress Charts-	M/K	M/K	M/K
Maximum Safe Cruising Speed-	Warp 7	Warp 7	Warp 7
Emergency Speed-	Warp 9	Warp 9	Warp 9
Impulse Engine Type-	FIC-3	FIC-3	FIC-3
Power Units Available-	6	6	6

Weapons and Firing Data:

Beam Weapon Type-	FH-4	FH-5	FH-5
Number-	6 in three banks	6 in three banks	6 in three banks
Firing Arcs-	2f, 2s, 2p	2f, 2s, 2p	2f, 2s, 2p
Firing Chart-	Q	R	R
Maximum Power-	3	4	4
Damage Modifiers			
+3			
+2	(1 - 8)	(1 - 8)	(1 - 8)
+1	(9 - 14)	(9 - 16)	(9 - 16)
Missile Weapon Type-	FP-1	FP-1	FP-1
Number-	2	2	3
Firing Arcs-	F	F	F
Firing Chart-	L	L	L
Power To Arm-	1	1	1
Damage-	10	10	10

Shields Data:

Deflector Shield Type-	FSF	FSF	FSF
Shield Point Ratio-	1/2	1/2	1/2
Maximum Shield Power-	10	10	10

Defense Factor-	77.17	76.46	80.03
------------------------	-------	-------	-------

Weapon Damage Factor-	24.40	27.40	31.80
------------------------------	-------	-------	-------

[<<<< GO BACK](#)

IMPORTANT NOTE:

It is entirely possible that you have surfed to this page from an internet portal and are now viewing this page without frames. **The STSSTCSMU&A is best viewed from within its own set of frames**, so [click here to jump to the main STSSTCSMU&A web page](#) and then [see the site as it was meant to be seen!](#)

WELLINGTON CLASS CRUISER

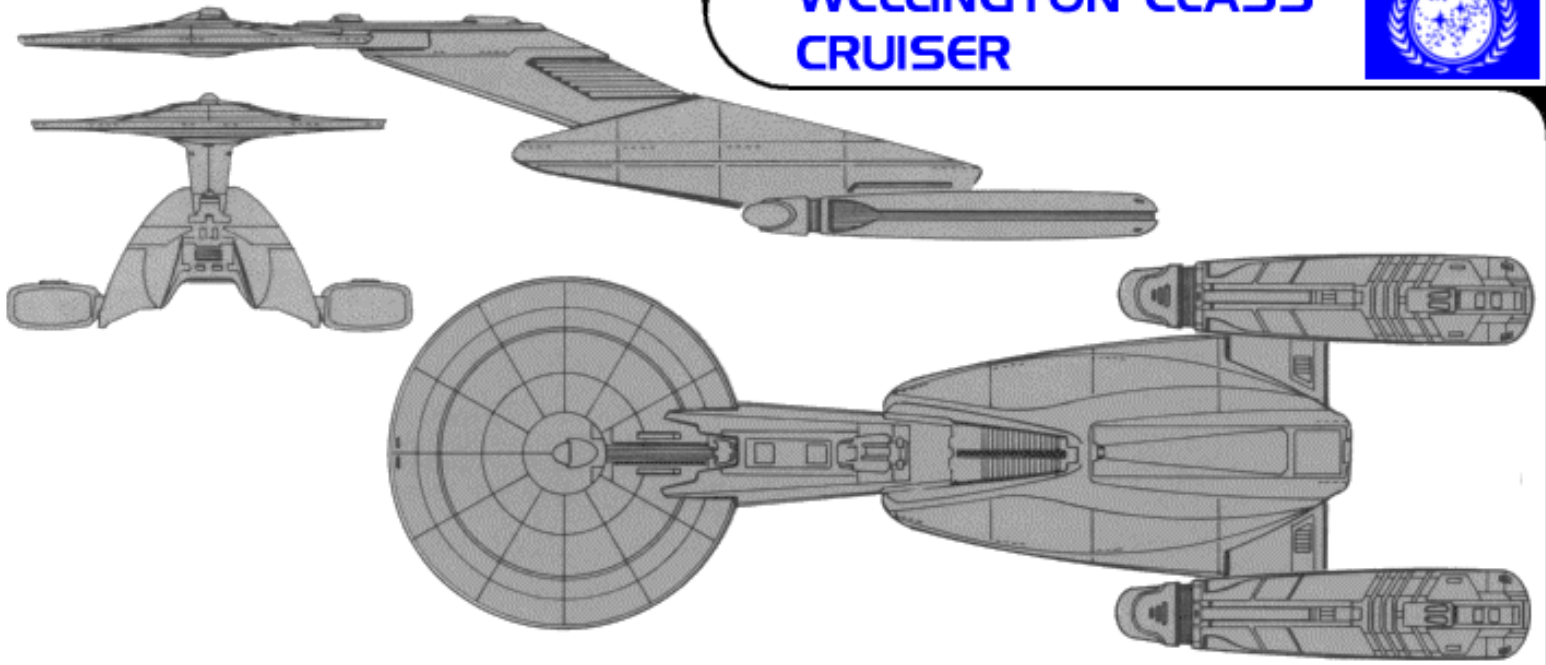

[Click here if you want to view this ship in its own window](#)

BRAD'S COMMENTS: More of that funky TNG-style extrapolation, though I have never liked the looks of the Wellington that much. I dunno, something about the ever-downward slope of the hull as you move from saucer to stern... It just seems unbalanced in my opinion! Play-wise the ship can dish out some good damage compared to older vessels, but the superstructure is not as strong as newer enemy ships so the Wellington has a tendency fold up under intense torpedo fire. Best trick is to have heavier ships with more superstructure try to engage in close-in fights with the enemy while the Wellington fires from distance. The power output is terrible compared to other TNG-era cruisers like the [Excelsior](#), so powering shields is made doubly difficult when you're trying to pour as much juice into the phaser banks as you can. If it was not for the potent FP-4 torps, this class would be a total and complete turkey.

Construction Data:

Model Numbers-	MK I
Ship Class-	XI
Date Entering Service-	2/8802
Number Constructed	33

Hull Data:

Superstructure Points-	28
Damage Chart-	B
Size	
Length-	175 meters
Width-	62 meters
Height-	37 meters
Weight-	165,475 tons
Cargo	
Cargo Units-	100 units
Cargo Capacity-	5,000 tons
Landing Capability-	None

Equipment Data:

Control Computer Type-	M-7A
Transporters-	
Standard 6-person-	3
Combat 12-person-	2
Emergency 22-person-	none
cargo large-	2
cargo small-	2

Other Data:

Crew-	175
Passengers-	50
Shuttlecraft-	4

Engines and Power Data:

Total Power Units Available-	64
Movement Point Ratio-	5/1
Warp Engine Type-	FTWC-1
Number-	2
Power Units Available-	20
Stress Charts-	D/E
Maximum Safe Cruising Speed-	Warp 8
Emergency Speed-	Warp 9.9
Impulse Engine Type-	FIG-1
Power Units Available-	24

Weapons and Firing Data:

Beam Weapon Type-	FH-9
Number-	6 in three banks
Firing Arcs-	2f/p/s, 2s, 2p
Firing Chart-	X
Maximum Power-	6
Damage Modifiers	
+3	
+2	(1 - 12)
+1	(13 - 22)
Missile Weapon Type-	FP-4
Number-	5
Firing Arcs-	2f/p/s, 1s, 1p, 1a
Firing Chart-	S
Power To Arm-	1
Damage-	20

Shields Data:

Deflector Shield Type-	FSO
Shield Point Ratio-	1/3
Maximum Shield Power-	16

Defense Factor- 145.04

Weapon Damage Factor- 98.5

[<<<< GO BACK](#)

IMPORTANT NOTE:

It is entirely possible that you have surfed to this page from an internet portal and are now viewing this page without frames. **The STSSTCSMU&A is best viewed from within its own set of frames**, so [click here to jump to the main STSSTCSMU&A web page](#) and then [see the site as it was meant to be seen!](#)

AMBASSADOR CLASS CRUISER

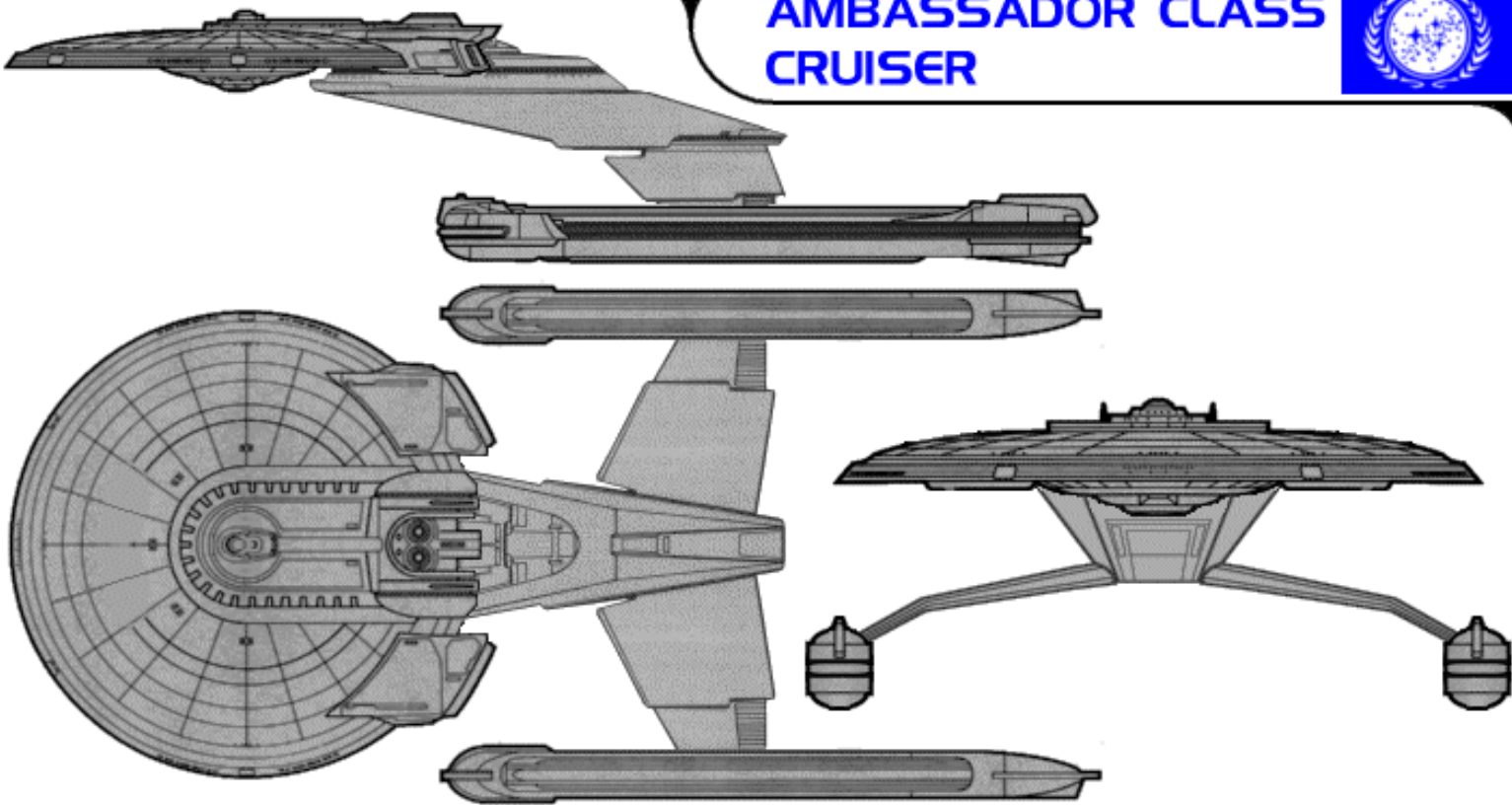

[Click here if you want to view this ship in its own window](#)

BRAD'S COMMENTS: There are TWO "Ambassador Class" ships in Starfleet lore. [One of them is official canon](#), as seen in the **ST:TNG** episode "Yesterday's Enterprise". The other is a fictional creation that appeared several years earlier in the TNG Officers Manual. So please don't get confused if you see two listings for the same class name here at the STSSTCSMU&A.

Originally a very hot looking ship, my only bitch with the FASA Ambassador is that the damned designers borrowed a [Constitution Refit](#) saucer section, and then pasted it down such that it was waaaaaaay out of proportion with the warp nacelles. Those are [Excelsior](#) nacelles after all, and I think the designers would have been VERY smart to mount an Excelsior-style saucer in proportion with the nacelles! So, as has been my want in the past, I set about correcting what I consider to be a design mistake. I replaced the saucer and nacelles with designs a bit more appropriate, and re-drew the bow view in order to reflect the correct slope of the secondary hull, which the original drawing also failed to do. (Click on the small picture at right in order to see the original drawing from the TNG Officers Manual.)

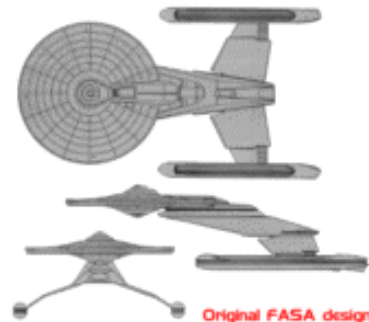

Offensively, the FASA Ambassador is one of the most powerful of the TNG-era FASA designs, featuring a total of ten FP-4 photon torpedoes, with eight of those ten capable of firing into the forward arc at any given moment. Combine that with 70 superstructure points and over 112 power points, and the FASA Ambassador class is one mean sumbitch! Almost as lethal as the [Galaxy](#) class, at least as potent as the [Royal Sovereign](#) class, this ship kicks butt unless faced against an equally powerful single enemy, or numerous less powerful enemies. Those FP-4 torps allow a player to really beat the tar out of any opponent, and quickly too, so gamers are advised to use this class with caution.

Construction Data:

Model Numbers-	MK I
Ship Class-	XIV
Date Entering Service-	2/9912
Number Constructed	15

Hull Data:

Superstructure Points-	70
Damage Chart-	C
Size	
Length-	350 meters
Width-	200 meters
Height-	100 meters
Weight-	286,605 tons
Cargo	
Cargo Units-	200 units
Cargo Capacity-	10,000 tons
Landing Capability-	None

Equipment Data:

Control Computer Type-	M-9A
Transporters-	
Standard 6-person-	5
Combat 12-person-	3
Emergency 22-person-	none
cargo large-	1
cargo small-	2

Other Data:

Crew-	400
Passengers-	100
Shuttlecraft-	6

Engines and Power Data:

Total Power Units Available-	112
Movement Point Ratio-	5/1
Warp Engine Type-	FTWD-2
Number-	2
Power Units Available-	40
Stress Charts-	E/F
Maximum Safe Cruising Speed-	Warp 8
Emergency Speed-	Warp 9.9
Impulse Engine Type-	FIG-2
Power Units Available-	32

Weapons and Firing Data:

Beam Weapon Type-	FH-11
Number-	8 in 4 banks
Firing Arcs-	2f, 2p, 2s, 2a
Firing Chart-	Y
Maximum Power-	10
Damage Modifiers	
+3	(1 - 10)
+2	(11 - 17)
+1	(18 - 24)
Missile Weapon Type-	FP-4
Number-	10 in 4 banks
Firing Arcs-	4f, 2f/p, 2f/s, 2a
Firing Chart-	S
Power To Arm-	1
Damage-	20

Shields Data:

Deflector Shield Type-	FSQ
Shield Point Ratio-	1/4
Maximum Shield Power-	17

Defense Factor- 240.1

Weapon Damage Factor- 210.6

IMPORTANT NOTE:

It is entirely possible that you have surfed to this page from an internet portal and are now viewing this page without frames. **The STSSTCSMU&A is best viewed from within its own set of frames**, so [click here to jump to the main STSSTCSMU&A web page](#) and then [see the site as it was meant to be seen!](#)

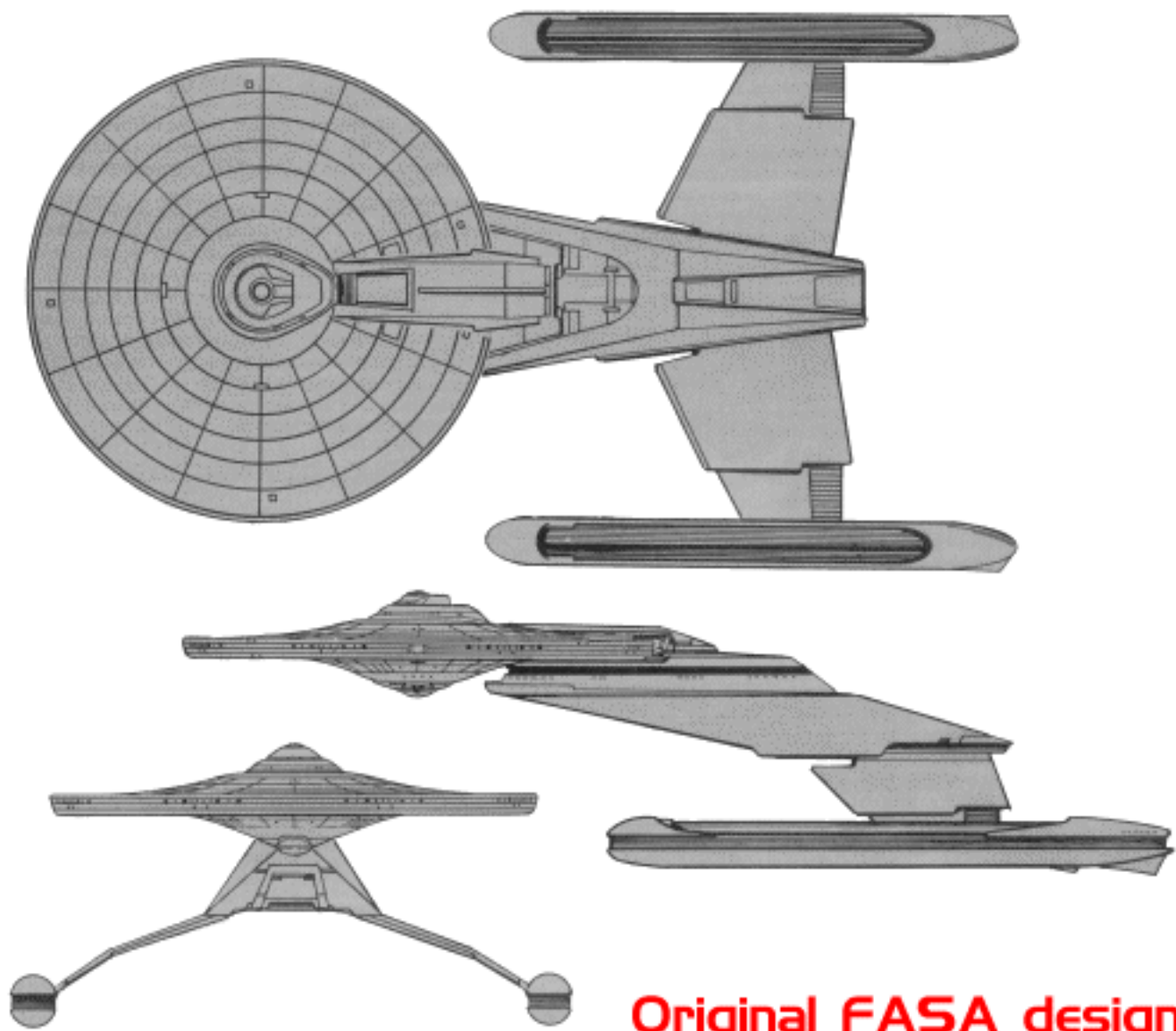

Original FASA design

AMBASSADOR CLASS HEAVY CRUISER

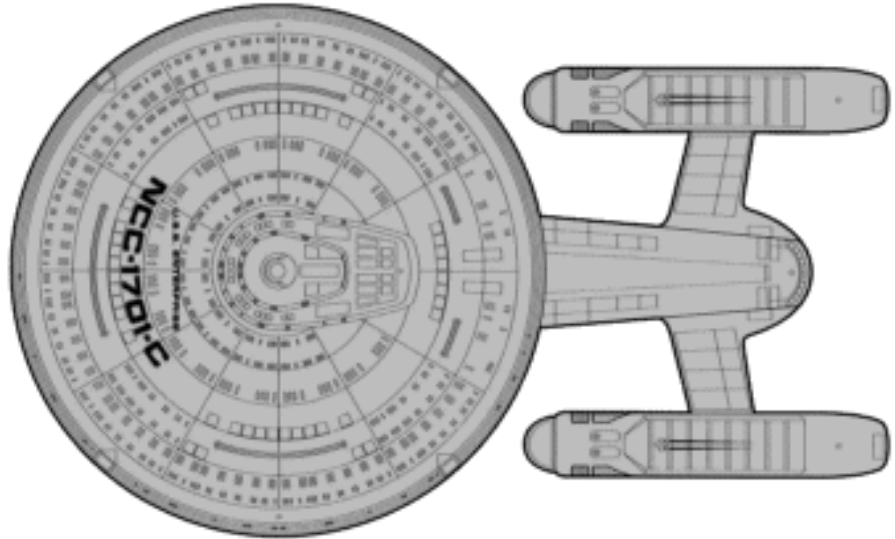
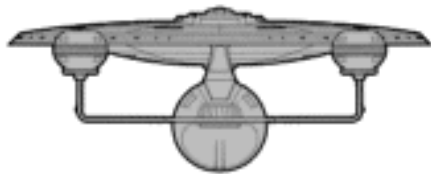
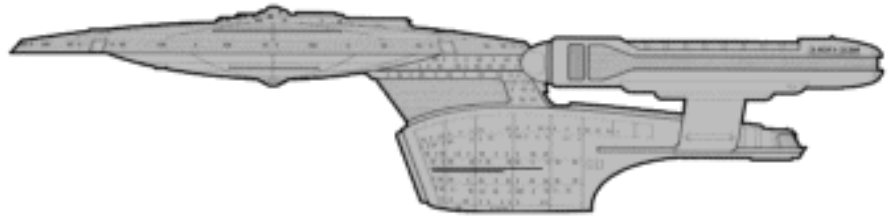

[Click here if you want to view this ship in its own window](#)

BRAD'S COMMENTS: Not to be confused with FASA's own [Ambassador Class](#) heavy cruiser, the *actual* Ambassador Class of Trek canon did not appear until the **ST:TNG** episode "Yesterday's Enterprise". Constructed under the assumption that the Ambassador had to bridge the design gap between the [Excelsior](#) cruiser and the [Galaxy Class](#) exploration series, the model does incorporate many elements from both of the previous ships. However, I've often thought that the Ambassador also borrows from the [Constitution Refit](#) in that its engineering hull is remarkably tubular in design, with a large, circular deflector dish. The secondary hull of the Galaxy is too flattened and elliptical, while the Excelsior hull isn't a circle nor is it an ellipse, so the Ambassador's engineering hull seems very 'retro' in comparison.

When it comes to combat, I was unsure how to rate this vessel. There is much evidence to suggest that the Ambassador is an explorer, like the Galaxy that would follow it. There is also much evidence to suggest that the Ambassador is a fighting man's ship, equipped with a potent array of phasers and torpedoes. Therefore I have taken the middle road, assuming that the Ambassador's pedigree is the same as its ancestors, the Excelsior and the Constitution: a heavy cruiser loaded down with science and exploration equipment, but also armed for bear in the event that the Ambassador has to deal with hostile situations while exploring the Federation frontier.

I also made the assumption that the Ambassador is designed to have a lengthy lifespan, like the Excelsior before it, so that any late-model ships ought to be as well armed and well equipped as possible, bringing them roughly up to par with their younger, more potent siblings, like the [Sovereign Class](#). Naturally the Ambassador shouldn't be an exact match for the mighty Sovereign, but a late-model Ambassador ought to at least be close to an early-model Galaxy. Or at least that is how I feel.



Construction Data:

Model Numbers-	MK I *	MK II *	MK III *	MK IV *
Ship Class-	XV	XV	XV	XV
Date Entering Service-	2305 A.D.	2327 A.D.	2344 A.D.	2360 A.D.
Number Constructed	unknown	unknown	unknown	unknown

Hull Data:

Superstructure Points-	68	74	80	87
Damage Chart-	C	C	C	C
Size				
Length-	526 meters	526 meters	528 meters	528 meters
Width-	317 meters	317 meters	317 meters	317 meters
Height-	130 meters	130 meters	132 meters	132 meters
Weight-	318,200 tons	327,900 tons	340,100 tons	349,500 tons
Cargo				
Cargo Units-	350 units	350 units	375 units	375 units
Cargo Capacity-	17,500 tons	17,500 tons	18,750 tons	18,750 tons
Landing Capability-	None	None	None	None

Equipment Data:

Control Computer Type-	MBT-08	MBT-09	MBT-09	MBT-10
Transporters-				
Standard 6-person-	10	11	11	11
Emergency 22-person-	8	8	8	8
cargo-	6	6	6	6

Other Data:

Crew-	875	910	900	890
Troops-	none	none	none	none
Passengers-	35	40	40	45
Shuttlecraft-	12	14	14	14

Engines and Power Data:

Total Power Units Available-	124	136	155	158
Movement Point Ratio-	5/1	6/1	6/1	6/1
Warp Engine Type-	FNWD-4C	FNWD-5A	FNWD-5B	FNWD-5B
Number-	2	2	2	2
Power Units Available-	47	53	60	60
Stress Charts-	K/F	F/K	F/K	F/K
Maximum Safe Cruising Speed-	Warp 8	Warp 8	Warp 8	Warp 8
Emergency Speed-	Warp 9.9	Warp 9.9	Warp 9.9	Warp 9.9
Impulse Engine Type-	FNIS-220	FNIS-220	FNIS-300	FNIS-320
Power Units Available-	30	30	35	38

Weapons and Firing Data:

Beam Weapon Type-	FAHW-20	FAHW-22	FAHW-23	FAHW-25
Number-	10	12	13	14
Firing Arcs-	4f, 2p, 2s, 2a	4f, 3p, 3s, 2a	4f, 3p, 3s, 3a	4f, 3p, 3s, 4a
Firing Chart-	T	U	U	V
Maximum Power-	12	14	15	17
Damage Modifiers				
+3	(1 - 6)	(1 - 7)	(1 - 7)	(1 - 8)
+2	(7 - 14)	(8 - 14)	(8 - 14)	(9 - 15)
+1	(15 - 18)	(15 - 20)	(15 - 20)	(16 - 21)
Missile Weapon Type-	FP-4	FP-13	FP-13	FP-15
Number-	7	9	9	9
Firing Arcs-	3f, 1f/p, 1f/s, 2a	4f, 1f/p, 1f/s, 3a	4f, 1f/p, 1f/s, 3a	4f, 1f/p, 1f/s, 3a
Firing Chart-	S	V	V	W
Power To Arm-	1	3	3	3
Damage-	20	23	23	25

Shields Data:

Deflector Shield Type-	NGSS-E	NGSS-F	NGSS-G	NGSS-H
Shield Point Ratio-	1/3	1/3	1/3	1/3
Maximum Shield Power-	18	21	24	27

Defense Factor-	unknown	unknown	unknown	unknown
Weapon Damage Factor-	unknown	unknown	unknown	unknown

* Denotes completely hypothetical model number and stats, devised by Brad R. Torgersen.

[<<<< GO BACK](#)

IMPORTANT NOTE:

It is entirely possible that you have surfed to this page from an internet portal and are now viewing this page without frames. **The STSSTCSMU&A is best viewed from within its own set of frames**, so [click here to jump to the main STSSTCSMU&A web page](#) and then [see the site as it was meant to be seen!](#)

AKIRA CLASS BATTLE-CRUISER

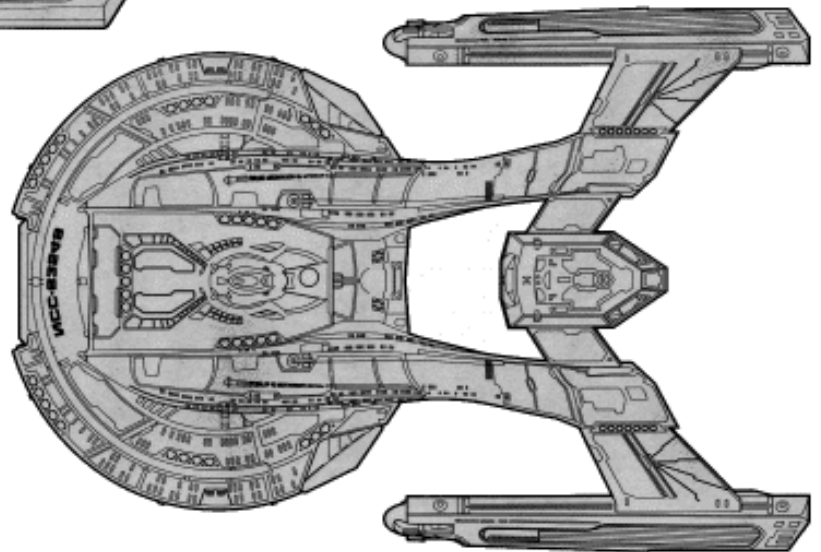
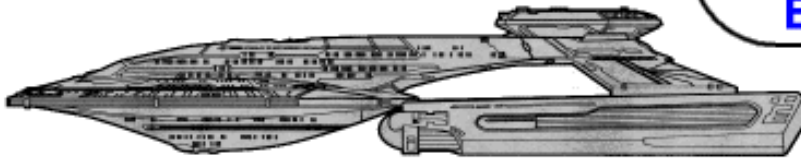

[Click here if you want to view this ship in its own window](#)

HYPOTHETICAL SIZE COMPARISON

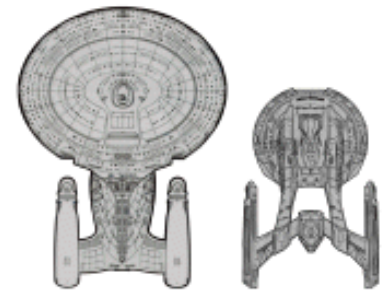

GALAXY

AKIRA

BRAD'S COMMENTS: Of all the CGI ships to have emerged from the **ST:DS9** TV series and the **Next Generation** movies, none have received more fan scrutiny than the Akira Class. Is it a cruiser? A frigate? How big is this thing? By some accounts it is smaller than an [Excelsior](#) Class. By other accounts it is as wide or wider than the [Sovereign](#) and perhaps half to two-thirds as long. Based on the comments of the ship's original creator, Alex Jaeger, the class is intended as a heavy weapons platform with an obscene number of torpedoes (15?) and lots of phasers. There is also some indication that the Akira has limited through-deck carrier capability for shuttlecraft, though I have not confirmed this. So, how to approach adapting this class for the STSSTCS? I guess the safest thing to say is that I know going in that not all fans will be happy with my adaptation. Some will find my adaptation too strong, others will find it too weak. My apologies in advance if I didn't seem to get it quite right. However, there are three different models of varying potency, so if you are using this ship for a simulation I hope you can find at least one model that suits your purposes.

Of course, no discussion of the Akira can be complete without also discussing the [NX-01 Enterprise](#). When UPN launched its new "retro" Trek series, even the most retarded person could tell that the NX design was a thinly-veiled ripoff of the Akira. I myself have been struck by the similarities that both the Akira and the NX have to the FASA [Loknar](#) design, which predates both the NX and the Akira by a number of years. If I could get in a time machine and go back a year or two when they were ramping up pre-production for the new TV show, I'd hold a gun to somebody's head until they came up with a truly original design for the NX class. Ripping off the Akira for the design of a ship that predates the Akira by over two hundred years is just plain lazy. I have read the arguments that try to explain or support the Akira/NX connection, but I just don't buy it. The ENTERPRISE staff had all the time and the money in the world to devise a truly original ship (as happened with **ST:VOY**, and **ST:TNG**) and instead they handed us a warmed-over retread. Blech.

LOKNAR, 1985

AKIRA, 1996

NX-01, 2001

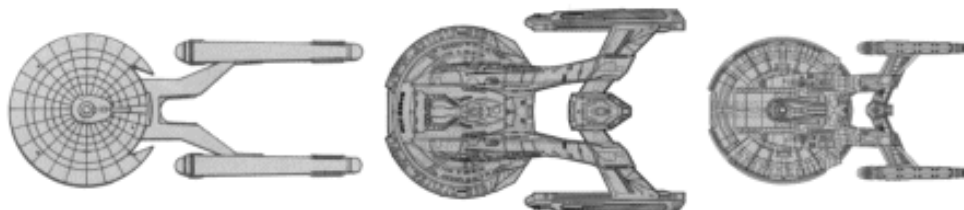

**Three different classes, three different
periods, but basically the same ship?**

Construction Data:

Model Numbers-	MK I *	MK II *	MK III *
Ship Class-	XV	XV	XV
Date Entering Service-	2357 A.D.	2364 A.D.	2373 A.D.
Number Constructed	classified	classified	classified

Hull Data:

Superstructure Points-	70	78	86
Damage Chart-	C	C	C
Size			
Length-	443 meters	443 meters	443 meters
Width-	304 meters	304 meters	304 meters
Height-	79 meters	79 meters	79 meters
Weight-	270,600 tons	285,200 tons	297,000 tons
Cargo			
Cargo Units-	200 units	200 units	200 units
Cargo Capacity-	10,000 tons	10,000 tons	10,000 tons
Landing Capability-	None	None	None

Equipment Data:

Control Computer Type-	MBT-10	MBT-10	MBT-10
Transporters-			
Standard 6-person-	7	7	7
Emergency 22-person-	5	5	5
cargo-	2	2	2

Other Data:

Crew-	520	505	490
Passengers-	50	60	60
Shuttlecraft-	12	14	15

Engines and Power Data:

Total Power Units Available-	138	150	162
Movement Point Ratio-	6/1	6/1	6/1
Warp Engine Type-	FNWD-5A	FNWD-5B	FNWD-5C
Number-	2	2	2
Power Units Available-	54	60	66
Stress Charts-	F/K	F/K	F/K
Maximum Safe Cruising Speed-	Warp 8	Warp 8	Warp 8
Emergency Speed-	Warp 9.9	Warp 9.9	Warp 9.9
Impulse Engine Type-	FNIS-220	FNIS-220	FNIS-220
Power Units Available-	30	30	30

Weapons and Firing Data:

Beam Weapon Type-	FAHW-24	FAHW-25	FAHW-26
Number-	12 in four banks	12 in four banks	12 in four banks
Firing Arcs-	4f/p, 4f/s, 2a/p, 2a/s	4f/p, 4f/s, 2a/p, 2a/s	4f/p, 4f/s, 2a/p, 2a/s
Firing Chart-	V	V	W
Maximum Power-	16	17	18
Damage Modifiers			
+3	(1 - 8)	(1 - 8)	(1 - 9)
+2	(9 - 15)	(9 - 15)	(10 - 16)
+1	(16 - 21)	(16 - 21)	(17 - 20)
Missile Weapon Type-	FQT-4	FQT-5	FQT-6
Number-	5	5	5
Firing Arcs-	3f, 2a	3f, 2a	3f, 2a
Firing Chart-	Y	Y	Y
Power To Arm-	4	5	5
Damage-	26	28	30
Missile Weapon Type-	LYFP-AX1	LYFP-AX1	LYFP-AX2
Number-	10	10	10
Firing Arcs-	4f, 2p, 2s, 2a/p, 2a/s	4f, 2p, 2s, 2a/p, 2a/s	4f, 2p, 2s, 2a/p, 2a/s
Firing Chart-	U	U	V
Power To Arm-	1	1	1
Damage-	12	12	14

Shields Data:

Deflector Shield Type-	NGSS-I	NGSS-J	NGSS-M
Shield Point Ratio-	1/3	1/3	1/4
Maximum Shield Power-	30	33	36
Defense Factor-	241.1 **	264.5 **	320.4 **
Weapon Damage Factor-	344.1 **	362.2 **	415.3 **

* Denotes completely hypothetical model number and stats, devised by Brad R. Torgersen.

** D and WDF numbers provided by [Bryan Jecko](#). Thanks Bryan!

[<<<< GO BACK](#)

IMPORTANT NOTE:

It is entirely possible that you have surfed to this page from an internet portal and are now viewing this page without frames. **The STSSTCSMU&A is best viewed from within its own set of frames**, so [click here to jump to the main STSSTCSMU&A web page](#) and then [see the site as it was meant to be seen!](#)

LOKNAR CLASS FRIGATE



TOS-ERA ORIGINAL

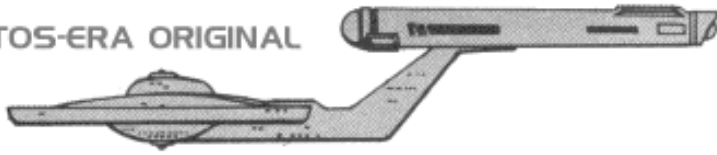

TMP-ERA REFIT

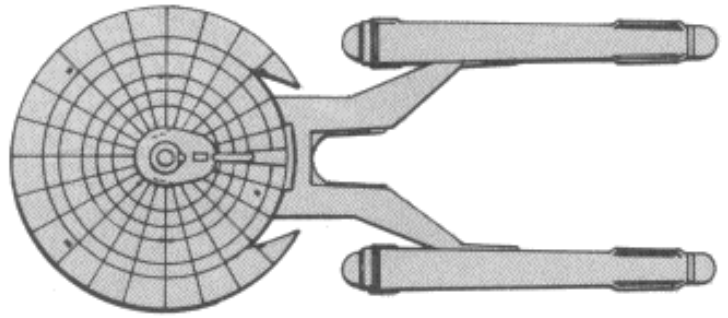

[Click here if you want to view this ship in its own window](#)

BRAD'S COMMENTS: Who says that the [NX-01](#) is based purely on the TNG-era [Akira](#) design? The moment I saw the NX-01 Enterprise, I didn't think of the Akira as much as I thought of the old FASA Loknar design! At last, another thread tying an otherwise apocryphal FASA design to the bedrock of Trek canon! Or, well, maybe... You've got to admit that the two ships are remarkably similar. Fans have taken to derisively calling the NX-01 the "Akiraprise" in reference to its thinly-veiled resemblance to the Akira. To heck with that, I say, that's no damned Akiraprise! It's really the Loknarprise!

The Loknar class is one of the most powerful TOS-era ships in the entire STSSTCS system, with later models--refitted to TMP-era stats--being more than a match for many mid-range Klingon cruisers. The triple-forward torpedo armament gives the Loknar a brutal first punch, while good warp engines provide generous power for both phasers and shields. Next to the Chandley, the Loknar is my most favorite Federation frigate and I have played it in numerous campaigns, most notably against the Klingon Empire. The Mark V Loknar is a good opponent for the Type G [D-10 Riskadh](#) cruiser, or the Types B and E [L-9 Saber](#).

The backstory for the class is rubbish by current canon, but contains some notable references, especially to the "blue fleet" which is mentioned in other parts of the STSSTCS. Though there is no official mention in Trek of any such entity within Starfleet, given the recent developments with the Andorians in ENTERPRISE it does seem plausible. The Andorians are aggressive, war-bent, and not just a little racist. I have no trouble that the Andorians would seek out warship design, and would push to crew warships exclusively so that they could get away from all those damned "pink skins".

One Neutral Zone skirmish that gamers may find interesting is as follows: A Mark VI [Anton Class](#) science cruiser from Starfleet has gone missing near the Klingon Neutral Zone. Suspecting foul play, Starfleet sends a Mark III [Constitution Class](#) along with two Mark IV Loknars to investigate and possibly retrieve the Anton. Set up a map sheet littered with asteroids, and place the Anton in the middle of the asteroid field. The UFP player controls the Anton, but the Anton is damaged and has only a third its normal power output and half its normal superstructure. The other three UFP ships should be arrayed along one edge of the map sheet. Along the opposite edge are two M type [Klingon D-7 cruisers](#). Somewhere within the asteroid field are three cloaked Type C [D-18 Gull destroyers](#). The goal of the Federation player is to get the Anton back to the UFP side of the mapsheet intact, along with at least one of the other Starfleet vessels. The goal of the Klingon player is to lure as many Starfleet ships into the asteroid field as possible, using the wounded Anton as bait, then destroy the Federation search fleet *without* destroying the Anton.

The Klingons will have superior numbers, but the Federation has superior firepower. The Anton cannot be used as an offensive weapon lest it be destroyed, nor can the Klingons destroy it because they want it as a war prize. At no time can any ship flee the map sheet.

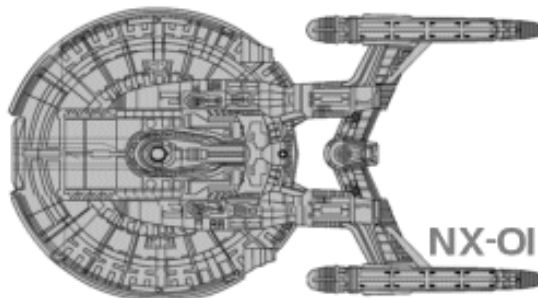

NX-01

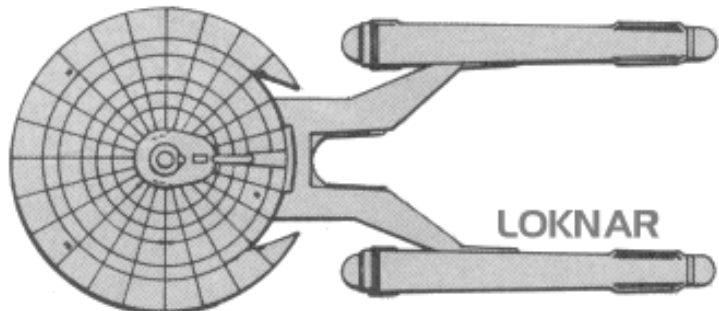

LOKNAR

That's no "Akiraprise", It's really the LOKNARPRISE!!!

NOTES: The Loknar Class frigates were built "The Great Awakening", a period of expansion by the Federation. During this time, many research and exploration vessels were designed and built to aid in the effort to solidify an enlarged and growing United Federation of Planets. Also during this period, a smaller number of warships were built. The Loknar, the most noted of these warships, is still in service to this day, a tribute to the quality of the Andorian design.

Soon after the Federation Appropriations Committee granted Star Fleet the funds necessary to construct fleets to expand and patrol the limits of the UFP, Andorian factions began pushing for warship construction. The basic Andorian philosophy was that, in expanding, the Federation might come upon races as hostile as the Romulans and Klingons, leading to another protracted war broke out for which the Federation and Star Fleet were unprepared. The Andorians argued that, were this to happen or were the Klingons or Romulans to escalate hostilities, Star Fleet needed to be better prepared and would need ships to protect the new borders and colonies. The Andorian arguments were successful, and Star Fleet began a limited build-up of warships. Several ship-building facilities were constructed by Andorian firms to design and manufacture these warships, the most notable of these on Sol IV and Salazaar, the largest and most productive in the Federation.

Introduced on Stardate 1/9010, the Loknar Class frigate mounted the new, but already proven, FWE-1 warp drive, in Star Fleet's inventory for only two years. The FIC-2 impulse engine was introduced on the Loknar and has since proven itself to be one of the most reliable of all production. The Loknar Mk I was considered a 'muscle' ship because of its four heavy lasers and single accelerator cannon, making it equal to all but the largest Klingon vessels and more powerful than any ship in the Romulan navy. In addition, the Loknar mounted FSH shield generators, more efficient than any used by the enemies of the Federation.

During the Four Years War, the Loknar saw more action than any other vessel in Star Fleet. Although it was considered to be successful, the Andorian designers felt a need to improve it. The FWE-2 warp drive systems, still being tested, would produce 60% more power than the FWE-1 and would increase the ship's overall performance. The Mk II was commissioned into service on Stardate 1/9801 mounting the FWE-2, even though this engine was not officially adopted by Star Fleet until Stardate 2/0002.

The most significant advance in starship technology came with the phaser and photon torpedo. The phaser delivers more firepower at longer ranges, weighs less, and requires less structural reinforcing than the laser. The newly developed photon torpedo delivered the same explosive power at 75% less power requirement, was considerably lighter, and required less structural reinforcement than the accelerator cannon. Eight FH-5phasers and four FP-3 torpedoes were incorporated into the Mk II, making it more powerful than anything in the Klingon fleet with the exception of the D-10. The Mk II also mounted an upgraded binary shield generator, the FSK, giving 33% more protection at the same output level as they earlier system.

The next major change in the Loknar's design came with the introduction of the FWD-2 warp drive to the Mk IV. This increased the power output and overall performance by 40%. Furthermore, this model was modified to fire the FP-1 photon torpedo.

Loknar Class frigates have served Starfleet faithfully for 33 years and will remain in the inventory for many years to come. Loknars are produced at the Salazaar and Sol VI facilities at a rate of 2 ships per year, including refits. The current production rate is low due to the number of ships required and the high levels of reliability in the existing ships.

The Loknar Class frigates are named after cities and provinces of the Federation. More than half of these vessels are crewed by Andorians and the majority of these are assigned to the 'Blue Fleet'; ships whose crew and officer contingent are entirely Andorian. The *USS Loknar* was the first ship commissioned into the Blue Fleet, Serving as the flagship for many years.

The infamous *IKVS Staav'eMara* (Slave of Justice), was originally the *USS Morgan City*, a Loknar Class frigate captured by Admiral Kamato's forces during the Four Years War and later used in Kamato's abortive coup attempt on the Klingon throne. After failing, Kamato retreated into the Triangle, taking the Loknar Class frigate with him. From their location within the Triangle, the rebels began attacking unprotected convoys and merchant vessels by using the *Staav'eMara* to lure them in. This ruse lasted for several years, then a general recall of all Loknar Class vessels made it difficult for the Klingon vessel to operate as though it were from Starfleet. The IKS Admiralty then decided to have the vessel painted in the standard steel gray color of their navy. The *Staav'eMara* still operates with the IKS Navy and has been seen as recently as stardate 2/2301.

Construction Data:

Model Numbers-	MK I	MK II	MK IV	MK V
Ship Class-	VII	VIII	IX	X
Date Entering Service-	1/9010-1/9912	1/9801-2/1502	2/1308	2/1709
Number Constructed	48	42	86	42

Hull Data:

Superstructure Points-	14	18	21	24
Damage Chart-	C	C	C	C
Size				
Length-	290 meters	290 meters	290 meters	290 meters
Width-	127 meters	127 meters	127 meters	127 meters
Height-	56 meters	56 meters	56 meters	56 meters
Weight-	109,000 tons	115,800 tons	140,400 tons	145,975 tons
Cargo				
Cargo Units-	260 units	280 units	280 units	280 units
Cargo Capacity-	13,000 tons	14,000 tons	14,000 tons	14,000 tons
Landing Capability-	none	none	none	none

Equipment Data:

Control Computer Type- Transporters-	M-2	M-2	M-3	M-3
Standard 6-person-	3	3	3	3
Combat 20-person-	none	none	none	none
Emergency 22-person-	1	1	1	1
cargo-	1	1	1	1

Other Data:

Crew-	76	79	84	84
Passengers-	4	4	4	4
Troops-	none	none	none	none
Shuttlecraft-	2	2	2	2

Engines and Power Data:

Total Power Units Available-	19	29	39	42
Movement Point Ratio-	3/1	3/1	2/1	2/1
Warp Engine Type-	FWE-1	FWE-2	FWD-2	FWD-2
Number-	2	2	2	2
Power Units Available-	8	13	18	18
Stress Charts-	L/G	G/K	M/G	M/G
Maximum Safe Cruising Speed-	Warp 7	Warp 7	Warp 6	Warp 6
Emergency Speed-	Warp 9	Warp 9	Warp 8	Warp 8
Impulse Engine Type-	FIC-2	FIC-2	FIC-2	FIC-3
Power Units Available-	3	3	3	6

Weapons and Firing Data:

Beam Weapon Type-	FL-4	FH-5	FH-5	FH-5
Number-	4 in one bank	8 in four banks	8 in four banks	8 in four banks
Firing Arcs-	4f/p/s	2f/p, 2f/s, 4a	2f/p, 2f/s, 4a	2f/p, 2f/s, 4a
Firing Chart-	G	R	R	R
Maximum Power-	3	4	4	4
Damage Modifiers				
+3				
+2		(1 - 8)	(1 - 8)	(1 - 8)
+1	(1 - 4)	(9 - 16)	(9 - 16)	(9 - 16)
Missile Weapon Type-	FAC-2	FP-3	FP-1	FP-6
Number-	1 in one bay	4 in two bays	4 in two bays	4 in two bays
Firing Arcs-	F	3f, 1a	3f, 1a	3f, 1a
Firing Chart-	G	D	L	O
Power To Arm-	4	1	1	1
Damage-	10	6	10	12

Shields Data:

Deflector Shield Type-	FSH	FSK	FSK	FSK
Shield Point Ratio-	1/2	1/2	1/2	1/2
Maximum Shield Power-	12	16	15	15

Defense Factor-

65.0 76.7 76.7 114.3

Weapon Damage Factor-

5.4 29.6 42.4 51.6

[<<<< GO BACK](#)**IMPORTANT NOTE:**

It is entirely possible that you have surfed to this page from an internet portal and are now viewing this page without frames. **The STSSTCSMU&A is best viewed from within its own set of frames**, so [click here to jump to the main STSSTCSMU&A web page](#) and then [see the site as it was meant to be seen!](#)

FIRESTORM CLASS DESTROYER

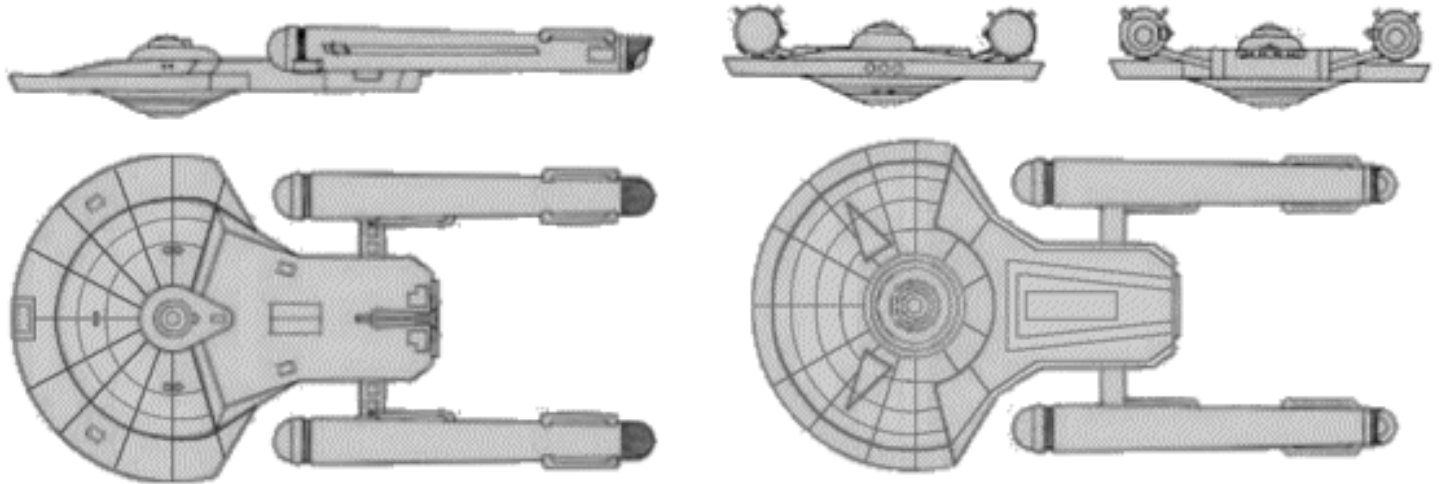

[Click here if you want to view this ship in its own window](#)

BRAD'S COMMENTS: Dallas did the stats and story, Jeff did the art. As received by me, the ship seems to have been hand-drawn! And with aft and ventral views no less! What a treat. Alas, the sizes of the two JPEG files I got were horribly small. I would have liked much bigger files. And the drawings themselves were not very well detailed. In the process of formatting the graphics for this site I took the liberty of drawing in a shield grid on the saucer and sharpening up a few lines that were muzzy or otherwise faded. All in all I think the class looks pretty decent. TOS-era ships are far and away the quickest to draw because you can get away with not having a lot of detail. By contrast, TNG-era ships take forever to draw because they are ultra-detailed. Yech. Anyway, the backstory is fairly cool too, indulging in the apocryphal Four Years War that we all know and love so much. I look forward to trying this class in a TOS scenario, if I can ever get around to playing again. As with so many smallish ships, the addition of torpedoes seems to have been the decisive design decision. Lacking power, this ship would be an offensive dunce without the ability to deliver up to 20 damage points for only 2 energy points expended.



FANSHIP DESIGN & STATS: Dallas Reinhart & Jeff Willoughby (collaborators), 2002

Firestorm Class V Destroyer

NOTES: Shortly after the Four Years War, the vessel classes that took part in most of the combat were under heavy review, and some of the results were unfavorable. Larsons had poor shields, Antons didn't have enough weapons, and the Loknar's photon torpedo system was well below combat expectations. But when the Firestorm was first offered to the fleet, Starfleet Command quickly jumped at the opportunity to test the new combat vessel.

Created shortly after the Four Years War, the Firestorm Class Destroyer was built for one purpose: to hunt down and destroy vessels. The Federation wanted a cheap, small and powerful vessel. Through the experimentation of cramming in the most guns in a rejected scout design, the designers at the Antares Shipyard came up with the Firestorm class.

It was originally supposed to be armed with the experimental FH-6 or FH-7 phaser banks, and it was rumored that it would also be equipped with FH-3 long range phasers, but due to weight restrictions and computer problems, they opted for the reliable, economical and still powerful FH-5 phasers. To give the Firestorm more offensive punch, it was given two FH-1 torpedos in response to the Loknar's lack of photon torpedo power and range. The shields were added to be superior to it's closest competitor, the Larson.

The most important part of the ship are the warp engines themselves. Using experimental FWB-2 warp engines, engineers were able to take destroyer speed to the next level. The Firestorm's superior speed (clocked at warp 8 on safe cruise, as fast as a Nelson scout except for emergency speed which is Warp 9 and ample power

gave the Firestorm the perfect traits for its role as a hunter/pursuer, and its cost was brought down enough to be readily bought in large numbers. But first, the ship had to go through its growing pains. Balancing out firepower and speed in a tiny package was not easy (as the Project Defiant team in the future later realized!) and there had to be a lot of compromise in the project. They had to employ weaker phasers not only because of weight and room restrictions, but also because in combat it was found out that most ships, even Constitution class cruisers, didn't power their weapons to the absolute maximum without risking a major drain on the shielding systems.

Not only that, the first experimental vessel, the USS Firestorm (NX-2088) later exploded after a flaw in the ship's photon torpedo/deflector dish rollbar. Therefore, the twin torpedo tubes had to be relocated to the saucer section, and the deflector dish had to be moved to underneath the engineering section, much like a Klingon Bird of Prey or an Anton.

The Firestorm was pushed off the assembly line shortly after the MK II Constitution class, and designed as a hunter/pursuer vessel. They were not popular vessels because of the phasers, but they did act as excellent pursuit ships against Orion pirates and other smugglers thanks to their photon torpedoes. They also acted in 'wolfpacks' of two or three, because the Firestorm was not well adapted to one on one combat against other vessels.

Though it did have its flaws, it worked well in its intended role. A pack of Firestorms were deadly opponents to face for even a large vessel, hence the name Firestorm; fast and furious, small, nimble... it was a very aggressive ship. Some captains even gave their vessels lurid exterior hull markings like shark's teeth and menacing eyes to show their aggressive behavior.

However, the Firestorm was the victim of peace. They never saw any heavy combat, save for a few isolated incidents where they performed somewhat well. The Firestorm was not needed so much when the Federation was at peace, so after ten years of service, most were phased out. Some survived for combat training, while others were upgraded to MK II's at the same time the Constitution class vessels were being upgraded.

The MK II variant was supposed to be equipped with the FP-4 photon torpedo launcher and an additional bank of FH-4 'Viper Fang' variant phasers. The refit was done on the USS Firestorm and the USS Dervish for test trials. Though the vessel functioned well, the Viper Fangs were inadequate as a weapon, and the single powerful photon torpedo launcher made the Firestorm a target with a well painted bullseye; to seek out and destroy when participating in wargames. Not only that, the costs to 'upgrade' the ship with impotent phasers and an overpowered photon was not worth the benefits gained. Therefore, the project was scrapped. The Firestorm and the Dervish were mothballed at Utopia Planetia Shipyards, while the other Mark 1 Firestorms were slowly phased out of service.

Construction Data:

	MK I	MK II
Model Numbers-	V	V
Ship Class-	2/1155	2/1900
Date Entering Service-	56	5
Number Constructed		

Hull Data:

Superstructure Points-	12	12
Damage Chart-	C	C
Size		
Length-	256 meters	256 meters
Width-	127 meters	127 meters
Height-	32 meters	32 meters
Weight-	59,805 tons	59,875 tons
Cargo		
Cargo Units-	100 units	100 units
Cargo Capacity-	5,000 tons	5,000 tons
Landing Capability-	None	None

Equipment Data:

Control Computer Type-	M-1	M-1
Transporters-		
Standard 6-person-	2	2
Combat 20-person-	none	none
Emergency 22-person-	none	none
cargo large-	none	none
cargo small-	1	1

Other Data:

Crew-	109	109
Marines-	none	none
Passengers-	20	20
Shuttlecraft-	1	2

Engines and Power Data:

Total Power Units Available-	30	30
Movement Point Ratio-	2/1	2/1
Warp Engine Type-	FWB-2	FWB-2
Number-	2	2
Power Units Available-	12	12
Stress Charts-	M/O	M/O
Maximum Safe Cruising Speed-	Warp 8	Warp 8
Emergency Speed-	Warp 9	Warp 9
Impulse Engine Type-	FIB-3	FIB-3
Power Units Available-	6	6

Weapons and Firing Data:

Beam Weapon Type-	FH-5	FH-5
Number-	4 in 2 banks	4 in 2 banks
Firing Arcs-	2f/p, 2f/s	2f/p, 2f/s
Firing Chart-	R	R
Maximum Power-	4	4
Damage Modifiers		
+3		
+2	(1 - 8)	(1 - 8)
+1	(9 - 16)	(9 - 16)
Beam Weapon Type-		FH-4
Number-		2 in one bank
Firing Arcs-		2f/p/s
Firing Chart-		Q
Maximum Power-		3
Damage Modifiers		
+3		
+2		(1 - 8)
+1		(9 - 16)
Missile Weapon Type-	FP-1	FP-4
Number-	2	1
Firing Arcs-	F	F
Firing Chart-	L	S
Power To Arm-	1	1
Damage-	10	20

Shields Data:

Deflector Shield Type-	FSH	FSH
Shield Point Ratio-	1/2	1/2
Maximum Shield Power-	14	14

Defense Factor-	85.8	85.8
Weapon Damage Factor-	22.1	30.0

[<<<< GO BACK](#)

IMPORTANT NOTE:

It is entirely possible that you have surfed to this page from an internet portal and are now viewing this page without frames. **The STSSTCSMU&A is best viewed from within its own set of frames**, so [click here to jump to the main STSSTCSMU&A web page](#) and then [see the site as it was meant to be seen!](#)

WILKERSON CLASS DESTROYER



[Click here if you want to view this ship in its own window](#)

BRAD'S COMMENTS: I hate how this class looks. I really, really do. It makes NO SENSE to me at all. Another copy-cat on the [Constitution Refit](#) saucer, with no secondary hull whatsoever, and somehow this ship masses as much as a [Baker](#)??? Compare the Wilkerson to the Baker and the Baker ought to mass at least TWICE as much as the Wilkerson! Oh my God, what were the writers and graphic artists thinking?? Where is Engineering supposed to be located? The navigational deflector?? Why don't the two nacelles face the same direction, either both up or both down??? And look at that nonsensical warp pylon structure that is paper-thin and connects to each nacelle at an odd angle!

Oh my goodness I cannot express how much I detest this ship. It looks like a cheap hack fanship off the internet or something. No style, no imagination at all, and no effort made to think logically. The warp nacelles are out of scale with the saucer, and there is no way a saucer could hold a warp core and all the other warp machinery necessary to support a warp drive! Even if we (somehow) believe that the saucer contains the warp core, where is the crew supposed to have their quarters, their mess hall, their sick bay? Engineering would occupy so much space within the saucer that there would be *no room* for a sizeable crew. At least not the 200+ people listed in the stats!

Having said this, the Wilkerson plays fairly well, almost as good as the Baker class. If the two torpedoes were facing forward the Wilkerson would be almost identical to a Baker in game play, but with the second torp bay facing aft the Wilkerson cannot mass as much offense into the forward arc as I would like for a destroyer. I admit I never play this ship at all, simply because I can't stand it's looks, and because the Baker is just better. There are not very many ships out of the original UFP Ship Recognition Manual that I think truly suck. This is one of them!



From the FASA Star Trek FEDERATION SHIP RECOGNITION MANUAL, circa 1985

Wilkerson Class IX Destroyer

Notes: The Wilkerson Class destroyers, which first entered service on Stardate 2/1804, have since become a favorite among the personnel of Star Fleet's Destroyer Command. These sleek ships are not only fast and maneuverable, but also well-armed and shielded. Spacious crew quarters and work areas make tours of duty aboard a Wilkerson much sought after.

The Wilkersons were tested for combat readiness shortly after they began arriving at their duty stations. Six of them participated in Solar Wind IV, a fleet-level training operation designed to test the fleet's ability to respond to and repulse an invasion by limited Romulan forces. The after-action reports showed the Wilkerson to be a formidable opponent. During this operation, the Wilkersons were in combat four times and suffered no losses. The only pertinent negative reports from the operation were due to an overzealous captain who was so flushed with victory during a successful engagement that he pursued the fleeing enemy ships and left his support behind. Luckily, he broke off the action after realizing that he was the only ship in pursuit of the five enemy ships.

During a docking operation on Stardate 2/2010, the *USS Carmichael* was pulled into the *USS Henley*. Both Wilkersons were destroyed, along with the docking facility and 730 personnel. Post-accident investigations revealed that a faulty tractor beam guidance control aboard the docking facility pulled the *Carmichael* into the *Henley*.

Of the 132 Wilkersons built, 128 remain in active service, 2 are used by Star Fleet Training Command, and 2 have been destroyed. The Wilkerson Class destroyers are produced at the Sol IV and Salazaar shipyards at a combined rate of 26 per year. Star Fleet has contracted for the construction of 340 of these destroyers.

Construction Data:

Model Numbers-	MK I
Ship Class-	IX
Date Entering Service-	2/1804
Number Constructed	132

Hull Data:

Superstructure Points-	15
Damage Chart-	C
Size	
Length-	240 meters
Width-	150 meters
Height-	60 meters
Weight-	112,500 tons
Cargo	
Cargo Units-	100 units
Cargo Capacity-	5,000 tons
Landing Capability-	none

Equipment Data:

Control Computer Type-	M-3
Transporters-	
Standard 6-person-	3
Emergency 22-person-	2
cargo small -	none
cargo large -	1

Other Data:

Crew-	200
Troops-	none
Passengers-	20
Shuttlecraft-	2

Engines and Power Data:

Total Power Units Available-	38
Movement Point Ratio-	3/1
Warp Engine Type-	FWF-2
Number-	2
Power Units Available-	13
Stress Charts-	G/K
Maximum Safe Cruising Speed-	Warp 7
Emergency Speed-	Warp 9
Impulse Engine Type-	FIF-1
Power Units Available-	12

Weapons and Firing Data:

Beam Weapon Type-	FH-3
Number-	4, in two banks
Firing Arcs-	2f/p, 2f/s
Firing Chart-	W
Maximum Power-	5
Damage Modifiers	
+3	(1 - 10)
+2	(11 - 17)
+1	(18 - 20)
Missile Weapon Type-	FP-1
Number-	2
Firing Arcs-	1f, 1a
Firing Chart-	L
Power To Arm-	1
Damage-	10

Shields Data:

Deflector Shield Type-	FSI
Shield Point Ratio-	1/3
Maximum Shield Power-	12

Defense Factor-
Weapon Damage Factor-

93.5
32.0

[<<<< GO BACK](#)

IMPORTANT NOTE:

It is entirely possible that you have surfed to this page from an internet portal and are now viewing this page without frames. **The STSSTCSMU&A is best viewed from within its own set of frames**, so [click here to jump to the main STSSTCSMU&A web page](#) and then [see the site as it was meant to be seen!](#)

LARSON CLASS DESTROYER

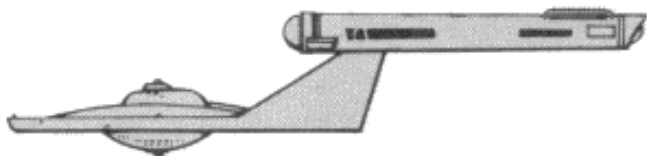

TOS-ERA ORIGINAL

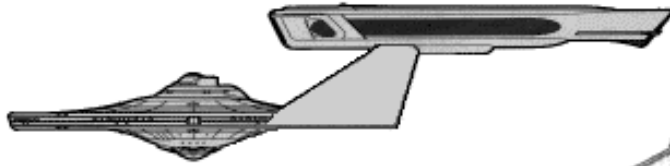

TMP-ERA REFIT

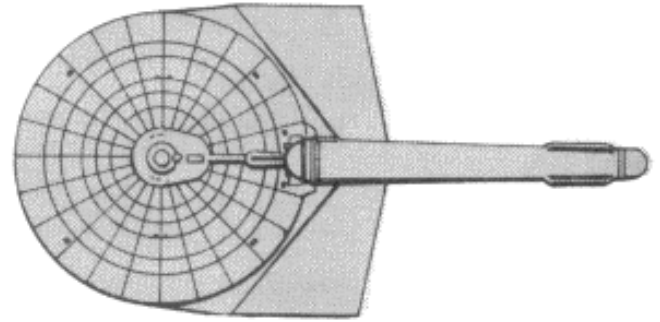

[Click here if you want to view this ship in its own window](#)

BRAD'S COMMENTS: Perhaps the best TOS-style destroyer from the UFP Ship Recognition Manual, the Larson is a great companion for [Constitution](#) and especially [Anton](#) class cruisers--the latter benefiting enormously from the Larson's ability to deliver torpedo blows where the Anton itself musters only phasers. One on one the Larson can best many older Romulan cruisers, while played in pairs or trios a pack of Larsons can usually cause trouble for even the more advanced Klingon ships. The only great disadvantage the Larson suffers is the lack of power due to its singular use of warp technology. With a double-nacelle drive system the Larson would be truly formidable. As it stands the Larson can't pump up the shields without sacrificing phaser power, and loading up the phasers leaves the ship weakly shielded.

Aesthetically, the Larson is okay in my book, though I never understood why that single warp nacelle was not just mounted on a vertical pylon, as was done with the [Remora](#) escorts. Perhaps a triangle--the most stable of all the basic geometric shapes--adds stability to the Larson warp pylon design? Even so, the antimatter intermix chamber would have to split up in two directions and kink around on itself before heading up the pylon to the nacelle. Something I think any reasonable Starfleet engineer would advise against. Hehe! Oh well, I guess it's just a drawing.

And hey, how about that verbose backstory? Pretty good!



From the FASA Star Trek FEDERATION SHIP RECOGNITION MANUAL, circa 1985

Larson Class VII Destroyer

NOTES: Designed at the same time as the Nelson class scouts and the Constitution class cruisers, Larson Class destroyers share many of the same physical features of these ships. An efficient ship that performed its function well, it was intended to perform the same tasks as other dual-function vessels, namely both research and defense. Even so, most of the existing Larsons in service are employed by Star Fleet's Military Operations Command, with several serving in the Galaxy Exploration Command.

Destroyers such as the Larson frequently are employed on patrol duty along the frontier areas. In time of war or other military emergencies, Larsons and other destroyers may be assigned to escort convoys or used as scouts by squadrons or small fleets. With its array of weapons, it is a fine combat vessel, though not as powerful as a cruiser or larger ship.

As can be seen by reviewing the statistics, the Larson Mk I was introduced into service on Stardate 1/8801, remaining unchanged until the introduction of the Mk II on Stardate 1/9804, when laser weaponry was replaced by the newer phaser and photon technology. All Mk I vessels were refitted with the new weapons by 2/0109. Several small interior changes were also made, but these did not affect the combat performance of the vessels until the introduction of the Mk VI.

The Mk VI mounted a more powerful impulse drive system, improved phaser weapons and the more efficient FSD shield generators. The Mk VII, introduced on Stardate 2/1403, mounted the newer style engine nacelle and a more powerful impulse drive system. This increased the overall power output by 25% and extended the service life of the Larson class by several years. As of Stardate 2/2205, all Larsons in active service have been upgraded to the Mk VI, and several have been modified to Mk VII's.

Production of the Larson Class was halted on Stardate 2/1808 with the commissioning of the *USS Juno*. This class is being supplemented by several newer destroyer designs and may see and end to service within the next 5 to 7 years.

No ships sold to the private sector have been refit, and most retain the characteristics they had at the time of sale. All vessels sold were disarmed by Star Fleet, though the weapon-mounting hardpoints usually were left intact.

Larsons are named for military leaders and battles of Terran origin. The class vessel is named for Admiral William G. Larson, hero of the battle at Gamma Hydra during the Romulan War. The only exception to this naming convention is *NCC 4305 Thelenth*, which is named after an Andorian admiral who defeated the Klingons in a pitched battle at Donovan's Star at the cost of his own ship and crew.

The ships *Hammurabi* and *Troy* were both destroyed while escorting a convoy of merchant ships bound for a frontier area. During this battle, seventeen freighters were destroyed and an additional four were taken as prizes by the Klingons. Of the five ships that survived the encounter, all reported that the *Hammurabi* destroyed two Klingon D-7 cruisers and crippled two others before being

destroyed itself. The *Troy* apparently was disabled in the initial exchange of fire and left for dead. When a Klingon cruiser ventured too close to the derelict, however, it opened fire and destroyed the enemy vessel in a single volley. Of course, without maneuvering power, the *Troy* later was easily dispatched.

On Stardate 2/0208, the *Bolivar* led a small detachment consisting of the *Normandy*, *Alesia*, *Babur*, and *Tecumseh* into an uncontrolled area near the Romulan Neutral Zone. The task force maintained radio silence and failed to report back at its scheduled time. When extensive communications attempts were made unsuccessfully, a rescue group was dispatched to the last reported position of the task force. Upon arrival, nothing was to be found, and an extensive search was begun, ultimately discovering the engine nacelle of the *Alesia* adrift in an unknown asteroid cluster. At the time no determination was made as to what had caused the loss of the ships, but it was suspected by many that the Romulans had ambushed the group and successfully destroyed them before they were able to send a call for aid. This theory was never proved, and no action was ever taken against the Romulans, largely because it was felt that the Romulans could not have crossed the Neutral Zone unnoticed. Since the discovery of the Romulan cloaking capability, the theory has been given new weight.

On Stardate 2/1502, the *USS Richtofen* was recalled for an engine refit and scheduled maintenance to shipboard systems. As the ship's refit and maintenance checks neared completion, spirited Ensigns and sympathetic workers painted it bright red in honor of its namesake. Star Fleet Command has decided to leave the ship this color despite the breach of regulations, though all Ensigns were mildly disciplined. The vessel is still in service and is assigned to the Klingon sector.

On its maiden flight, the *USS Sheridan* experienced a critical overload in its warp drive system. All backup systems failed to correct the problem. It was decided to jettison the engine pod because an uncontrolled matter anti-matter mix was underway and could not be stopped. The systems used to eject the engine also failed, and the ship was totally destroyed in the subsequent explosion. Three crewmembers who had taken refuge in a shuttle survived.

The Larson Class destroyers were produced at the Sol V and Proxima shipyards.

Construction Data:

Model Numbers-	MK I	MK II	MK VI	MK VII
Ship Class-	VII	VII	VII	VII
Date Entering Service-	1/8801-2/0109	1/9804-2/2205	2/0912	2/1403
Number Constructed	109	34	36	13

Hull Data:

Superstructure Points-	11	10	14	16
Damage Chart-	C	C	C	C
Size				
Length-	269 meters	269 meters	269 meters	272 meters
Width-	134 meters	134 meters	134 meters	134 meters
Height-	62 meters	62 meters	62 meters	62 meters
Weight-	82,400 tons	80,750 tons	87,000 tons	88,600 tons
Cargo				
Cargo Units-	200 units	200 units	200 units	200 units
Cargo Capacity-	10,000 tons	10,000 tons	10,000 tons	10,000 tons
Landing Capability-	None	None	None	None

Equipment Data:

Control Computer Type-	M-1	M-1	M-1	M-1
Transporters-				
Standard 6-person-	4	4	4	4
Combat 20-person-	None	None	None	None
Emergency 22-person-	3	3	3	3
cargo-	1	1	1	1

Other Data:

Crew-	195	195	200	200
Passengers-	10	10	10	10
Shuttlecraft-	6	6	6	6

Engines and Power Data:

Total Power Units Available-	22	22	23	28
Movement Point Ratio-	2/1	2/1	2/1	2/1
Warp Engine Type-	FWC-2	FWC-2	FWC-2	FWC-2
Number-	1	1	1	1
Power Units Available-	20	20	20	20
Stress Charts-	M/K	M/K	M/K	M/K
Maximum Safe Cruising Speed-	Warp 7	Warp 7	Warp 7	Warp 7
Emergency Speed-	Warp 9	Warp 9	Warp 9	Warp 9
Impulse Engine Type-	FIB-1	FIB-1	FIC-2	FIE-2
Power Units Available-	2	2	3	8

Weapons and Firing Data:

Beam Weapon Type-	FL-2	FH-4	FH-7	FH-7
Number-	6 in three banks	6 in three banks	6 in three banks	6 in three banks
Firing Arcs-	2f/p, 2f, 2f/s	2f/p, 2f, 2f/s	2f/p, 2f, 2f/s	2f/p, 2f, 2f/s
Firing Chart-	F	Q	Q	Q
Maximum Power-	2	3	4	4
Damage Modifiers				
+3	-			
+2	-	(1 - 8)	(1 - 8)	(1 - 8)
+1	-	(9 - 15)	(9 - 15)	(9 - 15)
Missile Weapon Type-	FAC-1	FP-2	FP-2	FP-2
Number-	1	2	2	2
Firing Arcs-	F	F	F	F
Firing Chart-	F	H	H	H
Power To Arm-	3	1	1	1
Damage-	8	6	6	6

Shields Data:

Deflector Shield Type-	FSC	FSC	FSD	FSF
Shield Point Ratio-	1/1	1/1	1/2	1/2
Maximum Shield Power-	8	8	7	10

Defense Factor-	36.2	34.8	63.0	77.0
Weapon Damage Factor-	4.2	19.6	23.2	23.2

[<<<< GO BACK](#)

IMPORTANT NOTE:

It is entirely possible that you have surfed to this page from an internet portal and are now viewing this page without frames. **The STSSTCSMU&A is best viewed from within its own set of frames**, so [click here to jump to the main STSSTCSMU&A web page](#) and then [see the site as it was meant to be seen!](#)

REMORA CLASS ESCORT

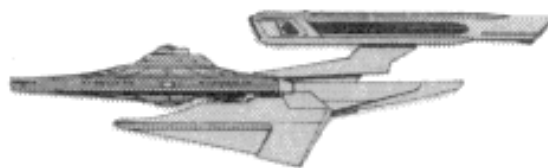
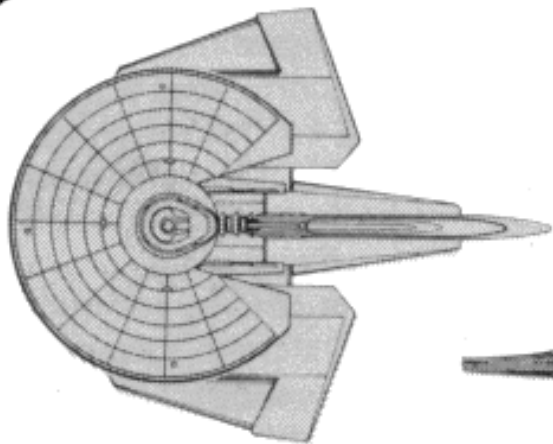

[Click here if you want to view this ship in its own window](#)

BRAD'S COMMENTS: The Remora Class is noteworthy in that it is the class featured on the cover of the Federation Ship Recognition Manual. A single-nacelle design based around the *de rigueur* [Constitution Refit](#) saucer, the Remora is doubly handicapped by its lack of power and its lack of photon torpedoes. Adding one or the other--or preferably both!--would substantially improve the Remora and make it a fine escort or even a destroyer. Instead, because it only has one warp engine, the Remora never has enough power to move and raise shields without leaving the phaser banks dry. Building an underpowered ship and then equipping it exclusively with power-hungry energy weapons is a sure recipe for disaster. So in spite of its looks--of which I am fond--the Remora is kind of a stinker, and unless I am playing one of my custom-build classes, which always feature torpedoes, I don't like this ship very much.



From the FASA Star Trek FEDERATION SHIP RECOGNITION MANUAL, circa 1985

Remora Class VI - VII Escort

NOTES: Of the 861 Remoras built, 175 Mk II and 205 Mk III remain in active service, with 280 Mk II and 12 Mk III in reserve fleets. Eight Mk II are used by Star Fleet Training Command; 102 Mk II and 20 Mk III have been destroyed; 3 Mk II have been captured by the Klingons. Twelve Mk II are listed as missing, and 2 are likely to have been captured by the Romulans; 28 Mk II and 2 Mk III have been scrapped; and 12 Mk II and 2 Mk III have been sold to private commercial concerns. Production of the Mk II has been halted, but the Mk III are being produced at Sol VI at a rate of 32 per year.

Construction Data:

Model Numbers-	MK II	MK III
Ship Class-	VI	VII
Date Entering Service-	2/0509	2/1601
Number Constructed	620	241

Hull Data:

Superstructure Points-	12	18
Damage Chart-	C	C
Size		
Length-	210 meters	210 meters
Width-	170 meters	170 meters
Height-	60 meters	60 meters
Weight-	78,200 tons	88,450 tons
Cargo		
Cargo Units-	100 units	100 units
Cargo Capacity-	5,000 tons	5,000 tons
Landing Capability-	None	None

Equipment Data:

Control Computer Type-	M-2	M-2
Transporters-		
Standard 6-person-	3	3
Combat 20-person-	None	None
Emergency 22-person-	2	2
cargo-	1	1

Other Data:

Crew-	162	162
Troops-	20	20
Passengers-	20	20
Shuttlecraft-	none	1

Engines and Power Data:

Total Power Units Available-	22	28
Movement Point Ratio-	2/1	2/1
Warp Engine Type-	FWD-2	FWC-2
Number-	1	1
Power Units Available-	16	20
Stress Charts-	L/F	M/K
Maximum Safe Cruising Speed-	Warp 6	Warp 7
Emergency Speed-	Warp 8	Warp 9
Impulse Engine Type-	FIB-3	FIE-2
Power Units Available-	6	8

Weapons and Firing Data:

Beam Weapon Type-	FH-4	FH-4
Number-	8 in four banks	8 in four banks
Firing Arcs-	2f/p, 2f/s, 2a/p, 2a/s	2f/p, 2f/s, 2a/p, 2a/s
Firing Chart-	Q	Q
Maximum Power-	3	3
Damage Modifiers		
+3		
+2	(1 - 8)	(1 - 8)
+1	(9 - 14)	(9 - 14)

Shields Data:

Deflector Shield Type-	FSF	FSH
Shield Point Ratio-	1/2	1/2
Maximum Shield Power-	10	13

Defense Factor-	62.2	80.0
Weapon Damage Factor-	20.8	20.8

[<<<< GO BACK](#)

IMPORTANT NOTE:

It is entirely possible that you have surfed to this page from an internet portal and are now viewing this page without frames. **The STSSTCSMU&A is best viewed from within its own set of frames**, so [click here to jump to the main STSSTCSMU&A web page](#) and then [see the site as it was meant to be seen!](#)

THUFIR CLASS DESTROYER

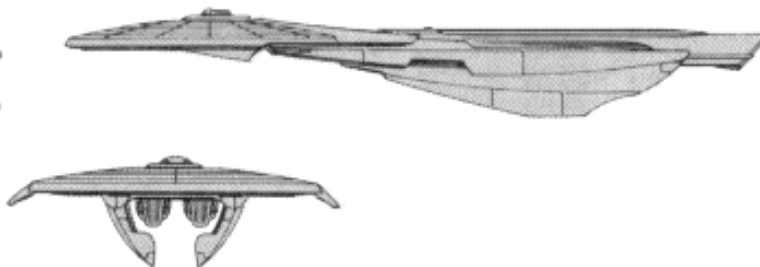
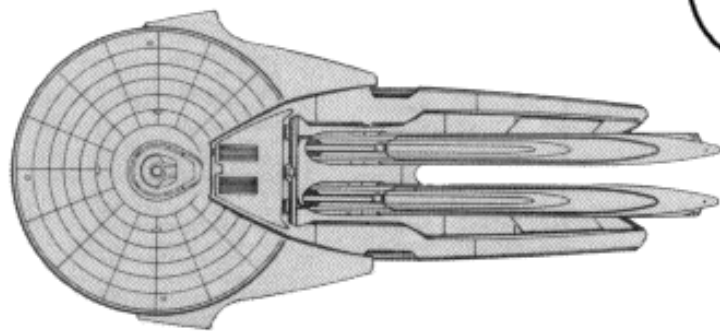

[Click here if you want to view this ship in its own window](#)

BRAD'S COMMENTS: One more "Andorian" style ship for the pile of similar ships. Well, at least the scale looks half decent this time. And this ship performs pretty well during game play thanks to its strong power--on the Mk II--and its torpedoes. Like the [Larson](#), this ship does okay by itself against really old Romulan cruisers and really old Klingon destroyers/cruisers. Against more modern and tougher competition these ships work best in groups. Shields are not as strong as they could be, but you won't care because you'll need the juice to spare for phasers.

One final note. Is it just me, or is this class named after the House Atreides mentat? Can't be a coincidence!



From the FASA Star Trek FEDERATION SHIP RECOGNITION MANUAL, circa 1985

Thufir Class VIII - IX Destroyer

NOTES: Of the 374 Thufir Class destroyers built, 192 Mk Is and 136 Mk IIIs remain in active service, with 6 Mk Is in reserve fleets. Of the remainder, 1 Mk III is used by Star Fleet Training Command, 26 Mk Is and 8 Mk IIIs have been destroyed; 1 Mk III is listed as missing; 1 Mk I and 2 Mk IIIs have been scrapped; and 1 Mk I has been sold to civilian commercial concerns. The Thufir, an Andorian design, is produced at the Morena and Salazaar shipyards at a combined rate of 15 per year.

Construction Data:

	MK I	MK III
Model Numbers-	VIII	IX
Ship Class-	VIII	IX
Date Entering Service-	2/1011	2/1503
Number Constructed	226	148

Hull Data:

	MK I	MK III
Superstructure Points-	15	16
Damage Chart-	C	C
Size		
Length-	280 meters	280 meters
Width-	130 meters	130 meters
Height-	40 meters	40 meters
Weight-	110,900 tons	132,430 tons
Cargo		
Cargo Units-	100 units	100 units
Cargo Capacity-	5,000 tons	5,000 tons
Landing Capability-	None	None

Equipment Data:

	MK I	MK III
Control Computer Type-	M-3	M-3
Transporters-		
Standard 6-person-	3	3
Combat 20-person-	None	None
Emergency 22-person-	2	2
cargo-	1	1

Other Data:

Crew-	180	180
Passengers-	15	15
Shuttlecraft-	4	4

Engines and Power Data:

Total Power Units Available-	29	39
Movement Point Ratio-	3/1	2/1
Warp Engine Type-	FWE-2	FWD-2
Number-	2	2
Power Units Available-	13	18
Stress Charts-	G/K	M/G
Maximum Safe Cruising Speed-	Warp 7	Warp 6
Emergency Speed-	Warp 9	Warp 8
Impulse Engine Type-	FIC-2	FIC-2
Power Units Available-	3	3

Weapons and Firing Data:

Beam Weapon Type-	FH-5	FH-5
Number-	6 in three banks	6 in three banks
Firing Arcs-	2f/p, 2f/s 2a	2f/p, 2f/s 2a
Firing Chart-	R	R
Maximum Power-	4	4
Damage Modifiers		
+3		
+2	(1 - 8)	(1 - 8)
+1	(9 - 16)	(9 - 16)
Missile Weapon Type-	FP-2	FP-2
Number-	2	2
Firing Arcs-	F	F
Firing Chart-	H	H
Power To Arm-	1	1
Damage-	6	6

Shields Data:

Deflector Shield Type-	FSF	FSF
Shield Point Ratio-	1/2	1/2
Maximum Shield Power-	8	8

Defense Factor- 62.9 88.9

Weapon Damage Factor- 20.4 20.4

[<<<< GO BACK](#)

IMPORTANT NOTE:

It is entirely possible that you have surfed to this page from an internet portal and are now viewing this page without frames. **The STSSTCSMU&A is best viewed from within its own set of frames**, so [click here to jump to the main STSSTCSMU&A web page](#) and then [see the site as it was meant to be seen!](#)

DECKER CLASS DESTROYER

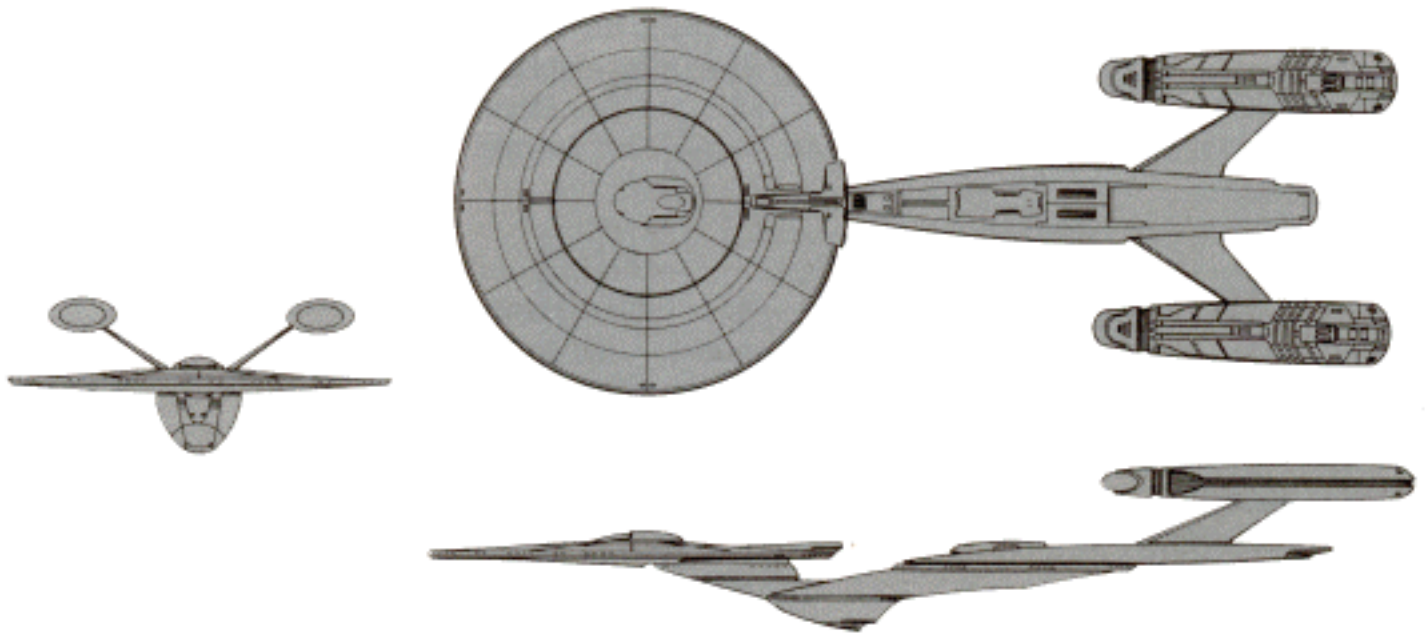

[Click here if you want to view this ship in its own window](#)

BRAD'S COMMENTS: The Decker class is one of the first ship designs in the old TNG Officers Manual from FASA that exhibits the "TNG Look" as I like to call it. Borrowing warp nacelles straight from the Enterprise-D, the Decker has semi-organic lines that defy much of the industrialism of the TMP-era ships, and that seem far removed from the boxy slab-faced look of TOS-era vessels. Even though the Decker is not part of official canon, I have always had an easy time picturing it as part of the 24th century Starfleet. Sleek, spindly, a design aesthetic taken to the extreme. If the Decker class were a dog it would probably look like a whippet!

The Decker class 'destroyer' is also a good lesson in how far ship design has advanced since Kirk's time. The Decker is roughly of the same mass as, and has more potency than, a [Reliant \(Miranda\)](#) class cruiser. But as the name suggests this is a destroyer; among the smallest of the capital ships in the time of Picard. If a vessel as capable as the *USS Reliant* is now demoted to the role of destroyer, what does that say about the frigates, cruisers, and battleships of the Picard-era, and beyond?!

Game play depends on era of placement. The blurb from the manual states that this destroyer was developed as a companion to the Excelsior class, so it is just believable that this ship might have seen its trial runs about the same time as the launching of the Excelsior Refit NCC-1701-B, which means it could be included in scenarios with Kirk-era Klingon or Romulan ships. If so, then the little 'destroyer' can be played just like a Kirk-era heavy cruiser, and its strong superstructure, power, and weapons make it a tough nut to crack without the benefit of updated Klingon or Romulan weaponry. The only bad thing about this class is the shielding. It looks as if the FASA designers wanted to give the Decker at least one flaw, and the wimpy shield strength and bad energize ratio are a potential achilles heel for any game player.

In a TNG or DS9 setting, facing advanced Klingon, Romulan, Cardassian, or Dominion ships, the Decker assumes its given role as a support craft for the larger capital ships like the [Galaxy class](#) or the [Excelsior Refit](#). Incapable of standing on its own against, say, a [D'Daridex warbird](#), the Decker is best used as a swift strike vessel that can draw enemy fire away from bigger ships and inflict secondary damage during battle.

As with most of the TNG ships from the TNG Officers Manual I have not included the text blurb that accompanied this design in print. The assumptions being made at the time of printing are so far distant from the actual evolution of TNG, and later DS9 and VOY, that the paragraph is rendered almost incoherent. There is no transwarp drive, no ultradrive, and none of the history that was devised to surround these failed plot

Construction Data:

Model Numbers-	A
Ship Class-	X
Date Entering Service-	2/7502
Number Constructed	240

Hull Data:

Superstructure Points-	35
Damage Chart-	C
Size	
Length-	288 meters
Width-	120 meters
Height-	52 meters
Weight-	140,603 tons
Cargo	
Cargo Units-	200 units
Cargo Capacity-	10,000 tons
Landing Capability-	None

Equipment Data:

Control Computer Type-	M-6A
Transporters-	
Standard 6-person-	4
Combat 12-person-	4
Emergency 22-person-	none
cargo large-	2
cargo small-	2

Other Data:

Crew-	200
Passengers-	10
Troops-	100
Shuttlecraft-	4

Engines and Power Data:

Total Power Units Available-	66
Movement Point Ratio-	4/1
Warp Engine Type-	FTWC-2
Number-	2
Power Units Available-	25
Stress Charts-	D/E
Maximum Safe Cruising Speed-	Warp 8
Emergency Speed-	Warp 9.9
Impulse Engine Type-	FIF-2
Power Units Available-	16

Weapons and Firing Data:

Beam Weapon Type-	FH-11
Number-	5
Firing Arcs-	2f/p, 2f/s, 1a
Firing Chart-	Y
Maximum Power-	10
Damage Modifiers	
+3	(1 - 10)
+2	(11 - 17)
+1	(18 - 24)
Missile Weapon Type-	FP-4
Number-	3
Firing Arcs-	2f/p/s, 1a
Firing Chart-	S
Power To Arm-	1
Damage-	20

Shields Data:

Deflector Shield Type-	FSM
Shield Point Ratio-	1/1
Maximum Shield Power-	11

Defense Factor- 85.18

Weapon Damage Factor- 91

[<<<< GO BACK](#)

IMPORTANT NOTE:

It is entirely possible that you have surfed to this page from an internet portal and are now viewing this page without frames. **The STSSTCSMU&A is best viewed from within its own set of frames**, so [click here to jump to the main STSSTCSMU&A web page](#) and then [see the site as it was meant to be seen!](#)

DEFIANT CLASS DESTROYER

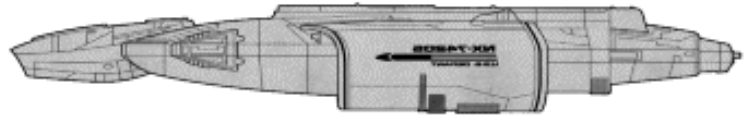
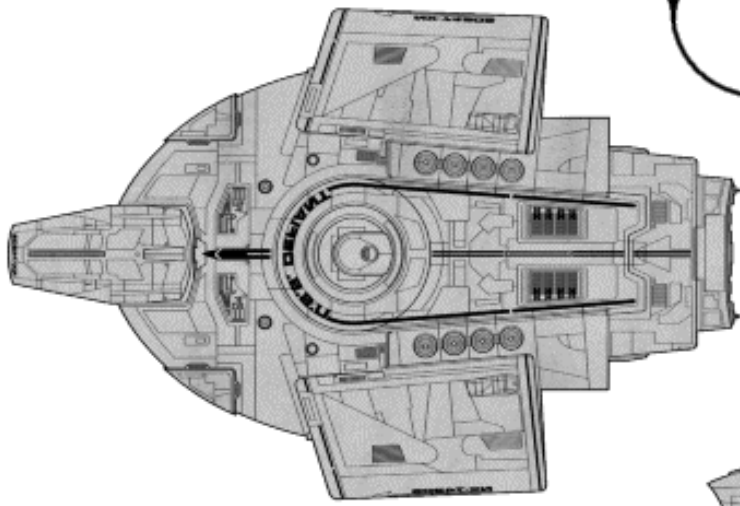

[Click here if you want to view this ship in its own window](#)

BRAD'S COMMENTS: From the outset, building stats for this DS9-era class was not an easy chore. The Defiant is quite unlike anything ever before seen in the Federation inventory. Roughly the size of a small escort or a large corvette, the Defiant employs tremendously powerful weapons along with tremendously powerful engines. Also, the original prototype that eventually came under the command of Captain Sisko, and saw heavy action against Gamma Quadrant foes such as the Jem'Hadar, was equipped with a *cloaking device*!

Official text seems to indicate that the cloaking device on the original prototype was a one-time loaner from the Romulans, so it might be argued that one and *only* one Defiant Class vessel would ever have the ability to cloak. Just the same, it has always been my personal understanding that Starfleet's non-use of cloaking technology is not a matter of can't, but instead just a matter of won't. Recall that Kirk and the original *USS Enterprise* stole a Romulan cloaking device in the 23rd century, taking it intact back to Starfleet after it successfully tested out on the [Constitution Class](#) *USS Enterprise* itself. Now, unless Federation engineers and scientists are awesomely inept, it stands to reason that Starfleet very soon figured out how the Romulan cloaking technology works. Therefore, it also stands to reason that ever since the Kirk-era, Starfleet has been perfectly capable of building cloaking devices for starships, yet they choose not to use this technology because it flies in the face many of Starfleet's ethics.

The Jem'Hadar threat seems to have scared Starfleet so silly that the ethic against cloaking technology was suspended, at least for the prototype Defiant. But does this mean that any future Defiant Class ships are also cloak-capable? We have seen in **ST:DS9** and **ST:VOY** that more Defiant Class ships have been built since Sisko originally dragged the prototype Defiant out of mothballs. If the cloaking device on the original was seen as such a necessity when combating advanced foreign threats like the Jem'Hadar, why wouldn't future Defiant Class vessels be similarly equipped?

To make game fans happy, I have therefore built stats for two different kinds of Defiant Class ships, one cloaked and one not cloaked. I have also tried to make the weapons few, but potent, and give this class a good movement point ratio as well as abundant power from the engines. The ship's size easily places it as an escort, but its mission seems to be simply that of an advanced destroyer, so I have grouped it in with the other destroyers as a result. Some fans would no doubt argue with me on this point, but it seems to me to be the most logical decision. The Defiant is definitely *not* a conventional escort, nor is it underpowered like so many corvette and scout sized ships. The Defiant is a vessel with one and only one purpose in mind: hard, fast attacks on the best the enemy has to offer.

P.S: for a fun and informative look at the Defiant class, [see this web site](#).

Construction Data:

Model Numbers-	I	II
Ship Class-	V	V
Date Entering Service-	2370 A.D.	2372 A.D.
Number Constructed	(classified)	(classified)

Hull Data:

Superstructure Points-	38	40
Damage Chart-	C	C
Size		
Length-	130 - 170 meters?	130 - 170 meters?
Width-	95 - 120 meters?	95 - 120 meters?
Height-	20 - 40 meters?	20 - 40 meters?
Weight-	50,000+ tons	50,000+ tons
Cargo		
Cargo Units-	10 units	10 units
Cargo Capacity-	500 tons	500 tons
Landing Capability-	yes	yes

Equipment Data:

Control Computer Type-	DCAX-1	DCAX-1
Transporters:		
Standard 6-person-	2	2
Cloaking Device-	DCD-1XA	none!
Power to energize-	75	

Other Data:

Crew-	47	47
Passengers-	none	none
Shuttlepods-	4	4

Engines and Power Data:

Total Power Units Available-	100	107
Movement Point Ratio-	2/1	2/1
Warp Engine Type-	FXMW-2	FXMW-2
Number-	2	2
Power Units Available-	40	40
Stress Charts-	D/E	D/E
Maximum Safe Cruising Speed-	Warp 8	Warp 8
Emergency Speed-	Warp 9.9	Warp 9.9
Impulse Engine Type-	FNIS-120	FNIS-210
Power Units Available-	20	27

Weapons and Firing Data:

Beam Weapon Type-	Pulse Phasers	Pulse Phasers
Number-	4 in two banks	4 in two banks
Firing Arcs-	2f/p, 2f/s	2f/p, 2f/s
Firing Chart-	U	U
Maximum Power- **	x2, 15	x2, 15
Damage Modifiers		
+3	(1 - 10)	(1 - 10)
+2	(11 - 17)	(11 - 17)
+1	(18 - 24)	(18 - 24)
Beam Weapon Type-	FAHW-28	FAHW-31
Number-	4	4
Firing Arcs-	1f, 1p, 1s, 1a	1f, 1p, 1s, 1a
Firing Chart-	X	Y
Maximum Power-	20	23
Damage Modifiers		
+3	(1 - 10)	(1 - 11)
+2	(11 - 16)	(12 - 18)
+1	(17 - 22)	(19 - 24)
Missile Weapon Type-	FP-17	FP-17
Number-	2	2
Firing Arcs-	1f, 1a	1f, 1a
Firing Chart-	X	X
Power To Arm-	3	3
Damage-	27	27
Missile Weapon Type-	FQT-8	FQT-8
Number-	2	2
Firing Arcs-	F	F
Firing Chart-	Y	Y
Power To Arm-	5	5

Damage-

38

38

Shields Data:

Deflector Shield Type-	NGSS-O	NGSS-OP
Shield Point Ratio-	1/5	1/5
Maximum Shield Power-	30	35

Defense Factor-	(classified)	(classified)
Weapon Damage Factor-	(classified)	(classified)

* Denotes completely hypothetical model number and stats, devised by Brad R. Torgersen.

** The Pulse Phasers were an interesting problem, in that they are assumed to be radically more powerful than your ordinary phasers. When applied to the STSSTCS gaming system, it would seem to me that the most straightforward way to do this would be to afford the Pulse Phasers a power-to-damage *ratio* making them inherently more potent than standard phasers. The "x 2" in the maximum power listing indicates that whatever energy is dumped into the Pulse Phasers during the game, the damage done is at least *double* the amount allocated. For instance, if you charge one Pulse Phaser with 6 points of energy, when that weapon is fired it will inflict 12 points of damage on a direct hit; two times as much as an ordinary phaser. And that's even before we figure in damage modifiers for range. The "15" after the comma indicates that the total maximum power any Pulse Phaser can be charged to is 15 energy points, for a total of 30 damage points, excluding range modifiers. I hope this makes sense, and if not, [let me know](#).

[<<<< GO BACK](#)

IMPORTANT NOTE:

It is entirely possible that you have surfed to this page from an internet portal and are now viewing this page without frames. **The STSSTCSMU&A is best viewed from within its own set of frames**, so [click here to jump to the main STSSTCSMU&A web page](#) and then [see the site as it was meant to be seen!](#)

GENSER CLASS ESCORT

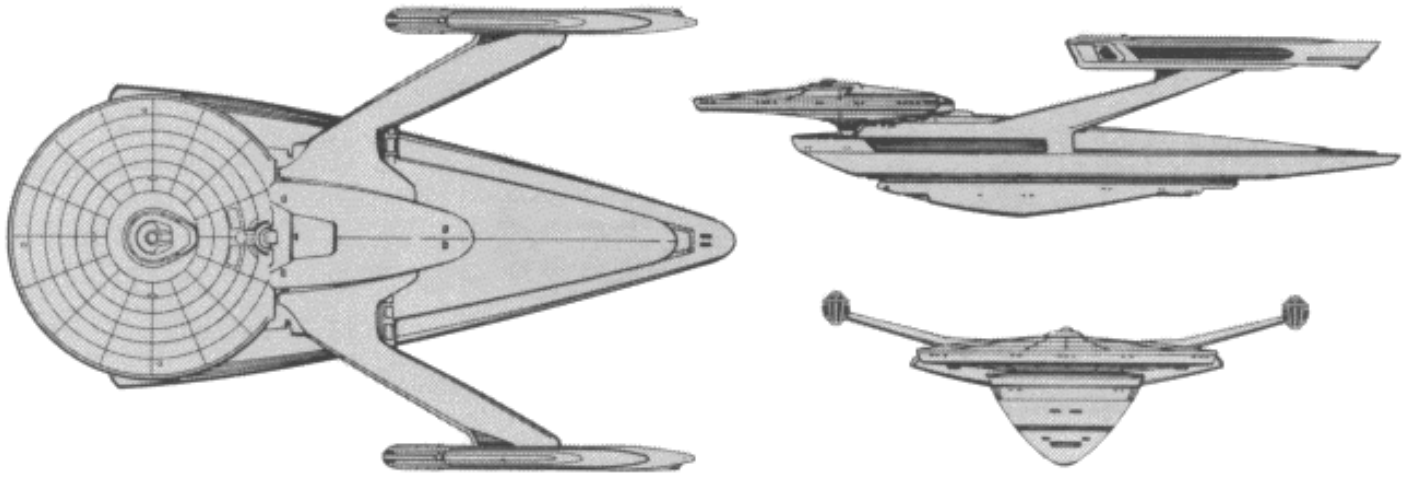

[Click here if you want to view this ship in its own window](#)

BRAD'S COMMENTS: Wow, talk about a ship that is not in scale with its parts!! The Genser is an escort, but if those nacelles and that saucer are sized to the same scale as the [Enterprise class](#), then this ship should be HUGE. I know, I know, I am overly obsessed with size and scale. But it just irritates me forever that the original artists for the STSSTCS did not pay much attention to this important detail. The saucer and the nacelles on this ship should NOT look the way they do if we're expected to believe this "little" craft is an escort. 'Nuff said!



From the FASA **Star Trek FEDERATION SHIP RECOGNITION MANUAL**, circa 1985

Genser Class IV Destroyer

NOTES: The Genser Class escort is not only the newest ship in Materiel Command's fleet of escorts, it is also the smallest. Like all escorts, it is inexpensive to build, maintain, and operate. The Genser is even cheaper to build and operate than earlier escorts because of its size and design simplicity.

Because the maneuverability of the Mk I was unacceptable for escort duties, the design was modified and FWA-2 warp engines were installed on four test models before being approved for installation on all Gensers. In addition, the weapon systems were upgraded from the FH-6 to the FH-7 phaser, creating the Mk II. All Genser Class ships will be converted to this design no later than Stardate 2/2404.

On Stardate 2/1912, the USS Genser, along with five other escorts, was accompanying a convoy of neutronic fuel carriers to the rimward frontier when sensors scanned a small object traveling on a parallel course. The object could not be identified through computer search nor would it respond to any radio communications. The Genser broke away from the convoy to investigate the object and, as the other ships watched, disappeared. After several minutes, the Genser reappeared, maintaining its last course and speed, though it did not respond to radio calls; the small, mysterious object was nowhere to be found. Sensor scan revealed that the entire crew of the Genser had disappeared. The convoy was halted and searches were made, but nothing was found that would help solve the mystery. The connection between the unidentified object and the disappearance of the ship remains clouded in mystery and may never be solved. The USS Genser is on active duty and operates in the rimward frontier areas.

Of the 259 Genser Class escorts built, 226 Mk Is and 12 Mk IIs remain in active service. One Mk I is used by Star Fleet Training Command, 16 have been destroyed, 2 are listed as missing, 1 has been scrapped, and 14 have been sold.

The Genser is produced at the Cait facility at a rate of 30 per year.

Construction Data:

Model Numbers-	MK I	MK II
Ship Class-	IV	IV
Date Entering Service-	2/1712	2/2210
Number Constructed	251	12

Hull Data:		
Superstructure Points-	13	14
Damage Chart-	C	C
Size		
Length-	180 meters	180 meters
Width-	120 meters	120 meters
Height-	45 meters	45 meters
Weight-	33,200 tons	32,300 tons
Cargo		
Cargo Units-	50 units	50 units
Cargo Capacity-	2,500 tons	2,500 tons
Landing Capability-	None	None

Equipment Data:		
Control Computer Type-	M-1	M-1
Transporters-		
Standard 6-person-	2	2
Combat 20-person-	None	None
Emergency 22-person-	1	2
cargo-	1	1

Other Data:		
Crew-	82	80
Passengers-	10	10
Shuttlecraft-	1	1

Engines and Power Data:		
Total Power Units Available-	24	22
Movement Point Ratio-	3/1	2/1
Warp Engine Type-	FWH-1	FWA-2
Number-	2	2
Power Units Available-	10	8
Stress Charts-	Q/R	J/M
Maximum Safe Cruising Speed-	Warp 5	Warp 6
Emergency Speed-	Warp 6	Warp 8
Impulse Engine Type-	FIB-2	FIB-3
Power Units Available-	4	6

Weapons and Firing Data:		
Beam Weapon Type-	FH-6	FH-7
Number-	8 in four banks	8 in four banks
Firing Arcs-	2f/p, 2f/s, 2p/a, 2s/a	2f/p, 2f/s, 2p/a, 2s/a
Firing Chart-	N	Q
Maximum Power-	3	4
Damage Modifiers		
+3		
+2	(1 - 7)	(1 - 8)
+1	(8 - 13)	(9 - 15)

Shields Data:		
Deflector Shield Type-	FSF	FSF
Shield Point Ratio-	1/2	1/2
Maximum Shield Power-	13	13

Defense Factor-	59.6	70.0
Weapon Damage Factor-	18.4	25.6

[<<<< GO BACK](#)

IMPORTANT NOTE:

It is entirely possible that you have surfed to this page from an internet portal and are now viewing this page without frames. **The STSSTCSMU&A is best viewed from within its own set of frames**, so [click here to jump to the main STSSTCSMU&A web page](#) and then [see the site as it was meant to be seen!](#)

GRIFFON CLASS ESCORT

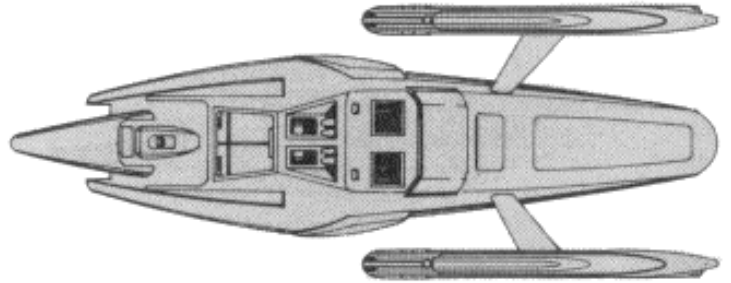
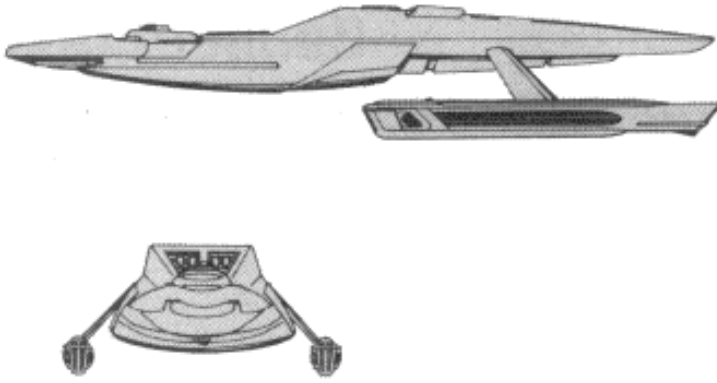

[Click here if you want to view this ship in its own window](#)

BRAD'S COMMENTS: A non-standard Federation design that departs from the typical saucer-centric models. The Griffon is a good little escort mainly because it totes a torpedo, giving it increased punch over other other classes like the [Genser](#). The Griffon is the largest of the Federation escorts, and can sometimes be played as a light destroyer against weak Klingon or Romulan cruisers. As usual with smaller ships, there is strength in numbers.



From the **FASA Star Trek FEDERATION SHIP RECOGNITION MANUAL**, circa 1985

Griffon Class VIII Escort

NOTES: Of the 236 Griffon Class escorts built, 177 Mk Is and 26 Mk IIs remain in active service, with 4 Mk Is in reserve fleets; 1 Mk II is used by Star Fleet Training Command; 20 Mk Is and 1 Mk II have been destroyed; 3 Mk IIs are listed as missing; 1 Mk I and 1 Mk II have been scrapped; and 2 Mk IIs have been sold to private commercial concerns. The Mk I Griffon is no longer in production, but the Mk II is produced at the Morena facility at a rate of 24 per year.

Construction Data:

Model Numbers-	MK I	MK II
Ship Class-	VIII	VIII
Date Entering Service-	2/1503	2/2008
Number Constructed	208	28

Hull Data:

Superstructure Points-	14	14
Damage Chart-	C	C
Size		
Length-	220 meters	220 meters
Width-	85 meters	85 meters
Height-	40 meters	40 meters
Weight-	107,195 tons	107,450 tons
Cargo		
Cargo Units-	50 units	50 units
Cargo Capacity-	2,500 tons	2,500 tons
Landing Capability-	None	None

Equipment Data:

Control Computer Type-	M-2	M-2
Transporters-		
Standard 6-person-	3	3
Combat 20-person-	None	None
Emergency 22-person-	2	2
cargo-	1	1

Other Data:

Crew-	146	148
Passengers-	10	10
Shuttlecraft-	2	2

Engines and Power Data:

Total Power Units Available-	34	34
Movement Point Ratio-	3/1	3/1
Warp Engine Type-	FWE-2	FWE-2
Number-	2	2
Power Units Available-	13	13
Stress Charts-	G/K	G/K
Maximum Safe Cruising Speed-	Warp 7	Warp 7
Emergency Speed-	Warp 9	Warp 9
Impulse Engine Type-	FIE-1	FIE-1
Power Units Available-	8	8

Weapons and Firing Data:

Beam Weapon Type-	FH-4	FH-4
Number-	4 in two banks	4 in two banks
Firing Arcs-	2f/p, 2f/s	2f/p, 2f/s
Firing Chart-	Q	Q
Maximum Power-	3	3
Damage Modifiers		
+3		
+2	(1 - 8)	(1 - 8)
+1	(9 - 14)	(9 - 14)

Shields Data:

Deflector Shield Type-	FSH	FSK
Shield Point Ratio-	1/2	1/2
Maximum Shield Power-	12	16

Defense Factor-	66	72
Weapon Damage Factor-	14.4	20

[<<<< GO BACK](#)

IMPORTANT NOTE:

It is entirely possible that you have surfed to this page from an internet portal and are now viewing this page without frames. **The STSSTCSMU&A is best viewed from within its own set of frames**, so [click here to jump to the main STSSTCSMU&A web page](#) and then [see the site as it was meant to be seen!](#)

CYGNUS CLASS FRIGATE

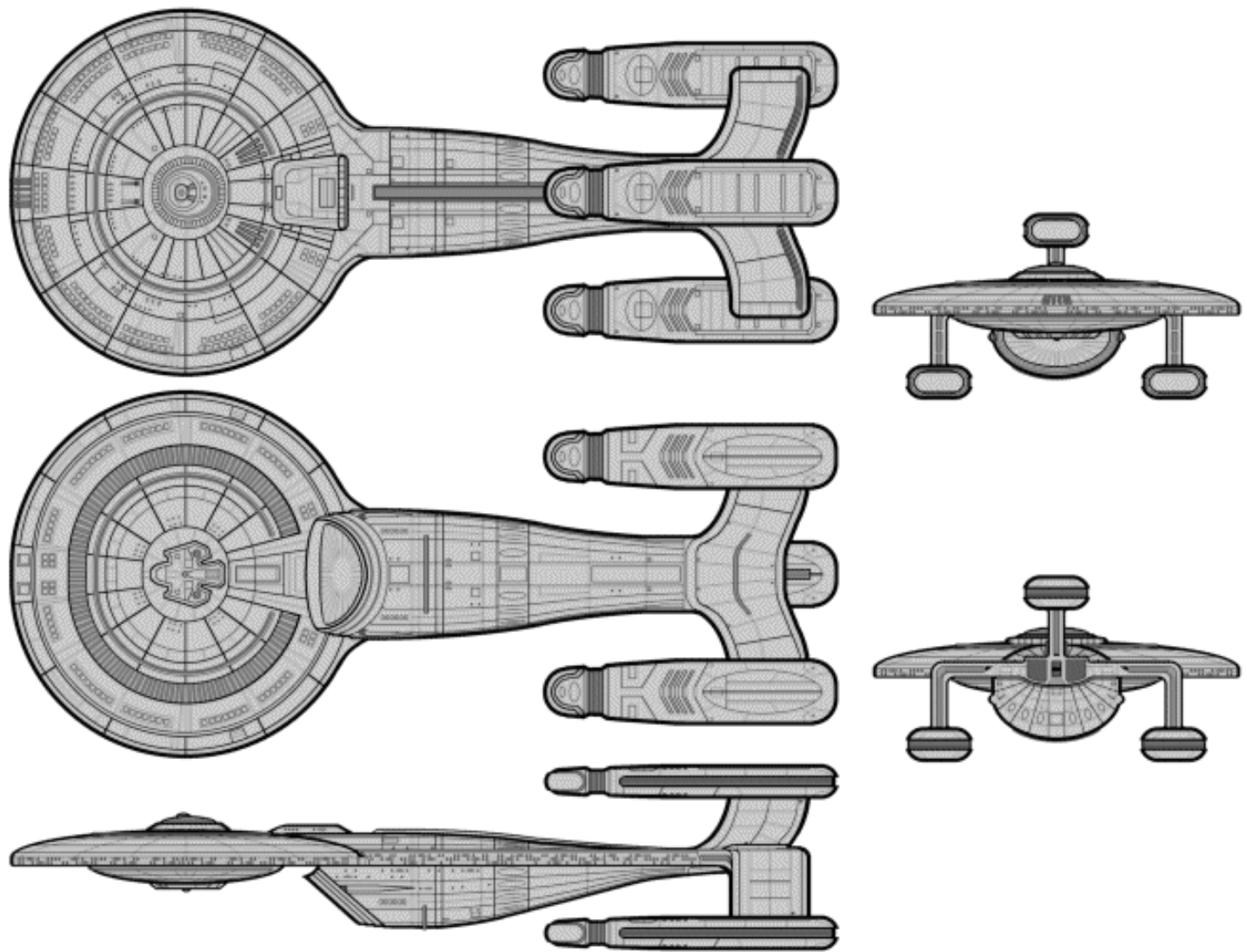

[Click here if you want to view this ship in its own window](#)

CLICK BELOW TO SEE LARGER VIEWS!

[Port view](#) [Dorsal view](#) [Ventral view](#) [Bow view](#) [Stern view](#)

FANSHIP DESIGN & STATS: Brad R. Torgersen, 1996 - 2002

Triton Class XVI Heavy Frigate

NOTES: The Cygnus class ships emerged from the same peacetime melting pot that produced larger classes such as the Galaxy and Nebula exploration cruisers. Originally intended as a heavy companion for the defense of both the Galaxy and Nebula classes when exploring hostile areas, the Cygnus is not as large as either of the previous ships, lacking much of the expanded research and scientific facilities of the Cygnus's sisters. There is also little room for passengers or civilians, seeing as how the class charter specifies a warship design that often goes into harm's way where large compliments of non-Starfleet personnel would be inappropriate. Instead, the Cygnus devotes much of its surplus interior space to the housing of a sizeable compliment of marines, and their equipment.

The original Cygnus design, as laid down in 2365, called for a modest installation of off-the-shelf armament: FP-4 torpedoes and FH-12 phasers; the same weapons featured on the Mark I Galaxy class. The original Cygnus design also employed a standard configuration of two warp nacelles, slung in the downward position like the Nebula and Miranda classes.

However, the skeleton for the prototype *USS Cygnus* was still in spacedock in 2365 when the Galaxy class *USS Enterprise* returned from a far-flung encounter with the new alien menace known as the Borg; an encounter instigated by the omnipotent alien intelligence known as Q. As one might expect, Federation scientists and engineers were forced to seriously reassess all of their prototype ship designs in the face of such a potent and technologically advanced threat as the Borg. Construction on the *USS Cygnus* was halted and a six-month emergency refit project was announced, intending to sharpen the teeth of the new frigate before it went into production.



[Click here to see a size comparison chart!](#)

The reliable, yet dated FH-12 and FP-4 systems, both of which yield superior damage when compared to older models. All was not well, however. Computer simulations revealed that a two-nacelle configuration would not be able to provide enough power to the frigate if it had to energize phasers and shields at the same time. After several failed attempts to upgrade the frigate with a larger warp nacelle model, a backward-seeing junior engineer suggested that the Cygnus project team take a page from one of the Federation's old designs: the Triton.

The retired Triton class dated from the previous century, and had been built with an unorthodox configuration of three warp engines; the third engine used exclusively as a bonus power generator whose energy was employed for shields and weapons. While the other two engines on the Triton maintained warp field geometry, the third engine dumped all its output into the ship's power grid. What was more, if one of the two main warp engines were to be damaged or destroyed, the third engine could then be employed in an asymmetric warp field to power the ship at standard warp speeds in spite of damage that would cripple other vessels.

Seeing as how the Cygnus was facing similar issues as had faced the Triton in its time, the Cygnus project team was intrigued by their junior engineer's suggestion. Computer simulations commenced immediately, and the team was pleased to see that the addition of a third nacelle identical to the Cygnus's original two nacelles would nicely resolve the energy deficiency issue. The warp core was summarily reconfigured and the aft superstructure strengthened to support a warp pylon that would be mounted centerline along the spine. In short order the profile of the Cygnus had been reborn, with a 'shark fin' dorsal warp pylon sprouting from the rear and a third nacelle perched at its top. Not only did the third nacelle dramatically increase the ship's total power output, it lent a striking cosmetic improvement to what had initially been a somewhat dull-looking class.

With more power at their disposal, and the superstructure already strengthened as a result of the addition of the third warp nacelle, the Cygnus team revamped the shield system to complete the process.

Full-time construction on the naked frame of the *USS Cygnus* began once again, this time using plans for what had officially become known as the Mark II version (the Mark I having never even reached the point of trials.) Construction would continue through 2365 and into 2366, with the *USS Cygnus* being commissioned into Starfleet late in 2366. The ship spent nine months in trials, ironing out problems with the standard and asymmetric warp geometry, as well as fire control and shielding systems difficulties. Satisfied with the quick shake-down cruise, Starfleet ordered additional Cygnus hulls into production at four Federation facilities. Shortly afterward, a Borg cube invaded Federation space and reached Earth, destroying an entire Starfleet armada at Wolf 359 in the process.

Ironically, the *USS Cygnus* was undergoing minor maintenance at a starbase while escorting the Nebula class *USS Kirilenko* to the Beta Quadrant, and was therefore unable to return to either Wolf 359 or Earth in time to test its mettle against the very enemies it had been re-designed to combat.

The decimation of the Wolf 359 fleet only redoubled Starfleet's efforts to get more dedicated warships into action. Several modern vessels, like the Nebula class, as well as a host of older designs, had all proven to be poorly matched with the Borg at Wolf 359. The need for the Cygnus class heavy frigate seemed to be greater than ever, with both Galaxy and Nebula class exploration cruisers continuing to push into uncharted territory, at grave risk of encountering either more Borg, or advanced foes as yet unknown.

By 2370 over thirty Cygnus class frigates had been built, and had seen relatively routine service escorting various large Federation cruisers on exploration duties. A few had seen actual combat, with no losses, but Starfleet believed that the ship's true test lay in the future.

This hunch proved ominously prophetic, when hostilities with the Gamma Quadrant's powerful Dominion government broke out that same year. As with the battle of Wolf 359, the Cygnus class missed yet another vital chance to prove itself against a worthy adversary.

A group of vacationers, under the auspices of Deep Space Nine station commander Benjamin Sisko, was captured in the Gamma Quadrant by the then as yet unheard of military muscle behind the Dominion: the fearsome Jem'Hadar. A Federation rescue effort was hastily organized, and the Galaxy class starship *USS Odyssey*, under the command of Captain Keogh, arrived at Deep Space Nine to lead a rescue effort through the Bajoran wormhole. Ignoring advice from Starfleet Command that he wait until a trio of Cygnus class ships could reach Deep Space Nine to enter the Gamma Quadrant alongside the *Odyssey*, Keogh was confident in the prowess of his ship, and decided precious time was wasting. The *Odyssey* was escorted into the Gamma Quadrant by a paltry squadron of Danube class runabouts crewed by officers from Deep Space Nine.

A quick and deadly battle ensued, with the *Odyssey* being disabled almost immediately. The more maneuverable yet weakly-armed runabouts were able to complete their mission, but the *Odyssey* herself was obliterated when a Jem'Hadar attack ship made a suicide run on the secondary hull, puncturing the *Odyssey*'s matter and anti-matter containment fields near the warp core, which caused an uncontrolled matter/anti-matter reaction.

Though the rescue of Sisko and his party was itself successful, the Galaxy class had proven remarkably cumbersome and awkward against the much smaller and much faster Jem'Hadar attack ships. The *Odyssey* had been dispatched with ease, and to this day many strategists and military historians in Starfleet wonder what might have happened had Keogh waited for the Cygnus ships to arrive.

Properly escorted, the *USS Odyssey* might have withstood the attack by the Jem'Hadar. Indeed, the Cygnus class is smaller, faster, and more maneuverable than the Galaxy class. The Cygnus ships might have been able to combat the Jem'Hadar attack craft on an even footing, allowing Keogh and the *Odyssey* to fight from a distance with torpedo volleys and crippling phaser strikes. If the Federation had won that initial battle with the Dominion, showing coordinated force instead of bungling weakness, it is just possible that the Dominion might have reconsidered their eventual invasion of the Alpha Quadrant, and the resulting Dominion War might never have taken place.

Thus, even though Keogh and his crew were heralded for their sacrifice in the rescue of Sisko, and even though the Federation did put up a brave--if muted--first fight against the Jem'Hadar, in hindsight it is difficult to measure how much the destruction of the *Odyssey* eventually cost the Federation, as the first major defeat at the hands of Dominion forces only seemed to embolden the Founders and demoralize Starfleet.

In the wake of the destruction of the *Odyssey*, engineers across the Federation once again entered into a period of frenzied re-evaluation. Virtually every modern class of starship was slated for some kind of weapons upgrade, much like after first contact with the Borg. Research and development of better weapons systems--initiated since the Borg invasion of 2367--was already starting to offer shipbuilders a new array of slings and arrows with which to combat advanced alien threats, and the Cygnus class was at the top of the list of classes being examined. Having missed out on its first two chances to fulfill its primary combat role alongside both the Nebula and

Galaxy classes, Starfleet would be ready and available for the next fight. The Mark III debuted in early 2371, featuring improvements across the board, from structural strength to shield power to weapons potency. All Mark II Cygnus class ships were scheduled for refit to the Mark III, and work was begun on still another possible upgrade of the Cygnus class, deemed the Mark IV, which would use some of the most powerful weapons in the experimental inventory.

When the Mark III Cygnus class finally did get its trial by fire, it came not at the hands of the Borg, nor the Dominion, but rather against former friends: the Klingon Empire. Under the paranoid leadership of Chancellor Gowron, the Klingons attacked the Cardassians in 2372 out of fear that Dominion shapeshifters had infiltrated the Cardassian government and were planning to use the Cardassians as a puppet nation through which they would stage a takeover of the Alpha Quadrant. Balking at this unwarranted and unprovoked aggression, the Federation split with the Klingons and the Klingon Empire went on the offensive against not only Cardassia, but the Federation as well.

Suddenly besieged on borders that had been friendly for almost a century, the Federation hurled every available warship into the fray, as Gowron's hostile Klingon nationalist policy undid virtually all of the progress made between the Federation and the Klingons since the signing of the Khitomer Accords.

The moment of truth came for the Cygnus class in 2373 while escorting several battle-damaged Starfleet ships back to a friendly starbase.

The Mark III Cygnus class frigates *USS Mezek* and *USS Gan'ylar* were escorting three wounded Excelsior class ships and one wounded Nebula class ship away from the Klingon border, when no less than five Klingon cruisers of varying age and design decloaked and attacked from two different angles. One of the Excelsior ships was destroyed, but the *Mezek* and *Gan'ylar* responded quickly. Concentrating torpedo volleys from both their frigates, the Captains of the *Mezek* and the *Gan'ylar* wiped out the lead Klingon cruiser.

Thrown off by the loss of their flag vessel, two of the three Klingon ships from the main Klingon formation evaded fire and began swinging around, while the other two cruisers in the second formation reached killing distance. All of the limping Federation ships tried to return what fire they could, but a second Excelsior had both its warp nacelles blown apart before the Cygnus frigates could swing about and drive off the Klingons by destroying a second Klingon cruiser with a combined phaser barrage.

Their sterns facing the wrong direction, both the *Mezek* and the *Gan'ylar* sustained damage as the three remaining Klingon vessels regrouped and attacked from the rear with torpedoes and disruptors. Shields collapsing, the *Mezek* lost a warp nacelle and part of its saucer section, while the *Gan'ylar* sustained damage to her secondary hull. The two Cygnus ships had rearward torpedoes armed, however, and again they concentrated their volleys on a single Klingon ship, smashing it to bits before the two surviving Klingon cruisers broke off their attack and began to make a getaway.

With warp-charged phasers blazing, the *Gan'ylar* used her impulse maneuverability to pursue the Klingons. The *Mezek* assumed a defensive stance between her charges and the Klingons while her sister, the *Gan'ylar*, lanced at the flanks of the Klingons with concentrated phaser strikes. One of the Klingon ships was disabled before it could jump to warp, and the *Gan'ylar* cruised into position alongside the foundering Klingon craft as the frigate's compliment of heavily armed marines hit their transporter pads.

The shipboarding of the Klingon cruiser was brutal, but Starfleet marine casualties were relatively light. The disabled Klingon cruiser and its surviving crew were hauled back to the rest of the flotilla, and towed home along with the wounded Federation vessels as a war prize. The crews of the two Cygnus class vessels were given commendations for their actions, while the Klingons were sent to prison as P.O.W.'s and their ship was impounded for Starfleet military R&D purposes.

As if the recent Klingon and Dominion aggression had not bad enough, a *second* Borg cube invaded Federation space in late 2373, again intent on taking Earth. Unlike Wolf 359 however, several Cygnus class ships were in the vicinity and able to intercept the cube along with the rest of the Starfleet defense forces, including the Sovereign class *USS Enterprise* and Defiant class *USS Defiant*. One Cygnus class ship was destroyed and one more hopelessly crippled before the fleet was able to destroy the cube using critical combat information provided by *Enterprise* captain Jean Luc Picard.

At the end of 2373, all surviving Cygnus class frigates had been refitted to Mark III specifications, and the Mark IV was officially brought into use. Again, the ship's systems were upgraded virtually across the board, again with the idea in mind of keeping the class armed with the latest technology to better fight the advanced threats of the day. Of special note was the addition of the new *quantum torpedo*, which is quickly making even advanced photon torpedo technology obsolete. The quantum torpedo requires more power than tried and tested models like the reliable FP-4, but the damage yield can be staggering.

At least ten Mark IV ships were built in 2374 and thrust into battle against the Dominion alongside the surviving Mark IIIs. With the Klingons finally re-allied with the Federation, and the Federation joining the Romulans in an Alpha Quadrant-wide alliance against the Dominion and its Alpha Quadrant puppets--the Breen and the Cardassians--Mark III and Mark IV Cygnus class ships saw tremendous fighting as a final push was made to drive the Jem'Hadar back and force the Founders to the bargaining table. By the time the Dominion War came to an end, scores of Cygnus class ships had seen fierce combat against the best the Breen, Cardassians, and Dominion had to offer. In some cases the Cygnus came out the winner, in other cases, the loser.

As of 2377, the Dominion War is over and the Jem'Hadar have vacated Federation space. The political climate of the Alpha Quadrant has been altered dramatically, with the Cardassian government a ruin and the Federation/Klingon alliance slowly healing under the care of the new chancellor, a man friendly to the Federation: General Martok.

The Romulans still pose a vexing problem, as they have somewhat returned to their catty aloofness after a brief warming while battling the Dominion. The Breen are still around too, and more dangerous than before thanks to Dominion meddling. Occasional attacks by rogue Cardassian ships or Jem'Hadar vessels stranded in the Alpha Quadrant after the end of the war make things more interesting still. Thus, even after eleven years of service, and even with new ship types like the advanced Intrepid class, Steamrunner class, and Akira classes being rushed into service for the war, the Cygnus class is still playing a vital role in maintaining the restored security of the federation, as well as safeguarding the continued exploration of uncharted regions in the Beta Quadrant and elsewhere.

There are currently no plans for a Mark V Cygnus, though the original charter for the frigate envisioned a productive lifespan of at least seventy years, so by the dawning of the 25th century there are very likely going to be still more changes to the design.

Production is currently steady at a combined rate of 8 ships per year at two different shipyards. All of the remaining Mark III models are slated for eventual upgrade to the Mark IV, and out of the entire combined production run to date--Mark IIs, IIIs, and IVs--thirty five ships have been destroyed, twenty three more have been scrapped as a result of crippling damage, six are used exclusively by Starfleet Academy for training purposes, four are detailed to Starfleet Reserve, and the rest are registered and active with Starfleet Command.

Ships of this class are often named for popular star constellations in the various tongues of Federation member species.

Construction Data:

Model Numbers-	MK II	MK III	MK IV
Ship Class-	XVI	XVI	XVI
Date Entering Service-	2366	2371	2373
Number Constructed	32	48	27

Hull Data:

Superstructure Points-	77	85	92
Damage Chart-	C	C	C
Size			
Length-	591 meters	592 meters	592 meters
Width-	240 meters	242 meters	242 meters
Height-	90 meters	91 meters	91 meters
Weight-	312,400 tons	326,100 tons	341,000 tons
Cargo			
Cargo Units-	200 units	200 units	200 units
Cargo Capacity-	10,000 tons	10,000 tons	10,000 tons
Landing Capability-	None	None	None

Equipment Data:

Control Computer Type-	MBT-09	MBT-09	MBT-10
Transporters-			
Standard 6-person-	10	10	10
Combat 20-person-	5	5	5
Emergency 22-person-	8	8	8
cargo large-	2	2	2
cargo small-	2	2	2

Other Data:

Crew-	620	630	630
Marines-	200	200	200
Passengers-	20	20	20
Shuttlecraft-	18	18	18

Engines and Power Data:

Total Power Units Available-	145	166	178
Movement Point Ratio-	4/1	5/1	5/1
Warp Engine Type-	FNWD-4A	FNWD-4C	FNWD-4C
Number-	3	3	3
Power Units Available-	40	47	47
Stress Charts-	K/F	K/F	K/F
Maximum Safe Cruising Speed-	Warp 7	Warp 8	Warp 8
Emergency Speed-	Warp 9.9	Warp 9.9	Warp 9.9
Impulse Engine Type-	FNIS-200	FNIS-200	FNIS-300
Power Units Available-	25	25	37

Weapons and Firing Data:

Beam Weapon Type-	FAHW-22	FAHW-26	FAHW-31
Number-	12 in 6 banks	12 in 6 banks	12 in 6 banks
Firing Arcs-	2f, 2f/p, 2f/s, 2a/s, 2a/p, 2a	2f, 2f/p, 2f/s, 2a/s, 2a/p, 2a	2f, 2f/p, 2f/s, 2a/s, 2a/p, 2a
Firing Chart-	Y	W	Y
Maximum Power-	14	18	23
Damage Modifiers			
+3	(1 - 7)	(1 - 9)	(1 - 11)
+2	(8 - 14)	(10 - 16)	(12 - 18)
+1	(15 - 20)	(17 - 20)	(19 - 24)
Missile Weapon Type-	FP-13	FP-17	FQT-7
Number-	6	6	6
Firing Arcs-	2f, 1f/s, 1f/p, 2a	2f, 1f/s, 1f/p, 2a	2f, 1f/s, 1f/p, 2a
Firing Chart-	V	X	Y
Power To Arm-	3	3	5
Damage-	23	27	34

Shields Data:

Deflector Shield Type-	NGSS-G	NGSS-J	NGSS-M
Shield Point Ratio-	1/3	1/3	1/4
Maximum Shield Power-	24	33	36
*Defense Factor-	364.11	371.55	322.06
*Weapon Damage Factor-	261.96	261.96	443.76

* Special thanks to [Bryan](#) for figuring out the D and WDF for this fanship!

[<<<< GO BACK](#)

IMPORTANT NOTE:

It is entirely possible that you have surfed to this page from an internet portal and are now viewing this page without frames. **The STSSTCSMU&A is best viewed from within its own set of frames**, so [click here to jump to the main STSSTCSMU&A web page](#) and then [see the site as it was meant to be seen!](#)

THOTH CLASS FRIGATE

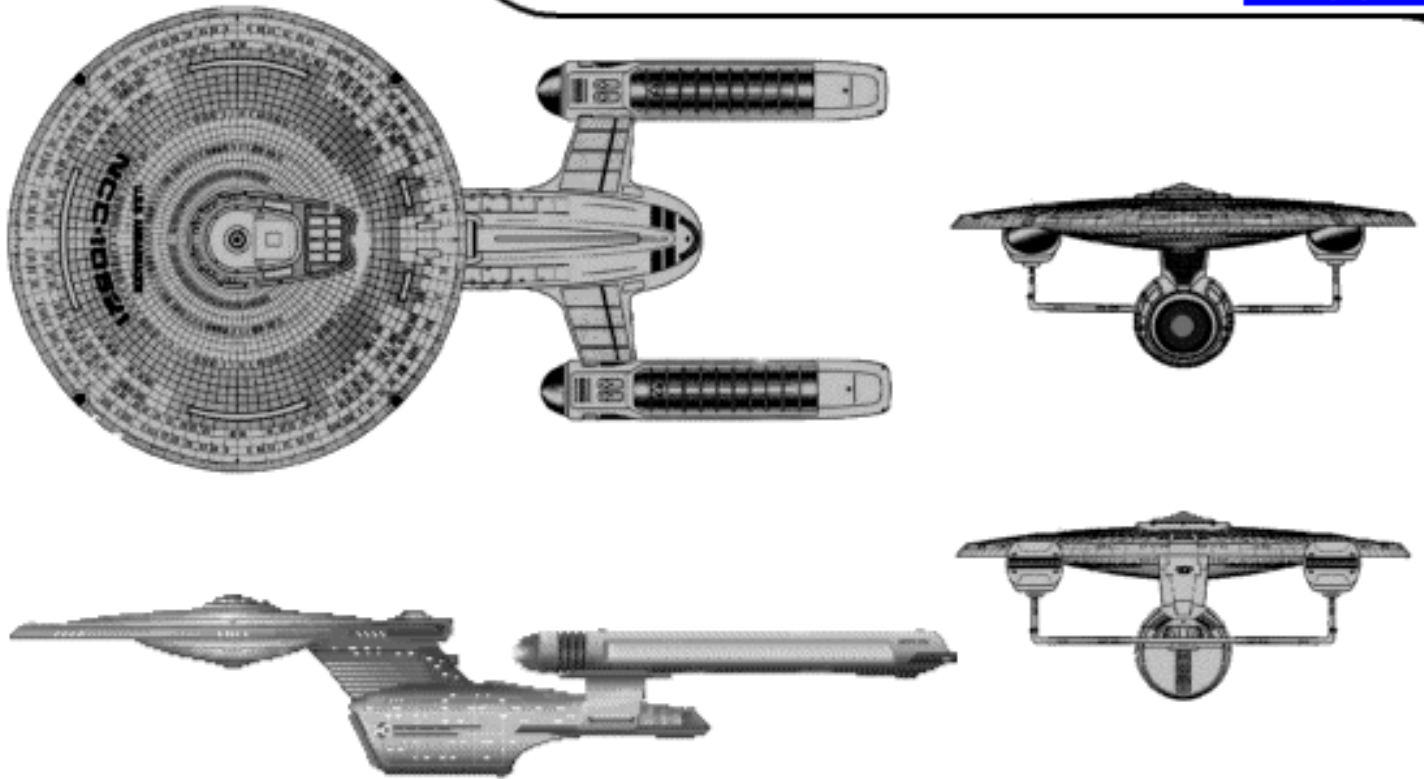

[Click here if you want to view this ship in its own window](#)

BRAD'S COMMENTS: I have posted this ship to the site, not because I am particularly thrilled with its stats or designs, but because I believe it is instructive in terms of what I do and do NOT want from a fanship submission. The designer, a nice young fellow named Brian Seals, also worked with me over two weeks to satisfy some of my griping about the fact that he could only initially present me with a side-on view for his class. Since Bri is a fan of this site, and since he worked hard, he gets a B+ for his effort, though I believe Bri probably did not intend for me to critique this ship as much as I have critiqued it.

For starters, lets talk about the design. Even a passing Trek fan can tell that the Thoth is nearly identical to the [Ambassador class exploration cruiser](#), which was the precursor to the [Galaxy class exploration cruiser](#).

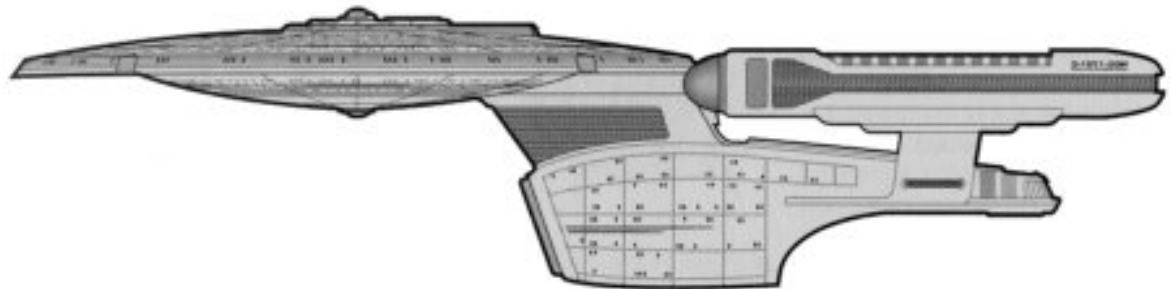

Visibly, there is perhaps NO significant difference between the Ambassador and Bri's Thoth, save for the fact that Bri has drawn up a slightly different warp engine for the side-on view and mounted it further back than the original Ambassador's warp engines were mounted. At right we can see a side-on view of the actual Ambassador class, as scanned from M.Okuda's Star Trek Encyclopedia. Comparing it with the Thoth it is plain that that the fanship is hardly very different at all from the actual design. Which is a huge no-no in my book of fanship design rules. A fanship, at least if it is going to appear on this site, ought to be significantly different from any known official canon ship design. I don't know about anyone else, but when I was 15 years old in 1989 and I started drawing fan designs for this game, the whole point behind a fanship was to draw something that was *markedly different from anything seen in film*. Yes, certain themes and design aesthetics ought to be carried over, like warp engines or the saucer section or whatnot. But the idea is to arrange these elements in a configuration not seen before on the screen, nor even in a book or manual; and to add enough hand drawn or manually drawn

detail that the ship could truly be claimed to be an *original piece of art*. Kindred to the other Trek ships, yet different just the same. And as much as I hate to say it, Bri's Thoth class has failed miserably in this regard, so remember that if you're thinking of submitting a ship of your own.

The class is also deemed a frigate type, massing XIII on the old game scale. That means the ship's total mass has to be between 210,000 tons and 240,000 tons, and as a frigate companion to the Ambassador the ship ought to possess armament approaching that of its cruiser sister, without actually equaling its cruiser sister.

Now, there were never official STSSTCS game stats for the Ambassador, but based on size comparisons with the Galaxy class which masses 400,000 according to the TNG Officers Manual, the Ambassador ought to mass close to the Galaxy class, plus or minus 50,000 tons, or so I figure. Let's assume, for the heck of it, that the Ambassador class cruiser masses 340,000 tons. Less than the Galaxy, but still greater than just about any Federation ship before it. Now, the problem is, if the Thoth class "frigate" looks identical to the Ambassador, how can it mass at least 100,000 tons less than the Ambassador? Is the Thoth therefore smaller than the Ambassador? And if so, why is the Thoth identical in design to the Ambassador? When modern ship designers set about building a 100,000 ton nuclear aircraft carrier, then turn around and construct a 15,000 ton cruiser, there is no way in hell the cruiser is going to look even remotely like the aircraft carrier, regardless of whether or not they share the same roles within the Navy.

The stats also do not support a "frigate" companion for the Ambassador. Other than the total energy output, which is quite generous at 143 points, the Thoth is horribly undergunned and underarmored with only two torpedoes and only 5 phaser banks. The Kirk-era Excelsior class, which is much smaller than the Ambassador, packs a hell of a lot more punch than the Thoth, yet the Thoth is 40 years more recent than the Excelsior? The TNG Officers Manual seems to indicate that as Federation engineering advanced into the TNG-era and away from the Kirk-era, yesterday's cruisers wind up possessing as much capability as recent TNG-era frigates or even destroyers. It then seems reasonable to me that a frigate companion for the Ambassador ought to carry a LOT more torpedoes than the Thoth carries. Maybe not torps doing more damage individually, but more torps that can inflict more damage collectively? The superstructure could use some more beefing up, and phasers too. Generally, this ship really does need some work stat-wise. I know Bri said he was trying to follow my admonishment that fanship designers not create "superships" that are impossible to defeat. But I think Bri went too far in the other direction by limiting the stats for this ship to the point where they seem appropriate only for a TOS-era cruiser or a TMP-era frigate, not a frigate concurrent with the Ambassador.

Finally, Bri's story is too spare. Now, spare can be good. You don't always need a huge 10-page tale to describe your ship. But as with the stats, I think perhaps Bri went too far in the other direction. A frigate companion to the Ambassador is worthy of at least a few paragraphs. But Bri's Thoth gets only a single paragraph, with no backstory on how the design was built, problems or events during construction, flight testing, or the shakedown cruise. It is not known whether or not the Thoth participated with the Ambassador in any noteworthy events, though we do find out that the class faired poorly during the Dominion war, as could probably be said for all but the most cutting edge Federation ships. Were all Thoth class ships truly scrapped, or is there still one lurking in a fleet museum somewhere, or maybe a mothballing facility? The story also seems somewhat contradictory in that there is no mention of troops being onboard, and there seems to be room reserved for science facilities. In terms of the old STSSTCS, this flies in the face of all frigate logic in that frigates are defined as combat support ships that usually pack heavy firepower AND carry troops, with little or no mention of science facilities or research equipment.

In summation, the Thoth does a whole pile of "wrong" things. I know Bri probably never intended to have his ship ripped up like this. I hope he is not angry. But I was looking for a way to show the fans what I wanted, and what I did NOT want, in a fanship submission. Bri's ship gave me a great chance to do this since it makes so many different mistakes at one time. Hopefully Bri and others will be able to learn from this and do a better job the next time around. I'm probably a lot more anal than most other web masters who take other fan's designs and post them to their sites. But I guess I've just seen way too many mistakes made, seen way too many fans disregard even basic ship construction logic. I feel compelled to employ draconian standards, if only to maintain the integrity of the site and prevent it from degrading into just another unremarkable fanship gallery.

Hey Bri, keep trying. I am always here.

Thoth Class XIII Frigate

NOTES: When the Ambassadors were in production, some Federation ship designers came up with a frigate that would support the Ambassadors & Excelsiors in various duties. The Thothes did badly in patrol & minor exploration duties. The class wasn't as capable as the Klingons' KDF-1 frigates or the Romulans' T-39 Midnight Attacker Destroyers, & its science facilities weren't as complex as those on other ships. However there was one notable scenario: in 2335, the Durrett class cruiser *U.S.S. Lovell* was on its way to Starbase 461 to be decommissioned after many years of service. The *Lovell* was attacked by a group of Orion pirates who were using a new model cruiser. The Thoth class *U.S.S. Deimos* arrived to the spot & fought the Orion ship. The *Deimos* was damaged & lost some of its crew but the *Lovell* made it to the starbase. During the Dominion war, the Thothes did very badly, & were easily devastated by the Jem'hadar fighters. The remaining ones were often taken out of battle & scrapped for spare parts & there were none left by the end of the war.

Construction Data:

Model Numbers-	MK I	MK II
Ship Class-	XIII	XIII
Date Entering Service-	2325	2330
Number Constructed	63	?

Hull Data:

Superstructure Points-	44	55
Damage Chart-	C	C
Size		
Length-	? meters	? meters
Width-	? meters	? meters
Height-	? meters	? meters
Weight-	240,000(?) tons	240,000(?) tons
Cargo		
Cargo Units-	200 units	200 units
Cargo Capacity-	10,000 tons	10,000 tons
Landing Capability-	None	None

Equipment Data:

Control Computer Type-	M-13	M-13
Transporters-		
Standard 6-person-	8	8
Combat 20-person-	none	none
Emergency 22-person-	4	4
cargo large-	6	6
cargo small-	none	none

Other Data:

Crew-	254	254
Marines-	none	none
Passengers-	20	20
Shuttlecraft-	3	3

Engines and Power Data:

Total Power Units Available-	143	143
Movement Point Ratio-	7/1	7/1
Warp Engine Type-	FBPX-1	FBPX-1
Number-	2	2
Power Units Available-	50	50
Stress Charts-	F/J	F/J
Maximum Safe Cruising Speed-	Warp 7	Warp 7
Emergency Speed-	Warp 9.2	Warp 9.2
Impulse Engine Type-	FBSI-1	FBSI-1
Power Units Available-	43	43

Weapons and Firing Data:

Beam Weapon Type-	FH-16	FH-16
Number-	4 in 2 banks	10 in 5 banks
Firing Arcs-	2f, 2f/p/s	2f, 2f/p/s, 2p, 2s, 2a
Firing Chart-	Y	Y
Maximum Power-	11	11
Damage Modifiers		
+3	(1 - 10)	(1 - 10)
+2	(11 - 17)	(11 - 17)
+1	(18 - 24)	(18 - 24)
Beam Weapon Type-	FH-11	FH-11
Number-	6, in 3 banks	8, in 4 banks
Firing Arcs-	2f, 2pa/, 2s/a	2f/p, 2f/s, 2a/p, 2a/s
Firing Chart-	Y	Y
Maximum Power-	10	10
Damage Modifiers		
+3	(1 - 10)	(1 - 10)
+2	(11 - 17)	(11 - 17)
+1	(18 - 24)	(18 - 24)
Missile Weapon Type-	FP-10	FP-10
Number-	2	7
Firing Arcs-	1f/p, 1f/s	2f, 1f/p, 1f/s, 2 360° arc, 1a
Firing Chart-	U	U
Power To Arm-	1	1
Damage-	14	14

Shields Data:

Deflector Shield Type-	FPBT-1	FPBT-1
Shield Point Ratio-	1/5	1/5
Maximum Shield Power-	25	25

Defense Factor-	(classified)	(classified)
Weapon Damage Factor-	(classified)	(classified)

[<<<< GO BACK](#)

IMPORTANT NOTE:

It is entirely possible that you have surfed to this page from an internet portal and are now viewing this page without frames. **The STSSTCSMU&A is best viewed from within its own set of frames**, so [click here to jump to the main STSSTCSMU&A web page](#) and then [see the site as it was meant to be seen!](#)

NORTHAMPTON CLASS FRIGATE

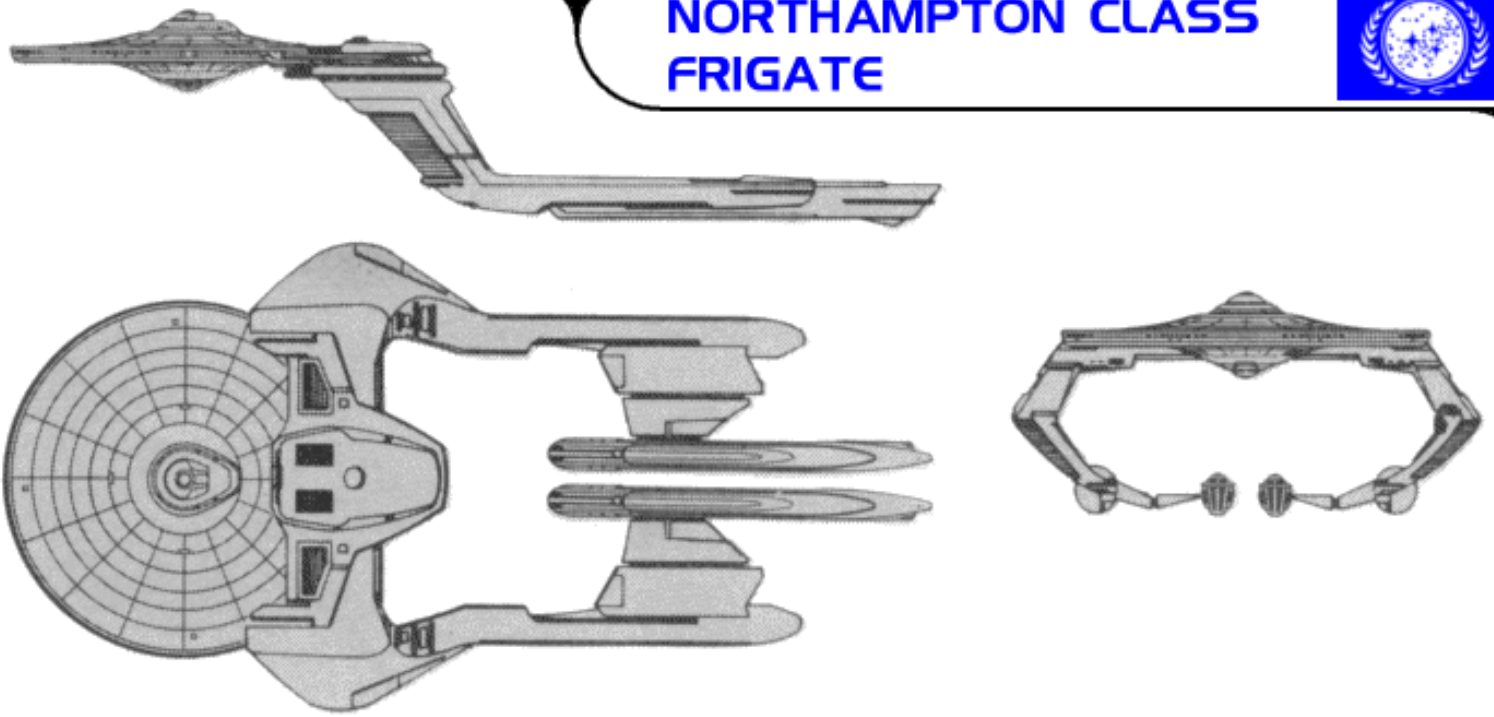

[Click here if you want to view this ship in its own window](#)

BRAD'S COMMENTS: Yet another of the many Federation designs that face the warp nacelles inward. I've already gone into great detail on other pages as to why this design practice at FASA bothers me so much--most notably in my comments on the [Andor Class](#) missile cruiser. Like the Andor, the Northampton has an impressive torpedo spread in the forward arc, giving it good knock-down power against enemy ships. The dual FWG-1 warp engines give the Northampton almost as much power as the [Enterprise \(Constitution Refit\)](#) Class cruiser, enabling it to adequately power shields and arm phasers during hostile engagements. Overall, in spite of the nonsensical warp pylon structure, the Northampton is a potent ship and will radically boost the capability of any Federation squadron it is added to.



From the **FASA Star Trek FEDERATION SHIP RECOGNITION MANUAL**, circa 1985

Northampton Class X Frigate

NOTES: The Northampton Class frigate, stationed by Star Fleet in all sensitive areas, to prevent foreign aggression, enjoys the respect and admiration of its crews and troops. These ships have numerous recreation facilities and spacious quarters for the crewmembers and marines. Swimming pools, gravball courts, and physical fitness centers are all located in the lower hull adjacent to the shuttlebay and near the engineering section.

The Northampton mounts the most powerful of Star Fleet's engines, the FWG-1 warp engine, which allows it to reach trouble spots quickly. Although the hull design incorporates the single-engine lock found on several Andorian designs, the Northampton is a Martian design.

The weapons array is similar to that found on the Chandley Class frigates, though the arrangement is not the same. Both classes mount 6 FH-11 phasers, but the fields of fire are quite different, with the Northampton having better aft-firing capabilities and the Chandley having better forward-firing capabilities. Unlike the Chandley, the Northampton has concentrated all three of its torpedo tubes forward, which makes it offensively powerful.

Reports on the exploits of the *USS Bremerton* while in the Triangle have made quite a stir in military circles. After spending one year in the Triangle conducting business of an undisclosed nature, the Northampton Class *Bremerton* returned to Starbase 10 and reported that it had encountered both Romulan and Klingon ships, all of which it was forced to fight. Details of the encounters are still classified.

Of the 67 Northamptons built, 66 remain in active service and 1 is used by Star Fleet Intelligence. The Northampton is produced at the Sol IV shipyards at a rate of 20 per year.

Construction Data:

Model Numbers-	MK I	MK III
Ship Class-	X	X
Date Entering Service-	2/1905	2/2002
Number Constructed	39	28

Hull Data:		
Superstructure Points-	29	29
Damage Chart-	C	C
Size		
Length-	300 meters	300 meters
Width-	150 meters	150 meters
Height-	75 meters	75 meters
Weight-	154,600 tons	154,570 tons
Cargo		
Cargo Units-	500 units	500 units
Cargo Capacity-	25,000 tons	25,000 tons
Landing Capability-	None	None

Equipment Data:		
Control Computer Type-	M-6	M-6
Transporters-		
Standard 6-person-	6	6
Combat 20-person-	4	4
Emergency 22-person-	none	none
cargo-	2	2

Other Data:		
Crew-	325	328
Passengers-	none	none
Troops-	220	220
Shuttlecraft-	6	6

Engines and Power Data:		
Total Power Units Available-	56	56
Movement Point Ratio-	4/1	4/1
Warp Engine Type-	FWG-1	FWG-1
Number-	2	2
Power Units Available-	26	26
Stress Charts-	D/F	D/F
Maximum Safe Cruising Speed-	Warp 8	Warp 8
Emergency Speed-	Warp 10	Warp 10
Impulse Engine Type-	FID-2	FID-2
Power Units Available-	4	4

Weapons and Firing Data:		
Beam Weapon Type-	FH-11	FH-11
Number-	6 in three banks	6 in three banks
Firing Arcs-	2f, 2a/p, 2a/s	2f, 2a/p, 2a/s
Firing Chart-	Y	Y
Maximum Power-	10	10
Damage Modifiers		
+3	(1 - 10)	(1 - 10)
+2	(11 - 17)	(11 - 17)
+1	(18 - 24)	(18 - 24)
Missile Weapon Type-	FP-7	FP-6
Number-	3	3
Firing Arcs-	F	F
Firing Chart-	R	O
Power To Arm-	1	1
Damage-	8	12

Shields Data:		
Deflector Shield Type-	FSO	FSO
Shield Point Ratio-	1/3	1/3
Maximum Shield Power-	16	16

Defense Factor-	124.0	124.0
Weapon Damage Factor-	78.6	84.3

IMPORTANT NOTE:

It is entirely possible that you have surfed to this page from an internet portal and are now viewing this page without frames. **The STSSTCSMU&A is best viewed from within its own set of frames**, so [click here to jump to the main STSSTCSMU&A web page](#) and then [see the site as it was meant to be seen!](#)

CHANDLEY CLASS FRIGATE

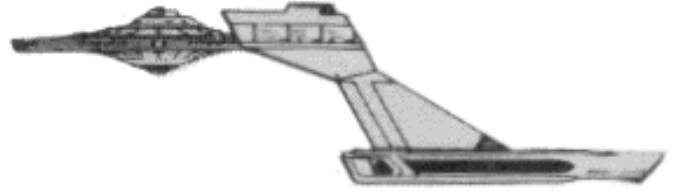
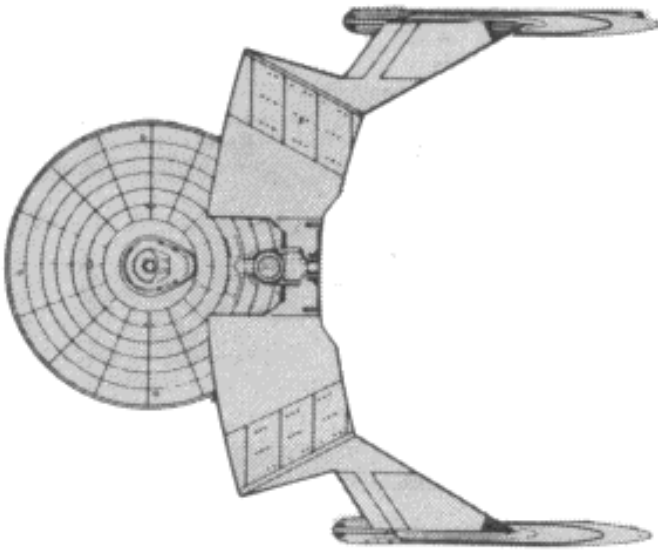

[Click here if you want to view this ship in its own window](#)

BRAD'S COMMENTS: Of all the non-canon ships that were created for the original STSSTCS, the Chandley is far and away the most beloved. Over the years I have seen more positive comments about the Chandley from more fans than just about any other non-canon ship in the entire game. People just LOVE this ship, and rightly so.

The Chandley is a complete package. Aesthetically gorgeous, statistically formidable, the Chandley is one of those well-designed vessels that even non-gamer fans have heard of. Which is a testament to how nicely this ship fits into the TMP-era mythos of the Trek franchise. Fan fiction aplenty has been written around this class, and it has been adopted by not just a few fan "starship" clubs. What else can be said? This class is well known and well adored by gamers and non-gamers alike, and just once before I die I'd love to see somebody involved with the movies or TV shows make SOME official mention of the Chandley. That way it could truly attain its proper place in the Trek canon.

In game terms, there are few ships from the STSSTCS that can match the Chandley one-on-one. It can beat just about any other frigate, friendly or enemy, and bests all but the largest cruisers and battleships. Possessing powerful multiple torpedoes both fore and aft, plus strong phasers and power to energize them, the Chandley can cripple all but the largest enemy vessels with only a few well-placed shots. When playing the Klingons or Romulans versus a Chandley I have only ever been able to beat the Chandley by using a [Romulan V-30](#) or a [Klingon D-10](#), both of which are heavy cruisers. Otherwise, it comes down to overwhelming the Chandley's strong offensive and defensive capability with multiple ships.

The backstory is lengthy but well written. The reference to the fictional Admiral Chandley who blockades the Soviets in 2003 is amusing considering modern history in the real world. Back in the 1980's few of us in America could conceive of the idea that the Soviet Union would fall apart before the turn of the century. Certainly we never imagined that Russia would wind up as a democratic ally at the start of the new millenium.



From the FASA Star Trek FEDERATION SHIP RECOGNITION MANUAL, circa 1985

Chandley Class XI Frigate

NOTES: After the conclusion of the Four Years War, Star Fleet Command initiated the Strategic Forces Survey to evaluate every major operation of the war, from its conception to its final outcome. All aspects of these operations, starting with the initial planning stages, to the deployment of forces, their use during the operation, and the after-action requirements of those forces, were evaluated. The results of this survey have directly influenced plans made by Star Fleet Command ever since.

One of the weaknesses identified by the survey was that Star Fleet needed combat vessels carrying boarding parties or prize crews so that it could follow up a successful campaign with rapid and decisive blows against a retreating or routed enemy. Star Fleet warships did not carry marine assault teams, and, therefore, they were unable to board and capture enemy vessels or outposts. In many operations, Star Fleet vessels were held back so that their combined boarding groups could take control of disabled enemy vessels or outposts; this caused lengthy delays in follow-up operations and allowed the enemy to recover. To take enemy outposts, assault ships were called in, frequently a poor choice because they were slow, vulnerable, and usually carried too many troops for small operations. To solve this problem, Star Fleet began developing the frigate class of ships to carry marines trained to board hostile vessels and complexes. Of the several different ships with this design, the

most impressive is the Chandley Class frigate.

On Stardate 2/1612, the *USS Chandley*, the first of this prestigious line of vessels, was commissioned. The *Chandley* not only met the requirements of being a deep-space fighting vessel but also could beam its 250 marines in less than four minutes. With this vessel, Star Fleet had the ability to follow up combat more efficiently. The *Chandley's* large, wing-like assembly houses the company of marines, their equipment, training areas, shuttlebay, and the combat transporters needed. The marines are billeted by platoons, with each platoon having its own spacious training, mess, dormitory, and recreation areas. The training areas, located in the central core of the wing structures, are made up of modules that may be positioned to resemble the interior of enemy ships and installations, allowing assault teams to familiarize themselves with their intended operation area; this training technique is largely responsible for the high success rate in boarding actions. The training areas are also used for physical training and firing ranges. Each platoon has a recreation area containing a swimming pool, gymnasium, gravball chamber, and complete health facilities; these facilities are largely responsible for the notable successes enjoyed by marine sports teams.

Since its inception, the Chandley Class frigate has used the older FWC-1 warp drive system, an engine proven to be highly reliable. Though many ship designers have wanted to put newer, more powerful warp systems on the Chandleys, each time the power systems have been upgraded, it has been through improvements to the impulse drive system. Warp drives larger than the FWC-1 are more costly to run and maintain, an important factor that must be considered because of the relatively great expense required to keep a company of marines aboard.

The Chandley Mk II design merely increased the size of the marines' storage cargo bays, but the Mk III changed the computer system, cargo bays, impulse drive system, and photon torpedo launchers. The computer was altered to the experimental M-6A for improved fire control, as the standard M-6 would not efficiently handle the increased capabilities of the FP-5 photon torpedo; the Chandley is the only class of ship in Star Fleet to possess this computer, as it has not been needed in other designs. The Mk IV design improved the shields; the earlier FSO shield generator was changed to the more efficient FSP. With this change, the Chandley Class frigate is one of the most powerful ships in known space. In all its modifications, it has gained a high level of respect from Romulan, Klingon, and Gorn commanders.

The Chandley is the only ship in Star Fleet named after the company that designed and built the class vessel. Actually, the company is owned by the descendants of Rear Admiral Thomas Chandley, one of the most-decorated naval heroes of Terran history. Chandley, an admiral in the U.S. Navy, is well known for his brilliant blockade of Soviet ports during the Aleutian Incident of 2003.

The first combat experience of any Chandley Class vessel was considered a total success. While patrolling in the Gorn Sector, the *USS Hanson* (NCC 2309), received a distress call from a commercial freighter stating it was under attack by unknown vessels. Upon reaching the coordinates given by the freighter, the *Hanson* encountered two Gorn cruisers involved in a boarding action against a Liberty Class freighter. When called upon to withdraw, the Gorn cruisers put up shields and opened fire. The *Hanson* made short work of the Gorn vessels, but the marine boarding parties found their task difficult at best, for they encountered Gorn marines who refused to give ground easily. Victory was won only after the Star Fleet marines gained access to the life support systems and shut them down. When the bridges of the Gorn vessels were entered, it was discovered that the entire bridge crew had committed suicide. Interrogation revealed that the ships had defected from the Gorn Alliance and were operating as renegades. The *Hanson's* marines sustained only three deaths and 17 casualties during this spirited action; all units involved received Commendations of Valor. This was the first time a Gorn ship had been boarded by Star Fleet personnel; much of the current knowledge about the Gorn Navy stems from this encounter.

In another incident, this one occurring Stardate 2/1910, the *USS Monson* (NCC 2392), on a fact-finding mission within the Triangle, was overtaken by four Klingon K-23 Class destroyers. At first, the Klingons merely scanned the *Monson* at a seemingly safe distance to its rear, but eventually two closed with the frigate, declared it had entered Klingon Imperial space, and demanded it heave to and prepare to be boarded. Finding himself well within the boundaries of the Triangle, and realizing that the Klingon demands were the prelude to an unprovoked attack, the *Monson's* Captain immediately raised shields and warned the Klingons off. The Klingons attacked immediately, and the *Monson* returned fire. The *Monson's* aft torpedoes hit the bridge of the lead K-23, causing it to veer off course and into the path of the other oncoming vessels, whose fire crippled their comrade. Seeing this as an ill omen, the Klingons immediately departed the area, leaving the crippled ship behind. The *Monson* approached the Klingon, accepted its surrender, and beamed aboard two marine platoons before the Klingon ship exploded, killing all aboard. An after-action investigation revealed that an unidentified device in the engine room had been touched by an unsuspecting trooper, initiating a critical overload in the matter/anti-matter mix chamber. The explosion was of low yield and caused no damage to the *Monson*. The device that caused it has never been seen or reported since, and it is suspected by Star Fleet Intelligence to have been a jury-rigged self-destruct unit.

Because of this incident, Star Fleet policy states that before marines board any enemy vessel, a complete scan will be made of the vessel to determine if the destruct systems are in operation. Only if the scan results are negative will the boarding operation proceed. If the scan is positive, the enemy will be given the chance to disarm any such devices, and should they fail to do so promptly, the vessel is to be disabled and the crew subjected to intense phaser stun. Only then will engineers and UXB personnel beam aboard to disarm the device.

On Stardate 2/2005, one of the most decorated frigates in Star Fleet, the *USS Blackheart* (NCC 2327), was reported missing while patrolling the Rimward Sector. A search was made, but all that was found was a communications buoy apparently discharged by the *Blackheart*. This buoy had only the partial message "...small object paralleling our course...no response on hailing freq..." The remainder of the tape was garbled, and portions had been intentionally erased. Star Fleet has no more information on the fate of the ship or its crew. The *Blackheart* is most remembered for the large black hearts painted

on each of its lower wing assemblies; such painting is typical of Chandley Class ships, making them easily distinguished on visual scan. The practice is thought to keep the crew's pride in their vessel at a peak.

Of the 184 Chandleys built, 63 Mk Is, 64 Mk IIIs, and 47 Mk IVs remain in active service. Two Mk Is are used by Star Fleet Training Command; 4 Mk Is and 1 Mk IV have been destroyed; 1 Mk I is listed as missing; 1 Mk I has been scrapped, and 1 Mk I has been sold to the private sector.

The Chandley Class frigate is produced at the shipyards of Sol IV, Sol VI, and Andor at a rate of 4 Mk Is, 10 Mk IIIs, and 14 Mk IVs per year.

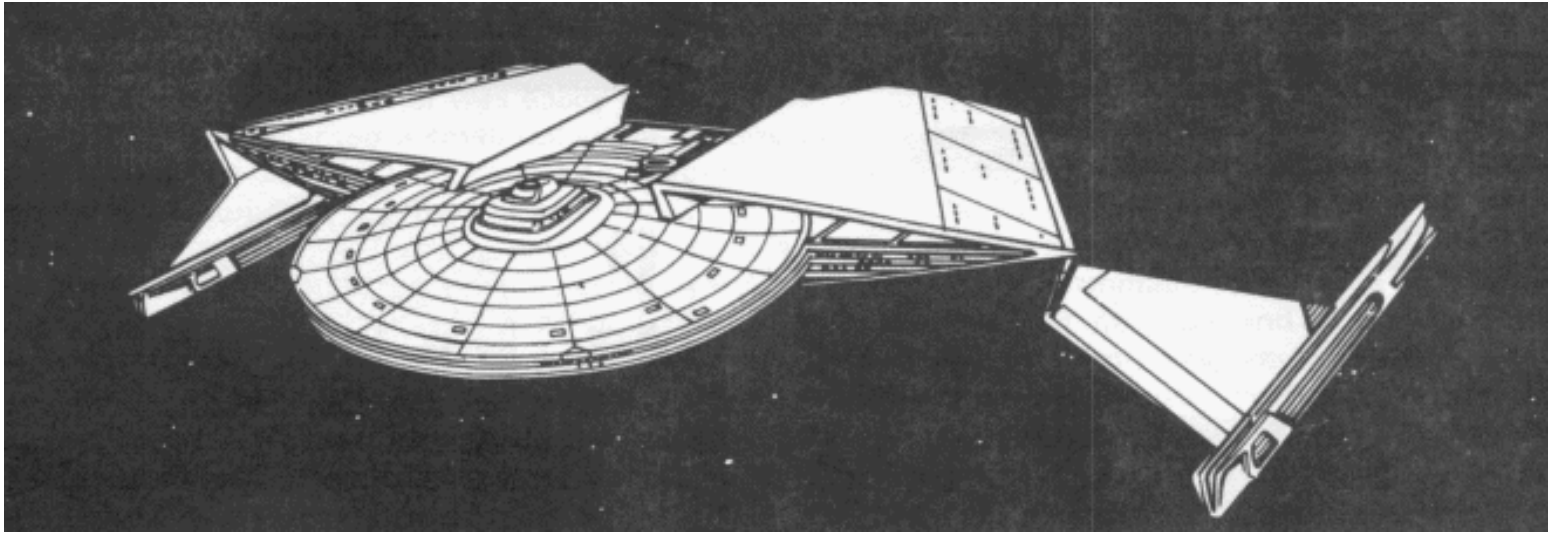

Construction Data:

	MK I	MK III	MK IV
Model Numbers-	XI	XI	XI
Ship Class-	XI	XI	XI
Date Entering Service-	2/1612	2/1902	2/1912
Number Constructed	84	64	48

Hull Data:

	MK I	MK III	MK IV
Superstructure Points-	28	28	28
Damage Chart-	C	C	C
Size			
Length-	315 meters	315 meters	320 meters
Width-	262 meters	262 meters	264 meters
Height-	90 meters	90 meters	92 meters
Weight-	173,300 tons	176,700 tons	177,500 tons
Cargo			
Cargo Units-	825 units	850 units	850 units
Cargo Capacity-	41,250 tons	42,500 tons	42,500 tons
Landing Capability-	None	None	None

Equipment Data:

	MK I	MK III	MK IV
Control Computer Type-	M-6	M-6A	M-6A
Transporters-			
Standard 6-person-	8	8	8
Combat 20-person-	8	8	8
Emergency 22-person-	none	none	none
cargo-	4	4	4

Other Data:

	MK I	MK III	MK IV
Crew-	363	370	370
Passengers-	10	10	10
Troops-	250	250	250
Shuttlecraft-	12	12	12

Engines and Power Data:

Total Power Units Available-	48	52	56
Movement Point Ratio-	3/1	3/1	3/1
Warp Engine Type-	FWC-1	FWC-1	FWC-1
Number-	2	2	2
Power Units Available-	16	16	16
Stress Charts-	O/M	O/M	O/M
Maximum Safe Cruising Speed-	Warp 7	Warp 7	Warp 7
Emergency Speed-	Warp 9	Warp 9	Warp 9
Impulse Engine Type-	FIF-2	FIF-3	FIG-1
Power Units Available-	16	20	24

Weapons and Firing Data:

Beam Weapon Type-	FH-11	FH-11	FH-11
Number-	6 in three banks	6 in three banks	6 in three banks
Firing Arcs-	2f/p, 2f, 2f/s	2f/p, 2f, 2f/s	2f/p, 2f, 2f/s
Firing Chart-	Y	Y	Y
Maximum Power-	10	10	10
Damage Modifiers			
+3	(1 - 10)	(1 - 10)	(1 - 10)
+2	(11 - 17)	(11 - 17)	(11 - 17)
+1	(18 - 24)	(18 - 24)	(18 - 24)
Missile Weapon Type-	FP-6	FP-5	FP-5
Number-	4 in 2 bays	4 in 2 bays	4 in 2 bays
Firing Arcs-	2f, 2a	2f, 2a	2f, 2a
Firing Chart-	O	R	R
Power To Arm-	1	1	1
Damage-	12	16	16

Shields Data:

Deflector Shield Type-	FSO	FSO	FSP
Shield Point Ratio-	1/3	1/3	1/4
Maximum Shield Power-	16	16	16

Defense Factor-	131.5	137.5	170
Weapon Damage Factor-	91	102.2	102.2

[<<<< GO BACK](#)

IMPORTANT NOTE:

It is entirely possible that you have surfed to this page from an internet portal and are now viewing this page without frames. **The STSSTCSMU&A is best viewed from within its own set of frames**, so [click here to jump to the main STSSTCSMU&A web page](#) and then [see the site as it was meant to be seen!](#)

BABCOCK CLASS FRIGATE

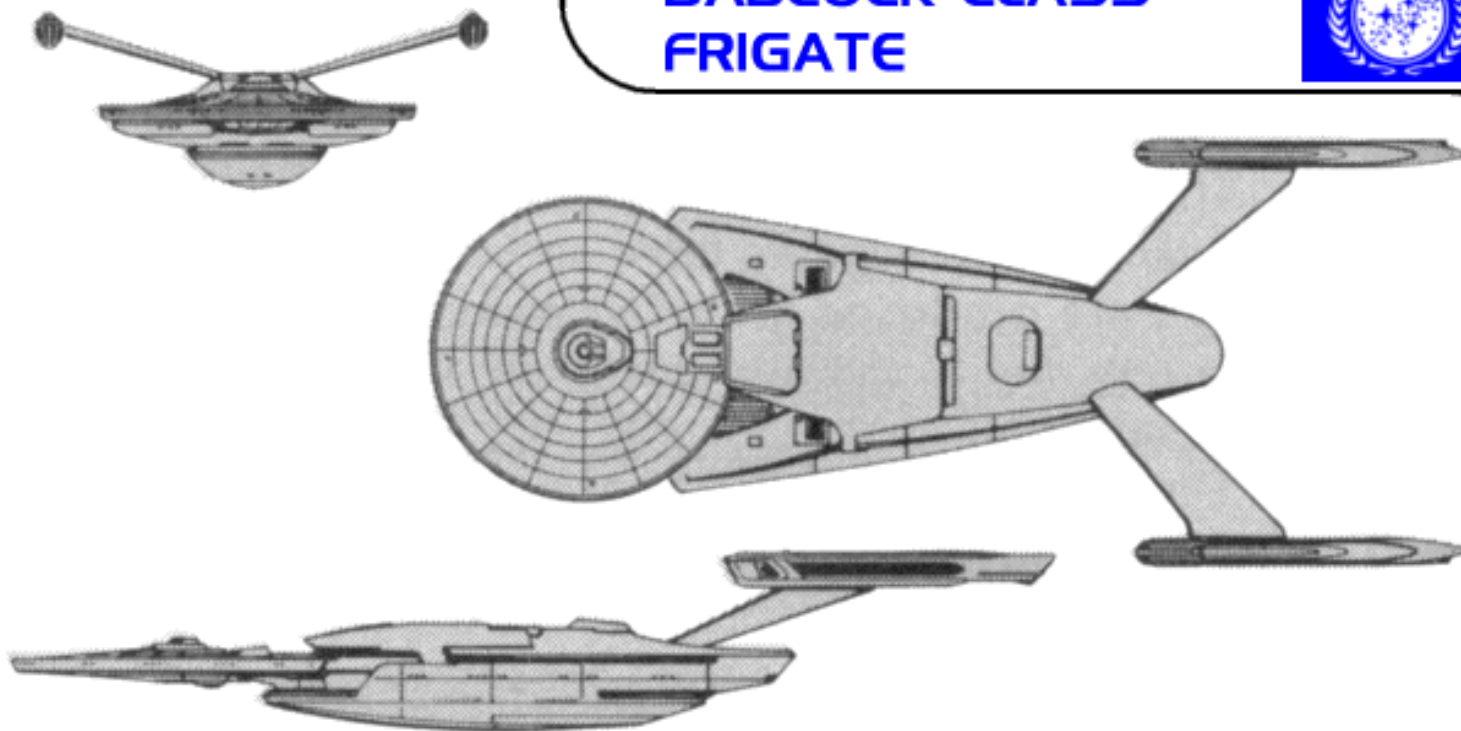

[Click here if you want to view this ship in its own window](#)

BRAD'S COMMENTS: While the Babcock Class is a solid frigate with a potent mixture of power, speed, and defense, it is also one of the worst violators of the "parts proportion" rule. Above you can see the ship as originally designed by FASA. At right is my scale comparison graphic of the Babcock next to a [Constitution Refit Class](#) cruiser. The warp nacelles and saucer section are scaled to match, as they should be. But the Babcock winds up looking preposterously HUGE compared to the Constitution Refit! And somehow both ships are roughly the same mass? Yes, the FASA guys did sorta get things right when they listed the Babcock as being 50 meters longer than the Constitution Refit. But even so, if the saucer and nacelle scales are a match, then the Babcock should be at least 75 to 100 meters longer than the Constitution, or about double the length originally listed. And the Babcock's bulky secondary hull gives the impression that this ship is packing a hell of a lot more under its belt than the Constitution Refit could ever hope to. So I say boo on the FASA designers for (once again) being lazy and not thinking through their designs before they tossed them into the book. The overall looks of this class are just fine, but that saucer and those nacelles need to be totally different from the Constitution Refit in order to resolve the discrepancy between mass and scale.

What the Hell?!

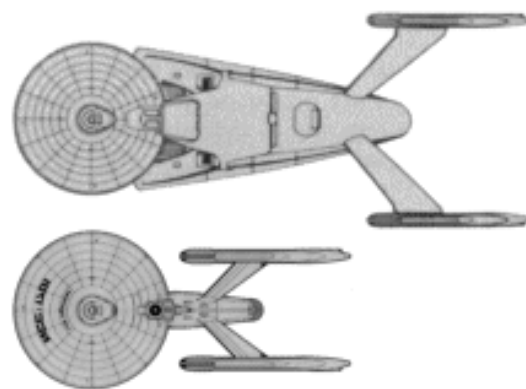

All anal scale bitching aside, the Babcock is a competent frigate that is not quite as ballsy as the [Northampton](#) or the [Chandley](#), but still much more powerful than older [Loknars](#) or destroyers like the [Lenthal](#). The FWF type warp engines crank out over 40 energy points between them, and both Babcock models dual-mount a destructive torpedo design in both the forward and rear arcs. The shields are the best in the TMP-era Federation inventory, and the Babcock can go toe-to-toe with some of the biggest Romulan and Klingon ships of the same time period. Due to this fact the Babcock can operate as both a heavy escort and a stand-alone ship, able to execute scenarios on its own so long as the competition is not too potent, or too numerous.



From the FASA [Star Trek FEDERATION SHIP RECOGNITION MANUAL](#), circa 1985

Babcock Class XI Frigate

NOTES: Of the 140 Babcock Class frigates built, 84 Mk IIs and all 48 Vs remain in active service. One Mk II is used

by Star Fleet Training Command, 6 Mk IIs have been destroyed, and 1 Mk II is listed as missing. The Babcock is manufactured at the Morena and Merak facilities at a combined rate of 16 per year.

Construction Data:

Model Numbers-	MK II	MK V
Ship Class-	XI	XI
Date Entering Service-	2/1709	2/2002
Number Constructed	92	48

Hull Data:

Superstructure Points-	24	26
Damage Chart-	C	C
Size		
Length-	355 meters	355 meters
Width-	150 meters	150 meters
Height-	60 meters	60 meters
Weight-	170,900 tons	173,750 tons
Cargo		
Cargo Units-	600 units	600 units
Cargo Capacity-	30,000 tons	30,000 tons
Landing Capability-	none	none

Equipment Data:

Control Computer Type-	M-4	M-4
Transporters-		
Standard 6-person-	8	8
Combat 20-person-	8	8
Emergency 22-person-	none	none
cargo-	3	3

Other Data:

Crew-	360	368
Passengers-	10	10
Troops-	250	250
Shuttlecraft-	8	8

Engines and Power Data:

Total Power Units Available-	46	46
Movement Point Ratio-	4/1	4/1
Warp Engine Type-	FWF-1	FWF-1
Number-	2	2
Power Units Available-	20	20
Stress Charts-	G/L	G/L
Maximum Safe Cruising Speed-	Warp 6	Warp 6
Emergency Speed-	Warp 8	Warp 8
Impulse Engine Type-	FIC-3	FIC-3
Power Units Available-	6	6

Weapons and Firing Data:

Beam Weapon Type-	FH-3	FH-9
Number-	6 in three banks	6 in three banks
Firing Arcs-	2f/p, 2f, 2f/s	2f/p, 2f, 2f/s
Firing Chart-	W	X
Maximum Power-	5	6
Damage Modifiers		
+3	(1 - 10)	
+2	(11 - 17)	(1 - 12)
+1	(18 - 20)	(13 - 22)
Missile Weapon Type-	FP-6	FP-6
Number-	2 in two bays	2 in two bays
Firing Arcs-	1f, 1a	1f, 1a
Firing Chart-	O	O
Power To Arm-	1	1
Damage-	12	12

Shields Data:

Deflector Shield Type-	FSP	FSP
Shield Point Ratio-	1/4	1/4
Maximum Shield Power-	16	16

Defense Factor-	130.3	133.2
Weapon Damage Factor-	48.2	49.4

[<<<< GO BACK](#)

IMPORTANT NOTE:

It is entirely possible that you have surfed to this page from an internet portal and are now viewing this page without frames. **The STSSTCSMU&A is best viewed from within its own set of frames**, so [click here to jump to the main STSSTCSMU&A web page](#) and then [see the site as it was meant to be seen!](#)

KIEV CLASS FRIGATE

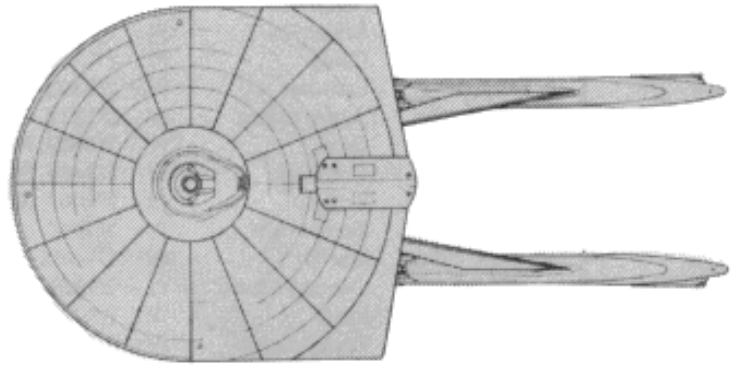

[Click here if you want to view this ship in its own window](#)

BRAD'S COMMENTS: If the [Babcock Class](#) was an exercise in underestimating the true apparent size and mass of a vessel, the Kiev Class is a step in the opposite direction, sporting stats and mass that are flatly *impossible* if the saucer and nacelles are scaled to the same size as the [Constitution Refit](#). Ironically, in the Federation Ship Recognition Manual, both the Babcock and Kiev appear on the *same page*. I suppose this is an instructive lesson in how to botch your scaling when designing Federation starships??

The Constitution Refit is listed as massing roughly 160,000 metric tons, placing it squarely in the mass XI range according to the old FASA ship construction rules. The Kiev Class frigate, also mass range XI, tops out at 165,000 tons! Where is all that extra mass supposed to be? For that matter, where the hell is the damn engineering compartment supposed to be? Or the shuttle bay?? The Kiev is like the [Wilkerson Class](#) destroyer in that it is basically a Constitution

Refit saucer decorated with Constitution Refit nacelles on improbably spindly pylons. There is, of course, the Reliantesq torpedo bay assembly mounted above and behind the bridge, and a Reliantesq squaring of the aft saucer section. But at a glance this hardly seems to make up for the invisible mass nor does it explain exactly where the warp core and other vital engineering apparatus is supposed to live. Are they plating the toilets with neutronium? Does engineering take up the whole back half of the saucer?? And if so, where is the crew supposed to live? This ship carries 300 staff and 120 marines!

I tear my hair out just looking at this class because it flat out does not match the stats given for it, in any way, shape, or form. At best the Kiev ought to be just a warmed-over Wilkerson style destroyer, not a heavy Frigate capable of giving the [Miranda/Soyuz](#) classes a run for their money. For this reason I almost never played the Kiev when I ran any scenarios. I just couldn't buy it. I'd look at that ship counter sitting on the map sheet, then look at the stats and power given on the game control panel, and I'd say to myself, "That's f---ing bulls--t!"

160,000 TONS

165,000 TONS?

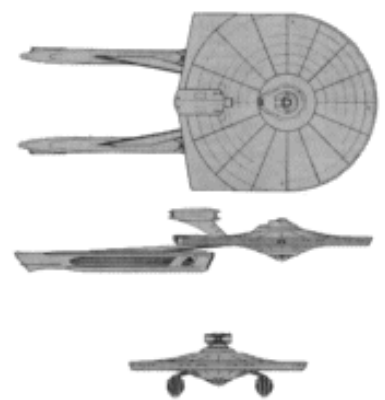
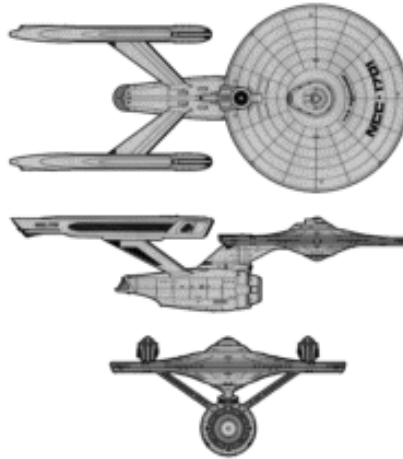

From the FASA Star Trek FEDERATION SHIP RECOGNITION MANUAL, circa 1985

Kiev Class XI Frigate

NOTES: Of the 84 Kiev Class frigates built, 68 remain in active service, 1 is used by Star Fleet Training Command; 12 have been destroyed; 1 is listed as missing; and 2 have been scrapped. The Kiev is produced at the Salazaar and Merak shipyards at a combined rate of 14 per year.

Construction Data:

Model Numbers-	MK I
Ship Class-	XI
Date Entering Service-	2/1610
Number Constructed	84

Hull Data:	
Superstructure Points-	24
Damage Chart-	C
Size	
Length-	280 meters
Width-	140 meters
Height-	50 meters
Weight-	165,200 tons
Cargo	
Cargo Units-	150 units
Cargo Capacity-	7,500 tons
Landing Capability-	none

Equipment Data:	
Control Computer Type-	M-3
Transporters-	
Standard 6-person-	4
Combat 20-person-	3
Emergency 22-person-	none
cargo-	2

Other Data:	
Crew-	300
Passengers-	none
Troops-	120
Shuttlecraft-	4

Engines and Power Data:	
Total Power Units Available-	44
Movement Point Ratio-	3/1
Warp Engine Type-	FWC-1
Number-	2
Power Units Available-	16
Stress Charts-	O/M
Maximum Safe Cruising Speed-	Warp 7
Emergency Speed-	Warp 9
Impulse Engine Type-	FIF-1
Power Units Available-	12

Weapons and Firing Data:	
Beam Weapon Type-	FH-8
Number-	6 in three banks
Firing Arcs-	2f/p, 2f/s, 2a
Firing Chart-	T
Maximum Power-	5
Damage Modifiers	
+3	
+2	(1 - 10)
+1	(11 - 18)
Missile Weapon Type-	FP-4
Number-	2 in two bays
Firing Arcs-	1f, 1a
Firing Chart-	S
Power To Arm-	1
Damage-	20

Shields Data:	
Deflector Shield Type-	FSL
Shield Point Ratio-	1/3
Maximum Shield Power-	14

Defense Factor-	119.8
Weapon Damage Factor-	50.0

IMPORTANT NOTE:

It is entirely possible that you have surfed to this page from an internet portal and are now viewing this page without frames. **The STSSTCSMU&A is best viewed from within its own set of frames**, so [click here to jump to the main STSSTCSMU&A web page](#) and then [see the site as it was meant to be seen!](#)

PAINE CLASS FRIGATE

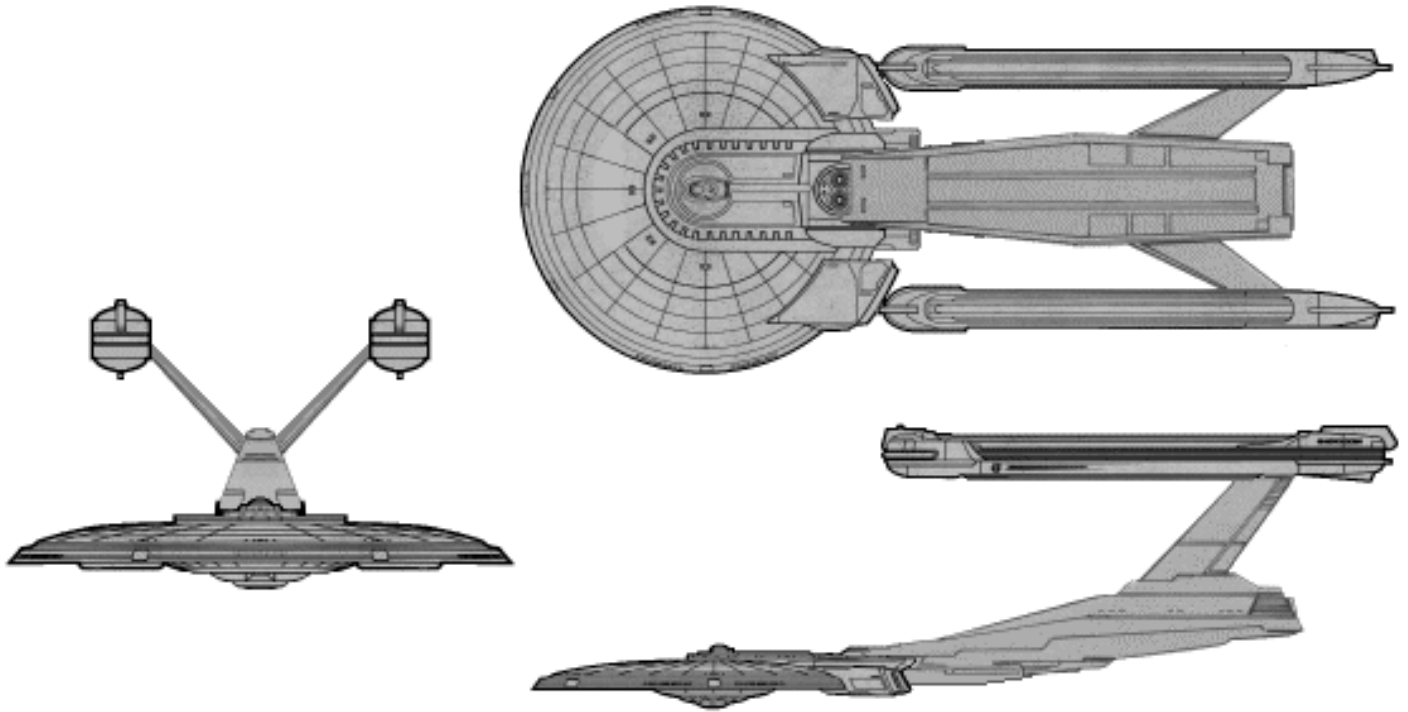

[Click here if you want to view this ship in its own window](#)

BRAD'S COMMENTS: Like FASA's original [Ambassador Class](#) heavy cruiser from the TNG Officer's Manual, the Paine Class appeared as a bastardized hybrid between the [Constitution Refit](#) and the [Excelsior](#). Employing the Constitution Refit's ubiquitous saucer section and the Excelsior's streamlined warp nacelles, the Paine (as it originally appeared) is a ship completely out of proportion! So, like I did with the Ambassador, I took the liberty of revamping the Paine to look more like it *should* have looked all along, using the Excelsior warp nacelles as my scale reference, then pasting in the saucer and nacelles from the [Excelsior Refit](#). All in all, I think it turned out pretty well, and was not as grueling a chore as revamping the Ambassador, which was not only out of scale but had some problems in the shape of the secondary hull in the forward view. At right you can click on the picture and see how the Paine originally looked. Which is better? You decide.

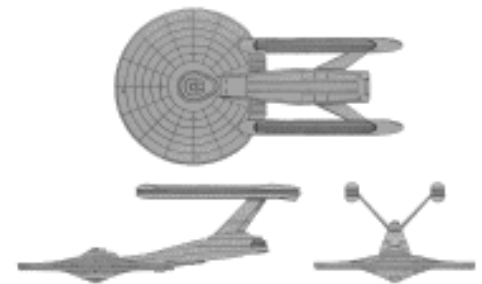

[Click here to see the original Paine!](#)

As for combat efficiency, the Paine is pretty weak compared to other ships of the same era, especially in its torpedo armament. Those FP-7's do not do a lot of damage, and there are only two of them concentrated into the forward arc. Even the older [Chandley](#) and [Northampton](#) frigates have more ferocious firepower. Also, the Paine's superstructure is weaker than many older frigates and cruisers, and the engines don't put out much juice, leading me to wonder what's the use of playing this class at all if it's not any kind of improvement over the older classes? The Paine plays more like a scout or maybe an escort, not a frigate as we've come to know them in the FASA universe.



Construction Data:

Model Numbers-	MK I
Ship Class-	IX
Date Entering Service-	2/9002
Number Constructed	25

Hull Data:

Superstructure Points-	17
Damage Chart-	C
Size	
Length-	250 meters
Width-	120 meters
Height-	80 meters
Weight-	139,805 tons
Cargo	
Cargo Units-	10 units
Cargo Capacity-	500 tons
Landing Capability-	None

Equipment Data:

Control Computer Type-	M-7
Transporters-	
Standard 6-person-	2
Combat 20-person-	none
Emergency 22-person-	1
cargo, large-	1
cargo, small-	1

Other Data:

Crew-	85
Passengers-	15
Troops-	none
Shuttlecraft-	3

Engines and Power Data:

Total Power Units Available-	46
Movement Point Ratio-	4/1
Warp Engine Type-	FTWC-1
Number-	2
Power Units Available-	20
Stress Charts-	D/E
Maximum Safe Cruising Speed-	Warp 8
Emergency Speed-	Warp 9.9
Impulse Engine Type-	FIB-3
Power Units Available-	6

Weapons and Firing Data:

Beam Weapon Type-	FH-9
Number-	3 in two banks
Firing Arcs-	2f/p/s, 1a
Firing Chart-	N
Maximum Power-	6
Damage Modifiers	
+3	
+2	(1 - 7)
+1	(8 - 13)
Missile Weapon Type-	FP-7
Number-	3
Firing Arcs-	2f/p/s, 1a
Firing Chart-	R
Power To Arm-	1
Damage-	8

Shields Data:

Deflector Shield Type-	FSC
Shield Point Ratio-	1/3
Maximum Shield Power-	16

Defense Factor- 127.81

Weapon Damage Factor- 21.3

[<<<< GO BACK](#)

IMPORTANT NOTE:

It is entirely possible that you have surfed to this page from an internet portal and are now viewing this page without frames. **The STSSTCSMU&A is best viewed from within its own set of frames**, so [click here to jump to the main STSSTCSMU&A web page](#) and then [see the site as it was meant to be seen!](#)

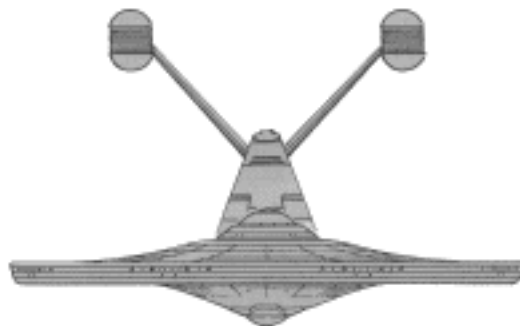
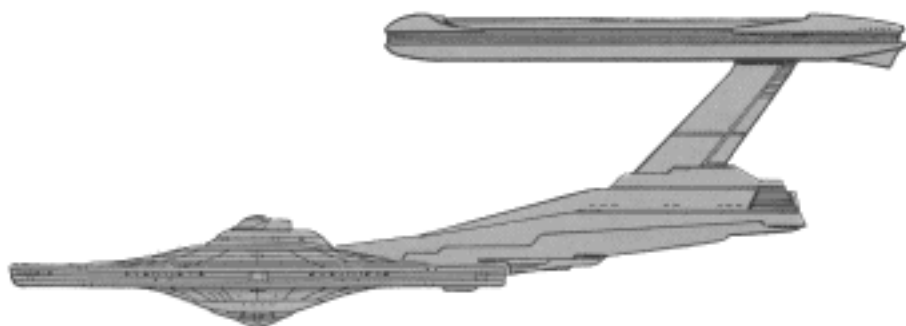
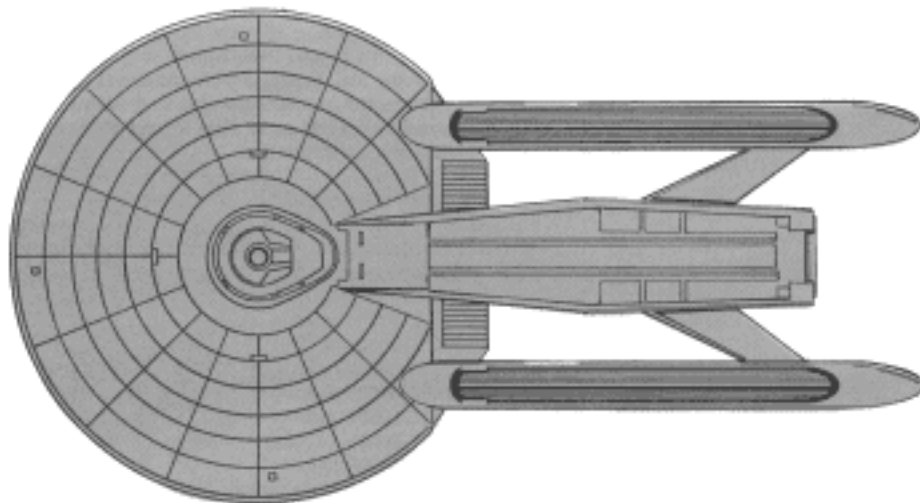

SCORPIO CLASS CORVETTE

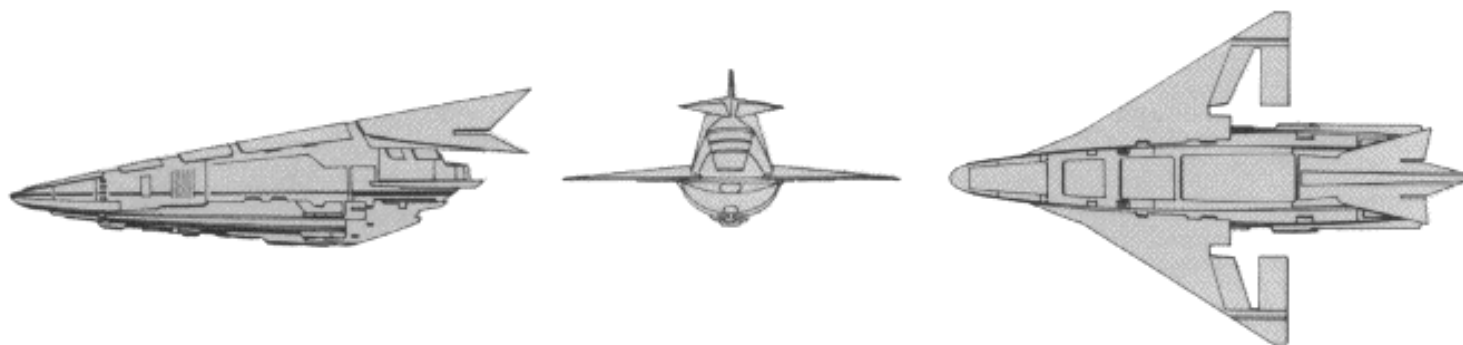

[Click here if you want to view this ship in its own window](#)

BRAD'S COMMENTS: Featured on the back cover of the UFP Recognition Manual, The closest thing the old FASA game had to a fighter, the Scorpio is a complete clay pigeon in game play. It has almost no power available to charge up its shields, has almost no superstructure, and its only weapon of value is a torpedo that inflicts a measly 6 points of damage. The description from the manual does have it right, though, you need to play these babies in numbers to have them amount to much. Even then, a relatively well-armed cruiser or frigate can dispatch them at will with one or two good hits per corvette. You could also try some midget combat scenarios, putting the Scorpio against similarly undersized and undergunned scouts and gunboats, but I've never found this to be much fun because even still, one good shot to the superstructure, and the Scorpio is toast.

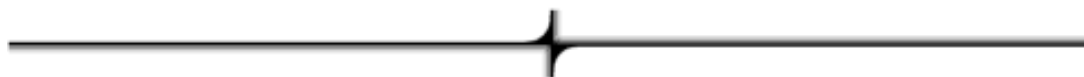

From the FASA Star Trek FEDERATION SHIP RECOGNITION MANUAL, circa 1985

Makin Class VII Assault Ship

NOTES: The Scorpio Class corvettes have been commissioned to supplement Star Fleet's monitors, most of which are restricted to in-system or near-base patrols because of their sub-light engines. The Scorpio Class is lightweight and warp-capable, thus extending the defensive range of the bases or systems that require protection. These small ships are expected to improve the overall defensive posture of the UFP by allowing capital ships to operate for longer periods in sensitive areas.

The corvettes are organized into groups consisting of 12 ships operating in 3 flights of 4 ships each. At the present time, there are 15 operational groups with plans for an additional 45. The operational groups are assigned as follows: The 1st, 2nd and 5th Pursuit Groups at Starbase 10; the 3rd, 6th and 7th Pursuit Groups at Starbase 12; the 4th, 8th, and 9th Pursuit Groups at Starbase 20; the 1st Andorian, 10th, and 11th Pursuit Groups at Starbase 27; the 2nd Andorian, and 12th Pursuit Groups at Starbase 15; and the 13th Pursuit Group at Starbase 14.

Though the original design for the Scorpio came from Andorian contractors, construction contracts were awarded to the shipyards at Morena and Salazaar, the latter being an Andorian-operated facility. Like so many Andorian designs, these vessels are made to close quickly with their enemies and deal crippling or fatal blows. The highly efficient FWA-1 warp engines allow the corvettes to rapidly surround an enemy vessel, causing it to divert power to an all-around defense, and therefore, weakening its offensive capability.

These ships carry only two FH-1 phasers and one FP-3 photon torpedo, but they are considered to have sufficient offensive power to deter pirates, smugglers, and small enemy warships from operating in their patrol areas.

The Morena and Salazaar shipyards are currently producing approximately 180 Scorpio Class corvettes per year. Of the 192 ships built, 180 remain in active service, and 12 are assigned to Star Fleet Training Command.

Construction Data:

Model Numbers-	MK I
Ship Class-	II
Date Entering Service-	2/2206
Number Constructed	192

Hull Data:

Superstructure Points-	3
Damage Chart-	C
Size	
Length-	22 meters
Width-	7 meters
Height-	7 meters
Weight-	8,240 tons
Cargo	
Cargo Units-	1 unit
Cargo Capacity-	50 tons
Landing Capability-	Yes

Equipment Data:

Control Computer Type-	L-13
Transporters-	
Standard 6-person-	1
Combat 20-person-	None
Emergency 22-person-	None
cargo small-	None
cargo large-	None

Other Data:

Crew-	4
Troops-	None
Shuttlecraft-	None

Engines and Power Data:

Total Power Units Available-	7
Movement Point Ratio-	1/3
Warp Engine Type-	FWA-1
Number-	1
Power Units Available-	6
Stress Charts-	F/G
Maximum Safe Cruising Speed-	Warp 7
Emergency Speed-	Warp 9
Impulse Engine Type-	FIA-1
Power Units Available-	1

Weapons and Firing Data:

Beam Weapon Type-	FH-1
Number-	2
Firing Arcs-	2f/p/s
Firing Chart-	F
Maximum Power-	2
Damage Modifiers	
+3	None
+2	None
+1	None
Missile Weapon Type-	FP-3
Number-	1
Firing Arcs-	F
Firing Chart-	D
Power To Arm-	1
Damage-	6

Shields Data:

Deflector Shield Type-	FSB
Shield Point Ratio-	1/2
Maximum Shield Power-	11

Defense Factor- 81.2**Weapon Damage Factor-** 2.2

IMPORTANT NOTE:

It is entirely possible that you have surfed to this page from an internet portal and are now viewing this page without frames. **The STSSTCSMU&A is best viewed from within its own set of frames**, so [click here to jump to the main STSSTCSMU&A web page](#) and then [see the site as it was meant to be seen!](#)

EPSILON CLASS CUTTER

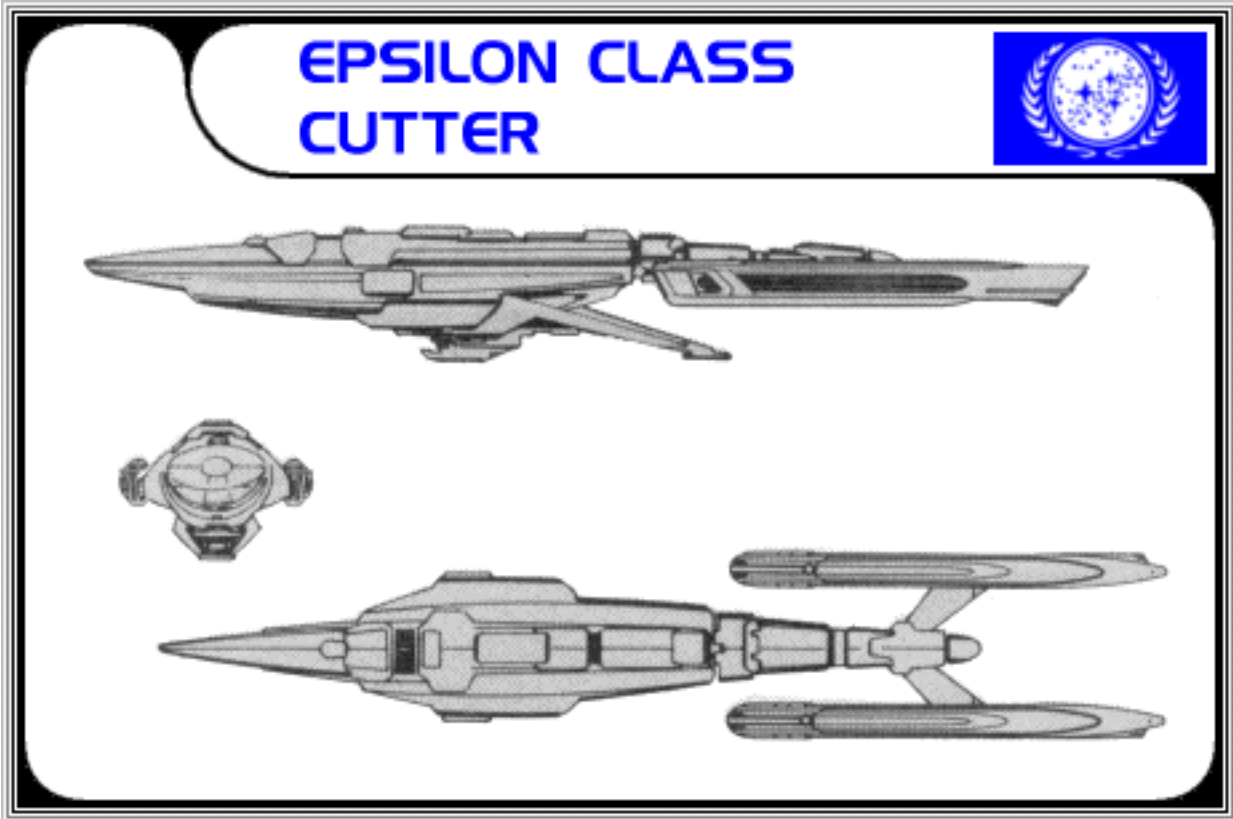

[Click here to view this ship in its own window](#)

BRAD'S COMMENTS: Undergunned and lacking hitting power, the cutter class(es) are not really much good in a real fight. I have only found them to be playable during midget wars, pitted against other dinky vessels. Of course, since cutters are mainly defensive weapons against pirates and criminals and such, it seems unlikely a Federation cutter would ever fight a Klingon gunboat, though I have tried this. It's an interesting exercise.



From the **FASA Star Trek FEDERATION SHIP RECOGNITION MANUAL**, circa 1985

Epsilon Class III-IV Cutter

NOTES: Of the 805 Epsilons built, 363 Mk Is and 266 Mk IIs remain in active service, with 16 Mk Is and 8 Mk IIs in reserve fleets; 4 Mk Is and 2 Mk IIs are used by Star Fleet Training Command; 87 Mk Is and 41 Mk IIs have been destroyed, 4 Mk Is disappeared along the Triangle border, and 2 Mk Is disappeared on the Rimward frontier; 2 Mk Is and 4 Mk IIs have been scrapped, and 6 Mk Is have been sold to civilian commercial interests. The Epsilon Class cutters are produced at the Morena, Salazaar, and Merak shipyards at a combined rate of 18 per year.

Construction Data:

Model Numbers-	MK I	MK II
Ship Class-	III	IV
Date Entering Service-	2/1104	2/1412
Number Constructed	461	344

Hull Data:

Superstructure Points-	7	9
Damage Chart-	C	C
Size		
Length-	96 meters	96 meters
Width-	18 meters	18 meters
Height-	12 meters	12 meters
Weight-	17,925 tons	25,975 tons
Cargo		
Cargo Units-	5 unit	5 unit
Cargo Capacity-	2 50 tons	250 tons
Landing Capability-	Yes	Yes

Equipment Data:

Control Computer Type-	L-14	L-14
Transporters-		
Standard 6-person-	1	1
Combat 20-person-	1	1
Emergency 22-person-	None	None
cargo small-	1	1
cargo large-	None	None

Other Data:

Crew-	25	28
Troops-	10	10
Passengers-	10	10
Shuttlecraft-	None	None

Engines and Power Data:

Total Power Units Available-	18	26
Movement Point Ratio-	2/1	3/1
Warp Engine Type-	FWA-2	FWH-1
Number-	2	2
Power Units Available-	8	10
Stress Charts-	J/M	Q/R
Maximum Safe Cruising Speed-	Warp 6	Warp 5
Emergency Speed-	Warp 8	Warp 6
Impulse Engine Type-	FIB-1	FIB-3
Power Units Available-	2	6

Weapons and Firing Data:

Beam Weapon Type-	FH-6	FH-6
Number-	4 in two banks	4 in two banks
Firing Arcs-	2f/p, 2f/s	2f/p, 2f/s
Firing Chart-	N	N
Maximum Power-	3	3
Damage Modifiers		
+3		
+2	(1 - 7)	(1 - 7)
+1	(8 - 13)	(8 - 13)

Shields Data:

Deflector Shield Type-	FSB	FSB
Shield Point Ratio-	1/2	1/2
Maximum Shield Power-	9	9

Defense Factor-
Weapon Damage Factor-

49
10

47.9
10

[<<<< GO BACK](#)

IMPORTANT NOTE:

It is entirely possible that you have surfed to this page from an internet portal and are now viewing this page without frames. **The STSSTCSMU&A is best viewed from within its own set of frames**, so [click here to jump to the main STSSTCSMU&A web page](#) and then [see the site as it was meant to be seen!](#)

SOLAR CLASS CUTTER

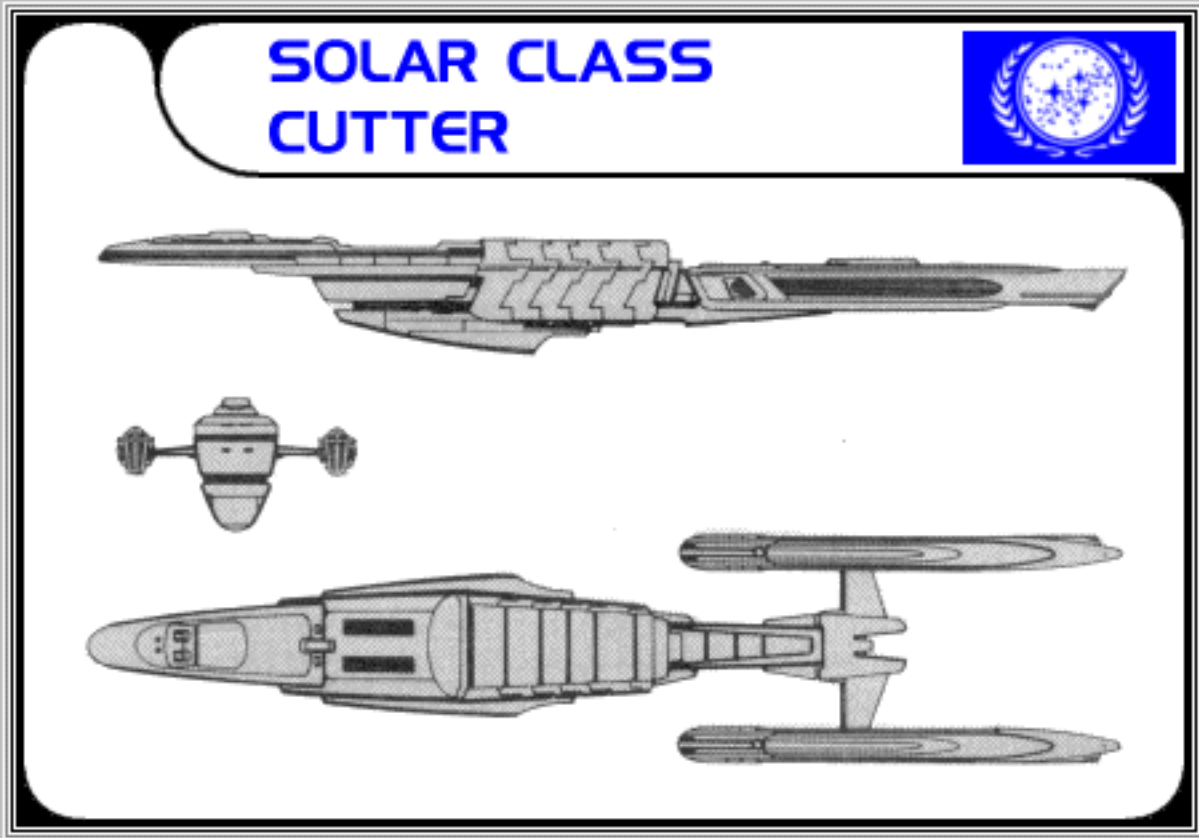

[Click here if you want to view this ship in its own window](#)

BRAD'S COMMENTS: Undergunned and lacking hitting power, the cutter class(es) are not really much good in a fight. I have only found them to be playable during midget wars, pitted against other dinky vessels. Of course, since cutters are mainly defensive weapons against pirates and criminal and such, it seems unlikely a Federation cutter would ever fight a Klingon gunboat, though I have tried this. It's an interesting exercise.



From the FASA Star Trek FEDERATION SHIP RECOGNITION MANUAL, circa 1985

Solar Class III Cutter

NOTES: Of the 1,297 Solar Class cutters built, 144 Mk IIIs and 524 Mk VIs remain in active service, with 196 Mk Is and 42 Mk IIIs in reserve fleets. Twenty-four Mk IIIs and 24 Mk VIs are used by Star Fleet Training Command; 79 Mk Is, 48 Mk IIIs, and 46 Mk VIs have been destroyed; 2 Mk Is, 1 Mk III and 3 Mk VIs are listed as missing; 16 Mk Is, 14 Mk IIIs, and 14 Mk VIs have been scrapped; and 81 Mk Is, 29 Mk IIIs, and 10 Mk VIs have been sold to civilian commercial concerns. The Solar class cutters are manufactured at the Salazaar and Alpha Centauri shipyards at a combined rate of 26 per year.

Construction Data:

Model Numbers-	MK I	MK III	MK VI
Ship Class-	III	III	III
Date Entering Service-	1/9805-2/1501	2/1010	2/1206
Number Constructed	588	410	621

Hull Data:

Superstructure Points-	6	7	8
Damage Chart-	C	C	C
Size			
Length-	90 meters	90 meters	90 meters
Width-	20 meters	20 meters	20 meters
Height-	12 meters	12 meters	12 meters
Weight-	17,100 tons	18,100 tons	20,400 tons
Cargo			
Cargo Units-	5 units	5 units	5 units
Cargo Capacity-	2 50 tons	2 50 tons	2 50 tons
Landing Capability-	Yes	Yes	Yes

Equipment Data:

Control Computer Type-	L-14	L-14	L-14
Transporters-			
Standard 6-person-	1	1	1
Combat 20-person-	1	1	1
Emergency 22-person-	None	None	None
cargo small-	1	1	1
cargo large-	None	None	None

Other Data:

Crew-	23	25	28
Troops-	10	10	10
Passengers-	6	6	6
Shuttlecraft-	None	None	None

Engines and Power Data:

Total Power Units Available-	15	19	19
Movement Point Ratio-	1/1	1/1	1/1
Warp Engine Type-	FWA-1	FWA-2	FWA-2
Number-	2	2	2
Power Units Available-	6	8	8
Stress Charts-	G/K	J/M	J/M
Maximum Safe Cruising Speed-	Warp 7	Warp 7	Warp 7
Emergency Speed-	Warp 9	Warp 9	Warp 9
Impulse Engine Type-	FIA-3	FIA-3	FIA-3
Power Units Available-	3	3	3

Weapons and Firing Data:

Beam Weapon Type-	FH-1	FH-1	FH-2
Number-	6 in three banks	6 in three banks	6 in three banks
Firing Arcs-	2f/p, 2f/s, 2f	2f/p, 2f/s, 2f	2f/p, 2f/s, 2f
Firing Chart-	F	F	H
Maximum Power-	2	2	3
Damage Modifiers			
+3	-	-	
+2	-	-	
+1	-	-	(1 - 10)

Shields Data:

Deflector Shield Type-	FSB	FSB	FSB
Shield Point Ratio-	1/2	1/2	1/2
Maximum Shield Power-	11	11	11

Defense Factor-
Weapon Damage Factor-

66.6
3.0

80.6
3.0

80.6
7.8

[<<<< GO BACK](#)

IMPORTANT NOTE:

It is entirely possible that you have surfed to this page from an internet portal and are now viewing this page without frames. **The STSSTCSMU&A is best viewed from within its own set of frames**, so [click here to jump to the main STSSTCSMU&A web page](#) and then [see the site as it was meant to be seen!](#)

DANUBE CLASS RUNABOUT

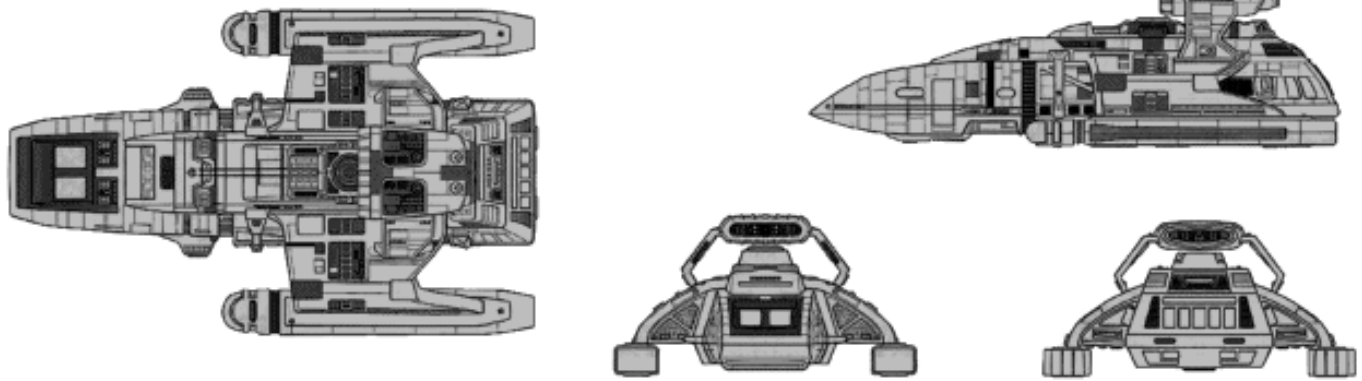

[Click here if you want to view this ship in its own window](#)

BRAD'S COMMENTS: The Danube Class did not appear until the debut of **ST:DS9**, where it would function as that series' primary starship type until the arrival of the prototype [Defiant](#). As ships go, the Danube is kind of hard to place. It's arguably the smallest operational Federation starship in the Starfleet inventory, being not much more than an oversized shuttlecraft with warp capability. It is also armed; always with phasers, but sometimes too with torpedoes when the "roll bar" weaponry pod is in place. It is this armament that distinguishes the Danube from being a mere warp shuttle, along with its sensor suite and science equipment. In many ways the Danube is in a category by itself, being an entirely new breed of ship that the Trek universe had never seen prior to **ST:DS9**. For the sake of coherency in the STSSTCS setting, however, I have decided to list the Danube with other ships of its size and capability: cutters and corvettes. The closest thing to the Danube that FASA ever came up with was the [Scorpio](#), which like the Danube is a micro-sized warp-capable ship with some degree of armament. When building stats for the Danube, I used the Scorpio as a starting point, assuming that the Danube is the 24th century answer to the 23rd century corvette.

Construction Data:

	MK I	MK II
Model Numbers-	I	I
Ship Class-		
Date Entering Service-	2369 A.D.	2369 A.D.
Number Constructed	unknown	unknown

Hull Data:

Superstructure Points-	8	8
Damage Chart-	A	A
Size		
Length-	23 meters	23 meters
Width-	13 meters	13 meters
Height-	5.5 meters	5.5 meters
Weight-	(classified)	(classified)
Cargo		
Cargo Units-	1 unit	1 unit
Cargo Capacity-	50 tons	50 tons
Landing Capability-	Yes	Yes

Equipment Data:

Control Computer Type-	DCAX-2	DCAX-2
Transporters-		
Standard 2-person-	1	1

Other Data:

Crew-	2 minimum	2 minimum
Passengers-	optional	optional
Max Compliment-	25 total	25 total
Shuttlecraft-	none	none

Engines and Power Data:

Total Power Units Available-	32	36
Movement Point Ratio-	1/2	1/2
Warp Engine Type-	FXMW-1	FXMW-1
Number-	2	2
Power Units Available-	12	12
Stress Charts-	C/D	C/D
Maximum Safe Cruising Speed-	Warp 6	Warp 6
Emergency Speed-	Warp 7.9	Warp 7.9
Impulse Engine Type-	FNIS-010	FNIS-040
Power Units Available-	8	12

Weapons and Firing Data:

Beam Weapon Type-	FAHW-21	FAHW-24
Number-	2	2
Firing Arcs-	1f, 1a	1f, 1a
Firing Chart-	T	V
Maximum Power-	13	16
Damage Modifiers		
+3	(1 - 6)	(1 - 8)
+2	(7 - 14)	(9 - 15)
+1	(15 - 18)	(16 - 21)
Missile Weapon Type-	FP-11	
Number-	2	
Firing Arcs-	F	
Firing Chart-	U	
Power To Arm-	1	
Damage-	21	

Shields Data:

Deflector Shield Type-	NGSS-F	NGSS-F
Shield Point Ratio-	1/3	1/3
Maximum Shield Power-	21	21

Defense Factor-

(classified) (classified)

Weapon Damage Factor-

(classified) (classified)

[<<<< GO BACK](#)**IMPORTANT NOTE:**

It is entirely possible that you have surfed to this page from an internet portal and are now viewing this page without frames. **The STSSTCSMU&A is best viewed from within its own set of frames**, so [click here to jump to the main STSSTCSMU&A web page](#) and then [see the site as it was meant to be seen!](#)

NELSON CLASS SCOUT

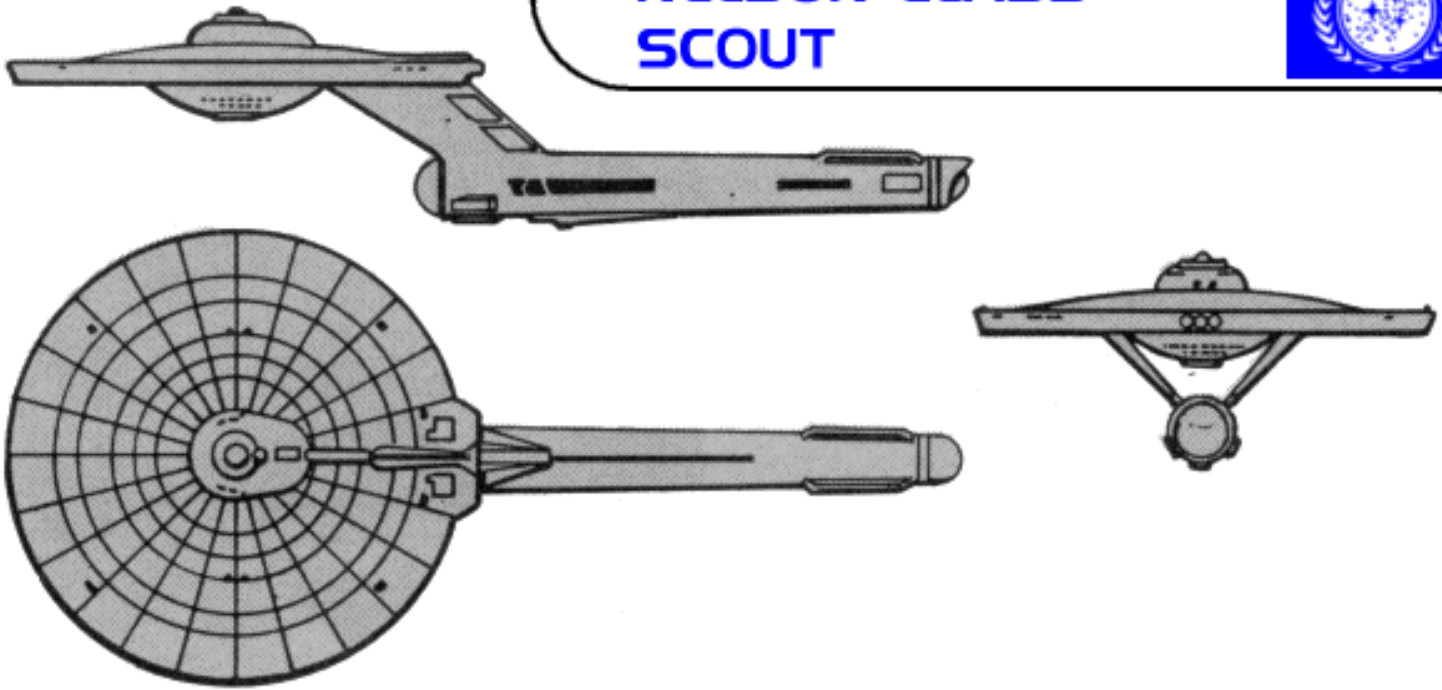

[Click here if you want to view this ship in its own window](#)

BRAD'S COMMENTS: The Nelson Class is an almost identical carbon copy of the [Saladin Class Destroyer](#) that was created by Franz Joseph for the old, beloved [Star Fleet Technical Manual](#). The only minor cosmetic changes that FASA did were to split the warp pylon into two diagonally-angled pieces and remove the deflector dish which was mounted on the ventral surface of the saucer. This to me smacks of FASA's **Battletech** franchise, specifically the designs of their Mechs. Many of those FASA Battletech Mechs were like the Nelson: carbon copy ripoffs of designs that originated from other sources. But where Battletech ripped off alternative SF franchises like **Robotech** (which was itself an Americanized amalgam of Japanese series like **Macross** and **Genesis Climber MOSPEADA**) the FASA people at least stuck to the same SF universe when they lifted the Nelson from Joseph's old 1970's book. What's more, the Nelson bears more than a little resemblance to [Durrett](#) and [Larson](#) Classes, both of which probably owe a great deal of their design influence to the original Saladin.

In terms of game play the Nelson is a pretty durable scout ship, especially the later models. I have always believed that this ship would have made a nice poor man's destroyer if only it had come equipped with a torpedo, but alas the Nelson is armed only with laser or phaser weaponry. Along with ships like the [Constitution](#), the Larson, the [Loknar](#), the [Federation](#), and the [Anton](#), the Nelson is

part of what I like to think of as the TOS Fleet. The ships of the TOS Fleet are all designs that employ the simplistic TOS-era design ethic, before the sleek industrial detailing of the [Constitution Refit](#) that we first see in **Star Trek: TMP**. The saucer sections all look the same, the warp nacelles all look the same, and we can probably assume that both of these parts were to scale on all of the ships.

During scenarios I will sometimes use one or more Nelsons as picket or vanguard ships on the leading edge of a larger Federation flotilla. Especially in an area where I believe there are cloaked Klingon or Romulan craft hiding. Using its sensors I will try and sniff out the cloaked enemy, or if I am playing a newer gamer sometimes he or she will take the bait and attack the Nelson Class decoys before my main Federation fleet arrives, thus spoiling the enemy

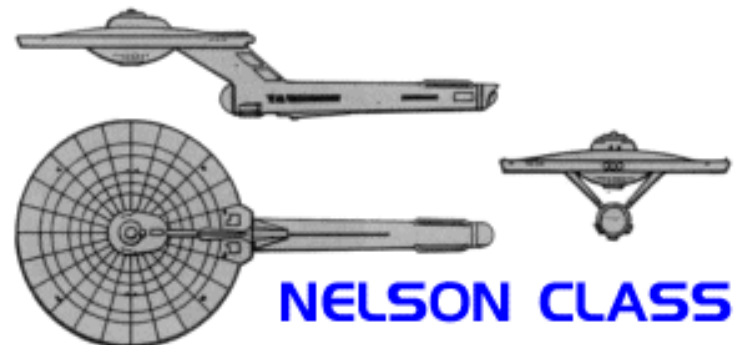
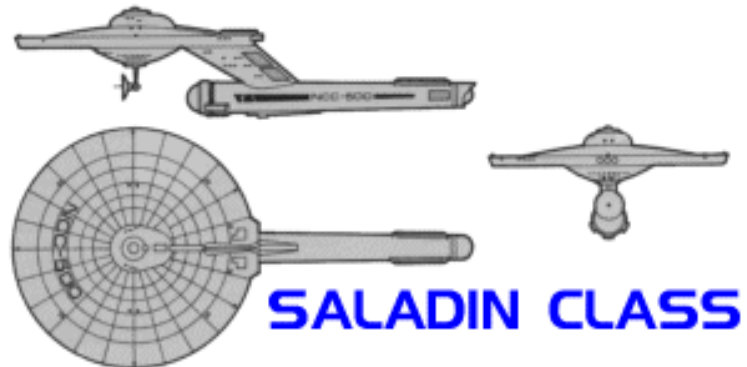

surprise attack without me having to put any of my larger Federation craft into the line of fire.

Ship to ship, later model Nelsons do okay against very early Romulan cruisers and some very early Klingon designs, but again the lack of a torpedo really hampers this class in terms of its offensive potency. Better to use the ship as an expendable decoy, which is what I usually end up doing.

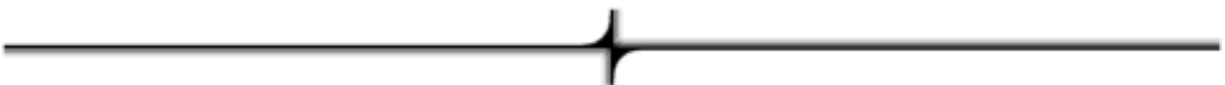

From the FASA Star Trek FEDERATION SHIP RECOGNITION MANUAL, circa 1985

Nelson Class VII Scout

NOTES: "The Great Awakening" was responsible for the addition of many ships to Star Fleet, not the least of which was the Nelson Class scout. This vessel shares many design features with the Constitution Class cruisers and the Larson Class destroyers, though it is not intended to act as a warship. The primary mission of the Nelson is to explore and map uncharted areas of space, to observe new civilizations and cultures, and, in some cases, to make initial contact. This has made the Nelson Class scout responsible for more contacts with alien cultures than any other vessel class in Star Fleet.

When introduced on Stardate 1/8804, the Nelson was the most modern vessel in the Galaxy Exploration Command; it would prove to be one of the finest ships of its day. It mounted the powerful FWC-1 warp engine and was capable of cruising at Warp 8 for up to two years at a time. The Mk I was not particularly maneuverable and relied on its emergency speed of Warp 9.9 to carry it to safety if it were attacked. Because of its mission, the Mk I mounted two forward-firing only, medium-power lasers, and the FSG shield generator, a single transducer system.

When phaser weapons were brought into the inventory, the Mk Is were refitted as they returned from their missions. At this same time, the impulse engines were replaced with the FIC-3 system, increasing the power output by 10%. Experiences during the Four Years War dictated an upgrade to the FSF shield generator, its binary transducer giving the same protection at half the power expenditure. By Stardate 2/0006 all Mk Is had been refit to Mk IIs.

On Stardate 2/0801 Star Fleet passed down the order to refit the Mk II vessels to the Mk III by installing FWC-2 warp engines, FH-7 phasers, and FSH shield generators. The change in the main engines would increase the overall power output by 30% and the maneuverability by 50% at the expense of the cruising and emergency speeds. FSH shield generators were installed for more protection, and, as an added defensive element, FH-7 phasers replaced the FH-2s. On Stardate 2/0806 the first of the refit Nelsons, the *USS Sager*, was put into service. In all, 114 of the Mk IIIs would be commissioned before the introduction of the Mk V.

The Mk IV mounted the FIE-2 impulse drive system. Only two of this model, the *USS Moisanen* and *USS Manzer*, ever entered service. Prior to their completion, the Mk IV design was changed and all other vessels under construction were altered to conform to this change. The *Moisanen* and *Manzer* were refit to the Mk V model within two years after their entry into service.

The Mk VII mounted the FH-8 phaser system and the FSN shield generators. A major change in the arrangement of the weapons was incorporated in the Mk VII. The earlier models mounted two phasers with separate fire control systems, which meant that both could be fired independently but they required more space and operating personnel. In the Mk V, the phasers were put into a bank and a single phaser was added to cover the aft quadrant. The FH-8s, being more sophisticated and having a longer range, required the M-2 computer system. The FSN shield generators increased the shielding protection by 20%.

Of the 273 Nelsons built, 88 Mk Vs remain in active service, with 14 Mk IIs, 12 Mk IIIs, and 8 Mk Vs in reserve fleets. One Mk V is used by Star Fleet Training Command, and 32 Mk Is, 11 Mk IIs, 8 Mk IIIs, and 3 Mk Vs have been destroyed. Four Mk Is were captured by the Klingons during the Four Years War; 16 Mk Is, 6 Mk IIs, 2 Mk IIIs, and 1 Mk V have been listed as missing; 8 Mk Is, 10 Mk IIs, 22 Mk IIIs, and 9 Mk Vs have been scrapped; and 4 Mk Is, 4 Mk IIs, 8 Mk IIIs, and 2 Mk Vs have been sold to civilian commercial concerns.

Construction Data:

Model Numbers-	MK I	MK II	MK V	MK VII
Ship Class-	VII	VII	VII	VII
Date Entering Service-	1/8804-2/0006	1/9702-2/1010	1/0806-2/1811	2/1602
Number Constructed	84	118	114	112

Hull Data:

Superstructure Points-	10	11	12	13
Damage Chart-	C	C	C	C
Size				
Length-	263 meters	263 meters	263 meters	270 meters
Width-	127 meters	127 meters	127 meters	127 meters
Height-	61 meters	61 meters	61 meters	61 meters
Weight-	79,700 tons	80,600 tons	82,300 tons	85,600 tons
Cargo				
Cargo Units-	45 units	45 units	45 units	45 units
Cargo Capacity-	2,250 tons	2,250 tons	2,250 tons	2,250 tons
Landing Capability-	None	None	None	None

Equipment Data:

Control Computer Type-	M-1	M-1	M-1	M-2
Transporters-				
Standard 6-person-	3	3	3	3
Emergency 22-person-	2	2	2	2
cargo-	1	1	1	1

Other Data:

Crew-	176	180	184	190
Passengers-	10	10	10	10
Shuttlecraft-	1	1	1	1

Engines and Power Data:

Total Power Units Available-	18	20	26	28
Movement Point Ratio-	3/1	3/1	2/1	2/1
Warp Engine Type-	FWC-1	FWC-1	FWC-2	FWC-2
Number-	1	1	1	1
Power Units Available-	14	14	20	20
Stress Charts-	N/L	N/L	M/K	M/K
Maximum Safe Cruising Speed-	Warp 8	Warp 8	Warp 7	Warp 7
Emergency Speed-	Warp 9.9	Warp 9.9	Warp 9	Warp 9
Impulse Engine Type-	FIB-2	FIC-3	FIC-3	FIE-2
Power Units Available-	4	6	6	8

Weapons and Firing Data:

Beam Weapon Type-	FL-3	FH-2	FH-7	FH-8
Number-	2 in one bank	2 in one bank	2 in one bank	3 in two banks
Firing Arcs-	F	2f/p/s	2f/p/s	2f/p/s, 1a
Firing Chart-	G	H	Q	T
Maximum Power-	2	3	4	5
Damage Modifiers				
+3				
+2			(1 - 8)	(1 - 10)
+1	(1 - 4)	(1 - 10)	(9 - 14)	(11 - 18)

Shields Data:

Deflector Shield Type-	FSG	FSF	FSH	FSN
Shield Point Ratio-	1/1	1/2	1/2	1/2
Maximum Shield Power-	10	10	13	16

Defense Factor-

37.3

49.8

73.2

82.6

Weapon Damage Factor-

1.4

2.6

6.4

12.9

IMPORTANT NOTE:

It is entirely possible that you have surfed to this page from an internet portal and are now viewing this page without frames. **The STSSTCSMU&A is best viewed from within its own set of frames**, so [click here to jump to the main STSSTCSMU&A web page](#) and then [see the site as it was meant to be seen!](#)

BADER CLASS SCOUT

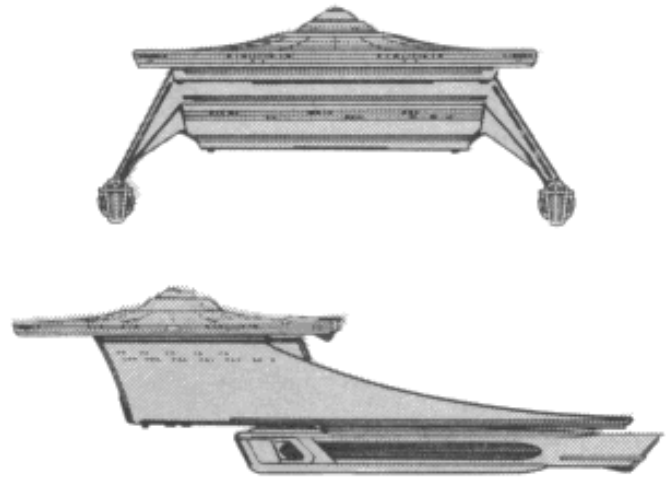
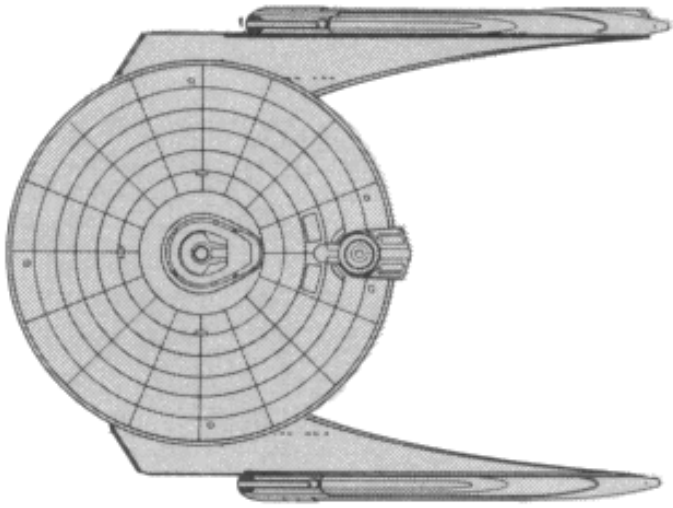

[Click here if you want to view this ship in its own window](#)

BRAD'S COMMENTS: I admit, I never played this class. Un ugly little scout with a weird design that I never liked. What is up with those warp pylons and that boxy "thing" slung beneath the saucer? Is that supposed to be engineering? Who knows. Anyway, like I said, I never played it, so I don't have any comments on it, other than that I think it's a dog. (Okay, I will say one thing: I like that there is a nod in the backstory to [Carl Sagan](#), in the form of the Sagan Award. I am a big fan of Carl Sagan and own his famed COSMOS series on DVD. Carl, we miss you!)



From the FASA Star Trek FEDERATION SHIP RECOGNITION MANUAL, circa 1985

Bader Class VIII Scout

NOTES: Shortly after the Organian Treaty had been imposed, Star Fleet began a buildup of its research ships. Contracts were let out for ships with limited combat ability and extensive research facilities. The most famous of those commissioned was the Bader. Although classified and armed as a scout because of its military role, it was in all respects a research vessel. The research facilities aboard the Bader were the most extensive of any on a Star Fleet vessel until the Gagarin Class research vessel entered service.

The *USS Bader*, *USS Clifton*, and *USS Tombaugh* are the research vessels awarded to the winner of the coveted Sagan Award for research contributing to the advancement of Federation science. Every year, each of the three research teams that win the award is given one of these vessels for two years, fully equipped to perform whatever studies and research the teams wish. This has made the Bader Class a popular and easily-recognized vessel throughout the scientific community.

In its military role, the Bader is not quite as exciting. The warp engines are not as efficient as those mounted on other scouts, and the vessels are not as maneuverable. Due to the displacement of the Bader, this deficiency cannot be corrected. Attempts have been made to increase the impulse drive power, but even this has not brought the performance level up to that of other scouts. Furthermore, compared to other scout vessels, the Bader is undergunned, mounting only 4 phasers. The Bader is the only modern scout that does not mount photon torpedo tubes. For these reasons, the Bader is not popular among the crews assigned to the borders of the other major powers.

Of the 164 Baders built, 117 Mk IIs and 15 Vs remain in active service, with 4 Mk IIs in reserve fleets. Five Mk Is, 6 Mk IIs, and 1 Mk V have been destroyed; 4 Mk Is and 2 Mk IIs are listed as missing; 2 Mk IIs have been scrapped; and 4 Mk Is and 2 Mk IIs have been sold to private commercial concerns. The Bader is produced at the Sol V shipyards at a combined rate of 4 per year.

Construction Data:

Model Numbers-	MK I	MK II	MK V
Ship Class-	VIII	VIII	VIII
Date Entering Service-	2/1208-2/2004	2/1410	2/2202
Number Constructed	81	135	16

Hull Data:			
Superstructure Points-	16	16	16
Damage Chart-	C	C	C
Size			
Length-	232 meters	232 meters	232 meters
Width-	180 meters	180 meters	180 meters
Height-	80 meters	80 meters	80 meters
Weight-	109,920 tons	110,100 tons	109,900 tons
Cargo			
Cargo Units-	510 unit	600 unit	600 unit
Cargo Capacity-	25,500 tons	30,000 tons	30,000 tons
Landing Capability-	None	None	None

Equipment Data:			
Control Computer Type-	M-2	M-2	M-2
Transporters-			
Standard 6-person-	3	3	3
Combat 20-person-	None	None	None
Emergency 22-person-	2	2	2
cargo small-	2	2	2
cargo large-	1	1	1

Other Data:			
Crew-	160	166	166
Passengers-	30	30	30
Shuttlecraft-	4	4	4

Engines and Power Data:			
Total Power Units Available-	30	34	38
Movement Point Ratio-	3/1	3/1	3/1
Warp Engine Type-	FWE-2	FWE-2	FWE-2
Number-	2	2	2
Power Units Available-	13	13	13
Stress Charts-	G/K	G/K	G/K
Maximum Safe Cruising Speed-	Warp 7	Warp 7	Warp 7
Emergency Speed-	Warp 9	Warp 9	Warp 9
Impulse Engine Type-	FID-2	FIE-2	FIF-2
Power Units Available-	4	8	12

Weapons and Firing Data:			
Beam Weapon Type-	FH-4	FH-7	FH-12
Number-	4 in two banks	4 in two banks	4 in two banks
Firing Arcs-	2f/p, 2f/s	2f/p, 2f/s	2f/p, 2f/s
Firing Chart-	Q	Q	R
Maximum Power-	3	4	6
Damage Modifiers			
+3			
+2			(1 - 9)
+1	(1 - 8)	(1 - 8)	(10 - 16)
	(9 - 14)	(9 - 14)	

Shields Data:			
Deflector Shield Type-	FSH	FSH	FSH
Shield Point Ratio-	1/2	1/2	1/2
Maximum Shield Power-	12	12	12

Defense Factor-	68.9	72.9	76.9
Weapon Damage Factor-	10.2	12.8	19.9

[<<<< GO BACK](#)

IMPORTANT NOTE:

It is entirely possible that you have surfed to this page from an internet portal and are now viewing this page without frames. **The STSSTCSMU&A is best viewed from within its own set of frames**, so [click here to jump to the main](#)

[STSSTCSMU&A web page](#) and then [see the site as it was meant to be seen!](#)

KEITH CLASS SCOUT

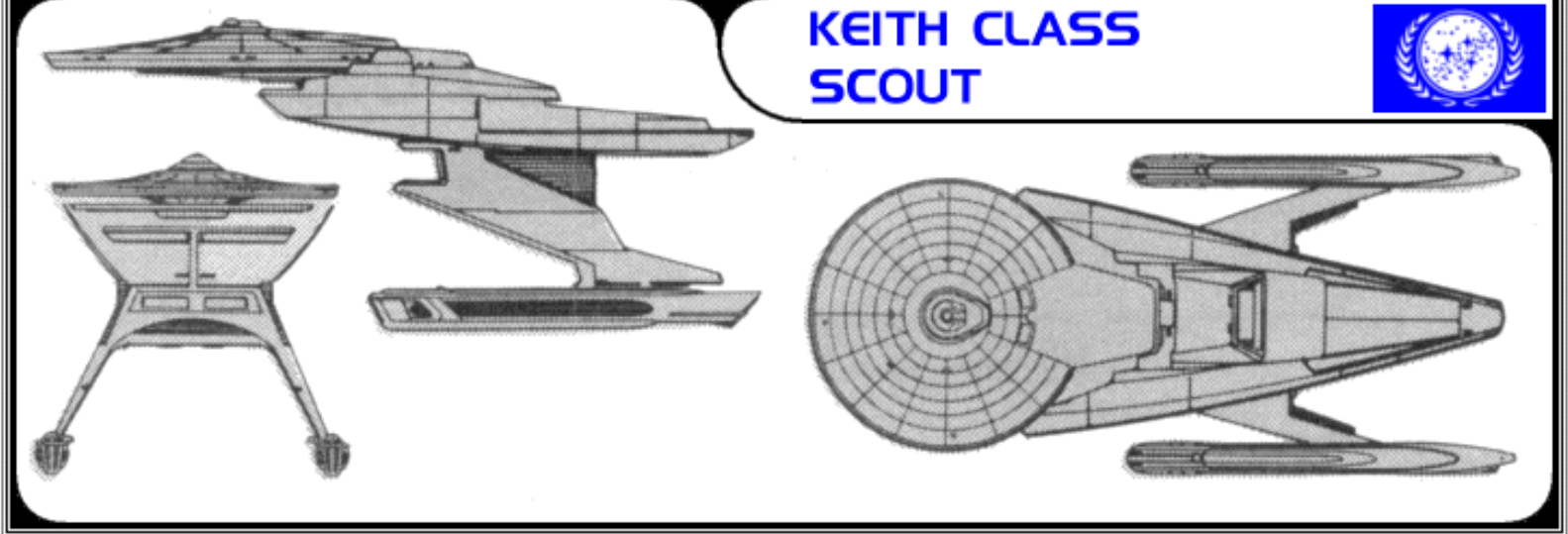

[Click here if you want to view this ship in its own window](#)

BRAD'S COMMENTS: Another one of those whacked out "small" ships that actually looks bigger than the Enterprise herself! If the saucer and nacelles on this design were to scale with the [Constitution Refit](#), then this ship would be quite large and outweigh even the larger Federation cruisers. And how come the secondary hull has to drop *down* so far? The ship ends up being at least as tall as it is long; not very sleek nor sexy in my book. For this reason I have rarely used this class, though it does have the benefit of being fairly well armed for a small ship.



From the FASA Star Trek FEDERATION SHIP RECOGNITION MANUAL, circa 1985

Keith Class VI Scout

Notes: Of the 202 Keith Class scouts built, 54 Mk IIIs remain in active service, with 101 Mk Is in reserve fleets. One Mk III is used by Star Fleet Training Command; 16 Mk Is and 4 Mk IIIs have been destroyed; B Mk Is and 2 Mk IIIs are listed as missing (both Mk IIIs in the Triangle area); 12 Mk Is have been scrapped; and 4 Mk Is have been sold to civilian commercial concerns. The Keith Class scouts are produced at the Salazaar and Proxima Centauri shipyards at a combined rate of 8 per year.

Construction Data:

Model Numbers-	MK I	MK III
Ship Class-	VI	VI
Date Entering Service-	2/0405-2/2001	2/1603
Number Constructed	172	61

Hull Data:

Superstructure Points-	14	15
Damage Chart-	C	C
Size		
Length-	180 meters	180 meters
Width-	80 meters	80 meters
Height-	80 meters	80 meters
Weight-	61,595 tons	63,535 tons
Cargo		
Cargo Units-	400 units	400 units
Cargo Capacity-	20,000 tons	20,000 tons
Landing Capability-	none	none

Equipment Data:

Control Computer Type-	M-1	M-1
Transporters-		
Standard 6-person-	3	3
Emergency 22-person-	1	1
cargo small -	2	2
cargo large -	1	1

Other Data:

Crew-	96	100
Troops-	none	none
Passengers-	20	20
Shuttlecraft-	2	2

Engines and Power Data:

Total Power Units Available-	30	34
Movement Point Ratio-	2/1	2/1
Warp Engine Type-	FWB-2	FWB-2
Number-	2	2
Power Units Available-	14	14
Stress Charts-	M/O	M/O
Maximum Safe Cruising Speed-	Warp 8	Warp 8
Emergency Speed-	Warp 9	Warp 9
Impulse Engine Type-	FIB-1	FIB-3
Power Units Available-	2	6

Weapons and Firing Data:

Beam Weapon Type-	FH-6	FH-4
Number-	4, in two banks	4, in two banks
Firing Arcs-	2f/p, 2f/s	2f/p, 2f/s
Firing Chart-	N	Q
Maximum Power-	3	3
Damage Modifiers		
+3		
+2	(1 - 7)	(1 - 8)
+1	(8 - 13)	(9 - 14)
Missile Weapon Type-	FP-2	FP-1
Number-	1	1
Firing Arcs-	F	F
Firing Chart-	H	L
Power To Arm-	1	1
Damage-	6	10

Shields Data:

Deflector Shield Type-	FSD	FSF
Shield Point Ratio-	1/2	1/2
Maximum Shield Power-	7	10

Defense Factor-	76.0	83.5
Weapon Damage Factor-	11.2	14.8

[<<<< GO BACK](#)

IMPORTANT NOTE:

It is entirely possible that you have surfed to this page from an internet portal and are now viewing this page without frames. **The STSSTCSMU&A is best viewed from within its own set of frames**, so [click here to jump to the main STSSTCSMU&A web page](#) and then [see the site as it was meant to be seen!](#)

MOSCOW CLASS SCOUT

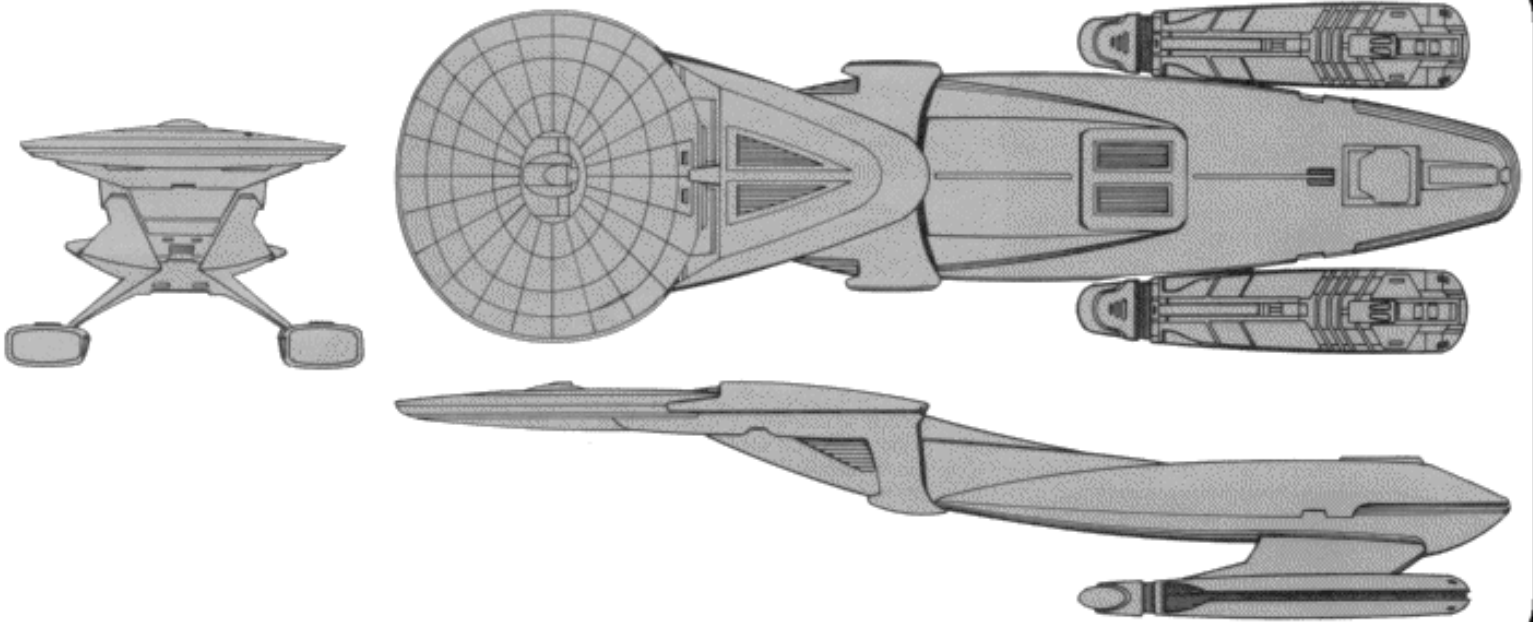

[Click here if you want to view this ship in its own window](#)

BRAD'S COMMENTS: It's ironic that the Moscow Class scout is a better fighting ship than the [Paine Class frigate](#) of the same era. Overall, the Moscow has more power, better weapons, and at least equal the amount of superstructure compared to the Paine. As heavy scouts go, the Moscow is the 24th century equivalent of many 23rd century cruisers and frigates, with multiple torpedoes and phasers in both the forward and the aft arcs. Like many of FASA's Federation ships from the TNG Officer's Manual, the Moscow is an attempt to emulate the swooping, organic look of the [Galaxy Class](#) supercruiser. I'm not sure it's a very good attempt, as I believe the saucer section is too small and I do not like the overall shape of the secondary hull. Just the same, on paper, the Moscow is well designed and plays nicely in many scenarios.

Construction Data:

Model Numbers-	MK I
Ship Class-	IX
Date Entering Service-	2/9004
Number Constructed	22

Hull Data:

Superstructure Points-	17
Damage Chart-	C
Size	
Length-	155 meters
Width-	45 meters
Height-	35 meters
Weight-	123,193 tons
Cargo	
Cargo Units-	50 units
Cargo Capacity-	2,500 tons
Landing Capability-	none

Equipment Data:

Control Computer Type-	M-7
Transporters-	
Standard 6-person-	2
Emergency 22-person-	2
cargo small -	1
cargo large -	1

Other Data:

Crew-	45
Troops-	none
Passengers-	5
Shuttlecraft-	2

Engines and Power Data:

Total Power Units Available-	64
Movement Point Ratio-	6/1
Warp Engine Type-	FTW-?
Number-	2
Power Units Available-	26
Stress Charts-	D/F
Maximum Safe Cruising Speed-	Warp 8
Emergency Speed-	Warp 9.9
Impulse Engine Type-	FIF-1
Power Units Available-	12

Weapons and Firing Data:

Beam Weapon Type-	FH-8
Number-	4 in three banks
Firing Arcs-	2f/p/s, 1a/s, 1a/p
Firing Chart-	T
Maximum Power-	5
Damage Modifiers	
+3	
+2	(1 - 10)
+1	(11 - 18)
Missile Weapon Type-	FP-7
Number-	4 in two bays
Firing Arcs-	2f/p/s, 2a/p/s
Firing Chart-	R
Power To Arm-	1
Damage-	8

Shields Data:

Deflector Shield Type-	FSN
Shield Point Ratio-	1/2
Maximum Shield Power-	16

Defense Factor- 71.31

Weapon Damage Factor- 36.4

[<<<< GO BACK](#)

IMPORTANT NOTE:

It is entirely possible that you have surfed to this page from an internet portal and are now viewing this page without frames. **The STSSTCSMU&A is best viewed from within its own set of frames**, so [click here to jump to the main STSSTCSMU&A web page](#) and then [see the site as it was meant to be seen!](#)

CLARK CLASS SCOUT

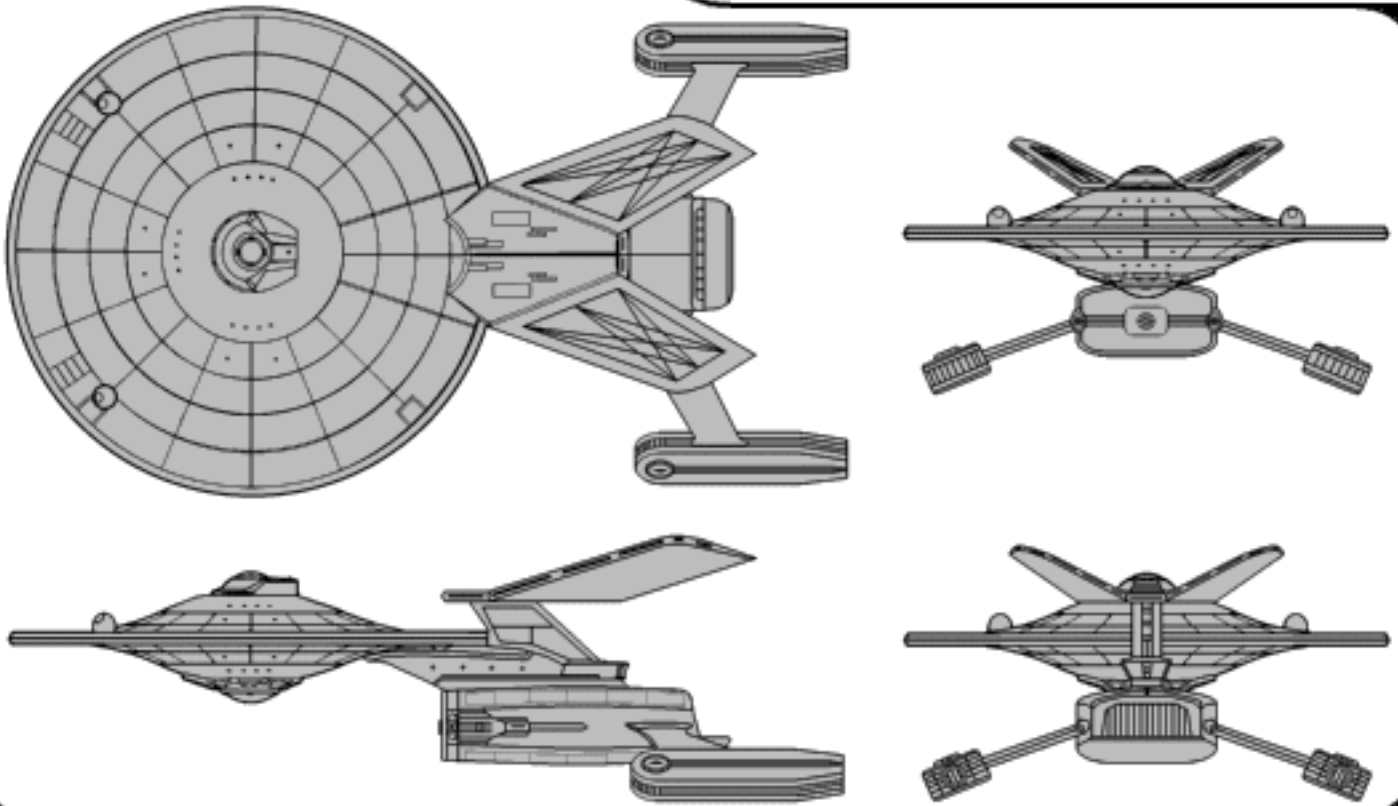

[Click here if you want to view this ship in its own window](#)

BRAD'S COMMENTS: Another solid design from Glenn. I liked the fact that, while the saucer is still recognizable as being based on the [Constitution Refit](#) hull, the rest of the ship is 100% original, right down to the unique warp nacelles. Glenn tells me this ship is based on another model he built, though he was unable to send a picture of the model itself as it is not finished yet.



FANSHIP DESIGN & STATS: [Glenn Gagnon](#), 2002

Clark Class VI Scout

NOTES: With the shocking revelation of a Klingon D-32 that was capable of weapon firing during cloaked operations, the strategists at Starfleet Command were knocked for a loop. Although the Khitomer Conference was--miraculously--a success, the Pandora's box of enhanced cloak technology was opened. With the fear that more of this type of vessel might be seen within the Klingon sphere of influence, it was deemed to be of the highest importance that recently-improved sensing technology be deployed on new starships, especially those that patrolled near Klingon, Triangle, and Romulan spaces.

The Clark-class scout incorporates the first-generation of that technology, along to improvements in warp and impulse drive systems. The primary sensors are a differential-based asymmetric passive platform combined with enhanced gravimetrically-targeted active scanners. The warp-drive nacelles take advantage of the miniaturization of some older, yet still reliable, drive systems. The Clark-class is manufactured at the Sol V and

Proxima Centauri shipyards, and is named for William Clark, a Terran explorer from Earth's 18th century.

The Clark-class scout U.S.S. Ceres became effective bait in a sting to draw out rebellious Klingon vessels from the IKS. The scout would cruise in or near the Triangle border and actively scan for cloaked ships. Once the Ceres found them, they would hail the cloaked ships and announce that they were in violation of the Khitomer Accords. The Klingons, seeing that they outgunned the lone scout, would attack, and the Ceres would jump to warp. They would be drawn along on the chase until they arrived at a small, non-descript nebula near Starbase 10. Once they were in range, the Klingons would be surprised by a force consisting of one Constellation-class cruiser and two Wilkerson-class destroyers. This operation netted about a dozen IKS ships before the IKS got the idea and didn't try to take the bait anymore.

Of the 38 Clark-class vessels commissioned, 27 are used by Galaxy Exploration Command, five are utilized by Starfleet Intelligence, three are assigned to Starfleet Training Command, two have been destroyed, and one has been declared lost.

Construction Data:

Model Numbers-	MK I
Ship Class-	VI
Date Entering Service-	2294 A.D.
Number Constructed	38

Hull Data:

Superstructure Points-	32
Damage Chart-	C
Size	
Length-	180 meters
Width-	105 meters
Height-	50 meters
Weight-	76,000 tons
Cargo	
Cargo Units-	250 units
Cargo Capacity-	12,500 tons
Landing Capability-	None

Equipment Data:

Control Computer Type-	M-4A
Transporters-	
Standard 6-person-	3
Combat 20-person-	none
Emergency 22-person-	2
cargo large-	1
cargo small-	2

Other Data:

Crew-	265
Passengers-	20
Shuttlecraft-	8

Engines and Power Data:

Total Power Units Available-	36
Movement Point Ratio-	2/1
Warp Engine Type-	FWB-2B
Number-	2
Power Units Available-	15
Stress Charts-	J/L
Maximum Safe Cruising Speed-	Warp 8
Emergency Speed-	Warp 9.9
Impulse Engine Type-	FIB-3A
Power Units Available-	6

Weapons and Firing Data:

Beam Weapon Type-	FH-3
Number-	3 in three banks
Firing Arcs-	1f/p, 1f, 1f/s
Firing Chart-	W
Maximum Power-	5
Damage Modifiers	
+3	(1 - 10)
+2	(11 - 17)
+1	(18 - 20)
Missile Weapon Type-	FP-1
Number-	1
Firing Arcs-	F
Firing Chart-	H
Power To Arm-	1
Damage-	6

Shields Data:

Deflector Shield Type-	FSF
Shield Point Ratio-	1/2
Maximum Shield Power-	10

Defense Factor- (classified)

Weapon Damage Factor- (classified)

SPECIAL RULES FOR THIS SHIP

- 1 to hit moving cloaked ship (-2 for any other craft allied with this vessel).
- 3 to hit stationary cloaked ship (-4 for any other craft allied with this vessel).
- Ship still has to declare a shield facing to scan, but scans are always ruled successful if a cloaked ship is in that arc.

[<<<< GO BACK](#)

IMPORTANT NOTE:

It is entirely possible that you have surfed to this page from an internet portal and are now viewing this page without frames. **The STSSTCSMU&A is best viewed from within its own set of frames**, so [click here to jump to the main STSSTCSMU&A web page](#) and then [see the site as it was meant to be seen!](#)

SCYLLA CLASS SCOUT

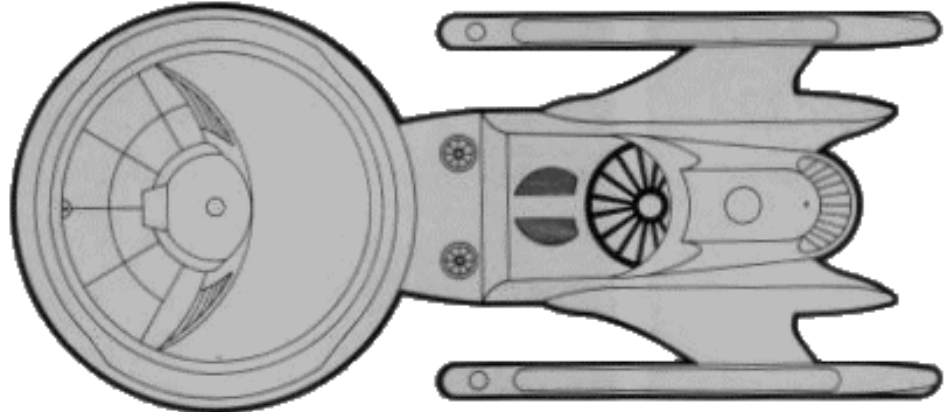
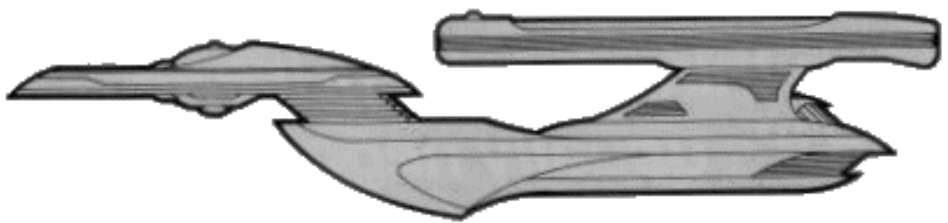

[Click here if you want to view this ship in its own window](#)

BRAD'S COMMENTS: This is a rare class that was not included in the FASA Ship Recognition Manuals. Many thanks to [Gary Perry](#) for digging it up out of the old, now-defunct Star Trek Stardate Magazine (once officially endorsed by FASA). This class is but one of several such ships that Gary has kindly submitted to the MU&A, almost all of which came under the Stardate Magazine header "Jaynz Ships of the Galaxy", an obvious nod to the real [Janes](#) military hardware information service.



From STARDATE MAGAZINE, courtesy of contributor [Gary Perry](#)

Class design by J.M. Kuzee and Pete Rogan

Scylla Class VI Scout

NOTES: When the radically-new design for the Excelsior class battleship was proposed to Star Fleet, there was no doubt in Procurement about the entire design. Not only were the proposed trans-warp engines an unknown quantity, but the controls and engineering spaces, the wiring and the layout of the vessel itself were very new. Star Fleet was unwilling to commit the funds to construction until some of the uncertainty had been dispelled.

An engineering "testbed" vehicle, incorporating as much of the Excelsior's new features--minus the engines--was therefore proposed for full testing. Only a quarter of the battleship's displacement, it would nonetheless simulate all the calculated stresses and include all the intended equipment, and it could be constructed in less than a year. Construction was at the Sol IV shipyards, under the code designation 'Scylla'. (Rumor says that Project 'Charybdis' was the trans-warp development program, but there is no proof.)

The new design proved exceptionally sound and very serviceable, and did everything the engineers wished, including showing some minor faults and design errors that could have shown up on the battleship. All were found and corrected, and a few that could have crept in when the full-size Excelsior was constructed. The 'Scylla' project, in fact, proved so successful that Star Fleet determined that the testbed starship could be modified into a serving vessel and added to the lists. All it would take was the addition of armament and the removal of the engineering instruments.

The Scylla class of scouts posed a unique problem in defining a mission they could carry out. They were not natural warships. Conventional design philosophy for such ships is to set the weapons package first and then build a ship to carry it.

The Scylla was not intended to be armed; the weapons added to it (two banks of adequate phasers and two photon torpedo tubes) make it a creditable but not formidable threat.

Its shipkeeping qualities, on the other hand, are above-average, and its sizeable cargo capacity, combined with its overall sound design, make the Scylla a very reliable craft for frontier patrol and remote base replenishment. In this mission capacity the Scylla class performs like a normal cruiser, though its small size and only normal endurance restrict its operational radius. Star Fleet is not troubled by this; they had the design in hand already, and there is always a need for additional ships of any good size on the frontier.

Because the design is so closely related to that of the Excelsior, Star Fleet has restricted the operation of the class to Quadrants I and II, far from the prying Romulan, Klingon, and Orion eyes.

Construction Data:

Model Numbers-	MK I
Ship Class-	VI
Date Entering Service-	2/2208
Number Constructed	6

Hull Data:

Superstructure Points-	18
Damage Chart-	C
Size	
Length-	196 meters
Width-	86.5 meters
Height-	44 meters
Weight-	68,875 tons
Cargo	
Cargo Units-	135 units
Cargo Capacity-	7,200 tons
Landing Capability-	None

Equipment Data:

Control Computer Type-	unknown
Transporters-	
Standard 6-person-	2
Combat 20-person-	none
Emergency 22-person-	2
cargo large-	unknown
cargo small-	unknown

Other Data:

Crew-	184
Troops-	none
Passengers-	unknown
Shuttlecraft-	4

Engines and Power Data:

Total Power Units Available-	32
Movement Point Ratio-	3/1
Warp Engine Type-	FWB-2
Number-	2
Power Units Available-	14
Stress Charts-	M/O
Maximum Safe Cruising Speed-	Warp 6
Emergency Speed-	Warp 7
Impulse Engine Type-	FIE
Power Units Available-	4

Weapons and Firing Data:

Beam Weapon Type-	FH-4
Number-	6 in two banks
Firing Arcs-	3f/p, 3f/s
Firing Chart-	Q
Maximum Power-	3
Damage Modifiers	
+3	
+2	(1 - 8)
+1	(9 - 14)
Missile Weapon Type-	FP-6
Number-	2 in one bay
Firing Arcs-	2f
Firing Chart-	O
Power To Arm-	1
Damage-	12

Shields Data:

Deflector Shield Type-	FSH
Shield Point Ratio-	1/2
Maximum Shield Power-	13

Defense Factor-	65.8
Weapon Damage Factor-	23.8

[<<<< GO BACK](#)

IMPORTANT NOTE:

It is entirely possible that you have surfed to this page from an internet portal and are now viewing this page without frames. **The STSSTCSMU&A is best viewed from within its own set of frames**, so [click here to jump to the main STSSTCSMU&A web page](#) and then [see the site as it was meant to be seen!](#)

RANGER CLASS SCOUT

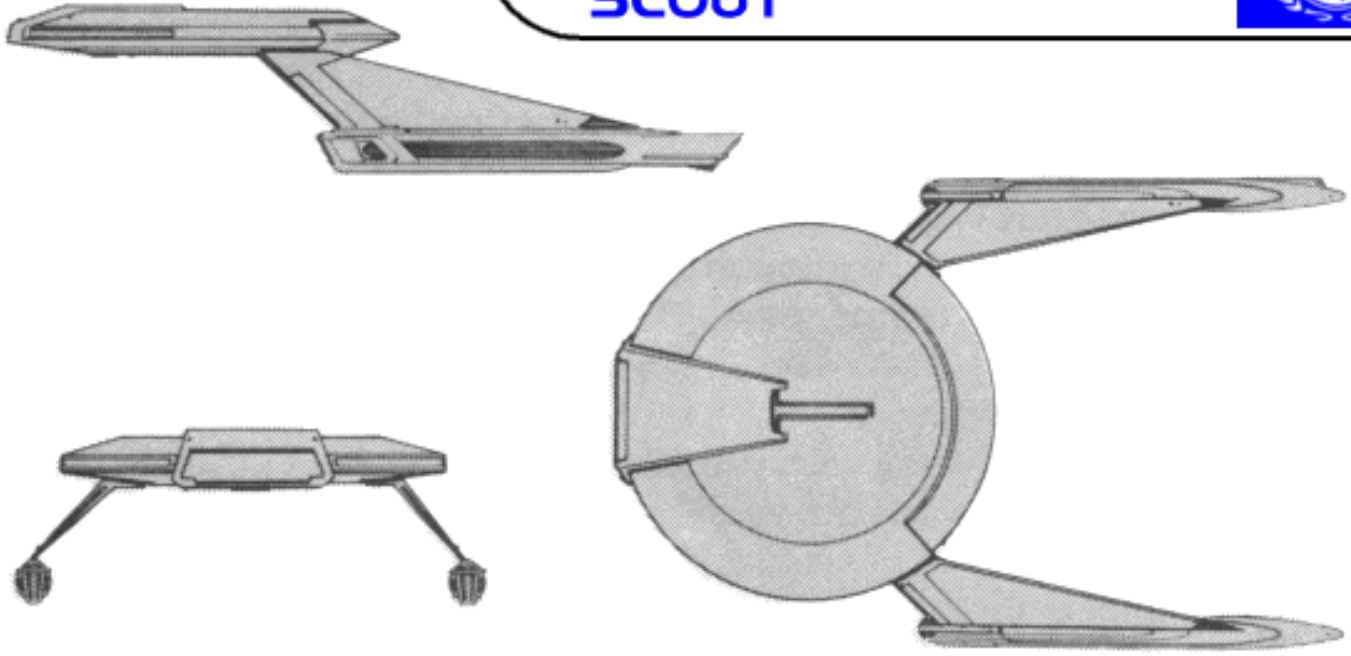

[Click here if you want to view this ship in its own window](#)

BRAD'S COMMENTS: A strange-looking little scout, the Ranger would get good marks from me for not using (abusing?) the Constitution Refit saucer section, only it makes that mistake with the warp engines. I don't care what the designers at FASA were thinking, a ship this small should NOT have warp nacelles identical to the *USS Enterprise!* It's way too small and ought to have some kind of different nacelle design. But hey, at least it's got some torpedoes, something many other small ships cannot say. In fact, the Mark III Ranger is tough enough to take on some of the older Romulan cruisers and early Klingon destroyers, so in spite of my gripes about its looks, the Ranger is a good fighting piece.



From the FASA Star Trek FEDERATION SHIP RECOGNITION MANUAL, circa 1985

Ranger Class V - VI Scout

Notes: Of the 159 Rangers built, 12 Mk Is, 31 Mk IIs, and 52 Mk IIIs remain in active service, with 2 Mk Is and 2 Mk IIs in reserve fleets. Two Mk IIs and 1 Mk III are used by Star Fleet Training Command; 26 Mk Is, 8 Mk IIs, and 1 Mk III have been destroyed; 2 Mk Is and 1 Mk II are listed as missing; 1 Mk I and 12 Mk IIs have been scrapped; and 6 Mk Is and 1 Mk II have been sold to civilian commercial concerns. The Ranger is produced at the Sol IV and Morena facilities at a combined rate of 8 per year.

Construction Data:

Model Numbers-	MK I	MK II	MK III
Ship Class-	V	V	VI
Date Entering Service-	2/1203	2/1710	2/2001
Number Constructed	102	108	54

Hull Data:

Superstructure Points-	10	12	14
Damage Chart-	C	C	C
Size			
Length-	87 meters	87 meters	87 meters
Width-	57 meters	57 meters	57 meters
Height-	21 meters	21 meters	21 meters
Weight-	55,285 tons	59,145 tons	63,325 tons
Cargo			
Cargo Units-	20 units	20 units	20 units
Cargo Capacity-	1,000 tons	1,000 tons	1,000 tons
Landing Capability-	none	none	none

Equipment Data:

Control Computer Type-	M-1	M-2	M-2
Transporters-			
Standard 6-person-	2	2	2
Emergency 22-person-	1	1	1
cargo small -	none	none	none
cargo large -	none	none	none

Other Data:

Crew-	73	77	77
Troops-	6	6	6
Passengers-	none	none	none
Shuttlecraft-	2	2	2

Engines and Power Data:

Total Power Units Available-	32	34	34
Movement Point Ratio-	2/1	2/1	2/1
Warp Engine Type-	FWB-2	FWB-2	FWB-2
Number-	2	2	2
Power Units Available-	14	14	14
Stress Charts-	M/O	M/O	M/O
Maximum Safe Cruising Speed-	Warp 8	Warp 8	Warp 8
Emergency Speed-	Warp 9	Warp 9	Warp 9
Impulse Engine Type-	FIB-2	FIB-3	FIB-3
Power Units Available-	4	6	6

Weapons and Firing Data:

Beam Weapon Type-	FH-2	FH-6	FH-7
Number-	2	4 in two banks	4 in two banks
Firing Arcs-	2f/p/s	2f/p, 2f/s	2f/p, 2f/s
Firing Chart-	H	N	Q
Maximum Power-	3	3	4
Damage Modifiers			
+3			
+2		(1 - 7)	(1 - 8)
+1	(1 - 10)	(8 - 13)	(9 - 15)
Missile Weapon Type-	FP-3	FP-7	FP-7
Number-	2	2	2
Firing Arcs-	1f, 1a	1f, 1a	1f, 1a
Firing Chart-	D	R	R
Power To Arm-	1	1	1
Damage-	6	8	8

Shields Data:

Deflector Shield Type-	FSF	FSH	FSH
Shield Point Ratio-	1/2	1/2	1/2
Maximum Shield Power-	12	14	14
Defense Factor-	74.3	80.2	81.0
Weapon Damage Factor-	5.0	14.0	22.4

[<<<< GO BACK](#)

IMPORTANT NOTE:

It is entirely possible that you have surfed to this page from an internet portal and are now viewing this page without frames. **The STSSTCSMU&A is best viewed from within its own set of frames**, so [click here to jump to the main STSSTCSMU&A web page](#) and then [see the site as it was meant to be seen!](#)

FENLON CLASS MONITOR

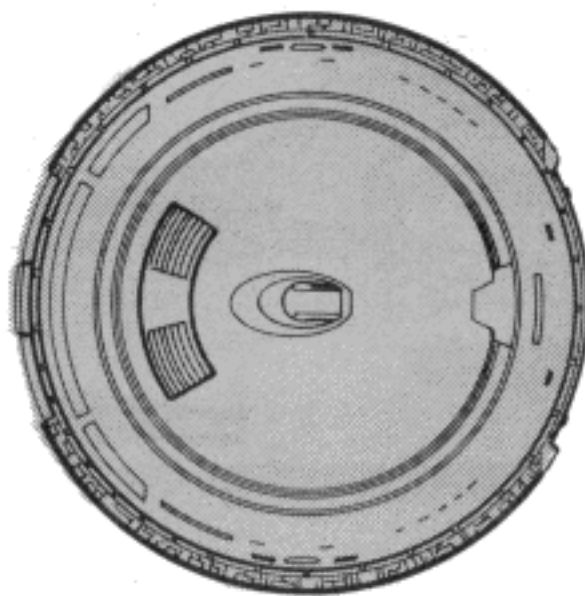
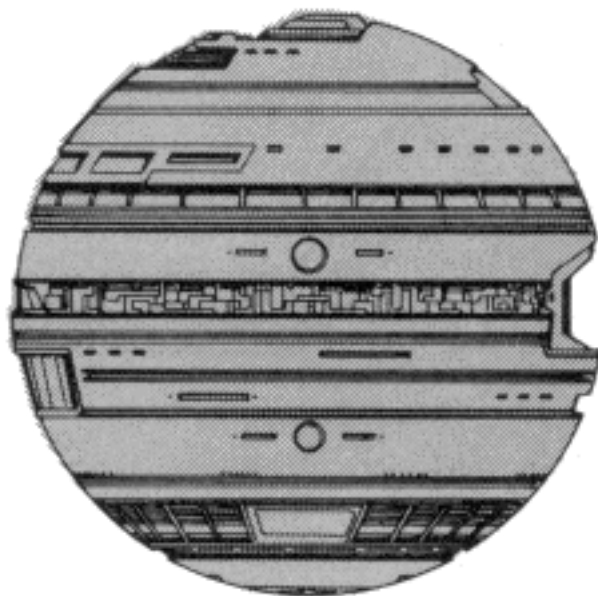

[Click here if you want to view this ship in its own window](#)

BRAD'S COMMENTS: What can you say about a ship that's shaped like the little sparring droid in **Star Wars** that Luke fights with his light saber when onboard the *Millennium Falcon*? Not much I guess. The Fenlon is just plain dumb, at least aesthetically, though it does play okay for a ship in the mass V range. Stranger still is the realization that if we ever do have to fight wars with ships in outer space, they may very well look like the Fenlon! No, really. As any hard SF fan can tell you, shapes like spheres and cylinders would be the ideal shapes for warships in outer space, where we don't need wings to fly in an atmosphere and the less surface area we expose to hostile fire, the better. So even though the Fenlon is the most radical departure from Federation design philosophy of any ship in the entire game, it is the ship that probably best represents the true future of warships in outer space. I kid you not.



From the FASA Star Trek FEDERATION SHIP RECOGNITION MANUAL, circa 1985

Fenlon Class V Monitor

Notes: The Fenlon is the only monitor class in Star Fleet. Because ships of the monitor type generally are used to patrol and maintain order over subjugated worlds, the UFP has little need for a vessel of this type, except near the borders. These ships patrol border systems and protect them from marauders and pirates.

The spherical hull design is a drastic departure from normal Star Fleet designs. The engines are mounted centrally and are difficult to locate on a visual scan. The sub-light drive system is capable of moving the Fenlon at 0.9 warp for periods of up to 6 months. Of course, being stationed in-system or at a border outpost because their limited top speed limits their range, the monitors will seldom need this capability because they are always near their supply depots.

The Fenlon Class monitor is seldom found alone. Its primary function is to support the cutters that are operating in the area. It will act as a heavy support vessel when the cutters have encountered a ship that they cannot deal with alone. The Fenlon, with its 10 phasers, is an unwelcome sight to smugglers, pirates, and marauders.

Of the 876 Fenlons built, 334 Mk IIs and 130 Mk IVs remain in active service, with 110 Mk IIs and 42 Mk IVs in reserve fleets. One of each type is used by Star Fleet Training CQmmand; 132 Mk IIs and 68 Mk IVs

have been destroyed; 4 Mk IIs and 2 Mk IVs are listed as missing; 39 Mk IIs and 8 Mk IVs have been scrapped; and 4 Mk IIs and 1 Mk IV have been sold to private commercial concerns.

The Fenlon is produced at the Alpha Centauri shipyards at a rate of 2 per year.

Construction Data:

Model Numbers-	MK II	MK IV
Ship Class-	V	V
Date Entering Service-	1/9701-2/1512	2/1010
Number Constructed	620	587

Hull Data:

Superstructure Points-	14	14
Damage Chart-	C	C
Size		
Length-	120 meters	120 meters
Width-	120 meters	120 meters
Height-	120 meters	120 meters
Weight-	48,080 tons	48,335 tons
Cargo		
Cargo Units-	100 units	100 units
Cargo Capacity-	5,000 tons	5,000 tons
Landing Capability-	None	None

Equipment Data:

Control Computer Type-	M-1	M-1
Transporters-		
Standard 6-person-	3	3
Combat 20-person-	1	1
Emergency 22-person-	1	1
cargo-	1	1

Other Data:

Crew-	72	76
Passengers-	20	20
Troops-	20	20
Shuttlecraft-	6	6

Engines and Power Data:

Total Power Units Available-	27	30
Movement Point Ratio-	2/1	2/1
Antimatter Engine Type-	FSLB	FSLB
Number-	2	2
Power Units Available-	12	12
Stress Charts-	O/M	O/M
Impulse Engine Type-	FIC-2	FIB-3
Power Units Available-	3	6

Weapons and Firing Data:

Beam Weapon Type-	FH-2	FH-4
Number-	10 in three banks	10 in three banks
Firing Arcs-	2f 4p, 4s	2f 4p, 4s
Firing Chart-	H	N
Maximum Power-	3	3
Damage Modifiers		
+3		
+2		(1 - 8)
+1	(1 - 10)	(9 - 14)

Shields Data:

Deflector Shield Type-	FSD	FSF
Shield Point Ratio-	1/2	1/2
Maximum Shield Power-	8	12

Defense Factor- 69.0 79.0

Weapon Damage Factor- 13.0 26.0

[<<<< GO BACK](#)

IMPORTANT NOTE:

It is entirely possible that you have surfed to this page from an internet portal and are now viewing this page without frames. **The STSSTCSMU&A is best viewed from within its own set of frames**, so [click here to jump to the main STSSTCSMU&A web page](#) and then [see the site as it was meant to be seen!](#)

ALAMO CLASS DEFENSE STATION

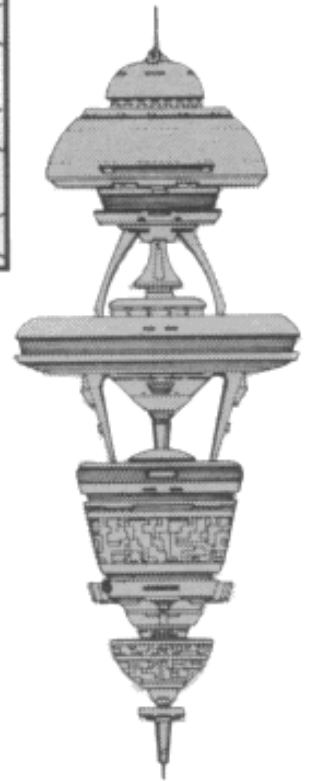
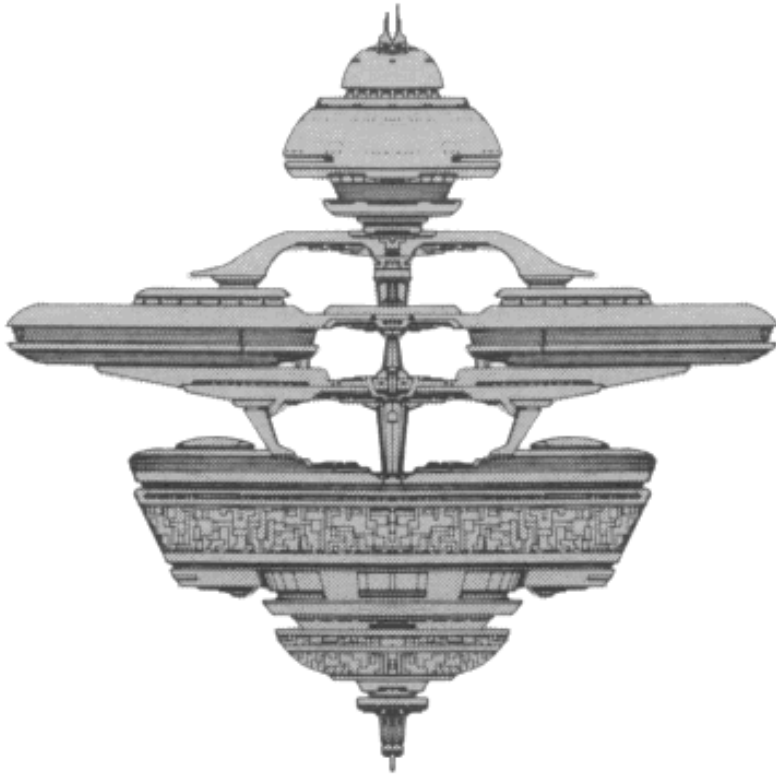
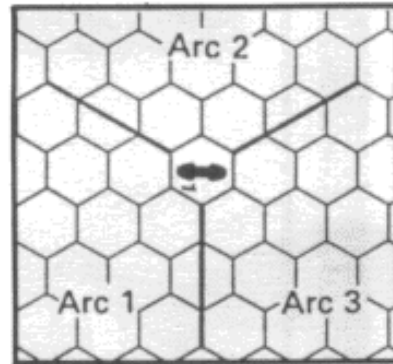
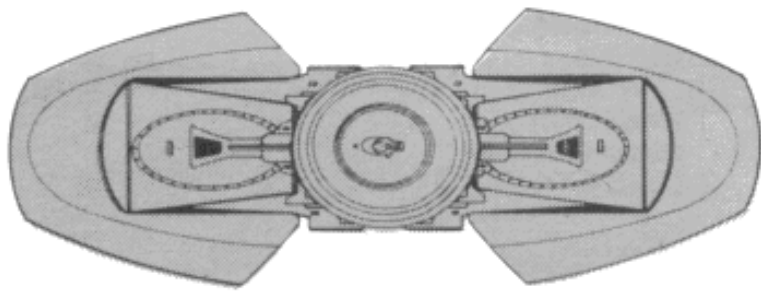

[Click here if you want to view this ship in its own window](#)

BRAD'S COMMENTS: The one Federation space station featured in the STSSTCS that does *not* appear on screen and therefore does not seem to have any basis in canon, the Alamo is like all defense outposts in that it is the Maginot Line of Star Trek weaponry: huge, bristling, capable of swatting away even the largest of battleships in a single blow, yet unwieldy in combat and quickly overcome by numerous and/or maneuverable opponents. Unlike the [R-1](#) and the [Spacedock](#) stations, the Alamo is actually capable of movement, but only after a limited fashion. At 10 to 1 the Alamo cannot sustain movement across the map sheet without seriously cutting into its power allocation for weaponry and shields. Conversely, with shields and weapons fully energized the Alamo is one tough sumbitch of a fighting machine--a fighting machine rooted in place and as liable to outmaneuver enemy starships as an 18-wheeler is liable to outmaneuver a horde of Geo Metros. So while it is mighty tempting to employ the Alamo in any game scenario (at least if you're the Federation player!), in practice the Alamo is a troublesome playing piece and unless your scenario involves a Romulan or Klingon assault on a Federation colony world, the Alamo doesn't have much practical purpose.

Moreover, consider the Alamo in the real world. Space is vast and distances are impossibly large. Any defensive line that covers an interstellar border is going to have to be made up of units swift enough to patrol the area to the point of sensor saturation, and able to respond en masse once a border breach has been detected.

The Alamo would make a rotten deep space monitor in that, once contact with the enemy was made, it could not give chase. Any enemy fleet wishing to breach the Federation border might as well stay at high warp and fly right around the Alamo's outer weapons radius, knowing that the Alamo cannot pick up and chase after the intruders. Also, since the Alamo is so big and expensive, it is unlikely the Federation could build enough of them to sensor saturate even a tiny portion of its territory.

Even if the Alamo remains in planetary or solar orbit, as seems to be the case according to the FASA writers, the Alamo cannot cover all areas of planetary or interplanetary space at all times. If an enemy assault force wishes to take a planet, it need do nothing more than insert itself into a matching orbit on the *opposite* side of the planet as the Alamo, landing troops and attacking ground based installations while the planet itself acts as a shield against the Alamo's sensors and weapons. A cloaked Klingon or Romulan fleet could easily slip into a given star system, assume a matching orbit opposite an Alamo, then de-cloak and start beaming down the troops. By the time the Alamo got word from the ground that an attack was underway, it would probably be too late, and the Alamo itself would suddenly be cut off as a defense outpost with nothing left to defend.

The Alamo's best real world function would probably be that of an armed and armored traditional space station, able to act as a secure waypoint between groundside and ships docked in orbit. This makes sense for colony worlds and starbases in contested or hostile areas of the Federation frontier, where space stations would be vital parts of colonial development, therefore making them prime

targets for raiders bent on disrupting colonial efforts. Ideally a space station like the Alamo would serve as home base for a small flotilla of cutters, corvettes, monitors, or even light destroyers, all of which would patrol the colony system and act as mobile interceptors while the Alamo itself served as the final, strongest link between the relatively helpless colony on the ground and their orbital supply chain.

See more of my comments on space stations and defense outposts at the page for the [Klingon Z-4 Deathgame](#).

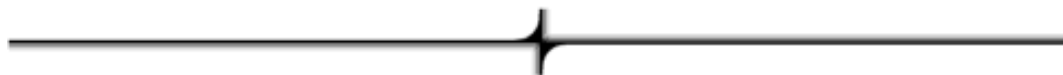

From the FASA Star Trek FEDERATION SHIP RECOGNITION MANUAL, circa 1985

Alamo Class V Defense Outpost Space Station

Notes: The Alamo Class defense outpost was first placed on location on Stardate 2/0811. Since that time, 287 of these units have been positioned, usually in orbits around whatever planets are vital, serving as a defensive ring or wall. Alamo Class outposts, capable of withstanding a tremendous amount of punishment while delivering powerful offensive blows, are the best deterrent to Klingon aggression. Alamo Class defense outposts are built on location. They can be moved by several specially-designed [Samson Class](#) tugs.

Construction Data:

Model Numbers-	MK III	MK IV
Ship Class-	off the scale!	off the scale!
Date Entering Service-	2/0811	2/1212
Number Constructed	161	126

Hull Data:

Superstructure Points-	64	72
Damage Chart-	C	C
Size		
Length-	560 meters	560 meters
Width-	195 meters	195 meters
Height-	510 meters	510 meters
Weight-	2,200,000 tons	2,500,000 tons

Cargo		
Storage Units-	2,800 units	3,000 units
Storage Capacity-	140,000 tons	150,000 tons
Landing Capability-	none	none

Equipment Data:

Control Computer Type-	M-7	M-7
Transporters-		
Standard 6-person-	8	8
Combat 20-person-	none	none
Emergency 22-person-	4	4
cargo small-	4	4
cargo large-	2	2

Other Data:

Crew-	410	460
Residents-	280	300
Shuttlecraft-	30	30

Engines and Power Data:

Total Power Units Available-	179	204
Movement Point Ratio-	10/1	10/1
Antimatter Generator Type-	FMAPG-2	FMAPG-3
Number-	1	1
Power Units Available-	155	180
Impulse Engine Type-	FIPG-2	FIPG-2
Power Units Available-	24	24

Weapons and Firing Data:

Beam Weapon Type-	FH-3	FH-9
Number-	12	18
Firing Arcs-	4 per arc	6 per arc
Firing Chart-	W	X
Maximum Power-	5	6
Damage Modifiers		
+3	(1 - 10)	
+2	(11 - 17)	(1 - 12)
+1	(18 - 20)	(13 - 22)
Missile Weapon Type-	FP-1	FP-4
Number-	6	6
Firing Arcs-	2 per arc	2 per arc
Firing Chart-	L	S
Power To Arm-	1	1
Damage-	10	20

Shields Data:

Deflector Shield Type-	FDS-X	FDS-X
Shield Point Ratio-	1/2	1/2
Maximum Shield Power-	16	16

Defense Factor-	151.3	210
Weapon Damage Factor-	111	198

[<<<< GO BACK](#)

IMPORTANT NOTE:

It is entirely possible that you have surfed to this page from an internet portal and are now viewing this page without frames. **The STSSTCSMU&A is best viewed from within its own set of frames**, so [click here to jump to the main STSSTCSMU&A web page](#) and then [see the site as it was meant to be seen!](#)

R-1 CLASS SPACE STATION

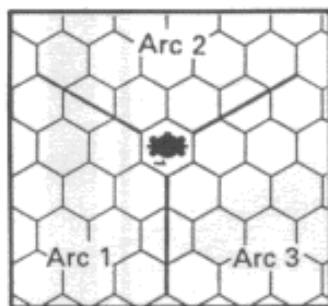
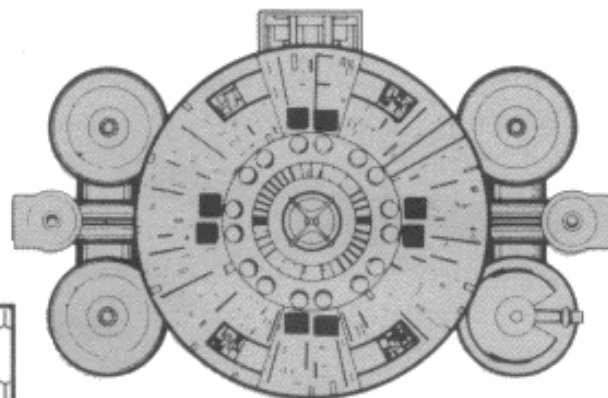
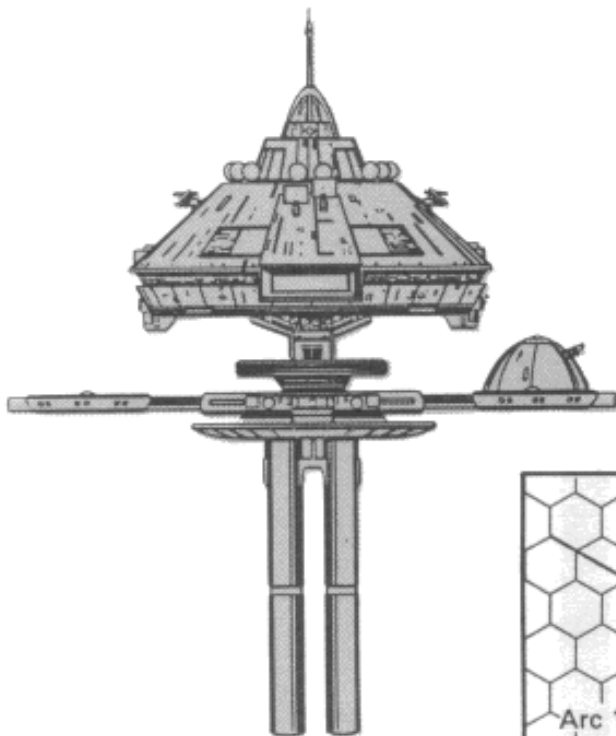

[Click here if you want to view this ship in its own window](#)



BRAD'S COMMENTS: The model for this station first appeared in **ST:TMP** but would later be resurrected in a modified form for **Star Trek II**, as well as making cameos in episodes of **ST:TNG**. Like the [Earth Spacedock](#), the R-1's exact scale has been cast in doubt by its use (overuse?) in the various films and on television, appearing alongside various spacecraft of different size. By some accounts the station is smallish, not much larger than a



[Constitution Class cruiser](#). But if the TNG-era stills are to be believed, then the R-1 is on the same scale as a [Galaxy Class](#). Explanation? It could be reasoned that there were many different space stations constructed in the same mold as the R-1, only of different sizes, like the Klingon '[Bird of Prey](#)' series.

Also, is the R-1 closer in mission to the unarmed Earth Spacedock, or is it more like the [Alamo Defense Outpost](#), intended to act as a weapons platform instead of a true space station? My copy of the STSSTCS does not give any background data on the R-1, though the sheet sent to me by [Bernard Guignard](#) indicates that there are two main types of R-1: a research model that is unarmed, and a border defense model that is armed. In either case, the R-1 seems like a kid brother to the larger and power powerful Alamo and Spacedock space stations.



As with the Alamo, it is a matter of some debate among gamers whether or not the R-1 is capable of acting as a repair/resupply facility for starships. Certainly the Spacedock is capable of repairing scads of ships, if not outright building them from scratch. But to me the R-1 seems too small to act as a full-on repair base, lacking the equipment and the manpower of Spacedock or a mobile repair facility like the [Pearl MRF](#). Though in its original form from **ST:TMP** the R-1 certainly seems to be a companion component for the many "bird cage" starship construction platforms that orbit Earth (and presumably many other worlds in the Federation, too). Scotty worked in an R-1 during the refit of the *USS Enterprise*. Could it be that the R-1 is a "tinker toy" modular design, with independent pieces that can be pulled apart and stuck back together in any desired configuration? Or is the R-1 merely a "canned" design that is assembled from off-the-shelf parts that are ubiquitous throughout the Federation? Or are both theories true?

Finally, it should be noted that the R-1 has a specially created towing ship, the [Samson class](#), dedicated specifically to moving R-1's to and fro across the Federation. Unfortunately, this class is never seen on film, and may be considered part of the apocryphal line of ships from FASA.



From the FASA Star Trek Starship Tactical Combat Simulator, circa 1983 - 1986

R-1 Class V Space Station

Notes: The R-1 is the standard pre-fabricated orbital station that is widely used in the Federation. The basic design features a truncated cone as the main hull, including a large shuttle bay and several standard docking collars. At the small end of the cut-off cone is a smaller communications/sensor equipment area topped with a communications mast. Though most stations are unarmed, 8 hardpoints are available for weapons mounts, if desired. Some stations have only navigational deflectors, while others are equipped with combat-quality shields.

Attached to the broad end of the cone are several smaller deck section modules, including an engineering deck. One of these decks can be a horizontal bar-shaped extension to which four circular pod modules may be attached for special functions.

Below the modular special decks are four cylindrical pods parallel to the long axis of the station; most often these contain such consumables as water, air, and food base. The large capacity of these storage tanks gives the stations a longer operational life between supply shipments. Thus, stations of this type are ideal for use in frontier areas, or out-of-the-way areas infrequently visited by cargo ships.

Power is provided by a matter/antimatter generator and an auxiliary impulse power generator. Though these are not engines and cannot move the station, their power output is equivalent to a standard warp or impulse engine type. The matter/antimatter generator is usually contained in one of the cylindrical pods so it can be jettisoned if necessary.

These stations are constructed in orbit from several Star Fleet major construction facilities. After construction, they may be towed intact by a specially-designed warp tug/tender that attaches to built-in, reinforced grappaling points on the R-1 hull. A station that has outlived its usefulness in one location can be moved to another spot, or it may be returned for refitting. Once in place, the station cannot be moved without the warp tug/tender, except for orbital corrections accomplished with small ion thrusters.

Variants of this basic design are used as manufacturing facilities, research stations, observation posts, orbital administrative offices, and so on. Two well known examples of the design are the ill-fated *Regula I* deep space research station, originally under the authority of Dr. Carol Marcus and the Project Genesis team, and the Orbital Administration Facility of Star Fleet's San Francisco naval yards, Terra.

Construction Data:

Model Numbers-	Orbital Defense Outpost	Research/Science Station
Ship Class-	XXIV	XXIV
Date Entering Service-	2/0911	2/0902
Number Constructed	63	22

Hull Data:

Superstructure Points-	24	24
Damage Chart- Size	C	C
Length-	200 meters	200 meters
Width-	215 meters	215 meters
Height-	420 meters	420 meters
Weight-	1,103,000 tons	1,103,000 tons
Cargo		
Storage Units-	unknown	unknown
Storage Capacity-	unknown	unknown
Landing Capability-	none	none

Equipment Data:

Control Computer Type-	unknown	unknown
Transporters-		
Standard 6-person-	1	1
Combat 20-person-	none	none
Emergency 22-person-	none	none
cargo small-	2	2
cargo large-	none	none

Other Data:

Crew-	150	150
Passengers-	none	none
Shuttlecraft-	8	8

Engines and Power Data:

Total Power Units Available-	24	24
Movement Point Ratio-	cannot move!	cannot move!
Antimatter Generator Type-	FMAPG-FWF	FMAPG-FWF
Number-	1	1
Power Units Available-	20	20
Impulse Engine Type-	FIPG-FID	FIPG-FID
Power Units Available-	4	4

Weapons and Firing Data:

none!

Beam Weapon Type-	FH-6
Number-	9 in three banks
Firing Arcs-	1 bank of 3 per arc
Firing Chart-	N
Maximum Power-	3
Damage Modifiers	
+3	
+2	(1 - 7)
+1	(8 - 13)
Missile Weapon Type-	FP-2
Number-	6 in three bays
Firing Arcs-	1 bay of 2 per arc
Firing Chart-	H
Power To Arm-	1
Damage-	6

Shields Data:

Deflector Shield Type-	FSF	navigational only!
Shield Point Ratio-	1/2	
Maximum Shield Power-	10	

Defense Factor-	unknown	unknown
Weapon Damage Factor-	unknown	none

[<<<< GO BACK](#)**IMPORTANT NOTE:**

It is entirely possible that you have surfed to this page from an internet portal and are now viewing this page without frames. **The STSSTCSMU&A is best viewed from within its own set of frames**, so [click here to jump to the main STSSTCSMU&A web page](#) and then [see the site as it was meant to be seen!](#)

EARTH "SPACEDOCK" SPACE STATION

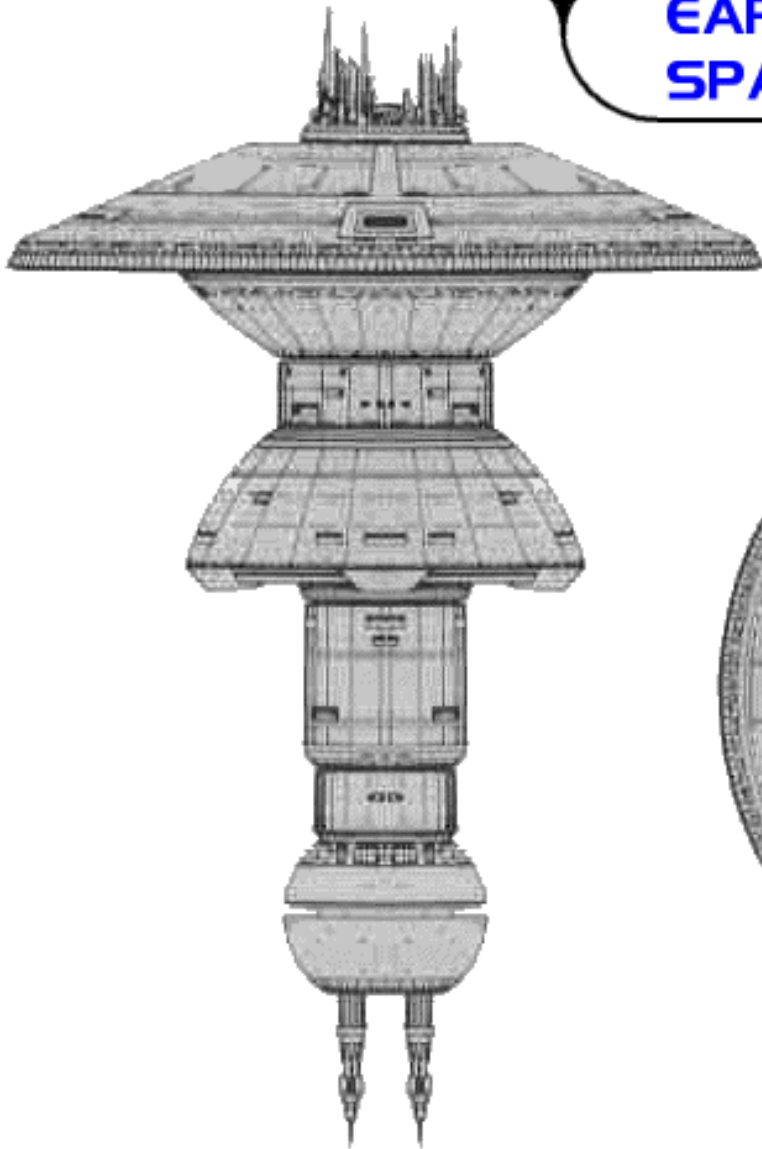

[Click here if you want to view this ship in its own window](#)

NOTE: many thanks to [Bernard Guignard](#) for the scans of this rare class!

The Spacedock design was *never* part of my edition of the Federation Ship Recognition Manual, nor was it part of my copy of the STSSTCS game manual, making this class an unusual treat. Enjoy.

BRAD'S COMMENTS: I have always admired this design. I am not sure why. Perhaps because it is visually more imposing than the flimsy cagework of the spacedocks seen in **Star Trek TMP**, **Star Trek II**, and **Star Trek Generations**. Perhaps also because the sequence in **Star Trek III** where the Enterprise returns to dock after taking a beating at the hands of Khan is one of my favorite starship scenes in all of Trekkdom. In any case, the true scale of the Earth Spacedock dwarfs even the largest Starfleet starships, which up until the third Trek film were the largest human-made structures featured on the Trek screen. Even by **ST:TNG** standards it seems that the Spacedock is still the largest spaceborne facility in the Starfleet inventory, as the 'starbase' from episode 11001001 easily engulfs the [Galaxy Class](#) Enterprise prior to being hijacked by the Bynars.





But the space station seen in 11001001 presents a certain problem. It looks physically identical to the Spacedock seen to orbit Earth in several of the Trek films, yet in **Star Trek III** we plainly see that the [Constitution Refit Class](#) Enterprise barely fits through the giant space doors that guard entry and exit into the Spacedock's primary hangar. So how can the Galaxy Class, which is remarkably taller and especially wider than the Constitution Refit, pass through such an orifice? Are we to accept, as we must with the Klingon [Bird\(s\) of Prey](#) ships, that there are several sizes of Spacedock, all identical in outward appearance? Moreover, Star Trek has never made clear whether or not such a massive orbital satellite like the Spacedock qualifies as a "starbase" all by itself, or if the Spacedock is merely an

orbital extension of a much larger ground-based facility?

My hunch tends towards the latter.

Gamers will find the Spacedock quite disappointing to play in that, unlike a defense outpost, it possesses no weaponry at all. Which may be just as well because with a superstructure of 2,000 and a total power output of over 500, it would take a substantial fleet to make even a minor scratch in this behemoth. If it had weapons mounted, the Spacedock would be nearly invincible, requiring large fleets of Klingon and Romulan battleships to bring it down--or a lesser number of super-powerful ships from the TNG-era or, possibly, from super-powerful races like the Borg.

The one big question I always ask is how does the Spacedock compare in size to other space stations, like the [Nor Class](#) stations from **ST:DS9**? I have never found a scale chart that successfully compares all of the Star Trek space stations, and I am curious if anyone knows if such a chart exists somewhere on the internet. Push come to shove I may try and create my own, though I would just as soon use an official scale chart from a canonical source.



From the FASA Star Trek Starship Tactical Combat Simulator, circa 1983 - 1986

Earth Spacedock

NOTES: This gigantic, one-of-a-kind space station orbiting Terra is the most massive artificial satellite ever placed in orbit. Usually just referred to as the 'Space Dock,' the structure was completed and put into service on Reference Stardate 2/2011.05. It fills the need for more orbital docking facilities more elaborate than the free-standing, single-ship dock frameworks. The design includes orbital facilities for other uses, such as administrative offices, transient apartments, freefall hospital facilities, and laboratories. The result was a kilometers-long station that dwarfs the mighty starships it services.

The Space Dock, despite its huge size, is an unarmed facility, built-in armament unnecessary considering its position in orbit around the most heavily defended planet in the Federation. The station does possess special shield generators, more powerful than any others ever built. In addition, the huge matter/antimatter generators that power the station are quite capable of powering massive phaser batteries if, in a time of war, Star Fleet should ever decide to mount them. The Space Dock is homebase for the new *USS Excelsior* battleship during its in-service testing period; as well as several other starships assigned to the quadrant containing the Sol/Terra system. It also is the home special overhaul facilities used for starships too badly damaged for field repair.

Construction Data:

Model Numbers-	MK I
Ship Class-	off scale!
Date Entering Service-	2/2011
Number Constructed	1

Hull Data:

Superstructure Points-	550
Damage Chart-	C
Size	
Length (top to bottom)-	4,700 meters
Diameter (largest saucer)-	3,800 meters
Weight-	110,000,000 tons!
Cargo	
Cargo Units-	variable
Cargo Capacity-	variable
Landing Capability-	none

Equipment Data:

Control Computer Type-	multiple; co-processing
Transporters-	
Standard 2-person-	200
Standard 6-person-	300
Combat 20-person-	none
Emergency 22-person-	200
cargo large-	20
cargo small-	100

Other Data:

Resident Operational Staff-	50,000
Non-resident Staff-	4,500
Resident Dependents-	100,000
Transient Population-	20,000 maximum
Shuttlecraft-	40 to 110; varies

Engines and Power Data:

Total Power Units Available-	550
Movement Point Ratio-	cannot move, station-keeping thruster only!
Antimatter Generator-	FMAPG-X1
Number-	2
Power Units Available-	250 each
Backup Impulse Generator-	FIPG-X1
Power Units Available-	50

Weapons and Firing Data: Unarmed

Shields Data:

Deflector Shield Type-	FDSG-X1
Shield Point Ratio-	3/1
Maximum Shield Power-	35

Defense Factor- Holy crap!
Weapon Damage Factor- none

[<<<< GO BACK](#)

IMPORTANT NOTE:

It is entirely possible that you have surfed to this page from an internet portal and are now viewing this page without frames. **The STSSTCSMU&A is best viewed from within its own set of frames**, so [click here to jump to the main STSSTCSMU&A web page](#) and then [see the site as it was meant to be seen!](#)

SAMSON CLASS TUG / TENDER

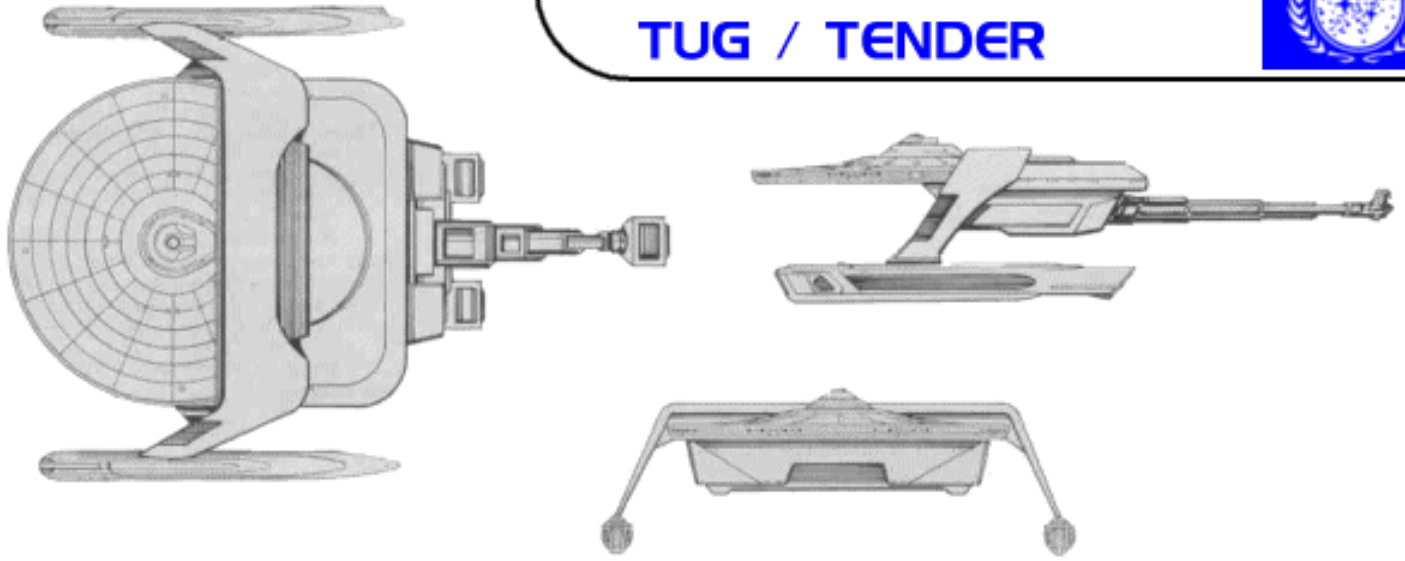

[Click here if you want to view this ship in its own window](#)

NOTE: many thanks to [Bernard Guignard](#) for the scans of this rare class!

The Samson design was *never* part of my edition of the Federation Ship Recognition Manual, nor was it part of my copy of the STSSTCS game manual, making this class an unusual treat. Enjoy.

BRAD'S COMMENTS: Many thanks to [Bernard Guignard](#) for this class. Bernard has been a real treasure of hard-to-find FASA material, much of it from his editions of the STSSTCS manuals; editions which seem to predate mine. I had no idea that so much material had been stripped from the later editions of manuals! So getting this new, never-before-seen-by-me material is a total treat.

From the FASA Star Trek Starship Tactical Combat Simulator, circa 1983 - 1986

Samson Class X Tug/Tender

Notes: The Samson class warp tender was designed by Onto Rantura and built by Chiokis Shipyards especially to tow the R-1 Orbital Station. It is basically a pair of big warp engines with a hull to hold them together and house crew, tractor beam equipment, towing hookups, and so on. Even with two big warp engines, these ships are well over tonnage rating when towing a station, and thus move more slowly when laden than is normal for their engines. These vessels have only minimum defensive shields and no offensive armament to drain power. For this reason, they never travel unescorted.

Three heavy-duty, extensible, towing arms attach to the station, but they do not bear all of the towing burden. Several heavy-duty tractor/pressor beams also are installed for towing. These beams are so powerful that they can actually draw an appreciable amount of ship's power when active, as is noted in the specifications.

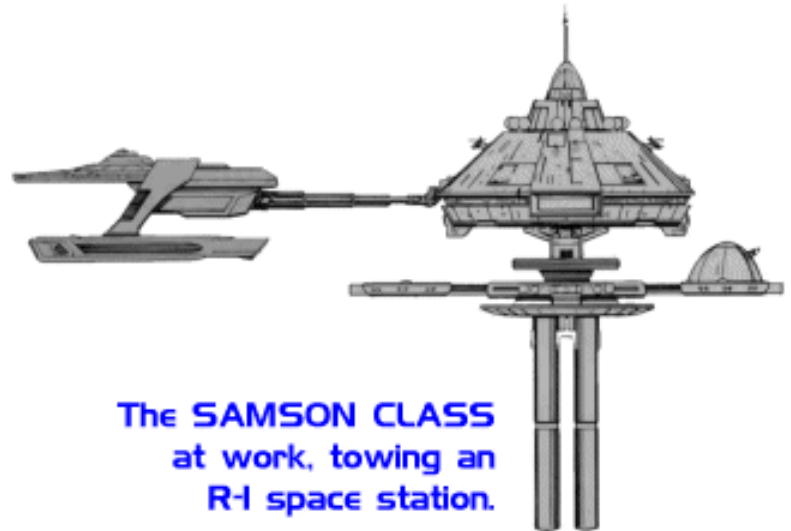

The **SAMSON CLASS**
at work, towing an
R-1 space station.

Construction Data:

Model Numbers-	MK I
Ship Class-	X
Date Entering Service-	2/0902
Number Constructed	26

Hull Data:

Superstructure Points-Damage Chart-Size	20 B
Length-	200 meters
Width-	140 meters
Height-	60 meters
Weight-	152,000 tons
Cargo	
Cargo Units-	none
Cargo Capacity-	none
Landing Capability-	none

Equipment Data:

Control Computer Type-Transporters-	unknown
Standard 6-person-	1
Combat 20-person-	none
Emergency 22-person-	none
cargo small-	none
cargo large-	none

Other Data:

Crew-	52
Troops-	none
Shuttlecraft-	2

Engines and Power Data:

Total Power Units Available-	44
Movement Point Ratio-	4/1 unloaded, 8/1 loaded
Warp Engine Type-	FWF
Number-	2
Power Units Available-	20
Stress Charts-	G/L
Maximum Safe Cruising Speed-	Warp 6 unloaded, Warp 3 loaded
Emergency Speed-	Warp 8 unloaded, Warp 5 loaded
Impulse Engine Type-	FID
Power Units Available-	4

Weapons and Firing Data: none!

Shields Data:

Deflector Shield Type-	FSB
Shield Point Ratio-	1/2
Maximum Shield Power-	6

Defense Factor- unknown

Weapon Damage Factor- none

[<<<< GO BACK](#)

IMPORTANT NOTE:

It is entirely possible that you have surfed to this page from an internet portal and are now viewing this page without frames. **The STSSTCSMU&A is best viewed from within its own set of frames**, so [click here to jump to the main STSSTCSMU&A web page](#) and then [see the site as it was meant to be seen!](#)

PEARL CLASS MOBILE REPAIR FACILITY

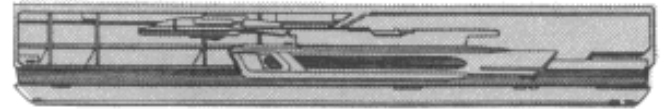
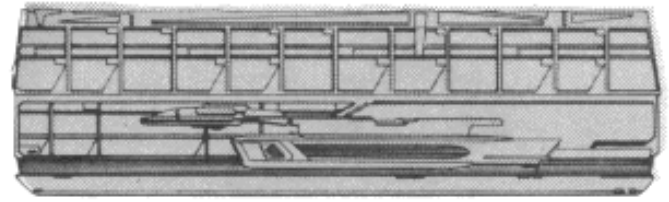
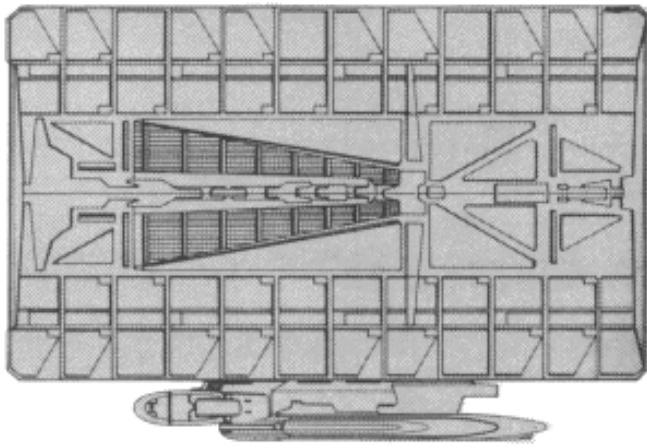

[Click here if you want to view this ship in its own window](#)

BRAD'S COMMENTS: Very similar in shape and function to the S-8 ['folding box'](#) MRF of the Klingon Empire, the Pearl is basically a modified "bird cage" space dock outfitted with a warp nacelle. Think of the space dock seen in *Star Trek TMP*, *Star Trek II*, or *Star Trek: Generations*, and then picture that dock traveling with the fleet as it warps around the galaxy.

As I mentioned when I discussed the Klingon ship, using these vessels in game play presents certain problems. They are almost worthless as combat pieces, redundant as scenario plot devices (freighters and auxiliaries work better), and it does not seem feasible that the MRF can quickly repair a starship within the time frame of a ship-to-ship melee--in spite of what the official FASA text states. Even minor damage would realistically take days to fix, while major engine and structural damage ought to take weeks, or even months. Therefore the Pearl and other vessels like it are not meant to be instant rejuvenators, returning ships hale and whole to the fight the moment such ships reach their nearest friendly MRF.

I used to play the MRF this way, and soon lost my taste for it simply because it did seem too unrealistic for an MRF to repair *anything* during the compressed chaos of battle. It takes time for an injured ship to slip into dock, moor up, then inspections have to be made and damage repair plans are drawn up, to say nothing of doing the work itself. Ultimately, the Pearl certainly cannot replace totaled equipment on the fly. A Starfleet ship with its starboard warp nacelle severed is not going to cruise into dock and have the Pearl magically fabricate an entirely new nacelle for it. So I suggest gamers use a lot of caution when playing MRFs. It is tempting to turn them into magic wands, with a steady stream of damaged ships limping in to "tag up" with the MRFs, before streaming away again to the battle.

Yes, Star Trek era technology is certain to be advanced, mechanized, and rapid. But let's keep our feet on the ground, shall we?



From the FASA Star Trek FEDERATION SHIP RECOGNITION MANUAL, circa 1985

Pearl Class VII Mobile Repair Facility

Notes: The first Pearl Class mobile repair facility was commissioned on Stardate 2/1212 to replace the Newport News Class facility, which was not capable of rapid deployment or housing larger ships. Unlike the older facility, the Pearl facility was designed to travel under its own power at Warp 6 and has enough internal bay capacity to hold no fewer than two of the Constitution Class cruisers. This makes it an asset in forward military operations.

Pearl repair facilities are an integral part of all Star Fleets and accompany them at all times. They are the lifeline of the fleet during combat, for they keep all ships operational. This ability was used to advantage and was decisive in the Four Years War, in which Newport News facilities were towed close to the front. Once in position there, they were able to keep the ships of Star Fleet in constant repair, whereas the Klingons possessed no such facility until after the war. Nevertheless, the Klingons actually launched the first truly mobile repair facility, the S-8, on Stardate 2/1208; it was this model that inspired the Pearl Class.

The repair facility has the ability to actually manufacture almost all components needed to keep the warships in repair. With limited onboard space, the repair facilities are always accompanied by several freighters carrying the spare parts needed. When in operation, a Pearl Class facility is surrounded by its compliment of worker bees and manned pods, giving it an appearance reminiscent of a Terran beehive.

Of the 140 mobile repair facilities built, 124 are in active service, 2 are in reserve fleets, 4 are used by Star Fleet Training Command, 6 have been destroyed, 1 is listed as missing, 2 have been scrapped, and 1 has been sold to a commercial concern. Pearl Class facilities generally are produced at Morena, though some actually have been built by other Pearl Class facilities. The production rate for this facility is three per year.

Construction Data:

Model Numbers-	MK I
Ship Class-	VII
Date Entering Service-	2/1212
Number Constructed	140

Hull Data:

Superstructure Points-	12
Damage Chart-	B
Size	
Length-	360 meters
Width-	200 meters
Height-	85 meters
Weight-	79,445 tons
Cargo	
Cargo Units-	700 units
Cargo Capacity-	35,000 tons
Landing Capability-	none

Equipment Data:

Control Computer Type-	L-14
Transporters-	
Standard 6-person-	2
Emergency 22-person-	2
cargo small -	2
cargo large -	2

Other Data:

Crew-	220
Troops-	none
Passengers/engineers-	140
Shuttlecraft-	18

Engines and Power Data:

Total Power Units Available-	16
Movement Point Ratio-	3/1
Warp Engine Type-	FWD-1
Number-	1
Power Units Available-	10
Stress Charts-	K/F
Maximum Safe Cruising Speed-	Warp 6
Emergency Speed-	Warp 8
Impulse Engine Type-	FIC-3
Power Units Available-	6

Weapons and Firing Data: none!

Shields Data:

Deflector Shield Type-	FSB
Shield Point Ratio-	1/2
Maximum Shield Power-	5

Defense Factor- 40.2

Weapon Damage Factor- none

[<<<< GO BACK](#)

IMPORTANT NOTE:

It is entirely possible that you have surfed to this page from an internet portal and are now viewing this page without frames. **The STSSTCSMU&A is best**

viewed from within its own set of frames, so [click here to jump to the main STSSTCSMU&A web page](#) and then [see the site as it was meant to be seen!](#)

GREYHOUND CLASS WARP SHUTTLE

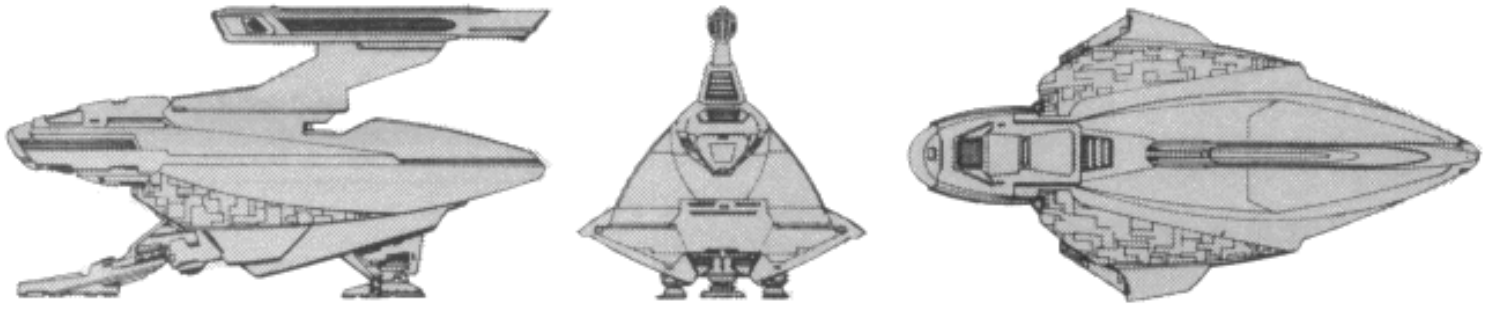

[Click here if you want to view this ship in its own window](#)

BRAD'S COMMENTS: Strange looking and unarmed, this warp shuttle really doesn't have much purpose in the game, other than as a plot device..



From the FASA Star Trek FEDERATION SHIP RECOGNITION MANUAL, circa 1985

Greyhound Class I Warp Shuttle

Notes: Of the 1,910 Greyhound Class warp shuttles built, 1,342 Mk Is and 456 Mk IVs remain in active service; 40 Mk Is and 20 Mk IVs are used by Star Fleet Training Command; 28 Mk Is and 8 Mk IVs have been destroyed; 4 Mk Is and 4 Mk IVs are listed as missing; 2 Mk Is have been scrapped; and 6 Mk Is have been sold to civilian commercial concerns. The Mk IV is used commercially by Universal Parcel Service and is a very common sight around spaceports. Greyhound Class vessels are produced at the Sol II, Sol VI, Andor, Tellar, Cait, Salazaar, and Merak shipyards. The combined production rate is 170 Mk Is and 160 Mk IVs per year.

Construction Data:

Model Numbers-	MK I	MK IV
Ship Class-	I	I
Date Entering Service-	2/1612	2/2009
Number Constructed	1,422	488

Hull Data:

Superstructure Points-	1	1
Damage Chart-	C	C
Size		
Length-	32 meters	34 meters
Width-	16 meters	16 meters
Height-	16 meters	16 meters
Weight-	4,210 tons	4,210 tons
Cargo		
Cargo Units-	4 units	16 units
Cargo Capacity-	200 tons	800 tons
Landing Capability-	yes	yes

Equipment Data:

Control Computer Type-	L-12	L-12
Transporters-		
Standard 3 person-	1	1

Other Data:

Crew-	2	2
Passengers-	12	6

Engines and Power Data:

Total Power Units Available-	7	7
Movement Point Ratio-	1/4	1/4
Warp Engine Type-	FWA-1	FWA-1
Number-	1	1
Power Units Available-	6	6
Stress Charts-	F/G	F/G
Maximum Safe Cruising Speed-	Warp 8	Warp 8
Emergency Speed-	Warp 9.9	Warp 9.9
Impulse Engine Type-	FIA-1	FIA-1
Power Units Available-	1	1

Weapons and Firing Data: none! none!

Shields Data:

Deflector Shield Type-	FSA	FSA
Shield Point Ratio-	1/1	1/1
Maximum Shield Power-	12	12

Defense Factor- 57.0 57.0

Weapon Damage Factor- none none

[<<<< GO BACK](#)

IMPORTANT NOTE:

It is entirely possible that you have surfed to this page from an internet portal and are now viewing this page without frames. **The STSSTCSMU&A is best viewed from within its own set of frames**, so [click here to jump to the main STSSTCSMU&A web page](#) and then [see the site as it was meant to be seen!](#)

PULSAR CLASS WARP SHUTTLE

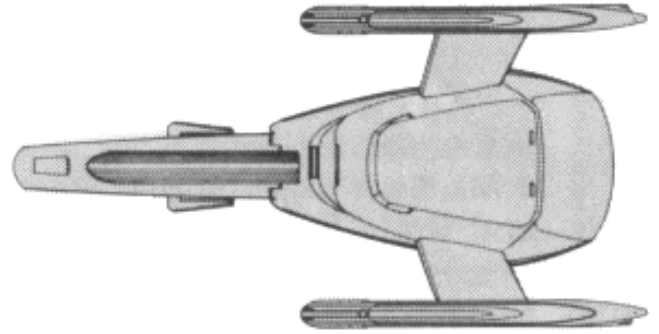
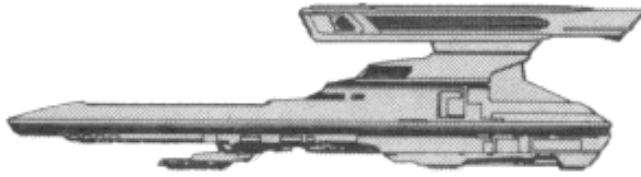

[Click here if you want to view this ship in its own window](#)

BRAD'S COMMENTS: The later model Pulsar actually has some phasers on it, but with barely 3 superstructure points, what is the purpose?



From the FASA Star Trek FEDERATION SHIP RECOGNITION MANUAL, circa 1985

Pulsar Class II Warp Shuttle

Notes: Of the 1,692 Pulsar Class warp shuttles built, 1,459 Mk Is and 159 Mk IIs remain in active service. Of the remainder, 40 Mk Is and 6 Mk IIs are used by Star Fleet Training Command, 18 Mk Is have been destroyed, 2 Mk Is and 1 Mk II are listed as missing, 4 Mk Is have been scrapped, and 3 Mk Is have been sold to private individuals. This Warp shuttle is also commercially available and is used by several transit companies, most notably the Galactic Trailways Corporation. The Pulsar is manufactured at the Sol II, Sol III, Sol V, Alpha Centauri, and Morena facilities. The combined production rate is currently 185 Mk Is and 22 Mk IIs per year.

Construction Data:

Model Numbers-	MK I	MK II
Ship Class-	II	II
Date Entering Service-	2/1608	2/1702
Number Constructed	1,530	166

Hull Data:

Superstructure Points-	2	3
Damage Chart-	C	C
Size		
Length-	40 meters	40 meters
Width-	21 meters	21 meters
Height-	9 meters	9 meters
Weight-	9,175 tons	9,675 tons
Cargo		
Cargo Units-	15 units	20 units
Cargo Capacity-	650 tons	1,000 tons
Landing Capability-	yes	yes

Equipment Data:

Control Computer Type-	L-14	L-14
Transporters-		
Standard 6 person-	1	1

Other Data:

Crew-	2	3
Passengers-	16	10

Engines and Power Data:

Total Power Units Available-	14	14
Movement Point Ratio-	1/1	1/1
Warp Engine Type-	FWA-1	FWA-1
Number-	2	2
Power Units Available-	6	6
Stress Charts-	G/K	G/K
Maximum Safe Cruising Speed-	Warp 7	Warp 7
Emergency Speed-	Warp 9	Warp 9
Impulse Engine Type-	FIA-2	FIA-2
Power Units Available-	2	2

Weapons and Firing Data:

	none!	
Beam Weapon Type-		FH-1
Number-		2
Firing Arcs-		1f/p/s, 1a/p/s
Firing Chart-		F
Maximum Power-		2
Damage Modifiers-		none

Shields Data:

Deflector Shield Type-	FSD	FSD
Shield Point Ratio-	1/2	1/2
Maximum Shield Power-	12	12

Defense Factor-	59.8	59.8
Weapon Damage Factor-	none	1.0

[<<<< GO BACK](#)

IMPORTANT NOTE:

It is entirely possible that you have surfed to this page from an internet portal and are now viewing this page without frames. **The STSSTCSMU&A is best viewed from within its own set of frames**, so [click here to jump to the main STSSTCSMU&A web page](#) and then [see the site as it was meant to be seen!](#)

SW-21 CLASS WARP SHUTTLE

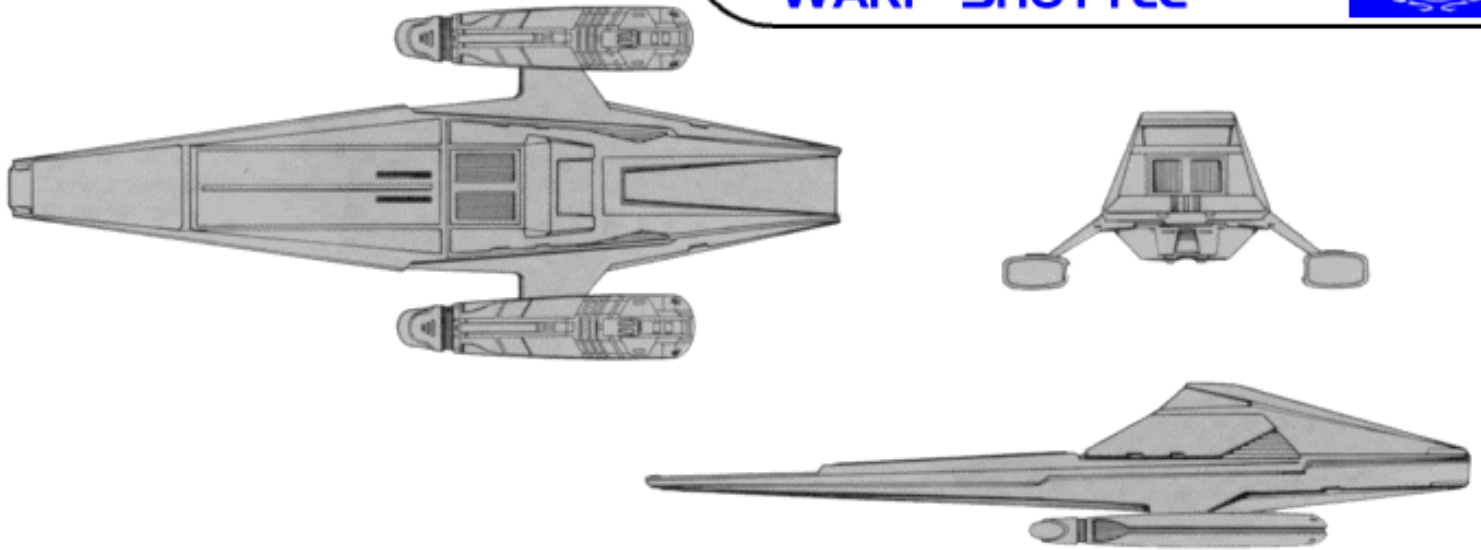

[Click here to view this ship in its own window](#)

BRAD'S COMMENTS: Unarmed and possessing no combat capabilities, the SW-21 is a neat-looking ship that I have always assumed is the grandchild of the Vulcan warp sled w/ shuttle that Spock uses in the first Star Trek movie. It appears sleek and fast, and its only real use in a game is as a plot device, that must either be captured or destroyed, or protected against capture and destruction.

Construction Data:

Model Numbers-	MK I
Ship Class-	1
Date Entering Service-	2/9709
Number Constructed	1,500

Hull Data:

Superstructure Points-	3
Damage Chart-	C
Size	
Length-	70 meters
Width-	30 meters
Height-	15 meters
Weight-	2,360 tons
Cargo	
Cargo Units-	4 unit
Cargo Capacity-	200 tons
Landing Capability-	Yes

Equipment Data:

Control Computer Type-	unknown
Transporters-	none

Other Data:

Crew-	2
Passengers-	10
Shuttlecraft-	none

Engines and Power Data:

Total Power Units Available-	5
Movement Point Ratio-	1/1
Warp Engine Type-	FWMA
Number-	2
Power Units Available-	2
Stress Charts-	A/A
Maximum Safe Cruising Speed-	Warp 8
Emergency Speed-	Warp 9.9
Impulse Engine Type-	FMIA-1
Power Units Available-	1

Weapons and Firing Data: none!

Shields Data: navigational only!

Defense Factor- unknown

Weapon Damage Factor- unknown

[<<<< GO BACK](#)

IMPORTANT NOTE:

It is entirely possible that you have surfed to this page from an internet portal and are now viewing this page without frames. **The STSSTCSMU&A is best viewed from within its own set of frames**, so [click here to jump to the main STSSTCSMU&A web page](#) and then [see the site as it was meant to be seen!](#)

ILLUSTRIOUS CLASS CARRIER

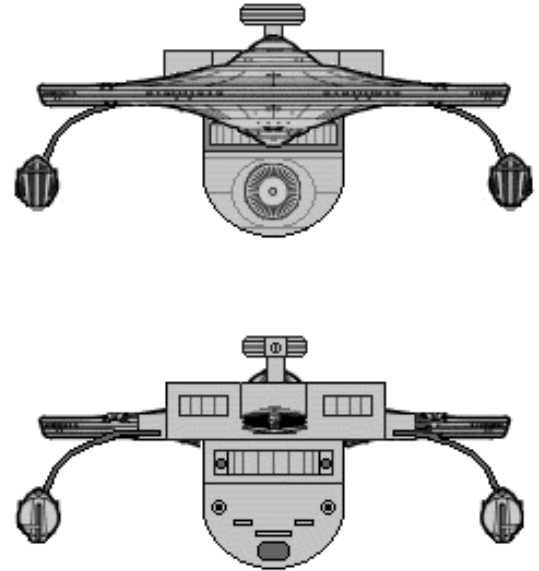
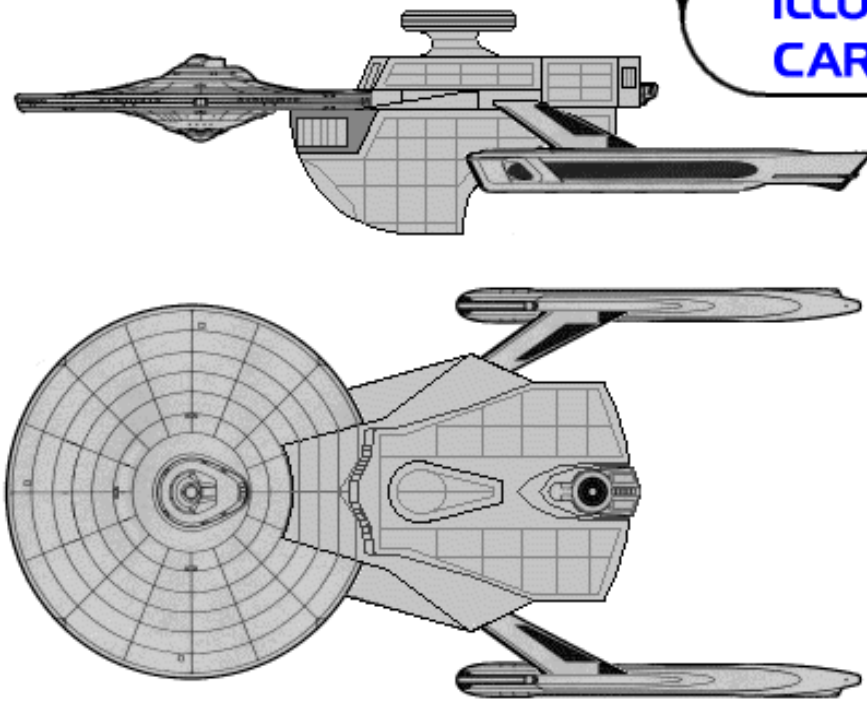

[Click here if you want to view this ship in its own window](#)

BRAD'S COMMENTS: Okay, I just want to say right now that Glenn's fanship is probably the best fanship I have looked at yet. This guy has truly gone the extra mile and produced an extremely attractive vessel. He even has a model(?) built for it. Amazing! The Illustrious class is different in that it is a carrier designed to tote fighters. Glenn sez he will try and build stats for the fighters at a later time. For now, I find the looks of the illustrious to be very believable. That secondary hull is huge and roomy, with lots of hangar doors on the fore and aft surfaces for spacecraft launch and retrieval. All the parts are in scale too, which gets Glenn extra kudos from me. Saucers and warp nacelles being out of proportion is a huge turn-off to me, especially where fanships are concerned. Glenn also wrote up some good backstory, though it may confuse those fans out there who are not aware of the Kzinti. The Kzinti are an aggressive felinoid race that famed hard SF writer Larry Niven created for his [Known Space](#) universe. When one of Larry's stories for Known Space ("The Soft Weapon") got picked up for the short-lived Trek animated series, the Kzinti from the tale were retained as bad guys. Official canon has never acknowledged this, but there are lots of fans who loved the animated series. For myself, I am a voracious Niven reader so I was charmed to see Glenn's references to the Kzinti in the backstory for his superb fanship.



FANSHIP DESIGN & STATS: [Glenn Gagnon, 2002](#)

Illustrious Class XII Strike Carrier

NOTES: Shortly before the events leading to the Genesis Incident, Starfleet noted an increase in the number of outlying colonies and native systems being attacked by small, swift craft. These were often operated by the Kzinti and a few Orion interests. The standard defenses of monitors and corvettes were not effective against these fast-attack craft, and Starfleet's fighter-carriers were too few and too slow to respond in the time needed. A rapid-response light carrier was needed, and the Illustrious-class carrier was the end result. Although not as fast as a Constitution (Enterprise)-class vessel, the Illustrious-class is still far quicker than standard carriers. A wing of up to 47 fighters and auxiliary craft could be brought to a hot zone, where the low-warp-capable fighters could jump into a hostile area while the carrier stood off, usually just outside the system or just out of easy reach of an enemy.

The Illustrious-class is not extremely heavy in armament, just enough for a potent defense. They rely on their fighter contingent for primary defense, along with good shield capabilities. The Illustrious-class is manufactured at the Sol IV (Utopia Planitia) Fleet Yards.

The first operational deployment saw the U.S.S. Illustrious herself becoming the flagship of a 13-vessel task force sent to investigate and prevent incursions by the Kzinti. The Illustrious recovered a near-derelict vessel containing several members of the Kzinti ruling council, victims of a coup engineered by a Romulan splinter group. This group was the driving force behind the Kzinti acquiring cloaking technology for their fighter carriers (or "space-control ships"), thus enabling the daring raids upon several border systems and scientific outposts. The task force was able, after several skirmishes with Kzinti forces, to repatriate the ousted Kzinti leadership, and establish a basis for normalized diplomatic relations approximately a year later.



[Click to enlarge model picture!](#)

Of the 12 Illustrious-class vessels commissioned, 11 are on active duty, and one is assigned to Starfleet Training Command.

Construction Data:

Model Numbers-	MK I
Ship Class-	XII
Date Entering Service-	2/2406
Number Constructed	12

Hull Data:

Superstructure Points-	32
Damage Chart-	C
Size	
Length-	330 meters
Width-	147 meters
Height-	86 meters
Weight-	198,000 tons
Cargo	
Cargo Units-	variable
Cargo Capacity-	variable
Landing Capability-	None

Equipment Data:

Control Computer Type-	M-6A
Transporters-	
Standard 6-person-	4
Combat 20-person-	1
Emergency 22-person-	4
cargo large-	2
cargo small-	1

Other Data:

Crew-	440
Air Wing-	150
Passengers-	30
Shuttlecraft-	15
Fighters-	32

Engines and Power Data:

Total Power Units Available-	68
Movement Point Ratio-	5/1
Warp Engine Type-	FWG-1
Number-	2
Power Units Available-	26
Stress Charts-	F/H
Maximum Safe Cruising Speed-	Warp 7
Emergency Speed-	Warp 8
Impulse Engine Type-	FIF-2
Power Units Available-	16

Weapons and Firing Data:

Beam Weapon Type-	FH-11
Number-	6 in three banks
Firing Arcs-	2f/p, 2f, 2f/s
Firing Chart-	Y
Maximum Power-	10
Damage Modifiers	
+3	(1 - 10)
+2	(11 - 17)
+1	(18 - 24)
Beam Weapon Type-	FH-8
Number-	3 in three banks
Firing Arcs-	1pa, 1a, 1s/a
Firing Chart-	T
Maximum Power-	5
Damage Modifiers	
+3	
+2	(1 - 10)

+1	(11 - 18)
Missile Weapon Type-	FP-4
Number-	2
Firing Arcs-	F
Firing Chart-	S
Power To Arm-	1
Damage-	20

Shields Data:

Deflector Shield Type-	FSP
Shield Point Ratio-	1/4
Maximum Shield Power-	16

Defense Factor-	(classified)
Weapon Damage Factor-	(classified)

[<<<< GO BACK](#)

IMPORTANT NOTE:

It is entirely possible that you have surfed to this page from an internet portal and are now viewing this page without frames. **The STSSTCSMU&A is best viewed from within its own set of frames**, so [click here to jump to the main STSSTCSMU&A web page](#) and then [see the site as it was meant to be seen!](#)



COCHRANE CLASS COLONIAL TRANSPORT

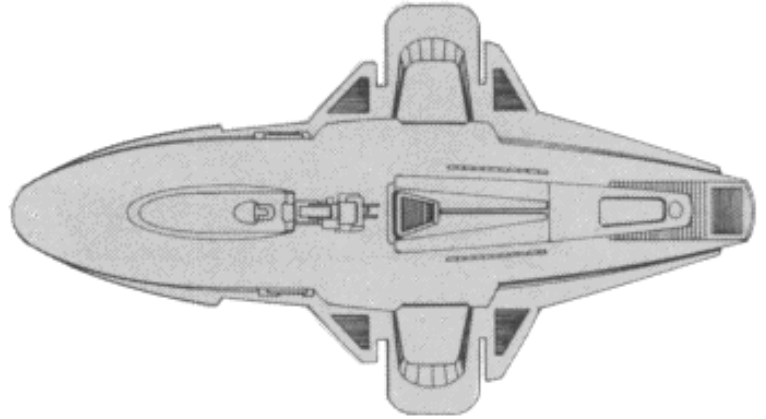
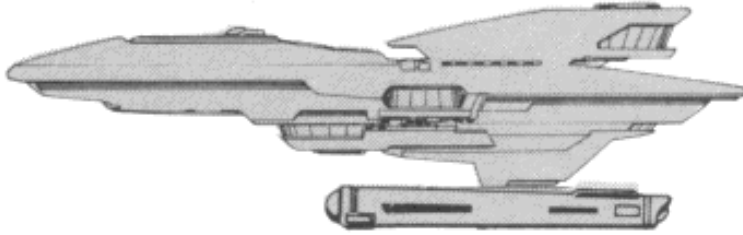
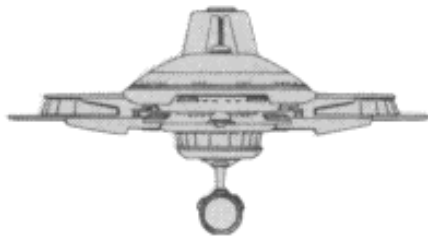

[Click here if you want to view this ship in its own window](#)

BRAD'S COMMENTS: named after the (obviously) creator of Earth Warp Drive, I have always liked this design. It has a sharp, arrowheaded appearance that is both streamlined and symmetrical. The large, visible shuttle bays make good sense because the craft cannot rely on transporters alone to accomplish its task. Also, the centerline warp engine mounted on the ventral surface of the craft looks like nothing so much as a keel. All in all, the Cochrane seems like nothing so much as a 23rd century caravel, bound for literally new worlds with a hold full of hopeful colonists. As such, it makes a decent plot device for Kirk-era campaigns, with the Federation player(s) having to defend small flotillas of Cochranes against raiding Klingon and Romulan warships. It even has some teeth to it, albeit baby teeth compared to even small UFP destroyers. The Cochrane might be able to lob occasional glancing blows from behind a screen of escorts, but it can't last long in a melee by itself.



From the **FASA Star Trek FEDERATION SHIP RECOGNITION MANUAL**, circa 1985

Cochrane Class VI Colonial Transport

Notes: The Cochrane Class ships are used by Star Fleet Colonial Operations Command to transport Federation colonists to new unexplored worlds. Each vessel has the capacity to carry up to 2,400 passengers and their necessities. These ships travel in large groups and are always escorted by the ships of Military Command.

When a new, undeveloped world has been charted and readied for colonization, Cochranes are prepared and colonists recruited. The number of ships used depends on the size of the world to be settled and the rate of development required by the UFP Council. The largest colonial convoy to date has been the Star's End settlement of Stardate 2/0310, in which 42 Cochranes were used. They carried over 100,000 colonists and were accompanied by freighters and transports carrying over 10,000,000 tons of supplies and building materials.

Cochranes are armed only as a protective measure. The weapons have never been used on any of these ships, largely because they are always accompanied by armed escorts.

On Stardate 2/0904, six Cochranes and their escorts disappeared while en route to New Deimos. These vessels have never been found and are listed as missing. The colonial expedition consisted of 13,200 colonists and 1,250 Star Fleet officers and men. Many people have speculated that the Gorn were responsible, but no evidence has surfaced to bear this out.

Of the 308 Cochranes built, 120 Mk IIs remain in active service, with 58 Mk Is and 12 Mk IIs in reserve fleets ready to be recalled when the need arises. Of the remainder, 6 Mk Is and 2 Mk IIs have been destroyed; 6 Mk Is are listed as missing; 12 Mk Is and 2 Mk IIs have been scrapped; and 64 Mk Is and 26 Mk IIs have been sold to civilian commercial concerns. The Cochrane, once actively produced at the Sol V facility, is no longer in production.

Construction Data:

Model Numbers-	MK I	MK II
Ship Class-	VI	VI
Date Entering Service-	1/9010-2/0802	2/0311
Number Constructed	206	162

Hull Data:		
Superstructure Points-	13	13
Damage Chart-	C	C
Size		
Length-	370 meters	370 meters
Width-	210 meters	210 meters
Height-	110 meters	110 meters
Weight-	61,415 tons	61,150 tons
Cargo		
Cargo Units-	4,800 units	4,800 units
Cargo Capacity-	240,000 tons	240,000 tons
Landing Capability-	None	None

Equipment Data:		
Control Computer Type-	L-13	L-13
Transporters-		
Standard 6-person-	10	10
Combat 20-person-	none	none
Emergency 22-person-	8	8
cargo small-	8	8
cargo large-	4	4

Other Data:		
Crew-	36	38
Passengers-	2,400	2,400
Shuttlecraft-	22	22

Engines and Power Data:		
Total Power Units Available-	10	10
Movement Point Ratio-	2/1 unloaded	2/1 unloaded
	5/1 loaded	5/1 loaded
Warp Engine Type-	FWE-1	FWE-1
Number-	1	1
Power Units Available-	8	8
Stress Charts-	F/I	F/I
Maximum Safe Cruising Speed-	Warp 7 unloaded	Warp 7 unloaded
	Warp 5 loaded	Warp 5 loaded
Emergency Speed-	Warp 9 unloaded	Warp 9 unloaded
	Warp 6 loaded	Warp 6 loaded
Impulse Engine Type-	FIB-1	FIB-1
Power Units Available-	2	2

Weapons and Firing Data:		
Beam Weapon Type-	FL-1	FH-1
Number-	2	2
Firing Arcs-	2f/p/s	2f/p/s
Firing Chart-	D	F
Maximum Power-	2	2
Damage Modifiers	none	none

Shields Data:		
Deflector Shield Type-	FSG	FSF
Shield Point Ratio-	1/1	1/2
Maximum Shield Power-	12	12

Defense Factor-	41.8 unloaded	47.0 unloaded
	37.4 loaded	38.2 loaded
Weapon Damage Factor-	0.8	1.0

[<<<< GO BACK](#)

IMPORTANT NOTE:

It is entirely possible that you have surfed to this page from an internet portal and are now viewing this page without frames. **The STSSTCSMU&A is best viewed from within its own set of frames**, so [click here to jump to the main STSSTCSMU&A web page](#) and then [see the site as it was meant to be seen!](#)

AAKENN CLASS FREIGHTER

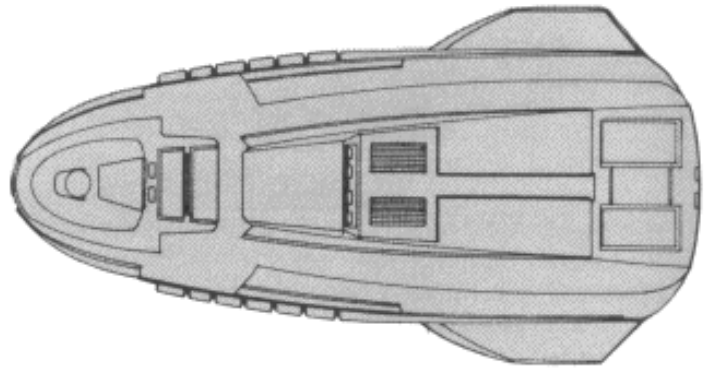
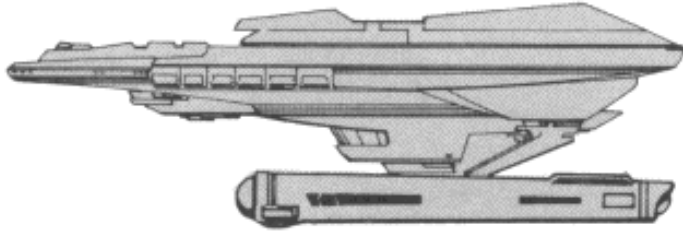
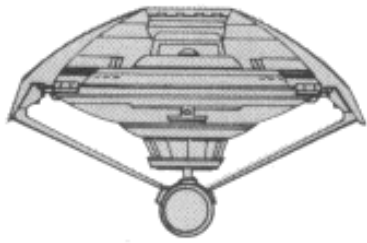

[Click here if you want to view this ship in its own window](#)

BRAD'S COMMENTS: Similar to the [Cochrane](#), though not as graceful. Another Kirk-era piece that can be good auxiliary fodder for scenarios with good guys out to keep the bad guys from blowing up the freighters. I have found it fun sometimes to run "Battle of the Atlantic" scenarios wherein a flotilla of Aakenn's escorted by UFP frigates or destroyers must fend off a menacing enemy fleet of cloaked Klingon or Romulan ships. It's a pretty straightforward re-enactment of the Allied defense against German submarine warfare in the early stages of World War II, and can be really fun if the players are clever. Make sure that neither the Klingon "wolfpacks" nor the UFP escort squadrons are overly powerful. destroyers and frigates, at most, if not scouts and escorts.



From the FASA Star Trek FEDERATION SHIP RECOGNITION MANUAL, circa 1985

Aakenn Class VI Freighter

Notes: The Aakenn Class freighter entered service during the Four Years War, during which the class was used to move men and materiel to the front and supplies to the rear to keep the Federation's wartime production at high levels. Presently, this freighter is a common sight on the spacelanes, with thousands in commercial service. Star Fleet uses its more than 100,000 tons of capacity to move all sorts of materials to the outer reaches of the Federation; because the vessel is not landing-capable, all cargo must be containerized and beamed aboard using the vessels 8 cargo transporters. As an added feature, the Aakenn has staterooms for up to 6 passengers; these small rooms, though not designed for luxurious travel, are reasonably comfortable.

On Stardate 2/1309, the *USS Mundy* was found adrift near Starbase 21. The vessel's onboard life support systems were operating, but there were no crewmembers aboard. The bridge area showed signs of a struggle, but nearly all computer files had been lost and there was no recorded data to reveal what had happened. The last entry in the Captain's Log, from about four months earlier, made no mention of any emergency or possible danger. When the cargo hold was breached, it was found to contain millions of live Tribbles, living on the food produced by a synthesizer that had somehow been left on.

The "Tribble Ship", as it came to be called, was taken into Starbase 21 where it was learned that it had been stolen two years earlier. This mystery remained unsolved until Stardate 212205, when two of its crewmembers were found in a nearby asteroid cluster, somehow having been missed when the search parties checked the area for survivors. They revealed that they had been boarded by a band of renegade Klingons, who, when they discovered that the cargo was Tribbles, became so infuriated that they killed the captain and officers and left the crewmen on the asteroid.

Of the 1,432 Aakenn Class freighters built, 244 Mk IIs and 760 Mk IVs remain in active service and 12 Mk IIs are in reserve fleets. One Mk II and 4 Mk IVs are used by Star Fleet Training Command; 186 Mk IIs and 102 Mk IVs have been destroyed; 17 Mk IIs and 8 Mk IVs are listed as missing; 119 Mk IIs and 71 Mk IVs have been scrapped; and 93 Mk IIs and 32 Mk IVs have been sold to commercial enterprises.

The Aakenn Mk IV is manufactured at the Tellar, Proxima Centauri, and Cait facilities at a combined rate of 30 per year.

Construction Data:

Model Numbers-	MK II	MK IV
Ship Class-	VI	VI
Date Entering Service-	1/9610	2/0312
Number Constructed	672	760

Hull Data:		
Superstructure Points-	10	10
Damage Chart-	C	C
Size		
Length-	190 meters	190 meters
Width-	100 meters	100 meters
Height-	60 meters	60 meters
Weight-	70,640 tons	71,010 tons
Cargo		
Cargo Units-	2,180 units	2,780 units
Cargo Capacity-	109,000 tons	139,000 tons
Landing Capability-	None	None

Equipment Data:		
Control Computer Type-	M-2	M-3
Transporters-		
Standard 6-person-	2	2
Combat 20-person-	none	none
Emergency 22-person-	none	none
cargo small-	4	4
cargo large-	4	4

Other Data:		
Crew-	54	58
Passengers-	6	6
Shuttlecraft-	6	6

Engines and Power Data:		
Total Power Units Available-	13	19
Movement Point Ratio-	2/1 unloaded	2/1 unloaded
	4/1 loaded	5/1 loaded
Warp Engine Type-	FWD-1	FWD-2
Number-	1	1
Power Units Available-	10	16
Stress Charts-	K/F	L/F
Maximum Safe Cruising Speed-	Warp 7 unloaded	Warp 6 unloaded
	Warp 6 loaded	Warp 4 loaded
Emergency Speed-	Warp 9 unloaded	Warp 8 unloaded
	Warp 7 loaded	Warp 6 loaded
Impulse Engine Type-	FIC-2	FIC-2
Power Units Available-	3	3

Weapons and Firing Data:		
Beam Weapon Type-	FL-3	FH-2
Number-	2	2
Firing Arcs-	1f/p/s, 1a/p/s	1f/p/s, 1a/p/s
Firing Chart-	G	H
Maximum Power-	2	3
Damage Modifiers		
+1	(1 - 4)	(1 - 10)

Shields Data:		
Deflector Shield Type-	FSF	FSH
Shield Point Ratio-	1/2	1/2
Maximum Shield Power-	10	13

Defense Factor-	46.9 unloaded	60.3 unloaded
	37.7 loaded	44.3 loaded

Weapon Damage Factor-	1.4	2.6
------------------------------	-----	-----

[<<<< GO BACK](#)

IMPORTANT NOTE:

It is entirely possible that you have surfed to this page from an internet portal and are now viewing this page without frames. **The STSSTCSMU&A is best viewed from within its own set of frames**, so [click here to jump to the main](#)

[STSSTCSMU&A web page](#) and then [see the site as it was meant to be seen!](#)

MOKAL CLASS TRANSPORT

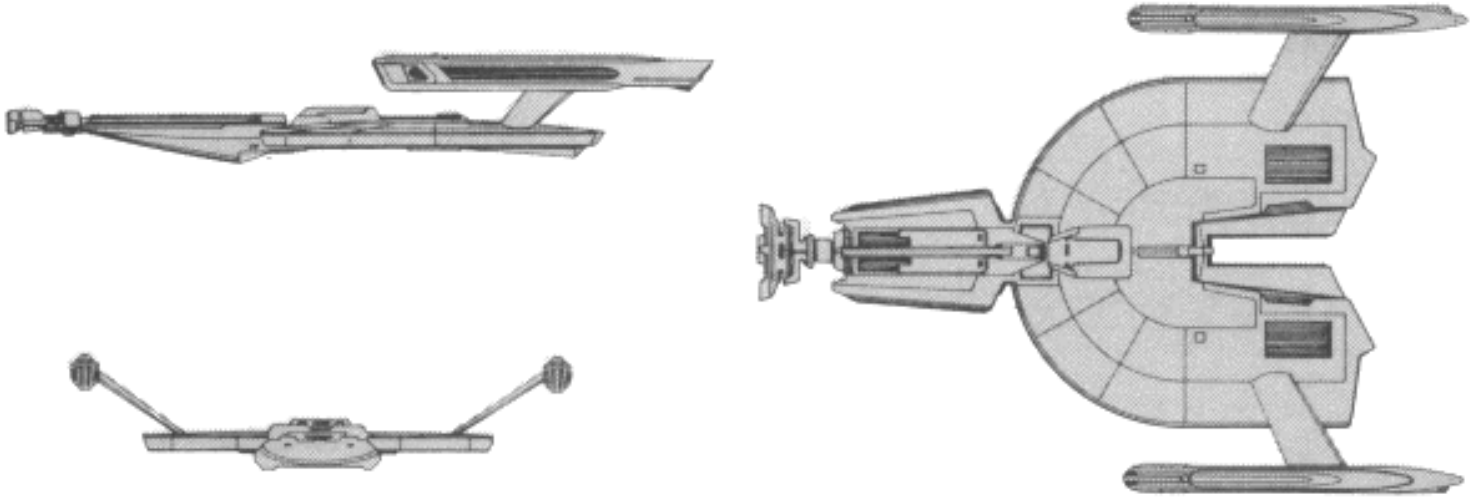

[Click here if you want to view this ship in its own window](#)

BRAD'S COMMENTS: The MoKal would appear to be a "pusher" type transport, in that it is merely a set of warp engines that can be attached to external cargo pods, freight boxes, or other such equipment, and then "push" that freight via warp speed. The text from the manual backs this up, though sadly we are never given a picture of what the MoKal looks like when it has freight attached, so the image above is misleading and incomplete at best.



From the FASA Star Trek FEDERATION SHIP RECOGNITION MANUAL, circa 1985

MoKal Class X Transport

Notes: The MoKal Class, the oldest of all Star Fleet's transport vessels, is designed to push its cargo pods from behind. The MoKal is used by Star Fleet throughout Federation space, and is operated by civilian concerns in all of known space. On Stardate 2/0804, the Mk I was commissioned into service; although it does not have the cargo capacity of later models, it is still in production because of its reliability and the need for moving cargoes in its particular tonnage range. The Mk I is used commercially by many corporations and transfer companies. On Stardate 2/1611, the Mk II was commissioned into service. This version of the MoKal is capable of transporting over 550,000 tons (11,000 SCU), an increase of 110% over the capacity of the Mk I.

Of the 360 MoKals built, 178 Mk Is and 113 Mk IIs are in active service, with 6 Mk Is in reserve fleets. One Mk I and 1 Mk II are used by Star Fleet Training Command; 21 Mk Is and 6 Mk IIs have been destroyed; 2 Mk Is are listed as missing; 20 Mk Is and 4 Mk IIs have been scrapped; and 6 Mk Is and 2 Mk IIs have been sold to civilian commercial concerns.

The MoKal is produced at the Sol V, Sol VI, and Morena facilities. The combined annual production rate is 18 of each model.

Construction Data:

Model Numbers-	MK I	MK II
Ship Class-	X	X
Date Entering Service-	2/0804	2/1611
Number Constructed	234	126

Hull Data:

Superstructure Points-	13	13
Damage Chart-	C	C
Size		
Length-	140 meters	140 meters
Width-	100 meters	100 meters
Height-	20 meters	20 meters
Weight-	145,200 tons	141,900 tons
Cargo		
Cargo Units-	5,100 units	11,000 units
Cargo Capacity-	255,000 tons	550,000 tons
Landing Capability-	None	None

Equipment Data:

Control Computer Type-	M-4	M-4
Transporters-		
Standard 6-person-	1	1

Other Data:

Crew-	28	30
Passengers-	6	6
Shuttlecraft-	4	4

Engines and Power Data:

Total Power Units Available-	44	48
Movement Point Ratio-	4/1 unloaded	4/1 unloaded
	6/1 loaded	6/1 loaded
Warp Engine Type-	FWF-1	FWG-2
Number-	2	2
Power Units Available-	20	22
Stress Charts-	G/L	H/K
Maximum Safe Cruising Speed-	Warp 6 unloaded	Warp 8 unloaded
	Warp 5 loaded	Warp 6 loaded
Emergency Speed-	Warp 8 unloaded	Warp 9 unloaded
	Warp 6 loaded	Warp 7 loaded
Impulse Engine Type-	FID-2	FID-2
Power Units Available-	4	4

Weapons and Firing Data:

	none!	none!
--	-------	-------

Shields Data:

Deflector Shield Type-	FSB	FSF
Shield Point Ratio-	1/2	1/2
Maximum Shield Power-	4	8

Defense Factor-

	59.2 unloaded	62.2 unloaded
	49.2 loaded	48.8 loaded

Weapon Damage Factor-

	none	none
--	------	------

[<<<< GO BACK](#)

IMPORTANT NOTE:

It is entirely possible that you have surfed to this page from an internet portal and are now viewing this page without frames. **The STSSTCSMU&A is best viewed from within its own set of frames**, so [click here to jump to the main STSSTCSMU&A web page](#) and then [see the site as it was meant to be seen!](#)

KETHKIN CLASS TRANSPORT

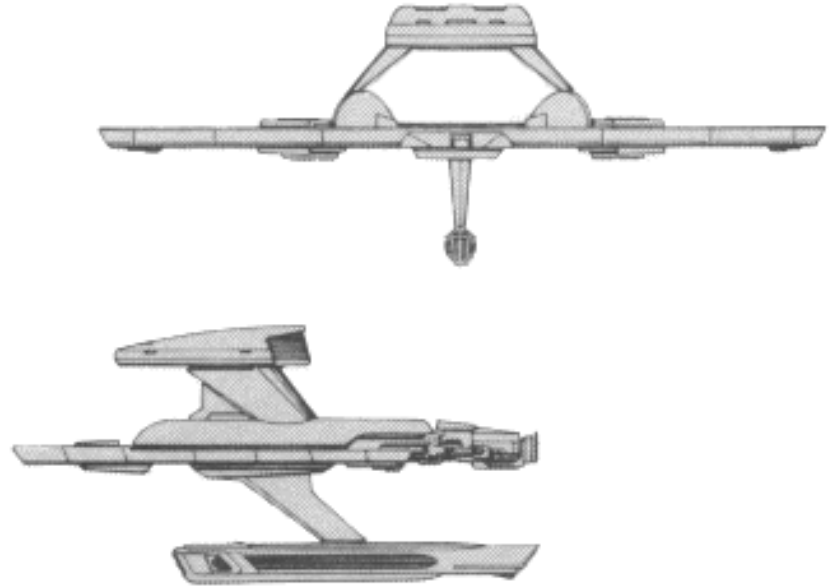
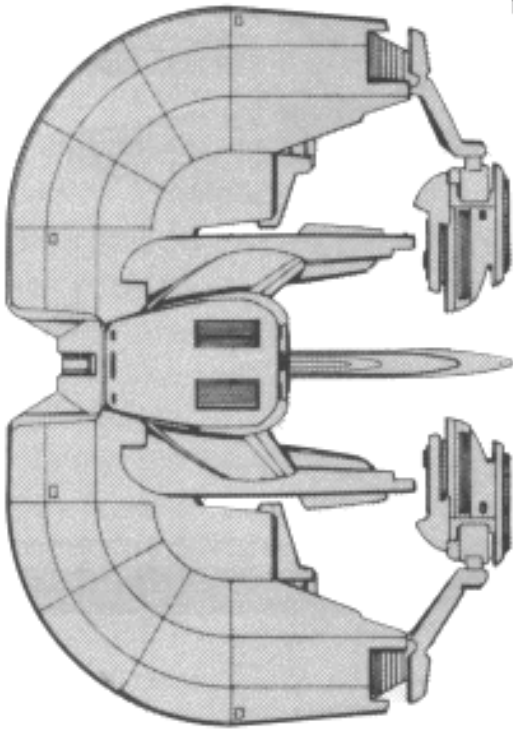

[Click here if you want to view this ship in its own window](#)

BRAD'S COMMENTS: Unlike the [MoKal](#), the Kethkin is a tower-transport ship, capable of hauling long trains of cargo carriers behind it in twin rows. Like the MoKal, the Kethkin graphic does not illustrate what the ship looks like when fully loaded, so the image is incomplete at best. Certainly this is an odd-looking vessel, cargo or no cargo, having little resemblance to anything else in Starfleet. The FASA designers also screwed up badly during the original creation of the stats for this ship, because they listed the Kethkin as having *two* warp engines, when the ship clearly possesses just *one* warp nacelle. I have corrected the stats accordingly.



From the FASA Star Trek FEDERATION SHIP RECOGNITION MANUAL, circa 1985

Kethkin Class IX Transport

Notes: The Kethkin tugs, which trail their cargo pods in two rows behind them, have an overall cargo capacity of more than 325,000 tons (6,500 units). When loaded to this capacity, these transports are sluggish and unmaneuverable.

To aid them in maneuvering during cargo pick-up or drop-off, the Kethkins carry 6 specially-designed craft called 'mules'. These little vessels push the pods into position for loading or move them away during unloading operations.

Of the 128 Kethkins built, 124 remain in active service. One is used by Star Fleet Training Command; 1 has been destroyed; 1 is listed as missing; and 1 has been scrapped due to structural damage suffered during loading operations.

The Kethkin is manufactured at the Tellar, Cait, Salazaar, and Sol VI facilities.

The combined rate of production is 28 per year. This vessel is commercially available.

Construction Data:

Model Numbers-	MK II
Ship Class-	IX
Date Entering Service-	2/1801
Number Constructed	128

Hull Data:

Superstructure Points-Damage Chart-Size	12 C
Length-	120 meters
Width-	170 meters
Height-	60 meters
Weight-	124,300 tons
Cargo	
Cargo Units-	6,500 units
Cargo Capacity-	325,000 tons
Landing Capability-	None

Equipment Data:

Control Computer Type-Transporters-	M-6
Standard 6-person-	2

Other Data:

Crew-	34
Passengers-	10
Shuttlecraft-	6

Engines and Power Data:

Total Power Units Available-Movement Point Ratio-	30 4/1 unloaded 7/1 loaded
Warp Engine Type-	FWG-1
Number-	1
Power Units Available-	26
Stress Charts-	D/F
Maximum Safe Cruising Speed-	Warp 8 unloaded Warp 5 loaded
Emergency Speed-	Warp 9 unloaded Warp 7 loaded
Impulse Engine Type-	FID-2
Power Units Available-	4

Weapons and Firing Data: none!

Shields Data:

Deflector Shield Type-	FSF
Shield Point Ratio-	1/2
Maximum Shield Power-	8

Defense Factor- 68.2 unloaded
52.4 loaded

Weapon Damage Factor- none

[<<<< GO BACK](#)

IMPORTANT NOTE:

It is entirely possible that you have surfed to this page from an internet portal and are now viewing this page without frames. **The STSSTCSMU&A is best viewed from within its own set of frames**, so [click here to jump to the main STSSTCSMU&A web page](#) and then [see the site as it was meant to be seen!](#)

LIBERTY CLASS FREIGHTER

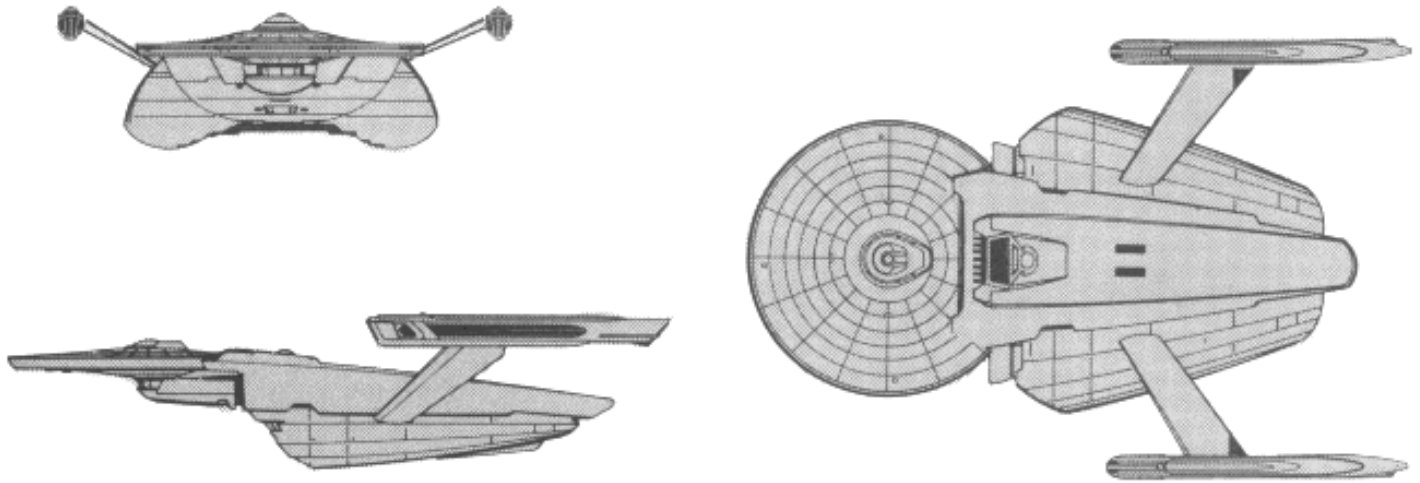

[Click here if you want to view this ship in its own window](#)

BRAD'S COMMENTS: Long, long ago, in a childhood far, far away, I actually built this ship as a crude cardboard and typing paper model, [in the same fashion as I built the USS Enterprise](#). Even more than the [Aakenn](#), the Liberty is ripped from history as an analog to the [Liberty Ship](#)--that 20th century hero of the Second World War which braved the dangerous Atlantic during the German "wolf pack" days. Like I stated with the Aakenn, it's fun to set up small flotillas of Liberty freighters, or even mixed-bag groups of Liberty, Aakenn, [Cochrane](#), [Lotus Flower](#), and other cargo vessels, then surround them with an escort fleet that must fight off a 'pack' of aggressive Klingon or Romulan raiders. I also like the design of the Liberty, as its warp nacelles are in scale with the saucer, and the overly massive secondary hull looks vast and roomy, just as a freighter's hold should be.



From the FASA Star Trek FEDERATION SHIP RECOGNITION MANUAL, circa 1985

Liberty Class VII Freighter

Notes: The Liberty Class freighters have been in the service of Star Fleet since Stardate 1/8806. For 35 years, these ships have plied the spacelanes, carrying untold quantities of goods and materials to all corners of the Federation. More than any other ship, the Liberty Class ships symbolize the UFP's commercial advance into known space.

These freighters were used extensively during the Four Years War to carry supplies into forward areas. For such missions, they were armed to help in protecting the convoys from Klingon ambush, but their light weapons were of little use against the sophisticated weapons of the Klingons. On one occasion, a convoy made up of 20 Liberties was attacked by a small group of Klingon ships. They managed to drive off the Klingons, destroying one with a loss of only two vessels.

Of the 1,260 Liberty Class freighters built, 161 Mk Is and 492 Mk IIIs remain in active service, with 68 Mk Is and 10 Mk IIIs in reserve fleets. Four Mk IIIs are used by Star Fleet Training Command; 188 Mk Is and 51 Mk IIIs have been destroyed; 24 Mk Is have been captured by the Klingons; 33 Mk Is and 9 Mk IIIs are listed as missing; 126 Mk Is and 18 Mk IIIs have been scrapped; and 48 Mk Is and 28 Mk IIIs have been sold.

Production of the Mk I was halted on Stardate 2/1203. The Mk III is produced at the Tellar, Cait, Morena, and Sol II facilities. The combined annual production rate is 32.

Construction Data:

Model Numbers-	MK I	MK III
Ship Class-	VII	VII
Date Entering Service-	1/8806	2/0609
Number Constructed	648	612

Hull Data:		
Superstructure Points-	10	11
Damage Chart-	C	C
Size		
Length-	240 meters	240 meters
Width-	160 meters	160 meters
Height-	50 meters	50 meters
Weight-	98,585 tons	99,690 tons
Cargo		
Cargo Units-	7,030 units	10,000 units
Cargo Capacity-	351,500 tons	500,000 tons
Landing Capability-	None	None

Equipment Data:		
Control Computer Type-	M-1	M-2
Transporters-		
Standard 6-person-	2	2
Combat 20-person-	none	none
Emergency 22-person-	none	none
cargo small-	6	6
cargo large-	4	4

Other Data:		
Crew-	70	72
Passengers-	20	20
Shuttlecraft-	8	8

Engines and Power Data:		
Total Power Units Available-	22	32
Movement Point Ratio-	3/1 unloaded	3/1 unloaded
	7/1 loaded	7/1 loaded
Warp Engine Type-	FWE-1	FWE-2
Number-	2	2
Power Units Available-	8	13
Stress Charts-	G/K	G/K
Maximum Safe Cruising Speed-	Warp 7 unloaded	Warp 7 unloaded
	Warp 4 loaded	Warp 4 loaded
Emergency Speed-	Warp 9 unloaded	Warp 9 unloaded
	Warp 5 loaded	Warp 5 loaded
Impulse Engine Type-	FIB-3	FIC-3
Power Units Available-	6	6

Weapons and Firing Data:		
Beam Weapon Type-	FL-2	FH-2
Number-	2	2
Firing Arcs-	1f/s, 1a/p	1f/s, 1a/p
Firing Chart-	F	H
Maximum Power-	2	3
Damage Modifiers		
+1		(1 - 10)

Shields Data:		
Deflector Shield Type-	FSG	FSH
Shield Point Ratio-	1/1	1/2
Maximum Shield Power-	10	13

Defense Factor-	38.6 unloaded	49.2 unloaded
	34.5 loaded	52.3 loaded

Weapon Damage Factor-	1.2	2.6
------------------------------	-----	-----

[<<<< GO BACK](#)

IMPORTANT NOTE:

It is entirely possible that you have surfed to this page from an internet portal and are now viewing this page without frames. **The STSSTCSMU&A is best viewed from within its own set of frames**, so [click here to jump to the main](#)

[STSSTCSMU&A web page](#) and then [see the site as it was meant to be seen!](#)

DERF CLASS TENDER

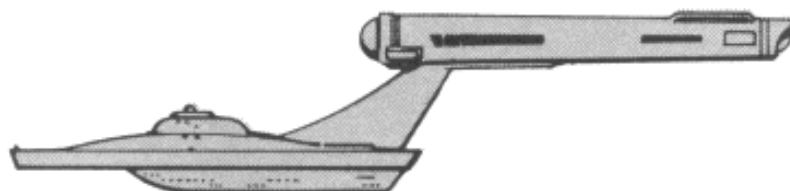
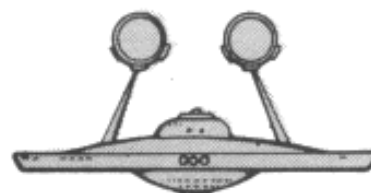
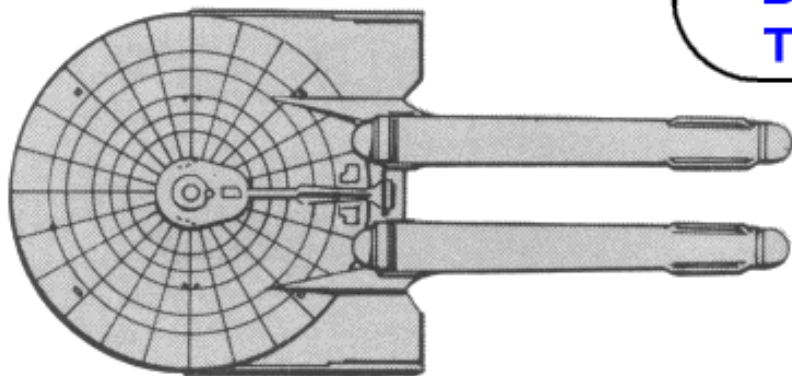

[Click here if you want to view this ship in its own window](#)

BRAD'S COMMENTS: Looking like a cross between the [Loknar](#) and the [Larson](#), the Derf is a pretty tough ship for a mere tender. The later models have up to 40 points of power to expend during battle, with a full spread of phasers firing into all arcs. Sure, the Derf is easy prey for more advanced Klingon and Romulan ships equipped with torpedoes, but the Derf actually handles itself well against older enemy vessels; especially those limited to beam weaponry, as the Derf itself is limited. Long ago, a friend of mine drew up some nice stats for a faux Derf frigate-type ship that was intended to act as a "wolf among the sheep" for scenarios involving Derfs. The idea being that the custom class had the outward appearance of the Derf, but was more heavily armed and armored, able to surprise attacking Klingons and Romulans who might attack a squadron of Derfs mistaking them for easy prey. I've since lost the stats, but like the idea, especially since the basic Derf stats are sound, and it doesn't take much tweaking to upgrade them to true cruiser or frigate standards.

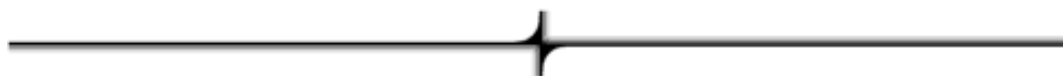

From the FASA Star Trek FEDERATION SHIP RECOGNITION MANUAL, circa 1985

Derf Class IX Tender

NOTES: The Derf Class tender has been operational in Star Fleet for more than 25 years. When it entered service on Stardate 1/9807, the Derf Class marked a new concept in navigational beacon repair. Before its introduction, marker buoys and navigational beacons had to be retrieved and returned to a repair facility to be serviced. Derf Class tenders eliminated this need because they carried repair facilities on board.

When a Derf arrives at a malfunctioning beacon's location, a shuttle uses a tractor beam on the beacon and tows it into the lower hull, which is the tender's main repair facility. The beacon is then placed on an assembly line and repaired robotically. When the work is finished, the shuttle tows the beacon back into the spacelanes, and the Derf moves on.

Although the Derf is not designed as a fighting vessel, it is capable of aggressive defense. Most repair missions take place along the borders between the major powers, where the chances of encountering enemy ships is very high. Because of this high risk, the Derf is armed with medium-range phasers.

This protection does not prevent them from falling prey to enemy ships. On Stardate 2/0702, the *USS Acropolis* responded to signals from a malfunctioning marker buoy. As its shuttle neared the beacon, a Klingon warship appeared and opened fire before defensive action could be taken. The volley crippled the *Acropolis'* engines, and the tender was boarded and towed into Klingon territory.

Intelligence later discovered that the beacon had been planted by Klingon operatives to entrap the repair tender. It is theorized that the Klingons gained technical information concerning robotics and repair techniques that they lacked, but it is not known just what gain this action brought them in the overall situation. Some analysts believe that study of the robotic repair systems will make it possible for Klingons to alter the functioning of navigation beacons robotically, creating potential havoc in border spacelanes.

Of the 545 Derfs built, 16 Mk Is, 362 Mk IIIs, and 68 Mk IVs remain in active service, and 38 Mk Is and 17 Mk IIIs are in reserve fleets. Two Mk Is and 2 Mk IIIs are used by Star Fleet Training Command; 12 Mk Is, 8 Mk IIIs, and 1 Mk IV have been destroyed; 1 Mk III has been captured by the Klingons; 1 Mk I and 3 Mk IIIs are listed as missing; 4 Mk Is, 4 Mk IIIs, and 2 Mk IVs have been scrapped; and 2 Mk Is have been sold to the private sector.

The Derf Class is built at Merak. The rate of production is 4 per year.

Construction Data:

Model Numbers-	MK I	MK III	MK IV
Ship Class-	IX	IX	IX
Date Entering Service-	2/9807	2/0403	2/1811
Number Constructed	180	396	71

Hull Data:

Superstructure Points-	14	14	17
Damage Chart-	C	C	C
Size			
Length-	274 meters	274 meters	274 meters
Width-	128 meters	128 meters	128 meters
Height-	65 meters	65 meters	65 meters
Weight-	126,860 tons	127,820 tons	133,120 tons
Cargo			
Cargo Units-	350 units	350 units	350 units
Cargo Capacity-	17,500 tons	17,500 tons	17,500 tons
Landing Capability-	None	None	None

Equipment Data:

Control Computer Type-	M-2	M-3	M-3
Transporters-			
Standard 6-person-	2	2	2
cargo-	1	1	1

Other Data:

Crew-	72	72	72
Passengers-	none	none	10
Shuttlecraft-	7	7	5

Engines and Power Data:

Total Power Units Available-	27	40	40
Movement Point Ratio-	3/1	2/1	2/1
Warp Engine Type-	FWD-1	FWD-2	FWD-2
Number-	2	2	2
Power Units Available-	12	18	18
Stress Charts-	L/G	M/G	M/G
Maximum Safe Cruising Speed-	Warp 7	Warp 6	Warp 6
Emergency Speed-	Warp 9	Warp 8	Warp 8
Impulse Engine Type-	FIC-2	FID-2	FID-2
Power Units Available-	3	4	4

Weapons and Firing Data:

Beam Weapon Type-	FH-4	FH-4	FH-4
Number-	4 in two banks	4 in two banks	6 in three banks
Firing Arcs-	2f/p, 2f/s	2f/p, 2f/s	2f/p, 2f/s, 2a
Firing Chart-	Q	Q	Q
Maximum Power-	3	3	3
Damage Modifiers			
+3			
+2	(1 - 8)	(1 - 8)	(1 - 8)
+1	(9 - 14)	(9 - 14)	(9 - 14)

Shields Data:

Deflector Shield Type-	FSH	FSH	FSI
Shield Point Ratio-	1/2	1/2	1/3
Maximum Shield Power-	12	12	12

Defense Factor-	64.0	92.0	102.0
Weapon Damage Factor-	10.4	10.4	15.6

[<<<< GO BACK](#)

IMPORTANT NOTE:

It is entirely possible that you have surfed to this page from an internet portal and are now viewing this page without frames. **The STSSTCSMU&A is best**

viewed from within its own set of frames, so [click here to jump to the main STSSTCSMU&A web page](#) and then [see the site as it was meant to be seen!](#)

M'BENGA CLASS HOSPITAL SHIP

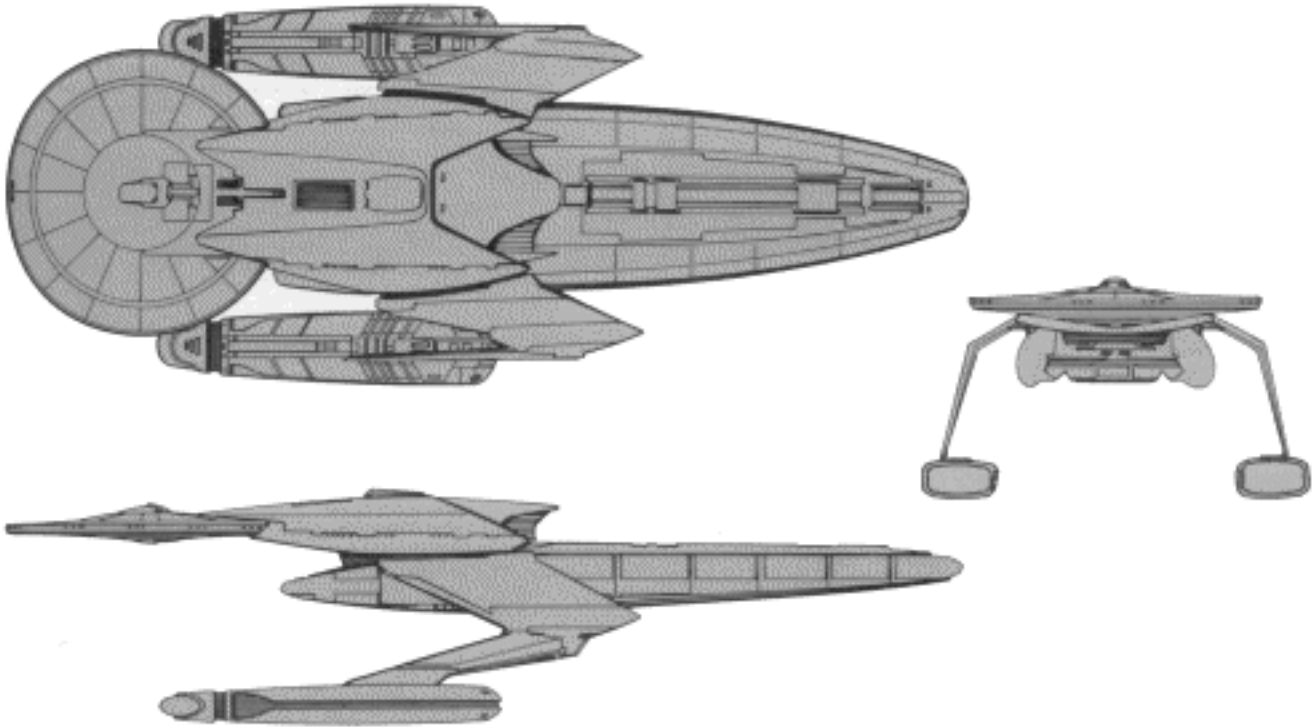

[Click here if you want to view this ship in its own window](#)

BRAD'S COMMENTS: The M'benga makes a rotten combat ship, being unarmed and all, but for TNG-era campaigns I believe the M'benga has an important role as a plot device. Like freighters and science vessels, the M'benga is ideal as that hapless ship that wanders into the neutral zone, or that requires protection by escorts while crossing uncharted territory, or that must be defended within a war flotilla posed against an enemy fleet. Certainly if the scenario involves hypothetical ground combat or the seizure of a planet, then several hospital ships might have to be standing by, ready to beam up the wounded at a moment's notice. These are just a few of the reasons I have found for playing the M'benga, a very different-looking ship with a very different kind of mission.

Construction Data:

Model Numbers-	MK I
Ship Class-	VI
Date Entering Service-	2/8003
Number Constructed	13

Hull Data:

Superstructure Points-	17
Damage Chart-	C
Size	
Length-	220 meters
Width-	88 meters
Height-	55 meters
Weight-	92,000 tons
Cargo	
Cargo Units-	900 units
Cargo Capacity-	45,000 tons
Landing Capability-	None

Equipment Data:

Control Computer Type-	M-2
Transporters-	
Standard 6-person-	6
Combat 20-person-	none
Emergency 22-person-	4
cargo small-	2
cargo large-	2

Other Data:

Crew-	130
Patient capacity (beds)-	170
Shuttlecraft-	4

Engines and Power Data:

Total Power Units Available-	40
Movement Point Ratio-	4/1
Warp Engine Type-	FWH-2
Number-	2
Power Units Available-	14
Stress Charts-	Q/R
Maximum Safe Cruising Speed-	Warp 6
Emergency Speed-	Warp 8
Impulse Engine Type-	FIF-1
Power Units Available-	12

Weapons and Firing Data: none!

Shields Data:

Deflector Shield Type-	FSN
Shield Point Ratio-	1/2
Maximum Shield Power-	16

Defense Factor- 75.31

Weapon Damage Factor- none

[<<<< GO BACK](#)

IMPORTANT NOTE:

It is entirely possible that you have surfed to this page from an internet portal and are now viewing this page without frames. **The STSSTCSMU&A is best**

viewed from within its own set of frames, so [click here to jump to the main STSSTCSMU&A web page](#) and then [see the site as it was meant to be seen!](#)

CLASSIFIED AUTHORIZED PERSONNEL ONLY

The **Federation Ship Recognition Manual** is intended for Star Fleet personnel with a "need to know" concerning information on the Star Fleet Vessels. This comprehensive study discloses all known combat, visual, and historical data on 42 different Federation ships and their variants. Also included is a chronology of service and silhouette recognition chart. This manual is a must for all *Star Trek* enthusiasts.

Shown on the front cover is a cutaway view of the Remora class VII escort. Shown on the back cover are the Scorpio class II corvettes.



STAR TREK is a trademark of Paramount Pictures Corporation and is used under exclusive license by FASA Corporation.
Copyright © 1985, 1986 Paramount Pictures Corporation
All Rights Reserved



ISBN 0-931787-42-4 FASA800