

A STAR FRONTIERS®

ALPHA DAWN ADVENTURE

Sundown on Starmist

By Garry Spiegle



Something ancient and powerful is hidden inside the pyramid constructed by the primitive alien culture. The crew of the UPF Centispeed must discover what it is to save the planet.

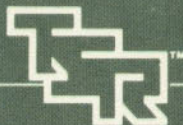

TSR, Inc.

PRODUCTS OF YOUR IMAGINATION™

DUNGEONS & DRAGONS, PRODUCTS OF YOUR IMAGINATION and STAR FRONTIERS are trademarks owned by TSR, Inc.

Sundown on Starmist

by Garry Spiegle

Editors: Marlene Weigel, Anne Gray
Cover Artist: Clyde Caldwell
Interior Artist: Jim Roslof
Maps: Dave LaForce
Graphic Design: Ruth Hoyer, Kitty Thompson

©1983 TSR, Inc. All Rights Reserved.

STAR FRONTIERS and PRODUCTS OF YOUR IMAGINATION are trademarks owned by TSR, Inc.

Distributed to the book trade in the United States by Random House, Inc. and in Canada by Random House of Canada Ltd.

Distributed to the toy and hobby trade by regional distributors.

Distributed in the United Kingdom by TSR (UK) Ltd.

This module is protected under the copyright laws of the United States of America. Any reproduction or other unauthorized use of the material or artwork contained herein is prohibited without the express written permission of TSR, Inc.

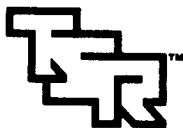

TSR, Inc.
PRODUCTS OF YOUR IMAGINATION™

TSR, Inc.
POB 756
Lake Geneva
WI 53147

TSR (UK) Ltd.
The Mill, Rathmore Road
Cambridge CB14AD
United Kingdom

Printed in USA
ISBN 0-88038-039-X
394-53461-1TSR0600

7803

Table of Contents

Introduction	2
How To Use This Module	2
Background for the Adventure	3
Plot Synopsis	4
The Rift Landing Site	5
General Notes	5
Random Encounters	5
Planned Encounters	5
The Heliopo Village	6
General Notes	6
Required Encounters	6
Planned Encounters	7
The War Tank	13
General Notes	13
Required Encounters	14
Planned Encounters	14
Sathar Training Base and Weapons Bunker	16
General Notes	16
Random Encounters	16
Required Encounters	16
Planned Encounters	16
Tables	22
Star System Brief	24
Alien Culture Background Report	24
Alien Creature Update File	25
Nonplayer Characters	26
Sathar Bio-genetic Constructs	27
Player Character Background Report	29
Pregenerated Characters	Cover
Maps	31-32

INTRODUCTION

Welcome to a new adventure in the *Star Frontiers*® role-playing game. You are about to enter the world of *Starmist* where you will meet strange beings and many dangers. Prepare yourself for fun and excitement!

This booklet is a guideline for the referee. If you are planning to be a player, stop reading now!

How To Use This Module

CONTENTS

Starmist is designed for the *Star Frontiers*® game and cannot be played without the Basic and Expanded Rule booklets. *Starmist* is played with four to eight player characters (PCs) of any game race. You may include additional non-player characters (NPCs) if there are fewer than four players.

The introduction which follows includes explanations of how to run the adventure using the parts of the module, background information that will explain the plot of the story so far, and a synopsis of the story as it will probably unfold during play. The center sections of the module are devoted to the adventure itself, and the sections get their titles from the major areas where the action takes place: the landing area, the village, the war tank, the Sathar bunker, and the Sathar training base. At the back of the module are the alien culture background report, the star system brief, profiles of creatures and major NPCs, and a list of pre-generated characters that may be used as either player characters or NPCs. On the cover and inside the booklet are also included maps keyed to the text.

The booklet contains two perforated pages designed to be removed and given to the players at the proper time. On these pages are the Player Character Background Report, Pre-generated Character List, Rift Landing Map for players, and the Village Map for players.

Abbreviations

Characters playing in this adventure will encounter aliens and numerous new creatures. The numbers of NPCs are scaled to four to eight players. If your game has a smaller or larger number, adjust the number of NPCs accordingly.

Abbreviations used in statistics are listed below:

MV: Movement	SD: Special Defense
IM: Initiative Modifier	NPC: Non-player Character
RS: Reaction Speed	RW: Ranged Weapon Score
STA: Stamina	M: Melee Score
ATT: Attack Score	
PS: Punching Score	
DM: Damage	RS: Reaction Speed
SA: Special Attacks	

Movement

Characters should use the movement factors listed in the *Star Frontiers*® rules. Standard movement is not affected by *Starmist*'s gravity or atmosphere (See System Brief page 24). Terrain affects movement as follows:

Plains: The plains area consists of rolling hills covered by grass 1-2 m high. Visual sighting for characters traveling on foot in the plains area is 10-100 m. If the characters ask how far they can see, roll 1d10 and multiply that result by 10. The total is the distance in meters that the characters can see before vision is blocked by intervening hills. The height of hills varies from 10-100 m and is found the same way.

Forest: Trees in the forests of *Starmist* grow 1-5 meters apart. They are of various sizes and shapes but most have drooping branches which block vision and hinder movement. Travel on foot is fairly easy but vision is limited to a maximum of 10 m. Vehicles can travel through the hanging branches but only at slow speeds. If the PCs wish to travel at any speed above that of a walking human, roll 1d10. On a roll of 1 or 10, the vehicle will run into a tree.

In the Air: If characters travel through the air in any manner, determine their distance

above ground level. Standard movement rates will apply to the method they are using to fly. However, if their altitude is 30 m or more, they will be shot down by the Sathar. Whatever vehicle the characters are in will crash and each character in the vehicle will take 2d10 of damage. The vehicle will be damaged beyond their ability to repair on this planet. Characters using parawings will fall to the ground from a near miss, taking 4d10 of damage.

On Water: Travel in, on, or over the water, is at rates listed in the *Star Frontiers*® rules. Random encounter rolls must be made by characters traveling in the air above the river. Characters attaining an altitude of 30 m or more can be shot down by the Sathar or, if they are within 30 m of the surface, they may be snatched by a gasp (see Alien Creature Update File on page 25).

Scaling Rifts: Characters begin play at the bottom of a rift 7 km deep. Temperature at more than 3 km above ground level is sub-freezing. Air pressure and temperature drop below life support levels at the top of the rift walls which are 7 km high.

Maps

Maps are included of the following areas: the rift landing site, the Heliopie village, the war tank, and the Sathar training base and weapons bunker. The maps given to players are those of the rift landing site and the Heliopie village.

Player Characters' Equipment

Starmist has been designed to enable players to use some of the many weapons and devices in the *Star Frontiers*® Rule Books. Even new, poorly outfitted characters will have a chance for success. If your players already have a variety of equipment, this may be a good time to let them bring it along.

Also, the VSS Last Legs may contain various kinds of equipment. In addition to possessions PCs already have, you may select whatever extra equipment you wish to allow in the game. Weapons such as rocket launchers and heavy lasers may be used, so if your players have such equipment or you would like them to have it, place it in the ship's hold for them to obtain. In general, vehicles should be avoided, but explorers and hovercycles can be used without problem. The native Heliopes have powerful pincers that can tear through the roof of a tough explorer car.

Following is a list of possible equipment:

- Any standard equipment desired from the Star Frontiers® Rule Books.
- Spacesuits are in the ship but are not usable as protection, cannot move well under normal gravity, and have no defense fields.
- Six rocket packs that will not move any character in a gravity field.
- Four passenger space launch, not usable in an atmosphere or gravity field.
- Laser power torch (20d10); ammo 300 SEU/clip; SEU 30; rate 1. Ammo (power pack) requires vehicle to carry (heavy/bulky); no variable SEU setting; used to cut heavy metal or as a weapon.

Random Encounters

Random encounters are those which you will use during the game to add excitement and action but which are not usually essential to play. The encounters are listed on tables and randomly chosen by means of die rolls. All random encounter tables are on p. 22; which table you are to use is indicated where the encounter takes place. A roll of 1d10 is made twice during the day and twice at night. A roll of 1 or 10 during the day or a 1, 5, or 10 at night will indicate an encounter. The exact hour of an encounter is up to you.

When using an encounter table, roll the dice required by the table and read the entry beside the number rolled. Check for any additional notes which may apply.

Required Encounters

Required encounters are essential to play and may take place at various times or at different locations on the map. As referee you may have to decide when and where the encounter will take place, so it is essential that you keep the encounters in mind during the game.

Planned Encounters

A planned encounter is usually essential to play but need not be. For example, many of the Heliopes village encounters beginning on p. 6 will not take place simply because the player characters do not choose to proceed there. However, when an encounter is essential a note to that effect will be included in the details. Material to be read to PCs telling what they see is indented at the beginning of the encounter.

The exact point in a scenario at which an encounter occurs will be up to you and the PCs. All encounters are numbered according to their number on the map.

Background for the Adventure

Planet History

The planet Starmist was formed eons ago around an unknown star. Because of a number of factors, including slow rotation, the planet never formed any extensive soil depth. The poor development of soil coincided with the slow development of life forms.

However, an orbital instability caused gravitational distortions in the bedrock so that massive splits occurred in the planet's crust. Huge rifts formed in the surface, much like gigantic canyons, many of them miles deep. The planet, unable to hold its orbit, swung wider and wider around the star, and finally hurtled into space, a cold, frozen ball of ice. After ages, it was captured by its present star, Sundown, taking up an orbit somewhat tighter than its original orbit. Gradually the planet warmed.

Water and atmosphere collected in the rifts and they slowly became habitable. Vegetable, insectoid and fish-like forms were the first to appear and are now fairly widespread in the rifts. Mammals and

related species are few in number.

The nights are very dark on Starmist because there is no moon and few close stars.

The Heliopes

There are no intelligent, competitive species native to Starmist. The Heliopes, the humanoid inhabitants of Starmist, are from a different system. They were slaves of a race called the Klikks, resembling the Vrusk, who explored the Sundown area. One of the military exploration vessels, mapping in the region of Starmist, had problems that required dumping any extra weight. Unloaded on Starmist were a war tank of advanced design and all nonessential personnel. Nonessential personnel included the Heliopes. Before leaving, the Klikks subjected the Heliopes to a mind-wipe that caused amnesia. Heliopes who survived on the planet filled in their missing past by making up legends and stories that eventually became their history. Culture among the Heliopes is shallow since they have developed on Starmist for only 600 years. The Heliopes religion is focused around the tank and relics left by the Klikks.

All Heliopes on Starmist are descendants of the original group. Now there are nearly 200 tribes spread out over five large rifts. These rifts are those explored by the Klikk ship. Heliopes are superb fighters, and they have competed successfully for food and space with native plant and animal life. There are only a few dozen tribes living in the rift where the *Starmist* adventure takes place, and warfare and violence among the tribes are common. A village developed by the Heliopes at the dump site is the first and only one of its kind. The village is located next to the river and contains reasonably complex homes. The buildings house families and their primitive government. The villagers are the only Heliopes who are not nomadic.

The War Tank

To the Heliopes whose culture had been erased in the mind-wipe, the abandoned tank was a mysterious object that "came from the sky." Its defense field gave them a pleasant sensation when touched. As a result, the tank soon took on a religious significance and helped them fill that void in their lives. Over the tank they built a wooden pyramid and in front of the pyra-

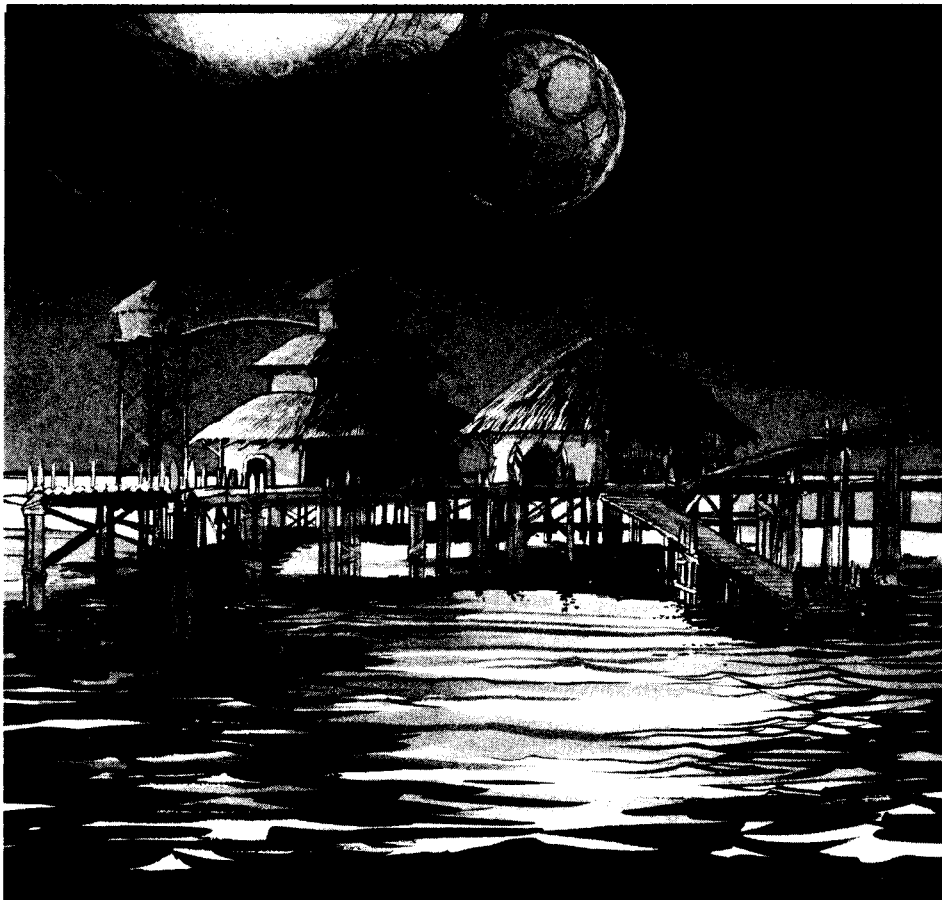

mid a temple. The wooden pyramid conceals the vehicle from view. Any other junked materials have been transferred to a group of huts on platforms over the river. The platforms are of different heights and the higher the platform, the more revered the object inside the hut. Only priests occupy the river buildings. No one is permitted on the platforms except those allowed by the gods, and the priests speak for the gods. Any attempt by the PCs to approach the island huts, temple, or pyramid will be opposed by the villagers.

Although impressed by the power of the PCs, the Heliopes will not be afraid to fight. All weapons carried by Heliopes are listed on p. 22.

The Sathar

Training alien agents has always been carried out far from any Sathar home planets because the Sathar seem to find other beings repellent. Several years ago

the Sathar established a training base for espionage agents on a lake close to the Heliopie village on Starmist. The Heliopie provided excellent cover for the Sathar operation. The Sathar have built a heavy weapons bunker and set up a watch on the Heliopie. Sathars also use the base to work on bio-genetic constructs such as the Slither (See Alien Creatures Update File in the Star Frontiers Expanded Rule Book).

A while ago the planet was discovered by the merchant ship carrying Maximillian Malligigg. Alarmed, the Sathar decided to use the delay between the time they sent their official report and the resulting investigation to evacuate the base. When the warships arrive and after evacuation is complete, the Sathar plan to destroy all life-forms on Starmist. The Sathar will let the PCs land since they plan mass destruction anyway, but they will shoot the PCs down if they try to leave.

While he was on Starmist, Malligigg found a piece of fused metal unlikely to be produced by a culture as primitive as the Heliopie. He suspected the metal was left by alien visitors or manufactured by an

ancient, advanced culture. Malligigg planned to return in his own ship to search for artifacts and treasure.

Plot Synopsis

The adventure on Starmist will follow a basic plot which is outlined below. To obtain maximum play value and fun, try to follow this plot outline as closely as possible.

Characters begin their adventure aboard Malligigg's ship, the VSS Last Legs. They have just landed in a giant rift on the planet. A basic list of equipment contained in the ship is on page 3. Maximillian Malligigg is aboard as owner and the PCs' employer. He has hired them to help him search for the source of the fused metal and any treasure or artifacts they can find. Max is important to the adventure, so you are encouraged to study his background on p. 26. You may change, delete, or add any equipment or NPCs as desired.

After equipping themselves from the ship, the characters should travel to the forest. There they will find non-native animals and plants which may give them a clue to the Sathar presence. The normal animals are those set free by the Sathar after their experiments. See the Sathar Bio-genetic Constructs described on p. 27. Then nomad Heliopes will attack and village Heliopes will come to the rescue.

Characters should then proceed to the village and attempt to locate the source of the fused metal. The Heliopie river ceremony will occur at the time the players first see or enter the village. They should take note of the strange lights flashing from the pyramid which betray the location of the tank. They should also note the sophisticated weapons worn by the Heliopie priests. While they are there, they must find Akhan's rod which is needed to enter the war tank. They will see more normal, non-native animals. Then characters must, during the course of their investigations, discover the war tank, find the way inside, and learn how to operate it.

Both before and after the characters have found the tank, the village will be attacked by Sathar robots. This will confirm Sathar involvement on Starmist. If the PCs follow the robots or their signal beams, they will locate the Sathar base hidden behind the holograph image. At the base they will find the bio-constructs of the non-native animals. They will then enter combat with the Sathar military bunker.

THE RIFT LANDING SITE

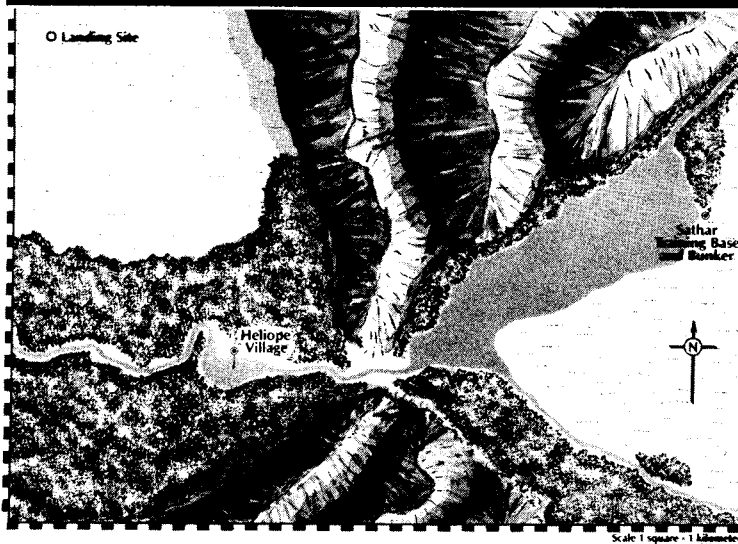

General Notes

Give the players the Rift Landing Map and the Player Character Background Report.

Eventually the PCs should reach the village; however, let them move toward and through the forest in any manner they wish.

Random Encounters

Roll for random encounters each day and night. Use Table 1, Normal Alien Plants and Animals, on p. 22. Also roll for an encounter with Starmist creatures from Table 2, on p. 22. The type of encounter you use will depend on the terrain over which the PCs are traveling.

Planned Encounters

1. START OF THE ADVENTURE

Spread before you is a deep rift valley, misty in the distance. On either side soar the towering stone walls of the rift, forbidding any ascent. Straight ahead, gentle rolling hills covered in tall waving grasses merge with a mass of green forest.

The VSS Last Legs has a Vrusk pilot and engineer who will under all circumstances remain with the ship. If for any reason character statistics are needed for them, use the average value of 45 for all races.

2. NOMADS AMBUSH PARTY

From 20 meters away all you can see of the forest is a dismaying tangle. But trees on the fringe show mighty trunks having an umbrella-like spread of flimsy branches reaching to the ground and covered with feathery leaves. The distance between one

trunk and another is ample for passage, although it is almost impossible to see a trunk until you are near it. This single species of tree dominates the forest, with many other varieties of the same species intermingled. Ground vegetation is sparse, and the soil firm and occasionally rocky.

As you enter the thick groupings of trees, masses of low hanging branches surround the party. Travel is slow and vision is limited. Suddenly you hear a loud screech and whizzing sounds as small stones fly past your ears. The stones seem to be coming from beneath the trees, and you glimpse what appears to be pincer-like hands.

7 Nomad Heliopes (STA 50; RS 55; PS pincers; IM 6; RW 28; M 28)

Trago-khan (STA 65; RS 45; PS pincers; IM 5; RW 23; M 30) Weapons: stone bullets.

Out of the trees burst the Heliopes led by Trago-khan. You may allow Maximillian to enter the battle but do not allow him to be killed as he will be necessary to the players later; adjust rolls if needed. If players are in a vehicle, it will not be able to maneuver in the close confines of the forest to escape. The overhead branches will prevent any lift upward by a flying vehicle. Allow the battle to progress as usual for a general melee for

several rounds. Go to encounter 2 only after the battle is well under way.

3. HERE COME THE VILLAGE HELIOPES!

During the melee you see four more of the creatures. These have painted tails. Their pincers are upraised and they are rushing forward. Maximillian yells that they are Heliopes from the village. One Heliopes is carrying an automatic weapon.

3 Village Heliopes (STA 50; RS 55; PS pincers; IM 6; RW 28; M 28)

Lekeekh (RW 28; M 30; PS pincers; IM 6; RS 55; STA 60) Weapons: automatic pistol holding 6 rounds; 4 extra clips.

The village Heliopes attack the nomads. If any PC fires at the newcomers the villagers will attack the PCs. It will be up to the PCs to straighten out the mistake. Anyone who asks what Maximillian is doing should be told that he is greeting the villagers in a friendly way. He has recognized they are villagers by their painted tails.

Lekeekh, leader of the rescuers, has an automatic pistol (see Table 3 on p.22) that is alien in design but its function is obvious to anyone with a military PSA. Lekeekh will not use it except in action against the PCs, and only then if attacked. Lekeekh is a sub-chief and can serve as the contact between the PCs and the villagers.

THE HELIOPE VILLAGE

General Notes

Show players the Heliope Village Map.

In general, the PCs should watch the river ceremony, explore the village, find Malligigg in the river complex, then proceed to the pyramid and discover the war tank. The PCs must find the small, black and red striped rod which will deactivate the defense field and open the rear hatch of the tank. They will see Akhan use such a rod during the river ceremony. One rod is normally kept in a small chest in Akhan's tower room (24) on the river platforms; he wears the other on a chain at his belt. On each rod is a metal tag with a stylized drawing of the tank stamped on it. If PCs wish to avoid the village, have Malligigg try to change their minds. If they persist, have Malligigg investigate the village separately.

The Heliope village is at present being ruled by three Heliopes, a chief, Rokakar, and two subchiefs, Chukak and Lekeekh. The Heliopes have one high priest, Akhan, and six lesser priests: Chaka, Gokul, Okalla, Edaku, Kuku, and Killok. Along with the chiefs, the priests rule the Heliopes. They direct all religious ceremonies, including a ritual during which they touch the surface of the war tank fin at the altar well on top of the holy pyramid. The shock of the tank's electric defense field gives Heliopes a pleasant sensation comparable to that produced in a human by a glass of wine, and their immunity to most electrical phenomena prevents their being harmed.

The priests and the chiefs possess technological equipment, such as weapons, salvaged from the Klikk relics. Because it is alien, the equipment will be unfamiliar in design to the PCs but they will recognize it as high-tech material. The statistics for the Klikk projectile weapons are the same as for the automatic pistol in the Star Frontiers Weapons Table. A Klikk would insert a long, sharp, foreleg into the conical tube and clench the tip to fire the weapon. The long pinners of a Heliope barely reach into the tube to fire the weapon, and Heliopes find using the weapons painful.

The architecture of the village is primitive and very much of a style. All huts are made of wood with wood shingle or thatched roofs. Buildings are rectangular and divided when needed by heavy movable screens that provide what little privacy is available. All the buildings are heavily carved. You may describe any carving you wish; specific carved scenes would include vague outlines of the war tank beneath the pyramid.

If the PCs have entered the village openly, the Heliopes will be friendly and curious about them; however, they shy away from Vrusks. An official delegation will attempt to find out what the PCs want. Play this as a town/city encounter, using average Heliope stats for villagers if needed. In general, Heliopes will allow the PCs free range of the village but will fight anyone who approaches the pyramid, temple or river huts. They will freely speak about their religious ceremonies or about the sacred relics in the huts on the river. Use the background information to guide you in responding to questions.

An empty hut (11) will be turned over to the PCs if they are friendly to the villagers and have not caused trouble.

Required Encounters

A. RIVER CEREMONY

You hear the sound of large wooden trumpets being blown by the Heliopes. As you watch, all the villagers gather along the route from the river complex bridge to the door of a building in front of the pyramid. A Heliope dressed in ceremonial attire steps from a doorway in the highest tower of the river complex and starts across the bridge. As he passes through the complex he is joined by six others. You can see that all are carrying various pieces of technical equipment made from artificial materials. They proceed into the building in front of the pyramid and up a

wooden walkway to a platform at the pyramid's summit. The other villagers have followed and now surround the pyramid.

On the highest platform the leader of the Heliopes removes a red and black striped rod from his robes and extends it down into what looks like an opening. There is a flash of light. All the onlookers cry out in awe. The leader and one of his party reach out, placing their hands into the well. The strange light flashes again and the two Heliopes sway happily as though they enjoy the contact.

The others in the lead group now approach the opening two at a time and stretch out their hands to the flash of light. When they finish, Heliopes from the crowd bring objects to the leader who examines them. Some of the Heliopes are allowed to mount the platform and perform the strange ceremony. Others are turned away. When all have had their turns, the gathering breaks up and the lead party returns to the river buildings.

The player characters will observe the river ceremony when they first approach the village, regardless of time of day or their vantage point. Obviously, if they approach at night, the ceremony will take place in torchlight. All locations mentioned in the above description are on the village map and fully described below under "Planned Encounters." If they have made friends with the Heliopes and a Heliope is with them, they may be told the following information.

- The pyramid (28) is the spot most sacred to the Heliopes and only the priests and those Heliopes making appropriate sacrifices are allowed on its platform (28, 29).
- The priests live in the huts (18, 20, 24) out on the river.

- In the river huts are stored many religious objects and no one is allowed near them except the priests.
- The gods live in the sky. The flash of light, which gives a pleasant sensation to all Heliopes, comes from a gift left for them by the gods.

B. THE KIDNAPPING OF MALLIGIGG

At a convenient time tell the PCs that Maximilian Malligigg has disappeared. If they investigate, the villagers will reveal that several Heliopie priests seized Malligigg and took him to the river complex where he will now serve the gods. Being allowed to serve the gods is an honor.

No negotiation will free Malligigg and if he possesses a communicator he will call the PCs for help as soon as he can. Malligigg has been taken to Akhan's Tower (24) in the river complex. The tower and other buildings in the river complex are fully described below under "Planned Encounters."

Use the kidnapping to get the PCs on the river complex in order to rescue Malligigg. If they go by boat they will be attacked by gasps and cudda. The priests in the river buildings will try to stop them. Although the villagers will not venture on the platforms themselves they will hurl stones at anyone in range of the bank and attack any PC still in the village. They may follow the PCs out onto the river in their boats. Any Heliopes, such as the subchiefs, who own automatic weapons will use them.

Most important, the PCs must obtain one of the black and red rods which will give access to the tank. One is hidden in a trunk in Akhan's Tower (24); he wears the other.

If the PCs seem to be in no hurry to investigate the pyramid, the kidnapping may occur at almost any time they are in or near the village.

C. S.A.S.E. ROBOTS ATTACK

Mysterious explosions are heard from the fringes of the village. Smoke rises into the sky as the outermost huts turn into blazing torches. All around, panic-stricken Heliopes run in search of their families and friends. Among them you see four Heliopes who seem to be moving without quite touching the ground. Beams of

light are flashing from these Heliopes and everything the beams touch bursts into flame. As the destruction mounts, streams of Heliopie refugees flee the village.

4 S.A.S.E. (MV 50 km/h; IM 7; STA 125; ATT 70; DM by weapon type)(See also Table 8, p.24)

The robots should attack after the PCs have found Akhan's rod. If the PCs have no interest yet in the tank, the robots can burn down the pyramid exposing it. If battle with the Heliopes is too difficult, the robots can be used to scare them away. The robots should not concentrate their fire on the PCs or their possessions; they are being used for maximum destruction of the area and not against individuals.

Planned Encounters

1. FAMILY HUTS

Most family huts are 6 m wide and 18 m long. The outer walls are wood and the roofs are thatch. Family huts are shared by a number of families. There will be as many families as there are doors to the hut. Each family separates itself from the neighbors in the hut by heavy wooden walls with no connecting doors. To visit one's neighbors requires leaving one entrance of the hut and going to another. Family rooms are divided into two spaces, one for the head male, the other for the remainder of the family. Family interiors are divided by flimsy, movable wooden screens that are highly carved. The screens provide soft cover. Floors are dirt and are covered by woven or fur rugs. Utensils are made from clay, wood, or gourds. Beds are wooden racks. Meals are cooked over open fires banked by circles of stones. Holes in the roof let out the smoke. Cloth woven from the fur of the dopees as from water and plains animals are used throughout. The arrangement of the families and rooms needed for the game is up to you.

2. GARDEN PLOTS

Before you is an area of green growth. Various types of plants grow in regular rows. The areas are broken

by occasional rows of tall plants 2 m high and as wide as the plot.

1-10 Heliopes (STA 50; RS 55; PS pincers; IM 6; RW 28; M 28)

During the day the gardens are tended by families who live nearby. All Heliopie children are curious and friendly and show no fear of the PCs.

3. DOPEE PEN

Before you is a square corral made of wooden poles and posts. Within the corral are large, slow moving creatures that resemble rabbits. Piles of green plants are scattered about the corral and the creatures are eating them.

1-10 Heliopie Females (STA 50; RS 55; PS pincers; IM 6; RW 28; M 28)

2-20+5 Dopees (MV slow; IM/RS 4/35; STA 30; ATT 0; DM 0; SA 0; SD 0)

The Heliopes are learning to raise animals for food. Contained in these pens are dopees usually tended by the village women. The dopees are commonly owned and the meat is divided after a slaughter.

4. BACHELOR HUTS

5-10 Heliopes (STA 50; RS 55; PS pincers; IM 6; RW 28; M 28)

When attaining adulthood males of any family go to these bachelor huts. They live in them until they marry and move into their own huts. The huts are round in shape and about 30 m in diameter. The interiors are completely open and only movable screens mark off spaces within where the occupants keep their personal possessions. Food is provided by the village families each day.

5. SLAVE HUT

11 Heliopie Slaves (STA 40; RS 40; PS pincers; IM 4; RW 23; M 15)

Within this large, circular hut are kept eleven nomads captured in battle by the villagers. They are a brutalized and dispirited lot as they are overworked and occasionally made sport of. Most bear scars from battle or cruel treatment. Some may have lost a leg. If the village Heliopes discover any PC trying to help a slave or ask its aid, they will try to kill the PC or make him/her a slave too.

6. WELLS

A small open pit in the ground is shaded by foliage. The ground around the edge is hard and dusty and shows footprints. One meter below the edge is a pool of water.

These are crudely dug wells that are open and free for use by anyone. They are not very deep but the water is safe to drink. No device for drawing the water is provided as its surface is normally within 3 m. The Heliopes use ropes tied to gourds to draw the water up.

7. ROKAKAR'S HUT

The hut is large and spacious. It measures 10 m wide by 30 m long. There is a small room at its north end which measures 10 m wide and 3 m long. The room is partitioned by very heavy, carved walls. The remainder of the hut is devoted to the rest of Rokakar's family.

8. FISHING HUTS

Fishers are the craft experts of the village as fishing in the river is dangerous. All homes of the fishers are ornate and well constructed. Otherwise the huts are similar to other family huts in design, construction, size, and layout. Harpoons and small barrels of purple liquid that will keep gasps from attacking the crude boats are in the huts.

9. LEKEEKH'S HUT

Lekeekh (STA 60; RS 55; PS pincers; IM 6; RW 28; M 30) Weapons: automatic pistol, 4 clips.

This is a circular, single family dwelling. It contains a small private room for Lekeekh and a large common room for the others.

10. CUKKAR'S HUT

Cukkar (STA 65; RS 60; PS pincers; IM 6; RW 30; M 33) Weapons: 4 tangler grenades.

This hut is the same as 9.

11. EMPTY HUT

This hut will be turned over to the players if they do not make enemies of the Heliopes. Several of the village females will come to build a cooking fire, lay down rugs, cloths, and eating utensils for the PCs. Unless the PCs speak Heliopie, the females will not understand them. However, they will get the idea if PCs want them to leave.

12. BOATS

Along the river bank are dugout canoes 3-4 m long, hewn from the trunks of single trees then carved and polished. None are over 1 m wide. The aft portions are flatter and wider than the bow portions. From the bows jut small platforms equipped with several leather straps. There are openings in the bottoms of the platforms, reachable by someone sitting in the bow. In the bow of each boat is a barrel of purple liquid with a drip spout in the bottom. Each boat carries six paddles, all of them intricately carved, and some are wrapped in oiled leather.

These are the boats made by the Heliopie fisher families. They are crude, clumsy, and difficult to handle and control. If anyone with a dexterity below 60 is in the boat, then the chance of capsizing is 10% per square traveled. PCs having a dexterity of 60 or higher will not have to roll unless there is someone in the boat with a dexterity of less than 60.

The purple liquid in the barrels is gasp repellent that is slowly dripped into the water through the opening in the bow platform. The Heliopes will not tell the PCs about the liquid as this is a craft secret.

13. ATTACK OF THE GASPS!

Small bubbles stream upward and burst with tiny clicks on the river's surface. Swiftly the water begins to darken, as if a cloud were passing below you. Swirls of current, swiftly growing stronger and more powerful, appear over a large expanse of surface. Suddenly, with a roar, the water explodes into violence. Gigantic tentacles, slimy, green, and dripping with weeds, rise swiftly into the air and close in around you, smashing in and pulling everything down into the cold depths.

1 Gasp (MV slow; IM/RS 4/35; STA 200; ATT 75; DM special; SA gasp; SD none)

The gasps will attack anything swimming or riding in the water or flying above it at an altitude of less than 30 m. The Heliopes' repellent will keep gasps away.

14. WOODEN BRIDGE

Extending from the shore is a wooden bridge with native boats moored to the first few pilings. Small ladders lead to the water and boats. The bridge is 6 m wide for the first 10 m and rises 300 mm above the water. After the first 10 m the bridge narrows to 2 m, although its height remains the same. The narrower portion extends into the widest part of the river for 1 km and enters a building on a platform in the river's center. There is no railing.

11-20 Cudda (MV very fast; IM/RS 8/75; STA 20; ATT 45; DM 1-10; SA feeding frenzy; SD none)

At this point the river is 2 km wide. Although the bridge has no railing the water is too shallow for the guardian gasps to be a problem. Ten meters beyond the bridge, however, gasps will be found. Anyone swimming in the water within 10 m of the bridge will be attacked by cudda on a percentile die roll of 25 or less per square traveled. Cudda will not attack boats.

15. BOAT DOCK

From the building platform extends a 3 m wide by 12 m long boat dock. It is resting on pilings 300 mm above the water and beginning 1 m from the wooden bridge. A small crane arm is centered in the dock. The arm will reach any boat moored to the dock. Near the arm is a coil of rope 1250 mm long. In the wall of the building is a 2 m by 2 m door which is closed. A stout ladder leads up from the dock to the door. There is a small wooden box at the edge of the dock nearest the platform.

From this boat dock supplies of food and large quantities of terrible smelling fish oil are unloaded. The crane arm is used for unloading boats. The wooden box on the dock contains 3 bone knives. No gasps live within 1 square of the dock, but there are schools of cudda under the entire river complex.

16. CHAKA'S HUT

Chaka (STA 50; RS 55; PS pincers; IM 6; RW 28; M 25) Weapon: projectile, 1 clip.

The platform is 3 m above the water. The hut (10x10 m) is a little smaller than its platform so that the platform makes a 300 mm ledge all the way around. Because of water damage, the hut has been repaired many times and the walls are braced. The entrance door is double, built of 150 mm thick wood and barred from the inside. The doors open on wooden walkways that lead to the firetowers (18). The doors will be left open during the religious ceremony when all the priests are at the pyramid; otherwise they are closed. The hut is stacked to the roof with junk left by the Cliks centuries ago. Larger pieces of equipment, such as generators and transformers, take up most of the available space. None of the equipment is of any value. Massive tools and heavy structural members from the Klikk ship are corroded and broken from age and lack of proper maintenance.

The minor priest Chaka lives here. Chaka has a small cot and a few possessions, such as beads and robes. He is charged with the polishing and cleaning of the Klikk relics with fish oil. The oil smell

permeates the hut. Chaka will defend the room to the death against invaders. He will always be here except during the river ceremony (Required Encounter A).

All characters fighting in this room have hard cover. This will include the priests. All firing must be at short range and from around and beside the piles of junk.

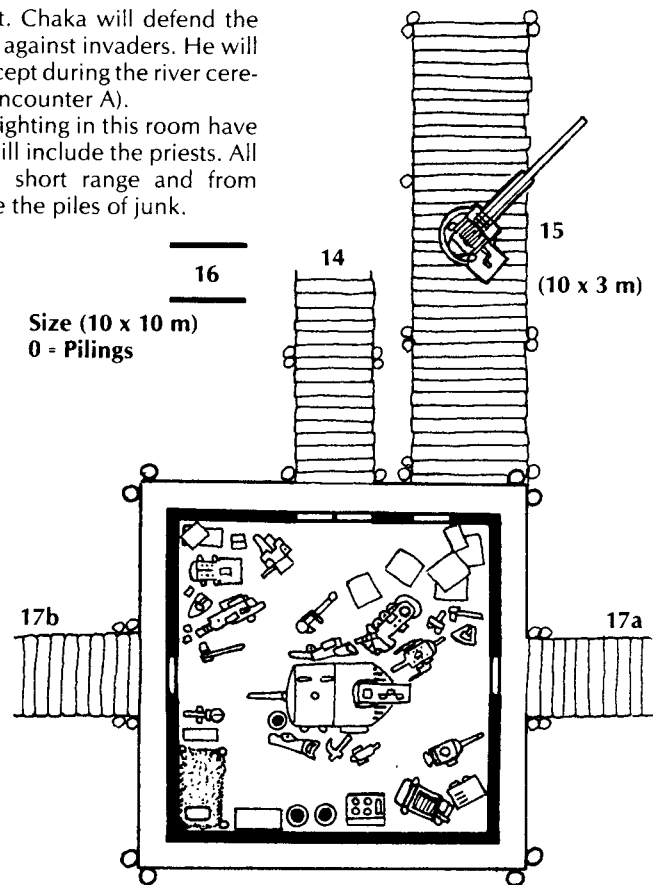

17. WOODEN WALKWAY

Narrow wooden walkways rise in a gentle slope as they continue out over the river toward platforms in either direction to the east and to the west. The walkway is 1 m wide and rests on pilings spaced at 3 m. There is no railing.

11-20 Cudda (MV very fast; IM/RS 8/75; STA 20; ATT 45; DM 1-10; SA feeding frenzy; SD none)

1 Gasp (MV slow; IM/RS 4/35; STA 200; ATT 75; DM special; SA grasp; SD none)

Walkways rise from 3 m above the water at Chaka's Hut (16) to 6 m above the water at the firetowers (18). Walkways rise from 6 m above the water at the firetowers to 9 m above the water at the priests' hut

(19). Anyone traveling over the walkways who falls into the water or who chooses to swim will be attacked repeatedly by a school of cudda unless they use the purple repellent. Any boat more than 10 m from the walkway will be attacked by a gasp 75% of the time unless the purple liquid is used to repel it. Remember that gasps will attack anything to 30 m above the water.

18. FIRETOWER

Before you is a round platform 6 m above the surface of the water. The platform is 10 m in diameter and serves as the roof of a cylinder 2 m high. There are no visible openings in the cylinder. Below the cylinder are the pilings that support the firetower. There is a light balustrade, 1 m high, around the edge of the platform. Two small, intricately carved, hinged doors in the balustrade are located where the walkways meet the platform. A large barrel stands on the

10

FIRETOWERS

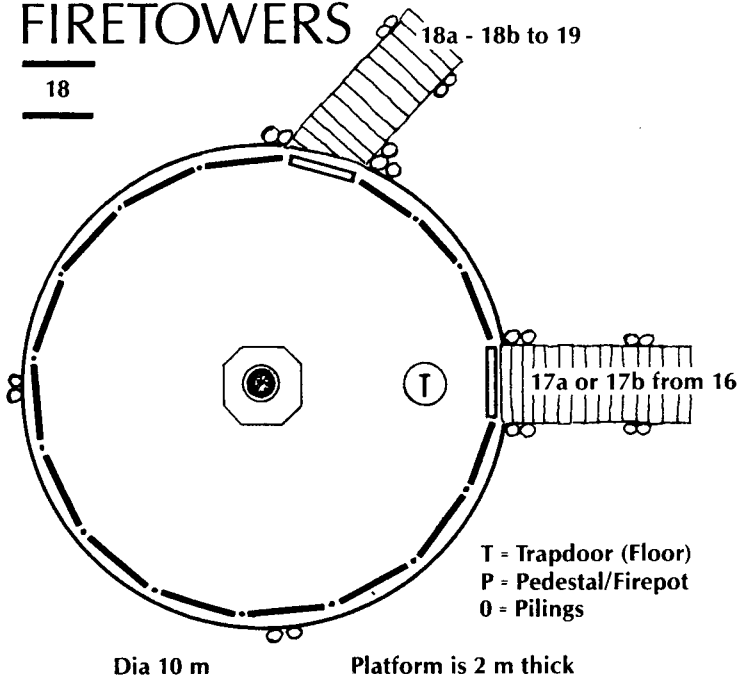

shore side of the walkway. A massive wooden pedestal 1 m tall rises from the center of the platform and a huge clay bowl sits atop it. Fire is burning in the bowl, and the smoke smells like greasy fish.

Gokul and Okalla (STA 50; RS 55; PS pincers; IM 6; RW 28; M 28) Weapons: projectile, 1 clip; inertia screen.

1 Snikker (MV medium; IM/RS 6/60; STA 75; ATT 55; DM 2-20 bite; SA acidic poison; SD none)

The priests maintain the clay pots of burning oil both day and night. The priest Gokul is responsible for keeping the west tower and the priest Okalla is responsible for the east tower. The two priests will attend the river ceremony; otherwise they will be on the firetowers 35% of the time and will be there all of the time if the village is attacked. They will fight intruders to the death.

Each firetower platform has a trapdoor on its east side that can be opened by the priest tending the fire. The trapdoor leads to the cylinder below the platform which contains a snikker. The snikker will crawl out

and attack the nearest creature, PC, or NPC. The trapdoor will open automatically when either of the doors in the balustrade are opened unless a lever hidden in the door carvings is pressed. The barrel contains the same kind of fish oil that is burning in the bowl. The fire can be extinguished by smothering, but if the attempt is successful an alarm will be raised at once on the shore.

19. PRIESTS' HUT

Gokul, Okalla and Edaku (STA 50; RS 55; PS pincers; IM 6; RW 28; M 25) Weapons: projectile, 1 clip; inertia screen.

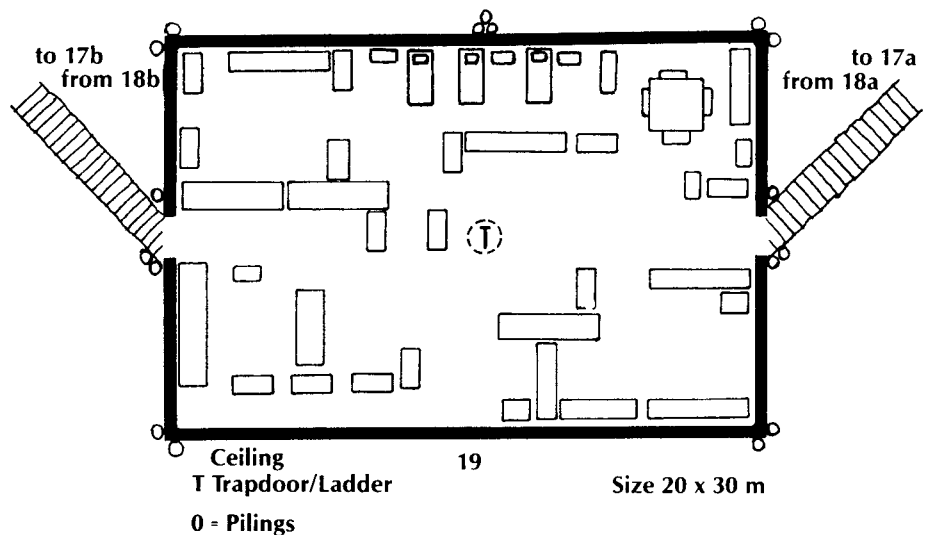

This hut extends to the edge of its platform (20x30 m) and is 9 m above the water. This far out, the river is deep enough for gasps. Any vehicle that hovers at the level of this hut, even at night, can be reached by them. Heavy doors that can be barred from the inside lead into the hut. The hut contains a mass of Klikk relics, some made of plastic and ceramic. The relics are in bad shape or completely useless. Three minor priests live here: Gokul, Okalla, and Edaku. They sleep on cots and have a few simple possessions, such as robes and beads. The job of these priests is to care for the precious relics, and they will be here 65% of the time unless the village is being attacked, when they will be at the firetowers. In the center of the room, which measures 5 m high, is a heavy ladder that leads up to a trapdoor in the ceiling. On the roof of this building is another building (20). Anyone fighting inside this hut has hard cover.

20. KUKU'S HUT

Kuku (STA 50; RS 55; PS pincers; IM 6; RW 28; M 25) Weapons: projectile, 1 clip; albedo screen.

Kuku's hut is 15x25 m square and 3 m high and is built on top of 19. It is filled with Klikk relics that look like bits and pieces

that have broken or fallen off other relics. All of the pieces are arranged neatly, although without any apparent order. The priest Kuku lives here. He and the priest Edaku from the hut below take care of the cooking, housework, and ritual painting for the other priests. Food and useful equipment for religious functions and everyday life are stored here. There are two trapdoors. A ladder leads to one in the ceiling that goes to Killok's tower (21). The other is in the floor and leads to the priests' hut (19). The trapdoor in the floor may be barred with a heavy wooden bar. All characters fighting inside have hard cover.

21. KILLOK'S TOWER

Killok (STA 50; RS 55; PS pincers; IM 6; RW 28; M 25) Weapons: projectile, 1 clip; albedo screen.

This is a circular room built in the center of the roof of building (20). The room is 3 m high and 10 m in diameter. A trapdoor in the floor leads into Kuku's hut below (20). A trapdoor in the ceiling leads to the roof (22). The room is filled with the usual Klikk relics. Characters inside the tower will fight as if in hard cover. Killok lives here and will be here all the time except when he attends the river ceremony.

22. TOWER ROOF

This is the roof to 21. It is 20 m above the water. A 1 m high balustrade runs along its edge and has a small hinged door leading to a wooden walkway that angles up to another tower (24) further out into the river.

23. WALKWAY

A wooden walkway leads south from the tower roof to the entrance to the last and highest tower. The walkway gradually slopes from 20 to 23 m above the water, has no railing, and is 3 m wide and 15 m long. At the end of the walkway is a door to the highest tower.

The walkway leads from (22) to (24).

24. AKHAN'S TOWER

Akhan (STA 40; RS 50; PS pincers; IM 5; RW 25; M 20) Weapons: nuclear pistol (see "Akhan," p. 26); inertia screen.

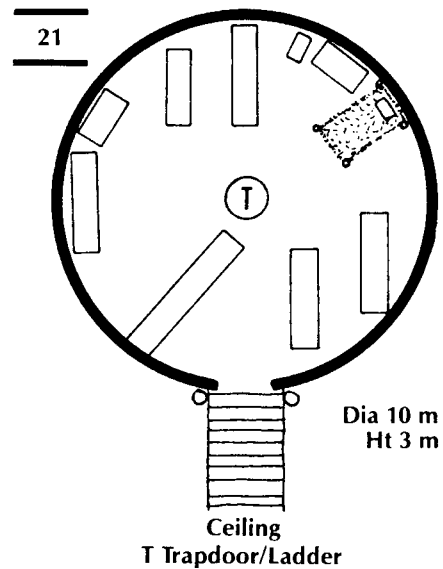
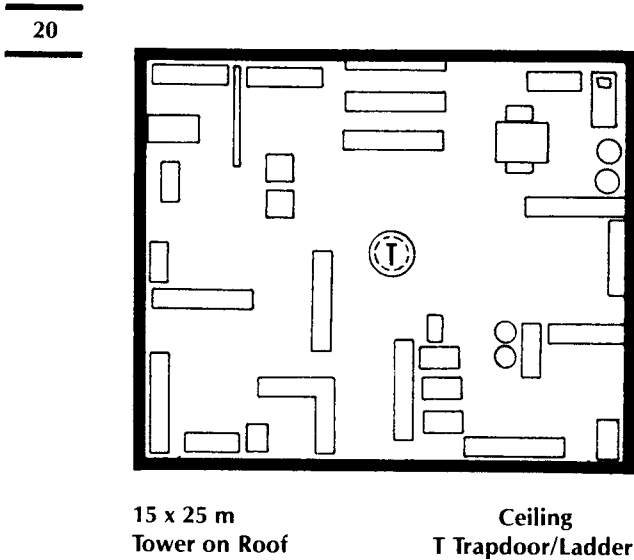

AKHANS TOWER

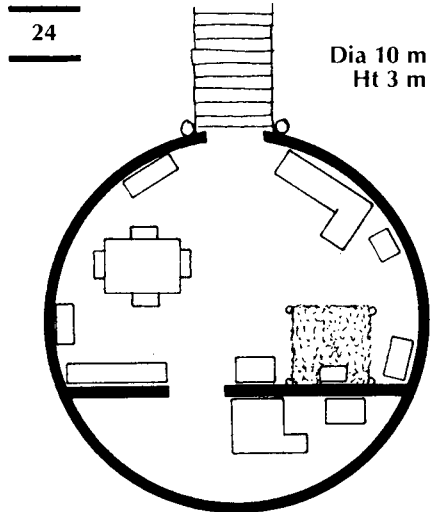

This tower rests on a platform 23 m above the surface of the river. Numbers of huge tree trunks lashed together in tiers form the pilings that support it.

The door to the tower has slits that allow the high priest to fire out if necessary. Other slits are located in the walls, floor and ceiling. The roof is very pointed and angled sharply to prevent easy climbing.

Akhan's tower is 10 m in diameter and 3 m tall. Within can be found Akhan's bed, food, decorative clothing, leather goods, ceremonial paints, and vestments. Beautiful objects carved from wood and bone by the Heliopes crafts people are found here, and many are extremely valuable. In one corner are pieces of electronic equipment with lights that flash and shine. One is readily identifiable as a type of albedo screen unit. The other is an emergency radio receiver. The radio emits occasional bursts of static and flashes of light. See p. 26 for a complete list of Akhan's possessions.

After the kidnapping (see Required Encounter B) Malligigg will be tied up and hidden in this hut.

In a small chest in the corner is a black and red tube that deactivates the tank's defense field and opens its rear hatch.

25. TEMPLE OF THE SKY

The massive wooden building has an angled, thatched roof. The walls and entryway are heavily decorated with colorful carvings. The entry opening is 4 m wide. This building is 10 m

wide, 30 m long, 3 m high, and has no windows. At its north end is a stairway of heavily carved wood that continues through an opening in the roof. This stairway leads to the great pyramid. There is no other exit at the north end.

The temple has no furniture although some beautiful statues and carvings of wood are displayed on the walls. The Heliopes bring their offerings here every few days.

26. STAIRS TO HEAVEN

This is a 3 m wide wooden stairway that leads to the first platform of the pyramid. It has no railing and is ornately carved every foot of the way. Its total length is 25 m.

27. PYRAMID OF THE GODS

The massive, wooden, stepped pyramid is 10 m high at its highest point. The carved wooden steps from the temple lead to the pyramid's top. At the top are two platforms. The larger platform is south of and 3 m below the smaller. A short set of steps lead to the smaller platform which has a roof. The entire pyramid is intricately carved. Large, beautifully carved screens, colorful cloth, strings of crystal and shell beads are strewn over its surface.

This is the holiest place of the Heliopes. The beads, etc., over its surface are gifts from the Heliopes.

28. PYRAMID PLATFORM

This heavy, wooden platform extends across the southern end of the pyramid's summit. Steps coming up from the temple lead here. The platform is scattered with items such as cloth, beads, baskets, and carved wooden screens. The platform is 10x30 m and has no railing. A small, 1 m wide stairway leads to the smaller platform at the northern end of the summit.

29. ALTAR WELL

This unenclosed platform is 10x10 m and has a small, carved wooden roof supported by pillars. In its center is an enclosure 1 m wide and 1 m high that looks like a well.

The well exposes the highest point on the tank, the 9 m high stabilizer fin. It is here that the electric defense field will shock anyone who touches it. For the Heliopes it causes a pleasant feeling but for any others it will cause 3d10 of electrical shock. No shield protects against shock as it will not occur unless someone actually touches the tank. Akhan's small, black and red rod negates the field and the tank can be touched without damage. In addition the rod opens the access hatch in the rear of the tank.

General Notes

Use the War Tank Map.

The pyramid covers the war tank completely. The larger platform is directly over the center of the machine. If any character(s) get inside the pyramid structure they will be able to see the shape of the tank well enough during the day but will need some form of light or night vision devices during the night.

The tank is designed to be played with, and the characters should be allowed to explore and experiment. When you feel they have familiarized themselves with it, the Sathar robots should attack again. The PCs should follow the robots to the hidden base and bunker. If the robots are destroyed, their signal beams will still operate and be traceable back to the base.

If the PCs find the tank too difficult to figure out within a reasonable length of time, Malligigg may be used to help them.

Following is a list of the information you will be able to tell the characters as they experiment with the war tank.

- This war tank is a hovercraft machine with two massive, high-speed rotors beneath the vehicle, protected by mesh screens.
- The war tank will lift 2 meters above the ground during travel and is very noisy.
- Four gun turrets are located on the top, on two sides and in the front of the war tank. All are controlled from within the tank by use of computer consoles. Characters with computer skills can use those skill levels as firing levels. Each turret is connected to the tank by an extending, flexible arm that can raise each turret from the body of the machine, stabilize its platform and angle it for firing. None of the turrets can be entered physically from within the war tank, but all have a small entry hatch outside. This hatch can be entered and the turret can be controlled and fired manually. No turret can be fired unless it is extended from the tank.
- The base attack number for tank weapons is 30. The computers are level 2 for firing, giving a base attack number of 50. Characters can add their computer skills at 10 per skill level to this base attack number when using any turret.
- Maximum speed of the war tank is 30 km/h in open terrain or over water. It will be able to travel 15 km/h on uneven surfaces and may thrust itself through the forests at 2 km/h. Hitting trees will not harm the tank. If it enters the water for any reason the blades will be damaged but the machine will be able to limp noisily to shore and ground. Characters will be able to repair rotor damage, length of time is in one day.
- Characters wishing to learn how to operate the war tank or any computer position in it must sit on the stool in front of the desired control and make a logic roll. Any PC can roll for any position, and one successful character can show another the method of operation.
- The war tank has full radio communication capacity and any character sitting in a functioning position can talk to any other character in the tank, including the turrets. Whether radio communication outside the vehicle is possible will be left up to you to decide, depending on the circumstances of your game.
- The tank hull has 700 structural points and an inertia shield. Hand weapons will not be able to damage it. The varying damage rates and totals are listed in Table 3 on p. 22. A damage total of 15 points or more, taken in a single round from one weapon, has a chance of penetrating the interior of the tank. If this occurs, see the War Tank Hit Location Table on p. 23 for method of handling. If the tank takes hull damage or a shot causes damage to the interior, then the damage can be recorded on the Tank Hit Location Chart on p. 23.
- The tank is provided with a special security device to keep it out of enemy hands. Once the tank is under power, the code must be entered daily from the captain's position; otherwise a self-destruct sequence is activated. The code has been permanently lost and the device cannot be bypassed. The time required for self-destruct is up to you as the length play time will vary from game to game. It is recommended that if characters take excessive amounts of time, an extended sequence be allowed. In no case should the sequence be allowed to extend past a week in time on the planet, as the Sathar evacuation ship is due. It may be necessary to inform the characters that the destruct sequence is activated and let them sweat out the time they have left to use the war tank.

When countdown for self-destruct begins, interior lights will flash from red to yellow and a klaxon will sound every second. PCs should make logic rolls to see if they understand what the noise and lights mean. The self-destruct cannot be stopped by anyone without the security code and this code no longer exists. Once the main sequence time has expired (days), then the flash warning sequence will last 5 minutes. The war tank will shut down and settle to the ground, all weapons and power systems dead, hatch open and lights/klaxon getting brighter and shriller. Anyone remaining in the war tank past the 5 minute time period will die in the small nuclear explosion. All characters within one half km radius take 10d10 of shock and radiation damage. Albedo screens and suits will not stop the radiation effects and full damage will occur. Hard cover will reduce damage by one half.

- Inside the tank is a missile that will halt all electronic functions for a radius of 2.5 km around the area of impact. If the missile is improperly fired and lands within range of the tank, the tank will shut down. If the tank shuts down and cannot be successfully reactivated from the bridge, this too will initiate the self-destruct mechanism.

Required Encounters

A. SATHAR S.A.S.E. ATTACK

After PCs are familiar with the tank and begin to move around the village with it, the S.A.S.E. should attack them.

4 S.A.S.E. (MV 50 km/h; IM 7; STA 140; ATT 70; DM by weapon type) (See also Table 8, p. 24)

B. THE WAR TANK

This is a vehicle with a bullet shape that is nine m high, 16 m long and 10 m wide at its widest point. About two-thirds of the way forward a fin merges with a hemispherical turret resembling a recessed headlight. The turret faces forward. Two turret hemispheres 2.5 m in diameter are located on opposite sides of the forepart of the vehicle. They appear on close examination to be detachable. A fourth hemisphere is inset into the front and forms its nose. This hemisphere is 4 m in diameter and slightly more convex than the others. Two equally spaced grids are at the base of the machine, front and rear. A small portion of the gridwork is visible from the sides. Behind the grid you can see fan blades. There is a closed entry port at the lower rear of the vehicle.

The PCs will be able to make out the general outlines of the tank with the aid of daylight seeping in through the pyramid or with a light source they bring with them at night. The turrets cannot be seen into. The weapons are described in the War Tank Weapons Table, p. 22. The nose turret holds the nuclear rifle. The two side turrets fire the rocket launchers. The top turret fires a twin heavy laser. The launch port for the electronic missile is not a turret. All turrets

can be operated from the computer position inside the tank or manually from inside the turrets.

Planned Encounters

1. ACCESS HATCH

You see a closed circular metal hatch. Near its handle is a small hole.

This is the access hatch. It is guarded by a defense field which will cause 3d10 of electrical shock to anyone touching the hull of the tank. If the tank engines are operating, the field will do 6d10 electrical damage. Shining a light into the hole shows it is about 150 mm deep. One of Akhan's rods inserted into the hole will allow the characters to open the hatch without damage. To learn how the rod works, PCs must make a logic roll.

2a. ACCESS TUNNEL

Before you extends a long metal tunnel to the south. It is 1 m high and 1 m wide. The light is soft and indirect. There is an opening 5 m ahead on the right and one directly above it in the ceiling. Thirteen meters ahead the tunnel turns to the right.

This is an access tunnel into the tank. The opening on the right is a repair niche for some sealed equipment. One person may stand comfortably in the niche. The ceiling shaft is a cylindrical hatchway with ladder leading up for about 2 m to the power room (5).

2b. ACCESS TUNNEL

Large control panels and hydraulic machinery flank the sides of this tunnel. The tunnel extends for another 5 m. About 2 m past the turn there is a shaft in the ceiling.

The shaft is cylindrical hatchway with a ladder leading up for about 2 m to the bridge (3). This is an access tunnel to the interior of the tank. It contains protective panels behind which are massive cable and control equipment. Some equipment will be familiar, some unfamiliar.

3. BRIDGE

This room is shaped like an upside-down V with ceilings 2 m high. At the ends of the V are two rounded, mushroom-like seats. Across the wall in front of the seats are glassy viewing screens. All are dark at the moment. In front of the two seats are several simple levers. Each lever has for its "handle" a narrow funnel depression. Something might be inserted in them. Also on the panels are horizontal bars almost flush with the facing and dials and indicators. All are lettered or numbered in an unfamiliar language. Nothing is operating except a small red light on the left control panel that faces forward. At the opposite end of the room is a sliding door which is open. A hatch is in the floor.

This is the bridge. The red light is the indicator for the electronic defense field. The seats facing forward are those of the captain and driver. The captain's position is on the left, the driver's on the right.

Any character who sits at the captain's position causes a small box with a hole in the top to extrude from the front of the control panel. If a character fits Akhan's rod into the hole, he or she will start the tank engines. The rod need not remain inserted. Lights will flash, control mechanisms will extrude from protective panels and the computer will count the occupants. For security reasons, the computer will try to keep the number of occupants at six. If there are more, and if anyone leaves the tank, then the computer will seal the access hatch from the inside. The characters cannot control or override this program function.

The red light will go to bright yellow when the tank is under full power, and the electronic defense field will increase its damage potential to 6d10. The field will now cause the Heliopes 3d10 of damage if they touch it. Characters who sit in either of the bridge positions must roll initiative to understand how to operate the positions. One successful roll is effective for all positions. Manual operation of the turrets will, however, require a separate roll. This applies to all interior weapons and control positions. Any character with computer skills may add this skill number to their chance of understanding a position and to their attack score when rolling to hit using that weapon.

4. COMBAT CENTER

This room is shaped like the letter C. Along one wall are three mushroom-like seats and a hatch in the floor. Over the hatch is a control panel but no seat. Along the opposite wall are a seat in front of a control panel, a large computer set in a block of machinery, and then another seat. In the center of the ceiling is a hatch which is closed. At one end of the room is a sliding panel which is shut. At the opposite end is the opening to another compartment.

The ceiling hatch leads to the inspection area of the upper laser turret, not into the turret itself. Only machinery is visible, and there is enough room for one person to crawl inside and make repairs. The floor hatch leads to the automatic ammunition magazine. The sliding panel leads to the power room and will open at a touch. The opposite opening is to the bridge.

PCs who sit in computer positions must make a logic roll to understand how to operate them. One successful roll is effective for all positions.

5. POWER ROOM

This room is roughly square in shape but the walls are irregular, having many niches formed by sealed machinery. Lights blink on and off and there are dials and gauges but no chairs or anything that resembles a control panel. In one wall is a sealed hatch. Near its handle is a small hole.

This room contains the nuclear fusion power supply system. It is smaller and far more streamlined and efficient than anything produced by the UPF. It cannot be understood by the characters in the time they have. The machinery is under the con-

trol of the main computer. The hatch is sealed and can be opened by the same control rod used to enter the tank. The walls around the hatch are electrified with a 3d10 defense field similar to the one protecting the tank. It is deactivated as long as the control rod is in the hole by the door. The hatch is the entrance to the missile launch room.

6. MISSILE LAUNCH ROOM

This room measures 2x3 m. In its center is a bright yellow rocket with silver nose and guidance fins. The rocket rests on a launch rail. There are numerous monitoring panels around the room but only one control panel. On this panel are a large dial and a bright yellow button. The dial has five positions and the pointer on the dial points to the first position.

This missile was designed to halt all electronic functions for a range of 1-4 km. It takes two turns per kilometer to reach its target. When the missile hits it does not explode but generates a field that alters the conductivity of all metals except a few alloys.

All radios, radar, computers (not computer memory as that is shielded in military equipment), detection and range finding equipment, and weapons systems that contain electronic components (such as sonic and laser weapons) will cease working. It will also distort holoscreen images and make them unusable. To determine the effect on any equipment, simply decide if it contains electronic components. If the equipment does, it will be inoperative. The equipment will work again when the field is turned off or the equipment is moved out of range.

If it is within range, the missile will also affect the tank and cause it to shut down. Only the self-destruct mechanism, warning system, and hatch openings will operate. A Klikk would be able to shield the tank from

the missile field, but other races do not have the technical ability to do so.

The missile's effect may be countered by someone in the captain's position if he or she makes a successful initiative roll. If the roll fails, self-destruct will begin and the PCs have five minutes to get out. Any player within one-half kilometer of the explosion will take 10d10 of shock and radiation damage; screens are ineffective. Any character remaining in the tank will die.

The missile range is set with the five-position dial. The first four positions are for launching the missile at targets within 1-4 km. The fifth position does not launch the missile but activates the electronic neutralizer alone. The missile can be fired by someone in the captain's seat and with the yellow button on the missile control panel.

The missile may be upon and a hit destroys it without any explosion. It can also be destroyed while it is still inside the tank by breaking through its hull with blunt weapons.

7. TURRET

Inside is a single padded round seat in front of a small control panel. The walls are close and packed with machinery. You can see through the dome.

A simple twist lock opens an ingress panel in the turret. Only one person can fit into a turret at one time, and turret occupants do not count toward the tank limit of six. The PC who wishes to fire the turret guns manually must either be trained in that particular weapon skill or make a logic roll. If the logic roll is successful, fire is the same as for weapons fired by untrained PCs given in the Expanded Rules. However, a PC can maneuver the turret manually without training or die rolls. The turrets have 360 degrees of traverse as well as lateral movement on the extension arm. This makes it possible for someone in the turret to fire on the tank. The turret cannot fire when retracted into the side of the tank.

SATHAR TRAINING BASE

General Notes

Use the Sathar Training Base and Weapons Bunker Map.

During the day the players will see the hologram (see Required Encounter A). The hologram projects an image of the bluff and rolling hills as well as the pond. At night the hologram is turned off and the PCs will be able to see the buildings by means of night vision or a light. The only way to enter the bunker is by means of the elevator (Planned Encounter 16).

The Rocket Launcher in this bunker is not the same as that listed in the Expanded Rules. This is a larger, military version capable of shooting down aircraft and/or spacecraft in orbit. Check the optional scenario on page 21 for use of this device by the players. It is the weapon used by the Sathar to shoot down any flying machine that travels above 30 meters.

The Sathar weapons bunker is located behind a small bluff at the northeast end of the lake (see Rift Landing Map). The three main turrets stick up above the level of the bluff and can fire in any direction using heavy lasers, a sonic devastator, and a recoilless rifle. The recoilless rifle fires only on alternate rounds and rises on hydraulic jacks for firing over the top of the sonic devastator. The next round it will lower into the turret area and reload.

The bunker and training base are being evacuated. None of the buildings contain anything of real value, only trash or low value equipment such as lighting units, switches, etc. No doors in the training base are locked unless noted and will slide open at a touch.

When a weapon is fired and hits the bunker complex, use the Bunker Hit Location Table on page 23 to determine the location and any special results from that hit. The bunker has numerous albedo screens with independent power supplies usable if the main power is cut off. The power pack for each screen is 100 SEU.

The PCs cannot enter the bunker from the outside area. If the weapons are operative then the armor and walls will be impos-

sible to pass. If they use weapons or explosives against turrets, then the possible entrances will be choked by rubble that would take days to remove. The only entrance is through the elevator in the training base.

While PCs are in the training base area, they will encounter the Sathar bio-constructs.

The S.A.S.E. and S.A.S.I. robots are programmed to self-destruct on the verbal command of any Sathar. The programming cannot be altered or removed without destroying the robot.

Random Encounters

Roll for a random encounter each day and night. Use the Bio-construct Plant and Animal Tables on p. 22 and the Starmist Creature Table on p. 25.

Required Encounters

A. HOLOGRAM OF BLUFF AND POND

Before you is a peaceful scene of a green bluff, scattered trees, and a quiet pond. Utter stillness prevails.

If the PCs go on foot, they may sneak past the bunker weapons. If they use a vehicle, they will be fired upon out of the four main turrets as soon as they come in range of a weapon. The holoscreen can be destroyed. If PCs choose to fight back, use Table 5 for hit locations.

Anyone who enters the holoscreen area will have distorted vision limited to 6 m. All weapon fire outside the 6 m range is at -30 to attack number during the day only.

Planned Encounters

1. POND

Before you stretches a large, still pond. The shore is lined with heavy reeds and flotsam. Although there is no wind, as you watch a ripple appears in the pond's center, and you hear a "Ploop!" as if something has moved in the water. All of a sudden a huge slither with plantlike growths on its back emerges from the water and rushes toward you.

1 Slither (MV slow; IM/RS 5/45; STA 400; ATT 30; DM 6-60; SA camouflage; SD none)

11-20 Cudda (MV very fast; IM/RS 8/75; STA 20; ATT 45; DM 1-10; SA feeding frenzy; SD none)

This pond is 3 m deep along the shore and 6 m deep in its center. The slither will attack anyone within sight of the pond, and the cudda will attack anyone entering the water.

See Expanded Rules p. 33 for using the slither, a Sathar attack monster. It will attack the nearest character but will not follow anyone into the buildings. If avoided it will stalk around the training base compound for several hours before returning to the pond. It will attack PCs on sight.

2. COMBAT ARENA/GYMNASIUM

This building is 25 m long and 15 m wide. The interior consists of one large room with a dirt floor. Holes in the floor show where objects were once located. There is a large quantity of packing material, such as broken pieces of plastic, on the floor. In the northeast corner is a raised

AND WEAPONS BUNKER

wooden floor that is gouged and scratched.

At one time this combat arena contained training machines and athletic equipment.

3. STORAGE DOME

This is a large, geodesic dome with a single door in one side. The opaque walls are made of a heavy-duty plastic. There are no windows or visible lights.

All these domes are empty and none have any power or light sources.

4. INTELLIGENCE CENTER

This room measures 15x30 m. The north and south walls are slightly curved. There is a dim glow from the walls. The interior shows evidence that massive machines were once mounted here and the building structure was damaged when these machines were removed. Massive clamps and connectors litter the floor along with packing material and wire ties. There are doors with colorful alien symbols on them in the western and southern walls. The southern door is open revealing a small, empty anteroom with three doors in its southern wall.

This room contained large computer data files used for research in preparing fake identities and counterfeit credit cards and for coordinating other intelligence and sabotage activities. All of this material has been removed but some of the litter on the floor might give clues to PCs.

The power is on and small emergency lights can be used. The southern doors lead to buildings 7 and 8 and the outdoors where a robot waits. The western door leads to building 5.

The door to the west is marked with unreadable Sathar symbols for power and radiation danger. This door is locked. It has 10 structural points of value.

5. EQUIPMENT ROOM

This 10x10 m room is empty. There is a door in the west wall and one in the east wall. A dim glow from the walls makes the room visible.

Small equipment and robots for the power reactor were kept here and the room is shielded, preventing any radio transmissions. The western door is locked and has 10 structural points.

The robot detailed in 9 is outside the middle southern door to this building. If he sees the PCs he will attack.

6. POWER ROOM

This room is roughly 20x20 m square and glows red from lights flashing on huge machines along its walls. Four robot arms extend from the machines. The arms are shielded from radiation.

This room contains a nuclear power unit set to self-destruct. Any characters with technological PSA of level 2 or higher, will know what is happening and will be able to determine that the unit will explode in three hours. They will not know that the self-destruct can be shut off by the base commander (at your discretion). If the commander is killed, the system is programmed to explode in 12 hours from the time of his death. A character with technological PSA of level 4 or higher can prevent the explosion. An explosion will destroy all unprotected lifeforms within the rift. If PCs shut the reactor down then all power to the training base is cut off. The weapons bunker has its own auxiliary generator which also powers the elevator.

7. TRAINEES' LIVING QUARTERS

Rows of bunks line both sides of this 15x25 m room. Most have crumpled and stained mattresses. Empty containers, spilled liquids, and papers litter the room. A few open footlockers are at the ends of bunks and several are stacked in corners. Otherwise the room is empty. The lights are off but a glow emanates from the walls. The north and south walls are slightly curved. Doors are in the north and south walls.

Tragger (STA 30; RS 50; PS 2; IM 5; RW 25; M 20) Weapons: laser pistol; wrist pistol.

1 S.A.S.E. (MV 50 km/h; IM 7; STA 140; ATT 70; DM by weapon type)

Tragger's wrist pistol fires one shot at short range. Use the statistics for auto-pistol with the following changes: range: short; rate 1, damage double normal; ammo 1. The pistol uses standard shells but looks like a wristwatch; it can tell time.

The agents, human and otherwise, being trained at the base were quartered here. The power to this building is still on. The glow is emergency lighting. Tragger, one of the Sathar's human agents, is hiding here behind a stack of foot lockers and will ambush the first character to enter the building. If he is wounded, see the description on p. 18 for his further behavior. The robot detailed in 9 is between this building and building 8. Anyone entering the space between them or leaving by the southern door and heading east will be seen.

8. CLASSROOM

This dusty, 25x15 m room has several temporary interior walls which have collapsed. No lights are on. There are doors in the slightly curved southern and northern walls.

Training classes in military, economic and social sabotage were held in this building. The interior walls were used to vary the size of the classrooms. There is no cover. Lights and power are off. The robot (detailed in 9) is outside. PCs will be seen by the robot if they enter the building from the southern door.

9. HOVERCYCLE

An unmarked UPF standard model Hovercycle stands here. No one seems to be nearby.

1 S.A.S.E. (MV 50 km/h; IM 7; STA 140; ATT 70; DM by weapon type)

All of the Hovercycles are the same as described in the Expanded Rules, p. 29. None require keys to operate and all are fully fueled. Anyone attempting to reach the hovercycle will be seen by the robot and attacked.

10. OFFICE BUILDING

This building, shaped like a trapezoid, is empty except for ceiling lights and papers and other trash on the floor. Along the walls are small power outlets as might be used for office equipment. There is no light and no windows, but the east and west walls have doors.

A'ssuu, Sathar Base Commander kept his office here. The ceiling lights may be turned on by touching a simple floor switch near the doors. The east wall is 25 m wide and the west wall is 15 m wide. The north and south walls are 16 m long.

11. SATHAR BATH

Inside this geodesic dome are two rooms, one containing a large tub with plumbing connections, the other empty. Both rooms show evidence that other plumbing-related equipment was once located here. Outer doors are located on the south and north. The wall material is a hard, opaque plastic; there are no windows.

The tub is a bathtub and the water supply is still working. None of the doors are locked. The exit door to the north leads onto a porch that runs west for 35 m and is covered but open to the sides. The building is 15 m in diameter. Power is on, but the lights are turned off. The robot detailed in 15 is outside and will see any PCs leaving this building and turning west.

12. JETCOPTER

Five m from the door to a building is an unattended standard UPF jetcopter. The copter doors are closed and there are no markings on the outside. From the front of the machine extends the barrel of a heavy beam weapon.

Tragger (STA 30; RS 50; PS 2; IM 5; RW 25; M 20) Weapons: Laser pistol; wrist pistol (see 7).

The doors of the jetcopter are unlocked. It is a standard UPF model (see Expanded Rules, p. 29 for information on its use). The weapon is a heavy laser and can be fired only by a character with computer skill. It cannot be removed from the copter. There is nothing else in the copter. The power for the laser comes either from the power plant of the vehicle or, in an emergency, from a 100 SEU power pack. PCs can take off in the jetcopter, but if they reach an altitude above 30 m they will be shot down by the bunker turrets or rocket launcher. If he hasn't been killed earlier, Tragger from building 7 will make a dash for the copter and try to use it against the PCs. Tragger will stay below the 30 m altitude limit unless you want to dispose of him. The copter is also within the visual range of the robot detailed in 15; it will attack any PCs it sees.

13. HOVER CAR

An empty hover car is parked 10 m from a building. It is unmarked and has space for six passengers. A heavy projectile weapon extends from the front of the vehicle.

This vehicle is another standard UPF machine. In a forward fixed turret is

mounted a recoilless automatic cannon with 40 rounds. The machine is fully fueled. Keys are not needed to start it. The hover car is also within the visual range of the robot detailed in 15. It will attack any PCs it sees.

14. A'SSUU'S OFFICE

The east wall of this empty room is slightly concave. There are closed doors in the north, west, and south walls. Equipment, such as communication gear, panels, switching units, and connectors lies on the floor. Crates stand about the room. Those that are open are either empty or contain additional equipment. A large viewing screen, dismounted, is propped against the east wall. The lights are off.

15. PORCH

A 5x7 porch runs east and west. Its floor and roof are made of wooden slats. Lightweight wooden beams support the roof. There is no railing.

1 S.A.S.I. (MV 20 km/h; IM 7; STA 125; ATT 70; DM by weapon type)

This deck connects buildings 11 and 14, bridging the gap between them. Anyone crossing the deck will be seen by the robot between 11 and 14 and will be attacked.

16. ELEVATOR LOBBY

The west wall of this 10x15 m room is slightly curved. Open crates stand about as well as complex units of bent metal bars. In the northwest corner of the floor is a large square shaft. Something is moving in the shaft.

Riss'aad (STA 53; RS 55; PS 2; IM 6; RW 25; M 25) Weapons: laser pistol; 2 auto pistols.

This was an equipment storage and lounge area. The elevator has no walls and its floor is a few feet below the floor of the room. Riss'aad is hiding in the elevator. As soon as PCs enter the room he will stick his head up out of the shaft and fire on them. If

he is killed, two implanted explosives will detonate, causing 3d10 points of damage to any characters within 2 m.

17. BUNKER ELEVATOR

A few feet below the edge of the shaft, which is 5 meters square, is a floor with no walls. On the floor is a small pedal.

This open sided elevator operates automatically once the pedal is pressed. It will descend 10 meters, stop, shift, and then travel horizontally eastward toward the bluff and the weapons bunker. It will travel 50 meters, stop and rise into the bunker. When it stops, the west wall of the shaft will slide aside to reveal corridor (18).

18. CORRIDOR

A corridor stretches before you for 20 m. Thirteen meters ahead there is a door in the north wall and one directly across in the south wall. A Sathar robot stands near the doors and is turning toward you.

1 S.A.S.I. (MV 20 km/h; IM 7; STA 125; ATT 70; DM by weapon type)

The robot is a Sathar Attack Simulacra Interior. It will attack and pursue any who enter the corridor. Three combat rounds after this robot fires any weapon, the robot from room 22 will move to assist. The elevator door is 1 m wide and has 10 structural points.

19. OPERATIONS CENTER

This 6x10 m room has doors in the northeast section of the north wall and in the center of the south wall. There are no windows. Four saddle-like chairs made of bent bars are here, each on a raised dais. Controls are inset into the chair arms. In the chair in the southeast corner is a Sathar; in the southwest chair a Dralasite; and in the two northwest chairs a Vrusk and a human. All are armed. The Sathar is wearing a gas mask and the others wear skinsuits.

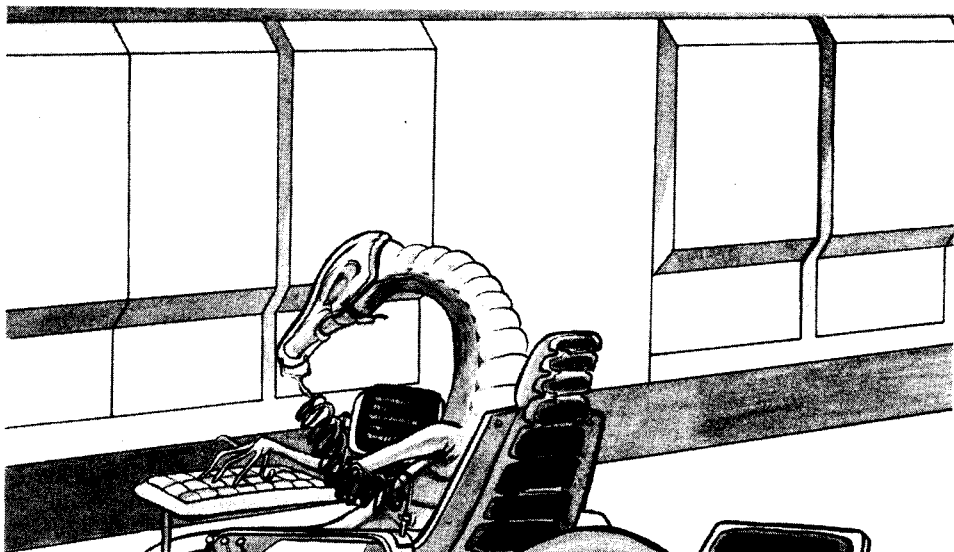

A'ssuu (STA 50; RS 60; PS 2; IM 6; RW 30; M 25) Weapons: laser pistol. He is wearing an albedo screen which cannot be operated within an active inertia screen.

Drosophage (STA 45; RS 45; PS 4; IM 5; RW 23; M 23) Weapons: laser pistol.

Vuzzie'vaz (STA 50; RS 60; PS 3; IM 6; RW 30; M 23) Weapons: sonic disrupter.

Micky Pinker (STA 50; RS 50; PS 5; IM 5; RW 25; M 25) Weapons: needle pistol.

The four chairs are control units occupied by A'ssuu, the Sathar base commander, and three of his non-Sathar agents. The chairs are powered and can be turned at will; all have inertia screens. They can take 50 points of stamina damage before dropping the screens. The chairs control the following:

- (A) Station for Base Command
- (B) Control of Sonic Devastator and Albedo Screen (25)
- (C) Control of Heavy Lasers and Albedo Screens (23)
- (D) Control of Recoilless Rifle and Albedo Screen (25)

A transmitter is implanted in A'ssuu's body. Upon his death it will trigger a self-destruct system that will destroy the base and melt down the reactor in one hour. Once this signal has been sent, explosives implanted in his body will detonate, causing 3d10 damage to all characters within 2 m.

Before he dies, A'ssuu will communicate with the incoming Sathar warship. If you want to include a warship scenario in your game, see Optional Encounter 30.

20. MAIN COMPUTER ROOM

This narrow 2x6m room runs north and south. The east wall is the control panel for a computer unit in full operation. The controls are marked with unreadable Sathar symbols.

This level 3 computer operates most of the bunker equipment, including the command chairs in room 19, and acts as a fire

control system for the weapons turrets. If damaged, destroyed or cut off, its loss will reduce the attack number of the bunker weapons by 30. The main power to the turrets and life support systems are not affected. Bunker weapons will have to be fired manually. If the computer is destroyed the Sathar attack robots will shut down. The computer can be reprogrammed if a character has the skills, this will give that character control of the robots.

21. POWER ROOM

A large, sealed unit fills nearly the entire 6x20 m room. A 5x7 m area in the northwest corner is the only open space. Masses of dials and screens along the sides of the unit indicate some type of power generation. None of the symbols are familiar. In the far northwest corner of the room is a small sealed computer console. No operating controls are visible and the unit appears inaccessible. In the southeast corner of open space are a low dais and dismantled chair unit. There are two doors, one in the north wall and one in the west wall.

This is a large emergency power unit for the bunker weapons systems and is controlled by the bunker computer. It will take even knowledgeable players at least four hours to break through its protective armor and shielding and halt the power flow. The computer unit in the northwest corner is only used to monitor and operate the control chair and anyone with computer skill will recognize the fact; it cannot affect the main power supply. Both the chair and the computer are inoperative.

22. WEAPONS ACCESS

This room measures 8x9 m. There is a closed door in the southwest wall and a closed door in the southeast wall. In the east end of the north wall is the opening to a corridor. Power cables and wiring are strung along the walls and floors and dangle from the ceiling to the floor. The area is well lit by indirect lighting.

1 S.A.S.I. (MV 20 km/h; IM 7; STA 125; ATT 70; DM by weapon type)

The doors (structural value 10) to 21 and 23 are locked. A robot is guarding the area. It will move to assist the robot in 18 at the first sign of trouble. Here is the housing for the holographic projector that shows the image of open ground cast over the base and bunker complex (see Required Encounter A). The housing measures 1x1 m and has no armor. The antenna outside is protected by an albedo screen. The holograph does not operate at night.

23. LASER TURRET

Massive cables lead up into a turret housing in the east wall. The back half of a mounted heavy laser is also visible. A small computer stands against the south wall.

The heavy laser is completely under control of either the main computer (20) or the small computer in the corner. It fires in a 360 degree arc. There is an emergency power storage unit under the floor containing a 100 SEU charge that will operate the laser if main power is cut off.

24. CORRIDOR

This corridor is 2 m wide and 10 m long and opens out into rooms at its north and south ends. In the east wall is the opening to another corridor. In the west wall are two doors, both closed.

The doors, to rooms 25 and 26, are both locked. Their structural value is 10.

25. MAIN AND RECOILLESS RIFLE TURRET

This mushroom-shaped room runs from east to west with the mushroom's "head" making up the western half. It is 15 m long, 5 m wide in the "stem," and 9 m wide at the widest portion of the head. The east wall of the head portion contains the housings for a huge beam weapon and turret. In the stem is hydraulic equipment for a large gun that fires from the roof. Beneath the gun are feed hoppers and stacks of ammunition.

The weapon in the head is a heavy sonic devastator. It fires in a 360 degree arc, its above-ground armor has 150 structural points, and it is protected by an indepenent albedo screen. The gun is a recoilless rifle. The auto-feed mechanism can be easily jammed. The hydraulic equipment raises and lowers the gun during reload every other round. The hydraulic equipment is operated automatically by machinery at its base, and there is no provision for manual loading or firing.

26. STORAGE/CONTROL ROOM

Large panels of electrical connections line the walls of this 5x6 m room. A block of machinery sits in the center and extends to the ceiling. It is connected to three small computers.

The machinery is a sensor/scanning unit that feeds data to the main computer. Destruction of the scanning unit reduces the attack number of the bunker weapons (see Table 6). The wall panels contain power terminals for the various weapons systems and, if destroyed, will force the weapons bunker onto internal power supplies and halt fire from the recoilless rifle.

27. WEAPONS ACCESS

This room is empty and measures 4x8 m. In its west wall is a closed door.

The door to room 23 is locked; its structural value is 10.

28. ROCKET LAUNCH ROOM

This room measures 10x15 m. There is a door in the south end of the east wall and one in the east end of the south wall. Along the east wall is a moving conveyor belt. The area under the belt is sealed and three mechanical arms protrude from the wall along its length. It disappears into a block of machinery that extends to the roof in the northeast corner. Lights on the side of the machine are glowing. An opening is in the east side of the machine and a smaller belt runs from it to a massive, solid tube in the northwest corner.

The belt stops at an opening in the tube's east side. One meter from the west wall sits a large computer. On a small dais in the southwest corner is a chair formed of bars. Several electronic units are attached to it and lights are glowing on their panels. A Sathar attack robot is standing guard.

1 S.A.S.I. (IM 20 km/h; STA 125; ATT 70; DM by weapon type)

The attack robot stands near the door. It will attack anyone entering the room but will not leave the room. This room contains the rails, loading mechanism, controls and launch tube for the Sathar rocket launcher.

The level three fire control computer has been programmed to launch a missile at any vehicle (including spaceships) operating in the rift at more than 30 m above ground level. It cannot be reprogrammed from the control chair but may be affected by direct input on its console. Under manual control, the chair unit can track targets with aboveground sensors (including targets in orbit around the planet), and assign and fire missiles. There are nine missiles in the magazine (29) and one in the launch tube. If any character vehicles have been shot down, deduct the number of missiles used from the magazine supply.

Rockets from the magazine are transported along the conveyor belt to the loader in the northeast corner. The mechanical arms insure the proper positioning of the rockets and are controlled entirely by the computer. The missile loader takes missiles from the belt and loads them directly into the launch tube. The computer will not allow the launcher to be used against the approaching Sathar warship in the Optional Encounter (30) unless it is reprogrammed.

29. MAGAZINE

Standing area in this room is only 2 m square. All along the east wall are lights forming a pattern repeated nine times.

The lights show the status of the magazine. Lights on in a pattern indicate that the unit has a missile. The maximum storage capacity is nine and there is one missile in the launcher for a total of 10 missiles. If any missiles have been used during play, sub-

tract this number from the total. For every missile used, one pattern of lights will be dark.

The bunker turrets rise above the level of the bluff near the river. The heavy lasers and heavy sonic devastator fire in a 360 degree arc. The rifle fires only on alternate rounds and rises on hydraulic jacks to fire over the top of the sonic devastator. The next round it will lower into the turret area and reload. The recoilless rifle also fires in a 360 degree arc.

30. OPTIONAL ENCOUNTER

If you wish to continue the game and include the approach of the Sathar warship, the following suggestions may be used. If you wish to use the Star Frontiers™ Knight Hawks Game System, the approaching ship will be a heavy cruiser. It may or may not be escorted by destroyers as you choose.

The ship may remain in orbit and send down a party of Sathar for full interaction with the player characters. PCs may use both the wartank and the Sathar base against the new forces. If this option is chosen, you will have to delay or eliminate the self-destruct systems of the bunker and tank.

The PCs may fire the bunker's rocket launcher at the approaching warship. This will also require delaying the bunker self-destruct as well as the possibility of the weapons and computers needing extensive repair from damage taken during play.

One method of handling the fire of the rocket launcher is to use a cumulative base 10% per round. If a rocket hits the warship (roll as many times as there are missiles—maximum of 100% on a tenth missile) then the warship will crash as it would not be prepared for fire from its own base. To extend the scenario further, characters might hunt down Sathar survivors of the crash.

Table 1. STARMIST CREATURE RANDOM ENCOUNTERS

Roll 1d10 each day and night. Encounter occurs on a roll of 1 or 10 by day; 1, 5, or 10 by night. Encounter distance is determined by surprise, terrain (see "Movement" on p. 2); or creature description (see Alien Creature Update File, on p. 24).

(b) Bison do not seem to notice intruders unless they come into charging range. Then they attack without warning.
 (c) Puff-puckers are easy to see at short range.
 (d) If nomads attack they will be hiding in the grass. Use average Heliopie stats of 45 or those in Planned Encounter 2, p. 7, minus the clan leader.

(b) Nomads will hide in the grass. Use average Heliopie stats of 45 or those in Planned Encounter 1, p. 5.
 (c) She is in the nest and attacks anything in range but will not leave the nest. There will be 1-10 young but none are poisonous; all bite for 1d10 damage with the same attack number as adult.

Plains

Die Roll	Creature
1	Snikker (a)
2	Bisron (b)
3	Puff-puckers (c)
4	Snikker (a)
5	Bisron (b)
6	Nomads (d)
7	Snikker (a)
8	Bisron (b)
9	Nomads (d)
10	Snikker (a)

(a) If PCs are not surprised then snickers will raise the forepart of their bodies and spit venom at the nearest person or object they perceive as dangerous. They can spit twice a day only.

Forest

Die Roll	Creature
1	Wispees
2	Puff-puckers
3	Crazed bisron (a)
4	Nomads (b)
5	Wispees
6	Puff-puckers
7	Female snikker (c)
8	Nomads (b)
9	Wispees
10	Puff-puckers

(a) Sometimes a bisron will go mad and wander into the forest. Most encounters will be at short range and the bisron will attack instantly. There is a 15% chance per charge that the bisron will hit a tree.

River

Die Roll	Creature
1	Puff-puckers
2	Wispees
3	Gasp
4	Cudda (a)
5	Puff-puckers
6	Slither
7	Wispees
8	Gasp
9	Cudda (a)
10	Gasp

(a) Cudda only attack in the water.

Table 2. NORMAL OFF-WORLD PLANT AND ANIMAL RANDOM ENCOUNTERS

Die Roll	Creature
1	Lilly-po
2	Clinging violets
3	Creepspine
4	Froggs
5	Grapals
6	Fingerllies
7	Weeping wallows
8	Squirrillets
9	Sailsnails
10	Tick-tock trees

Table 3. WEAPONS AFFECTING TANK

Weapon	Points Structural Damage
Laser Rifle (discharge of 10+ SEU in single shot)	5
Heavy Laser	1 per SEU
Sonic Devastator	1 per SEU
Laser Rifle	1 per SEU
Recoilless Rifle	30
Grenade	15; 30 if placed
Rocket Launcher	30
Nuclear Pistol*	2 per shot
Nuclear Rifle*	30 per shot

Table 4. WAR TANK WEAPONS

	Nuclear Rifle	Rocket Launcher	Heavy Laser	Electronic Missile
Damage	20-200	15-150	Special*	1-10/SEU
Ammo	Power Plant	Rockets 915)	Rocket (1)	Power Plant
SEU	NA	—	—	5-20
Rate	1	1	1	1
Defense	None	Inertia	None	Albedo
PB	0-300 m	—	—	—
Short	300-800 m	0-70 m	1 km	—
Medium	800-1.2 km	71-200 m	1-2 km	101-500 m
Long	1.2-3 km	201-500 m	2-3 km	501-1 km
Ext	3-5 km	501-1000 m	3-5 km	1-2 km

*Missile range 1-4 km; neutralizes electronic functions within 5 km.

Table 5. WAR TANK HIT LOCATIONS

If the number of structural points of damage from a single weapon equals or exceeds 15 in a single round of combat, use the following table to determine if any damage has been taken in the interior of the tank. Use the tank diagram to locate and mark off hits.

Die Roll	Location
01-05	Power supply (a)
06-10	No effect
11-15	Combat center (b)
16-20	No effect
21-25	Bridge (c)
26-30	No effect
31-35	Nuclear rifle (d)
36-40	No effect
41-45	Rocket launcher (e)
46-50	No effect
51-55	Rocket launcher (f)
56-60	No effect
61-65	Heavy laser (g)
66-70	No effect
71-75	Electronic missile (h)
76-100	No effect

- (a) Reduce all cumulative beam weapon damage by 1d10. Reduce cumulative nuclear rifle damage by 3 points.
- (b) All characters in combat center take 1d10 damage.
- (c) All characters on bridge take 1d10 damage.
- (d) Character at nuclear rifle computer position takes 1d10 damage.
- (e) Character at west rocket launcher takes 1d10 damage.
- (f) Character at east rocket launcher takes 1d10 damage.
- (g) Character at heavy laser computer position takes 1d10 damage.
- (h) Electronic missile room penetrated; roll percentile die. If number is 10 or less then the missile is activated within tank, not launched. If number is above 10 then missile is destroyed.

Hull - 700 structural points

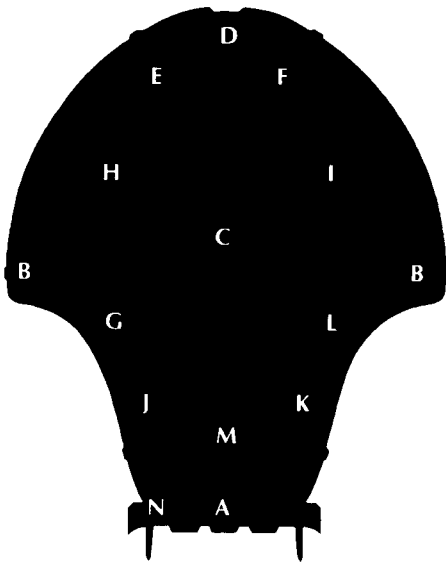

- A - Electronic missile
- B - Rocket launcher
- C - Heavy laser
- D - Nuclear rifle
- E - Captain's position
- F - Driver's position
- G - Nuclear rifle operator
- H - Port rocket launcher operator
- I - Starboard rocket launcher operator
- J - Heavy laser Operator
- K - Auxiliary driver
- L - Inertia shield control panel
- M - Power supply
- N - Access hatch

Table 6. BUNKER HIT LOCATION TABLE

When the bunker takes a successful hit from any heavy weapon, including any brought by the PCs to Starmist, use the following table to determine location and damage. Roll damage first against albedo screens then armor, if applicable.

PCs with military PSA know that lasers are useless against albedo screens unless the power supply is destroyed.

The bunker computer is level 2. The base attack for bunker fire is 30 plus 20 for computer plus 10 for the target ranging sensor. If the sensor is destroyed reduce the attack number by -10. If the computer is destroyed or shut down reduce the attack number by -20. If both systems are lost the weapons will continue to operate with a base attack of 30.

Die Roll	Location	Result
0-10	26	Albedo screen/sensor. Any damage will destroy this sensor system and result in a continuous -10 to all attack fire from the bunker weapons.
11-30	25	Albedo screen/armor/sonic devastator. If damage is to armor, then subtract the damage total from the armor value (structural points). If armor is reduced to zero the first 20 points of additional damage destroy the sonic devastator.
31-50	23	Albedo screen/armor/heavy laser. Subtract damage total from armor value (structural points). When armor value reaches zero, the first 20 points of further damage destroy the heavy laser.
51-70	23	Albedo screen/armor/heavy laser. Subtract damage total from armor value (structural points). When armor value reaches zero, the first 20 points of further damage destroy the heavy laser.
71-90	25	Albedo screen/recoilless rifle. When hit during a turn of fire this gun is destroyed by any amount of damage exceeding 25 points. If hit during the reloading round then subtract from armor value of 100. When armor value (structural points) reaches 0, then 20 cumulative points of damage destroy the gun.
91-100	22	Albedo screen/holographic projector. Any hit that penetrates the albedo screen destroys the holographic screen over the entire complex, including the training base.

Table 7. BIO-GENETIC CONSTRUCT RANDOM ENCOUNTERS

Die Roll	Creature
1	Grapals
2	Lilly-po
3	Fingerllies
4	Tick-tock trees
5	Clinging violets
6	Squirrillets
7	Creeps pine
8	Sailsnails
9	Weeping wallows
10	Frogs

Table 8. SATHAR ROBOTS

SASE Sathar Attack Simulacra Exterior

Movement: Lift/hover unit - 50 km/h on level ground
Equipment: Infra-red (IR), ultra-violet (UV), visible light scanners; surface/air search radar; IR/UV jamming systems, laser searchlight; radio/radar jamming unit; level 4 computer brain; albedo skin insulation; holoscreen generator.

Weapons

Rocket launcher with (4) missiles
Electric defense field (touch - 3d10)
Sonic stunner/arm
Laser rifle/arm (5 SEU/shot)

The secondary tentacles of this robot are used for heavy lifting. As weapons they strike for 2d10 damage each, at single or twin targets. Range of the arms is 3 m.

Attack: 70
IM: 7
Stamina: 140 (stamina points)

SASI Sathar Attack Simulacra Interior

Movement: Tracked (20 km/h on level ground)
Equipment: Infra-red (IR), ultra-violet (UV), visible light scanners; surface/air search radar; IR/UV jamming systems, laser searchlight; radio/radar jamming unit; level 4 computer brain; albedo skin insulation; holoscreen generator.

Weapons

Rocket launcher with (4) missiles
Electric defense field (touch - 3d10)
Auto-pistol/arm (30 rounds ammo; no reload required)
Auto-pistol/arm (30 rounds ammo; no reload required)
Stun pistol - fires forward only in direction robot is facing

The secondary tentacles of this robot are used for heavy lifting. As weapons they strike for 2d10 damage each, at single or twin targets. Range of the arms is 3 m.

Attack: 80
IM: 7
Stamina: 125 (stamina points)

STAR FRONTIERS® SYSTEM BRIEF

SYSTEM NAME: Sundown

STAR COLOR: Orange

HABITABLE PLANETS: Starmist

Moons:None

Climate Range: Cool; warm to frigid

Atmosphere: 70% nitrogen, 24% oxygen, 6% inert gases

Diameter: 9880 km

Gravity:.93

Length of Day: 21 hours

Average Surface Temperature: 5 degrees Celsius

Colonizers

None; newly discovered by VSS Centispeed. System presently under investigation by Clarion Department of Extra-solar Affairs. No determination as to procedure or disposition has been made.

None; newly discovered by VSS Centispeed. System presently under investigation by Clarion Department of Extra-solar Affairs. No determination as to procedure or disposition has been made.

Native Life

Only reported species is an erect, bipedal hominid having a primitive nomadic economy and low technology. These natives are known as Heliopes in their own language.

ALIEN CULTURE BACKGROUND REPORT

THE HELIOPE

Heliopes stand erect and average two meters tall. They look slightly reptilian. The head is man-shaped with a long, sensory, whiplike antenna dropping down from the rear and curving back up into the air. Heliopes have superb hearing because this appendage is sensitive to atmospheric vibrations.

Heliopes are omnivores, having large teeth and mandibles for chewing and cutting. Heliopes have one, large central eye that is protected by bony ridges and two nictating membranes. Heliopes possess two long arms with average strength but the 'hands' are two pincers, slightly rigid, with a sharp nail along the edges. Two extremely powerful legs dominate the lower body. A long tail sweeps up like a scorpion's, to rest over the shoulder. The Heliopes are neither right nor left handed but right or left shoulder-tailed. The feet are large, long, and splayed. All Heliopes seem awkward and clumsy in confined spaces and look totally unsuited to riding in vehicles or on animals. They are excellent swimmers.

Heliopes have translucent skin. The normal network of upper musculature and veins is visible and Heliopes vary in colors from violet to deep purplish red. The whip tail changes color toward the tip to opaque, shiny black.

Because of their body chemistry the Heliopes are immune to normal electric current and will take only one-half damage from lasers. Because of their antennae, Heliopes take double damage from sonic weapons. Both pincers and mandibles deliver a 1d10 bite. The damage from the mandibles is subtracted from a skeinsuit value but the damage from a pincer is against the character through the skeinsuit. The tail is not prehensile and it cannot strike. Heliopes carry pouches of small stones which they can throw with terrific force. The bullet/stones cause 1d10 of damage if they hit. Inertia shields and skeinsuits will affect the missiles. Although Heliopes use harpoons to fish, they are not adept with such tools as weapons.

The basic social unit of the Heliopo tribe is the family. Marriage ties cause complex relationships. Government is a simple system of chiefs and subchiefs chosen for ability in combat and leadership. Priests have great influence on the tribe but no official power.

All Heliopes enjoy color and collect gemstones, polished rock crystals, and similar baubles. They are superb sculptors and do intricate, detailed work on wood and bone. They paint and decorate their tails and mandibles in patterns that differ from tribe to tribe.

Average Heliopo Statistics

STR/STA	45/45	PS	Pincers (1d10)
DEX/RS	45/45	IM	23
INT/LOG	45/45	RW	23
PER/LDR	45/45	M	23

Special Abilities: Immune to electrical attacks; take one-half damage from lasers; take double damage from sonic-weapons; pincers penetrate skeinsuits; three attacks per round in melee (2 pincers/1 bite).

ALIEN CREATURE UPDATE FILE

Bison

Type:	Large herbivore
Number:	10-20
Move:	Slow (see Special Attack)
IM/RS:	5/45
Stamina:	100
Attack:	45
Damage:	10d10/20d10
Special Attack:	Charge*
Special Defense:	None
Native World:	Starmist meadows and grasslands

The bison is a large animal with massive ram-like horns curling over its head. Short forelegs cause the body to slope upwards in the rear. The bison requires large amounts of meadow grass to sustain its bulk. Its nose is long, narrow, and partially prehensile and is used to help uproot plants. Bison gather in family groups up to 20. The males attack anything that approaches within 100 m of the group. There is one male per four bison encountered.

*Charge: this special attack form is terrifying in its speed and power. In one melee turn the bison covers 100 m. If it hits, the target takes 10d10 of damage as well as possible displacement as noted below. During the second melee round, if a second target is within the bison's vision the animal will cover 200 m to deliver 20d10 of damage as well as displacement.

Because of its immense power, weight, and speed, a bison may displace its target. Weight to 100 kg will be hurled 1d10 times 10 m. Weight to 1000 kg will be moved 1-100 m (% dice roll). Weight over 1000 kg may be knocked over depending upon circumstances and size of target. As an example, a bison will not overturn a spaceship but will knock over most ground vehicles and hover vehicles if within 2 m of the ground.

If the bison survives two charges, it will have to roll for a base 25% chance of heart attack on each additional attack, with 5% being added cumulatively. Bison will faint after five total attacks, although they may not die. They will be unconscious for several hours.

Cudda

Type:	Small carnivore
Number:	1d10+10
Move:	Very fast
IM/RS:	8/75
Stamina:	20
Attack:	45
Damage:	1d10
Special Attack:	Feeding frenzy
Special Defense:	None
Native World:	Starmist water

Cudda are carnivorous fish one meter long that usually school in the feeding areas of the gasp. However, schools and individuals can be found anywhere there is flowing water.

A cudda attack is simple and straightforward. They bite and do 1d10 points of damage per turn if successful. If they succeed they do not have to roll for attack in subsequent rounds. They bore into the victim as they bite and no further roll is required unless they are dislodged. Victims may dislodge a cudda in one round if their strength is 50 or over.

Those who have successfully pulled the fish out may then destroy it in two additional rounds. If the cudda is let go, it will immediately attack again.

Gasp

Type:	Giant aquatic herbivore
Number:	1
Move:	Slow
IM/RS:	4/35
Stamina:	200
Attack:	75
Damage:	-
Special Attack:	Sudden grasping of objects on/above surface
Special Defense:	None
Native World:	Starmist rivers and lakes

The gasp is an enormous squid with 10 60-meter long tentacles. Gasps rest and nest in shallow waters from 3-6 m deep. Its body is 20 m in diameter and flat. The creature eats on greenery growing along the bottom and is usually accompanied by schools of cudda (q.v.). They are essentially harmless and will swiftly retreat if attacked.

Unfortunately, gasps are territorial and nervous. If something passes over its head, either on the surface or within 30 m of the surface, a gasp will reach up with its tentacles and pull the offending item down. Even a large machine can be diverted from its course by a gasp. People, small boats, and small flying vehicles will be pulled below the surface. All so grabbed will take 3d10 impact damage. Effect on machines and boats is usually devastating. The gasp will try to drown anything that fights and will release anything that doesn't struggle.

If the war tank in this module is attacked, and if its speed is from 1-20 km/h, then the tank is diverted into the water. The blades, rotating rapidly, foul in the water and the tank is damaged. The PCs will be able to guide it to shore but will require two days to repair and straighten the blades. If its speed is greater, the tank avoids the crash into the water and no damage occurs.

Puff-puckers

Type:	Tiny insect
Number:	1-10
Move:	Slow
IM/RS:	8/75
Stamina:	1
Attack:	30
Damage:	1d10
Special Attack:	Explode and drive their heads into victims
Special Defenses:	None
Native World:	Starmist (all habitable environments)

A puff-pucker looks like a fat, slimy, white grub. It is about 100 mm long. The shiny black head of the creature is about 20 mm long. The body of the insect generates hydrogen gas allowing it to float on the breezes through forest, swamps, and mountains. When within 3 m of living beings they will, on a percentile die roll of 50 or less, explode, driving their tiny black heads into the bodies of their victims as if they were bullets from a projectile weapon. Treat inertia fields and skein suits as if a pistol had been fired. If a puff-pucker does not explode it will drift harmlessly. A roll must be made for each character within range. If a puff-pucker is exploded by any means within 20 m of a creature there is a 10% chance the creature will be hit.

The embedded head of the puff-pucker can only be removed by some sort of surgery. Otherwise an infection will result and the wound will not heal. After three days any character or animal with a head still embedded will die of poison.

Snikker

Type:	Medium carnivore
Number:	1-2
Move:	Medium
IM/RS:	6/60
Stamina:	75
Attack:	55
Damage:	2d10 bite
Special Attack:	Spits acidic poison
Special Defense:	None
Native World:	Starmist meadows and grasslands

Snickers are grass snakes, approximately 2-3 m long and 500 mm thick. They move silently through the high grass of plains and meadows in the rifts. Occasionally they lift the forepart of their bodies to look for enemies or prey. A tapering dorsal fin runs from the back of the skull to the tail. When the snikker spits venom the fin extends fully. Snickers vary in color from pale green to a dark maroon during moments of excitement. The snikker can spit twice at full effect; then it must rely on its bite as its venom will be exhausted.

Snikker venom will hit as a ranged weapon to a distance of 20 m. Base attack for the venom spray is 70%, subject to modifiers such as cover or wind. Inertia screens have no effect on the venom. Venom will penetrate any type of protective suit within 1d10 melee turns. Damage to individuals is 1d10+5 plus an additional 1d10 of damage for two consecutive turns as the combined acid/poison works on skin. Some method of neutralizing

secondary damage may be possible. This type of acidic poison is extremely valuable.

Wispees

Type:	Tiny insect
Number:	5d10
Move:	Fast
IM/RS:	8/75
Stamina:	1
Attack:	50
Damage:	2 points
Special Attack:	Swarm
Special Defense:	Transparency
Native World:	Starmist forest

Wispees are 40 mm long and they live in hives throughout the forest. A hive of wispees possesses a rudimentary intelligence. It will direct the attacks of its "cells" on other creatures. Wispees are transparent and the only sign of their presence is a small whirlwind effect in the air.

They attack in groups of 5. Divide the number of attacking wispees by 5 and roll the attack number for each group only. A roll of 1-5 on the die will mean that the victim has been bitten for 2 points of damage. The players may strike at wispees with any extension of their bodies classified as an arm. They will hit a wispee group on each successful attack. Roll a percentile die; the wispee group is mashed on 50 or less.

NONPLAYER CHARACTERS STATISTICS

Akhan (Heliopie High Priest)

STR/STA	40/40	PS	1-10
DEX/RS	50/50	IM	5
INT/LOG	65/65	RW	25
PER/LDR	70/70	M	25

Weapons: Nuclear pistol; 15 points damage at a flat range of 100 m; has 15 charges; only source of recharge is the tank and recharging is beyond ability of PCs; any PC or NPC firing this weapon has +1 added to skill level with beam weapons (if unskilled with beam weapons the pistol fires as a normal laser pistol).

Equipment: An inertia shield worn under his robes.

Akhan carries the black and red striped rod that is the tank command key. It will allow anyone who possesses it to touch the tank without activating the electric defense field and to operate equipment and hatches inside.

Akhan is shrewd, powerful, and charismatic.

A'ssuu (Sathar Base Commander)

STR/STA	50/50	PS	3
DEX/RS	60/60	M	6
INT/LOG	45/45	RW	30
PER/LDR	40/60	M	30

Weapons: Laser pistol.

Skill level 2 with beam weapons; hypnotism.

Equipment: Albedo screen, gas mask, and skeinsuit.

A'ssuu's death triggers a "dead-man switch" that activates the base self-destruct mechanism. Several implanted explosives in his body activate at his death. No revival is possible.

Chaka, Gokul, Okalla, Edaku, Kuku, and Killok (Heliopie Priests)

STR/STA	50/50	PS	1-10
DEX/RS	55/55	M	6
INT/LOG	50/50	RW	28
PER/LDR	40/40	M	25

Weapons: Projectile; 8 shots, 1 clip.

Chaka, Gokul, Okalla, and Edaku have inertia screens under their robes that function as UPF shields. Kuku and Killok have albedo screens.

All the priests are subordinate to Akhan and there is no power struggle within their ranks.

Cukkar (Heliopie Subchief)

STR/STA	65/65	PS	1-10
DEX/RS	60/60	IM	6
INT/LOG	40/40	RW	30
PER/LDR	50/50	M	33

Weapons: Four tangler grenades; they are very old, and there is a 40% chance per grenade that they will not explode; effects are the same as for the tangler grenade in the Weapons Table. Smoke grenade so powerful it will cause a 1d10 of damage to anyone within 5 m and totally blanket the village and river area with dense smoke; infrared can pierce the smoke easily, ultraviolet can allow vision to 10 m only; the smoke will last for one hour; in smoke normal vision for PCs and Heliopes is 1 m.

Cukkar is angry, bitter, and fearless, and has a touchy sense of honor. He will be openly contemptuous of the Vrusk PCs. He will not insult them but if offended will attack quickly.

Drosophage (Sathar Agent)

STR/STA	45/45	PS	3
DEX/RS	45/45	IM	5
INT/LOG	50/50	RW	23
PER/LDR	50/50	M	23

Weapons: Laser pistol.

Skill level 1 with beam weapons; elasticity, lie detection (.05%).

Equipment: Skeinsuit, and gas mask.

Dralasite traitor and fugitive murderer wanted by the UPF for military sabotage and treason.

Lekeekh (Heliopie Subchief)

STR/STA	60/60	PS	1-10
DEX/RS	55/55	IM	6
INT/LOG	45/45	RW	28
PER/LDR	55/55	M	30

Weapons: Auto-pistol (see Weapons Table - Basic Rules) and 4 clips of ammunition; each clip has 8 shots.

Tangler grenade (see Weapons Table - Basic Rules).

Stone bullets.

Lekeekh is insatiably curious about the PCs, their mission, their clothes and equipment, and especially any metal items they carry. He has two wives and 14 children.

Malligigg, Maximillian

STR/STA	50/50	PS	3
DEX/RS	65/70	IM	7
INT/LOG	40/40	RW	33
PER/LDR	40/40	M	33

Weapons: Laser pistol.

Special characteristics: Ambidexterity

Skills: Technological PSA - computer skill 2; robotics skill 1; military PSA - weapons skill 2 (beam weapons)

Equipment: Radio; toxy-rad; magni-goggles; gas mask

Malligigg was born in the Vrusk K'onklave, Valentina City Complex. After education in the Vrusk Center for Children he was apprenticed to a relative in the shipping trade as cargo officer ensign and pilot trainee. He completed courses for a degree in science and astrophysics from the University of Southern Kalph, Ken'zah Kit, and served as master-assistant on three Vrusk freemercants during his standard training period.

Malligigg holds master and owner status aboard the VSS Last Legs, private registry, Kra K'ow City, K'aken-K'ar. VSS Last Legs, has clearance for an exploration trip into quadrant [Data Classified].

Maximillian's purpose is to aid you in running the adventure. He is ambitious and eager but neither brave nor smart. Max will fight when he is forced to do so but will negotiate or bargain whenever possible. Maximillian can know information that you wish to give the PCs.

Pinker, Micky (Sathar Agent)

STR/STA	50/50	PS	3
DEX/RS	50/50	IM	5
INT/LOG	45/45	RW	25
PER/LDR	45/45	M	25

Weapons: Needler pistol.

Skill level 1 with projectile weapons.

Equipment: Skeysuit, and gas mask.

Human extortionist and thief. Deserts and/or surrenders whenever things go wrong. Will demand his rights under UPF law if captured.

Riss'aad (Sathar Second-in-Command)

STR/STA	60/60	PS	3
DEX/RS	40/40	IM	4
INT/LOG	45/40	RW	20
PER/LDR	30/50	M	30

Weapons: Two auto-pistols. Riss'aad has the unusual ability to fire both weapons simultaneously without any minuses to attack number. If captured he will detonate the explosives implanted in his body; they detonate automatically at his death.

Equipment: Skeysuit, and albedo screen.

Skill level 1 with projectile weapons; hypnotism.

Rokakar (Heliopie Chief)

STR/STA	70/70	PS	1-10
DEX/RS	65/65	IM	7
INT/LOG	55/55	RW	33
PER/LDR	60/60	M	35

Weapons: Projectile pistol (see Weapons Table - Basic Rules); 2 the pistol has 3 clips of shells with 8 shots per clip; ammunition is getting low. Fragmentation grenades (see Weapons Table - Basic Rules). Stone bullets.

Rokakar has three wives and 16 children of various ages. He will respect the PCs for their power but will attack them if he feels that is necessary.

Tragger (Sathar Agent)

STR/STA	45/30	PS	3
DEX/RS	60/60	IM	6
INT/LOG	45/45	RW	30
PER/LDR	45/45	M	30

Weapons: One-shot pistol; double normal pistol damage at short range; laser pistol.

Skill level 1 with beam weapons.

Tragger can fly the hovercraft and the jet-copter. He will be able to fire their weapons systems as well but only at -10 to attack numbers.

Tragger is a human mercenary who deserted from the UPF military when young. There is a 75% chance that he will fight to the death rather than surrender; however, he is not above surrendering and using the small one-shot pistol attached to his wrist to kill someone.

Vuzzie'vaz (Sathar Agent)

STR/STA	50/50	PS	3
DEX/RS	60/60	IM	6
INT/LOG	45/45	RW	30
PER/LDR	45/45	M	30

Weapons: Sonic disrupter, fragmentation grenade.

Skill level 2 with beam weapons; ambidextrous; comprehension 16.

Equipment: Skeysuit.

Vrusk terrorist wanted on six planets for terrorism. Former head of piracy ring. Under mandatory death sentence.

SATHAR BIO-GENETIC CONSTRUCTS

Sathar genetic manipulations have produced the form of the following species, but not the function. Each has been restructured so that the outward shape is normal but all are capable of deadly functions.

Clinging Violets

Type:	Plant
Number:	Small patches
Move:	NA
IM/RS:	NA
Stamina:	NA
Attack:	NA
Range:	50 meters (gas effect)
Damage:	Gas (-10% to all character attack rolls)
Special Attack:	Gas generation to 50 meters; undetectable
Special Defense:	None
Native World:	Human planets

These beautiful climbing violets are common on the human worlds and quite popular. The violet constructs produce an inhibiting gas that reduces attacks by 10 of characters who inhale it. The gas spreads over a 50 m area and is completely undetectable. Any character wearing a gas mask or sealed suit or in a vehicle will be immune. Effects last for 10 turns (100 combat rounds) after the characters leave the area of the plants.

Creepsines

Type:	Large herbivore
Number:	1-5
Move:	Slow
IM/RS:	4/40
Stamina:	70
Attack:	35 (roll only if character sits on creepspine, then roll each turn afterward)
Damage:	Paralysis
Special Attack:	None
Special Defense:	None
Native World:	.All character planets (see below)

The true creepspine is a large caterpillar about 3 m long and 1 m in diameter. It stands about 1 m off the ground on a multitude of legs. All the PCs will recognize the furry creature and will know that it is used as a tireless riding animal on many worlds. Within the soft, furry exterior of the creepspine constructs are tiny spines tipped with a paralyzing poison that incapacitates the lower extremities. Anyone poisoned will be unable to walk for four hours. Any PC with a biosocial PSA and medical skill of 3 or more will be able to neutralize the poison completely with a proper kit. If medical skill is less than 3 the paralysis will last for 1 hour.

Froggs

Type:	Small carnivore
Number:	1-10
Move:	Very fast (see below)
Special Move:	Leap
IM/RS:	8/80
Stamina:	10
Attack:	75
Range:	10 m (leap)
Damage:	3 points
Special Attack:	None
Special Defense:	Camouflage allows surprise 85% of the time
Native World:	All character planets (see below)

Frog constructs resemble many types of frogs found on home worlds. Totally invisible in most terrain, they attack instantly, leaping for the face of any character for a successful bite causing 3 points of damage. If they miss, they disappear into the surroundings. Only a character with an RS equal to or better than the frogg has the chance to hit one. Roll a percentile die each time a frogg attacks; the frogg can surprise 85% of the time. Each attacks randomly only once.

Fingerllies

Type:	Small carnivore (fish)
Number:	1-100 (groups of 10; see below)
Move:	Very fast
IM/RS:	8/80
Stamina:	1
Attack:	50
Range:	3 m
Damage:	1
Special Attack:	None
Special Defense:	None
Native World:	See below

Fingerllies are small, minnow-like fish from human worlds. They travel in schools and resemble baby fish. Fingerllies constructs have a needle-like nose that is nearly invisible in the water. They strike with uncanny accuracy and each strike is a point of damage. If any character is in the water or within 3 m of the water, roll a percentile die. This will be the number of fingerllies that hurl themselves at the character. Roll their attack score in groups of 10 rounded up. If 46 fling themselves at a target then roll five attacks. Skeinsuits will affect the damage rolls.

Grapal

Type:	Plant
Number:	NA
Move:	NA
IM/RS:	NA
Stamina:	NA
Attack:	NA
Damage:	Delayed toxic poison
Special Attack:	None
Special Defense:	None
Native World:	Dralasite Planets

Grapals are native to the rivers and lakes of the Dralasite planets. They are grapelike vines that produce a superb wine. Difficult to grow at best, they will survive off-planet only in specially constructed hothouses. Any Dralasite will remember that a true grapal allows them to "grow" an extra, usable arm or leg during a period of three hours after eating. Grapal constructs, on the other hand, produce a toxic fruit that is deadly to Dralasites, either in their raw form or as grapal wine. If they eat a construct, no arm will grow and anti-toxin is needed quickly. Other races become violently ill for four hours.

Sailsnails

Type:	Small herbivore
Number:	1-5
Move:	Very slow
IM/RS:	3/30
Stamina:	5
Attack:	90
Damage:	Disease
Special Attack:	None
Special Defense:	None
Native World:	All character planets (see below)

The sailsnail is a cute, furry, flying, snail-like creature popular as a pet on many worlds. The children of all races love them. Their bodies are 200 mm long and covered with a lush, velvet fur in a rainbow of colors. They "sail" by means of a self-generated helium gas that raises them up and a beautiful sail-wing which catches the wind. A sailsnail construct is an exact duplicate except for a tiny needle proboscis which it sticks into exposed flesh and through which it injects a debilitating disease. There is no pain. If untreated within 24 hours, the victim loses a limb.

Squirrillets

Type:	Small carnivore
Number:	1-10
Move:	Very fast
IM/RS:	9/90
Stamina:	12
Attack:	60
Damage:	1d10-3 (bite) (minimum 1)
Special Attack:	None
Special Defense:	None
Native World:	All character planets (see below)

Squirrillets are common on all of the worlds of the four space traveling races. The species have different names and slightly different forms but all are harmless nut gatherers about 500 mm long. However, the constructs are vicious killers. The constructs attack on sight only those from the planet which was home for their normal counterparts. Who is attacked is determined randomly. Use normal attack methods. Protective suits are used as normal.

Tick-tock Trees

Type:	Plant
Number:	1
Move:	NA
IM/RS:	NA
Stamina:	NA
Attack:	50
Damage:	1 point/seed
Special Attack:	None
Special Defense:	Noise
Native World:	Vrusk planets

Tick-tock trees are very common on Vrusk planets. True tick-tocks are sensitive to the presence of living creatures and the large, dry pods hanging from their willow-like branches make loud tick-tock sounds if any creature the size of a small animal or larger comes near. The secret of passing through the trees without making a sound is known to the Vrusk. Tick-tock constructs, however, explode seeds, alerting anyone in the area to intruders and causing flesh wounds. This will occur at any time a character comes within 3 m of the tree, Vrusk or not. Roll a percentile die once for the number of seeds striking. Roll for attack only once for the seed mass. A skeinsuit or inertia screen will stop 90% of all damage.

Lilly-po

Type:	Plant
Number:	2d10
Move:	None
IM/RS:	5/40
Stamina:	20
Attack:	65
Damage:	Immobilization and drowning
Special Attack:	None
Special Defense:	None
Native World:	Yazirian planets

Lilly-pos are large lilly-pads, about 1 m in diameter that have a most unusual property. When plucked from the water and wrapped around an individual, true Lilly-pos act as natural holoscreens. The hologram is of whatever the character wishes and will last for one hour or longer if the character has part of the pad in water. The constructs look exactly like real lilly-pos to any Yazirian. They float on ponds in groups of 20. If characters decide to pluck a lilly-po construct, the pads will wrap suddenly around them, snatching them underwater. PCs will be completely immobilized and can be damaged by weapons that might be used against the lilly-po.

Weeping Wallows

Type:	Plant
Number:	1
Move:	NA
IM/RS:	6/60
Stamina:	35
Attack:	65
Range:	100 m
Damage:	-20 to attack rolls
Special Attack:	Sonic crying
Special Defense:	Immune to sonic attacks
Native World:	Yazirian planets

The true weeping willow is a curiosity on most worlds as it makes crying sounds. However, the low frequency weeping of a construct causes disquiet to all within 100 m who hear it. The frequency reduces all attack rolls by 20 in addition to all other modifiers and damage. The sound effect can be neutralized by inertia/sonic screens.

PLAYER CHARACTER BACKGROUND REPORT

Maximillian Malligigg, a former second-master and navigator of a Vrusk freemercant ship, has hired you for a private expedition to an uncharted planet he calls Starmist. During his last voyage, Malligigg made an emergency landing on Starmist. The planet was within the normal range of for all races.

According to Max, the surface of Starmist is broken by cracks that are kilometers deep, called rifts. It was in one of these rifts that his ship landed. In the rift the crew found intelligent life: a predominantly nomadic culture and one native village located along the river near a narrow section of the rift. Maximillian learned the native language using polyvox computers and that the natives called themselves Heliopes.

During the course of his short stay on the planet, Maximillian found a small piece of fused metal near the village. The native culture lacked the sophistication to produce high temperatures, and it was obvious the metal had not fused by any natural means, such as volcanic action. Max took the metal with him when he left Starmist.

Later Max had the piece of material tested and found it to be a product of nuclear fusion. This information startled him, for it implied that an advanced civilization may have been on Starmist sometime in the past. Since he knew an official expedition would be sent to Starmist soon following his captain's report to the authorities, Max was eager to get there first. If he could find evidence of a lost civilization, and perhaps locate some artifacts, he could become a wealthy man. Therefore, after raising the funds, he purchased and refitted an old ship, the VSS Last Legs, and hired you to accompany him to Starmist on an interstellar treasure hunt.

Maximillian has landed the VSS Last Legs in the same rift site as before. He wishes to proceed immediately to the village area and re-establish contact with the natives. He wants to learn more about the fused material. For this reason you must take care to maintain friendly relations with the Heliopes, for Max feels that the secret of the strange material is in the area of the village.

The village culture is obviously more highly developed than that of the other nomads in the rift. Aerial photographs taken during re-entry show sizable buildings and a large complex on platforms standing in the river.





○ Landing Site

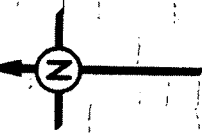

©1983 TSR, Inc. All Rights Reserved.

Scale 1 square = 1 kilometer

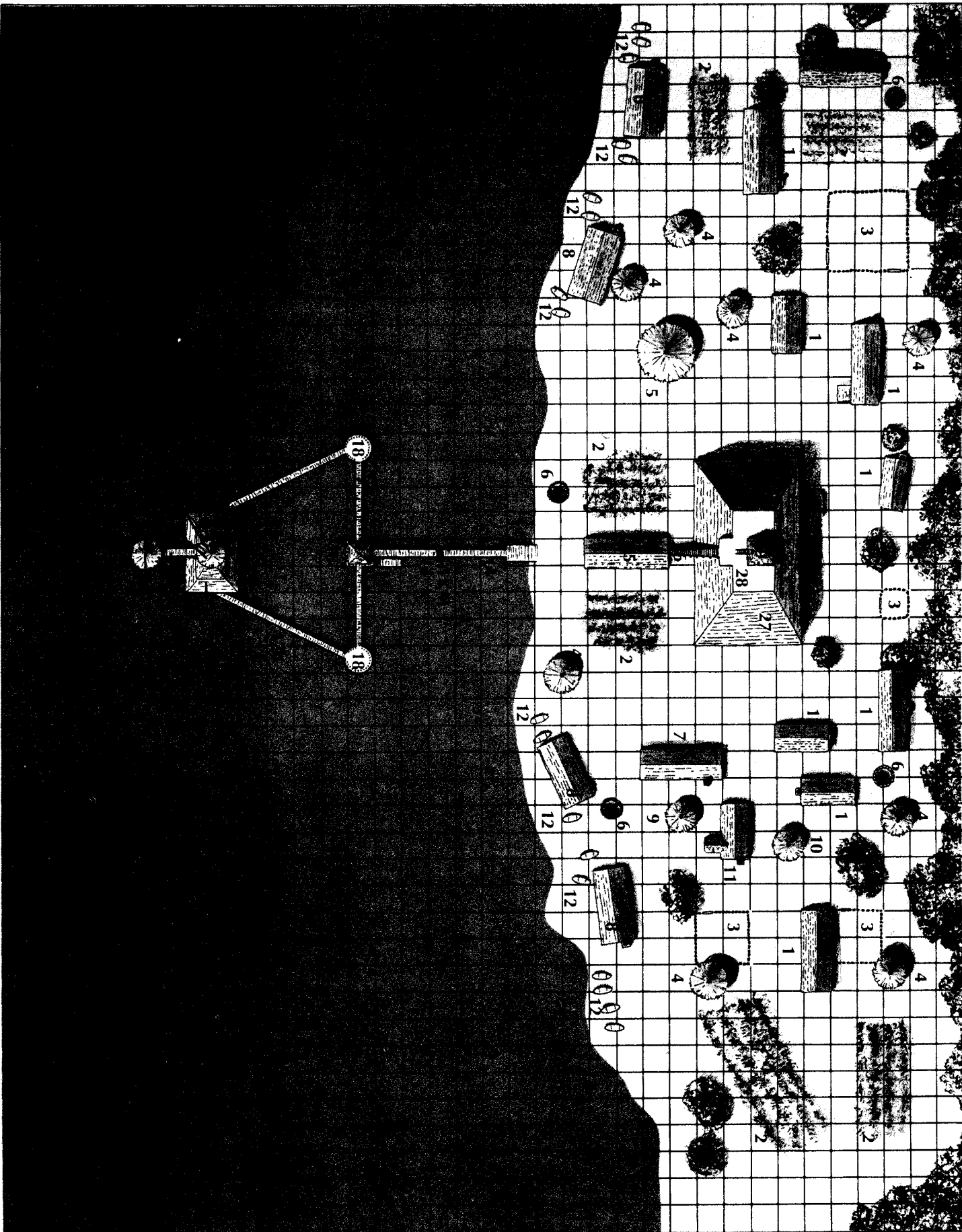

WARTANK MAP

Length 31 m Width 24 m Height 6 m

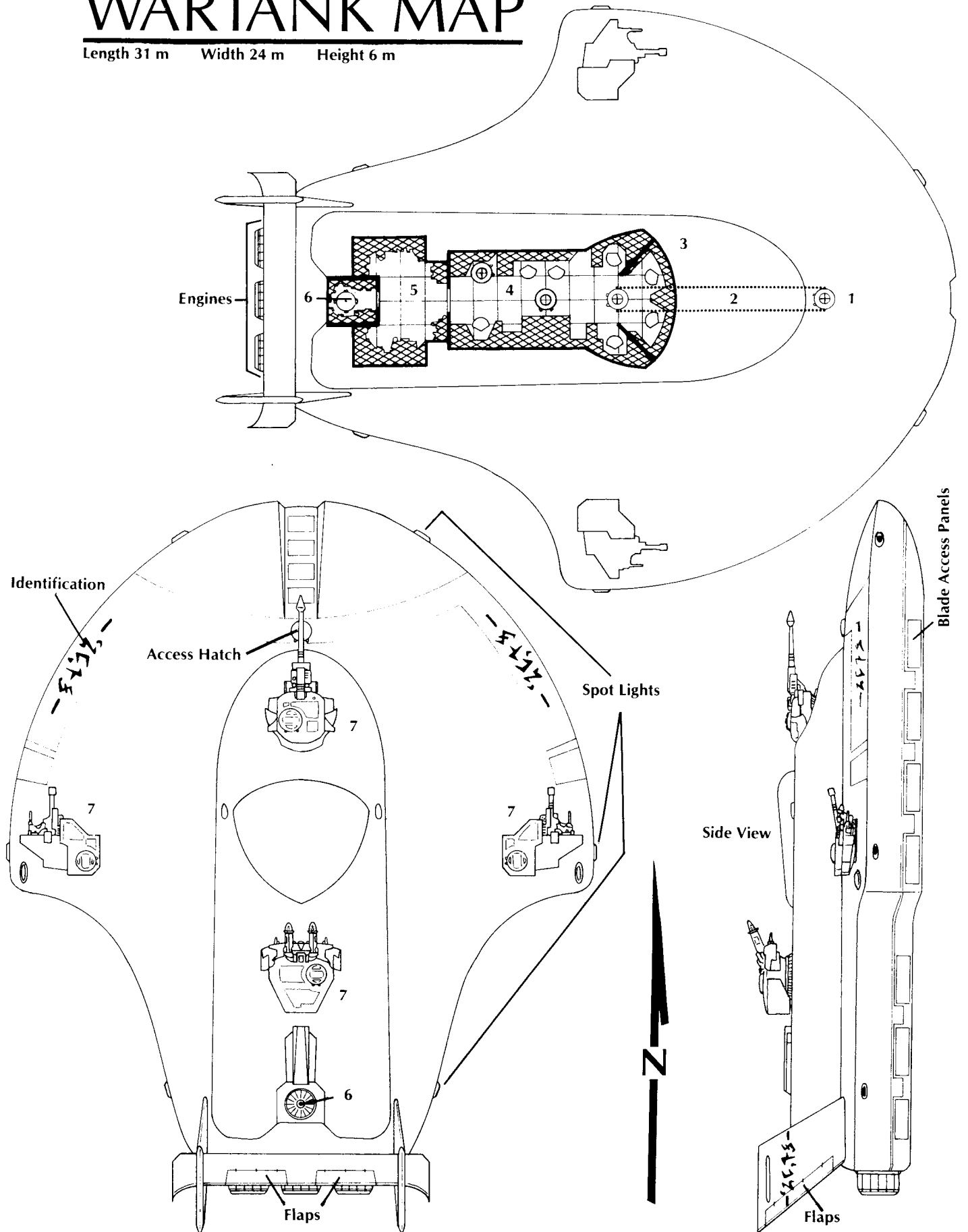

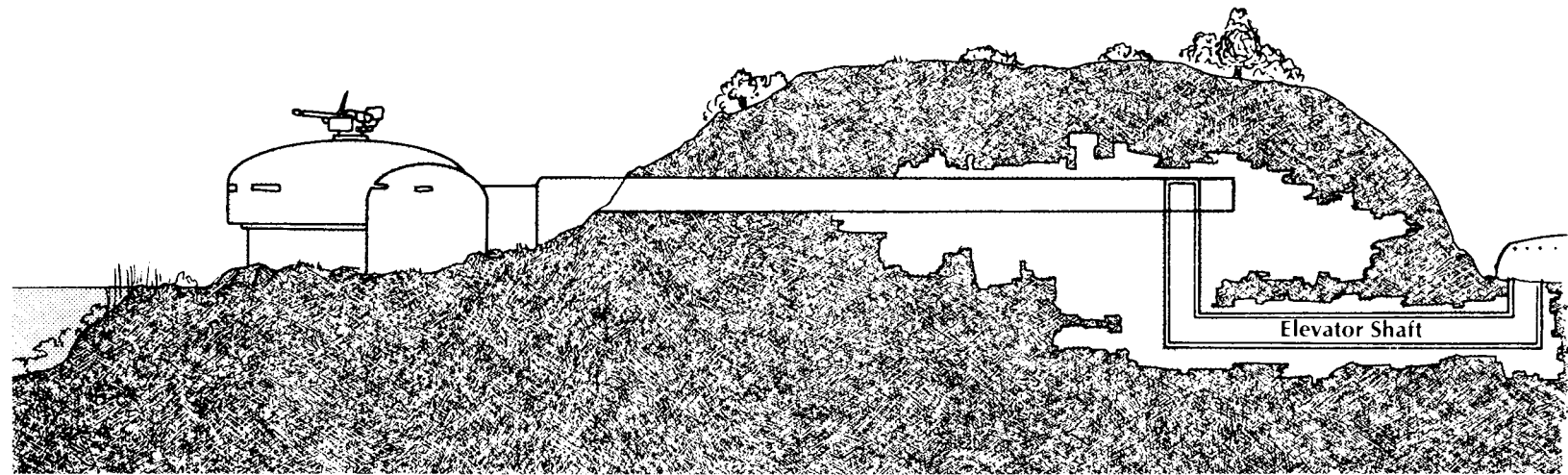

INSIDE BUNKER

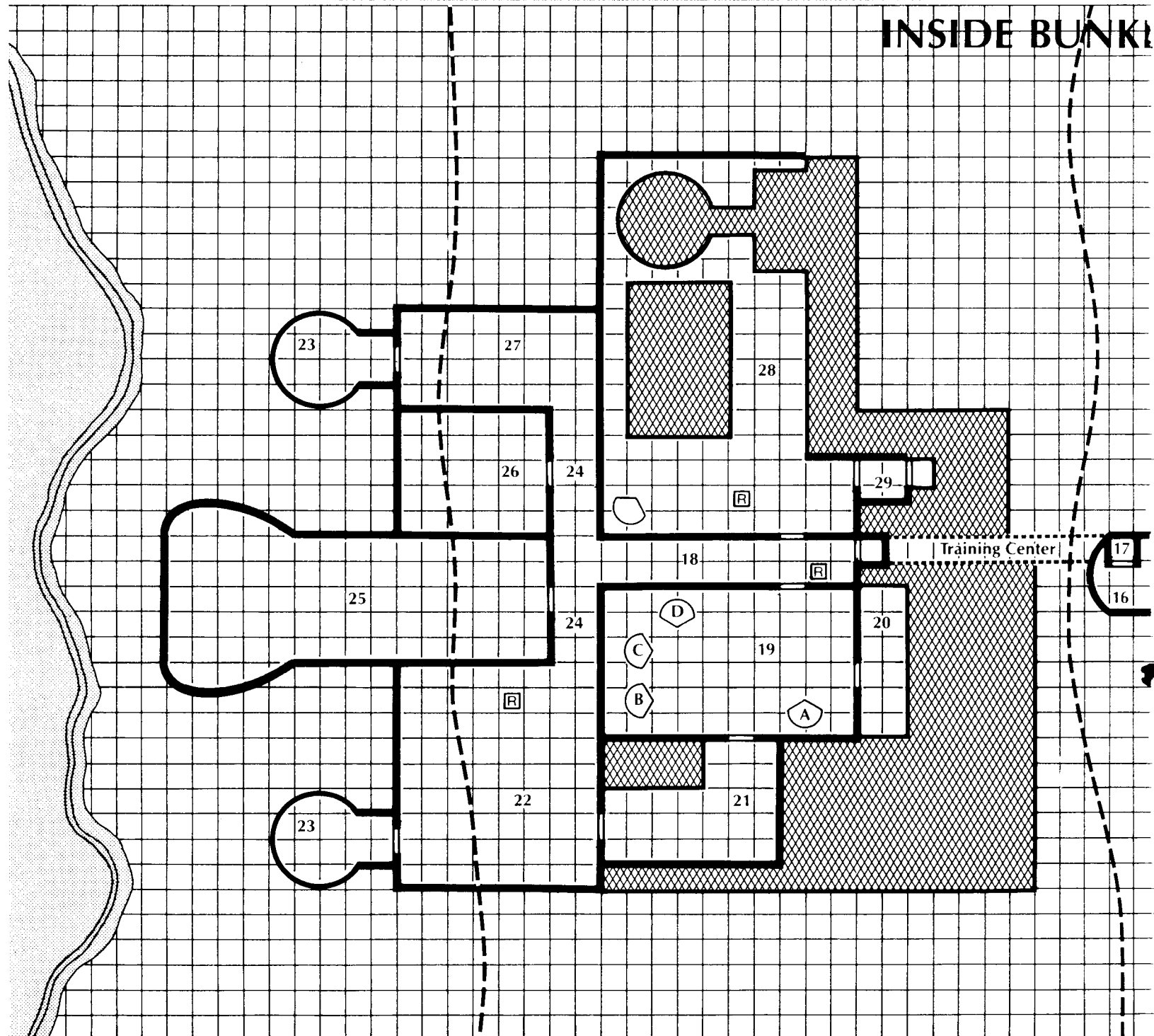

SATHAR TRAINING BASE AND WEAPONS BUNKER



TR COMPLEX

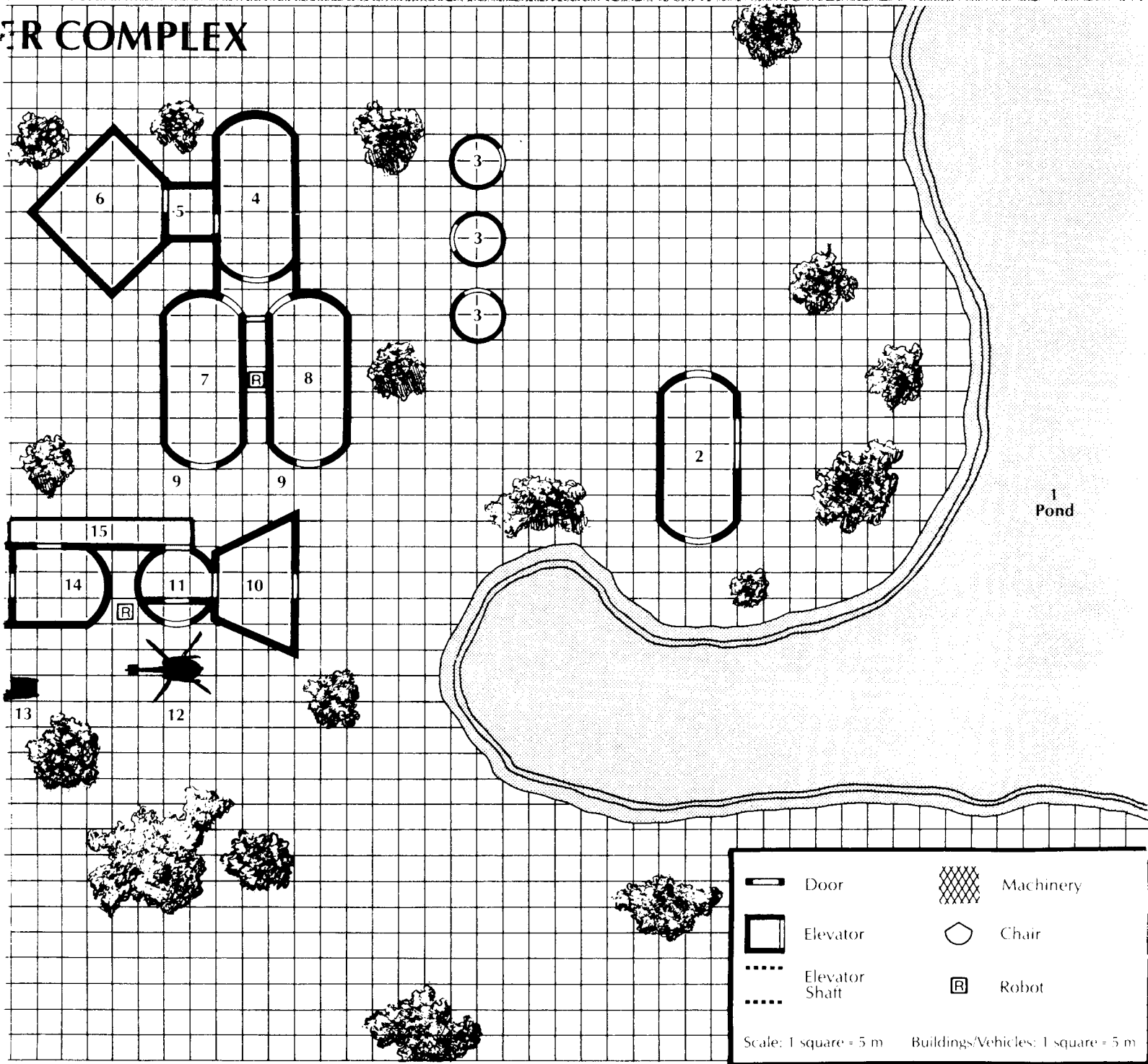

	Door		Machinery
	Elevator		Chair
	Elevator Shaft		Robot

Scale: 1 square = 5 m Buildings/Vehicles: 1 square = 5 m

PREGENERATED CHARACTERS

If the players do not wish to roll up their own characters, they may choose from the selection below.

Character Name: Dromond **Character Race: Dralasite**

STR/STA	65/65	PS	4
DEX/RS	55/45	IM	6
INT/LOG	40/50	RW	28
PER/LDR	55/55	M	33

Special Abilities: Form Change, Perception (05%)
 Skills: Military PSA, Beam Weapon 2
 Equipment: 2 Laser pistols, 3 Frag grenades, Skeinsuit, Albedo screen

Character Name: Diracman **Character Race: Dralasite**

STR/STA	65/65	PS	4
DEX/RS	45/35	IM	5
INT/LOG	55/55	RW	23
PER/LDR	45/35	M	33

Special Abilities: Form Change, Perception (05%)
 Skills: Military PSA, Projectile Weapons 3, Beam Weapons 1
 Equipment: Auto-pistol, Throwing vibro-blades (3), Gas Mask, Skeinsuit, Albedo screen, Hovercycle (in hold of ship)

Character Name: Viyizzi **Character Race: Yazirian female**

STR/STA	45/45	PS	3
DEX/RS	65/55	IM	6
INT/LOG	55/55	RW	33
PER/LDR	35/35	M	33

Special Abilities: Gliding, Battle Rage (05%), Night Vision
 Skills: Military PSA, Beam Weapons 2, Projectile Weapons 2
 Equipment: Magnigoggles, Radiophone, Laser pistol, Skeinsuit

Character Name: Yoe **Character Race: Yazirian**

STR/STA	30/40	PS	2
DEX/RS	65/55	IM	6
INT/LOG	60/60	RW	33
PER/LDR	45/35	M	33

Special Abilities: Gliding, Battle Rage (05%), Night Vision
 Skills: Military PSA, Projectile 1, Beam Weapons 1, Heavy Beam Weapons 1
 Equipment: Radiophone, Skeinsuit, Auto-pistol

Character Name: Mase Carrigon **Character Race: Human**

STR/STA	50/50	PS	3
DEX/RS	55/55	IM	6
INT/LOG	50/50	RW	28
PER/LDR	45/35	M	28

Special Abilities: None
 Skills: Biosocial PSA, Medical 2, Environmental 2, Beam Weapon 1
 Equipment: Medkit, Gas Mask, Laser pistol, Inertia screen

Character Name: Judith Chosto **Character Race: Human**

STR/STA	50/50	PS	3
DEX/RS	45/45	IM	5
INT/LOG	50/60	RW	23
PER/LDR	50/50	M	25

Special Abilities: None
 Skills: Technological PSA, Technician 2, Robotics 2, Beam Weapons 1, Martial Arts 1
 Equipment: Laser Pistol, Radiophone, Inertia screen, Tech Toolkit, Robot Repair Kit, *Personal Robot (Violet)

*VIOLET - Humanoid form, robot servant
 Level 2 Parabattery
 Attack/Defense Program Level 4
 Radio/Computer Link
 Visual, Sound and Radio Sensors
 Weight: 155 kg
 Stamina: 100
 Equipment: Chronocom, Radio/Computer Link, Radiophone, Infra-red and Ultra-violet Jamming, Radio Direction Finding, Toxi-rad gauge, Albedo screen, Laser Pistol

Violet was built by Judith and is not a standard robot model. This machine is human in form and can walk or run as fast as a human. It responds to Judith either in voice or over the radio. Violet will not respond orders from any other character or NPC unless reprogrammed by Judith. If any attempt to change this is made then the robot will attack instantly. Violet can jam radio, radar, infra-red and ultra-violet systems (causing a 30' area of indistinct haze around itself to those systems). This robot can maintain a full computer link with the Last Leggs main computer and has excellent optical sensors, as well as radio communications.

Character Name: Krakker Jakk **Character Race: Vrusk**

STR/STA	45/45	PS	3
DEX/RS	45/35	IM	5
INT/LOG	45/45	RW	23
PER/LDR	60/60	M	23

Special Abilities: Ambidexterity, Comprehension (20%)
 Skills: Technological PSA, Computer 2, Robotics 2, Psycho-Social 2, Beam Weapons 1, Heavy Beam Weapons 1
 Equipment: Laser Pistol, Laser Rifle, Inertia screen, 2 Frag grenades, Radio-phon, Magnigoggles, Chronocom

Character Name: Dazzell **Character Race: Vrusk**

STR/STA	55/55	PS	3
DEX/RS	45/45	IM	5
INT/LOG	40/40	RW	23
PER/LDR	45/45	M	28

Special Abilities: Ambidexterity, Comprehension (24%)
 Skills: Military PSA, Projectile Weapons 2, Heavy Projectile Weapons 1, Martial Arts 3
 Equipment: Auto-pistol, Auto-rifle, Skeinsuit, Albedo screen, 2 Frag grenades, 2 Tangler grenades

A STAR FRONTIERS®

ALPHA DAWN ADVENTURE

Sundown on Starmist

by Garry Spiegle

Starmist! A new planet, discovered by a Vrusk merchant ship. A planet whose surface is a frozen waste crossed by giant canyons, kilometers deep. In those canyons are air, water, life, and above all, mystery.

After an emergency landing on Starmist, Maximillian Malligigg, Second Officer of the VSS Centispeed, stumbled on a puzzling clue. While his fellow crewmen repaired the drive on their ship, Max made tentative contacts with the humanoids called Heliopes, who live on Starmist.

The Heliopes are members of a primitive, nomadic culture. There is a single village among these nomadic tribes: a village whose people display excellent workmanship. In the village's center is a massive pyramid and an entire building complex set on platforms above the river.

What did Max find that made him eager to hire you, an intrepid band of adventurers, to join him in returning to Starmist? What secret gave Max visions of wealth and brought you all to this golden rift and the promise of danger!

STAR FRONTIERS is a registered trademark owned by TSR, Inc.
©1983 TSR, Inc. All Rights Reserved. Printed in the U.S.A.



ISBN 0-88038-039-X
394-53461-1TSR 0600
7803XXX1501