

FASA CORPORATION



CONTENTS

ANGEL'S SONG: A Prologue	4
INTRODUCTION	6
Gamemaster's Notes	6
Shadowrun Rules	6
Making Success Tests	6
Success Tables	6
Decision-tree Format	6
How to Use This Book	6
Plot Synopsis	7
Running Dark Angel	8
THE ADVENTURE	9
Fallen Angel	9
Club Chiaroscuro	11
Icelandy's Doss	14
Members of the Band	15
Xanadu Studios	20
Calling the Cops	25
Heaven Bound	27
Mindwarp	31
Marian Parks	37
Brother to an Angel	40
Up the Ante	48
Kat's Dreadnought	51
PICKING UP THE PIECES	57
After the Adventure	57
Epilogue	57
Awarding Karma	58
Team Karma	58
Individual Karma	58
LEGWORK	59
Contacts	59
Electronic Legwork	60
Dark Angel	60
Xanadu Studios	60
Edward Crull	61
Oni-do	61
Kat Akmura	62
Shiro Usaka	62
Homatsu Jinjiro	62
CAST OF SHADOWS	63
Akimoto	63
Kat Akmura	63
Chigo Akwe	64
Dynamo Blue	65

Edward Crull	66
Dark Angel (Jim Crull)	66
Homatsu Jinjiro	67
Kojlka	68
Kure	68
Shiro Usaka	69
PLAYER HANDOUTS	70

DARK ANGEL

Writing

Thomas Kane

Development

Tom Dowd

Editorial Staff

Senior Editor

Donna Ippolito

Associate Editor

Sharon Turner Mulvihill

Editorial Assistants

Diane Piron

Robert Cruz

Production Staff

Art Director

Jeff Laubenstein

Project Manager

Mike Nielsen

Cover Art

Doug Andersen

Cover Design

Mike Nielsen

Illustration

Janet Aulisio

Mike Nielsen

Karl Waller

Maps

Aardvark Studios

Layout

Carol Brozman

Keyline and Pasteup

Ernesto Hernandez



ANGEL'S SONG: A Prologue

The stage lights faded one by one as Dark Angel tossed his long, black hair from his face and raised his arms in a final salute to the audience, his Stratocaster slapping against his synthleather-clad body. The menagerie of elves, streetmages, scuzboys and go-girls that crowded The Whistler responded to his gesture with a loud wave of applause. From the stage, Angel took one last look at the mass of bobbing fluorescent mohawks and flashing earrings before he turned and made his way backstage.

The tall, thin elf ignored the dreamqueens and androgynous fanboys who lined the hallway and beckoned to him, and stopped in the club's back room, a small, squalid area decorated with bare wires and stained plascrete walls. He looked over at Monarch, The Whistler's overweight, pasty-skinned owner, and gave her a gallant nod as he inserted his credstick into her payroll computer. The stick's gray digits flickered and Angel watched his credit balance rise from 9.34 to 1,009.34 nuyen.

Angel stepped outside into the shadowy alley behind the club. The dim glow of distant streetlights showed him the alley was abandoned; even the usual chipheads and party-girls were nowhere in sight. Uneasiness tickled the pit of his stomach.

Angel dismissed the feeling as soon as he felt it, unwilling to let anything spoil his postperformance buzz. After all, fresh credit warmed his credstick and tonight he and the band could party; drek, he and Lili could even eat out, have some real food for a change instead of the usual krill filler. A small smile crept across the elf's face at these thoughts. The soft ringing in his ears that always followed a night of cranking rock and roll made his steps begin beating out an easy, loping rhythm, and he sang to himself in the blackness of the alley.

*Let me tell you the tale of a businessman
One Mr. Johnson by name
Who had his perks and his clerks and a limousine
But couldn't buy love with his gain
Cause the moon still shines brighter than satellites
And magic's not science but art
Some girls will turn tricks to put yen on their sticks
But Trista's not selling her...*

Angel stopped at the end of the alley as the rumble of an engine drowned out his song.

He could see a lone, dull black van cruising along the club strip, its smoked-glass windows bulging from their frames like the eyes of a mantis. The van was the only vehicle on the road, and it slowly traveled some three blocks down the strip before executing a U-turn and beginning a second pass.

The elf shrank back into the alley's shadows and pressed himself against the dank, graffiti-covered concrete. Slowly he began edging back in the direction he had just come. Angel could feel his heartbeat accelerate with each step as he cautiously

moved across the litter and loose gravel of the alley.

The van rolled to the curb. Under the low growl of its engine, a growl Angel imagined was not unlike that of a large predator nearing its prey, the elf heard the unmistakable click of a shotgun



locking and loading. Dark Angel lurched into a run toward the nearest turn in the alley, some thirty meters ahead. He stepped on a discarded can and slid, his arms windmilling. The can skipped over a wall and bounced to the ground, clattering.

Light flooded the alley and Angel glanced over his shoulder, immediately blinded by the van's glaring headlights. The elf began running full tilt, the headlights' afterimage still dancing before his eyes.

His vision cleared just in time for him to avoid running into an ill-defined tower of flesh that could only be a troll. The creature stood more than twice Angel's height. The van's headlights were reflected in the metahuman's squinting, asymmetrical eyes, which seemed to glow with a red fire. The elf caught a quick glimpse of the troll's Oriental features, goblinized into a parody of a Japanese ogre, as the creature produced a cigar-thin iron bar.

Dark Angel tensed himself to dodge, flip, and run, but never got the chance. The troll was on him before he even flexed his knees. The iron bar rose and fell and Angel went to the ground, clutching his head. A line of pain stretched from his temple to his ear.

Dark Angel looked up, his eyes fixing on the troll's arm, and realized his attacker had either cyber- or magically enhanced reflexes. The troll met his gaze for a moment, then raised the iron bar and struck him again, landing a carefully aimed blow on the roof of Angel's skull.

Pain flooded the elf's senses. For a moment he thought of Lili, saw her nimble movements and her small, mysterious smile. The troll struck him again, and Angel realized the troll was now bending over him, its eyes glittering in the headlights. The troll lifted the elf's legs, spun him around and began dragging him toward the van. The rough concrete shredded his synthsatins jacket and tore at his skin.

Warm blood from Angel's scalp ran down his cheek as he looked up at the dark buildings silhouetted against the orange, glowing sky. Then he saw nothing.

It seemed as if forever passed.

Angel awakened from a deep, dreamless sleep to a vague sense of warmth and motion. Through a cloudy, drug-induced numbness he could feel dull, hollow aches where the troll had struck him. The elf tasted bitter bile in the back of his throat as the world seemed to undulate, slowly swelling then dropping abruptly in a steady, repeating cadence.

Against his skin Angel felt clammy bed sheets, moist from his own perspiration. As his eyes began to focus, he saw white metal walls hemming him in like the sides of a coffin. Above his head, the wall was interrupted by a small, circular window, and Angel suddenly realized he was on a ship.

A subtle change in the room's light alerted the elf that he was no longer alone. A woman stood in the doorway, leaning against the steel bulkhead. The figure regarded Dark Angel with a tight, triumphant smile. For several moments, she merely looked at him, her black eyes shining. Angel, in turn, studied the woman. Her dark, close-fitting clothes showed every sleek muscle on her spare frame.

"You insulted me, Angel," the woman said in a low voice. "I never forget that."

In his dazed state, the elf could barely hear the woman. He did

not comprehend the meaning of her words, but the way she said them frightened him.

"Do you remember me, Angel?"

Dark Angel's tongue worked in his dry mouth. He struggled against the fog in his brain, trying to think of grim, lean women he had known. A name gurgled from his throat. "Lili?" But even as he spoke, the elf knew the woman in the room was not his lover.

"My name is Kat, Kat Akmura. And this is what you should have remembered before you offended me."

The woman smiled unpleasantly as she undid the buttons of her blouse with lacquered fingernails. Intricate tattoos swirled around the navel of her flat stomach. Dragons, phoenixes, turtles, apes and all the beasts of Japanese tradition danced across her golden skin.

"I am *yakuza*. I am *oyabun*," Akmura said as she watched the elf's eyes trace the colorful patterns. "Your elder brother knew who I was. You should not have mocked him ... or me."

Dark Angel drew in his breath and then released it in a long sigh.

"That was a long time ago."

"Exactly."

Akmura smiled as she drew her blouse together. "I waited." After a moment, she laughed lightly. "I was waiting for you to meet someone like Lili."

The elf shook and raised himself on his elbows at the mention of his lover's name.

"I was waiting until you had something to lose," Akmura said, her lips still curled in a smile. "You are fond of Lili, are you not?" Angel held his breath, struggling to mask his alarm.

"What did the two of you say, the last time you parted?"

Remembering, the elf shut his eyes.

"You quarreled didn't you? I thought so. And now it's too late for you to make any kind of apology. Do you know why?" A tiny laugh escaped Akmura's throat. "Because you are dead."

The *oyabun* paused as if waiting for a reply, but the elf remained silent.

"Do you know how Lili feels? Disgusted. She is thoroughly and utterly disgusted with you."

Kat drew a fresh newsfax from her pocket. She tossed it to Dark Angel's mattress.

"You see, your death was hardly a noble one."

The elf scanned the page and saw a color photograph of a burned corpse. Blisters pocked its blackened, wrinkled skin. The face could, perhaps, have been Angel's, before fire melted it beyond recognition. The arms rose from the body like rigid sticks.

"Singer Dead," ran the headline. "Lone Star security officers recovered the burned remains of musician Dark Angel from a notorious BTL den," the copy began. "City medical examiners have ruled the death a suicide, induced by illegal simsense chips. Chip-induced suicide remains popular among entertainers, quoted the usual expert. For more details, access 456."

"Do you know what happens now, Dark Angel?"

"You kill me," the elf replied, collapsing against the sheets once more.

"Not at all," Akmura said, licking her lips. "You have already died. No, now you are going to become the most popular dead singer in the history of music."

INTRODUCTION

Dark Angel is a roleplaying adventure set in the world of **Shadowrun**.

The year is 2054. Advances in technology are astonishing, with humans able to merge with computers and travel through that electronic netherworld of data known as the Matrix. Even more astonishing is the return of magic. Elves, dragons, dwarfs, orks, and trolls have assumed their true forms, while megacorporations (rather than superpowers) rule much of the world. Moving among it all like whispers in the night are the shadowrunners. No one admits their existence, but no one else can perform their clandestine work.

This adventure takes place in the shadows and back alleys of Seattle's urban sprawl. The vast sprawl includes the original city of Seattle and the surrounding sixteen hundred square miles on the eastern shore of Puget Sound. Yet even this vast megaplex is but an enclave set amid even larger sovereign states ruled by Native American nations, metahumans, and Awakened beings.

GAMEMASTER'S NOTES

Dark Angel uses a decision-tree format that allows the players' team to arrive at the same encounter via different routes, depending on the choices they make. It is possible for players to skip a planned encounter but still complete their task. To run the adventure, the gamemaster needs a thorough familiarity with the contents of this book, and both the gamemaster and the players should be familiar with the basic **Shadowrun (SR)** rules. The contents of **Dark Angel** are for the gamemaster's eyes only, except for certain items earmarked as **Player Handouts**.

Dark Angel is designed for a party of three to six player characters representing a variety of talent, including at least one mage or shaman and one decker. A successful run will also depend on the team's combat skills. Players may use any of the character Archetypes listed in the **SR** rules or in various supplements, or they may generate their own characters.

Dark Angel combines several approaches to gamemaster information. Some encounters are thoroughly planned and described in detail. Others merely set the scene, remaining open-ended. Hints for directing the various encounters appear in each section.

SHADOWRUN RULES

Dark Angel may be played using the original **Shadowrun** or **Shadowrun, Second Edition (SRII)** rules. Game information, specifically statistics, appears in the **SRII** format. Gamemasters still using the first edition rules will need to convert the non-player characters (NPCs) presented in this book to their first-edition equivalents. The gamemaster must also adjust weapons for differ-

ent Damage Codes, watch for differences in some spells, and calculate various Dice Pools for use with first-edition rules.

MAKING SUCCESS TESTS

During the course of **Dark Angel**, the players will make a number of Success Tests using a skill and a given target number. These Success Tests are indicated by the name of the appropriate skill and the target number. For example, a Stealth (4) Test refers to a Stealth Success Test with a Target Number of 4.

SUCCESS TABLES

At times, the gamemaster will use success tables to determine how much information the players receive. Each success table lists different information for different numbers of die roll successes. Rolling a high number of successes always reveals the information for the lower numbers of successes as well. For example, a character rolling three successes would learn the information for 3 successes as well as the information for both 1 and 2 successes.

DECISION-TREE FORMAT

The order in which the events of **Dark Angel** occur depend on what the shadowrunners decide to investigate. Some sections describe places the player characters might visit. Others cover occurrences such as assassination attempts, which happen whether the party finds them convenient or not. The gamemaster should read through all the sections and then use them as the situation requires.

HOW TO USE THIS BOOK

Aside from the basic **Shadowrun** rules, **Dark Angel** includes everything needed to run this adventure. The gamemaster also may find **Sprawl Sites**, **The Grimoire**, the **Street Samurai Catalog**, and the **Seattle Sourcebook** useful. Some equipment used by the NPCs in this adventure appears only in the **SR** sourcebook **Shadowtech**. Gamemasters who do not have access to this resource may simply choose not to use those items, or may replace them with similar items from other sourcebooks.

The gamemaster should read through the entire adventure before beginning the game; some important plot developments will not become apparent to the players until well into the adventure, but the gamemaster will have to lay the groundwork early on. He or she can do that best by being familiar with the storyline. The gamemaster should also carefully examine any maps, plans, or diagrams found throughout **Dark Angel**, especially the floor plans of the various buildings.

The **Plot Synopsis** in this section summarizes the story

background and the most probable course of the adventure.

Most of the chapters contain four sections titled **Tell It To Them Straight**, **Hooks**, **Behind the Scenes** and **Debugging**. **Tell It To Them Straight** describes the team's location and what is happening to them as though the player characters were actually there. Any special instructions to the gamemaster are printed in **boldface** type. Depending on the actions of the player characters, the gamemaster may need to adapt the description in **Tell It To Them Straight** to better fit the current situation.

Tell It To Them Straight is followed by a new section called **Hooks**. This section gives the gamemaster an emotional background to fill out the facts of an encounter, providing hints and tips about imagery to use in the scene, emotions to convey, sounds, sensations, textures, and so on. Gamemasters can use **Hooks** to bring color to the encounters. The information provided varies in form and content from scene to scene, ranging from general themes to specific emotions.

Next comes the information entitled **Behind the Scenes**. The real story exists here, and only the gamemaster knows what is really going on at any given moment in an adventure. Straightforward encounters presenting no important plot complications (for example, hiring a vehicle or street samurai, and so on), may skip this section. If the players or gamemaster need a map to play an encounter, it appears in this section. Minor non-player character stats needed to roleplay the encounter also appear here.

Finally, each encounter includes hints for running the encounter titled **Debugging**. This section suggests ways to get the story back on track if things go too far wrong. For example, most gamemasters will not want the player characters to get too discouraged or killed off too easily. The gamemaster can, of course, ignore these hints and let the chips fall where they may.

Legwork contains the information the player characters can obtain through their contacts or through the public data nets. Stats for important non-player characters appear in **Cast of Shadows**. Minor non-player character stats appear in the appropriate encounter within the adventure. **Picking Up the Pieces** sums up the results of the adventure, depending on the characters' actions, and provides tips on awarding Karma. **Player Handouts** contains different newsnet items for the players, depending on the outcome of the adventure.

PLOT SYNOPSIS

The only crime **Jim Crull**, a.k.a. **Dark Angel**, committed against the yakuza was to resist them, but that single act sealed his fate.

Jim's trouble began in 2043, when his elder brother, **Edward**, sought a promotion within the hermetic-research division of Mitsuhamma Computer Technologies. Nobody, least of all a *gaijin*, could achieve such an ambition without the blessing of the local yakuza *oyabun*, **Kat Akamura**. In return for her approval, Akamura demanded a traditional rite of fealty in which the petitioner offers not only himself, but his entire household, to the yakuza.

Unfortunately for Edward, Jim Crull fancied himself a rock 'n' roll rebel. His elven identity fueled a fierce idealism and equally fierce contempt for the criminal, racist yakuza. Jim expressed his contempt by skipping the yakuza indenture ceremony, horrifying

Edward and enraging Akamura. Instead, he hit the street, guitar in hand, and began singing a bit more truth than Akamura liked to hear.

Booking himself under the name **Dark Angel**, he became a musical legend in Seattle. Despite the wild critical and popular acclaim his music garnered, he lived on the streets, playing cheap clubs and refusing many lucrative offers from the yakuza-tainted recording industry. Along the way, he met **Lili Ice**, a rock fan and smalltime talismonger. The two moved into their own squat. Years passed and **Dark Angel** believed he had found his place in the world.

Akmura never forgot Jim Crull's insult. She simply bided her time, watching him and waiting to strike at the moment when it would afford her the most amusement. She allowed him to build a reputation, to grow secure in his love for Lili. Then she snatched away everything he had.

First, Akamura had Angel kidnapped, disguising the crime by staging his BTL-induced suicide. Then, she forced Angel to record a series of music chips. Under duress, Angel signed a will leaving full ownership of his music to **Dynamo Blue**, a record promoter known for her unscrupulous and predatory business practices and loose morals. Naturally, Dynamo pays the yakuza a percentage of her returns, but her revenge against Angel pleases Akamura much more than the money does.

Edward Crull planned and executed Angel's kidnapping after Akamura informed him that destroying his brother would be a step toward yakuza approval for his promotion within Mitsuhamma.

Akmura's scheme left Angel's admirers believing the singer died a shameful death. Angel's girlfriend, Lili, concluded that her lover had been unfaithful, trysting with one of Seattle's most wanton party-girls and even breaking his well-known code of honor by recording audio chips for her. Akamura made sure that Angel knew how far his reputation had fallen. Now Akamura holds Angel in her floating headquarters, where she can continually savor the proud elf's humiliation.

The shadowrunners enter this story when Angel's girlfriend, Lili, hires them. Though completely disillusioned by **Dark Angel's** ignominious death and heartbroken by his apparent betrayal of their love, Lili maintains her practicality. She believes she has a legitimate claim on **Dark Angel's** earnings and wants the profits from **Dark Angel's** music. Unaware of Akamura's hand in Angel's fall, she blames Dynamo for everything that has happened. If someone can prove that Dynamo murdered Angel, the will would become invalid, and Lili might eventually win the copyrights from Angel's brother. However, Lili prefers a more direct solution, and would not at all mind the runners using violence to get Dynamo to give up the music rights.

The runners decide whether the job begins with a bang or a whisper. If they decide to attack **Dynamo Blue**, the player characters are drawn into a battle that ensures them a steady stream of firefights until they resolve the entire matter. Killing Dynamo resolves nothing, because she is no more than Akamura's pawn.

Either before or after the gunfight, the shadowrunners start looking for information. Three obvious choices seem clear: to spy on Dynamo instead of attacking her, to check the files on Angel at **Lone Star Security**, or to visit the scene of Angel's death.

By investigating Dynamo's **Xanadu Studios**, the runners

INTRODUCTION

learn that Dynamo plays a peripheral role in this affair. They may even discover a connection between Dynamo and the hermetic researchers at Mitsuhamma. Needless to say, runners who pursue this clue too brazenly may regret it.

The players can find another lead at Lone Star. Nobody should be surprised to learn that the police have suppressed investigations of Dark Angel's death. The proper bribes or threats reveal who orchestrated the cover-up—Edward Crull.

At some point, Angel's old friends involve themselves in the story. Several of Angel's band members also question the circumstances surrounding the singer's death, and they suspect Lili Ice of playing a sinister role in it all, a suspicion strengthened by a cryptic note planted by Akmura's agents. If the runners do not go to the band members first, the musicians begin harassing the Icelady, and she demands that the player characters protect her. This episode may end with plenty of hard feelings, though probably little bloodshed. By talking to the band members, the player characters may learn a little about Dark Angel's life and habits. They may also find a trail of clues leading back to Akmura's agents.

Shadowrunners can expect danger at the scene of Angel's death. Always a den for chipheads and dealers, the death of a rock-and-roller has drawn gangers, culties, fans, and media types to the neighborhood. If the runners get past all this, they can find two witnesses who know that Angel's corpse was actually someone else's body. If the team manages to pump the witnesses and follow up on the clues, the shadowrunners may develop a fairly accurate picture of Angel's fate. However, all but the most subtle information points to Angel's brother, Edward Crull.

At some point, the yakuza will learn of the team's efforts. Edward Crull attempts to correct that problem. If his agents fail, Akmura sends a team of her own. If the group gets lucky and captures and interrogates its would-be assailants, how much information the hitters reveal is up to the gamemaster. In any event, life in Seattle becomes a great deal more stimulating for the runners.

Eventually, the team closes in on Akmura or Crull. The shadowrunners finally learn Angel's true fate and current location. To recover the copyrights to Angel's music, the team must stage a rescue. And to keep something similar from happening again, they must help him settle the score with Akmura, in itself an entirely different kind of challenge.

Akmura, after all, is a senior member of the yakuza, an ancient Japanese criminal organization with long traditions of brotherhood and revenge. If the player characters kill a senior yakuza member without laying the proper groundwork, they can expect to live in fear of assassination for the rest of their short lives. Fortunately for the runners, Akmura's enemies are many and her friends are fickle. If the shadowrunners speak with other yakuza *oyabuns*, they may gain permission to ice Akmura. Either of two crime bosses may grant them the authority to carry out this attack: **Shiro Usaka**, one of Akmura's treacherous allies; or **Homatsu Jinjiro**, the senior *oyabun* of Seattle's Sword Water clan.

The gamemaster must make player characters aware of the dangers of rash action when dealing with the yakuza. Any contact can warn them about this. If necessary, the gamemaster may even drop a direct hint.

The simple end to this adventure would be an attack on

Akmura. Killing the *oyabun* eliminates Angel's enemy and frees him to continue his career. However, a battle is not the only way to end the adventure. If the gamemaster and players want future shadowruns involving the yakuza, Akmura may bargain with the shadowrunners. Angel constitutes only a tiny part of Akmura's overall ambitions in Seattle. The shadowrunners may be able to offer her something—influence, information, or, most likely, services rendered—in exchange for Angel. As to the exact nature of those services, well, that is another adventure.

RUNNING DARK ANGEL

This story line does not rest on any particular encounter. In the early parts of the adventure, the shadowrunners have many overlapping sources for clues; it does not matter which they find and which they miss. The team's interpretation of these clues dictates the story's final ending. Shadowrunners may get their initial information by investigating any combination of three leads. If they fail to answer their questions at the beginning, the attack of two hit teams gives them a sharp hint about the nature of their enemies.

Dark Angel uses a "decision tree" plotline with extremely flexible parameters, and the gamemaster decides just how flexible these parameters can be. The chief villainess, Kat Akmura, may serve as nothing more than the final enemy for the team to destroy. However, she can also become a recurring figure in the campaign, a link to the yakuza underworld. The details depend on the gamemaster's plans for the campaign. The section titled **Picking Up the Pieces** describes opportunities for making Kat a long-term non-player character.

If, at any point, the player characters become completely confused, the gamemaster has a vehicle for getting them back on track. Homatsu Jinjiro, the area's senior yakuza *oyabun*, is growing weary of Kat Akmura's excesses. He is not so crass as to involve himself in her murder, but he may drop the player characters an anonymous hint of whatever sort the gamemaster considers most useful. See **Marlan Parks**, p. 37, for more information on Homatsu.

The runners must also understand the dangers of fighting yakuza. These crime lords have a worldwide network of contacts and a legendary genius for revenge, and runners cannot simply attack them. To fight an *oyabun* and survive, a runner must obtain support from elsewhere in the yakuza. In this adventure, that means the player characters must reach an agreement with either Shiro or Homatsu. If necessary, the gamemaster should use non-player characters to make sure the team understands this protocol. If the player characters make an honest effort to find Shiro or Homatsu, the gamemaster should give them a fair chance of succeeding.

FALLEN ANGEL

TELL IT TO THEM STRAIGHT

Hell hath no fury like a woman scorned, and that's where folks like you come in, chummer. This wiz-fixer called Icelady feels seriously fragged, and she's looking for some runners to help her make things right.

If you're up for a score, you can meet the Icelady at Club Chiaroscuro, three blocks from the Space Needle.

When the team goes to the meet, read the following:

The glow of black lights and colored neon bathes the neomystic decor of Club Chiaroscuro. Electroslam blasts from large floor speakers; posters on the walls advertise a rocker called Dark Angel, but he doesn't seem to be onstage.

If the runners want to spend some time investigating the club, consult Club Chiaroscuro (p. 11) for more details. Read the following information when they begin looking for Icelady:

A word to the bartender gets you where you want to go. Icelady meets you in a small back room, where you squeeze yourselves in among the wires, pipes, and guts of the building. This is one savage-looking little woman, with a tangle of black hair and dark, flashing eyes. Her sharp voice reveals her anger, and her whole presence shouts danger.

"You ever hear of Dark Angel? Maybe not. He was a street rocker, with a pretty hot career. If he'd played the recording game, he'd have been a nova. Well anyway, I was...close with Angel. You scan?

"Two weeks ago, I find out the hard way that Angel geeked himself. Guess he used a match and chem-gas, 'cause Lone Star pulled his roasted remains out of some BTL joint called Heaven. That's in Lowell, down in Everett. The coroner called it suicide and chalked it up to a bad chip.

"Angel's ashes weren't even *cold* when word hit the street. Turns out some slut calling herself Dynamo Blue owns all Angel's music—she's flashing around a signed and validated will giving her full title to all his songs. Her studio, Xanadu, already released a Dark Angel album that's sitting at the top of the local charts.

"It doesn't scan. Angel always refused to record his songs—drek, he wouldn't even play the big clubs, claimed it was some kind of artistic thing. So I work like a fraggin' slave to pay his rent and now this joygirl Dynamo is making a slotting fortune off him.

"If Angel's songs belong to anyone, they belong to me. You get them for me, and I'll pay you one hundred grand.

"If Dynamo geeked Angel and you can prove it, the will is hosed and you'll get your nuyen. If you can't do that, I'm sure you can somehow encourage the chica to give up the songs, you scan? I'll leave the details to you."

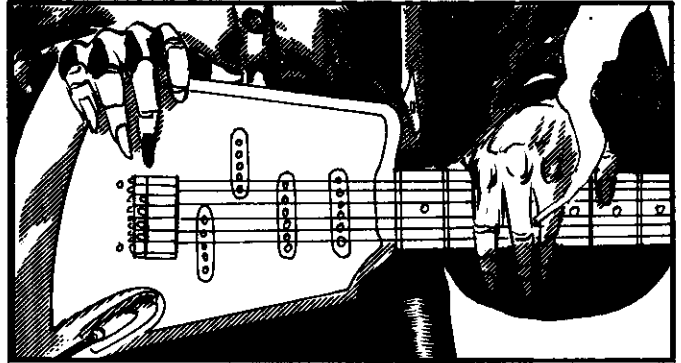

HOOKS

Chiaroscuro is a drek-hot night spot, and the theme of this scene is *energy*. It's thrumming through the club, it's flashing in Icelady's eyes and voice. Her charge demands action.

BEHIND THE SCENES

The owner of Club Chiaroscuro, Julie Wallace, uses six Force 3 watcher spirits to spy on meets within her establishment. In all likelihood, these spirits will not affect the opening encounter. But if a runner does an astral check for security and notices the watchers, he or she may suggest a "cleaner" meeting place. Icelady thanks them for their caution and agrees.

Icelady, whose real name is Lili Ice, tells the runners the truth as she knows it. She wants the group to acquire the title to Angel's songs for her, and she obviously wants to see Dynamo killed or horribly maimed in the process. Even Icelady can see that the account of Angel's suicide has more than a few holes in it, but she needs further information to prove the story a lie.

Icelady knows the most about Angel's recent movements and gigs. If the team asks her for more information, she relates one or more of the following facts, at the gamemaster's discretion.

"Angel never had his own place. He kept his stuff at my doss and spent the night whenever he felt like it. He hung with some other rockers, and they partied where and whenever they chose. When he disappeared, I hadn't seen him for, oh, three days."

"Angel's rocker friends were a pack of go-gangers from Tacoma who called themselves the Fallen Heroes. But they were really more of a band. The bunch of them had this empty lot, they called it the Partyzone, where they went to jam. All the local street types would turn out to listen."

"Two of the Fallen Heroes are brothers, Bryan and Drew, a couple of real mean slots. Some chica called Persian and a guy called Nolan make up the rest of the group. Their music's okay, but

they're going nowhere without Angel. I have no fraggin' clue what's happened to them."

"I'd just pulled down a real club date for Angel before he died. He was going to play right here, in the Chiaroscuro. See, I kinda know Wallace, the girl who owns this joint. I convinced her to bring Angel in and even talked her into putting out a little promotion. 'Course, now Angel won't be making the gig. Wallace is giving me drek about that too, the fraggin' slot."

Icelady intends to pay the runners out of profits on Angel's record. She currently has only modest funds available and offers only 1,000 nuyen per runner in advance. If the team bargains, they can raise the final fee to 1,500 nuyen per shadowrunner. If the team tries to bargain the fee up beyond this level, Icelady gets angry and insists that she is at her limit. To negotiate, one runner from the team makes an opposed test using a number of dice equal to his Negotiation Skill against a target number equal to the Icelady's Willpower Rating. Each net success raises or lowers the runners' fee by 5 percent, depending on whether the runner or the Icelady rolls more successes.

Unlike some Mr. Johnsons, Icelady does not enjoy the advantages of limitless power. If the group wants to get paid, they must give some thought to keeping her alive. So far, Akmura likes keeping Ice alive so she can continue to appreciate Angel's degradation. However, if word of Icelady's current operations gets out, Akmura may decide that Lili's continued existence is more trouble than it's worth.

Icelady lives in Pinehurst, Everett. See **Icelady's Doss**, p. 14, for details. If the team recommends reasonable precautions for her security, Lili agrees to abide by them. She does not agree to go to ground until the group earns her trust. However, when faced with imminent danger, Lili behaves sensibly.

If Icelady's location becomes important at some point, the gamemaster rolls 1D6. On a result of 1 or 2, Lili is in her apartment; a 3 or 4 means she is at the Chiaroscuro, doing biz with wizards; a 5 or 6 places her elsewhere in the city.

LILI ICE (ICELADY)

B	Q	S	C	I	W	E	M	R	Armor
2	3	3	2	3	4	6	6	3	5/3

Initiative: 3 + 1D6

Threat/Professional Rating: 2/3

Skills: Enchanting 4, Etiquette (Street) 4, Magic Theory 8, Negotiation 6, Sorcery 4

Special Skills: Evaluate Magical Goods 6, Metalworking 4, Woodworking 4

Gear: Armor Jacket (5/3), Browning Max-Power [Heavy Pistol, 10 (clip), SA, 9M], Credstick (30,000¥)

A smalltime talismonger, Lili works the clubs for biz. She met Angel during one of his gigs and stuck with him, but often told him he should sign a recording contract and make himself a success. Current events have brought out her jealous streak and vindictive temper.

		LIGHT STUN		MODERATE STUN		SERIOUS STUN		DEADLY STUN	
STUN	+1 TN#	-1 Init.	+2 TN#	-2 Init.	+3 TN#	-3 Init.			Unc.
PHYSICAL	+1 TN#	-1 Init.	+2 TN#	-2 Init.	+3 TN#	-3 Init.			Unc. maybe dead
		LIGHT WOUND		MODERATE WOUND		SERIOUS WOUND		DEADLY WOUND	

NEXT MOVE

The runners begin this adventure with five main options. They can investigate **Club Chiaroscuro** (p. 11), the planned site of Angel's last scheduled performance. Or the team may choose to visit **Xanadu Studios** (p. 20). If the shadowrunners decide to visit Lone Star, go to **Marian Parks** (p. 37). Go to **Heaven Bound** (p. 27) if the runners visit the scene of Angel's "suicide" and **Members of the Band** (p. 15) if they choose to investigate Angel's old band.

DEBUGGING

If the runners refuse Lili's offer, the gamemaster may present the offer again with a new angle. Perhaps one of the shadowrunners' contacts knew Angel too, or maybe another club owner will offer some extra nuyen. If the shadowrunners still refuse to take this job, they miss a potentially rewarding mission.

At some point in this story, the yakuza may try to dust Icelady. If the team allows her to die, they do not automatically lose everything; Dark Angel himself will still reward his rescuers. However, if the shadowrunners believe Dark Angel dead they may simply give up hope and abandon the adventure. Let them: in that case, they end up with drek.



CLUB CHIAROSCURO

TELL IT TO THEM STRAIGHT

Light and shadow are the themes of Club Chiaroscuro. Patches of darkness flit across the room, chased by oddly shaped beams of light. Colored lamps flash from the ceiling, creating multihued shadows on the ground. The tables, chairs, and the bar itself are trimmed in a deep, luminescent violet, triggered by black lights in the floor. Well-dressed patrons drink at the tables, others spin wildly across the mirrored dance floor.

If a runner astrally assenses the club, read the following:

The rosy auras of drinking, talking, and dancing flicker over the happy patrons of the club. More than a few display the deeply colored auras of the magically proficient. Above the crowd, half a dozen miniature spirits hover, three-foot tall apparitions resembling men and women. These spirits appear to be dressed in tight jeans, silk shirts, and shaded sunglasses and drink from tiny glasses. They circulate through the club, occasionally lingering near one patron or another.

HOOKS

Energy, chummer! Energy! This is a nightclub after all. Owner Julie Wallace's behavior may also show an edge of mystery and suspicion, a result of her connection to the yakuza *oyabun* Shiro.

BEHIND THE SCENES

Club Chiaroscuro is where the runners meet their Mr. Johnson, in this case, Icelady. Icelady also works out of this club, and her various enemies may harass her, or even attempt to kill her, in the club. If trouble breaks out, the runners find Club Chiaroscuro can mount defenses of its own, but the club's guards may prove more of a hindrance than a help.

Anything the player characters say inside the club may be overheard by the watchers who work for Julie Wallace. Though she pays protection to the *oyabun* Shiro, part of the price of doing business, she usually does not report what happens in her club to the yakuza. At least initially, the team has nothing to fear from conducting biz in the club.

If asked about Dark Angel, Wallace mentions that Icelady arranged for him to play at the club. She spent more than 3,000 nuyen on word-of-mouth promotion (gotta pay those mouths) for the ostensibly spontaneous performance. She freely admits that she feels pretty fragged about canceling the concert.

Wallace can also provide general knowledge about the politics of the local yakuza. The player characters must approach her tactfully to persuade her to share it, however, because the

yakuza ruthlessly protect their secrecy. She reveals useful information to the team only when she trusts that they will not do anything foolish and infuriate the local *oyabuns*. The gamemaster may judge by their roleplaying whether or not the players inspire Julie with confidence, or else he may direct one or more of them to make an Etiquette (Street) (6) Test. If the player rolls even one success, he or she earns Wallace's trust. Wallace also expects money for revealing what she knows. She never actually requests payment, but keeps her information close to her chest until the player characters make her a gift of at least 1,000 nuyen.

Julie can tell player characters the following information. Read the first paragraph and let the team ask questions. This keeps players from becoming bored with a lecture, encourages roleplaying, and allows careless player characters to overlook important points.

Once the team has won Wallace's trust, read the following:

"We deal with three *oyabuns* in this part of the sprawl, all from the Sword Water clan. First you've got Kat Akmura and Shiro Usaka. Both are young and greedy, which has created lots of tension between them during the past few years. Homatsu Jinjiro is the senior yak, and he doesn't go for any of this internal rivalry. In the old days, the yakuza presented a united front."

If the team asks about the rivalry between Akmura and Usaka, read the following:

"Between the two younger yaks, Akmura seems to be on top. She has her finger in several corporate pies and seems to have struck big nuyen somewhere along the way. In the past, Shiro would have fragged her any way he could, but he's keeping pretty quiet lately. It's pretty clear they have an alliance, but who knows how secure it is.

"I don't know what Homatsu thinks about his subordinates. Maybe he's too powerful to care, or maybe he's too old. All I know is that he's a real traditionalist. I don't deal with him much because he doesn't involve himself in street-level drek anymore."

If they ask for it, Julie can give the team addresses for Shiro's (see *Mindwarp*, p. 31) and Homatsu's headquarters (*Marian Parks*, p. 37).

As a general rule, Julie updates Shiro on anyone who asks for information on the local yakuza (see *Mindwarp*). The runners can buy her silence for 2,000 nuyen, or may be able to threaten or impress her enough to keep her from passing information. The gamemaster may decide Julie's actions through the players' roleplaying. He may also make a secret Success Test for the player character who spoke with her, using a number of dice equal to the character's Etiquette (Street) Skill against a Target Number of 6. If the character scores 2 or more successes, Julie keeps quiet.

CLUB CHIAROSCURO

The gamemaster may also use Wallace to give the team general information about the yakuza. See pages 153–154 of the **Seattle Sourcebook** for general information about the Seattle yakuza, or the **Mindwarp**, **Marian Parks**, **Kat's Dreadnought**, and **Legwork** sections of this adventure.

Club Chiaroscuro employs two troll bouncers known as the Genies. These nine-foot monsters wear baggy trousers, tight jackets of sequined black satin, and blue fezzes. One Genie usually stands by each of the main doors to watch for troublemakers. They use no more violence than necessary on ordinary drunks but weighted nightsticks materialize from their pockets if confronted with a more dangerous problem.

In addition to the trolls, Wallace uses six Force Rating 3 watcher spirits to protect her establishment. Two watch for spellcasting, astral intruders, and other magical threats in the club. The others follow guests they find interesting and spy on them, reporting all their findings (as best they can) to their mistress. Julie considers anyone associating with Icelady interesting. Those patrons with obvious cyberware, magical abilities, or similar enhancements also attract her attention. Unless the player characters use astral perception to keep an eye on the watchers, they are not aware that someone is eavesdropping on them.

If a battle the trolls cannot handle breaks out in the club, Julie becomes invisible, using a water elemental to sustain the spell. Then she casts spells at the troublemakers, using fire elementals to boost her power. If necessary, she flees under the cover of her invisibility spell. She can also send her elementals to deal with astral intruders.

If a fight breaks out and Julie cannot tell who started it, the club's security forces attack both sides indiscriminately, hoping to restore order. The gamemaster rolls 1D6 each round. On a result of 1–3, club security attacks the runners. On a result of 4–6, Julie and the Genies attack the runners' opponents. After the excitement dies down, Julie sends anyone with yakuza connections into the street and turns everyone else over to Lone Star.

Lone Star responds to any disturbance at the club within 4D6 minutes.

THE CLUB

Club Chiaroscuro resembles many other night spots of this size, differing mainly in decor.

Entrances (A)

Club Chiaroscuro has two main entrances, each guarded by one of the Genies. The doors are translucent plastic, studded with flickering lights.

Bar (B)

This dimly lit corner offers beverages of all types. Most are legal.

Private Booths (C)

Sound-dampening bamboo screens separate these booths from the rest of the club. The screens are made from synthetic bamboo, and so do not restrict the passage of the watcher spirits in astral space.

Office (D)

Julie Wallace spends most of her time at the club in this curtained office. The windows of the office are shatterproof, and the curtains are made of bulletproof cloth.

Storeroom (E)

Supplies for the bar, cleaning supplies, and spare electronic equipment for the stage fill the shelves lining the walls of this area.

Stage (F)

The bandstand sits at the center of a holographic pentagram that continually changes color, flickering from red to green to midnight blue. Towering speakers fill the inside of the pentagram, but most of the patrons ignore the recorded music blaring from them.

Dressing Rooms (G)

Artists performing at Club Chiaroscuro change clothes and rest between sets in these rooms.

Public Restroom (H)

Part of Julie Wallace's success with her club lies in the fact that she has not spent any more money than necessary to meet public building standards. Even though it makes for long lines of impatient customers, Club Chiaroscuro has only one public bathroom.

Employee Restroom (I)

This restroom is kept locked to ensure that only employees use it.

Back Room (J)

This area serves as a break room for the employees, and additional storage area for the bar.

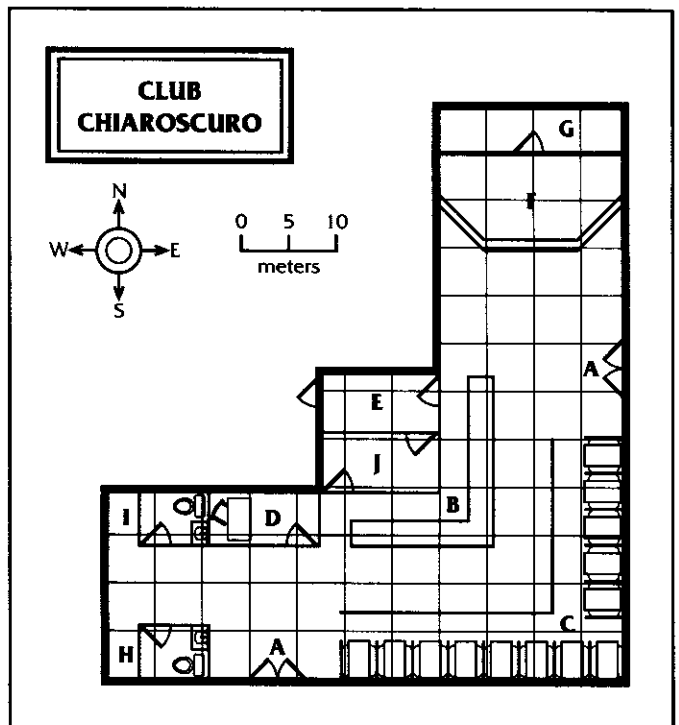



JULIE WALLACE

B 3 **Q** 3 **S** 3 **C** 6 **I** 4 **W** 5 **E** 6 **M** 6 **R** 3 (6) **Armor** 3/0

Initiative: 3(6) + 1D6

Threat/Professional Rating: 3/3

Skills: Conjuring 6, Etiquette (Media) 4, Etiquette (Street) 4, Magic Theory 3, Negotiation 4, Sorcery 6

Gear: Armor Clothing (3/0), Spell Lock (Increase Reaction +3), Spirit Focus (Watchers) Rating 3

Spells: Clout 2, Detox D Toxin 2, Increase Reaction (+3) 5, Invisibility 2, Magic Fingers 2, Mind Probe 2, Sleep 4, Stun Bolt 4, Trid Spectacle 2

Julie Wallace is a club owner on the rise, her personal sense of power represented by mirrored shades and a constant expression of indifference. This slim woman wears her hair tied back in a bun and speaks in a low, musical tone. Having made her mark as the owner of a successful nightclub, Julie has never allowed herself too many scruples. She does what she needs to do, without worrying about ethical consequences.

Julie has six Force 3 elementals on call: two fire elementals, two water elementals, one earth elemental, and one air elemental. Each owes her two services.

CONDITION MONITOR				
	LIGHT STUN	MODERATE STUN	SERIOUS STUN	DEADLY STUN
STUN	+1 TN# -1 Init.	+2 TN# -2 Init.	+3 TN# -3 Init.	Unc.
PHYSICAL	+1 TN# -1 Init.	+2 TN# -2 Init.	+3 TN# -3 Init.	Unc. maybe dead
	LIGHT WOUND	MODERATE WOUND	SERIOUS WOUND	DEADLY WOUND



THE GENIES (2)

B 10 **Q** 2 **S** 8 **C** 2 **I** 2 **W** 3 **E** 6 **R** 2 **Armor** 3/0

Initiative: 2 + 2D6

Threat/Professional Rating: 4/3

Skills: Armed Combat 6, Etiquette (Street) 3, Unarmed Combat 4

Cyberware: Wired Reflexes (1)

Gear: Armor Clothing (3/0), Club [Reach 1, 11M Stun]

These trolls speak with thick Turkish accents, and dress in an historical Near-Eastern style. Though unusually cultured for this part of town, these two hulking trolls are quick to use violence when necessary.

CONDITION MONITOR				
	LIGHT STUN	MODERATE STUN	SERIOUS STUN	DEADLY STUN
STUN	+1 TN# -1 Init.	+2 TN# -2 Init.	+3 TN# -3 Init.	Unc.
PHYSICAL	+1 TN# -1 Init.	+2 TN# -2 Init.	+3 TN# -3 Init.	Unc. maybe dead
	LIGHT WOUND	MODERATE WOUND	SERIOUS WOUND	DEADLY WOUND

CONDITION MONITOR				
	LIGHT STUN	MODERATE STUN	SERIOUS STUN	DEADLY STUN
STUN	+1 TN# -1 Init.	+2 TN# -2 Init.	+3 TN# -3 Init.	Unc.
PHYSICAL	+1 TN# -1 Init.	+2 TN# -2 Init.	+3 TN# -3 Init.	Unc. maybe dead
	LIGHT WOUND	MODERATE WOUND	SERIOUS WOUND	DEADLY WOUND

DEBUGGING

This is a simple scene, and little can go wrong here. The worst that could happen (potentially far worse than starting a fight and drawing in Lone Star) is that the shadowrunners alarm Julie Wallace and she in turn alerts Shiro to the runners' interest in yakuza affairs. If that happens, things could get uncomfortable quickly. See **Mindwarp** (p. 31) for more information on Shiro, his motives, and his likely responses.

ICELADY'S DOSS

TELL IT TO THEM STRAIGHT

Icelady lives on the fifth floor of an apartment house in Pinehurst, Everett. An ordinary tan-colored door swings open to reveal the main room, which serves as living area, kitchen, and storeroom. Icelady's trid set and Micron III food unit compete for space with her supply of magical trinkets. Piles of gray shipping containers rise to the ceiling. A few lie open on the carpet, revealing stones, feathers, and carved-wood fetishes. The magical implements appear strangely solid among the plastic crates and synthfoam packing.

HOOKS

The hook or theme for this encounter depends on the scene being played out in the apartment. This scene can resolve many different developments throughout the adventure.

BEHIND THE SCENES

The runners may come to Icelady's apartment to talk with their employer about developments. They may also need to

protect her from the members of Dark Angel's band, or from more serious attempts to harm her. On each visit they make, Lili welcomes the team into her apartment and arranges to install any security equipment they suggest. However, any money the team spends for security systems must come from the 30,000 nuyen maximum the Icelady can spare. Lili may also agree to move to a safer location if the team requests it.

If the player characters set up an alarm system at Lili's apartment, any approaching attackers must make successful Stealth or Electronics Tests (as appropriate) to defeat the system. The target number for these rolls equals the highest Intelligence Rating among all the player characters on watch, or an arbitrary rating set by the gamemaster for automated systems. Generally, a simple video camera has a Rating of 4, a sound sensor or IR beam has a Rating of 5, and a high-tech combination of systems uses a Rating of 6. The gamemaster makes the final decision regarding the effectiveness of a security system. The gamemaster may wish to consult the **SR** sourcebook, the **Neo-Anarchists' Guide To Real Life**, for more information on security systems.

To determine the results of the attackers' approach, the gamemaster may wish to make a combination of Perception and Reaction Tests, as detailed on p. 185-6 of **SRII**.

Icelady owns 20,000 nuyen worth of assorted fetishes and magical trinkets. The player characters can find any common item they might need here. Icelady can also arrange to provide more exotic items if player characters have the money. She can obtain most enchanted gear within 24 hours.

DEBUGGING

Several different encounters in the course of this adventure may unfold in this apartment, and each individual encounter has its own **Debugging** section. However, the advice about Angel's death under **Debugging** in **Fallen Angel**, p. 10, applies to all the encounters. The runners should protect Icelady's life at all costs. However, if the player characters let her die but still rescue Dark Angel, they still may receive a reward.

If the player characters deliberately antagonize Icelady, they are simply being stupid. Runners who decide to burglarize or trash her apartment, or otherwise take advantage of the tallsmonger, have little to gain. Even her magical trinkets are unlikely to sell for anything near their real value on the black market (use the usual rules for fences, p. 188, **SRII**). Furthermore, Icelady has a keen sense of pride and a fierce temper. Shadowrunners who turn against her need not expect to be paid, and she may even bring in another team of shadowrunners to complete the job and punish the traitors.

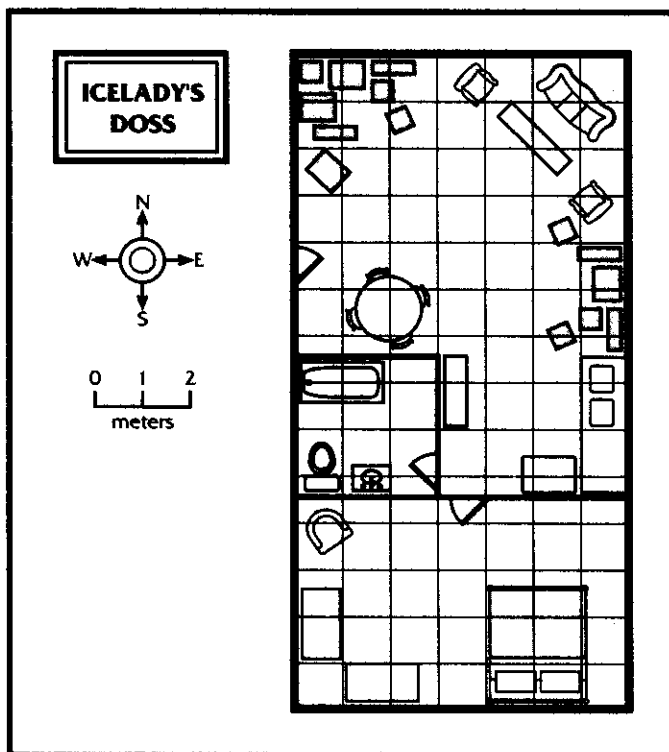

MEMBERS OF THE BAND

TELL IT TO THEM STRAIGHT

If the runners arrive during the day, read the following:

The Partyzone is nothing more than a large vacant lot in South Tacoma. Gang symbols and scorch marks decorate the plascrete walls of the surrounding buildings, and crushed cans and ashes litter the broken asphalt. A gutterpunk in a torn black T-shirt lies amid the debris, his head resting on a damp, green garbage bag.

If the runners arrive after dark, read the following:

Strains of electroslam shake the tenements and rumble across the pavement surrounding the vacant lot called the Partyzone. The chrome studs of leather jackets flash yellow under the streetlights as orks, gangers, and elf poseurs mix freely with other sprawl dwellers, moving to the rhythms of Seattle's street musicians. The music swells and falls, its angry chords rippling the crowd like a single organism.

HOOKS

The deafening noise and bustle of activity make it virtually impossible to track down anyone in the Partyzone, where anything

and everything is available on request.

BEHIND THE SCENES

The Partyzone serves as neutral ground for many of the street gangs of South Tacoma. People from all over Seattle party here, regardless of race or gang affiliation. A group of musical musclemen named the Fallen Heroes enforce the peace and set up the nightly concerts.

The Partyzone's spirit of brotherhood and street chic appealed to Dark Angel and the other members of his band, who continue to meet in Heroes turf, nursing their shock at his death and plotting their revenge.

The band members are Bryan and Drew, African-American elf brothers and members of the Fallen Heroes; Sheera Persian, a sloe-eyed female singer; and Nolan, a barefoot Irish elf with a mop of unruly hair and a perpetual, ironic smile. The four currently squat in one of the empty warehouses shown on the map.

THE BAND

The shadowrunners may come to the Partyzone seeking information from Dark Angel's band. If they do not approach them

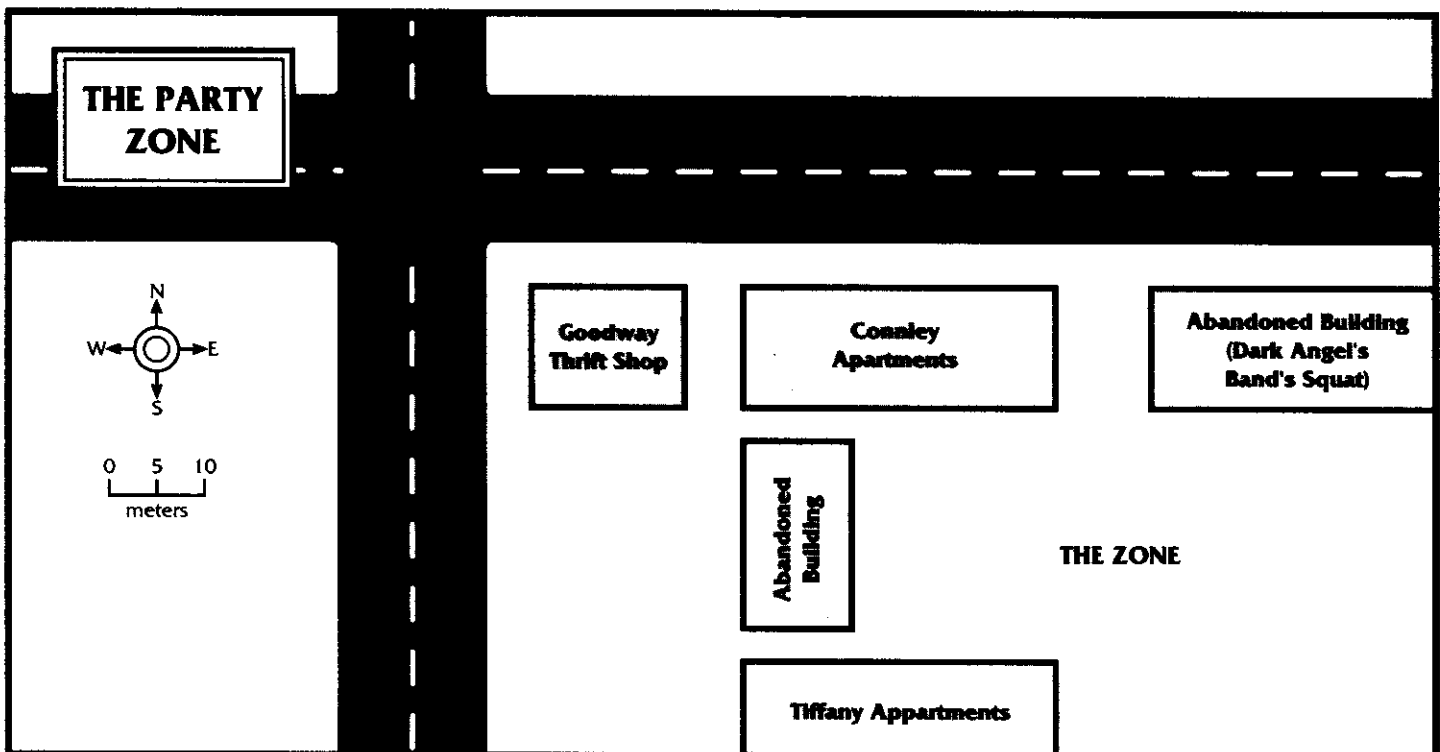

here, the band members make their presence known in other ways.

The band found out that Icelady hired some runners, and wants to know why. They refuse to believe that Angel committed suicide or sold his music to Xanadu Studios, and they want a share of the profits from Dark Angel's recordings. The band members will do anything to "get what we've got coming to us."

The band never trusted Icelady, and they firmly believe she planned Angel's death and sold his music to the studio. An encounter with a Japanese punker shortly after Dark Angel's disappearance confirmed their suspicions. The punker worked for Kat Akmura, but Dark Angel's chummers do not know that.

Several hours after the runners accept the assignment offered by Lili Ice, Sheera Persian, who loathes the talismonger, phones Icelady and accuses her of the band's worst suspicions. "You may have fragged Angel, but you ain't pulling that drek on us. We're gonna be seeing each other soon, chummer. Global Trust, account two two three four three. You know what it is and so do we. You just watch your magical little back, ya scan?"

The Icelady contacts her shadowrunners immediately after she receives this call. She is deeply hurt by the accusation that she killed her lover; furthermore, she hates Sheera as much as Sheera hates her, and since she cannot take out her frustrations on the band, she takes them out on the runners. As soon as the team arrives, Icelady demands to know what progress they have made so far. She greets their understandably confused response with sarcasm. "Oh...wiz. I love the drek-hot work I'm getting from this group. Can't you people slot and run?"

If the runners answer rudely, Icelady flies into a rage. Her sharp tongue is clever enough to make her barbs sting. Roleplay the spat thoroughly. If goaded, Icelady eventually walks away, muttering a choice remark about the joker runners. Unless the player characters attempt to soothe their employer, they will not find out what prompted her demand for a progress report so soon, and certainly will not learn about the band's call.

If the team tries to calm the Icelady, she repeats Sheera's message to the runners. Icelady has never heard of Global Trust—this development worries her, and she asks the runners to speed up their original investigation and produce proof of her innocence in the whole affair.

If the shadowrunners fail to contact the band, Sheera eventually convinces her cohorts to rough up Icelady. This attack takes place two days into the adventure if nothing occurs to prevent or delay it. The band members simply catch Icelady outside her apartment and give her some bruises. However, if the runners happen to be with Lili at the time, the fight can have a very different ending. The gamemaster should manipulate the scene as necessary to avoid killing the band or the runners, as either development would seriously disrupt the storyline.

If the runners are not around for the band's attack on Icelady, or if she does not consider the band sufficiently roughed up in the encounter, then she tells the shadowrunners to return the favor by attacking the band members. If the player characters refuse to add this task to the job, or demand large sums of money to do so, she gives them a long, cold stare and states her intention of finding another team of "real" runners.

THE PARTYZONE

If for some reason the shadowrunners feel their only option is to attack the band in the Partyzone, or if an encounter there degenerates into a battle, members of the Fallen Heroes join the fight. Angel's friends gain 1–3 (roll 1D6 and divide by 2, rounding up) allies in the second Combat Turn and an additional 1–3 allies in the fourth Combat Turn. Game statistics for the Fallen Heroes appear at the end of this section. If the team can stalk their targets without being detected, they eventually get a chance to accost the band members outside the Partyzone. Once the runners begin surveillance, 1D6 hours pass before the band leaves the Partyzone.

The band members do not want to kill anyone, but if one of their number dies at the hands of the runners, they go for blood. They know where Icelady lives and works, and the surviving band members will attempt to murder Icelady by any means available. The gamemaster develops their tactics based on their resources and knowledge.

The band members will gladly talk instead of fighting. They are eager to explain why they hate Icelady so vehemently: when Drew and Bryan went to Heaven after Angel's death (see **Heaven Bound**, p. 27), a Japanese-looking punker who obviously recognized the pair gave them a datachip showing transfers of more than 1,000,000 nuyen from Xanadu Studios to a Global Trust account in the name of Lili Ice. The band members consider this chip undeniable proof of Icelady's part in Angel's death.

The data on the chip does not match any accounts stored in the Xanadu computers (see **Xanadu Studios**, p. 20). Have any decker who examines the chip make a Computer (6) Test, applying a –2 modifier to the target number if the character uses a cyberdeck or computer. Consult the table below for the results of the test.

Successes	Results
0	It's a drekky datachip, Einstein. Geez...
1	The chip is a rare Mitsuhamma format.
2+	The data on the chip is a poor forgery that would fool only the unskilled.

The source of the chip works for Edward Crull, who, in turn, works for Kat Akmura. If prompted, Bryan and Drew can describe the man who gave them the chip well enough for the runners to find him in the crowd at Heaven (see **Heaven Bound**, p. 27) on a successful Perception (4) Test. If necessary, the gamemaster can fudge the die rolls in this test to keep the story moving if he decides the runners need help getting to Edward Crull. When they find the young Japanese punker, he is in the company of known yakuza enforcers and hangers-on. If the runners decide to kidnap the punker for questioning, or try to talk to him at Heaven, use the Mafia Soldier Contact (p. 22, **Shadowrun Gamemaster's Screen, Archetypes and Contacts Book**) or the Gang Member Archetype (p. 57, **SR11**). The punker can reveal a direct line to Crull and confirm yakuza involvement in the chip's appearance. (That is, in fact, all they can learn. The punker knows only that a yakuza higher-up, one he knows to work for Edward Crull at Mitsuhamma, approached him at Heaven and gave him the chip to give to Bryan and Drew.)

In fact, Kat Akmura directed her agents to give the band the chip. She hopes that either the band will kill Icelady or Icelady will

MEMBERS OF THE BAND

kill them. Either way, she has one less potential enemy and will have further muddled the story of Dark Angel's last days. Crull had nothing to do with the chip.

If the runners prove the chip to be fake or provide other physical proof that someone other than Icelady engineered Angel's disappearance, the band stops harassing her. Acceptable evidence includes the real Xanadu accounting files (see **Xanadu Studios**, p. 20), testimony from Hack and Slash (see **Heaven Bound**, p. 27), or any other proof the gamemaster considers valid. All the proof in the world of Icelady's innocence cannot make the band members like the talismonger.

The band can provide other pertinent information about Dark Angel. If treated with respect, the band members prove happy to reminisce about their leader. The band members all agree that Angel would never have voluntarily abandoned his vow to not record his music. "Not Angel, man, he's made of steel." The band members also know all the information listed under Dark Angel in the **Legwork** section (see p. 59).



BRYAN

B **Q** **S** **C** **I** **W** **E** **R** **Armor**
5 6 5 6 5 4 5 5 5/3

Initiative: 5 + 2D6

Threat/Professional Rating: 2/3

Skills: Armed Combat 5, Bike 4, Etiquette (Street) 4, Firearms 4, Projectile Weapons 3, Stealth 5, Unarmed Combat 4

Special Skills: Instrumental Music 4, Musical Composition 5, Singing 3

Cyberware: Mastoid Speakers, Retinal Modification (Thermographic), Synthlink Interface, Wired Reflexes (1)

Gear: Armor Jacket (5/3), Browning Max-Power [Heavy Pistol, 10 (clip), SA, 9M, w/2 extra clips, Explosive Rounds, Laser Sight (-1 modifier to target numbers)], Club [Reach 1, 6M Stun]

Bryan wears torn jeans, a heavy leather jacket, and a black T-shirt emblazoned with the Thundering Herd logo. His aquiline nose and glittering eyes hint at his power. Bryan's deep voice and swift decision-making put him in charge of the group. This elf smokes constantly, and drinks heavily and without pleasure.

CONDITION MONITOR

	LIGHT STUN	MODERATE STUN	SERIOUS STUN	DEADLY STUN
STUN	+1 TN# -1 Init.	+2 TN# -2 Init.	+3 TN# -3 Init.	Unc.
PHYSICAL	+1 TN# -1 Init.	+2 TN# -2 Init.	+3 TN# -3 Init.	Unc. maybe dead
	LIGHT WOUND	MODERATE WOUND	SERIOUS WOUND	DEADLY WOUND

DREW

B **Q** **S** **C** **I** **W** **E** **R** **Armor**
4 6 6 6 5 4 5.5 5 5/3

Initiative: 5 + 1D6

Threat/Professional Rating: 2/3

Skills: Armed Combat 5, Bike 4, Etiquette (Street) 4, Firearms 4, Projectile Weapons 3, Stealth 5, Unarmed Combat 4

Special Skills: Instrumental Music 3, Musical Composition 3, Singing 5

Cyberware: Mastoid Speakers, Retinal Modification (Thermographic), Synthlink Interface

Gear: Armor Jacket (5/3), Browning Max-Power [Heavy Pistol, 10 (clip), SA, 9M, w/2 extra clips, Explosive Rounds, Laser Sight (-1 modifier to target numbers)], Club [Reach 1, 7M Stun]

Drew's dreadlocks swing around his waist. This elf has the innocent expression and ready smile of a baby. Round, mirrored sunglasses complete his image. Drew has a naturally high-pitched voice and speaks in a cultured British accent. This singer's skill at manipulating his voice made him a natural choice as the band's lead vocalist.

CONDITION MONITOR

	LIGHT STUN	MODERATE STUN	SERIOUS STUN	DEADLY STUN
STUN	+1 TN# -1 Init.	+2 TN# -2 Init.	+3 TN# -3 Init.	Unc.
PHYSICAL	+1 TN# -1 Init.	+2 TN# -2 Init.	+3 TN# -3 Init.	Unc. maybe dead
	LIGHT WOUND	MODERATE WOUND	SERIOUS WOUND	DEADLY WOUND

SHEERA PERSIAN

B **Q** **S** **C** **I** **W** **E** **R** **Armor**
3 6 5 6 5 6 6 5 5/3

Initiative: 5 + 1D6

Threat/Professional Rating: 3/3

Skills: Armed Combat 5, Bike 4, Etiquette (Street) 4, Magical Theory 4, Sorcery 5 (Spellcasting 7), Stealth 5, Unarmed Combat 4

Special Skills: Instrumental Music 4, Musical Composition 4, Singing 4

Gear: Armor Jacket (5/3), Browning Max-Power [Heavy Pistol, 10 (clip), SA, 9M, w/2 extra clips, Explosive Rounds, Laser Sight (-1 modifier to target numbers)], Club [Reach 1, 6M Stun]

Spells: Entertainment 5, Fashion 2, Healthy Glow 2, Improved Invisibility 2, Mana Bolt 3, Physical Mask 2, Power Bolt 3, Sleep 2

MEMBERS OF THE BAND



This dark-skinned woman sports gleaming mirrored shades and a perpetually cold expression. Long, black hair sweeps down on either side of her heart-shaped face. A woman of strong dislikes, she hates Icelady with a passion, mostly due to her own secret obsession with Dark Angel. She would risk anything to punish his killers.

Sheera Persian is a hermetic sorcerer adept.

		CONDITION MONITOR						
		LIGHT STUN	MODERATE STUN	SERIOUS STUN	DEADLY STUN			
STUN		+1 TN# -1 Init.	+2 TN# -2 Init.	+3 TN# -3 Init.	Unc.			
		<table border="1" style="width: 100%; border-collapse: collapse;"> <tr> <td style="width: 25%;">+1 TN# -1 Init.</td> <td style="width: 25%;">+2 TN# -2 Init.</td> <td style="width: 25%;">+3 TN# -3 Init.</td> <td style="width: 25%;">Unc. maybe dead</td> </tr> </table>				+1 TN# -1 Init.	+2 TN# -2 Init.	+3 TN# -3 Init.
+1 TN# -1 Init.	+2 TN# -2 Init.	+3 TN# -3 Init.	Unc. maybe dead					
PHYSICAL		LIGHT WOUND	MODERATE WOUND	SERIOUS WOUND	DEADLY WOUND			
		<table border="1" style="width: 100%; border-collapse: collapse;"> <tr> <td style="width: 25%;">+1 TN# -1 Init.</td> <td style="width: 25%;">+2 TN# -2 Init.</td> <td style="width: 25%;">+3 TN# -3 Init.</td> <td style="width: 25%;">Unc. maybe dead</td> </tr> </table>				+1 TN# -1 Init.	+2 TN# -2 Init.	+3 TN# -3 Init.
+1 TN# -1 Init.	+2 TN# -2 Init.	+3 TN# -3 Init.	Unc. maybe dead					

NOLAN

B Q S C I W E R Armor
4 6 4 6 6 5 5.5 5 5/3

Initiative: 5 + 1D6

Threat/Professional Rating: 2/3

Skills: Armed Combat 5, Bike 4, Etiquette (Street) 4, Firearms 4, Projectile Weapons 3, Stealth 5, Unarmed Combat 4

Special Skills: Instrumental Music 5, Musical Composition 4, Singing 4

Cyberware: Mastoid Speakers, Retinal Modification (Thermographic), Synthlink Interface

Gear: Armor Jacket (5/3), Browning Max-Power [Heavy Pistol, 10 (clip), SA, 9M, w/2 extra clips, Explosive Rounds, Laser Sight (-1 modifier to target numbers)], Club [Reach 1, 5M Stun]

Nolan has a reddish blond beard and a warm, knowing smile. His standard uniform is a tank top and jeans, and he often can be found relaxed against a nearby wall or lamppost, playing his guitar. The elf possesses a remarkably even temper and acts as a stabilizing influence on the rest of the band. He liked Dark Angel a lot, and kept an open mind about Icelady.

		CONDITION MONITOR						
		LIGHT STUN	MODERATE STUN	SERIOUS STUN	DEADLY STUN			
STUN		+1 TN# -1 Init.	+2 TN# -2 Init.	+3 TN# -3 Init.	Unc.			
		<table border="1" style="width: 100%; border-collapse: collapse;"> <tr> <td style="width: 25%;">+1 TN# -1 Init.</td> <td style="width: 25%;">+2 TN# -2 Init.</td> <td style="width: 25%;">+3 TN# -3 Init.</td> <td style="width: 25%;">Unc. maybe dead</td> </tr> </table>				+1 TN# -1 Init.	+2 TN# -2 Init.	+3 TN# -3 Init.
+1 TN# -1 Init.	+2 TN# -2 Init.	+3 TN# -3 Init.	Unc. maybe dead					
PHYSICAL		LIGHT WOUND	MODERATE WOUND	SERIOUS WOUND	DEADLY WOUND			
		<table border="1" style="width: 100%; border-collapse: collapse;"> <tr> <td style="width: 25%;">+1 TN# -1 Init.</td> <td style="width: 25%;">+2 TN# -2 Init.</td> <td style="width: 25%;">+3 TN# -3 Init.</td> <td style="width: 25%;">Unc. maybe dead</td> </tr> </table>				+1 TN# -1 Init.	+2 TN# -2 Init.	+3 TN# -3 Init.
+1 TN# -1 Init.	+2 TN# -2 Init.	+3 TN# -3 Init.	Unc. maybe dead					

FALLEN HEROES (6)

B Q S C I W E R Armor
5 6 5 6 5 4 6 5 5/3

Initiative: 5 + 1D6

Threat/Professional Rating: 2/2

Skills: Armed Combat 5, Bike 4, Etiquette (Street) 4, Firearms 4, Projectile Weapons 3, Stealth 5, Unarmed Combat 4.

Gear: Armor Jacket, Beretta Model 101T [Light Pistol, 12 (clip), SA, 6L, w/extra clip], Club [Reach 1, 6M Stun]

These gangers sport armored jackets and Day-Glo mohawks. They love music as much as gang action, which makes them all the more determined to stop anyone from fragging with the bands hanging out on their turf.

		CONDITION MONITOR						
		LIGHT STUN	MODERATE STUN	SERIOUS STUN	DEADLY STUN			
STUN		+1 TN# -1 Init.	+2 TN# -2 Init.	+3 TN# -3 Init.	Unc.			
		<table border="1" style="width: 100%; border-collapse: collapse;"> <tr> <td style="width: 25%;">+1 TN# -1 Init.</td> <td style="width: 25%;">+2 TN# -2 Init.</td> <td style="width: 25%;">+3 TN# -3 Init.</td> <td style="width: 25%;">Unc. maybe dead</td> </tr> </table>				+1 TN# -1 Init.	+2 TN# -2 Init.	+3 TN# -3 Init.
+1 TN# -1 Init.	+2 TN# -2 Init.	+3 TN# -3 Init.	Unc. maybe dead					
PHYSICAL		LIGHT WOUND	MODERATE WOUND	SERIOUS WOUND	DEADLY WOUND			
		<table border="1" style="width: 100%; border-collapse: collapse;"> <tr> <td style="width: 25%;">+1 TN# -1 Init.</td> <td style="width: 25%;">+2 TN# -2 Init.</td> <td style="width: 25%;">+3 TN# -3 Init.</td> <td style="width: 25%;">Unc. maybe dead</td> </tr> </table>				+1 TN# -1 Init.	+2 TN# -2 Init.	+3 TN# -3 Init.
+1 TN# -1 Init.	+2 TN# -2 Init.	+3 TN# -3 Init.	Unc. maybe dead					

		CONDITION MONITOR						
		LIGHT STUN	MODERATE STUN	SERIOUS STUN	DEADLY STUN			
STUN		+1 TN# -1 Init.	+2 TN# -2 Init.	+3 TN# -3 Init.	Unc.			
		<table border="1" style="width: 100%; border-collapse: collapse;"> <tr> <td style="width: 25%;">+1 TN# -1 Init.</td> <td style="width: 25%;">+2 TN# -2 Init.</td> <td style="width: 25%;">+3 TN# -3 Init.</td> <td style="width: 25%;">Unc. maybe dead</td> </tr> </table>				+1 TN# -1 Init.	+2 TN# -2 Init.	+3 TN# -3 Init.
+1 TN# -1 Init.	+2 TN# -2 Init.	+3 TN# -3 Init.	Unc. maybe dead					
PHYSICAL		LIGHT WOUND	MODERATE WOUND	SERIOUS WOUND	DEADLY WOUND			
		<table border="1" style="width: 100%; border-collapse: collapse;"> <tr> <td style="width: 25%;">+1 TN# -1 Init.</td> <td style="width: 25%;">+2 TN# -2 Init.</td> <td style="width: 25%;">+3 TN# -3 Init.</td> <td style="width: 25%;">Unc. maybe dead</td> </tr> </table>				+1 TN# -1 Init.	+2 TN# -2 Init.	+3 TN# -3 Init.
+1 TN# -1 Init.	+2 TN# -2 Init.	+3 TN# -3 Init.	Unc. maybe dead					

		CONDITION MONITOR						
		LIGHT STUN	MODERATE STUN	SERIOUS STUN	DEADLY STUN			
STUN		+1 TN# -1 Init.	+2 TN# -2 Init.	+3 TN# -3 Init.	Unc.			
		<table border="1" style="width: 100%; border-collapse: collapse;"> <tr> <td style="width: 25%;">+1 TN# -1 Init.</td> <td style="width: 25%;">+2 TN# -2 Init.</td> <td style="width: 25%;">+3 TN# -3 Init.</td> <td style="width: 25%;">Unc. maybe dead</td> </tr> </table>				+1 TN# -1 Init.	+2 TN# -2 Init.	+3 TN# -3 Init.
+1 TN# -1 Init.	+2 TN# -2 Init.	+3 TN# -3 Init.	Unc. maybe dead					
PHYSICAL		LIGHT WOUND	MODERATE WOUND	SERIOUS WOUND	DEADLY WOUND			
		<table border="1" style="width: 100%; border-collapse: collapse;"> <tr> <td style="width: 25%;">+1 TN# -1 Init.</td> <td style="width: 25%;">+2 TN# -2 Init.</td> <td style="width: 25%;">+3 TN# -3 Init.</td> <td style="width: 25%;">Unc. maybe dead</td> </tr> </table>				+1 TN# -1 Init.	+2 TN# -2 Init.	+3 TN# -3 Init.
+1 TN# -1 Init.	+2 TN# -2 Init.	+3 TN# -3 Init.	Unc. maybe dead					

		CONDITION MONITOR						
		LIGHT STUN	MODERATE STUN	SERIOUS STUN	DEADLY STUN			
STUN		+1 TN# -1 Init.	+2 TN# -2 Init.	+3 TN# -3 Init.	Unc.			
		<table border="1" style="width: 100%; border-collapse: collapse;"> <tr> <td style="width: 25%;">+1 TN# -1 Init.</td> <td style="width: 25%;">+2 TN# -2 Init.</td> <td style="width: 25%;">+3 TN# -3 Init.</td> <td style="width: 25%;">Unc. maybe dead</td> </tr> </table>				+1 TN# -1 Init.	+2 TN# -2 Init.	+3 TN# -3 Init.
+1 TN# -1 Init.	+2 TN# -2 Init.	+3 TN# -3 Init.	Unc. maybe dead					
PHYSICAL		LIGHT WOUND	MODERATE WOUND	SERIOUS WOUND	DEADLY WOUND			
		<table border="1" style="width: 100%; border-collapse: collapse;"> <tr> <td style="width: 25%;">+1 TN# -1 Init.</td> <td style="width: 25%;">+2 TN# -2 Init.</td> <td style="width: 25%;">+3 TN# -3 Init.</td> <td style="width: 25%;">Unc. maybe dead</td> </tr> </table>				+1 TN# -1 Init.	+2 TN# -2 Init.	+3 TN# -3 Init.
+1 TN# -1 Init.	+2 TN# -2 Init.	+3 TN# -3 Init.	Unc. maybe dead					

		CONDITION MONITOR						
		LIGHT STUN	MODERATE STUN	SERIOUS STUN	DEADLY STUN			
STUN		+1 TN# -1 Init.	+2 TN# -2 Init.	+3 TN# -3 Init.	Unc.			
		<table border="1" style="width: 100%; border-collapse: collapse;"> <tr> <td style="width: 25%;">+1 TN# -1 Init.</td> <td style="width: 25%;">+2 TN# -2 Init.</td> <td style="width: 25%;">+3 TN# -3 Init.</td> <td style="width: 25%;">Unc. maybe dead</td> </tr> </table>				+1 TN# -1 Init.	+2 TN# -2 Init.	+3 TN# -3 Init.
+1 TN# -1 Init.	+2 TN# -2 Init.	+3 TN# -3 Init.	Unc. maybe dead					
PHYSICAL		LIGHT WOUND	MODERATE WOUND	SERIOUS WOUND	DEADLY WOUND			
		<table border="1" style="width: 100%; border-collapse: collapse;"> <tr> <td style="width: 25%;">+1 TN# -1 Init.</td> <td style="width: 25%;">+2 TN# -2 Init.</td> <td style="width: 25%;">+3 TN# -3 Init.</td> <td style="width: 25%;">Unc. maybe dead</td> </tr> </table>				+1 TN# -1 Init.	+2 TN# -2 Init.	+3 TN# -3 Init.
+1 TN# -1 Init.	+2 TN# -2 Init.	+3 TN# -3 Init.	Unc. maybe dead					

		CONDITION MONITOR						
		LIGHT STUN	MODERATE STUN	SERIOUS STUN	DEADLY STUN			
STUN		+1 TN# -1 Init.	+2 TN# -2 Init.	+3 TN# -3 Init.	Unc.			
		<table border="1" style="width: 100%; border-collapse: collapse;"> <tr> <td style="width: 25%;">+1 TN# -1 Init.</td> <td style="width: 25%;">+2 TN# -2 Init.</td> <td style="width: 25%;">+3 TN# -3 Init.</td> <td style="width: 25%;">Unc. maybe dead</td> </tr> </table>				+1 TN# -1 Init.	+2 TN# -2 Init.	+3 TN# -3 Init.
+1 TN# -1 Init.	+2 TN# -2 Init.	+3 TN# -3 Init.	Unc. maybe dead					
PHYSICAL		LIGHT WOUND	MODERATE WOUND	SERIOUS WOUND	DEADLY WOUND			
		<table border="1" style="width: 100%; border-collapse: collapse;"> <tr> <td style="width: 25%;">+1 TN# -1 Init.</td> <td style="width: 25%;">+2 TN# -2 Init.</td> <td style="width: 25%;">+3 TN# -3 Init.</td> <td style="width: 25%;">Unc. maybe dead</td> </tr> </table>				+1 TN# -1 Init.	+2 TN# -2 Init.	+3 TN# -3 Init.
+1 TN# -1 Init.	+2 TN# -2 Init.	+3 TN# -3 Init.	Unc. maybe dead					

MEMBERS OF THE BAND



DEBUGGING

The band should not pose a major threat to the runners. This encounter serves primarily as an opportunity for the team to gather clues about their mission. If a running battle with the band seems likely to overshadow more important parts of the adventure, the band may lose interest in revenge and stop harassing Icelady of its own accord. Any fights with the musicians should remain low-level skirmishes—everyone should survive. If the runners kill any band members or their friends, the runners will find the Fallen Heroes on their trail in future adventures.

The greatest stumbling block in this section may be the potential friction between the runners and Icelady. She is being forced to ask the runners for extra help, and does so in the only way she knows how. Unfortunately, sarcasm may not sit well with the team. If the runners are too sensitive to put up with a little abuse without flying off the handle in turn, the gamemaster may make

a big show of the talismonger controlling her temper. She politely asks the team to cope with the band, and if necessary, offers up to 1,000 nuyen extra per shadowrunner to keep them all happy.

Her behavior may even convince the shadowrunners that the band's suspicions about Icelady are true, and the gamemaster may let them believe it with no effect on the outcome of the adventure. After all, the runners need not trust Icelady in order to work for her. In fact, a bit of paranoia usually improves the game. If the runners look like they might simply walk away from the run, however, the gamemaster has several options to re-involve them. Drop hints that Icelady's enemies want to frame her, have one runner suddenly "notice" blatant mistakes in the forged datachip, or have a contact drop tantalizing hints to get them involved again. The easiest way to keep the player characters' interest is to make them the victims of an attack obviously related to the case, with signs clearly pointing to repeat performances unless they get to the bottom of the matter.

XANADU STUDIOS

TELL IT TO THEM STRAIGHT

In Xanadu did Kublai Khan a stately pleasure-dome decree and all that happy drek. If you don't know the poem, you can read it from the little display screen above the door, which is covered with chipping brown paint. Other than that touch of high culture, Xanadu Studios looks like drek.

Xanadu rents offices in a little industrial center in Renton's Merideth district. The recording studio doesn't even have the whole building—half belongs to some other company, which doesn't hang a sign. Electronic locks flicker on the doorways. They need 'em in this part of town.

BEHIND THE SCENES

Xanadu Studios may own the hottest recording in Seattle music history, but it remains a smalltime operation, mainly because the yakuza siphon off most of the real money from Angel's songs. Success came so quickly that Dynamo Blue has yet to redecorate accordingly, and the run-down condition of these studios should give the runners an immediate, oversized hint that Angel's fate involves someone more powerful than Dynamo Blue.

Dynamo and her studio make a logical target for the party's initial investigations, but Dynamo is no more than Kat's pawn. The runners cannot intimidate Dynamo into signing away the rights to Angel's songs, because she fears the yakuza more than the shadowrunners. Physically penetrating the studios does not yield much solid information or evidence.

Dynamo Blue employs capable guards, but not as many as the runners expect. A widespread system of security cameras helps the guards keep an eye on the premises. In the event of a disturbance, a guard from the Security Station (C) comes to investigate. In a firefight, the guards attempt to fire from cover and hold off intruders long enough for Lone Star to arrive, approximately 2D6 minutes.

Dynamo and her superiors respond to a disturbance at the studio in two ways. First, Xanadu doubles the number of guards at all stations. Second, Edward Crull dispatches a hit team to deal with the runners. If any of Xanadu's security cameras captured the runners on film, Crull's assassins have an extra advantage. See **Brother to an Angel** (p. 41) or **Up the Ante** (p. 49) for details.

If the shadowrunners choose to spy on this facility using spirits or electronic bugs, they discover more useful information. After 1D6 hours, Dynamo Blue telephones Edward Crull, addressing him with the Japanese honorific "san" and speaking deferentially. Dynamo reports on the sales of *Flaming Wings*, the Dark Angel album. She then assures him that she remembers his cut. "You rake 80 percent, 'kay."

Any decker who examines Dynamo's communications database (see below) can find out where Crull lives (see **Brother to an Angel**, p. 40). Shadowrunners may also find this information in **Legwork**, p. 59.

XANADU STUDIOS ROOM DESCRIPTIONS

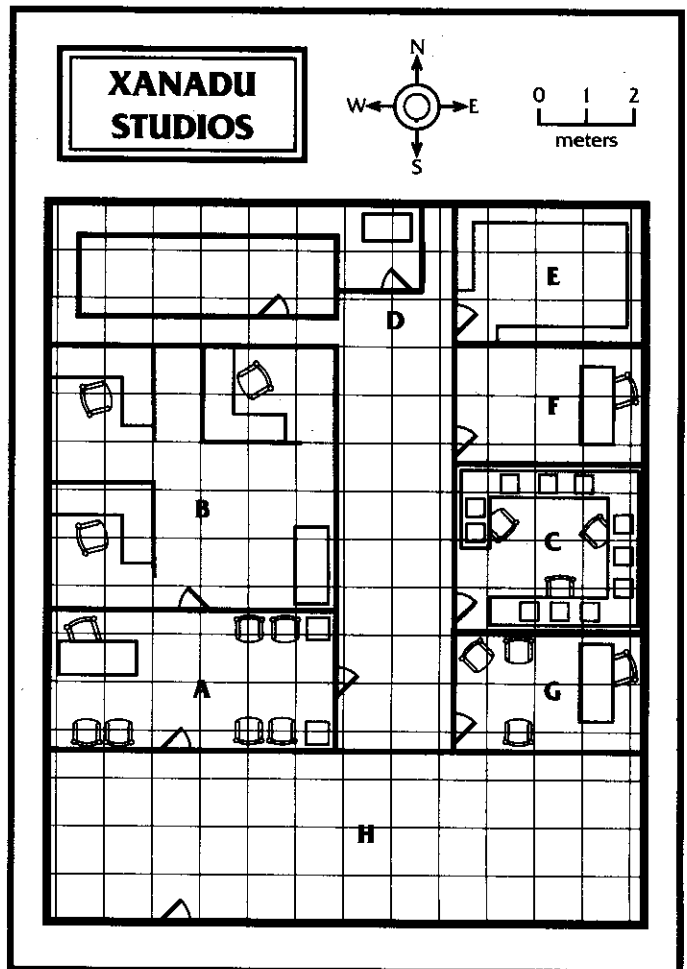

Lobby (A)

Faint promotional holos illuminate the walls of this room. Eight plexers in spray-painted denim pace back and forth, wearing chains and pipes like jewelry. In one corner, a pasty skinned corp-type in a lime suit sits reading last week's copy of *Rocker Born*. A secretary sits at the receptionist's desk, occasionally looking up from a trid show on her telecom to gaze around the room. She wears her neon pink hair in a bun. A cheap hairpin accentuates the white highlighting.

The youths belong to a new band called the Lab Rats. The man in the suit is their agent. Dynamo put out their first record, and they want to negotiate a contract with Dynamo for their latest product, *Child of Fire*. The Rats are proud to be produced by the same company handling Dark Angel. "Like, way to go Dynamo, way to go Rats." Their agent refuses to let Xanadu's recent successes impress him.

The Lab Rats can handle themselves in a fight, and jump right in to defend their employers at Xanadu Studios. If the shadowrunners start a free-for-all or look like they plan to, the band tries to cool them down.

If the team comes here a second time or late at night, they do not meet the same people. The gamemaster should feel free to invent other innocent bystanders with business at Xanadu Studios.

Offices (B)

These pastel cubicles hold the scuffed desks and plastic work stations common to low-budget offices throughout the world. A trio of wageslaves tap away at their terminals. The three office workers hide under their desks at the first hint of violence.

Little in this area would interest the shadowrunners except the terminals themselves, which offer a direct line into Xanadu's Matrix account. Any runner who decks into one of these terminals appears in I/OP-1 of the Xanadu Matrix system (see below).

Security Station (C)

A bluish glow suffuses this room, cast by half a dozen black-and-white video monitors. Men in gray security armor slouch in front of the screens, smoking, watching and shooting the drek. A holo on one wall depicts the chromed beauties of the band Naked Steele.

Xanadu security consists of a team of ten guards led by two elite-trained veterans. Most street gangs boast stronger squads than this one, but the Xanadu guards know their limits and fight intelligently with the available resources and training. They respond to trouble immediately and attempt to subdue intruders until help arrives. Each guard carries a PANICBUTTON, in addition to one mounted in the security station, that summons Lone Star immediately.

The PANICBUTTON installed in Xanadu Studios summons a squad car of police in 2D6 minutes. A patrol of four officers in a Chrysler-Nissan Patrol vehicle responds to the call.

The security force may also use an alternative PANICBUTTON system. This blue button links them with Hermetic Securities Unlimited, a magical-protection agency, and summons a Force 7 fire elemental to dispose of astral enemies. The elemental appears within one Combat Turn of the call (astral response times are fast).

Studio (D)

A plate-glass window separates this soundproofed room from the rest of the office. Microphones point in every direction, and the nozzles of a smoke apparatus flank the stage. A technician's console takes up one corner, its switches set in bewildering patterns along ivory-colored boards.

Shadowrunners who loot this room find portable electronics worth 10,000 nuyen.

Archives (E)

This room contains row after row of steel cabinets. Each holds a gray rubber tray, which in turn cradles recording chips.

Most of the chips contain the efforts of second-rate bands, but the runners also find Angel's recordings here, though these are not the originals. The chips in the archives are worth 15,000 nuyen before a fence takes his cut.

Marketing Office (F)

A hulking chrome terminal covers most of the surface of the desk in this room, its screen lit with the psychedelic colors of sound-chip album art.

Xanadu's advertising executive, Mike Orduffer, works in this office. Orduffer already owes Kat Akmura 20,000 nuyen, and will go to almost any lengths to avoid even the hint of further trouble. He reports the slightest irregularities in office routine to Akmura and attempts to flee at the first sign of trouble. If forced to defend himself, Orduffer fights using the statistics of a Media Producer Contact (p. 209, **SRII**).

Dynamo's Office (G)

The imitation brass sign screwed to the corner office door proclaims "Office of the Director." The room contains a thick carpet, a molded-plastic desk, and a few armchairs for guests. Large windows provide an indescribable view of the streets of Seattle.

The office belongs to Dynamo Blue, who has pampered herself by adding an automatic soykaf maker, electronic secretary, telephone censor, and a work-station system to her office equipment. However, Xanadu Studios is a tiny corporation, and the mogul wannabe cannot afford the truly posh accessories of Seattle's elite executives.

The team will find Blue in her office. Her statistics appear in **Cast of Shadows**, p. 66.

If the runners search this office they can find a platinum ring in one of Blue's drawers. Icelady would recognize it immediately as a gift she bought for Angel. Angel always wore the ring, and if Icelady learns that it turned up in Blue's office, she demands that the runners dust Dynamo. Shadowrunners who take the ring to Lone Star (see **Calling the Cops**, p. 26) can convince the police to put some effort into investigating Angel's death. The police will not arrest Dynamo on the basis of this evidence, but the ring may persuade Lone Star agents to answer some of the runners' questions, on the theory that the team already knows part of the story.

Neighboring Complex (H)

The black, polished doors separating the building's other tenant from the Xanadu offices practically scream nuyen. The visible security cameras mounted outside the offices indicate that the tenant values privacy, but anyone who gets inside finds only bare plaster walls and dusty floors.

The complex actually belongs to a shadow operation financed by Knight Errant Security, which plans to convert the facility into a clinic manned by undercover operatives. If the shadowrunners search the rooms, they eventually discover a small tag attached to an unfinished electrical system that instructs repairmen to bill a

certain LTG. Any character who makes a successful Computer (4) Test can use telecom databases to learn that the LTG belongs to Knight Errant.

Knight Errant does not welcome intruders. Comm connections link the cameras in this complex to KE headquarters and instantly transmit images of any intruders to the main security offices. If the gamemaster needs to rough up the player characters for any reason, the corporation may send a team of four special agents to track down the trespassers and find out what they were doing on Knight Errant property. Dark Angel, and any of the runners' actions other than those directly related to the secret site, do not interest Knight Errant. Once the Knight Errant agents satisfy themselves that the runners pose no immediate threat, they ignore the team and abandon the site. This encounter has no bearing on the adventure, and the gamemaster may use it as needed.

XANADU STUDIOS COMPUTER SYSTEM

Player character deckers can obtain the access code to Xanadu's computers through contacts (see **Legwork**, p. 59) or by decking (see the passcodes section, p. 163, **SR11**). Shadowrunners may also use a computer terminal on the Xanadu premises to go straight into the Matrix.

The Xanadu system uses the UMS (Universal Matrix Specifications) image set. All constructs, unless otherwise noted, consist of interlinking geometric and/or fractal designs.

If deckers trigger an active alert, the Xanadu system shuts down in three Combat Turns.

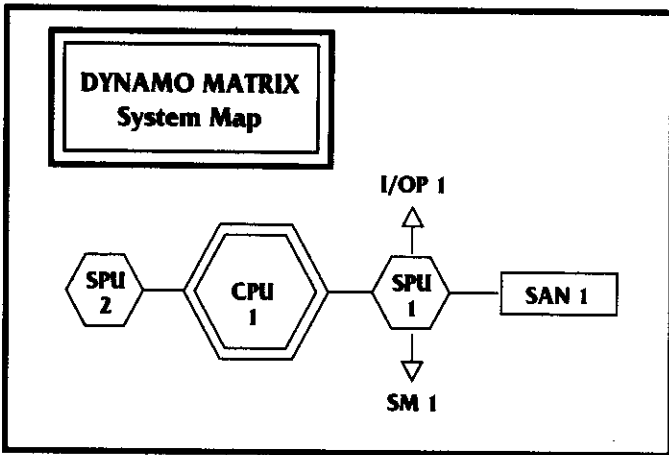

- CPU** = Central Processing Unit
- DS** = Datastore
- I/OP** = Input/Output Port
- SAN** = System Access Node
- SM** = Slave Module
- SPU** = Subprocessor Unit

SAN-1: Orange-5, Access 5, Trace and Burn 5. The trace system alerts Edward Crull to the decker's location. See **Brother to an Angel**, p. 41, for details on his response.

SPU-1: Orange-4, Access 5. This subprocessing unit contains Xanadu Studios' business data, including extensive telecom records. An examination of Dynamo Blue's calls shows that she

speaks frequently with a Mr. Crull at Mitsuhama Inc. Go to **Brother to an Angel**, p. 41, if the team investigates Mr. Crull.

I/OP-1: Orange-5, Access 4. This node connects the computer system to all office terminals in Xanadu Studios. Deckers can ransack the office systems for data on Xanadu's upcoming releases that would net 5,000 nuyen from rival recording studios.

SM-1: Orange-4. This module controls recording equipment in the studio.

SPU-2: Orange-5, Tar Baby 4. This subprocessing unit contains Xanadu's accounting data. Deckers can steal 50,000 nuyen of petty cash from this node. The decker may also notice payments of several million nuyen to Mr. Crull, under such headings as "Community Donations," "Annual Gratuities," and "Miscellaneous Services Rendered." Observant deckers realize that these expenditures roughly equal the income from Dark Angel's recordings.

CPU: Orange-4, Tar Pit 5.

LAB RATS (8)

B	Q	S	C	I	W	E	M	R	Armor
4	5	5	6	4	6	5.6	6	3	5/3

Initiative: 3 + 1D6

Threat/Professional Rating: 2/2

Skills: Armed Combat (Clubs) 8, Bike 2, Etiquette (Media) 3, Etiquette (Street) 5, Firearms 2, Unarmed Combat 2

Special Skills: Instrumental Music 6, Music Composition 3

Cyberware: Datajack, SynthLink Interface

Gear: Armor Jacket (5/3), Club [Reach 1, 6M Stun]

Little more than a group of gutterpunks from the harder side of town, the Lab Rats are always jazzed for a little action—after all, they say, thrills keep the music pumpin'. The clubs that book the Rats provide plenty of opportunities for such excitement, and the band members travel prepared to do battle.

The Lab Rats wear assorted pipes, chains, and other hardware as part of their costumes when they perform, and can easily use these props as weapons.

The image displays eight "CONDITION MONITOR" charts arranged in a 4x2 grid. Each chart has two rows: "STUN" and "PHYSICAL". The "STUN" row has four columns: LIGHT STUN, MODERATE STUN, SERIOUS STUN, and DEADLY STUN. The "PHYSICAL" row has four columns: LIGHT WOUND, MODERATE WOUND, SERIOUS WOUND, and DEADLY WOUND. Each column contains a horizontal bar with a scale from 1 to 10. The bars are partially filled with black, representing the current damage level.



CLIFTON PERKINS, MUSIC AGENT

B	Q	S	C	I	W	E	R	Armor
2	3	2	5	4	4	4.8	3	—

Initiative: 3 + 1D6

Threat/Professional Rating: 1/1

Skills: Computer 3, Etiquette (Corporate) 4, Etiquette (Media) 4, Etiquette (Street) 2, Negotiation 4

Cyberware: Datajack, 100 Mp of Memory

Mr. Perkins expertly manages the careers of several aspiring novastars, but generally feels uncomfortable around his clients' associates. If a firefright breaks out, Perkins covers behind his chair and pleads for his clients to stay out of the line of fire.

		LIGHT STUN	MODERATE STUN	SERIOUS STUN	DEADLY STUN
STUN	+	+1 TN#	+2 TN#	+3 TN#	Unc.
	-	-1 Init.	-2 Init.	-3 Init.	
PHYSICAL	+	+1 TN#	+2 TN#	+3 TN#	Unc. maybe dead
	-	-1 Init.	-2 Init.	-3 Init.	
		LIGHT WOUND	MODERATE WOUND	SERIOUS WOUND	DEADLY WOUND

OFFICE WORKERS (2)

B	Q	S	C	I	W	E	R	Armor
2	2	2	4	4	2	4.8	3	—

Initiative: 3 + 1D6

Threat/Professional Rating: 0/1

Skills: Computer 3, Etiquette (Corporate) 4

Cyberware: Datajack, 100 Mp of Memory

These workers are ordinary wageslaves, no more, no less.

		LIGHT STUN	MODERATE STUN	SERIOUS STUN	DEADLY STUN
STUN	+	+1 TN#	+2 TN#	+3 TN#	Unc.
	-	-1 Init.	-2 Init.	-3 Init.	
PHYSICAL	+	+1 TN#	+2 TN#	+3 TN#	Unc. maybe dead
	-	-1 Init.	-2 Init.	-3 Init.	
		LIGHT WOUND	MODERATE WOUND	SERIOUS WOUND	DEADLY WOUND

		LIGHT STUN	MODERATE STUN	SERIOUS STUN	DEADLY STUN
STUN	+	+1 TN#	+2 TN#	+3 TN#	Unc.
	-	-1 Init.	-2 Init.	-3 Init.	
PHYSICAL	+	+1 TN#	+2 TN#	+3 TN#	Unc. maybe dead
	-	-1 Init.	-2 Init.	-3 Init.	
		LIGHT WOUND	MODERATE WOUND	SERIOUS WOUND	DEADLY WOUND

XANADU GUARDS (10)

B	Q	S	C	I	W	E	R	Armor
4	3	3	2	2	2	6	2	5/3

Initiative: 2 + 1D6

Threat/Professional Rating: 3/2

Skills: Etiquette (Corporate) 3, Firearms 4, Interrogation 2, Unarmed Combat 3

		LIGHT STUN	MODERATE STUN	SERIOUS STUN	DEADLY STUN
STUN	+	+1 TN#	+2 TN#	+3 TN#	Unc.
	-	-1 Init.	-2 Init.	-3 Init.	
PHYSICAL	+	+1 TN#	+2 TN#	+3 TN#	Unc. maybe dead
	-	-1 Init.	-2 Init.	-3 Init.	
		LIGHT WOUND	MODERATE WOUND	SERIOUS WOUND	DEADLY WOUND

		LIGHT STUN	MODERATE STUN	SERIOUS STUN	DEADLY STUN
STUN	+	+1 TN#	+2 TN#	+3 TN#	Unc.
	-	-1 Init.	-2 Init.	-3 Init.	
PHYSICAL	+	+1 TN#	+2 TN#	+3 TN#	Unc. maybe dead
	-	-1 Init.	-2 Init.	-3 Init.	
		LIGHT WOUND	MODERATE WOUND	SERIOUS WOUND	DEADLY WOUND

		LIGHT STUN	MODERATE STUN	SERIOUS STUN	DEADLY STUN
STUN	+	+1 TN#	+2 TN#	+3 TN#	Unc.
	-	-1 Init.	-2 Init.	-3 Init.	
PHYSICAL	+	+1 TN#	+2 TN#	+3 TN#	Unc. maybe dead
	-	-1 Init.	-2 Init.	-3 Init.	
		LIGHT WOUND	MODERATE WOUND	SERIOUS WOUND	DEADLY WOUND

		LIGHT STUN	MODERATE STUN	SERIOUS STUN	DEADLY STUN
STUN	+	+1 TN#	+2 TN#	+3 TN#	Unc.
	-	-1 Init.	-2 Init.	-3 Init.	
PHYSICAL	+	+1 TN#	+2 TN#	+3 TN#	Unc. maybe dead
	-	-1 Init.	-2 Init.	-3 Init.	
		LIGHT WOUND	MODERATE WOUND	SERIOUS WOUND	DEADLY WOUND

		LIGHT STUN	MODERATE STUN	SERIOUS STUN	DEADLY STUN
STUN	+	+1 TN#	+2 TN#	+3 TN#	Unc.
	-	-1 Init.	-2 Init.	-3 Init.	
PHYSICAL	+	+1 TN#	+2 TN#	+3 TN#	Unc. maybe dead
	-	-1 Init.	-2 Init.	-3 Init.	
		LIGHT WOUND	MODERATE WOUND	SERIOUS WOUND	DEADLY WOUND

		LIGHT STUN	MODERATE STUN	SERIOUS STUN	DEADLY STUN
STUN	+	+1 TN#	+2 TN#	+3 TN#	Unc.
	-	-1 Init.	-2 Init.	-3 Init.	
PHYSICAL	+	+1 TN#	+2 TN#	+3 TN#	Unc. maybe dead
	-	-1 Init.	-2 Init.	-3 Init.	
		LIGHT WOUND	MODERATE WOUND	SERIOUS WOUND	DEADLY WOUND

		LIGHT STUN	MODERATE STUN	SERIOUS STUN	DEADLY STUN
STUN	+	+1 TN#	+2 TN#	+3 TN#	Unc.
	-	-1 Init.	-2 Init.	-3 Init.	
PHYSICAL	+	+1 TN#	+2 TN#	+3 TN#	Unc. maybe dead
	-	-1 Init.	-2 Init.	-3 Init.	
		LIGHT WOUND	MODERATE WOUND	SERIOUS WOUND	DEADLY WOUND

		LIGHT STUN	MODERATE STUN	SERIOUS STUN	DEADLY STUN
STUN	+	+1 TN#	+2 TN#	+3 TN#	Unc.
	-	-1 Init.	-2 Init.	-3 Init.	
PHYSICAL	+	+1 TN#	+2 TN#	+3 TN#	Unc. maybe dead
	-	-1 Init.	-2 Init.	-3 Init.	
		LIGHT WOUND	MODERATE WOUND	SERIOUS WOUND	DEADLY WOUND

		LIGHT STUN	MODERATE STUN	SERIOUS STUN	DEADLY STUN
STUN	+	+1 TN#	+2 TN#	+3 TN#	Unc.
	-	-1 Init.	-2 Init.	-3 Init.	
PHYSICAL	+	+1 TN#	+2 TN#	+3 TN#	Unc. maybe dead
	-	-1 Init.	-2 Init.	-3 Init.	
		LIGHT WOUND	MODERATE WOUND	SERIOUS WOUND	DEADLY WOUND

		LIGHT STUN	MODERATE STUN	SERIOUS STUN	DEADLY STUN
STUN	+	+1 TN#	+2 TN#	+3 TN#	Unc.
	-	-1 Init.	-2 Init.	-3 Init.	
PHYSICAL	+	+1 TN#	+2 TN#	+3 TN#	Unc. maybe dead
	-	-1 Init.	-2 Init.	-3 Init.	
		LIGHT WOUND	MODERATE WOUND	SERIOUS WOUND	DEADLY WOUND

Gear: Portacom, Uzi III [SMG, 24 (clip), BF, 6M, w/2 extra clips, Gas Vent II, Laser Sight (-1 modifier to target numbers)]

These guards are professionals, but have little combat experience. They go into a fight confidently but cautiously.

XANADU GUARD CAPTAINS (2)

B	Q	S	C	I	W	E	R	Armor
6	5	6	2	4	5	2.75	4(8)	5/3

Initiative: 8 + 3D6

Threat/Professional Rating: 3/3

Skills: Car 5, Etiquette (Corporate) 4, Firearms (SMG) 7, Stealth 5, Unarmed Combat 6

Cyberware: Smartlink, Wired Reflexes (2)

Gear: Heckler & Koch HK227 [SMG, SA/BF/FA, 7M, 28 (clip), w/2 extra clips, Gas Vent III, External Smartlink], Portacom

These guards are experienced mercenaries, skilled enough to successfully lead average fighters against a superior foe. They deploy their resources with good judgment, spending lives but not wasting them. These mercenaries fight to the best of their abilities, but feel no excessive loyalty to their employers; in the face of disaster, they cut their losses and bug out.

CONDITION MONITOR				
LIGHT STUN	MODERATE STUN	SERIOUS STUN	DEADLY STUN	
STUN	1-10 1 Init	11-20 2 Init	21-30 3 Init	31-40 4 Init
PHYSICAL				
1-10	11-20	21-30	31-40	
LIGHT WOUND	MODERATE WOUND	SERIOUS WOUND	DEADLY WOUND	

CONDITION MONITOR				
LIGHT STUN	MODERATE STUN	SERIOUS STUN	DEADLY STUN	
STUN	1-10 1 Init	11-20 2 Init	21-30 3 Init	31-40 4 Init
PHYSICAL				
1-10	11-20	21-30	31-40	
LIGHT WOUND	MODERATE WOUND	SERIOUS WOUND	DEADLY WOUND	



FIRE ELEMENTAL

B	Q	S	C	I	W	E	R	Armor
8	10	5	7	7	7	7	8	—

Initiative: 18 + 1D6 physical, 28 + 1D6 astral

Threat Rating: 4

Powers: Engulf, Fire Aura, Fire Projection, Guard, Manifestation

Weakness: Vulnerability (Water)

A fire elemental "in the employ" of Hermetic Protection Services, Inc., this spirit follows precise instructions. Because Xanadu has no magical defenses, anyone or anything present in astral space in or near the studio is considered a threat, and the fire elemental will attack any such threat.

CONDITION MONITOR				
PHYSICAL	+1 TN# -1 Init	+2 TN# -2 Init	+3 TN# -3 Init	Unc. Maybe dead
LIGHT WOUND	MODERATE WOUND	SERIOUS WOUND	DEADLY WOUND	

LONE STAR OFFICERS (4)

B	Q	S	C	I	W	E	R	Armor
3	5	5	6	5	6	6	5	5/3

Initiative: 5 + 1D6

Threat/Professional Rating: 3/3

Skills: Armed Combat 3, Etiquette (Corporate) 3, Etiquette (Street) 4, Firearms 4, Throwing Weapons 3, Unarmed Combat 4

Special Skills: Police Procedures 4

Gear: Ares Predator [Heavy Pistol, 15 (clip), SA, 9M, w/2 extra clips, Laser Sight (-1 modifier to target numbers)], Armor Jacket, Club [Reach 1, 6M Stun], Plastic Restraints

All members of this Blue Crew pack Ares Predator pistols.

CONDITION MONITOR				
LIGHT STUN	MODERATE STUN	SERIOUS STUN	DEADLY STUN	
STUN	1-10 1 Init	11-20 2 Init	21-30 3 Init	31-40 4 Init
PHYSICAL				
1-10	11-20	21-30	31-40	
LIGHT WOUND	MODERATE WOUND	SERIOUS WOUND	DEADLY WOUND	

CONDITION MONITOR				
LIGHT STUN	MODERATE STUN	SERIOUS STUN	DEADLY STUN	
STUN	1-10 1 Init	11-20 2 Init	21-30 3 Init	31-40 4 Init
PHYSICAL				
1-10	11-20	21-30	31-40	
LIGHT WOUND	MODERATE WOUND	SERIOUS WOUND	DEADLY WOUND	

CONDITION MONITOR				
LIGHT STUN	MODERATE STUN	SERIOUS STUN	DEADLY STUN	
STUN	1-10 1 Init	11-20 2 Init	21-30 3 Init	31-40 4 Init
PHYSICAL				
1-10	11-20	21-30	31-40	
LIGHT WOUND	MODERATE WOUND	SERIOUS WOUND	DEADLY WOUND	

CONDITION MONITOR				
LIGHT STUN	MODERATE STUN	SERIOUS STUN	DEADLY STUN	
STUN	1-10 1 Init	11-20 2 Init	21-30 3 Init	31-40 4 Init
PHYSICAL				
1-10	11-20	21-30	31-40	
LIGHT WOUND	MODERATE WOUND	SERIOUS WOUND	DEADLY WOUND	

DEBUGGING

Nothing the runners do here, short of dying, will derail the adventure. If the team attacks the studios packing a disgusting quantity of heavy weapons and armor, the gamemaster can improvise an encounter with Lone Star police. If the runners attack, learn nothing, and become absolutely mired in indecision, the **Introduction** provides directions for jumpstarting the story.

Regardless of any havoc the team wreaks, Xanadu Studios stays in business. Akmura can replace guards, she can replace buildings, she can even replace Dynamo Blue. Akmura has all of Xanadu's music and business documents on chips in cold storage at her headquarters. In short, no matter how many times the team destroys this place, it will always bounce back.

CALLING THE COPS

TELL IT TO THEM STRAIGHT

Angel "died" in Lone Star Precinct 249. A station in Pinehurst, Everett is handling the case. You find the place easily enough—the seedy little station with its blue neon sign looks like every other cop-office you've seen. An occasional squad car cruises by, and you instinctively flinch from every one. Inside, the cop shop has scuffed floors and gray walls. The constant beep of the telecom makes a rhythm with the whooshing of the automatic doors.

HOOKS

Lone Star's famed indifference and corruption hits the runners like a wall as soon as they enter the station. The runners' main emotion here should be anxiety, considering where they are.

BEHIND THE SCENES

The team can come here to file charges (perhaps against Angel's band for assault) or find information. If the shadowrunners believe that they have evidence connecting Dynamo Blue to Angel's death, they must show it to the duty officer and ask to speak with the officer in charge of the case. The runners must also visit this station if they want to read Lone Star's files on the case. In either event, the duty officer hands over the team to Lieutenant Dolchev, supervisor of the case.

Regardless of what information the runners find or fabricate for Lone Star, they cannot convince the police organization to take immediate action. "Investigations take time, chummer. And we're not gonna just take the word of the likes of you."

The runners can pick up the official version of Dark Angel's demise from any public datanet. This version claims that Lone Star received Angel's corpse indirectly from two bodyboys (underprivileged citizens who supplement their meager income by turning recently deceased bodies over to medical clinics, which pay a finder's fee and recycle the body parts). Reports indicate that the bodyboys, Hack and Slash by name, operate from a BTL den called Heaven, in Lowell, Everett. Lone Star forensics experts identified the badly burnt corpse as Angel, and noted that the body showed signs of heavy BTL use. All evidence points to a suicide by self-inflicted burns.

Dolchev knows the burned corpse was not Angel. The police forensics experts privately identified it as the recently murdered body of a squatter, apparently geeked as part of a cover-up ordered by a Lone Star executive. The detective heard through the corp rumor mill that one Edward Crull of Mitsuhamma requested the cover-up. Dolchev accepted the fabrication without question, because he knows Crull has ties to the local yakuza.

Shadowrunners slick enough to deal with a crooked police lieutenant can learn a bit more. Though Lieutenant Dolchev is hardly a sterling servant of the law, he feels no special loyalty to the yakuza either. He considers himself a man of his times, able to do business with all the real powers in Seattle. The team must pursue his knowledge with cool and credsticks.

Dolchev deals only with professionals, those "in the know." To learn anything from him, the team must mention facts the general public would not have, such as Dynamo Blue's connection with Edward Crull and her possession of Angel's ring.

If Dolchev agrees to listen to the runners and maybe reveal a bit of his own knowledge, he expects a bribe of at least 5,000 nuyen. However, he demands that the runners behave with as much subtlety and professionalism as he does himself.

The gamemaster determines the success or failure of the bribery based on the team's roleplaying. If necessary, have one runner make an Etiquette (Street) (8) Test. If the player rolls even one success, Lieutenant Dolchev quietly accepts the "small contribution the runners have been meaning to make to the Police Widows Fund." If the runners fail to understand the unwritten Lone Star rules regarding information, Dolchev arrests them for attempting to bribe an officer of the law.

Lone Star never directly investigates Angel's disappearance, but the team can use Lone Star as a feint to draw its enemies into the open. As soon as someone formally presents evidence against Dynamo Blue that suggests her involvement in Angel's death (such as the platinum ring from her office), word quickly reaches Edward Crull, who immediately sets in motion plans to stop the shadowrunners. See **Brother to an Angel**, p. 40, for more information.

LIEUTENANT DOLCHEV

B	Q	S	C	I	W	E	R	Armor
5	5	4	4	5	4	4.95	5	5/3

Initiative: 5 + 1D6

Threat/Professional Rating: 3/3

Skills: Armed Combat 4, Car 4, Etiquette (Street) 7, Firearms 5, Negotiations 6, Unarmed Combat 4

Cyberware: Cybereyes, Low-Light and Camera; Radio

Gear: Ares Predator [Heavy Pistol, 15 (clip), SA, 9M, w/2 extra clips, Laser Sight (-1 modifier to target numbers)], Armor Jacket (5/3), Medkit, Micro-Recorder, Plastic Restraints, 4 Trauma Patches

Lieutenant Dolchev is good at his job. He keeps the go-gangs quiet, the burglars cautious, and the chipheads under control. The streets in his precinct are as safe as streets in Pinehurst get. Nevertheless, Dolchev knows from personal experience just what the sprawl can do to someone who refuses to play the game.

Lieutenant Dolchev plays the game. He knows how not to



investigate a crime and which bribes to accept: In short, Dolchev is an ideal policeman for the 2050s, with a healthy respect for power and professionalism on the street and off.

CONDITION MONITOR				
	LIGHT STUN	MODERATE STUN	SERIOUS STUN	DEADLY STUN
STUN	+1 TN# -1 Init.	+2 TN# -2 Init.	+3 TN# -3 Init.	Unc.
PHYSICAL	+1 TN# -1 Init.	+2 TN# -2 Init.	+3 TN# -3 Init.	Unc. maybe dead.
	LIGHT WOUND	MODERATE WOUND	SERIOUS WOUND	DEADLY WOUND

LONE STAR MATRIX SYSTEM

The idea of making a run on Lone Star's computer system makes most deckers shudder. With so many criminals eager to alter their own and other police records, it stands to reason that Lone Star must use the most powerful IC available. Particularly cocky deckers still may attempt to break into the Precinct 249 system. They can obtain access codes using the usual methods (p. 163, **SR11**).

Deckers looking for discrepancies or buried information come up empty in Lone Star's matrix. Lieutenant Dolchev knows enough to make his Matrix files coincide with the official story of Angel's suicide. Anyone who reaches the Lone Star records on the case will be disappointed or misled.

The Precinct 249 Lone Star matrix system uses the UMS (Universal Matrix Specifications) image set. All constructs, unless otherwise noted, consist of interlinking geometric and/or fractal designs.

If invading deckers trigger an active alert, two police deckers enter the Lone Star system to dispose of the intruder.

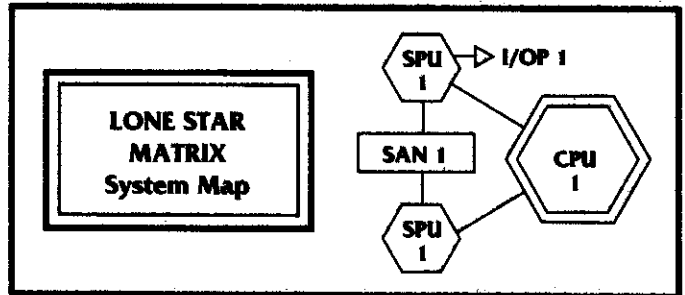

- CPU** = Central Processing Unit
- DS** = Datastore
- I/OP** = Input/Output Port
- SAN** = System Access Node
- SM** = Slave Module
- SPU** = Subprocessor Unit

SAN-1: Orange-5, Access 5, Trace and Bum 5.

SPU-1: Orange-4, Access 5, Scramble 5. This system contains administrative files, auto registrations, patrol reports, and other items of minor interest. One patrolman claims to have seen an unleashed barghest in the city but the sighting remains unconfirmed.

I/OP-1: Orange-5, Access 4. This node connects all the station's office terminals to the system.

SPU-2: Red-4, Access 5, Blaster 5, Tar Pit 5, Trace and Bum 4. This subprocessing unit contains databanks on current investigations. According to information in this unit, Angel died of an apparent suicide in the BTL den Heaven. Other files contain approximately 30,000 nuyen-worth of information on street snitches and undercover officers operating in the precinct. Anyone with underworld contacts can make a small fortune selling such information.

CPU: Red-4, Blaster 5, Tar Pit 5, Trace and Bum 5.

DEBUGGING

Only if the shadowrunners do something irredeemably foolish, such as attacking a Lone Star officer, do the police arrest them. Otherwise, the runners simply end up disappointed. Treat the precinct station as a Police Station Archetype, (p. 30, **Sprawl Sites**). Fifteen police officers and five detectives are in the building. All wear armor jackets and have access to both Ares Predator heavy pistols and FN-HAR assault rifles. The runners should also keep in mind that Lone Star always puts its near-infinite resources to work to pursue criminals who attack police officers.

If they prefer to not go inside the station, the runners may decide to follow Lieutenant Dolchev from work, kidnap him off the street, and interrogate him for his information. However, this definitely falls into the category of harming a Lone Star officer.

If previous events (a firefight, breaking and entering) bring the team to Lone Star's attention, the gamemaster may arrange this meet in order for both sides to reach agreement on an "arrangement;" probably information in exchange for temporary amnesty. The player characters may also come up with a way to avoid being taken into custody while still gaining necessary information, or the gamemaster can turn the meeting into a straightforward legwork/contact encounter.

HEAVEN BOUND

TELL IT TO THEM STRAIGHT

Angel picked a fraggin' charming place to die. "Heaven" turns out to be a lot in Lowell, Everett, which makes most Toxic Zones look like picnic spots. Once, a long time ago, it was a public health clinic. Now half the building has caved in, strewing rubble into the street. Jagged plasteel spars jut up from the ruins. A fire roars in a dumpster and graffiti covers every inch of the walls still standing.

Nevertheless, Heaven seems to be a popular place. Everyone in Seattle has seen newsvids about this notorious BTL den, and for once, the reports don't exaggerate. Chipheads as pale as zombies creep through the dark interior, occasionally showing their faces at the broken windows. Sweet-faced gangers jander past the doors selling chips and watching for the cops. Their jackets are decorated with a picture of a gray rock below crossed keys and the words, "Golden Gators."

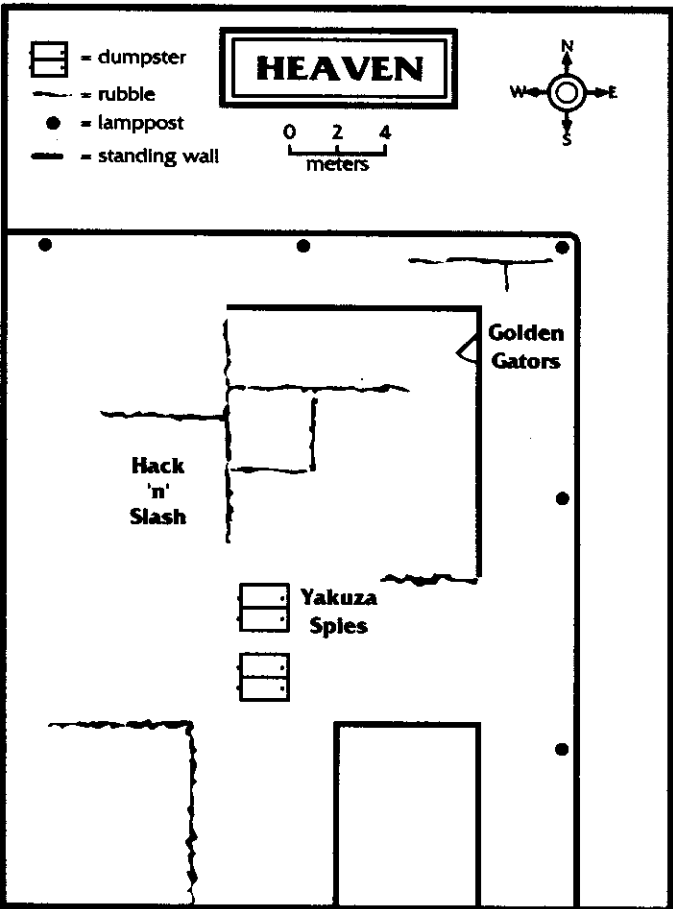

Angel's death apparently has attracted a whole new clientele to Heaven. Rock fans from miles around make pilgrimages to the den to pay homage to their idol. Girls with rainbow-hued mohawks dance to the new Angel record while a cluster of culties lurks in the ruins, each one an eerie clone of the deceased singer. A cameraman scans the whole scene with a palm-sized lens.

BEHIND THE SCENES

The runners meet a diverse assortment of lowlifes in Heaven. None of them came to Heaven looking for a fight, but most of them would welcome an excuse to scrag some street-runners. Depending on how the shadowrunners approach the people here, this encounter could be a quiet investigation, a brief battle, or an all-out melee.

The gamemaster determines how the non-player characters react to the shadowrunners. If the team provokes a fight, the non-player characters gladly give them one. And even if the runners try to avoid a scrap, they may irritate the wrong people and get one anyway. If a fight develops, the gamemaster decides whether or not bystanders join in. Consult the non-player character entries at the end of this section for specific information on roleplaying the denizens of Heaven.

The gamemaster should take special note of the following three facts. The Golden Gators attack any runners who create a disturbance; the yakuza spies among the culties attempt to eavesdrop on anyone who asks questions about Angel; and Hack and Slash attempt to sneak away as soon as they hear anyone asking about events on the night of Angel's death. The map shows the approximate location of each group when the team arrives.

THE GOLDEN GATORS

The Golden Gators, led by a shaman named Lizard Pete, consider themselves the proprietors of Heaven. They control Heaven's BTL trade, watch for Lone Star, and keep other gangs away. The Gators ignore shadowrunners who blend in with the other sprawl dwellers, but see any attempt to "crash their turf" as a personal affront, and they immediately attack anyone who starts a fight in Heaven. If the runners do not fit in with the locals, seem nervous, or ask too many questions, the Golden Gators warn them to leave. "Chummer, we're writin' you a ticket to hell." If the team ignores the threat, the Golden Gators attack.

The Golden Gators usually engage their enemies in hand-to-hand combat, because most of their fights develop during arguments. If the shadowrunners open fire on the Golden Gators from long range, the gang scurries into the basements under Heaven and hides there. Anyone who crawls in after them meets the gang at close quarters.

HEAVEN BOUND

The Gators sell BTL chips for 50 nuyen per five minutes playing time or 3,000 nuyen a chip. If one of the runners buys a chip and jacks in, the gamemaster rolls 2D6 to determine if the chip is dangerous. On a result of 12, the chip's code carries a potentially lethal feedback error and the runner must make a Damage Resistance Test against 4D Stun damage. The runner must also make a successful Willpower (2) Test to avoid permanently losing a point of Essence.

The Gators are smart enough not to get involved in Dark Angel's mess. If the shadowrunners ask the Gators questions about Angel, the gamemaster should pay close attention to their technique, because the Gators attack anyone they consider nosy. Only the smoothest talkers actually find out what the gangers know. If roleplaying alone does not resolve the encounter, have one of the player characters make an Etiquette (Street) (6) Test to determine how much information the Gators reveal. Consult the following table for the results.

Successes	Result
0	"Buzz, chummer." (If the team hangs around, the gangers attack.)
1	"Whatchu talkin' bout, cobber? Angel never hung here."
2	"Talk to the salvage team, chummer. Y'might learn something from them." (The gang points out Hack and Slash.)

Golden Gators (6)

B	Q	S	C	I	W	E	R	Armor
5	5	6 (8)	6	5	4	4	5	5/3

Initiative: 5 + 1D6

Threat/Professional Rating: 2/2

Skills: Armed Combat (Sword) 8, Etiquette (Street) 4, Firearms 4, Negotiations 4, Unarmed Combat (Grapple) 7

Cyberware: Muscle Replacement (2)

Gear: Armor Jacket (5/3), Browning Max-Power [Heavy Pistol, SA, 9M, 10 (clip), w/2 extra clips], Sword [Reach 2, (STR + 2)S]

CONDITION MONITOR	
	LIGHT STUN MODERATE STUN SERIOUS STUN DEADLY STUN
STUN	1-12 (1 hr) 13-24 (2 hrs) 25-36 (3 hrs) 37-48 (4 hrs)
PHYSICAL	1-12 (1 hr) 13-24 (2 hrs) 25-36 (3 hrs) 37-48 (4 hrs)
	LIGHT WOUND MODERATE WOUND SERIOUS WOUND DEADLY WOUND

CONDITION MONITOR	
	LIGHT STUN MODERATE STUN SERIOUS STUN DEADLY STUN
STUN	1-12 (1 hr) 13-24 (2 hrs) 25-36 (3 hrs) 37-48 (4 hrs)
PHYSICAL	1-12 (1 hr) 13-24 (2 hrs) 25-36 (3 hrs) 37-48 (4 hrs)
	LIGHT WOUND MODERATE WOUND SERIOUS WOUND DEADLY WOUND

CONDITION MONITOR	
	LIGHT STUN MODERATE STUN SERIOUS STUN DEADLY STUN
STUN	1-12 (1 hr) 13-24 (2 hrs) 25-36 (3 hrs) 37-48 (4 hrs)
PHYSICAL	1-12 (1 hr) 13-24 (2 hrs) 25-36 (3 hrs) 37-48 (4 hrs)
	LIGHT WOUND MODERATE WOUND SERIOUS WOUND DEADLY WOUND

CONDITION MONITOR	
	LIGHT STUN MODERATE STUN SERIOUS STUN DEADLY STUN
STUN	1-12 (1 hr) 13-24 (2 hrs) 25-36 (3 hrs) 37-48 (4 hrs)
PHYSICAL	1-12 (1 hr) 13-24 (2 hrs) 25-36 (3 hrs) 37-48 (4 hrs)
	LIGHT WOUND MODERATE WOUND SERIOUS WOUND DEADLY WOUND

CONDITION MONITOR	
	LIGHT STUN MODERATE STUN SERIOUS STUN DEADLY STUN
STUN	1-12 (1 hr) 13-24 (2 hrs) 25-36 (3 hrs) 37-48 (4 hrs)
PHYSICAL	1-12 (1 hr) 13-24 (2 hrs) 25-36 (3 hrs) 37-48 (4 hrs)
	LIGHT WOUND MODERATE WOUND SERIOUS WOUND DEADLY WOUND

CONDITION MONITOR	
	LIGHT STUN MODERATE STUN SERIOUS STUN DEADLY STUN
STUN	1-12 (1 hr) 13-24 (2 hrs) 25-36 (3 hrs) 37-48 (4 hrs)
PHYSICAL	1-12 (1 hr) 13-24 (2 hrs) 25-36 (3 hrs) 37-48 (4 hrs)
	LIGHT WOUND MODERATE WOUND SERIOUS WOUND DEADLY WOUND

The Gators are ready to join the ranks of Seattle's dishonest businessmen. After years of thrill-slashing, the gang discovered that trading in BTL chips offered far higher profits at a comparatively lower risk. The Gators want order in their turf to preserve their BTL trade, and revert to their old violence if someone threatens the peace.

Lizard Pete, Alligator Shaman

B	Q	S	C	I	W	E	M	R	Armor
6	4	1	4	4	6	6	6	4	5/3

Initiative: 4 + 1D6

Threat/Professional Rating: 2/3

Skills: Conjuring (City Spirits) 7, Etiquette (Street) 4, Leadership 5, Sorcery (Spellcasting) 7, Unarmed Combat 3

Gear: Armor Jacket (5/3), Browning Max-Power [Heavy Pistol, SA, 9M, 10 (clip), w/2 extra clips], Sword [Reach 2, (STR + 2)S]

Totem: Gator

Spells: Armor 2, Combat Sense 2, Manablast 5, Mana Bolt 4, Powerball 5, Treat 2

This Urban Gator shaman worked hard to establish the Golden Gators and set himself up as their leader. Now he just relaxes and

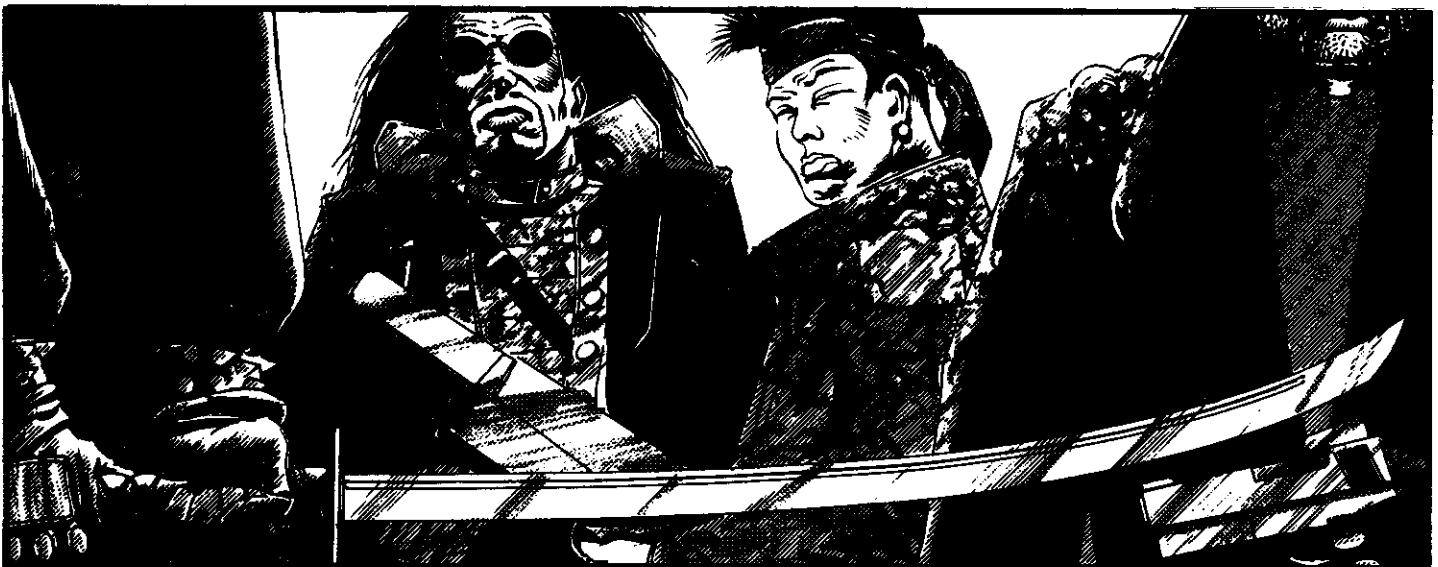

HEAVEN BOUND



waits for the money to flow in. Pete cares little for the gang's business, as long as he gets a cut, but he enjoys their battles. The shaman wears a perpetually smug expression, reinforced by his wide mouth and smooth, tanned skin.

In a fight, Lizard Pete likes to summon a Force 5 city spirit, which uses its confusion power to disorient Pete's most dangerous-looking enemy. The spirit manifests as a trash bag filled with wet, greasy garbage, which lands on the enemy's head. Once the apparent danger is eliminated, Pete enters the battle armed with spells.

		CONDITION MONITOR			
		LIGHT STUN	MODERATE STUN	SERIOUS STUN	DEADLY STUN
STUN	+1 TN# -1 Init.	+2 TN# -2 Init.	+3 TN# -3 Init.		Unc.
	-1 TN# -1 Init.	-2 TN# -2 Init.	-3 TN# -3 Init.		Unc. maybe dead
PHYSICAL	+1 TN# -1 Init.	+2 TN# -2 Init.	+3 TN# -3 Init.		Unc. maybe dead
	-1 TN# -1 Init.	-2 TN# -2 Init.	-3 TN# -3 Init.		Unc. maybe dead
		LIGHT WOUND	MODERATE WOUND	SERIOUS WOUND	DEADLY WOUND

BYSTANDERS

People swarm around Heaven like maggots on a corpse. Emaciated chipheads mix with Dark Angel fans, some of whom have actually undergone plastic surgery to resemble their idol. A reporter for TectonicRock, Channel 234, scans the scene, stopping to interview anyone who cares to comment on Dark Angel or his death. Aside from their relatively worthless opinions, these people possess little information and generally avoid contact with the shadowrunners.

A runner who questions people for information at random makes an Etiquette (Street) (4) Test to determine his or her skill at selecting a cooperative informant. Consult the table below for the results.

Successes	Result
0-1	These bystanders know nothing. If the runners insist on questioning them, they scream obscenities and the Gators advise the runners to leave.
2+	"You wanna know about a dead dude, ya talk to Hack and Slash." (The bystander points out the trolls.)

Rock fans and chipheads use the statistics for a Pedestrian Contact (p. 116, **Sprawl Sites**, or p. 25, **Archetypes and Contacts** book from **SR11 Gamemaster Screen**). The reporter uses the statistics of a Media Producer Contact (p. 209, **SR11**). These people avoid combat if possible.

YAKUZA SPIES

Two of the bystanders spy for the yakuza. Their cybernetic ears can dampen the ordinary sounds of the city to pick up any unguarded words, but cautious shadowrunners can foil eavesdroppers by using white noise generators, arranging for noisy machinery to operate in the area, or by simply leaving Heaven.

The spies take note if the runners try to get anything out of Angel's fans beyond the expected drivel. If they decide the team has an unhealthy interest in the case, they report it to Crull, who sends his assassins against the runners. See **Brother to an Angel**, p. 40, for details.

Yakuza Spies (2)

B	Q	S	C	I	W	E	R	Armor
3	6	6	3	6	6	4.34	6	3/0

Initiative: 6 + 1D6

Threat/Professional Rating: 4/4

Skills: Armed Combat 6, Etiquette (Street) 4, Firearms 4, Unarmed

Combat (Hand Razors) 8

Cyberware: Cyberears (Damper Recorder), Datajack, Hearing Amplification, Improved Hand Razors, Radio

Gear: Armor Clothing (3/0), Browning Max-Power [Heavy Pistol, 10 (clip), SA, 9M, w/2 extra clips]

These two Japanese Informers dress in the worn synthleather of the street and wear their hair in dreadlocks, with each braid dyed a different hue. Little distinguishes them from the other street types. Only their narrowed eyes, scanning the scene with professional detachment, hint at their true vocation.

The yakuza trained these agents by building on their natural abilities, and the two feel a fierce loyalty to their employer. These spies usually stay undercover and report their findings to Crull via radio. However, if the team detects them eavesdropping and attacks, the yakuza spies fight to the death to avoid capture.

CONDITION MONITOR	
STUN	PHYSICAL
LIGHT STUN	LIGHT WOUND
MODERATE STUN	MODERATE WOUND
SERIOUS STUN	SERIOUS WOUND
DEADLY STUN	DEADLY WOUND
UNC.	UNC.

CONDITION MONITOR	
STUN	PHYSICAL
LIGHT STUN	LIGHT WOUND
MODERATE STUN	MODERATE WOUND
SERIOUS STUN	SERIOUS WOUND
DEADLY STUN	DEADLY WOUND
UNC.	UNC.

HACK AND SLASH

Hack and Slash serve as "freelance collection agents" for BodyBits Organ Donation Service, which pays them a fee for every unclaimed corpse they deliver. The two trolls linger near Heaven because the frequent firefights and lethal BTL provide them with a ready source of merchandise. Their involvement in the Angel affair began when Edward Crull paid them to disguise the corpse of a burn victim as Angel and report it to the police.

Hack and Slash know better than to discuss work they



performed for the yakuza with anyone. A loaded gun trained on their faces may persuade the trolls to talk, but the runners cannot use this interrogation tactic on the street. Kidnapping these bodyboys presents another kind of challenge, once again because the Gators jump in to stop any fracas in Heaven.

Rather than using force, the team can lure Hack and Slash

away from Heaven with a reasonable story. An offer to sell or buy a corpse might interest these trolls. If the player characters create enough details to make their story believable. The gamemaster may determine whether or not the trolls accept the team's story through roleplaying, or else have one runner make an opposed Success Test using a number of dice equal to the character's Negotiation Skill against one troll's Intelligence. The troll makes an opposed Success Test using a number of dice equal to his Negotiation Skill against a target number equal to the character's Intelligence. If the player character rolls more net successes, Hack and Slash accept the story and leave with the runners. If the troll rolls more net successes, they tell the runners to frag off.

Hack and Slash know Crull has ties to the yakuza and can direct the runners to his Renton house. By questioning the trolls about what exactly Crull asked them to do, the runners can learn that he wanted them to produce a burned male corpse with dark hair, wide-set gray eyes and a cleft in its chin. Hack and Slash do not realize that those features match Dark Angel's, but the shadowrunners do.

Hack and Slash

B	Q	S	C	I	W	E	R	Armor
10	1	10	1	1	4	6	1	5/3

Initiative: 1 + 1D6

Threat/Professional Rating: 1/2

Skills: Armed Combat (Combat Axe) 8, Biotech 3, Etiquette (Street) 2, Firearms 4, Unarmed Combat 6

Gear: AK-97 [Assault Rifle, 38 (clip), SA/BF/FA, 8M, w/2 extra clips], Armor Jacket (5/3), Combat Axe [Reach 2, (STR + 2)S], dissection gear, plastic body bags

These trolls enjoy their work. BodyBits pays them pretty well for a pair of unskilled trolls, and they take the more gruesome aspects of their job in good humor. Hack and Slash studiously avoid any activity that might land them in trouble and are actually a little timid. Despite their basic cowardice, the two trolls give a good account of themselves in a fight.

Hack and Slash have Caucasian features and light blue eyes. They are brothers and the family resemblance shows.

CONDITION MONITOR	
STUN	PHYSICAL
LIGHT STUN	LIGHT WOUND
MODERATE STUN	MODERATE WOUND
SERIOUS STUN	SERIOUS WOUND
DEADLY STUN	DEADLY WOUND
UNC.	UNC.

CONDITION MONITOR	
STUN	PHYSICAL
LIGHT STUN	LIGHT WOUND
MODERATE STUN	MODERATE WOUND
SERIOUS STUN	SERIOUS WOUND
DEADLY STUN	DEADLY WOUND
UNC.	UNC.

DEBUGGING

This section simply provides the runners with another potential source for clues, specifically pointing them toward Edward Crull and the yakuza. Because the team can get this information other ways, the gamemaster need not help player characters accomplish their goals at Heaven. The runners can easily get information without resorting to violence, and so if they start a battle they are not prepared to fight, they deserve a horror show. In the unlikely event the Golden Gators actually threaten to exterminate the shadowrunners, the gamemaster uses Lone Star to break up the fight.



MINDWARP

TELL IT TO THEM STRAIGHT

The bright lights of downtown Seattle sparkle outside the Mindwarp. Inside, patrons find themselves awash in a sea of color, surrounded by six enormous vidscreens that serve as walls, floor, and ceiling. The translucent panels vibrate to the deafening music and repeat patterns of garish, undulating waves, blinking checkboards, bouncing balls, whirlpools, and sunbursts.

Dancers race across the floor like whirling dervishes, while other patrons sit limply at the bar, apparently overwhelmed by the Mindwarp.

An enclosed loft shadows half the dance floor, serving as a club-within-a-club that is open to only a select few. A well-dressed troll stands near the elevator that carries lucky patrons to the overhead chamber, scrutinizing those who enter and challenging anyone he does not recognize.

If a runner assesses the Mindwarp, read the following:

The frenzied atmosphere of the Mindwarp extends into astral space. Garish colors pulsate around the dancers, fading to gray around the exhausted patrons at the bar. Several drinkers seem nearly dead, displaying only the muted tones of barely felt emotions around their heads. The astral security is obvious: a large, bright-orange fire elemental flickers over the crowded nightclub.

When the runners make it to the loft, read the following:

The music is less frenetic here, soft enough that people can talk over it. Men and women sculpted into impossibly perfect proportions linger at the bar. Everyone in the club is wearing the stiff, angular cuts of the latest fashion designs from Tokyo. A handful of beetle-browed Japanese men sip drinks in the corners, as if to provide contrast with the surgically enhanced beauties at the bar.

Rice-paper walls divide the loft into several semi-private alcoves. The largest contains a dais supporting a small couch, where a balding Japanese man in his late 30s reclines. Two women, as striking as any in the loft, nestle under his outstretched arms and toy with the folds of his suit. Two trolls in dark suits flank this throne, menacing-looking hoglegs hanging from their shoulders on black web slings.

HOOKS

The Mindwarp's main room combines the atmospheres of Club Chiaroscuro and Heaven. The energy in the room is overwhelming. Even the most innocent liner would realize that behind the blinding glitz is enough intrigue to make a dragon dizzy.

In contrast, the loft radiates a profound sense of leashed energy. Every move, every action is precise and deliberate. This room reflects the confident, efficient power of the club's owner, Shiro Usaka.

BEHIND THE SCENES

The Mindwarp serves as a pleasure palace and headquarters for Usaka, a leader in the Seattle yakuza. The runners may visit Usaka in search of information about Angel, or may need to try to prevent the yakuza from avenging Kat Akamura's death. The team will have to work hard to reach an agreement with Usaka, because he is currently allied with Akamura.

If the runners start a fight in the Mindwarp, the club's guards react quickly and precisely. Seven troll guards serve as bouncers and bodyguards, posted in the locations shown in the layout. These brutes immediately confront the threat while the security force, special assistants, and the mage Kojika counterattack with cunning and efficiency. They approach a fight cautiously, using the Mindwarp's corridors to cut off runners attempting to escape. These forces may also appear in an ambush if Shiro decides to attack the runners.

Because the yakuza organization does not permit outsiders to kill their members without permission, any unauthorized attack on Shiro attracts the wrath of Homatsu JInjiro, the local senior oyabun (see *Marian Parks*, p. 37).

For statistics on Shiro and his mage Kojika, consult *Cast of Shadows*, p. 63.

TROLL GUARDS (7)

B	Q	S	C	I	W	E	R	Armor
10	3	12	1	1	4	1.3	1(3)	5/3(4)

Initiative: 1(3) + 1D6 (+ 3D6)

Threat/ Professional Rating: 4/4

Skills: Armed Combat 6, Etiquette (Street) 2, Firearms 6, Unarmed Combat (Hand Strikes) 8

Cyberware: Boosted Reflexes (3), Muscle Replacement (2)

Gear: Armor Jacket (5/3), Browning Max-Power [Heavy Pistol, 10 (clip) SA, 9M, w/2 extra clips], Club [Reach 1, 13M Stun], Forearm Guards (+1 Impact Armor, 13M Stun)

These muscular guards always appear to be on the verge of bursting their seams. They do not hesitate to physically restrain troublemakers, even if the troublemakers are better armed.

MINDWARP

CONDITION MONITOR LIGHT STUN 1 2 3 4 5 6 7 8 9 10 MODERATE STUN 1 2 3 4 5 6 7 8 9 10 SERIOUS STUN 1 2 3 4 5 6 7 8 9 10 DEADLY STUN 1 2 3 4 5 6 7 8 9 10 STUN 1 2 3 4 5 6 7 8 9 10 PHYSICAL 1 2 3 4 5 6 7 8 9 10 LIGHT WOUND 1 2 3 4 5 6 7 8 9 10 MODERATE WOUND 1 2 3 4 5 6 7 8 9 10 SERIOUS WOUND 1 2 3 4 5 6 7 8 9 10 DEADLY WOUND 1 2 3 4 5 6 7 8 9 10	
CONDITION MONITOR LIGHT STUN 1 2 3 4 5 6 7 8 9 10 MODERATE STUN 1 2 3 4 5 6 7 8 9 10 SERIOUS STUN 1 2 3 4 5 6 7 8 9 10 DEADLY STUN 1 2 3 4 5 6 7 8 9 10 STUN 1 2 3 4 5 6 7 8 9 10 PHYSICAL 1 2 3 4 5 6 7 8 9 10 LIGHT WOUND 1 2 3 4 5 6 7 8 9 10 MODERATE WOUND 1 2 3 4 5 6 7 8 9 10 SERIOUS WOUND 1 2 3 4 5 6 7 8 9 10 DEADLY WOUND 1 2 3 4 5 6 7 8 9 10	
CONDITION MONITOR LIGHT STUN 1 2 3 4 5 6 7 8 9 10 MODERATE STUN 1 2 3 4 5 6 7 8 9 10 SERIOUS STUN 1 2 3 4 5 6 7 8 9 10 DEADLY STUN 1 2 3 4 5 6 7 8 9 10 STUN 1 2 3 4 5 6 7 8 9 10 PHYSICAL 1 2 3 4 5 6 7 8 9 10 LIGHT WOUND 1 2 3 4 5 6 7 8 9 10 MODERATE WOUND 1 2 3 4 5 6 7 8 9 10 SERIOUS WOUND 1 2 3 4 5 6 7 8 9 10 DEADLY WOUND 1 2 3 4 5 6 7 8 9 10	
CONDITION MONITOR LIGHT STUN 1 2 3 4 5 6 7 8 9 10 MODERATE STUN 1 2 3 4 5 6 7 8 9 10 SERIOUS STUN 1 2 3 4 5 6 7 8 9 10 DEADLY STUN 1 2 3 4 5 6 7 8 9 10 STUN 1 2 3 4 5 6 7 8 9 10 PHYSICAL 1 2 3 4 5 6 7 8 9 10 LIGHT WOUND 1 2 3 4 5 6 7 8 9 10 MODERATE WOUND 1 2 3 4 5 6 7 8 9 10 SERIOUS WOUND 1 2 3 4 5 6 7 8 9 10 DEADLY WOUND 1 2 3 4 5 6 7 8 9 10	
CONDITION MONITOR LIGHT STUN 1 2 3 4 5 6 7 8 9 10 MODERATE STUN 1 2 3 4 5 6 7 8 9 10 SERIOUS STUN 1 2 3 4 5 6 7 8 9 10 DEADLY STUN 1 2 3 4 5 6 7 8 9 10 STUN 1 2 3 4 5 6 7 8 9 10 PHYSICAL 1 2 3 4 5 6 7 8 9 10 LIGHT WOUND 1 2 3 4 5 6 7 8 9 10 MODERATE WOUND 1 2 3 4 5 6 7 8 9 10 SERIOUS WOUND 1 2 3 4 5 6 7 8 9 10 DEADLY WOUND 1 2 3 4 5 6 7 8 9 10	
CONDITION MONITOR LIGHT STUN 1 2 3 4 5 6 7 8 9 10 MODERATE STUN 1 2 3 4 5 6 7 8 9 10 SERIOUS STUN 1 2 3 4 5 6 7 8 9 10 DEADLY STUN 1 2 3 4 5 6 7 8 9 10 STUN 1 2 3 4 5 6 7 8 9 10 PHYSICAL 1 2 3 4 5 6 7 8 9 10 LIGHT WOUND 1 2 3 4 5 6 7 8 9 10 MODERATE WOUND 1 2 3 4 5 6 7 8 9 10 SERIOUS WOUND 1 2 3 4 5 6 7 8 9 10 DEADLY WOUND 1 2 3 4 5 6 7 8 9 10	



YAKUZA SOLDIERS (8)

B	Q	S	C	I	W	M	R	Armor
5	6	5	5	4	3	5.1	5	5/4

Initiative: 5 + 2D6

Threat/Professional Rating: 5/4

Skills: Armed Combat 5, Etiquette (Street) 2, Firearms 4, Unarmed Combat 5

Cyberware: Boosted Reflexes (1), Smartlink

Gear: Armor Jacket (5/3), Club (Reach 1, 6M Stun), Heckler & Koch HK227 [SMG, 28 (clip) SA/BF/FA, 7M, w/2 extra clips, Gas-Vent II]

These rough-looking Japanese fellows appear to be uncomfortable wearing suits, and their long hair hangs out from under their gray hats. These men defend Shiro, carry out his orders with ruthless efficiency, and are, if anything, more violent than their troll counterparts.

CONDITION MONITOR LIGHT STUN 1 2 3 4 5 6 7 8 9 10 MODERATE STUN 1 2 3 4 5 6 7 8 9 10 SERIOUS STUN 1 2 3 4 5 6 7 8 9 10 DEADLY STUN 1 2 3 4 5 6 7 8 9 10 STUN 1 2 3 4 5 6 7 8 9 10 PHYSICAL 1 2 3 4 5 6 7 8 9 10 LIGHT WOUND 1 2 3 4 5 6 7 8 9 10 MODERATE WOUND 1 2 3 4 5 6 7 8 9 10 SERIOUS WOUND 1 2 3 4 5 6 7 8 9 10 DEADLY WOUND 1 2 3 4 5 6 7 8 9 10	
CONDITION MONITOR LIGHT STUN 1 2 3 4 5 6 7 8 9 10 MODERATE STUN 1 2 3 4 5 6 7 8 9 10 SERIOUS STUN 1 2 3 4 5 6 7 8 9 10 DEADLY STUN 1 2 3 4 5 6 7 8 9 10 STUN 1 2 3 4 5 6 7 8 9 10 PHYSICAL 1 2 3 4 5 6 7 8 9 10 LIGHT WOUND 1 2 3 4 5 6 7 8 9 10 MODERATE WOUND 1 2 3 4 5 6 7 8 9 10 SERIOUS WOUND 1 2 3 4 5 6 7 8 9 10 DEADLY WOUND 1 2 3 4 5 6 7 8 9 10	
CONDITION MONITOR LIGHT STUN 1 2 3 4 5 6 7 8 9 10 MODERATE STUN 1 2 3 4 5 6 7 8 9 10 SERIOUS STUN 1 2 3 4 5 6 7 8 9 10 DEADLY STUN 1 2 3 4 5 6 7 8 9 10 STUN 1 2 3 4 5 6 7 8 9 10 PHYSICAL 1 2 3 4 5 6 7 8 9 10 LIGHT WOUND 1 2 3 4 5 6 7 8 9 10 MODERATE WOUND 1 2 3 4 5 6 7 8 9 10 SERIOUS WOUND 1 2 3 4 5 6 7 8 9 10 DEADLY WOUND 1 2 3 4 5 6 7 8 9 10	
CONDITION MONITOR LIGHT STUN 1 2 3 4 5 6 7 8 9 10 MODERATE STUN 1 2 3 4 5 6 7 8 9 10 SERIOUS STUN 1 2 3 4 5 6 7 8 9 10 DEADLY STUN 1 2 3 4 5 6 7 8 9 10 STUN 1 2 3 4 5 6 7 8 9 10 PHYSICAL 1 2 3 4 5 6 7 8 9 10 LIGHT WOUND 1 2 3 4 5 6 7 8 9 10 MODERATE WOUND 1 2 3 4 5 6 7 8 9 10 SERIOUS WOUND 1 2 3 4 5 6 7 8 9 10 DEADLY WOUND 1 2 3 4 5 6 7 8 9 10	
CONDITION MONITOR LIGHT STUN 1 2 3 4 5 6 7 8 9 10 MODERATE STUN 1 2 3 4 5 6 7 8 9 10 SERIOUS STUN 1 2 3 4 5 6 7 8 9 10 DEADLY STUN 1 2 3 4 5 6 7 8 9 10 STUN 1 2 3 4 5 6 7 8 9 10 PHYSICAL 1 2 3 4 5 6 7 8 9 10 LIGHT WOUND 1 2 3 4 5 6 7 8 9 10 MODERATE WOUND 1 2 3 4 5 6 7 8 9 10 SERIOUS WOUND 1 2 3 4 5 6 7 8 9 10 DEADLY WOUND 1 2 3 4 5 6 7 8 9 10	
CONDITION MONITOR LIGHT STUN 1 2 3 4 5 6 7 8 9 10 MODERATE STUN 1 2 3 4 5 6 7 8 9 10 SERIOUS STUN 1 2 3 4 5 6 7 8 9 10 DEADLY STUN 1 2 3 4 5 6 7 8 9 10 STUN 1 2 3 4 5 6 7 8 9 10 PHYSICAL 1 2 3 4 5 6 7 8 9 10 LIGHT WOUND 1 2 3 4 5 6 7 8 9 10 MODERATE WOUND 1 2 3 4 5 6 7 8 9 10 SERIOUS WOUND 1 2 3 4 5 6 7 8 9 10 DEADLY WOUND 1 2 3 4 5 6 7 8 9 10	
CONDITION MONITOR LIGHT STUN 1 2 3 4 5 6 7 8 9 10 MODERATE STUN 1 2 3 4 5 6 7 8 9 10 SERIOUS STUN 1 2 3 4 5 6 7 8 9 10 DEADLY STUN 1 2 3 4 5 6 7 8 9 10 STUN 1 2 3 4 5 6 7 8 9 10 PHYSICAL 1 2 3 4 5 6 7 8 9 10 LIGHT WOUND 1 2 3 4 5 6 7 8 9 10 MODERATE WOUND 1 2 3 4 5 6 7 8 9 10 SERIOUS WOUND 1 2 3 4 5 6 7 8 9 10 DEADLY WOUND 1 2 3 4 5 6 7 8 9 10	

MINDWARP MAP KEY

Lobby (A)

The lobby is a bright room filled with groupings of molded plastic chairs. A bored-looking man sits behind a counter, accepting coats, hats, and other baggage. The lobby entrance also contains sophisticated magnetic anomaly scanners designed to detect guns. If a runner tries to smuggle a gun into the club, the gamemaster makes a Success Test against the weapon's Concealability using 3D6. If the gamemaster rolls any successes, the runner must check the gun. A troll guard stands by to enforce the code banning weapons in the club.

Bar (B)

The bar is a glittering slab of crystalline plastic abutting the dance floor. Fenswick, a young man in a light suit, tends the bar. A skagman peddles BTL chips near the bar for 50 nuyen apiece. Any player who makes a successful Etiquette (Street) (3) Test notices the sales and recognizes the well-to-do chipheads as they burn their brains. The chip peddler is a young Japanese man in a tight-fitting suit of white synth-leather and rhinestones.

Dance Floor (C)

A troll stands guard by each entrance along the dance floor. Another is posted at the elevator to the loft, and two more lounge in the back room, watching trid. Unlike typical barroom bouncers, these trolls have cybernetic implants that make them dangerous

MINDWARP

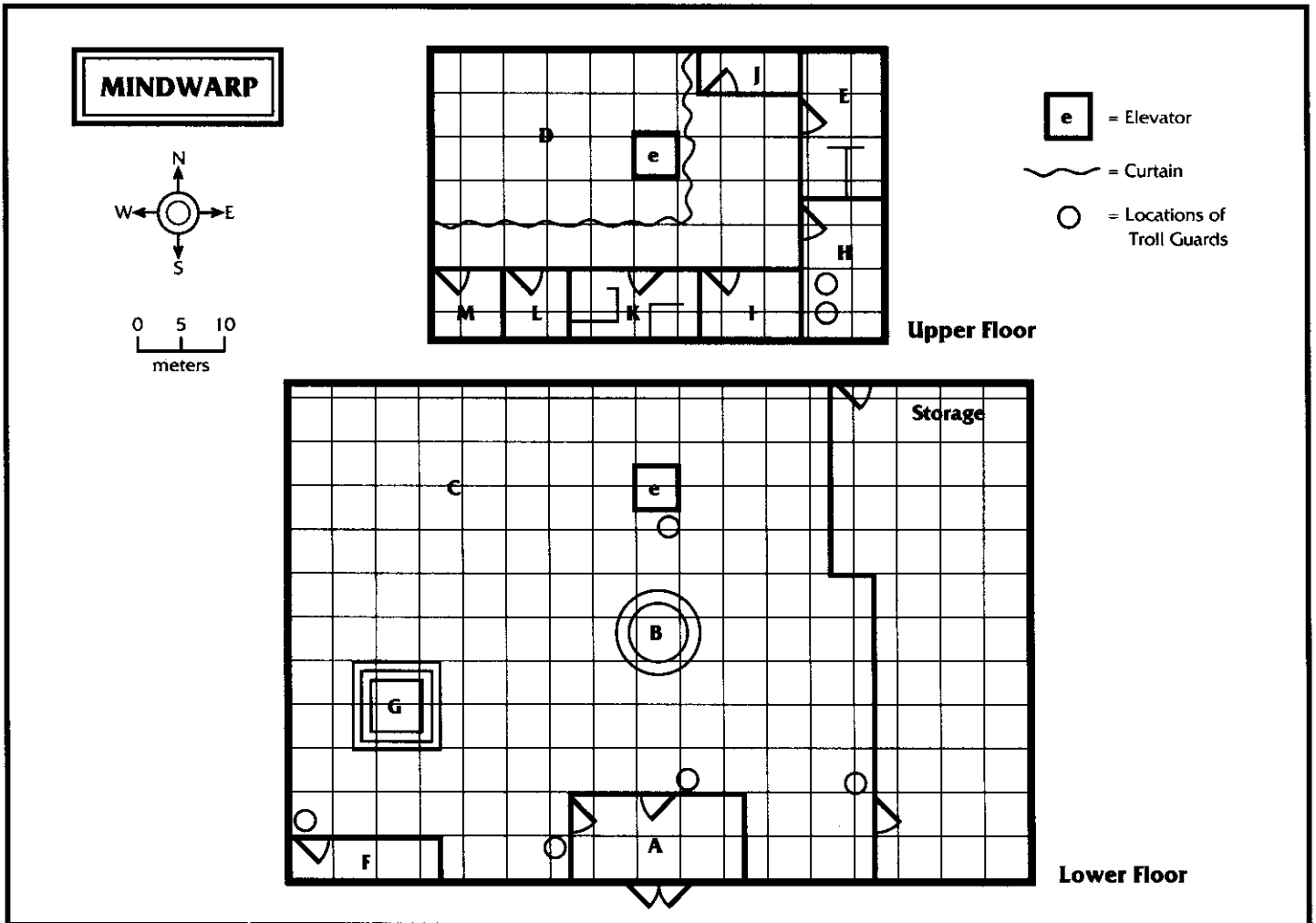

in actual combat. A Force 6 fire elemental protects the nightclub from astral intrusion by attacking anyone or anything that astrally projects in the space. The elemental will, however, allow astral perception. More warriors wait in the loft. If a general brawl or attack goes down, they come down to join the battle.

Anyone who wants to visit the loft must get past the troll posted at the elevator. This guard admits only friends and guests of Usaka, club members, and patrons with a Charisma Rating 6 or higher. Club members officially pay a 500 nuyen initiation fee and then undergo a three-week waiting period before gaining entry to the loft. The troll, however, can "hurry things up" for 1,500 nuyen, adjusting the records to show the membership of the person in question. Patrons can also get in by mentioning crucial business. The troll has a headset transceiver linking him to Usaka's entourage and any mention of Edward Crull, Kat Akmura, Homatsu or Dark Angel gets a patron upstairs. Of course, it also marks him to Usaka and his associates.

The team can avoid all these difficulties in reaching Usaka if they make an appointment with him in advance. This requires contacting him through a third party, but any Fixer or Yakuza Boss contact can pass a request for a meet to Usaka. Runners who make appointments through middlemen not only avoid trouble in the Mindwarp, they also look like pros to Usaka.

Upper Level (D)

The loft is a private playground for Usaka and his companions. See **Tell It To Them Straight** for a description of the room.

Private Rooms (E)

Yakuza meet for private conferences amid the pricey furniture and fine ceramic tea sets in these shadowy rooms. Usaka has had the air ducts in each room designed to conduct sound, allowing distant electronic equipment to record all conversations within the rooms. Electronic bug detectors cannot locate the equipment, because the receiving devices are too far away.

Dressing Rooms (F)

Cold fluorescent lights illuminate these mirrored rooms.

Stage (G)

This dais of rose-colored plastic rises over the dance floor.

Back Room (H)

This dusty room serves primarily as guard quarters. Two troll guards and eight heavily armed yakuza soldiers pass the time here, playing two bleeping trideo games or watching a trid set on a card table.

MINDWARP

Control Station (I)

A single terminal in the control station governs all the vidscreens of Mindwarp. The technician Eric Girard works at this terminal.

ERIC GIRARD

This thin, dark-haired fellow sports a small mustache.

B	Q	S	C	I	W	E	R	Armor
1	4	2	2	6	5	5.5	5	—

Initiative: 5 + 1D6, 5 + 2D6 when operating in the Matrix

Threat/Professional Rating: 1/2, 3/3 when operating in the Matrix

Skills: Computer 6, Electronics 6.

Cyberware: Datajack, 30 Mp of Memory

Gear: Fuchi Cyber-4 cyberdeck

Fuchi Cyber-4

MPCP Hardening Active Memory Storage Load Speed I/O

6	3	100	500	20	20
---	---	-----	-----	----	----

Persona: Bod 5, Evasion 4, Masking 5, Sensors 4

Programs: Attack 6

Notes: Response Increase (1)

CONDITION MONITOR

	LIGHT STUN	MODERATE STUN	SERIOUS STUN	DEADLY STUN
STUN	+1 TN# -1 Init.	+2 TN# -2 Init.	+3 TN# -3 Init.	Unc.
PHYSICAL	+1 TN# -1 Init.	+2 TN# -2 Init.	+3 TN# -3 Init.	Unc. maybe dead
	LIGHT WOUND	MODERATE WOUND	SERIOUS WOUND	DEADLY WOUND

CYBERDECK CONDITION MONITOR

^	^	^	^
LIGHT	MODERATE	SERIOUS	DECK CRASHED

Kojika's Chamber (J)

The mage Kojika sleeps in this windowless room. The stark, ivory walls are bare and the room is empty except for an alcove containing Kojika's hermetic circle. See **Cast of Shadows**, p. 63, for details on Kojika.

Offices (K)

Leather chairs and dark cherry desks grace these lavish offices. Any runner who snoops through the records can find information on yakuza activity worth 100,000 nuyen. Of course, the fence value of these documents may be considerably lower. If the runners spread this information, the gamemaster may design yakuza attempts to avenge the theft.

Special Assistants (L)

These rooms house Usaka's special assistants, a trio of elite killers. These men deliver the deathblow to any intruder in the Mindwarp, and lead any ambushes against the runners.

SPECIAL ASSISTANTS (3)

B	Q	S	C	I	W	E	R	Armor
6	6	5	3	6	4	0.75	6(12)	5/4

Initiative: 12 + 4D6

Threat/Professional Ratings: 4/4

Skills: Armed Combat 8, Etiquette (Street) 4, Firearms 8, Throwing Weapons 4, Unarmed Combat 8

Cyberware: Wired Reflexes (3), Smartlink

Gear: Armor Jacket (5/3), Heckler & Koch HK227 [SMG, 28 (clip) SA/BF/FA, 7M, w/2 extra clips, Gas-Vent III]

The special assistants have smooth, Oriental features and fidget with the typical impatience of the highly wired. Their quick reactions enable them to wound their enemies before ever taking a hit in return.

CONDITION MONITOR

	LIGHT STUN	MODERATE STUN	SERIOUS STUN	DEADLY STUN
STUN	+1 TN# -1 Init.	+2 TN# -2 Init.	+3 TN# -3 Init.	Unc.
PHYSICAL	+1 TN# -1 Init.	+2 TN# -2 Init.	+3 TN# -3 Init.	Unc. maybe dead
	LIGHT WOUND	MODERATE WOUND	SERIOUS WOUND	DEADLY WOUND

CONDITION MONITOR

	LIGHT STUN	MODERATE STUN	SERIOUS STUN	DEADLY STUN
STUN	+1 TN# -1 Init.	+2 TN# -2 Init.	+3 TN# -3 Init.	Unc.
PHYSICAL	+1 TN# -1 Init.	+2 TN# -2 Init.	+3 TN# -3 Init.	Unc. maybe dead
	LIGHT WOUND	MODERATE WOUND	SERIOUS WOUND	DEADLY WOUND

CONDITION MONITOR

	LIGHT STUN	MODERATE STUN	SERIOUS STUN	DEADLY STUN
STUN	+1 TN# -1 Init.	+2 TN# -2 Init.	+3 TN# -3 Init.	Unc.
PHYSICAL	+1 TN# -1 Init.	+2 TN# -2 Init.	+3 TN# -3 Init.	Unc. maybe dead
	LIGHT WOUND	MODERATE WOUND	SERIOUS WOUND	DEADLY WOUND

Usaka's Quarters (M)

A large waterbed dominates this room. Along the walls hang large silk curtains, where ink-black Japanese dragons wander amid handpainted mountain scenes. Usaka sleeps in this chamber.

DEALING WITH SHIRO

When the runners reach the upper level, read them the Shiro's Loft section from **Tell It To Them Straight**. Usaka listens to what the runners have to say, but offers no information or opinions right away. The yakuza chieftain always insists that "there is no need for haste." He has scored more than one stunning success simply by holding back until a situation unfolds fully and then stepping in on the winning side.

To determine Shiro Usaka's reaction to the runners, the gamemaster must first understand the man's motivations. Although the crime boss is approaching forty, he is one of the younger generation in the yakuza. Shiro knows his rapid rise to wealth could easily vanish in an equally rapid fall, and he seeks to protect himself at all times. His alliance with Kat Akmura is only one of the many precautions he has taken. The agreement does not mean that he feels any friendship for her.

If the shadowrunners lose in their feud with Akmura, Usaka would want to play a part in their defeat, because Akmura would then owe him a favor. However, if the runners defeat Akmura, Usaka would want to be on their side. Such an arrangement would spare him the trouble of fighting a losing battle and put him in a position to take over many of Akmura's operations. The

shadowrunners' visit to Mindwarp gives Usaka a chance to form an opinion of the runners and gauge the odds of their success.

Determine Usaka's opinion through roleplaying or by making a secret Etiquette (Street), (Japanese), or (Yakuza) Test against a Target Number of 6 for the team's spokesperson. The following tables provide target number modifiers and possible results based on the number of successes rolled.

The following tables also may come in handy when resolving this encounter through roleplaying. The table of target number modifiers shows the criteria Usaka uses when judging runners, while the success table shows decisions the gamemaster may make on Usaka's behalf.

Target Number Modifiers	
Runners have already defeated Edward Crull, without complications	-2
Runners make an appointment with Shiro through a third party	-2
Gamemaster makes Etiquette (Yakuza) Test	-2
Runners ask Ignorant questions (what happened to Dark Angel, who does Crull work for, and so on)	+1
Runners ask blunt questions (which side are you on, and so on)	+1
Runners show fear (excessive fawning, bribes, and the like)	+1
Runners exhibit unseemly behavior in the Mindwarp	+2
Runners have allowed word of their shadowrun to hit the streets (gamemaster's discretion)	+2
Runners insult Usaka	+4

Successes	Results
0	Usaka tips off Kat Akmura, whose assassins begin stalking the runners. If the party survives the assassins' attack, Usaka and Akmura pool their forces for future assassination attempts. Akmura also hires two extra trolls from Oni-do to guard her ship and Usaka secretly sends his own killers after the team, as described below.
1-2	Usaka says nothing to Akmura about the runners. However, he sets up the ambush described below to test the team. If the assault succeeds, he turns over all prisoners and corpses to Akmura as a token of his esteem. If the runners defeat the assassins, Usaka judges them capable of defeating Akmura and sends the lead runner an antique ivory thimble, with miniature scenes of Mount Fuji painted on the sides. This art object is worth 20,000 nuyen, although the shadowrunners must use the normal

fence procedure to sell it (see p. 188, **SR11**). After this, Usaka takes no more action against the party and uses his influence in the yakuza to prevent anyone from avenging Akmura's death. Meanwhile, Usaka prepares to take control of Akmura's rackets. Usaka takes no action against the runners. If he can help in some minor way, such as by filling in a missing piece of information, he does so. Should the team defeat Akmura, Shiro uses his influence to prevent his fellow yakuza from avenging Akmura's death.

3+

USAKA'S AMBUSH

Usaka may order attacks on the team for two reasons: to avenge any serious losses Kat Akmura's forces may suffer in the runners' assault, or to stage a minor ambush to test the runners' mettle. These assaults may take place anywhere the runners go. The team cannot evade Usaka's men without taking extreme steps to change their identities.

To determine whether or not Usaka finds the runners, make a Success Test using Usaka's Etiquette (Street) Skill against a Target Number 5. If the shadowrunners switch to a different hideout, the Target Number becomes 8. If the runners acquire the hideout under new identities, the Target Number becomes 9. And if the runners undergo plastic surgery and identity re-creation, the Target Number rises to 11.

If Usaka actually wants to kill the runners, he sends a force consisting of Kojika, three yakuza soldiers and two of his special assistants. Kojika and a special assistant track the targets on the street, the mage using a motor scooter if necessary. Meanwhile, the rest of the assassination team follow two blocks behind in a black Ford Americar, communicating with the others via a radio transceiver. A carload of yakuza soldiers arrives at the scene 1D6 Combat Turns after Kojika calls for them.

The runners may spot Usaka's men before they can spring the ambush. To determine whether or not the team notices the assassins, have the runners make a series of secret, separate opposed Success Tests, pitting each runner's Perception Skill against Kojika's Stealth. Kojika uses a mask spell to change the appearances of the assassins and himself. Use of this spell reduces his Stealth Skill by 1 for the purposes of the opposed tests.

If a runner makes a successful opposed test, he sees Kojika in the act of changing. The gamemaster should then inform the runner that the middle-aged woman behind the team has suddenly begun to flicker. Her face twists like putty, becoming that of an adolescent male with a shaved head and a dragon tattoo on his scalp. The runners react any way that seems appropriate.

As soon as the runners reach a deserted spot or turn to attack Kojika, the yakuza soldiers go into action. First, the special assistant and four soldiers from the Ford move toward the team. The five attackers keep at least three meters away from each other, as insurance against area-effect weapons. Meanwhile, the soldier in the car drives around to block the road. If possible, he rams the runners' vehicle.

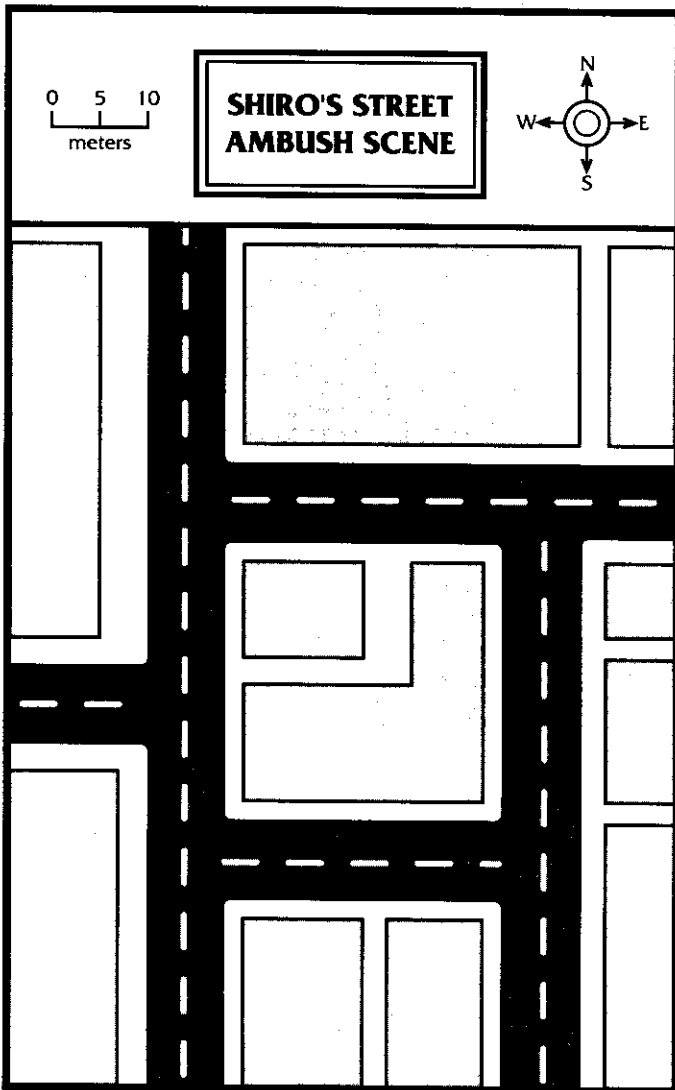

The internal structure of the yakuza car gives it a Body Rating of 4 during ramming attacks. To resolve a ramming attack, the gamemaster makes an opposed Success Test using the Body Ratings of both the runners' and the yakuza vehicles. The driver of the losing vehicle must make a Success Test using his Car Skill against a target number of the vehicle's Handling Rating +4 (to compensate for the vehicle's speed and the urban terrain). If the driver fails, the vehicle goes off the road and its occupants suffer 6M Stun damage. The gamemaster may also resolve this action using the more complex rules of vehicle combat on p. 104-9, **SR11**, or p. 128-30, **Rigger Black Book**.

If the ramming attack fails to stop the runners, the yakuza soldiers open fire on the vehicle and its passengers. Kojika helps with chaotic world and wrecker spells.

In battle, Kojika disappears, calls on a water elemental to sustain the invisibility spell, and takes cover. One special assistant stays close by to defend him. The rest of the forces surround the runners' vehicle, using all available cover, and pour fire into it. Kojika assists the group with his offensive spells and elementals. If the team contains a spellcaster, Kojika allocates two elementals to astral defense. He helps his comrades by allocating dice to spell

defense unless he sees the team's magician. If he does so, Kojika attacks the enemy spellcaster with his most effective magic. See the description of Kojika in **Cast of Shadows**, p. 63, for a complete list of his magical powers.

If the battle goes against Kojika and the special assistants, they flee to the Mindwarp and try to rejoin Usaka's bodyguards. Although such a loss means that his employees have shamed themselves, Usaka needs his mage too much to allow foolish sacrifices, and will grudgingly take him back into his good graces.

One attack will not satisfy Usaka. Although he may not risk further forces in this adventure, he remains a powerful enemy of the runners, and the gamemaster should feel free to bring him back in subsequent adventures.

If Usaka merely wishes to test the team, he sends only three soldiers and one special assistant after the runners. In this case, Kojika does not join the assassins, but he does sustain combat sense and invisibility spells over the special assistant.

This group tries to stop the runners with a hail of gunfire. The special assistant tries to pick off the most dangerous opponent at the beginning of each Combat Turn, but Usaka's men are not out to kill the runners. The special assistant carries six trauma patches, which he uses to save wounded runners because Usaka prefers to present Akmura with live captives.

Usaka's killers know they are merely testing the runners and therefore will not risk their lives in the process. Anyone with a Serious wound attempts to escape, and the special assistant takes any necessary steps to escape with his life.

DEBUGGING

The runners have much to lose and little to gain at the Mindwarp. The runners may receive yakuza permission to attack Kat Akmura here, but may also invite yakuza assassination attempts by offending the hostile and powerful Usaka.

If the runners insist on making fools of themselves in front of Usaka, let them. However, the team should know what they are getting into, to give them a decent shot at success. Make sure the runners know of Usaka's reputation before they arrive at the Mindwarp, if necessary by having a non-player character warn them of Usaka's position in the yakuza.

If Usaka decides to ambush the party, the runners need less coddling. The ambush takes place only if the runners either attack Akmura without taking precautions or invite an ambush during a visit to Usaka. Give the team ample warning of the impending attack and play the battle straight, but if the runners lose, they lose. Tough luck, chummers.

If Usaka captures any runners, he does not kill them. Instead, Kojika interrogates them individually for information about their mission and then Usaka sends them to Kat Akmura as goodwill presents. Go to **Kat's Dreadnought**, p. 51, for information on Akmura's treatment of prisoners. Runners may try to escape at any point during their transfer from Usaka's control to Akmura's.



MARIAN PARKS

TELL IT TO THEM STRAIGHT

Check it out, chummers. Country living at its finest!

Stand at the driveway's stainless steel gate and take in the view of Phantom Lake to the north, or look east for the skyline of downtown Seattle—seems like another world.

Drek, this guy must really like his privacy—scan the black iron fence hidden in the nine-foot hedge surrounding the place.

Inside the grounds, read the following:

Inside Marian Parks, you see low buildings with tile roofs, like a village in feudal Japan. Curtains of tapered evergreens separate these buildings, and across the grounds a sleek black limousine is parked in a white, modern garage that supports three satellite dishes on its roof. Through a clearing you glimpse a tennis court. Be sure and wave at the little cameras in the trees—smile, you're on trideo!

If a runner astrally assesses the estate, read the following:

The steel fences and prefabricated buildings fade away, leaving the trees and gardens clear and visible. From this new viewpoint, the estate seems exquisitely ordered, its trees and stones deliberately arranged to create the illusion of vast space in a small area. Homatsu's estate looks like a Japanese landscape garden, designed with incredible skill. You see three ruddy beings resembling Oriental peasants wandering the paths of the garden, wearing broad hats and carrying hoes made of fire.

HOOKS

A solemn serenity exists at Marian Parks that cannot be found near Shiro Usaka, Edward Crull, or Kat Akmura. Homatsu Jinjiro respects and reveres the old ways and his tranquil home is a testament to his power among the yakuza.

BEHIND THE SCENES

This chapter covers the runners' encounter with Homatsu Jinjiro, the senior *oyabun* of the Sword Water clan. This aging crime boss is the nominal superior of Kat Akmura and Shiro Usaka, and he is quick to avenge an attack on his people by outsiders. Because he finds Akmura's audacity disturbing, if the runners make their pitch to him in just the right way, he gives them the authority they need to attack her.

Jinjiro can also enter the adventure in a less pleasant way. If the runners kill Akmura without permission from either Jinjiro or Usaka, yakuza tradition requires the senior *oyabun* to avenge her death. The team just bought itself some big-time trouble.

Any Fixer or Yakuza Boss contact will have the necessary connections to arrange a meeting with Jinjiro. If the runners appear at Marian Parks for an arranged meeting, Homatsu himself meets them at the gate with a bow. An elderly gentleman in loose, cotton clothing, he does not look threatening; but any runner with half a brain knows how much appearances can deceive. He explains that it is customary for guests to remove their weapons and shoes. Once the runners comply with this request, he escorts them to an open courtyard shaded by an enormous weeping willow. Homatsu sits on a straw tatami in the courtyard. He appears to be alone, but five bodyguards hide among the surrounding screens. The elite ninja Chigo Akwe waits with them.

Jinjiro offers the runners traditional Japanese refreshments from a priceless porcelain tea set. After observing the required five minutes of small talk, the runners can start talking business. If they raise the subject of Kat Akmura, Jinjiro raises his eyebrows and listens, but says nothing.

Homatsu views Akmura as an upstart. She lacks the style and honor of the old generation of yakuza and has far too much power for his liking. He would not mind seeing her embarrassed or even eliminated. Though he is far too discreet to suggest this himself, if the runners ask his permission to attack her, he gives it to them on one condition: the runners must make a single, clean hit. Jinjiro does not want a prolonged war on the streets of Seattle that might attract undesirable attention from civil authorities.

Cooperation with Homatsu offers the runners several advantages. If the team clears its plans with him, they need not fear yakuza retaliation for killing Akmura. Jinjiro retains control over his people and does not break his word. Homatsu can give the runners a deck plan of Akmura's ship, the *Shio-Zuchi*, and warns them that Akmura's bodyguards include the Oni-do, a band of troll martial artists.

If the runners fail to get permission from either Jinjiro or Usaka before carrying out their hit on Akmura, yakuza tradition requires Jinjiro to punish them. The **Cast of Shadows** section describes Chigo Akwe, the chief ninja in Homatsu's service. This killer will stalk the runners until he finds an opportunity for an attack. The gamemaster should design the details of this assassination to suit the situation.

In all likelihood, Chigo will attack during a future shadowrun. Patient, ingenious, and merciless, the ninja typically employs such exotic tactics as poison gas, contact poison with DMSO, sabotaging shadowrunners' vital equipment, or waiting until other enemies have captured runners, then killing them in prison. In the unlikely event that Chigo decides to attack the team directly, he calls on two of Homatsu's bodyguards for extra firepower. Though less fiendishly talented than Chigo, even the run-of-the-mill muscleboys have exceptional skills at stealth and murder.

MARIAN PARKS

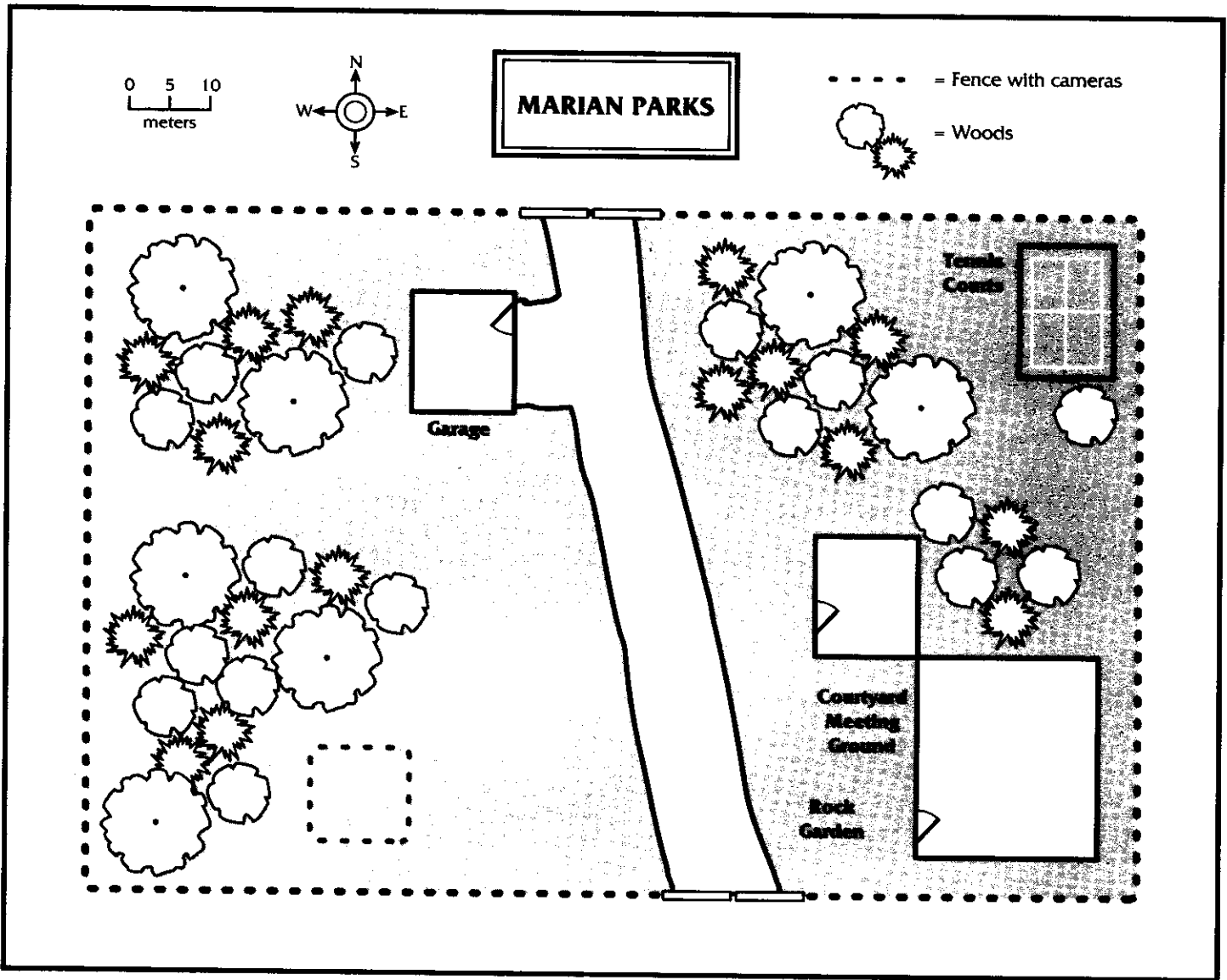

If the runners are foolish enough to attack Homatsu, they immediately face a counterattack from five bodyguards and Chigo himself. In addition, three Force 6 fire elementals guard astral space above the estate, attacking enemy spells and any astral intruders. A fourth Force 6 fire elemental manifests physically to attack spellcasters. Jinjiro's guardians do all they can to extract the *oyabun* safely. If routed, they retreat to the garage, where they climb aboard a Eurocar Westwind 2000 armored to Level 8.

Any player who attacks Homatsu has effectively sentenced his or her character to death. The estate has ten servants as witnesses, not to mention a web of trideo cameras, some out in the open and some hidden. These devices operate using internal batteries and have no connection to the Matrix. The runners cannot possibly keep the yakuza from learning who attacked Jinjiro, and *oyabuns* from across the world will commission hits against the runners in revenge. These assaults may last for the rest of the campaign.

FIRE ELEMENTALS (4)

B Q S C I W E R Armor
11 12 8 10 10 10 10 11 —

Initiative: 21 + 1D6, 31 + 1D6 when acting in astral space

Attacks: 10M as Ranged Combat (Skill 11); Range = 20 meters

Powers: Engulf, Flame Aura, Flame Projection, Guard, Manifestation, Movement

Weaknesses: Vulnerability (Water)

CONDITION MONITOR					
PHYSICAL	1-10m	11-20m	21-30m	31-40m	41-50m
	LIGHT WOUND	MODERATE WOUND	SERIOUS WOUND	DEADLY WOUND	DEADLY WOUND

CONDITION MONITOR					
PHYSICAL	1-10m	11-20m	21-30m	31-40m	41-50m
	LIGHT WOUND	MODERATE WOUND	SERIOUS WOUND	DEADLY WOUND	DEADLY WOUND

CONDITION MONITOR					
PHYSICAL	1-10m	11-20m	21-30m	31-40m	41-50m
	LIGHT WOUND	MODERATE WOUND	SERIOUS WOUND	DEADLY WOUND	DEADLY WOUND

CONDITION MONITOR					
PHYSICAL	1-10m	11-20m	21-30m	31-40m	41-50m
	LIGHT WOUND	MODERATE WOUND	SERIOUS WOUND	DEADLY WOUND	DEADLY WOUND

MARIAN PARKS

JINJIRO'S BODYGUARDS (5)

B **Q** **S** **C** **I** **W** **E** **M** **R** **Armor**
 5 5 6 3 5 6 6 6 7 3/0

Initiative: 7 + 3D6

Threat/Professional Rating: 5/4

Skills: Armed Combat 6, Firearms 6, Unarmed Combat 6

Gear: Armor Clothing (3/0), Monofilament Whip [Reach 2, 10S] SCK Model 100 SMG [SMG, 30 (clip), SA/BF, 7M, w/2 extra clips, Gas Vent III, Laser Sight (-1 modifier to target numbers)]

Physical Adept Abilities: Improved Ability [Armed Combat (2), Stealth (2)], Increased Reflexes (2), Improved Physical Senses (Low-Light Vision, Hearing Amplification)

Each bodyguard dresses in a simple gi of light gray cloth. Even in combat, their faces remain utterly serene under their close-cropped hair.

CONDITION MONITOR	
	STUN
LIGHT STUN	1 Hit
MODERATE STUN	2 Hit
SERIOUS STUN	3 Hit
DEADLY STUN	4 Hit
PHYSICAL	1 Hit
LIGHT WOUND	2 Hit
MODERATE WOUND	3 Hit
SERIOUS WOUND	4 Hit
DEADLY WOUND	5 Hit

CONDITION MONITOR	
	STUN
LIGHT STUN	1 Hit
MODERATE STUN	2 Hit
SERIOUS STUN	3 Hit
DEADLY STUN	4 Hit
PHYSICAL	1 Hit
LIGHT WOUND	2 Hit
MODERATE WOUND	3 Hit
SERIOUS WOUND	4 Hit
DEADLY WOUND	5 Hit

CONDITION MONITOR	
	STUN
LIGHT STUN	1 Hit
MODERATE STUN	2 Hit
SERIOUS STUN	3 Hit
DEADLY STUN	4 Hit
PHYSICAL	1 Hit
LIGHT WOUND	2 Hit
MODERATE WOUND	3 Hit
SERIOUS WOUND	4 Hit
DEADLY WOUND	5 Hit

CONDITION MONITOR	
	STUN
LIGHT STUN	1 Hit
MODERATE STUN	2 Hit
SERIOUS STUN	3 Hit
DEADLY STUN	4 Hit
PHYSICAL	1 Hit
LIGHT WOUND	2 Hit
MODERATE WOUND	3 Hit
SERIOUS WOUND	4 Hit
DEADLY WOUND	5 Hit

CONDITION MONITOR	
	STUN
LIGHT STUN	1 Hit
MODERATE STUN	2 Hit
SERIOUS STUN	3 Hit
DEADLY STUN	4 Hit
PHYSICAL	1 Hit
LIGHT WOUND	2 Hit
MODERATE WOUND	3 Hit
SERIOUS WOUND	4 Hit
DEADLY WOUND	5 Hit

DEBUGGING

The runners need not consult Jinjiro in order to succeed in the adventure, because Usaka can give them the authority they need to attack Kat Akmura. Jinjiro, however, grants this permission more freely and has far more power to back up his promises. Unless the runners act like idiots, this encounter should go their way.

If the runners decide to kill Homatsu, give them a strong hint from a helpful non-player character that such an attack equals suicide. If they persist, go ahead and destroy them, either immediately or later on in the adventure. Drekkbrained runners deserve what they get.

Runners who just don't think to consult Jinjiro or Usaka before nailing Akmura deserve slightly more leniency. Though potentially fatal, the oversight need not ruin the story. Jinjiro wants to see Akmura punished and may ease up on those who perform the task. In fact, Chigo may not even make lethal attacks on such runners. Instead, he may settle for sending them a terrifying "warning" along with a summons to Jinjiro's estate. If the runners plead for their lives with sufficient enthusiasm, Homatsu forgives them their indiscretion in attacking Akmura without permission. He then orders Usaka to halt any action against the team. In fact, Jinjiro may hire the runners for future operations.

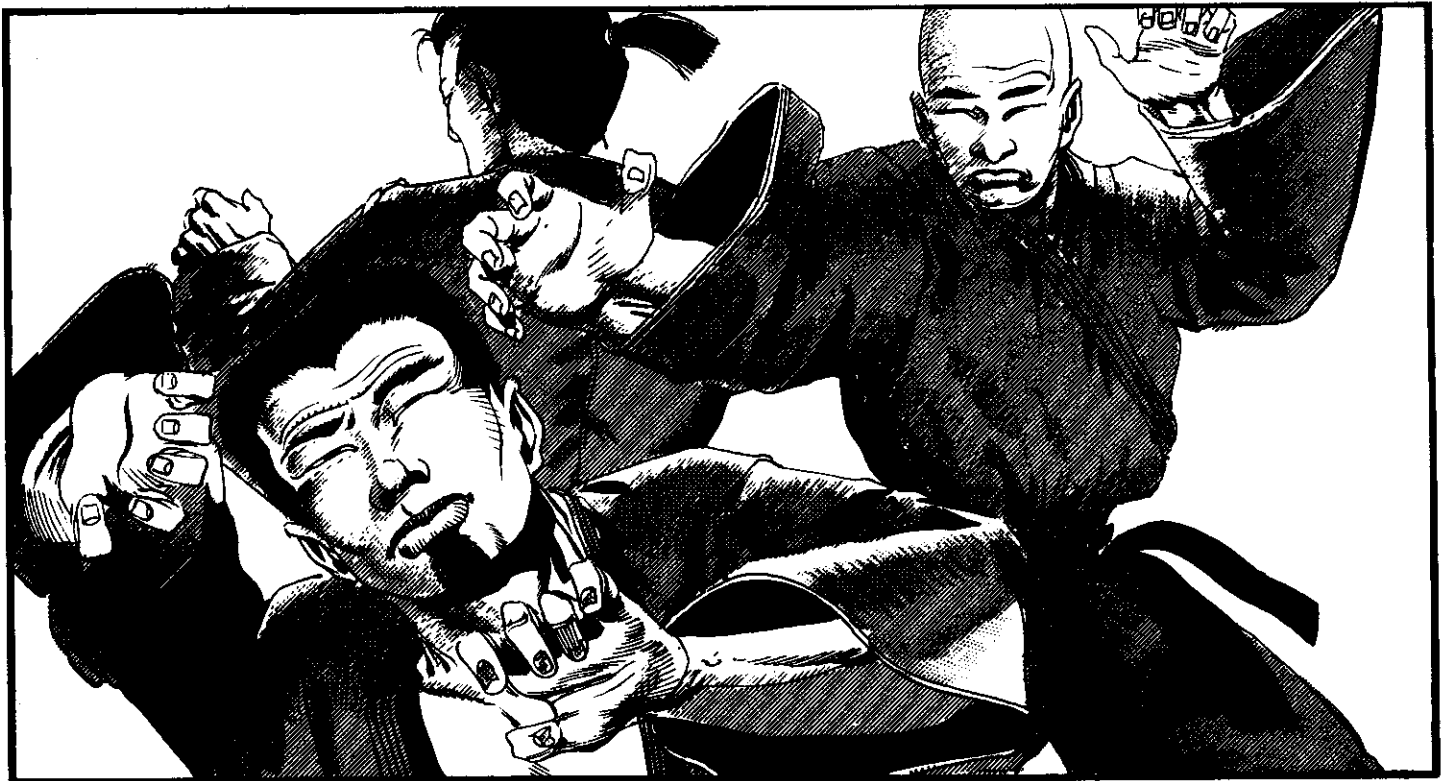

BROTHER TO AN ANGEL

TELL IT TO THEM STRAIGHT

If the runners go to Edward Crull's Renton house, read the following:

They call this place a Mitsuhamas Modular Residential Facility. It looks about as homey as it sounds. The dull blue plaswood walls support a sloped roof bearing the MCT corporate logo, and in front, a small Japanese rock garden fills a hinky patch of ground the brochures call a "yard." Even the garden rocks are fake.

If the team goes to Crull's downtown office, read the following:

The black towers of Seattle rise around you, their windows flickering with light as the sararimen slave away for their corporate masters. Guards in bulky armor pace around the Mitsuhamas building, their plasteel boots scuffing the asphalt.

If Crull's assassins attack the team, read the following:

A pool of red spreads from the *shaikujin* lying on the pavement. Rain and vomit stain his suit coat, and a thousand miniscule lines radiate from a hole in his Nikon Optik where a bullet entered the cybereye.

"Getcher head down, moron!" a wiry woman in Lone Star blue shouts as she catches you in a flying tackle. A bullet whistles overhead, slicing through the space lately occupied by your head.

Another cop crouches in the gutter, trading lead with an unseen target. Somewhere overhead, among the rooftops and fire escapes, a sniper's rifle sounds again.

HOOKS

The hooks and themes of this section depend on when and where each encounter takes place. Crull's house is crammed full of nervous people and stretched emotions. The Mitsuhamas office building is an intimidating megalith. (If the runners don't show the appropriate awe of the corporation, remind them that Mitsuhamas is a multinational megacorp, very likely run by the yakuza. If that doesn't cool their jets, let them roast.)

BEHIND THE SCENES

In this encounter, the team investigates Angel's brother, Edward Crull, and solves many of the mysteries surrounding the Angel affair. The runners can obtain information in several ways, from kidnapping and interrogating Crull to quietly interviewing his wife. The encounter also describes what happens if Crull decides to scrag the runners.

Crull works as a thaumaturgical analyst for Mitsuhamas Computer Technologies, a glamorous career he owes to the yakuza. His

life and employment depend on pleasing Kat Akamura, and so he does Akamura's dirty work, arranging Angel's kidnapping and attempting to geek anyone (such as the runners) who interferes with the plan.

If the shadowrunners defeat Crull and his killers, Akamura sends her specialists to destroy the team. See **Up the Ante**, p. 48, for details.

CRULL'S LIFESTYLE

Edward Crull lives in a Mitsuhamas Residential Facility in Renton's Maple Valley district. The corporation permits Crull to keep several junior magicians and assistants in adjoining apartments, ostensibly to help him carry out his corporate duties. These people actually serve as Crull's bodyguards. In the evenings, the team can find Crull at the house, usually in his office or bedroom.

During the day, Crull goes to the Mitsuhamas building downtown. He leaves his house at 8:00 a.m. and returns at 9:00 p.m. Crull rides in a Toyota Elite, with Rating 7 vehicle armor. Three hired punks ride with him. One of the punks drives, leaving Crull free to scan for ambushes using astral perception. When confronted with danger, Crull immediately tries to escape.

Runners who visit the Renton house during the evening may actually meet Crull, but he certainly does not discuss the Angel episode. As a practicing wizard, he is familiar with mind probe spells and tries to destroy anybody who uses one on him. His bodyguards are posted in Area H (see the map of the house, p. 42) to support him in physical combat.

An ultrasonic security system covers all external doors and windows. To neutralize the system, a player character must make a successful Electronics (6) Test. The external doors also have Rating 8 maglocks. The alarm system alerts both Lone Star and Crull's killers in Area H. A squad car with four Lone Star officers appears 1D6 minutes after an alarm sounds. Crull's own guards arrive on the scene within seconds. The system alerts these guards with flashing lights rather than sound, giving intruders no warning that they have been spotted.

LONE STAR OFFICERS (4)

B	Q	S	C	I	W	E	R	Armor
3	5	5	6	5	6	6	5	5/3

Initiative: 5 + 1D6

Threat/Professional Rating: 2/2

Skills: Armed Combat 3, Etiquette (Corporate) 3, Etiquette (Street) 4, Firearms 4, Throwing Weapons 3, Unarmed Combat 4

Special Skills: Police Procedures 4

Gear: Ares Predator [Heavy Pistol, 15 (clip), SA, 9M, w/2 extra clips, Laser Sight], Armor Jacket (5/3), Club [5M Stun], Plastic Restraints

BROTHER TO AN ANGEL

Mitsuhaman provides its employees with the best protection available. These officers have a bit more training than the typical street cop and are decidedly sympathetic to the district's corporate citizens. The Renton police respond to emergencies in patrols of four, carrying Ares Predator pistols on their belts. Each patrol also packs an FN-HAR assault rifle in their squad car.

CONDITION MONITOR	
LIGHT STUN	MODERATE STUN
SERIOUS STUN	DEADLY STUN
STUN	PHYSICAL
1 1 hr	1 1 hr
2 2 hr	2 2 hr
3 3 hr	3 3 hr
4 4 hr	4 4 hr
5 5 hr	5 5 hr
6 6 hr	6 6 hr
7 7 hr	7 7 hr
8 8 hr	8 8 hr
9 9 hr	9 9 hr
10 10 hr	10 10 hr
11 11 hr	11 11 hr
12 12 hr	12 12 hr
13 13 hr	13 13 hr
14 14 hr	14 14 hr
15 15 hr	15 15 hr
16 16 hr	16 16 hr
17 17 hr	17 17 hr
18 18 hr	18 18 hr
19 19 hr	19 19 hr
20 20 hr	20 20 hr
21 21 hr	21 21 hr
22 22 hr	22 22 hr
23 23 hr	23 23 hr
24 24 hr	24 24 hr
25 25 hr	25 25 hr
26 26 hr	26 26 hr
27 27 hr	27 27 hr
28 28 hr	28 28 hr
29 29 hr	29 29 hr
30 30 hr	30 30 hr
31 31 hr	31 31 hr
32 32 hr	32 32 hr
33 33 hr	33 33 hr
34 34 hr	34 34 hr
35 35 hr	35 35 hr
36 36 hr	36 36 hr
37 37 hr	37 37 hr
38 38 hr	38 38 hr
39 39 hr	39 39 hr
40 40 hr	40 40 hr
41 41 hr	41 41 hr
42 42 hr	42 42 hr
43 43 hr	43 43 hr
44 44 hr	44 44 hr
45 45 hr	45 45 hr
46 46 hr	46 46 hr
47 47 hr	47 47 hr
48 48 hr	48 48 hr
49 49 hr	49 49 hr
50 50 hr	50 50 hr
51 51 hr	51 51 hr
52 52 hr	52 52 hr
53 53 hr	53 53 hr
54 54 hr	54 54 hr
55 55 hr	55 55 hr
56 56 hr	56 56 hr
57 57 hr	57 57 hr
58 58 hr	58 58 hr
59 59 hr	59 59 hr
60 60 hr	60 60 hr

CRULL'S HOUSE LAYOUT

Foyer (A)

Crull's living room contains the plastic furniture and austere art of corporate fashion. Blacks and whites dominate the decor.

Office (B)

A Rating 8 maglock protects this room. Like all other locks in the house, it is connected to the alarm system described in **Crull's Lifestyle**. A teak desk rests on the bare slate floor of the dim office. An ivory-colored computer terminal sits on the desk. The room also contains a hermetic circle for conjuring elementals.

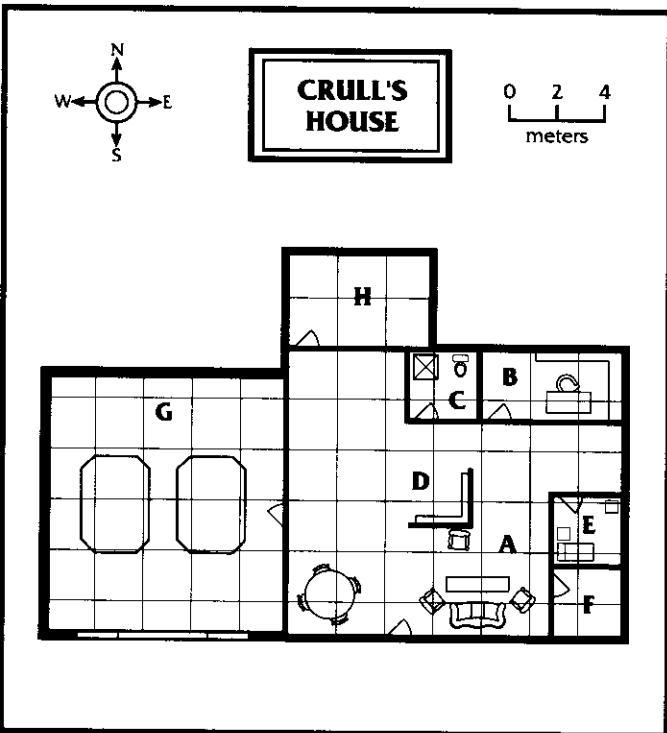

The computer has no link to the Matrix. A runner who wants to scan its files must make a Computer (6) Test. If the runner succeeds, he discovers accounting files revealing that Crull pays almost one-third of his income to a mysterious Fuji bank account.

Runners can track down the owner of the Fuji account by scanning tax records. To avoid a lengthy diversion, use the Quick Matrix Resolution System from **Virtual Realities**. The Target Number for the run is 6. Otherwise, have the team decker make a Computer (6) Test. One success reveals that the account's owner lives in Seattle and can afford elaborate (and illegal) methods of concealing her identity. Two or more successes reveal Kat Akmura as the account owner.

Bathroom (C)

A basic bathroom, this room contains a shower stall instead of a bathtub.

Kitchenette (D)

This cubicle consists of a sink and a formica counter with a microwave sitting on top of it.

Master Bedroom (E)

Crull sleeps on a gray foam mattress, beneath a wall-mounted steel cabinet. However, the room does not completely reflect his Spartan tastes. A wooden nightstand holds assorted toiletries and a small, framed mountain scene. A painted mask hangs from one wall. Runners with a background in Indian lore recognize the mask as a non-magical relic of the Haida people. The mask belongs to Crull's wife, Sarah.

A Rating 8 maglock protects this room.

Entertainment Center (F)

Simsense units and trideo sets crowd this tiny room, leaving no room for chairs. Sarah Crull spends a lot of time here, sitting on the thick carpet, nibbling stuffers and watching trideo while her husband occupies himself with business.

Carport (G)

This sunken concrete chamber holds a Toyota Elite and two Ford Americans. A Rating 6 maglock protects the outer door. To pick the maglock, a player must make a successful Electronics (8) Test. If the runner fails, he or she must make a second Electronics (8) Test. If the player rolls no successes on this second test, the runner has activated the automated gun that protects the carport. This weapon fires a single burst of explosive submachinegun slugs (effective Firearms Skill of 6), which inflict 10S damage to anyone standing directly in front of the door.

Guest House (H)

Clothes hang from chairs and cardboard pizza boxes lie on tables in this cluttered apartment. Crull's hired thugs live here. Unless the runners have already drawn the guards elsewhere, they meet these killers here.

If the runners prowl inside Crull's house, the gamemaster should keep track of real time and roll 1D6 every five minutes to check for the approach of Sarah Crull or patrolling bodyguards. On

BROTHER TO AN ANGEL

a roll of 1, Sarah Crull wanders into the room and sees the shadowrunners. On a roll of 2 or 3, one of Crull's samurai appears. The results of these encounters depend on the team's reaction. Under most circumstances, the samurai tries to call for help and geek the intruders. If Sarah discovers the team, she naturally attempts to save her skin and may call the guards. If the team demonstrates friendly intent, however, Sarah may keep quiet and become an invaluable source of information. See the following section for details.

SISTER-IN-LAW TO AN ANGEL

If the team visits the house openly, Crull's wife Sarah greets them at the door and treats them with reasonable courtesy, as she does all visitors. If the runners come without visible weapons and present what the gamemaster considers a plausible business or social reason for their visit, Sarah lets them in. She takes this risk because she knows she can summon the guards from Area H with a single call.

Runners who contrive excuses to talk with Sarah may find the conversation rewarding. Sarah neither loves nor respects her husband and has a keen sense of adventure. The prospect of an affair, a hefty credstick, or simply the thrill of assisting a shadowrun may tempt her into revealing her husband's secrets. If the players roleplay this conversation with sufficient glibness, reward them liberally with information. Less persuasive players must pay bribes of about 5,000 nuyen. Gamemasters who feel incapable of judging the team's roleplaying may resolve this question by having the speaker make a Charisma (5) Test. One success indicates that Sarah would accept a bribe. If the player rolls two or more successes, the bribe is unnecessary.

Crull's guards take an interest in prolonged conversations between Sarah and strangers, and so the runners must either distract the guards or enter the house without alerting them if they want information. Once inside, the shadowrunners can speak freely with Sarah, because the walls of the house muffle whispered speech. Remember to check for patrolling guards every five minutes, as noted above.

Crull tells Sarah nothing of his business, but she delights in spying on him and knows almost the entire story of the Angel affair. She does not know the location of Kat Akmura's stronghold, however. To learn that, the team must talk to Edward Crull.

If the runners want Sarah's help in ambushing or questioning her husband, she agrees only under certain circumstances. First, she must be on good terms with the team, and the runners must impress her as both capable and dashing. Second, the team must convince her that helping them will bring her money or power. Let the shadowrunners come up with the details.

SARAH CRULL

Sarah Cold-Stream-Water grew up among the oppressed Haida tribe in Tsimshian. With no assets but her striking looks, she inevitably became involved with some of the less savory members of the tribe. Sarah, being far more intelligent than most pimps gave her credit for, managed to charm her way out of Tsimshian. The yakuza brought her to Seattle and sold her to Edward Crull.

Crull considered Sarah the ideal wife. Her stunning looks impressed his corporate colleagues, and the yakuza assured him

she had no ties to other corporations or nations that might hamper his career. He believed she would remain a loyal wife, because she had nowhere else to go. Marrying Sarah seemed like a sound career move.

Materially speaking, Sarah has little to complain about. As the wife of a businessman in a society where white slavery is only technically illegal, she enjoys the security, freedom, and toys of the upper class. However, Sarah has an active intellect, a powerful imagination, and considerable ambition. She feels lonely, restless, and unappreciated and finds life as Crull's wife boring.

If the team develops a rapport with her, Sarah may become a useful contact or even a companion on future shadowruns. Eventually, she may leave Edward Crull and find a place of her own. The runners may decide to help her in this effort.

Sarah has wide, dark eyes and bronze-colored skin. Her lustrous hair glistens with oil but she uses few other cosmetics.



SARAH CRULL

B	Q	S	C	I	W	E	R	Armor
3	5	5	6	5	6	6	5	3/0

Initiative: 5 + 1D6

Threat/Professional Rating: 2/3

Skills: Armed Combat 3, Athletics 6, Biotech 3, Etiquette (Street) 3, Firearms 6, Stealth 6

Gear: Ares Predator [Heavy Pistol, 15 (clip), SA, 9M, w/2 extra clips], Armor Clothing (3/0)

		CONDITION MONITOR			
		LIGHT STUN	MODERATE STUN	SERIOUS STUN	DEADLY STUN
STUN	+1 TN# -1 Init.	+2 TN# -2 Init.	+3 TN# -3 Init.	Unc.	
	+1 TN# -1 Init.	+2 TN# -2 Init.	+3 TN# -3 Init.	Unc maybe dead	
PHYSICAL	+1 TN# -1 Init.	+2 TN# -2 Init.	+3 TN# -3 Init.	Unc maybe dead	
	LIGHT WOUND	MODERATE WOUND	SERIOUS WOUND	DEADLY WOUND	

CRULL'S KILLERS

Crull maintains five thugs in the guest room of his house (Area H). In the evenings, all of them are present. During the day, the three punks go to the Mitsuhamma office with Crull while the two samurai stay at the house. Crull may also send the five on errands, such as assassination attempts against the shadowrunners. If he does this, use the thugs' ambush plan described on pp. 44-45.

Crull can replace lost members of his team, but not with professionals of the same caliber. If the runners kill any of the thugs but fail to eliminate Crull, he hires members of the Hot Papas street gang to replace the dead men.



Crull's Punks (3)

B 6 **Q** 6 **S** 6 **C** 1 **I** 5 **W** 6 **E** 5.3 **R** 5 **Armor** 5/3

Initiative: 5 + 1D6

Threat/Professional Rating: 3/3

Skills: Armed Combat 6, Bike 2, Car 3, Etiquette (Street) 3, Firearms 6, Unarmed Combat 4

Cyberware: Retinal Modification (Thermographic), Smartlink

Gear: AK-97 [Assault Rifle, 38 (clip), SA/BF/FA, 8M, w/2 extra clips, Gas Vent III, Imaging Scope (Magnification 3), Internal Smartlink], Ares Predator [Heavy Pistol, 15 (clip), SA, 9M, w/2 extra clips], Armor Jacket (5/3), Sword [Reach 1, 8S]

These punks wear uncomfortable-looking suits, but their youthful faces bear the ragged scars of life in the sprawl. As hired soldiers for a yakuza executive, they have to wash and shave, but they also receive better food and higher pay than any street job

could give them. The punks spend their free time eyeing and drooling over Sarah Crull. She can occasionally charm information out of them, but their loyalties lie with their master, Edward.

As executive bodyguards, these punks have licenses for their AK-97 assault rifles.

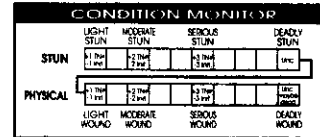
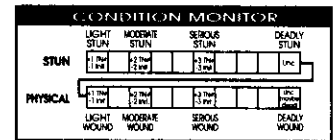
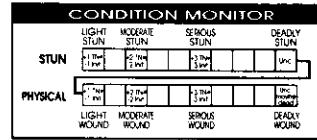

Samurai (2)

B 6 (9) **Q** 6 (8) **S** 5 (7) **C** 2 **I** 6 **W** 6 **E** 1.5 **R** 6 (9) **Armor** 5/3

Initiative: 9 + 3D6

Threat/Professional Rating: 3/4

Skills: Armed Combat 1, Car 1, Etiquette (Street) 1, Firearms (FN HAR) 8, Throwing Weapons 4, Unarmed Combat (Grapple) 8, Unarmed Combat (Spurs) 8

Cyberware: (all Beta grade): Cybereyes [Thermographic w/Flare Compensation and Optical Magnification (3)], Dermal Plating (3), Muscle Replacement (1), Retractable Spur (7M), Smartlink, Wired Reflexes (2)

Gear: AFR-7 Flash Grenade (see p. 44, **Street Samurai Catalog** for game use; otherwise treat as concussion grenade [5L, +6 modifier added to target numbers with penalty reduced by 1 per five meters distance from flash]), Ares Predator [Heavy Pistol, 15 (clip), SA, 9M, w/2 extra clips, Internal Smartlink], Armor Jacket (5/3), 3 Defensive Grenades (10S), FN HAR [Assault Rifle, 35 (clip), SA/BF/FA, 8M, w/2 extra clips, APDS Ammunition, External Smartlink, Gas Vent III]

Eagle and Sal, Crull's two samurai, form a man-woman team. Both have the same stony faces, the same whipcord-lean builds. Although both have grown ruthless and cynical during their long careers on the streets, they remain committed to each other. They may desert Crull in a losing battle, but will make every effort to get each other out alive.

Eagle and Sal hate a straight fight, preferring to ambush their targets with grenades. The two make full use of their wired reflexes to finish off foes and retreat to safety before any opponents still standing can react. These samurai recognize their lack of magic as a major weak point, and make every effort to neutralize enemy mages during the early stages of combat.

Both have retractable spurs mounted below their right wrists.

Note also that Edward Crull has locked an increase +3 cybered attributes spell onto both his samurai.

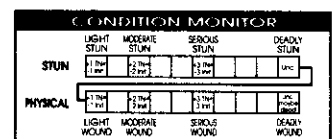
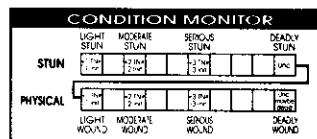

Hot Papas

B	Q	S	C	I	W	E	R	Armor
5	6	5	6	5	4	5.8	5	5/3

Initiative: 5 + 1D6

Threat/Professional Rating: 2/2

Skills: Armed Combat 5, Bike 4, Biotech 1, Etiquette (Street) 4, Firearms 6, Projectile Weapons 3, Stealth 5, Unarmed Combat 4

Cyberware: Retinal Modification (Thermographic)

Gear: Ares Predator [Heavy Pistol, 15 (clip), SA, 9M, w/2 extra clips, Internal Smartlink], Armor Jacket (5/3), FN HAR [Assault Rifle, 35 (clip), SA/BF/FA, 8M, w/2 extra clips, APDS Ammunition, External Smartlink, Gas Vent III]

The Hot Papas are a Tacoma street gang with dreams of cutting-edge cyberware. They gladly contract themselves out to corporate executives in hopes of acquiring enhancements. Crull uses these gangers to replace any losses in his forces. The Hot Papas consist mainly of heavysset human men, of mixed ethnic groups.

ASSASSINATION ATTEMPT

If Crull finds out about the shadowrunners' mission, he tries to kill them. When Crull launches his strike against the runners, the gamemaster should decide how much Crull knows about the team's plans and how long it will take him to find them. Crull's assassination plot consists of the following steps.

Step One

Once Crull learns that the team is sniffing around the Dark Angel case, he guesses that Icelady probably sent them and decides to lean on her. One of Crull's punks recruits half a dozen trolls from the Smash 'n' Grabber thrill-gang and this merry bunch goes off to smash the windows of Lili Ice's talisman shop. They linger outside, shouting threats, but Icelady holds them at bay. If she can, she calls the runners. "Help me toast these fraggin' slots! Yeah, I'll make it worth your while." If the prospect of rescuing their employer (and their paychecks) from an assault by two-bit thugs intimidates the team, have Icelady offer them a large enough bonus that they can't refuse. One way or the other, the team should head for Lili's shop.

Meanwhile, the rest of Crull's team sets up its real trap on the street outside as detailed in Step Three.

Crull does not intend to allow the runners to reach Icelady. He wants to ambush them as they respond to her call. Once he has disposed of the team, he can easily geek the talismonger. Should the runners reach Lili's shop, however, or if they are already there when the gangers arrive, they easily dispatch their opponents. The Smash 'n' Grabbers flee at the first sign of trouble. They may be trolls, but they are pretty timid for such hulking brutes and will do anything to avoid a real fight. The punk executes a fighting retreat from armed enemies.

Smash 'n' Grabbers (6)

B	Q	S	C	I	W	E	R	Armor
9	3	9	1	1	2	6	2	5/3

Initiative: 2 + 1D6

Threat/Professional Rating: 2/3

Skills: Armed Combat 4, Etiquette (Street) 4, Firearms 3, Projectile Weapons 3, Stealth 5, Unarmed Combat 6

Gear: Ares Predator [Heavy Pistol, 15 (clip), SA, 9M, w/2 extra clips], Armor Jacket (5/3), Sword (Reach 1, 115)

The Smash 'n' Grabbers believe their sheer size should terrify smaller races into submission. When this strategy fails, the Smash 'n' Grabbers turn tail and run.

These trolls support their gang through burglaries, muggings, and car theft, which they perform by assembling a group of gangers, then lifting the car and carrying it away by hand. The leader of the gang, Sweet Petunia, has covered his body with tattoos depicting bloody daggers, dragons and hairy mythological

Step Two

If the above gambit fails, or if the runners don't show, Crull tracks the team. Akmura supplies him with extensive contacts, and Crull may also summon watcher spirits to assist his hunt.

If the shadowrunners talk with street contacts for any reason, they hear that yakuza agents are asking questions about them. "Hoi, chummer, time for you to hide." Magicians who project into astral space may see Crull's watchers as potbellied, luminescentimps. Crull summons these watcher spirits at Force 4.

Crull locates an average team within one day. If the runners take special precautions, they can hide from him indefinitely. However, if the team remains inactive for more than two days and Crull knows about Icelady's involvement, he uses this time to geek her.

Step Three

Crull's killers set their ambush at a spot where they feel sure to meet the party. If they have managed to frighten Icelady into calling for the runners, they set their trap a block from her shop. Otherwise, Crull uses his watchers to find a suitable spot. The map provided shows a typical ambush site. The gamemaster may modify this scene as he or she sees fit.

BROTHER TO AN ANGEL

All of Crull's killers take part in the ambush, while Crull himself sits tight at his Renton house. Note, however, that one punk may be busy threatening Icelady and therefore unavailable for the street battle.

The assassins begin their attack with a bit of play-acting. The punks stand on a nearby rooftop, and shoot a businessman walking along the street. The samurai, disguised as Lone Star officers, try to nail the "snipers." By simulating this common street scene, the killers hope to lure the team into the ambush.

When the runners reach the ambush site, read the attack description under **Tell It To Them Straight**. The snipers make a real attempt to geek the shadowrunners with well-aimed autofire. Meanwhile, the "police" feign an attempt to drag the runners to safety. They are actually grappling with the shadowrunners, trying to keep the victims from effectively using magic or weapons against the snipers. They grapple magicians if possible. The snipers lie flat on the roof, behind a plasteel ledge that provides a Barrier Rating 4 against weapons fired from the street.

If the shadowrunners try to wriggle free, use the rules for subduing combat, p. 103, **SR11**. Eagle and Sal keep up their act as long as possible. "Just keep down, chummer. Those slots'll waste

you. Just sit tight 'till the SWAT boys can move in." The samurai grapple with their victims for as long as the ruse seems effective.

Eagle and Sal abandon the grappling tactic when the runners attack them or begin breaking free. At that point, the samurai backpedal, using their heightened reflexes and quickness to widen the range between themselves and their foes. Then they open up on the team with their FN HAR rifles. If trapped in melee combat, the two use their wrist spurs. If forced to flee, they drop flash grenades behind them.

Step Four

If the runners defeat this ambush team, Akmura activates a band of ninja to waste the runners. Go to **Up the Ante**, p. 48.

CRULL'S OFFICES

If the runners choose, they can spy on Crull at his Mitsuhaman office complex on 68th Avenue in downtown Seattle. This entails considerable danger, because it involves operating under the nose of Mitsuhaman security. No one can enter the building without a valid corporate identity card.

A team of five security guards watches each external door of

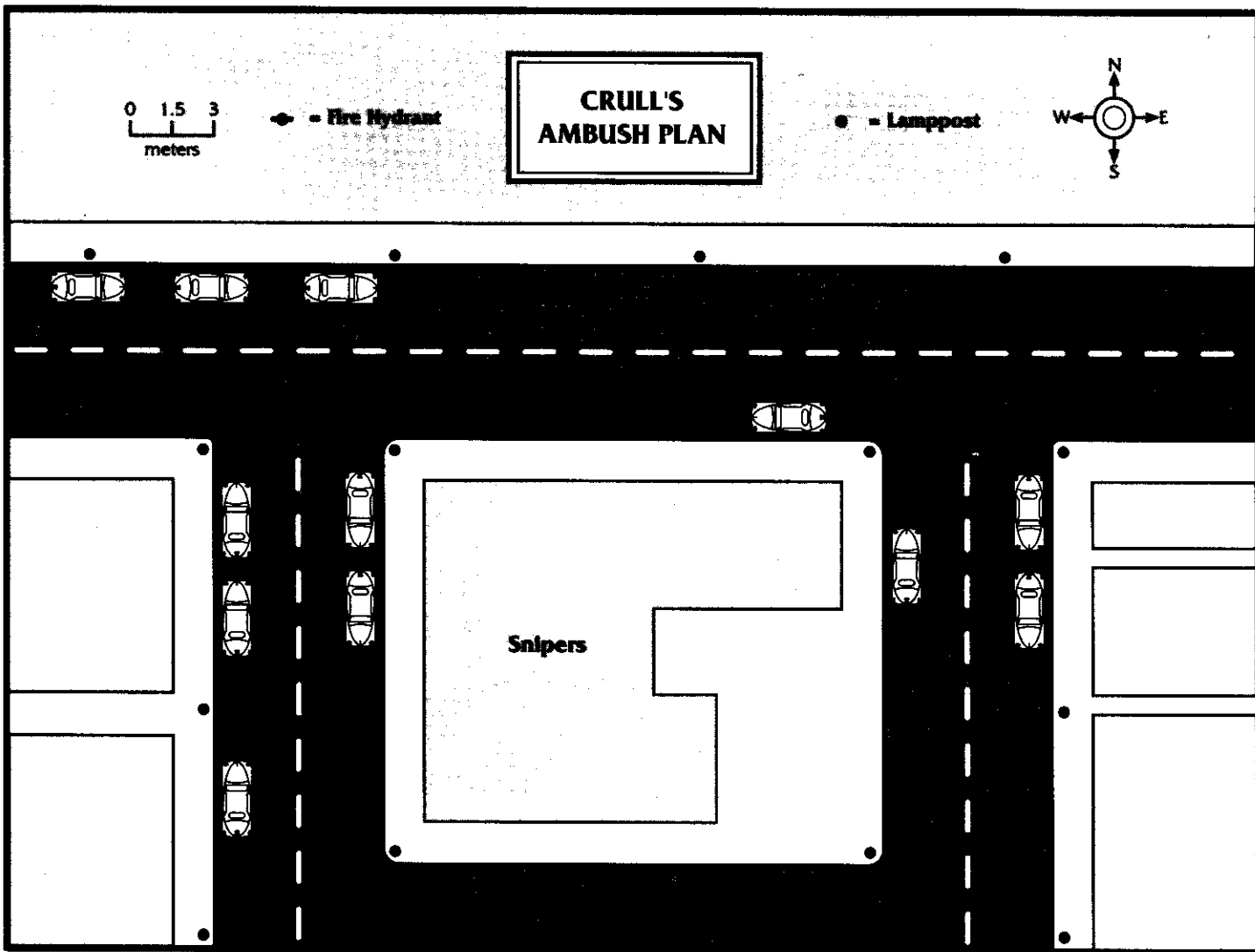

BROTHER TO AN ANGEL

the Mitsuhamas building. If a battle breaks out, roll 1D6. The result indicates how many Combat Turns elapse before a special response team arrives. This team consists of four senior technicians and two security mages. Runners foolish enough to start a rumble will battle at least one team of security guards plus one special response team. Whether or not any others appear is up to the gamemaster.

Security Guards (5)

B	Q	S	C	I	W	E	R	Armor
5	3	4	2	2	2	6	2	6/4

Initiative: 2 + 1D6

Threat/Professional Rating: 4/3

Skills: Etiquette (Corporate) 2, Firearms 3, Interrogation 2, Unarmed Combat 3

Gear: Armor Jacket (5/3), Helmet (1/1), SCK Model 100 SMG [SMG, 30 (clip), SA/BF, 7M, w/2 extra clips, Gas Vent II, Internal Smartlink, Laser Sight (-1 modifier to target numbers)]

These low-paid security guards have few advantages other than their first-rate equipment. Most are brawny fellows with minimal education, matching the Mitsuhamas stereotype of *gaijin* fighting men. The Mitsuhamas guards do not hesitate to call for backup. However, they also do not hesitate to surrender or run away. The security guards wear navy blue armored jackets, and red helmets bearing the MCT logo.

Senior Technicians (4)

B	Q	S	C	I	W	E	R	Armor
6	5	6	2	4	5	3	6(8)	5/4

Initiative: 8 + 2D6

Threat/Professional Rating: 5/4

Skills: Etiquette (Corporate) 3, Firearms 7, Interrogation 6, Stealth 5, Unarmed Combat 6

Cyberware: Smartlink, Wired Reflexes (1)

Gear: Armor Jacket (5/3), Forearm Guards (+1 Impact Armor, 7M Damage), SCK Model 100 SMG [SMG, 30 (clip), SA/BF, 7M, w/2 extra clips, Gas Vent III, Internal Smartlink]

These Japanese guards know their role as elite troubleshooters. They dress in loose black trousers, with expandable pockets for grenades and clips. Tight-fitting armored jackets, forearm guards and gleaming Ivory helmets complete their uniforms. The senior technicians move with practiced menace, their narrow eyes steely with determination.

Security Mages (2)

B	Q	S	C	I	W	E	M	R	Armor
2	3	1	3	5	6	6	6	4	6/5

Initiative: 4 + 1D6

Threat/Professional Rating: 4/4

Skills: Conjuring 6, Etiquette (Corporate) 4, Firearms 2, Magic Theory 6, Negotiation 2, Psychology 2, Sorcery (Spellcasting) 7

Gear: Armor Jacket (5/3), Forearm Guards (+1 Impact Armor, 2M Damage), SCK Model 100 SMG [SMG, 30 (clip), SA/BF, 7M, w/2 extra clips, Gas Vent III, Internal Smartlink]

Spells: Chaos 4, Mana Bolt 4, Personal Combat Sense 3, Power Bolt 4, Sleep 4, Treat 2, Urban Renewal 4

The security mages dress like the senior technicians. They primarily suppress enemy magic or heavy weapons. In battle, the mages target enemy spellcasters with the most powerful combat spells they possess. Each security mage also has two Force 4 fire elementals on call, for use in astral combat or to aid sorcery against important targets, and a Force 1 air elemental to sustain a personal combat sense spell.

In addition to the security forces described above, Mitsuhamas also has three more special response teams in the building and a total force of 30 security guards. Smart runners will not indulge in any open violence here. If the shadowrunners make a brief mistake, the gamemaster may allow them to slip away. But if the runners brazenly attempt an assault, they deserve harsh punishment.

In return for penetrating the Mitsuhamas building, the team receives only tantalizing clues and vague impressions. Office workers and secretaries know that Crull owes much of his career to unwholesome sources. They also know that Dark Angel's indiscretions nearly ruined Edward's career. To discover this information, a shadowrunner must find someone to talk to and make a successful Etiquette (Corporate) (5) Test.

Crull has an extensive office on the tenth floor. Use the Junior Executive Office on p. 20 of **Sprawl Sites**. Among his computer software is a chip labeled BlackBook Plus. This electronic datebook includes Kat Akamura's phone number and the name and location of her ship, the *Shio-Zuchi*.

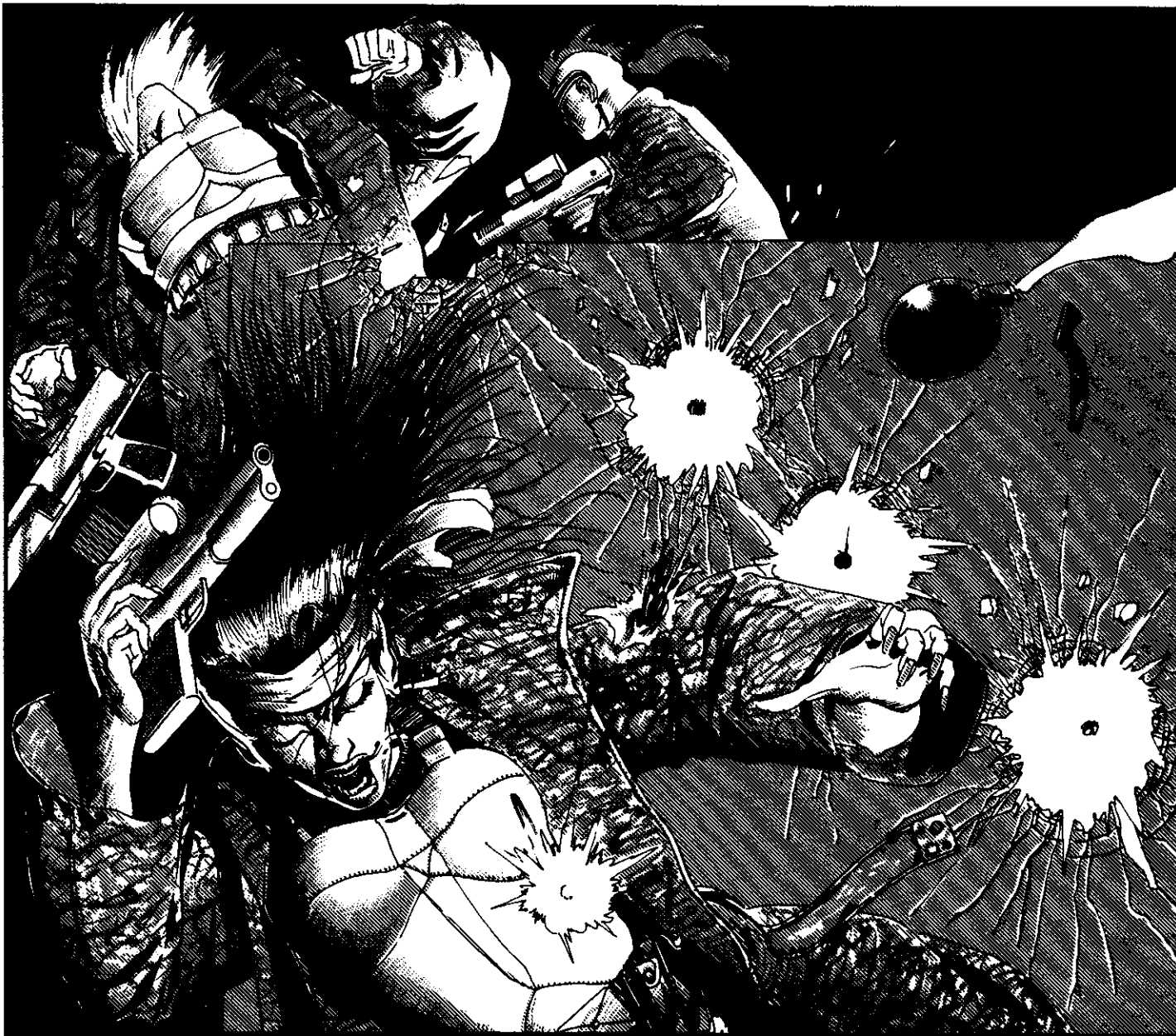

DEBUGGING

In this encounter, the gamemaster must keep the team involved in the game. If the runners do not take the initiative, their enemies will. The attack of Crull's killers gives the runners added incentive to complete this adventure and should help steer them toward their enemies. If one attack does not suffice to do this, the elite assassins in **Up the Ante**, p. 48, perform the same function.

Several powerful opponents confront the runners in this encounter, and if the team loses a battle badly, the gamemaster may take steps to keep some of them alive. To justify this, assume that Crull's thugs want to capture the runners for interrogation and later sale in the Orient as slaves. If the shadowrunners fail to take advantage of this reprieve and escape, Sarah Crull may release them.

Never allow an easy attack on the Mitsuhamas offices. If the runners assault these buildings, the most they deserve is a (slim) chance to escape. Shadowrunners simply must treat corporate offices with respect.

Theoretically, the shadowrunners could follow other leads to Kat Akmura, no matter what occurs here. However, players who fail to take advantage of the opportunities offered in this encounter will not find the same information elsewhere. Therefore, the gamemaster may need to cut the player characters considerable slack when the team questions Crull, Sarah, or the assassins. Try to ensure that the runners end their investigation of Crull with a reasonably clear grasp of who their enemies are and what happened to Angel.

Now that they know the score, they need to take some action.



UP THE ANTE

TELL IT TO THEM STRAIGHT

If a team member assesses astral space shortly before the ambush, read the following:

Material objects fade from view and the astral landscape appears around you. For an instant, you glimpse something out of place. A shadowy, manlike shape crouches among the rainbow of auras. As you look at this shape, it vanishes.

When the ambush actually occurs, read the following:

Howls of challenge erupt around you as gangers charge from all sides. The punks have vacant eyes, their youth concealed beneath armor of kevlar, chain mail and chrome. Their jackets bear the name Caesar's Scythers, and they're out to slot your stick. They're not the first who've tried, and won't be the last.

HOOKS

Heads up, chummers! Watch out for flying lead.

BEHIND THE SCENES

If Edward Crull fails to exterminate the shadowrunners, Kat Akmura sends her best hit team—the shaman Akimoto and Kure, a troll physical adept. Both these killers come from the warrior society Oni-do. To increase their firepower and disguise their identities, the assassins drag a local gang into the battle, controlling the punks with a mob mind spell.

The hit team must find the runners before they can attack. Using Akmura's contacts, this job takes a mere 1D6 hours. Lengthen this period if the runners use some especially secure hideout, but once the runners hit the streets, the assassins should be waiting for them.

The hit team stalks the runners briefly before closing in for the kill. Akimoto, the shaman, tails them in astral space. The assassins would love it if the team splits up, allowing them to attack different runners separately. If the team sticks together, the assassins launch their attack after an hour has passed.

If a runner mage assesses astral space during that hour, he spots Akimoto. Read aloud the description of astral space from **Tell It To Them Straight**. Runners who examine the apparition carefully recognize it as the astral form of a human magician. Akimoto masks his aura to disguise his status as an initiate.

Akimoto has six watchers and a Force 6 city spirit at his command. If the runners attack him in astral space, he and his spirits attempt to kill all astral opponents. Akimoto tries to escape any astral battle that resembles a fair fight, and his spirits protect him as he flees.

When the assassins strike, they attack the smallest number of runners possible, wherever the shadowrunners happen to be. This section includes a map of a typical ambush site. If some other layout seems more appropriate, use it instead.

Four spellbound Caesar's Scythers begin the attack with a reckless charge, as described in **Tell It To Them Straight**. When the lead starts to fly, the gangers dive for cover and dig in for a long firefight. The Scythers hold these positions until they die. As the dupes of a mind-control spell, they retain glimmerings of tactical sense but not enough to perceive the battle as a losing proposition and cut out.

Akimoto and his troll companion enter the fight cloaked by invisibility spells. The shaman has 8 successes on his spell; Kure, the physical adept, has 3 successes. Akimoto positions himself at a convenient spot to watch the battle, preferably with some cover and an escape route. If using the ambush site shown on the map, perch Akimoto on the indicated dumpster. The shaman assigns his six watchers to cover astral space and attack any other magicians who appear there.

Except as noted, Akimoto stays out of the actual fighting. After all, he has three spells to maintain. He does, however, contribute his entire Magic Pool to spell defense and may enter the astral plane to dispel any particularly powerful enchantments the runners cast. He attempts such dispelling only if necessary to win the battle, or if the rest of the fight is completely under control. If the assassins' plan works, most of the runners will not know the killers exist, even as they dice up the team.

As the team fights the gang, Akimoto sends his city spirit to alienate the most powerful runner. The invisible physical adept then moves in to geek that target. Akimoto does nothing to draw attention to his position.

If Akimoto and Kure scrag one group of runners (assuming the team has split up), the shaman heals any wounds the assassins have received and they move on to the next group. The assassins use roughly the same strategy in every assault. If possible, Akimoto intends to wipe out the whole team this way.

The shaman has little real courage. Once he starts taking Physical damage, he runs. Kure, however, fights on regardless of the odds. If the team recognizes the nature of its opposition and manages to launch a determined attack on Akimoto, it may drive him away, giving the runners a chance to overpower Kure and survive the assault.

Any character who examines Kure's and Akimoto's equipment may discover the symbols of the Oni-do, a fanged face along with Japanese characters reading, "Goblin Way." Kure has an Oni-do insignia on the hilt of his katana, and Akimoto has the symbols on his fetishes.

If captured, Kure refuses to talk, even if tortured. His dim

UP THE ANTE



Intellect seems dense even under mind probe spells (add a +2 modifier to target numbers). A clever interrogator, however, can draw information from him with leading questions. "You worked for Crull, right? No? Of course not, it was somebody more important. I thought so." If the team wants to try this sort of questioning, the gamemaster plays the role of Kure. Kure never intentionally reveals information, but he sneers each time the team makes a statement that is clearly wrong. The troll shudders if his interrogators make an accurate guess. These reactions enable the team to confirm or deny their suspicions.

Akimoto has three sets of lies he uses under interrogation. First, he refuses to talk and impersonates a thrill-ganger. "You'll pay for this, fragger," he spits out. "Scythers rule!" If forced to admit he is not a Scyther, he claims to work for a fixer named Jackal, a member of the Fenris Nacht polclub. Under extreme pressure, he fakes a breakdown and says he works for Aztechnology Incorporated. "Chummer, you fragged with the Big Pyramid once too often." If all three stories fail, Akimoto may tell the truth, because he does not hold up well under extreme pain.

Both Kure and Akimoto have spent time in Akmura's ship-board headquarters and know she holds Angel prisoner there. These killers can provide general facts on the layout and defenses of the headquarters, though they do not know numbers or possess detailed maps. Interrogating Kure and Akimoto can prove highly informative.

Statistics on Kure and Akimoto appear in **Cast of Shadows**, p. 63.

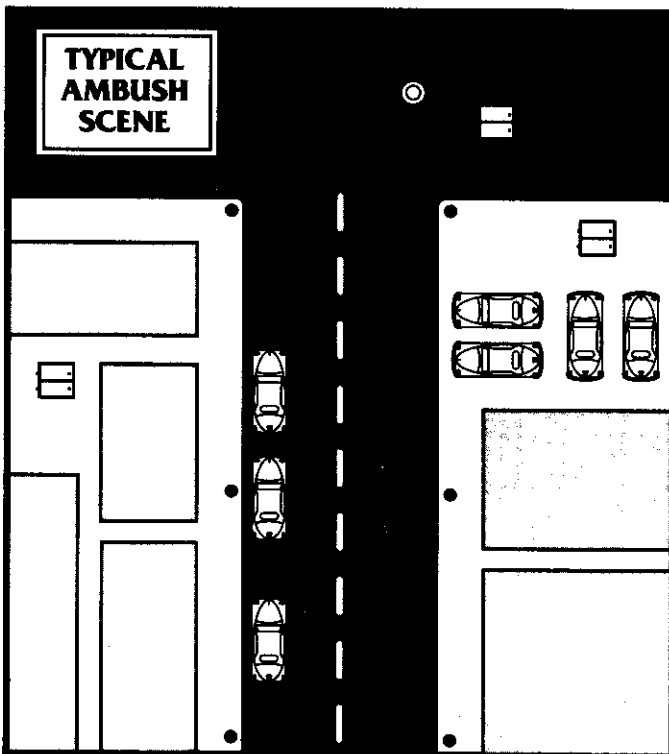

CAESAR'S SCYTHERS (4)
B **Q** **S** **C** **I** **W** **E** **R** **Armor**
 6 6 6 4 3 2 4.8 4 5/3
Initiative: 4 + 1D6

Threat/Professional Rating: 5/4 while under the mob mind spell, 1/2 if the spell is dropped

Skills: Armed Combat 4, Bike 3, Etiquette (Street) 3, Firearms 6, Unarmed Combat 6

Cyberware: Retinal Modification (Thermographic), Spurs (8M)

Gear: AK-97 [Assault Rifle, 38 (clip), SA/BF/FA, 8M, w/2 extra clips, Gas Vent III], Armor Jacket (5/3)

The sprawl breeds thousands of punks like these gangers. Caesar and his Scythers just happened to be in the wrong place at the wrong time when Akimoto decided to collect muscle for his run. The shaman uses a mob mind spell to control the Scythers.

The gangers have a basic sense of tactics. They prefer to rush small groups of enemies, grapple, and overwhelm their victims in melee combat with sheer numbers. Even under the mob mind spell, they will not suicidally charge through gunfire to execute this tactic.

CONDITION MONITOR									
	LIGHT STUN		MODERATE STUN		SERIOUS STUN		DEADLY STUN		DEADLY STUN
STUN	1-10	1-10	1-10	1-10	1-10	1-10	1-10	1-10	1-10
PHYSICAL	1-10	1-10	1-10	1-10	1-10	1-10	1-10	1-10	1-10
	LIGHT WOUND		MODERATE WOUND		SERIOUS WOUND		DEADLY WOUND		DEADLY WOUND

CONDITION MONITOR									
	LIGHT STUN		MODERATE STUN		SERIOUS STUN		DEADLY STUN		DEADLY STUN
STUN	1-10	1-10	1-10	1-10	1-10	1-10	1-10	1-10	1-10
PHYSICAL	1-10	1-10	1-10	1-10	1-10	1-10	1-10	1-10	1-10
	LIGHT WOUND		MODERATE WOUND		SERIOUS WOUND		DEADLY WOUND		DEADLY WOUND

CONDITION MONITOR									
	LIGHT STUN		MODERATE STUN		SERIOUS STUN		DEADLY STUN		DEADLY STUN
STUN	1-10	1-10	1-10	1-10	1-10	1-10	1-10	1-10	1-10
PHYSICAL	1-10	1-10	1-10	1-10	1-10	1-10	1-10	1-10	1-10
	LIGHT WOUND		MODERATE WOUND		SERIOUS WOUND		DEADLY WOUND		DEADLY WOUND

CONDITION MONITOR									
	LIGHT STUN		MODERATE STUN		SERIOUS STUN		DEADLY STUN		DEADLY STUN
STUN	1-10	1-10	1-10	1-10	1-10	1-10	1-10	1-10	1-10
PHYSICAL	1-10	1-10	1-10	1-10	1-10	1-10	1-10	1-10	1-10
	LIGHT WOUND		MODERATE WOUND		SERIOUS WOUND		DEADLY WOUND		DEADLY WOUND

DEBUGGING

This encounter changes the team from hunters into prey. If the runners have failed to prepare for this turn of events, they may all end up dead. The team should not get too many cheap breaks, because they have only two skilled opponents doing the same thing to them that runners do to NPCs all the time. Nevertheless, give the team some edge if the game seems headed for a screeching halt.

A word of warning may help the team survive the brawl. A mumbling street mage might hint that all is not well in astral space. Gamemasters who enjoy roleplaying spirits might have an ally, bound elemental, or nature spirit appear to a runner, rubbing its hands. "I've got a tip for you chummer. Real hot tip. 'Course, it'll cost you one service."

To bail the runners out during a battle, have the leaders of Caesar's Scythers show up. They know Akimoto cast a spell over their chummers, and they are not happy campers. For Caesar, the leader, use the Street Samurai archetype on p. 62, **SR11**. For Cleopatra, his wizlady, use the Street Shaman archetype on p. 63, **SR11**. These two may not have quite the firepower of the Oni-do assassins, but they know enough to look for the invisible pair. Their actions may tip off the team to pinpoint its enemies and hose them with superior numbers.

If the runners fail to learn of Akmura's ship HQ from Akimoto or Kure, they can get it from Crull or Homatsu Jinjiro. If Crull is dead or otherwise inaccessible, or if they hose up their encounter with Jinjiro (or simply never meet him), allow the runners' regular street contacts to supply the information. For a fraggin' outrageous price, of course.

KATS DREADNOUGHT

TELL IT TO THEM STRAIGHT

If the team approaches Kat Akmura's ship by sea or air, read the following:

The *Shio-Zuchi* floats placidly on the water, well outside the harbor. Waves lap against its black, streamlined hull. Although enormous, this vessel has the needle nose and slim body of a racing craft. It looks more like an aircraft than a boat.

If the team approaches Kat Akmura's ship underwater, read the following:

The murk of Puget Sound surrounds you. Although the *Shio-Zuchi* must be near, you see only dark water, thick with sediment and bits of trash, and a greenish glow that must be the sky. An enormous shape snakes through the waters. Something large and alive has found you.

If the team assesses Kat Akmura's ship on the astral plane, read the following:

The ships in the harbor pale to mere specters. Only the land and sea remain. The trees on Council Island appear more vivid than the skyscrapers of Seattle.

One ship, the *Shio-Zuchi*, remains clearly visible. A constellation of glimmering spirits surrounds the sleek vessel's warded hull.

HOOKS

The encounter on the *Shio-Zuchi* represents the end of the game and should play like something out of a James Bond film. Either the runners will attempt some foolhardy but spectacular assault against the ship, or they will finesse their way aboard and deal directly with the *oyabun*. Regardless of their tactics, play this scene like the climax it is.

BEHIND THE SCENES

Kat Akmura operates her Seattle organization from a ship, the *Shio-Zuchi*, anchored far outside the harbor to ensure privacy. To free Angel and resolve this adventure, the team must defeat Akmura on the *Shio-Zuchi*. Presumably, by the time the runners reach the ship they have a rough idea of what happened to Angel and what they need to do. If not, they need to scan it fast. Deckers might deduce what happened to Angel from Kat Akmura's files, or the sight of Angel in chains may give the runners the clue they need.

Kat keeps Angel in chains in her quarters (Area H).

AKMURA'S DEFENSES

Akmura surrounds herself with bodyguards from the warrior cult Oni-do, the Way of the Goblin. These masters of combat watch for enemies underwater, on the sea and in the astral plane. The mage Kachu keeps a detect enemies spell locked on Kat Akmura, giving the yakuza chieftain an uncanny ability to sense danger. This spell has a range of 60 meters. Kachu also has a team of six watchers circulating in the waters around the boat; the watchers inform the Oni-do of any intruder who approaches within 1,000 meters of the ship.

Even the yakuza cannot simply blast away at everything they encounter in Puget Sound. Therefore, when the runners' unidentified craft approaches the *Shio-Zuchi*, a crew member tries to warn the strangers away. He goes to the bridge with a megaphone and calls to the runners in heavily accented English. "Seafarers! This is vessel *Shio-Zuchi*. Too close, please. Beg you withdraw a little farther." If the team leaves, Akmura's guards do not molest them, though everyone on the ship keeps extra careful watch for the next two hours.

Assuming that the runners do not immediately retreat, the ship goes on alert. If the team presses forward without trying to communicate, the *Shio-Zuchi* opens fire. If the runners ask for an audience with Kat Akmura, or present some other plausible, non-threatening reason for approaching the ship, the gamemaster must decide whether or not the guards trust them. This decision should depend on the plausibility of the runners' story and the confidence with which they present it. If the gamemaster leaves this decision up to the luck of the dice, have one runner make a successful Etiquette (Japanese) or (Yakuza) (6) Test to reassure Akmura's guards.

If the yakuza allow the runners on the ship, the three Oni-do guards from Area E escort them wherever they go. Akmura's two lookouts remain in their tower but react in seconds to the sight or sound of battle.

Oni-do has the following forces on the ship. The gamemaster should use them together in a coordinated defense plan. Suggestions on their tactics appear below.

One Oni-do troll and the mage Mushui stand watch at Area D. This team observes both the physical and astral planes. In the event of a battle, their elevated position gives them a clear line of sight to all points of the deck and the surrounding ocean. If all attackers board the ship, Mushui and the troll descend from the tower to engage in melee combat.

Three Oni-do guards are posted at Area E. They can ready themselves for battle at a moment's notice, no matter what the hour. In a surprise attack, they reach their firing positions in 1D6-2 actions (not necessarily Combat Turns). When fighting an opponent approaching on the sea, they usually fire from the

KAT'S DREADNOUGHT

gunports in Area B. If the enemy boards the ship, these fighters join forces with other guards and engage opponents in melee combat.

The magician Kachu stays with Akmura at Area H. He does not live by the discipline of the Oni-do. Even when his watchers detect intruders, they report to the Lookout Tower, Area D, instead of disturbing Kachu. Therefore, it takes Kachu 1D6 actions (not necessarily Combat Turns) to respond to a surprise attack. In a pitched battle, he remains with Akmura and may render her and himself invisible to aid an escape.

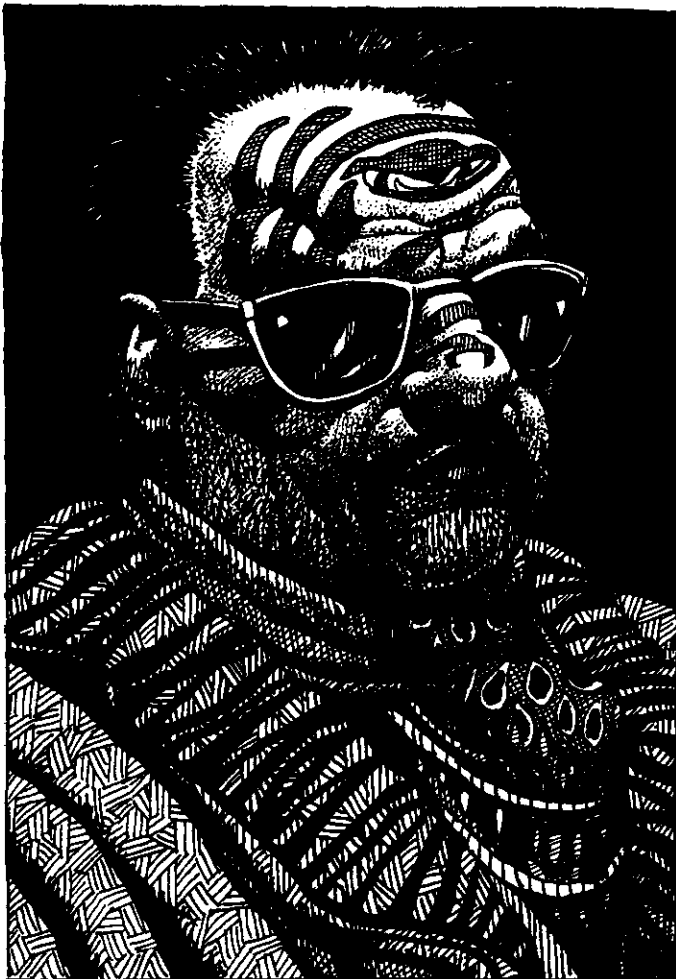

Kachu

B **Q** **S** **C** **I** **W** **E** **M** **R** **Armor**
4 6 1 3 6 6 6 6 6 5/3

Initiative: 6 + 3D6

Threat/Professional Rating: 5/2

Skills: Conjuring 6, Enchanting 4, Etiquette (Japanese) 5, Magic Theory 3, Sorcery (Spellcasting) 7

Gear: Armor Jacket (5/3), Fetishes (10 of each type), Spell Lock (Increase Reflexes +2)

Spells: Barrier 5, Detect Enemies 4, Heal 2, Increase Reflexes (+2) 4, Invisibility 4, Mana Barrier 4, Mana Bolt 5, Stunblast 5

The son of a senior yakuza, Kachu's magical aptitude and his parentage assured him an easy career in organized crime, which has made him soft and addicted to luxury. Although he supposedly serves Akmura as an advisor and bodyguard, Kachu spends

much of his time enjoying the fringe benefits—gourmet food, swanky clothes, and legal or illegal entertainment—a powerful gangster can command. A coward at heart, he avoids risking either Akmura's life or his own.

Kachu wears a gray leisure suit, a gem-studded chronometer and gold-rimmed sunglasses. His ample stomach protrudes over his belt. Despite his bulk, which can make him look clownish, the hermetic trinkets dangling around his tie warn observant people not to treat him lightly.

Kachu has two water elementals and one earth elemental bound to him, all available to aid sorcery or fight astral opponents. All are Force 4 and each owe him one service.

		CONDITION MONITOR			
		LIGHT STUN	MODERATE STUN	SERIOUS STUN	DEADLY STUN
STUN	+1 TN# -1 Init.	+2 TN# -2 Init.	+3 TN# -3 Init.	Unc.	
	+1 TN# -1 Init.	+2 TN# -2 Init.	+3 TN# -3 Init.	Unc. maybe dead	
PHYSICAL	+1 TN# -1 Init.	+2 TN# -2 Init.	+3 TN# -3 Init.	Unc. maybe dead	
	LIGHT WOUND	MODERATE WOUND	SERIOUS WOUND	DEADLY WOUND	

Mushui

B **Q** **S** **C** **I** **W** **E** **M** **R** **Armor**
4(8) 4 1 5 6 6 6 6 5(13) 5/3

Initiative: 5 + 1D6

Threat/Professional Ratings: 3(5)*/3 (*physical combat only)

Skills: Athletics 3, Conjuring 6, Etiquette (Japanese) 2, Gunnery 4, Sorcery (Spellcasting) 7, Stealth 3

Gear: Armor Jacket (5/3), Fetishes (10 of each type), Spell Lock (Armor, 8 successes; Combat Sense, 8 successes)

Spells: Armor 4, Chaos 2, Chaotic World 4, Clout 4, Combat Sense 2, Levitate Item 4, Resist Pain (Serious) 2, Stunblast 3, Wrecker 4

Mushui sees himself as an artist of combat wizardry. Although human, he attached himself to the Oni-do troll warrior society to practice his craft. This sorcerer uses his magic to disable opponents at long range, sinking boats, levitating heavy weapons out of reach, and casting chaos spells over magicians. He uses elementals to sustain his most effective spells.

A small man, Mushui has long fingernails and wears a simple martial artist's robe.

Mushui has five Force 3 elementals bound to him, each owing one service. Two are fire elementals, two are water elementals and one is an earth elemental.

Mushui has cast a Resist Pain spell over himself.

		CONDITION MONITOR			
		LIGHT STUN	MODERATE STUN	SERIOUS STUN	DEADLY STUN
STUN	+1 TN# -1 Init.	+2 TN# -2 Init.	+3 TN# -3 Init.	Unc.	
	+1 TN# -1 Init.	+2 TN# -2 Init.	+3 TN# -3 Init.	Unc. maybe dead	
PHYSICAL	+1 TN# -1 Init.	+2 TN# -2 Init.	+3 TN# -3 Init.	Unc. maybe dead	
	LIGHT WOUND	MODERATE WOUND	SERIOUS WOUND	DEADLY WOUND	

KAT'S DREADNOUGHT

Oni-do Troll (4)

B 11 (13) **Q** 3 (4) **S** 10 (11) **C** 1 **I** 1 **W** 5 **E** 6 **M** 6 **R** 2 (4) **Armor** 5/3

Initiative: 2 + 3D6

Skills: Athletics 2, Armed Combat 6, Axe 8; Firearms 4, Gunnery 3, Unarmed Combat 5

Gear: Armor Jacket (5/3), Combat Axe [Reach 2, (STR + 2)S], SCK Model 100 SMG [SMG, 30 (clip), SA/BF, 7M, w/2 extra clips, Gas Vent II, Laser Sight (-1 modifier to target numbers)]

Physical Adept Abilities: Improved Ability, Armed Combat 2; Improved Physical Attributes, Quickness 1, Strength 1; Increased Reflexes (2)

The yakuza trained these trolls from birth as elite warriors. The trolls' inhuman physical characteristics, as well as their complete indoctrination by the yakuza, have prevented them from even trying to acquire outside interests or friends. They live for their duty alone.

These trolls have a severe allergy to silver. Mushui has cast Resist Pain (Serious) spells on all the Oni-do.

CONDITION MONITOR									
LIGHT STUN		MODERATE STUN		SERIOUS STUN		DEADLY STUN		PHYSICAL	
1 TN#	2 TN#	1 TN#	2 TN#	1 TN#	2 TN#	1 TN#	2 TN#	1 TN#	2 TN#
LIGHT WOUND		MODERATE WOUND		SERIOUS WOUND		DEADLY WOUND		PHYSICAL	

CONDITION MONITOR									
LIGHT STUN		MODERATE STUN		SERIOUS STUN		DEADLY STUN		PHYSICAL	
1 TN#	2 TN#	1 TN#	2 TN#	1 TN#	2 TN#	1 TN#	2 TN#	1 TN#	2 TN#
LIGHT WOUND		MODERATE WOUND		SERIOUS WOUND		DEADLY WOUND		PHYSICAL	

CONDITION MONITOR									
LIGHT STUN		MODERATE STUN		SERIOUS STUN		DEADLY STUN		PHYSICAL	
1 TN#	2 TN#	1 TN#	2 TN#	1 TN#	2 TN#	1 TN#	2 TN#	1 TN#	2 TN#
LIGHT WOUND		MODERATE WOUND		SERIOUS WOUND		DEADLY WOUND		PHYSICAL	

CONDITION MONITOR									
LIGHT STUN		MODERATE STUN		SERIOUS STUN		DEADLY STUN		PHYSICAL	
1 TN#	2 TN#	1 TN#	2 TN#	1 TN#	2 TN#	1 TN#	2 TN#	1 TN#	2 TN#
LIGHT WOUND		MODERATE WOUND		SERIOUS WOUND		DEADLY WOUND		PHYSICAL	

AKMURA'S ESCAPE

If her Oni-do guards begin losing ground in battle, Kat Akmura tries to escape. As a rule of thumb, Akmura takes off once four of the six Oni-do fall. At the gamemaster's discretion, she may flee whenever the situation warrants it. Akmura has a minisubmarine based in the hold of the *Shio-Zuchi*. Its statistics appear below.

When Akmura strikes for tall timber in her submarine, water rushes into the *Shio-Zuchi's* hull and everyone aboard feels the ship list. Once the submarine clears the ship, Akmura detonates a 5-kilogram charge of Compound 12, tearing the bottom out of the boat. Runners do not take damage from this explosion unless physically present in the hold (Area L) with the charge. After the blast, the ship disintegrates and sinks in 4D6 minutes.

Under most circumstances, the shadowrunners can use the life rafts or their own transportation to escape the sinking ship. Remember, however, that unless they move fast, they will go down with the *Shio-Zuchi*. Have runners make Swimming Tests as appropriate.

In the confusion of a quick escape, Kat Akmura makes no effort to kill Angel or take him with her. Nothing matters to her at this point except getting away.

Minisubmarine

Handling 4 **Speed** 10/30 **Body** 2 **Armor** 3 **Signature** 8 **Pilot** 4

VEHICLE CONDITION MONITOR									
^ LIGHT		^ MODERATE		^ SERIOUS		^ DESTROYED			

UNDERWATER

The Oni-do employ a torpedo shark for underwater security, which tries to snack on any warm-blooded creature it meets. Pheromones released from the *Shio-Zuchi's* hull keep this monster from straying.

Torpedo Shark

B 7/2 **Q** 5 x 4 6 **S** — **C** 1/3 **I** 3 **W** 6 **E** 5 **R** 8S3 **Attacks**

Powers: Enhanced Physical Attributes [Quickness, three times per day, for (Essence-2)D6 turns], Enhanced Senses (Improved Smell)

CONDITION MONITOR									
LIGHT STUN		MODERATE STUN		SERIOUS STUN		DEADLY STUN		PHYSICAL	
1 TN#	2 TN#	1 TN#	2 TN#	1 TN#	2 TN#	1 TN#	2 TN#	1 TN#	2 TN#
LIGHT WOUND		MODERATE WOUND		SERIOUS WOUND		DEADLY WOUND		PHYSICAL	

SHIP'S CREW (15)

B 3 **Q** 4 **S** 4 **C** 3 **I** 3 **W** 3 **E** 6 **R** 3 **Armor** —

Initiative: 3 + 1D6

Threat/Professional Rating: 1/1

Skills: Boats (B/R) 4, Electronics 5, Etiquette (Japanese) 5, Motorboats 6

Note: One crew member, the surgeon, also has the following skills: Biology 6, Biotech 8. All crewmembers will withdraw from any fight after taking one box of damage (any wound).

The *Shio-Zuchi* has a total of fifteen sailors and onboard servants. These workers want only to do their jobs without becoming personally involved in their mistress' skulduggery. They scurry away from any fighting.

KAT'S DREADNOUGHT

THE SHIO-ZUCHI

Based on the principles of Japanese art, the *Shio-Zuchi's* design contains no wasted features. The yacht provides everything its owner needs to live in luxury, as well as ample provisions for defense.

The hull and interior walls of the *Shio-Zuchi* exist as steel barriers on the physical plane and wards on the astral plane (see p. 92, *Grimoire II*). Mushui and Kachu renew these wards as necessary.

Shio-Zuchi

Handling	Speed	Body	Armor	Signature	Pilot
4	30/60	10	2	4	4

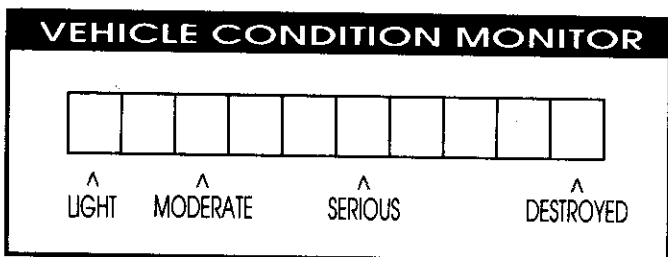

Deck (A)

Dark, smooth and slightly convex, the deck of the *Shio-Zuchi* contains neither footholds nor clutter. Four modules under the deck each contain an inflatable life raft, which can be inflated and ejected by pushing a single button.

Gun Ports (B)

The Oni-do have four sunken firing positions in strategic areas of the ship. These gun ports provide the vessel with full cover. Runners who try to shoot through the gunport sides must contend with a Barrier Rating of 4. Each gunport also contains a pivot-mounted medium machine gun with a 1,000-round ammunition belt. The mountings reduce all recoil penalties by one-half. Rounds do 11S damage.

Because gunners are visible when firing from these ports,

they are vulnerable to spells.

Bridge (C)

The bridge rises slightly from the deck, more a black, sausage-shaped blister than a separate structure. Thin, mirrored-glass, wraparound windows cover the bridge's bubble shape. A sliding door on the rear of the bridge allows access to the interior. Inside, a hatch leads to the ship's lower decks.

The bridge contains all the *Shio-Zuchi's* navigational equipment. Normally, two crew members operate this gear. Because anyone who seizes control of the bridge can pilot the ship, the Oni-do posted at Area E immediately respond to any incursion on the bridge. To perform ordinary maneuvers, a runner must make a successful Boat (4) Test. A shadowrunner can also reprogram the ship's autopilot by making a successful Electronics (8) Test.

Observation Tower (D)

This rounded turret rises over the bridge. It provides a shielded gunport (see B) and a clear view of the sea around the ship.

Guard Post (E)

The Oni-do live in this barren cylinder. Each one has a bunk and a rack of weapons. Hidden passages connect this chamber directly to the bridge and the gunports.

Galley (F)

This chamber has microwave ovens, refrigerators and cupboards built into the walls. It contains enough food to sustain the passengers and crew of the ship for one month.

Bathroom (G)

This room contains a Japanese-style toilet.

Akmura's Chambers (H)

This uncluttered suite contains everything Kat Akmura requires, and she spends most of her time in it. Akmura's bedroom

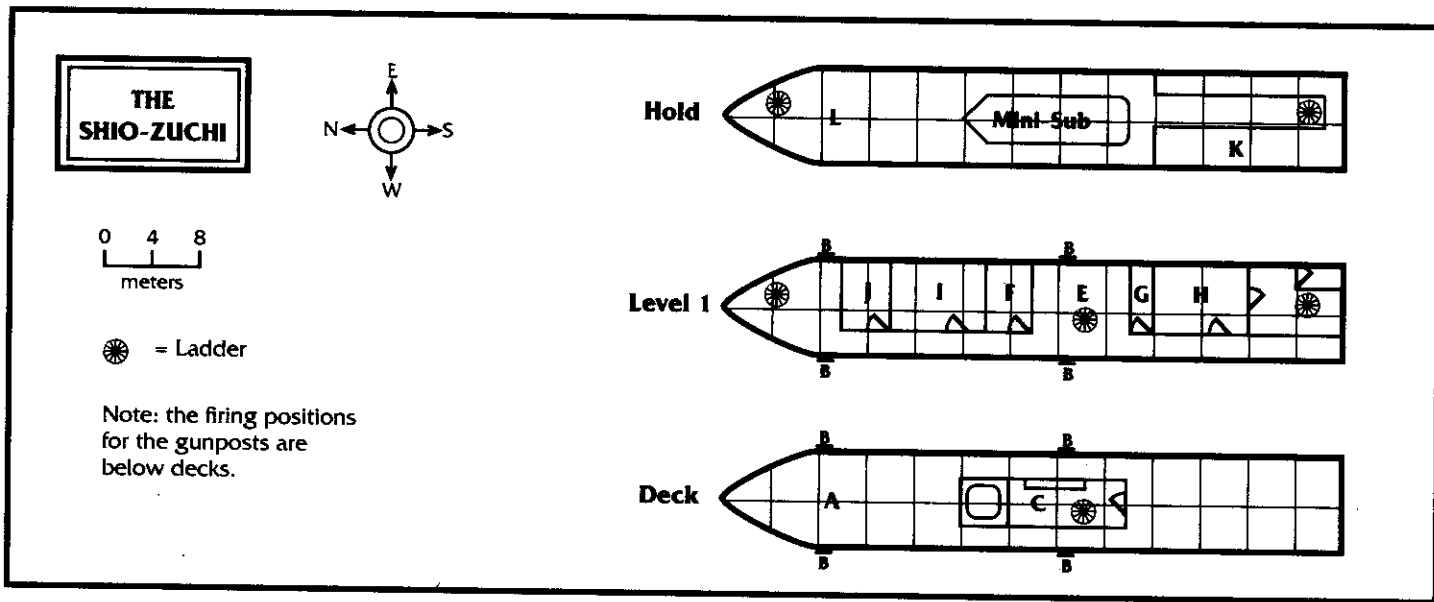

has a waterbed and multi-entertainment system. A single office terminal gives her access to the empire of legal and illegal enterprises under her control. Her advisor and bodyguard Kachu lives with her in the suite.

Akmura and Kachu keep Angel chained in the living room of these chambers, next to a tank of exotic, sapphire-blue fish. At times they command him to sing, either for their own amusement or to create more recordings.

All chairs, desks and electronic appliances in these rooms contain composite-fiber armor, making them useful as shields against an assassin's bullets. The reinforced furniture has a Barrier Rating 6. Akmura uses this cover to full effect if attacked.

Crew Compartment (I)

The crew sleeps in quadruple bunks along the walls of this room.

Infirmary (J)

This chamber contains two beds with starched sheets and a surgical theater. Medical machinery hangs from tracks on the ceiling. The surgeon can slide the equipment along these tracks to whatever position he needs.

Engine Room (K)

Gleaming cases enclose the machinery of this ship. A runner can take control of the ship's engines from here by making a successful Boat (B/R) (8) Test. Control commands from the engine room override commands from the bridge.

Hold (L)

Crates of food, medical supplies and munitions line the hold. A hatch in the floor of the ship leads to Kat Akmura's minisubmarine, described on p. 54. The hold also contains explosive charges designed to scuttle the ship. To disarm them, a runner must make a successful Demolitions (6) Test.

AKMURA'S COMPUTER

Deckers running in the yakuza computers can find plenty of tips and stray cash. However, Akmura's system has vicious Ice, meant to dust any interlopers. The following layout shows the matrix geography of Akmura's personal system. The yakuza, of course, have far larger matrix realities elsewhere.

Any runner attempting to penetrate this system from Seattle must make a Computer (5) Test. With one success, the team decker can sense static in Akmura's system, indicating a tenuous connection to the Matrix. By making a successful Computer (10) Test, the decker discovers that Akmura's system connects to the Matrix via a high-speed, experimental wireless system, based on the technology used in satellite uplinks. Another successful Computer (10) Test reveals that Akmura's computers must be physically located on Puget Sound.

Except as noted, all ice conforms to UMS specifications.

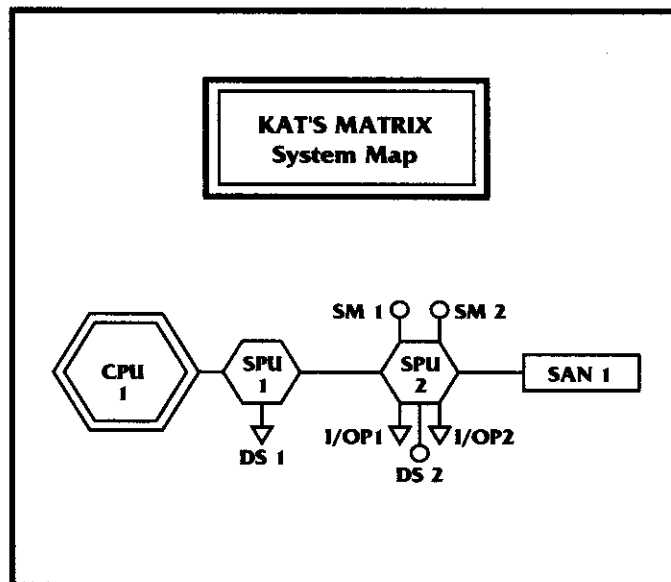

CPU = Central Processing Unit

DS = Datastore

I/OP = Input/Output Port

SAN = System Access Node

SPU = Sub-Processor Unit

SM = Slave Module

SAN-1: Orange-4, Barrier 4, Tar Pit 4, Trace and Burn 5. If the team triggers the trace program, Akmura uses the assassins of *Icelandy's Doss*, p. 14, or *Members of the Band*, p. 15, to attack them. In the event these encounters have been run, Akmura dispatches a team of five assassins with the statistics of the Street Samurai archetype (p. 62, **SR11**).

SPU-1: Communications Routing. Orange-5, Blaster 5.

DS-1: Directory. Red-3, Scramble 5, Black-4. The black IC appears as a descending sheet of darkness. This datastore contains a list of Kat Akmura's contacts and enemies through out Seattle, California, and Japan. The information would bring 200,000 nuyen on the black market and requires 500 Mp of memory to store. Naturally, selling this information makes the party some enemies. Invent details to suit the campaign. Akmura's file on Angel reads: "Neutralized. Presumed dead—operation clean. The bird sings quite prettily in my cage. For the moment, I shall keep him."

SPU-2: Systems management. Orange-4, Blaster 4.

I/OP-1: Orange-4. Terminal in Akmura's chambers. See Area I of the ship layout.

DS-2: Finances. Red-4, Access 6, Scramble 6, Tar Baby 4, Trace and Burn 5. This datastore contains Kat Akmura's petty cash account. It holds 500,000 nuyen, which require 500 Mp of memory to transport. If the team triggers the trace program, Akmura uses assassins similar to Shiro Usaka's special assistants in *Mindwarp*, p. 32, or Crull's thugs in *Brother to an Angel*, p. 40, to attack them. If these encounters have already been run, Akmura dispatches a team of five assassins with the statistics of the Street Samurai archetype (p. 62, **SR11**).



I/OP-2: Navigational equipment. Orange-5, Tar Pit 4. This port displays precise coordinates and navigational information to those on the bridge of the *Shio-Zuchi* (see Area C of the ship layout). Invading deckers may also use this information to pinpoint the location of the *Shio-Zuchi*.

SM-1: Ship management systems. Red-4, Access 5, Blaster 5. This module controls the *Shio-Zuchi*. Deckers may use it to obtain a layout of the ship or to pilot the vessel. See Area C of the ship layout for more details.

SM-2: Recording equipment. Orange-4. This module controls apparatus for recording Angel's music. Anyone who examines it finds several unreleased tapes of performances.

CPU: Red-3, Blaster 6, Black-4. The black IC appears as an Oriental dragon with a transparent body.

DEBUGGING

This encounter has two major ways to go wrong. First, the team can fail to appreciate the encounter's importance and com-

mit some fatal blunder. Second, the runners simply may not have the firepower to cope with Akmura's forces. If the second scenario seems likely, make the battle less deadly. Ruling that the Oni-do will not use machine guns in the public waters of Puget Sound and thereby allowing the group to board the ship safely, for example, is one way to do this. The attack on *Shio-Zuchi* is the major battle of the adventure, however, and should present a challenge for the team. Ease up on the danger level a little, if necessary, but do not make things too simple.

In another possible snafu, the runners might attack the ship with a weapon destructive enough to kill Angel. If so, the gamemaster must decide what happens next. A team of violent blunderers deserves to suffer the consequences of their actions. However, if the shadowrunners simply had bad luck, allow Angel to live through some miraculous coincidence.

Needless to say, killing Angel infuriates Icelady. If the team can make a strong case for having completed its original mission, she may still pay them, because nobody wants to stiff a team of shadowrunners. Nevertheless, Icelady does everything she can to soil the team's reputation, and the runners can expect less money and less desirable jobs in the future.

DEALING WITH THE YAKUZA

For the sake of tying up every loose end, this adventure assumes that the runners kill Kat Akmura. However, the adventure need not end this way. In an extended campaign, Kat Akmura may be far more useful alive, lurking in the shadows of Seattle. For example, the gamemaster may use her to introduce an extensive yakuza campaign.

Akmura may escape or, if the players enjoy negotiation and roleplaying, the shadowrunners may free Angel by cutting a deal. The yakuza specialize in gaining advantage from compromises, and Angel ultimately means little to Kat. What Akmura wants from the shadowrunners depends on the campaign. Anyone living in the sprawl, however, knows of a few operations the yakuza might like a cut of. And Kat has more than enough jobs for enterprising shadowrunners.

In a truly grim game, the team might actually enjoy working for Kat. She has the status of an established crimelord, but is young and ambitious enough to have a constant string of private wars. Those who can work under her icy temper can expect ample pay and extensive support. Gamemasters can also use Kat Akmura as a recurring villain or a sinister neutral. It all depends on the campaign.

Gamemasters who wish to use Akmura in future games should provide her with friends in the yakuza that the team would hesitate to offend, and should make the runners aware that these friends exist. The gamemaster may also add a few more Oni-do to Kat's bodyguard, giving her a better chance to escape in the final battle.

In any event, the yakuza have a tradition of holding grudges, and so the runners should develop schemes to conceal their identities when planning to attack Akmura. Wise shadowrunners do not show their faces. Runners may also attempt more elaborate cover-ups, aimed at disguising the motivations and means behind their attack. Consider such measures or the lack of them when awarding karma and planning future encounters with the yakuza.

PICKING UP THE PIECES

AFTER THE ADVENTURE

The shadowrunners started this adventure with the objective of recovering the rights to Angel's music. During the story, they probably changed their goal to rescue Angel, because the presence of Angel, alive, is the easiest way to invalidate the will awarding the rights to Dynamo.

If the team rescues him, Angel issues a bland statement to the press about his disappearance. He then markets *Flaming Wings* under his own name. A few months later, he records a new album, *Earth Dawn*. A departure for Angel, this concept album offers tales of the world's magical past. Although Angel claims to retain all his old principles, he now sees no reason to abstain from selling records and eventually becomes a multimillionaire. Runners may find Angel an invaluable patron and source of information on affairs in the music industry.

Wealth holds little fascination for Angel. He soon spends, lends or gives away much of his fortune. Shadowrunners with the personality and smarts to maintain a friendship with him may manage to get a decent chunk of money from him, depending on the gamemaster's desires and the nobility of the team's motives. Apart from gifts to old pals and down-and-outers, Angel spends the bulk of his remaining money promoting elven culture.

Angel wastes no time returning to Lili. Their meeting, however, is not the sentimental reunion the runners might have expected. The two exchange few words, and tension shows on both their faces. Lili remembers her humiliation before Dynamo Blue, and she has thought much about the years she spent supporting Angel and how little she received in return. Angel has changed deeply and cannot feel quite sure whether he is still right for Lili, or she for him.

Shadowrunners who visit Angel in later months find him still with Icelady, and he eventually marries her. She enjoys her fair share of his recording profits and manages to invest enough to keep them from falling into poverty again. However, Angel's experiences at Kat Akmura's hands prevent the two from ever fully understanding each other.

If the runners refuse to rescue Angel or deal with Akmura, they can drag this adventure on until the yakuza wipe them out. Akmura has enough influence to keep legal measures or common blackmail from interfering with her plans. Any team that refuses to decisively end this adventure must fight an endless stream of Onido, and the organization has other operatives with skills at least equal to those found in this adventure.

If the team defeats Akmura but Angel also dies, the runners may still invalidate the will by producing witnesses and evidence proving Angel signed the document under duress. Akmura could easily manipulate the legal system and foil this strategy, but after

her death the other yakuza do not want to get entangled in the case. With Angel's will invalidated, his music rights become the property of Edward Crull, Angel's next-of-kin. To obtain the rights for Icelady, the team must implicate Crull in the plot. Crull's wife may prove valuable in this effort.

If both Angel and Icelady die, manipulations of the will become pointless. Runners cannot name themselves beneficiaries of Angel's estate.

As previously mentioned, the gamemaster can use Kat Akmura to introduce any number of future scenarios featuring the yakuza. The details of her friends, enemies and ambitions lie beyond the scope of this adventure. The team may work for Akmura for a while, particularly if they owe her a favor for releasing Angel. They may eventually sell her out, or use her as a pawn in schemes of their own. Not much difference between heroes and villains in the world of *Shadowrun*, eh, chummer?

Sarah Crull offers the team a different kind of ally. Sarah has the competence to find herself a place anywhere. If the runners help her gain a position of power now, she may reward them later. In the event that her husband continues to live and work at Mitsuhama, Sarah may prove most valuable staying put.

A team that acts without considering all the angles may make an enemy of Dynamo Blue. However, the promoter never really intended any malice toward them or Icelady, and if the runners avoid a battle with Blue she may become a useful contact for the music industry or street life.

In the course of this adventure, runners may make mistakes that identify them to the yakuza. These slip-ups could become death sentences. See *Mindwarp*, p. 31, and *Marian Parks*, p. 37, for details on the local *oyabuns* and the forces they may send to avenge Kat Akmura's death. If the runners fail to clear their actions through Shiro Usaka or Homatsu Jinjiro, these two may become enemies in future adventures.

The yakuza bosses may also respond by giving the team a "warning" at some inopportune point in a future adventure. Again, the gamemaster should choose the details to fit the situation. Alternatively, an enterprising yakuza may decide to employ the runners who managed to overcome Akmura. Should such a crime lord make this proposition, the runners would be unwise to refuse.

EPILOGUE

Sometime after the re-release of *Flaming Wings* and the release of *Earth Dawn*, press reports announce that Dark Angel plans to release another concept album titled *Earth Dawn: The Scourge*. Shortly afterward, a fire destroys his home and studio, and both he and Lili vanish. If the runners check into these events, they find nothing except a lone witness who saw a trio of elves



near Angel's home shortly before the fire. Angel and Lili have simply disappeared, and the album is never released.

AWARDING KARMA

Award Karma as follows.

TEAM KARMA

Party saves Angel	4
Party deals with Akmura	2
Party clears actions with yakuza	1
Icelady killed	-2

If Angel dies but the runners eliminate Akmura and provide proof of Angel's fate, Icelady can recover the rights to Angel's music. Award the team two Karma points for a partial success.

INDIVIDUAL KARMA

Award Individual Karma per p. 199, **SRII**, with the following addition:

Shadowrunner identified by yakuza	1
-----------------------------------	---

LEGWORK

CONTACTS

To follow up on or discover clues in this adventure, the player characters need to investigate people, places, and organizations. One of the best ways to get the information they need is through their contacts. This section provides success tables containing information on major characters, locations, and organizations available to the runners through these sources. The entries appear in the order in which players will likely investigate them.

To find out what a particular contact does or does not know, a player must make a Success Test using Street or Corporate Etiquette against a Target Number 4. The amount of information available from the contact depends on the number of successes the player achieves. Characters who achieve more than one success gain all the information available to all previous levels of success.

The gamemaster should try to make the player character's interaction with his contact consist of more than a few abstract die rolls. Play out the meeting in full: contacts are characters with their own lives, points of view, and needs, not simply spigots of information to be turned on and off automatically.

The player character rolls a number of dice equal to his Etiquette Skill to determine what information the contact knows and will impart. Once the number of successes is determined, the gamemaster can roleplay the encounter with the appropriate information level in mind. Tailor the meetings to the personality of specific contacts. Some will prefer a straightforward meet in a specific place, while others will only feel comfortable with elaborate forms of information exchange.

Contacts are generally considered trustworthy, as long as the runners play it safe. A player character should never compromise his contact by later tipping others to his source. Are the contact's ties stronger to his group or to the runner? A good runner never tests those ties by placing his contact in a position where he must choose.

The questions of whether or not the runner has to pay for his contact's services, and how soon the contact may want information or a favor in return, add another dimension to these encounters. Gamemasters who need a base-line value to determine fees for information can use the following formula. Multiply the contact's Skill Rating in his or her most appropriate Etiquette Skill by the number of successes the player rolled in his Etiquette Test. Multiply that total by the sum of the contact's Charisma and Intelligence. Then multiply that final value by 10. The result is in nuyen. Gamemasters will, of course, adjust the base result to reflect the actual contact involved. Apply normal Negotiation procedures to determine the final payment for the information.



Runners may also ask their contacts to "check around," "keep their ear to the ground," or some other idiom describing generally listening for news. In such a case, the gamemaster makes an appropriate Etiquette Test for the contact at +2 against the target number given in the information table. If the Etiquette Test results in any successes, the contact reports the appropriate information to the runner in 2D6 hours, or at a time determined by the gamemaster. This is an excellent way for gamemasters to ensure that a certain piece of information makes it to the runners. The cost of this service is determined as if the contact initially had access to the information (see above formula).

The gamemaster can add complexity to legwork by acknowledging that contacts are not always available at the convenience of the runners. Arrangements must be made before the actual meeting can take place. When a player character wants to meet with a contact, the gamemaster rolls 2D6, then multiplies the result by 30. The resulting base time is the number of minutes

needed to arrange the meeting with the contact. Players may elect to trade off successes from their Etiquette Test to reduce the time it takes to reach the contact, but they risk receiving less helpful information. In this case, the gamemaster can have the player make the character's Etiquette Test at the time he announces his intention to meet with the contact. The player should also decide at that time how many successes he will trade off to reduce the waiting period. The base time value should be kept secret.

ELECTRONIC LEGWORK

Deckers may also take an active role in acquiring general information. Many electronic information services exist in the era of **Shadowrun**—public, private, and secret—and these contain gigapulses of data comprising on-line conversations, rumors, stolen and dumped files, and the like. Deckers can create simple programs to search vast databases for key words and related terms, then download the information to their cyberdeck or Matrix-connected personal computer. Creating the search program is a trivial matter; gamemasters should assume all deckers have one.

Virtually any information available in this section can be found in the Matrix, if one knows where to look and has the time. The base time for such a search is 2D6 hours. The decker makes a Success Test against his or her Etiquette (Matrix) Skill, or defaults to Intelligence on the Skill Web. The target number is the same as given on the Information table. Hacking Pool dice may not be used to supplement this Success Test roll. Etiquette Test successes can be traded off to reduce the base time for receiving information. Appropriate Contact restrictions do not apply to obtaining information through the Matrix, though the player must indicate what kind of information sources he is searching. If the character is searching corporate-related databases, Corporate Contact information is appropriate. If the character is searching a street-level chat-line database, Street Contact information is appropriate.

A decker is limited in the number of subjects he can research simultaneously, based on his own abilities and the available time. The maximum number of searches that the decker can conduct at any one time is equal to half the character's Intelligence, divided by 2, rounded up. This base value assumes the decker does nothing but sit and search, continually adjusting the search paths and parameters. If the character wishes to perform other activities, the gamemaster must decide how much time those other activities take up and adjust the base value accordingly.

DARK ANGEL

A legend of the streets, Dark Angel made his career singing a strange, haunting style of protest music. Disgusted by the commercialism of the music industry, he never made records and turned down gigs in major establishments. Death transformed Dark Angel into a pop hero. The unexpected posthumous release of an Angel album, *Flaming Wings*, made him a novastar.

Appropriate Contacts

Club Habitué, Club Owner, Media Producer, any reporters or rocker types.

Successes	Result
1	"Angel comes from a corporate family, name of Crull. His folks worked in a Seattle branch of MCT. But Angel, he just didn't scan the <i>shaikujin</i> scene. Angel told the MCT boys to take their contract and slot it."
2-3	"Angel's brother, Edward, stuck with MCT. I heard Lone Star found Angel's body with a coupla trolls called Hack and Slash who wuz gonna sell him for spare parts. Ya wanna find the trogs, they hang out at Heaven."
4	"You know how Angel refused to make recordings? There's more to that than principle. Sure, he fraggin' hated the commercial drek, but there's some wiz producers out there, they ain't all suits. No, something scared him. He loved to sing, but he was scared of the public eye and even more fraggin' scared of making nuyen."
5	"Angel ain't dead. I can't tell you the where and the who, but I know a suit who says he's seen Angel since the so-called suicide. Claims he gives private concerts for some big wheel."

XANADU STUDIOS

This tiny studio meant nothing to anybody until its owner, Dynamo Blue, suddenly obtained rights to Dark Angel's music.

Appropriate Contacts

Club Habitué, Club Owner, Media Producer, any reporters or rocker types.

Successes	Result
1-2	"Dynamo? We're talking the chica with the highest body count in the biz. She comes from the old school of love 'em and dump 'em, and if they hang around, pound the drek out of 'em."
3	"Dynamo had no connection with Angel before Xanadu released <i>Flaming Wings</i> . None, nada, nothing."
4+	"I'll tell you this. Blue should be a lot richer than she is. Xanadu Studios has had two or three little successes, and now it's got a real hit on its hands, but you couldn't tell from her credstick. The studio's still a fragging hole, and Dynamo's still living on Nuke-&-Serve takeout."

EDWARD CRULL

Appropriate Contacts

Corporate Secretary, Company Man, Former Wage Mage, Mr. Johnson, Yakuza Boss. (Contacts with no connection to MCT or the yakuza are not likely to know anything about Crull. Roll 1D6 for each such contact the players approach. On a result of 4 or less, the source never heard of Crull, regardless of the Etiquette Test result. Contacts may remain close-mouthed in hopes of seeming more knowledgeable than they are, in order to net bribes or simply look important.)

Successes	Result
1	"Crull? He's a thaumaturgical analyst at MCT. He's not bad at what he does, but his career's going nowhere fast. Too bad for him, 'cause he's an ambitious little suitboy."
2	Same as above, but the contact knows Crull's address. See Brother to an Angel , p. 40.
3	"Apparently, Crull's family is a real embarrassment to him."
4+	"From what I hear, Crull needs some favors from the yak. He's sucking up to them real hard."



JANET KAWANO 1993

ONI-DO

Appropriate Contacts

Fixer, Street Samurai, Talismonger, Yakuza Boss, any dockworker type.

Successes	Result
1	"I guess you could call it an orphan society. You know how the Japanese feel about goblin kids? Well, if you're a mama-san in the Ginza with a troll in the family tree, the Oni-do will take the little trog off your hands."
2	"Buncha wizboys run the Oni-do. They take goblin kids and teach 'em to kill. They even breed trolls and train them from birth as hitters."
3	"Oni-do doesn't bother with drek like a cause. They dust folks for the fraggin' honor of a clean kill. And they sell their services to anyone with the cred."
4+	"Who do you think hires the Oni-do? Yakuza love that drek. In this city, their biggest employer's gotta be Akmura."

YAKUZA

Everybody in Seattle knows the yakuza. Like rats on a merchantman, the ancient crime syndicate rode Japan's expanding economic influence into every corner of the world. Yakuza tentacles extend everywhere, from simporn parlors and chip houses to corporate boardrooms. Famous for their code of *zuni*, or honor, in many places the yakuza serve as an unofficial government, enforcing their own brand of law.

Yakuza members mark themselves with colorful tattoos, always drawn in concealable places. The higher a gangster's rank in the yakuza, the more extensive the tattooing.

The yakuza have an ancient tradition of fraternity and vendetta, and may spend decades planning the perfect punishment for anyone who offends them. Anyone who harms a yakuza member without the sanction of other members has signed his own death warrant.

Appropriate Contacts

Fixer, Media Producer, Street Cop, Yakuza Boss, any Mafia type.

Successes	Result
1	"The three big <i>oyabuns</i> with their fingers in MCT are Shiro Usaka, Homatsu Jinjiro, and Kat Akmura."
2	"Homatsu's the senior <i>oyabun</i> of the bunch."
3+	"Usaka and Akmura are a pair of young Turks in the organization. They used to be fierce rivals, but they seem to be getting along lately."

KAT AKMURA

Appropriate Contacts

Club Habitué, Fixer, Media Producer, Yakuza Boss, any Mafia type.

Successes	Result
1	"She's a big lady in the yak. Don't frag with her."
2	"Akmura has her fingers in everything. Music, body-dumping, office politics at MCT—she's a woman of many interests."
3	"Akmura has a nasty taste for vengeance. She likes to keep her victims alive so she can gloat over them."
4+	"They say Kat stole Seattle out from under two or three big <i>oyabun</i> in Japan. She's aggressive and dangerous even by yakuza standards, but she's also made some big-time enemies."

SHIRO USAKA

Appropriate Contacts

Club Habitué, Fixer, Media Producer, Yakuza Boss, any Mafia type.

Successes	Result
1-2	"Shiro's a rising star in the yakuza. You know the Mindwarp? That's his club. If you want, I can probably set up a meet." (The contact may demand a bribe to set up the meet. See Mindwarp , p. 31, for more information.)
3+	"Usaka used to rumble with another hotshot yak, Kat Akmura. But they seem to have gotten kind of chummy recently."

HOMATSU JINJIRO

Although Homatsu keeps a low profile, his name sounds vaguely familiar to most contacts. He gets involved in Seattle politics and turns up at corporate social gatherings, but few people know exactly what he does or why the big shots listen to him.

Appropriate Contacts

City Official, Fixer, any corporate official or Mafia type.



JANET FALKIO '83

Successes	Result
1-2	"Homatsu Jinjiro is one of the oldest powerbrokers in this 'plex, chummer. He's <i>oyabun</i> in the Sword Water Society. I don't wanna say more, but if you have business with the man, I think I could set up a meet. He lives at an estate called Marian Parks." (The contact may demand a bribe to set up the meet. See Marian Parks , p. 37, for more information.)
3+	"Homatsu is most disturbed at the trend of the times. The younger yakuza lack the respect for honor of his generation, and their wanton greed and violence infuriate him. He will soon teach them their place."

CAST OF SHADOWS

The following NPCs play principal roles in the story of **Dark Angel**. Because they will likely appear more than once in the course of the adventure, their statistics and descriptions are grouped together here for convenience. The characters are presented in alphabetical order. Descriptions and statistics for other, minor characters are presented in the particular encounter sections where those characters appear.

AKIMOTO

This taciturn, grim-faced loner drifted for many years, unable to fit into Japan's conformist, corporate society until he discovered the Oni-do. As a man lacking honor, morality, or loyalty to anything other than the Oni-do, he finds the life of an assassin to his liking. His skills as a Rat shaman make him invaluable to the troll killers of the Oni-do.

Akimoto uses meditation as a Centering Skill.



Attributes

Body: 4 Willpower: 6
 Quickness: 5 Essence: 6
 Strength: 1 Magic: 8
 Charisma: 3 Reaction: 5
 Intelligence: 5

Initiative: 5 + 1D6

Threat/Professional Rating: 4/4

Skills

Conjuring: 5 Sorcery (Spellcasting): 7
 Firearms: 3 Stealth (Urban): 8

Gear

Armor Jacket (5/3)
 Browning Max-Power [Heavy Pistol, 10 shots (clip), w/2 extra clips, SA, 9M, Laser Sight (-1 modifier to target numbers)]
 Fetishes (10 of each type)

Totem: Rat, Grade 2 Initiate, (initiated by Oni-do, no geasa outstanding)

Spells

Detection	Manipulation
Combat Sense: 2	Barrier: 2
Health	Clout: 3
Treat: 2	Mob Mind: 4
Illusion	
Chaos: 2	
Chaotic World: 3	
Invisibility: 5	

CONDITION MONITOR				
	LIGHT STUN	MODERATE STUN	SERIOUS STUN	DEADLY STUN
STUN	+1 TN# -1 Init.	+2 TN# -2 Init.	+3 TN# -3 Init.	Unc.
PHYSICAL	+1 TN# -1 Init.	+2 TN# -2 Init.	+3 TN# -3 Init.	Unc. maybe dead
	LIGHT WOUND	MODERATE WOUND	SERIOUS WOUND	DEADLY WOUND

KAT AKMURA

From lowly gutterpunks to powerful corporate officials, all the denizens of the sprawl give Kat Akmura a wide berth. This diminutive tyrant of organized crime never fails to punish those who offend her, and she may wait decades to achieve the perfect revenge.

Akmura obtained power rapidly by yakuza standards, resorting to any tactic she could get away with to ruin her enemies. Although Akmura technically kept her activities within the crime syndicate's codes of acceptable behavior, her meteoric rise has displeased the more conservative yakuza, especially those who harbor private desires to control her operations.

The Angel affair constitutes a footnote in Akmura's rise to power. Although Akmura naturally appreciates the chance to skim profits from a mega-hit record, it was Angel's defiance rather than a lust for nuyen that prompted Akmura to strike out at him. Angel

insulted her, and she sought revenge.

Kat Akmura harbors traditional yakuza ambitions, wishing to gradually expand her power and destroy those who oppose her. Having shown Angel her power, she would gladly release him in return for some more valuable prize. The team may succeed in negotiating with her, but she is not a pleasant woman to deal with.

A plain little woman, Akmura wears her hair in two black braids and her eyes glitter like a hawk's. Her features seem frozen in a permanent frown. Akmura dresses in casual Western clothing, with an arrogant disregard for high fashion.

Attributes

Body: 5 Intelligence: 6
 Quickness: 6 Willpower: 6
 Strength: 4 Essence: 2
 Charisma: 3 Reaction: 6 (10)

Initiative: 10 + 3D6

Threat/Professional Rating: 3/4

Skills

Etiquette (Corporate): 6 Leadership: 5
 Etiquette (Street): 5 Negotiation: 6
 Etiquette (Yakuza): 6 Stealth: 5
 Firearms: 6 Unarmed Combat: 4

Cyberware

Datajack
 Cybereyes (Flare Compensation, Thermographic)
 Headware Memory (10 Mp)
 Smartlink
 Wired Reflexes (2)

Gear

Armor Clothing (3/0)
 SCK Model 100 [SMG, 30 (clip), SA/BF, 7M, w/2 extra clips,
 Gas Vent III, Internal Smartlink]

		CONDITION MONITOR			
		LIGHT STUN	MODERATE STUN	SERIOUS STUN	DEADLY STUN
STUN	+1 TN#	+2 TN#	+3 TN#		Unc.
	-1 Init.	-2 Init.	-3 Init.		
PHYSICAL	+1 TN#	+2 TN#	+3 TN#		Unc. maybe dead
	-1 Init.	-2 Init.	-3 Init.		
		LIGHT WOUND	MODERATE WOUND	SERIOUS WOUND	DEADLY WOUND

CHIGO AKWE

At the age of 14, Akwe sought enlightenment in the arts of ninjutsu. The silent warriors of the Sword Water clan offered Chigo the teaching he desired, and he gradually attained wisdom as well as great skill in the martial arts. Unconcerned with the politics or motivations of the yakuza, Chigo cares only for the mystic beauty of his art. Every move Akwe makes displays grace and simplicity of action.



Attributes

Body: 6 Willpower: 6
 Quickness: 6 Essence: 6
 Strength: 4 Magic: 6 (10)
 Charisma: 2 Reaction: 6
 Intelligence: 6

Initiative: 6 + 3D6

Threat/Professional Rating: 5/4

Skills

Athletics: 6 Stealth: 8
 Armed Combat: 7 Unarmed Combat: 7
 Firearms: 4

Grade of Initiation: 4 (Initiated by Sword Water clan ninja)

Gear

Ares Squirt [w/2 10-round cartridges of DMSO, Special]*
 1 Ampule of Cyanide (4D3, 10 rounds)
 1 Ampule of Hyper (4S2, 10 rounds)**

Armor Jacket (5/3)

2 Offensive Grenades (10S)

Heckler & Koch HK227 [SMG, 28 (clip), SA/BF/FA, 7M, w/2 extra clips, Gas Vent II]

Monofilament Whip, ready for use (Reach 2, 10S)

Monofilament Whip, taped to leg (Reach 2, 10S)

*DMSO is used as a carrier to deliver other chemical agents.

It forces the skin to instantly absorb a delivered chemical. Rigid armor (higher than 5, or plated) applies half its Defensive Rating (rounded up) against DMSO attacks; porous armor, such as armor clothing, provides no protection.

**Apply a +1 modifier to all target numbers for tests a victim makes while under the drug's influence, which normally lasts 60 minutes. Following exposure, the victim makes a Body (4) Test; each success the player character achieves reduces the duration of the drug's effects by 5 minutes. Add a +4 modifier to all target numbers for concentration tasks (including spellcasting) a victim attempts during this time. For any additional damage taken by the victim while drugged, add half the value of the actual inflicted damage (round up) to the victim's Mental Condition Monitor.

Physical Adept Abilities

Improved Ability (Armed Combat): 3

Improved Ability (Athletics): 2

Improved Ability (Stealth): 4

Improved Physical Senses: Hearing (Damper, Hearing Amplification), Sight (Flare Compensation, Thermographic Vision)

Increased Reflexes: (2)

Pain Resistance: (4)



the price of doing business. The studio owner can guess that Angel is still alive, because her contacts behave as if they have a bottomless supply of his recordings for eventual release.

Attributes

Body: 5 Intelligence: 4
 Quickness: 6 Willpower: 6
 Strength: 4 Essence: 5.6
 Charisma: 5 Reaction: 5

Initiative: 5 + 1D6

Threat/Professional Rating: 3/3

Skills

Etiquette (Media): 5 Stealth: 5
 Etiquette (Street): 4 Unarmed Combat: 4
 Firearms: 6

Cyberware

Datajack
 Synthlink Interface

Gear

Armor Jacket (5/3)
 Heckler & Koch HK227 [SMG, 28 (clip), SA/BF/FA, 7M, w/2 extra clips, Gas Vent III, Laser Sight (-1 modifier to target numbers)]

CONDITION MONITOR				
	LIGHT STUN	MODERATE STUN	SERIOUS STUN	DEADLY STUN
STUN	+1 TN# -1 Init.	+2 TN# -2 Init.	+3 TN# -3 Init.	Unc.
PHYSICAL	+1 TN# -1 Init.	+2 TN# -2 Init.	+3 TN# -3 Init.	Unc. maybe dead
	LIGHT WOUND	MODERATE WOUND	SERIOUS WOUND	DEADLY WOUND

DYNAMO BLUE

Dynamo Blue operates one of Seattle's minor recording studios. Sometimes, her business seems downright charitable; she gives young bands a place to start and markets records too radical for the major corporations to touch. Other times, Dynamo's business gets nastier. The world of small time rock 'n' roll overlaps with the world of big-time crime, and she has no choice but to work with the yakuza.

Tough and shrewd, Dynamo can handle the rougher side of her career. Because her aggressiveness often leads her into turbulent love affairs, Dynamo has a racy reputation. This lady knows how to protect herself, carries a respectable weapon and even makes the occasional shadowrun.

Dynamo played no part in planning the Angel affair until Edward Crull ordered her to release *Flaming Wings*, an order she happily carried out. The yakuza take nearly all Xanadu's profits for themselves, but as long as she gets a cut, Dynamo can live with

CONDITION MONITOR				
	LIGHT STUN	MODERATE STUN	SERIOUS STUN	DEADLY STUN
STUN	+1 TN# -1 Init.	+2 TN# -2 Init.	+3 TN# -3 Init.	Unc.
PHYSICAL	+1 TN# -1 Init.	+2 TN# -2 Init.	+3 TN# -3 Init.	Unc. maybe dead
	LIGHT WOUND	MODERATE WOUND	SERIOUS WOUND	DEADLY WOUND

EDWARD CRULL

Born in the Mitsuhamas corporate complex, Edward grew up to become the ultimate corporate suit. He lives by office memos and quarterly reports and measures the value of his life by his salary. His gray suit and dark tie have become a part of him.

When Edward discovered his aptitude for magic, he naturally sought a position in Mitsuhamas's Thaumaturgical Department. Once there, however, he found the road to promotion slow and his competition fierce. Craving advancement and willing to do anything to get it, Edward became an agent of the yakuza.

Even as a child, Edward hated having a metahuman as a younger brother. Angel's dreamy ideals and musical pretensions struck Edward as frivolous. When Angel's affront to Kat Akmura blocked Edward's promotion at MCT, Edward wanted to kill his brother. Instead, he gladly assisted in his sibling's kidnapping.

Edward keeps two earth elementals, an air elemental, and two water elementals in readiness at all times. All are Force 5. Crull uses these spirits to sustain combat senses, chaotic world and barrier spells to protect himself in a battle. The others aid his sorcery.

Attributes

Body: 2 Willpower: 5
 Quickness: 5 Essence: 6
 Strength: 1 Magic: 6 (9)
 Charisma: 5 Reaction: 5
 Intelligence: 5

Initiative: 5 + 1D6

Threat/Professional Rating: 3(6*)/4 (*for sorcery only)

Skills

Conjuring: 5 Magic Theory: 6
 Etiquette (Corporate): 6 Sorcery (Spellcasting): 7

Gear

Armor Clothing (3/0)
 Fetishes (10 of each type)
 Power Focus (3)
 Walther Palm Pistol [Hold-Out, 2 (barrel), SS, 4L]

Spells

Combat

Stunblast: 4
 Stun Bolt: 4

Illusion

Chaos: 4
 Chaotic World: 5

Detection

Analyze Device: 5
 Combat Senses: 2
 Mind Probe: 3

Manipulation

Barrier: 4
 Magic Fingers: 4
 Personal Physical Barrier: 5

DARK ANGEL (JIM CRULL)

From the day he was born, Jim Crull seemed determined to be different. In a family of human *shaikujin*, he was an elf and a rebel. As the youngest child, he monopolized his parents' attention, infuriating his elder brother, Edward. No matter how much they wanted to, Angel's family could not deny his musical talent.

Like a good little *shaikujin*, Edward set his sights on a corporate career. Jim, the misfit, wanted to be a rocker. Their ambitions clashed disastrously when Edward sought career help from the yakuza. Kat Akmura demanded that Edward's entire family pledge their loyalty to her in a traditional ceremony, but Jim refused to go along. Instead, he fled to the streets, where he could pursue his dream free from the demands of his family.

Jim's musical interests lie in reviving the lost elven ballads. He hears these songs in his dreams and believes that they are fragments of racial memory. He incorporates these tunes into his songs to create his unique style of music. Magicians, elves, Amerindians and haters of soulless cyber culture delight in Dark Angel's fresh approach to rock and roll. Some call Angel a new kind of adept, a true bard whose music is a form of magic.



CONDITION MONITOR

	LIGHT STUN	MODERATE STUN	SERIOUS STUN	DEADLY STUN
STUN	+1 TN# -1 Init.	+2 TN# -2 Init.	+3 TN# -3 Init.	Unc.
PHYSICAL	+1 TN# -1 Init.	+2 TN# -2 Init.	+3 TN# -3 Init.	Unc. maybe dead
	LIGHT WOUND	MODERATE WOUND	SERIOUS WOUND	DEADLY WOUND

CAST OF SHADOWS

During most of his career, Angel refused to record his songs, citing his distaste for the music industry and commercialism in general. Jim did not want to grow rich, because he knew that acquiring wealth would make him vulnerable to Kat Akmura. Though Angel remained poor, Akmura got her revenge nonetheless.

Angel's experiences as Kat Akmura's "guest" aged him dramatically. He tried to sustain himself through his music, magic and elven heritage, but captivity stripped him of his carefree spirit. The forced incarceration, however, led him into a period of introspection that deepened his spiritual awareness. When freed, Angel seems properly grateful to his rescuers, but quiet and pensive.

Though Angel has handsome features, his tall, gaunt build and long dark hair make him look almost spectral. His rich, sonorous voice rises slightly when he sings.

Attributes

Body: 2	Willpower: 4
Quickness: 7	Essence: 6
Strength: 2	Magic: 6
Charisma: 8	Reaction: 5
Intelligence: 4	

Initiative: 5 + 1D6

Threat/Professional Rating: 3/4

Skills

Etiquette (Street): 4
Firearms: 2
Unarmed Combat: 2

Special Skills

Elven History: 2
Instrumental Music: 6
Singing: 6

Notes: Angel's talent for song borders on the supernatural. This talent has no special powers in combat, but gives him a musical ability beyond that of any mundane. Whether or not this makes his music superior, of course, remains a matter of taste. In any event, Angel never uses synthesized sound. If viewed astrally, Dark Angel displays a magician's aura.

		CONDITION MONITOR			
		LIGHT STUN	MODERATE STUN	SERIOUS STUN	DEADLY STUN
STUN	+1 TN#	+2 TN#	+3 TN#		Unc.
	-1 Init.	-2 Init.	-3 Init.		
PHYSICAL	+1 TN#	+2 TN#	+3 TN#		Unc. maybe dead
	-1 Init.	-2 Init.	-3 Init.		
		LIGHT WOUND	MODERATE WOUND	SERIOUS WOUND	DEADLY WOUND

HOMATSU JINJIRO

Homatsu Jinjiro ranks among the legends of the Seattle underworld. One of the city's oldest *oyabun*, Jinjiro has managed his territory for more than thirty years and has grown extremely powerful. Few on the street would recognize him; he wields his



vast influence from behind the scenes, overseeing lesser yakuza who carry out his operations.

Jinjiro rose to his position through tact, caution and ancient yakuza traditions. The rash, flamboyant tactics of the younger gangsters disgust him, and he fears their activities might prompt a police crackdown on the entire Seattle racket or even a ruinous civil war within the yakuza.

Jinjiro speaks in a low, calm voice. No shock can break his outward serenity and only his snow-white hair and the tiny wrinkles around his eyes betray his age.

Attributes

Body: 4	Intelligence: 6
Quickness: 6	Willpower: 6
Strength: 4	Essence: 2.9
Charisma: 5	Reaction: 6 (10)

Initiative: 10 + 3D6

Threat/Professional Rating: 3/3

Skills

Armed Combat: 6	Leadership: 7
Etiquette (Corporate): 6	Negotiation: 8
Etiquette (Street): 7	Stealth: 5
Etiquette (Yakuza): 9	Unarmed Combat: 4

CAST OF SHADOWS

Cyberware

Datajack
Wired Reflexes (2)

Gear

Armor Clothing (3/0)
Monofilament Whip [Reach 2, (10S)]

CONDITION MONITOR																																					
			LIGHT STUN	MODERATE STUN	SERIOUS STUN	DEADLY STUN																															
STUN	+1 TN#	-1 Init.	+2 TN#	-2 Init.	+3 TN#	-3 Init.						Unc.																									
	<table border="1" style="width: 100%; border-collapse: collapse; text-align: center;"> <tr> <td style="width: 10%;">PHYSICAL</td> <td style="width: 5%;">+1 TN#</td> <td style="width: 5%;">-1 Init.</td> <td style="width: 5%;">+2 TN#</td> <td style="width: 5%;">-2 Init.</td> <td style="width: 5%;">+3 TN#</td> <td style="width: 5%;">-3 Init.</td> <td style="width: 5%;"></td> <td style="width: 5%;"></td> <td style="width: 5%;"></td> <td style="width: 5%;"></td> <td style="width: 5%;"></td> <td style="width: 5%;">Unc. maybe dead</td> </tr> <tr> <td colspan="3"></td> <td>LIGHT WOUND</td> <td>MODERATE WOUND</td> <td>SERIOUS WOUND</td> <td colspan="4">DEADLY WOUND</td> <td colspan="3"></td> </tr> </table>												PHYSICAL	+1 TN#	-1 Init.	+2 TN#	-2 Init.	+3 TN#	-3 Init.						Unc. maybe dead				LIGHT WOUND	MODERATE WOUND	SERIOUS WOUND	DEADLY WOUND					
PHYSICAL	+1 TN#	-1 Init.	+2 TN#	-2 Init.	+3 TN#	-3 Init.						Unc. maybe dead																									
			LIGHT WOUND	MODERATE WOUND	SERIOUS WOUND	DEADLY WOUND																															



KOJIKA

A talent for magic propelled Kojika from the ranks of yakuza soldiers to a position as Shiro Usaka's chief henchman, and he shares his master's lack of scruples and appetite for pleasure. Kojika's rapid rise has made him arrogant and cruel, and his plump, pouting face makes him look like a jaded dilettante.

Kojika keeps two water elementals, two earth elementals, and one air elemental at his command, all Force 5. If he expects trouble, he commands his air elemental to sustain a combat sense spell while an earth elemental sustains an armor spell. When feasible, he uses a water elemental to sustain an invisibility spell.

Attributes

Body: 4
Quickness: 4
Strength: 1
Charisma: 5
Intelligence: 4
Willpower: 6
Essence: 6
Magic: 6
Reaction: 4

Initiative: 4 + 1D6

Threat/Professional Rating: 4/4

Skills

Conjuring: 6
Interrogation: 4
Sorcery (Spellcasting): 7
Stealth: 6

Gear

Armor Jacket (5/3)

Spells

Combat

Stun Bolt: 4
Stunblast: 4
Wrecker: 4

Illusion

Chaotic World: 4
Invisibility: 2
Physical Mask: 2

Detection

Analyze Device: 5
Combat Sense: 2
Mind Probe: 3

Manipulation

Armor: 3
Clout: 2
Influence: 2
Levitate Item: 2

Healing

Cure D Disease: 2
Detox D Toxin: 2
Heal: 2

CONDITION MONITOR																																					
			LIGHT STUN	MODERATE STUN	SERIOUS STUN	DEADLY STUN																															
STUN	+1 TN#	-1 Init.	+2 TN#	-2 Init.	+3 TN#	-3 Init.						Unc.																									
	<table border="1" style="width: 100%; border-collapse: collapse; text-align: center;"> <tr> <td style="width: 10%;">PHYSICAL</td> <td style="width: 5%;">+1 TN#</td> <td style="width: 5%;">-1 Init.</td> <td style="width: 5%;">+2 TN#</td> <td style="width: 5%;">-2 Init.</td> <td style="width: 5%;">+3 TN#</td> <td style="width: 5%;">-3 Init.</td> <td style="width: 5%;"></td> <td style="width: 5%;"></td> <td style="width: 5%;"></td> <td style="width: 5%;"></td> <td style="width: 5%;"></td> <td style="width: 5%;">Unc. maybe dead</td> </tr> <tr> <td colspan="3"></td> <td>LIGHT WOUND</td> <td>MODERATE WOUND</td> <td>SERIOUS WOUND</td> <td colspan="4">DEADLY WOUND</td> <td colspan="3"></td> </tr> </table>												PHYSICAL	+1 TN#	-1 Init.	+2 TN#	-2 Init.	+3 TN#	-3 Init.						Unc. maybe dead				LIGHT WOUND	MODERATE WOUND	SERIOUS WOUND	DEADLY WOUND					
PHYSICAL	+1 TN#	-1 Init.	+2 TN#	-2 Init.	+3 TN#	-3 Init.						Unc. maybe dead																									
			LIGHT WOUND	MODERATE WOUND	SERIOUS WOUND	DEADLY WOUND																															

KURE

Kure entered puberty as a human in Japanese corporate society. The shock of goblinization occurring soon afterward ravaged his mind, and his parents' attempts at "treatment" deranged him further. By the time the Oni-do found Kure, he had the mentality of a young child, but the body of an enormous troll, as well as the magical gifts of a physical adept.

CAST OF SHADOWS

Kure thinks of the leaders of Oni-do as parents. He loves and trusts them enough to do absolutely anything they ask, and they have no difficulty convincing him to work as an assassin.

Attributes

Body: 10 (11) Willpower: 4
 Quickness: 3 Essence: 6
 Strength: 10 Magic: 6
 Charisma: 1 Reaction: 2 (4)
 Intelligence: 1

Initiative: 4 + 2D6

Threat/Professional Rating: 4/3

Skills

Athletics: 2 Gunnery: 3
 Armed Combat (Katana): 8 Stealth: 6
 Firearms: 4 Unarmed Combat: 3

Gear

Armor Jacket (5/3)
 Heckler & Koch HK227 [SMG, 28 (clip), SA/BF/FA, 7M, w/2 extra clips]
 Katana [Reach 1, 13M]

Physical Adept Abilities

Improved Ability (Armed Combat): 3
 Improved Physical Attributes (Body): 1
 Increased Reflexes (2)

CONDITION MONITOR				
	LIGHT STUN	MODERATE STUN	SERIOUS STUN	DEADLY STUN
STUN	+1 TN# -1 Init.	+2 TN# -2 Init.	+3 TN# -3 Init.	Unc.
PHYSICAL	+1 TN# -1 Init.	+2 TN# -2 Init.	+3 TN# -3 Init.	Unc. maybe dead
	LIGHT WOUND	MODERATE WOUND	SERIOUS WOUND	DEADLY WOUND

SHIRO USAKA

Shiro is the weakest of the three *oyabun* appearing in **Dark Angel**. This ambitious and frustrated crime boss wants to advance any way he can, and for many years he fought to take over rackets belonging to Kat Akmura. After repeated defeats, he switched tactics. Realizing that his constant battles with Akmura merely ensured that Homatsu Jinjiro would remain the senior *oyabun* in their crime ring, Shiro formed an alliance of convenience with Akmura.

Usaka has the smile and personality of a shark. He makes his headquarters within the glittering pleasure palace known as the Mindwarp and never misses a chance to indulge in food, drink or women. Shiro possesses considerable cunning, but his impatience prevents his more subtle plans from succeeding. Although Usaka is only in his thirties, he is nearly bald.



Attributes

Body: 5 Intelligence: 6
 Quickness: 5 Willpower: 5
 Strength: 4 Essence: 3.15
 Charisma: 4 Reaction: 5 (7)

Initiative: 7 + 2D6

Threat/Professional Rating: 4/3

Skills

Etiquette (Corporate): 5 Leadership: 4
 Etiquette (Street): 5 Negotiation: 4
 Etiquette (Yakuza): 5 Unarmed Combat: 4
 Firearms: 6

Cyberware

Chipjack
 Cybereyes (Flare Compensation, Thermographic)
 Datajack
 Smartlink
 Wired Reflexes (1)

Gear

Armor Jacket (5/3)
 SCK Model 100 [SMG, 30 (clip), SA/BF, 7M, w/2 extra clips,
 Gas Vent III, Internal Smartlink]

CONDITION MONITOR				
	LIGHT STUN	MODERATE STUN	SERIOUS STUN	DEADLY STUN
STUN	+1 TN# -1 Init.	+2 TN# -2 Init.	+3 TN# -3 Init.	Unc.
PHYSICAL	+1 TN# -1 Init.	+2 TN# -2 Init.	+3 TN# -3 Init.	Unc. maybe dead
	LIGHT WOUND	MODERATE WOUND	SERIOUS WOUND	DEADLY WOUND

GAMEMASTER'S NOTE: If the players are unsuccessful, give them this to read.

Seattle News Intelligencer Update-Net Friday, September 8 2051/14:00/1. Local News/Seattle

TODAY'S HEADLINES:

KNIGHT ERRANT WINS AT CANNES

The world's connoisseurs of commercials bestowed their highest honor on the Seattle branch of Knight Errant Securities Thursday. In a ceremony in Cannes, France, the Association of Advertising Producers selected KE's recent advertising campaign as the best commercial art of 2051. The well-known ads consist of video clips apparently filmed during an actual security operation. The spots feature scenes of subterranean combat, complete with automatic weapons, high explosives and extended footage of a berserk shaman in action.

RESEARCH SCIENTIST DIES IN SHARK ATTACK

A local parazoologist was killed by a school of torpedo sharks Thursday while conducting field studies of the species. Researcher Luke Emerson of the Seattle Paranormal Facility was gathering data for a study of feeding frenzies among *Portheus velocis*, colloquially known as the torpedo shark, when he was killed in such a frenzy. "He had said he really wanted to 'get inside' these animals," commented a colleague, Dr. Sheila Clinton of Seattle University. "I guess he got his wish."

FALLEN ANGEL

Earth Dawn, the second Dark Angel album from Xanadu Studios, hit the record stores Thursday. Although sales have been respectable, public interest in the elven singer has clearly waned since the release of *Flaming Wings*, which coincided with news of the singer's dramatic suicide.

"These trends only last so long," said Nigel Spector, the owner of Infinity Music, a major Seattle record emporium. "Even death can't make you immortal."

FRIENDS OF TROLLS ANNOUNCES RECRUITMENT DRIVE

The metahuman awareness group, Friends of Trolls, kicked off its second recruitment drive this week. For a donation of 5,000 nuyen, individuals receive T-shirts and bumper stickers identifying themselves as Trollfriends.

"I think this group is a really positive thing," says Butch Hatchett, himself a troll and a leader in the Trollfriends movement. "Showing one's support for the troll community isn't just a matter of politics. It's a very healthy step for an individual."



GAMEMASTER'S NOTE: If the players are successful, give them this to read.

Seattle News Intelligencer Update-Net Friday, September 8 2051/14:00/1. Local News/Seattle

TODAY'S HEADLINES:

KNIGHT ERRANT WINS AT CANNES

The world's connoisseurs of commercials bestowed their highest honor on the Seattle branch of Knight Errant Securities Thursday. In a ceremony in Cannes, France, the Association of Advertising Producers selected KE's recent advertising campaign as the best commercial art of 2051. The well-known ads consist of video clips apparently filmed during an actual security operation. The spots feature scenes of subterranean combat, complete with automatic weapons, high explosives and extended footage of a berserk shaman in action.

RESEARCH SCIENTIST DIES IN SHARK ATTACK

A local parazoologist was killed by a school of torpedo sharks Thursday while conducting field studies of the species. Researcher Luke Emerson of the Seattle Paranormal Facility was gathering data for a study of feeding frenzies among *Portheus velocis*, colloquially known as the torpedo shark, when he was killed in such a frenzy. "He had said he really wanted to 'get inside' these animals," commented a colleague, Dr. Sheila Clinton of Seattle University. "I guess he got his wish."

BACK FROM THE DEAD

Disproving recent reports of his suicide, the well-known elven musician Dark Angel returned to Seattle Thursday, where he appeared at a downtown record store to announce the release of his second album, *Earth Dawn*.

Angel revealed little about his disappearance and reported death. "What lies in the past is over," he said, declining to comment further.

The musician also withheld to comment on the abrupt cancellation of his relationship with Xanadu Studios, which released Angel's first album, *Flaming Wings*. Zor Entertainment now handles all Angel productions.

FRIENDS OF TROLLS ANNOUNCES RECRUITMENT DRIVE

The metahuman awareness group, Friends of Trolls, kicked off its second recruitment drive this week. For a donation of 5,000 nuyen, individuals receive T-shirts and bumper stickers identifying themselves as Trollfriends.

"I think this group is a really positive thing," says Butch Hatchett, himself a troll and a leader in the Trollfriends movement. "Showing one's support for the troll community isn't just a matter of politics. It's a very healthy step for an individual."

