

Palladium Books® Presents:

Free Quebec™

Rifts® World Book 22:

By Francois DesRochers
& Kevin Siembieda



Warning!

Violence and the Supernatural

The fictional world of Rifts® is violent, deadly and filled with supernatural monsters. Other-dimensional beings often referred to as “demons,” torment, stalk and prey on humans. Other alien life forms, monsters, gods and demigods, as well as magic, insanity, and war are all elements in this book.

Some parents may find the violence, magic and supernatural elements of the game inappropriate for young readers/players. We suggest parental discretion.

Please note that none of us at Palladium Books® condone or encourage the occult, the practice of magic, the use of drugs, or violence.

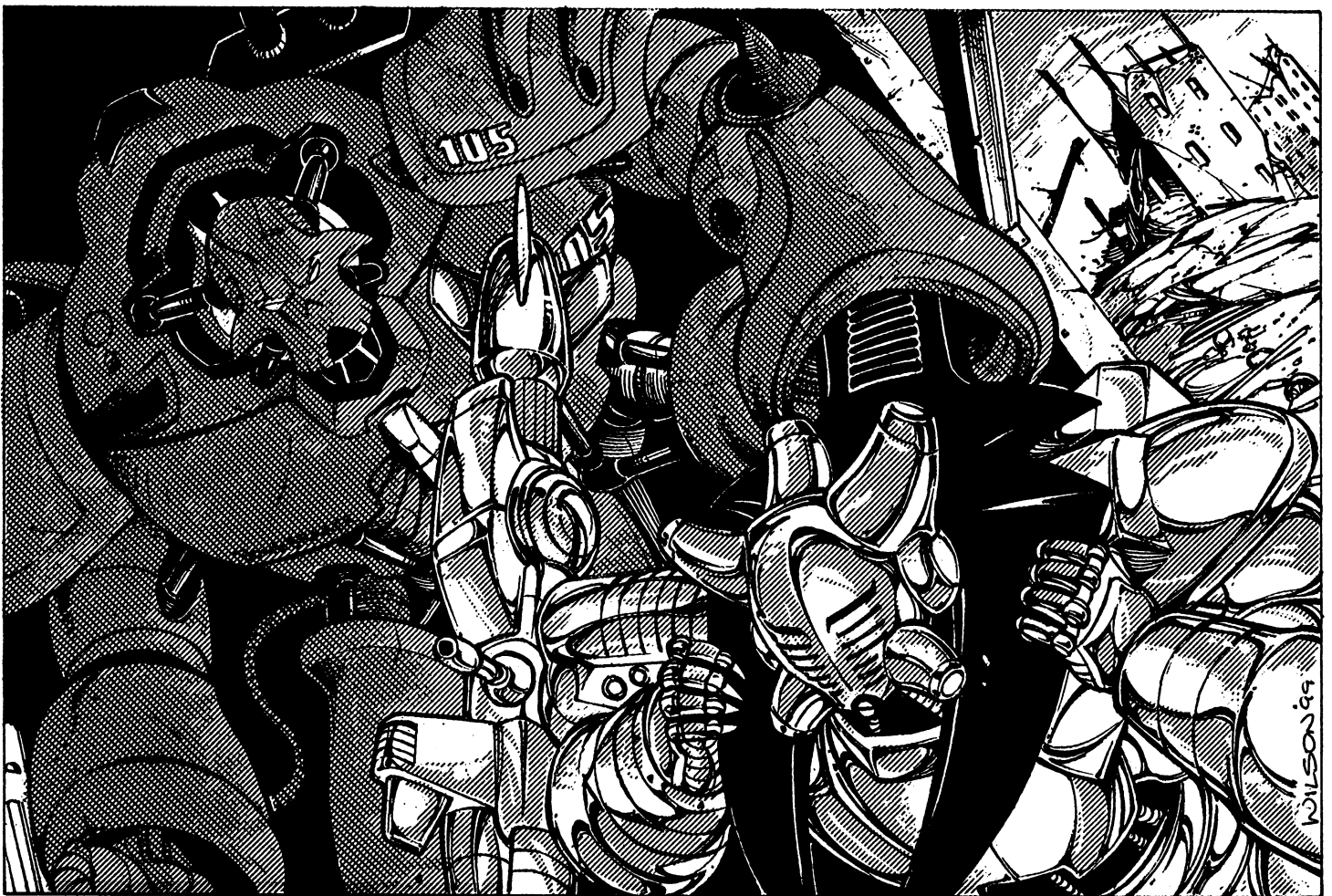

An epic world book for the Rifts® series.

Compatible with the entire Palladium Books® Megaverse®!

Dedication

To all our fans who have waited so patiently for this sourcebook, we hope you enjoy it.

— *Kevin Siembieda, 2000*

The cover is by John Zeleznik, and depicts a classic Glitter Boy facing a trio of Glitter Boy Killers in the ruins of a border city.

PDF Edition – March 2016

Copyright 2000 Palladium Books Inc. & Kevin Siembieda

All rights reserved, worldwide, under the Universal Copyright Convention. No part of this book may be reproduced in part or whole, in any form or by any means, without permission from the publisher, except for brief quotes for use in reviews. All incidents, situations, institutions, governments and people are fictional and any similarity, without satiric intent, of characters or persons living or dead, is strictly coincidental.

Palladium Books®, Rifts®, The Rifter®, RECON®, Phase World®, The Mechanoid Invasion® and Megaverse® are registered trademarks owned and licensed by Kevin Siembieda and Palladium Books Inc.

Coalition War Campaign, Coalition Navy, Coalition States, Old Bones, Free Quebec, Lazlo, Northern Gun, Manistique Imperium, Wilk's, Chi-Town, Iron Heart, Triax & The NGR, Lone Star, Psyscape, Federation of Magic, Glitter Boy, Glitter Girl, Boom Gun, Erin Tarn, Emperor Prosek, Skelebots, Xiticix, SAMAS, V-SAM, Violator SAMAS, Dog Boy, Dog Pack, Techno-Wizard, Ley Line Walker, Shifter, Headhunter, Cyber-Knight, Psi-Stalker, Mind Melter, Burster, Zapper, Brodkil, Juicer, Crazy, 'Borg, 'Bot, 'Burb, D-Bee, Cyber-Doc, Kitanni, Splugorth, Splynn Dimensional Market, Tundra Ranger, and other names, titles, character names and character likenesses are trademarks owned by Kevin Siembieda and Palladium Books Inc.

Palladium On-Line: www.palladiumbooks.com

Rifts® World Book 22: Free Quebec™ is published by Palladium Books Inc., 39074 Webb Court Westland, MI 48185. Printed in the USA.

**Palladium Books® Presents:
Rifts® World Book 22:**

Free Quebec™

Written by: **Kevin Siembieda**
& **Francois DesRochers**

Additional Text: **Bill Coffin**

Editors: **Alex Marciniszyn**
Wayne Smith

Proofreader: **Julius Rosenstein**

Cover Painting: **John Zeleznik**

Interior Artists: **Ryan Beres**
Wayne Breaux Jr.
Kent Burles
Brandon C. Clark (DSS)
Scott Johnson
Ramon Perez Jr.
Michael Wilson

Art Direction, Keylining & Maps: **Kevin Siembieda**

Typography: **Maryann Siembieda**

Based on the RPG rules, text, characters,
concepts and Megaverse® created by **Kevin Siembieda**.

Palladium Books On-Line: www.palladiumbooks.com

Special Thanks to Ryan Beres for his dynamic concepts and designs for the new *Glitter Boy variants* and to Ramon Perez for his design work for the Quebec military, weapons, V-SAM and war machines. Also to Francois for his valued contributions and professionalism, and last but not least, to the pulse pounding contributions of Wayne B., Kent, Mike, and my other artists, as well as Maryann, Steve, Alex, Wayne S. and the Palladium crew.

— *Kevin Siembieda, 2000*

Content

The Coalition at War	7	Cougar Hover Jeep	53
Danger Signs	7	Bobcat Hover Cycle	55
Erin Tarn's Perspective	9	Glitter Boy Transport	57
Catalyst for War	11	Reloader Hover Vehicle	60
Coalition Fronts	14	Robot Vehicles	62
Tolkeen: The Western Front	14	QR-1 Enforcer Prime	63
Free Quebec: The Eastern Front	15	QR-2 Abolisher Prime	65
Coalition Casualty Report (105 P.A.)	15	QR-3 Guardian Robot	66
Standard Procedure Against Free Quebec	16	Glitter Boys	70
Facing the Enemy	16	Erin Tarn on Glitter Boys	70
Behind the Scenes	17	Free Quebec's Glitter Boy Advantage	72
Iron Heart	18	Glitter Boys of Today	74
CS Military	18	GB Weaknesses & Vulnerabilities	74
Triax & The NGR	19	GB Small Squad Tactics	76
Free Quebec	19	Glitter Boy Legions	77
Re-birth of a Nation (overview)	19	Typical Glitter Boy Legion	77
The Glitter Boy Legacy	20	Percentage breakdown by type	79
The Coalition Years	20	Power Armor Features	79
Battle Lines Drawn	22	Classic Glitter Boy	81
The Quebec Military	23	Glitter Boy Improvements	82
Quebec Soldiers (overview)	23	Triax Glitter Boy	84
Infantry Divisions	26	Glitter Girl	87
Glitter Boy Legion	28	Glitter Boy Side Kick	92
Armored Corps	28	Tarantula Glitter Boy	95
Air Force Corps	28	Taurus Glitter Boy	98
Quebec Military Intelligence Corps	29	Silver Wolf Glitter Boy	101
Special Forces	30	QPA-201 Power Trooper	105
The Quebec Navy	30	"Pale Death" QPA-101 SAMAS	107
Le Sûreté du Québec (SQ)	30	"Violator" SAMAS (V-SAM)	109
Operation Aide Memoire	31	Cyborgs of Free Quebec	113
Operation War Doves	31	The Liberty Reserve	113
le Sûreté du Québec O.C.C.s	32	Cyborg Shock Troopers	113
Deep (undercover) Intel Agent O.C.C.	32	FX-200C Imprimer	115
O.C.C.s Common to Free Quebec	33	FX-320C Dervish	117
O.C.C. Overview & Reference	33	FX-340C Slasher	119
O.C.C.s of the Quebec Military	34	FX-370C Leviathan Cyborg	121
Headhunters	34	The Quebec Navy	124
Juicers	35	War Tactics	125
Psychics	35	Naval Forces	126
New O.C.C.s	36	1st Fleet Commodore Jacques LeFevre	127
"Descended" Glitter Boy Pilot O.C.C.	36	Quebec Navy Resources	128
Glitter Girl Pilot O.C.C.	38	NS-B20 'Borg Dive Armor	129
Side Kick RPA O.C.C.	39	Sea Dragon	130
Reload Team O.C.C.	40	Free Quebec	133
Weapons & Equipment of the Quebec Military	42	Technology	135
Quebec Weapons	43	Quebecois Worldview	138
Old-Style CS Weapons	43	People & Groups of Note	141
Uniquely Quebec Weapons	44	Prime Minister James Lorne	141
Mini-HUD System	44	The National Assembly	142
Q2-10 Laser Pulse Rifle	45	C.F.Q.C. Radio Free Quebec	144
Q2-20 LLG Infantry Standard	45	Sylvain Richard	144
Q4-40 "Mule" Assault Rifle	47	Julie Tremblay	145
Q5-50 Light Rail Gun	48	les Soldats de St. Jean	147
Free Quebec Body Armor	49	D-Bees in Free Quebec	148
Juicer Military Armor	50	Franko	149
TX-J50 Juicer EBA	51	Colonel Robert Miller	150
Other types of Modern Body Armor	51	Old Bones	152
Combat Vehicles	52	Conspiracy Theories & Rumors	153

Trading Center	153
The Coalition Presence	154
Places of Note	155
New Town	155
Southside Factory District	156
Trade Center District	157
Pierre Champlain (Gambler & Playboy)	157
The Bunker	158
Sylvette's	158
Salmand Special Investigations	160
Shade of Atlantis	161
Old Bones Rumor Mill	162
Conspiracy Theory Generator	162
Who?	163
Where?	164
How?	165
Rumor/Conspiracy Theory Accuracy	166
Where Did You Hear This?	167
War!	171
And so it begins	171
The Shadows of War	171
War Days	172
The Children of Freedom	172
Viper Delta	172
Captain Jeunet NPC	173
Robert Carlye	174
CS vs Quebec Military	175
A Unique Approach	176
Adventure Ideas & Outlines	177
Situation Critical (HLS)	177
The Privateers of Montreal	178
The Mary Ellen Carter	179
Barrett's Privateers	179
Running the Blockade	181
The Triax Witch Hunt	181
Putting the Boot In	181
A Traitor Among Us	183
The Hard Sell	184
Open Season	184
Final Exam	185
See Jean Run	186
Hunters' War	187
Other Adventures	188
A Man's Best Friend?	188
D-Bee Uprisings	189
Dangerous Game	189
Rescue the CS?!	190
The Patrol	190
Militia Madness	190
No Entry, Turn Back	190
Bandits!	190
Delivery	190
Please Help Us, Please	191
D-Bee Warpath	191
D-Bees in Trouble	191
Human Sacrifice	191
Map of Free Quebec	192

Quick Find

Art: Infantry Uniforms	24
Art: Quebec Army Insignia	27
Art: Standard Quebec Body Armor & Helmets	25
Art: Standard Quebec Body Armor (back view)	26
CS Military	18
CS Overview of the War	17
CS Propaganda	17
Dark Ages: Legends	19
Dark Ages: Glitter Boys	20
D-Bees in Free Quebec	148
Dragon Kings (Tolkeen)	17
Erin Tarn: Danger Signs (104 P.A.)	7
Erin Tarn: Historical Side Bar	14
Erin Tarn: On Glitter Boys	70
Erin Tarn: Overview (Catalyst for War)	11
Erin Tarn: Her Perspective on the War (105 P.A.)	9
Iron Heart	18
Free Quebec General Overview	19
Glitter Boys: Legacy & Legend	20
Glitter Boys: Legions	28 & 77
Glitter Boys: O.C.C.s	36
Longhouse Preserve: Encounter	7
Longhouse Preserve: Julie Riverwind	8
Militia: See Soldiers of St. John	147
Montreal (brief mention)	19
New Quebec City (brief mention)	19
Old Bones (brief mention)	19
Old Bones (main description)	152
Old Bones: CS Presence	154
Old Bones: Map of Districts	156
Old Bones: Map of Trade Center	159
Old Bones: Places of Note	155
Quebec, City & People of	133
Quebec: How the War Starts	171
Quebec: Militia (Soldats de St. Jean)	147
Quebec: Military O.C.C.s	34
Quebec: No D-Bees	33 & 148
Quebec: No Skelebots	33
Quebec: O.C.C.s	33
Quebec: Old Quebec/"Old Bones"	152
Quebec: Prime Minister Lorne	141
Quebec: Radio Station	144
Quebec: Terrorist Group (Children of Freedom)	172
Soldiers of St. John	147
Spies: QMI (Quebec Military Intelligence)	29
Spies: SQ (le Sûreté du Québec; the best)	30
Spies: SQ Deep Agent O.C.C.	32
Rumors: New German Republic	8
State of El Dorado (new, 106 P.A.)	12
State of Lone Star	11
State of Missouri	11
St. Lawrence River Combat	16
Tolkeen: CS Front	14
Tolkeen: Dragon Kings	17
Tolkeen: Operation Aide Memoire (SQ)	31
Triax & The NGR	19
V-SAM	109



The Coalition at War

You hold in your hands the launching point for **Coalition Wars!** The first of a series of books that will follow the military campaign of the Coalition States. A methodical plot to eliminate its enemies, subjugate lands, unite its allies and extract bloody revenge.

Other **Rifts®** books will continue to explore the rest of the world and other people, but the **Free Quebec™ World Book** sets the stage for the Eastern Front in the CS War Campaign. Meanwhile the **Siege on Tolkeen™** series will take readers into the depths of war on the Western Front. **Siege on Tolkeen™** boils down to “magic vs technology” in a conflict where neither side will be satisfied until the other is decimated.

Meanwhile, the war at **Free Quebec** is effectively “The Coalition vs The Coalition!” Both sides share similar origins, politics, and world view, right down to their anti-magic sentiments and hatred for all that is inhuman. Furthermore, until recently, **Free Quebec** has been a card carrying member of the Coalition States, and as such shares much of the same technology and many of the *same* weapons. While the CS has unveiled its “new” Army (see **World Book 11: Coalition War Campaign™**; a must to play these wars to the fullest), Free Quebec is only beginning to reveal its own range of *secret weapons*.

At the forefront of its defenses are the *Glitter Boy Legions*. Not just the classic Glitter Boy, but a host of new types armed with a range of unique and devastating weapons. Moreover, the Glitter Boy forces of Quebec are much larger than anyone has ever imagined and represent a grave new danger to the world at large. Free Quebec will not fall easily. Surrender is out of the question and although the Coalition Military will not publicly admit it, secretly they agree that Free Quebec is an enemy they have grossly underestimated. With the Siege on Tolkeen in full swing, the War at Free Quebec has been slow to get started but once it gets going, it will be a long, bloody, pitched battle.

As an adventure sourcebook **Free Quebec** offers details about the Quebec Military and its resources, and key personalities, and should serve as a catalyst for many nights of exciting adventures, battles, sabotage, espionage and treachery for years to come. We have tried to make it a compelling story with many avenues of conflict, intrigue, suspense and raw excitement.

As a world book, it provides insight behind the people of Free Quebec, their heritage, motivation and dreams for the future. Key locations, important leaders, new O.C.C.s and overviews provide a rich sense about the nation that dares to oppose the CS. It also offers hints about events and plots transpiring at Tolkeen, particularly where the CS is concerned.

Francois and I hope this book is everything our readers want it to be. To make good on this goal, **Free Quebec** has met with delay after delay (which we are very sorry about), but we hope the end result will have made it worth the wait. Enjoy.

— Kevin Siembieda, March 2000

Danger Signs

A letter to Plato on Free Quebec from Erin Tarn — Spring 104 P.A.

Note: These events took place roughly a year and a half before Free Quebec’s secession from the Coalition States and Emperor Prosek’s declaration of war in September of 105 P.A.

My dear Plato, we have been traveling for nearly three weeks through the eastern wilderness of the old American Empire; Maine, Vermont, and New York. We have been taking our time, relaxing and enjoying the lovely spring weather. Traveling from village to village and stopping in the occasional town, we paid our way either with small amounts of gold we had with us, or by telling fireside stories. As usual, my reputation precedes me and we have been, with rare exception, warmly greeted. It seems everywhere I turn, there is somebody who has at least heard of the name Erin Tarn. I guess I have the Coalition to thank for that, in some twisted fashion.

We have found most communities to be very similar to those we know in Ontario, Canada. Most are small to tiny and range in technology from the medieval to 19th or 20th Centuries. Of course, there are those places where the overall lifestyle is simple and generally low-tech, farms and such, but most residents possess some modern energy weapons, and the occasional suit of body armor, modern vehicle, and generator. Even among the Psi-Stalkers the most primitive of hunter and gatherer tribal people, we have been well received.

I would dare say that these have been among the most enjoyable three weeks I have experienced in a long time. After the heat of the New West and the turbulent happenings of the Juicer Uprising and events within the Pecos Empire and the Magic Zone, it was nice to relax. Of course, I should have known this tranquility and quiet could not last.

Over this past year, you and I have received a constant stream of reports telling about the growing discontent, strife, and disputes between the Coalition State of Free Quebec and the CS authorities at Chi-Town. It is safe to say that both factions of the States are unhappy with one another. In recent months, things have deteriorated so badly that rumors suggest Free Quebec’s desire for greater independence and autonomy may drive them to secede from the States. While we find this hard to believe, the rumors persist, and even our own psychics and seers have foreseen trouble brewing between the seat of CS power and Free Quebec. I fear these misgivings and rumors may have more truth to them than we would like to give them credit for.

After crossing over the Appalachian Mountains we descended into the plains of what was once central New York State. Today it is the range area claimed by the Native Americans of the Longhouse Preserve. It wasn’t long before we were met by a group of warriors from the Preserve. They galloped towards us at what seemed to me, breakneck speed. They drove their horses to the limit and seemed to be thrilled by the power the animals displayed. We too were impressed by the show. They slowed down and lined up not twenty feet in front of us, a

dozen warriors in all. They were all dressed in buckskin outfits and had war paint covering their faces and bodies.

The leader dismounted and approached us on foot. He spoke to us in fluent American. He said they had been tracking us for nearly two days, a tribute to their skill and prowess since we hadn't detected them the entire time. He seemed perturbed by our presence and the direct course we had been following to the heart of their land. I explained that we were actually heading to the Longhouse Preserve and that I hoped to speak with the Tribe Elders. Not being one to overlook an opportunity, I asked if they would be so kind as to lead us to their camp. Looking over our group, and paying particular attention to Sir Thorpe, he turned around and leapt upon his steed in one fluid motion. "Yes," he said, and began to lead the way.

The next morning we entered the main camp of the Longhouse Preserve, located on the ruins of the city of Albany. Before us was a city of wooden houses, tents and tepees, as well as several rebuilt cement buildings. We could see bonfires burning the morning fog away from the city. We were led to the center of the city and to a large log cabin that had several chimneys lazily billowing smoke. Greeting us in front of the cabin structure was a woman who introduced herself as **Julie Riverwind** and warmly welcomed us.

The inside was a well furnished Council's Chamber, where the leaders met to discuss important events, engage in celebrations, and meet with visitors. The walls were carved with intricate designs of animals and a few creatures I couldn't recognize. The level of artwork and craftsmanship was exquisite. I could also make out several Fetish devices, some weapons, most others ranging from masks to necklaces and the sort. The cabin had a very relaxing atmosphere, our hostess doing much to make us feel at ease. Riverwind sat in front of a roaring fire and asked us to join her. I can say that within a few minutes I knew I liked this young woman, whom I would guess to be around 30 years of age. I later learned she is one of the high ranking tribal Shamans. There are very few women to hold such a high place, let alone one so young, an accomplishment in which she takes great pride.

I noticed she was sizing me up with her eyes, when she abruptly asked who I was. I knew our identity and impending arrival had reached the camp long before we had, so I was a bit puzzled. When I explained who I was, Riverwind beamed a smile at me and quickly rose to a shelf I had not noticed before. She picked up a book and handed it to me. I found myself looking at a dog-eared copy of my book, **Traversing Our Modern World**. She had read the book many times and thanked me for my courage to write it. I must admit, no matter how many times this sort of thing happens to me, it makes me blush. I thanked her and explained that I only did what I felt was right.

We spent the next three days within the protection of the Preserve. Sir Thorpe and I spent most of that time with Julie Riverwind who proved to be a most inquisitive, intelligent and mature young woman. I learned a great deal about her people's struggles over the last generation. They especially suffered from the Mechanoid hordes who swept through this part of the wilderness, and face continuing conflicts with the denizens from the Magic Zone, the Coalition States, Free Quebec and the occasional run-in with Splugorth Slavers and Shemarrian Warriors. Apparently, the Magic Zone is the breeding ground for an

creasing number of monsters and evil sorcerers, but we were surprised to learn their greatest concern was with the widening chasm between the Coalition States and the State of Free Quebec. They have heard the rumors about secession and are positive it will happen. Riverwind also predicts war.

Free Quebec has always been something of an outsider even as a member of the Coalition States. These Canadians are very prideful and independent — some might even say arrogant and defiant. While we have heard stories of squabbles between the CS leadership at Chi-Town and the leaders of Free Quebec, Riverwind and her people have witnessed limited, armed conflicts firsthand. According to the Shaman, there have been many acts of open disobedience and armed skirmishes. So far, few have resulted in bloodshed, but there has been some bloodletting. None of this is a terrible surprise to me, but I never dreamt things had gone so far. The Coalition States have certainly kept this discord out of the public eye. Another tribute to the Coalition's propaganda machine, I guess.

Of greater concern was Riverwind's report of a Free Quebec Military build-up and what sounds like secret military exercises. The maneuvers would seem to involve the deployment of Glitter Boys and Glitter Boy variants which we know nothing about!

During my recent adventures in the **New German Republic** I learned that Free Quebec had entered into a questionable trade agreement with the Germans and, more to the point, Triax Industries. Part of that deal involved giving the NGR the secrets of the Glitter Boy power armor and weaponry in trade for weapons, electronics and power armor, including the cyclopien, Triax "Tee-Five-Fifty" Glitter Boy design. If there was any doubt of this, I can assure you that it is gone. One of Riverwind's artisans drew me a picture of the power armor their warriors and scouts have seen conducting exercises in the old American States of New York, Vermont and the New England area. One is the classic Glitter Boy we all know and fear. Another was unmistakably the Triax version. In addition, there are variant designs I have never heard about nor encountered, including a man-sized flying one that sounds like a variation of the SAMAS! According to the eyewitnesses I spoke with, over one thousand have been observed over the last two years. This would support the validity of Chi-Town's charges that Free Quebec continues to build-up and experiment with Glitter Boy technology. In direct defiance, I might add, of the Emperor's edict that Quebec discontinue these "non-Coalition" armaments.

As if this were not enough, our Longhouse friends reported witnessing two battles between Coalition Reconnaissance squads from the west and Glitter Boy troops they are certain originate from Free Quebec! It seems when the CS squads were discovered, the Free Quebec troops obliterated them, making a point not to allow any survivors. All evidence of the Chi-Town troops were then taken away and presumably concealed. In addition, these forces have "picked" fights with the Minions of Splugorth and Shemarrian Warriors. It is the opinion of the Longhouse Warriors who have witnessed many of these clashes, that Quebec factions are deliberately initiating these battles to combat "test" and "observe" their new weapons and Glitter Boys. The fact that these field tests and exercises are taking place in wilderness regions away from the Coalition States' usual sphere of influence adds further credibility (to me at

least), that these are, indeed, secret Quebec operations. The question is why? Are the rumors of their growing dissatisfaction with the Chi-Town leadership true? Are they really so unhappy that they plan to secede from the Coalition States? Is this Glitter Boy build up in anticipation of Coalition retaliation? Would even Emperor Prosek take action against one of his own States? Or is it for some new Coalition campaign? Or Free Quebec's own military expansion? Whatever the case, none of this can bode well for the rest of us.

The many stories told to us by the Longhouse Tribe have made me that much more curious about the current state of Free Quebec. We have said our goodbyes and ready ourselves to head north. Julie Riverwind has insisted that a group of the tribe's finest Warriors accompany us and lead us along the safest path. They have granted us the use of fine horses for the trip, so Sir Thrope and I are now on horseback with the others in our little troupe riding in the small hover transport with which we started this journey.

— A letter to Plato from Erin Tarn,
Spring, 104 P.A.

War at Free Quebec Erin Tarn's Perspective

The following are excerpts from Erin Tarn's current work in progress, **War of Unity**, **War of Revenge**, a book that is intended to chronicle the war between the CS and Free Quebec. Observations and events begin in the Summer & Fall of 105 P.A.

Foreword

Although I divide my attention between two Coalition war-fronts, Tolkeen and Free Quebec, I intend to focus most of my attention on the war at Free Quebec. This may surprise some people who incorrectly believe my loyalties would be more strongly aligned with the free-thinkers, mages, and D-Bees of Tolkeen. Sadly, I fear I already know the outcome of the War at Tolkeen. It can only end in slaughter and tragedy with the Coalition States triumphant in their carnage. The only questions that remain: To what extent the horror, and how many hundreds of thousands will perish?

I apologize if this sounds callous. Truth be told, I have many friends, acquaintances and associates at Tolkeen. A fact that makes their decision to challenge the Coalition all the more personal and painful for me.

The reasons for my decision to cover the War at Free Quebec are many. For one, I doubt I could remain terribly objective at Tolkeen. At Free Quebec I believe I can maintain a reasonable amount of objectivity.

Two, I have no doubt that the siege on Tolkeen will be covered by many scholars and firsthand participants, including mages and Cyber-Knights, so I am not needed. But who will accurately record what transpires at Free Quebec? Not the Coalition States. They are infamous for their self-serving rewrites of history. As is Free Quebec, who is cut from the same limb as the CS.

Three, the war in eastern Canada comes frighteningly close to the place I consider my adopted home, Lazlo and southeastern Ontario. As a result, this war will have the greatest impact on my home and the people I care about most in the world. For months now, we have seen an increase in the number of mercenaries, carpetbaggers, and cutthroats in the area. Lawlessness and trouble came with the first wave of the hounds of war.

Four, the war at Free Quebec is a war of brother against brother. A conflict that could cripple or destroy not only Free Quebec, but Chi-Town and the Coalition States.

If you think I overstate my fourth point, think again. There is little doubt that the siege on Tolkeen will come at a great cost to the Coalition States. Add to this the foolish war against Free Quebec, and you have a disaster in the making.

If the Coalition States faced only Free Quebec, I would fathom to say that their vastly larger and equally (perhaps more) advanced army would make easy work of Quebec. However, this is not the case. The Coalition forces are divided between two major wars, plus the defense of its expansive borders, key cities and strategic positions, as well as dealing with other ongoing threats from the likes of the Federation of Magic, Pecos Empire, the Xiticix, and demonic invaders to name but a few. They are stretched thin. Dangerously thin.

To compound the situation, Free Quebec is no push-over. They possess the second largest and most technologically advanced standing army in North America. Only the Army of the Coalition States surpasses it in size, albeit by several fold. The Navy of Free Quebec is more skilled, seasoned and nearly as large as that of the Coalition States. In fact, it was in large part through the efforts of Free Quebec that the *Coalition Navy* was created. Moreover, Free Quebec has established trade relations with Triax Industries of Germany, as well as favorable relations with the New German Republic — two incalculably valuable resources and *potential allies* that could change the outcome of the war.

In the end, what all this means is if somebody does not give in, if the current stand-off and threats escalate into all-out-war, the Coalition Army will lay waste to Free Quebec. But the campaign is likely to last years. A million or more Quebecois could die, cities reduced to rubble and resources depleted. Meanwhile, the Coalition States will also lose hundreds of thousands of troops and suffer immeasurable expenses. Even a triumphant Coalition Army will leave the States at their weakest condition in history! The cost of the two wars in manpower, money and resources will be unparalleled. In all likelihood, crippling the CS economy and leaving the individual States vulnerable to other powerful enemies like those I noted earlier.

I have no love for the leaders of the Coalition States. I condemn the atrocities they perpetrate in the name of peace and humanity, and I hate what the Coalition has come to represent. But the people — the average citizens — are not evil monsters. Deluded yes, but not evil. They don't deserve to suffer or die over this folly, but they will. If

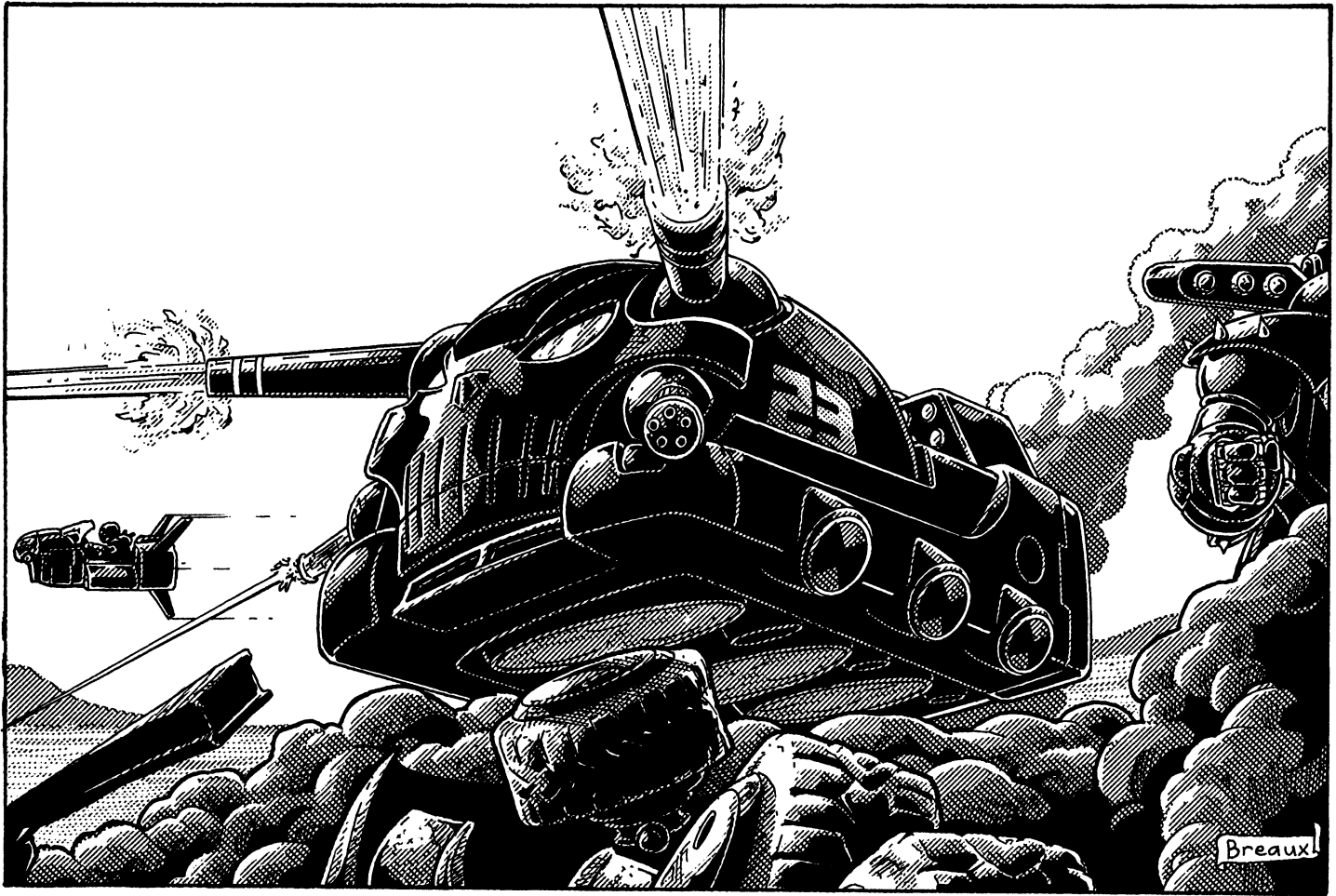

the CS should fall, it may herald a new age of chaos and anarchy. A new dark age that may obliterate everything we have accomplished these past one hundred years. Our homelands will become the playground for every monster, invader, madman, or tyrant who sees a new opportunity. In a few short years, we may all be fighting for our lives.

And so I observe and write what I see as truthfully as I can. It is what I do best. With any luck, future generations will learn from our mistakes. If my prayers are answered, this tragedy will be averted, although I can not imagine how. The Emperor must save face. The Empire must prove its superiority. War must come.

And yet, I see hesitancy and uncertainty. Unlike Tolkien, where covert operations and brutal border wars have been ongoing for years, the CS forces in Canada have drawn a line, gathered their troops, and wait. No war has yet begun. No real war, anyway. Only minor skirmishes, intelligence gathering and acts of sabotage. All of which have produced 20 casualties on the side of Free Quebec and six for the Coalition (and they, I am told, two of them accidentally blew themselves up).

Instead, it seems as if they gather to rattle their sabers and spit forth venomous threats. When it comes to open combat, they hesitate. I sense few of the soldiers on either side have the heart for this war. Few want to target and kill their fellow humans. It's one thing to hunt down and slaughter inhuman Dimensional Beings — the so-called "D-Bees." It is easy to destroy monstrous demons, dragons and alien creatures. It is easy to imagine practitioners

of magic who wield strange (to the CS) powers as something less than human and a danger to mankind. It is another thing entirely to kill your own. And that is what this war represents. Brother against brother. Friends and one-time allies facing each other down the barrel of a gun. Fellow humans who share the same fundamental beliefs, dreams and goals. Kindred human beings. People whose only crime is to be independent. No, their hearts are not in this war. Yet both sides stand ready.

I look into the faces of not only grunts, but the eyes of seasoned veterans and Dog Boys, and I see sorrow and regret. The soldiers wait with angst and loathing for the first shots to be fired and the order to retaliate. I pray this apprehension and dislike turns into a grass roots movement to stop the madness before it is unleashed. I pray (and I think tens of thousands of soldiers secretly pray with me) that some general or advisor can stay the hand of the Emperor before the blood of the innocent covers the ground of Quebec.

But who has the ear of the Emperor? Who may dare speak honestly and risk invoking his ire? Still I hope upon hope.

Perhaps the Emperor himself will recognize his foolishness? Perhaps reason will touch his mind or compassion his heart, and he will recall his troops before too much damage is done. You would think this is not that great a thing to hope for. After all, are not the people of Quebec humans? The very souls he claims to champion? The people he is sworn to protect?

Only time will tell. I shudder at what the future may have in store for us all.

— Erin Tarn, November 105 P.A.

Catalyst for War — by Erin Tarn

To understand what is happening before our eyes, we must know what has come before. The gifts that history gives us are perspective and understanding. Without going into too much detail, here is what has led the Coalition States to the brink of civil war.

The States came into being when several independent kingdoms growing near each other decided it was to their mutual benefit to join forces. This “Coalition” of kingdoms was proposed by the largest of the group, **Chi-Town**.

Free Quebec, Iron Heart and a few others were quick to recognize the value in such an alliance and chose to unite under one, Chi-Town centered, government and nation. Even after they became members of the **Coalition States**, each smaller kingdom/nation maintained its own government and continued to function, “business as usual.” Chi-Town was recognized as the Capital and seat of the Coalition Government, but all were equal. Together they established a uniform currency (the Universal Credit), trade agreements and regulations, and fundamental laws, policies and procedures upheld by all. Information and technology (with select exclusions and trade monopolies for each) were exchanged and resources shared. Establishing and maintaining reliable lines of communications was a priority that helped to keep them united and strong. All prospered and grew.

On paper, this is all well and good. A perfect and equitable solution in a troubled and chaotic world. Together the Coalition States are greater than the sum of their parts. United they are a power to be feared and reckoned

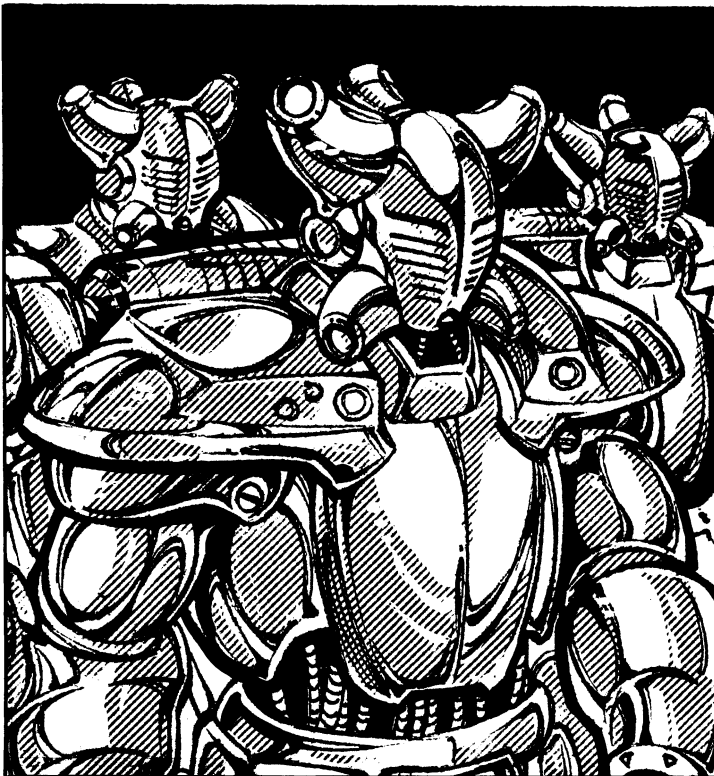

with. However, equity seldom survives in the real world. Inevitably, Chi-Town grew even larger than it was in the beginning, to become the most powerful of the States. Over time, the other Coalition States began to defer more and more to the powers-that-be at Chi-Town. Individual community identity, heritage and even traditions and laws began to fade into one homogenous nation. A nation ruled and directed by an “emperor” and his chosen henchmen rather than by a president and the people.

I believe the first signs of trouble began early on when many of the smaller and weaker members of the “States” found true self-reliance too difficult or troublesome to maintain. It was easier to turn to big brother, Chi-Town, for help, protection, and *guidance*. In return, these States became, in effect, extensions of Chi-Town itself. They capitulated to Chi-Town’s “requests,” followed Chi-Town’s lead and rarely challenged their authority or position.

Most people today don’t know it, but for a brief while, in the earliest years of the Coalition States, **Iowa** and **North-ern Illinois** (once known as the Illinois Contingent) were separate and independent States. They were the first to turn to Chi-Town (even then a massive fortress city of millions) for assistance and support. A short time later, they requested (and Chi-Town cheerfully agreed) to be absorbed into the State of Chi-Town.

Over the years, Chi-Town has annexed numerous farms, towns, cities, and lands, but its power and influence extends far beyond the State’s official borders. For example, the **State of Missouri** is officially a separate, self-governing region. However, in truth it is little more than another extension of Chi-Town. Although it has a regional government (more like regional management), CS Missouri always defers to Chi-Town, and for good reason. Without Chi-Town, this agricultural region would fall easy prey to the many hostile forces around it. Moreover, while rich in croplands and food they are poor in technology, industry and manufacturing. As a result, the people of Missouri rely completely on the Coalition Army for its defense and survival, and the State of Chi-Town for virtually all of its high-tech equipment, from electronics and guns to communications and vehicles. In fact, it is Chi-Town who funds, builds and maintains over 60% of Missouri’s infrastructure.

Likewise, the **State of Lone Star** (which claims all of Texas while ownership of 80% of the State is disputed and remains in the hands of bandits and D-Bees) is little more than a Chi-Town military operation. It is centered around a pre-Rifts Military complex seized by Chi-Town and supported by a cluster of small human supremacist towns and villages. To call this a “State,” “nation” or “kingdom” of any kind is a joke, if not an insult to real kingdoms. Still, the Coalition Military presence here is undeniable, as is Lone Star’s strategic importance. All manner of genetic, cybernetic and other scientific experimentation takes place at the top secret Lone Star Military Complex, the birthplace of the Dog Pack and other wonders (and horrors) of genetic engineering.

Of all the States, only Chi-Town, Iron Heart and Free Quebec could have ever been considered viable,

self-sufficient nations in their own right. For **Iron Heart**, their relationship with Chi-Town is too beneficial to ever jeopardize. While they have stood, and could again stand, completely on their own two feet, being a member of the Coalition States (and now, Chi-Town's favorite son) means wealth, prosperity and security the likes of which they could never achieve on their own. Besides, Iron Heart agrees with most of Chi-Town's laws, policies and views. They see Chi-Town's leadership as wise and benevolent men and women to be respected (if not revered) and obeyed. Thus, Iron Heart rarely questions or challenges Chi-Town, deferring to their greater experience, knowledge and insight.

Since the secession of Free Quebec and the Declaration of War, rumors have been running rampant that Arkansas will soon be officially recognized as the newest member of the CS. Word on the street is that the "State" of **El Dorado** may be declared as early as the summer or fall of 106 P.A. This persistent rumor has turned the old American State of Arkansas into a boomtown, especially in and around the military city-state of Fort El Dorado.

It is public knowledge that the region has been accepted as a "candidate" for membership to the Coalition States. As word of mouth continues to spread, hundreds of thousands of human refugees from the surrounding wilderness as well as the 'Burbs of Chi-Town, Iron Heart and elsewhere, are flooding to the region. Their hope is to establish a life at El Dorado now, as an easy means of becoming true CS citizens (with all the perks that come with citizenship) when Arkansas is accepted to Statehood. These rumors also suggest the name of this new State will be "El Dorado," in recognition of Fort El Dorado's decades of support for the Coalition and its heroic role in containing the *Juicer Uprising*. Just a scant year after the Uprising, El Dorado has not only rebuilt itself, but is 50% larger and has helped to rebuild and support scores of growing townships in the region. Fort El Dorado also continues its crusade against the bandits and renegades of Texas/Lone Star, as well as efforts in The Magic Zone and Oklahoma — all CS enemies. Chi-Town has encouraged El Dorado's aggressive attitude toward "the enemies of all humans," and has traded weapons and goods with the kingdom for some time now. The Emperor has been quoted as saying he "applauds their positive and take-charge attitude, and wishes more communities would follow El Dorado's good example." It is little wonder that the CS looks to them as their new lap-dog.

Politically and militarily, recognizing El Dorado as a new Coalition State is a good move for the CS. It basically says to the world that while Free Quebec may have left the fold, others clamor to join the CS. It also compensates for the loss of Free Quebec and suggests that the CS is as strong as ever. The fact that El Dorado is known for being an aggressive, military power only adds strength to the Emperor's *Campaign of Unity* — conquest and unity through force.

This brings us full-circle, back to the **ex-State of Free Quebec**. Free Quebec has always seen the Coalition States as an ally and kindred spirit, but a growing number

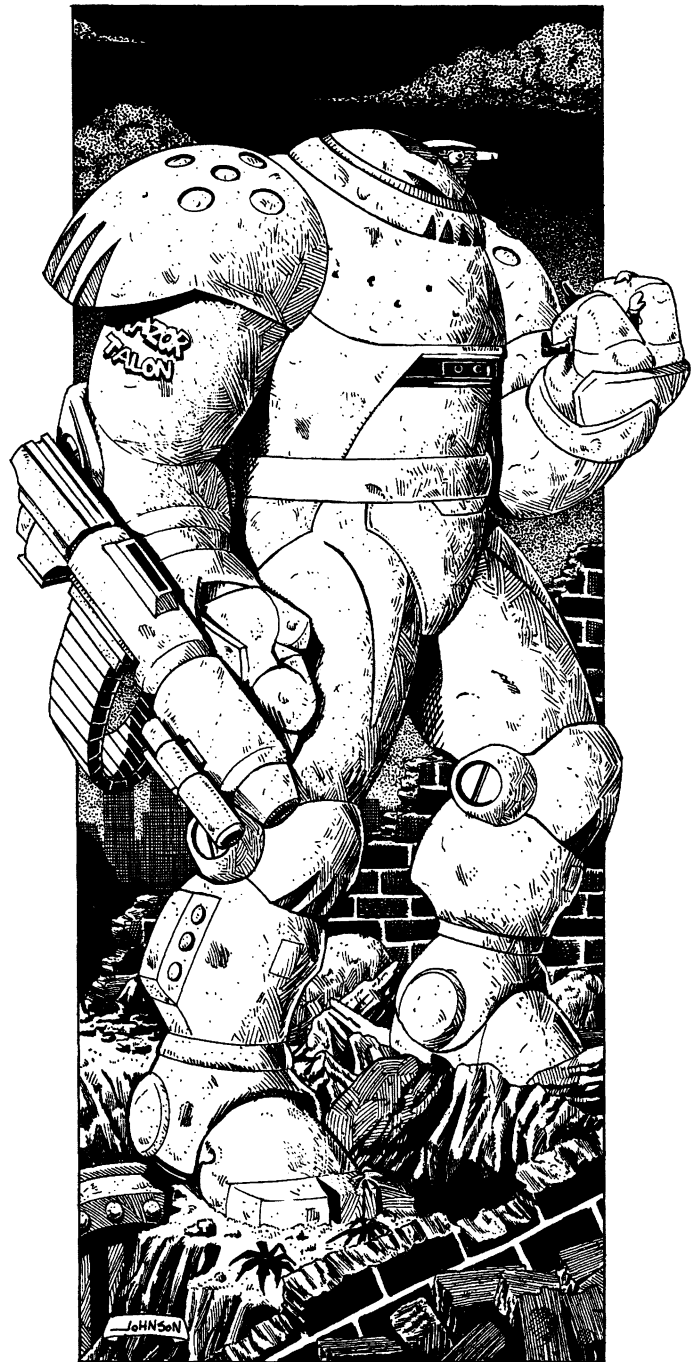

of issues were forcing them apart. For the last decade Chi-Town had begun to make unilateral policy decisions for the greater good of the Coalition States. Decisions that Free Quebec either disagreed with or which they felt removed from the decision making process. Consideration for the individual allied States seemed to have evaporated. They no longer seemed to be regarded or treated as equals, but as silent partners meant to do as they were told. Fiercely independent, the people and government of Quebec saw this disregard as an insult and a violation of the people's civil liberties and the regional government's autonomy. The very name, "Free" Quebec, is tribute to the century of struggle they had survived to become a free nation. As a result, the people's self-image is independent and strong. They see themselves as bold and resourceful leaders and conquerors, not sheepish followers.

Free Quebec was willing to work *with* Chi-Town and the other states, but they demanded to govern and defend themselves as “they” saw fit. To make their own laws, maintain their own unique military and live under their own regional laws, traditions and moral sensibilities. Chi-Town, full of itself, ignored their concerns and protests, and continued to hand down mandates and rulings without Quebec’s involvement or consideration.

Free Quebec began to see edicts like the dismantling of the Glitter Boys, supposedly in favor of a uniform (Chi-Town designed) army, as a thinly disguised plot to undermine their nation. They felt the discontinuation (and presumably destruction) of their Glitter Boy legions was a deliberate effort to limit and control the Quebec Army, making them reliant on Chi-Town for its defenses and military technology. Other policies, laws and “requests” were also seen to challenge or undermine their traditional way of life, ethics, military and government.

In protest, Free Quebec refused to comply with the Glitter Boy Mandate and modified or ignored other unilateral Chi-Town/CS edicts with which they disagreed. Chi-Town responded with unreasonable pressure tactics, politicking, demands, threats, and sanctions. The people of Quebec felt like a rebellious teenager being punished by an angry and unreasonable parent. The last straw was the Chi-Town leadership making demands upon all the States to support military operations which Free Quebec did not agree with and the warning that the Coalition Army would take measures to insure that Free Quebec complied with all laws and demands, which prompted their move to secede from the union.

No threats or demands were made. No hostile action taken. Free Quebec clearly defined its position as an action to preserve its national identity, independence and freedom. The government and people of Quebec realized that despite a handful of strong philosophical and political differences, they and the Coalition States were much more alike than different. Consequently, on the eve of their secession, they proposed a continuing alliance in which both nations would maintain “friendly” relations, trade, keep their borders open to one another, and enter into a military pact in which one would come to the immediate defense and support of the other during times of crisis or invasion. In many ways, they suggested keeping things very much the way they had been for decades. The big difference being Free Quebec would no longer be an official “State” but a completely independent, self-governing nation, separate from the CS.

Sadly, the knee-jerk reaction of Emperor Prosek and the hawks of his government was to condemn this action as an act of treason and to declare war on their long-time comrades. Nobody, Emperor Prosek included, ever imagined Free Quebec would quit and leave the Coalition States. The powers-that-be were shocked and mortified. I imagine the discussion between the Emperor and his High Command involved a lot of shouting and screaming. Ending with fist-pounding and words like, “Nobody quits the Coalition States. Nobody! It’s insane ... and treasonous! How will our enemies see us now? Weak. Divided. Vulner-

able. How do we know Quebec hasn’t allied themselves with one of them? Or are they just cowards who are glad to enjoy the fruits of our victories, but are unwilling to join in our fights.”

In an effort to save face, prove their strength, and reclaim their lost compatriots, Chi-Town (on behalf of all the Coalition States) declared war against the “rebel” government of Free Quebec. To justify their action, they painted the leaders of Quebec as the ones out of touch with their people and acting in their own self-interests rather than for the good of the united Coalition States. According to the CS, the people of Free Quebec do *not* support the secession, and the war is designed to topple the rebel government and restore Free Quebec to its rightful place as one of the Coalition’s greatest States.

In truth, the Chi-Town strategists hope that seeing the Coalition War Machine appear on their borders and a few well-placed attacks will cause both the government and the people to reconsider their position. It is believed that when “faced with the reality of war and obliteration” the people of Free Quebec will surrender and rejoin the CS under a Chi-Town selected leadership. From what I have seen, this is a fool’s dream. Both the people and government of Free Quebec are firmly resolved to live free and independent or die trying. I can’t express it any plainer than that.

With the decree of independence from the **Prime Minister** and **The National Assembly**, all levels of Free Quebec society have turned to activities that will insure their survival as a “free nation.” The Declaration of War by Emperor Prosek of the Coalition States only confirms that they have narrowly escaped absolute domination by the Coalition. It is this powerful sense of independence and national identity that has galvanized the people and keeps morale high. The current surveys indicate the leaders of government enjoy an unprecedented 87% approval rating, while 96% of the people claim to support secession from the Coalition States even if it means years of war and severe hardship. My own research suggests less than five percent of the population are more concerned with their personal welfare than that of the nation as a whole. To the dedicated patriots of Free Quebec, the independence of their nation means true autonomy, self-identity and their own chosen way of life. And they *are* willing to die for it.

From what I can tell, there is only a tiny percentage of the population (less than five percent?) that openly disapproves with the breaking from the CS, and whom may be considered loyalists to Emperor Prosek and the Coalition in general. This minority is rebuked as dangerous radicals and the dupes of the CS. As such, they are the targets of scrutiny and persecution by the police/military as well as by their neighbors. Squads of Sûreté operatives are assigned to maintain constant surveillance against the most outspoken or suspicious of these Coalition sympathizers, and pursue any hint of CS loyalist activity. The primary reason for such attention is to prevent sedition, sabotage, insurrection, counterintelligence, and the harboring of Coalition Spies (of which, I suspect, there are many).

Coalition Fronts

Tolkeen:

The Western Front

The Coalition military has seen some massive troop movements and build-ups within the last several years. One of the most notable forces assembled by the Coalition has become the troops stationed along the Tolkeen Front. For years now they have been sending in military companies of various sizes and compositions, all the while slowly increasing their hold on the surrounding lands. As one looks to the front-lines, a defensive ring of Tolkeen defenders has been established. This ring is slowly constricting as CS forces tighten their hold around the throat of their enemy.

Although this war will fall into place “by the numbers,” its end will come at a high price and will not be as easy as anticipated. The conflict is likely to last 18 months to three years. The enemy is resourceful, cunning and treacherous. Plus the CS troops will face magical forces, weapons and opponents beyond their understanding, increasing the magnitude of horror and the unpredictable. Already, the Emperor and Military High Command have been both puzzled and troubled by an increase in encounters and casualties along the southwestern section of their lines. More and more patrols seem to meet with deadly forces, ranging from D-Bees to supernatural monsters, to warrior mages, dragons and highly effective guerilla fighters led by Native Americans and Cyber-Knights. As a result, the Coalition Army must dispatch more troops to this troublesome area to reinforce their positions, but also to conduct more frequent patrols and search & destroy missions. Armies of Skelebots sent to contain and shred Tolkeen’s defenses have been alarmly *ineffective*. Meanwhile, the Tolkeen defenders respond with unexpected aggression, power and malice — striking without mercy and often without regard to their own people. The enemy has proven to be unpredictable and deadly.

Smaller kingdoms around Tolkeen have tried to remain outside the conflict, but have quickly found themselves the subject of Coalition siege. Even communities who insist they have never harbored D-Bees nor endorsed the use of magic, must make a choice. Side with and support the Coalition Army, and assist in the campaign to destroy Tolkeen, or be themselves destroyed. For in the old American State of Minnesota, one is either a friend of the Coalition or foe — there is no in-between. As for communities where D-Bees and/or magic are welcomed, they have no hard choice to make. They are systematically eliminated. Those places that hold tactical importance are subjected to the most ardent military and economic siege, forcing them to eventually surrender or turn to Tolkeen for assistance. This means either drawing out Tolkeen fighters or causing the community under siege to flee behind Tolkeen’s lines. Either way, the Coalition wins, for fleeing refugees sap the Tolkeen stronghold’s resources and weaken its infrastructure. Meanwhile, localized skirmishes, border wars and locked combat serve to both test and weaken the enemy’s troops and provide the Coalition Army with more valuable information and motivation to close-in and finish the job. Over the last year, a hundred farms, a

At least for the moment, the economy of Free Quebec remains strong and spirits are high. The nation has always been self-sufficient and capable, second only to Chi-Town in size, power and resources. I am told that the leadership anticipated strong action by Chi-Town and has, for the last two years, been stockpiling food, goods and other resources, as well as building a secret army of Glitter Boys. However, I suspect the insightful leaders of Free Quebec never anticipated a declaration of war. Trade sanctions, yes. All-out war, I doubt it. That having been said, I will be the first to admit that I may be wrong. There can be no doubt that the Army of Quebec is at least 70% larger than had been officially recognized by Chi-Town and independent sources. Some claim the Quebec Army is actually two or three times larger than anybody had suspected. As unlikely as that may seem, it may be true.

From all intelligence reports and independent observations of which I am aware, Free Quebec has been gearing up its military for at least the past five years. I find it interesting that unauthorized military expansion was one of Chi-Town’s charges against Free Quebec. A situation brought on by Chi-Town’s insistence that the nation retire its famous Glitter Boys. Let me state here and now that rumors regarding the existence of new, variant types of Glitter Boys *are* true. Just how true is yet to be seen, but I’m sure we will see exactly what *secret weapons* Free Quebec has developed when war really gets underway. I myself have caught glimpses of the small, sleek version that has been dubbed the “Glitter Girl,” as well as the Triax T-550 model. I was the first to report the trade agreement between Free Quebec and Triax Industries of Germany, and that a new type of German Glitter Boy had been designed. This was no great feat of detective work, as I accidentally stumbled across this information while overseas. However, I am only now realizing the full impact such an “alliance” might mean. For one, it would not surprise me in the least to learn that there are bunkers and warehouses full of traditional and Triax Glitter Boys waiting to be unleashed. Perhaps some other surprises as well.

Historical Side Bar: This is my biased opinion, but I believe had cooler heads prevailed and Free Quebec been recognized as an independent nation and friend of the Coalition States, there would have been an excellent chance that a decade of political finagling might have brought them back into the fold. If nothing else, Free Quebec could have remained a true CS ally and trade partner. As it is, the Declaration of War has proven Free Quebec’s worst fears true and driven a wedge between these two great and once allied nations. A wedge that I don’t think can ever be completely removed or forgotten.

— Erin Tarn 105 P.A.

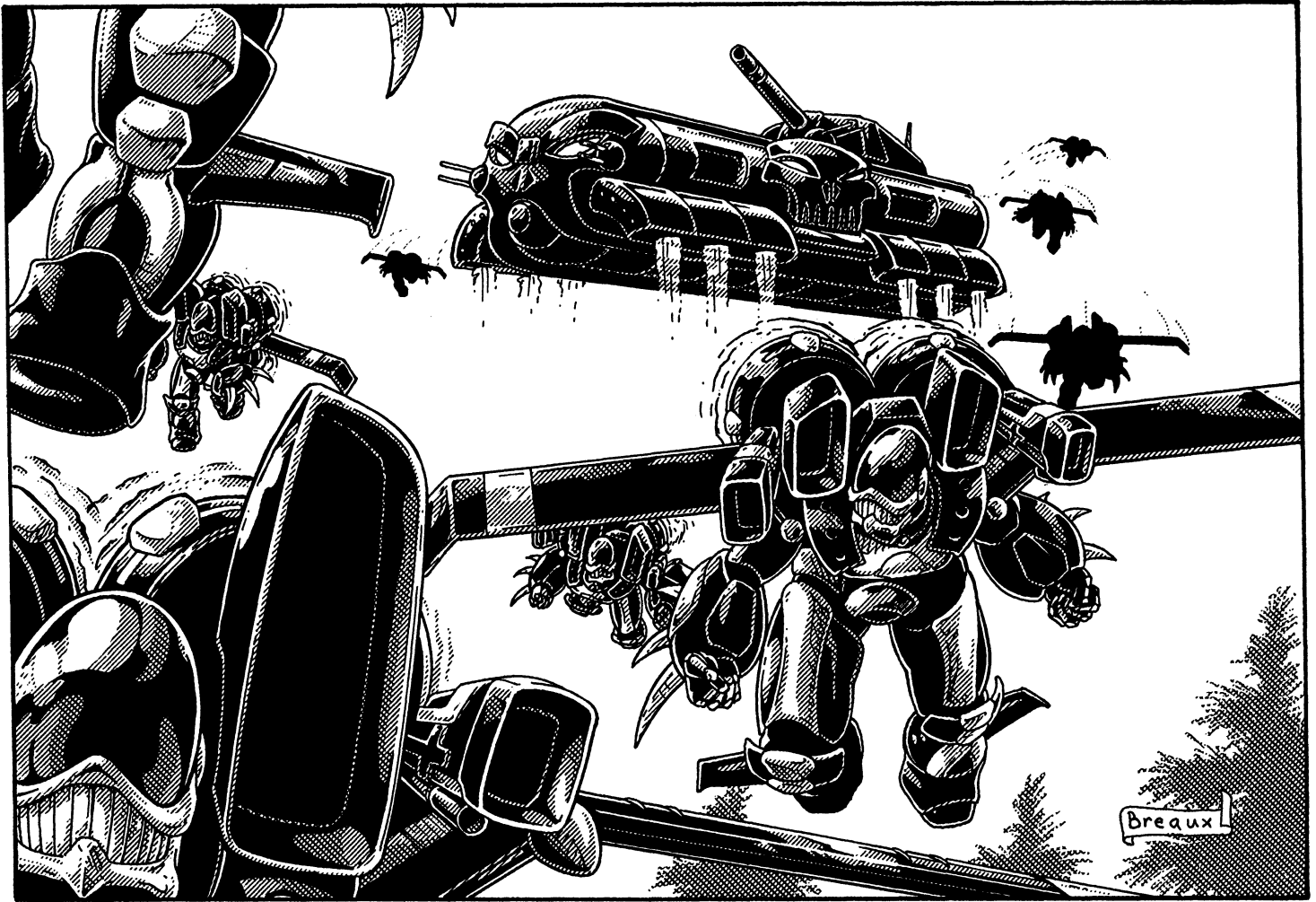

dozen towns, two major cities and an untold number of enemy clans, camps and troops have fallen to Coalition aggression — double the casualties of the previous five years combined.

The leaders and people of Tolkeen have been feeling the results of the Coalition embargo for some time now. For months they have had to get by without the luxuries and creature comforts they had come to expect. Through the course of CS military intervention they are increasingly unable to get basic supplies and foodstuffs. Even though the Coalition has been slowly and progressively cutting off supply routes, it was the treaty with Ishpeming and the Manistique Imperium that has hit them the hardest. Both of these parties were once heavy trading partners, and now both are under the auspices of Chi-Town. There is limited trade with other small kingdoms as intermediaries, but this has still drastically reduced trade into Tolkeen. The only routes the CS have not been able to contain are the ley line routes Tolkeen uses for limited imports and exports, as well as strategic military operations.

The Kingdom of Tolkeen and its closest allies can only watch and wait for the inevitable as they prepare for the final battles.

Free Quebec: The Eastern Front

The eastern front has appeared overnight. Within 48 hours of the Emperor's *Campaign of Unity* address, 200,000 troops massed near the eastern border of Free Quebec. Within a month, a half million troops stretched from the northeast to the southern

U.S. borders of New York, Vermont, New Hampshire and Maine. Additional troops (estimated at 200,000), heavy armored divisions, and Skelebots (estimated at over one million) have joined the initial invasion force. Although there have been reports of small reconnaissance and containment operations, tiny, short-lived skirmishes and fly-bys, "war" against Free Quebec has not yet begun.

However, Coalition blood has been spilt. Not at the hands of Quebec patriots but by raiding parties of bandits, freebooters, rebels, mercenaries and D-Bees, all with a hate for the CS. Since the CS is known as "the destroyers of all things not human," there is no shortage of those who revile them. CS soldiers have also met their maker at the hands of supernatural horrors and practitioners of magic. Some perished when they accidentally disturbed monsters or denizens of magic from their lairs. Others from refugees and monsters who find the CS troops too delightful a target to ignore. The majority of supernatural attackers have been predators and vile creatures like the *Loup Garou*, *Demon Bears* and *Windigo* who see the soldiers as easy prey or new playthings. Others fight to defend their homes or to extract deadly revenge from their eternal enemy. Still others are rebels, bandits and adventurers who regard the troops as an opportunity for plunder — soldiers who get in the way suffer the consequences. The CS will neither confirm or deny these incidents, saying only, "a certain amount of collateral damage is to be expected in any wilderness based campaign."

**Coalition Casualty Report (November 31st, 105 P.A.) —
Re. Assaults from enemies not allied with Free Quebec: Al-**

though officially refuted by the CS, approximately 4,400 CS soldiers have been slain by “unallied” wilderness monsters, raiders and assailants. An additional 30,000 troops have suffered injury or illness, and over 37,000 Skelebots have been lost in combat outside the borders of Free Quebec. A full third of these injuries are the result of large scale attacks by Shemarrian Warriors along the Pennsylvania-New York border. Another 10% fell to a “robot” legion of unknown origin. (Note: ARCHIE Three and Hagan Lonovich are responsible for these conflicts and casualties. They launched the attacks for two reasons: One, to keep the CS north of their secret base and operations in Aberdeen, Maryland; and two, to test their robots against the mighty CS in open combat, the results of which Archie and Hagan are pleased with). Another 10% of these casualties came from a terribly brief but devastating battle with Splugorth Traders along the coast of Nova Scotia. Much to the CS Navy’s embarrassment, they lost half their ships in this chance encounter. Meanwhile, property damage, sabotage and theft also plague military operations in the east, with small platoons and base camps away from the main armies being the most vulnerable to such trouble (these small groups make for easier targets).

Standard procedure against Free Quebec

The same basic strategies and tactics used against Tolkeen are planned against **Free Quebec**, at least initially to test the “enemy.” However, there are some serious barriers and flaws to this approach.

1. Free Quebec represents a much larger land area.
2. It has long-established military bases equal to anything possessed by the Coalition Army — namely because it was, until a short while ago, part of the CS Army.
3. The Quebec Army is seasoned and trained in all aspects of CS military operations. It is intimately familiar with CS Military operations, procedures, weapons, Special Forces, strategies and tactics (some of which were originally developed by Quebec Generals). This means not only does Free Quebec use many of the same military procedures, but the Quebec Army, anticipating a Coalition assault, is prepared with many countermeasures and can second guess, adjust and counter the Coalition troops more effectively than any enemy the CS has ever faced (or ever will).
4. Free Quebec has a superior naval force and currently controls the Atlantic seaboard of Canada as well as the eastern half of the Saint Lawrence Seaway. This makes the Quebec forces highly mobile and versatile with ground, air and sea capabilities. Moreover, they cannot be easily land-locked, penned in, contained and slowly crushed on all sides by surrounding troops (as is the case at Tolkeen). **Note:** CS attempts to establish blockades to prevent overseas trade, the transport of vital goods and naval operations *will* be futile and result in their greatest losses of the war. The Quebec Navy is just that prepared and good.
5. Coalition Technology! The Army of Free Quebec wields many of the same equipment, weapons and vehicles of destruction as the Coalition Army, including Death’s Head Transports, Sky Cycles, SAMAS, UAR-Robots, helicopters, and hover vehicles, in addition to Glitter Boys and an unknown number of new and alternative weapons and vehicles.

On the other hand, the recently unveiled “new” Coalition Army has many forces Free Quebec does not, most notably the

new SAMAS (Smiling Jack and Super-SAMAS), Glitter Boy Killers, new IAR combat robot series, new Skelebots and an array of tanks and aircraft.

All in all, both are relatively equal in technology. And with the CS forces currently spread thin against Tolkeen, the Xiticix and the defense of its sprawling borders, roughly equal in man-power and resources.

6. X-Factors and preparedness. Free Quebec has spent the last five years secretly building its army, creating new Glitter Boys and stockpiling supplies for the contingency of war. Consequently, they are much better prepared for war than the quickly, and unexpectedly, mobilized Coalition Military. Furthermore, the “defender,” hunkered down behind its fortified defenses always has the advantage against a mobile field army.

X-Factors include tactical countermeasures and surprise moves, new fortifications and defenses, new and previously unknown weapons, and the morale and resolve of the people. **Note:** Currently, the Coalition High Command believes a show of force combined with sieges against select strategic targets will break the will of the Quebec people and cause them to capitulate to the will of the CS. They are wrong. Furthermore, when these tactics do not bring about the anticipated results, the CS end of the war will *stall* while the Coalition High Command rethinks their position and formulates a new plan of attack. This pause, coupled with the dramatic wins by Quebec’s navy, and the Coalition Army’s inability to inflict significant damage in the first phase of attack, will fuel the resolve of Free Quebec to never surrender and send their spirits soaring. Morale will never be higher. Surrender will be out of the question.

Facing the Enemy

The first skirmishes with Free Quebec have come along the Saint Lawrence River and the coasts of New Brunswick and Newfoundland. The Coalition Navy’s futile “first strike” attempts to cutoff the sea routes and river traffic in and out of Free Quebec have met with disaster. However, the loss of human life has been negligible, because the Quebec Army has made a point to scuttle CS vessels, scatter naval forces and cutoff the CS lines of communication and sea routes to render their navy impotent rather than destroy it (and adding insult to injury). The discovery of Splugorth activity in and around southern Newfoundland and the heavy losses from a chance encounter near Cape Breton, Nova Scotia only adds to the Coalition Navy’s embarrassment and dilemma. Unless something changes soon, the CS Navy will be a non-factor in this war.

Moreover, the show of force and threat of war that the Coalition High Command believed would frighten Free Quebec into capitulating has only served to unite the nation with absolute resolve to stay free and independent. Faced with a foe committed to fight, compounded with the strategic failures of the Coalition Navy and a reluctance to do battle on the part of the CS troops, the Emperor has been forced to slow his advance against the rebellious Free Quebec.

Economically and strategically, the Coalition States are committed to the Tolkeen Front and, for the moment, can only rely on secondary efforts against the Free Quebec offensive. To draw forces and supplies from the west would compromise their positions and allow them to become vulnerable to sorcerers and their inhuman allies. The Generals among the western armies are un-

easy about the upcoming battle plans to destroy Tolkeen and a hundred or more smaller magic-based and D-Bee-infested cesspools. Recent skirmishes have displayed more resourcefulness and a greater degree of power and ruthlessness on the part of the lesser Tolkeen allies than had been expected. Not only have the Tolkeen forces been joined by the fabled *Cyber-Knights* and the incredibly powerful *Dragon Kings*, but scores of small kingdoms and communities. (With the advancing CS Army, even communities unallied to Tolkeen have no choice but to flee or join forces with Tolkeen lest they be destroyed by the Coalition.)

While the Coalition has a distinct advantage in firepower, technological war machines and strength in numbers, *magic* is the great equalizer. The CS is now entering the heart of the region's greatest network of magic. It is said a hundred ley lines crisscross the area around Tolkeen, and that even the smallest village is likely to harbor dozens of wizards and/or dragons and other mystical creatures. Consequently, the heaviest and most deadly combat is yet to come, with the siege on Tolkeen expected to reach its zenith by the end of summer or fall, 106 P.A. This being the case, a second major war front at Free Quebec is a dangerous liability, indeed. The added drain on resources and manpower could put the Coalition in a compromising and vulnerable position. A position the CS can ill afford. The consolidation of resources, food and supplies needed for the Tolkeen Front, as well as possible threats from the Federation of Magic, Xiticix and other dangers, all play a role in the slow and cautious approach to war with the rebel State of Free Quebec.

As one might expect, publicly, the Coalition States paints everything as rosy. The Tolkeen monsters and evil mages are on the run and each confrontation ends in victory for the CS. (This is more or less true. The CS just fails to mention at what price some of these "victories" come, or how heavy casualties may have been, or the fact that the heaviest of the Tolkeen resistance is yet to be challenged). Likewise, the CS propaganda machine reports that Free Quebec has been "contained" and is effectively surrounded (the latter is patently untrue). For the moment, the CS states it is letting the people of Quebec "stew" as they ponder their fate. In an act of self-proclaimed benevolence, Emperor Prosek is giving the people of Quebec the opportunity to "reconsider" their position, reject their government and rejoin the States. In truth, this is all a delaying action designed to make the Coalition Military and the Emperor look merciful, strong and in control, while buying them time to focus upon the Siege on Tolkeen and the reformulating of their strategies against an unshakable Free Quebec.

Behind the scenes

Now that the Emperor has shown his true feelings for the former-State of Free Quebec, the *National Assembly of Quebec* is glad it has declared Free Quebec an independent state. This declaration has had several side effects. The first, it shows Emperor Prosek they have nothing to lose by fighting a war with Chi-Town or the Coalition Army. To allow the Emperor's iron fist to rule them would be akin to losing their independence, and their humanity. Secondly, it allows them to officially extend

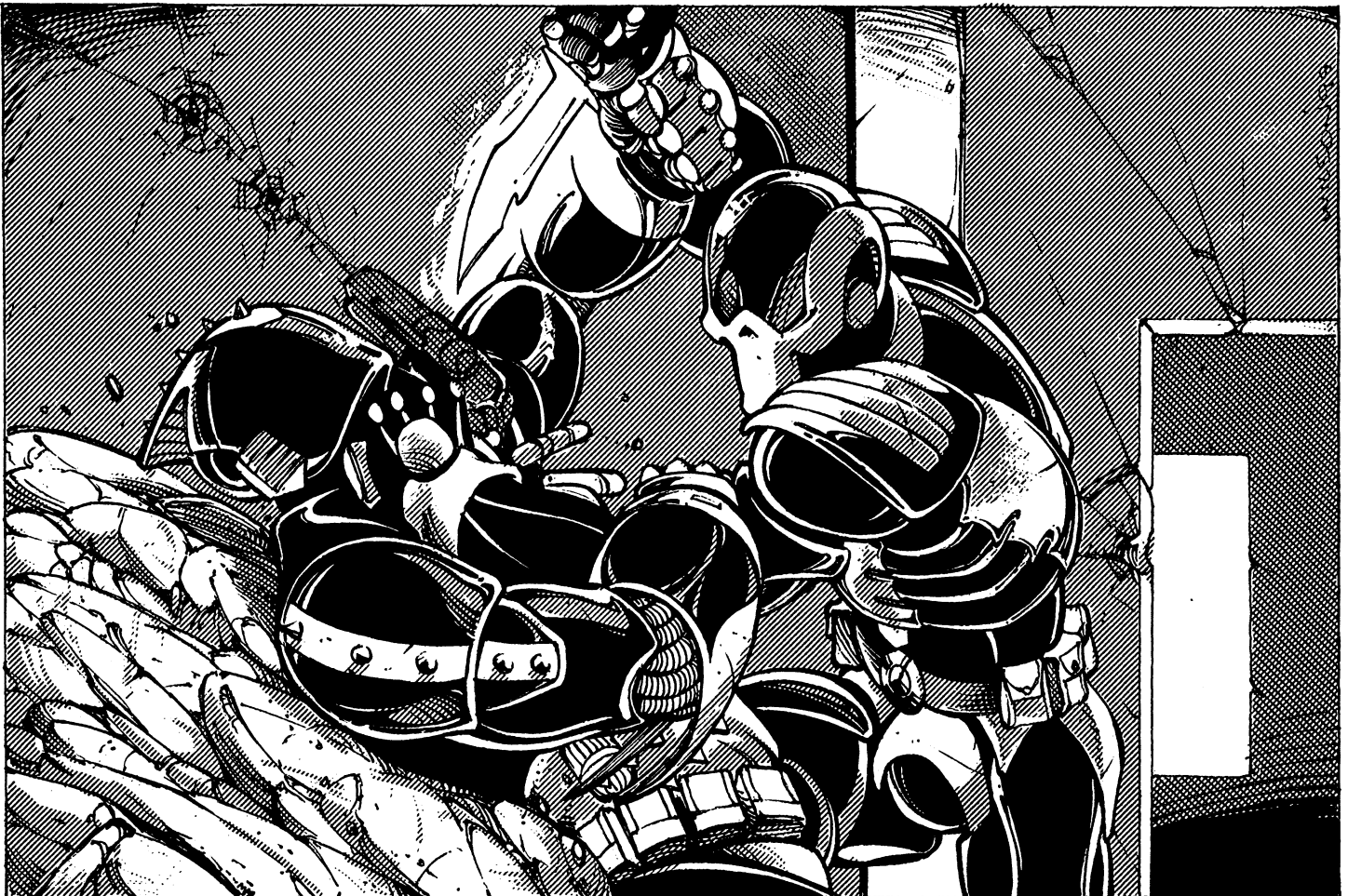

their borders and gives them more freedom in choosing the political path they will follow. Thirdly, it gives them the chance to strengthen their alliance with the New German Republic without running behind the Emperor's back and having to cover their tracks. Lastly, it has united the people like never before.

What the Emperor hadn't realized when he declared war was the overwhelming public support people would give their leadership. With the majority of the people living in the cities having at least a moderate education, they all know the risks involved, and the consequences of standing and fighting against the combined strength of the Coalition States. However, they find these dire consequences preferable to allowing Chi-Town to rule their lives. The illiterate and uneducated have equal reason to believe in and support their leaders, for they are as independent and patriotic as anybody.

Politically several factors are at play against the Coalition and Emperor Prosek. Government officials and military supporters within the CS are eager to make war against Tolkeen, but hesitant to battle Free Quebec. Tolkeen has long been a bastion of magic forces, the supernatural and those who would conspire against humankind (or at least the CS). They are seen as a blight that deserves to be eradicated. In this regard, the people of the Coalition States and the government are completely united thanks to the charismatic Emperor Prosek and his son's well crafted propaganda against Tolkeen, users of magic and non-humans. As for Free Quebec, here, their own propaganda machine works against them. That nation has been, for too long, an ally and its people, brethren. Its heroics and contributions to its sister States over the decades are too well known and celebrated. The generations Quebec has served as a vibrant and viable member of the CS has won it tremendous respect and sympathy. As a result, while most Coalition citizens see the act of secession as foolishness, a great disappointment, and a slap in the face or even treason, they stop short at war. Few want to destroy their long-time brethren. It just seems too extreme and just plain wrong. A recent survey indicates only 32% of the CS population completely supports the idea of using whatever military force is necessary to "quell the Free Quebec rebellion" and bring it back into the fold as a member State. Most of the rest are uncertain and/or feel other "sanctions" and measures should be considered before war. A surprising 19% are even willing to "consider" the possibility of accepting Quebec as a free and sovereign nation, provided they remain allies and trade partners and do not threaten or challenge the Coalition States. These are unprecedented numbers especially for the Coalition States where the Emperor and government usually enjoy 68-90% approval and support ratings.

Even the Emperor and his chief advisors privately admit their motives against Quebec are to save face and regain the economic and political power that is inherent with Free Quebec as a member State. However, they are beginning to question the wisdom of their actions. Joseph Prosek the Second has privately suggested that their declaration of war may have been hasty and ill conceived. He has even gone so far as to ask if he should begin to plot a contingency plan enabling the CS to reasonably back out of the "war." Emperor Prosek angrily condemned this suggestion, insisting that Quebec (he refuses to address them as "free" Quebec) is an ungrateful traitor that needs to be punished and subjugated for their insubordination. He then ordered his son, the Head of Propaganda, to use his resources to change the

people's minds, and to do so quickly. This has prompted the propaganda experts, lead by Colonel Joseph Prosek II, to introduce a new series of reports and messages aimed at creating anti-Quebec sentiment among the people of the CS. This campaign promotes the leadership of Free Quebec as a group of idealists gone awry and, if left unchecked, a threat to the Coalition dream. The people of Free Quebec are talked about as pawns under the iron grip of a maniacal National Assembly which heeds only their own whims. So far the campaign has done little to sway public opinion.

Iron Heart is the loudest proponent for sanctions — if not all-out war — against the former State of Free Quebec. Long the "little brother" to Free Quebec, the leaders of Iron Heart are confident in the new power and the new army they employ. Their motivations are to gain the political and economic wealth of Free Quebec, usurp Quebec's long held position as "favored son," and to deal them a crushing blow for the years of arrogance displayed against Iron Heart by the National Assembly and the Quebecois people. They argue that only a secure and cohesive Coalition can properly secure the continent for the good of humankind. To do otherwise, they insist, is a sign of weakness and will inspire others to challenge the Coalition States unless there are clear consequences. There is no love lost between these two factions, and Iron Heart wants to get out from the shadow of Free Quebec.

That having been said, the leaders at Iron Heart do feel serious qualms about fighting fellow human supremacists and the danger of weakening the CS (especially since they are looking at war against the Xiticix swarms). Consequently, they will condone an independent Free Quebec, provided this new nation does not threaten their own security and elevated position among the Coalition States. To this end, they argue Free Quebec can not be trusted, trade should be very limited, and any possible alliance loose and in the Coalition's favor.

The Coalition Military is pretty much split down the middle, with half ready to blast "the rebels" back into the Dark Ages, and the other half reticent about destroying their brethren. For a great number of years, soldiers and officers from both Chi-Town and Free Quebec would be stationed in other States for tours of duty, so many are intimately familiar with each other's culture and are likely to have military and civilian friends. Free Quebec was also a major player in the creation and development of the Coalition Navy. Those who are reluctant to battle their friends know they are subject to political decrees and will fight if necessary. However, even the lowliest soldier remembers "yesterday" when Free Quebec was a valued member of the Coalition States.

Military planners and tacticians realize Free Quebec has some very distinct advantages. They know about some of the newly developed types of Glitter Boys, but can only guess about their field capabilities as none have been observed in combat (at least not by anybody who has lived to tell the tale). Likewise, little is known about the new, redesigned Quebec versions of giant robots, and SAMAS. While CS Intelligence strives to be accurate, they just don't know how many of each war machine may be laying in wait, nor what other surprises the rebel forces may have up their sleeves. The Coalition Army has recently added *cyborgs* and *Juicers* to their forces, but Free Quebec has designed and deployed their own line of cyborgs for years. Con-

sequently, not only is their bionic augmentation as advanced and powerful as anything possessed by the Coalition States, but the Army of Quebec has many more thousands of cyborg soldiers at their disposal than the CS.

Triax & the NGR. The Emperor and his military leaders are painfully aware of the infamous “Glitter Boy deal” between Free Quebec and Triax Industries of the New German Republic (NGR). They know a German-style Glitter Boy has been designed by Triax under government contract with Free Quebec, and shipped to the rebel State. They just don’t know how many were shipped or what the capabilities of this new design are. Despite petitions to the NGR for full disclosure to preserve diplomatic relations, the German government has refused to force Triax to reveal “privileged client information.” On the other hand, the NGR assures the CS that it will stay out of any “war” on North American soil, and they hope this “unfortunate incident” will not damage their own fledgling diplomatic relations with the Coalition. The leaders at Chi-Town are disapproving of the NGR’s lack of cooperation and unnerved by this exchange of technologies, but have yet to sever their own ties with the NGR. Meanwhile, CS spies have gotten their hands on some test footage of the Triax Glitter Boy and continue (unsuccessfully) to secretly acquire actual factory design statistics and schematics.

Note: The deal with Free Quebec was hailed as the exchange of Glitter Boys, but it goes much deeper than that. Free Quebec and the NGR have actively traded several other lesser technologies, but more importantly, Free Quebec has been exporting large quantities of surplus grain and other foodstuffs to the besieged nation.

The leadership of the NGR sees the conflict between Free Quebec and the CS as a “civil” squabble, and honestly has no desire to join one side or the other. The NGR regards both of the feuding nations as important potential allies and trading partners as well as like-minded governments. Consequently, they would like to see the two reach a peaceful resolution, and have offered to act as arbitrators should the two sides agree. Both have declined.

The NGR has its own problems to face at home. The prolonged war with the aggressive invaders from the Gargoyle Empire is a constant strain on their defenses and resources, which is why the NGR has turned to North America in search of new allies. It could not afford to become embroiled in a foreign war even if it wanted to. See **Rifts® World Book Five: Triax & The NGR™** for details.

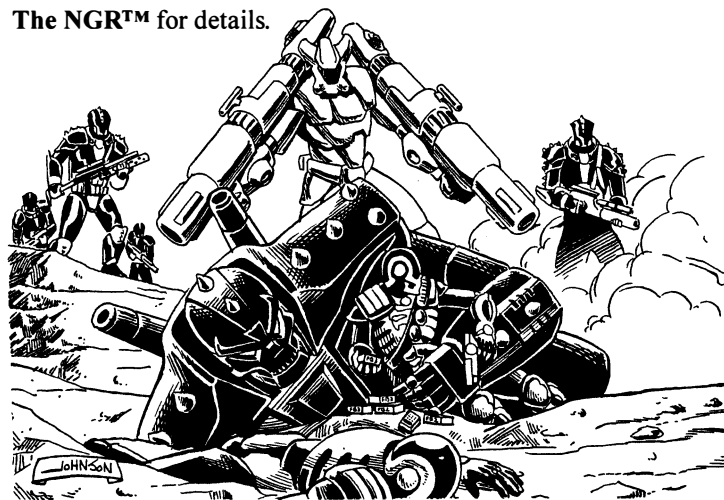

Free Quebec

Re-birth of a Nation

The “nation” of Free Quebec rests on the same ground that was once the pre-Rifts *Province of Quebec*. Even as a part of the old Canadian Empire, it stood apart, yearning for independence and the recognition of its differences. Traditions, language and institutions set them apart from the other provinces. As fate would have it, centuries after the Great Cataclysm reshaped the world, the people of Quebec again yearn for independence and strive to preserve their unique identity.

The great city was fortunate. More than half of it survived the Cataclysm, although casualties were high. The pestilence and monsters that followed would kill many more and inflict more destruction. Still, Quebec fared much better than Prince Edward Island, Nova Scotia, New Brunswick, and much of the world. At these places civilization was wiped clean from the face of the planet — no or few survivors (less than 10% of the total population).

As one of the few partially standing cities, thousands of survivors converged on the City of Quebec. Many others collected at Montreal — the largest city in the province before the Rifts came. Quebec would face many challenges during the centuries that followed in a time known as the Dark Ages, when civilization came to an end and anarchy reigned. Much of the city would be destroyed and rebuilt many times. Often it teetered on the brink of collapse, and war upon war decimated it repeatedly. Eventually the old city was abandoned and the foundation was laid for the fortified Quebec City of today. Old Quebec became known as **Old Bones**, a battered, ramshackle, sister city roughly 100 miles (160 km) to the southeast, part of which is always under reconstruction, while half or more lays in ruin.

Despite all the trials and tribulations, “New” Quebec City grew, and the nation known as *Free Quebec* slowly clawed its way back to civilization and prominence. Eventually, the designation of “new” was dropped from its name, and **Quebec City** became the center of the reclaimed Quebec province and the soul of Free Quebec. Sadly, while the Quebec region would manage to survive and, with time, prosper, others like Montreal, Ottawa, Toronto, and London would crumble and fall. What remains of them today are entirely new incarnations like Lazlo, half buried ruins (like London and much of the world), or the crumbling lairs of scavengers or cutthroats like Montreal, dominated by D-Bees, monsters, bandits or worse.

Throughout the Dark Ages and into the New Age of Mankind beginning with the Post Apocalyptic calendar, the sovereignty and survival of Quebec would be challenged hundreds of times. Although removed from the most severe dimension-warping activity, demon infestations and magical forces, the St. Lawrence River Valley has its fair share of ley line and supernatural dangers. Quebec was ravaged many times by demons, monsters and alien invaders. Only the establishment of large communities protected by heavy fortifications and Mega-Damage weaponry salvaged from the previous era helped to deter attackers. It is from these conflicts and Quebec’s enduring ability to survive and rebuild like the mythical Phoenix, that the word “free” was

added to the nation's name. Taken from the battle cry, "Forever free!"

The city-state of **Free Quebec** (its seat of government at Quebec City) did not become a true power till the last few decades of the Dark Ages — perhaps 50 or 60 years before the Post Apocalyptic calendar began (roughly 155 to 165 years before our current time-line). Many factors contributed to the nation's rise to power, but most historians point to Quebec's unraveling of the secrets behind the famous Glitter Boy as the most significant.

The Glitter Boy Legacy

According to legend, the first Glitter Boys came into Free Quebec's possession during the Dark Ages. It is said explorers unearthed a cache of the armored suits from the ruins of a USA military installation, probably in Maine, New York or Pennsylvania (the exact location is unknown). This legendary first Quebec Glitter Boy "legion" is said to have numbered 288 strong, although some insist it was three or four times that number — according to legend, the most Glitter Boys ever discovered at any one time or place. It was these armored juggernauts that gave Quebec the edge it needed to fight back and survive. However, after the passage of the first four generations and countless battles, that number had been reduced to one hundred, and all of them had been repaired many, many times.

It would be the warrior-pilots of Quebec and tales of their battles and practices that began the tradition of maintaining and rebuilding Glitter Boys, and passing them down to their heirs, generation to generation. This tradition was adopted by outsiders who heard stories about these warriors, particularly during the Dark Ages when technology and manufacturing of any kind were lost among barbarism and savagery. This established the *traditional Glitter Boy O.C.C.* known today, for except in Free Quebec, the majority of warrior-adventurers who call themselves Glitter Boy pilots have inherited a machine that dates back to before the Great Cataclysm and which has been in use and rebuilt numerous times spanning decades. An estimated 55-65% of the Glitter Boys outside of Free Quebec have been in active service for 100-200 years. The more recently discovered relics are those found in the last 50 years, typically among the ruins of old military bases and bunkers — forgotten and lost weapon reserves that once belonged to the army of the old American Empire (the original creators of the GBs). It is believed that 5,000-10,000 Glitter Boys were destroyed in the first decades of the Dark Ages (SAMAS too, but they were all lost and forgotten until Chi-Town reintroduced them). Fewer than 3,000 have been unearthed, activated and put into service over the last 200 years. How many *may* still remain hidden is unknown. Legends that tell of thousands hidden away in some forgotten arsenal at mythical places like NORAD have persisted for centuries, but have never been unearthed. Instead, of pre-Rifts built Glitter Boys are typically discovered in pairs or small clusters of 10-40. **Note:** No old, unused Glitter Boy is known to have been discovered in the last 20 years, although a few are likely to have been and gone unreported.

If his identity is known, the leaders of Free Quebec have kept it secret for a century, maybe longer, but at some point near the end of the Dark Ages, some mechanical genius at Quebec found or figured out how to create and manufacture Glitter Boys. Despite their denials, it has been suspected for at least 70 years that

Free Quebec has held the secret of the Glitter Boy. A secret they have guarded jealously and attempted to disguise by producing very small numbers of the amazing (and expensive) power armor. Although the Quebec Glitter Boy "legion" never seemed to exceed four or five hundred (Quebec City has approximately 300 and the rest are scattered throughout the province, making an accurate count by outsiders impossible), they never seemed to diminish. Free Quebec maintained that the majority of their Glitter Boys were ancient, but expertly repaired and restored. Others were newly acquired from scavengers and mercenaries. Indeed, Free Quebec has always paid top dollar for GBs and spare parts. However, even to the casual observer, many of Quebec's Glitter Boys look brand new, as if they had only recently come off the production line. Rumors dating as far back as 20 P.A. have claimed Free Quebec possessed not only the secrets but the manufacturing capabilities to mass produce Glitter Boys. Many believe that they kept it secret to avoid being attacked by those who would covet such knowledge and to keep a low profile; i.e. maintain enough power armor suits to dissuade attackers and intimidate enemies, but not so many that would-be kings would regard Free Quebec as an enemy or threat to be destroyed. If this is true, then they have played this deception perfectly. Modern urban legends over the last 30 years have conjectured that hidden away in Free Quebec are thousands of Glitter Boys that have been built and stockpiled until the day they are needed.

Under the protection of its armor clad warriors, guided by a strong democratic government, coupled with their somewhat remote location, even fifty years before 100 P.A., Free Quebec had become the second most powerful human community in North America. With this recognition, particularly in the area of military might, came economic stability, growth, development of natural resources, political clout and recognition. Smaller communities — trading posts, farms, towns and cities — began to spring up around the City-State of Free Quebec. Soon trade agreements, alliances and requests for protection began to flood the kingdom. Over the ensuing years, scores of once independent communities became official members of the city-state. As such, they answered to Free Quebec, accepted its leadership, followed its laws and existed as satellite communities to a larger regional government. This also increased the land holdings as the surrounding communities sprawled across the eastern half of the old province. A nation was in the making.

The Coalition Years

So it was with a bit of hesitancy that Free Quebec agreed to join Chi-Town and a few other growing kingdoms to form the more powerful and long-reaching nation known as the **Coalition States**. The big attraction was that each State would remain autonomous, yet at the same time establish a power network through which they could help each other and preserve humankind's place in the world. Indeed, with this political, economic and military alliance, came fewer conflicts, rapid growth and a sharing of technologies. This led to the creation of uniform trade regulations, currency, laws, communications, and military protocol. Combined with strong leadership and a sense of purpose, the Coalition States blossomed into a power the likes of which Rifts Earth has never before seen.

The alliance between Free Quebec and the rest of the Coalition, especially Chi-Town, was a wary one at best. Chi-Town

valued Free Quebec's power and economy to help stimulate other States, but rankled at their ally's strong, personal identity and persistent reliance on Glitter Boys, bionic augmentation, and Juicer technology, to name just a few differences. When Emperor Prosek rose to power, dissension and conflict intensified. Free Quebec constantly struggled with what they saw to be an Emperor ever trying to increase his power and sphere of influence. They felt he often overstepped his authority and bullied the other allied States to conform to his personal vision of the way things should be.

Both sides slowly grew more distant, distrusting and hostile toward one another. The Emperor was displeased with the second greatest State in the union. He was especially disturbed by the existence of a formidable Glitter Boy army and chose to believe that a secret army of at least a thousand was hidden away in storage (Free Quebec did admit to having what Emperor Prosek considered to be the archaic technology to manufacture new Glitter Boys). In an effort of compromise, Free Quebec reluctantly halted further deployment of bionic troops. However, Emperor Prosek recognized this as the hollow gesture it was, for the Quebec Army had all the cyborg troops and spare bionic components it needed. Free Quebec also "officially" halted all

Juicer creation, while Chi-Town spies confirmed that Juicer creation, although dramatically curtailed and outlawed, had simply gone underground and few were prosecuted for breaking the law. Free Quebec's refusal to use Dog Boys was also a matter of hot contention. The Quebecois would have no part of the mutants whatsoever. This time it was the Emperor who reluctantly capitulated. Various other minor differences regarding military, economic, social or political issues were also sore points.

It was Free Quebec's unilateral decision to enter into a significant trade agreement and an exchange of technologies and goods with the New German Republic and Triax Industries that marked the beginning of the end. Chi-Town officially chastised this action and repudiated the exchange of technologies, specifically Free Quebec's monopoly on Glitter Boys. CS leaders also questioned and condemned Free Quebec's sudden increase in the number of Glitter Boys, having learned (through spies at Lazlo via Erin Tarn's reports) that several hundred (perhaps thousands) of new style (and old?) Glitter Boys had been commissioned by the State. Chi-Town knew for years that a major contributing factor to low Glitter Boy production had been the high cost of manufacturing, particularly the nuclear power system. Consequently, the Chi-Town leadership was more dis-

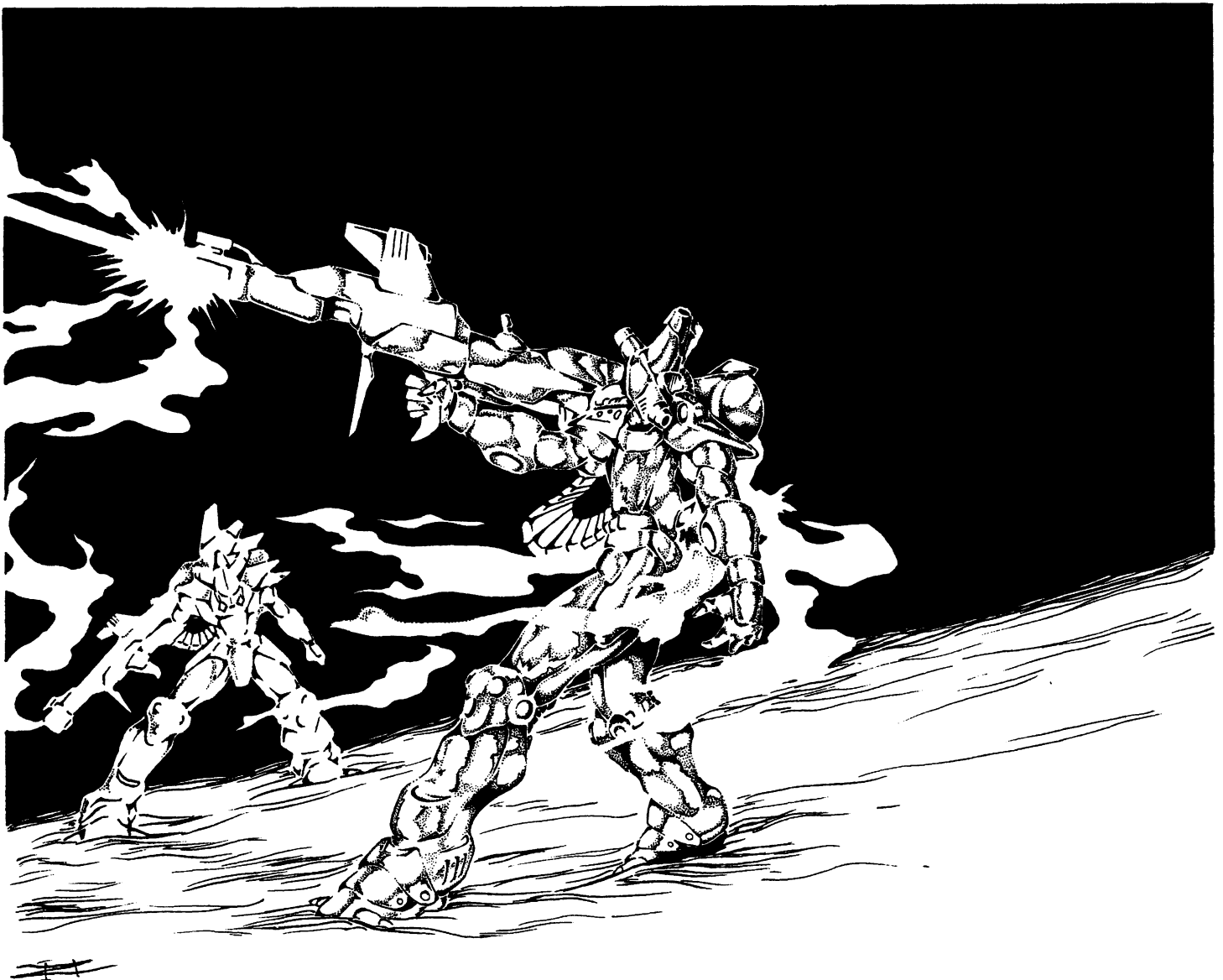

turbed to learn that Free Quebec had ordered thousands more Glitter Boy-style power supplies than the order for Glitter Boys. (This suggested that either thousands of GBs really did exist somewhere in storage, waiting for power systems to be installed, or that production was about to go into overdrive.) This ultimately led to Chi-Town's *demand* that Quebec retire and dismantle all Glitter Boys in favor of a uniform Coalition Army (i.e. all Coalition States were to use the same combat vehicles, robots, weapons, and equipment). This demand to conform also included the placement of Dog Pack troops in the Quebec Army and other less sweeping changes.

Free Quebec flatly refused.

Chi-Town's response to Free Quebec's insubordination used to be continuous irritation and frustration, but it was now quickly turning into anger, paranoia and intolerance.

Ultimately, these clashes led to Free Quebec's decision to separate itself from the Coalition States and the intrusive power of Emperor Prosek. This, in turn, led to Chi-Town's accusations of treason and the declaration of war. The Emperor has seemed to convince himself that the former State is a collection of misguided, small-minded souls, swayed by their corrupt and biased leaders, whom they blindly follow. It was only the creation of the New Army and the expected Tolkeen offensive that allowed Emperor Prosek to play his hand and openly challenge the leaders of Free Quebec.

Battle Lines Drawn

With the threat of the Coalition's New Army bearing down on them, the Quebec leadership and Military have set into motion a plan of defense. One of the key factors in this defense is an expansion of their borders to include all of the original province of Quebec. The idea being that this will be the no-man's-land where the majority of the fighting will take place and, with any luck, help to preserve the cities themselves — a buffer zone to keep the conflict from coming inside the state proper. Along these lines, the populations of many outlying communities have been evacuated and brought to the fortified interior. The land they have added nearly doubles what they claimed as their own before the Emperor's Campaign of Unity was announced, although they are unlikely to be able or willing to keep these new lands after the war. Additionally, most generals don't really believe this move will significantly diminish the damage and casualties their nation will suffer, but it is worth a try.

Surprisingly, their policy of expansion has not included the basic Coalition human supremacist attitudes. Several alien and D-Bee villages have been for the most part, left intact, with even those that are extremely hostile being left unscathed (let the CS troops deal with them). This is not a change in policy, but a matter of practicality and expedience.

This strategy is the brainchild of **Colonel Deschamps**, Commander of the Southern Expeditionary Divisions. His idea was to let the Emperor's troops deal with hostile natives in hope of delaying the CS invasion operation and to stir up outside resistance. The idea met severe opposition, however, the threat of the Emperor's troops swayed most of the opposed to accept the unorthodox defense measure.

A series of mobile military observation posts have been established to provide accurate intelligence on the incoming Co-

alition Armies. A line of these posts stretches from Lake Ontario to the southern tip of Lake Champlain and along the St. Lawrence River. In all cases, the outposts, whether manned or unmanned, have been designed for the utmost concealment from all forms of detection. Even in the case of an army walking right over an observation unit, it should remain unnoticed.

Several naval observation posts and underwater mine fields have also been established, and a massive area of underwater mines have been set up near the *ruins of Cornwall*.

More troops are in position at forts and strategic locations with several new bunkers and fortifications under hasty construction.

The northern region of Free Quebec has always been a large, hostile wilderness. Long before the Coalition Army arrived on its borders, the leadership of Free Quebec set to locating and obtaining various resources and strategic positions. But except for scattered outposts, towns, mining operations and forts, the north is largely unpopulated and lawless. Human woodsmen, small native tribes, bandits, D-Bee squatters, alien beings, monsters and demons all inhabit this massive trek of wilderness. Most of these inhabitants will not take kindly to the Coalition's presence and will retaliate in one way or another. Here, the Quebec Army will engage the CS invaders with small squad tactics and guerrilla warfare, and help to incite the "regional hostiles" to do their fair share of damage.

To the east lies the sparsely populated forest and plains, another area rife with demons and monsters as well as magical energies. In this region there are several ley lines that cross the landscape, as well as two moderately large nexus points. This means the likely presence of practitioners of magic, the occasional dragon and the supernatural. What little bits of civilization exist here are small farms, trading posts, trappers, small nomadic tribes (Native Americans, Psi-Stalkers and various D-Bees), tiny communities/bands of D-Bees and a few Quebec military outposts and patrols. This is another place where guerrilla warfare and small squad tactics will be the initial response to CS incursion. However, large scale battles are also likely in the east, as divisions of the Quebec Army, Glitter Boys and SAMAS included, engage large-scale invasion forces of the Coalition Army.

The mouth of the **St. Lawrence River** opens up directly into the Atlantic Ocean. The shallow waters are a ripe source of fish and other seafood. As such, it is also a prime location for seagoing demons to collect. The Free Quebec Navy keeps the waters from the **Island Kingdom of Montreal** into the **Gulf of St. Lawrence** and up to the southern coasts of **Newfoundland**, open and under the complete control of Free Quebec. The only fortified naval base is a hidden observation post, complete with dry dock and repair capabilities, on what's left of **Anticosti Island**. The island base looks over the inlets on both sides and monitors them for activity. It also serves as a communications relay station and has a complement of 36 classic Glitter Boys, 48 Sea Dragons, 96 old style SAMAS, eight CS patrol boats, and a contingent of 144 Skelebots. Troops and crew are limited to under 500 (typically 384) in order to maintain maximum mobility, however, there are quarters and facilities for up to 2000. This base is only three years old and equipped with all the modern advancements.

Free Quebec has been careful to take only a defensive posture, making no outwardly hostile gestures with any of these moves —stop-gap measures against an impending invasion. They have resolved to NOT fire the first shot. That will be on the Coalition's head. The Quebec military forces have unanimously voted to follow their political leaders. Under the leadership of their generals, they have worked feverishly to develop the defenses needed to hold off the Emperor's troops. They don't relish the idea of firing upon fellow humans, but self-defense and self-preservation are two very powerful forces at work. If it comes to war, the soldiers of the Free Quebec Military are ready and willing to defend their homeland. To the death. The battle cry, "Forever free!" again rings throughout the nation.

Quebec Military

By Francois DesRochers & Kevin Siembieda

While part of the Coalition States, Free Quebec had been the model Coalition Army. If not for the notable inclusion of the Glitter Boys and the absence of Dog Packs, Psi-Stalkers and psychics, the Quebec Military could not have been distinguished from that of Chi-Town or any other Coalition State. The same "Dead Boy" armor and weapons were used, the same robots and vehicles, and the same fundamental military organization, procedures, strategies and tactics.

Unlike Chi-Town, the Free Quebec Military has never been very expansionistic. Except to support CS operation in other parts of the country, Free Quebec had kept to itself, concentrating on the building of cities and the protection of the citizens within its already expansive and sparsely populated borders. As noted elsewhere, much of the region claimed by Free Quebec is very much a wild and untamed wilderness rife with D-Bee squatters, monsters, and supernatural horrors. Consequently, the few "foreign" military campaigns they have undertaken in the last few decades were in support of allied CS operations, such as the defense of mutually vital resources and strategic locations, response to CS enemy aggression, tactical strikes, purges against inhuman forces encroaching on CS (and Quebec) territories, and similar. For decades Free Quebec enjoyed the position of being able to extend their borders in almost every direction, but has chosen to consolidate and fortify their current holdings.

In recent years, the Quebec Armed Forces have been particularly reserved and quiet, allowing the military to rest and prepare itself for possible CS transgressions. The National Assembly and military leaders anticipated that Chi-Town might respond with force when they finally announced their secession from the States, and had been preparing during the last five years for every possible contingency, including war. However, being "prepared" for war and living through it are two different things. For one, nobody can ever truly be prepared for war and the level of anxiety and paranoia that comes with it. Consequently, with the growing CS Military presence along the nation's borders, a strong military presence, particularly Glitter Boys and SAMAS, means more to the people than ever. Their

world will soon be under siege, thus it is comforting to see the light glinting off the chrome of Glitter Boys on patrol, troopers stationed at every major intersection and Violator SAMAS soaring overhead in the skies above. The sacrifice these soldiers make is appreciated by all members of society, from the lowliest street beggar to the Prime Minister himself. A sense of national pride, enforced with government propaganda, has produced an army of *patriots*, supported by its citizenry, ready to fight any battle threatening their homes and families.

Free Quebec still uses many of the old-style CS armor, weapons, equipment and vehicles. These weapons of war, particularly body armor, power armor and select vehicles have been cosmetically changed to give the Quebec forces their own distinctive appearance, while others have been *modified* or improved in other ways (i.e. greater range, M.D.C., firepower, versatility, etc.). Although not as technologically diverse as the combined Coalition States, Free Quebec is a close second and has a few things the Coalition does not, most notably thousands of Glitter Boys and a capable Navy. In the hands of the valiant soldiers of Free Quebec, the nation looks toward its borders in quiet anticipation and mute apprehension for all-out war against the Coalition.

Quebec Soldiers

Generally speaking, the soldiers of Free Quebec are highly motivated, professional troops equal to any in North America. They are well equipped, well trained and completely dedicated to defending their nation at all costs. Supplies, at least for the first year or so of war, will be plentiful, with most new items not already stockpiled to be manufactured as needed. Trade with the New German Republic and regional people (particularly mercenaries, freebooters and adventurers) will keep the economy from collapsing.

- Raw recruits with basic training and less than one year's experience are typically first or second level (roll 1D4 for random determination). Approximately 40% of the current Quebec Army is composed of "raw recruits."

Infantry
Soldier

Cavalry
Officer

Infantry
Officer



- Average level of experience for the typical seasoned soldier or police officer (has been in the Service for at least three years) is 3-6th level (1D4+2).
- Average level of experience for the elite “Descended” Glitter Boy pilots is 6-9th level (1D4+5).
- Average level of experience for most other power armor troops and newly trained Glitter Boy pilots is 3-5th level (1D4+2).
- Average level of experience for “elite troops” and “shock troopers,” specifically *Cyborgs* and *Juicers*, is 4-7th level (1D4+3).
- Average level of experience for Commissioned Officers is 7-12th level (1D6+6 for random determination).
- Quebec troops also have the large advantage of intimate knowledge of the region, years of preparation and holding the defensive position.

Note: Coalition troops are roughly comparable to those of Quebec. CS elite troops, Special Forces and officers will be one or two levels higher, but the majority of newly created and recruited CS *Cyborgs* and CS *Juicers* are roughly half as experi-

enced as Quebec’s forces (typically 1st to 4th level), and CS grunts and most other military personnel are typically a level or two lower than Free Quebec. However, the CS has a greater range of combat vehicles, aircraft and more manpower. Currently, Coalition forces only outnumber Quebec 2 to 1, but that is likely to change to 4 to 1 before long.

Components of the Quebec Military

Regular Army

The vast majority of the armed forces that fight and defend the political powers that be in Free Quebec fall under the Regular Army. They form the bulk of the forces and have access to the majority of resources and facilities. It functions very much like the Coalition Military with the same system of ranks, command structure, similar salaries and accommodations, organiza-

Front View
Infantry Soldier

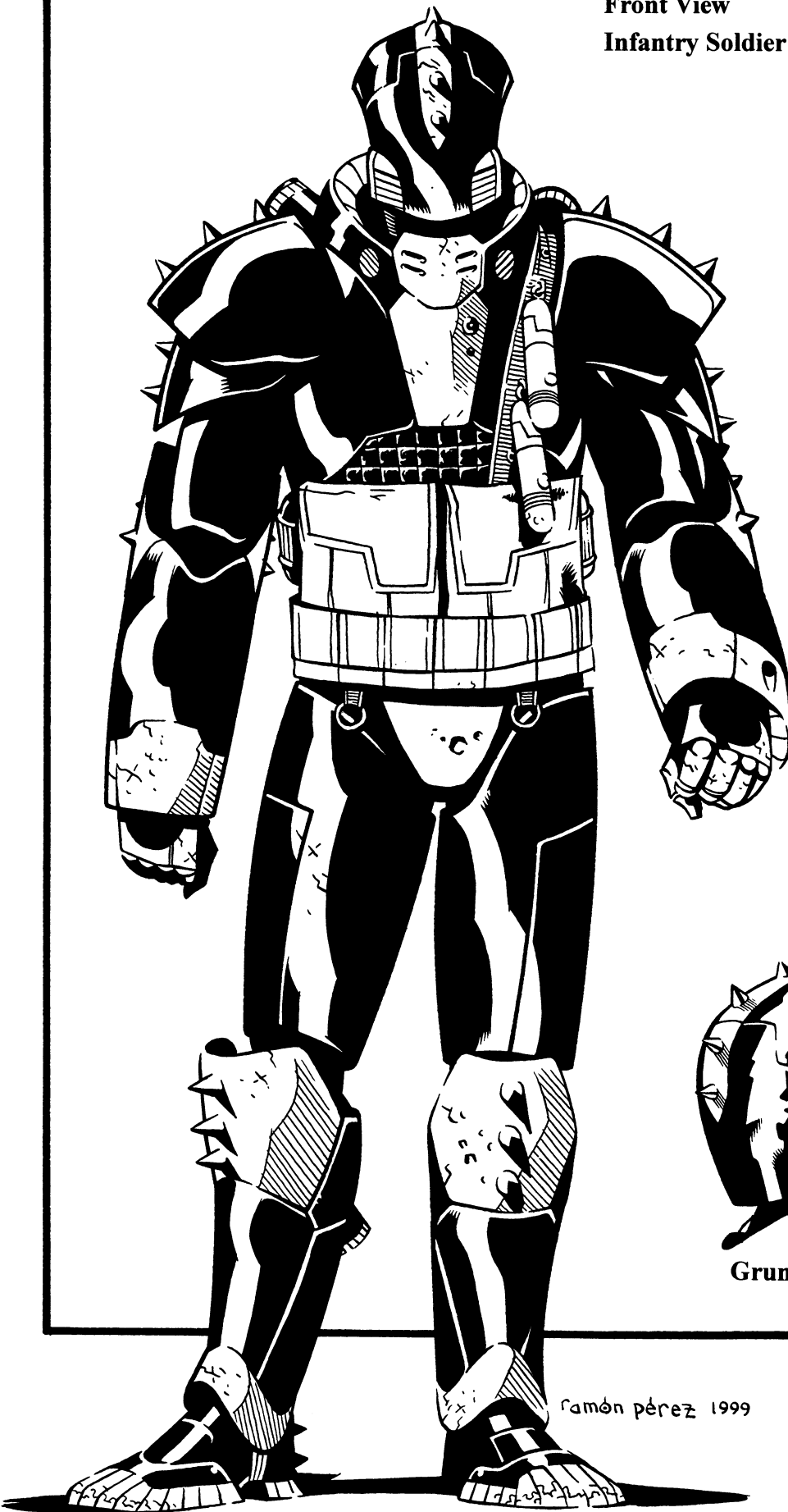

ramón perez 1999



Platoon Leader



Officer



Elite Robot,
Sky-Cycle Pilot



Grunt



Glitter Boy Pilot

Perez 1999

tion, operation and administration. It even uses many of the same (or slightly modified) old-style weapons, power armor, bots and vehicles. The major exceptions are large numbers of Juicers, Cyborg Shock Troopers and Glitter Boys (these are in addition to the fabled *Glitter Boy Legions*).

These soldiers are the backbone of the Quebec Military and front-line infantry troops. In addition to combat duty, they also guard and maintain military bases, forts, and strategic positions.

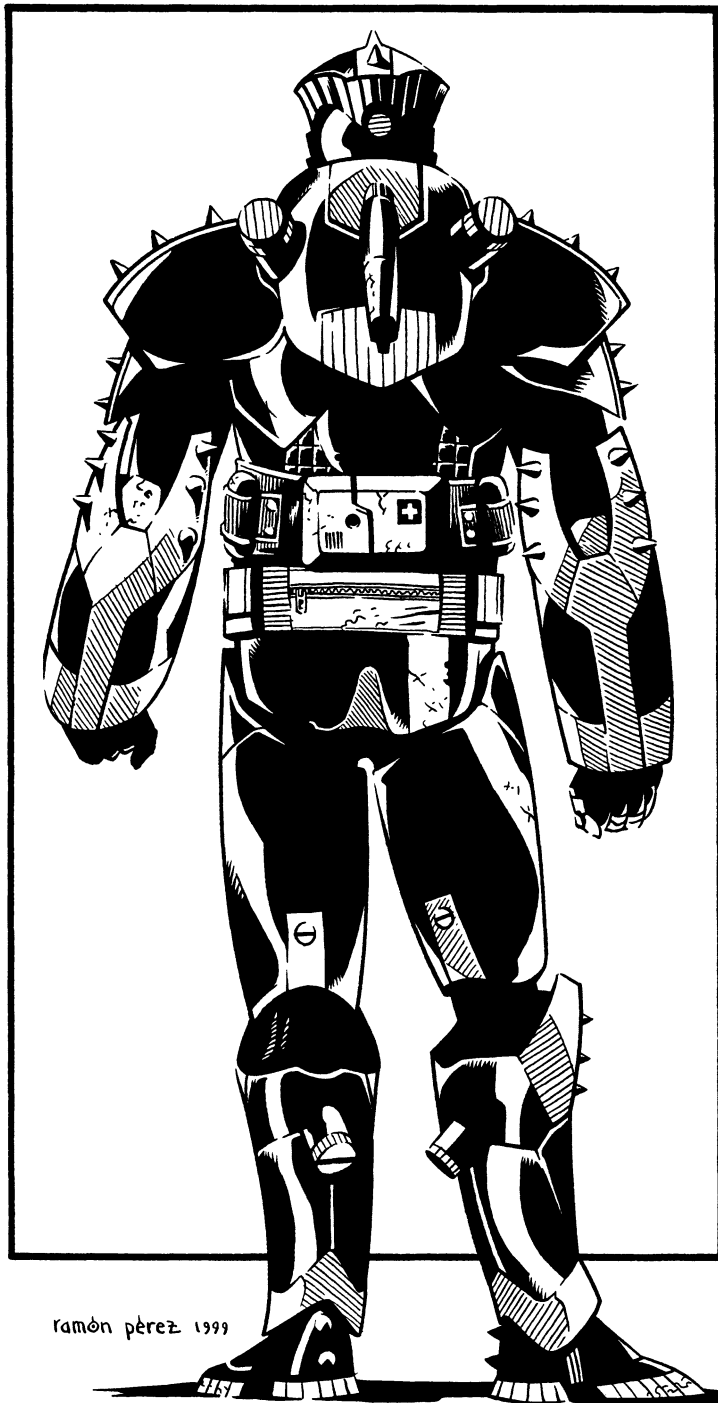

Infantry Divisions

The basic unit of any army, the infantry troops are the grunts, the common soldiers that endure much of the dirty work and sacrifice in the name of their nation. Whether it be the Coalition Army, Free Quebec, Ishpeming, Lazlo or other kingdom em-

ploying modern armies, the Infantry is an integral part of their armed forces. Free Quebec is no different; the majority of their armed forces rest under the classification of infantries.

Supported by Glitter Boys, power armor, robots, tanks and APCs for mechanized operations and tactical assaults, they are the backbone of the Free Quebec military. All other units revolve around the infantry, performing specialized tasks to facilitate them in their goals. Whether it be moving from point to point, attacking an enemy position or unit, or holding a piece of land or strategic position against enemy assault, it is the infantry who gets the job done (hence the nickname “grunt”).

The basic armored infantry battalion consists of 640 combat troops divided into four companies of 160 each. Each company is allotted eight old-style CS **Mark V APC**'s for troop transport duties. A Death's Head Transport may be substituted or added if the situation or terrain dictates. A dozen Hover Jeeps and two dozen hovercycles are assigned for reconnaissance purposes. Ten percent of a platoon of troops (40) or up to a company (160) may be equipped with SAMAS, V-SAM or other power armor suits for mobile support and quick response.

Quebec Rapid Deployment Force (QRDF)

These regular army troops are the warriors that spearhead infantry charges and are the first to respond to enemy aggression. They are able to remain in the field and sustain an offensive action with or without any assistance or logistical support from the rest of the Military, however, they are part of the Regular Army and get support by other branches of the Military as the situation calls for (i.e. Glitter Boy Legion, Air Force, etc.). The three full combat divisions that have been selected to fill the role of this tactical force are ready to deploy at a moment's notice. These forces are equipped with their own combat personnel, service battalions and other combat and support units like Glitter Boys (each Division has two GB companies), communications and various aircraft (including SAMAS).

At present, all members earmarked for these units are on-call and prepared to move whenever hostilities with Coalition troops erupt — the Regular Army and other Military branches are already positioned along the demilitarized zones, borders and at strategic locations, the QRDF responds to new insurgent actions. In this capacity, they might be considered the “cavalry of the Old American West” (or the Marines of the 20th Century) — wherever trouble erupts, the Quebec Rapid Deployment Force rides to the rescue. After they get things under control, some other branch of the Army takes over and the QRDF waits for some new crisis to address. As such, all members are looked after closely by the Military High Command Administrative Branch and never given a posting outside of the nation nor stationed near any active zone of ongoing conflict unless a crisis situation.

These troops represent the best-of-the-best the Quebec Armed Forces has to offer. Each of the three Divisions (approx. 6000 troops each) includes the following:

- Two GB companies (320): One is a mix of Classic, Triax, Gigi and Silver Wolf Glitter Boys. The other a mix of Classic, Taurus and Tarantula GBs — the big guns.
- One Company of Side Kicks (160 troops; assist GBs)

One Company of Reload Team Specialists (40 four-man teams or 53 three-man teams).

One Company of Rangers (160 troops)

Two Companies of Commandos (320 troops)

Four Companies of Cyborg Shock Troopers (640 troops)

Four Companies of Juicers (640 troops)

Six Companies of Violator SAMAS (960 troops)

Two Artillery Companies (320 other power armor, tanks, & bots)

Two Air Wings (320 aircraft of various types)

Note: The remaining 2000 troops are Regular Army and Support Personnel.

Expeditionary Force

Typically Rangers function as long-range reconnaissance personnel without the support of military installations. They don't usually perform any missions involving assassination, sabotage, or espionage; they leave that to the QMI. Their primary job is intelligence and scouting — observe and report any suspicious activity, events, or personnel that happen to cross their path, particularly enemy troop movement. Sent into the field with little or no backup and only the equipment they carry, supplemented by whatever they can make or acquire along the way, these resourceful soldiers perform some of the most dangerous missions behind enemy lines. Amazingly the loss ratio is less than what might be expected at only 12-15% killed in the line of duty or missing in action. In addition to long-range reconnaissance missions, the members of an Expeditionary Force may engage in scientific study/observation, rescue and recovery, tracking fugitives, scouting to find locations for ambush/sniping, locating resources (as well as enemy patrols) and may be assigned to espionage missions or to accompany and assist Special Forces operatives from the QMI.

Army Recce Battalions

The Recce is another infantry unit developed specifically for ground level patrols and holding operations. With the majority of land claimed by Free Quebec being unmonitored wilderness, the ARB plays an increasingly important role in the defense of the nation. Recce Platoons and Companies are sent into the wilderness on long missions with little or no support. They are expected to be self-sufficient, relying on periodic supply drops and living off the local environment or economy (for those lucky enough to be stationed near a town, village or farm). Their job is to patrol large regions of wilderness and serve as both lawmen and military authorities. In the former capacity they are responsible for keeping the peace, reassuring the (sparse) civilian population, making sure civilians are not fraternizing/trading with the enemy, investigating serious criminal activity and crushing opportunistic outsiders such as bandits, raiders, invading monsters, D-Bee squatters, practitioners of magic, and other threats to the local region and the nation as a whole.

As soldiers, these troops are charged with the defense of the remote borders and regions under their charge, including outposts, towns, villages, farms and huge areas of land, from enemy aggression and exploitation. This means the Recce troops are constantly vigilant for the presence of the enemy, from patrols and troop outposts to spies living among the civilian population. When such evidence is found, they are expected to track the enemy down, evaluate their strength and purpose, and when-

ever possible, engage and destroy the enemy threat. If the enemy forces outnumber or overpower the Quebec Defenders, they are to call for Tactical Support. This "support" usually comes in the form of a mobile or air strike force while the Recce group provides exact coordinates, up to the minute enemy troop movement and combat support (often laying in wait to ambush any enemy troops who escape the strike force). If Tactical Support is not available, the ARB is expected to secretly follow the enemy and systematically sabotage and attack using guerilla hit and run tactics.

The "enemy" not only includes CS soldiers, but suspected spies, mercenaries hired by the CS, and civilian sympathizers supporting the CS in any way, as well as D-Bees, practitioners of magic, and monsters. Civilian residents, travelers, and adventurers are also observed and questioned. If suspicious, they may be detained, interrogated, and possibly sent to one of the military bases for further interrogation. The specter of war and the Recce troops' small numbers and limited resources have created a dangerous "presumption of guilt" that can result in harassment, physical abuse and murder.

The simple truth is these isolated and outnumbered troops can not afford to take chances, nor do they have the resources to handle captives and suspects, especially dangerous looking ones or those with special "powers." Thus, it is safer and more expedient to eliminate the threat. Period. Kill, move on, and forget about it. Cold justice for dangerous times. The degree of understanding, compassion, real justice and level of violence will vary dramatically from military unit to military unit. Acts of derision, failure to cooperate, resisting arrest or act of aggression is likely to result in a presumption of guilt and lethal action taken by the Quebec soldiers. Even refusing to answer questions, not answering truthfully, joking around, making negative statements about the Quebec military or its government, or just giving the soldiers a hard time can result in a brutal interrogation, torture or being

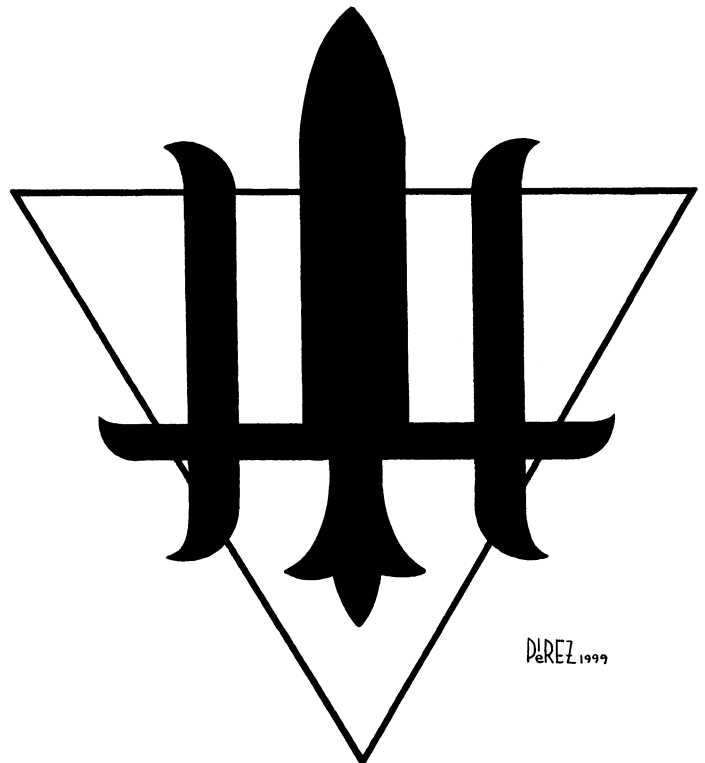

D&REZ 1999

attacked on the spot with deadly force. Likewise, captives who act guilty or cannot prove their innocence or try to run away are presumed guilty and gunned down.

Rece troops may also engage in long-range border patrols, surgical strike operations, guerrilla warfare, counter-measure missions and support of other infantry units.

A Battalion consists of 640 combat troops divided into four companies of 160 each. Each company operates with two Mark V APC's, twelve Hover Jeeps and four old-style Spider Skull Walkers (see **Rifts® Ultimate Edition**, page 250). They may also consist of a platoon of ground and/or air (SAMAS) power armor pilots to ordinary grunts in standard body armor on foot or using hovercycles. **Note:** *Juicers* and *Cyborg Storm Troopers* are frequently attached to these operations; typically representing 10-20% of the troops, and power armored troops representing a minimum of 20%.

Storm Trooper Brigades

Cyborgs & Juicers

These forces, both bionic and Juicer, add up to approximately three divisions in total! For the most part, they are scattered throughout the Army in attachment to other units, but others work as single units no larger than company size (160 Storm Troopers).

Army Service Support Division

These support personnel (communications officers, Operators, mechanical and electrical engineers, cargo haulers, transport and maintenance people, and similar) are typically composed in a Service Battalion of 1220 troops. These men and women are responsible for inventory control and the maintenance and repair of all the machinery, weapons, vehicles and equipment used by the Armed Forces in both their day-to-day operations and special missions. All are combat trained and may be posted on or near the front-line, but are not usually directly involved in combat itself.

Most Service Support Battalions, with 1220 soldiers, have nearly enough troops to form a Light Brigade, but retain their Battalion status because of the constant demands placed on these men and women. Since service support units require larger numbers of personnel, most are attached to other infantry Brigades.

Rarely will a Service Support Battalion be stationed with a group smaller than a Brigade or larger than a Division. Of course a Service Battalion may be broken down to service smaller units in the field. A Service Support Company consists of 220-280 members, a Service Support Platoon consists of 80 troops, and both are usually attached to some other military unit no smaller than a Company, such as one or more Armored or Air Companies, a Battalion, etc.

Glitter Boy Legion

The Glitter Boy Legion is a separate and distinct Army Corps of approximately 18,000 combat troops of which roughly 71% (12,800) are active Glitter Boys. The Legion works hand in hand with the Regular Army and serves many functions, from infantry troop support and defense operations to reconnaissance, rescue and front-line combat, and everything in between. They are generally deployed similar to how pre-Rifts armies used

tanks and armored divisions. However, GBs are comparatively small, man-shaped all-terrain vehicles with much greater versatility, so they are used in virtually every capacity imaginable.

Note: See the *Glitter Boy Section* of this book for complete details about the Glitter Boy Legions, new Glitter Boys, strategies and tactics. See the O.C.C. section for **Side Kick** power armor and **Reload Teams**.

Armored Corps

This Army Corps basically includes all power armor other than Glitter Boys, giant robots, tanks, Armored Personnel Carriers (APCs) and any other armored combat vehicles. Six Companies (960 troops) of Glitter Boys (35% Classic, 35% Taurus, 10% Triax, the rest mixed) are also part of the Armored Division. The Armored Corps, like the GB Legions, is used for both offensive and defensive operations as well as general troop support.

Armored Infantry (ground) Battalions

A heavy support unit for the armored infantry, they provide robot brute strength and firepower to any confrontation. Usually attached to an infantry unit, they perform the central support role to help keep the enemy under effective suppressing fire to allow the infantry troops to advance and accomplish their objectives. Their primary purpose as a *support unit* is to eliminate any enemy robots, power armor, artillery, armored vehicles and entrenched, fortified positions. Secondary objectives involve anti-personnel and defense roles.

Free Quebec Armored Robot Battalions are formed of various mixes consisting of the old-style CS Enforcer Prime, Abolisher Prime, Spider Skull Walker, heavy ground vehicles, and power armor troops, including a smattering of Glitter Boys (roughly 10%). Combat units usually incorporate a mixture of models, but single companies or battalions of one type are not completely unheard of.

Battalion level units consist of 640 combat troops divided into four companies of 160 each. Hover jeeps, trucks, and the occasional old-style CS Death's Head Transport or Mark V APC (see **Rifts® Ultimate Edition**, pages 251-252) are assigned per company as well. It is also becoming more frequent for battalion level and higher to have a Storm Trooper platoon or more attached to their units.

Air Force Corps

A relatively new concept that has been embraced by the Free Quebec Military High Command is the air forces. Quebec's Air Force Corps is only about a quarter of the size of the Army Air Corps of the Coalition States, and nowhere near as developed and diversified. Still the SAMAS dominated Quebec Air Force provides a limited but capable air attack and support platform. It is especially adept at working in tandem with the Glitter Boy Legions and other heavy ground troops. The troops are placed into combat regiments and fighting "wings" (aerial squads and platoons) which are mainly comprised of traditional SAMAS, Violator Class SAMAS, Sky Cycles and NG Sky Kings (see **Rifts® Game Master Guide**, page 239).

These pilots are specially trained in power armor dog-fighting, anti-robot and anti-tank tactics. They have proven to be particularly effective in small skirmishes, surgical hit and

run strikes, and SAMAS vs SAMAS dog-fights. The real test for these pilots and daredevils will come when they face the full force of their Coalition counterparts and the overpowering CS air force. An air force equipped not only with SAMs but a veritable armada of rocket bikes, Sky Cycles, (non-CS) attack helicopters and fighter jets, not to mention Death's Head Transports and the occasional (non-CS) hover tank.

Typical Aircraft Breakdown

- 15% SAMAS, old style (standard and modified)
- 23% SAMAS, Violator Class
- 34% Sky Cycle
- 8% NG Sky Kings
- 20% Other (mixed; includes Death's Head Transports)



SAMAS Battalions

Specializing in power armor tactics and combat support roles with the infantry, these units are typically deployed as battalion and brigade-sized military units. They are more frequently found supporting infantry and armored ground troops or providing mobile support for fixed defensive outposts and escorting convoys and troop movements. They also engage in aerial border patrols, low altitude reconnaissance, fly-bys, rescue missions, hit and run raids, search and destroy, and surgical strikes, but the SAMAS Battalions specialize in SAMAS to SAMAS dog-fights and power armor counter-measures to eliminate enemy armor, robot and air support. Very much the specialists in their tactical field, they are often placed as direct support units for armored infantry divisions, including the Glitter Boy Legions.

Battalion level units consist of 640 combat troops divided into four companies of 160 each. Although predominantly SAMAS of one kind or another, each company includes at least one platoon of (40) Sky Cycles or other type of fast aircraft. Each Battalion will also have one Death's Head Transport.

Armored Air Cavalry Companies

These are the elite pilots of the Death's Head Transports which airlift troops to their destinations, whether it be a remote site or directly into combat zones. Responsible for a variety of missions, they transport troops, equipment, supplies, vehicles or

other personnel and civilians. The AACC also includes other types of aircraft, the Glitter Boy flying transport and power armor "aces" (mostly SAMAS). Operating mostly from airfields on protective bases, they are constantly on stand-by, ready to respond to enemy incursions, rescue mission, troop insertion and extraction, and combat over the skies of Free Quebec. As direct support for the infantry and armored robot troops, these pilots are responsible for engaging and destroying enemy flying power armor, incoming missiles and aircraft, as well as targeting ground armor and entrenched positions.

Combat Battalions consist of 640 combat pilots divided into four companies of 160 each. Each Air Company has four "flight wings" (a combination of aircraft and power armor; typically a 50/50 split), each with forty pilots (160 total). In addition to one- and two-man fighters (aircraft and power armor), each Air Company usually has 1D4+6 Death's Head Transports and 40-60 other types of aircraft of various makes at their disposal. An Air Company will usually have a ground support crew of 640-1280 (Operators/mechanics, maintenance, communications, etc.) with access to ground vehicles and the usual Army facilities.

Quebec Military Intelligence Corps (QMI)

Quebec Military Intelligence is the *espionage* wing of the Military. While it is responsible for the coordination of most intelligence operations and the assessing, rating and distribution of data, it also orchestrates Special Operations, including Black Ops (sabotage, assassination, and similar). In fact, the QMI plays a key role in all Military Special Operations. Some critics believe the QMI's aggressive involvement in proactive espionage operations severely diminishes their effectiveness in intelligence gathering, which is why the civilian *le Sûreté du Québec* is much more proficient in this area. However, the QMI is so good at espionage the Quebec Military ignores its shortcomings.

QMI field agents include most of the Special Forces, select squads of hand-picked Commandos and Military Specialists, a special Glitter Girl Company (160), and two Silver Wolf Platoons (80 total). In addition to its own, elite Brigade of Special Operatives, it will select squads from other branches of the Military as well as work with them in coordinated efforts.

QMI Special Ops may frequently work and cooperate with all branches of the Quebec Military, but many of its elite QMI Forces engage in "Deep Cover" operations and work outside the Army's sphere of knowledge and influence. Deep Cover operatives are typically lone agents, pairs and small squads (6-12) sent on missions so top secret that only the highest ranking officers know anything about them, and even those select individuals are informed on a very limited "need to know" basis. This may even include agents who are plants inside the Army, Police or government in addition to squads operating outside the Regular Army. This could mean that Corporal La Salle is not an ordinary grunt, but is really a Major in the Black Ops division on special assignment. Or a QMI Squad may be working behind enemy lines (perhaps disguised as a squad of mercenaries, bandits, or adventurers, or not) without the knowledge of the local troops stationed in the same area — so those CS accusations of sabotage, night raids and murder *are* true. There are many rea-

sons for the QMI to work outside the official boundaries of the Regular Army, but whatever they are, the QMI is diligent in making certain its field operatives do NOT jeopardize, harm or interfere with Army operations. The QMI's purpose is to assist and inform the Regular Army, not hurt it.

Note: Also see *Le Sûreté du Quebec*.



Special Forces

Never formed into units larger than a Company, there are relatively few of these units in existence. They are the Military Specialists, Headhunters, Commandos, Special Forces operatives, saboteurs, assassins, smugglers and spies that accomplish highly specialized and dangerous missions. They usually operate in squads of 6-10, but are occasionally sent out as entire platoons (40 troops). The Squad is ideal for maintaining speed, stealth and concealment.

They perform only the missions that most standard units are either untrained for or incapable of doing as a result of training, resources, or political considerations. Assassinations, sabotage, smuggling, guerrilla warfare, search and destroy and deep reconnaissance are their bread and butter.

There is no set method to distinguish one company from another, only in that for administration purposes, there are 160 soldiers per company. Almost never are they able to collect together as a whole, with squads away on missions all the time. For the most part, these personnel are unaugmented humans, with 25% being Juicers, 15% partial cyborgs/Headhunters, 5% full conversion cyborgs, 5% Glitter Girls and 2% Silver Wolf Glitter Boys.

The Quebec Navy

As a nation that depends on the St. Lawrence Seaway, Free Quebec places great importance on the proper defense of the river and associated waterways. The Quebec Navy, although half the size of the Coalition States', is by far more seasoned, skilled and effective — a superior force. Free Quebec has started expanding the fleet with additional CS style patrol boats and warships, as well as the construction of new shipyard facilities in the Saguenay Region. The shipyards can produce any of the five classes of vessels in service. Several newly developed Naval port facilities have been added to the Isle d'Orleans command base. See the section devoted to the Quebec Navy elsewhere in this book.

le Sûreté du Quebec (SQ)

Le Sûreté du Quebec (SQ) may be considered the Civil Intelligence Agency assigned to *national security*. It is this agency that maintains security within the government and cities of Quebec, keeping its government and civilian leaders, as well as the public at large, safe from enemy infiltrators, spies, saboteurs, and traitorous sympathizers. Gathering, updating and confirming the accuracy of information, following enemy positions, troop movements, infiltration, threats, suspicions, counter-espionage, and other matters relating to National Security are all the jurisdiction of le Sûreté du Quebec. It is also responsible for setting intelligence mission parameters, conducting briefings, debriefings, and interrogations.

As an independent nation, Free Quebec now relies on intelligence more than ever for its military and political strategy making. Le Sûreté du Quebec is the instrument to that end. This high level intelligence agency has been in operation for decades, starting shortly after Free Quebec joined the Coalition States. It was originally created to spy on and collect information about their allied States in a concerted effort to protect its own national security and independence. With Quebec's secession from the CS and the onset of war, SQ now has the very difficult responsibility of keeping their superiors informed on all that is happening within the Coalition States, how it may impact Free Quebec and/or affect the war, as well as maintaining national security. So far, they have done an outstanding job.

Years ago, it was SQ who warned the leaders of Quebec that Emperor Prosek was increasingly disenchanted with their nation. It was SQ who uncovered evidence that the Coalition Army was secretly expanding and retooling in preparation for a new military campaign. An agenda that obviously did not include Free Quebec, at least not as an equal participant. It was agents of the SQ that uncovered a year before the Emperor's Campaign of Unity address that the CS was in the process of cutting a nonaggression pact with Northern Gun and the Manistique Imperium and that Free Quebec "may" be branded as a rebel and enemy of the Coalition States unless it complied with Chi-Town's most recent ultimatum.

During its years as a member State, detailed dossiers have been compiled on hundreds of influential people inside and outside of the Coalition States, specifically the leadership of Chi-Town and her Military. The Emperor and his family, along with his top advisors alone account for volumes of information and intelligence. When word of the "Skeleton Raiders" first

reached Free Quebec, le Sûreté du Québec already had operatives investigating the rumors. When the Emperor made his now famous speech, Free Quebec had already deduced there were troops field testing new army equipment and robots. Furthermore, SQ's collection of reports, rumors and sightings provided the Quebec Military with some idea of what these new war machines were and how the CS planned to deploy them, which gave Quebec a better picture for determining their own, ongoing defense strategy.

The SQ has become notorious for making astonishing forays behind enemy lines to uncover the movements, plans, plots and covert operations of the Coalition Army and leaders of the Coalition States. To this end, it has even established spy rings within Chi-Town and Iron Heart! A vast network of spies, moles and other informants has been created throughout the Coalition, even as far down as the city of Lone Star (the Military Complex itself remains out of reach). Each State, as well as many of the allied independent nations like Arkansas, Ishpeming and the Manistique Imperium, are also "tapped" into. Informants range from Coalition technicians, soldiers, pilots and military advisors to Black Market smugglers, 'Burb gang members and ordinary citizens. To a lesser degree, Lazlo, New Lazlo and Tolkeen have also been targets of Sûreté observation. For the most part, they only look out for possible actions, military or otherwise, that would compromise the Coalition's or Free Quebec's security. Those that have been sent to Tolkeen watch in fascination as defense plans are enacted, and to observe the Coalition Army in action to better anticipate how the CS may attack them. A small group of agents also operate into the Magic Zone; this more out of curiosity than anything. This area is too far from Quebec to warrant great expense. These spies look for leadership figures, study the Zone's strengths and weaknesses, and possible plans for expansion and conquest, especially against Chi-Town.

SQ agents are constantly out in the field on reconnaissance and intelligence gathering missions, and have proven to be incredibly skilled at infiltration — ingratiating themselves with those close to enemy leaders and operations, sniffing out reliable leads and vital information about enemy activity and plans for the future. This information helps the SQ and QMI to assess threats and weaknesses, and make appropriate responses. Changes in a community's daily routine is often an indicator of external events and influences. A sudden increase in production at the factories or buzz of activity among the local militia, police, government or businesses can indicate the presence and involvement of an enemy or a crisis that may have long-reaching repercussions. Clear indicators of danger include the building of fortifications, sudden transfer of money and assets, stockpiling of food and resources, the closing of businesses and/or schools, increased military or police (or mercenary) presence, evacuations, and mass exodus. Quick and accurate reporting of such events can tip off Quebec defenders, indicate the need for further investigation and help them to identify and counter or circumvent enemy plots and activity.

Part of their success has been through establishing an invisible network of spies, undercover agents, reliable and discrete sympathizers, and unwitting informants (the latter occurs when enemy sympathizers, allies, agents and soldiers talk too much, boast and reveal information through their words and deeds). What differentiates le Sûreté du Québec from the QMI or other "spy" operations is that it is strictly dedicated to the *passive*

gathering of information. It does not engage in sabotage, assassination, smuggling or any other acts to undermine the enemy. Nor does it associate with QMI, the Quebec Army or any other military force (mercs, freebooters, etc.). SQ has become the eyes and ears for Quebec on the home-front and behind enemy lines by turning its agents and informants into members of the faceless, law-abiding masses drifting quietly through life in the background; non-threatening, unnoticed, and constantly watching, listening and remembering. The vast majority lead normal lives and can not be distinguished from any one of the local people, whether peasants, hard-working businessmen or wealthy. They study their language, customs, rituals and nuances of life and report changes in activity, rumors, tips, hints and leads to their SQ leaders. They fight and kill only when the situation demands it. To do otherwise is to jeopardize their undercover position, true identities, information source and fellow agents.

As the Quebec National Security Agency, le Sûreté du Québec also operates within the cities and towns of Free Quebec. Here they keep their eyes and ears open for hints of dissidence, CS sympathy, spies, sabotage and suspicious activity that might undermine their nation from within. The SQ is responsible for accurately providing intelligence to the National Assembly, Police and, to a lesser degree, the Military High Command. Although not an official part of the Quebec Army, they are accepted as the premier intelligence operatives in Free Quebec, surpassing even the QMI (Free Quebec Military Intelligence)!

Operation Aide Memoire

Under the auspices of the SQ Division, this is a low profile operation being conducted inside the borders of Tolkeen. Two pairs and 9 individual agents (code name: Baker's Dozen) have infiltrated different parts of Tolkeen society. Each operative is working independently and without knowledge of the others. Their job is to observe and provide accurate intelligence on Tolkeen, her people, prominent figures, her strengths and weakness, front-line defenses, internal defenses, strategies and tactics. What has been collected shows a region so heavily influenced by magic that the Coalition Army will have a very difficult time overpowering them. It is the general consensus that Tolkeen will fall, but only after a spectacular display of magic versus technology.

Primary Objective: Tactical Assessment.

Subject: Magic community and its deployment of magic for defense and combat under the conditions of war.

Secondary Objective: Magic vs technology.

Subject: Strategic response and counter-measures to magic.

Operation War Doves

A second operation (code name: War Doves) involves a joint effort with the Quebec Military Intelligence Corps (QMI) in which six Special Forces teams and twenty SQ undercover operatives (working as moles inside some of the outlying towns under Tolkeen's control) observe the war between the CS and Tolkeen, paying particular attention to Coalition Military operations, troop deployment, strategies and tactics. The hope is that this information will better enable the Quebec High Command to develop effective counter-measures, defenses and preparations against the CS Army. Observing the Tolkeen forces and their tactical use of magic in combat will also help prepare Free Quebec for possible skirmishes and war from hostile supernatu-

ral forces and practitioners of magic, such as the Federation of Magic and Lazlo (being eternally paranoid, they fear they will someday come to blows with the peaceful kingdom of Lazlo).

Primary Objective: Tactical & Strategic Assessment.

Subject: Coalition Armed Forces under combat conditions.

Secondary Objective: Magic vs technology.

Subject: Strategic response and counter-measures to magic.

le Sûreté du Quebec O.C.C.s

Excluding informers and sympathizers, most SQ operatives are the equivalent of the Coalition Law Enforcement Officers described in **Coalition War Campaign™**, pages 178-185.

10% are effectively ISS Peacekeepers.

15% are effectively ISS Specters (detectives).

20% are effectively ISS Intel Specters.

40% are SQ "Deep" Intel Agents (stats below).

15% others; mostly administration and communications.

le Sûreté du Quebec Deep (undercover) Intel Agent

These are the undercover agents who assume a passive role watching, listening and reporting what they see and hear. Two thirds are on assignment outside of Free Quebec, deep within enemy territory, including the Coalition States and, to a much lesser degree, even the CS Military. ISS Intel Specters may also engage in this type of duty.

Attribute Requirements: I.Q. 10 and M.A. 10 or higher (the higher the better), and a P.B. of 12 or *lower* (they want average looking people). A high M.E. and P.P. are helpful but not necessary.

O.C.C. Bonus: +1D4 to M.A. and +1 to P.P. attribute, +1 to roll with impact, punch or fall, +2 to disarm, +4 to pull punch, +3 to save vs Horror Factor and +1 to save vs psionic attacks, mind control and illusions. +4 to Perception Rolls.

O.C.C. Skills:

Language: English & French at 90% +1% per level of experience.

Literate in both (+30%), but may pretend otherwise.

Basic Math (+30%)

Radio: Basic (+20%)

Radio: Scrambler (+15%)

Surveillance Systems (+15%)

Cryptography (+15%)

Disguise (+10%)

Escape Artist (+10%)

Find Contraband (+16%)

Intelligence (+20%)

Land Navigation (+10%)

Camouflage (+10%)

Seduction (+10%)

Pilot: Select two of choice (+5%; any except Military types)

W.P. Energy Weapon of choice (typically Rifle or Pistol).

W.P. Ancient of choice.

Hand to Hand: Basic

Hand to Hand: Basic can be changed to Expert at the cost of two O.C.C. Related Skills, or Martial Arts (or Assassin if an evil alignment) for the cost of three.

O.C.C. Related Skills: Select four other skills. Plus select one additional skill at levels 3, 6, 9, 12 and 15. All new skills start at level one proficiency.

Communications: Any (+10%)

Domestic: Any (+5%)

Electrical: Basic only.

Espionage: Any (+5%)

Mechanical: Basic only.

Medical: First Aid only.

Military: None (other than O.C.C. skills above).

Physical: Any, except Wrestling and Acrobatics.

Pilot: Any

Pilot Related: Any (+5%)

Rogue: Any (+2%)

Science: Any (+10% to Math skills only).

Technical: Any (+5%)

W.P.: Any

Wilderness: None

Secondary Skills: The character also gets to select four Secondary Skills from the Secondary Skills list. These are additional areas of knowledge that do not get the advantage of the bonus listed in parentheses. All Secondary Skills start at the base skill level.

Standard Equipment: This will vary dramatically depending on the assignment. Gear typically includes a suit of light to medium environmental body armor (usually NOT Quebec types), a few sets of civilian and/or adventurer clothing, SQ uniform, dress uniform, 1D4 signal flares, 1D4 smoke grenades, survival knife, a weapon that corresponds to the character's W.P.s, 1D4 E-clips, utility belt, air filter, backpack, canteen, language translator, hand-held computer, CD player/recorder, note pad or sketch book, a half dozen markers, mechanical pencil and personal items.

Equipment Available upon Special Assignment: Surveillance, listening and recording equipment, special optics, portable laboratory, still and video cameras, radio equipment (long-range, etc.), additional weapons and ammunition, vehicle, fake documents and similar spy equipment.

Average Level of Experience (NPCs): 1D4+2.

Money: Monthly salary is 4,200-6,000 credits depending on the level of experience and skill. A modest expense account is often provided for undercover operations, although the agent typically holds a job or position with the environment he has infiltrated. Starts off with one month's pay. SQ agents also get full medical care and access to SQ computers and other facilities. They are responsible for their own housing and personal lives; many have families.

Cybernetics: Starts with none and usually keeps it that way to maintain their "ordinary Joe" appearance. Otherwise restricted to medical implants and prosthetics.

O.C.C.s COMMON TO FREE QUEBEC

By Kevin Siembieda

The majority of O.C.C.s found in and around the nation of Free Quebec are the same as those found in the *Rifts® RPG*, *Coalition Navy™*, and *Coalition War Campaign™*, as well as the *mercenaries* of *Rifts® Mercenaries*, the *Psi-Stalker* in *Xiticix Invasion™* and *Headhunters (and D-Bees)* of *Rifts® Canada* (the Trapper/Woodsman O.C.C. too).

In fact, it is probably easier to list the O.C.C.s *not* found in Free Quebec:

- **No Practitioners of Magic** (other than the super-rare citizen who secretly practices magic in defiance of the law, and those who live outside the border of the nation).

Of course, practitioners of magic are found scattered throughout Canada, including the wilderness regions claimed by Free Quebec. Such undesirables are “encouraged” to leave Free Quebec territory and troublemakers are terminated, usually on the spot!

- **No Crazies/humans augmented via M.O.M. conversions**, at least not within the nation itself nor its military.

However, the Quebec government and military will associate with and employ Crazies freelance “help” — typically as scouts, spies, assassins, bounty hunters and mercenaries with whom they can deny any “official” connection. Crazies are not usually allowed into large population centers nor on military bases; they are kept at an arm’s distance.

- **No mutant animals**, including Dog Boys. The people, government and military of Free Quebec consider Dog Boys and similar CS creations as the result of genetic engineering as “unholy abominations” no better than D-Bees.

- **No D-Bees!** Nonhumans, including D-Bees and supernatural monsters, are chased off Quebec land, and trespassers are beaten and usually killed. This is done with the frequency, callousness and lack of conscience as a farmer might shoot a fox raiding his chicken coop or an exterminator kills rats. The Quebec Military routs and slaughters D-Bees in the border country in a regular, ongoing campaign.

Meanwhile, ordinary citizens and wilderness allies are encouraged to report “D-Bee sightings” as well as taking matters into their own hands. As a result, many Quebec “good ol’ boys,” wilderness people, zealous human supremacists and adventuresome sportsmen go out “hunting” D-Bees! The only involvement from the government is a warning to D-Bee hunters to be careful about who they shoot at. While it is legal to slaughter nonhumans, killing a human being, even by accident, and even if the victim is NOT a citizen of Free Quebec, carries stiff penalties and harsh punishment. Typically a fine of 150,000 credits (involving the liquidation of house and property) goes to the family or heirs of the deceased and the guilty party is sentenced to 20 years in jail. Repeat offenders and those guilty of killing several innocent humans are often executed themselves. Consequently, those who participate in such a despicable pastime are usually extremely careful even when drunk. Government and local authorities both investigate such *wrongful shootings* as well as disappearances.

- **Avoid Psi-Stalkers.** Most of the mutant humans known as Psi-Stalkers are found west and south of Free Quebec. While Chi-Town and the Coalition States include them among their citizens and military personnel, Free Quebec simply “tolerates” their modest presence. This means Psi-Stalkers are not openly persecuted or hounded, but they are not accepted into human society either. There are no Psi-Stalkers within the Quebec Military, Law Enforcement or citizenry. While a few hundred live within the borders of Free Quebec, they are considered to be squatters or resident aliens without the common rights or privileges afforded all true citizens. So far this has not been a problem because what few hundred Psi-Stalkers there are live in mostly uninhabited wilderness regions. Likewise, the occasional nomadic band of Psi-Stalkers who cross Quebec’s territorial borders rarely cause trouble and rarely visit modern cities. They are non-entities whose presence is tolerated.

Unlike Crazies, Psi-Stalkers are rarely hired by the Quebec Military and only occasionally are they hired by independent businesses in the private sector (and never by the government).

- **No Skelebots!** Although not a character class, it is important to note that Free Quebec has *never* used Skelebots for a variety of reasons. One being a certain amount of paranoia: Quebec leaders always feared the bots might be implanted with a Chi-Town override mechanism that could wrest control from them and give it to Chi-Town commanders.

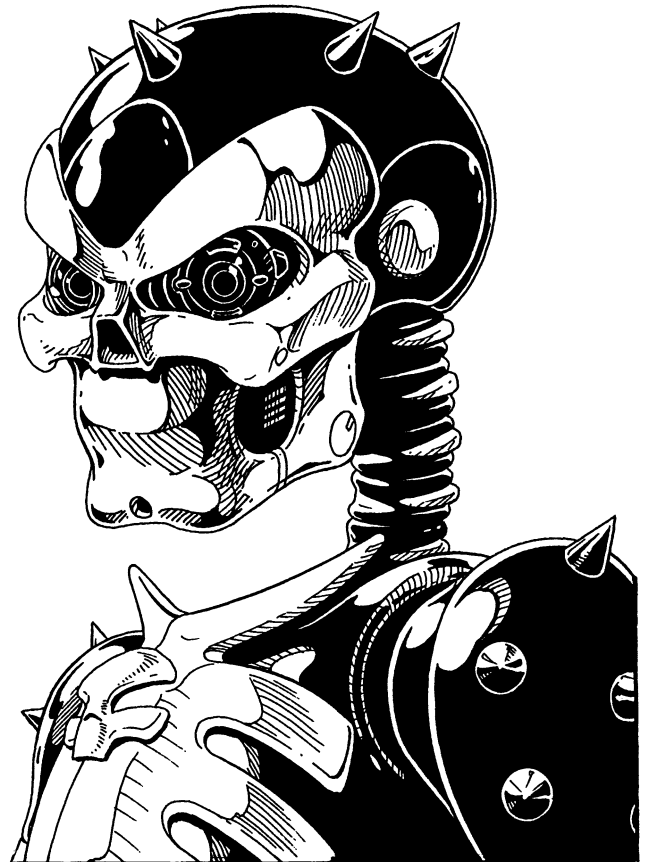

O.C.C.s of the Free Quebec Military

Basically all those found in the pages of **Coalition War Campaign™** and the CS section of the **Rifts® RPG**, minus *Dog Boys*, *Crazies*, and *Psi-Stalkers*. Likewise, *psychics* do not share the illustrious place they hold in the rest of the Coalition States.

- 3% Commando
- 10% Cyborg Strike Trooper
- 0- Dog Boys (none)
- 1% EOD Specialists (includes Reload Teams)
- 23% Grunt/Soldier
- 12% Juicer
- 5% Military Specialist
- 0- Psychics (none)
- 5% Ranger/Wilderness Scout
- 1% RCSG-type Scientist
- 13% RPA Elite Pilot (non-GB power armor, includes Side Kick & Sams)
- 7% RPA Glitter Boy Pilots (exclusively GB; includes Gigi)
- 8% RPA “Fly Boy” Ace (aircraft pilots & Sam aces)
- 0- Skelebots (none)
- 2% Special Forces
- 10% Technical Officers & Support

Note: Nautical Officer is not listed because the Quebec Navy is a separate and distinct entity. Nor does this include Headhunters and other mercenary forces who may be employed by the army. Special operatives who may be professional spies, thieves, and similar espionage type O.C.C.s fall under the Special Forces category. Medical, communications, mechanics and similar personnel are generally considered Technical Officers and Support.

The percentage number of Glitter Boys may seem surprisingly low, but there are no more than 19,000 Glitter Boys currently in the entire Quebec Army (another 5000-6000 will be added in one year but that will effectively cover attrition through combat). Just remember that a Glitter Boy squad is the equivalent of a platoon to an entire company (40-160 troops) depending on the opponent.

Cyborgs

The Quebec Military has always included cyborgs among its military and law enforcement (which during time of war, police double as the core of civil defense). Partial and full conversion cyborgs are an important part of the Quebec Army with over 55% serving as career soldiers. Quebec uses the same basic program for service, retirement and decommission as the Coalition States (see **World Book 11: Coalition War Campaign™** for details). Specific types of Free Quebec Cyborgs are presented elsewhere in this book.

Headhunters

- Headhunter Techno-Warrior
- Headhunter Assassin
- Headhunter Anti-Robot Specialist
- Headhunter Techno-Hound
- Momano Headhunter

The classification of “Headhunter” is typically reserved for men and women who have undergone *partial bionic reconstruction* and have made a life as a mercenary, wilderness scout, bounty hunter, special operative or other combat oriented line of work. Headhunters (defined in the pages of **Rifts® Canada**) are plentiful in Canada, especially in the eastern half of the country in and around the old provinces of Ontario and Quebec.

These “hired guns” are frequently employed by both *Free Quebec* and the *Coalition Military* (as well as outside and independent communities, business people, and groups). Why a Headhunter or mercenary group may choose one over the other, especially during this time of war, will vary with each individual or group. Money is always a factor. Headhunters who have no affiliation, history, like or dislike for one or the other, are likely to go where the money and/or opportunities seem best. Others will seek employment with the side they personally believe will be victorious (such an arbitrary decision may or may not have any bearing in facts or reality, only with personal conviction). Still others take combat duty because they like the excitement or it is all they know.

Headhunters with a grudge against one side or the other are likely to take a position against the offending party. **For example:** “I remember how the Free Quebec Army run me and my buddies outta town when we come to do a little tradin’. How was we ‘posed to know that Glitter Boy was stolen from the Quebec Army? Hell, we took it from some stinkin’ bandits. Half o’ them D-Bees too. For them to seize ‘our’ Glitter Boy and run us out was robbery. I coulda retired with that money. We was cheated and now it’s payback time.” On the other hand, sentiments could go the other way, “I hate those CS sons of ... ah man, don’t get me started. Dead Boys have killed more than one or two friends of mine just because they were a spell caster or associated with D-Bees. A man has to do what he has to do to survive. Ain’t anything wrong with using magic. I’ve known many a good man who used magic instead of a gun. And D-Bees, I don’t have no love for them myself, but to kill a man just because the merc group he’s running with happens to have a few in it. That’s just not right. That’s why I’m fighting for Free Quebec.”

The bottom-line is Headhunters are independent, freelance warriors enhanced with bionics, experienced in combat and attracted to violence and war. Where they go, what they do, and who they do it to depends on the individual and opportunity. With the war brewing at Free Quebec, there are lots of opportunities for Headhunters, mercenaries and adventurers from all walks of life, and they are arriving in droves to get their piece of the action.

They are often hired by large armies as cannon fodder — expendable troops — to send ahead of the regular armor as scouts or front-line fighting troops to soften up the enemy. Headhunters are pros who know this and take no offense by it. Being treated as a second-rate and/or expendable soldier comes with the job. On the other hand, unlike regular soldiers, the Headhunters and other hirelings have some say in the types of assignments they take. Many opt for the following types of duty: Guard and escort, scouting detail, spying, setting up ambushes, foiling ambushes, sniper and seek and destroy missions, raiding parties, and all kinds of down and dirty Black Ops (assassination, sabotage, and espionage assignments). **Note:** The Head-

hunter Techno-Warrior, Assassin and Anti-Robot Specialist will all be in high demand by both sides in this war.



Juicers

Free Quebec has always loved Juicer technology and sees nothing wrong with it. Even after the government yielded to Chi-Town's demands they stop "official" use of Juicers in the Quebec Army, the government continued to use Juicers in its Special Forces, and turned a blind eye to all "illegal" operations going on in the 'Burbs and places like Old Bones. As soon as the CS announced it was adding a limited number of Juicers to its "new" army, the Quebec Military immediately restarted its Juicer augmentation program. This was quick and easy consid-

ering they had shut down and mothballed the old facilities, but never dismantled them.

With the Coalition's declaration of war, there have been more volunteers for Juicer Conversion than ever before. The Quebec Military carefully screens all candidates to make certain each is physically sound and mentally stable enough to undergo the chemical augmentation process. Furthermore, the number of Juicers is deliberately limited, so thousands of qualified candidates have been turned away (10-20% turning to bionic augmentation as an alternative).

The Military Juicer Program is carefully regulated and follows strict standards and procedures. First of all, a Juicer in the Quebec Military serves as such for only three years before he or she undergoes "detox" and is returned to being a normal human still on active duty. **Note:** 10% die in the "detox" process, 15% suffer from chronic physical and mental side effects, 20% go on to volunteer for bionic augmentation, and 15% volunteer for the *Juicer Maturation Program*. The rest live normal lives, with 77% serving in the military for another 10-40 years.

The Juicer Maturation Program is a volunteer death sentence. Typically, only the best of the best are selected, and the Juicer soldiers must usually show mental stability and have a record of good conduct to be allowed to continue from Juicer to the *JM Program*. Those who are accepted are nicknamed, "Jimmy Juicers" and are among the most feared and respected soldiers in the Army. Basically these dedicated Juicers (often super-patriots, or "psycho-patriots" as some call them) are allowed to continue on as Juicers in the Quebec Military until they literally "burn out" and die. If the pain or effects of Juicer "Burn-out" becomes too unbearable, they are mercifully put to rest, but most die in a blaze of glory on the field of combat. Those who participate in the JM Program get one million credits "death bonus" paid to any beneficiary of their choice. The beneficiary receives an annual payment of 50,000 credits over twenty years or a lump-sum payment of 400,000 immediately (the Juicer makes the choice). There is one stipulation, the Jimmy Juicer must perform as a soldier for at least two years after entering the JM Program. A premature death means the beneficiary receives only 250,000 credits.

Juicer augmentation is illegal for the average citizen. It is reserved exclusively for military purposes. Illegally created Juicers are not persecuted, but they are stripped of their citizenship and expected to make their life outside the borders of Free Quebec. Those who wish to have their Juicer augmentation *removed* can apply for it through the military. To qualify, the applicant must pledge eight years of subsequent military duty in the Quebec Army or ten years in law enforcement at one third the usual salaries. For Juicers who are "too far gone" to have the process reversed, and who are suffering from any stage of "last call," arrangements can be made to "put them to rest." This involves a gentle, painless method of euthanasia that costs only 10,000 credits (free for those under military service).

Psychics

In Free Quebec, *psychics* are regarded as second-class citizens who are catalogued, undergo IC registration and branding, and are watched with more than a little bit of apprehension. They are seldom given positions with the military or law enforcement, and are usually stuck with the least desirable areas of

employment — and few (if any) that utilize their unique abilities. Moreover, those who cause trouble or commit crimes are judged by a higher, less flexible standard than the average (completely human) citizen and typically suffer harsh punishment and receive maximum sentencing.

This “outcast” status is prevalent throughout Free Quebec society on every level. Most ordinary humans regard *psychics* as mutants — aberrations who are less than human. Most will not date or even associate with psychics let alone marry one (and those who do marry a psychic are treated like lepers for tainting pure human genes). Most psychics live in ghettos among other psionic people and lowlifes. Consequently, those who discover they possess psionic abilities either try hard to keep it a secret and rarely use their powers (thus, they rarely progress beyond 2nd or 3rd level even when at an advanced age), or leave Free Quebec to make their life elsewhere. Like Psi-Stalkers, psychics are not accepted by the public at large, merely “tolerated.” Thus, it is made known by their fellow citizens that they are not liked or wanted and that they should leave. In something of a humanitarian gesture, the government of Free Quebec will help subsidize “relocation ventures” for psychics. This is a program by which the psychic permanently relinquishes his citizenship and leaves the *nation* entirely. Whether he or she goes to one of the Coalition States or wherever, the government does not care. Upon military escort beyond Quebec’s borders, each psychic (they are typically released in small groups) is given 30,000 credits and a simple hover vehicle (typically a hovercycle for an individual or truck for a family). The psychic is also allowed to bring whatever possessions and additional credits earned and saved legally as he desires. Alternative travel arrangements (i.e. his own vehicle, special means of transportation, etc.) can also be made by the individual. Being stripped of citizenship means the character can never return to Free Quebec to live, and any “visit” requires digging through a ton of paperwork and red tape that can take months, even years.

New O.C.C.s

The “Descended” Glitter Boy Pilot O.C.C.

Subject to much controversy within the Coalition States, feared and respected by most others, the Glitter Boy pilots of Free Quebec have become legendary heroes in their own right. Having been scrutinized, and verbally and politically attacked by the Chi-Town authorities for decades, GB pilots have come to symbolize rebellious patriots who stand for Free Quebec and against all who oppose her — including Emperor Prosek and the Coalition States. This, their teamwork and famous power armor has made them the elite among the fighting forces of the Quebec Military and patriotic heroes in the public eye.

The most illustrious Glitter Boy pilots can trace their lineage as far back as 10 generations (roughly 200-250 years) and some claim to be descendants of the original 288 Quebec pilots of legend. For these men and women, being a Glitter Boy pilot is a matter of tradition and tremendous prestige. They are the elite of

the elite, and most get special privileges, officer’s training and recognition. A full half of all Commissioned Officers in the Glitter Boy Legions are said to have descended from these historic families.

These men and women (roughly one third are female) are highly motivated, loyal and disciplined soldiers dedicated to their country. They rarely hot shot or defy orders. **Note:** These professional “soldiers” have different training than the “independent” or “freelance” Glitter Boy O.C.C. presented in the **Rifts® RPG**, even though half of those are also “descended” from generations of GB pilots (such “Descended Independents” get the following bonuses: +1 on initiative, +1 to strike, +2 to pull punch, +3 to save vs Horror Factor, +20 S.D.C., and +1 additional melee attack when using a GB, but these bonuses only apply to those with a long family tradition, not those who have recently acquired a GB).

The “Descended” Glitter Boy Pilot of Quebec

Attribute Requirements: I.Q. 9 and P.P. 10 or higher. A high P.S. and M.E. are helpful but not necessary.

O.C.C. Bonus: +1 attack/action per melee round when using a Glitter Boy (any type) at levels 5 and 11 in addition to the normal bonuses from Elite GB Combat Training. Also +20 to S.D.C., +1 on initiative at levels 3, 8, and 12, +1 to strike, +1 to roll with impact, punch or fall, +3 to pull punch, +1 to save vs Horror Factor at levels 1, 3, 5, 7, 9, 11 and 13. All bonuses, other than H.F. and S.D.C., apply only when piloting a Glitter Boy.

O.C.C. Skills:

Language: American and old French at 88% +1% per level of experience. Literate in both (+15%).

Military Etiquette (+15%)

Land Navigation (+8%)

Radio Basic (+10%)

Pilot Robots & Power Armor (+10%)

Power Armor/Robot Combat Elite: Glitter Boy (all types).

Robot Combat Basic (general)

Pilot Automobile (+10%)

Pilot Hovercraft (+15%)

Pilot Tank & APC (+10%)

Read Sensory Equipment (+10%)

General Athletics

Weapon Systems (+10%)

W.P. Energy Rifle

W.P. Heavy Weapons

Hand to Hand: Basic

Hand to Hand: Basic can be changed to Expert at the cost of one O.C.C. Related Skill, or Martial Arts (or Assassin if an evil alignment) for the cost of two.

O.C.C. Related Skills: Select seven other skills. Plus select two additional skills at level three, one at level six, one at level nine, and one at level twelve. All new skills start at level one proficiency.

Communications: Any (+5%)

Domestic: Any

Electrical: Basic only.

Espionage: Wilderness Survival and Intelligence only.

Mechanical: Automotive and Basic Mechanics only (+5%).

Medical: None

Military: Any (+5%), excluding Trap skills.

Physical: Any, except Acrobatics or Gymnastics.

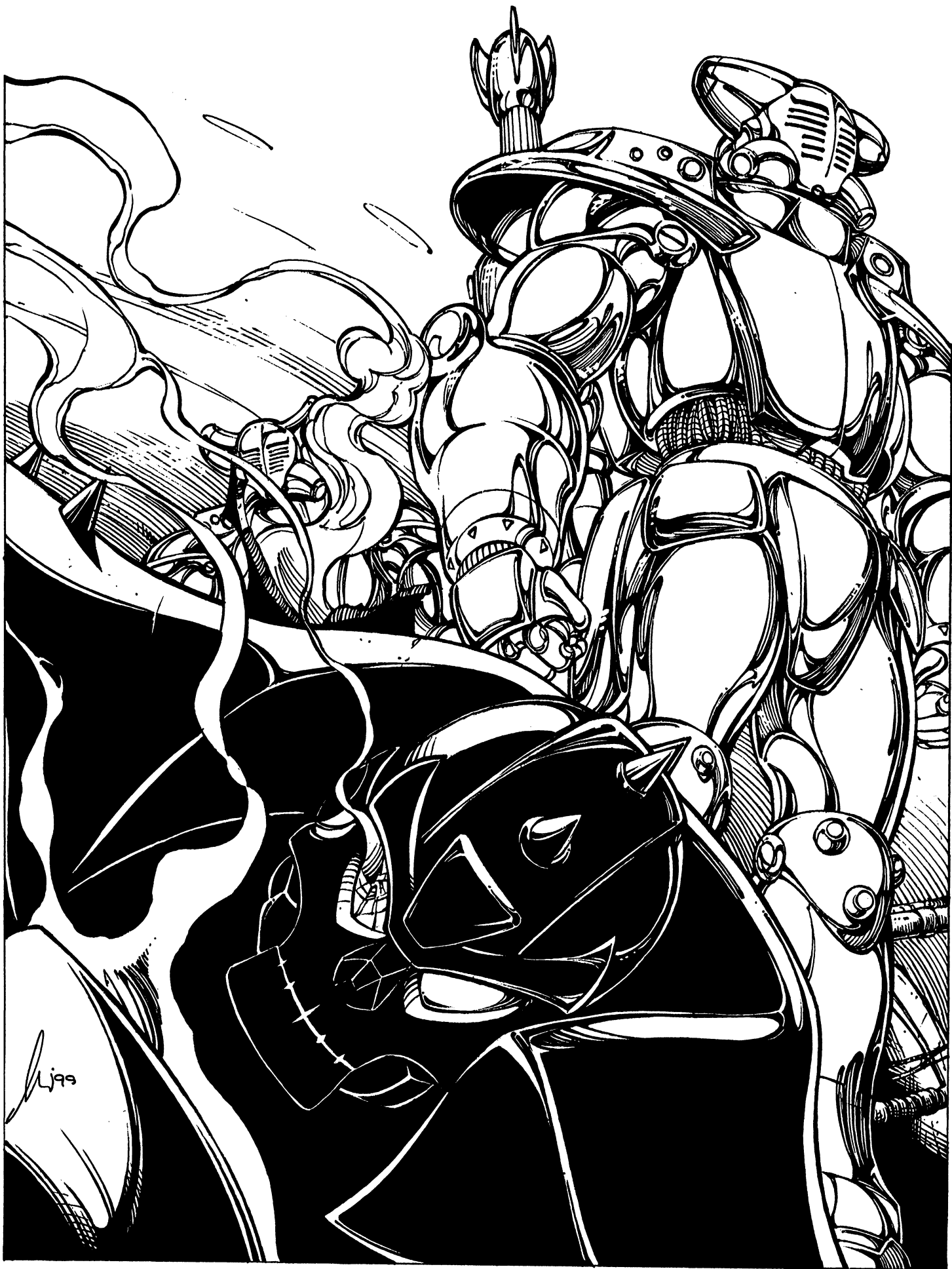

Pilot: Any (+10%)
Pilot Related: Any (+5%)
Rogue: None
Science: Math only (+10%)
Technical: Any (+5%)
W.P.: Any
Wilderness: None

Secondary Skills: The character also gets to select five Secondary Skills from the Secondary Skills list. These are additional areas of knowledge that do not get the advantage of the bonus listed in parentheses. All Secondary Skills start at the base skill level.

Standard Equipment: Glitter Boy power armor with standard heavy weapon. Each military pilot is assigned his own personal suit of armor as his main armor (see the various types described elsewhere), however, a different type of Glitter Boy may be assigned as the situation demands or supply allows. In addition to the Glitter Boy, the soldier also gets the standard issue body armor with a GB helmet, uniform, dress uniform, energy rifle and energy sidearm of choice, four extra E-clips for each, two high explosive grenades (3D6 M.D.), four signal flares, survival knife, utility belt, air filter and gas mask, standard ammo belts, canteen, robot medical kit and IRMSS, as well as personal items. The “vehicle” is the Glitter Boy Power Armor complete with Boom Gun or other heavy weapon and full payload of ammunition. Special transportation and alternate weapons may be made available upon assignment.

Note: An individual or pair of Taurus GBs is usually assigned a Reload Team and a Side Kick. As a rule, most Glitter Boy “squads” of 6-10 members are assigned 2-4 Side Kicks and one Reload Team otherwise. Squads sent on covert or intelligence gathering missions may have no Side Kicks to as many as one for each, depending on the mission, but no Reload Team.

Average level of experience (NPCs): 1D4+4 — high ranking officers are 1D4+6 (GB pilots who are not among the Descended range at 1D4+2 levels of experience).

Average Rank: Starts as a 2nd Lieutenant, with experienced officers having the average rank of Colonel. Known as the “Officers of Generations” and “The Descended.” Currently 70% of Quebec Glitter Boy pilots are The Descended.

Money: A Glitter Boy Pilot gets military accommodations, a roof over his head, food, clothing, medical, and all other basics provided free as part of his pay, as well as access to military garages and other facilities. Monthly salary is 3,200 credits. Starts off with one month’s pay.

The soldier’s quarters is a nice, small apartment typically in the same building as his fellow teammates. There is a living room, bathroom with tub and shower, study/den/library, kitchenette and a bedroom. Comes complete with CD stereo system, television and VCD, mini-refrigerator, basic furniture and a comfortable bed.

Cybernetics: Starts with clock calendar and gyro-compass, plus select one additional cybernetic augmentation from any category. Otherwise restricted to medical implants and prosthetics.

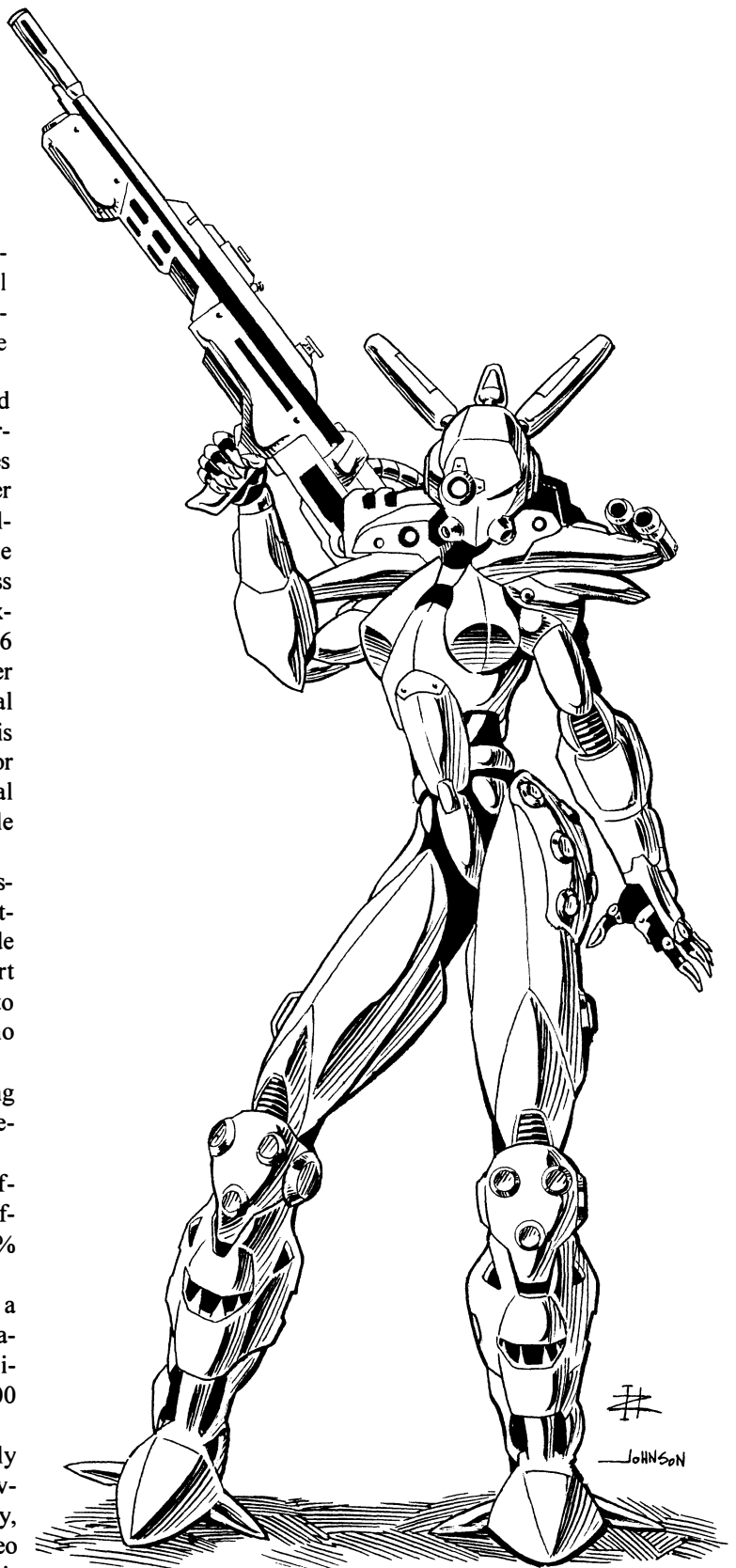

Glitter Girl Pilot O.C.C.

Glitter Girls (a.k.a Gigis) are fundamentally Glitter Boy pilots with training in intelligence gathering and espionage. They are extremely alert, observant and resourceful. All are female.

Glitter Girl Pilot of Quebec

Attribute Requirements: I.Q. 9 and M.E. 13 or higher. A high P.S. and P.P. are helpful but not necessary. Must be female.

O.C.C. Bonus: +1 on M.E. and +2 to P.P. attribute, +1 attack/action per melee round when using a Glitter Boy (any type) at levels 4 and 10 in addition to the normal bonuses from Elite GB Combat Training. Also +15 to S.D.C., +1 on initiative at levels 2, 4, 8 and 12, +1 to strike, +1 to roll with impact, punch or fall, +5 to pull punch, +1 to save vs Horror Factor at levels 1, 4, 7, 10, 12 and 15. All bonuses, other than H.F. and S.D.C., apply only when piloting a Glitter Boy.

O.C.C. Skills:

Language: English & French at 88% +1% per level of experience. Literate in both (+25%).

Radio: Basic (+15%)

Radio: Scrambler (+10%)

Pilot Robots & Power Armor (+10%)

Power Armor/Robot Combat Elite: Glitter Boy (all types).

Robot Combat Basic (general)

Pilot Automobile (+10%)

Pilot Hovercraft (+15%)

Read Sensory Equipment (+10%)

Surveillance Systems (+5%; +10% to "tail" when not in GB)

Intelligence (+10%)

Land Navigation (+10%)

Tracking (+5%)

Wilderness Survival (+10%)

Weapon Systems (+10%)

W.P. Energy Rifle

W.P. Heavy Weapons

Hand to Hand: Basic

Hand to Hand: Basic can be changed to Expert at the cost of one O.C.C. Related Skill, or Martial Arts (or Assassin if an evil alignment) for the cost of two.

O.C.C. Related Skills: Select four other skills. Plus select two additional skills at level three, one at level six, one at level nine, and one at level twelve. All new skills start at level one proficiency.

Communications: Any (+10%)

Domestic: Any

Electrical: Basic only.

Espionage: Any (+5%)

Mechanical: Basic only (+5%)

Medical: None

Military: Any (+10%), excluding Trap skills.

Physical: Any, except Wrestling and Acrobatics.

Pilot: Any (+10%)

Pilot Related: Any (+5%)

Rogue: Any (+2%)

Science: Math only (+10%)

Technical: Any (+5%)

W.P.: Any

Wilderness: Any

Secondary Skills: The character also gets to select four Secondary Skills from the Secondary Skills list. These are additional areas of knowledge that do not get the advantage of the bonus listed in parentheses. All Secondary Skills start at the base skill level.

Standard Equipment: Glitter "Girl" power armor with standard weapon, however, a different type of Glitter "Boy" may

be assigned as the situation demands or supply allows. In addition to the Glitter Girl, the soldier also gets the standard issue body armor with a GB helmet, uniform, dress uniform, energy rifle and energy sidearm of choice, four extra E-clips for each, two high explosive grenades (3D6 M.D.), four signal flares, survival knife, utility belt, air filter and gas mask, standard ammo belts, canteen, robot medical kit and IRMSS, as well as personal items. The "vehicle" is the Glitter Girl armor with standard weapon and a full payload of ammunition. Special transportation and alternative weapons may be made available upon assignment.

Note: Rarely assigned a Side Kick or Reload Team unless involved in mass combat and sieges.

Average level of experience (NPCs): 1D4+6.

Average Rank: Starts as a 2nd Lieutenant, with experienced officers having the average rank of Colonel.

Money: A Glitter Girl Pilot gets military accommodations, a roof over her head, food, clothing, medical, and all other basics provided free as part of her pay, as well as access to military garages and other facilities. Monthly salary is 3,200 credits. Starts off with one month's pay.

The soldier's quarters is a nice, small apartment typically in the same building as her fellow teammates. There is a living room, bathroom with tub and shower, study/den/library, kitchenette and a bedroom. Comes complete with CD stereo system, television and VCD, mini-refrigerator, basic furniture and a comfortable bed.

Cybernetics: Starts with clock calendar and gyro-compass, plus select one additional cybernetic augmentation from any category. Otherwise restricted to medical implants and prosthetics.

Side Kick RPA O.C.C.

These are basically the same as the **Elite RPA Pilot O.C.C.** described in **Rifts® Ultimate Ed.**, page 233, except their main type of power armor is the Side Kick. That being said, they can pilot SAMAS and other types of power armor and armored vehicles. Side Kicks are a separate division within the Elite RPA. The stats are reprinted here for the reader's convenience, along with modifications appropriate to the Quebec Military.

Military Power Armor Pilot

Attribute Requirements: I.Q. 10, P.P. 10 or higher.

O.C.C. Skills:

Language: English & French at 84% +1% per level of experience. Literate in both (+10%).

Land Navigation (+10%)

Radio Basic (+10%)

Pilot Automobile (+15%)

Pilot Hovercraft (+15)

Pilot Tank & APC (+15%)

Pilot Robots & Power Armor (+10%)

Robot Combat: Elite

Read Sensory Equipment (+15%)

Weapon Systems (+15%)

Running

W.P. Energy Pistol

W.P. Energy Rifle

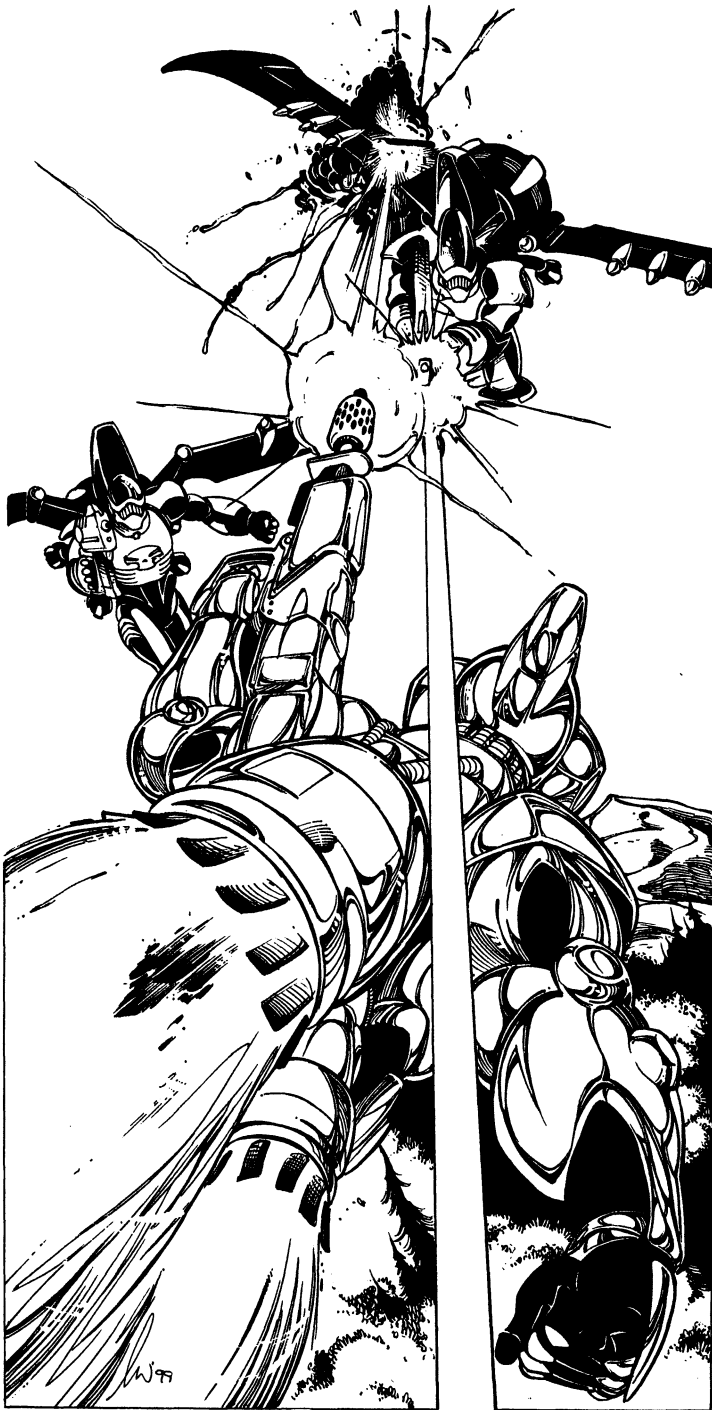

W.P. of choice

Hand to Hand: Expert

Hand to Hand: Expert can be changed to Martial Arts (or Assassin if an evil alignment) for the cost of two "other" skills.

O.C.C. Related Skills: Select eight other skills, but at least three must be selected from Pilot. Plus select two additional skills at level three, two at level six, one at level nine, and one at level twelve. All new skills start at level one proficiency.

Communications: Any (+10)

Domestic: Any (-5% penalty!).

Electrical: Basic Electronics only (+5%).

Espionage: Wilderness Survival only.

Mechanical: Aircraft and Automotive only (+10%).

Medical: First Aid only.

Military: Any (+5).

Physical: Any, except Acrobatics.

Pilot: Any (+15%).

Pilot Related: Any (+10%).

Rogue: Streetwise and Cardsharp only.

Science: Math only.

Technical: Any

W.P.: Any

Wilderness: None

Secondary Skills: The character also gets to select eight Secondary Skills from the Secondary Skills list. These are additional areas of knowledge that do not get the advantage of the bonus listed in parentheses. All Secondary Skills start at the base skill level.

Standard Equipment: Side Kick power armor and standard weapon, as well as a standard suit of Quebec body armor, energy rifle and energy sidearm of choice, four extra E-clips for each, two high explosive hand grenades, two smoke grenades, three signal flares, pocket laser distancer, survival knife, utility belt, air filter and gas mask, walkie-talkie, uniform, combat boots, canteen, and a number of personal items. Conventional military vehicle of choice (motorcycle, jeep, hover cycle or hover truck) for daily use and the previously mentioned Side Kick for field use only.

Equipment available upon Special Assignment: Other types of "non-Glitter Boy" power armor, robot vehicles, tanks and APCs, hovercraft, sky cycle, jet pack, tank, APC, transports and aircraft. Any weapon types, extra ammunition, camera, disc recorder, optical enhancement, and food rations for weeks. Also vehicle and equipment repair. **Note:** All weapons and equipment are allocated based on the necessity of the assignment and availability. If the officer doesn't like the character(s) the availability of items may be extremely limited.

Rank: Starts at Corporal.

Money: The Elite RPA Pilot gets a roof over his head, food, clothing, and all other basics provided free as part of his pay, as well as access to military facilities. His or her monthly salary is 2400 credits. Starts off with one month's pay.

The soldier's quarters is a nice dormitory arrangement shared with three other individuals. Each gets a private bedroom/study complete with CD stereo system, television and VCD, mini-refrigerator, desk, dresser, and comfortable bed.

Cybernetics: Starts with clock calendar and gyro-compass. Additional cybernetic augmentation from any category *may* be provided as a reward for outstanding service. Otherwise restricted to medical implants and prosthetics.

Reload Team O.C.C.

Also known as "Loaders" or "Moes" (short for *munitions experts*), each member of the 3-4 man Reload Team is a combination munitions/explosives expert and assistant Operator (mechanic). They are used only in the Quebec Army and specialize in power armor mechanics, weapon systems and explosives with an emphasis on Glitter Boy systems.

Moes are trained to ignore the danger and chaos around them and to stay focused on the task at hand: typically reloading and maintaining one to ten Glitter Boys under combat conditions.

The primary mission of a Reload Team is to keep their Glitter Boy(s) fighting. This means performing a reload of ammunition as quickly as possible, making weapon adjustments, changes and modifications, bypassing damage, jury-rigging weapon systems (if necessary) and making whatever field repairs and adjustments needed to keep their Glitter Boy(s) fighting as efficiently as possible!

Most have extraordinary Mental Endurance, are dedicated, driven and fearless. Although their first priority is to load and maintain Glitter Boys of all types (with the Classic and Taurus GBs especially dependent upon them), Loaders are also combat trained soldiers who will not hesitate to fight. However, unless ordered to do otherwise, they fight to defend the Glitter Boy to which they are assigned. If the original GB they have been assigned to is destroyed, they rescue the pilot and either quickly return to base camp for reassignment or "adopt" another Glitter Boy (several if circumstances require it) to keep it in action.

Glitter Boy Munitions Expert/"Reloader" O.C.C.

Attribute Requirements: I.Q. 9, M.E. 12, P.S. 12, P.P. 12 or higher.

O.C.C. Bonuses: The following bonuses do not apply to combat attacks/actions, only to the performance of *mechanical operations and skills* such as repairs, reloading and all types of mechanics. +1 melee action to reload or repair at levels 2 and 6, +1 on initiative at levels 2, 4, 8 and 12.

Other O.C.C. bonuses: +10 to S.D.C., +2 to roll with impact, punch or fall, +1 to dodge, and +2 to save vs Horror Factor.

O.C.C. Skills:

Language: American and old French at 88% +1% per level.

Literate in both (+20%)

Basic Math (+25%)

Radio: Basic (+15%)

Radio: Scramblers (+5%)

Basic Electronics (+10%)

Mechanical Engineer (+15%)

Weapons Engineer (+15%)

Weapon Systems (+15%)

Read Sensory Equipment (+10%)

Camouflage (+5%)

Demolitions (+20%)

Demolitions Disposal (+13%)

Underwater Demolitions (+10%)

Pilot: Hover Vehicle (+10%)

Pilot: Vehicle of Choice (+5%)

W.P. Energy Rifle

W.P. of choice (ancient or modern).

Hand to Hand: Basic, which can be changed to Expert for the cost of two O.C.C. Related Skills or to Martial Arts for the cost of four.

O.C.C. Related Skills: Select five other skills at level one and one additional skill at levels 3, 6, 9 and 12. All new skills start at level one proficiency.

Communications: Any (+10%)

Domestic: Any

Electrical: Any (+10%)

Espionage: None

Mechanical: Any (+10%)

Medical: None

Military: Any (but +10% to Field Armorer, Find Contraband and Recognize Weapon Quality skills only).

Physical: Any, excluding acrobatics and gymnastics.

Pilot: Any (+5%); excluding Robot and Power Armor (this is a fail-safe measure for security purposes).

Pilot Related: Any

Rogue: Pick Locks (+5%) only.

Science: Any (+5%)

Technical: Any (+10%)

Weapon Proficiencies: Any

Wilderness: None

Secondary Skills: The character also gets to select two Secondary Skills from the Secondary Skills list at levels 1, 4 and 8.

These are additional areas of knowledge that do not get the advantage of the bonus listed in the parentheses. All Secondary Skills start at the base skill level.

Standard Equipment: Standard issue body armor with a GB Team helmet, a black and grey jumpsuit, camouflage fatigues, work fatigues and a dress uniform, portable tool kit with an electric screwdriver and interchangeable heads, wrenches, etc., large tool kit, soldering iron, laser torch (for welding), laser scalpel (for fine work), a roll of duct tape, two rolls of electrical tape, pen flashlight, large flashlight, notebook, portable disc recorder, protective goggles, work gloves, robot medical kit, grappling hook, 100 feet (30.5 m) of super-lightweight rope (total weight 10 lbs/4.5 kg), canteen, rucksack, air filter, utility belt, hand-held computer, and similar tools of the trade. Diagnostic equipment, optical enhancements, and sensory equipment are part of a Reloader's hover vehicle.

Standard Weapons: LLG-2-20 assault rifle, Vibro-Knife (1D6 M.D.), six flares, two fragmentation hand grenades (2D6 M.D.), two plasma grenades (5D6 M.D.) and four smoke grenades.

Equipment available upon assignment: Fusion Blocks, plastique and additional explosives, EOD equipment and other types of munitions, heavy weapons, tools and equipment are available upon assignment. The exact type of equipment will depend on the mission, the commanding officer and availability of items at base.

RHV-60 Reloader Hover Vehicle: To help them in their mission, the Reload Team pilots a small vehicle that seats four, and has a large, covered or open-air cargo bay which holds additional ammo-drums, mortar shells, munitions and power packs as well as tools and replacement parts. It also has magnetic clamps and straps to carry a back-up GB big gun, tools and other gear. In some ways it resembles a long, flat hovercycle or a hover pick-up truck. The four man team sits in the open like a hovercycle so they don't have to actually leave their hover platform to do their work; they can lean over, stand up, walk around, etc. The vehicle is designed to be a mechanic's work station and hover platform complete with a small crane and hydraulics system.

Average Rank: Typically Corporal to Lieutenant, but each has high clearance and access to Glitter Boys, heavy weapons and munitions.

Money: The Loader gets military accommodations, a roof over his head, food, clothing, medical, and all other basics provided free as part of his pay, as well as access to military ga-

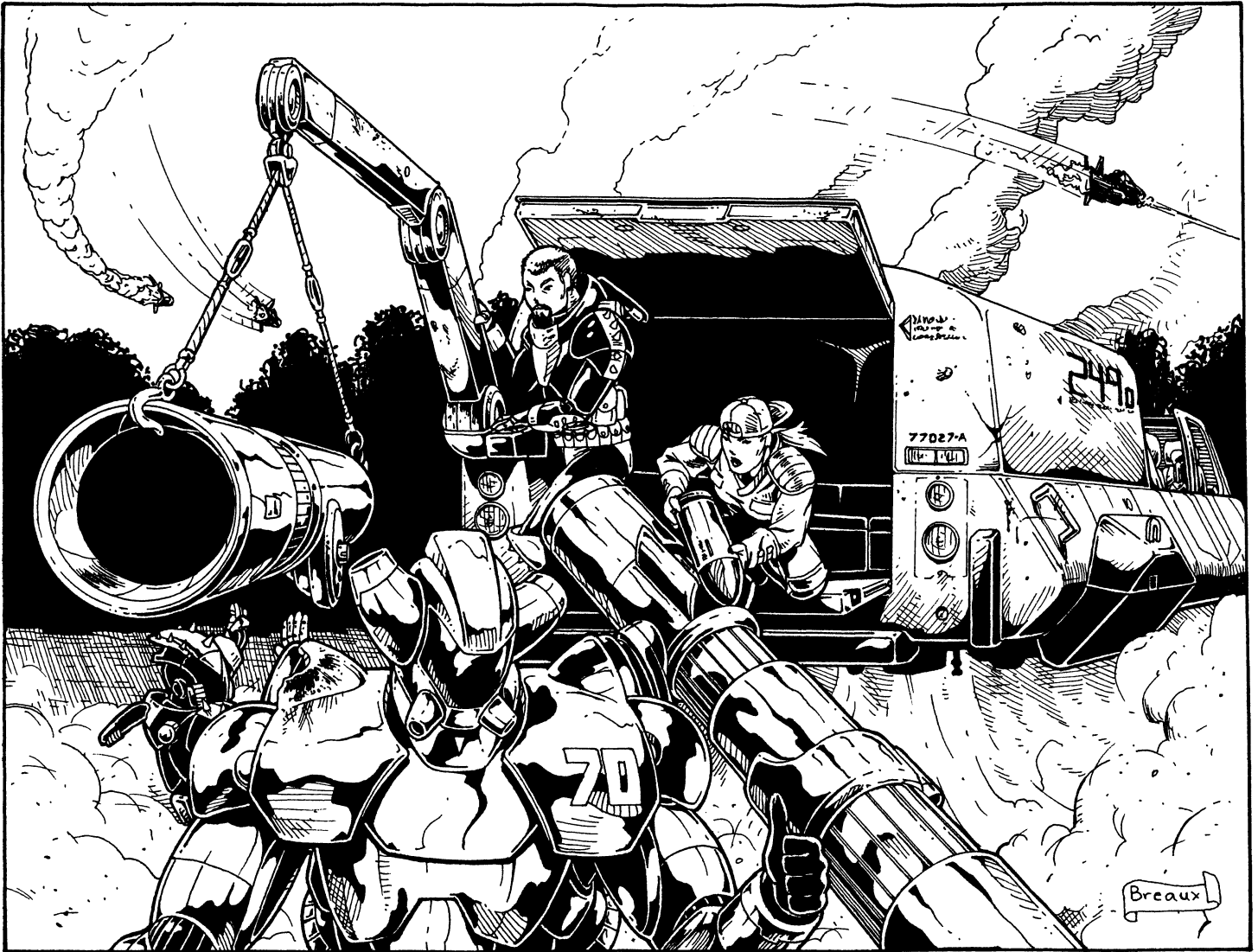

rages and other facilities. Monthly salary is 2100 credits. Starts off with one month's pay.

The soldier's quarters is a nice dormitory arrangement shared by four individuals (his/her "teammates"). Each gets a private bedroom/study complete with CD stereo system, tele-

vision and VCD, mini-refrigerator, desk, dresser, and comfortable bed.

Cybernetics: Starts with clock calendar and gyro-compass, plus select one additional cybernetic implant or bionic eye. Otherwise restricted to medical implants and prosthetics.

WEAPONS & EQUIPMENT OF THE QUEBEC MILITARY

By Kevin Siembieda and Francois DesRochers

Much of Free Quebec's technology is either comparable to the old Coalition armaments or actually *are* the old-style CS weapons and equipment. As a long-time member of the Coalition States, Free Quebec willingly used (and in some cases, tested or co-developed) the standard CS arms and armor for years. Of course Free Quebec was frozen out of the developments for the "new" Coalition Army (as presented in *Coalition War Campaign™*), so Quebec's weapons and equipment is a generation older than the CS. Basically, all the weapons, armor,

robots, and vehicles presented in the **Rifts® Role-Playing Game** is in the hands of the Quebec Army and Police. In some cases, like the *Death's Head Transport* and *IAR-2 Abolisher*, the availability of some things is severely limited, but in other cases they are plentiful. For example, Free Quebec manufactures its own CS-style pistols, rifles, light rail guns, explosives, SAMAS power armor, Sky Cycles, Spider Skull Walkers and Mark V APCs — as well as their own stylized M.D.C. body armor, weapons, Glitter Boys and vehicles.

All of the old-style CS items are good, reliable, high-tech equipment, they just aren't state of the art, and are frequently a notch or two lower on the power scale than the more recent CS counterparts (i.e. inflicts a bit less damage, has a bit shorter range, isn't quite as fast or as well armored, etc.), but all can hold their own against the "new" Coalition Army.

Quebec Weapons

The following pages represent the bulk of the weapons, vehicles and equipment either "officially" or "most commonly" used by the Free Quebec Armed Forces. The old-style Coalition gear is simply listed with reference page numbers; see the **Rifts® RPG** for complete stats. Items *unique* to Free Quebec are described in glorious detail. The weapons of Northern Gun, Wilk's, Triax and other manufacturers may also be used but on a limited or unofficial basis (they are more commonly used by mercenaries and adventurers).

As for equipment, electronics, and other gear, Free Quebec is a modern nation and as such, has most modern items (i.e. whatever the CS has, they probably have).

Old-Style CS Weapons

The following are the most commonly used weapons in the Quebec Military and Police Force. Most items listed are found in the **Rifts® Ultimate Edition RPG**.

C-18 Laser Pistol: Page 257 of **Rifts® Ultimate Edition**. Still a popular sidearm used by both the Quebec Military and Law Enforcement Agencies. It is also available to government officials for personal protection.

C-10 Light Assault Laser Rifle: Page 257 of **Rifts® Ultimate Edition**. Primarily used as a sniper rifle and by the Police.

C-12 Heavy Assault Laser Rifle: Page 257 of **Rifts® Ult. Ed.** A reliable heavy combat weapon used by Rangers, Commandos and Special Forces, as well as the Air Force and Navy.

C-14 "Fire Breather" Assault Laser Rifle & Grenade Launcher: Page 258 of **Rifts® Ultimate Edition**. This weapon is still popular among the CS as well as a favorite weapon among the Quebec Infantry, Juicers and Headhunters.

C-27 Heavy Plasma Cannon: Page 258 of **Rifts® Ultimate Edition**. A heavy infantry weapon that is favored by Headhunters, Juicers, Side Kicks and other light power armor pilots.

CR-1 Rocket Launcher: Page 258 of **Rifts® Ultimate Edition**. An anti-tank/anti-armor weapon.

C-40R SAMAS Rail Gun: Page 240 of **Rifts® Ultimate Edition**. A reliable rail gun used by Quebec power armor troops and Cyborg Shock Troopers, as well as by the "pig man" (an old pre-Rifts term for machine-gunner) in a typical Squad or Platoon and the occasional Juicer.

CS Vibro-Blades: Page 259 of **Rifts® Ultimate Edition**. These CS standard weapons are unchanged and as popular as ever. "Knock-offs" of the CS Vibro-Blades are produced by virtually every weapon manufacturer in the Americas. They are ideal for all troops and police assigned to urban duty because the weapons provide close combat Mega-Damage capabilities without the potential danger of long-range weapons which are in-

credibly hazardous to both human life and property. All city-patrol units are issued either two Vibro-Blades of choice, or a blade and a neural mace. Unfortunately these weapons are also popular with mercenaries and criminals.

CS Neural Mace: Page 259 of **Rifts® Ult. Ed.** Primarily used by Quebec Law Officers and Military personnel on covert operations to silently incapacitate (not kill) enemy guards, etc.

A Note about Uranium Rounds: One of the few things Free Quebec and the Coalition States have ever agreed on is to ban the use of Uranium Rounds for long-term environmental reasons. Both sides will honor this pact no matter what. Triax does not export U-Rounds to North America as part of a joint agreement with Free Quebec and the CS.

Skelebots: None. Quebec never trusted them and refused to use them.

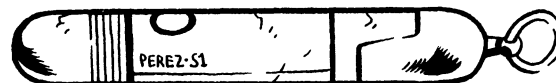

CS Explosives (Hand Grenades & Fusion Blocks): Page 260 of **Rifts® Ult. Ed.** All are standard issue for the Quebec Army.

Effective Throwing Range of Hand Grenades: About 40 yards/meters.

Cost: 250 credits for fragmentation, 200 credits for light high explosive, 275 credits for heavy high explosive, and 350 credits for plasma.

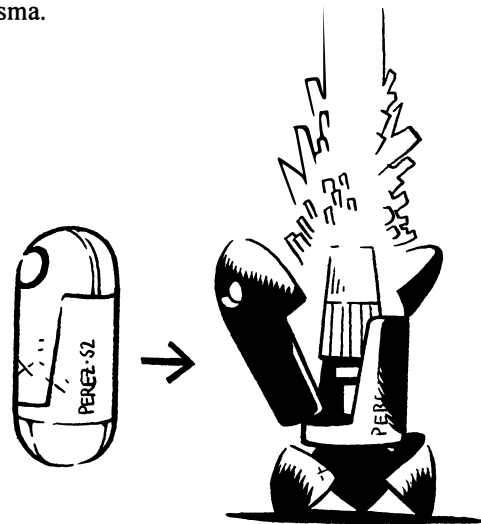

Stun/Flash Grenade: This riot/anti-terrorist weapon is designed to disorient and confuse criminals who are holding hostages in confined places. The grenade makes a loud exploding boom and emits a bright flash followed by a shower of white-hot sparklets and smoke. The flash, burning sparks, and smoke should blind and startle any character without environmental armor or protective goggles. The victims of a stun/flash grenade are -8 to strike, parry and dodge, -1 on initiative and lose one melee attack/action for the next 1D4 melee rounds (15 to 60 seconds). Even those in armor should be momentarily distracted for 1D4 seconds and lose initiative. **Cost:** 100 credits.

Tear Gas Grenade: The gas will instantly affect characters without protective masks or environmental body armor. The eyes burn, sting and water profusely, which causes great discomfort and makes seeing clearly impossible. The gas also makes breathing difficult and irritates exposed skin. The effects last for 3D4 minutes. The 25 foot (7.6 m) cloud dissipates in

about 5 minutes unless blown away by wind (dissipating more quickly in 1D4 minutes). The victims of tear gas are -10 to strike, parry and dodge, -3 on initiative and lose one melee attack/action for each of the next 1D6+1 melee rounds. Those in environmental body armor are completely safe and not affected. Cost: 200 credits.

Smoke Grenade: This type of grenade releases a thick cloud of smoke that covers a 20 to 40 foot (6 to 12 m) radius. The smoke obscures vision in and throughout the cloud from those outside of it. Infrared cannot penetrate a smoke cloud or be used inside one. Those inside the cloud will be blinded and have trouble breathing. Those who are not protected by environmental suits or a gas mask and goggles will be -5 to strike, parry and dodge, and -1 on initiative. Attackers firing into/through the cloud will be shooting wild. Note that passive nightscopes will work in a smoke cloud.

Hand-held Flare: This is the type of item truck drivers and road patrols use to signal for help or to warn others of an accident or danger. The flare burns for 20 minutes. Cost: One credit each.

Parachute Flares: This pyrotechnic device usually comes in a hand-held, throw-away launch tube. Three seconds after launching, it ignites into a bright, sparkling light that slowly drifts back to earth. While in the air, the flare burns for 60 seconds and illuminates an area roughly 150 feet (45.7 m) in diameter. Cost: 10 credits each. Note: This is NOT a weapon, but if shot into a person, the flare does 6D6 S.D.C. each melee round for one minute (4 rounds). There is also a 50% chance of causing combustibles to catch fire.

Missiles: Mini-missiles and short-range full-sized missiles are plentiful and manufactured at Free Quebec. However, full-sized medium- and long-range missiles are in short supply.

Other Notable Weapons not made in Quebec

Triax TX-5 Pump Pistol: Page 167 of *Rifts® Game Master Guide* or page 143 of *World Book Five: Triax & The NGR*. This handgun is popular among Rangers/Scouts, Commandos and Special Ops. Good availability for the Quebec Army.

Triax TX-11 Sniper Laser Rifle: Page 168 of *Rifts® Game Master Guide* or page 144 of *World Book Five: Triax & The NGR*. A favorite among snipers and assassins. Fair availability for the Quebec Army.

Triax TX-26 Particle Beam Pistol: Page 144 of *World Book Five: Triax & The NGR*. Exclusive to Juicer Officers and select Commandos and Special Operatives. Rare even in the Quebec Army.

Northern Gun NG-P7 Particle Beam Rifle: Page 270 of *Rifts® Ultimate Edition*. Typically limited to special assignments and Commandos. Note: Since Northern Gun and the Manistique Imperium's *alliance* with the CS, they no longer sell/trade with Free Quebec on any level! Likewise, Triax and the NGR are keeping its distances in order to placate the CS and establish stronger relations with them.

Wilk's Weapons are not used by the military or the authorities, but are common among mercenaries and adventurers in the Central and Eastern parts of Canada (and the USA), as well as the occasional Quebec citizen and SQ agents. See *Rifts® New West* page 203-210 for a large listing.

Uniquely Quebec Weapons

Many of Free Quebec's weapons have a bit of an old German Mauser styling. They are also a bit reminiscent of the sleek, black Wilk's laser weapons. These guns were introduced only in the last two years and have been enthusiastically accepted as "standard" issue for the Quebec Army. Now that they are on the outs with the Coalition, their distinct styling has become preferable over the old CS look, although many of the Coalition weapons remain hugely popular. All the following weapons are exclusive to the Quebec Army (the police use the old CS weapons and Northern Gun imports).

Mini-HUD System

Applying some of the cybernetic technology and coupling it with advanced optical enhancement systems through the trade agreement with the NGR and Triax, Free Quebec has co-developed (with Triax) this advanced optic system for use with assault rifles. The mini-Head Up Display weighs around one pound (0.45 kg), fits onto most rifles like a scope and can either be used for "visual" targeting as a *multi-optics* scope, or through a direct link to the user's helmet. The link provides a Heads Up Display (HUD) to help the shooter more accurately "acquire" his target. It provides telescopic, passive nightvision, infrared and thermo-imaging optical enhancements as well as the exact distance, angle and targeting hairs all displayed on the shooter's face plate/visor.

The mini-HUD is an experimental system which is, for now, only available on assignment to Special Forces, Commandos, Rangers, snipers and other personnel who warrant the system on special assignment. The Free Quebec Army is endeavoring to supply them to Side Kicks and Cyborg Shock Troopers (most Juicers prefer to rely on their natural abilities).

Weight: One pound (0.45 kg).

Bonuses: +1 on initiative and +2 to strike with long-range weapons, in addition to any applicable W.P. bonuses and the obvious benefits of the optic enhancements (i.e. can see in darkness, read heat images, etc.).

Free Quebec Cost: 15,000 credits. The mini-HUD is only available to the Free Quebec military and its existence is presently unknown to outsiders. It has *never* been available to the Black Market, but if it is knocked off it will sell for at least 35,000 credits.

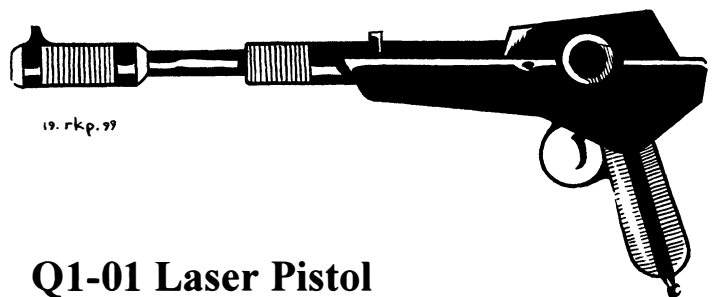

Q1-01 Laser Pistol

The "Que-One-Oh-One" is the new, standard issue sidearm for the Free Quebec Military. It is primarily issued to officers, guards, and Special Operatives. It has the advantage of heavier damage capacity without sacrificing its light weight, excellent balance, or range.

Weight: 3.5 lbs (1.57 kg).

Mega-Damage: 3D4 M.D. per single shot or 4D6 per short burst (counts as one attack but fires four blasts).

Rate of Fire: Each single shot or burst counts as one attack.

Effective Range: 800 feet (244 m).

Payload: 20 shots per standard E-Clip or 30 shots per long E-Clip.

Free Quebec Cost: 10,000 credits. The Black Market has only been able to obtain a few of these weapons and sells them for around 16,000 credits.

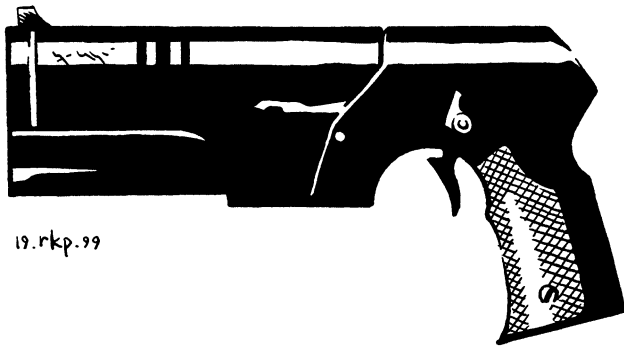

19. rkp. 99

Q1-02 "Stopper" Ion Pistol

This is a heavy energy pistol with tremendous damage capabilities and represents a breakthrough in Quebec weapon tech-

nology. Well, at least a partial breakthrough. The "Stopper" has two major drawbacks: terrible range and it's heavy. Still, Commandos, Special Forces, Juicers and Cyborg troopers love it for close combat.

Weight: 4.5 lbs (2 kg).

Mega-Damage: 4D6+4 M.D. per single blast. Can't fire bursts.

Rate of Fire: Semi-automatic. Equal to the hand to hand attacks of the shooter. Each shot counts as one melee action/attack.

Effective Range: 200 feet (61 m).

Payload: 12 shots per standard E-Clip or 24 shots per long E-Clip.

Free Quebec Cost: 12,000 credits. Not available on the Black Market (when it is, it will probably sell for 18,000-20,000 credits).

Q2-10 Laser Pulse Rifle

A durable laser with three settings and the capability of firing a single shot for precision shooting and sniping, or as an automatic weapon firing short bursts of five. Comes standard with a telescopic scope but can use the Mini-HUD System.

Weight: 6 lbs (2.7 kg).

Mega-Damage: 1D6 M.D., 2D6 M.D. or 3D6 M.D. per individual shot, or 6D6+6 per short burst (counts as one attack but fires five blasts).

Rate of Fire: Each single shot or burst counts as one attack.

Effective Range: 2000 feet (610 m).

Payload: 20 shots per standard E-Clip or 30 shots per long E-Clip.

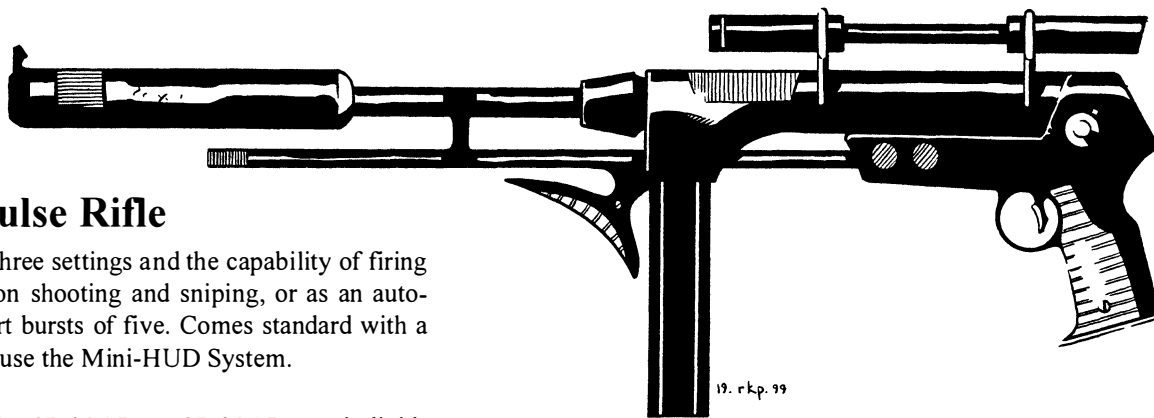

19. rkp. 99

Free Quebec Cost: 16,000 credits. Not yet available on the Black Market. When it is, it should sell for 22,000-24,000 credits.

Q2-20 LLG "Infantry Standard" Light Laser & Grenade Launcher

The LLG was inspired by the CS "Fire Breather" assault rifle and is proving to be just as versatile. A bayonet (typically a Vibro-Blade) can be mounted to the lower barrel via a special attachment housing (with magnetic lock), and the mini-HUD system can also be used. The LLG is the standard issue weapon for all Free Quebec Infantry troops and available to all branches of the Quebec Military. The same weapon with a slightly differ-

ent styling (shown in the illustration with bayonet and bayonet holder) is used by the Quebec Navy.

Weight: 7 lbs (3.2 kg); 8 lbs (3.6 kg) with mini-HUD, 9 lbs (4 kg) if the bayonet is added.

Laser:

Primary Purpose: Assault

Mega-Damage: 3D6 M.D. per single shot or 6D6 per short burst (counts as one melee attack but uses up five blasts).

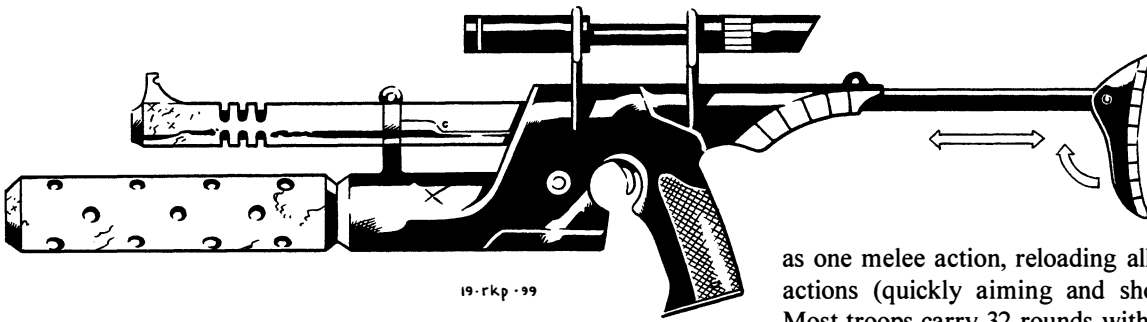

19.rkp.99

Rate of Fire: Each single shot or short burst counts as one attack.

Effective Range: 2000 feet (610 m).

Payload: 20 shots per short E-Clip (standard), or 30 shots per long E-Clip.

Mini-Grenade Launcher: A separate standard unit that attaches below the laser barrel. To reload, flip open the bottom plate; holds four grenades.

Primary Purpose: Assault, Anti-Personnel and Anti-Monster.

Mega-Damage: Typically uses high explosive (4D6 M.D. to a 6 foot area/1.8 meters in diameter) or a concussion charge. The latter does 2D6 M.D. to what it hits and knocks everybody/thing within a 15 foot (4.6 m) radius off their feet (victims lose initiative and one melee attack/action). Smoke grenades (no damage) to provide cover or to mark an area can also be used.

Rate of Fire: One at a time, or in volleys of two.

Effective Range: 1100 feet (335.5 m).

Payload: The grenade launcher part of the weapon holds four rifle grenades at a time. Reloading one explosive round counts

as one melee action, reloading all four counts as four melee actions (quickly aiming and shooting counts as another). Most troops carry 32 rounds with them plus four in the gun. Additional rounds may be carried in a hip-pouch (24 rounds, weighs 15 lbs/7 kg), backpack or shoulder satchel (32-64 extra rounds depending on the size of the container; 22 lbs/10 kg or 44 lbs/20 kg respectively).

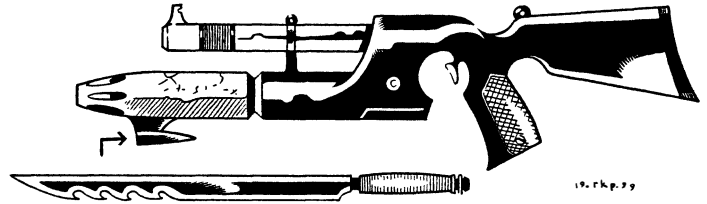

19.rkp.99

Vibro-Bayonet (optional): The blade can be used as a bayonet attached to the rifle, or removed and used as a hand weapon.

Primary Purpose: Anti-Personnel/Close Combat.

Mega-Damage: 2D4 M.D. per strike.

Rate of Fire: Equal to the number of hand to hand attacks per melee.

Effective Range: Within reach.

Free Quebec Total Cost: 26,000 credits with Vibro-Bayonet, one E-Clip and 36 grenades. Not yet available on the Black Market. When it is, it should sell for around 40,000 credits. Black Market Grenades cost 550 apiece or 4500 a dozen.

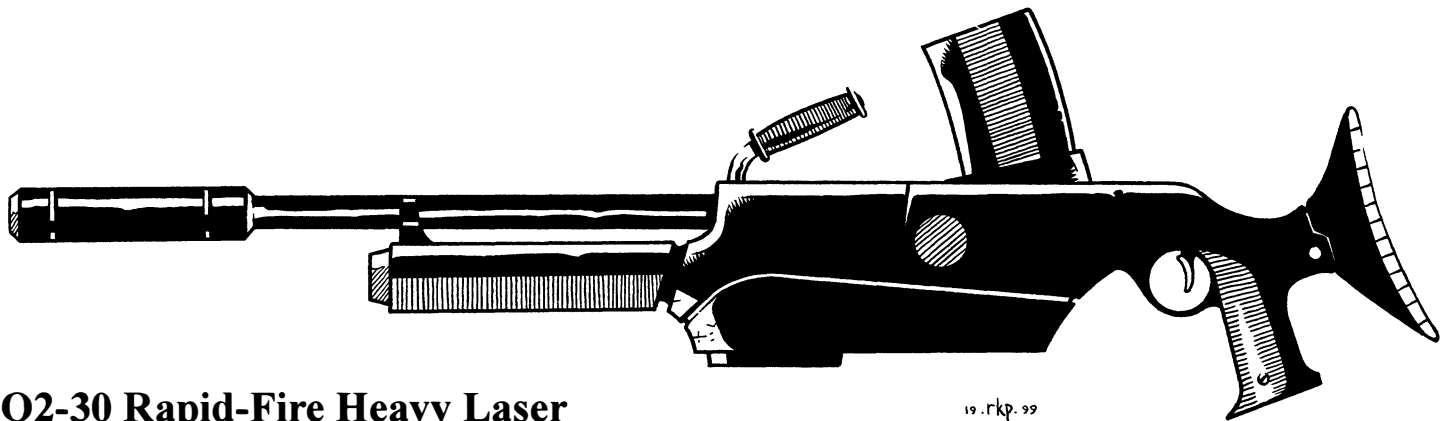

19.rkp.99

Q2-30 Rapid-Fire Heavy Laser

The Q2-30 is a heavy, long-range laser that resembles a rail gun in its size and weight. It has surprising firepower, a large payload and is used like a light machinegun. It comes with a long E-Clip inserted in the top housing, a standard E-Clip in the handle, and another long E-Clip concealed inside (crack open the lower half of the gun to gain access; takes three melee actions to open, remove and reload this clip; the others take only one or two).

This is something of an experimental design created with Cyborg Shock Troopers, Juicers and power armor units in mind. Ordinary soldiers must have a P.S. of 22 or higher to effectively use this big, awkward weapon (-2 to strike and takes twice as long to reload if P.S. is lower than 22). It is also mounted on hover jeps and trucks, and used like a machinegun on a tripod.

Note: An energy power pack can be attached to the weapon for additional fire power but requires either a second man or vehicle to haul it (weight 50 lbs/22.5 kg) or the mechanical strength and stamina of a full conversion cyborg or power armor.

Weight: Weapon fully loaded. 24 lbs (10.8 kg); 26 lbs (11.7 kg) with tripod and mini-HUD unit.

Primary Purpose: Assault and Anti-Personnel.

Mega-Damage: 3D6 M.D. per single shot. +3 to strike if the shooter has the W.P. Heavy Weapons skill (no bonus without a W.P.).

6D6 M.D. per short burst. Counts as one melee attack but uses up five blasts. +2 to strike with the W.P. Heavy Weapons skill.

1D6x10 M.D. per medium burst. Uses up 20 shots and counts as two of the shooter's melee attacks/actions. +1 to strike with W.P.

2D6x10 M.D. per long burst. Uses 40 shots and counts as two of the shooter's melee attacks/actions. +1 to strike with W.P.

4D6x10 M.D. when the entire payload (80 shots) is emptied into a target or expended in spray shooting (3D6 M.D. done to 4D4 targets when a spray attack is used)! No bonuses to strike.

Rate of Fire: Special.

Effective Range: 3000 feet (914 m).

Payload: Standard 80 shots total; 20 from the standard E-Clip and 30 each from the two long E-Clips. An additional 120

shots can be added from a small, portable power pack attached to the heavy rifle with a power cable. The power pack weighs 50 lbs (22.5 kg) and can be carried as a backpack or with a back-mounted harness by cyborgs or power armor.

Note: This weapon and the QR-12A were designed with the help of Triax engineers a year before Free Quebec seceded from the CS. A fact that Triax and the NGR has tried to keep secret. Quebec does not broadcast this fact in an effort to help Triax and the German government avoid trouble with the CS.

Free Quebec Cost: 35,000 credits. Fair to poor availability. Typically reserved for elite, heavy combat troops like Juicers and cyborgs, as well as Rangers, Commandos and Special Forces. Not yet available on the Black Market. When it is, it should sell for 65,000-75,000 credits.

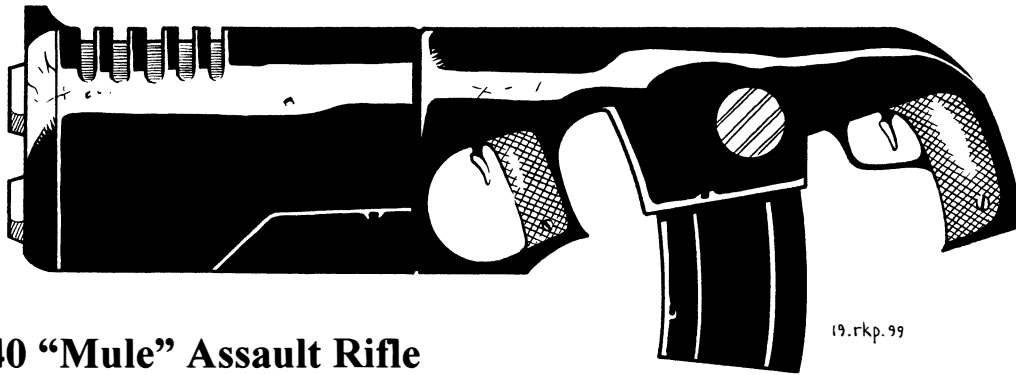

Q4-40 "Mule" Assault Rifle

This projectile weapon fires the same explosive rounds as the QST-104 Glitter Girl Assault Cannon. The main differences are this weapon is designed for use by ordinary humans, has a comparatively very short-range and a kick like a mule, which is why it has two handles. Only cyborgs, power armor and characters with a P.S. of 26 or higher can fire this weapon one-handed without penalty. Ordinary humans with a P.S. 26 or less are -2 to strike for a single shot and -4 to strike when firing a burst.

This weapon has the nice feature of being able to fire from either the front or the back handle grip. To use the traditional back handle trigger, a switch is flipped and the forward trigger depressed (without actually firing rounds). To shoot, pull the traditional back-handle trigger as usual. To use the front handle, flip a switch and fire away (the other trigger is momentarily immobilized). This can sometimes confuse those not familiar with the weapon.

Primary Purpose: Assault & Anti-Armor.

Weight: 15 lbs (6.75 kg), plus 5 lbs with ammo drum (20 lbs/9 kg).

Mega-Damage: One explosive round 2D6 M.D., a rapid-fire burst (3 rounds) fired at the same target does 6D6 M.D. and counts as one melee attack/action.

Rate of Fire: Equal to the number of combined hand to hand attacks of the shooter; each shot or burst (3 rounds) counts as one melee attack.

Maximum Effective Range: 800 feet (244 m).

Standard Payload: 12 total; six hand held in the weapon, six in the standard clip. The clip can be replaced with a 24 round drum (for a total payload of 30 rounds — six in the gun plus ammo drum).

Free Quebec Cost: 15,000 credits. Fair to good availability, but typically reserved for heavy combat troops like Juicers and cyborgs, and power armor troops, as well as Rangers, Commandos and Special Forces. Not yet available on the Black Market. When it is, it should sell for 45,000-50,000 credits with explosive rounds costing 700-800 credits each.

Q4-44 "Drummer" Double-Barreled Shotgun

Cheap, efficient, and practical, this high-tech variant is a shotgun that can fire conventional S.D.C. shotgun rounds or light M.D. rounds. Super-durable. Not only can it take a beating and keep firing without jamming, but can fire underwater even after being submerged for over an hour.

Primary Purpose: Assault & Anti-Armor.

Secondary Purpose: Anti-Personnel.

Weight: 16 lbs (7.2 kg) with ammo drum.

Mega-Damage: One explosive round does 1D6 M.D., or 2D6 M.D. from a simultaneous double-barrel blast (counts as one melee attack/action) fired at the same target. See *Rifts® Juicer Uprising™*, pages 73-74, for more available ammo types.

S.D.C. rounds typically inflict 4D6 S.D.C./H.P. damage from buckshot and 5D6 S.D.C. from solid slugs; double damage from a double barrel blast.

Rate of Fire: Equal to the number of combined hand to hand attacks of the shooter; each shot or double barrel blast (2 rounds) counts as one melee attack.

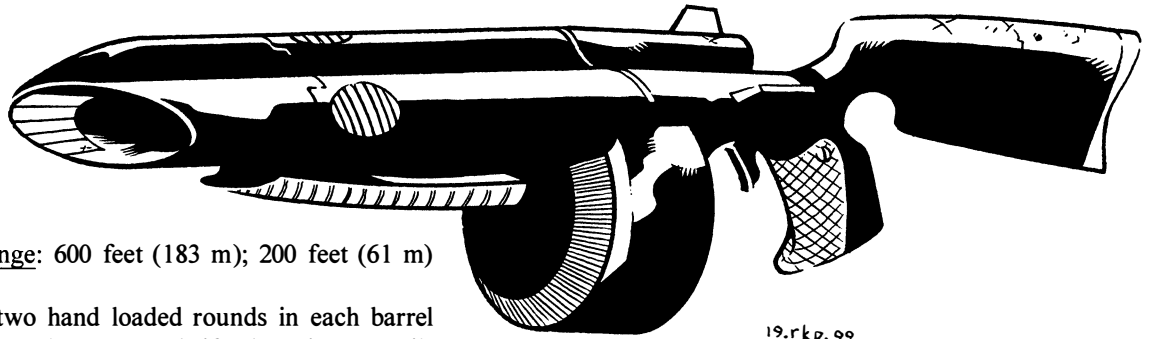

Maximum Effective Range: 600 feet (183 m); 200 feet (61 m) underwater.

Standard Payload: 42; two hand loaded rounds in each barrel plus a 40 round drum. Only two rounds if a drum is not available.

Free Quebec Cost: 4,500 credits. Good availability, and a favorite of Reload Teams, Headhunters, Rangers/Scouts, Juicers, Commandos and Naval troops. Not yet available on the Black Market. When it is, it should sell for 45,000-50,000 credits with explosive shotgun rounds costing 200-300 credits each.

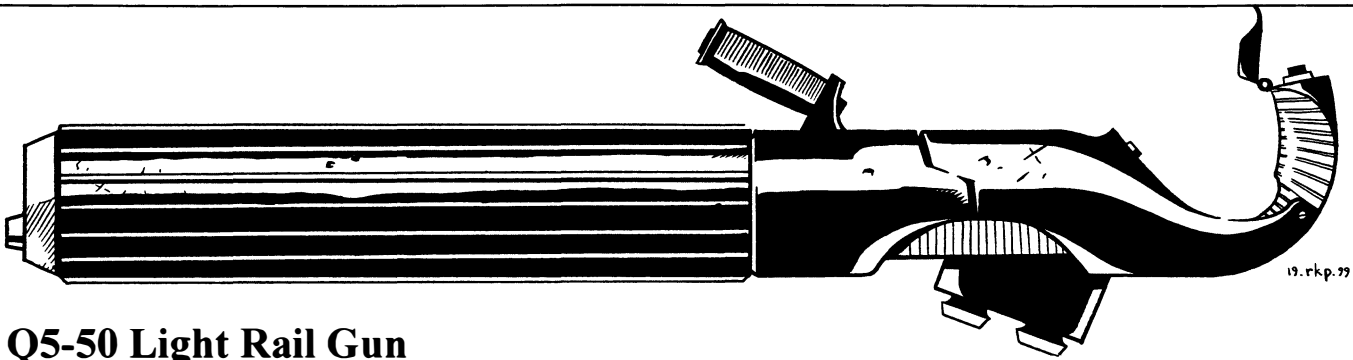

Q5-50 Light Rail Gun

This is a light, anti-personnel weapon used by human troops wearing power armor, cyborgs, and characters with a strength of 24 or greater. The Q5-50 rail gun can use what is called a short clip with 200 rounds (10 bursts), light drum with 600 rounds (30 bursts), or a heavy belt feed drum containing 2000 rounds (100 bursts). The latter is typically reserved for cyborgs and is carried as a backpack or by a partner in a two-man team.

Primary Purpose: Assault/Anti-Personnel.

Weight: Gun: 45 lbs (20.25 kg), short clip: 10 pounds (4.5 kg), light ammo-drum: 30 pounds (13 kg), or a heavy ammo-drum: 100 lbs (45 kg). Ammo-drums are hooked to the back of body armor or housing on the back of a 'Borg or power armor.

Mega-Damage: A full damage burst fires 20 rounds and inflicts 4D6 M.D.; a single round does 1D4 M.D.

Rate of Fire: Equal to the character's hand to hand attacks per melee round (usually 3 to 6).

Maximum Effective Range: 4000 feet (1219 m)

Payload: The short clip holds 200 rounds and is capable of firing ten full damage bursts (20 rounds).

The light drum holds 600 rounds and can fire 30 bursts.

The 2000 round drum is capable of firing 100 full damage bursts (20 rounds each).

Reloading a drum will take about two minutes for those not trained, but only 20-30 seconds by a capable field mechanic or Reload Team. A strength of 24 or higher is required to handle the drum.

Free Quebec Cost: 32,000 credits. Good availability. Not yet available on the Black Market. When it is, it should sell for 60,000-70,000 credits.

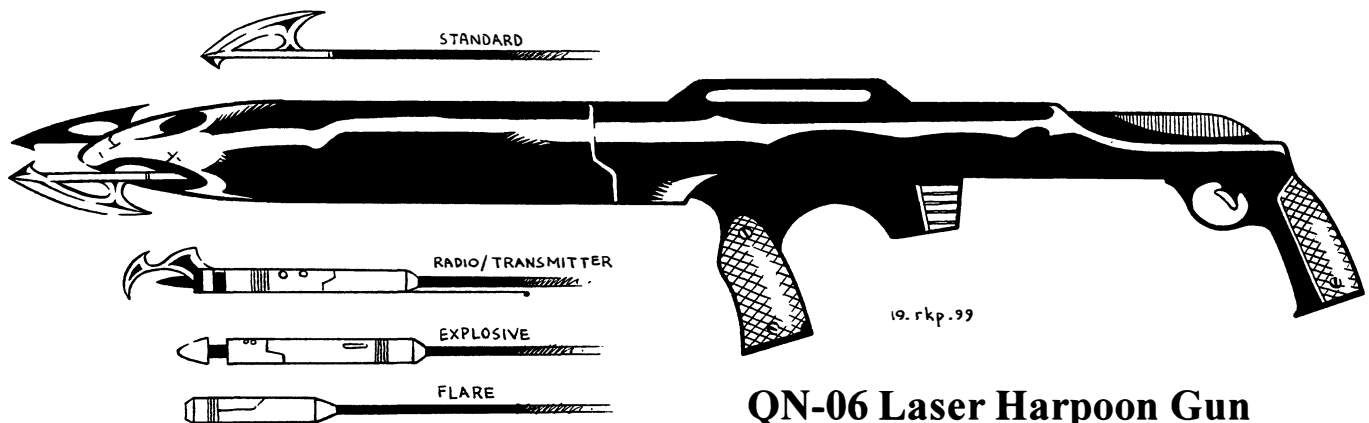

QN-06 Laser Harpoon Gun

This a Naval weapon used by Navy divers, Navy power armor troops and Army Special Forces (usually available to Army personnel on special assignment). The top notch in the barrel fires a blue-green laser, the two side and one bottom slots hold any variety of spears.

Weight: 6.5 lbs (3 kg).

Mega-Damage: Laser 3D6 M.D. per blast.

Damage from Spears: Varies with type.

- Standard: 2D6+3 S.D.C./Hit Points. Cost: 6 credits.
- Radio/Transmitter: 2D4 S.D.C./Hit Points as a weapon, plus the radio/transmitter can send a tracking signal (lasts 72 hours) and/or transmit sounds from wherever or whatever it is impaled into or hooked onto. Great spy device. A magnetic clip allows the harpoon to cling to M.D.C. metal structures. Transmits a radio signal that can be followed up to 8 miles (12.8 km) away. Battery powered with a limited life of 72 hours of constant transmission. The spear must stick into the target or fall on top of the object (without falling off). There is always a chance that the tracer bug will become dislodged and fall off (roll once for every half hour; 1-32% chance). Cost: 200 credits each.
- Flare: Emits a bright, sparking light; burns for 120 seconds. Cost: 15 credits.
- High Explosive: 4D6 M.D.; cost: 600 credits.

Rate of Fire: Each shot counts as one melee attack. Only one harpoon can be fired at a time.

Effective Range: Laser: 1200 feet (365.7 m). Harpoons: 350 feet (106.7 m) above water, or 200 feet (61 m) underwater.

Payload: Laser: 20 shots per standard E-Clip or 30 shots per long E-Clip. Harpoons: Three (types may vary). A pouch with 12 additional harpoons (conventional and/or explosive) is often carried by a diver, but each spear must be reloaded by hand and the reloading of each counts as one melee attack/action.

Free Quebec Cost: 15,000 credits. Northern Gun and the Black Market offer knock-offs at the price of 21,000 credits.

Free Quebec Body Armor

Free Quebec still has thousands of suits of “old-style” Dead Boy armor that have been mothballed and put into storage. Tens of thousands have been cannibalized for Quebec’s own standard issue body armor. Quebec armor is made of glossy black, light-weight ceramic with spikes and light colored accents, bonded on a molecular level, making it stronger than steel. Each suit of armor offers Mega-Damage protection and complete environmental systems, making it a self contained unit, like a spacesuit. Air filters, circulation and cooling, and an independent oxygen supply (engages when needed) ensure that toxic fumes, gas attacks, and smoke will not affect the soldier protected in the suit unless the armor is breached. The armor is slightly more flexible than the old Coalition “Dead Boy” armor but equally as good when it comes to protection.

There is only *one* type of Quebec Military Body Armor, although different headpieces/helmets are used to differentiate between divisions and indicate rank within the armed forces. The

helmet and face plate is smooth and featureless other than a range of spikes, horns and fins. A belt with 6-10 detachable pouches hangs from the hips. A second, wide-band, belt is placed above the waistline reminiscent to the wide belts worn by pre-Rifts gladiators and championship boxers. Attached to it are two large bags covering the belly, a grenade on each side above the hips and a first-aid kit or third bag or container at the small of the back. A shoulder strap for additional pouches or to hook flares and hand grenades runs from the shoulder down to the smaller belt to complete the package.

It is very much built upon the old Coalition Armor and has its own look and a few special features mainly to distinguish it from Coalition troops. Just issued in the last year.

Class: QEBA-10 all-purpose Environmental Battle Armor.

Size: Human equivalent.

Weight: Heavy: 18 pounds (8.1 kg).

Mobility: Good; -10% to climb, -20% to prowl, swim, acrobatics and similar physical skills/performances.

M.D.C. by Location:

Head/Helmet — 50

Arms — 35 each

Legs — 50 each

Main Body — 80 (heavy)

Free Quebec Cost: 42,000 credits (70,000 on Black Market; rare).

Standard environmental body armor properties:

- Complete environmental battle armor suitable for use in all hostile environments, including space.
- Computer controlled life support.
- Internal cooling and temperature control.
- Artificial air circulation systems, gas filtration, humidifier.
- Computer controlled, independent oxygen supply and purge system that automatically engages in low oxygen or contaminated air environments. Five hour oxygen supply.
- Insulated, high temperature resistant shielding for up to 300 degrees centigrade. Normal fires do no damage. Nuclear, plasma and magic fires do full damage.
- Radiation shielded.
- Polarized and light sensitive/adjusting tinted visor.
- Built-in loudspeaker; 80 decibels.
- Directional, short range radio built into the helmet. Range is 5 miles (8 km).
- Helmet face plate is removable.
- Concealed Wrist Mini-Comp: A multi-purpose miniature computer and display that will indicate system errors within the armor, damage levels, and oxygen supply, as well as a directional compass, time, and date. Ammo and supply waist belt, shoulder belts, and shoulder holster. Pilots and officers have their choice of shoulder or hip holster.
- Boot survival knife or Vibro-Blade for officers and Military Specialists.

Special Features:

1. Built-in language translator, includes English, Euro, Techno-can, the two most common Inuit tongues, old French (still a popular second language among locals), and a dozen other regional languages (four of which can be programmed by



the wearer). This feature is unique to Free Quebec environmental armor and power armor.

2. Video camera and long-range transmitter. This is a tube-like appendage that is most notable from the back of the armor. When in storage mode, it is locked down against the back and looks like nothing more than an air vent, or meaningless bit of tubing. When activated the tube slides up, and flips to the right or left shoulder in a horizontal position, jutting over the shoulder from behind the neck collar. In this position it is now ready to film and record or transmit pictures and sound.

Recordings are made on one of three, self-loading video discs with nine hours of available footage. If desired, the video disc can be recorded over again, although usually only after it has been viewed by the soldier's superiors and wiped clean to avoid confusing past events with current ones.

The images and sounds can also be transmitted to a communications or Mission Command Post, which can be a fixed outpost or base, or a mobile command or platoon center located in a vehicle such as an APC, Death's Head Transport, giant robot or aircraft. Standard range is ten miles (16 km), although field operations in the wilderness, away from cities, mountains and other types of interference have been successful up to 25 miles (40 km) away. Bouncing the digital transmission from relay stations (mobile or stationary) can increase the transmission to hundreds of miles, although typically about 50 miles (80 km) from station to station.

The camera is most commonly used as a means of communications, monitoring and recording troop operations, and intelligence by small units (squads and platoons). This enables officers at a main or mobile base, other teams, and rescue units to remain in unbroken contact with their teammates and constantly monitor the situation.

3. Protective Neck and Shoulder Collar: This raised, padded and armored collar helps to protect the neck and shoulders.

4. Forearm Flashlight (2): Built into the armor above each wrist is a flashlight that can be activated by a tiny wrist button or voice command.

5. Standard issue of weapons to the Infantry is the Q2-20 LLG Laser & Grenade Launcher rifle or Q2-10 laser rifle, two flares, four hand grenades, and a survival knife. Officers get the Q2-20 LLG, a pistol of choice (old CS laser or Quebec styles) and assault rifle. Other weapons are available upon assignment.

Juicer Military Armor

The Juicers of the Quebec Military either wear the standard QEBA-10 body armor (often with graffiti drawn over it), or a suit of armor that is a composite of the traditional Juicer Assassin Armor and the Bushman EBA. Basically the suit has the arms, legs and lower parts of the Bushman armor, with the upper chest and shoulders of the Juicer Assassin armor and the head/helmet of the standard Infantry QEBA. This *is* a medium-light environmental suit (all standard EBA features) with good mobility and reasonable M.D.C. protection. **Note:** When a Juicer is in the field or undercover, any type of body armor may be substituted.

Class: JEBA-13 medium (Juicer) Environmental Battle Armor.

Size: Human equivalent.

Weight: Heavy: 18 pounds (8.1 kg).

Mobility: Very good for Juicers (just good for most normal people; double penalties); -5% to climb, prowl, swim, acrobatics and similar physical skills/performances.

M.D.C. by Location:

Head/Helmet — 50

Arms — 25 each

Legs — 38 each

Main Body — 55 (light for Juicers, medium for normal humans)

Free Quebec Cost: 40,000 credits (50,000 on the Black Market).

Standard environmental body armor properties: All.

Special Features: None.

Standard Issue Weapons for Juicers: One Assault rifle of choice, one heavy or special weapon of choice (Q4-40 Mule, Q4-44 Drummer, etc.), sidearm of choice, two Vibro-Blades of choice (typically one knife, one sword or claws), two flares, two smoke grenades, and two explosive grenades.



TX-J50 Juicer EBA

Another incredibly popular suit of body armor used by Juicers in the Quebec Military and Juicers throughout Canada and the northeastern United States is the TX-J50 Juicer environmental body armor. This is a recent import from Triax of Germany and sold, in limited quantities, by Northern Gun (who is frantically trying to create a slightly less expensive “knock-off”) and the Black Market. After a strong petition by the Coalition

States arguing that these suits only “equipped” CS enemies, Triax has agreed to suspend the import of this armor, but not before having several thousand (perhaps as many as 15,000) brought into the country. In addition, Free Quebec has purchased several thousand, enough to equip one third of its Juicer troops.

The suit is surprisingly flexible while offering maximum armor protection. This is due in part to the advanced technology used to make the M.D.C. alloys and to the simple exoskeleton augmentation incorporated into the armor — effectively enhancing balance, shifting weight and supporting joints for ease of movement. The face plate has simplistic robot and demonic features, giving it a tough and scary appearance appealing to most Juicers. The top of the helmet has a modular clamp connector where a Juicer can crown himself with a ponytail or Mohawk that can be easily personalized and changed to fit the wearer’s mood.

Class: JEBA-TX-J50 heavy (Juicer) Environmental Battle Armor.

Size: Human equivalent.

Weight: Heavy: 20 pounds (9 kg).

Mobility: Very good to excellent for Juicers (just fair for most normal people; triple penalties); -5% to climb, prowl, swim, acrobatics and similar physical skills/performances.

M.D.C. by Location:

Head/Helmet — 70

Arms — 40 each

Legs — 55 each

Main Body — 90 (light for Juicers, heavy for normal humans)

Free Quebec Cost: 50,000 credits (80,000+ on the Black Market).

Standard environmental body armor properties: All.

Special Features: None.

Standard Issue Weapons: As per Military standards and/or assignment.

Other types of Modern Body Armor

Coalition Dead Boy Armor. As noted previously, Free Quebec has at least 9,000 suits of old-style “Dead Boy” armor which it sometimes uses for espionage and infiltration. Otherwise, Dead Boy armor is locked away in storage.

Note: Virtually any type of armor made and sold in North America can be found in and around Free Quebec. However, they are not Military standard issue, and typically their use is restricted for special assignments, Special Operations, and for espionage/disguise.

Military Insignias & Markings on Armor: When using non-Military standard armor, a white fleur-de-lis (the symbol of the Free Nation of Quebec) is typically emblazoned on the left shoulder, the right shoulder and chest, plus other markings or patches denoting rank and unit identification may also be present. Armor can come in any color desired upon special assignment. When not undercover, armor used by le Sûreté du Québec (SQ) is also marked in this fashion, expect with a green fleur-de-lis.

Urban Warrior: See *Rifts® Ultimate Edition*, page 268. Primarily used by Police and visiting dignitaries. May also be used by reconnaissance teams and those on special missions where mobility and stealth is more important than protection.

Plastic Man: See *Rifts® Ultimate Edition*, page 268. Primarily used by Police and non-Military personnel.

Huntsman: See *Rifts® Ultimate Edition*, page 268. Primarily used by Police and visiting dignitaries. May also be used by reconnaissance teams and those on special missions where mobility and stealth is more important than protection.

Bushman: See *Rifts® Ultimate Edition*, page 268. Used primarily by Police Swat Teams and le Sûreté du Québec (SQ) when not undercover.

Combat Vehicles

By Kevin Siembieda & Francois DesRochers

In some cases, like the *Death's Head Transport* and *IAR-2 Abolisher*, the availability of some vehicles, robots and equipment is severely limited, but in other cases they are plentiful. For example, Free Quebec manufactures its own CS-style pistols, rifles, light rail guns, explosives, SAMAS power armor, and Sky Cycles, while other items and vehicles were allocated to them when they were a member of the Coalition States (and which they refused to return), or are purchased from outside resources like Northern Gun. (To preserve what it can of its crumbling relationship with the CS, Triax and the NGR have "declined" selling Free Quebec any type of vehicle.)

Vehicles with wide availability

Note: These items are actually manufactured in Free Quebec. Also see Power Armor.

Hovercycles: Civilian and military types like the ATV Speedster (page 266 of *Rifts® Ultimate Edition*) and the half dozen or so described in *Rifts® Lone Star™*, pages 54-61.

Hover Vehicles: Cars and trucks of a conventional type used for both civilian and military purposes.

Hover Platform: CS-style Command Car: See *Coalition War Campaign™*, page 164.

Mark V APCs: See *Rifts® Ultimate Edition*, page 251. A deadly and capable Armored Personnel Carrier used by both the Quebec Military and CS Army.

Spider Skull Walkers: See *Rifts® Ultimate Ed.*, page 250. The Spider-Skull Walker is a frightening looking all-terrain robot vehicle that walks on six insect-like legs. The horrific thing towers nearly 30 feet high and is remarkably fast. It can easily amble through the debris of the battlefield and is a fair climber if the terrain is not too steep (40 degree incline maximum).

The giant robots are primarily used to patrol Free Quebec's cities, towns, borders, and military bases and base camps, as well as limited infantry support (they are heavily involved in city defense). They are a favorite vehicle for the Recce Battalions, especially when used in conjunction with the Cougar hover jeep. These formations are especially common along the borders of the Labradorian Badlands and the western borders of Free Quebec.

Sky Cycle: *Rifts® Ult. Ed.*, page 253. The old-style Coalition Sky Cycles are used by all branches of the Quebec Military and Police, but are most numerous and well coordinated by the Que-

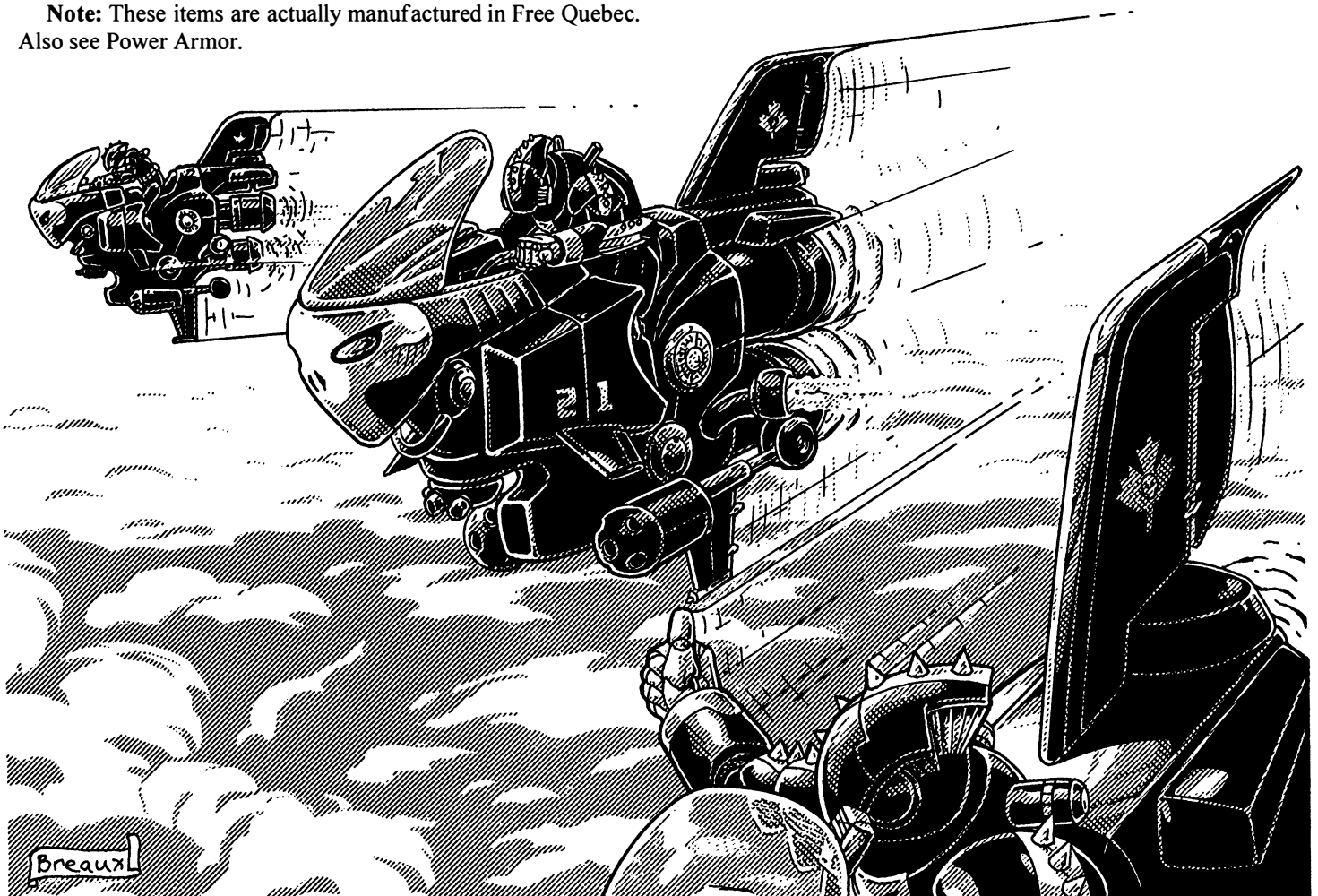

bec Air Force Corps. The Sky Cycle is a vehicle of war often used in conjunction with the Free Quebec giant robots and ground power armor troops. It is a high speed, one man, urban fighter designed to maneuver between buildings and capable of sharp turns and a vast range of speeds. The vehicle is used to patrol the cities and neighboring towns and borders, aerial reconnaissance, and for air strikes, rapid response, rescue, and aerial combat/dog-fights as well as air support for the infantry and some Reconnaissance Battalions.

Free Quebec has employed these units very effectively over the last several decades. They have become a favorite of the police (who use them extensively) and have seen much use by all branches of the Free Quebec military.

UAR-1 Enforcer (giant Robot): See *Rifts® Ultimate Ed.*, page 249. A couple hundred are used by the Police and Civil Defense Agency, and another 800 have been allocated to the Quebec Army. These giant robots are in short supply because they are so expensive and time consuming to make. It is pointless to try to rush out more because they are fairly obsolete compared to the Coalition's new stable of combat robot. Still, the UAR-1 is a reliable machine excellent for base defense and light infantry support. The robot is known as *The Enforcer "Prime."*

Limited Availability:

The following vehicles are not manufactured by Free Quebec. They were part of the CS military resources supplied when Quebec was a member State.

Death's Head Transport: See *Rifts® Ult. Ed.*, page 252.

IAR-2 Abolisher: See *Rifts® Game Master Guide*, page 222, or *Coalition War Campaign™*, page 134. This combat robot is in low supply with only about 120 at Free Quebec's disposal. Referred to Abolisher Prime as they are equally distributed to the military and civil defense.

CS Combat Aircraft: None!

Other Aircraft: Limited imports. Free Quebec has never had much use for fighter jets or even helicopters, and SAMAS, Sky Cycles and light hovercrafts fit their needs much better. Except for those listed and described in this section, Quebec has only a smattering of combat aircraft and even transport and cargo aircraft are minimal — all are purchased and imported from outside sources.

—Unique Vehicles—

Cougar Hover Jeep

The Cougar hover jeep is an extremely versatile, light infantry assault vehicle specifically designed for military operations and combat. It is durable, reliable and quiet, able to hover as close to the ground as two feet (0.6 m) or as high as 800 feet (244 m). The Cougar has a pair of jet thrusters in the rear to give it extra speed, quick maneuvering and jetting out of harm's way. The jeep is widely used by all branches of Free Quebec's military, and has become a crucial component of the Armored Recce Battalions.

All Cougar hover jeeps are open-top vehicles (convertible) that can be covered with a light, semi-transparent "hard top" (20 M.D.C.). Since most combat troops wear body armor and carry

big guns and bulky gear, the cover is rarely used. Special drains efficiently prevent rainwater from collecting and light M.D.C. materials protect the interior from weather damage.

A forward laser turret, secondary fixed lasers and mini-missile launchers (both recessed) are standard to all combat versions. A *Q2-30 Rapid-Fire Heavy Laser*, *Q5-50 Light Rail Gun*, other rail gun or one of the new Glitter Boy energy weapons (nothing that "booms" or has a strong recoil) can be mounted on the top middle bar that runs from the front windshield to the rear (the canopy attaches to this beam also). This weapon is attached to a housing that can rotate 360 degrees, fire in a 45 degree up and down arc and can be manned and fired manually by a back-seat gunner or by the driver or co-pilot in the front seat via a separate set of controls. The various weapons and combat features helps the Cougar to fill a gap between the *Mark V APC* and other combat vehicles. It is specifically designed for a wide range of small squad and personal transportation needs, including reconnaissance and long-range patrols with little or no support. It used by Reconnaissance, Recce, and all sorts of small squad troops.

The Cougar hover jeep is also used by the Police and Civil Defense Agency. As such, there are a few different models in circulation. For example, the Police version does not have mini-missiles and the optional top mounted gun is replaced with police lights, siren and towline (has a variety of grappling hooks and magnetic clamps). Likewise the Quebec Military used a less expensive version called **The Lynx**. This version is stripped of most weapons with only the recessed, fixed forward lasers. Without the top gun, turret and missiles, the Lynx is lighter, more aerodynamic and moves 5% faster and 200 feet/61 m higher. **Note:** The fully loaded combat *Cougar* is described in the pages to follow.

Cougar Hover Jeep

Model Type: QV-119

Class: Military Transport

Crew: Two; 1 pilot, 1 copilot/gunner. Can accommodate two other passengers comfortably, a third or fourth can squeeze in, but makes for cramped, uncomfortable conditions. Two additional personnel can sit on the back section, "hanging" on to the rear gun or its mounting and/or the radio antenna for support. However, such passengers are likely to fall off if sudden turns are made and fall when speed exceeds 50 mph (80 km).

M.D.C. by Location:

* Directional Hover Jets (6) — 30 each

* Rear Jets (2) — 85 each

* Forward Laser Turret — 50

* Forward Fixed Lasers (2, recessed) — 25 each

* Mini-Missile Launchers (2) — 55 each

* Radio & Sensor Package (1, rear left) — 20

* Infrared Searchlights (2, hood) — 8 each

* Headlights (4, small) — 4 each

* Window Light (1) — 4

* Tail Lights (2, rear) — 4 each

Top Mounted Weapon (1, rear) — 75-100 (varies with weapon)

Retractable Canopy — 20

Windshield (1) — 15

** Main Body — 228

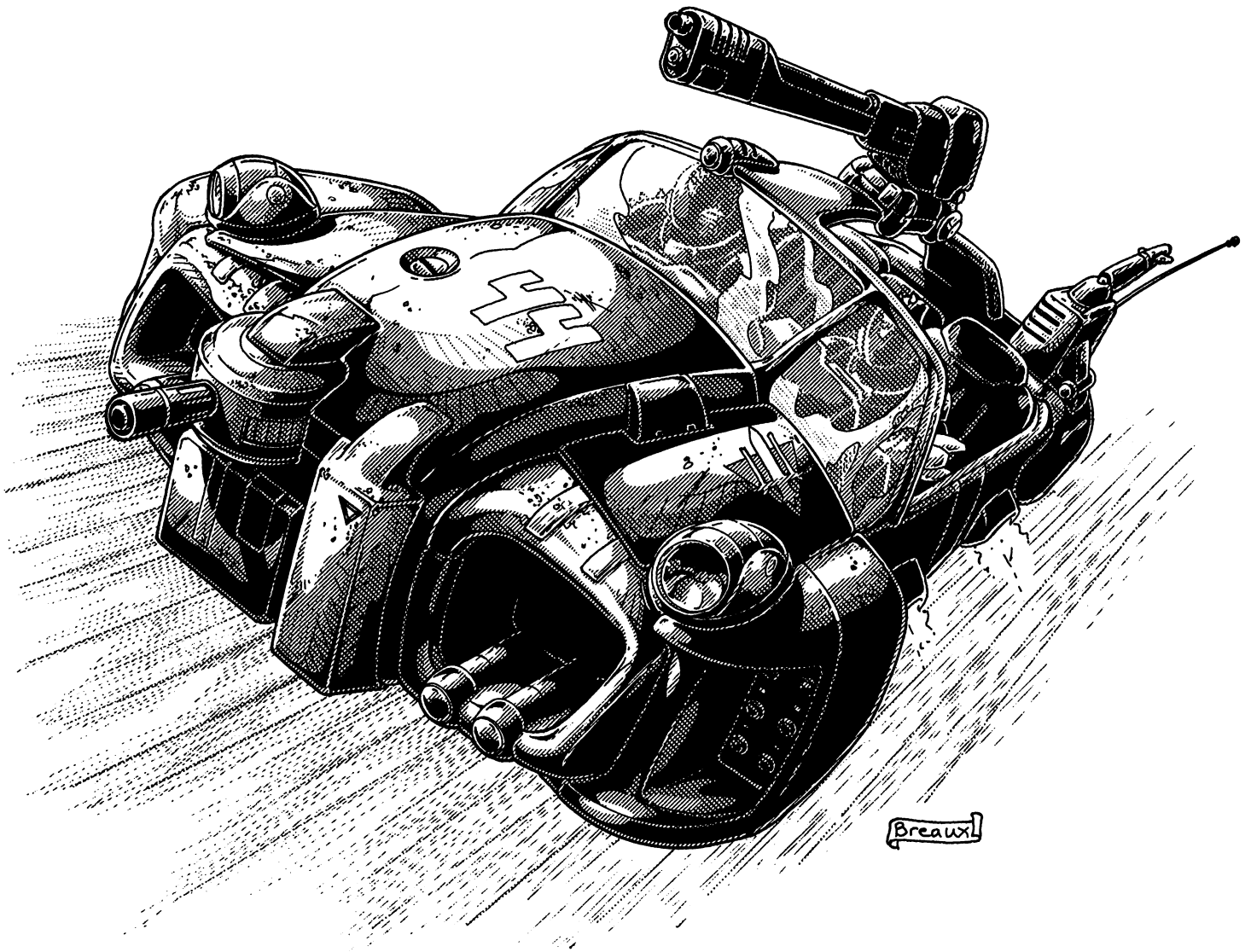

* A single asterisk indicates a small or difficult target to hit. An attacker must make a “called shot” to hit and even then he is -3 to strike.

Destroying one of the directional hover jets (6 total; bottom and sides) reduces speed by 10% with cumulative effect. Destroying one of the rear jets reduces speed by 20%.

** Depleting the M.D.C. of the main body completely destroys the vehicle.

Speed

Flying: 220 mph (352 km), but cruising speed is considered to range between 60 and 80 mph (96-128 km). Maximum altitude is limited to about 800 feet (244m; 1000 ft/305m).

Vertical Take-Off & Landing (VTOL) capable; can hover stationary. Retractable landing gear.

Water: The Cougar hover jeep can skim across the surface of water at a speed of 110 mph (176 km). It is submersible, however occupants must be wearing environmental armor to survive underwater. Underwater speed is about 40 mph (64 km), but a maximum ocean depth of only 200 feet (61 m) is possible.

Maximum Range: The nuclear supply gives the vehicle decades of life. The Cougar is the workhorse of the Quebec Military, particularly the Recce Battalions, and can be used continuously for 96 hours without fear of overheating.

Statistical Data

Height: 6 feet (1.8 m)

Width: 6 feet (1.8 m)

Length: 14 feet (4.3 m)

Weight: 2 tons fully loaded.

Cargo: Moderate storage space, about 3x3x3 three feet (0.9 m) in a trunk-like compartment behind the seats. And a nose compartment about the size of a carry-on suitcase or large backpack.

Power System: Nuclear; average energy life is 20 years.

Free Quebec's Cost: 1.5 million credits fully loaded. The Black Market sells the weapon-light **Lynx** for 1.1 million credits and the **Cougar** “knock-off,” complete with weapon systems, for 1.7 million credits. Good availability.

Weapon Systems

1. Nose Laser Turret (1): A rapid-fire laser turret is mounted in the “nose” of the vehicle. It is capable of 180 degree rotation and 90 degree arc of fire. It can be controlled by the pilot or co-pilot/gunner, typically the latter.

Primary Purpose: Anti-Personnel.

Secondary Purpose: Defense.

Mega-Damage: 2D6 M.D. per single pulse, or a triple pulse doing 6D6 M.D. (counts as two melee attacks due to the drain in energy).

Effective Range: 2000 feet (610 m)

Rate of Fire: Equal to the number of hand to hand attacks per melee round of the pilot or gunner (usually 4 to 6).

Payload: Effectively unlimited; draws its energy from the vehicle's energy supply.

2. Forward Lasers (2): On both sides of the vehicle's nose is a light laser. Each is fixed forward (cannot move) and recessed inside the forward air vents. Note many people mistake the pair of small headlights at the bottom of these vents as the lasers. These guns can be controlled by the pilot or co-pilot/gunner, typically the pilot.

Primary Purpose: Anti-Personnel.

Secondary Purpose: Defense.

Mega-Damage: 2D6 M.D. per single blast, 4D6 M.D. per simultaneous, dual blast (counts as one melee attack).

Effective Range: 2000 feet (610 m)

Rate of Fire: Equal to the number of hand to hand attacks per melee round of the pilot or gunner (usually 4 to 6).

Payload: Effectively unlimited; draws its energy from the vehicle's energy supply.

3. Mini-Missile Launchers (2): A pair of mini-missile launchers are mounted and recessed on the sides of the vehicle. Each contains a total of twelve mini-missiles.

Primary Purpose: Anti-Personnel

Secondary Purpose: Anti-Armor

Missile Type: Any type of mini-missile can be used, but standard issue is fragmentation (anti-personnel; 5D6 M.D.) and plasma (1D6x10 M.D.)

Mega-Damage: Varies with missile type.

Range: About one mile (1.6 km)

Rate of Fire: One at a time or in volleys of two, three, four, or six.

Payload: 24 total; twelve mini-missiles per launcher. An additional 12-24 mini-missiles can be carried in a case kept in the back-seat and/or the small cargo compartment in the nose, left of the laser turret. Takes roughly two minutes (8 melee rounds) to reload each launcher with a full payload of twelve.

4. Modular Weapon Mount (1, top): Located on the beam that runs along the spine of the vehicle where a roof would be, is a position for a weapon system. Depending on the mission, the weapon can be a rail gun, Q2-30 Rapid-Fire Heavy Laser, small (power armor backpack type) mini-missile launcher (typically holds 8-12 missiles), one of the new Glitter Boy energy weapons (nothing that "booms" or has a strong recoil; GB weapons are allowed only for special operations) or S.D.C. machinegun. Regardless of the weapon system, the turret can be operated by someone standing in the back seat (there is a shoulder harness to keep the character from falling out) or by computer control in the hands of the pilot or gunner/co-pilot (typically the latter if unmanned).

Primary Purpose: Anti-Personnel and Anti-Aircraft.

Secondary Purpose: Defense.

Mega-Damage: Varies with weapon type, usually no less than 6D6 M.D. per single blast.

Effective Range: Varies with weapon type, usually 3,000-4000 feet (914-1220 m).

Rate of Fire: Equal to the number of hand to hand attacks per melee round of the gunner/shooter (usually 4 to 6).

Payload: Effectively unlimited.

5. Special Features of Note: The Cougar has a few features that make it unusual as a hover jeep. The list of features almost makes one think this is a power armor of some sort.

Combat Computer: A special computer stores the tactical information on all Coalition and other types of robots, power armor, vehicles and aircraft. Identifies, calculates, stores and transmits data onto the Heads Up Display (H.U.D.) of the pilot's helmet, as well as monitors on the control panel. This information can also be transmitted via a scrambled frequency from the long-range radio. The combat computer is linked to the targeting systems, weapon systems and radar. If needed, any of the crew can punch up the appropriate model and type to quickly scan for weaknesses and armaments, giving the crew information on how to best respond to, counter and evade/outmaneuver the enemy. **Note:** The newer Coalition models are only partially researched and there is incomplete information on some.

Radar: Can identify 72 and track up to 32 targets simultaneously at a range of 30 miles (48 km).

Laser Targeting System: Assists in the selection and focusing of specific targets and adds a bonus of +1 on initiative and +1 to strike when using long-range weapon systems. Does not apply to personal weapons.

Long-Range Radio and other Communication Systems: Long-range, directional communication system with cycling scrambled transmission. Effective range of 500 miles (800 km).

Also has a directional, short-range radio with a ten mile (16 km) range, plus a built-in loudspeaker: 80 decibels.

Electronic Counter-Measure Systems: A system designed specifically for disrupting radio transmissions over a large area, causing general confusion among enemy units and troops. The system also ties into the radar and combat computer to trace an enemy's attempted transmissions over jammed frequencies to trace their general location. The system is powerful enough to disrupt all radio systems within a 100 mile (160 km) radius.

Voice Actuated Locking System: The vehicle's motor is shut down with the flip of a switch and a verbal command confirmed via voice I.D. using a six-digit spoken code programmed to a specific person's voice(s) pattern (six voice memory), as standard operating procedure. The manual override is located under the dashboard and takes about one minute to engage.

Infrared Searchlights: A pair of high-powered, infrared (can only be seen by infrared optics, which each pilot possesses, plus displayed on monitor screen in the visible light spectrum) searchlights is built into the hood of the jeep. Each can rotate 300 degrees and has an up and down arc of 30 degrees. Range: 1000 feet (305 m).

Bobcat Hover Cycle

The Bobcat hover cycle is actually a sleek, rocket cycle designed to work in concert with flying power armor troops, Sky Cycles and the Cougar hover jeep as well as provide close air support to other ground units. It has proven to be very useful for long-range reconnaissance, search and destroy missions, surgical strikes and infiltration behind enemy lines. The vehicle is also a match for most CS Rocket Cycles and has proven to be a favorite among Commandos, Special Forces and RPA "Fly-Boy" Aces.

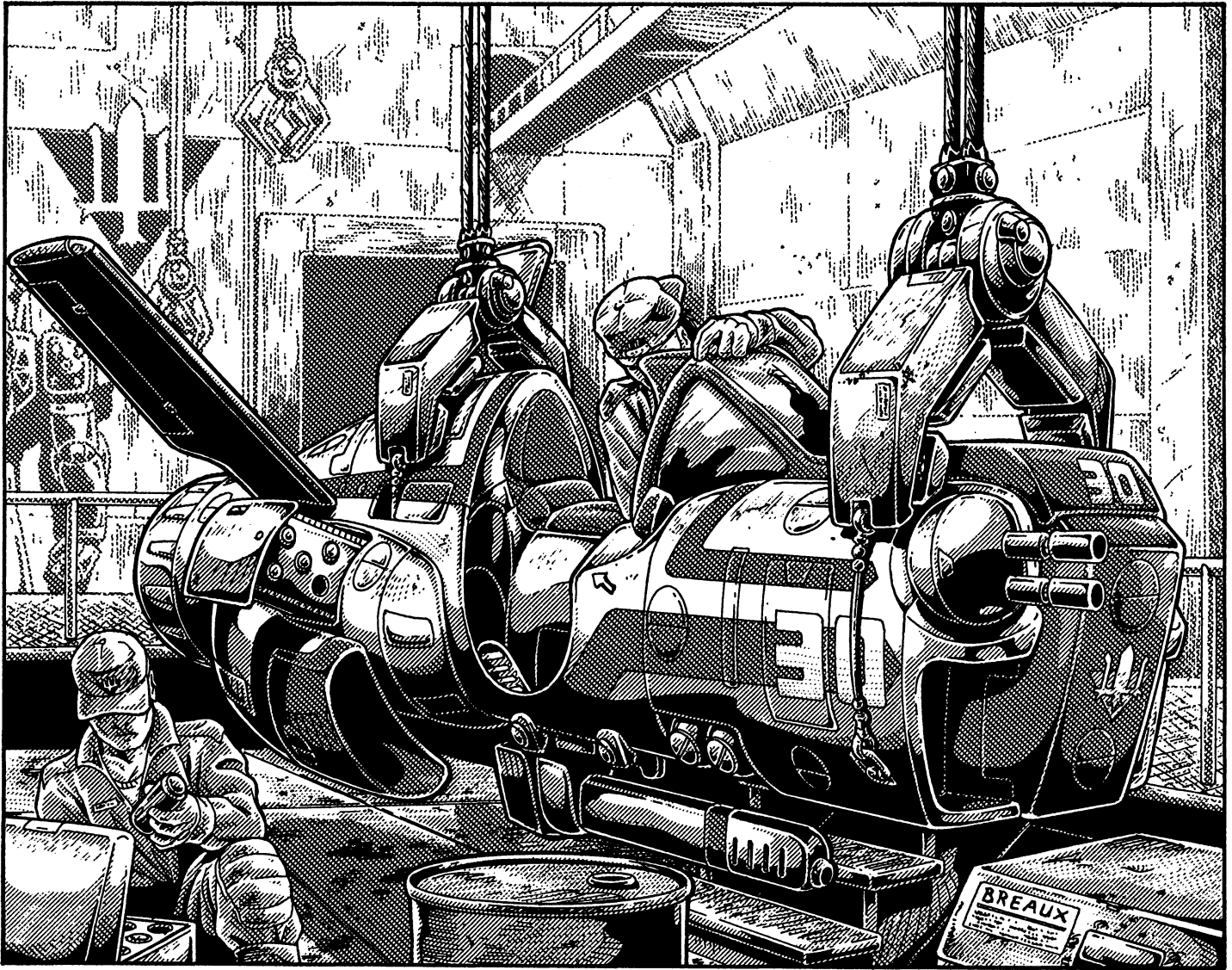

Armed to the teeth, the Bobcat is a small but very resilient vehicle. With its two pulse lasers, bottom mounted rail gun, and mini-missile launchers, the Bobcat handles itself very effectively in combat. Directional thrusters in the front, sides and rear help provide stability and great speeds. It is VTOL capable, has retractable landing gear and the jet engines provide travel at dizzying speeds.

Model Type: QV-229

Class: Aerial Military Combat Vehicle.

Crew: One.

M.D.C. by Location:

- * Forward Laser Turret (1, front) — 35
- Mini-Missile Launchers (2, sides) — 45 each
- * Rail Gun (1; undercarriage) — 50
- * Front Windshield — 30
- * Headlights (2; front) — 8 each
- * Tail Fins (2) — 20 each
- * Directional Jets (10) — 15 each
- Side/Rear/Main Jets (2) — 72 each
- ** Main Body — 180

* Items marked by a single asterisk are small and/or difficult to strike. A character must make a "called shot," but even then the attacker is -4 to strike.

Destroying three or more directional jets inflicts a piloting penalty of -15%. Destroying one of the rear jets reduces speed by 50% and inflicts a piloting penalty of -30%. Destroying both will send the hover cycle crashing to the ground.

** Depleting the M.D.C of the main body completely destroys the vehicle.

Speed

Flying: 440 mph (704 km), but cruising speed is considered to range from 80 to 150 mph (128 to 240 km). VTOL capable, can hover stationary, and has retractable landing gear. Maximum altitude is limited to about 2500 feet (762 m).

Water: The Bobcat hover cycle can also skim across the surface of water at a speed of 210 mph (336 km). It is *not* submersible.

Flying Range: The nuclear power supply provides the vehicle with decades of life. The Bobcat can be flown continuously for twelve hours without fear of overheating.

Statistical Data:

Height: 4 feet (1.2 m)

Width: 4 feet (1.2 m); including wingspan.

Length: 13.3 feet (4 m)

Weight: 1400 pounds (630 kg).

Cargo: Minimal storage space; about 3 feet (0.9 m) for additional clothes, supplies, weapons, or equipment in externally housed storage compartments in the rear.

Power System: Nuclear; average energy life is 20 years.

Free Quebec Cost: One million credits. The Black Market sells cheap “knock-offs” that have half the speed and altitude, but similar weapons and capabilities, for 850,000 credits. A rebuilt “Quebec” vehicle (typically acquired by the Black Market from scavengers, bandits and mercenaries) costs 820,000-985,000 depending on the amount of repairs and the appearance of the vehicle. Fair to poor availability for the slower knock-offs, rare availability for rebuilt models stolen from Free Quebec.

Weapon Systems

1. QL-22 Double-Barreled Laser Turret: Built into the right side of the nose protrudes a medium-power laser turret. The turret can rotate in all directions in a 90 degree angle.

Primary Purpose: Light Assault, Anti-Aircraft, Anti-Missile.

Secondary Purpose: Defense

Mega-Damage: 3D6 M.D. per single blast or 6D6 M.D. per dual blast.

Rate of Fire: Equal to the combined number of hand to hand attacks (usually 4-6).

Effective Range: 2000 feet (610 m)

Payload: Effectively Unlimited.

2. Light Rail Gun (1): Underneath the nose section is a light rail gun of any variety from the Q5-50 to the old CS-style rail gun. It is attached to the undercarriage and fed by an ammo drum also hooked to the undercarriage. The rail gun gives the vehicle some added fire power and much needed long-range capabilities. It can rotate 30 degrees in either direction and in a 30 degree arc of fire up or down. Can not shoot backwards.

Primary Purpose: Anti-Aircraft

Secondary Purpose: Defense

Mega-Damage: Varies with the specific type of rail gun; typically from 4D6 to 1D4x10 M.D. See the Q5-50 for easy to use burst fire damage.

Rate of Fire: Equal to the combined number of hand to hand attacks (usually 4-6).

Effective Range: 4000 feet (1220 m)

Payload: 4,000 round drum; that's 100 to 200 bursts depending on the type of rail gun. Reloading the drum will take about 10 minutes for those not trained, but a mere four minutes by Reload Teams and characters with engineering or field armorer skills.

3. QR-10 Concealed Mini-Missile Launchers (2): Mini-missile launchers are built into the rear sections of the two main jet housings. Each contains a total of ten mini-missiles.

Primary Purpose: Anti-Aircraft and Anti-Armor.

Secondary Purpose: Anti-Personnel.

Missile Type: Any type of mini-missile, but standard issue is fragmentation (anti-personnel; 5D6 M.D.), or plasma (1D6x10).

Mega-Damage: Varies with missile type.

Rate of Fire: One at a time, or in volleys two, three, four, or five.

Effective Range: About one mile (1.6 km)

Payload: 20 total; 10 per each launcher.

4. Sensors Systems of Note: Long- and short-range radio and short-range radar and targeting systems.

5. Combat Bonuses: *Elite RPA SAMAS pilots* and *RPA “Fly Boys”* get a bonus of +2 on initiative and two additional attacks per melee round when piloting one of these vehicles.

GB6-96

Glitter Boy Transport

Also Known as the “Sky Hawk”

A low flying, highly maneuverable VTOL, armored transport used for insertion and extraction of Glitter Boys and other power armor troops. The GB6-96 was specifically designed for Glitter Boy operations and has features to accommodate and utilize them. These heavily armored, and well armed transports are used very much like attack and transport helicopters in pre-Rifts times like the *Vietnam War*. Although they can swoop in low to support ground troops and strafe the enemy, the GB6-96 Sky Hawk is primarily designed to “insert” and “extract” (pick-up and drop off) Glitter Boy squads. The Vertical Take Off and Landing capabilities mean the vehicle can land almost anywhere, including small clearings in woodlands, mountain plateaus, the intersection of a city street, the top of a building and other small areas. The “Six-Ninety-Six” is also involved in search and rescue missions (Glitter Boys and other troops), reconnaissance, border patrols, and supply drops. Its heavy armor enables it to withstand enemy bombardment in combat zones to make its drop or pick-up, and its surprising maneuverability (if not speed) enables it to take evasive maneuvers to avoid serious damage.

The main VTOL hover jets are located in the front and rear of the vehicle where they are shielded from easy attack. A dozen directional thrusters located in the underbelly provide additional support and maneuverability. These jets alone can carry the Six-Ninety-Six at speeds of 172 mph (277 km) and maintain an altitude of 3,000 feet (914 m). However, it has a pair of huge jets in the rear that can send the Sky Hawk rocketing at speeds of 440 mph (704 km).

Model Type: GB6-96

Nicknames: “Six-Nintey-Six” and “Sky Hawk.”

Class: Aerial Military Support and Transport Combat Vehicle.

Standard Crew: Four: Pilot, co-pilot, communications officer, and door gunner (also assists in helping the injured inside). May include 1-5 additional crew men/medics, etc. in the cargo bay as the situation may require. Note that the cockpit actually seats five.

M.D.C. by Location:

* Forward Laser Turret (1, top of cockpit) — 70

* Mini-Missile Launchers (2, top on rear thrusters) — 100 each

* Sensor Array (1, left side near nose) — 120

Sliding Doors (2) — 120 each

* Cockpit Doors (2) — 75 each

Glitter Boy Riding Platforms (2) — 125 each

* Headlights (2; underside of nose) — 8 each

* Wings (2, rear) — 200 each

* Directional Jets (10) — 15 each

* VTOL Circular Jets (2, front and rear) — 200 each

Side/Rear/Main Jets (2) — 290 each

Pilot's Cockpit/Nose area — 220



Inner Reinforced Cockpit Compartment — 100

** Main Body (cargo bay to rear) — 998

* Items marked by a single asterisk are small and/or difficult to strike. A character must make a “called shot,” but even then the attacker is -3 to strike.

Destroying one wing will reduce speed 10% and inflict a -20% penalty to the piloting skill. Destroying both wings reduces speed to 172 mph (277 km) and inflicts a -15% penalty.

Destroying six or more directional jets inflicts a piloting penalty of -5%. Destroying one of the rear jets reduces speed by 25% and inflicts a piloting penalty of -20%. Destroying both main jets will reduce speed to approximately 150 mph (272 km) and add another -20% to the piloting skill due to damage, fire, smoke, and slow handling response, etc. Destroying one of the VTOL circular jets reduces speed by 15% and inflicts a penalty of -10% when trying to do a VTOL. If both are destroyed, speed is -30% and VTOL is impossible.

** Depleting the M.D.C. of the main body completely destroys the vehicle. Destroying the nose section where the pilot sits will send the vehicle crashing to the ground.

Speed

Flying: 440 mph (704 km), but cruising speed is considered to range from 80 to 150 mph (128 to 240 km); scouting speed is 50 mph (80 km) or slower. Can go from zero to 200 in four seconds (equal to one melee action) and from zero to maximum speed in about 7.5 seconds. VTOL capable, can hover stationary, and has retractable landing gear. Maximum altitude is limited to about 6000 feet (1829 m; 3,000 feet/914 m when relying entirely on VTOL circular jets).

Water: No amphibious capabilities.

Flying Range: The nuclear power supply provides the vehicle with decades of life. The Sky Hawk can be flown continuously for 120 hours without concern of overheating in the least.

Statistical Data:

Height: 16 feet (4.9 m) tall.

Width: 39 feet (11.9 m) with wings down, 27 feet (8.2 m) with wings up. Approx. 13 foot (4 m) wide cargo bay, from door to door.

Length: 56 feet (17 m).

Weight: 8073 pounds empty (3632 kg)/approx. four tons.

Cargo Capacity: 88,000 pounds (39,600 kg)/44 tons. This can be carried inside and/or cargo "air lifted" on a separate platform hooked to the underbelly of the Sky Hawk. A winch and several anchors for attaching cabling are located on the underside.

The cargo bay is large enough to comfortably carry 10 Glitter Boys or 12 SAMAS, or 20 human-sized troops, or any combination thereof. 25% additional can be squeezed in, but makes for cramped, uncomfortable conditions.

There is a small storage space for weapons and basic field gear in the pilot's compartment as well as a fifth seat that is usually available for stowing a box or two or 2-4 large duffle bags.

Power System: Nuclear; average energy life is 20 years.

Free Quebec Cost: 2.9 million credits with full armaments. Glitter Boy armor technology is incorporated in strategic areas of the hull, particularly the flooring, but is painted to prevent "glitter." There are no "knock-offs."

Weapon Systems

1. QL-22 Double-Barreled Laser Turret: Built into the right side of the nose protrudes a medium-power laser turret. The turret can rotate in all directions in a 90 degree angle.

Primary Purpose: Light Assault, Anti-Aircraft, Anti-Missile.

Secondary Purpose: Defense

Mega-Damage: 3D6 M.D. per single blast or 6D6 M.D. per dual blast.

Rate of Fire: Equal to the combined number of hand to hand attacks (usually 4-6).

Effective Range: 2000 feet (610 m)

Payload: Effectively unlimited.

2. Concealed Mini-Missile Launchers (2): Mini-missile launchers are built into the rear sections of the two main jet housings. Each contains a total of 24 mini-missiles.

Primary Purpose: Anti-Aircraft and Anti-Armor.

Secondary Purpose: Anti-Personnel.

Missile Type: Any type of mini-missile, but standard issue is fragmentation (anti-personnel; 5D6 M.D.), or plasma (1D6x10).

Mega-Damage: Varies with missile type.

Rate of Fire: One at a time, or in volleys two, three, four, or five.

Effective Range: About one mile (1.6 km)

Payload: 48 total; 24 per each launcher.

3. Optional use of 1-6 Gunners: As many as four Glitter Boys or other armored troops can stand on the GB running boards, plus one or two gunners can stand and fire from both sliding doors, for a possible total of six. That having been said, there is typically one or two door gunners and only one or two GBs on the exterior platforms. In any case, such gunners offer additional fire power. The presence of one or more gunners may be limited by the mission parameters (i.e. zero, one or two) and available manpower. **Note**: Boom Guns will rock the aircraft and add a -10% piloting penalty. Most experienced pilots can compensate for this (basically the equivalent of rough turbulence). The overall design of the Sky Hawk compensates for the use of Boom Guns to begin with.

In the alternative, additional mini-missile launchers (12 missiles each) or rail guns (100 bursts) can be mounted on the Glitter Boy gunner platforms. If necessary, one short- or medium-range missile can be hooked to each platform plus another two on each wing. However, full-sized missiles are seldom deployed this way and rarely mounted on the wings.

4. Optional: Troops: This is a combat transport vehicle that is likely to be carrying troops that can be unleashed once the Sky Hawk lands, or even while in mid-air if flying power armor.

5. Combat Bonuses: *Elite RPA SAMAS pilots* and *RPA "Fly Boys"* get a bonus of +2 on initiative, +1 to strike using built-in weapon systems, and +2 to dodge. Piloting skill penalties for taking evasive action, trick moves and dog-fighting are half, and the pilot gets one additional action/attack per melee round when piloting a Six-Ninety-Six.

6. Features of Note:

Wings fold up as necessary for VTOL purposes.

Sliding side doors on both sides of the cargo bay. Above each door is a heavy-duty harness to accommodate one "door gunner" at each opening; typically a Glitter Boy, but can be a Side Kick or other power armor. The doors may be opened in flight to allow parachute drops or SAMAS to enter or exit.

GB platforms/Running Boards. These front anchored platforms are designed with two purposes in mind. One, to carry four extra GBs anchored to the platform via pylons (there are pylon holes in the floor plus a railing for additional support if necessary) or other power armor troops (supplies may also be tied to the platforms). Two, provide additional firepower from 1-4 Glitter Boys riding on the platform (not recommended at speeds faster than 300 mph/480 km).

Combat Computer: A special computer stores the tactical information on all Coalition and other types of robots, power armor, vehicles and aircraft. Identifies, calculates, stores and transmits data onto the Heads Up Display (H.U.D.) of the pilot's helmet, as well as monitors on the control panel. This information can also be transmitted via a scrambled frequency from the long-range radio. The combat computer is linked to the targeting systems, weapon systems and radar. If needed, any of the crew can punch up the appropriate model and type to quickly scan for weaknesses and armaments, giving the crew information on how to best respond to, counter and evade/outmaneuver the enemy. **Note:** The newer Coalition models are only partially researched and there is incomplete information on some.

Radar: Can identify 72 and track up to 32 targets simultaneously at a range of 30 miles (48 km).

Laser Targeting System: Assists in the selection and focusing of specific targets and adds a bonus of +1 on initiative and +1 to strike when using long-range weapon systems. Does not apply to personal weapons.

Long-Range Radio and other Communication Systems: Long-range, directional communication system with cycling scrambled transmission. Effective range of 500 miles (800 km).

Also has also has a directional, short-range radio with a ten mile (16 km) range, plus a built-in loudspeaker: 80 decibels.

Electronic Counter-Measure Systems: A system designed specifically for disrupting radio transmissions over a large area, causing general confusion among enemy units and troops. The system also ties into the radar and combat computer to trace an enemy's attempted transmissions over jammed frequencies to find their general location (also to trace homing beacons). The system is powerful enough to disrupt all radio systems within a 100 mile (160 km) radius.

Voice Actuated Locking System: The vehicle's motor is shut down with the flip of a switch and a verbal command confirmed via voice I.D., using a six-digit spoken code programmed to a specific person's voice(s) pattern (six voice memory), as standard operating procedure. The manual override is located under the dashboard and takes about one minute to engage.

Searchlight: A high-powered searchlight is built into the underbelly of the nose section. It can rotate 360 degrees and has an up and down arc of 180 degrees. Range: 1000 feet (305 m).

Reloader Hover Vehicle

The number one tool of any Glitter Boy Reload Team is their famous RHV-60 Reloader — a heavy-duty hover vehicle, work station and mobile mechanic's shop all rolled into one. It has something of a "pick-up truck" look and feel, but is far more versatile. The four man team sits in the front of the vehicle, which is open like a hovercycle so they don't have to actually leave their hover platform to do their work; they can lean over, stand up, walk around, etc. There is ample room in the forward section for additional tools, ammunition, spare parts, equipment and/or 1-3 additional personnel (sitting on the floor or standing behind the two rear seats, holding onto the roll bars for support).

All RHVs have a cargo bay area designed to be a mechanic's work station and hover platform complete with a small crane and hydraulics to assist in the loading and reloading of Glitter

Boy ammo-drums and heavy repairs. This back section can be covered with a light M.D.C., pop-off cargo cover, or left as an open bay. It contains built-in tool chests, three diagnostic computers and sensor stations, portable generator/power supply, E-Clip recharger, welding equipment, magnetic clamps, straps, winch, cable and crane. It can carry and/or pull an impressive 32 tons (but reduce speed by one third), and can take a pounding and keep on going. There are a number of hooks and places to attach rope or cabling to haul extra loads of ammunition, supplies, tools, extra GB guns or replacement weapons and other gear. They can also be used to drag away damaged power armor, as well as tow broken down or stuck vehicles. A winch is located in the front (concealed) and back. Running boards along the front doors allow the Loaders to stand just outside the door, to leap on board and hang on without getting inside, or for extra passengers to hold on.

The RHV has no built-in weapons because armaments take up valuable space and draw upon energy reserves necessary for making field repairs and reloading GBs in the middle of a war zone. Techs going into the field of combat typically wear some kind of protective body armor (typically the standard Quebec EBA, but Bushman and other alternative light suits are also allowed) and carry assault rifles and sidearms. Although resourceful and courageous mechanics/Operators specializing as Glitter Boy Reloaders, these men and women are trained in basic combat and are not afraid to fight. However, their first priority is to keep Glitter Boys armed, loaded, patched and running! Everything else, including their own safety, is secondary. This vehicle helps them do their job. In fact, an old joke has it that, "Every Loader, man or woman, feels incomplete without their RHV and loves it more than any flesh and blood spouse."

Reloader Hover Vehicle/Truck

Model Type: RHV-60

Class: Military Mechanic's Platform and Transport.

Crew: Four man Glitter Boy Reload Team: 3-Reloader O.C.C.s plus another Reloader, Operator or Side Kick. Can carry an additional 1-3 crew members or passengers comfortably; six in cramped conditions without using the all important cargo bay-work station. The cargo bay is used to transport personnel only in evacuation and retreating from the field of combat. It can carry two Glitter Boys with half of the power armor hanging over the sides or another 6-12 troops (the more people, the more cramped conditions are).

M.D.C. by Location:

- * Main Hover Jets (6; undercarriage) — 40 each
 - * Small Directional Jets (6; small, underbelly) — 85 each
 - * Winch (2; front and back) — 15 each
 - * Radio Antenna (1, front) — 8
 - * Headlights (4, concealed, retractable) — 4 each
 - * Tail Lights (4, rear) — 4 each
 - * Dashboard (1, inside) — 80
 - Pop-up Mini-Crane (1, left or right side) — 80
 - "Pop-Top" Removable Cargo Bay Cover/Canopy — 25
 - Doors (4) — 65 each
 - Tailgate (1) — 80
 - Windshield (1) — 25
 - ** Main Body — 328
- * A single asterisk indicates a small or difficult target to hit. An attacker must make a "called shot" to hit and even then he is -3 to strike.

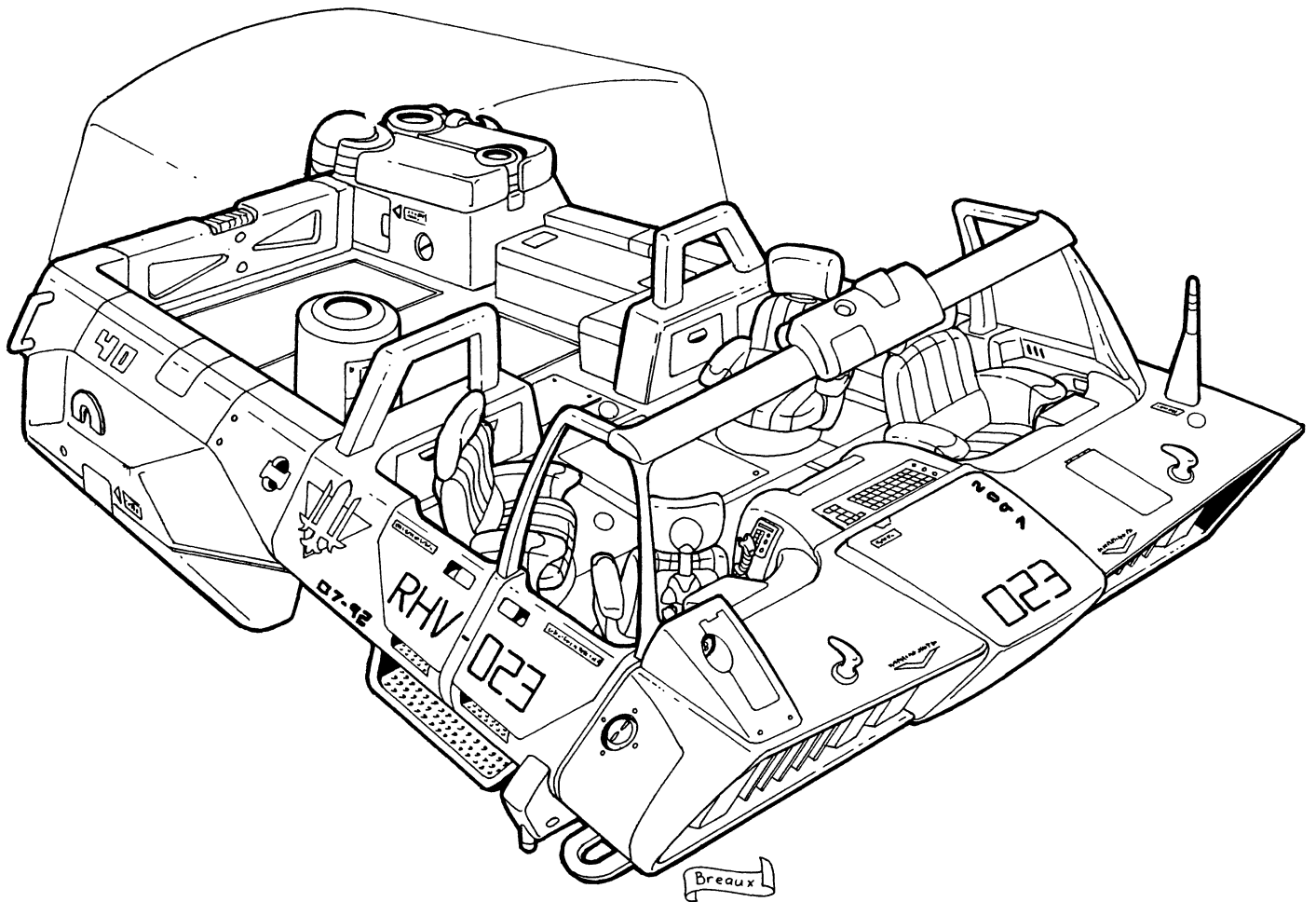

Destroying more than two of the directional hover jets (6 total; underbelly) reduces speed by 5% with cumulative effect. Destroying one of the main hover jets (underbelly) reduces speed by 10% and inflicts a -5% piloting penalty with cumulative effect.

** Depleting the M.D.C. of the main body completely destroys the vehicle.

Speed

Flying: 180 mph (288 km), but cruising speed is considered to range between 40 and 60 mph (64-96 km). Maximum altitude is limited to about 600 feet (183 m), but designed to ride low to the ground to service ground troops.

Vertical Take-Off & Landing (VTOL) capable; can hover stationary. Retractable landing gear.

Water: The RHV-60 can skim across the surface of water at a speed of 80-100 mph (128-160 km), but is NOT submersible and will sink like a rock unless hovering.

Maximum Range: The nuclear power supply gives the vehicle decades of life. The RHV is another workhorse vehicle in the Quebec Military, particularly among the Glitter Boy Legions and Ground Infantry. It can be used continuously, for hours on end, without fear of overheating.

Statistical Data

Height: 7 feet (2.1 m)

Width: 12 feet (3.6 m)

Length: 22 feet (6.7 m)

Weight: Four tons fully loaded.

Cargo: Cargo bay and front area as noted in the description. Can carry or pull 32 tons.

Power System: Nuclear; average energy life is 20 years.

Weapon Systems: None. Remember, Reload Teams typically service and maintain Glitter Boys, so they are partners with these walking tanks.

Free Quebec's Cost: 2.5 million credits fully loaded. Not available on the Black Market (but when they are, these knock-offs are likely to have 30% less M.D.C. and sell for 2.6 to 2.8 million credits).

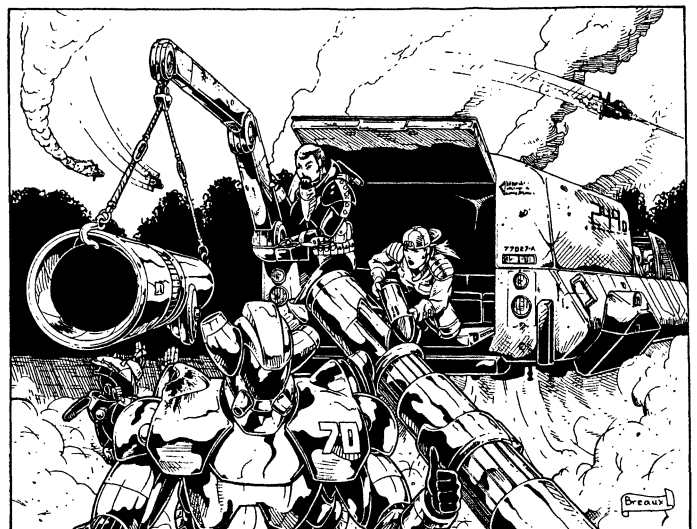

Robot Vehicles

All robot vehicles have the following common features:

- 1. Nuclear Powered:** Which means they have an effectively unlimited fuel capacity and power source. Average energy life is 15 to 20 years.
- 2. Radar:** Can identify 72 and track up to 32 targets simultaneously at a range of 30 miles (48 km).
- 3. Combat Computer:** Calculates, stores and transmits data onto the Heads Up Display (H.U.D.) of the pilot's helmet, as well as monitors on the control panel. It is linked to the targeting computer, weapon systems and radar.
- 4. Targeting Computer:** Assists in the tracking and identification of enemy targets. 30 mile range (48 km).
- 5. Laser Targeting System:** Assists in the selection and focusing of specific targets and adds a bonus of +1 on initiative and +1 to strike when using long-range weapons. Does not apply to hand to hand combat.
- 6. Radio Communications:** Long-range, directional communication system with an effective range of 500 miles (800 km). The typical giant robot also has a directional, short-range radio with a five mile (8 km) range, plus a built-in loudspeaker; 80 decibels.
- 7. External Audio Pick-up:** A sound amplification listening system that can pick up a whisper 300 feet (91.5 m) away.
- 8. Spotlights:** Most will have at least one or two spotlights. Typical range is 600 feet (182 m).
- 9. Ejector Seats:** In case of an emergency, the pilot and crew can be instantly ejected (about 1000 feet/305 m) and parachute to safety.
- 10. Self-Destruct:** A last resort measure to prevent one's robot from being captured by the enemy. The explosive damage is fairly self-contained, destroying most of the internal systems with 3D6x10 M.D. Those within a ten foot (3 m) radius of the bot will suffer 6D6 M.D. from concussion and/or flying debris. It is very likely, 01-89% chance, that the nuclear power system will rupture and spew forth deadly levels of radiation!
- 11. Voice Actuated Locking System:** The robot's access hatch is sealed by an automatic locking system. A six-digit spoken code programmed to a specific person's voice(s) pattern (six voice memory) is standard operating procedure. A manual key-pad is provided in case of system failure/override.
- 12. Complete reinforced, environmental pilot and crew compartment:** The compartment can usually seat 2-6 people and is reinforced to protect the occupants from Mega-Damage. It is airtight, pressurized and suitable for use in all hostile environments, including underwater (typically one-half to one mile/0.8 to 1.6 km depth) as well as outer space. The following features are included:
 - Computer controlled life support system.
 - Internal cooling and temperature control.
 - Air purification and circulation systems, gas filtration, and humidifier/dehumidifier automatically engages when needed. Can recirculate breathable air for up to four weeks before getting too stale to breathe.

- Computer-controlled, independent oxygen supply and purge system automatically engages in low oxygen or contaminated air environments. Twelve hour oxygen supply.
- Insulated, high temperature resistant shielding for up to 450 degrees centigrade. Normal fires do no damage. Nuclear, plasma, and magical fires do full damage.
- Radiation shielding.
- Polarized and light sensitive/adjusting tinted windshields when applicable.

Combat Robots Reminder

As noted earlier, Free Quebec has the following giant robots, mostly old Coalition designs. No other CS robots are available and only a handful of robots (maybe a few dozen) from other manufacturers such as Northern Gun are in the possession of Free Quebec. Since **Northern Gun** and the **Manistique Imperium's alliance** with the CS, they no longer sell or trade with Free Quebec on any level (never did much in the way of robots or power armor to begin with). Likewise, **Triax** and the NGR are keeping their distance in order to placate the Coalition and establish stronger political relations with the CS. Fortunately (at least for the moment), *Triax appears* to be honoring its prior contracts and trade agreement with Free Quebec in supplying it with the Glitter Boys and other supplies that nation ordered. The NGR will also continue to supply basic, non-combat trade goods indefinitely, despite CS protests to the contrary.

At least during the early years of war, Free Quebec will refuse to support the criminal network that is the **Black Market** in any way. Nor is it likely to make other purchases from or alliances with other outside groups like **Wilk's**. Free Quebec has always been independent and since crumbling relations with the Coalition States has led to war, they are more leery (dare we say "gun-shy") of outsiders than ever before.

Combat Robots of Note

New Coalition Robots: Quebec has Zero. These monstrous machines of war were unveiled *after* Free Quebec seceded from the States. Consequently, the only time they have ever seen any is when they are being deployed against them!

Skelebots: None. The leaders of Free Quebec never trusted them and refused to deploy them. They have nothing comparable.

Spider Skull Walkers: See **Rifts® Ultimate Edition**, page 250. Free Quebec has several hundred and the capability to manufacture more, but these bots are big, expensive and time consuming to build. Production and those in stock are limited.

UAR-1 Enforcer (giant Robot): **Rifts® Ultimate Ed.**, page 249, and in this section. Several hundred are currently deployed by Free Quebec and others are under construction. However, production is limited (see stats and description that follows).

IAR-2 Abolisher: *Rifts® Game Master Guide*, page 222 or *Coalition War Campaign™*, page 134. Free Quebec has a limited supply of about 120. Although they can repair what they have, they can not make new ones.

QR-3 Guardian is a limited production robot of Free Quebec's own design. A complete description and stats are presented in this section.

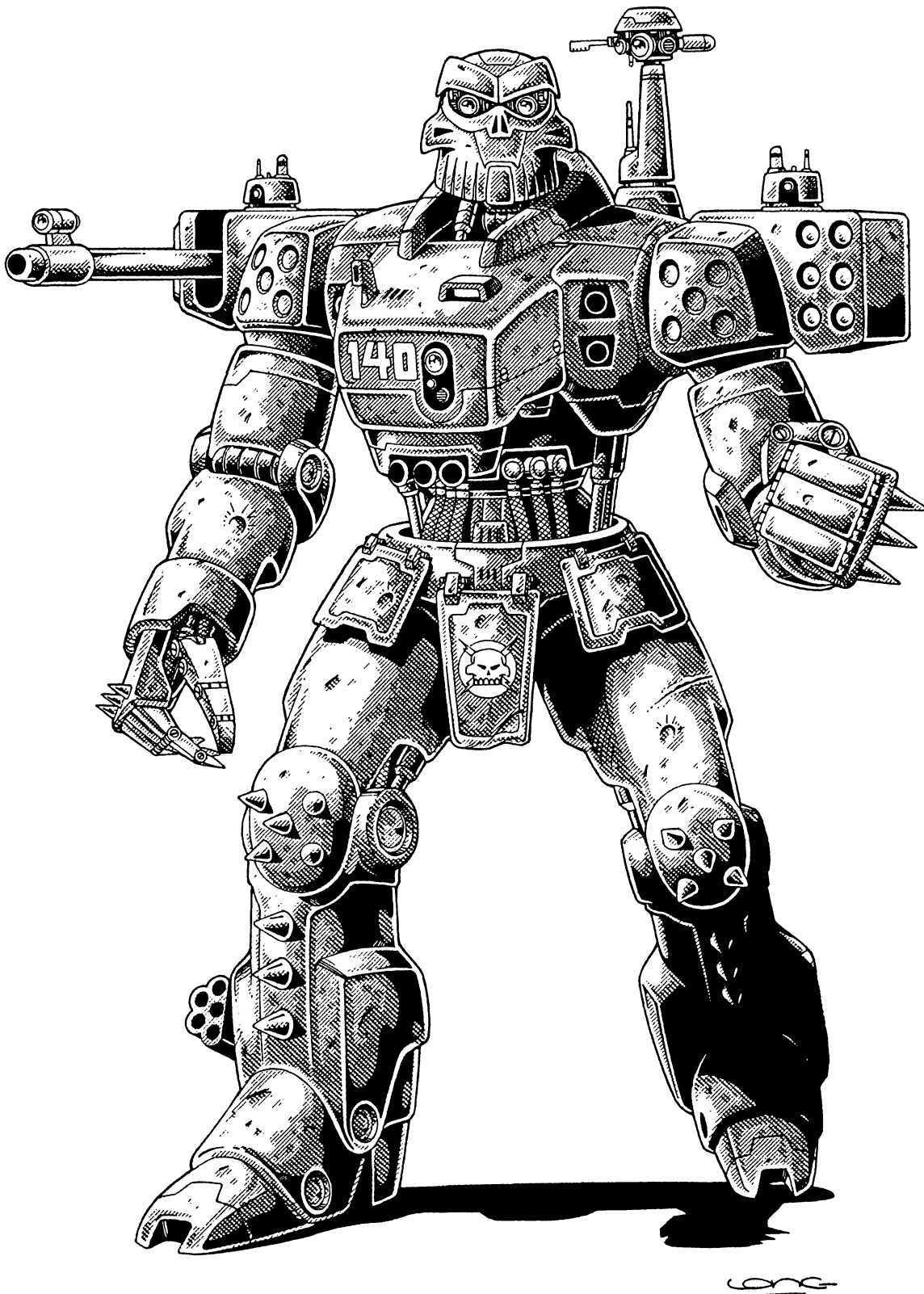

QR-1 Enforcer Prime

The Enforcer UAR-1 has been one of the most stable work-horse giant robots the Coalition Military has ever developed. Ever since their first model saw action in the ruins of Chicago against the forces of the Federation of Magic, it has become the mainstay of city defense forces. When Free Quebec joined the Coalition years ago, they fully embraced the Enforcer and became one of its manufacturing centers.

Both Chi-Town and Free Quebec designers were slow to upgrade designs, while other nations like the New German Republic and Northern Gun were creating cheaper, more powerful robots. Not wanting to have to look to an outside source for their robot forces, Chi-Town launched an aggressive robot design operation (the results of which are presented in **Coalition War Campaign™**), but truth be told, Free Quebec did not have

much use for giant robots. Their Glitter Boy Legion (much larger than anyone imagined), use of the SAMAS and Sky Cycles, among other vehicles and power armor, served them well. Still, over the last few years the Quebec Military has realized that the Enforcer was showing its age compared to the newer robot IAR-2 Abolisher, Triax creations and even some of the new Northern Gun robots, making the current Enforcer model obsolete. They decided to begin some strategic robot designing when the CS unveiled its “New” Army and launched its Campaign of Unity.

With war on Quebec’s doorsteps, there is no time and too little precious resources to spare on experimental robots. This means the Canadians will rely on their Glitter Boys, other power armor troops, ‘Borgs, Juicers, Sky Cycles and other aircraft to defend themselves as they always have. This sits well with the leaders of Free Quebec, because they have always opted for a small, quick army able to adapt and respond to most any situation. Obsolete or not, the nation has stepped up its production of UAR-1’s which they have renamed **Enforcer Prime**. The robot is used primarily for the civil defense of the cities, military bases, entrenched strategic positions and infantry support. There are at least 400 in active service with 30 new ones to be cranked out every month for the next year. A few minor improvements and up-grades have been made, but nothing significant.

The complete stats are reprinted here, from the pages of the **Rifts® Ultimate Edition**, for the gamer’s convenience. For additional details see page 249 of that book.

QR-1 Enforcer Prime

Model Type: QR-1 (CS UAR-1)

Class: Urban Assault Robot

Crew: One or two

M.D.C. by Location:

Right Shoulder Rail Gun — 100 (shielded)
Left Shoulder Medium Range Missile Launcher — 150
Shoulder Mounted Laser Turrets (2) — 50 each
Shoulder Missile Launchers (2) — 60 each
Waist Mini-Missile Turret — 25 each
Right Leg Smoke/Gas Dispenser — 25
Chest Spotlight and Video Camera — 10
*Sensor Turret (left shoulder) — 50
Head — 100
Arms (2) — 150 each
Hands (2) — 75 each
Legs (2) — 200 each
Reinforced Pilot’s Compartment — 100
**Main Body — 390 (improved from 350)

* Destroying the sensor turret on the left shoulder of the Enforcer will destroy the radar and targeting system. The pilot must then rely on his own human vision and other optical enhancements of the robot. **Note:** The turret is a small and difficult target to hit. Thus, it can only be hit when a character makes a *called shot* and even then the attacker is -2 to strike.

** Depleting the M.D.C. of the main body will shut the robot down completely, rendering it useless. **Note:** The chest spotlight and video camera are destroyed when the main body has endured 200 or more points of damage.

Speed

Running: 60 mph (96 km) maximum.

Leaping: The powerful robot legs can leap up to 15 feet (4.6 m) high or across. Add 10 feet (3 m) with a running start. It can also perform running jump kicks inflicting serious amounts of damage — Running Leap Kick: 1D4x10 M.D. This attack must be used at the beginning of a melee round and uses up all but one melee attack! In addition, there is a 01-45% chance of knocking giant-sized opponents to the ground. The victim loses two melee actions and initiative as well as suffers damage. Unfortunately, the E-Prime also loses initiative for the next melee (it is the last to attack in the next combat round).

Underwater Capabilities: The Enforcer Prime is not particularly well suited for underwater operations. The best it can do is walk along the bottom of the sea at about 25% its normal running speed.

Maximum Ocean Depth: 2000 feet (610 m).

Statistical Data

Height: 19 feet, 7 inches (6 m)

Width: 12 feet (3.6 m)

Length: 7 feet, 6 inches (2.3 m)

Weight: 18 tons fully loaded.

Physical Strength: Equal to a robot P.S. 40.

Cargo: Minimal storage space, about three feet (0.9 m) behind seats for extra clothing, weapons, and personal items.

Power System: Nuclear, with an average energy life of 20 years.

Black Market Cost: 28 million credits and up for a new, undamaged, full powered Enforcer complete with rail gun and missiles. Eight to 10 million for a rebuilt unit or one without missiles and rail gun. Rarely available.

Weapon Systems

1. C-50R Enforcer Rail Gun (1): This is a standard weapon system for the UAR-1 and is more powerful than that of the SAMAS. The gun draws its power from the main, nuclear power supply. The rail gun is in a fixed forward position, but can move up and down in a 30 degree arc. To shoot at a target to the left, the pilot must turn the robot’s entire body.

Primary Purpose: Assault

Secondary Purpose: Defense

Weight: Rail Gun: 700 lbs (315 kg).

Mega-Damage: A burst is 80 rounds and inflicts 1D6x10 M.D., one round does 1D6 M.D.

Rate of Fire: Equal to number of combined hand to hand attacks (usually 6-8).

Maximum Effective Range: 4000 feet (1200 m)

Payload: 20,000 round drum, that’s 250 bursts. Reloading an Enforcer’s rail gun requires special equipment or another giant-sized robot. It will take about 15 minutes for those not trained, but a mere five minutes by somebody trained in robot mechanics (or an Operator).

2. CR-6 Medium-Range Rocket Launcher: This is the more powerful missile launcher over the left shoulder.

Primary Purpose: Anti-Aircraft

Secondary Purpose: Anti-Armor (tanks, robots, dragons).

Missile Type: Any medium-range missile can be used, but standard issue is high explosive (heavy 2D6x10 M.D.), plasma (2D6x10), or multi-warhead smart bomb (2D4x10 and +5 to strike).

Mega-Damage: Varies with missile type.

Range: About 40 to 80 miles (64-128 km).

Rate of Fire: One at a time or in volleys of two, three, or four.

Payload: Six

3. CR-10 Short-Range Rocket Launchers (2): Each of the shoulders has a short-range missile launcher.

Primary Purpose: Anti-Aircraft.

Secondary Purpose: Anti-Armor (tanks, robots, dragons).

Missile Type: Any short-range missile can be used, but standard issue is armor piercing, high explosive, and/or plasma (all 1D6x10 M.D.).

Mega-Damage: Varies with missile type.

Range: About two miles (3.2 km).

Rate of Fire: One at a time or in volleys of two, three, or four.

Payload: Ten, five in each shoulder.

4. CR-20 Mini-Missile Turret: A turret mounted in the mid-section of the robot can rapidly fire mini-missiles.

Primary Purpose: Anti-Personnel.

Secondary Purpose: Defense.

Missile Type: Any type of mini-missile can be used, but standard issue is fragmentation (anti-personnel, 5D6 M.D.) and plasma (1D6x10 M.D.).

Mega-Damage: Varies with missile type.

Range: About one mile (1.6 km).

Rate of Fire: One at a time or in volleys of two, three, or four.

Payload: Twenty.

5. CR-2T Laser Turrets (2): A pair of laser turrets, one on each shoulder, is mounted on the top of the rail gun and the medium missile launcher. Both are capable of 360 degree rotation and a 90 degree angle of fire (up and down).

Primary Purpose: Anti-Personnel

Secondary Purpose: Defense

Mega-Damage: 2D6 M.D. per single blast, or 4D6 per simultaneous blast, e.g. both lasers fire at the same target simultaneously.

Range: 4000 feet (1200 m)

Rate of Fire: Equal to the total number of hand to hand attacks per melee (usually 6 to 8).

Payload: Effectively unlimited.

6. Smoke Dispenser: A smoke dispensing unit is attached to the right leg. The unit can release a dense cloud of smoke that will cover an 80 foot (24 m) area in front of it. It can also release tear gas.

Payload: Five total. The usual mix is three smoke and two tear gas.

7. Hand to Hand Combat: Rather than use a weapon, the pilot can engage in Mega-Damage hand to hand combat. See Robot Combat Training in the Robot Combat section of the *Rifts® RPG*.

8. Sensors & Features of Note: Free Quebec's Enforcer Prime has all standard features plus a few special ones.

1. Thermo-Imager: A special optical heat sensor that allows the infrared radiation of warm objects to be converted into a visible image. Enables the pilot to see in the dark, in shadows, and through smoke. Range: 2000 feet (610 m).

2. Infrared and Ultraviolet Optics: This optical system projects a beam of infrared light that is invisible to the normal eye. The system enables the pilot to see in the dark and to see other infrared beams. The ultraviolet system enables the pilot to see into the ultraviolet spectrum of light and is mostly used to detect the light beams of ultraviolet detection systems. **Note:** The infrared light beam can be seen by anybody who also has infrared

optics, and the beam can be traced back to its source. Smoke impairs the infrared beam making it impossible to see.

3. Infrared Searchlights: Built into the head of the Enforcer are a pair of red eyes. These are actually a pair of infrared searchlights. The lights can be used to scan an area at night using the invisible light to avoid detection. Only somebody who can also see infrared light will see the beams. Range: 500 feet (152 m).

4. Nightvision and Video Camera System: The sensor array has a standard multi-optic system with passive nightvision, telescopic sight and video camera (images transmitted to video screens inside the pilot's compartment).

5. Sensor Bonuses: Applicable to long range weapon combat only, not hand to hand. +1 to strike. See Robot Combat Training in the Robot Combat section of *Rifts® Ultimate Edition*, page 352, for other bonuses.

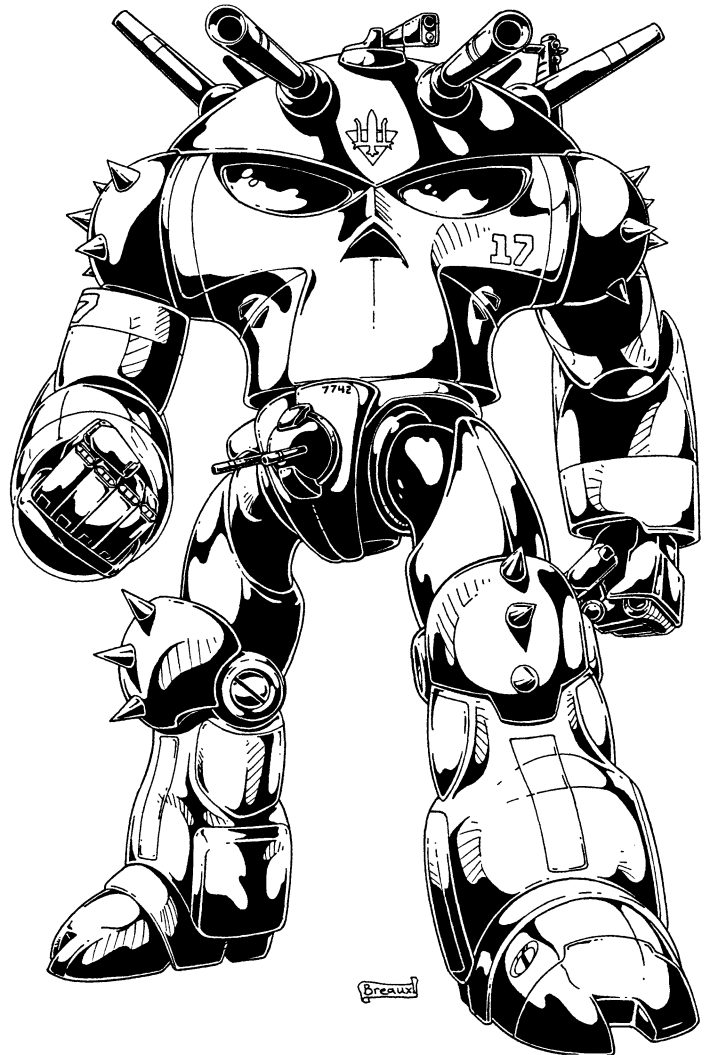

QR-2 Abolisher Prime

Free Quebec has renamed the old Coalition IAR-2 Abolisher robot vehicle, the **Abolisher Prime**. They have roughly 120 of these from when they were a member of the Coalition States, but have no means of manufacturing new ones. Unlike the *Enforcer Prime*, which is designed primarily for riot control and combating ground troops in an urban/city environment, the Abolisher Prime is a front-line infantry unit with long-range ca-

pabilities and heavy firepower. It is used to obliterate enemy troops, bots, and armored vehicles with a focus on anti-robot and anti-tank missions, hence the six heavy cannons bristling around what appears to be the head. The rim of cannons has given the thirty foot (9 m) robot the nickname “Thorn Head.”

Note: For complete stats and additional information, see **Rifts® World Book 11: Coalition War Campaign™**, pages 134-137.

QR-3 Guardian Robot

By Francois DesRochers

Free Quebec has not been completely asleep at the wheel when it comes to giant combat robots. Several years ago, the Free Quebec Military hired a disenchanting team of Northern Gun robot designers to work with them to create a new robot for their Army (ironically this came with Chi-Town’s blessings as they were themselves experimenting with new robot designs).

With the knowledge of the Northern Gun design team to assist them, and inspired by the Triax X-2500 Black Knight, they developed the **QR-3 Guardian Robot**. The Guardian remains an experimental model, which has seen fairly limited field use. The majority of the models have been tested along the wilderness borders where they have performed extremely well even against mobile targets.

The left arm of the robot is a unique design, containing a heavy particle beam cannon while keeping use of the limb’s hand. Although slightly more clumsy than the right arm, it allows for the robot to pick up and carry items, and perform articulated work. The right arm is armed with a special weapon pod, containing a large vibro-sword and a laser turret. The right arm’s weapons in no way interfere with normal functions. The last system incorporated into the Guardian is a comprehensive mini-missile launcher system for excellent anti-aircraft/flyer capabilities. More than most any other robot of its size, this hidden threat is one of the Guardian’s best advantages over other comparable models. **Note:** Only 48 are in the field with another 24 under construction.

QR-3 Guardian Assault Robot

Model Type: QR-3

Class: Infantry Assault Robot

Crew: Two; one pilot and one gunner. The gunner/co-pilot typically operates the mini-missiles and monitors the targeting computers, radar and sensors to coordinate combat actions and form strategies. As necessary, he may be allowed to take command of one or two of the arms and their respective weapons. The pilot usually operates the vehicle itself, engages in hand to hand combat and uses the “arm” weapon systems. A communications engineer and one passenger can fit comfortably in the pilot’s/crew compartment.

M.D.C. by Location:

* Head/Sensor Cluster — 120

Hands (2) — 80 each

Left Arm (Particle Beam Cannon) — 185

Right Arm (Vibro-Blade/Laser) — 160

Upper Arms (2) — 150 each

Shoulders/Missile Pods (2) — 180 each

Folding Missile Launchers (2, back) — 110 each.

Legs (2) — 220 each

Leg Missile Pods (2) — 40 each

Reinforced Pilot’s Compartment — 100

** Main Body — 560

* Destroying the head of the robot will eliminate all forms of optical enhancement and sensory systems. The pilot must rely on his own human vision and senses. Any robot combat bonuses are lost!

The head is a small and difficult target to hit, between the two heavily armored shoulder launchers. Thus, it can only be hit when an enemy makes a “called shot,” and even then the attacker is -3 to strike.

** Depleting the M.D.C. of the main body will shut the robot down completely, rendering it useless.

Speed

Running: 100 mph (160 km) maximum; it can go from zero to 60 mph (96.5 km) in 10 seconds. Note that the act of running does not tire its operator and maximum speed can be maintained indefinitely.

Leaping: The Guardian can leap 20 feet (6 m) high or lengthwise with a short running start. It can also perform running leaps or jump kicks inflicting serious amounts of damage and has a 01-55% chance of knocking giant-sized opponents to the ground (victim loses two melee actions and initiative as well as suffers damage).

Underwater Capabilities: The Guardian is not particularly well suited for underwater operations. The best it can do is walk along the bottom of the sea at about 25% its normal running speed.

Maximum Ocean Depth: 4000 feet (1219 km).

Statistical Data

Height: 24 feet (7.3 m)

Width: 16 feet (4.9 m)

Length: 11 feet (3.4 m)

Weight: 14 tons fully loaded.

Physical Strength: Equal to a robot P.S. of 50.

Cargo: None to speak of; enough to carry basic gear.

Power System: Nuclear; average energy life is 15 years.

Free Quebec Cost: 31 million credits for a new, fully loaded QR-3; exclusive to the Quebec Military. These bots are not available on the Black Market or to the CS.

Weapon Systems

1. GP-03 Particle Beam Cannon (1; left arm): Free Quebec is one of the few nations/weapon designers that continues to try to harness and master particle beam weaponry. Range, overheating and high energy requirements are all obstacles for this type of weapon, but the level of destructive power in one tight beam is capable of punching through Mega-Damage structures, enemy robots or tanks like butter. Attached to the left arm, it allows for greater mobility and still allows for a left “hand” to remain free for grappling or holding. This weapon is larger but only slightly more powerful than the Glitter Girl’s QST-180.

Primary Purpose: Anti-Tank/Anti-Armor.

Secondary Purpose: Assault.

Mega-Damage: 1D6x10+10 M.D. per blast

Rate of Fire: Equal to the number of hand to hand attacks per melee round of the pilot or gunner (typically 6-8). Each shot counts as one melee attack/action.



Effective Range: 2000 feet (610 m); this is excellent range for a P-Beam weapon.

Payload: 60 shots. The weapon slowly recharges at a rate of one shot every 3 minutes (20 per hour).

2. Forearm Laser Turret (1; right arm): Part of the right arm's weapon pod is a laser turret. The laser gives the Guardian another high-powered, long-range weapon for use against enemy troops and power armor. The weapon is mounted to allow for 30 degree movement in all directions from where the arm is actually pointed.

Primary Purpose: Assault.

Secondary Purpose: Defense.

Mega-Damage: 4D6 M.D. per single blast.

Rate of Fire: Equal to the hand to hand attacks per melee round of its gunner (typically 6-8).

Effective Range: 2000 feet (610 m).

Payload: Effectively unlimited.

3. Vibro-Blade (1; right arm): The second part of the weapon pod is a long Vibro-Sword. The blade is used to cut open enemy robots or even to sever cords and hoses, or to cut a swath through enemy troops. Hidden in an internal housing when not in use, it can be extended and retracted at will.

Primary Purpose: Defense

Mega-Damage: 4D6 M.D. per strike.

Attacks per Melee Round: Equal to the number of attacks per melee round of the gunner (typically 6-8).

Effective Range: Arm's reach is roughly 14 feet (4.2 m).

4. Folding Missile Launchers (2, back): Mounted behind the bulky shoulder sections on the back of the Guardian are a pair of rectangular missile pods. When not in use, they fold down close to the middle of the back. When needed to launch, the launchers fold up and out like tiny wings.

There are two types of launchers, those that each fire four *medium-range missiles* (8 total) or those that each fire two dozen *mini-missiles* (48 total). The medium-range missiles offer the advantage of much greater range (40-80 miles/64-128 km) and more destructive power in a single missile, while the mini-missiles offer tremendous close-range (one mile/1.6 km) firepower. The larger, heavier medium-range missiles are best against heavy armor, fortifications and targets many miles away. Mini-missiles are ideal for close combat against infantry troops, light armor and aerial adversaries. Only one type or the other can be used at a time. Roughly 60% of the time, particularly for wilderness and Recce missions, the medium-range missiles are selected because the Guardian has other mini-missiles and weapons for close combat.

Primary Purpose: Anti-Aircraft and Anti-Armor.

Secondary Purpose: Anti-Personnel and Defense.

Missile Type: Any medium-range missile can be used, but standard issue is high explosive (heavy 3D6x10 M.D.), plasma (4D6x10 M.D.), or multi-warhead smart bomb (5D6x10 M.D. and +5 to strike).

Mini-Missiles used for this launcher are typically Armor Piercing (1D4x10 M.D.) or Plasma (1D6x10 M.D.), with 4-6 being smoke.

Mega-Damage: Varies with missile type.

Range: Medium-Range: 40 to 80 miles (64 to 128 km).

Mini-Missiles: One mile (1.6 km).

Rate of Fire: One at a time, or in volleys of two, three, or four.

Payload: Medium-Range Missiles: Eight total; four per each launcher — or — Mini-Missiles: 48 total; 24 per launcher (only 12 show at a time).

5. Mini-Missile Shoulder Launchers: Each shoulder plate has four barely noticeable circular marks that indicate sliding panels that open to fire mini-missiles. Each shoulder holds eight mini-missiles.

Primary Purpose: Anti-Personnel and Assault.

Secondary Purpose: Anti-Aircraft/Anti-Missile.

Missile Type: Any type of mini-missile can be used, but standard issue is fragmentation (anti-personnel, 5D6 M.D. to a 20 foot/6 m radius) and/or Armor Piercing (1D4x10 M.D.).

Mega-Damage: Varies with missile type.

Range: About one mile (1.6 km).

Rate of Fire: One at a time or in volleys of two, three, four, or eight!

Payload: 16 total, eight per shoulder.

6. Leg Mini-Missile Launchers (2; lower leg): A low profile launch box is attached to the outside of each of the lower legs. Each holds ten mini-missiles, for a total payload of 20. Same basic stats as those listed above. Typically contain Armor Piercing (1D4x10 M.D.) or Plasma (1D6x10 M.D.) mini-missiles.

7. Hand to Hand Combat: The QR-3 Guardian has its own "Elite" Combat Training skill. Those not skilled in "elite" combat training with the QR-3 use the *Robot Basic Combat Training* stats found in *Rifts® Ultimate Edition*, page 351.

Elite Robot Combat Training: Guardian provides the following:

One extra hand to hand attack per melee round, plus those of the pilot at levels 1, 4, 8 and 13. Remember, all bonuses are in addition to the pilot's own hand to hand combat training and attribute bonuses. They do *not* apply to the pilot's physical abilities outside the robot.

Critical strike is the same as the pilot's.

+3 to roll with impact, punch or fall.

+1 on initiative.

+1 to strike in hand to hand combat.

+2 to parry (the Vibro-Sword and P-Beam gun barrel are excellent to parry with).

+2 to dodge.

+4 to pull punch.

Restrained Punch: 1D4 M.D.

Full Strength Punch, Elbow or Knee attack: 2D6 M.D.

Power Punch: 4D6 M.D. (counts as two melee attacks).

Vibro-Sword: 4D6 M.D.

Tear or Pry with hand: 1D4 M.D.

Kick Attack: 2D4 M.D.

Running Leap Kick: 2D6+4 M.D.! This attack must be used at the beginning of a melee round and uses up all but one melee attack. In addition, there's a 01-55% chance of knocking giant-sized opponents to the ground. The victim loses two melee actions and initiative as well as suffers damage.

Body Block/Tackle: 2D4 M.D.

Stomp: 1D4 M.D.; effective only against objects smaller than 10 feet (3 m) tall.

8. Sensory Systems of Note: Standard for robots.



WILSON '99

GLITTER BOYS OF FREE QUEBEC

By Kevin Siembieda, inspired by concepts from Ryan Beres.
Some additional text and ideas by Francois DesRochers.

“Power Armor” might be thought of as a sort of super-suit of environmental body armor. An “exoskeleton” that gives the wearer underneath impressive protection against the elements and enemy attack as well as enhancing the wearer’s own physical capabilities by providing robot strength and speed. An array of advanced weaponry — rail gun, lasers, mini-missiles, etc. — makes the wearer of “power armor” a walking (or flying) tank.

Many warriors prefer this form of external, mechanical *augmentation* because it does not require the user to submit to any permanent physical alteration. Of course, those who undergo such physical transformations, most notably the *Juicer*, *Crazy* and even *cyborgs*, often regard the power armor pilot as a wimp, technology dependent city-warrior, or a coward afraid to “go all the way.” Many refer to power armor pilots as “turtles” or “turtle pilots” because without their robotic armored shell, they are slow, powerless and vulnerable. In many ways they are correct. The armor is basically a robot *suit*. The human pilot steps into it and activates the armor to become a one-man, self-contained, combat system. Strip the suit away, and the pilot is an ordinary flesh and blood man who is easily vaporized by Mega-Damage weaponry and potent magic.

Power Armor Pilots contend this makes them all the more heroic, for unlike the Juicer, Crazies and ‘Borgs, they are *not* permanently transformed into “supermen,” they remain ordinary humans. Many argue this enables them to retain their complete humanity. It has long been argued that cyborgs and others augmented to become “more than human” often lose sight of their own humanity, becoming emotionally detached from their fellow human beings. In fact this is the main reason the authorities at Chi-Town have resisted adding cyborgs, Juicers and Crazies to the CS Army. The weight of powerful opposition and the desire to maintain military supremacy has recently compelled the CS to “officially” add the Juicer and cyborg to the Coalition Army, but the Crazy is still banned for military use and the Crazy creation process is outlawed in all Coalition States. Even now, the use of Juicers and Cyborgs is highly specialized and very limited. **Note:** This was another area where the leaders at Chi-Town and Free Quebec disagreed. Cyborgs had been an integral part of the Quebec Military very early on, and they refused to curb their use, let alone disband their cyborg forces as the Chi-Town leadership had suggested.

Traditionally, power armor was an augmented combat suit worn by a soldier or warrior like the knights of old. However, with improvements in robotics and nanotechnology, the line between power “armor” and “manned robot” has become blurred. So-called “suits” of power armor are frequently small, one-man

robots in which the “wearer” is a pilot who sits inside the armor and operates the “robot” systems. The accepted standard is that any humanoid shaped robot or exoskeleton that is manned by a single pilot, utilizes pedals, leg movement, hand-eye coordination and is under 15 feet (4.6 m) tall, is a suit of *power armor*. Anything that is not humanoid in appearance, or is fully automated, seats more than one person, and/or is larger than 15 feet (4.6 m) is considered to be a *robot vehicle*. All types of **Glitter Boys**, **SAMAS**, as well as the **Glitter Boy Killer**, **Mauler**, and **Terror-Trooper** are examples of the traditional power armor combat “suit.” Triax’s **Ulti-Max** is an example where the line between power armor and robot become unclear.

All that glitters ...

The **Glitter Boy** was the first power armor recorded after the Great Cataclysm (the SAMAS was rediscovered by the CS centuries later, only in the last 40 years). It is without question the most famous of the power armor suits. Although dozens of different variations, including flyers like the SAMAS and Quebec’s Violator, have been developed since, the Glitter Boy has withstood the test of time and remains as popular today as it ever was, maybe more so. This is due in large part to the role it played early on during the Dark Ages of North America.

Erin Tarn on Glitter Boys

There is an old pre-Cataclysm saying that goes something like this, “All that glitters is not gold.” For the Army of Free Quebec, all that glitters among their mechanized forces are their Glitter Boys. Thousands of them. Many times more than I, the Coalition States or most anyone has ever suspected possible.

I can not imagine anybody who does not know what a Glitter Boy is, but for those readers who may live in foreign lands or come from other worlds, I offer this brief explanation and history. Glitter Boys are suits of heavy power armor. They are traditionally armed with a high-powered rail gun that gives them superior range and firepower. They get their name from the polished, chrome-like composite alloys of their armor, a reflective material from which lasers harmlessly bounce off and plating that can survive the impact of a missile volley or the lightning bolts of a wizard and keep on fighting.

What some people do not realize is that the Glitter Boy pre-dates the Great Cataclysm. These chrome juggernauts are pre-Rifts war machines created during the golden age of science by the American Empire. They came to notoriety when a few thousand fell into the hands of brave heroes who helped humankind claw its way through the two centuries of the Dark Ages and into our modern era. This makes the famous Glitter Boy over three hundred years old.

Since the advent of the Great Cataclysm, advances in science as well as the incorporation of alien technology and even magic with existing technology has produced an ever increasing variety of power armor and robots. At high-tech communities, such machines are as commonplace as Juicers, Crazies and cyborgs. Many people would argue that these newer, often smaller and faster types of power armored suits surpass the abilities of the antiquated Glitter Boy. They would point to the recent designs by the Coalition States, Northern Gun, Triax of Germany, the Kittani of Atlantis, and even the creations of Techno-Wizardry (the hybrid science that combines magic and machine) as superior. Yet no one type of power armor or military vehicle, with the possible exception of the Coalition's SAMAS, has captured the respect, fear and imagination of people more than the Glitter Boy.

I believe this is due in large part to the Glitter Boy's long history. The very fact that they survived the Great Cataclysm gives them a certain mystique in and of itself. Glitter Boys represent a tangible link to our lost heritage, tugging at our imaginations to make us wonder about what other marvels must have existed before the ley lines erupted with magic and wiped the vestiges of the old world from the face of our planet. The fact that Glitter Boys were used to help tame our new world only serves to make them all the more romantic and the stuff of legend.

Glitter Boys were originally built and stockpiled by the old American Empire shortly before the Coming of the Rifts. After the Great Cataclysm shattered civilization, many were used by the survivors of the military who struggled to reestablish order and do battle against the onslaught of monsters from the Rifts. Later, the armor was adopted by their descendants or became the possession of lucky scavengers or adventurers who stumbled upon them, from time to time, hidden away in underground bunkers.

Of course, the decades immediately following the Great Cataclysm are forever lost to us. All that remains are unsubstantiated stories, myths and legends passed on by word of mouth from generation to generation. The oldest stories tell of entire Glitter Boy companies trying to preserve civilization and hold back the tide of destruction and madness that was sweeping our world. Which are true, and which may be complete fiction are impossible to tell. However, there is story upon story of those fortunate souls who found the pre-Cataclysm machines and were able to puzzle out how to operate them. These suits fell into the hands of heroes and scoundrels alike, but all who would pilot them would become the chrome warriors known as "Glitter Boys." Who first coined the name is unknown, but they have been known by this name since at least one hundred and fifty years before the Dark ages ended and the Post Apocalyptic calendar began.

According to legend, bands of Glitter Boys rose from the chaos as a force to be reckoned with, wading through the desolation, slaughtering monsters, and bringing some small measure of peace and hope to the hell our world had become. During the Dark Ages, one lone Glitter Boy could mean the difference between life and death for an entire village, town or kingdom. I have personally catalogued over 500 different stories about Glitter Boys during the Dark Ages, and this does not include scores of variations on the same tale. Many are tales of a lone warrior standing against impossible odds, others tell of warriors who

traversed the land as heroes, demon slayers and defenders of the weak. Others are cautionary tales that warn of corruption and tell of blackguards who used the power of the Glitter Boys to make themselves kings or to extract terrible revenge.

As difficult and brutal as our time may be, the Dark Ages were even worse. It was a period of unprecedented savagery as human survivors clawed their way from the abyss of near total destruction and competed with D-Bees, supernatural monsters and forces of magic they did not understand. It was a day and age when the strongest not only survived, but were able to impose their will over the land they dominated. Thus, the Glitter Boys became the symbol of hope, for they gave desperate communities the means to defend themselves and in so doing, fostered genuine hope to survive. To this day, the Glitter Boy represents power, heroism and the ability to stand against overwhelming odds. Consequently, I find it ironic (and more than a little appropriate) that the Glitter Boy symbolizes Free Quebec's best hope against the insurgent Coalition Army.

Many people, historians and scholars among them, believe neither Chi-Town or Free Quebec would have survived in the early days without the power of the Glitter Boys behind them. It is a known fact that a hundred Glitter Boys were recovered and used by the founders of the city-state that would become Chi-Town and eventually the heart and soul of the Coalition States. Likewise, it would be the discovery of a forgotten, underground military complex, with (according to legend) 288 Glitter Boys by the founders of Free Quebec, that would insure that fledgling nation's survival and their rise from the barbarism of the Dark Ages. A bit of history that people like Sylvain Richard and the Prime Minister of Quebec hope to keep alive for some time to come.

You see, the discovery of these one-man suits of armor and their strategic use as an organized military group instantly eliminated the need for conventional armies requiring thousands of foot soldiers. A single chrome covered warrior was the equal of an entire platoon, if not an entire company of men. Moreover, the Glitter Boy was a walking tank. An armored machine capable of withstanding incredible amounts of damage as well as unleashing devastating firepower of its own. Now add another eight or nine Glitter Boys to the equation, and you had a mechanized squad that could take on a dragon or a tribe of Monster Riders, a band of demons, or an entire company of bandits clad in simple body armor and using energy rifles. Now add another two or three hundred, let alone a thousand, and you have one of the most powerful, yet smallest armies in the world. With such a mechanized army, a kingdom no longer needed to dispatch thousands of troops to defend their land or to advance their causes. A squad of ten Glitter Boys could defend a border, village, or place of strategic importance against forces 15-20 times larger. Invaders and monsters would pay a high price for any incursions they might consider, and the very presence of a Glitter Boy Squad signaled an extreme level of power and resistance to any who would take them on. As a result, many would-be invaders, bandits and troublemakers avoided places under the protection of a dozen or more Glitter Boys, moving on in search of easier prey, of which there were many. So it was that the Glitter Boys gave the fledgling kingdoms of Chi-Town and Free Quebec the vital foothold each needed to survive and go on to become regional (and later, national) superpowers.

— excerpted from a work in progress, untitled, by Erin Tarn.

In the early years toward the very end of the Dark Ages, Chi-Town gave up on the Glitter Boys and adopted other means of defense and making war. Back then they lacked the scientific knowledge and manufacturing capabilities to make the laser resistant Glitter Boys. Consequently, as their original stockpile was slowly destroyed in combat, they were permanently lost.

The CS would ultimately benefit from other technological secrets from before the Coming of the Rifts. Secrets that included the SAMAS, genetic engineering, the science of cybernetics and advanced manufacturing of Mega-Damage materials in general. Ancient manuals, schematics and scientific and manufacturing documentation preserved in the fabled *Chi-Town Library* played an important role in Chi-Town's technological growth and prosperity. The discovery of the pre-Rifts *Lone Star Military Complex* bolstered their military and technological superiority, particularly in the areas of power armor technology (excluding Glitter Boys), military vehicles, robotics, bionics and genetic manipulation.

Unable to create Glitter Boys and having found suitable alternative weapons of war, the Coalition Government outlawed the use of Glitter Boys in the States. Under great protest and lobbying, the State of Free Quebec was given the only exemption, under the condition that it would slowly *phase out* its Glitter Boy Legion by not refurbishing damaged units and, under no circumstance, creating new ones (even though the nation disavowed any ability to manufacture GBs).

It was not lost on Free Quebec or outsiders that Chi-Town had declared Glitter Boys illegal mainly because they didn't have any and their enemies did. Making the power armor illegal effectively reduced competition and enabled the CS to confiscate or destroy any GB's that either entered or (in their sole discretion) threatened their domain. Moreover, since the famous Glitter Boy is indeed a symbol of hope, CS leaders felt it was best to keep them out of the hands of those who opposed Coalition rule. The majority of people piloting the power armor were mercenaries, adventurers and freebooters who had no affiliation with or love for the Coalition States. Furthermore, Glitter Boys were often used by rebels and enemies of the CS — giving those who desired to remain free of Coalition domination the “hope” and “inspiration” to challenge them.

Free Quebec's Glitter Boy advantage

Many outsiders, the heads of Chi-Town and Iron Heart among them, have long *suspected* that Free Quebec has had the secret of manufacturing Glitter Boys to themselves for decades. Free Quebec's official position has always been that they discovered approximately three hundred Glitter Boys ages ago, and have been able to repair, refurbish and maintain this original stockpile for decades, while supplementing it with new acquisitions from adventurers. Few believed this claim, but nobody could prove otherwise. When it was discovered that Free Quebec had sold the secret of the Glitter Boy design to Triax (in exchange for a very lucrative trade agreement, including a veritable army of traditional and new Triax-style Glitter Boys), the cat was out of the bag. Free Quebec's leaders tried to defuse the situation by claiming only after decades of research, experimentation and reverse engineering had they “recently” unravelled the mysteries of GB construction. Unfortunately, this weak claim

did not hold water, particularly with the other Coalition States who felt (and rightly so) Free Quebec had been holding out on them for generations. To add insult to injury, the nation had now sold those secrets to a foreign power rather than share them with its sister States. Perhaps needless to say, this arguably treasonous turn of events stretched already tattered relations with Chi-Town and Emperor Prosek to the breaking point. Word that Triax had delivered an undisclosed (but presumably large) shipment of new Glitter Boys to Quebec did not help matters, and served only to spark new and heated debates over the possible merits of the Glitter Boy in the Coalition Military, Quebec's special exempt status, and the argument to either revoke the GB's prohibition or make Free Quebec disassemble their Glitter Boy legion. This segued into questions concerning Free Quebec's independence, nonconformity, and loyalty to its sister States.

Earlier suspicions and discontent had prompted Chi-Town to leave the State of Free Quebec out of its secret renovations and expansion of the Coalition Army (as presented in **Coalition War Campaign™**). A decision that proved to be prudent with each new revelation and act of open defiance by the rebellious State. In the end, Chi-Towns demanded that Free Quebec dismantle its Glitter Boy legion — or else! Free Quebec's refusal to do so prompted it to sever its relationship with the CS and return to independent nation status. This in turn provoked Emperor Prosek to brand Quebec as a traitor and declare war on them. The Emperor and his advisors foolishly believed such a declaration of war would “jolt” the Quebec leadership into recanting their position and rejoining the CS, with their tails between their legs. They were wrong.

The truth is Free Quebec has had the ability to manufacture Glitter Boys since the early years of that nation. Its leaders kept this knowledge secret because it was their ace in the hole. The one thing no other North American power had at its disposal. Insurance, if you will, to keep their independence. While legends consistently report the first number of Quebec Glitter Boys to be “288,” the real number was closer to one thousand. Moreover, the legends make no mention that along with the Glitter Boy discovery was an entire military compound including a small, operational Glitter Boy factory and complete data on Glitter Boy design and manufacturing. Over the years, not only did Free Quebec replace damaged Glitter Boys with new units as people had suspected, but incrementally added to their Glitter Boy stockpile (2-3% annually), as a hidden reserve. Although the number of “extras” was small, over a period of two hundred years it has grown into the thousands. Eighty percent of these lacked the miniature nuclear power supply, the most difficult and costly part of GB construction, which is why Free Quebec has purchased thousands of such modular units from Triax. In addition, in an effort to raise cash when needed, as well as strategic attempts to undermine rival communities, Free Quebec has secretly *sold* refurbished, used models to mercenaries and adventurers in the Canadian north. Roughly 230 have been sold (garnering anywhere from 40 to 100 million credits each) and another 120 have been conveniently “lost or stolen” over the last century. All sales were always through third party pawns who had no idea they were actually working for Free Quebec.

Free Quebec risked their secret being revealed as a result of their quietly executed trade agreement with Triax, because they



could see the writing on the wall and knew Chi-Town would, sooner or later, threaten their independence, and quite possibly declare war. This risk was diminished by the fact that Triax agreed to provide Free Quebec with 6,000 new Glitter Boy troops (60% being the traditional GB and 40% being the Triax “Cyclops” Glitter Boy) and thousands of additional nuclear power supplies necessary to bring their own stockpile to life.

Glitter Boy production is extremely (almost prohibitively) expensive and time consuming for the Canadian nation. This made their production on Quebec soil limited to only 500-600 a year. To be prepared for a CS incursion they needed at least ten times that number. Furthermore, by farming out the work to Triax of the New German Republic (who could produce and ship 3000 in the first year of production and still maintain its own military production needs for their war against the Gargoyle Empire), Free Quebec could turn its full production capacity toward the manufacture of their new Glitter Boy models, such as the **Glitter Girl** and **Tarantula**. The result is an army of diverse, and in some cases, never before seen, Glitter Boys. The Coalition Army has no inkling of what they are about to face, although some frightening hints are starting to manifest themselves.

The original Glitter Boy Factory — one of the best kept secrets in North America. Nearly two hundred years ago, an Expeditionary Force from the fledgling kingdom of Free Quebec accidentally discovered an old military compound of the American Empire. What lay inside was almost as much a treasure trove as the Lone Star Complex. Although a tiny fraction the size of the Lone Star complex, the entire compound was in excellent condition. Apparently it was intended to serve the old American Empire (or perhaps a joint military operation between the USA and Canada) as a base for Glitter Boy operations. In one wing a breathtaking 864 brand spanking new Glitter Boy USA-G10's rested quietly in storage. The facility was locked up tight and its discovery kept top secret. After ten years of study and research, the Quebec Military was able to restore the failed nuclear generator. This revealed the manufacturing plant to be in working order, but they also found computer files, electronic systems, weapon caches and everything necessary to build Glitter Boys. It was this one single discovery that would insure the growth and survival of Free Quebec. Those first power armor pilots would help clear much of the old province of Quebec and push back the monstrous hordes into the Labradorian Badlands and help form the present borders of Free Quebec.

The original factory lies to the south of Free Quebec and remains secret to this very day. It would take 118 years (roughly 20 P.A.) for Quebec scientists and engineers to understand the technology well enough to build a second small underground factory within New Quebec City itself. Under intense guard, it is located in the highest possible security zone underneath the city's main military complex. Only highly trusted engineers and technicians are allowed access to the area containing the factory; even fewer are allowed into the factory. For obvious reasons, the policy makers and military leaders of Free Quebec wish to keep both the original and the second factory complex under lock-and-key. Even most citizens have no idea about the true history of Free Quebec's Glitter Boy legions or the existence of a GB factory in the heart of New Quebec City.

Glitter Boys of Today

Militarily, Free Quebec has very much risen up on the shoulders of their Glitter Boy Army. The armor has become the very symbol of the nation and is a tangible reminder of their free spirits and past triumphs.

One of the things that Free Quebec has long been developing is a special branch of their military to augment and support their regular armies. This specialized branch started out with the development of the Glitter Boys into a cohesive and devastating fighting force. For years the Glitter Boys provided an adequate addition to the regular armed forces. Even with the partial changeover to Coalition Military power armor and robots, the Glitter Boys were too valuable a commodity to release.

The policy to keep the secrets of GB construction from the Emperor and the other Coalition States has ultimately led to their expulsion from the Coalition. Alone, Free Quebec now stands apart from the rest of North America's citadels of humanity. The only other human state that has taken kindly to Free Quebec is the New German Republic (NGR), and they do so more for the trade of the Glitter Boy technology than any genuine friendship. As such, the NGR acts as a neutral partner, sharing among themselves the fruit of their efforts and trying to maintain diplomatic relations with the Coalition States. It is a political dance that makes the leaders of Quebec nervous.

Today, better than any kingdom on Earth, the Quebec Military knows how to best deploy their Glitter Boy Legions. They have developed innumerable strategies and tactics around Glitter Boy squads, platoons, companies, brigades and divisions. Tactics that minimize the Glitter Boys' weaknesses and maximize their assault and support capabilities.

GB Weaknesses & Vulnerabilities

To most laymen and those unfamiliar with mass troop combat, the Glitter Boy in any of its incarnations is little more than a walking tank. As such, many uninitiated pilots and military commanders use them like tanks — trudging straight ahead and blasting away. While this can be effective, especially with an entire company or division, it is only one, very basic and linear use of the mighty machine. Because of this very narrow view of Glitter Boys and the lack of availability in any large numbers (usually restricted to 1-10 GBs outside of Quebec), many arm-chair-generals have dismissed the Glitter Boy as antiquated and inferior compared to more recent designs, particular the high flying SAMAS and Ulti-Max, but if that were the case, why would Triax or the NGR be interested in them? Individuals who believe the Glitter Boy's time has passed point to the following weaknesses.

- **The laser resistant reflective surface is as much a liability as it is helpful.** The “gleaming” armor combined with its slow speed and literally “booming” attack announces its presence and gives the enemy a chance to entrench, prepare for bombardment and launch an effective counter assault.
- **Glitter Boys are painfully slow.** Their maximum speed is 60 mph (96 km) and they must stop, effectively root themselves to the ground, and aim before firing their, albeit powerful, Boom Gun. Thus, the GB is a comparatively easy, stop and go, target, easily keyed upon and especially vulnerable in open spaces. Moreover, their slow speed makes insertion and

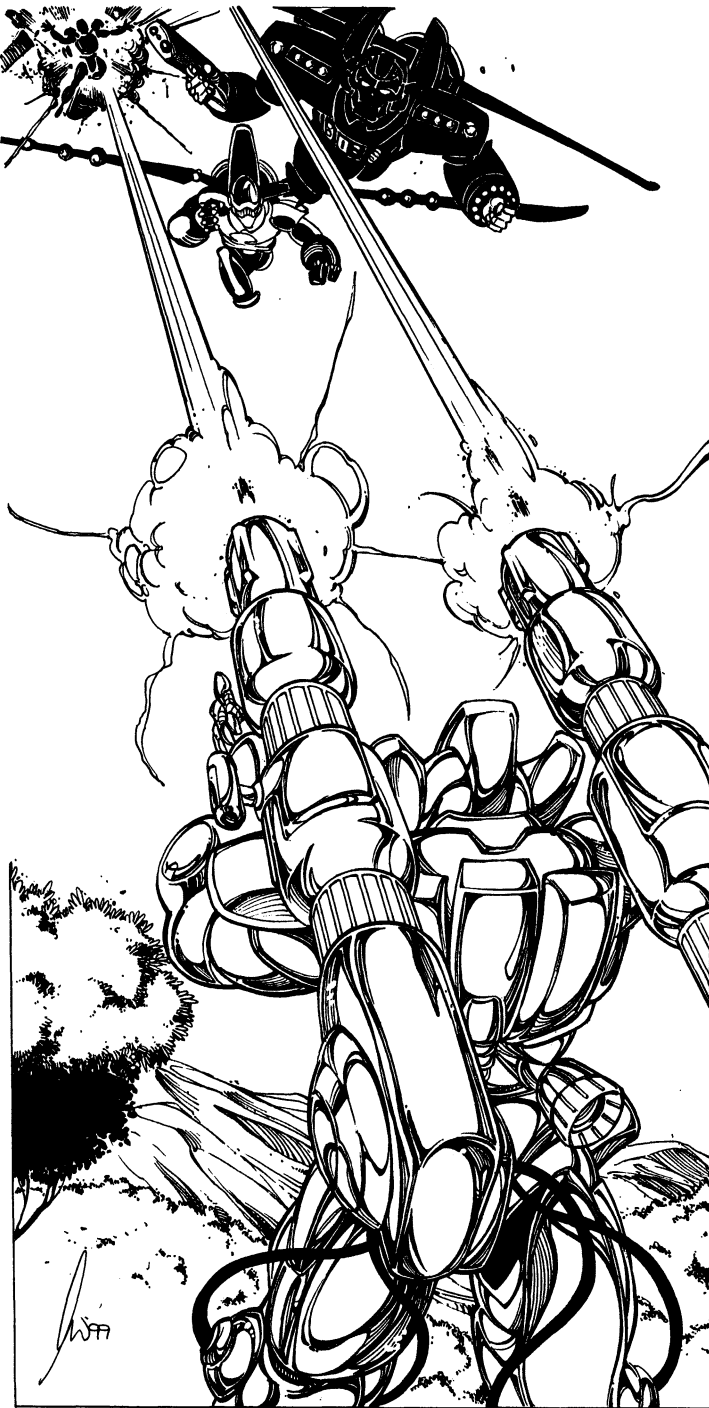

extraction or retreat slow and difficult. A retreating Glitter Boy is especially vulnerable to an aggressive, pursuing enemy and missile strikes.

Their slow speed also makes them vulnerable to faster and more maneuverable enemies, including cyborgs, Juicers, Cra-zies, certain D-Bees and creatures of magic, and fliers.

- **Vulnerable to aerial attacks.** Fast moving flying opponents can make mincemeat out of a Glitter Boy. Enemy forces piloting hovercycles, rocket bikes, aircraft, SAMAS and other flying war machines have a distinct advantage over the slow moving, land-locked Glitter Boy.
- **Vulnerability to missiles.** Missile attacks can blast a Glitter Boy into oblivion before it has a chance to launch its attack.
- **Reloading creates a sitting duck.** Even quick reloading of the spent ammunition housing by Free Quebec's expert Re-

load Teams takes nearly one minute (3 to 4 melee rounds or roughly 45-50 seconds). For the pilot to reload by hand takes 10-15 minutes and requires him or her to momentarily exit the power armor and make himself a stationary target in order to reload. Likewise, reloading by hand with the assistance of a fellow GB or other individual takes 10-15 minutes (20 or more if untrained and unfamiliar with GBs), and leaves both open to targeting and attack.

- **Lack of secondary weapon systems** also leaves the Glitter Boy defenseless.

All these things are true, especially when facing *one* Glitter Boy or a small squad of 2-6 — even a dozen or two if the pilots are poorly trained or inexperienced. What these naysayers do not realize is that the Glitter Boy, like the tank and most combat vehicles, is not designed for “all” types of combat or combat conditions. That’s why an army has a variety of weapons and vehicles and often coordinates its efforts with other military branches such as the air force. For example, a tank is just as vulnerable to the above as the Glitter Boy, but if it gets aerial support from SAMAS and/or other aircraft, the vulnerability to enemy missiles and fliers is negated!

Moreover, while the Glitter Boy can be devastatingly effective against low tech, and comparatively low powered M.D. opponents, it was designed as both a troop “support” mobile artillery *and* heavy front-line infantry armored artillery. **In a support capacity**, the Glitter Boy, like a tank, provides suppressing artillery fire, pounding the enemy’s front-line or entrenched positions (softening it up for the troops), and short-range heavy artillery fire while it escorts the forward moving troops from behind and/or the sides and draws the heaviest enemy fire (thus protecting the troops and giving them a chance to take action). Depending on the situation, the mobile artillery support is likely to target enemy armor (i.e. power armor, robots and armored vehicles), aircraft, bunkers, entrenched positions, and other heavy or strategic targets.

As a front-line infantry force, Glitter Boys will lead the charge, especially against an entrenched or fortified enemy position. In this case a Brigade (three or more companies) if not one or more Divisions (over 5700 GBs per Division) wages an attack.

In all combat situations, whether on the offensive, offering support or defensive, the mass deployment of Glitter Boys will involve GB troops working in tandem to address several strategic concerns and tactical weaknesses. This means a sizeable number of Glitter Boys fire in waves, thus when one line of GBs need to reload, they can step back and reload while a fresh line of GBs step forward to continue the assault on the enemy. Simultaneously either support troops known as “Reload Teams” (with a special vehicle and equipment) or other power armor troops (including other GBs) quickly reload the empty ammo-container with a fresh one from a mobile ammo-depot (typically an armored hover jeep). Forty-five seconds later, these Glitter Boy troops are ready to rejoin the battle. This process is repeated as often as necessary.

Meanwhile, at least 10% (and as much as 33% depending on the circumstance) of the Glitter Boys scattered throughout the attack force are positioned and ever alert for missile volleys and

aerial attackers. It is their job to track and engage such threats, and blast them out of the sky. This tactic dramatically reduces the threat from fliers and missiles by as much as 50-75%, again depending on the circumstance and enemy resources.

Likewise, it does not matter that their presence was announced before they came within range to actually strike, or that they are slow, because the GB is designed for mass attacks (hundreds if not thousands) against entrenched and fortified positions or to engage enemy troops in front-line combat where a line has been drawn as both sides wage bloody war.

In addition, as noted earlier, Glitter Boy troops were never intended to be stand-alone combat units and the Quebec Military knows this. They were used as such because the power armor can take a heavy beating and is absolutely devastating against ground troops. The flechette ammunition of the Boom Gun cuts through conventional foot soldiers, even those in M.D.C. body armor, with horrifying effectiveness. A squad of 8-10 Glitter Boys can mow down an entire Brigade (approx. 2000 men) without power armor, artillery or missiles without losing a single GB unit! Sometimes without losing more than a third of their own M.D.C. This is largely due to their superior range and the amount of damage inflicted by their flechette rounds against lightly armored opponents.

Against a more diverse and powerful enemy (i.e. those with armored vehicles, robots, cyborgs, heavy long-range weapons and/or power armor of their own), Free Quebec's Glitter Boy troops are supported by ground troops, Side Kicks, SAMAS and other ground and air forces all working in unison as a well organized combat force. Even the Quebec Navy may be partner to such military operations, and uses Glitter Boys and Girls as part of its naval force! All combat personnel are trained to work together and Free Quebec has had over 200 years of experience in combat utilizing Glitter Boys with their conventional army, although never on the scale they are preparing to use against the Coalition States.

The reason many people, especially the pilots of newer power armor designs, think of Glitter Boys as ineffective and obsolete is that outside of Free Quebec, most people have never witnessed groups of Glitter Boys in action nor entire companies engaged in large scale combat — and should be grateful for it. The leaders of the Coalition Military have no such delusions and are painfully aware of exactly what a well trained platoon, brigade or division of Glitter Boys can do. This makes them all the more worried about a “free” and “rebellious” Quebec nation and their massive build up of these war machines. A nation with one thousand Glitter Boys is reason for concern. One with 3,000 or 4,000, as the CS now (under)estimates is a force to be feared. Moreover, the Coalition is only now beginning to realize their estimates are probably conservative and that Free Quebec may have 8,000-10,000! **Note:** Fact is, Free Quebec has over 14,000 Glitter Boys of various types (not including the Side Kick or other types of power armor like the SAMAS and Navy units) with an additional 1000 under construction (should be ready to field in 8-12 months) and another 4000 still on order from Triax (scheduled to be delivered 12-16 months after the onset of the war).

The crack troops of the Quebec Army are the most skilled, mobile and most heavily armed troops in America, second only to the Coalition Army! CS Strategic Advisors are at something

of a loss as to suitable countermeasures against this force, mainly because for the first time ever, they are effectively fighting *themselves*! Remember, until a few months ago, Free Quebec was a member of the Coalition States with an army equipped with the old style Coalition Dead Boy body armor, SAMAS, Sky Cycles, and standard CS combat vehicles, weapons, and equipment. Consequently, this is war against one of their own well-trained armies with Glitter Boys and a few other surprises thrown into the mix! While Quebec Forces may not have the newest CS weaponry or the full range of new and old robots, aircraft and vehicles, the substantial presence of Glitter Boys, unexpected Glitter Boy variants, the V-SAM and a capable (and currently unstoppable) Navy, more than compensates. Thus, Quebec's Armed Forces are equal to anything the Coalition can field.

In the final assessment, only superior numbers and a lengthy war offers the CS any likelihood of success, and with the Tolkeen and Xiticix fronts, as well as continuing trouble from the Federation of Magic and other enemies, such a sustained and costly operation (in both equipment and the loss of its men) seems more detrimental to the States than a benefit. Even if the CS wins a long, sustained war (and they should), they might never recover from the losses sustained in such a brutal 10-20 year conflict. Furthermore, Quebec is likely to be so devastated that it loses any genuine value that it once held and the survivors are likely to hate the CS and remain rebellious for generations to follow. The main reward from such a victory is a tactical one, because the threat of a rival military power will have been permanently removed. Of course, the hope is that Free Quebec will fold long before that point, capitulate to CS demands and submit to CS occupation and rule.

GB Small Squad Tactics

Small squads of seasoned GB pilots, like most Free Quebec troops, will use strategies and tactics similar to the large combat companies. They work together, cover each other's backs, and have one or two hang back to snipe or surprise the enemy and/or shoot down missile volleys and enemy fliers.

Small squads are used for a variety of combat missions other than seek and destroy. These include reconnaissance and rescue, tank- and robot-killing, sniper operations, riot control and operations in urban environments and close-quarter combat. GB pairs and small squads (4-12) are also used to engage dragons, demons and monsters, as well as escort troops and other personnel, guard supplies and strategic locations, and offer support to other troops. They can even assist in construction and engineering operations.

Remember, a Glitter Boy is a walking tank only twice the size of a man. This means they are easy to transport and insert into enemy territory via truck, hover vehicle or aircraft, are comparatively easy to conceal (in fact, most GBs sent on reconnaissance, rescue or sniper missions wear a camouflage poncho) and are highly mobile ground units. Glitter Boys, with their hands, arms and legs are excellent all-terrain vehicles and even climb the side of a mountain and travel underwater. Their humanoid shape and size means they can also navigate city streets, alleyways, stairs and even squeeze through most doorways and negotiate many corridors. Since their mission is typically combat, it does not matter if the power armor smashes through a

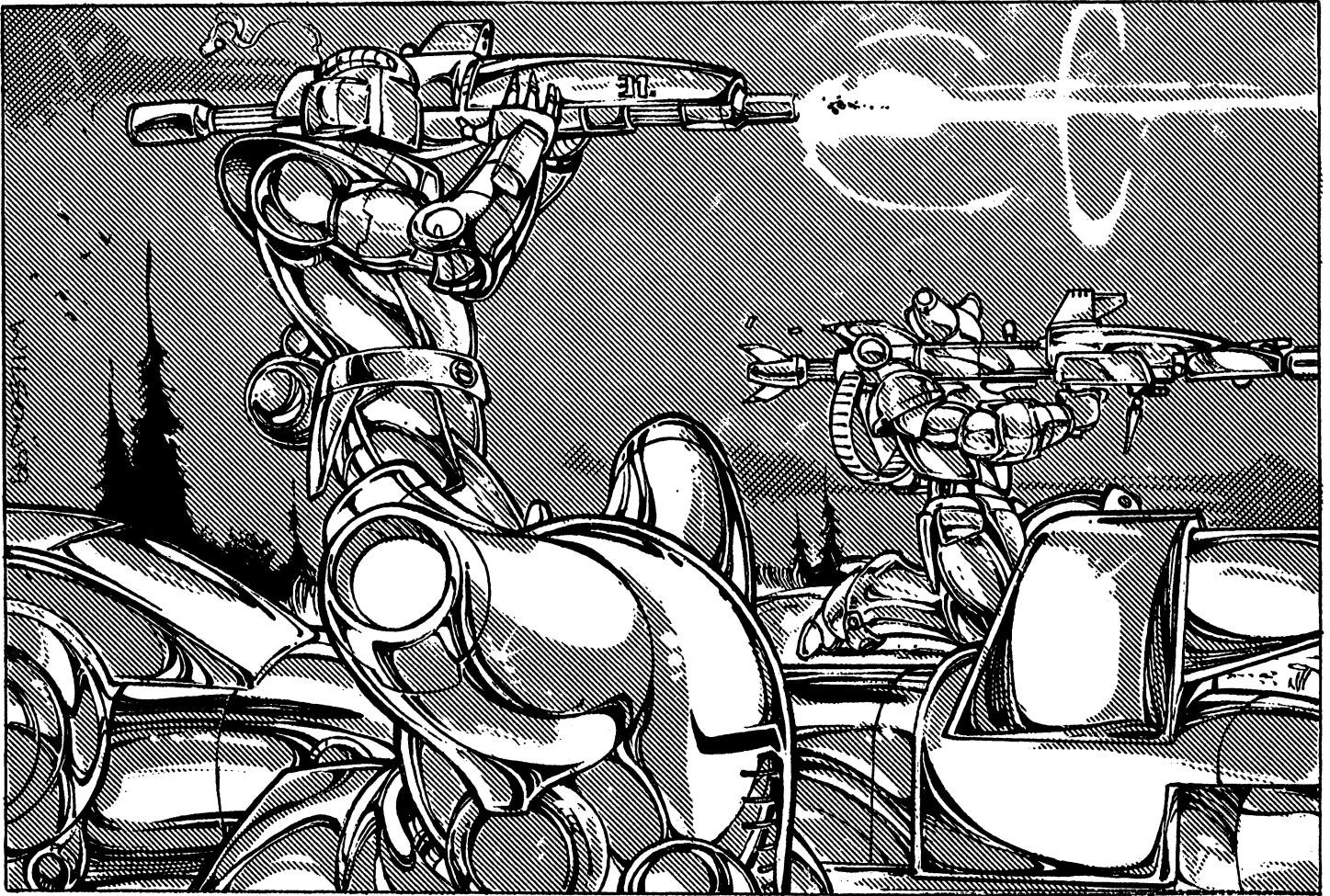

door, destroys the door jam, or inflicts additional collateral damage, but even this is comparatively minor, so any building they want to leave standing can be entered and is likely to remain standing — which means it can be repaired and reused. On the other hand, if necessary, the Glitter Boy squad can blast or tear the building into rubble, often while still inside, and walk away.

Glitter Boy Legions

Before political tensions mounted to their present point and military conflict was inevitable, the Glitter Boys were assigned to various positions inside Free Quebec and abroad in squads or small components attached to regular armored infantry or robot squadrons. With the way things have now developed, the Glitter Boys have become fully integrated into the military and form the backbone of Quebec's Armed Forces. The Glitter Boy Legions form the core of the Free Quebec Military with the new V-SAMs, traditional SAMAS, bionic shock-troopers and other military forces and war machines comprising the Rapid Deployment Force around the Glitter Boys (The Navy is a separate and independent Military Force).

Armed with their famous Boom Guns and additional heavy weapons, they deliver the heavy firepower, targeting primarily enemy armor, robots, and heavy defenses. When battling demons and other D-Bees, the Glitter Boys will primarily target

the heavier and more powerful monsters. When the entire Legion opens fire, they can cut a swath through almost any formation they face. Only the most disciplined forces will stand and bear the intense sonic booms and devastation the Glitter Boys can deliver. Acting as aerial support are SAMAS and Side Kicks. They are primarily there to keep the skies above clear of enemy power armor, aircraft and other forces.

Typical Glitter Boy Legion

Approximately 15,000 GBs of various types make up the Glitter Boy Legions. A Glitter Boy Legion is effectively a "Brigade" composed of smaller units. Conventional wisdom is that one Glitter Boy Legion is the equivalent of one CS field Division (5000-6000 troops). Against inferior opponents, a GB Legion may be the equivalent of an entire Army Corp (over 11,000 troops) or even a Field Army (over 23,000 troops).

A single Legion typically has 3560 troops: 2560 Glitter Boys plus 1,000 support troops. The number of GBs never falls below 2,000 — when they do fall under 2560, the number of GBs will be made up with other power armor troops (SAMAS, etc.) or Cyborg Shock Troopers, but Glitter Boys are always at the core of these Legions.

There are currently five Glitter Boy "Legions" in the Quebec Military. Each Legion is part of the Quebec Army and works with all other branches of that Army (Air Force, Intelligence, etc.) as well as cooperate with the Navy. This means a Glitter Boy Legion may be part of a larger and diverse field Army. A Glitter Boy Legion often divides its troops into smaller companies, platoons and squads for specific coordinated operations.

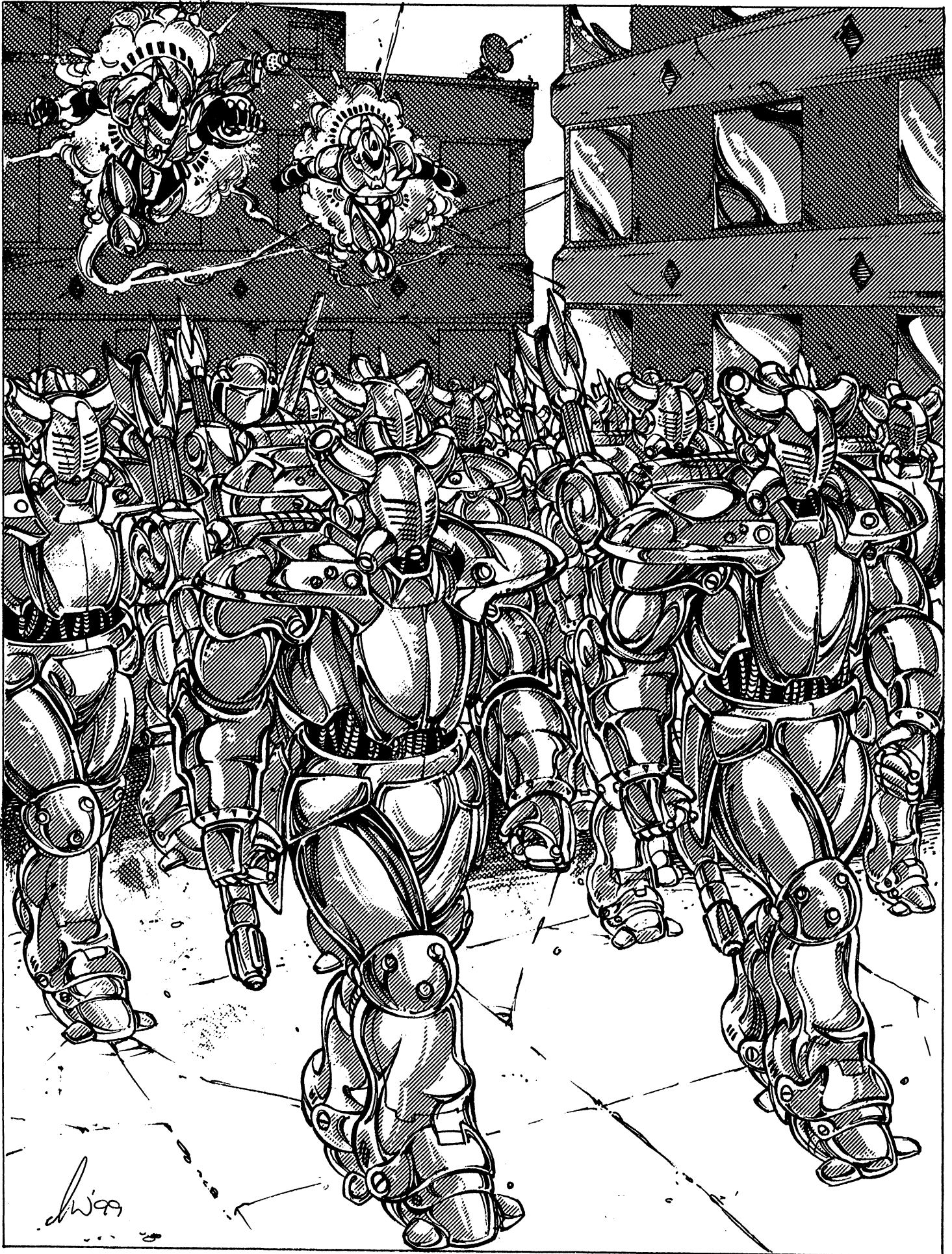

- **Two Glitter Boy Reconnaissance/Intelligence Companies:** 320 total GBs. 160 troops per each Company, divided into 8 twenty-man GB platoons or 16-26 Squads. A typical “Squad” is 6-10 GBs, but *may* include 2-4 Side Kicks, Juicers, Cyborg Shock Troopers or other Military personnel (Ranger, Scientist, Special Ops, Grunt, etc.).

One Company is composed primarily of Classic Glitter Boys, 40-50% of which are outfitted with the “Rimouski Weapon Package”, 10-20% being the Triax 550 Glitter Boy, and the rest a mix.

The other is 65% Glitter “Girls,” 20% Side Kicks, 5% other GB (typically Classic or Tarantula) and 10% V-SAMs (attached to the GB Legion).

- **Two Glitter Boy Rescue & Special Operation Companies:** 320 total GBs, 160 troops in each. Typically divided into eight 20 (or four 40) GB platoons or squads of 6-12.

Both Companies have the typical mix of 30% Classic GBs, 50% Glitter Girls, 10-15% Side Kicks, and 5-10% other (may include any variety of SAMAS or cyborgs attached to the Glitter Boy Legion). These companies engage in both rescue and Special Ops, including espionage, sabotage, sniping, and other “Black Ops.”

- **4 Glitter Boy Artillery Companies:** 640 total GBs; 160 troops each, typically divided into eight 20 GB platoons.

Standard mix is 40% Taurus, 40% Classic GBs, 20% Tarantula.

- **8 Glitter Boy Armored Infantry Companies:** 1280 total GBs; 160 troops each Company, typically divided into four 40 GB platoons.

Standard mix is 40% Classic GBs, 20% Tarantula, 20% Glitter Girls, 10% Taurus or Triax GBs, and 10% Side Kicks.

Support (non-Glitter Boy/non-Power Armor): Includes Reload Teams, mechanics, communications, logistics, medical, SAMAS air support squads, power armor squads, etc.

The 1000 support personnel includes three Side Kick Companies (480) and two Reload Companies (320 troops/106 three man-teams), the rest are and support personnel; all are combat troops.

Note: While the manufacturing of “new” Glitter Boys at Free Quebec is slow, they have the Glitter Boy repair and refurbishing down to a science. Hundreds of GB Garages and small factories which make replacement parts and components (often upon demand) are unbelievably adept at making quick, quality repairs. A severely damaged Glitter Boy, of any type, with less than 100 M.D.C. remaining can be stripped down and completely rebuilt to like-new condition with full M.D.C. and weapon systems within 36 hours! Replacement of weapon systems and internal sensors and features, as well as the repair of minor to medium structural damage (50-300 M.D.C.) can be done in 4-6 hours!

Approximately 2,200 Glitter Boys are held in reserve exclusively by the Glitter Boy Legions to replace units lost in combat (so far a rarity) or temporarily out of commission while under repairs.

Another 4000-5000 Glitter Boys are scattered throughout the other Military Branches including 960 assigned to the Navy.

Glitter Boys of Free Quebec

Percentage breakdown by type

50% Classic Glitter Boy
15% Triax Glitter Boy
15% Glitter Girl
10% Tarantula Glitter Boy
5% Taurus Glitter Boy
5% Silver Wolf Glitter Boy

Glitter Boy Support

- Side Kick (new light power armor); roughly one for every 10 GBs.
- Reload Teams (new); roughly one for every 60-100 GBs.
- As well as use of SAMAS, other power armor and conventional troops for support.

Note that the level of “support” will vary depending upon the Glitter Boy unit and mission. For example, a GB reconnaissance or Special Ops squad of 6-10 are likely to have one or two Side Kicks with them, but probably no Reload Team (too conspicuous because this GB squad travels light, quick and undercover). However, a same sized team assigned as a bunker squad or support team is likely to have 2-4 Side Kicks and one Reload Team. By comparison, each Taurus Glitter Boy is likely to have his own Side Kick and Reload Team, regardless of the circumstances. The only exception is when on a reconnaissance or Special Ops mission in which case it will only have a Side Kick. When short handed, one Reload Team may be assigned to 2-4 Taurus GBs, but each will have a Side Kick.

Remember, although each of the new Glitter Boys are capable on their own, their true power lies in combining them as a collective unit, each one *complimenting* the other.

All Quebec Power Armor have the following common features:

1. Nuclear Powered: Which means they effectively have an unlimited fuel capacity and power source with an average energy life of 15 to 25 years. Varies with the amount of use.

2. Radar (upgraded): Can identify 72 targets and track up to 48 simultaneously at a range of 10 miles (16 km).

3. Combat Computer: Calculates, stores, and transmits data onto the Heads Up Display (H.U.D.) of the pilot’s helmet. It is linked to the targeting computer, weapon systems and radar.

4. Targeting Computer: Assists in the tracking and identification of enemy targets. Ten mile range (16 km).

5. Laser Targeting System: Assists in the selection and focusing of specific targets and adds a bonus to strike when using long-range weapons. Does not apply to hand to hand combat.

6. Radio communications: Long-range, directional communications system with an effective range of about 500 miles (800 km).

7. Built-in loudspeaker: 80 decibels.

8. Complete environmental battle armor: Suitable for use in all hostile environments including water (from several hundred feet to one mile/1.6 km, depending on the suit) and even outer space. The following features are included:

- Computer controlled life support system.

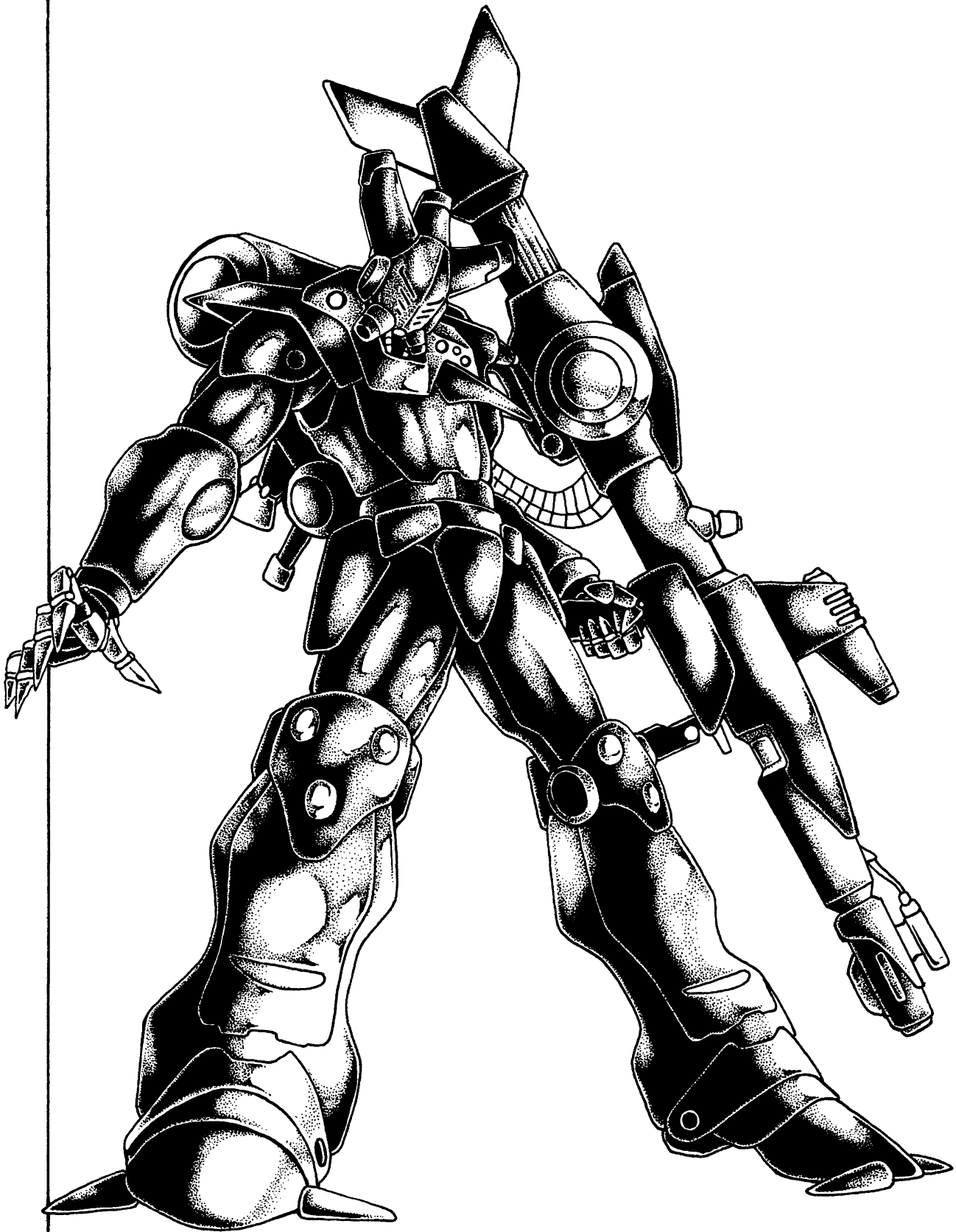

Ryan BERES

39

- Internal cooling and temperature control.
- Artificial air circulation system, gas filtration, humidifier.
- Computer controlled, independent oxygen supply, and purge system that automatically engages in low oxygen or contaminated air environments. Eight hour oxygen supply, but with the air recycling, circulatory system the wearer/pilot can remain inside the suit for days with breathable air.
- Insulated, high temperature resistant shielding for up to 400 degrees centigrade (752 F). Normal fires do no damage. Nuclear, plasma, and magic fires do full damage.
- Radiation shielding.
- Polarized and light sensitive/adjusting tinted visor (when applicable).

9. Special Bonuses: Unless stated otherwise, +2 on initiative and +1 to strike from combat computer and targeting systems. Other bonuses, or penalties, may apply to *specific* types of power armor.

Classic Glitter Boy

The last blast of explosives sent a plume of smoke rising into the air. Shards of metal, dirt and other debris rushed upwards as an audible release of pressure took place underneath. When the smoke cleared and people had regained their wits, Carter stepped in closer to have a look.

Down in the entrance they had created within the surrounding dirt, the two massive blast doors had finally been breached. "We did it," exclaimed the head excavator. "We did it!" he repeated, turning to face his colleagues and mercenary accomplices. Everyone's face showed a gleam of satisfaction, the mercenaries more out of a chance to see their payoff, the scholars and other adventurers thrilled at the prospective discovery. Grabbing his flashlight from his hip-belt and releasing his energy pistol from its holster, Carter slowly crept through the rubble of the shattered doors.

The effects of a dozen flashlights weren't nearly enough to reveal the breadth of what they had discovered. Standing at the end of a long manufacturing plant of some sort, they stared in awe, searching for the other ends of the walls. "It's huge," exclaimed one of the mercs. "That it is," replied Carter, no less in awe. "Let's follow the wall and see where we go from there," he commanded.

After walking for several minutes they reached a corner which contained a two-walled hatchway. Looking at the hatchway's keypad, he turned and motioned for another member to move forward. "Neilson, jump-start this console and open up the door. We'll be back in five minutes after we see what's down further on. Radio me if you get anywhere before that. I want two people to stay and guard while we move on," Carter ordered the mercenary leader, and without another thought, he moved on.

His heart was beating into his throat, his excitement level almost taking control of him. His lungs worked hard to keep pace with his mind. His muscles twitched in anticipation, almost enough to wonder if this was the kind of rush his Juicer companions felt on a regular basis. He was exhilarated. His heart, however, nearly jumped out of his throat when Neilson's screams could be heard over the radio-link. "Back to the corner!" yelled Carter.

Racing back Carter found Neilson lying back on his elbows, his eyes and mouth wide open, unmoving. His hacking equipment and portable generator lay on the floor near the keypad.

"He's all right, sir," said over one of the mercs. "Just scared the crap out of himself... and us. You boys might want to take a look inside though," he added, pointing into the room. The room was aglow with a red light from a chemical lamp they had set up. Inside, a Juicer stood unusually still, rifle at the ready.

Lining two sides of the wall was a series of armor standing ten feet (3 m) tall. Pointing his flashlight directly at one of them, the light bounced off brilliantly, causing a ripple effect of dancing light and shadows to move around the room.

"That's what scared him, the light reflecting," said the Juicer. "I threw him to the floor and jumped in shooting." Carter flashed him a look and was about to reprimand him, but then thought better of it. The sight before them was awesome.

"As you can see," continued the Juicer, "I didn't even scratch any of them. My laser bounced off and blasted into the ceiling."

Carter traced the Juicer's movements to the scorch mark in the ceiling. A closer look and he could barely make out the impact point on the armor. Carter felt like he must be dreaming. Glitter Boys. A dozen of them. The biggest find in twenty years. The kind of payday one only dreams about. With this jackpot they could keep two or three, sell the rest and retire wealthy men — each and every one of them. A single, brand new Glitter Boy would fetch them at least 12-15 million credits, maybe 20 or 25 million if they tried to sell them to Free Quebec (a dangerous option these days).

"Alright. We need to secure the area," barked Carter, wearing a vicious smile. "We have to play this carefully if we want to hold on to this jackpot. A lot of folks would kill for this, and dead men can't profit from anything! So let's do this quick, quiet and close to the vest. Once secure, I'll make contact with some of our more reliable friends."

Note: The description that follows reprints material from the **Rifts® RPG**, with additional text and information specific to Free Quebec.

The Glitter Boy environmental suit was the first fully field operational power armor to be deployed by the US military. The unit is an amazingly small and mobile, one person, armored robot vehicle. The robot suit stands approximately 10 feet tall (3 meters) and offers fully articulated hands and the mobility of the human body. As such it is considered an all-terrain vehicle. The super-dense chrome armor is constructed on a molecular level and can withstand more Mega-Damage than any other robot created since.

The robot frame is nearly indestructible, resilient, and virtually maintenance free. The armor shielded joints and padded pilot's compartment enable the machine to absorb impacts and cushion its pilot. It is also one of the few robots or power armor designed to comfortably accommodate a pilot for days or even weeks if necessary. A refrigeration unit holds 10 gallons of drinking water, while another contains a high protein, multi-vitamin nutrient paste (about a four week supply), as well as a few other storage compartments where additional food or personal items can be contained. However, it is not recom-

mended that the pilot remain inside for more than 24 hours at a time. The operator must exercise or muscles will begin to cramp and stiffen, especially the legs, which are the most restricted. Prolonged inactivity enclosed in the Glitter Boy or any power armor (3 or more weeks) will also reduce muscle strength. **Note:** Temporarily reduce P.S., P.P. and Spd. attributes by 1D4 until serious measures have been taken to *restore* strength by long hours of exercise and physical activity; at least four hours a day for 1D4 weeks. Periodic walks, exercise, and activity outside of the body armor will prevent loss of muscle tone and strength.

Free Quebec is the only kingdom on the North American continent to manufacture and deploy an entire army of Glitter Boys. The next biggest force outside of Quebec is likely to have fewer than one hundred. Typically, one seldom encounters more than a half dozen to a dozen of the chrome juggernauts at any given time. More often than not, one or more Glitter Boys are part of a larger and diverse group, whether it be adventurers, mercenaries or local defense forces.

Until the trade agreement between Free Quebec and Triax of the New German Republic, Glitter Boys were rare and exclusive to North America. This agreement now makes them part of the NGR's arsenal, with the promise that Glitter Boys or any variation will NOT be mass produced and sold to third parties. The NGR has promised to use the mighty Glitter Boys only in its own army and its continuing war against the Gargoyle Empire. The "arrangement" has allowed both nations to profit and bolster their Armed Forces.

Glitter Boy Improvements

The Glitter Boy is considered a *power armor suit* by most, but a robot by others, because it is so heavily armored and armed, and while the pilot operates foot pedals and hand levers, he does not actually "wear" the armor, but stands inside. Whether power armor or robot, because of the Free Quebec War, the Glitter Boy has made a striking comeback that will shatter the landscape and give other powers reason for concern.

The "Classic" Glitter Boy is the QGB-100 (originally known as the USA-G10). It remains one of the most lethal instruments of war, and an effective urban assault unit, and mass combat infantry artillery strike force. The massive Boom Gun, although superb in long range combat, leaves the unit unable to effectively engage in close combat. This means the Glitter Boy must rely on the support of additional ground troops or be used primarily as a mobile artillery unit. This limitation has been solved by engineers within the Quebec Military by what has been coined as **The Rimouski Augmentation** or **Rimouski Weapon Package** (named after the birthplace of the engineer who designed it).

Doctor Yves Thibodeau of Rimouski, a power armor and robotics design expert, has redesigned the QGB-100's arm, replacing it with a new, multi-purpose weapon package. It is intended to compensate for the lack of short-range weapon capabilities and make GBs isolated in the field, particularly those involved in reconnaissance, rescue and special operations, less vulnerable in close combat situations. This weapon package is typically installed in the left arm. Along with the newly modeled Rimouski arm, the laser targeting and computer radar tracking systems are upgraded with some of the new technology procured from Triax.

Virtually all Glitter Boys operating in small squads, recon, rescue and Special Operations have received the Rimouski Weapon Package. In addition, roughly 30% of all other Classic Glitter Boys have also been augmented with the Rimouski Weapon Package. All new models have been designed to include the new arm from their beginning. The only units not given over to the Rimouski Augmentation are the *QGB-550 NGR-style Glitter Boys*, which already have the advanced systems and close-quarter weapons.

The Classic Glitter Boy

Model Type: QGB-100 (a.k.a. USA-G10). QGB-100 M (for "modified") if the Rouminski Package is incorporated in the armor. The new weapon arm does not change the main model number.

Nicknames: "GB," "The Classic" and "One Hundred."

Class: Laser Resistant Infantry Personnel Assault Unit

Crew: One pilot.

M.D.C. by Location:

Rail Gun (Boom Gun) — 175

* Left Forearm Weapon Package — 110

* Head — 290

* Hands (2) — 100 each

Arms (2) — 270 each

Legs (2) — 450 each

Reinforced Pilot's Compartment — 150

** Main Body — 770

* A single asterisk indicates a small and difficult target to strike, requiring the attacker to make a "called shot," but even then the assailant is -4 to strike.

** Depleting the M.D.C. of the main body will shut the power armor down completely, rendering it useless. **Note:** Laser weapons do half damage!

Speed

Running: 60 mph (96 km) maximum. Note that the act of running does tire its operator, but only at 10% of the usual fatigue rate.

Leaping: The robot legs can leap up to 12 feet (3.6 m) high or across. Add 10 feet (3 m) with a running start. Jet thruster assisted leaps can hurl the power armor 80 feet (24 m) up or across. If necessary, the thrusters can momentarily hold the QGB-100 aloft as high as 12 feet (3.6 m) off the ground, but only for 1D6x10 seconds. The thrusters are not made for flying.

Underwater Capabilities: **Swimming:** The thruster system provides good mobility and control underwater but at a sluggish speed of 15 mph (24 km or 13 knots); roughly the same surface speed. It can also walk along the bottom of the sea or lake bed at about 25% of its normal walking/running speed. To fire its Boom Gun underwater it must be able to engage its pylon system to the sea floor, rocky outcropping or other means of firm support. (**Note:** Sinking the pylons into the hull of an M.D.C. ship or submarine takes several tries — using up 1D4+1 melee actions and signaling to those inside that something is hammering its hull — inflicts 1D4 M.D. and punches a pair of holes into the hull of the vessel). Without suitable support, the force of the shockwave will propel the GB backwards in a spiral for 1D4x100 yards/meters and cause it to lose initiative and its next 1D4+3 melee actions/attacks. Half this distance and 1D4 lost actions if sunken into typically soft underwater flooring.

Maximum Ocean Depth: One mile (1.6 km).

Statistical Data

Height: 10 feet, 5 inches (3.1 m)

Width: 4 feet, 4 inches (1.3 m)

Length: 4 feet (1.2 m)

Weight: 1.2 tons fully loaded.

Physical Strength: Equal to a P.S. of 40

Cargo: Minimal storage space; a foot compartment and storage for a rifle, handgun, survival knife and first-aid kit.

Power System: Nuclear; average energy life is 20 years.

Quebec's Cost: 20 million credits — exclusive to the Free Quebec and NGR Military. 15 million for a unit without the Boom Gun or Rimouski Weapon Package. Ancient USA-G10 models and stolen Quebec models sell on the Black Market for a minimum of 25 million credits and sometimes as high as 40 or 50 million. Very rare.

Weapon Systems

1. RG-15 Rapid Acceleration Electromagnetic Rail Gun (1):

The famous “Boom Gun” is a unique rail gun that can accelerate its flechette style rounds to a speed of Mach 5 (mistakenly catalogued by most to be Mach 2) and actually creates a sonic boom when fired. The gun is the most powerful personal or vehicle weapon to survive the Great Cataclysm and has not yet been successfully duplicated or seen as a worthwhile item for duplication by most high-tech weapon manufacturers. This makes it exclusive to independent Glitter Boy Pilots and the Armies of Free Quebec, and recently, the NGR. (Most believe other comparable weapons exist without the detriments of a sonic boom and shock waves to overcome.)

The weapon is typically attached to the back and right shoulder of the power armor. When not in use, the gun is flipped back and stored in an upward position. When needed for combat, the GB's operator simply reaches back, grasps the handle and pulls forward.

The blast is so powerful that without the automatic stabilization system, the Glitter Boy would be thrown to the ground and knocked back 30 feet (9 m). The automatic stabilization system is a synchronous system of jet thrusters and retractable reinforcement pylons in the legs that hold the armor steady. The pylons and the jets fly into action the moment the Boom Gun is fired.

Primary Purpose: Assault and Anti-Armor.

Secondary Purpose: Anti-Aircraft

Weight: Rail Gun: 867 lbs (390 kg)

Mega-Damage: One Boom Gun flechette round holds 200 slugs that inflict 3D6x10 M.D.!

Effects of the Sonic Boom: The GB suit is specially insulated from the shock waves of its own Boom Gun, however, everyone within 200 feet (61 m) will be temporarily deafened (triple that range underwater). Characters without any type of sound/ear protection will be temporarily deafened for 2D4 minutes and are -8 on initiative and -3 to parry and dodge. Characters who are in protective body armor or power armor will have some protection, but are still temporarily deafened for 1D4 minutes; same penalties apply but for a shorter duration. Each sonic boom adds to the duration of the deafness.

The sonic boom will also affect the physical surroundings by shaking buildings and shattering S.D.C. windows within a 300 foot diameter (91 m) of the boom.

Rate of Fire: Equal to the number of combined hand to hand attacks of the pilot and his power armor (usually 6-8; see Power Armor Training). *Bursts and sprays are not possible!*

Maximum Effective Range: 11,000 feet (about 2 miles/3.2 km).

Payload: 100 rounds/shots. Unlike some of the other power armor suits, the Glitter Boy's Boom Gun can be reloaded by hand, one round at a time, by the pilot. Unfortunately, this takes about 15 minutes to reload approximately 40 rounds. A carrying drum of 400 rounds is sometimes used to carry extra rounds. The drum has 30 M.D.C. and can attach to the hip/waist.

Quick Reload: The Quebec Military has developed a “quick reload” procedure involving what they call *Reload Teams*. These teams of munitions experts ride up behind the Glitter Boy in a hover vehicle specifically designed for reloading GBs. An automated reloading device is hooked up to the back-mounted ammo-drum and quickly refills all one hundred flechette rounds faster than any human fingers could possibly accomplish (typically done in 45 seconds or three melee rounds). These teams can also reload the GB by hand in six minutes instead of the 10-15 that it takes the pilot, because they are working in unison as 2-3 man teams. These teams are always available during mass combat, but rarely for field operations of small squads.

2. Rimouski Weapon Package (1): Part of the newer models used by Free Quebec, the Rimouski Package adds to the Glitter Boy's overall combat capability. The new arm combines several key short-range weapons to help defend the Glitter Boys. They are no match for the infamous Boom Gun, however all of the Glitter Boy pilots agree that the addition of the weapon packages allow for added tactical depth and defense.

- **RM-100 Laser Blaster (1, concealed):** A barely noticeable nozzle is located under the arm — point and shoot. A short-range laser.

Primary Purpose: Anti-Personnel.

Secondary Purpose: Defense.

Mega-Damage: 2D6 M.D. per blast.

Rate of Fire: Equal to the number of combined hand to hand attacks of the pilot and his power armor (usually 6-8).

Maximum Effective Range: 1000 feet (305 m).

Payload: Effectively Unlimited; tied to nuclear power supply.

Bonus to Strike: +1 to strike

- **Laser Finger (1, concealed):** Used primarily as a cutting and welding tool, but can also be used in close combat.

Primary Purpose: Tool.

Secondary Purpose: Defense.

Damage Settings (3): 2D6 S.D.C., one M.D. or 1D4 M.D. per blast.

Rate of Fire: Equal to the number of combined hand to hand attacks of the pilot and his power armor (usually 6-8).

Maximum Effective Range: 20 feet (6 m).

Payload: Effectively Unlimited; tied to nuclear power supply.

Bonus to Strike: +1 to strike

- **RM-100 Vibro-Sword:** An extendable Vibro-Blade concealed in a forearm housing.

Primary Purpose: Anti-Personnel.

Secondary Purpose: Defense.

Weight: A part of the power armor.

Mega-Damage: 2D6+3 M.D. per strike.

Attacks per Melee Round: Equal to the number of combined hand to hand attacks of the pilot and his power armor (usually 6-8). Maximum Effective Range: 3 foot blade (0.9 m).

3. Hand to Hand Combat: Rather than use a weapon, the pilot can engage in Mega-Damage hand to hand combat. Since the inception of the Glitter Boy Legions decades ago, the Glitter Boy Pilots of Free Quebec (as well as the *Descended GB Pilot O.C.C.*) have their own “Elite” GB Combat Training Skill. See the description that follows.

4. Standard GB Sensors & Features of Note: In addition to those standard to power armor, all Glitter Boys have the following:

1. Optical Systems: The QGB-100 has full optical systems, including laser targeting, telescopic, passive nightvision (light amplification), thermo-imaging, infrared, ultraviolet, and polarization.

2. Advanced Laser Targeting: As well as the usual robot standard features, the Boom Gun is +2 to strike.

3. Distress Homing Beacon: Most Quebec Glitter Boys are equipped with a scrambled radio, homing signal for location and extraction from combat zones. However, there is a 30% chance of detection by the enemy and some units assigned to reconnaissance and espionage operations have had the homing beacon disabled.

4. Self-Destruct Mechanism: All Quebec Glitter Boys are equipped with a self-destruct mechanism to prevent the armor and its technology from falling into enemy hands.

5. Laser Resistant Armor: All Glitter Boys are made from special alloys with a chrome-looking surface that is resistant to laser attacks (half damage). Other than Free Quebec (and now Triax of the NGR), no one has ever been able to duplicate this technology. The CS has written it off as obsolete and not worth wasting time and money trying to duplicate, and most others, including Northern Gun, Manistique and the Black Market concur with that sentiment.

Hand to Hand Bonuses from Glitter Boy “Elite” Combat Training

This power armor combat skill includes the ability to pilot *all* variant types of Glitter Boy power armor, including the **Classic Glitter Boy**, **Triax/Cyclops Glitter Boy**, **Tarantula** and **Glitter Girl**. An “elite” GB pilot can also operate the **Taurus Artillery Boy**, **Silver Wolf** and man-sized **Side Kick**, but the bonuses listed below are reduced by half or modified as noted for these last two. (See specific descriptions for possible special bonuses unique to that specific type of power armor.) **Note:** The GB Elite Combat Training skill is exclusive to *Free Quebec Glitter Boy Pilot O.C.C.s* and *The Descended GB Pilot O.C.C.* (which can apply to those outside Quebec). Ordinary Power Armor and RPA Pilots do not get in the “Elite Glitter Boy” Combat Training no matter how experienced they may be. They use either the *Power Armor “Basic”* or *“Elite” Combat Training* stats on page 351 of **Rifts® Ultimate Edition** as per their training. Remember, all bonuses are in addition to the pilot’s own hand to hand combat training and attribute bonuses. They do *not* apply to the pilot’s physical abilities outside of the robot.

- +2 extra attacks/actions per melee round, in addition to those of the pilot at level one; +1 additional attack at levels 3, 7, and 11.
- Critical Strike is the same as the pilot’s.
- +2 on initiative.
- +2 to strike when shooting the Boom Gun and other rail guns and cannons, in addition to any W.P. Heavy Energy Weapons skill bonuses.

- +2 to strike in hand to hand combat.
- +2 to parry in hand to hand combat.
- +2 to dodge.
- +1 to disarm.
- +4 to pull punch.
- +3 to roll with impact, punch or fall.

Restrained Punch: 1D4 M.D.

Full Strength Punch: 1D6 M.D. (One M.D. for the Side Kick.)

Power Punch: 2D6 M.D., counts as 2 attacks. (1D6 for Side Kick.)

Kick Attack: 2D4 M.D. (1D4 for the Side Kick.)

Running Leap Kick: 4D6 M.D. but counts as three attacks. (2D6 for the Side Kick.)

Tear or Pry with Hands: 1D6 M.D. (1D4 for the Side Kick.)

Body Block/Ram: 2D4 M.D. (1D4 for the Side Kick.)

Full Speed Running Ram: 3D6 M.D., but uses up three attacks.

Stomp: 1D6 M.D.; effective only against objects smaller than three feet (0.9 m) tall.

Pylon Impalement: 1D6 M.D., not very useful in most combat situations.

Triax Glitter Boy

Note: Reprinted from **Rifts® World Book Five: Triax & the NGR™**, pages 45-48, with additional text and data specific to Free Quebec.

The Triax 550 model of the Glitter Boy was acquired by Free Quebec through a trade agreement with the New German Republic and its national armaments company *Triax*. The Triax GB is also known as the “Tee-Five-Fifty” (keeping the same numerical I.D. number as used by the NGR) and the “Cyclops” because of its singular, upside down triangular view plate in the center of its forehead. The “Cyclops” sold to Quebec is identical to the T-550 Glitter Boy created and used by the Army of the NGR.

This German Glitter Boy is a sleeker, somewhat smaller version of the USA-G10 Glitter Boy used by Free Quebec. In addition to the changes in size and physical styling, the Triax Glitter Boy has several additional support weapons built into its overall armaments. These include mini-missiles, a laser and a Vibro-sword. The basic operation, mechanics and functions for the “Boom Gun,” recoil suppression system, feet pylons, and laser reflective armor remain unchanged.

Common Name: Triax Glitter Boy

Also Known as: The “Cyclops” Glitter Boy or “Tee-Five-Fifty.”

Model Type: QGB-5-50

Class: Laser Resistant Strategic Armor Military Assault Suit.

Crew: One.

M.D.C. by Location:

* Head — 200

Hands (2) — 75 each

Arms (2) — 200 each

Legs (2) — 400 each

Leg Stabilizer Units (2) — 60 each

Boom Gun (1, right shoulder) — 150

Rear Ammo Drum (1) — 150

Vibro-Sword — 30

Chest Spotlight (1) — 3

** Main Body — 650

* Destroying the head of the power armor will eliminate all forms of optical enhancement and sensory systems. The pilot

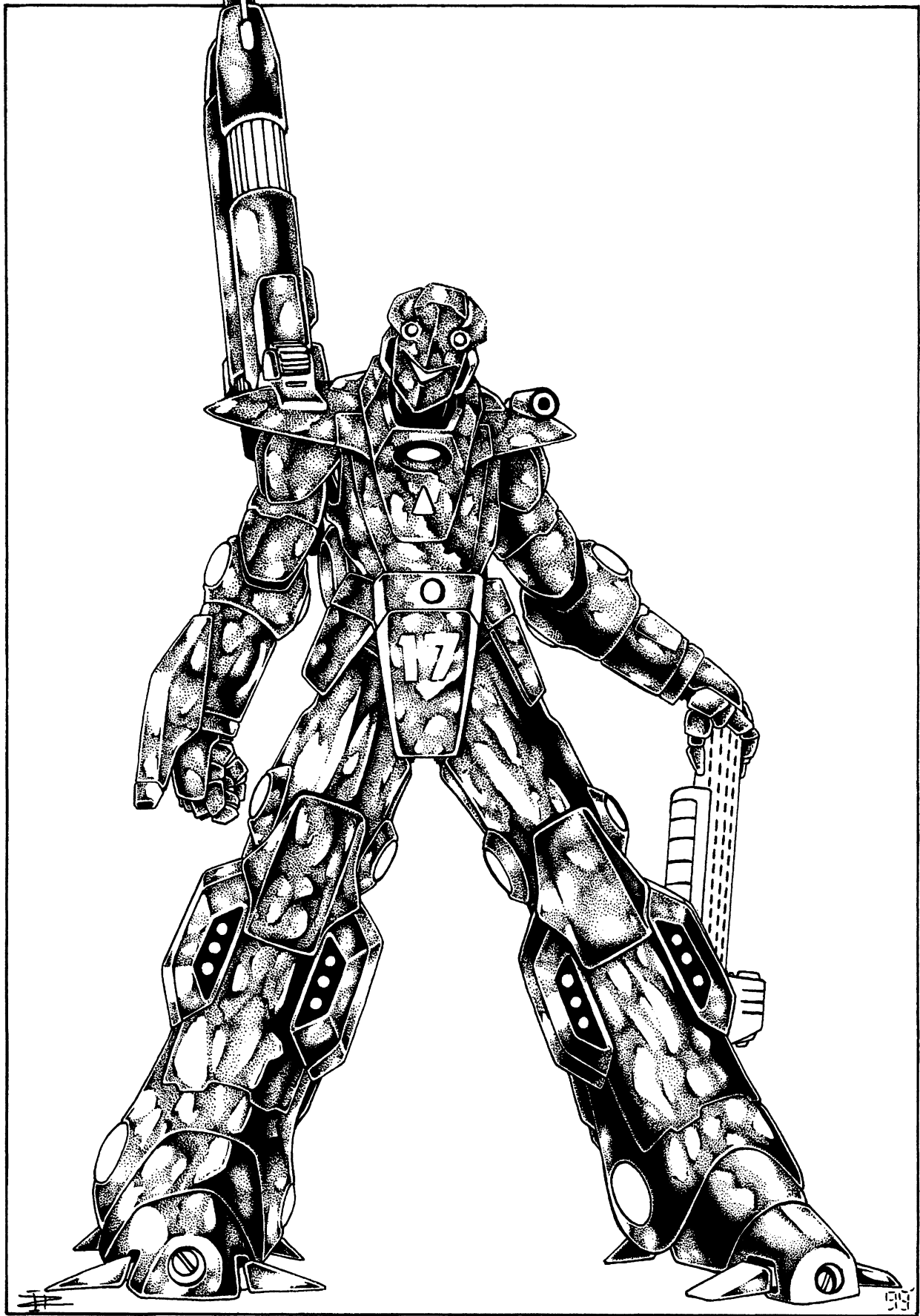

is forced to rely on his own human vision and senses. Furthermore, all power armor combat bonuses to strike, parry, and dodge are lost!

The head is a small and difficult target to strike. It can only be hit when a character makes a "called shot," but even then the attacker is -3 to strike. The two nozzles at the top of the helmet are part of the sensor system.

** Depleting the M.D.C. of the main body will shut the armor down completely, rendering it useless. **Note:** Laser weapons do half damage!

Speed

Running: 60 mph (96 km) maximum. Note that the act of running does tire out its operator, but at 20% of the usual fatigue rate thanks to the robot exoskeleton.

Leaping: The powerful robot legs can leap up to 10 feet (3 m) high or 15 feet (4.6 m) lengthwise from a short running start.

Flying: Flight is not a capability of the Five-Fifty Cyclops.

Statistical Data:

Height: 9 feet (2.7 m) from head to toe, or 10 feet (3 m) with boom gun in firing position.

Width: 3 feet, 9 inches (1.1 m)

Length: 4 feet (1.2 m), including ammo drum and recoil suppression system. 8 feet (2.4 m) from the nose of the gun to the back when the weapon is in firing position.

Weight: 2 tons.

Cargo: A tiny storage space is provided to place a rifle, handgun, survival knife, two signal flares, and food rations.

Power System: Nuclear; average energy life is 11 years.

Free Quebec's Cost: 28 million credits; exclusive to Free Quebec and NGR Military. On the Black Market this coveted and rare Triax product gets 60 million credits.

Weapon Systems

1. TX-550 Boom Gun/Rail Gun (1): This Triax version of the Boom Gun, like its predecessor, fires flechette style rounds at a speed of Mach 4 (slightly slower than the original) and actually creates a sonic boom when fired. The weapon is the first successful *duplication* of this pre-Rifts weapon, but the Triax version departs significantly from the original, combining laser targeting, and independent computer enhanced radar tracking systems and precision automated targeting calibration. When the gun is activated, the computer tracking and targeting systems take over. They instantly seek out the nearest target, or target specified by the pilot, automatically adjusting the angle of the gun. The Boom Gun can be set to auto-fire the instant the enemy is targeted, or to target and wait for the pilot's signal. Or the GB pilot can personally control and direct the movements of the weapon, targeting and shooting via voice command. Either way, the pilot never needs to physically touch the Boom Gun. This leaves both hands free to operate *other* weapons and equipment.

The Boom Gun can angle itself forward and upward in a vertical, 60 degree, arc of fire, but cannot pivot from side to side. To strike a target off to the side, the entire power armor must be turned to face that direction. Again, the radar-targeting computer will help direct the pilot to achieve the proper alignment. When not in use, the gun barrel rotates to an upward position and locks in place. Yes, it can fire in the upward position.

The blast from the big gun is so powerful that without the automatic stabilization and recoil suppression system, the Triax-550 Glitter Boy would be thrown backwards and to the ground. Like its American predecessor, retractable reinforced pylons in the back of the legs shoot into the ground to help hold the Tee-Five-Fifty in place. Synchronized jet thrusters also engage to hold the power armor steady. The pylons automatically retract and the small thrusters disengage when the unit needs to move or reposition itself.

Primary Purpose: Anti-Armor (tanks, robots, dragons, etc.).

Secondary Purpose: Anti-Aircraft/Defense.

Weight: 700 lbs (315 kg).

Mega-Damage: One Boom Gun flechette round holds 200 slugs and inflicts 3D6x10 M.D.

Effects of the Sonic Boom: Same as the *Classic Glitter Boy*.

Rate of Fire: Equal to the number of combined hand to hand attacks (usually 6-8); 5 attacks per melee on auto-fire.

Effective Range: 11,000 feet (about 2 miles/3.2 km)

Payload: 100 rounds. Unlike some power armor suits, the Triax GB can be reloaded by hand, one round at a time, by the pilot (takes about 15 minutes). Alternatively, the empty ammo drum can be removed and a new drum canister replaced by a field mechanic in a high-low or bot or 'Borg (takes about 1-3 minutes).

2. TX-550 Anti-Personnel Laser (1): Located above the left shoulder is a short-ranged, but high-powered Triax laser nozzle. The weapon can rotate 45 degrees in all directions.

Primary Purpose: Anti-Personnel

Secondary Purpose: Defense

Mega-Damage: 3D6 M.D. per blast.

Rate of Fire: Equal to the combined number of hand to hand attacks (usually 6-8).

Effective Range: 1000 feet (305 m)

Payload: Effectively Unlimited.

3. TX-550 Mini-Missile Launchers (4): Near the knees of each leg are a pair of mini-missile launchers. Each launcher contains three mini-missiles.

Primary Purpose: Anti-Aircraft/Anti-Missile.

Secondary Purpose: Defense

Missile Type: Any type of mini-missile can be used, but standard issue is armor piercing (1D4x10 M.D.) or plasma (1D6x10). Fragmentation (5D6 M.D.) may be used for anti-personnel operations.

Mega-Damage: Varies with missile type.

Rate of Fire: One at a time, or in volleys of two, three, or four.

Effective Range: About one mile (1.6 km).

Payload: 12 total; three per each launcher.

4. Vibro-Sword (1; right arm): A large, retractable Vibro-sword is built into the right forearm.

Primary Purpose: Anti-Personnel

Secondary Purpose: Defense

Mega-Damage: 3D6 M.D. per slash.

Rate of Fire: Equal to the number of combined hand to hand attacks (usually 6-8).

Effective Range: Within reach/close combat.

5. Energy Rifle, Light Rail Gun or other hand-held weapon can be used by this power armor. The TX-500 is standard issue, and the SK-50 Kicker, the Coalition C-40R and NG-202 are common substitutes. Heavier weapons such as the *Taurus Box Rocket Launchers* are available only for special missions and reduce speed and maneuverability by 25%.

6. **Hand to Hand Combat:** As per *Elite Glitter Boy Combat Training* presented under the Classic Glitter Boy description.
7. **Sensors and Features of Note:** Standard power armor and GB features (the latter noted under the Classic GB description).

Glitter Girl

Advanced technology and robotics shattered the barriers between the sexes. The greater physical strength and speed of the male warrior no longer played a vital role in the modern army. A woman could capably pilot a hover tank, robot or suit of power armor as well as any male — the gender of the pilot makes no difference. All that is required is a better than average hand-eye coordination, reflex response and a mind for combat. While good physical conditioning is still a requirement, women have taken on a larger and more aggressive role in front-line combat, particularly in the Quebec Military. This is nowhere more evident than among Free Quebec's **Glitter Boy Legions** where women have represented a full 25% of all power armor pilots. In fact, it was discovered that the typical female power armor pilot has a slightly faster reflex response time to outside stimuli, and is much better at taking note of details. This has made female troops particularly effective in reconnaissance and rescue missions, intelligence gathering and surveillance (**Note:** 40-42% of all Military Intelligence and Special Operations personnel, including field agents in the Quebec Military, are *female*. By comparison, only 18-20% hold such positions in the Coalition Army. Women play a more traditional role in the CS Military, where the majority of female personnel hold positions in communications, medicine, and logistics as opposed to front-line combat troops or Special Operations).

Having proven their skill and battle willingness for decades among the traditional Glitter "Boy" troops, the female GB pilots began to lobby for their own division and distinctive appearance. They just want the opposition to know they just got their ass kicked by a girl. High Command liked this idea and the women had earned it. Consequently, when the Military began to experiment with new Glitter Boy designs and styling, they developed the **Glitter Girl**.

This formidable environmental exoskeleton retains all the basic design parameters and abilities of the original design. The legendary "Boom Gun" can be mounted over the shoulder and the suit remains a Mega-Damage powerhouse. Much of the change has been cosmetic making the Glitter "Girl" more shapely and "feminine" in its appearance. Ironically, the "breasts" actually provide for greater protection with heavy armor plating for the upper torso. Since the Quebec female power armor pilots often engage in reconnaissance, rescue and Special Operations/Espionage missions, it has been made slightly smaller, lighter and faster. Likewise, in the spirit of maintaining greater mobility and versatility, the Glitter Girl does not typically use the famous "Boom Gun" unless marching into heavy combat. Instead the standard issue weapon of the Glitter Girl (nicknamed "Gigi") is a back mounted mini-missile launcher and the QST-104, dual system heavy assault rifle.

Despite what some people may believe, the distinctive female appearance works to the pilot's advantage because the reputation of the female pilots is that they are elite, veteran pilots and merciless combatants. Most opposition would rather face

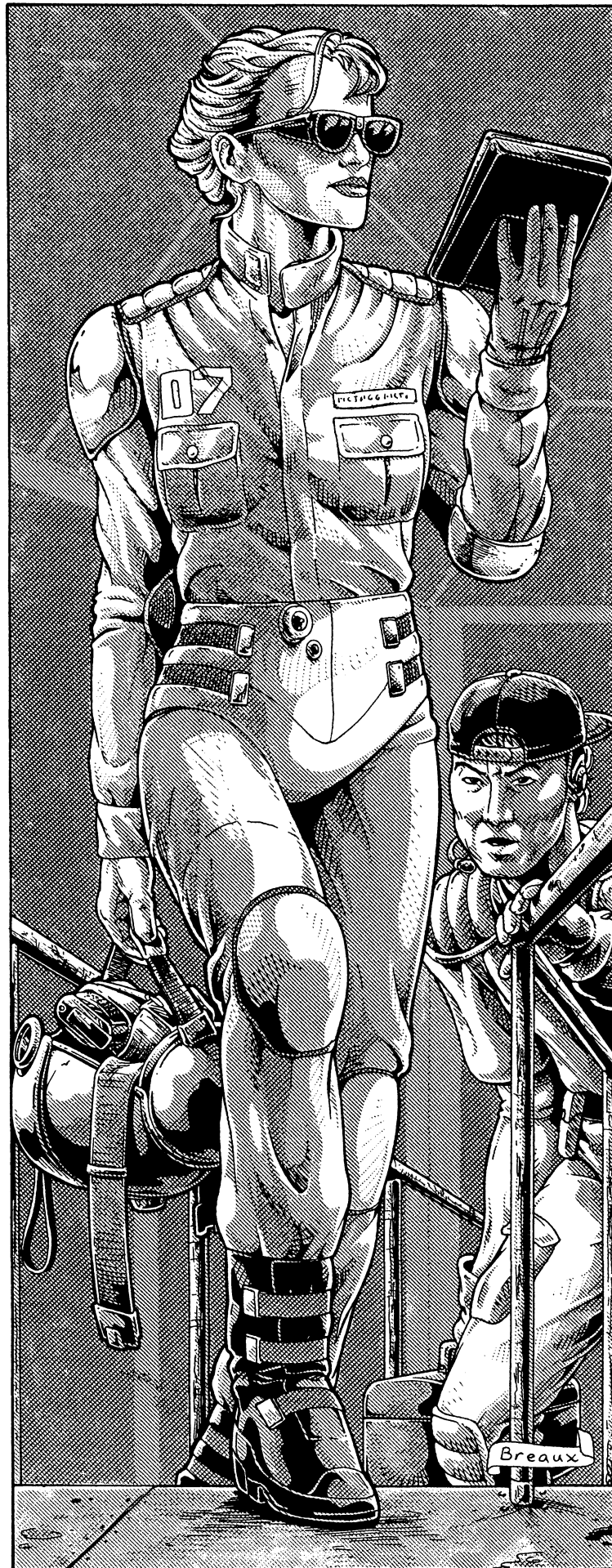

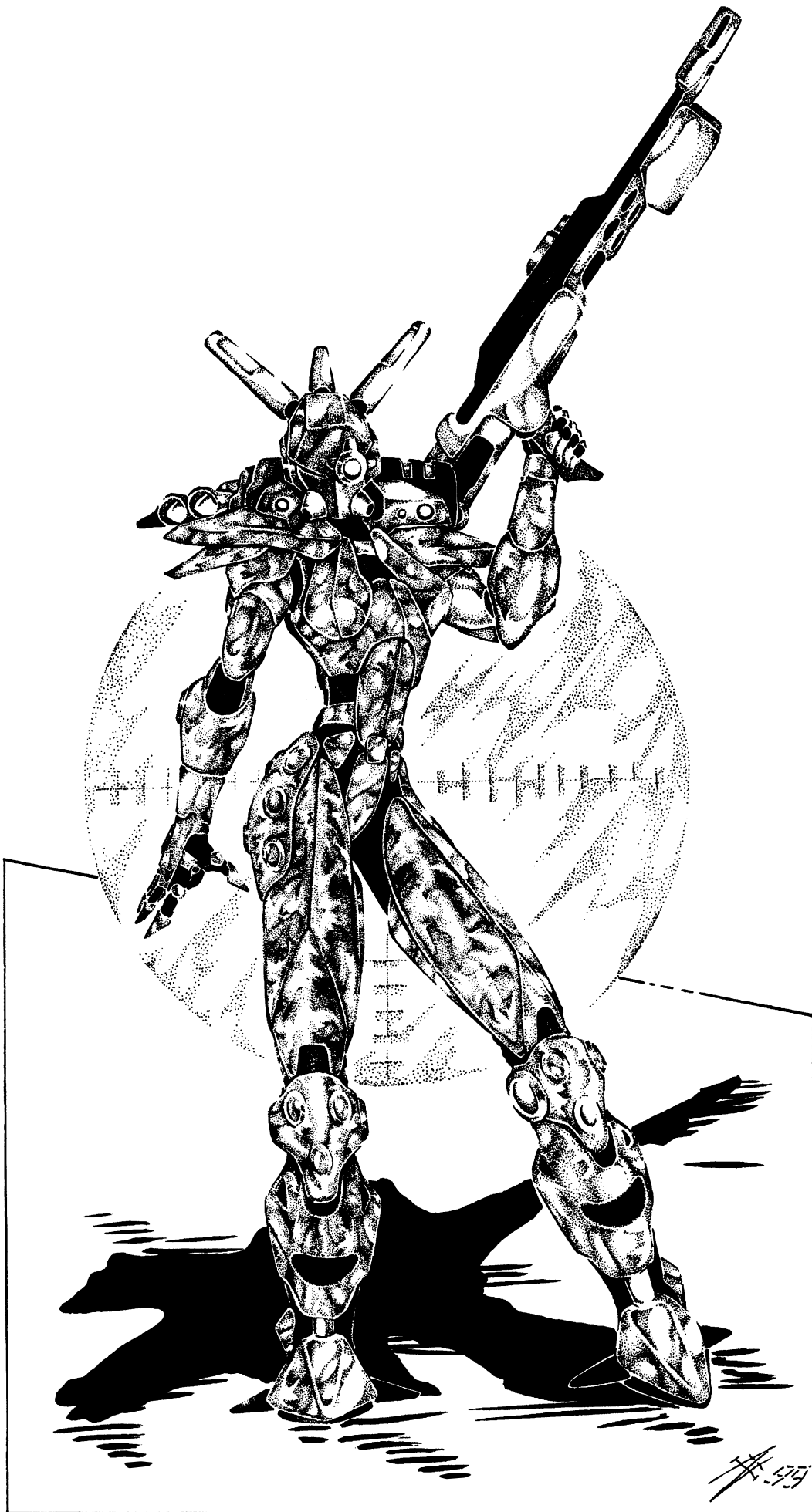

Glitter Boys of any variety, largely because these predominantly male troops are also more likely to have “green” recruits (1st and 2nd level pilots) and generally less seasoned pilots all around (2nd-5th level). The average level of the **Glitter Girl Legion** is 4th-6th, with one third being 7th-10th!

Notable Gigi Companies: The Vixens, Harpies, Harlots and Riot Girls. These four are the best of the best. Only 25% of their pilots are rookies at 2nd-5th level, with the rest ranging from 7th to 12th level! These formidable warriors will be assigned to lead surgical strikes and Special Operations against the CS Army well behind enemy lines. In less than six months, they will be counted among the most feared and hated of the Free Quebec power armor forces.

Glitter Girl

Model Type: QGB-2-20

Nicknames: “Gigi” (short for Glitter Girl/G.G.) and “Two-Twenty.”

Class: Laser Resistant Infantry Personnel Assault Unit.

Crew: One pilot.

M.D.C. by Location:

QST-104 Double-Up Assault Cannon — 150

* Optional: Back-Mounted Mini-Missile Launcher (1) — 50

* Shoulder Mini-Missile Launchers (2) — 20 each

* Head — 270

* Hands (2) — 80 each

Arms (2) — 240 each

Legs (2) — 400 each

Reinforced Pilot’s Compartment — 90

** Main Body — 650

* A single asterisk indicates a small and difficult target to strike, requiring the attacker to make a “called shot,” but even then the attacker is -4 to strike.

** Depleting the M.D.C. of the main body will shut the robot down completely, rendering it useless. **Note:** Laser weapons do half damage!

Speed

Running: 90 mph (145 km) maximum. Note that the act of running does tire its operator, but only at 10% of the usual fatigue rate.

Leaping: The robot legs can leap up to 15 feet (4.6 m) high or across. Add 12 feet (3.6 m) with a running start. Jet thruster assisted leaps can hurl the power armor 120 feet (36.6 m) up or across. If necessary, the thrusters can momentarily hold the Gigi aloft as high as 18 feet (5.5 m) off the ground, but only for 2D4x10 seconds. The thrusters are not made for flying.

Underwater Capabilities: Swimming: The thruster system provides good mobility and control underwater but a sluggish speed of 20 mph (32 km); roughly the same surface speed. It can also walk along the bottom of the sea at about 25% of its normal walking/running speed. To fire its Boom Gun it must be able to engage its pylon system (i.e. walking along the bottom).

Maximum Ocean Depth: One mile (1.6 km)

Statistical Data

Height: 9 feet, 6 inches (2.9 m)

Width: 3 feet, 6 inches (1.09 m)

Length: 3 feet (0.9 m)

Weight: One ton fully loaded.

Physical Strength: Equal to a P.S. of 36

Cargo: Minimal storage space; a foot locker and storage for a rifle, handgun, survival knife and first-aid kit.

Power System: Nuclear; average energy life is 20 years.

Quebec Cost: 24 million credits; exclusive to the Free Quebec Military. 18 million for a unit without any weapon systems.

Note: Gigi, like all Glitter Boy models, is equipped with a self-destruct mechanism to prevent the armor and its technology from falling into enemy hands.

Weapon Systems

1. **QST-104 “Double-Up” Assault Cannon:** This heavy, oversized (for normal humans) assault rifle is specifically designed with the Glitter Girl and Quebec SAMAS in mind. It is a dual weapon system that fires single shot, Mega-Damage explosive rounds and devastating plasma blasts.

The single shot, explosive rounds are specifically designed for precision shooting and sniper operations. It is recoilless, there is no muzzle flash, and it can be fired manually like a rifle or voice activated to shoot upon command.

This *voice activated feature* means Gigi can mount the weapon concealed in a tree, on a rooftop, under a vehicle, among rocks or rubble and leave it there while she goes off to investigate or to deliberately flush or lure out a hidden enemy (“Hey, look! She’s unarmed. This is our chance!”). An electronic eye and computer link keeps the weapon keyed to the position of the pilot, effectively “covering her back.” If any enemy should appear anywhere between the Glitter Girl and the 120 degree “vision” of her weapon she instantly knows it, and with a quick verbal command, the pilot can set the weapon to firing while she turns to engage them in a crossfire or moves to engage another group entirely!

The swivel mount and computer targeting system built into the weapon allows it to “track” enemy (non-Gigi) targets and continue to fire independent of its owner. **Note:** Range of this feature is limited to 1000 feet (305 m) and line of sight is required. The number of automated attacks per melee round is six via explosive rounds or three using plasma blasts. However, without human guidance the weapon has NO bonuses to strike and cannot parry or dodge enemy attacks. Once its location is identified, it is a sitting duck. This is another reason Gigi rarely goes more than 400-600 feet (122 to 183 m) from her weapon.

In the alternative, the concealed weapon can be positioned and used in such a way that it is locked onto the optics of the Glitter Girl. This means the weapon effectively “sees” and tracks whatever Gigi sees. With a short verbal command, the weapon fires at whatever target its mistress sees and wants shot as if she was aiming the gun herself. Under this condition, the weapon is +1 to strike. Obviously it cannot shoot around corners, so the target must be within the QST-104’s “line of sight” as well as the Glitter Girl’s. Most Gigis become expert at judging the range and limits of the weapon. One common ploy when outside the weapon’s “line of sight” is to attract the enemy and run, luring them to give chase, and into the weapon’s line of fire.

QST-104 Plasma feature. The lower portion of the cannon is a plasma ejection system. It is designed to inflict severe damage and directly combat the supernatural, magical and enemy power armor units.

QST-104 Statistics

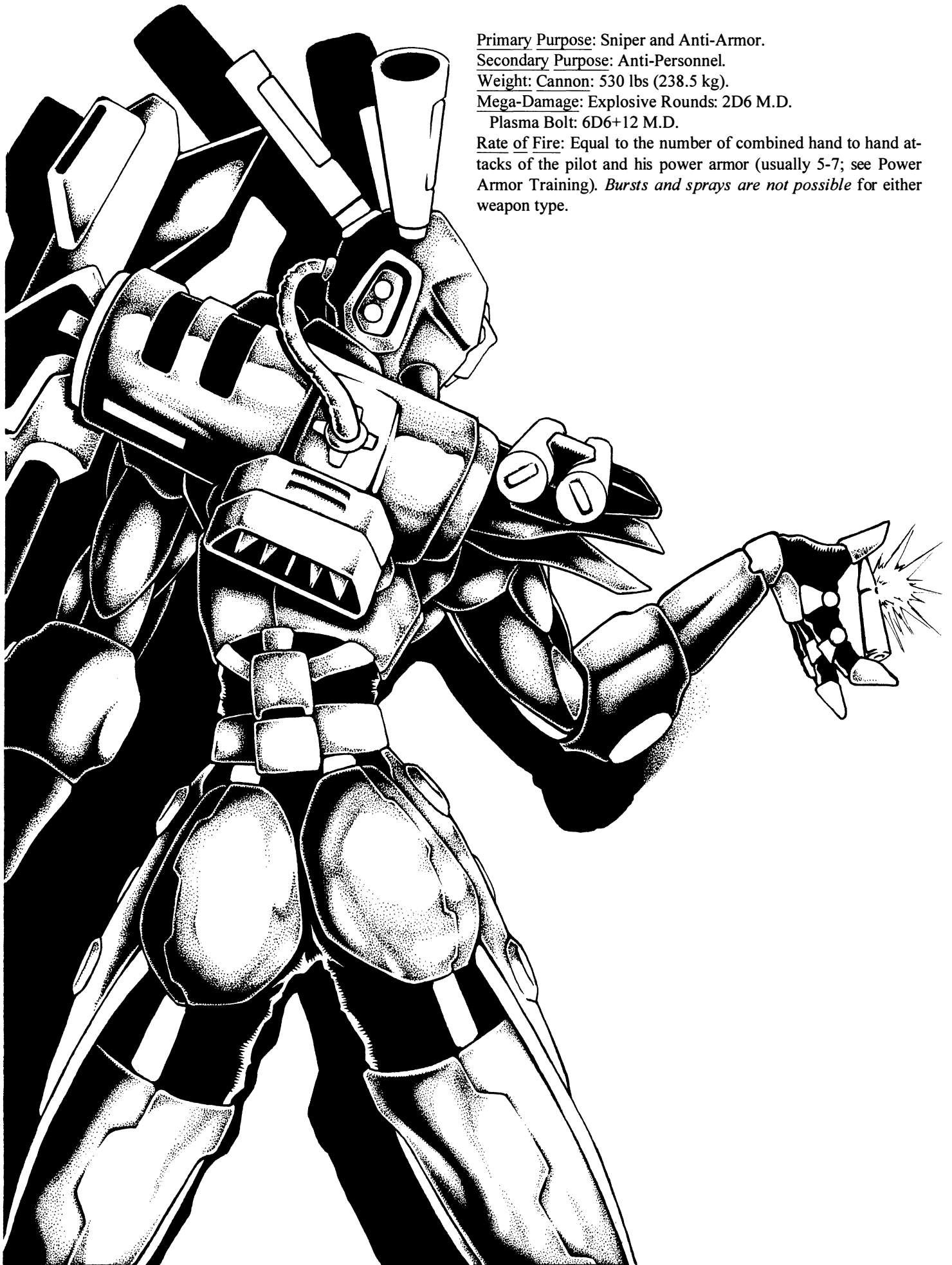

Primary Purpose: Sniper and Anti-Armor.

Secondary Purpose: Anti-Personnel.

Weight: Cannon: 530 lbs (238.5 kg).

Mega-Damage: Explosive Rounds: 2D6 M.D.

Plasma Bolt: 6D6+12 M.D.

Rate of Fire: Equal to the number of combined hand attacks of the pilot and his power armor (usually 5-7; see Power Armor Training). *Bursts and sprays are not possible for either weapon type.*

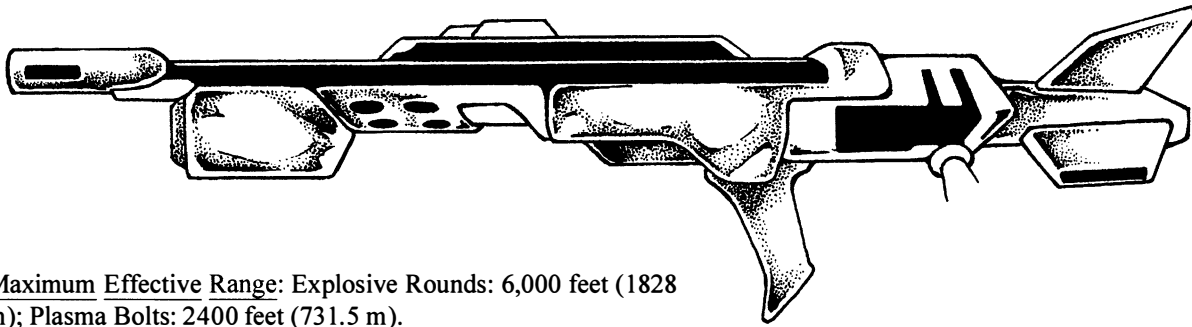

Maximum Effective Range: Explosive Rounds: 6,000 feet (1828 m); Plasma Bolts: 2400 feet (731.5 m).

Payload: 100 explosive rounds. The ammo clip is quick and easy to replace (counts as two melee actions), with 1D4+3 additional ammo clips typically carried in a hip pack or slung over the shoulders. The plasma generator and battery pack is mounted over the right or left shoulder with a connecting power cord to the QST-104. This provides 120 plasma blasts when at full storage capacity and regenerates plasma bolts at a rate of two per minute. A digital counter in the cannon keeps track of the current availability of blasts and rounds for both functions of the gun. When detached from the Glitter Girl, the plasma storage compartment holds 10 blasts, but the addition of a conventional E-clip provides an additional 4 blasts, a long Clip 8, and an E-clip Canister 14.

Notes: The cannon is mounted into the shoulder housing of the plasma generator and can be locked in a forward position, rotate up and down 360 degrees or stowed in a position with the gun barrel locked in an up or down position behind the shoulder. When shoulder mounted, the weapon can be angled 45 degrees right and left. The retractable power cord also enables the Glitter Girl to remove the weapon from its shoulder housing to use as a completely hand-held rifle. Under some combat conditions, Gigi is authorized to carry *two* Double-Up Cannons, one as the standard shoulder mounted unit and a second as an assault rifle.

2. Two Shoulder Mounted Mini-Missile Canister Launchers:

A pair of single-shot, mini-missile launchers are located over the shoulder opposite of the Double-Up Cannon.

Primary Purpose: Anti-Aircraft/Anti-Missile.

Secondary Purpose: Defense.

Missile Type: Any type of mini-missile can be used, but standard issue is armor piercing (1D4x10 M.D.) or plasma (1D6x10). Fragmentation (5D6 M.D.) may be used for anti-personnel operations.

Mega-Damage: Varies with missile type.

Rate of Fire: One at a time, or in a volley of two.

Effective Range: About one mile (1.6 km)

Payload: Two total; one each.

3. Optional: (1) Mini-Missile Backpack Unit. A compact, box style launcher that is mounted on the back of the Glitter Girl. A modular housing allows the missile-pack to “snap” easily and snugly in place.

Primary Purpose: Anti-Aircraft/Anti-Missile.

Secondary Purpose: Defense and assault.

Missile Type: Any type of mini-missile can be used, but standard issue is armor piercing (1D4x10 M.D.) or plasma (1D6x10). Fragmentation (5D6 M.D.) may be used for anti-personnel operations. Smoke types may be desirable for certain missions, particularly those where an enemy installation or strategic position is searched out, located and smoke is needed to mark the location for a tactical air strike.

Mega-Damage: Varies with missile type.

Rate of Fire: One at a time, or in volleys of two or four.

Effective Range: About one mile (1.6 km)

Payload: 12 total.

4. Optional: (1) Traditional RG-14 Rapid Acceleration Electromagnetic Rail Gun, better known as the “Boom Gun” in place of the shoulder mounted QST-104. In this case a hand-held QST-104 may be used like an assault rifle and second heavy weapon. Such use is only available upon special assignment and for squad leaders.

5. Hand to Hand Combat & Special Bonuses: As per *Elite Glitter “Boy” Combat Training*, plus the following additional and accumulative bonuses (add to the normal GB Elite Training bonuses).

+2 on initiative.

+3 to strike with GST-104 Double-Up Assault Cannon (or may use the traditional Boom Gun at usual +2 to strike).

+1 to dodge.

+2 to pull punch.

6. Sensor Systems of Note: Standard power armor and GB features, including a Distress Homing Beacon (a scrambled radio, homing signal for location and extraction from combat zones. There is a 30% chance of detection by the enemy), and a self-destruct mechanism to prevent the armor and its technology from falling into enemy hands.

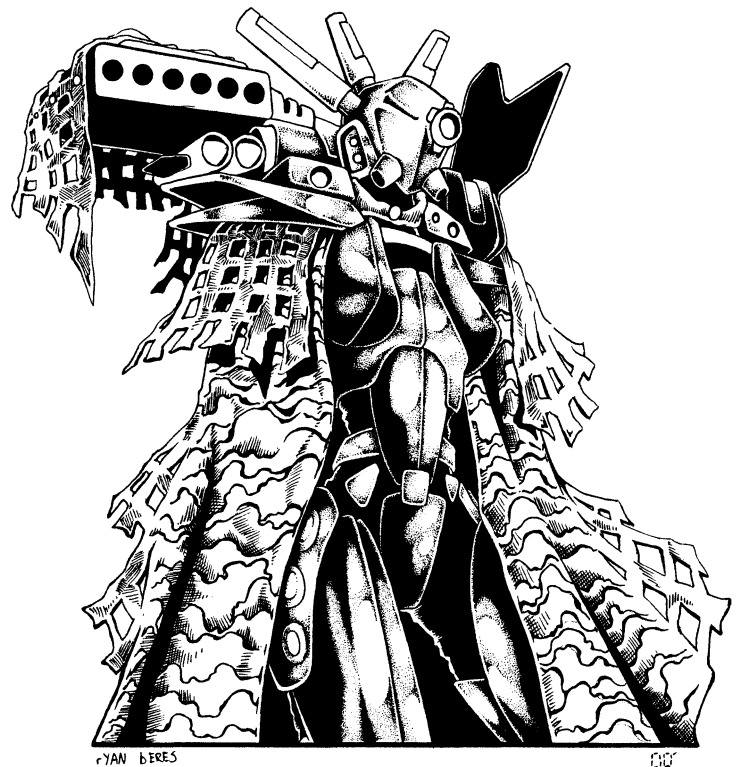



Glitter Boy Side Kick

The Side Kick, also known as the “Little Buddy,” is a small, man-sized suit that borrows a page from the Triax T-21 Terrain Hopper power armor. The Side Kick is a lightweight suit of environmental power armor designed for speed, extreme mobility and limited flight while providing maximum protection. It is the first “man-sized” power armor to utilize the Glitter Boy’s laser resistant, chrome plating. Its specific purpose is to accompany and support Glitter Boys, hence its name. One Side Kick is typically assigned to every 2-4 Glitter Boys (sometimes one SK is assigned to cover 6-10 GBs when availability of the smaller unit is poor or during mass combat operations).

The Side Kick’s job is a simple one: To assist and protect the Glitter Boys assigned to it. This includes protection from missile and aerial attacks as well as from ground troops, snipers, and other outside interference. Side Kicks may also scout ahead, flush out enemy troops, create diversions, help reload the Boom Gun and take other helpful and complementary action. This enables the GB pilot to focus his or her full attention on prime targets (i.e. enemy armor/tanks/robots, aircraft, bunkers and other entrenched positions or mass troop movement), while the smaller, faster Side Kick covers his or her back and lends a helping hand.

Part of the selection and training process of Side Kick pilots is to find men and women who are “team players” and who do not see their position as a Glitter Boy “Side Kick” as demeaning or inferior. As a result, most Side Kick pilots are dedicated and proud of the service they perform. Without them, the Glitter Boy is more vulnerable and less focused. Together, they are a dynamic force that is all the stronger. Of course, Side Kick pilots tend to take a second seat to the GB pilots who usually reap the majority of the accolades, but the Side Kick takes stock in a job well done, and knows the success of a mission often rests in his or her hands.

The Side Kick power armor is fitted with a detachable jet pack that provides limited, low altitude flight. However, the jet pack is not designed for prolonged flying. The ideal method of travel is a combination of walking and short jaunts of 1-50 miles (1.6 to 80 km) flying or by jet propelled leaps. In open combat, the Side Kick is often seen bounding across the battlefield, gun blazing, or rocketing into the sky, stopping momentarily in mid-leap to fire and either dropping back down to earth or zipping around like an angry bee, lighting for a moment before leaping or flying off again — all of which making for a difficult target to hit.

The jet pack is composed of one large rocket jet mounted between the shoulders with a smaller pair hanging below the waist. Additional mini-thrusters in the lower legs of the armor help provide control, direction and mobility. The jet pack is tied directly into the power armor and the boosters will automatically engage every time its operator runs and leaps, as well as upon a verbal command. Motion detectors and sensors in the feet indicate velocity and the moment when both feet have left the ground. At that instant, the booster jets kick in, hurling the character in a power leap 20 to 60 feet (6 to 18.3 m) into the air and that carries the wearer approximately 300 feet (91.5 m) horizontally (forward or backwards). The jet assisted leaps can be done indefinitely without fear of overheating, and give the wearer great ground speed and all-terrain capabilities. As noted earlier, the Side Kick is also capable of limited flight; see stats for details.

Side Kick Flying Power Armor

Model Type: QPA-98 Power Armor

Class: Strategic Armor Military Exoskeleton.

Crew: One

M.D.C. by Location:

*Main Jet Thruster (1) — 90

*Lower Jet Thrusters (2, back) — 30 each

*Leg Directional Thrusters (4, total) — 15 each

Forehead Searchlight (1) — 3

QST-98 Grenade Launcher (1) — 100

**Head — 100

***Main Body — 280 and laser resistant like the GB.

* A single asterisk indicates one of the jet thrusters. Destroying the main thruster makes flight impossible and reduces the leaping height and distance by half.

Destroying the lower jet thrusters reduces flying speed by 20% and makes mobility while flying or leaping unstable, reduce combat bonuses by half.

Destroying both the main and secondary thrusters makes flight impossible, reduce combat bonuses by half and leaping is limited to 12 feet (3.6 m) high and across.

Destroying two or more of the leg thrusters reduces speed by 10% and makes flying the Side Kick wobbly; -1 to strike and dodge.

All are small and/or difficult targets to hit requiring an attacker to make a *called shot* to strike one. Even then the attacker is -3 to strike; -6 if the SK is leaping or flying around.

** Destroying the head/helmet has a 01-70% chance of knocking the pilot unconscious. If conscious, the pilot has two problems. One, no power armor combat bonuses to strike, parry, and dodge. Two, the human head is now vulnerable to “aimed” attacks. **Note:** The head is a small and difficult target to hit (shielded by the main jet). Thus, it can only be hit when an attacker makes a *called shot* and even then the attacker is -3 to strike; -6 if the SK is leaping or flying around.

*** Depleting the M.D.C. of the main body will shut the armor down completely, making it useless and rendering the jet pack inert (no independent power supply). **Note:** Laser weapons do half damage!

Speed

Running: 40 mph (64 km) maximum. The act of running does tire its operator, but at a fatigue rate of 20% of normal, thanks to the robot exoskeleton.

Leaping: A height of approximately 12 feet (3.6 m) straight up or lengthwise is possible *unassisted* by the thrusters.

A jet thruster assisted leap from a stationary position can propel the unit up to 60 feet (18.3 m) high and 300 feet (91.5 m) across without actually attaining flight or requiring a running start.

Power Jumping and travel: The integrated jet pack enables the power armor to leap great heights and distances. Getting a running start will enable the individual to leap up to 60 feet (18.3 m) high and 300 feet (91.5 m) lengthwise. The height of the leap is controlled by the pilot and generally ranges between 20 to 60 feet (6 to 18.3 m); with 30 feet (9 m) of height being average. By leaping, landing, continuing to run a few dozen yards/meters, and power leaping again, the Side Kick can attain and maintain an impressive ground speed of *150 mph (240 km)*, even through light forest. Speed should be reduced by 40% or 50% when travelling through dense vegetation or hazardous terrain. Failure to do so will result in a jarring and potentially damaging collision or accident.

Direction is controlled by the pilot. The capabilities of the jet pack allow the pilot to stop in mid-air, change direction/trajec-tory and hover. However, having to suddenly engage the jet pack in mid-flight to avoid a collision or bad landing may slow one’s speed and make the character an easier target for attack. Likewise, crashing through underbrush or S.D.C. structures makes a lot of noise, alerting predators and the enemy to one’s presence, and reduces the pilot’s vision and awareness (-3 on initiative, -1 to strike, parry, and dodge due to obscured vision and rate of travel).

Limited Flight: Unlike the T-21 Hopper, the Side Kick can actually fly. Maximum height/altitude is 600 feet (183 m). Maximum flying speed is 120 mph (192 km), but cruising speed is considered to be around 60 mph (96.5 km).

Flying Range: The nuclear power supply of the armor gives it a decade of life, but the jet rockets get hot and need to cool after a maximum of one hour of continuous flight. In most cases, the

jets will start to sputter and speed decrease by half after one hour and for another 3D6 minutes before cutting out completely. If the jet pack burns out, the main and secondary thrusters are destroyed, making flying and jet propelled leaps impossible. Remember, traveling by power jumps can be maintained for an unlimited number of hours at a greater speed of 150 mph (240 km).

Underwater Capabilities: Swimming: The thruster system provides good mobility and control underwater but a sluggish speed of 25 mph (40 km); roughly the same surface speed. It can also walk along the bottom of the sea at about 25% of its normal walking/running speed. The range of the grenade launcher is reduced by 25% while the range of the laser pistol is increased by 50%, but most other types of projectile and energy weapons are reduced by half.

Maximum Ocean Depth: 1200 feet (366 m).

Statistical Data

Height: 7 feet (2.1 m)

Width: 3 feet (0.9 m)

Length: About 3 feet (0.9 m)

Weight: 600 lbs (270 kg) without jet pack, 1000 lbs (450 kg) with.

Physical Strength: Equal to P.S. 26.

Cargo: None, however a sidearm (energy pistol), Vibro-Knife, 2D4 hand grenades and basic field equipment (flare, canteen, flashlight, etc.) is usually carried on a waist belt and/or a bandoleer across the chest. A reload of rifle grenades for the gun is typically carried in a satchel slung over the shoulder or attached to a bandoleer style chest belt.

Power System: Nuclear, average life is 20 years.

Quebec's Cost: 8.5 million, largely due to the Glitter Boy, laser resistant, chrome plating used to make this power armor. Exclusive to the Quebec Military. Not available on the Black Market because until the CS war begins, its existence has been kept top secret!

Weapon Systems

No weapons are integrated into the power armor of the Side Kick. Instead a QST-98 Grenade Launcher, rail gun or other heavy weapon is carried as a hand held weapon.

1. QST-98 "Kicker" Grenade Launcher (standard issue):

This is a large, heavy duty grenade launcher with superior range and standard payload (40 rounds). An ammo drum with an additional 80 rounds can be attached to the top. This weapon can be hand carried like an assault rifle or attached to a shoulder support across the back of the armor similar to the mounting of the Glitter Boy's Boom Gun. It has a swivel mount to lower and raise the gun, and can be stowed in a locked position pointing up or down.

Weight: Gun 110 lbs (50 kg), 128 lbs (57.6 kg) fully loaded, 160 (72 kg) with additional ammo drum.

Mega-Damage: 5D6 M.D. per round to a six foot (1.8 m) radius.

Can also fire in short bursts of three inflicting 2D4x10 M.D. This burst attack counts as one melee action but is fired without benefit of *any* strike bonus (unmodified die roll only).

Rate of Fire: Equal to the number of combined hand to hand attacks of the person in the suit (usually 6-8).

Maximum Effective Range: 1800 feet (548.6 m).

Payload: 40 without ammo drum, 120 with ammo-drum.

Typically one full reload (one 80 round drum +40 hand loaded rounds) is carried by the power armor. It takes three melee actions to remove and snap on a new drum, but four melee rounds (one minute) to reload forty by hand (three times that for the untrained).

2. Standard Additional Weapons: In addition to basic field equipment like a canteen, food rations, and a few personal items, the following are standard issue.

Sidearm: The Coalition *C-18 Laser Pistol*, held either in a hip or shoulder holster. **Damage:** 2D4 M.D., **Range:** 800 feet (244 m), **Payload:** 10 shots. **Note:** Typically carries an additional 2-4 E-clips.

CS Vibro-Knife: Inflicts 1D6 M.D., typically sheathed and strapped to the back of the lower leg or forearm, but may be kept in the belt or bandoleer.

CS Hand Grenades: 1D4 explosive hand grenades, typically Fragmentation or Plasma (see the **Rifts® Ultimate Edition**, page 260, for complete list) and 1D4 Smoke grenades for creating ground cover or marking locations.

3. Optional Weapons: Being "man-sized" the Side Kick can use most any type of handgun, rifle or light rail gun. The old Coalition C-27 Plasma Cannon, C-12 laser assault rifle and C-14 Fire Breather are among the more favored alternatives to the QST-98, and are sometimes used as secondary/back-up weapons.

4. Sensors & Features: All basic features common to power armor, plus the laser resistant armor of the Glitter Boy (laser fire does half damage).

Sensors, Optics & Features of Note: The helmet is equipped with a searchlight (1000 foot/305 m range) and the SK has full optical systems, targeting, and other features common to all power armor.

Special Bonuses: +1 to strike is applicable to long-range weapon combat only. Hand to Hand Bonuses: +1 on initiative, +1 to parry, +2 to dodge, and is automatically +6 to dodge while travelling by means of power jumps. For other bonuses see *Power Armor Combat Training Elite* in the **Rifts® Ultimate Edition**, page 351.

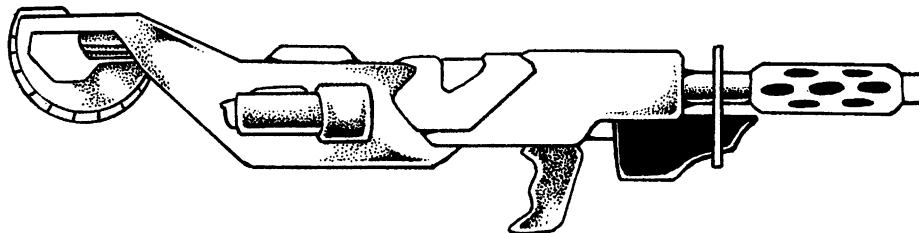

Tarantula Glitter Boy

The Tarantula is an attempt at restyling the Classic Glitter Boy to provide even greater armor protection and an alternative system of balance. As a result, a series of small stabilizer fins and two large fins on the back were designed to provide better balance in an attempt to get away from the pylon and thruster method of the "Classic" Glitter Boy (the Tarantula does not have pylons or the traditional thrusters). Without having to "plant" pylons into the ground, the Tarantula can respond quicker and is more mobile than the traditional models. When a *Boom Gun* is used by the Tarantula, a series of tiny jets in the upper back of the body engages to help keep it upright, while the fins catch the air to help hold the power armor in place. The result is not a complete success because the recoil from the traditional Boom Gun causes the Tarantula to stagger and step back 1D4 paces with each blast. While no melee actions are lost from this jarring motion, each blast after the first of each melee round shoots without benefit of any bonus to strike (only the first blast of the melee round gets a bonus). This is not a complete disappointment because the Tarantula has been designed to handle a new, experimental weapon known as the "Shaker," to replace the traditional Boom Gun (This weapon is described under Weapon Systems).

In addition to the devastating and versatile Shaker Cannon, the Tarantula has a short-range ion blaster mounted on one forearm (may be alternated with a two shot mini-missile launcher) and a retractable Vibro-Blade on the other. The standard model has a heavily plated head without any special weapons, but a recent "type two head" variant sports a pair of short-range lasers at the temples.

The Three-Thirty Glitter Boy is nicknamed the "Tarantula" because its designer felt the many small stabilizing fins resembled the hairs on a tarantula spider and the pair of large fins made its silhouette resemble that of a spider with outstretched legs. Whether one can see the spider resemblance or not (many can not), this variant Glitter Boy is strong, powerful and the biggest of the GB series.

The "Tarantula" Glitter Boy

Also known as the T-Boy.

Model Type: QGB-3-30

Class: Laser Resistant Infantry Personnel Assault Unit.

Crew: One pilot.

M.D.C. by Location:

- QST-333 Shaker Cannon (1) — 175
- * Ammo-Drum (1, lower back) — 120
- * Ion Blaster (1, left forearm) — 50
- * Vibro-Blade (1, right forearm) — 50
- * Head — 290 (310 for the Type Two variant)
- * Hands (2) — 100 each
- * Small Fins (14) — 12 each
- Large Fins (2, back) — 65 each
- Arms (2) — 300 each
- Legs (2) — 500 each
- Reinforced Pilot's Compartment — 120
- ** Main Body — 850

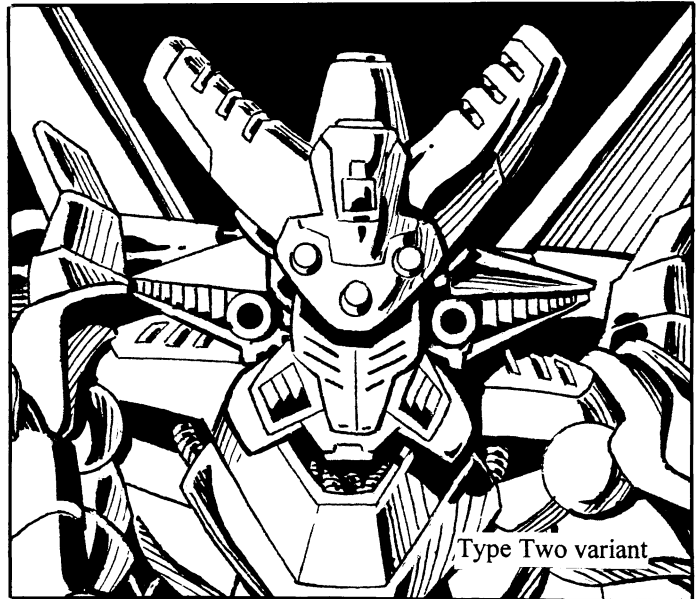

* A single asterisk indicates a small and/or difficult target to strike, requiring the attacker to make a "called shot," but even then the assailant is -4 to strike.

** Depleting the M.D.C. of the main body will shut the power armor down completely, rendering it useless. **Note:** Laser weapons do half damage!

Speed

Running: 50 mph (80 km) maximum. Note that the act of running does tire its operator, but only at 10% of the usual fatigue rate.

Leaping: The robot legs can leap up to 10 feet (3 m) high or across. Add 10 feet (3 m) with a running start. Jet thruster assisted leaps can hurl the power armor 60 feet (18 m) up or across. If necessary, the thrusters can momentarily hold the QGB-3030 a loft as high as 10 feet (3 m) off the ground, but only for 1D6x10 seconds. The thrusters are not made for flying.

Underwater Capabilities: Swimming: The thruster system provides good mobility and control underwater but at a sluggish speed of 15 mph (24 km or 13 knots); roughly the same surface speed. It can also walk along the bottom of the sea or lake bed at about 25% of its normal walking/running speed. Laser range underwater is increased by 50%, but the range of the plasma, ion and rail weapons are all reduced by half.

Maximum Ocean Depth: 1.2 miles (1.9 km).

Statistical Data

Height: 11 feet, 5 inches (3.4 m) from head to toe, plus 3 feet (0.9 m) for the pair of large back fins.

Width: 4 feet, 8 inches (1.46)

Length: 4 feet, 6 inches (1.4 m)

Weight: 1.6 tons fully loaded.

Physical Strength: Equal to a P.S. of 40

Cargo: Minimal storage space; a foot locker and storage for a rifle, handgun, survival knife and first-aid kit.

Power System: Nuclear; average energy life is 20 years.

Quebec's Cost: 23 million credits — exclusive to the Free Quebec and NGR Military. 19 million for a unit without the QST-333 or other weapon features. Not available on the Black Market because until the CS war begins, its existence has been kept top secret! Models that may be acquired by the Black Market in the future are likely to sell for a minimum of 30 million credits and as high as 50 million; very rare.

The "Tarantula" Glitter Boy

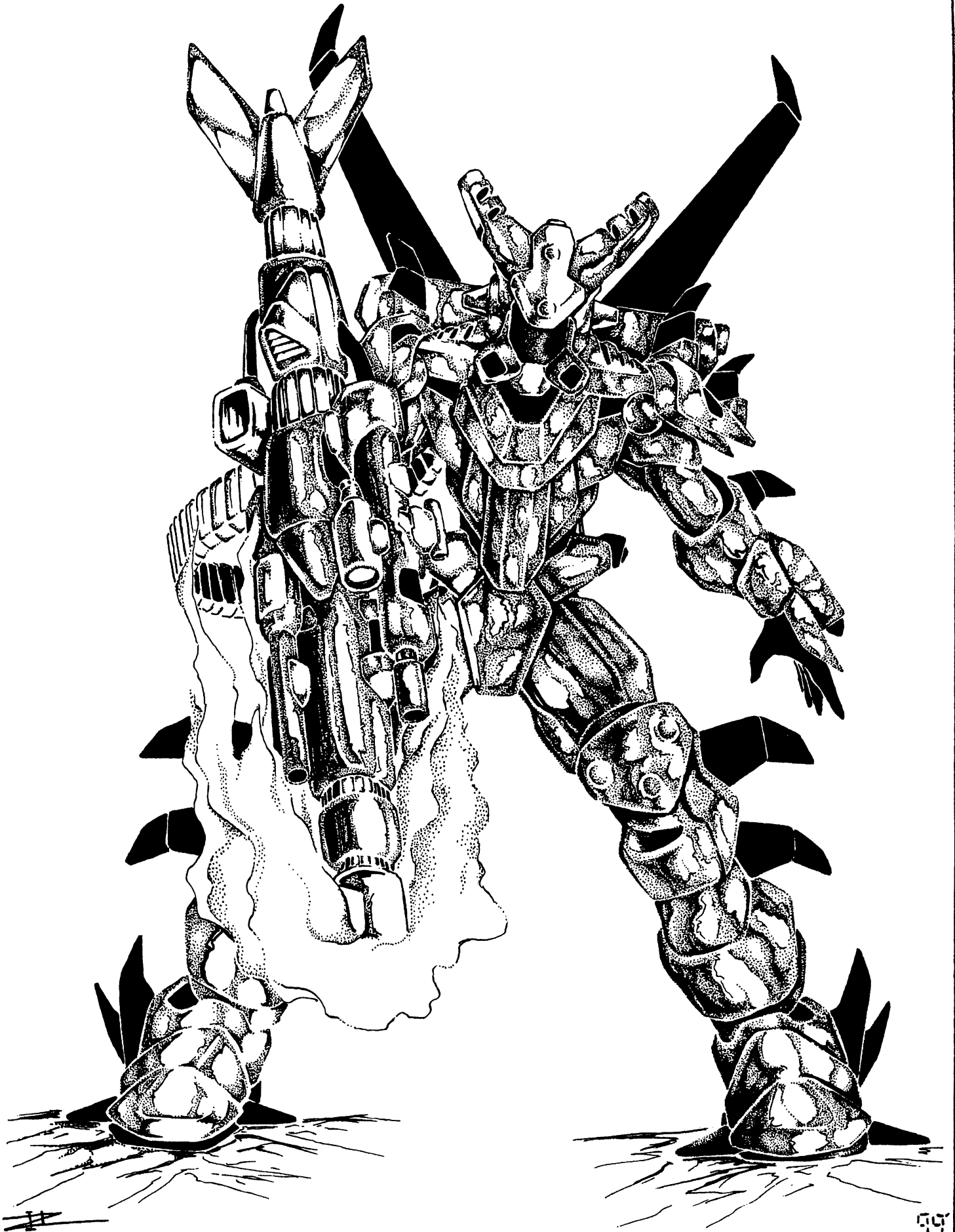

Weapon Systems

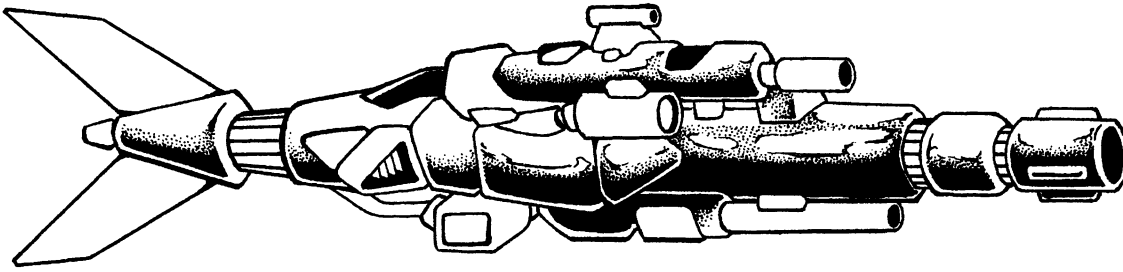

1. **The QST-333 or “Shaker” Cannon** (short for Shake and Bake) is a massive, triple function assault cannon that combines a high-powered rail gun with energy expulsion technology in a single unit. It is the pinnacle of Free Quebec weapon technology and a devastating multi-purpose infantry weapon.

Actually, the big gun has its share of problems, with size and weight being two of the most immediately obvious. However, the weapon engineers could not make this powerful weapon any smaller. Its massive size and bulk make it suitable only for use by the **Tarantula Glitter Boy** or a similarly large robot — except giant robots which is an area Free Quebec has avoided. Theoretically, the Shaker Tri-Cannon could be mounted on a heavy vehicle, but use on both a robot or vehicle has its own set of problems. One is the recoil and heat from the plasma ejector (which the heavy laser resistant Glitter Boy armor is protected from), another is the vibrations and shaking caused by the rail gun fire. Both of which quickly degrade the structural integrity of the bot or vehicle it is mounted on. In the case of vehicles, the vibrations and heat cause M.D. tires to blow, weld joints to snap, bolts to pop, damage to internal electronics, engines to stall, and structural damage, to say nothing of the wear and tear on the personnel manning the vehicle.

Likewise, a *Full Conversion Cyborg* can “attempt” to use the cannon but it requires the use of both hands and the ‘Borg is -5 to strike with the unwieldy thing. Furthermore, use of the “Shaker” Rail Gun feature will rattle the ‘Borg around like a spinning top (equal to shooting wild and the shooter loses initiative, one melee action, and his sense of direction and balance, usually falling down the moment he stops shooting). Firing the plasma ejector will knock a cyborg back twenty feet (6 m) and on his behind, resulting in the loss of two melee actions, initiative and suffers 1D6 M.D. from the searing backlash of heat — as will anybody standing directly next to or behind the shooter.

Glitter Boy Note: Even when used by other Glitter Boys or Gigi the shooter is -2 to strike and suffers one point of Mega-Damage; and the Side Kick can not use this monster of a cannon at all. The special design of the *Tarantula Glitter Boy* includes additional armor and heat resistant plates, a special cooling system (steam and smoke actually rises from the slots in the top of the GB’s head like a chimney as well as the back and barrel of the cannon) in order to handle the Shaker without damage to the power armor or its pilot. Meanwhile, the airfoil fins and rear mini-thrusters provide the balance and stability necessary to fire the Shaker without penalty.

QST-333 “Shaker” Tri-Cannon: The long side barrel is a high-powered laser. The main center barrel is the plasma ejector. The short side barrel is the rapid-fire rail gun. This weapon

sacrifices the unparalleled (well mostly unparalleled) range and devastating power of the Boom Gun for greater versatility.

Primary Purpose: Assault and Anti-Armor.

Secondary Purpose: Anti-Aircraft

Weight: 816 lbs (367 kg).

Mega-Damage:

Laser: 4D6 M.D.

Plasma Bolts: 1D6x10+6 M.D.

Rail Gun: A single round does 1D6 M.D., a typical burst is 30 rounds and does 1D6x10 M.D.

Rate of Fire: Equal to the number of combined hand to hand attacks of the pilot and his power armor (usually 6-8; see Power Armor Training). *Bursts and sprays are not possible for the laser or plasma weapon!*

Maximum Effective Range:

Laser: 2000 feet (610 m).

Plasma Bolts: 2400 feet (731.5 m); a North American record distance for this type of weapon, even a giant one.

Rail Gun: 6000 feet (1828 m).

Payload:

Laser: Effectively unlimited; tied to the GB’s power supply.

Plasma: Technically unlimited, but the gun can only fire three plasma bolts per melee round. To attempt to fire plasma more often than this will cause the weapon to overheat with in one melee round (15 seconds) and cause the fail-safe system to shut the entire weapon down completely! Disabling the fail-safe will allow the pilot to fire plasma attacks for 1D4 melee rounds before the weapon explodes, inflicting 4D6x10 M.D. to the GB and 1D6x10 M.D. to everything within a 15 foot (4.6 m) radius round it. The gun is melted into worthless slag (nothing is salvageable).

Rail Gun: The weapon itself holds 300 rounds (10 bursts) and is connected to an ammo drum that holds 3000 rounds (100 bursts). The drum is typically mounted on the lower back of the GB. A Reload Team can unlock and replace a T-Boy’s ammo-drum in 45 seconds.

Note: Like the Classic Glitter Boy, the Shaker Cannon is hooked to a shoulder mounting that can be stowed in a locked position over the right (or left) shoulder. To access it, the pilot need only reach back, grip the handle and pull forward.

2. **Forearm Ion Blaster (1):** Typically mounted on the left arm is a high-powered ion blaster for close combat

Primary Purpose: Anti-Personnel.

Secondary Purpose: Defense.

Mega-Damage: 4D6 M.D. per blast.

Rate of Fire: Equal to the number of combined hand to hand attacks of the pilot and his power armor (usually 4-6).

Maximum Effective Range: 1000 feet (305 m).

Payload: Effectively unlimited; tied to nuclear power supply.

3. Vibro-Sword (1): An extendable Vibro-Blade concealed in a forearm housing, typically the right arm.

Primary Purpose: Anti-Personnel.

Secondary Purpose: Defense.

Weight: A part of the power armor.

Mega-Damage: 2D6+3 M.D. per strike.

Attacks per Melee Round: Equal to the number of combined hand to hand attacks of the pilot and his power armor (usually 6-8).

Maximum Effective Range: 3 foot blade (0.9 m).

4. Optional: Type Two Head with Dual Lasers: This is a variant head with slightly larger heat vents, more facial armor, and a pair of short-range lasers level with the eye slit.

Primary Purpose: Anti-Personnel.

Secondary Purpose: Defense.

Mega-Damage: 2D6 M.D. per single blast or 4D6 per double blast.

Rate of Fire: Equal to the number of combined hand to hand attacks of the pilot and his power armor (usually 6-8).

Maximum Effective Range: 1200 feet (366 m).

Payload: Effectively unlimited; tied to nuclear power supply.

Bonus to Strike: +1

5. Optional: Forearm Mini-Missile Launcher:

Primary Purpose: Anti-Aircraft/Anti-Missile.

Secondary Purpose: Defense

Missile Type: Any type of mini-missile can be used, but standard issue is armor piercing (1D4x10 M.D.) or plasma (1D6x10). Fragmentation (5D6 M.D.) may be used for anti-personnel operations.

Mega-Damage: Varies with missile type.

Rate of Fire: One at a time, or in volleys of two, three, or four.

Effective Range: About one mile (1.6 km).

Payload: Two total.

6. Optional: RG-15 Rapid Acceleration Electromagnetic Rail Gun (1): The Shaker Tri-Cannon can be substituted with the famous "Boom Gun." See the *Classic Glitter Boy* for complete stats.

7. Hand to Hand Combat: Rather than use a weapon, the pilot can engage in Mega-Damage hand to hand combat. Since the inception of the Glitter Boy Legions decades ago, the Glitter Boy Pilots of Free Quebec (as well as the *Descended GB Pilot O.C.C.*) have had their own "Elite" **GB Combat Training Skill**. See the description under the Classic Glitter Boy.

8. Sensors & Features of Note: Standard power armor and GB features, including a Distress Homing Beacon (a scrambled radio, homing signal for location and extraction from combat zones. There is a 30% chance of detection by the enemy), and a self-destruct mechanism to prevent the armor and its technology from falling into enemy hands.

Taurus Glitter Boy

The Taurus is a limited production, experimental variant that emphasizes the *artillery* aspect of the Glitter Boy (the Taurus represents only 5% of the current Glitter Boy Forces). Like the Tarantula, the QGB-7-70 Taurus is big, heavy and better armored. Unlike the other Glitter Boys, however, it is not an infantry assault power armor, but designed for heavy support. Its weapons are a *pair* of massive cannon-like guns. Each Taurus is always accompanied by a Reload Team and a Side Kick, the former to keep loading and working the big guns, the latter to assist and defend the Taurus and Reload Team.

As a piece of walking artillery, the Seven-Seventy has no close combat weapons, not even the Rimouski Weapon Package. Instead, it wields either two massive, shell-launching mortars or a pair of powerful laser cannons with their own power supply (both weapons are very similar in their appearance to keep the enemy guessing). To fire either of these weapons, the QGB 7-70 grabs hold of a hooked handle with a press trigger clicked by the thumb to shoot.

One might wonder why make an expensive Glitter Boy a walking artillery unit when a tank or lightly armored vehicle could be used for similar purpose at half the cost. The answer is simple, concealment and mobility. A tank or artillery cannon is easy for the enemy to recognize and target. Such a "vehicle" is comparatively large and has a distinctive shape among infantry troops or Glitter Boy Legions, and is especially easy to spot and target from the air. However, another *Glitter Boy* among a group of fellow Glitter Boys, even with groups as small as a company (140 GBs) or a platoon (40 GBs), the Taurus is much more difficult to pick out, even with its two guns. Furthermore, as a Glitter Boy, it is a comparatively small, mobile *all-terrain* suit of power armor that can handle most environments, from city streets and woodlands to mountains and underwater. The Glitter Boy is easy to transport, maintain and camouflage. It also offers greater versatility than a tank because it is not limited to any one type of weaponry. The Taurus can literally pick up and use *any* of the Glitter Boy weapons, from Boom Gun to Gigi Laser Cannon. This means the Taurus has the standard pylon and thruster arrangement to maintain balance when using any of the big guns. In fact, for greater strength, the legs and feet are slightly enlarged, thicker and the feet have a set of four small pylon-like stakes, jokingly referred to as "cleats" that also fire into the ground for a firmer grip and toe hold. The head is the same basic design as the Silver Wolf and the rest of it is pretty standard.

The Taurus Glitter Boy

Model Type: QGB-7-70

Nicknames: Also known as "Two-Guns" and "Arty" (because of its primary use as an artillery support unit).

Class: Laser Resistant Infantry Personnel Artillery Unit.

Crew: One pilot.

M.D.C. by Location:

*Guns (2, type varies) — 150 each

*Head — 290

*Hands (2) — 100 each

Arms (2) — 290 each

Legs (2) — 500 each

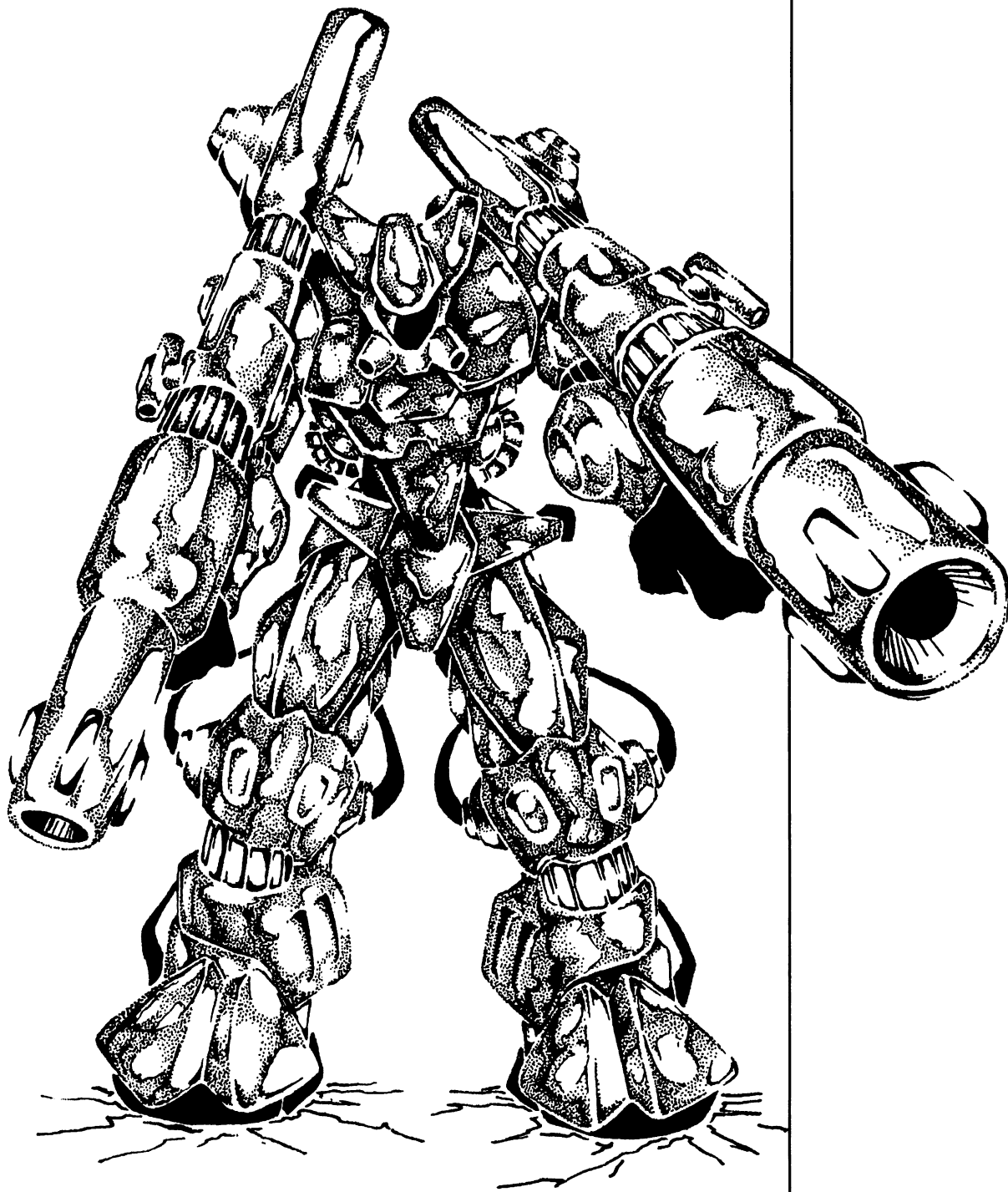

Handwritten signature or mark.

99

Reinforced Pilot's Compartment — 150

**Main Body — 800

* A single asterisk indicates a small and difficult target to strike, requiring the attacker to make a "called shot," but even then the assailant is -4 to strike.

** Depleting the M.D.C. of the main body will shut the power armor down completely, rendering it useless. **Note:** Laser weapons do half damage!

Speed

Running: 50 mph (80 km) maximum. Note that the act of running does tire its operator, but only at 10% of the usual fatigue rate.

Leaping: The robot legs can leap up to 8 feet (2.4 m) high or across. Add 10 feet (3 m) with a running start. Jet thruster assisted leaps can hurl the power armor 60 feet (18.3 m) up or across. If necessary, the thrusters can momentarily hold the QGB-7-70 a loft as high as 12 feet (3.6 m) off the ground, but only for 1D6x10 seconds. The thrusters are not made for flying.

Underwater Capabilities: Swimming: The thruster system provides good mobility and control underwater but at a sluggish speed of 15 mph (24 km or 13 knots); roughly the same surface speed. It can also walk along the bottom of the sea or lake bed at about 25% of its normal walking/running speed. Depending on the type of weapon, the range underwater is likely to be reduced by 50%. This applies to mortar fire as well and the recoil will propel the shooting GB at least 100 yards/meters.

Maximum Ocean Depth: One mile (1.6 km).

Statistical Data

Height: 10 feet, 10 inches (3.3 m) without weapons mounted on its shoulder, add 3 feet (0.9 m) for the standard artillery weapons of the Taurus.

Width: 4 feet, 4 inches (1.3 m); add four feet (1.2 m) when artillery guns are attached.

Length: 4 feet (1.2 m), but add 3 feet (0.9 m) when the artillery guns are attached.

Weight: One ton for the basic GB; two when fully loaded.

Physical Strength: Equal to a P.S. of 40.

Cargo: Minimal storage space; a foot locker and storage for a rifle, handgun, survival knife and first-aid kit.

Power System: Nuclear; average energy life is 20 years.

Quebec's Cost: 18 million credits without weapons — exclusive to the Free Quebec and NGR Military. A fully loaded Taurus GB on the Black Market is likely to command something in the range of 30-45 million credits. Very rare.

Weapon Systems

1. High-Powered Mortars (2): The standard weapon of the Taurus is a pair of high-powered mortars. The mortar round is loaded, locked, and fired. The Reload Team is responsible for the quick loading of the mortars while the Side Kick protects all parties. The big guns can be loaded with as many as six shells each and fired in tandem at the same target, one at a time, or at completely separate targets.

Mortar fire often requires pointing the firing tube up at 30 to 90 degree angle to "launch" the projectile in a looping arc to bombard an opponent up to two miles (3.2 km) away. In this case, the Reload Team assigned to the Taurus will also help pinpoint enemy targets, prepare coordinates and calibrate the angle for a successful hit. Mortar fire is most effective against ground troops (tears troops to shreds), vehicle convoys, large targets (including Death's Head Transports) and entrenched fortifications.

Weight: The pair of big guns weighs 1430 lbs (643.5 kg).

Primary Purpose: Artillery Strikes and Anti-Personnel.

Secondary Purpose: Anti-Armor, Anti-Monster and fortifications.

Mortar Type: Heavy Explosive or Smoke are standard.

Mega-Damage: Explosive: 1D6x10 per single mortar to a 20 foot (6 m) blast radius, 2D6x10 for a simultaneous double blast (counts as one melee action). Smoke provides cover and is used for targeting.

Rate of Fire: One at a time, or in a volley of two.

Effective Range: About 2.2 miles (3.5 km)/12,000 feet (3657 m).

Payload: 12 total; six per gun. However, the standard Taurus Reload Team (3 or 4 man team in standard M.D.C. body armor) pilots a light hover vehicle with a minimum of 96 mortar rounds for each gun, plus a *QST-104 "Double-Up" Assault Cannon* (see Glitter Girl) as an alternate or backup weapon.

Bonus: When the target is no more than one mile (1.6 km) away, the Taurus is +1 to strike. Add another +1 if the target is out in the open and clearly visible, and an additional +2 to strike if it is a large, stationary or slow moving target such as a giant robot, dragon, Death's Head Transport, a convoy of tanks or other vehicles, an army of ground troops, a town, fortification and similar.

Penalties: -2 to strike a specific, moving, Glitter Boy-sized or smaller target, or when the target (of any size) is more than one mile (1.6 km) away.

-3 to strike when the target is under cover, obscured, invisible or otherwise out of line of sight.

-6 to strike something that QGB-sized or smaller moving faster than 60 mph (96 km), like a dodging Juicer, running cyborg, speeding hovercycle or power armor, SAMAS, flyers, aircraft, and other small, fast targets.

2. Optional High-Powered Laser Cannons (2): A pair of huge, long-range laser cannons can be used instead of the mortars. These are typically used to make precision strikes against armor and aircraft. An independent, backpack power generator is hooked to the back of the Taurus GB and supplemented by the armor's own power supply.

Weight: The pair of laser guns weighs 1120 lbs (504 kg).

Primary Purpose: Anti-Aircraft and Anti-Armor.

Secondary Purpose: Defense.

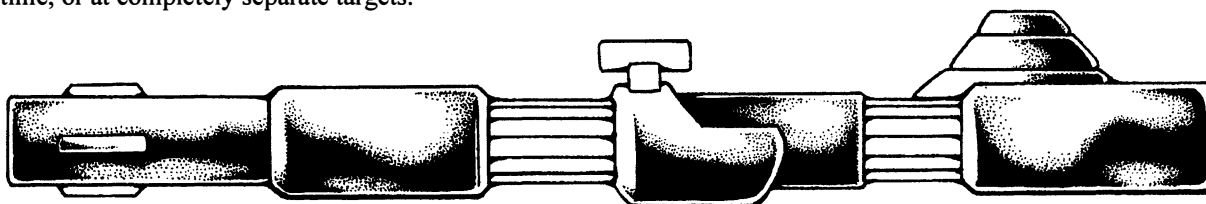

Mega-Damage: 1D4x10 M.D. per single blast or 2D4x10 per double blast at the same target (counts as one melee action).

Rate of Fire: Equal to the number of combined hand to hand attacks of the pilot and his power armor (usually 6-8).

Maximum Effective Range: 4000 feet (1220 m).

Payload: Effectively unlimited because the pair of laser cannons are given their own, independent, nuclear power supply (5 year life with frequent combat use). This is fundamentally the same micro-power system used in power armor and robots. Consequently, it is small, lightweight and incredibly powerful. It is built onto the back of the Taurus Glitter Boy and energy is channelled to both weapons via a short cable. Obviously with the laser guns, no Reload Team is necessary, except to switch laser cannons to mortars, or traditional rail gun or other weapon system, as well as to make adjustments and stand-by for general assistance and defense.

3. Optional Weapons: The Taurus can also use a Boom Gun, Gigi Double-Up Assault Cannon or Wolf's Bite assault rifle.

4. Sensors & Features: All basic features common to power armor, plus the laser resistant armor of the Glitter Boy (laser fire does half damage).

Silver Wolf Glitter Boy

The Silver Wolf is another attempt at making a smaller, lighter infantry power armor suit without significantly losing power or armor. Commonly referred to as the "Eight-Eighty-Eight" or simply as the "Wolf," this suit of power armor is designed to be deadly as both a mass combat infantry unit and small squad operative. Although the Silver Wolf works with other Glitter Boy troops and conventional soldiers, they are most often sent out in "Wolf Packs" — small squads of 6-10 Eight-Eighty-Eights, sometimes with one or two Glitter Girls, Side Kicks or SAMAS on espionage missions, Black Ops and surgical strikes.

The Silver Wolf remains remarkably well armored for its size and agility, comes equipped with the famous laser resistant GB armor (wears a poncho or other means of camouflage during covert operations) and wields a variety of weapons. Like all Glitter Boys, it is given an oversized assault weapon that is connected to its back housing. When not in use, the pilot stows it behind his back. When needed, he simply reaches back and pulls it forward. This weapon is not designed for long-range, but destructive power, consequently it uses CS particle beam technology. In addition to the big gun, the Silver Wolf also has a detachable forearm module on each arm that serves as both a shield that enhances its parrying/hand to hand combat abilities and has a range of additional weapons, namely a Vibro-Blade and short-range laser.

As a heavily armed covert agent, the Silver Wolf is regularly dispatched on seek and destroy missions, secret reconnaissance and rescue missions, acts of sabotage, assassination and diversionary operations.

Silver Wolf Glitter Boy

Model Type: QGB-8-88

Nicknames: "Wolf" and "Eight-Eighty-Eight."

Class: Laser Resistant Infantry Personnel Assault Unit.

Crew: One pilot.

M.D.C. by Location:

QST-188 Particle Beam Assault Cannon — 150

* Forearm Weapon Shields (2, one per arm) — 100 each

* Retractable Vibro-Blades (2, one per arm) — 60 each

* Head — 270

* Hands (2) — 75 each

Arms (2) — 210 each

Legs (2) — 330 each

Reinforced Pilot's Compartment — 90

** Main Body — 450

* A single asterisk indicates a small and difficult target to strike, requiring the attacker to make a "called shot," but even then the attacker is -4 to strike.

** Depleting the M.D.C. of the main body will shut the robot down completely, rendering it useless. **Note:** Laser weapons do half damage!

Speed

Running: 90 mph (145 km) maximum. Note that the act of running does tire its operator, but only at 10% of the usual fatigue rate.

Leaping: The robot legs can leap up to 15 feet (4.6 m) high or across. Add 12 feet (3.6 m) with a running start. Jet thruster assisted leaps can hurl the power armor 120 feet (36.6 m) up or across. If necessary, the thrusters can momentarily hold the Wolf aloft as high as 18 feet (5.5 m) off the ground, but only for 2D4x10 seconds. The thrusters are not made for flying.

Underwater Capabilities: **Swimming:** The thruster system provides good mobility and control underwater but a sluggish speed of 25 mph (40 km); roughly the same surface speed. It can also walk along the bottom of the sea at about 25% of its normal walking/running speed. Firing the Particle Beam Cannon underwater superheats the water around the Silver Wolf and makes it an easy target with heat sensors. Worse, the range of the P-Beam underwater is reduced by 75% to only 500 feet (152 m). The range of the laser is decreased by 50% and the mini-missiles are reduced by 25%. The range of most other projectile and energy weapons is reduced by half.

Maximum Ocean Depth: 3000 feet (914 m).

Statistical Data

Height: 8 feet (2.4 m)

Width: 3 feet, 3 inches (1.06 m)

Length: 3 feet (0.9 m); does not include the length of the P-Beam Cannon which is roughly 6.7 feet (2.04 m).

Weight: 1400 lbs (630 kg) fully loaded.

Physical Strength: Equal to a P.S. of 32.

Cargo: Minimal storage space; a foot locker and storage for a rifle, handgun, survival knife and first-aid kit.

Power System: Nuclear; average energy life is 20 years.

Quebec Cost: 20 million credits; exclusive to the Free Quebec Military. 15.4 million for a unit without any weapon systems.

Weapon Systems

1. QST-188 Particle Beam Assault Cannon (1): This heavy, over-sized (for normal humans) assault rifle is specifically designed with the Silver Wolf (and Glitter Girl) in mind. It is the largest, most powerful, and longest range particle beam weapon known to exist in North America (and is one of Free Quebec's many "Secret Weapons"). Although this cannon is

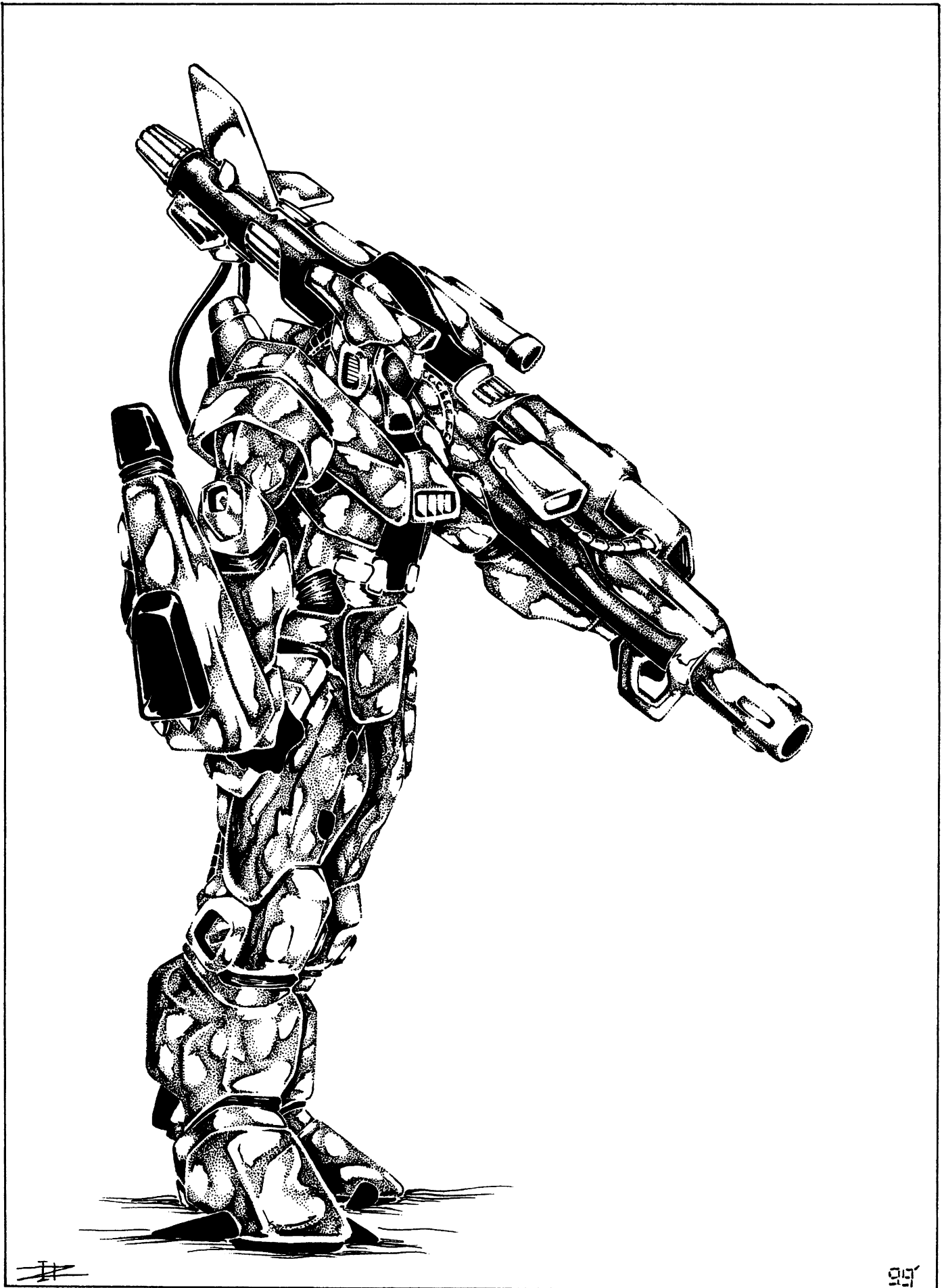

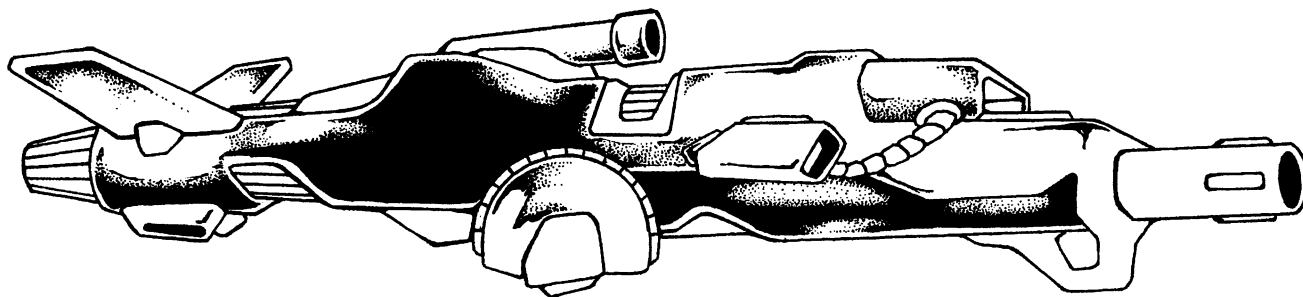

hooked to a shoulder housing like most Glitter Boy weapons, it can fire from a prone and locked position. Unlike the conventional Glitter Boys, the smaller and more mobile Silver Wolf does NOT use the pylon stabilization system, because the gun has only a slight kick, although it does get hot — too hot to be handled by an unshielded human. This means the Silver Wolf can fire from a kneeling or prone position (i.e. laying flat on the ground). This simple design consideration enables the Eight-Eighty-Eight to more easily hide and conceal itself, and, more importantly, strike from a concealed location. The Glitter Girl, with its detachable dual weapon system, also has similar capabilities, but in a different way. Additionally, most GB weapons can not fire when locked in a stowed position on the back, but the Silver Wolf can. In fact, while stowed on the back. It can be fired by physically pulling the trigger or via voice command from the pilot inside.

Primary Purpose: Sniper and Anti-Armor.

Secondary Purpose: Assault and Anti-Personnel.

Weight: Cannon: 415 lbs (187 kg).

Mega-Damage: 1D6x10+6 M.D. per blast.

Rate of Fire: Equal to the number of combined hand to hand attacks of the pilot and his power armor (usually 6-8; see Power Armor Training). Bursts and sprays are NOT possible.

Maximum Effective Range: 2000 feet (610 m).

Payload: Effectively unlimited! The weapon has its own, independent, nuclear power supply (5 year life with frequent combat use). This is fundamentally the same micro-power system used in power armor and robots. Consequently, it is small, lightweight and incredibly powerful. It is built onto the back of the Wolf Glitter Boy and energy is channelled to it via a short cable. **Note:** That having been said, the weapon tends to get very hot and heat the air around it. After heavy use for more than ten minutes (roughly 200 blasts), the weapon has a 01-66% chance of temporarily shutting down for 1D6 minutes, until it cools off a bit. Seasoned veterans try not to fire the big gun more than three times per melee round or not fire it at all for one melee round (15 seconds) every minute or so. This prevents the overheating. Of course, combat will dictate use.

2. Forearm Shield Mounted Mini-Missiles Launchers (2):

The Weapon Shield worn on each arm has a mini-missile launcher built onto the outside (30 M.D.C. each).

Primary Purpose: Anti-Aircraft/Anti-Missile.

Secondary Purpose: Defense.

Missile Type: Any type of mini-missile can be used, but standard issue is armor piercing (1D4x10 M.D.) or plasma (1D6x10). Fragmentation (5D6 M.D.) may be used for anti-personnel operations.

Mega-Damage: Varies with missile type.

Rate of Fire: One at a time, or in a volley of two.

Effective Range: About one mile (1.6 km)

Payload: Eight total; four missiles per each Weapon Shield.

3. Anti-Personnel Laser (1): Located at the wrist end of the Weapon Shield (where the Vibro-Blade is also housed) is a laser. Point and shoot.

Primary Purpose: Anti-Personnel

Secondary Purpose: Defense

Mega-Damage: 2D6 M.D. per single blast or 4D6 per double blast (but counts as two melee attacks).

Rate of Fire: Equal to the combined number of hand to hand attacks (usually 6-8).

Effective Range: 1000 feet (305 m)

Payload: Effectively Unlimited.

4. Vibro-Swords (2): A large, retractable Vibro-Sword is built into the forearm Weapon Shields.

Primary Purpose: Anti-Personnel

Secondary Purpose: Defense

Mega-Damage: 3D6 M.D. per slash.

Rate of Fire: Equal to the number of combined hand to hand attacks (usually 6-8).

Effective Range: Within reach/close combat.

5. Optional & Additional Weapons: Being smaller than usual (nearly man-sized), the Silver Wolf can use most large rifles, rail guns or the Side Kick's QST-98 "Kicker" Grenade Launcher as a hand-held weapon or in place of the Particle Beam Cannon. **Note:** The Silver Wolf is too small, and without the pylon stabilization system is unable, to use the traditional Boom Gun or most other large GB cannons. The exception is the Glitter Girl's QST-104 "Double-Up" Assault Cannon which can be used in place of the P-Beam cannon (not hand-held or removable).

6. Sensor Systems of Note: Standard power armor and GB features, including a Distress Homing Beacon (a scrambled radio, homing signal for location and extraction from combat zones. There is a 30% chance of detection by the enemy), and a self-destruct mechanism to prevent the armor and its technology from falling into enemy hands.

Sensors, Optics & Features of Note: The helmet is equipped with a searchlight (1000 foot/305 m range) and the Wolf has all the other optical systems, targeting, and other features common to all Glitter Boy power armor.

Special Bonuses: +2 on initiative and +1 to strike with energy weapons, but applicable to long-range weapon attacks only. Hand to Hand Bonuses: +3 on initiative, +1 to strike, +2 to parry, +2 to dodge, and paired weapons (Vibro-Blades). The parry bonus does not apply if the Weapon Shields are lost. For other bonuses see *Glitter Boy Combat Training Elite* at the end of the **Classic Glitter Boy** description, but is the same as the Side Kick plus bonuses above.

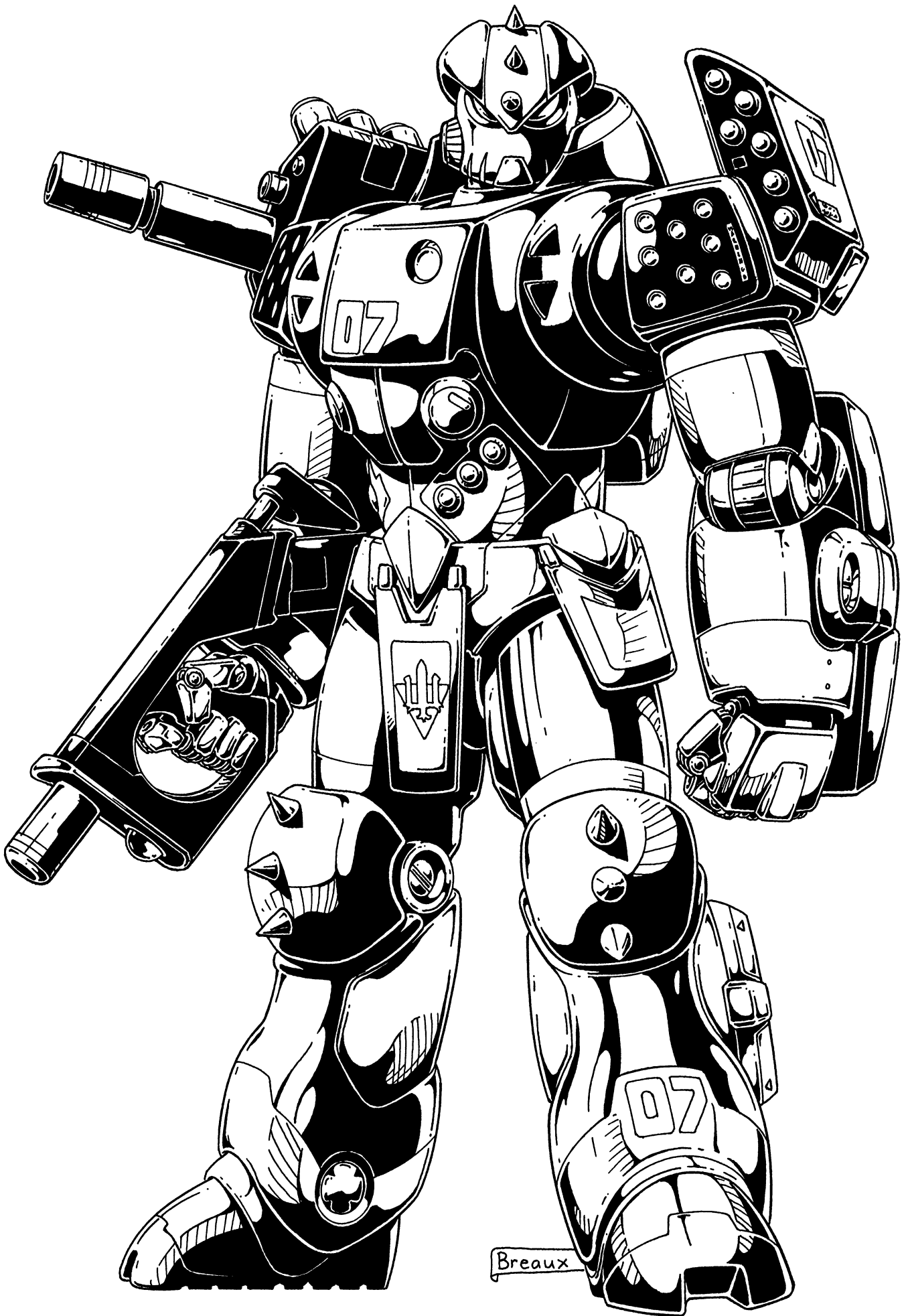

QPA-201 Power Trooper

The “Power Trooper” is a big, heavy, new power armor design by the engineers of Free Quebec. They were inspired by the *Triax Super-Trooper* to apply the basic concepts of the *SAMAS* and the *T-31 Super-Trooper* power armor to make a more heavily armored infantry power armor with both ground and flight capabilities. The end result is far from the soaring “juggernaut” they had hoped for, but is an interesting creation nonetheless. The Power Trooper is a suit of dense, heavily plated armor supplied with an array of mini-missiles and laser weapons, as well as Vibro-Blade and assault rifle. A Side Kick/Hopper-style propulsion system provides wingless flight capabilities. Although impressive and formidable in its own right, the Power Trooper is much larger than the Side Kick, borders on being a robot vehicle and lacks its stealth, speed and agility. Likewise, while it can “hop” and “hover,” the Power Trooper is as slow as a fluttering grasshopper compared to the traditional speedy and elusive SAMAS. Yes it has firepower, but the Glitter Boys and other mechanized creations are comparable or superior to it. Moreover, the Glitter Boys have superior M.D.C. protection.

In short, the Power Trooper is an interesting experiment, and would have tremendous appeal to mercenaries, adventurers and manufacturers such as Northern Gun or the Black Market, but it falls short of its expectations. As a result, it has been made in short supply (about 1440) and is typically deployed on Recce and other long-range, long-term wilderness operations and outposts. Early skirmishes have shown the heavy, slow, weapon-laden Power Trooper does better than expected against Coalition troops (in part because they have never seen one before and don’t know what to expect).

Like the *Terrain Hopper* and *Side Kick*, it uses jet thrusters on the back to hover and make jet assisted leaps to travel over the ground at rapid speeds. Also like the Side Kick, the Power Trooper was originally designed to assist and complement Glitter Boys, particularly as an anti-aircraft/anti-SAMAS weapon. However, as noted previously, this power armor is more often used as a stand alone weapon for wilderness operations. It also does well in urban settings although its 14 feet (4.3 m) of height can hamper it sometimes. In open field combat its size makes it a more attractive target for aircraft and missile attacks. A favorite tactic used by the pilots of this power armor is to cripple a giant robot, tank, aircraft or enemy power armor, rather than destroying it before moving on to a new adversary — the threat from a crippled enemy is dramatically reduced and this leaves it vulnerable to less powerful troops.

Although not intended as such, the Power Trooper performs extremely well underwater. The jet thrusters work very well as a propulsion system, giving it excellent underwater speed and mobility. Mini-torpedoes are substituted for mini-missiles, the laser weapons and Vibro-Blades remain unchanged and the thrusters also give the armor “water to air to land” capabilities. The Quebec Navy is looking very intently at adding it to its roster as a heavy amphibious assault unit. Three hundred and sixty are currently deployed as Naval troops.

QPA-201 Power Armor

Exclusive to the Free Quebec Military

Model Type: QPA-201

Class: Heavy Assault Combat Power Armor.

Crew: One

M.D.C. by Location:

- * Hand-Held Gun (1) — 80
- * Shoulder Mini-Missile Launchers (2) — 75 each
- Folding Launcher (1; extends from left shoulder) — 80
- Shoulder Mounted Laser Cannon & Launcher (1; right) — 120
- * Forearm Weapon Package (1, left) — 75
- * Chest Spotlight (1) — 4
- Lower Arms (2) — 115 each
- * Hands (2) — 40 each
- Legs (2) — 140 each
- Main Thrusters (2, back) — 100 each
- * Maneuvering Jets (12; 6 front, 6 back) — 25 each
- ** Head — 110
- *** Main Body — 295 (does not use GB materials)
- * A single asterisk indicates a small and/or difficult target to strike, requiring the attacker to make a “called shot,” but even then the attacker is -3 to strike.
- ** Destroying the head of the power armor will eliminate all forms of optical enhancement and sensory systems. The pilot must then rely on his own human vision and senses. No power armor combat bonuses to strike, parry, and dodge!
- The head is a small and difficult target to hit. Thus it can only be hit when a character makes a “called shot” and even then the attacker is -3 to strike.
- *** Depleting the M.D.C. of the main body will shut the armor down completely, making it useless.

Speed

Running: 40 mph (64 km) maximum; can go from zero to 40 mph (64 km) in 10 seconds. The act of running does tire its operator, but at a fatigue rate of 10% of normal. The pilot *sits* inside the upper torso of this border-line robot-power armor unit and works the legs with pedals and the arms with a pair of joystick controls.

Leaping: A height of approximately 12 feet (3.6 m) straight up or lengthwise is possible *unassisted* by the thrusters.

A jet thruster assisted leap from a stationary position can propel the unit up to 60 feet (18.3 m) high and 200 feet (61 m) across without actually attaining flight or requiring a running start.

Power Jumping and travel: The integrated, large jet pack enables the power armor to leap great heights and distances. Getting a running start will enable the individual to leap up to 100 feet (30.5 m) high and 300 feet (91.5 m) lengthwise. The height of the leap is controlled by the pilot and generally ranges between 30 to 60 feet (9 to 18.3 m); with 40 feet (12.2 m) of height being average. By leaping, landing, continuing to run a few dozen yards/meters, and power leaping again, the Power Trooper can attain and maintain an impressive ground speed of *180 mph (288 km)*, even through light forest. Speed should be reduced 40% or 50% when traveling through dense vegetation or hazardous terrain. Failure to do so will result in a jarring and potentially damaging collision or accident.

Directional control by the pilot is excellent. The capabilities of the jet pack allow the pilot to stop in mid-air, change direction/trajectory and hover. However, having to suddenly engage the jet pack in mid-flight to avoid a collision or bad landing may slow one’s speed and make the character an easier target for at-

tack. Likewise, crashing through the underbrush or S.D.C. structures makes a lot of noise, alerting predators and the enemy to one's presence, and reduces the pilot's vision and awareness (-3 on initiative, -1 to strike, parry, and dodge due to obscured vision and rate of travel).

Limited Flight: Like the T-21 Hopper, the Power Trooper can actually fly, but only for short periods and with the risk of "burning out" the propulsion system. Maximum flying speed is 80 mph (128 km), but cruising speed is considered to be around 40 mph (64 km). Maximum height/altitude is 200 feet (61 m).

Flying Range: The nuclear power supply of the armor gives it a decade of life, but the jet rockets get hot and need to cool after a maximum of one hour of continuous flight. In most cases, the jets will start to sputter and speed decreases by half after one hour, and after another 3D6 minutes they cut out completely. If the jet pack burns out, the main thrusters are destroyed, making flying and jet propelled leaps impossible. Remember, traveling by power jumps can be maintained for an unlimited number of hours at a greater speed of 180 mph (288 km).

Underwater Capabilities: Swimming: The big jets augmented by the dozen directional thrusters provide excellent mobility and control underwater. Speed is an impressive 60 mph (96 km); roughly the same speed skipping across the surface in a prone, torpedo-like position. It can also walk along the bottom of the sea at about 20 mph (32 km). The range of mini-missiles is reduced by 30% but those used as naval armor see the missiles replaced with mini-torpedoes. The ranges of most other types of projectile and energy weapons are reduced by half. Vibro-Blades work as well as usual.

Maximum Ocean Depth: 3000 feet (1828 m).

Statistical Data

Height: 14 feet (4.3 m)

Width: 6 feet, 6 inches (2 m)

Length: 5 feet (1.5 m)

Weight: 6 tons fully loaded.

Physical Strength: Equal to a robot P.S. 40.

Cargo: Small area for the pilot's personal items.

Power System: Nuclear; average energy life is 15 years.

Free Quebec Cost: 6 million credits; exclusive to Free Quebec military. Not available on the Black Market or to the CS.

Weapon Systems

1. QRL-201 High-Powered Laser Rifle (1): A giant-sized assault rifle (resembles a sub-machinegun) has been specifically developed by the Quebec Military for the Power Trooper. It can also be used by the *Enforcer Prime* and other large power armor or robots in the range of 12 to 20 feet (3.6 to 6 m) tall. It is standard issue for the Power Trooper and optional for the *Enforcer Prime* and *Guardian* robots and the *Tarantula Glitter Boy*. The user must have a robot P.S. of at least 28 to use it without penalty (-3 to strike, -2 on initiative). It is too large to be used by cyborgs or man-sized power armor.

Weight: 160 pounds (72 kg).

Primary Purpose: Assault

Mega-Damage: 3D6 M.D. per single shot or 1D4x10 per rapid-fire bursts (uses up four shots but counts as one melee attack).

Rate of Fire: Equal to the total number of hand to hand attacks.

Effective Range: 2000 feet (610 m).

Payload: 60 shots from the giant, energy clip. A special cable can connect the weapon to a robot's energy supply, giving it an effectively unlimited payload. The danger is that the weapon is rendered useless if the cable is cut.

2. Shoulder Laser Cannon (1): Mounted on the right shoulder is a heavy long-range laser cannon and sensor array. It can rotate 360 degrees and tilt along a 30 degree arc of fire.

The three upward pointed canisters are smoke generators (six charges) to generate defensive ground cover (creates a smoke cloud that is roughly 50 feet/15 m in diameter and height). They can also fire parachute flares (9 total payload) to light up the night sky and as a signal.

Primary Purpose: Assault

Mega-Damage: 6D6 per single blast. Burst shooting is not possible.

Rate of Fire: Equal to the total number of hand to hand attacks.

Effective Range: 4000 feet (1220 m).

Payload: Effectively unlimited. A cable connects the weapon to the robot's energy supply. Sixty shots are available from an independent power supply built into the shoulder housing in case the cable is cut.

3. Left Forearm Weapon Package (1): The left forearm weapon package contains a small, highly powered ion blaster and a Vibro-Sword combination. This gives the Troopers some very effective close range combat weapon systems they may choose from.

Forearm Laser Blaster:

Primary Purpose: Assault

Secondary Purpose: Defense

Mega-Damage: 5D6 per blast. Bursts are not possible.

Effective Range: 800 feet (244 m).

Rate of Fire: Equal to the combined number of hand to hand attacks (usually 4-7).

Payload: Effectively unlimited; linked to armor.

Vibro-Sword:

Primary Purpose: Assault

Mega-Damage: 2D6 M.D.

Range: Hand to hand combat.

4. Shoulder Mini-Missile System (2): A small mini-missile launcher system is housed in each of the shoulders. Each shoulder holds 16 mini-missiles and adds to the armor's over-all effectiveness.

Primary Purpose: Anti-Aircraft and Anti-Missile.

Secondary Purpose: Defense.

Missile Type: Any mini-missile can be used, but standard issue is armor piercing (1D4x10 M.D.) or plasma (1D6x10). Fragmentation will be used for anti-personnel operations.

Mega-Damage: Varies with missile type.

Range: Usually about a mile (1.6 km).

Rate of Fire: One at a time or volleys of two, three or four.

Payload: 32 total; sixteen missiles per shoulder.

5. Folding Mini-Missile Launcher (1): This additional launcher attaches to the left shoulder, providing even greater firepower.

Note: Same basic stats as number four, above.

Rate of Fire: One at a time or volleys of two, four or six.

Payload: 18 total.

6. Hand to Hand Combat: The Power Trooper may also engage in hand to hand combat — see *Hand to Hand Bonuses from Power Armor "Elite" Combat Training* on page 351 of the *Rifts® Ultimate Edition*.

7. Special Sensory Systems of Note: Same as the QR-1 Enforcer Prime.

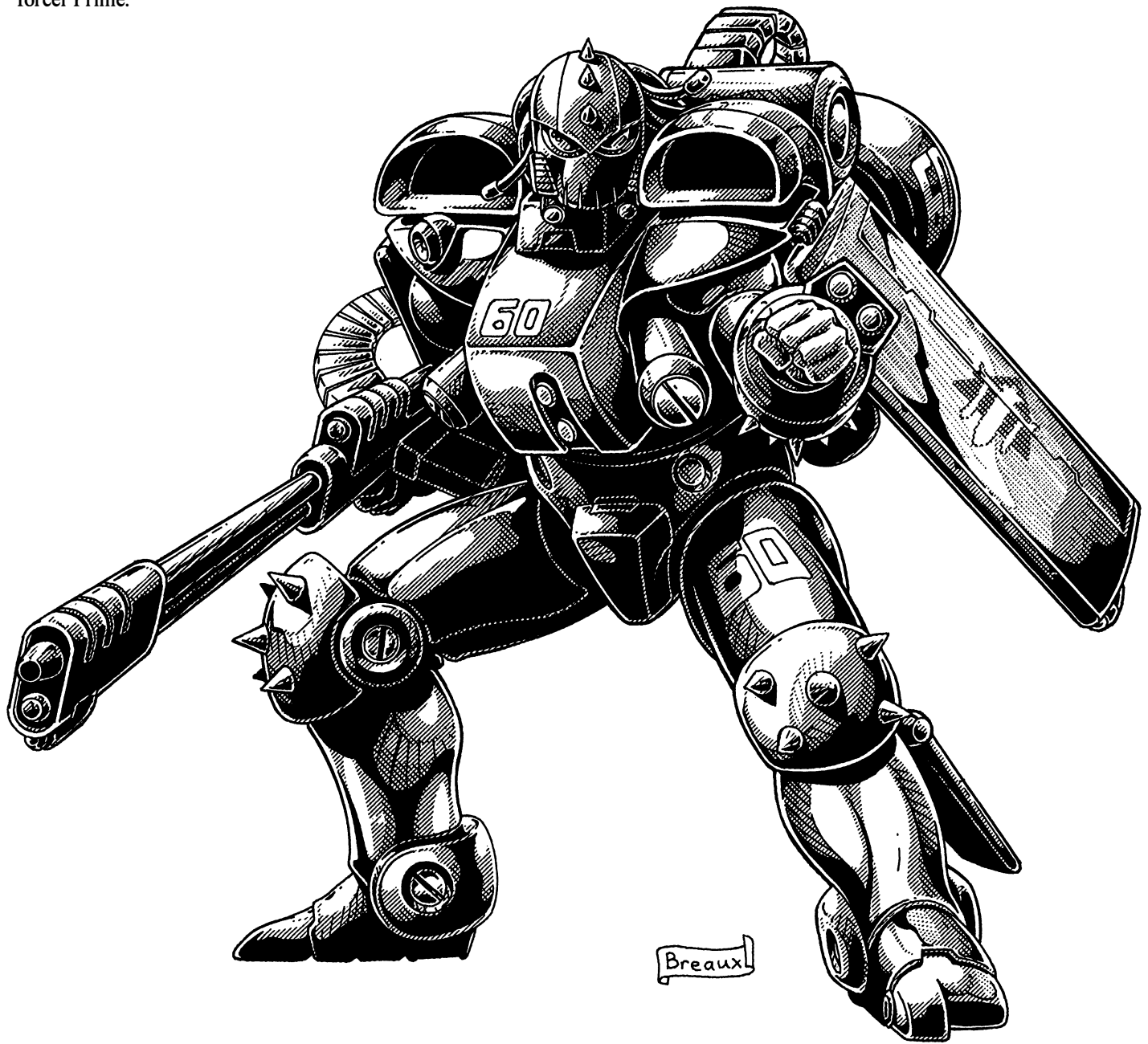

“Pale Death” QPA-101 SAMAS

The original *PA-06A SAMAS* has been a workhorse for the Coalition States, proving to be fast, maneuverable and deadly in all environments, from open field combat and city streets to air assaults and dog-fighting. The SAMAS’ amazing versatility has made it equally useful in infantry assault, front-line combat, surgical strikes, troop support, seek and destroy, reconnaissance, rescue, espionage and defense. It can hover, fly, and make tight turns while traveling at maximum speed. Being roughly man-size and having a relatively short wingspan, it maneuvers through narrow streets and corridors, yet does not sacrifice fire-power or armor protection for size and maneuverability. Its folding wings enable the armor to make Vertical Take-Offs and Landings (VTOL) with the wings in a down position, as well as allowing the wings to be folded partially or entirely and still

rocket down narrow hallways and through open doors. The “Death’s Head” SAMAS quickly became the most recognized power armor of the Coalition States and is famous and feared throughout North America.

As one of the earliest “States” in the Coalition, Free Quebec has had these units in military service for decades. Moreover, they have been a major manufacturer of SAMAS power armor (along with Chi-Town) for nearly as long and have helped to supply most of the other States and CS territories. Like the rest of the Coalition States, Free Quebec has come to depend heavily on this suit of power armor as a major part of their Military Force and have kept it even after the secession. Moreover, they have incorporated many of the designs into a new model of SAMAS uniquely “Quebec”: The *Violator SAMAS* or “V-Sam” as it is more commonly called.

The Pale Death, also known as the “Sky SAM,” “Pale SAMAS” and “Blue,” is fundamentally nothing more than the

classic old-style SAMAS with a paint job and a face lift. It has all the same basic stats and weapon systems right down to the C-40R rail gun and forearm rocket launcher. The only differences are some improvement in the overall M.D.C., a different face-plate, a spiked helmet and a pale “sky-blue” color with grey highlights and white insignias and I.D. numbers. The Free Quebec fleur-de-lis is emblazoned on both wings.

Note: Approximately 1200 unmodified “Death’s Head” SAMAS are in storage.

“Pale Death” SAMAS Power Armor

Also known as “Pale SAMAS,” “Sky SAM,” “Old Blue,” and “Blue.”

Model Type: QPA-101 (basically a retooled PA-06A CS SAMAS)

Class: Strategic Armor Military Assault Suit.

Crew: One

M.D.C. by Location:

* Shoulder Wings (2) — 50 each (improved M.D.C.)

Main Rear Jets (2) — 60 each

Lower Maneuvering Jets (2; small) — 25 each

* Ammo Drum (rear) — 35

* Rail Gun — 50

Forearm Mini-Missile Launcher (1; left) — 50

* Hands (2) — 25 each

Arms (2) — 50 each

Legs (2) — 100 each

** Head — 70

*** Main Body — 250

* A single asterisk indicates a small and difficult target to strike, requiring the attacker to make a “called shot”, but even then the attacker is -4 to strike.

** Destroying the head of the power armor will eliminate all forms of optical enhancement and sensory systems. The pilot must then rely on his own human vision and senses. No power armor combat bonuses to strike, parry, and dodge!

The head is a small and difficult target to hit, shielded by exhaust tubes and a weapon drum. Thus it can only be hit when a character makes a “called shot” and even then the attacker is -3 to strike.

*** Depleting the M.D.C. of the main body will shut the armor down completely, making it useless. **Note:** Destroying a wing will make flight impossible. However, even with no wing(s) the SAMAS can make jet powered leaps and hover stationary above the ground.

Speed

Running: 60 mph (96 km) maximum; can go from zero to 60 mph (96 km) in 12 seconds. Note that the act of running does tire out its operator, but at 10% of the normal fatigue rate, thanks to the robot exoskeleton.

Leaping: The powerful robot legs can leap up to 15 feet (4.6 m) high or across unassisted by the thrusters.

A jet thruster assisted leap can propel the unit up to 100 feet (30.5 m) high and 200 feet (61 m) across without actually attaining flight.

Flying: The rocket propulsion system enables the SAMAS to hover stationary up to 200 feet (61 m) or fly. Maximum flying speed is about 300 mph (480 km), but cruising speed is considered to be 150 mph (240 km). Maximum altitude has been suggested to be limited to about 500 feet (152 m), but use in the

field has proven that the classic SAMAS can easily attain and maintain an altitude of 6000 feet (1829 m; a little over one mile/1.6 km). Higher than this, high winds and rough weather make flight both erratic and dangerous. The SAMAS is just too small and light, it was designed to be a low altitude power armor suit that could hug the ground and slip under enemy radar, which it does admirably. *Optimal altitude range* is ground level to about 1000 feet (305 m).

Flying Range: The nuclear power supply gives the SAMAS decades of life but the jet rockets get hot and need to cool down after a maximum of 10 hours of continuous flight at speeds above cruising speed. It can fly indefinitely with rest stops every few hours.

Underwater Capabilities: Swimming: The SAMAS can *swim* using the same types of paddling leg and arm movements as a human at a maximum speed of roughly four mph (6.4 km). It can also walk along the bottom of the sea at about 25% its normal running speed. Using the jet thrusters, the SAMAS can travel on the surface of the water at 50 mph (80 km), underwater at 40 mph (64 km), or fly above the water’s surface at normal speeds.

Maximum Ocean Depth: 1000 feet (305 m).

Statistical Data

Height: 8 feet (2.4 m).

Width: Wings down, 3.5 feet (1.06 m); wings extended, 10 feet (3 m).

Length: 4 feet, 6 inches (1.4 m).

Weight: 340 lbs (153 kg) without the rail gun

Physical Strength: Equal to a P.S. of 30.

Cargo: None

Power Systems: Nuclear; average SAMAS energy life is 20 years.

Free Quebec Cost: 1.6 million credits. The Black Market sells captured and undamaged or “rebuilt” versions of the QPA-101 for 2.4 to 3 million credits (same for CS SAMAS) or 1.5 to 2 million without the weapon systems. Rarely available.

Weapon Systems

1. C-40R SAMAS Rail Gun (1): This is standard equipment for the “Death’s Head” SAMAS and is considered to be the most powerful, accurate, and lightweight rail gun in the world. It requires no separate power pack, because it hooks directly to the armor’s nuclear power supply. Other, heavier rail guns can be substituted. Likewise, the new QR-12A Laser Rifle (see V-SAM) can be used.

Primary Purpose: Assault

Secondary Purpose: Defense

Weight: Gun: 92 lbs (41.4 kg). One SAMAS Ammo-Drum: 190 lbs (85.5 kg).

Mega-Damage: A burst is 40 rounds and inflicts 1D4x10 M.D., one round does 1D4 M.D.

Rate of Fire: Equal to the number of combined hand to hand attacks (usually 6-8).

Maximum Effective Range: 4000 feet (1200 m).

Payload: 2000 round drum, that’s 50 bursts. A second drum can be hooked to the undercarriage of the rocket jets, but first the used drum must be manually removed by another SAMAS or a character with a strength of 26 or higher and the new ammo drum put in its place. Reloading the drum will take about 5 min-

utes for those not trained, but a mere minute by somebody trained in the use of SAMAS power armor.

2. CM-2 Rocket Launcher (1): The forearm not used to operate the rail gun, usually the left, is armed with a simple, two rocket, mini-missile launcher.

Primary Purpose: Anti-Aircraft.

Secondary Purpose: Defense.

Missile Type: Any mini-missile can be used, but standard issue is armor piercing (1D4x10 M.D.) or plasma (1D6x10 M.D.). Fragmentation (5D6 to a 20 foot/6 m radius) will be used for anti-personnel operations.

Mega-Damage: Varies with missile type.

Range: Usually about a mile (1.6 km)

Rate of Fire: One or two.

Payload: Two

3. Energy Rifles: The man-sized SAMAS can use most infantry weapons from pistols and Vibro-Blades to assault rifles. Any of these items can be substituted for the rail gun or kept as a back-up weapon; usually slung at the waist on an extra large utility belt or holstered on the upper leg. Space limitations and the bulk of the armor usually limit such additional man-sized weapons to one handgun and/or one rifle. Grenades can also be carried in a satchel (typically 6-12) and dropped like bombs. Grenades cannot be carried hooked to a belt or bandoleer for fear of being pulled off when traveling at great speed or struck and detonated by enemy attacks.

4. Hand to Hand Combat: Rather than use a weapon, the pilot can engage in Mega-Damage hand to hand combat. See *Basic and Elite Power Armor Combat Training* on page 351 of the **Rifts® Ultimate Edition** for combat bonuses.

5. Sensor Systems Note: The SAMAS has full optical systems including laser targeting, telescopic, passive nightvision (light amplification), thermo-imaging, infrared, ultraviolet, and polarization. Plus all other features common to all power armor.

Sensor Bonuses: The Blue SAMAS gets a bonus of +1 to strike and +1 to dodge in addition to the power armor target bonus and Basic or Elite Power Armor Combat Training bonuses.

Glitter Boys, any stray shots only glance off the Glitter Boys' reflective armor, minimizing damage from "friendly fire." It also has a pair of mini-missile launchers on the wings.

In fact it is the wings that are the most strikingly different. They are longer than the traditional SAM, almost touching the ground when folded. Unlike the flat, rectangular board style of the Coalition SAMAS, the wings of the V-SAM are curved and have a bird-like "feather" shape and styling to them. Not only are they deceptively attractive and elegant, but they are deadly weapons. The "feathered" portions are sharpened and effectively Vibro-Blades used to rake, slash and hamstring both aerial and ground opponents. The bladed wings can be used to sever power cords and ammo-feeds, disable limbs (primarily legs, wings, fins and arms), knock weapons out of an opponent's hands and play chicken. A Violator SAMAS pilot loves nothing more than to zoom past an opponent, clipping him with his wings and literally slicing him to pieces. In all practicality, such tactics only come into play in extremely close combat, dogfights and cat and mouse games, however it is one more weapon in the V-SAM's arsenal and adds to the armor's intimidation factor.

To avoid "friendly fire" and confusion on the battlefield, the V-SAM is a glossy and highly reflective black color (as opposed to the CS blue-black) with light blue highlights along the front and tips of the wings, and forward airfoils as well as the "cuffs" of the forearms, ankles and other places. The white fleur-de-lis on a light red triangular field is emblazoned on each wing. The stylized wings and spiked helmet also help distinguish them from the new blue-black, skeletal Coalition SAMAS.

Elegant and deadly, the Violator SAMAS is Quebec's most popular and beloved suit of power armor after the Glitter Boys. They can be seen gliding on updrafts or cruising the skies, weaving through the skyscrapers of the cities, streaking toward combat to answer a threat and locked in a brutal ballet of light, thunder and death against Coalition SAMAS and aircraft. There are tens of thousands who, together with the Glitter Boys, represent the soul of the Quebec Military. They also exemplify Free Quebec's style of fighting — using quickness, agility, small size, versatility and heavy firepower for rapid response to any kind of threat. And versatility is the strength of the V-SAM and all SAMAS. They can fly like lightning or slowly glide along like a leaf in the wind. They can alight anywhere — rooftop, mountain top, city street, playground, the hood of a vehicle, slight opening in a forest, etc. — or zoom through hallways, down streets and alleys, around corners or dodge through trees or a volley of missiles. They can land or fly a few feet above the ground to engage ground troops and soar into the clouds to respond to aircraft and enemy flyers (Wing Boards, dragons, winged aliens, wizards empowered with flight, and so on). The V-SAM can even operate underwater although they rarely do, except to hide or lay a trap.

The Coalition was surprised to learn (and learn the hard way) that **Violator SAMAS** are just as fast and agile as the "new" *CS Smiling Jack* and nearly as well armored and capable in combat as their *Super SAMAS*! The larger wings and their configuration make the V-SAM a more stable flyer and enhances maneuverability just ever so slightly. Likewise the absence of a heavy rail gun ammo drum marginally reduces the weight and adds a bit to the overall agility and flexibility of the power armor. Little things, subtle improvements, but in combat a tiny edge can often

“Violator” SAMAS

Commonly known as the “V-SAM”

The Violator or “V-SAM” is Quebec's innovative version of the SAMAS. While the suit of power armor is clearly inspired by and based on the Coalition's extremely successful PA-06A armor developed by Chi-Town, the V-SAM is unique and has a number of innovations. First, it was specifically designed for air combat, SAMAS dog-fighting, and Glitter Boy air support. This means V-SAM are specially shielded (as are Side Kicks) with sound filtration systems and padding to eliminate the shock effects from the sonic booms created by the Boom Guns. This system engages to muffle the sonic boom while still allowing the pilot to communicate on the built-in radio in the helmet. Its main armament is a heavy laser rifle tied to the power supply of the armor, thus sacrificing the superior range of the rail gun for an effectively unlimited payload. When working in concert with

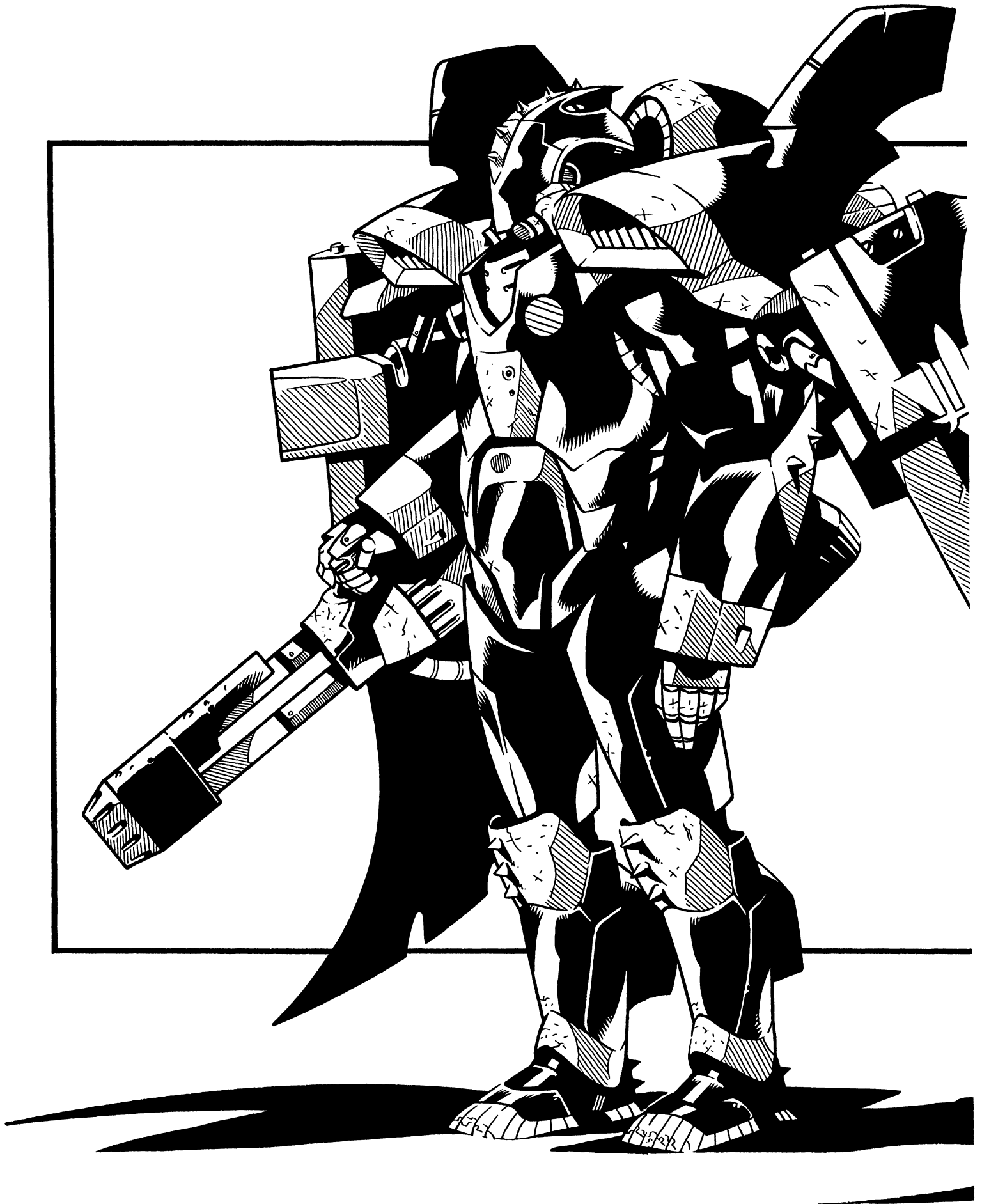

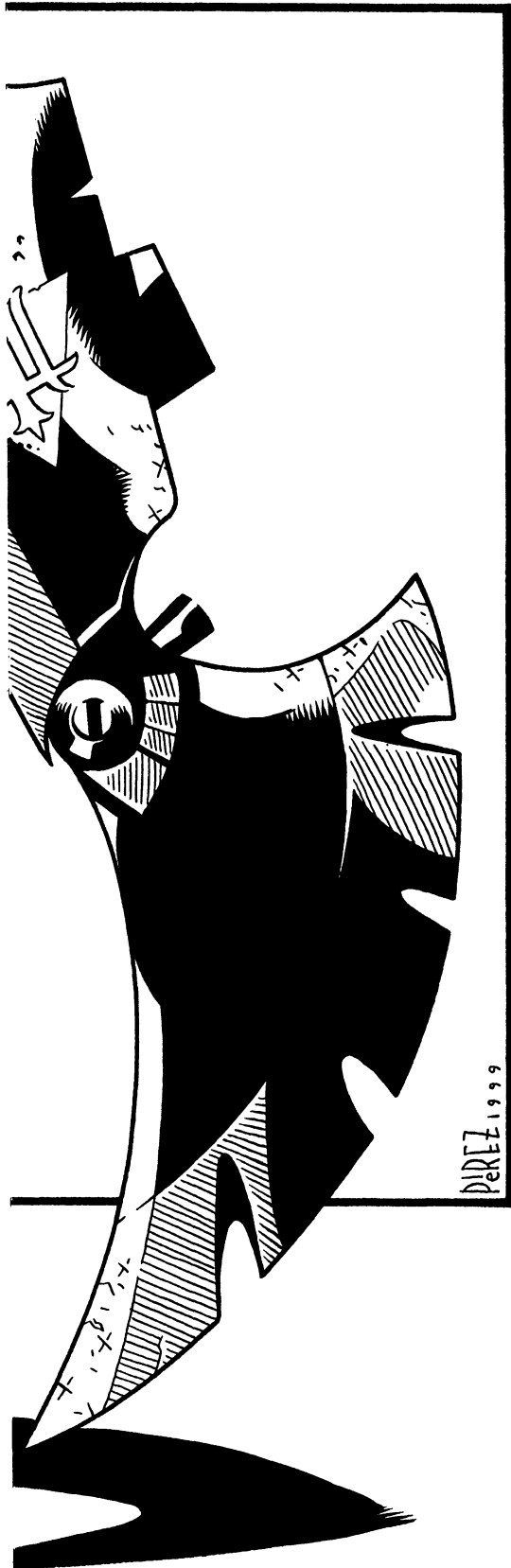

make the difference between defeat and victory, life or death! Furthermore, because Free Quebec has always embraced the SAMAS, and the V-SAM has been secretly in service for two years, most Quebec RPA SAMAS pilots tend to be a bit more experienced (average one level higher than CS troops). All Quebec SAMAS pilots have become expert at working in conjunction with Glitter Boys and complement each other wonderfully in combat; each watching the other's back and working in tandem to best defeat the enemy. They are also extremely adept in their approach and knowledge of enemy power armor and robot units. They have detailed knowledge of new and old Coalition combat vehicles and armor. As medium-sized support units themselves, they are very capable of providing flanking support for assaults on fixed positions where intense direct assault is as effective. They can jump from point to point and lay down suppressing fire to allow the ground forces or Glitter Boys to approach an enemy position, as well as cover retreating troops or slow the advance of enemy troops.

The use of Violator SAMAS with *Glitter Boys* is important because it has been shown repeatedly that as few as three "old style" SAMAS can defeat a single Glitter Boy in combat. Even two SAMAS manned by clever pilots can give a GB a run for its money, and succeed in besting a Glitter Boy 49.7% of the time (although one SAM is typically destroyed and the other crippled). This was a fact the Coalition knew and would exploit to the fullest in war — unless there was a *countermeasure*. While the Side Kick and Reload Teams provide good ground support, especially against ground troops, they and the Glitter Boy(s) they supported were still vulnerable to SAMAS attacks. That's where the V-SAM comes in — SAMAS to SAMAS combat, plus they are effective against other aircraft and flyers as well.

Violator SAMAS

Also known as "V-SAM"

Model Type: QPA-102

Class: Strategic Armor Military Assault Suit.

Crew: One

M.D.C. by Location:

- * Shoulder Wings (2) — 115 each
- * Shoulder Fins (2) — 25 each
- Main Rear Jets (3, top) — 100 each
- Lower Maneuvering Jets (3; lower) — 60 each
- Jet Intakes (2; top, front) — 50 each
- * Wing Mini-Missile Launchers (2) — 25 each
- * Laser Gun — 60
- * Hands (2) — 25 each
- Arms (2) — 70 each
- Legs (2) — 120 each
- ** Head — 90
- *** Main Body — 312

* A single asterisk indicates a small and difficult target to strike, requiring the character to make a "called shot," and even then the attacker is -4 to strike.

** Destroying the head of the power armor will eliminate all forms of optical enhancement and sensory systems. The pilot must then rely on his own human vision and senses. No power armor combat bonuses to strike, parry and dodge!

The head is a small and difficult target to hit, shielded by the air intakes and the main thrusters. Thus it can only be hit when a character makes a "called shot" and even then the attacker is -3 to strike.

*** Depleting the M.D.C. from the main body will shut the armor down completely, making it useless. Note: Destroying a wing will make flight impossible. However, even with no wing(s), the SAMAS can make jet powered leaps and hover stationary above the ground.

Speed

Running: 70 mph (113 km) maximum. Note the act of running does tire out its operator, but at 10% the usual fatigue rate.

Leaping: The powerful robot legs can leap 20 feet (6 m) high or across unassisted by the thrusters.

A jet thruster assisted leap can propel the unit up to 100 feet (30.5 m) high and 200 feet (61 m) across without actually attaining flight.

Flying: The rocket propulsion system enables the SAMAS to hover stationary in mid-air or fly. Maximum flying speed is 360 mph (576 km), but cruising speed is considered to be 60-150 mph (96-240 km). Maximum altitude is 10,000 feet (3048 m). Like its predecessor, however, the "Violator" is designed to be a low altitude power armor suit that can hug the ground, slip under enemy radar and engage ground troops.

Flying Range: The nuclear power supply gives the SAMAS decades of life but the jet rockets get hot and need to cool down after a maximum of 10 hours of continuous flight at speeds above cruising, 24 hours at cruising speed. It can fly indefinitely with rest stops every few hours.

Underwater Capabilities: Swimming: The SAMAS can swim using the same types of paddling leg and arm movements as a human at a maximum speed of roughly 4 mph (6.4 km). It can also walk along the bottom of the sea at about 20 mph (32 km). Using the jet thrusters, the SAMAS can travel on the surface of the water at 60 mph (96 km), underwater at 40 mph (64 km) or fly above the water's surface at normal speeds.

Maximum Ocean Depth: 2000 feet (610 m).

Statistical Data:

Height: 8 feet, 6 inches (2.6 m) from head to toe. The top mounted air intake jets add another two feet (0.6 m) for an overall height of 10 feet, 6 inches (3.2 m).

Width: Wings down, 3.7 feet (1.1 m).

Wings extended, 16 feet (4.9 m)

Length: 4 feet, 10 inches (1.45 m).

Weight: 680 lbs (306 kg) fully loaded, including laser gun and mini-missiles.

Physical Strength: Equal to a P.S. of 32.

Cargo: None.

Power System: Nuclear; average SAMAS energy life is 20 years.

Free Quebec Cost: 2.1 million credits. Exclusive to the Quebec Military. Not available on the Black Market or to the CS.

Weapon Systems

1. QR-12A SAMAS Laser Rifle (1): The standard "main gun" of the V-SAM is a heavy, rapid-fire laser rifle instead of the rail gun. It is hooked directly into the nuclear generator in the power armor and requires no E-Clip, although they can be used separately or as a back up system (takes standard and long E-Clips with 20 and 30 shots respectively). Any heavy energy weapon or rail gun may be substituted, but is rarely done so.

There are some *downsides* to this weapon. One is that it does less damage than a rail gun (3D6 M.D. per single blast; more from a less accurate burst) and has shorter range compared to a rail gun. Another is that the use of the laser draws from the V-SAM's power reserves inflicting some minor penalties. On the other hand, the weapon has unlimited payload.

Penalties: -1 on initiative and reduce maximum speed by 10% during combat when used as a *single shot* weapon. These penalties remain in effect as long as the gun is turned on.

-2 on initiative, -1 to strike and -20% to the V-SAM's speed when the weapon fires a triple pulse *burst*. These penalties last for an entire melee in which even one burst is fired. Thankfully, this is not an accumulative effect, so whether one or several bursts are fired in a melee round, the penalty remains the same.

Weight: 24 lbs (11 kg).

Primary Purpose: Assault.

Secondary Purpose: Defense.

Mega-Damage: 4D6 M.D. per single shot, or 1D6x10 per rapid-fire, triple beam burst. The burst counts as one melee action but causes a power fluctuation and penalties noted above.

Rate of Fire: Standard.

Effective Range: 2800 feet (853.4 m).

Payload: Effectively unlimited. A standard E-Clip (20 shots) or long E-Clip (30 shots or 10 triple bursts) can be substituted.

Note: This weapon and the Q2-30 were designed with the help of Triax engineers before Free Quebec seceded from the CS. A fact that Triax and the NGR has tried to keep secret (with Quebec's cooperation).

2. CM-2B Wing Mini-Missile Launcher: Near the base of each wing is a box mini-missile launcher that holds eight mini-missiles.

Primary Purpose: Anti-Aircraft/Flyer and Anti-Missile.

Secondary Purpose: Defense.

Missile Type: Standard issue is fragmentation (anti-personnel; 5D6 M.D.) when going against ground troops, but more commonly armor piercing (1D4x10 M.D.) and/or plasma (1D6x10 M.D.).

Mega-Damage: Varies with missile type

Rate of Fire: One at a time or in volleys of 2, 4, 8 or 16 mini-missiles.

Effective Range: Typically one mile (1.6 km).

Payload: 16 total, eight in each launcher.

3. Wing Blades: The V-SAM pilots are quite skilled at using their bladed wings as slashing weapons.

Primary Purpose: Close Combat/Dog-Fights.

Secondary Purpose: Intimidation factor (equal to an H.F. of 12 when an opponent realizes the V-SAM is trying to "slice and dice" him).

Mega-Damage: 1D6 M.D. from just a nick or glancing blow.

3D6 M.D. +1 for every 20 mph (32 km) of speed (+18 at full speed) from a full strength slicing attack.

Bonuses: Pilots experienced in piloting a Violator SAMAS are +1 to strike with the wings at levels 2, 5, 8, 11 and 14, as well as +2 to disarm, and can actually *parry* with them at +2.

4. Vibro-Blade Short-Sword (1): A short sword can extend and retract from the left forearm of the V-SAM.

Primary Purpose: Hand to hand combat.

Mega-Damage: 1D6+3 M.D.

5. **Energy Rifles & Other Weapons:** The V-SAM is small enough that it can use most infantry weapons from pistols and Vibro-Blades to rifles. It is also strong enough to use light and medium rail guns. In fact, a Vibro-Knife is kept in a sheath on the back of the lower leg. Any of these extra weapons are hung at the waist on an extra large utility belt or holstered on the upper leg. Space limitations and the bulk of the armor usually limits additional man-sized weapons to one handgun and/or one rifle. Grenades can also be carried in a satchel (typically 6-12) and dropped like bombs. Grenades cannot be carried hooked to a belt or bandoleer for fear of being pulled off when traveling at great speed or struck and detonated by enemy attacks.
6. **Rather than use a weapon,** the pilot can engage in Mega-Damage hand to hand combat. See Basic and Elite Power Armor Combat Training on page 351 of **Rifts® Ultimate Edition** for combat bonuses.
- Special Bonuses:** +2 on initiative, +1 to strike, +1 to dodge in addition to those acquired from Power Armor Training. These are the result of the V-SAM's subtle improvements in balance, stability, and weight, as well as sensor bonuses. Also see Wing Blade bonuses.
7. **Sensor System Note:** The V-SAMAS has full optical systems, including laser targeting, telescopic, passive night vision (light amplification), thermo-imaging, infrared, ultraviolet, and polarization. Plus all other features common to all power armor.

rumors and hints (gathered from their spies and informants) that Chi-Town appeared to be developing new weapons and armaments, as well as considering including CS Juicers, cyborgs and specialized mutant animals as new additions to its troops. Free Quebec took this as a non-verbal sign that Chi-Town (and the other Coalition States) was secretly expanding and reorganizing its Army without including Free Quebec in its plans (at the time, a member State).

Liberty Reserve is responsible for creating Juicers and cyborgs, and exploring other areas of human augmentation acceptable to Free Quebec's sensibilities (i.e. no mutant animals, genetic freaks or experiments, and no psychics). Since Free Quebec had been very adept at the use of bionic reconstruction, both partial and full-conversions, so a big part of The Reserve's efforts focused on developing innovative cybernetic systems and bionic troops. This was another area of military Research and Development forbidden by the Chi-Town High Command (such R&D was reserved exclusively for Chi-Town) so the entire operation had to be kept secret. Again, with the Sûreté's discovery of a military build-up at Chi-Town in complicity with Lone Star and Iron Heart, the leaders of Free Quebec ignored any political and military pacts and discreetly moved forward with their own designs.

Liberty Reserve spent a great deal of effort to keep Coalition agents and officials from discovering their handiwork. While the CS began to suspect such activity in the last few years, Liberty Reserve was in full swing, pumping out new combat cybernetics and lining up volunteers in case of war. Meanwhile, it was quietly increasing the number of cyborg soldiers already in active service.

Likewise, they were preparing for Juicer augmentation programs to add Juicers to the Military at a moment's notice (this included establishing numerous, secret Juicer Conversion Facilities throughout the nation).

Cyborg Shock Troopers

Cyborg troops play a strong role in the Quebec Army and are another example of Free Quebec's preference toward powerful, one-man units whether they be cyborgs, Juicers, Glitter Boys, SAMAS or other augmented troopers — e.g. individual, roughly man-sized soldiers who can move and function as an individual or small squad, but in which each team "member" is highly mobile and packs the firepower of an entire squad of ordinary human soldiers. The Quebec Military is built around the idea of man-sized, highly mobile and versatile combat troops who are equally formidable as a mass army or small hit and run squads, companies and battalions. The Cyborg Shock Troopers are just one component of this combat force.

Cyborg soldiers are used to provide sustaining fire using medium to heavy weapons, lead infantry charges, hold ground positions against enemy assault, provide Glitter Boys with close-range support, as well as engage in small squad reconnaissance, recce deep wilderness assignments, seek and destroy missions, rescue and Special Operations. As bionic units, they can (and usually are) armed with heavy weapons and heavy 'Borg armor (Light to Heavy Infantry Armor). When a Cyborg brigade is on the offensive, the bionic troops follow the Glitter Boys and provide intermittent fire against aerial targets and possible enemy flankers. When they approach their targets or come within

Cyborgs of Free Quebec

By Kevin Siembieda & Francois DesRochers

Part of the dispute with Chi-Town was the use of bionic and Juicer technology in the Quebec Military. Free Quebec argued for their continued inclusion (they always had them before) while the Emperor and his Military High Command lobbied for a "uniform CS Armed Forces." Ironically, a few years later the CS would take yet another cue from Free Quebec and slowly integrate Juicers and 'Borg soldiers into its own military, although on a very restricted basis (mainly Special Forces and special combat units). To placate Chi-Town, Free Quebec compromised by "officially" disbanding the use of Juicers while preserving a dramatically curtailed number of cyborgs.

The Liberty Reserve The Cyborgs of Free Quebec

In direct defiance of the Chi-Town agreement, the government sanctioned the creation of **The Liberty Reserve**, a covert Division of the Quebec Military given the responsibility to secretly design, create, organize and maintain the human augmentation programs to keep its troops diverse and well-rounded. It was formed seven years ago (99 P.A.) in response to persistent

range of their weapons, they all open fire to add to the barrage from the Glitter Boys or lead the charge along with and Infantrymen after the GBs have “softened up” the opposition and/or punched holes in the enemy line. The firepower possessed by a battalion of Cyborg Shock Troopers can rival that of the Glitter Boys. And when combined and working in tandem with GBs, SAMAS, and other troops, they create a force equal to anything the Coalition Army can muster. **Note:** All cyborg soldiers are outfitted with amplified hearing and the sound filtration system, to filter out the sounds of combat and focus on important communications and as a buffer against the sonic booms created by the Boom Guns. They suffer no penalty in combat, even if standing right next to a Glitter Boy!

Free Quebec Cyborg Soldier O.C.C.

A cyborg soldier must go through a full conversion. All candidates for such conversion are evaluated and prepared thoroughly for life as a living machine. Although there are special operatives, variants and exceptions (use the ‘Borg design rules in the *Rifts® RPG*), Free Quebec has several specific *military cyborg designs* exclusive to its Armed Forces. Partial and full conversion cyborgs are an important part of the Quebec Army, with over 55% of these cybernetic warriors serving as career soldiers. Quebec uses the same basic programs for service, retirement and decommissioning as the Coalition States (see **World Book 11: Coalition War Campaign™** for details). In fact, most of the Coalition programs were adopted from those already in place in Free Quebec.

Partial and full conversion cyborgs are also found among the Quebec law enforcement agencies, with roughly one third of the Police being partial cyborgs and 18% being full conversion cyborgs. During time of war the police double as the core of civil defense with legions of civilian volunteers assisting them.

Attribute Requirements: M.E. 15 or higher, a good I.Q. and P.E. are desirable but not necessary. Any human with the spirit to fight and that is in good mental health may choose to become a cyborg soldier.

Basic O.C.C. Skills for all Free Quebec Cyborgs: All Cyborg Shock Troopers are given the same basic training. See additional special skills, weapons and features by Cyborg Class: Imprinter, Dervish, Leviathan or Slasher, described elsewhere in this section.

Speak American 98% (see built-in language translator)

Math: Basic (+15%)

Radio: Basic (+10%)

Pilot Hover Vehicles (+15%)

Pilot skill of choice (+10%)

Intelligence (+10%)

Land Navigation (+10%)

Climb (+10%)

W.P. Energy Rifle

W.P. Heavy Energy Weapons

W.P. one of choice.

* Hand to Hand: Expert

* Hand to Hand: Expert may be changed for Martial Arts or Assassin at the cost of one O.C.C. Related Skill.

O.C.C. Related Skills: Select six other skills, plus select one additional skill at levels four, eight and twelve. All new skills start at level one proficiency.

Communications: Any (+10%)

Domestic: Any

Electrical: None

Espionage: Detect Ambush and Detect Concealment only.

Mechanical: None

Medical: First Aid only (+5%)

Military: Any (+10%)

Physical: Any that are still appropriate.

Pilot: Any (+5%), except Robots, Power Armor, and Combat Aircraft skills.

Pilot Related: Any (+5%)

Rogue: None

Science: Advanced Math (+10%) and Astronomy only.

Technical: Any (+10%)

W.P.: Any

Wilderness: Any (+5%)

Secondary Skills: The character also gets to select two secondary skills from the list, excluding those marked “None,” at levels two, five, nine and thirteen. These are additional areas of knowledge that do not get the advantage of the bonus listed in parentheses. All secondary skills start at the base level.

Standard Military issue for Cyborg Soldiers: All the appropriate ammunition and equipment for the ‘Borg’s body styling and weapon systems. Energy rifle of choice, four extra E-Clips, four grenades of choice, utility belt, backpack, walkie-talkie (for back-up) and regular maintenance and repairs.

Equipment Available Upon Assignment: Jet pack, hover vehicle or other transportation, rail gun, and additional weapons and equipment. The character also has access to most Free Quebec military bases (medium security clearance), hospitals and facilities. **Note:** Availability of equipment and resources may be dependent upon the local commander, supply stock, location, casualties and combat conditions.

Money: The character also receives a monthly salary of 2200 credits (the savings of a first level character is 1D6x1000 credits). All soldiers get a roof over their head, food, clothing, medical care and all other basic needs provided free as part of their pay.

Rank: Standard military ranking; private to general.

Bionic Conversion: Clock calendar, gyro-compass, universal headjack with amplified hearing and sound filtration system, multi-optic eyes, bionic lungs with gas filter and oxygen storage cell, built-in radio receiver and transmitter, built-in speech translator and modulating voice synthesizer are the basic systems common to all Free Quebec cyborgs under military service (bionic law enforcement have only half these cybernetics).

In addition, soldiers who volunteer for **Partial Bionic Reconstruction** will get the following common augmentation package:

- One bionic arm and hand with two weapons, an E-Clip port and one other feature of choice. Bionic Attributes: P.S. 20, P.P. 16.
- Two bionic feet and legs with one large compartment in each. Bionic Attributes: P.S. 20, Spd. 44 (30 mph/48 km).

Full Bionic Conversion typically (not always) results in one of the following Military Class Cyborgs: Imprinter, Dervish, Leviathan or Slasher. Each is described in the pages that follow.

Unique and variant cyborgs may be specially constructed for officers and Special Forces.

Note: Additional bionics and cybernetics may be added to both partial and full conversion 'Borgs as a reward and/or for special missions. Any of the bionics and cybernetics described in the **Rifts® RPG, Rifts® Triax and the NGR and Rifts® Underseas** are available.

FX-200C Imprimer

The Imprimer class cyborg is a medium-assault unit with speed, agility and reconnaissance roles in mind as well as full infantry capabilities. As such these 'Borgs are typically assigned to infantry, scouting, intelligence and Recce positions. The basic body styling employs a variety of weapons along with removable cyborg armor. The bionic body is strong, fast and agile. Standard coloration is matte black plating accenting light grayish-green. The face plate has a stern, featureless robot look with white or yellow eyes. The top of the helmet is crowned with two or three spikes. Underneath the cold mechanical features one typically finds the soldier's original, human face and hair or a human-looking facsimile. It has been found that keeping a normal looking face helps the soldier to stay in touch with his humanity.

Free Quebec FX-200C Cyborg Soldier Exclusive to the Quebec Military

Typical Training/Skills: In addition to the Basic O.C.C. Skills, the Imprimer gets these additional skills, but other O.C.C. skills are reduced to three (not six).

Boxing

Gymnastics (+5%)

Swimming (+10%)

Tracking (humanoids; +10%)

Lore: Demons & Monsters (+10%)

One W.P. of choice.

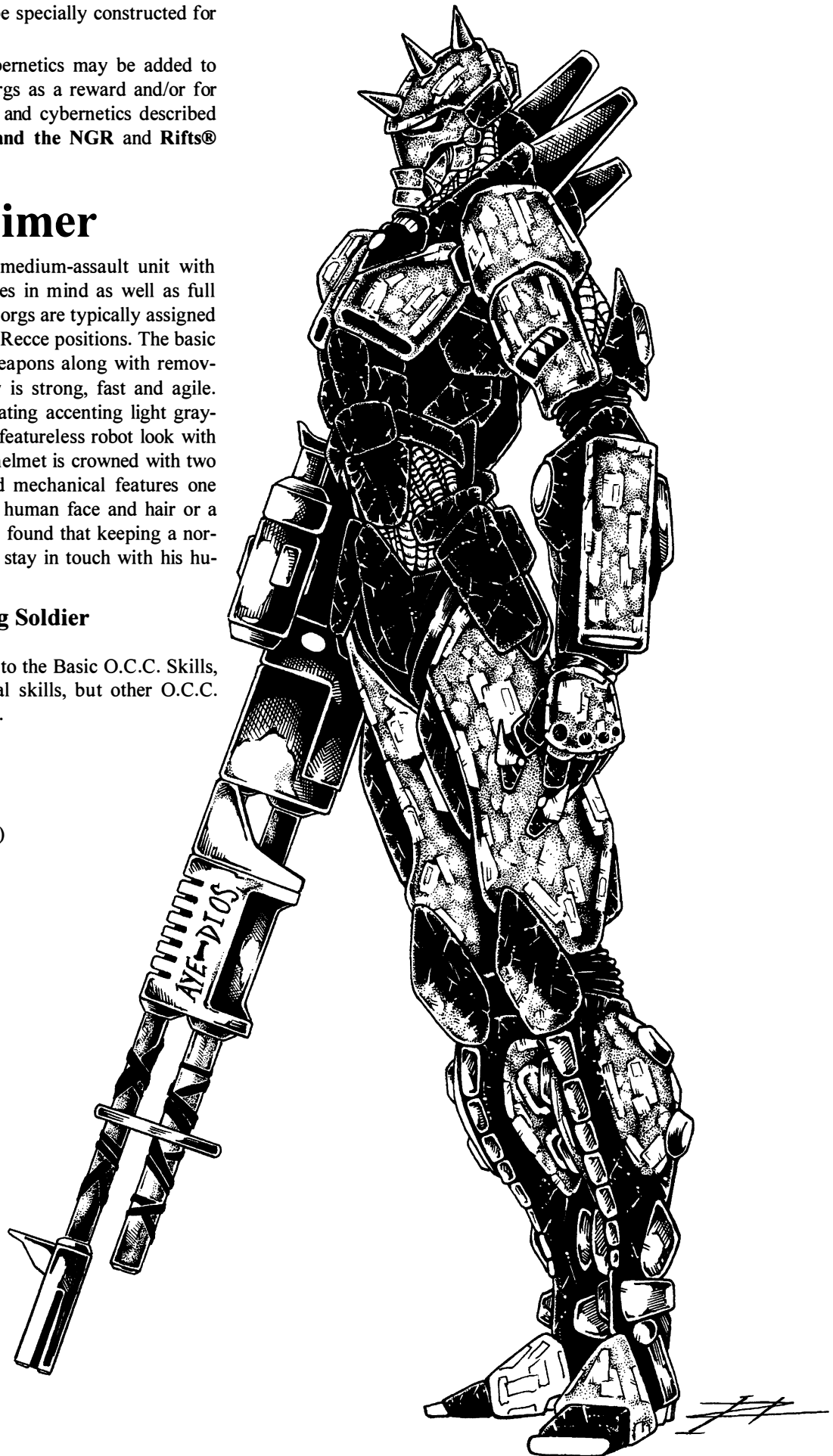

Note: The following stats are for the “standard” full conversion 'Borg. Specific weapons and bionic features may change slightly from 'Borg to 'Borg.

Model Type: FX-200C Imprimer

Class: Full Conversion Cyborg

Crew: One human volunteer.

M.D.C. by Location:

Hands (2) — 15 each

Arms (2) — 40 each

Vibro-Blade — 30

TX-500 Rail Gun — 75

Rail Gun Ammo Drum — 75

Legs (2) — 70 each

* Head (reinforced) — 65

** Main Body (standard) — 180 (**Note:** +130 M.D.C. for light body armor, or 230 for medium armor and 360 for heavy cyborg armor. Also increase the M.D.C. for the head, arms and legs by 25% for light armor, 50% for medium and 70% for heavy when wearing additional *cyborg body armor*. Cyborg armor typically hooks directly to the bionic body. Most Imprimer 'Borg wear light or medium armor unless part of a front-line Infantry assault. Armor Penalties: -5% on Prowl, Climb, Swim, Acrobatics and similar physical skills, -10% for medium and -20% for heavy.)

* Destroying the head of the cyborg will kill the character! However the head is small and difficult to hit. The attacker must make a called shot and even then he is -3 to strike. The hands are also difficult targets to hit and are -4 on a called shot.

** Depleting the M.D.C. of the main body will effectively destroy the artificial body, but emergency systems will keep the brain and vital organs alive for 36 hours. Recovery of the severely damaged body will enable doctors to place the character on a life support system that will keep him alive until a new bionic body (same style or other) is available for full conversion. Failure to find the damaged 'Borg within 36 hours means the character dies. Similarly, massive amounts of damage (125 points below zero) completely destroy the 'Borg with no hope of recovery.

Speed

Running: 80 mph (128 km) in the heavy armor, 100 mph (160 km) in the standard medium infantry armor or 120 mph (192 km) in light espionage armor or no additional armor at all.

Leaping: The powerful bionic legs are strong and capable of leaping 15 feet (4.6 m) high or lengthwise. A running start adds another 20 feet (6.1 m).

Flying: Via jet pack only; (reduce the normal jet pack speed by 30% due to the weight of the 'Borg).

Statistical Data

Average Height: 7 feet, 6 inches (2.3 m).

Width: 4 feet (1.2 m).

Length: 3 feet (0.9 m).

Weight: 1000 lbs (450 kg).

Physical Attributes: Equal to P.S. 26, P.P. 22, Spd. 154 with light infantry armor.

Power System: Nuclear; average life is 20 years.

Cost: 4.8 million credits with all standard features and weapons.

Bionic Features (non-weapon types): In addition to the standard bionics and cybernetics, the following are standard issue for Imprimer class cyborgs.

1. Climb cord (concealed)

2. Concealed energy-clip hand or arm port (left arm)

3. Psionic electromagnetic dampers (from NGR)

Weapon Systems

1. FX-200C Light Laser Blaster (1, standard issue): The left forearm typically houses this weapon.

Primary Purpose: Assault.

Mega-Damage: 2D6 M.D. per blast.

Rate of Fire: Equal to the character's total number of hand to hand attacks per melee.

Maximum Effective Range: 1500 feet (457 m).

Payload: Effectively unlimited; tied to the 'Borg's energy supply, or 20 blasts per E-Clip.

2. Concealed Vibro-Blade (1, standard issue): The opposite arm to the laser blaster is armed with a concealed Vibro-Sword that can be extended and retracted at will.

Primary Purpose: Anti-Personnel

Mega-Damage: 2D6 M.D. per strike.

Attacks per Melee Round: Total hand to hand melee actions.

Note: The 'Borg's P.P. of 22 provides a strike and parry bonus of +4, not including W.P. Sword bonuses.

3. Concealed Leg Laser Rod: The left or right hip contains a laser rod. Release, point and shoot.

Primary Purpose: Assault

Mega-Damage: 3D6 M.D. per blast.

Rate of Fire: Equal to the total number of hand to hand attacks.

Maximum Effective Range: 2000 feet (610 m).

Payload: 20 shots per E-Clip.

4. Rail Gun or other Heavy weapon: Before the Coalition States declared war, and Triax and the New German Republic stopped selling *military goods* to Free Quebec, the nation purchased 9,000 **TX-500 'Borg Rail Guns**. The TX-500 is a comparatively lightweight, portable weapon designed for 'Borgs and other creatures with a strength of 24 (or higher). It is standard issue in the NGR cyborg army and has been so effective that Free Quebec has also adopted it. Stats are as follows:

Weight: Gun: 80 lbs (36.3 kg), Power Pack: 50 lbs (22.7 kg), one light ammo-drum belt: 25 lbs (11 kg), a case of six light belts: 150 lbs (67.5 kg).

Mega-Damage: A full burst is 30 rounds and inflicts 6D6 M.D. A half burst is 15 rounds and inflicts 3D6 M.D. One round does 1D4 M.D. Free Quebec has outlawed the use of depleted uranium rounds.

Rate of Fire: One burst per hand to hand melee action/attack.

Maximum Effective Range: 4000 feet (1219 m).

Payload: Heavy ammo-drum: 1170 rounds (39 full 6D6 bursts), light drum/ammo-belt: 390 rounds (13 full 6D6 bursts). Or it can be fitted with a mini-clip which has 90 rounds (3 full bursts). Each mini-clip weighs 10 lbs (4.5 kg).

Market Cost: 85,000 credits. Good availability.

Standard Optics: The TX-500 comes equipped with a telescopic, nightvision scope and laser targeting system. Bonus: +1 to strike.

Note: In the alternative, the Q2-30 heavy, long-range laser is a favorite, and any type of rail gun, including the Q5-50 and old C-40R SAMAS rail guns, can be substituted. The Q4-44 “Drummer” Double-Barreled Shotgun is a popular back-up weapon.

5. Concealed Weapon Compartments: The standard FX-200C has two concealed compartments in the chest that typically hold a pair of Vibro-Knives (1D6 M.D.) or an energy pistol and 1D4 extra E-Clips and 2-8 hand grenades (any type).

6. Hand to Hand Combat: Rather than use a weapon, the cyborg can engage in Mega-Damage hand to hand combat. Remember, although sheathed in M.D. body armor and weapons, the cyborg's physical strength is S.D.C. based except for the occasional special attack, such as a power punch.

Attacks per Melee Round: Equal to the character's hand to hand combat skill selection and experience, plus one additional attack/action from heightened reflexes.

Combat Bonuses: +2 to initiative, +1 to dodge, +2 to pull punch, +1 to roll with impact, and +2 to save vs Horror Factor, plus attribute and W.P. bonuses.

Damage:

Restrained Punch — 1D6+12 S.D.C.

Full Strength Punch — 3D6+12 S.D.C.

Power Punch — 1D4 M.D. (counts as 2 melee attacks).

Head Butt — 2D4 S.D.C.

Kick — 4D6+12 S.D.C.

Jump Kick/Leap Attack — 2D4 M.D. (counts as 2 melee attacks).

Judo Style Throw/Flip — 3D6 S.D.C.

Full Speed Ram/Body Block — 1D4 M.D. (counts as 2 melee attacks).

7. Optional hand-held weapons, including other rail guns, energy rifles, grenades, magic weapons, etc., can be used. Other bionic weapons, such as concealed weapon rods, tools and compartments, may also be integrated into this 'Borg.

FX-320C Dervish

The Dervish is a covert action and special operations cyborg designed for close combat and assassination. It incorporates several special features, most notably four arms. Capable of using a

variety of weapons for several roles, the Dervish rarely uses heavy forearm weapons or heavy armor, preferring to use light weapons and armor to maintain maximum mobility and stealth capabilities. At least half of these cyborgs are sent behind enemy lines, alone, in pairs or in small squads to stalk, pick-off and sabotage the enemy. Primary enemy targets for assassination are officers, communications personnel, special advisors, enemy spies, and reconnaissance and special teams. They are also deployed for rescue missions, search and destroy, and Special Operations. They are most commonly assigned to the Infantry, Intelligence, the Commandos and Special Forces.

Prior to actual war, this cyborg soldier has already seen a significant amount of covert action, particularly in and around Old Bones, dealing with wilderness bandits, and in the 'Burbs of Chi-Town and Iron Heart. With the advent of war, the Dervish squads are among the first deployed to observe and sabotage enemy troops. The cyborgs gets their name from the fact that they are so fast and have so many limbs that they rather look like a whirling dervish when engaged in hand to hand combat. They are typically a dull, metallic silver color (most operatives prefer a nonhuman, machine look) with some black highlights. While most (66%) retain a human face under their robotic face plate, roughly one third prefer a mechanical one. **Camouflage Note:** When assigned to wilderness missions the cyborg's body or armor covering is usually "sprayed" with camouflage paint (easy to remove later from its M.D.C. hide). This quick, easy spray paint application is used on most cyborgs as necessary, and occasionally on ground based power armor (never on Glitter Boys).

Free Quebec FX-320C Cyborg Soldier

Exclusive to the Quebec Military

Typical Training/Skills: In addition to the Basic O.C.C. Skills common to all *Cyborg Soldiers*, the Dervish gets these additional skills, but only three other O.C.C. skills.

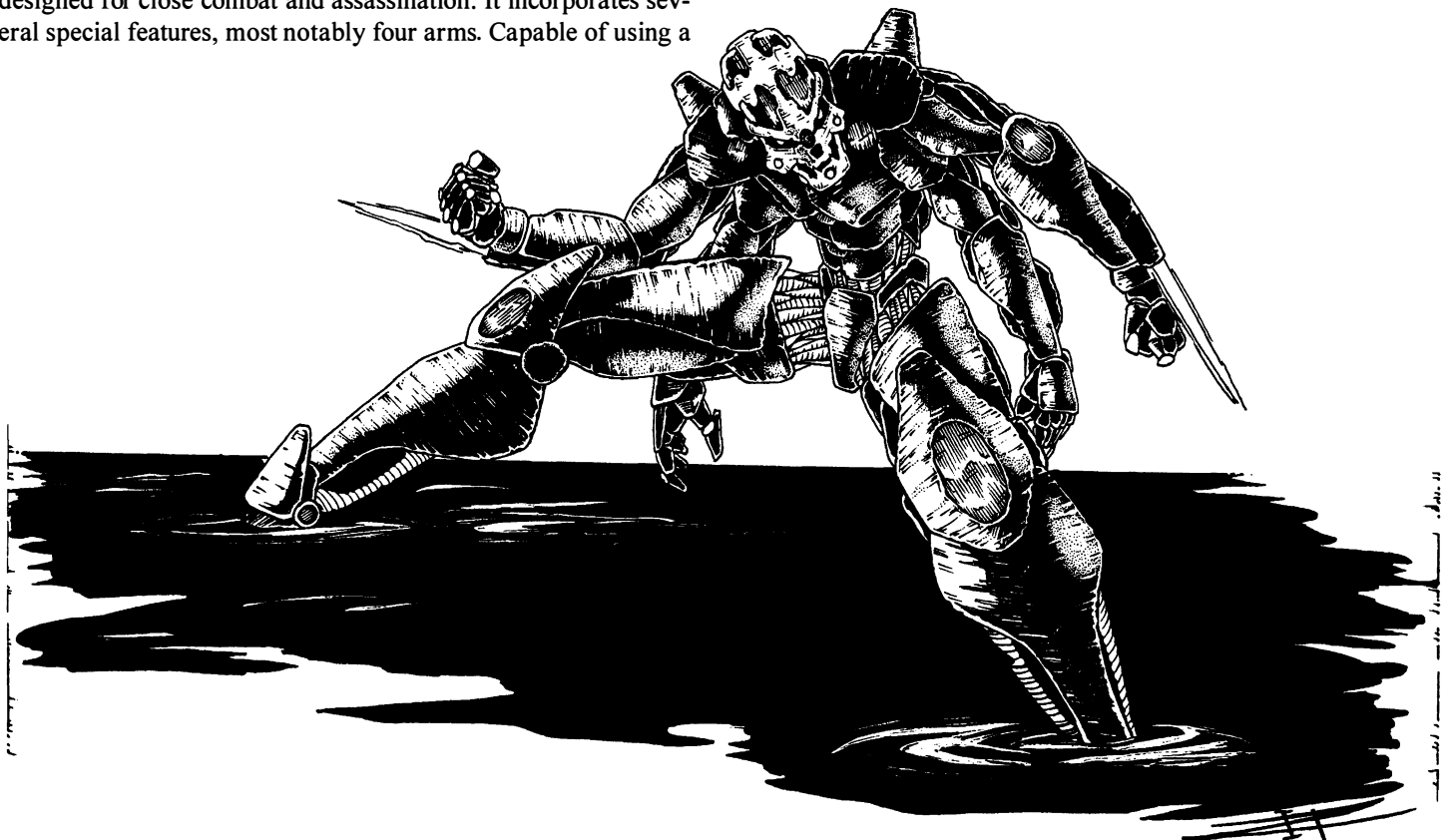

Boxing
 Wrestling
 Acrobatics (+5%)
 Prowl (+10%)
 Climbing (+20%)
 Swimming (+15%)
 Find Contraband (+10%)
 Tracking (humanoids; +10%)
 W.P. Sword
 W.P. Paired Weapons

Note: The following stats are for the “standard” FX-320C full conversion 'Borg. Specific weapons and bionic features may change slightly from 'Borg to 'Borg and operation to operation.

Model Type: FX-320C Dervish

Class: Full Conversion Cyborg.

Crew: One human volunteer.

M.D.C. by Location:

Hands (2; large) — 15 each
 Arms (4; large) — 40 each
 Hands (2; small) — 10 each
 Vibro-Blades (4) — 30 each
 Legs (2) — 90 each

* Head (reinforced) — 70

** Main Body (standard) — 200 (**Note:** +130 M.D.C. for light body armor, or 230 for medium armor; never wears the heavy, 360 M.D.C. cyborg armor except as a disguise. Also increase the M.D.C. for the head, arms and legs by 25% for light armor, 50% for medium and 70% for heavy when wearing additional *cyborg body armor*. Cyborg armor typically hooks directly to the bionic body. Most Dervish prefer the light armor in order to preserve speed, stealth and agility. Armor Penalties: -5% on Prowl, Climb, Swim, Acrobatics and similar physical skills, -10% for medium and -20% for heavy.)

* Destroying the head of the cyborg will kill the character! However the head is small and difficult to hit. The attacker must make a called shot and even then he is -3 to strike. The hands are also difficult targets to hit and are -4 on a called shot.

** Depleting the M.D.C. of the main body will effectively destroy the artificial body, but emergency systems will keep the brain and vital organs alive for 36 hours. Recovery of the severely damaged body will enable doctors to place the character on a life support system that will keep him alive until a new bionic body (same style or other) is available for full conversion. Failure to find the damaged 'Borg within 36 hours means the character dies. Similarly, massive amounts of damage (125 points below zero) completely destroy the 'Borg with no hope of recovery.

Speed

Running: 100 mph (160 km) in medium infantry armor or 120 mph (192 km) in light espionage armor or no armor at all.

Leaping: The powerful bionic legs are strong and capable of leaping 15 feet (4.6 m) high or lengthwise. A running start adds another 20 feet (6.1 m).

Flying: Via jet pack only; (half speed because of the weight of the 'Borg).

Statistical Data

Average Height: 8 feet (2.4 m).

Width: 4 feet, 6 inches (1.4 m).

Length: 3 feet (0.9 m).

Weight: 1300 lbs (585 kg).

Physical Attributes: Equal to P.S. 28, P.P. 24, Spd. 154.

Power System: Nuclear; average life is 20 years.

Cost: 5.6 million credits with all standard features and weapons.

Bionic Features (non-weapon types): In addition to the standard bionic and cybernetics common to all *Cyborg Soldiers*, the following are standard issue for Dervish class cyborgs.

1. Climb cord (concealed)
2. Garrote Wrist Wire
3. Finger Camera
4. Fingerjack
5. Psionic electromagnetic dampers (from NGR)
6. Additional hands and arms (2; four total)

Weapon Systems

1. FX-220 Concealed Vibro-Blades (4, standard issue): Each forearm comes equipped with a Vibro-Sword that can be extended or retracted at will.

Primary Purpose: Anti-Personnel & Assassination.

Mega-Damage: 2D6 M.D. per strike.

Attacks per Melee Round: Total hand to hand melee actions.

Note: The P.P. of 24 provides a strike and parry bonus of +5, not including W.P. Sword bonuses.

2. Concealed Leg Laser Rod (1): The left hip contains a laser rod. Release, point and shoot.

Primary Purpose: Assault

Mega-Damage: 3D6 M.D. per blast

Rate of Fire: Equal to the total number of hand to hand attacks.

Maximum Effective Range: 2200 feet (670.5 m).

Payload: 20 shots per E-Clip.

3. Concealed Leg Ion Rod (1): The right hip contains an ion rod. Release, point and shoot.

Primary Purpose: Assault

Mega-Damage: 4D6 M.D. per blast.

Rate of Fire: Equal to the total number of hand to hand attacks.

Maximum Effective Range: 1600 feet (488 m).

Payload: 20 shots per E-Clip.

4. Chemical Spray (chest): A Chemical Spray system is built into the chest of the Dervish. See page 240 of the **Rifts® RPG** for complete details.

Primary Purpose: Assault and incapacitation and capture.

Mega-Damage: Varies with type of chemical (blind, tear gas, burning vapors, sleep, and CO2 foam are the most common).

Rate of Fire: Equal to the total number of hand to hand attacks.

Maximum Effective Range: 20 feet (6 m).

Payload: 20 doses and as many as five different chemicals.

5. Concealed Weapon Compartments: The standard Dervish has two concealed compartments in the legs to hold additional tools, weapons, grenades or other items.

6. Hand to Hand Combat: Rather than use a weapon, the cyborg can engage in Mega-Damage hand to hand combat. Remember, although sheathed in M.D. body armor and weapons, the cyborg's physical strength is S.D.C. based except for the occasional special attack, such as a power punch.

Attacks per Melee Round: Equal to the character's hand to hand combat skill selection and experience, plus one additional attack/action from heightened reflexes, and another added attack/action from the extra set of arms.

Combat Bonuses: +3 to initiative, +4 to pull punch, +2 to parry, +4 to disarm, and +4 to save vs Horror Factor, plus attribute, Boxing, Wrestling and W.P. bonuses!

Damage:

Restrained Punch — 1D6+12 S.D.C

Full Strength Punch — 4D6+12 S.D.C.

Power Punch — 1D6 M.D. (counts as 2 melee attacks).

Head Butt — 2D4 S.D.C.

Kick — 4D6+12 S.D.C.

Jump Kick/Leap Attack — 2D4 M.D. (counts as 2 melee attacks).

Judo Style Throw/Flip — 3D6 S.D.C.

Full Speed Ram/Body Block — 1D4 M.D. (counts as 2 melee attacks).

7. Optional hand-held weapons, including other rail guns, energy rifles, grenades, magic weapons, etc., can be used. Other bionic weapons, such as concealed weapon rods, tools and compartments, may also be integrated into this 'Borg.

FX-340C Slasher

Note: Reprinted from *Rifts®: Triax & the NGR*, page 103, with some additional text.

Over one thousand Triax Slasher full conversion cyborgs were acquired from Triax and the NGR before the declaration of war, and have been added to the ranks of Free Quebec's Cyborg Shock Troopers. The FX-340C Slasher is fundamentally the same full conversion Triax cyborg also known as the "Gold Type 'Borg'" because of the metallic gold color used in mass market editions. The Slasher has a mechanical, demonic looking head and face plate to strike fear into its opponents. The cyborg rarely incorporates heavy forearm weapons so that it has maximum mobility, strike and parry bonuses, and free hands to set explosives and operate assault weapons. The Slasher is often sent on espionage or seek and destroy missions.

Free Quebec FX-340C Cyborg Soldier

Exclusive to the Quebec Military

Typical Training/Skills: In addition to the Basic O.C.C. Skills common to all Quebec Cyborg Soldiers, Slashers also get these additional skills. However, reduce the selection of other O.C.C. skills by half.

Boxing

Climbing (+10%)

Swimming (+10%)

Tracking (humanoids; +10%)

Wilderness Survival (+10%)

Lore: Demons & Monsters (+10%)

W.P.: One of choice.

Note: The following stats are for the "standard" FX-340C full conversion 'Borg. Specific weapons and bionic features may change slightly from 'Borg to 'Borg.

Although the model is of Triax origin, it has been adapted into the Free Quebec military.

Model Type: FX-340c Slasher

Class: Full Conversion Cyborg

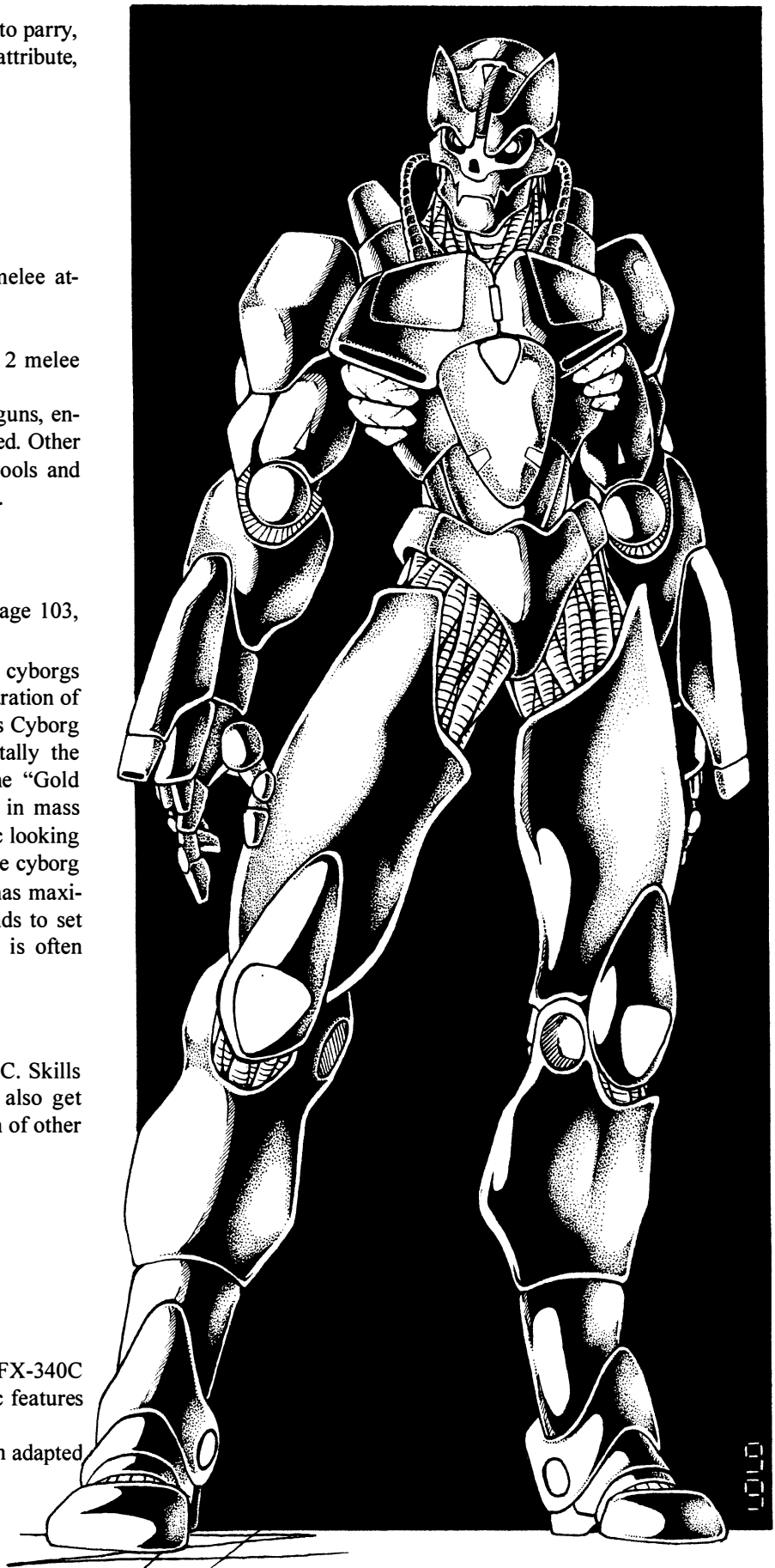

Crew: One human volunteer.

M.D.C. by Location:

Hands (2) — 15 each

Arms (2) — 40 each

Vibro-Blades (2) — 10 each

Mini-Missile Launch Tubes (4; back) — 20 each

TX-500 Rail Gun — 75

Rail Gun Ammo Drum — 75

Legs (2) — 80 each

* Head (reinforced) — 90

** Main Body (normal) — 180 plus an additional 270 M.D.C. from its light infantry armor (hooks directly to the bionic body).

* Destroying the head of the cyborg will kill the character! However the head is small and difficult to hit. The attacker must make a called shot and even then he is -3 to strike. The hands are also difficult targets to hit and are -4 on a called shot.

** Depleting the M.D.C. of the main body will effectively destroy the artificial body, but emergency systems will keep the brain and vital organs alive for 36 hours. Recovery of the severely damaged body will enable doctors to place the character on a life support system that will keep him alive until a new bionic body (same style or other) is available for full conversion. Failure to find the damaged 'Borg within 36 hours means the character dies. Similarly, massive amounts of damage (125 points below zero) completely destroy the 'Borg with no hope of recovery.

Speed

Running: 100 mph (160 km) in the standard light infantry armor or 120 mph (192 km) in light espionage armor or no additional armor.

Leaping: The powerful bionic legs are strong and capable of leaping 25 feet (7.6 m) high or lengthwise. A running start adds another 30 feet (9.1 m).

Flying: Via jet pack only; (half speed because of the weight of the 'Borg).

Statistical Data

Average Height: 8 feet (2.4 m)

Width: 4 feet (1.2 m)

Length: 3 feet (0.9 m) is the length of the body itself. Four feet (1.2 m) including the small launch tubes.

Weight: 1000 lbs (450 kg)

Physical Attributes: Equal to P.S. 27, P.P. 24, Spd. 154 with light infantry armor.

Power System: Nuclear; average life is 20 years.

Cost: Five million credits with all standard features and weapons.

Penalties: The so-called light infantry armor provides excellent Mega-Damage protection but is actually quite heavy so there are some movement penalties; -1 to parry and dodge, -1 to roll with impact, and -20% to Prowl.

Bionic Features (non-weapon types): In addition to the standard bionics and cybernetics common to all Quebec Cyber Soldiers, the following are standard issue for Slasher class cyborgs.

1. Climb cord (concealed)
2. Concealed energy-clip hand or arm port (1 in each arm)
3. Psionic electromagnetic dampers

Weapon Systems

1. **Concealed Vibro-Blades (2):** Each forearm has a Vibro-Sword that can be extended or retracted at will.

Primary Purpose: Anti-Personnel

Mega-Damage: 2D6 M.D. per strike.

Attacks per Melee Round: Total hand to hand melee actions.

Note: The P.P. of 24 provides a strike and parry bonus of +5, not including any W.P. Sword bonuses.

2. **FX-340C Mini-Missile Tube Launchers (4):** Four single-shot mini-missile tube launchers are mounted on the back of the 'Borg.

Primary Purpose: Anti-Aircraft

Secondary Purpose: Defense

Missile Type: Any mini-missile can be used, but standard issue is armor piercing (1D4 x 10 M.D.) or plasma (1D6 x 10). Fragmentation is seldom used by these anti-armor units.

Mega-Damage: Varies with missile type.

Range: Usually about a mile (1.6 km)

Rate of Fire: One at a time or in volleys of two or four.

Payload: Four total; one in each tube.

3. **Concealed Leg Laser Rod: The right or left hip contains a laser rod. Release, point and shoot.**

Primary Purpose: Assault

Mega-Damage: 3D6 M.D. per blast.

Rate of Fire: Equal to the total number of hand to hand attacks.

Maximum Effective Range: 3000 feet (914 m)

Payload: 20 shots per E-Clip.

4. **TX-500 'Borg Rail Gun (1; standard issue):** The TX-500 is a comparatively lightweight, portable weapon designed for use by 'Borgs and other creatures with a strength of 24 (or higher).

Weight: Gun: 80 lbs (36.3 kg), Power Pack: 50 lbs (22.7 kg), one light ammo-drum belt: 25 lbs (11 kg), a case of six light belts: 150 lbs (67.5 kg).

Mega-Damage: A full burst is 30 rounds and inflicts 6D6 M.D. A half burst is 15 rounds and inflicts 3D6 M.D. One round does 1D4 M.D. Free Quebec has outlawed the use of depleted uranium rounds

Rate of Fire: One burst per hand to hand melee action/attack.

Maximum Effective Range: 4000 feet (1219 m)

Payload: Heavy ammo-drum: 1170 rounds (39 full 6D6 bursts), light drum/ammo-belt: 390 rounds (13 full 6D6 bursts). Or it can be fitted with a mini-clip which has 90 rounds (3 full bursts). Each mini-clip weighs 10 lbs (4.5 kg).

Market Cost: 85,000 credits. Good availability.

Note: The TX-500 comes equipped with a telescopic, nightvision scope and laser targeting system. Bonus: +1 to strike.

5. **Concealed Weapon Compartments:** The standard FX-340c has two concealed compartments in the chest that typically hold a pair of Vibro-Knives (1D6 M.D.) and two to eight grenades (any type).

6. **Hand to Hand Combat:** Rather than use a weapon, the cyborg can engage in Mega-Damage hand to hand combat. Remember, although sheathed in M.D. body armor and weapons, the cyborg's physical strength is S.D.C. based except for the occasional special attack, such as a power punch.

Attacks per Melee Round: Equal to the character's hand to hand combat skill selection and experience, plus one additional attack/action from heightened reflexes.

Combat Bonuses: +2 to initiative, +3 to pull punch, +1 to roll with impact, and +2 to save versus Horror Factor. P.P. 24 bonus: +5 to strike, parry and dodge.

Damage:

Restrained Punch — 1D6+12 S.D.C

Full Strength Punch — 3D6+12 S.D.C.

Power Punch — 1D4 M.D. (counts as 2 melee attacks)

Head Butt — 2D4 S.D.C.

Kick — 4D6+12 S.D.C.

Jump Kick/Leap Attack — 2D4 M.D. (counts as 2 melee attacks)

Judo Style Throw/Flip — 3D6 S.D.C.

Full Speed Ram/Body Block — 1D4 M.D. (counts as 2 melee attacks)

7. Optional hand-held weapons, including other rail guns, energy rifles, grenades, magic weapons, etc., can be used. Other bionic weapons, such as concealed weapon rods, tools and compartments, may also be integrated into this 'Borg.

FX-370C Leviathan Cyborg

Leviathan class "cyborgs" are special soldiers used predominantly by the Quebec Navy (70%) and Special Forces (25%; 5% are attached to other military operations). These elite troopers are huge, armed to the teeth and armored enough to battle most underwater demons and power armor, and even take on small to medium-sized submarines and patrol boats. In fact a favorite ploy is to dispatch a squad (6-10) to sabotage, cripple, or scuttle boats, subs and other water vessels. They are most commonly deployed in and around bodies of water, often using a river, lake or coastline as a method of entering and travelling through a region unseen above water, exiting to do intelligence scouting or sabotage on land (as far inland as 200 miles/320 km) and then making a hasty escape back through the waterways. This method of insertion, travel and hit and run tactics is especially effective against opponents with no or little underwater capabilities. Mercenaries, D-Bees and most "land-lubbers" don't usually consider attacks from the water, they tend to consider only what they can see (i.e. ground and air attackers).

Even the Coalition troops on land and in the water have fallen prey to these underwater specialists. So far the Leviathan 'Borgs have proven to be incredibly effective against the Coalition Navy and troops along the many waterways of the Quebec territory. As is typical of Free Quebec troops, the Navy in particular, these cyborgs thrive on hit and run attacks and surgical strikes, and engage in sabotage and attacks that *cripple* rather than kill the enemy. This means sinking and damaging vessels (in most cases with 90-100% of the crew surviving), destroying other transport vessels (air, ground and water) and giant robots, destroying communications towers, sensor arrays, generators, weapon/munitions storage, and destroying or stealing cargo, food and supplies, as well as generally harassing, confusing and dividing the enemy. The latter includes crippling vessels in such a way that they block or collide with others, inflict damage that

requires hours or days to clear debris or make repairs, and keep the troops posted to a particular position constantly on edge.

The Leviathan is a big, ten foot tall, bulky underwater "cyborg" with a light, built-in underwater propulsion system that can be augmented by a detachable underwater propulsion unit like the one used by the *Sea Dragon* (described in the Navy section of this book).

Free Quebec FX-370C Cyborg Soldier

Exclusive to the Free Quebec Military

Typical Training/Skills: In addition to the Basic O.C.C. Skills, these additional special skills are included.

Swimming (+20%)

Swimming S.C.U.B.A. (+20%)

Navigation (+15%)

Read Sensory Instruments (+10%)

Demolitions: Underwater (+20%)

Demolitions Disposal (10%)

W.P. Trident

Note: The following stats are for the "standard" FX-370C full conversion 'Borg. Specific weapons and bionic features may change slightly from 'Borg to 'Borg.

Model Type: FX-370C Leviathan

Class: Full Conversion Cyborg.

Crew: One human volunteer.

M.D.C. by Location:

Hands (2) — 22 each

Arms (2) — 65 each

Legs (2) — 100 each

* Shoulder Mini-Missile/Torpedo Launcher (1, left) — 30

* Forearm Blaster (1, left) — 20

* Vibro-Blade (1, right arm) — 30

* Small Thrusters (4 back, 2 feet) — 8 each

* Chest Thrusters (2) — 30 each

* Head (reinforced) — 90

** Main Body (normal) — 220 (**Note:** +220 M.D.C. for medium armor or 380 M.D.C. for heavy; never wears light armor. Also increase the M.D.C. for the head, arms and legs by 50% when wearing additional medium or heavy *cyborg body armor*. Cyborg armor typically hooks directly to the bionic body. Armor penalties on land: -10% on Prowl, Climb, Acrobatics and similar physical skills requiring agility and flexibility of movement; -5% when underwater where the buoyancy of the water helps defer weight and encumbrance.)

* Destroying the head of the cyborg will kill the character! However the head, is small and difficult to hit. The attacker must make a called shot and even then he is -3 to strike. The hands are also difficult targets to hit and are -4 on a called shot.

** Depleting the M.D.C. of the main body will effectively destroy the artificial body, but emergency systems will keep the brain and vital organs alive for 36 hours. Recovery of the severely damaged body will enable doctors to place the character on a life support system that will keep him alive until a new bionic body (same style or other) is available for full conversion. Failure to find the damaged 'Borg within 36 hours means the character dies. Similarly, massive amounts of damage (125 points below zero) completely destroy the 'Borg with no hope of recovery.

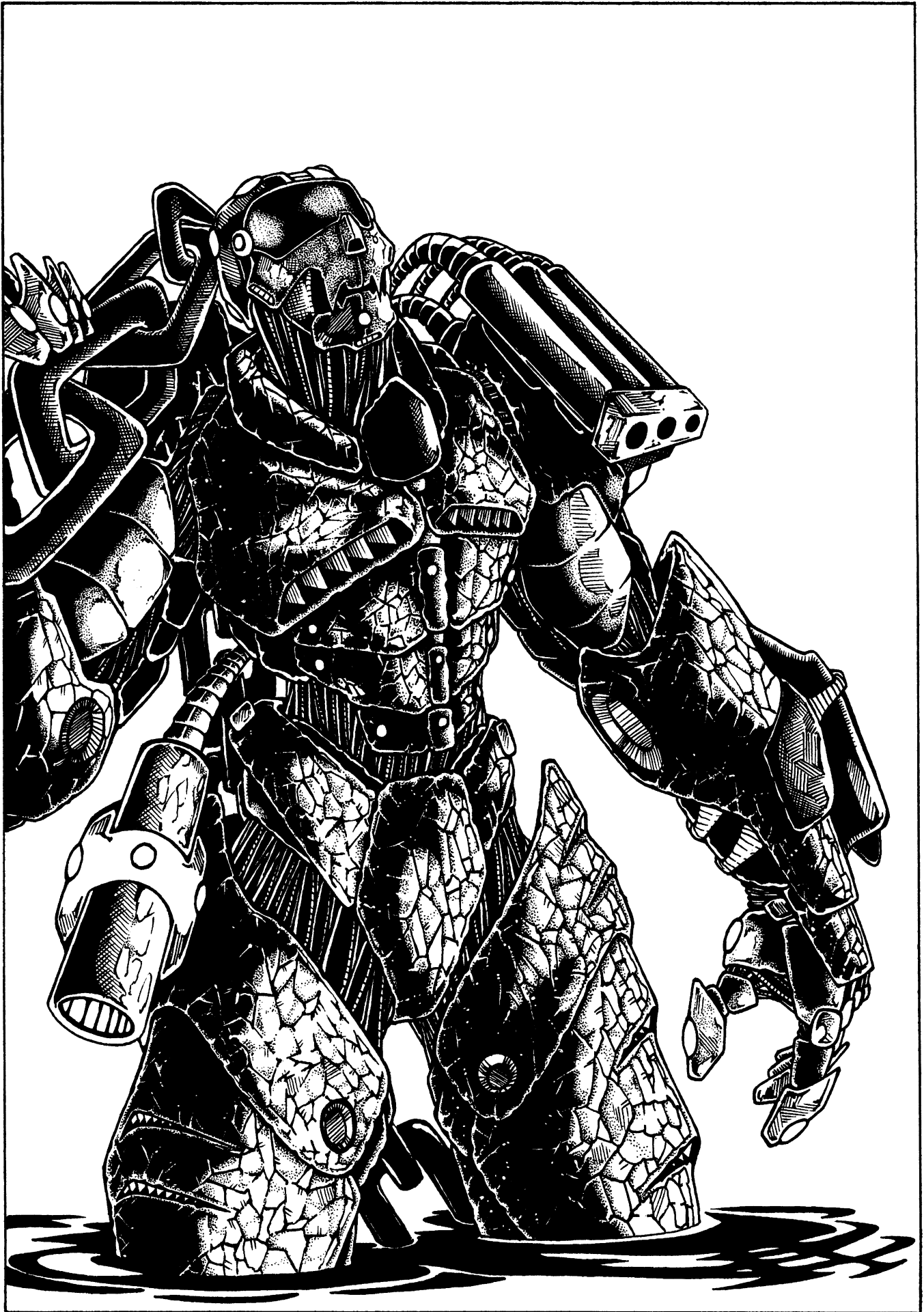

Speed

Running: 70 mph (112 km) in cyborg infantry armor or 80 mph (128 km) without armor.

Leaping: The powerful bionic legs are strong and capable of leaping 15 feet (4.6 m) high or lengthwise. A running start adds another 20 feet (6.1 m).

Underwater Capabilities: Swim without any means of propulsion: 15 mph (24 km or 13 knots).

Using the light, built-in propulsion system, the Leviathan has better speed and excellent mobility. 20 mph (32 km or 17 knots).

Using a large back-mounted propulsion system nearly identical to the one used by the *Sea Dragon* power armor, the cyborg can propel itself on the surface or underwater as speeds of 55 mph (88 km or 47 knots).

Maximum depth: 2000 feet (610 m). Actually a few have gone as deep as 2300 feet (701 m) but to do so risks the bends and death from decompression.

Flying: Via jet pack only; (half speed because of the weight of the 'Borg).

Statistical Data

Average Height: 10 feet (3 m).

Width: 5 feet (1.5 m)

Length: 3 feet, 5 inches (1 m); 5 feet (1.5 m) with propulsion system.

Weight: 2690 lbs (1210.5 kg); add another 240 lbs (108 kg) from the detachable propulsion system.

Physical Attributes: Equal to P.S. 26, P.P. 24, Spd. 118

Power System: Nuclear; average life is 20 years.

Cost: 6.2 million credits with all standard features and weapons.

Bionic Features (non-weapon types): In addition to the standard bionic and cybernetics, the following are standard issue for Leviathan class cyborgs.

1. Built-in depth gauge.
2. Bionic Lung with gas filter and Oxygen Storage cell (two hour supply). See *Rifts® Ultimate Edition*, page 48.
3. Bio-Comp self-monitoring system.
4. Bionic gills: This is a *new* bionic implant co-developed by Triax before the war. It is typically tied to a bionic lung which can also store and purify oxygen. The bionic gills convert oxygen within the water into breathable air for the cyborg, but can only be used at depths no greater than 600 feet (183 m). It has proven to be surprisingly reliable and sturdy, even though it is still considered to be experimental. Bionic gills are used extensively by full conversion cyborgs in the Quebec Navy. Gills leave no tell-tale bubbles and are completely silent, making them ideal for underwater espionage and sabotage.
5. Optional Tool Hand: A mechanical hand that contains a fingerjack, fingertip screwdrivers with changeable heads, finger pliers, tiny lights built into each fingertip, plus an additional laser cutter finger. There is also a small retractable drill in the middle knuckle. Cost: 24,000 credits.

Note: Other bionic weapons, such as concealed weapon rods, Vibro-Blades (a favorite forearm weapon of officers), tools and extra compartments, may also be integrated into this cyborg.

Weapon Systems

1. **FX-99N Plasma Torch and Ejector (1):** This item is designed specifically for the Leviathan as both an M.D.C. cut-

ting tool and short-range weapon. It is attached to a power supply hooked to the lower back of the cyborg and is used to cut anchors, cabling and the hulls of light M.D.C. ships. If necessary, the weapon can also be used as a blaster. It functions equally well underwater and on land. The firing mechanism is a short cylinder with a handle and trigger attached to a power cable. It vaguely resembles a flamethrower.

Primary Purpose: Sabotage.

Secondary Purpose: Defense and close combat.

Weight: Gun: 8 lbs (3.6 kg) plus 50 lbs (22.7 kg) for the power pack.

Mega-Damage: Has three settings as a plasma torch to cut: 1D6 M.D., 3D6 M.D. and 6D6 M.D. at full power.

Plasma blasts inflict 1D6, 3D6 of 6D6 M.D. as desired by the user.

Rate of Fire: Each cut or blast counts as one melee action/attack.

Maximum Effective Range: Up to 10 feet (3 m) as a cutter (usually used only inches away), and 400 feet (122 m) as a ranged weapon.

Payload: 50 full strength blasts or 100 half strength blasts. Six 1D6 M.D. cuts/shots count as one full blast

Market Cost: 140,00 credits with power supply. Exclusive to the Free Quebec Military and Navy.

2. **Forearm Laser Blaster:** Mounted on the left arm is a laser blaster; point and shoot.

Primary Purpose: Assault

Mega-Damage: 2D6 M.D.

Rate of Fire: Equal to the total number of hand to hand attacks.

Maximum Effective Range: 2000 feet (610 m).

Payload: 20 shots per E-Clip.

3. **Laser Finger (1):** One of the digits on the right or left hand has a small laser built into it. It is used primarily as a tool for cutting and welding.

Primary Purpose: Tool

Mega-Damage: Three settings: 6D6 S.D.C., one M.D. or 1D4 M.D.

Rate of Fire: Equal to the total number of hand to hand attacks.

Maximum Effective Range: 50 feet (15.2 m).

Payload: Unlimited, tied into the cyborg's power supply.

4. **Shoulder Mounted Mini-Missile or Torpedo Launcher (1):** Mounted on the left shoulder is a launch system that can fire either mini-missiles or torpedoes.

Primary Purpose: Anti-Aircraft and Anti-Missile.

Secondary Purpose: Defense.

Missile Type: Any mini-missile can be used, but standard issue is armor piercing (1D4x10 M.D.) or plasma (1D6x10), or comparable mini-torpedo.

Mega-Damage: Varies with missile type.

Range: Usually about a mile (1.6 km).

Rate of Fire: One at a time or volleys of two or three.

Payload: Six total.

5. **Rail Gun or other Heavy weapon:** The cyborg may also use a hand-held weapon. Any Naval weapon can be used, including harpoon guns and laser rifles to the Q2-30 heavy, long-range laser or rail guns, including the Q5-50 and old C-40R SAMAS rail gun.

6. **Hand to Hand Combat:** Rather than use a weapon, the cyborg can engage in Mega-Damage hand to hand combat. Remember, although sheathed in M.D. body armor and

weapons, the cyborg's physical strength is S.D.C. based except for the occasional special attack, such as a power punch. **Attacks per Melee Round:** Equal to the character's hand to hand combat skill selection and experience, plus one additional attack/action from heightened reflexes.

Combat Bonuses: +1 to initiative, +3 to pull punch, +2 to roll with impact, and +4 to save vs Horror Factor in addition to bonuses gained from attributes, skills and W.P.s.

Damage:

Restrained Punch — 1D6+12 S.D.C

Full Strength Punch — 4D6+12 S.D.C.

Power Punch — 1D6 M.D. (counts as 2 melee attacks)

Head Butt — 2D6 S.D.C.

Kick — 4D6+12 S.D.C.

Jump Kick/Leap Attack — 2D6 M.D. (counts as 2 melee attacks)

Judo Style Throw/Flip — 3D6 S.D.C.

Full Speed Ram/Body Block — 1D6 M.D. (counts as 2 melee attacks).

The Quebec Navy

By Kevin Siembieda with Francois DesRochers

Arguably, the greatest natural resource of Free Quebec is water. In fact, only about 6% of Quebec is suitable for agriculture and another 5% for grazing (sheep and cattle). Even its name is tied to the water, for the word *kebec* is Algonquian, meaning "place where the river narrows" — the name given to the site where the original City of Quebec (now Old Bones) was located.

Hundreds of rivers (some long and deep, cutting a third to half-way across the old Province, three actually slicing from one end of the country to the other; some rivers are comparatively shallow) and *countless lakes*, large and small, cover the countryside. To illustrate the point, the park region once known as **Parc Mont Tremblant** during pre-Rifts days, located about 90 miles (144 km) north of *Montreal*, has more than 380 lakes! Fishing, canoeing, swimming, white-water rafting, and windsurfing were all popular pastimes for Quebecois and visitors (and still are for many).

Traveling the waterways and plumbing their resources is as natural for the people of Quebec as breathing. Many humans and D-Bees make their living by fishing. Others trap small game like beaver, fox, otter, muskrat, goose, duck and other animals common to freshwater areas for their meat and pelts. Likewise, the population of deer, moose and caribou has exploded, providing ample game for those who inhabit the forests that cover 80% of the land claimed by Free Quebec. (Many use all parts of the animal, meat, fur/hide and bone.) The hundreds of years that have passed since the Great Cataclysm have allowed the forests to regrow dense and tall, supplying the slowly growing population of humanoids with lumber and the waterways by which to transport it.

The many rivers and lakes not only supply fish, fresh drinking water and means of transportation and cargo hauling, but energy. *Hydroelectric power plants* are found at virtually every

major city of modern Free Quebec, from Old Bones and the City of Free Quebec, to its many smaller, neighboring communities. Likewise, many of the more remote communities will have mills, electrical turbines and generators powered by water.

The higher water level, worldwide, has made many of Quebec's rivers and lakes, the St. Lawrence among them, deeper and wider, allowing for easier passage of medium and large vessels. However, small, light watercraft, like canoes, are still the most versatile means of water travel, especially inland. **The canoe** can traverse shallow rivers and rushing rapids as well as deep lakes and rivers. When the waterway ends, it can be removed and easily carried by two ordinary men, even through forest. Canoes and kayaks are the favorites of Wilderness Scouts, Trapper-Woodsmen, Tundra Rangers, Psi-Stalkers, Inuit tribes and other Native Americans, as well as nomadic D-Bees. The more modern traveler and CS and Quebec Military may also use canoes, but often lean toward small motorboats, hydrofoils and water sleds.

With the amazing number of lakes and rivers throughout Quebec and the ocean so near, pirates and raiders quickly appeared, using the waterways as the means to travel, attack and escape. Piracy has been a huge problem for Free Quebec for centuries. It has been made all the worse by the availability of small, light modern and Techno-Wizard watercraft as well as underwater capable suits of power armor and robot vehicles — all of which make the rivers and lakes more negotiable than ever before. Aquatic D-Bees and monsters only add to the dangers hidden in the wilderness.

There is little question as to why the nation of Free Quebec was the first to create a genuine *Navy*. Covered by lakes and rivers, with the St. Lawrence River to the south, the James and Hudson bay to the west, near by the Great Lakes, and the Atlantic Ocean to the east and north, it was natural.

The Quebecois have used the waterways as a means of travel and defense for centuries. After the Great Cataclysm, water travel became essential. When river pirates appeared, a naval defense force was created as a response. Over time, the Quebecois developed a naval force adept at both river combat and open sea warfare. It was the Quebecois who rebuilt (and maintain to this day) the network of locks and canals between *Montreal* and *Lake Erie*. They were the first to create great fishing fleets to navigate the St. Lawrence and plumb its rich waters for flounder, cod, haddock, pollack, sole, and salmon, and in the Gulf of St. Lawrence and the Atlantic coast, swordfish, herring, sardine, lobster, clams and oysters. A fleet of vessels were protected by the speedy patrol boats and winged SAMAS of the ever growing Quebec Navy.

During its tenure as a member of the **Coalition States**, it was Free Quebec who first proposed developing a truly capable naval force and pressed Chi-Town to build a formal Navy for all the Coalition States. Free Quebec argued that without a Navy the CS was lacking a critical military defense and offensive combat capability (They didn't know how true they were. Ironically, the Coalition's weak and inadequate Navy versus Free Quebec's large and experienced one is a pivotal factor in that nation's ability to defend itself against CS incursions). The Coalition High Command eventually agreed after the Emperor weighed in on the side of Free Quebec (one of the few times he

agreed with a Quebec point of view). Since Free Quebec had already established a strong naval force, its engineers, designers, advisors and naval tacticians played a huge role in creating the **Coalition Navy**. In fact, a full half of the ships, boats, other aquatic vehicles and underwater weaponry were originally designed by Free Quebec and adopted by the CS. The other half were co-developed by Chi-Town and Free Quebec design teams working together, typically with Quebec personnel in charge. Consequently, virtually every vessel, power armor and piece of equipment described in the pages of **Rifts® Sourcebook 4: Coalition Navy™** is available to Free Quebec. Moreover, Free Quebec has superior amounts of naval vessels, equipment, and manufacturing facilities, as well as a better trained and much more experienced Navy.

For years the St. Lawrence Seaway and the related waterways have been the lifeblood of Free Quebec. Her domination of these waters has kept her coasts and communities safe from pirates, raiders, and sea monsters, and keeps trade flowing without disruption. Overseas shipments to and from the New German Republic would first make their way through the St. Lawrence and then to other destinations. The nation also enjoys healthy fishing, logging, shipbuilding and cargo transport industries.

Since their split from the Coalition States, Free Quebec has invested heavily in its Navy. A strategic move that may make the difference in that nation's survival, and one that could certainly make the war last years, whatever the outcome.

War Tactics

Nowhere is the Quebec Military's approach to war more evident than with its Navy. The leaders of Quebec would prefer *not* to slaughter hundreds of thousands (or more) of their fellow humans and one-time CS allies. Consequently, they have taken to strong defense and countermeasures. They strike like a boxer who is a counterpuncher. Such a boxer peppers his opponent with *jabs* to frustrate and make him keep his distance. The heavy fighting comes in the form of *counterpunching* — a tactic in which the boxer lures his opponent in close, often after making his opponent believe he is hurt and on the ropes. It is at that moment, when the opponent strikes at last in frustration or anger, or carelessly because he believes his enemy is hurt, that the counterpuncher strikes with startling fury and power.

Staying with the boxing analogy, Free Quebec is not looking for a "knockout" win. They are simply trying to hold their own against a more powerful foe who outnumbers them by at least three to one — a real heavyweight. They have no desire to deci-



mate their opponent, simply to stay in the game long enough to pull out a win. They avoid suffering punishing beatings, but at the same time frustrate, hurt and slow down their opponent enough to prevent him from seriously hurting them. This also means the Free Quebec Army and Navy are satisfied with holding the enemy at bay, making them pay for any acts of aggression (i.e. Free Quebec makes a strong, merciless defense and counterattacks), pinning, crippling or hurting rather than killing.

This counterpunching approach means it's the Coalition Army who must always make the first move to engage in serious combat using up energy, emotion, time and resources, all of which takes its toll in the long-run. Meanwhile the Quebec Military watches carefully, dancing elusively just out of range or taking only minor damage while making small tactical strikes (like the jab) and waiting for the CS to commit to an attack. When the Coalition Army does, the Quebec Military tries to avoid the full brunt of it by either slipping out of harm's way (adding to the enemy's frustration) or *ambushing* their opponent and dancing away. Moreover, because of the constant dancing around (i.e. hit and run attacks, crippling blows, acts of sabotage, etc.), when the Quebec Navy or Army does stand and fight, they surprise the enemy who is not expecting or prepared for a pitched battle where the Quebecois hold their ground. In any case, it is the CS who must be the aggressor while Free Quebec is able to conserve its energy and resources. The attacks that come from the Quebec Navy (and Army) are *jabs*, small squad attacks and acts of sabotage designed to confuse, frustrate, breakdown and divide their opponent — "to take him out of his game," which makes the enemy anxious, careless and vulnerable to counterattack or a carefully planned ambush.

The overall strategy has been working wonderfully as the Coalition Army has been effectively stymied and contained, and feels increasingly frustrated and impotent with each passing week. As for the Coalition Navy, it has been soundly beaten, crippled and whittled away into a state of disarray and complete ineffectiveness.

The Quebec Navy has become frighteningly skilled at outmaneuvering, sabotaging and tearing apart the Coalition's feeble Navy. Attacks against the CS Navy include having the anchors of their ships cut and the vessel run aground, engines, rudders, stabilizers, and the like being blown up, vessels crippled at sea, taking days to limp home, and the sinking ships in such a way that the entire crew has time to escape without casualties or serious harm. The Quebec Navy has gotten so good at sneaking into CS camps near bodies of water and onto CS vessels to do their dirty work that they pretty much come and go with impunity. In the first six months of occupation and combat, the CS Navy will lose 1D4x10%+25% of its Naval ships, power armor and supplies at the hands of the Quebec Navy, setting it back years! By comparison, the Quebec Navy will lose less than 5% of its vessels and power armor, and fewer than 3% casualties among its troops. The *Leviathan cyborg*, *Sea Dragon* power armor, submarines and SAMAS play a huge role in this scuttling operation (as well as other types of power armor, patrol boats, warships, and Navy troops).

Naval Forces

Naval Infantry Battalions

Like their landlocked cousins, the Naval Infantry is a breed of soldier unto their own. They are the grunts of the seaways and oceans and perform a variety of tasks only they are trained for and capable of doing. As such, many of these troops have a somewhat elitist attitude when compared to regular army grunts. Their duties range from defending Naval bases and strategic sites to combating pirates and monsters, engaging enemy warships, and keeping the enemy off balance. Their primary purpose, however, is amphibious landings — the most dangerous and difficult of conventional military operations. These troops represent a naval and ground fighting force that can be transported over long distances, lay siege to island and coastal strongholds, and support the regular Army. (Basically the same as the *CS Naval Infantryman*, page 34 of **Rifts® Sourcebook 4: Coalition Navy™**). These amphibious combat troops work as a team with the regular Navy sailors.

A small number of those soldiers who apply to the Navy Infantry qualify for the advanced training. They are trained in amphibious tactics and to pilot the Navy's power armor, robots and heavy vehicles. The elite of these troops are selected for training in the **Reconnaissance Landing Teams (RLT)**, the Navy's equivalent to Infantry's Special Forces/Navy SEALs or the *CS Nautical Commando Specialist* (see **Coalition Navy™**, page 37).

A subset of the Navy Service Support Division is the *Maritime Service Support Division*. These are the personnel who have specialized in naval engineering and the intricacies involved with naval equipment and its upkeep (i.e. Operators who specialize in ship repair and building). The largest collection of maritime engineers is at the Dolbeau Dockyards in the Saguenay region and Isle de Orleans Naval base. At present, there are only five Maritime Service Support Battalions.

Nautical Commando Specialist Companies

Highly motivated and disciplined, these are the Special Forces of the Navy, performing many of the missions either the Naval Infantry is incapable of or which involve espionage and sabotage. Their jobs include long-range reconnaissance, sea-borne rescue, infiltration, sabotage (specifically naval vessels and installations), demolitions, crippling enemy vessels and communications, ambushes, and covert operations.

Training is highly specialized to give the soldiers in-depth knowledge of advanced weaponry, submersible vehicles and weapons, underwater operations, power armor, underwater demolitions, camouflage, small unit tactics, intelligence gathering, survival, communications and patrolling techniques. Navy Commando Operations usually involve small squads of 4-6 troops, rarely exceeding ten members. Some missions may, however, warrant platoon-sized units, with equipment ranging upwards to power armor, mini-sub, and heavy to special weapons and equipment.

Note: This character is fundamentally the same as the *CS Nautical Commando Specialist* (see **Coalition Navy™**, page 37) with the following modifications: +20% to all demolition

skills, Robot Combat: Elite includes the Sea Dragon, replace the parachuting skill with Pilot Water Scooters (surface vehicles) and add Pilot Submersibles (underwater sleds and subs).



First Fleet Commodore Jacques LeFevre

For the past fourteen years, Jacques LeFevre has been a man who has lived out his lifelong obsession, that of a sailor at sea. Since he was a young child growing up in the Saguenay region, he has had a fascination with the water and the men who make their living on it. His childhood was one of watching fishermen clear their nets and draw back their catches to be sorted and sold. As he grew, he recognized more and more the dangers of the sea. Several of the fishermen he knew would leave with the other boats but fail to return. The survivors brought back with them gruesome stories of monsters rising from the depths and consuming their victims whole, pirate raids and sudden storms.

The first display of power on the waterways was from a group of sailors hailing from the *Gaspe Peninsula*. They piloted sleek vessels, armored and armed to the teeth. The crew was armed with high-tech weaponry and knew their vessels and the

monsters threatening the waters better than anyone young Jacques had ever seen. At the age of sixteen he abandoned his life and land and went to sea, joining the daring sailors of Gaspé. His tutors were a rough collection of seaborne rogues who alternated from pirates to freebooters, working from job to job, robbing, raiding and pillaging as they went along. Initially the boy was bullied and badgered by these sailors. Biding his time and accepting the humiliation and punishment, he eventually built up the strength, courage and abilities to become one among them. For several years he worked with the group, earning their trust and camaraderie.

It was the *Chaleur Bay Incident*, when Jacques, at the age of 24, revealed his true leadership abilities and keen mind for naval tactics. As part of a two boat group hired by Free Quebec, they had been chasing down a fugitive pirate boat into the Chaleur Bay. His captain had lost sight of the target only to learn it had fallen under attack by a swarm of *Storm Riders* (see **Rifts® Underseas** for these fiends). Their two vessels were also assaulted by the beasts and the ensuing battle saw the sister vessel and the pirate's vessel adrift and sinking, and their own captain and pilot killed. Taking the controls of the vessel, Jacques fired off all remaining mini-missiles and pointed the vessel directly into the interior of the bay. Under full throttle and avoiding attacks, Jacques led them directly to the fabled location of the *Maelstrom Maker* within Chaleur Bay. Sure enough, sensing their presence it created a whirlpool which seemed to stretch over the entire horizon. Miraculously the young man steered his vessel directly to the Maelstrom and punched his way through the whirlpool. The pursuing monsters were not as fortunate and were pulled into the Maelstrom. Jacques was unanimously commissioned as Captain of the boat and soon after would find himself in command of a fleet of four vessels. Jacques' life as a Privateer was fairly long-lived and glorious. Some consider him a living legend. For twenty years, he and his crew were in the service of dozens of kingdoms, including Ishpeming, Manistique, Iron Heart, Chi-Town and Free Quebec.

Captain LeFevre gave up privateering when the leaders of Free Quebec asked him to help develop and lead their already impressive Navy. Given the title of Admiral and allowed to bring some of his top men with him, it was an offer he couldn't refuse. Over the decades that followed, Admiral LeFevre would devise strategies and tactics that would help make the Quebec Military the naval power it is today. He was one of the few members of the Quebec Navy who opposed creating a Coalition Navy and retired in protest. With the advent of war, the Admiral has come out of retirement, is part of the Navy High Command and commands the First Fleet which patrols the Gulf of St. Lawrence and into the Northern Atlantic. His flagship is the *FQS Redeemer* and he has been in command of the ship and the fleet for the past year.

Full Name: Jacques LeFevre

Alignment: Aberrant

Attributes: I.Q. 15, M.A. 22, M.E. 22, P.S. 14, P.P. 21, P.E. 18, P.B. 10 (use to be 14 when younger), Spd. 10

Hit Points: 61, **S.D.C.:** 34

Height: 6 feet, 4 inches (1.92 m)

Weight: 220 lbs (98 kg)

Age: 92, but thanks to the advance medicine and technology of Free Quebec (and the CS), he looks to be 70ish and is in excellent health, as strong and capable as any man half his age.

At the age of 92, he is by far the most experienced man in the Quebec Navy and on the seas today. He is a wealth of knowledge and experience.

P.P.E.: 9

Disposition: A very charismatic leader, Admiral LeFevre offers the combination of a well groomed textbook leader, and the hard-as-nails attitude of a lifelong sailor and naval combat veteran — and a long life it has been; 76 years at sea. He is capable of leading a simple patrol boat or small fleet to large-scale amphibious attacks and full-scale, mass ship combat! He exudes an air of confidence and command that keeps his troops and sailors focused and reassured. A very legendary leader, he thrives under pressure that would make most other officers “crack.”

When it comes to duty and completion of the mission, Admiral LeFevre has been known to sacrifice mission requirements and even ignore orders when they put his men at unconscionable risk. He has been known to use his uncanny instincts to curtail or alter missions as well as seize the moment and carry on farther than originally planned, as the circumstances dictated. That having been said, he is no coward and understands the need for sacrificing ships and men for the greater good of the people. In fact, he is known for his bold and daring maneuvers (and legendary luck).

Experience Level: 12th level sailor and ex-Privateer.

Weapon Proficiencies: W.P. Energy Rifle, W.P. Energy Pistol, W.P. Knife, W.P. Sword.

Skills of Note: Languages: American and Techno-can, both at 98%, old Quebec French at 75%, Basic Math, Radio: Basic, Navigation, Pilot: Sailing Vessels, Pilot: Ship (98%/89%), Pilot: Warships & Patrol Boats, and Naval History, Naval Tactics and Swimming, all at 98%. Other skills include Literacy American 80%, Streetwise 72%, Find Contraband 86%, Recognize Weapon Quality 75%, Lore: Demons & Monsters 90%, Undersea Salvage 80%, Intelligence 72%, and Computer Operations 80%.

Combat Skills: Hand to Hand: Assassin

Number of Attacks: Nine.

Bonuses: +8 on initiative, +7 to strike, +7 to parry, +8 to dodge, +5 to roll with impact, +4 to damage, Death Blow on a roll of a natural 20 (but only if trying to kill), +3 to save versus Horror Factor, knockout/stun on natural 17-20, 70% to trust/intimidate, +4 to save versus psionics, +2 to save versus magic, +6% to save versus death/coma. +2 to Perception Rolls.

Magic Knowledge: None.

Psionic Knowledge: None.

Weapons: Typically is not armed while on the bridge, but has a personal energy pistol and rifle in case of need. He is not trained in power armor combat but commands a detachment of Sea Dragons and understands their tactical value well.

Equipment: Has access to all Free Quebec Navy equipment, special communications and surveillance equipment, men and resources. Admiral LeFevre has free rein of all Navy facilities, including the Dolbeau Shipyards, and up to medium-high level clearance at Army bases.

Cybernetics: Universal headjack and ear implant with amplified hearing, sound filtration, plus gyro-compass, depth gauge, clock calendar and toxic filter. His right hand, left arm, spleen and heart have, at one time or another, been replaced with cybernetic bio-systems.

Money: Jacques LeFevre is a long-time veteran of the sea and has amassed a small fortune of 2.1 million credits and a personal collection of Black Market weapons, artifacts and items worth another million. This does not include his current pay or his life-long pension of 10,000 credits a month. He owns a large but modest home in Free Quebec and hunting lodge in the north. His wife of 23 years passed away a few years ago.

Quebec Navy Resources

Basically the Quebec Navy has most of the same weapons, explosives, mines, armor, power armor, underwater vehicles, scooters, sleds, subs, boats and warships as the **Coalition Navy**. Only color, insignias and styling may differ.

Since the Quebec Navy favors small, fast ships, the largest warships and submarines are not part of its forces. The following are *not* available to the Quebec Navy:

Defiance-Class Refitted Ohio Ballistic Missile Submarine
CSS Shark-Class submarines
Joseph Prosek Series Aircraft Carriers
CSN Wasp-Class Amphibious Warfare Ship
CS Naval Jets
CSN Sea SAMAS
Nuclear missiles

Available Equipment & Vehicles common to the Quebec Navy

Submarines:

CSS Orca-Class Attack Sub
CSS Stingray Mini-Sub (a favorite)

Patrol Boats, Sleds and Submersibles:

CSN-600 Deep Six Sea Pack (for body armor)
CSN Robot Shark Sled
CS Death's Head Underwater Sled (a favorite)
CS Jet Ski/Scooter (a favorite)
CS Wave Demon Patrol Hydrofoil
CSN Mark I Barracuda Patrol Boat (a favorite)
CSN Mark IV Hurricane Submersible Patrol Boat (a favorite)
“Sea-Runner” XS-120 style interceptor (a hydrofoil patrol boat based on the Triax XS-120; see page 204 of **Rifts® Underseas**).
CSN Sea-Spider Walker

Warships (large ocean vessels):

IHA Sea King Guided Missile Cruiser
CSS James Bay-Class Iron Heart Destroyer
CSS Revenge-Class Destroyer
CSN Wasp-Class Amphibious Warfare Ship

Navy Aircraft:

CS-500 Sky Pack (jet pack for body armor)
CS Ch-10N Sea Storm Attack Helicopter
CS Ch-12N Sea Wasp Attack/Transport Helicopter
Standard AFC-023 Sky Cycle

Power Armor:

Trident Power Armor
Sea SAMAS has been replaced by Quebec's own Sea Dragon.

The Quebec Navy also uses its own power armor, including all types of *Glitter Boys*, *Gigis*, *Side Kicks*, *SAMAS* and *V-SAMs*.

Body Armor:

CA-4 Mk2 Shark Body armor
Nautical Commando Armor
CSNA-1 Lightning Strike SCUBA Armor
CNA-2 Barracuda Commando Armor
Quebec Navy's own cyborg dive armor.

Weapons of Note:

CSN-20 Speargun
CSN-T30 Torpedo-Grenade Launcher
Limpet Mines
Naval Mines
Quebec's own special underwater weapons as well as Vibro-Blades, energy pistols and rifles (particularly lasers), bionic systems and other standard military gear.

Nuclear Arsenal:

None

NS-B20 'Borg Dive Armor

Even though a 'Borg's body is a Mega-Damage structure, the average *Headhunter* and *partial cyborg* needs special armor and extra oxygen at depths greater than 150 feet (45.7 m), while a *full conversion cyborg* in medium or full environmental cyborg armor can endure depths of up to 250 feet (76 m) without suffering from the bends. To dive and function in an underwater environment deeper than this, the cyborg needs NS-B20 Dive Armor. It comes specially equipped with special bionic features to allow full conversion 'Borgs to endure depths of up to 1200 feet (366 m; half for partial 'Borgs). It also provides an underwater propulsion system built right into the armor.

Class: NS-B20

Size: Human equivalent; 6-9 feet (1.8 to 2.7 m).

Weight: 145 lbs (65 kg).

Mobility: Excellent underwater, but poor on dry land; -10% to Climb, -15% to Prowl, perform Acrobatics and similar physical skills/performance.

M.D.C. by Location:

Head/Helmet — 70

Arms (2) — 65 each

Legs (2) — 110 each

Main Body — 290

Special Weapon Systems and Features: It also has some additional features unique to the NS-B20.

1. Underwater Propulsion System: Using the medium, built-in propulsion system, the Dive Armor can travel 20 mph (32 km or 17 knots) underwater and 30 mph (48 km or 26 knots) on the surface.

Maximum depth: 1200 feet (366 m).

2. Vibro-Blade "Fins" on the shoulders, forearms, and knees: These blades can be turned on when desired via voice command or six-digit code. Used for both protection (anybody grabbing the body where the blades are located will be cut, suffering 1D6

M.D.) and combat (raking an opponent with forearms, knee attack, or shoulder ram). A single blade does 1D6 M.D. and double blades do 2D6 M.D. Note that many aquatic animals, including sharks, dolphins, whales and sea serpents, can hear and feel the high frequency field emitted by the blades up to 2 miles (3.2 km) away.

3. Depth gauge and gyro-system: Built into the armor and transmitted via the Heads Up Display is a data and warning system that provides the Navy Trooper with a constant indication of the depth and general direction (i.e. pointed up, down, or sideways). This means the Marine can maneuver even in total darkness. An alarm sounds in the helmet when the character sinks towards dangerous depths — to go deeper is to suffer the bends from underwater pressure.

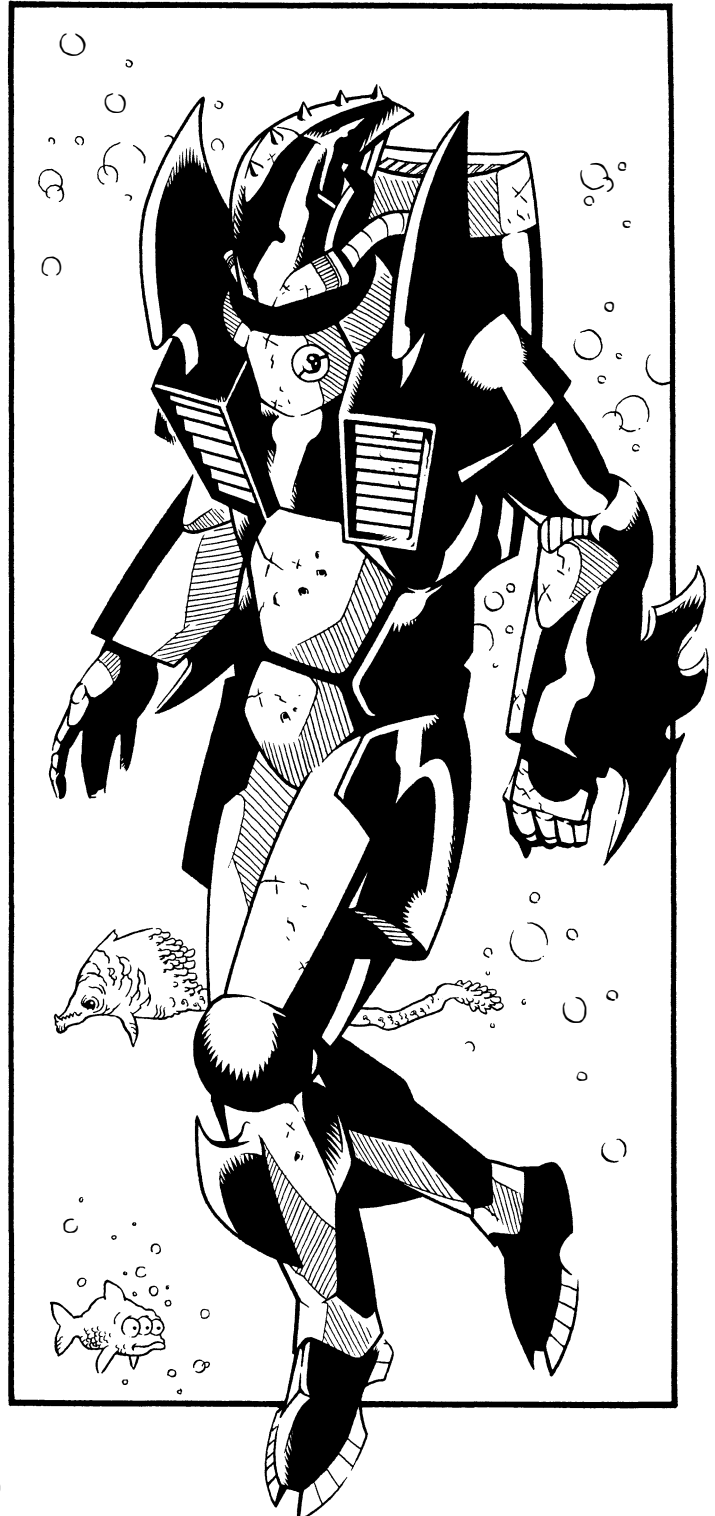

Sea Dragon

Power Armor

The Sea Dragon was inspired by the SAMAS, but is minus the wings and designed to work primarily underwater as part of maritime combat operations, deep sea exploration, underwater reconnaissance, escort and amphibious (water to ship or land) attacks. It was created specifically for service in the Navy of Free Quebec to be an all-purpose, versatile combat machine with limited land and air capabilities. In fact, it was prototypes of the Sea Dragon that inspired the Coalition's own *Sea SAMAS* (see *Coalition Navy*,™ page 49). The main focus of the design has been that of a small, but heavy-duty, fast and maneuverable, underwater, deep-sea assault unit. The ultimate one man submersible. A task that both the *Sea Dragon* and the Coalition's own *Sea SAMAS* have lived up to admirably. The Sea Dragon has already played an important role in the defense of Free Quebec's waterways and coastlines. These units have already performed hundreds of coastal and underwater raids, anti-ship and anti-submarine warfare, sabotage, ship defense/support, water to land combat, and water to air combat, as well as rescue operations, underwater repairs, deep sea diving, and surgical strikes against Coalition forces.

The Sea Dragon utilizes the same basic environmental, armor plating and robotic enhancement systems as the regular SAMAS. To survive greater pressure at ocean depths, the standard framework is reinforced, more heavily armored, and furnished with a special decompression system to protect the pilot. A powerful, yet small sonar system has been included in the sensor package, built into the elongated head/helmet. The rocket propulsion system has been replaced with a backpack-style, nuclear-powered twin propeller propulsion unit ideal for underwater. Built into the underwater propulsion system is a low-speed, low-altitude, secondary hover-jet for limited flight capabilities (mainly for boarding purposes, and when necessary, to engage low flying enemy targets). Weapon systems are also dramatically different from its land to air predecessor. A blue-green laser cannon has replaced the traditional rail gun, and there are mini-torpedoes/missile launchers located in shoulder housings. The stylized helmet provides the pilot with greater protection of the head and contains additional sensors.

Free Quebec has built and deployed nearly two thousand of these suits as part of its Navy. The Maritime Engineer Corps, along with the Army's Combat Engineer Corps, were able to construct a facility to create these suits of power armor, designated QPA-10. They represent the core of the naval underwater mechanized units within the Free Quebec Navy, often working with the cyborg Leviathan and divers or in coordinated attacks with gun boats and/or SAMAS or GBs.

Amphibious SAMAS Power Armor

Model Type: QPA-10

Class: Strategic Armor Military Assault Suit

Crew: One

M.D.C. by Location:

Arms (2) — 100 each

Legs (2) — 150 each

Underwater Propulsion System/Hover Pack — 90

* Main Jets (2) — 100 each

Ammo Drum (1; rear) — 50

Laser Cannon (1, hand-held) — 100

* Ion Blaster (1; concealed in the left arm) — 25

Shoulder Mini-Missile Launchers (2) — 50 each

* Forearm & Lower Leg Vibro-Blades (4) — 50 each

* Head — 100

** Main Body — 300

* A single asterisk indicates a small and/or difficult target to strike, requiring the attacker make a "called shot," but even then the attacker is -3 to strike.

Destroying the head of the power armor will eliminate all forms of optical enhancement and sensory systems, including sonar; the pilot must rely on his own human vision and senses and any bonuses to strike, parry and dodge are all lost. Also, in an underwater environment, the pilot is in jeopardy of drowning/suffocating or succumbing to deep sea compression (most suits have a small, emergency, mini-air tank with eight minutes of air, and many pilots have a bionic lung and/or air supply); decompression is the real danger if below 300 feet (91 m).

** Depleting the M.D.C of the main body will shut the armor down completely, rendering it useless and sending it sinking to a watery grave.

Speed:

Running: 60 mph (96 km) maximum. Note that the act of running does tire out its operator, but at 10% the usual fatigue rate thanks to the robot exoskeleton.

Leaping: The powerful robot legs can leap up to 15 feet (4.6 m) high or across unassisted by the thrusters. A jet assisted thruster leap can propel the unit up to 200 feet (61 m) high and 300 feet (91.5 m) across without actually attaining flight.

Flying: The hover-jet propulsion system allows the Sea Dragon to hover stationary up to 100 feet (30.5 m) or fly short distances. Maximum flight speed is 100 mph (160 km), but cruising speed is considered to be 50 mph (80 km). Maximum altitude is limited to about 200 feet (61 m) above land or water and it is a bit wobbly; no wings.

Flying Range: The nuclear power system gives the Sea Dragon decades of life, but the hover-jet engine overheats quickly and needs to cool after a maximum of two hours of flight when traveling at speeds above cruising, and after five hours of cruising speeds or less.

Underwater Propulsion: The Sea Dragon has a built-in underwater propulsion system that uses the two long jet thrusters to propel it through the water. Small maneuvering jets are located under the ribs, lower back and feet for good control. It is hooked directly to the nuclear power supply. 55 mph (88 km or 47 knots) underwater or 80 mph (128 km or 69 knots) skipping across the surface like a human torpedo or flying fish (the CS Sea SAMAS' best surface speed is 60 mph/96 km/51.6 knots).

Underwater Depth: The Sea Dragon can withstand pressure up to 4400 feet (1341 m) deep. A special decompression system helps to prevent the pilot from getting the bends and infrared optics provide sight in the deep, dark waters. A portable infrared or ultraviolet searchlight can be carried in place of the spear.

Statistical Data:

Height: 10 feet (3 m)

Width: 4 feet, 6 inches (1.35 m); no wings.

Length: 4 feet (1.2 m)

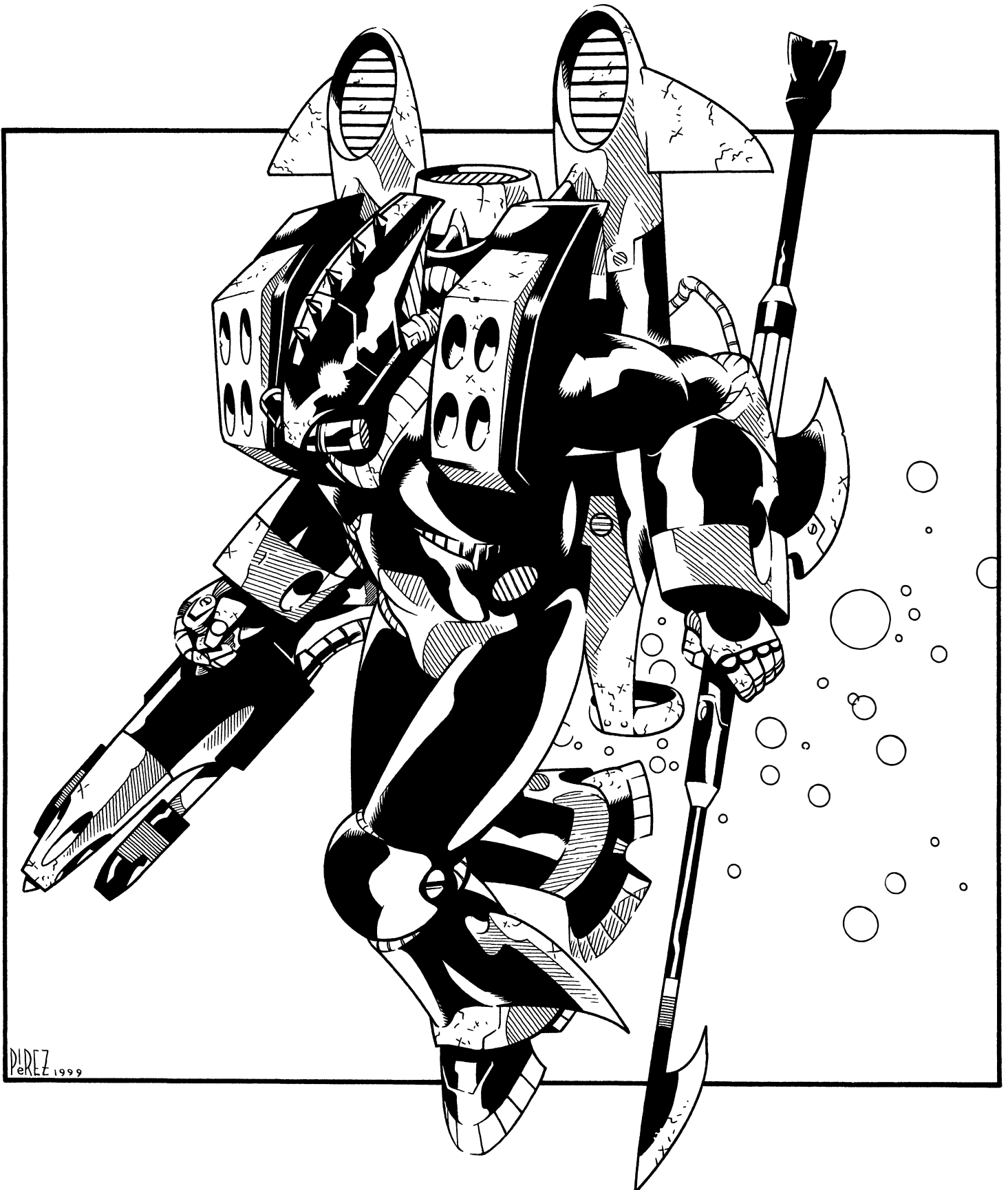

Weight: 600 lbs (270 kg)

Physical Strength: Equal to a P.S. of 36.

Cargo: None.

Power System: Nuclear; average SAMAS energy life is 20 years.

Free Quebec Cost: 2.3 million credits; worth twice that on the open market.

Weapon Systems

1. QN-60 Variable Beam Laser Cannon (1, hand-held): The QN-60 is essentially a high-powered laser cannon that is capable of firing regular laser beams for surface combat, and blue-green beams for underwater combat. It is a lightweight, accurate weapon that is hooked directly to the SAM's nuclear power supply, giving the operator a virtually unlimited payload. This weapon can be substituted with a standard rail gun.

Primary Purpose: Assault.

Secondary Purpose: Defense.

Mega-Damage: 5D6 M.D. per laser blast.

Rate of Fire: Equal to the number of combined hand to hand attacks (usually 6-8).

Effective Range: 2000 feet (610 m) underwater, 4000 feet (1220 m) on land.

Payload: Effectively Unlimited.

2. Ion Forearm Gun (1, left): A short-range ion blaster is built into the left forearm.

Primary Purpose: Assault

Secondary Purpose: Defense

Mega-Damage: 4D6 M.D. per blast.

Rate of Fire: Equal to the number of combined hand to hand attacks (usually 6-8).

Effective Range: 1000 feet (305 m); half this range underwater.

Payload: Effectively unlimited; tied to the armor's power supply.

3. CM-4 Shoulder Mini-Missile Launchers (2): Twin mini-missile launchers are positioned over the shoulders where the intake ports are found on the original SAMAS.

Primary Purpose: Assault

Secondary Purpose: Anti-Ship and Anti-Aircraft.

Missile Type: Any type of mini-torpedo or missile can be used, but standard issue is armor piercing (1D4x10 M.D.) or plasma (1D6x10), or comparable mini-torpedo.

Mega-Damage: Varies with missile type.

Range: Usually about 1 mile (1.6 km).

Rate of Fire: One at a time, or in volleys of two or four.

Payload: 16 total; eight per each launcher.

4. Electro-Spear: A high-tech looking spear that is powered by a cable attached to the power armor and capable of impaling and then electrifying its victim, or unleashing an electrical blast. The head is a small Vibro-Blade.

Primary Purpose: Assault

Secondary Purpose: Defense

Mega-Damage: Blade/spearhead does 1D6 M.D. as a stabbing or slashing weapon. The blunt end can be used as a staff or clubbing weapon that does 2D4 S.D.C.

An electrical blast to an impaled victim inflicts 2D6 M.D. Long-range electrical discharge/bolt does 1D6 M.D. on land. Underwater the blast does 1D6+6 M.D. to the primary target and one M.D. to everything within 50 feet (15.2 m) of the Power Armor. Water is a very good conductor of electricity. The Sea Dragon is insulated.

Rate of Fire: Equal to the number of combined hand to hand attacks (usually 6-8).

Effective Range: As a hand-held weapon or 20 feet (6 m) for an electrical blast on land (50 feet/15.2 m underwater).

Payload: Effectively unlimited for electric blasts.

5. Vibro-Blade "Fins" on the forearms and lower legs: These blades can be turned on when desired via voice command or six-digit code. Used for both protection (anybody grabbing the body where the blades are located will be cut, suffering 1D6 M.D.) and combat (raking an opponent with forearms, or leg sweep). A single blade does 1D6 M.D. and double blades do 2D6 M.D. Note that many aquatic animals, including sharks, dolphins, whales and sea serpents, can hear and feel the high frequency fields emitted by the blades up to 2 miles (3.2 km) away.

Primary Purpose: Self-Defense/Parrying & Cutting.

Mega-Damage: 1D6+2 M.D.

6. Energy Rifles and other normal weapons can be substituted in an emergency or as a back-up weapon. Space limitations and the bulk of the armor limits additional handguns or rifles to one.

7. Hand to Hand Combat: Rather than use a weapon, the pilot can engage in Mega-Damage hand to hand combat. See Power Armor Combat Training in the Robot Combat section of **Rifts® Ultimate Edition**, page 351, plus the following bonuses in addition to those listed.

+1 to initiative

+1 to parry

+2 to dodge underwater

8. Sensor System Note: All standard power armor features plus:

1. Full optical systems, including laser targeting, telescopic, passive nightvision (light amplification), thermo-imaging, infrared, ultraviolet, and polarization.

2. In addition to the standard radar package, there is a sonar system with a 15 mile (24 km) range that can track 32 targets. There is also a depth and pressure gauge included in the pilot's instrumentation.

3. Sensor Bonuses: Applicable to long-range weapon combat only, not hand to hand: +2 to strike and +1 to dodge. See Power Armor Combat Training in the Robot Combat section of **Rifts® Ultimate Edition** for other bonuses.



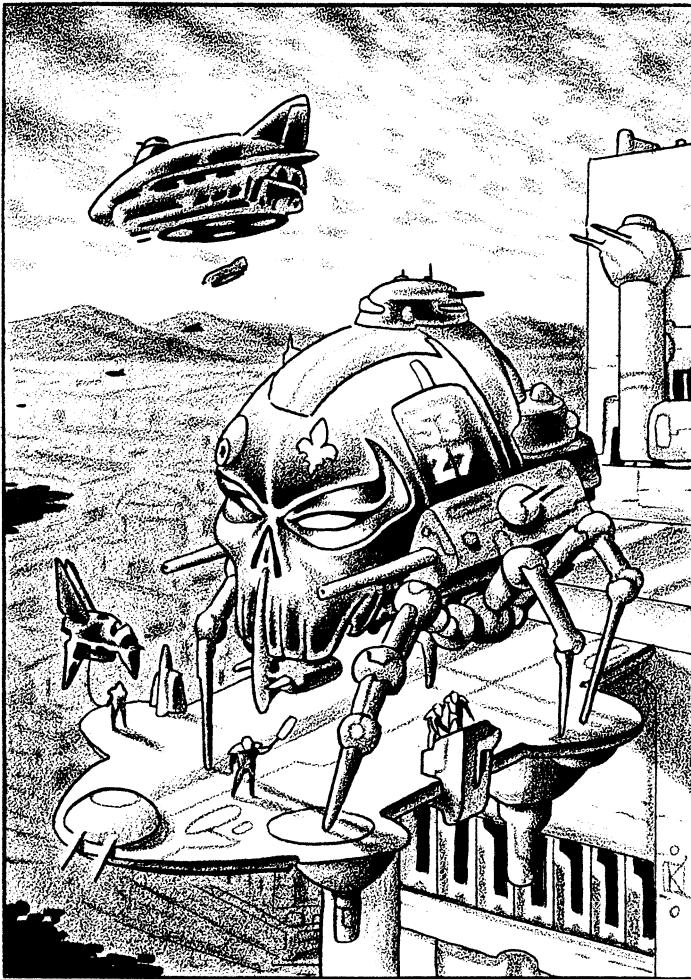

Free Quebec

By Francois DesRochers & Kevin Siembieda

Elements of Society

Free Quebec, until recently a member of the Coalition States, is very much an independent nation, self-reliant and an industrial and commercial giant in her own right. For generations the nation has battled and survived against monstrous hordes, dark magic and inhuman invaders. Somehow, with the help of their Glitter Boys, they have managed to hold on and grow as a people, civilized society and sovereign nation. This accomplishment has created a tremendous sense of pride and patriotism that has reached renewed heights under the leadership of Prime Minister Lorne. It has also created a fierce sense of independent nationalism, and some measure of arrogance, especially toward those who refuse to acknowledge their achievements and independence. It is these feelings that ultimately led to Free Quebec's continual disputes with its sister Coalition States, the loss of support from Emperor Prosek and the inevitable schism that would divide the two powers forever.

A powerful and self-reliant nation, the people of Free Quebec have always regarded their relationship with the Coalition States as one of choice and convenience. An alliance with a nation of like-minded humans and parallel ideals regarding human supremacy and anti-magic sentiments. Their mutually strong econ-

omies and industries stimulated each other and helped them both grow stronger. Equally as driven and fascist as Chi-Town, the people of Free Quebec remained fiercely independent, refusing to allow any outside power to "control them" — even their Coalition brethren. This refusal to follow Imperial decrees created a level of tension between the two States that eventually erupted as the secession of Free Quebec from the Coalition States and war!

Now a nation-state without outside interference, Free Quebec stands poised to make their mark in human affairs in North America. With the support of the populace, combined with their strategic geographic location, technology, industry and untamed spirit, they are ready to once again take charge of their own destinies. This confidence and bold independent spirit is pervasive throughout Free Quebec from their charismatic Prime Minister and other leaders to the ordinary man on the street.

St. Jean de Baptiste

The national holiday, as celebrated by the old Province of Quebec, has carried on into the time of Rifts. Every 24th of June the nation takes to celebration and enjoyment as they remember the day that has come to symbolize everything about their people and their culture. Grand spectacles are planned within the major urban centers, with large crowds going to enjoy the festivities.

In recent times the day has come to have new meaning, especially since the secession from the Coalition States. Now, not only do they celebrate their history on June 24th, it has come to be the sounding bell for Free Quebec to verbally reaffirm their independence and unity, and the grand future that awaits them all. The National Assembly has taken this day as an occasion to promote their positions, gather support for the war and to allay any fears the people may have about their future.

Education

Unlike the other Coalition States, Free Quebec citizens have always had easy access to formal education, information, documents and literature. This is just one point of contention that helped to drive the wedge between the CS leaders at Chi-Town and Free Quebec. Emperor Prosek sees the perfect society as a population completely trusting of its powerful leaders and blissfully ignorant of the world around them. By contrast, the leaders of Free Quebec have always felt knowledge and education were necessary to create a strong, free and resourceful nation. Although the level of Free Quebec's technology is approximately 15% to 20% less than that of Chi-Town, it is much more accessible to its people. Even before the secession from the Coalition States, 70% of urban people were educated at least to high school levels, 50% of which were highly educated and/or skilled professionals. On the other hand, only an estimated 10% of the rural populace can read and write, but even they appreciate the value of an education. (**Note:** Most wilderness folk are trained in one or more areas of labor such as farming, raising cattle, trapping, skinning, fishing, logging, and similar work, with a full half living off the land as independent "homesteaders." See **Rifts® Canada** for an excellent overview).

In contrast, only the *elite* of Chi-Town (approximately 12%-15%) are highly educated with maybe another 10% literate at a grade school (3rd to 8th grade) level. This level of formal education is common throughout the Coalition States and its ter-

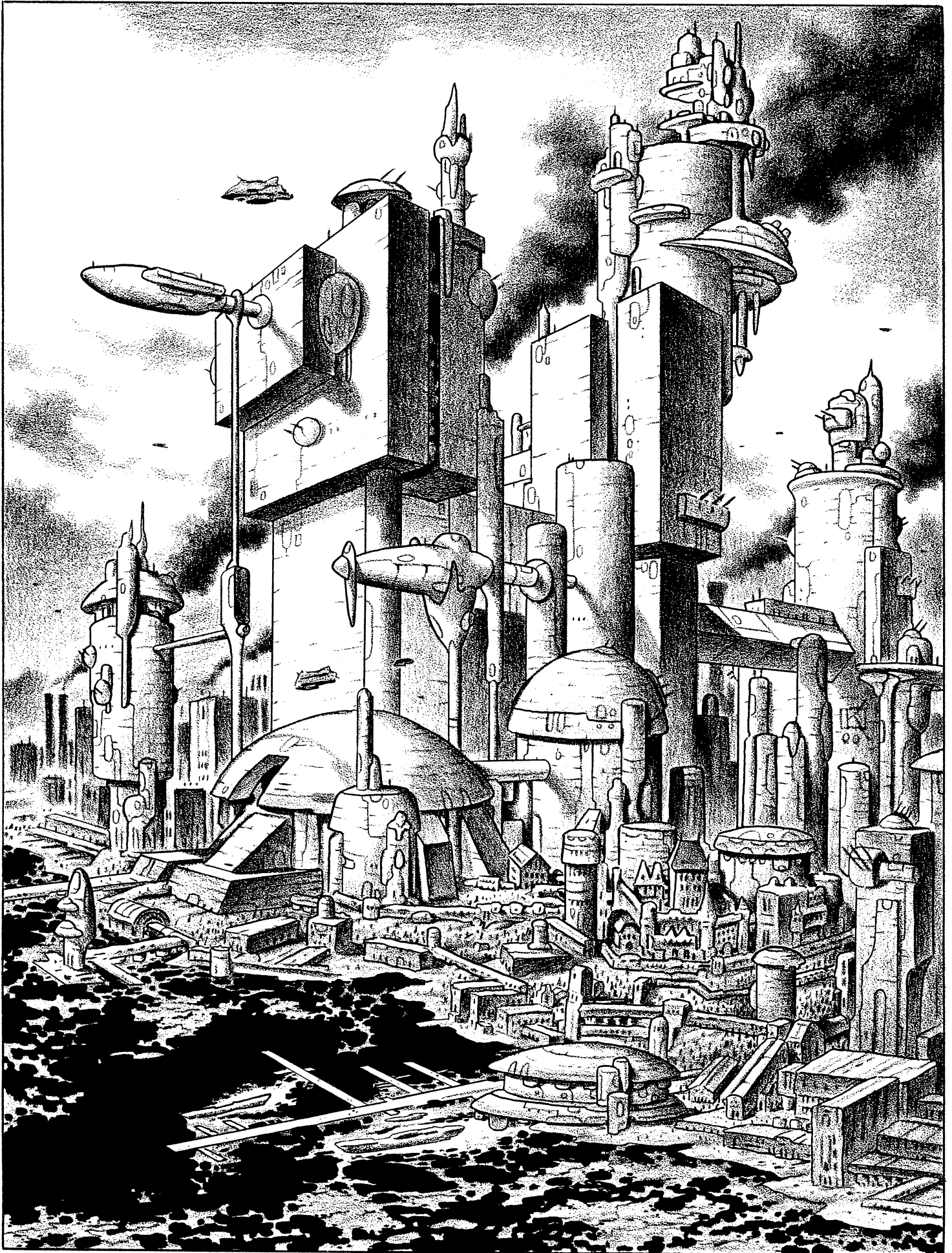

ritories located in the old American Empire, and about double at Iron Heart. Yet even the educated elite are blinded by propaganda and the careful *rewriting* of history. Moreover, the (real) history and views of people other than those approved and promoted by the CS government are forbidden. Daring to learn to read and write on the most basic level when it is not “appropriate” or approved by the government for one’s station in life, or worse, to seek out truth and dare to consider opposing views to the CS, is a crime with harsh consequences. Teaching the uneducated is treason punishable by death. So it is that education and knowledge is strictly controlled, edited, rewritten and funnelled to those the Coalition Government deems “appropriate and necessary.” Consequently, Free Quebec’s policies of public education and openness to history and the consideration (although seldom acceptance) of outside views and beliefs has always been a *threat* to the CS. So much so that travel to the Canadian State had been highly restricted for fear that a visit might corrupt or cause CS visitors to question CS rule and instigate trouble among its citizenry.

Tragically, education and the *appearance* of openness does not necessarily equate to true open-mindedness, wisdom, reason or compassion. The propaganda machines of Free Quebec’s government simply use knowledge and a sense of history to reinforce their often extreme views on human supremacy and an obsessive sense of independence and patriotism that invites its people to close their minds. Opposing views — i.e. most things not Free Quebec — and the acceptance of those different from the people of Quebec are all seen as dangerous and corrupting. Even downright evil. As such, they are to be avoided and rejected in the name of nationalism and freedom. Those who embrace opposing views or criticize life in Free Quebec are not branded as criminals or traitors by the government, but they are usually treated as pariahs by their fellow citizens, shunned and mistreated. At Free Quebec, a rigid society keeps people in line and segregates those who “don’t fit.” Like psychics, such free-thinkers and dissidents are viewed as undesirable misanthropes, treated as second-class citizens, and encouraged to leave the nation if they don’t like how things are done (or, in this case, how people think).

Since their secession, the National Assembly has launched a campaign to increase the education of its people. As such, the general urban population is now at 77% educated, 55% of which are educated and/or skilled professionals. Rural education has risen from about 10% to an estimated 14% (and a projected 20-25% over the next six years). This has led to an increase in educated scholars and scientists in the wilderness, teaching people without fear of retribution or harassment from Coalition forces.

Note: The average educated citizen of Free Quebec has the following skills:

Language: American (+20%)
 Language: Old French (+10%; +20% among the best educated)
 Literacy: American (+15%; +25% among the best educated)
 Literacy: Old French (+12%; +25% among the best educated)
 Basic Math (+10%; +25% among the best educated)
 Computer Operations (+10%)

Citizens without military experience have two hand to hand attacks/actions per melee plus one at levels 2, 6 and 12 and can select four skills from any one *skill category* (i.e. mechan-

ics, science, etc.) reflecting their profession (all at +10%), 1D4+2 other skills (+5%) from Domestic, Science, Technical, Physical or Piloting skill *categories* (no military skills) and four secondary skills. The only skill categories not available are Espionage, Military, Rogue, Wilderness, and Weapon Proficiencies. Additionally, they cannot select military related skills (i.e. pilot tank, robot combat: elite, etc.) unless trained in law enforcement.

Those with military experience, about 36% of the average males and 22% of the average females, have the additional skills of a soldier/grunt:

Radio: Basic (+10%)
 Running
 Climbing
 Body Building or General Athletics
 Pilot Tank & APC (+5%)
 Pilot Hovercraft (+10%) W.P. Energy Rifle
 Hand to Hand: Basic W.P. one of choice.

Technology

Although generally 15-25% less advanced than Chi-Town, Free Quebec is a modern nation. Very much like any of the Coalition States, technology has become a way of life within Free Quebec. The urban centers are high-tech communities with sprawling factories, commercial centers, countless office buildings, modern apartments, hospitals, research facilities, communication centers, television and radio broadcasting, theaters, sports arenas, M.D.C. fortifications and the occasional building towering above six stories. However, most buildings rarely exceed three or four stories, unless they are fortified, M.D.C. military or municipal buildings. The **City of Free Quebec** is the exception, for like Chi-Town it is a titanic megalopolis that stands like a man-made mountain reaching to the heavens, and enclosed in Mega-Damage walls and fortification. The city proper is home to over one million people with several smaller, less heavily fortified city-communities and industrial complexes broken by smaller, less advanced towns and farms scattered all around it. Monsters, bandits and raiders tend to stay away from the City and other modern communities for fear of battle with Free Quebec’s ever vigilant Military defenders and law enforcement. The fact that the response to such criminals and invaders is merciless deadly force from companies of powerhouse *Glitter Boys* or rocketing *SAMAS* keeps serious attacks away from the population centers. Instead it is the smaller, more distant communities and wilderness settlers who face the worst from brigands of all kinds.

Outside of the City of Free Quebec, most buildings follow modern architecture, and there are some districts within several cities or smaller communities that mimic their pre-Rifts era. In either case, all buildings are outfitted with modern amenities such as indoor plumbing, central heating and cooling, electric lights, video screens (TV), communication systems, computers, modern entertainment centers, appliances and most anything else one could imagine a home might need or want. Of course, the more money one has, the better the quality and more abundant these items become.

Mass transit systems have become popular once again, with underground systems of transport in place in almost every major urban center. The largest of these Metro Transport Systems is in

the City of Free Quebec. These, along with other forms of public transportation (buses and taxis) and privately owned hover-vehicles, help connect people to other portions of the sprawling cities, towns and 'burbs, with the City of Free Quebec (more or less) as the spiritual, governmental and military center.

Although not as vaunted as the system in place in the NGR, or the pre-Rifts "information superhighway," digital transmissions, fiber optics, and computer networks have seen increasing use within urban areas, especially in regards to Military and Government Networks (most Military complexes are linked by way of fiber-optic channels and/or scrambled radio transmission). Civilians, business and industry have been increasingly able to connect to exchange information for their personal use. This has mostly been for educational or commercial purposes, but an underground "web" has developed and is growing. This web has seen drastic influxes of people, mostly City Rats and other technophiles, as well as some social undesirables. A whole new breed of "cyber-punk" has been developing as gangs of City Rats have taken to the web like ducks to water. The Quebec Law Enforcement Agencies (roughly equal to the Coalition's I.S.S.) have even gone so far as to develop a new division of police to keep guard over the cyber-systems in place against unwanted access, sabotage or worse.

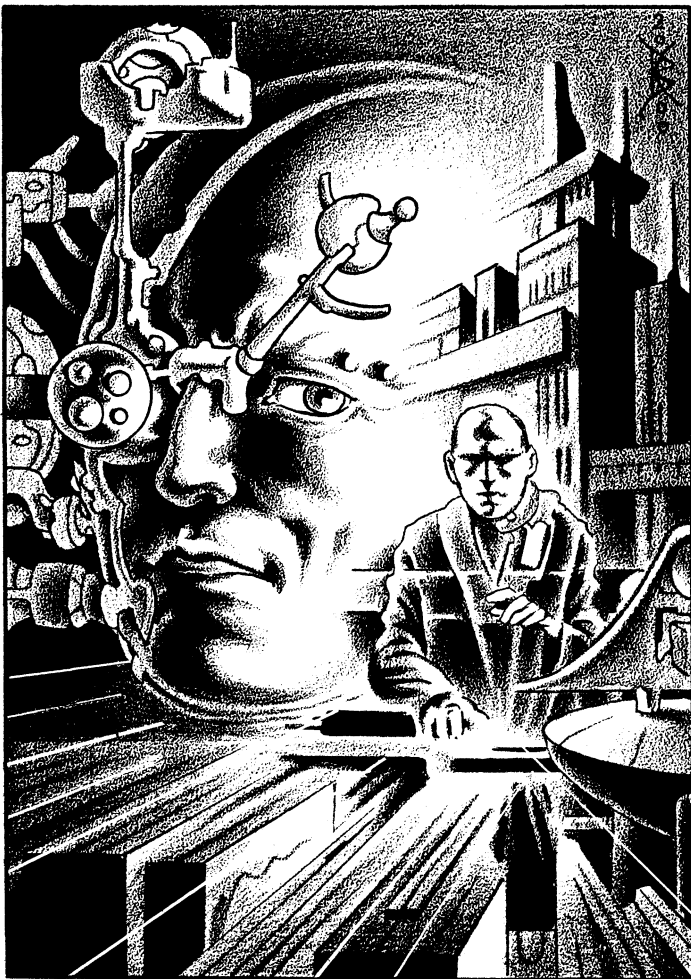

Cybernetics: Although they are technologically advanced where the science of cybernetic augmentation is concerned, the average people of Free Quebec do not rush to get cybernetics. They are legal (only weapon systems and concealed weapon

systems are illegal) but prohibitively expensive and don't actually do much to help or improve life for the average citizen. Other than life-saving implants, bio-systems and prosthetics for medical application, for soldiers, most ordinary folk just don't have any use for cybernetics. The most common implants are those that improve an individual's physical appearance or have everyday applications such as the clock calendar, gyro-compass, radiation detector, bio-comp monitor system, language translator, universal jack, hearing aid, eye implants/optics that are useful on the job, and similar.

The Free Quebec government estimates that 40% of the population (half of which are ex-military personnel) have some form of cybernetics, but usually minor. Partial reconstruction 'borgs account for 8% of the population and another 5% are full conversion 'borgs; most are ex-soldiers. Augmented military personnel who leave the Armed Services and return to civilian life undergo a dramatic reduction of bionics and cybernetics. All weapon systems are removed (unless involved with law enforcement) and bionic limbs are lowered to comparable "human" levels. (**Note:** Fundamentally the same CS program described in **Coalition War Campaign™**. In fact, they borrowed the idea from Free Quebec). Civilian bionic conversions are rare. Of those that receive them, they are usually only partial reconstruction and typically job related (i.e. deep-shaft mining, deep-sea mining, law enforcement officer, etc.). Most implants and cybernetics are cosmetically doctored to look "normal/human" or are under the skin and cannot be seen by the naked eye. Implants and minor augmentation (namely interfacing computer jacks, optics, and similar) are most common among City Rats and wealthy technophiles, including business executives, but even most of these people will have no more than four items. This technology is so passe and commonplace that there is no thrill or enticement to get it just for show or prestige. Moreover, many human supremacists strive to preserve the "purity and sanctity" of being human and avoid unnecessary cybernetics.

Juicer Technology: Chemical augmentation has been used by the Quebec Military for decades. It is not usually legal for citizens to get Juicer augmentation unless they get a special waiver and leave the country (typically to go adventuring or exploring, or to find work as a mercenary). Such individuals can not return as a citizen of Free Quebec unless they join the Army or undergo "detox" and begin a new life without augmentation. Unfortunately, illegal Juicer augmentation operations are epidemic throughout the country, especially since the government had turned a blind eye to it in Old Bones and elsewhere to spite Chi-Town. Now it is a problem because it has become especially popular among City Rats, bandits, criminals and mercenary groups. There have been a rash of illegal Juicer conversion shops that have risen in the last decade, adding a new problem to law enforcement within urban and wilderness areas alike. These super-soldiers are extremely elusive and difficult to battle. If an individual is suspected of being a dangerous criminal or rogue Juicer, the police will try to detain the character but tend to have "itchy trigger fingers" when dealing with such an adversary.

The public sees Juicers as excellent "soldiers," but they recognize the price paid to become a superhuman, so the average citizen will not consider Juicer augmentation except in the service of their country. As noted elsewhere in this book, the Que-

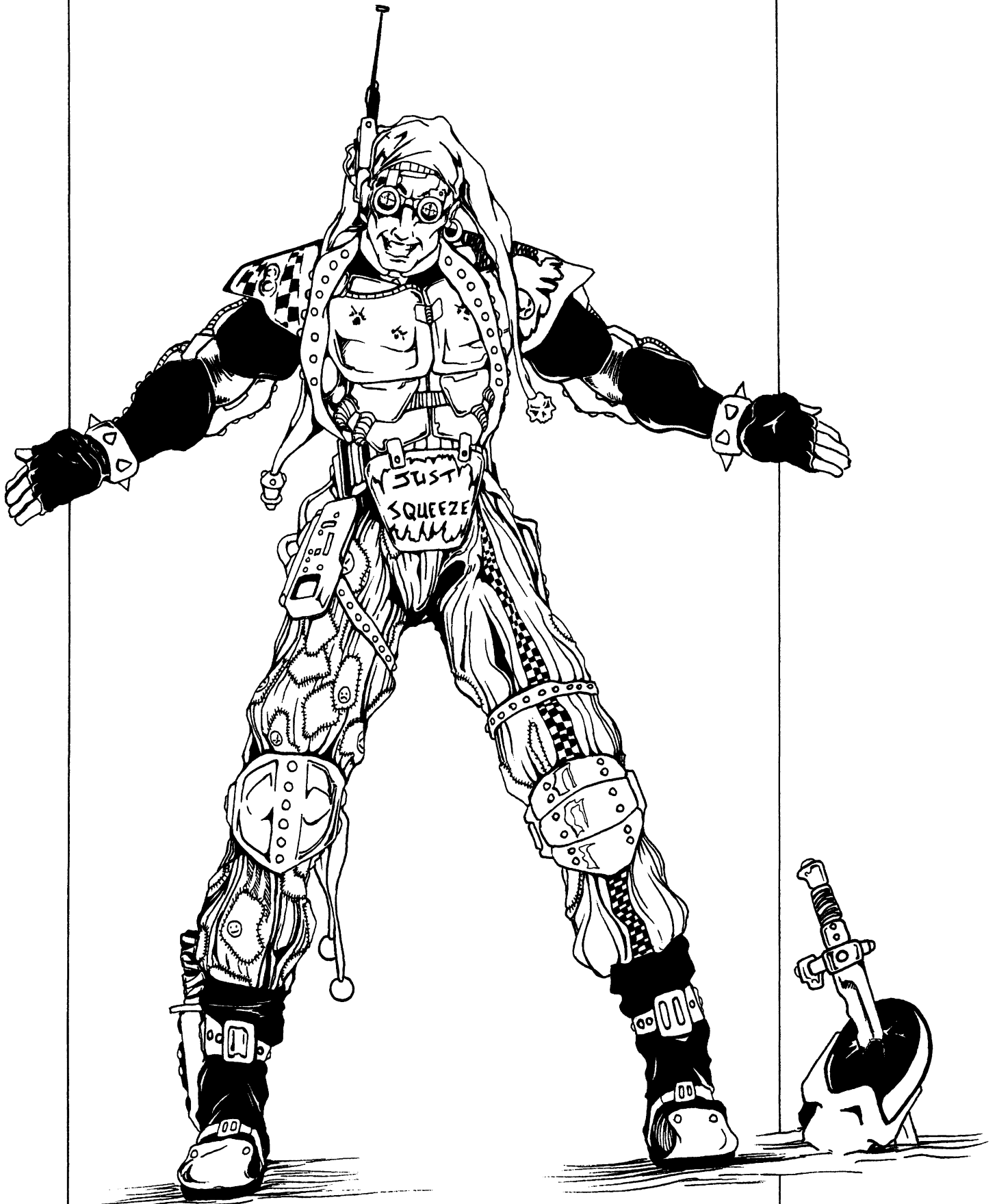

99'

bec Military has a few special programs for the use of Juicers in combat and their (relatively) safe detox and return to normal life.

Quebecois Worldview & Diplomatic Relations

Coalition States — Chi-Town: Within a generation after joining the Coalition States, relations between Free Quebec and Chi-Town were strained at best. With the political maneuvering, mutual distrust, arrogance and veiled threats issued by both States, the two looked upon each other with growing concern and animosity. It was not hatred, like the way they regarded D-Bees or sorcerers, but more like rival siblings who represented the opposite ends of the same spectrum. Fueled by wounded pride and paranoia, the leadership at the Coalition States sees Free Quebec very much as a dangerous rival. They point to the thousands of Glitter Boys, new designs, Violator SAMAS and Free Quebec's stubbornly reckless and independent spirit as proof that they are a threat to the States. Never mind that the nation only wants to be left alone to live as they desire without outside interference. Or that they have no plans to expand or conquer anybody, least of all the Coalition States. Free Quebec can barely manage the land they claim as their domain as it is.

Meanwhile, the leadership of Free Quebec sees Emperor Prosek and the Coalition States as increasingly imperialistic conquerors. They have no desire to fight the CS nor be part of some continent spanning empire. They would love nothing more than to find peace and engage in open trade and friendly relations with the States — they are like-minded "human" nations after all. However, peace is too high a price if it comes with losing their national identity and freedom. Free Quebec has decided it is not "The Coalition." A close cousin, like-minded, potential friend and ally, but not a card carrying, member State submissive to Chi-Town and willing to become part of the homogenous Empire. While they share many of the same philosophies and outlook, there are just as many that make them different, and it is in those differences where their identity and history lies. It is those differences the CS wishes to destroy and that the people desire to preserve. It is this that has caused Free Quebec to secede from the Coalition States and in so doing, make them their enemy. They accept war with the CS as a sad inevitability and the price of freedom, and will fight to the bitter end.

Coalition States — Iron Heart: The little brother of the Coalition has never been considered a major threat by the decision makers of Free Quebec. It has always sat in the shadow of Free Quebec and always will, or so the thinking goes. It has only been through recent developments and Free Quebec's leaving the States that they have advanced in technology and military potential to the number two State in the Coalition (and in the long term, that will be threatened by the acceptance of Arkansas, better known as El Dorado, as a member State). With a major influx in personnel, technology, cash and influence, Chi-Town has made Iron Heart the second fastest growing State in the Coalition, with Chi-Town number one and the soon to be State of El Dorado a close third.

Free Quebec has an abundant number of contacts and sympathizers at Iron Heart, but greatly underestimates the govern-

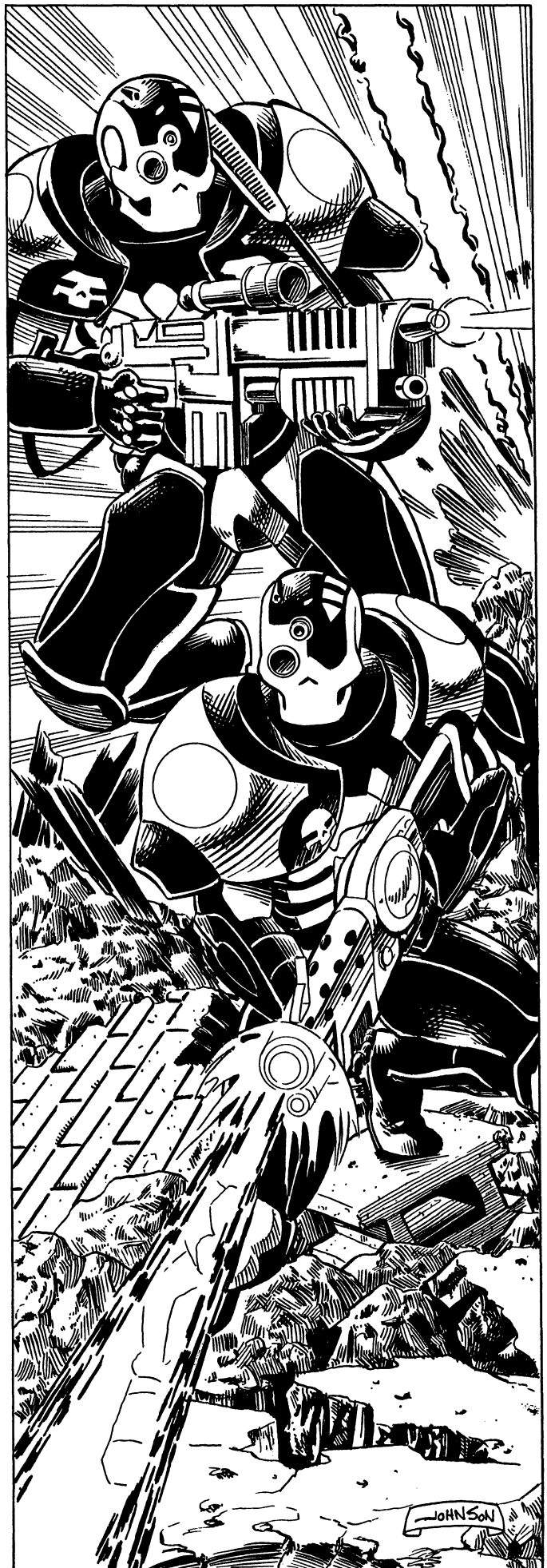

ment's commitment to the Coalition. Nor does Free Quebec understand just how much the leaders at Iron Heart resented having to live in its shadow and how much they welcome this opportunity to shine. While Iron Heart can sympathize about the suffering that comes with war, they are glad Free Quebec is gone and have no desire to see it return to the Coalition States unless it is as a broken and beaten step-child. Free Quebec will get no support from those in power at Iron Heart, not from the government or private industry. A recent poll by the Chi-Town Information Department (i.e. the Propaganda Department) shows that 86% of the people at Iron Heart can not understand why Free Quebec has left the States (i.e. why would anyone?), 80% believe the government is out of control and that this is NOT what the people of Quebec want, 59% believe the nation represents a threat to the Coalition's security, and 43% agree that war is justified if it will remove the corrupt government and bring Free Quebec back under CS control. Of course, these opinions are the result of Chi-Town propaganda and presentation of the situation.

Inuit Nations: The Inuit Nations as a whole are a scattered group of native people, too spread out and unorganized to threaten or concern the leaders of Free Quebec. These tribal people are allowed to wander the northlands without trouble or interference from the Quebec Military and government. See **World Book 20: Rifts® Canada** for more on the Inuit people and an overview of Canada.

Ishpeming (Northern Gun) & Manistique Imperium: The two nations in upper Michigan used to trade infrequently with Free Quebec, but have never enjoyed a strong relationship with the nation. There has never been any kind of formal trade agreement or alliance with these two weapons manufacturers, and the leaders of Free Quebec have always kept their distance from them. If anything, the two have caused Free Quebec more grief than anything else by supplying bandits, raiders, mercenaries, D-Bees and criminals with arms and armor. With Ishpeming and Manistique's recent *alliance* with the Coalition States, Free Quebec has become persona non grata — forbidding them to trade with the "rebel State" on any level. Both are living up to this agreement and making a tidy profit supplying the multitude of mercenaries and freebooters who have been attracted to the region by the war. Both arms dealers have always played fast and loose selling weapons and equipment, with profit always being their top priority and the consequences of their sales for others none of their concern.

Technically, their alliance with Chi-Town makes them enemies of Free Quebec, however neither is taking an active hand in the war effort, nor do they look at Free Quebec with any trepidation or great animosity. Free Quebec has several spies planted in both nations mainly to keep tabs on rumors and activities regarding the Coalition Army and mercenary activity. In the long term, the leaders of Free Quebec worry that the Emperor plans to make them member-States and incorporate the two fledgling countries' impressive manufacturing capabilities into the Coalition's war machine.

Iroquois League and Longhouse Preserve: Not an official ally, and likely never to be one, the Indian tribes that reside in the former state of New York see Free Quebec as the lesser of two evils. Chi-Town and the other Coalition States have a much more xenophobic response to Natives than Free Quebec. To a

certain degree, Free Quebec and Longhouse Preserve do a certain amount of business with each other, but only through intermediaries. The exchange of information, and certain supplies and equipment, flows through the small baronies and kingdoms between the two. There is almost an unofficial non-aggression agreement in place, where they mutually stay out of each other's business; an agreement both parties seem to enjoy. Another factor is the Native Indians' underlying respect for the troops of the Reconnaissance Battalions who patrol the region. So far, Free Quebec has done nothing to antagonize or jeopardize these people, but how long before the CS causes trouble?

Juicer Free Agents: After the debacle that came to be known as "The Juicer Uprising," many western Juicers have no love for the Coalition States. Hundreds of those seeking revenge have come to Free Quebec to offer their services as inexpensive mercenaries, scouts, saboteurs and military personnel — many have brought their friends with them (other Juicers, Headhunters, Crazies and other mercenary types). This has actually placed the Quebec Military in an awkward position because they recognize many of these "volunteers" as cutthroats, murderers and raiders who have no love or loyalty to Free Quebec. Their only motivation is revenge against the Coalition States, which makes them unpredictable and dangerous. Still, the Army of Quebec has agreed to use about half as mercenaries and has encouraged the least savory to do what they want against the Coalition troops without fear of repercussions from Free Quebec. They can even get resupplied at Old Bones, a place that is something of a political and societal no-man's zone.

Lazlo: The Kingdom of Lazlo still remains a mystery to Free Quebec. Even after extensive infiltration and planting various surveillance teams within this nation of D-Bees, humans and magic, their motives seem elusive and troublesome. On the surface, the kingdom is peaceful and forgiving. Like Quebec they value education and learning, although the people of Lazlo are way too open-minded and willing to accept the alien and unnatural (such as magic). It is this embracing of the alien, supernatural and inhuman that makes the kingdom a danger in the eyes of Free Quebec, for how could D-Bees, aliens, practitioners of magic and supernatural forces be anything but evil? Thus, the leaders of Free Quebec expect the Kingdom of Lazlo to show its true colors as a malignant, invading power any day now. (They've been waiting for that day for over 40 years now, but they know it will come.)

They know the extent magic plays in the daily lives of those living in Lazlo, and have reason to fear Lazlo on many levels, however, Free Quebec has no plans to invade, destroy, sabotage or otherwise harm the kingdom. Until Lazlo proves to be an immediate threat to Free Quebec, they are content to watch and worry. In keeping with their nonaggressive, isolationist policies, unless Lazlo begins to expand close to them or pose some tangible threat, the government and Military of Quebec are content to leave them alone. Ironically, Free Quebec's refusal to disband the Glitter Boy Legions and the increased size and improvements to its military has been as much a response to the existence of Lazlo as growing problems with the Coalition States. The Quebec Military has always preferred to have a strong defense rather than be an aggressor. Thus as long as Lazlo does nothing to threaten this eastern nation, they have nothing to fear from it. Of course, Free Quebec would never have anything to

do with a “kingdom of monsters and magic” as they refer to Lazlo, and continue to chase off and kill nonhumans and sorcerers who come too close to their borders.

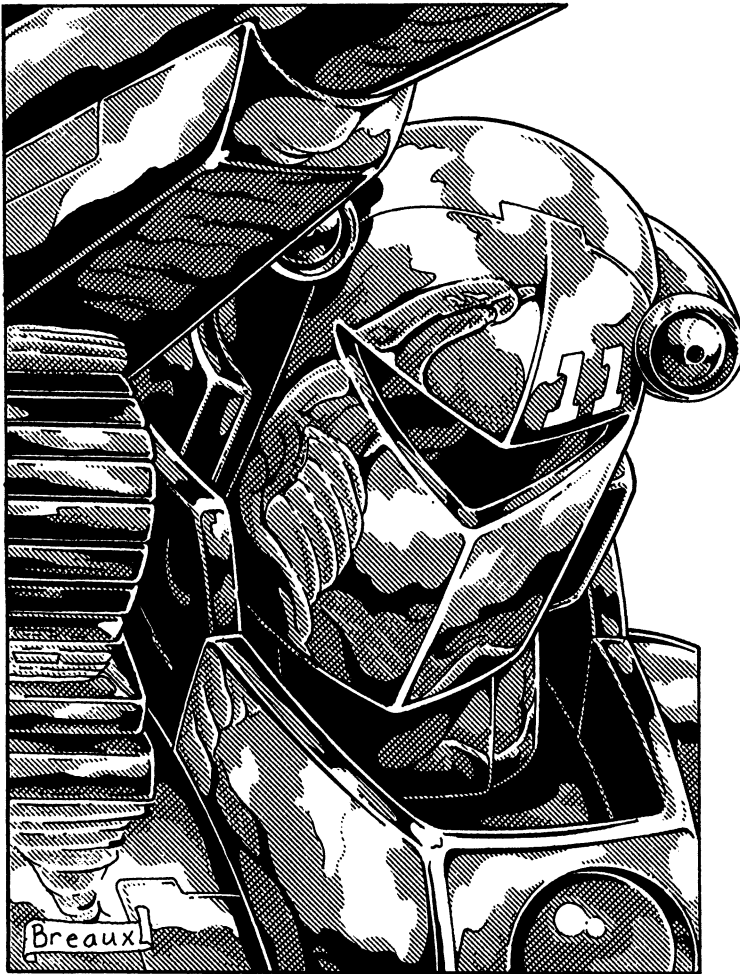

New German Republic (NGR) & Triax: The Germans are seen as their best and nearly sole ally in their war with the Coalition States. However, the NGR has no desire to get caught in the middle of the two warring factions, with whom they desire to establish diplomatic and trade relations. As a result, the NGR is taking a “soft” position regarding trade and support with Free Quebec, agreeing to trade foodstuffs, medicine, basic goods and some raw materials, but no weapons, armor or technology. They also offer their sympathies and moral support, and have even offered the disputing nations their services as intermediaries to try to broker a peace agreement. The CS has refused the notion of any peace-talks and the NGR has backed off to preserve their weakening relations with them. Military assistance and manpower from the NGR is completely out of the question.

Free Quebec has actively sought to increase relations with the New German Republic and are disappointed at the politically cool reception and painfully slow pace of forward progress. They have dramatically increased exports of foodstuffs and other raw materials that they have in abundant surplus to the NGR for low-end, non-military supplies. The two countries have even started trading literature and other passive goods and cultural information, both pre-Rifts and post. This has brought the two countries closer together than ever before on an emotional level, but the NGR simply can not afford to make the CS their enemy. As a result, diplomatic and trade relations are mini-

mal and strained. The leaders of Free Quebec understand and try not to press the matter. Their greatest fear is to lose the support of the NGR entirely.

Atlantis: Very little is known about the fabled continent of Atlantis. Only rumors have been collected, but most of them seem impossible to believe. They aren't even yet willing to admit much of what they hear is true, for its very existence represents the greatest potential threat to all people living in North America. As far as they can tell, the entire island continent is a haven for aliens and monsters who use both magic and technology. Intelligence has determined the monstrous “Slavers” operating along the Atlantic coast are from Atlantis and that they capture both humans and nonhumans alike. The Quebec Navy has had a few terrifying encounters with vessels believed to have originated from Atlantis but it is unknown whether such hostile encounters are part of a government sanctioned action or independent encounters with its hellish residents. The Navy is especially concerned about the strategic control of the Gulf of St. Lawrence. Also, Atlantis is the one place that remains impenetrable to intelligence agents, and even **le Sûreté du Québec** has failed — all agents vanish without a trace. Currently the authorities at Free Quebec keep their attention on more pressing matters, but the danger represented by Atlantis continues to haunt them.

Xiticix: The aliens known as the Xiticix are a remote enemy that are perceived only as a moderate threat. In actuality, Free Quebec officials see them more as a possible hindrance to the Coalition States, diverting their attention from Free Quebec. Free Quebec Intelligence believes it knows enough about the aliens to (erroneously) know they are not likely to make a home in their territory due to the overabundance of wetlands and lakes. However, they still look at the alien invaders with apprehension.

Others: Free Quebec's isolationist policy keeps contact with other outside forces to an absolute minimum. They know about the Shemarian warriors in the south, but don't care about them as they have yet to show any aggression toward their nation. They know about the **Federation of Magic** and have a few spies planted there but consider the Federation to be Chi-Town's concern. They know nothing about **Psyscape** other than that the CS has confirmed it exists. Likewise, other than the small communities, bands of adventurers and mercenary activity that borders their nation, particularly those in Canada to their west, Free Quebec has little contact with, or concern for, the outside world.

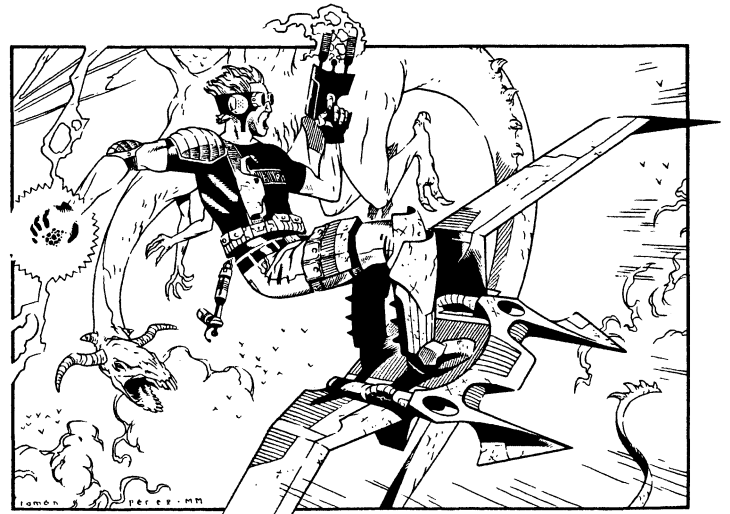

People & Groups of Note

Prime Minister James Lorne

For years now, James Lorne has been dictating terms for Free Quebec to Emperor Prosek. He has been in position as Free Quebec's policy leader for the last 22 years, under the full support of his advisors and security council, as well as the general public.

Very much a Quebecois, his loyalty lies with the state of Free Quebec before all others, and always will. This was part of the reason he was elected to the position of Prime Minister. Ever since their nation joined Chi-Town to form the *Coalition States*, the leadership found themselves constrained by new treaties and dictates from the Emperor. Nobody was ready or willing to stand up for their views or to the Emperor until a young politician by the name of James Lorne, a go-getter that was skyrocketing through the ranks and gaining appeal as he went, was nominated for a seat in the National Assembly.

Shortly after winning his seat and entering the Assembly, James Lorne made a name for himself as a hard-line pro-Quebecois, often taking harsh stances against the Emperor and CS Military. A few years later he was nominated for Prime Minister. With barely a token resistance, he took the position and has never looked back.

His ideas were originally thought of as idealistic or utopian, but with a determination few politicians have ever displayed, and heavily backed up by the people, he enacted several groundbreaking decisions, including the creation of *Liberty Reserve*, defying Chi-Town on numerous issues, and orchestrating the trade agreement with the NGR and Triax. He was also instrumental in supporting and secretly building up the Quebec Military, particularly the creation of the Glitter Boy variants and V-SAM. His many social programs and hard-line human supremacist attitude also won over votes and popular opinion. Additionally, over the last 15 years he has single-handedly reshaped the popular parliament with like-minded political leaders and brought into being a new sense of excitement, independence and patriotism. In the last century, Free Quebec, as a people and a nation, has never been more single-minded and united.

The Minister's consistent track record of placing the interests of Free Quebec and her people before his own or private industry and special interest groups (miraculously without offending or ostracizing most business people) has allowed him to remain in his position of power. He was heralded for the courage to secede from the Coalition States (with majority support of the people) and is seen as the leader who can get them through the war.



Prime Minister of Free Quebec

Real name: James Lorne

Alignment: Aberrant. His first loyalty is to Free Quebec and he is without question a patriot and a man of honor (keeps his word). However, Minister Lorne is a ruthless politician and strategist willing to do almost anything to win or get what he wants. He is also willing to bend and break the law, and use blackmail and treachery to preserve and protect “his” Free Quebec. Additionally, he is an zealot when it comes to human supremacy.

Hit Points: 56 **S.D.C.:** 22 **P.P.E.:** 14

Weight: 185 lbs (83 kg), **Height:** 6 feet, 1 inch (1.84 m). **Age:** 48.

Attributes: I.Q. 21, M.E. 17, M.A. 26, P.S. 15, P.P. 17, P.E. 20, P.B. 15, Spd. 19.

Disposition: James, although a polished leader and politician, has seen the world and knows the horrors that await humanity. With this knowledge he can portray himself as a fighter who has dragged himself through hordes of monsters to get to his position; a point of view not altogether untrue. He is demanding of people, expecting them to perform their best for him, and asks the same of himself. When people fail him, he forgives them and allows a second opportunity. After all, “they’re only human,” he reasons. A second failure results in removal/dismissal and harsh criticism that is likely to last a lifetime. Prime Minister Lorne hates failure.

His outlook for Free Quebec is infectious, contaminating all who hear him or walk in his presence. His most mundane meetings, policies and directives to Government Departments usually elicit a fervor that is unparalleled by other leaders (with the exception of the Prosek family in the CS). His bright vision for Free Quebec reflects through his charismatic persona — his aura — and further through the words and emotions of his speeches. A seemingly endless supply of energy and charm only add to his appeal.

His flaws include the same drive and charisma that make him so popular, for they lead him to ruthlessness, and frightening and quick decisions. He also suffers from an obsessive sense of rivalry (and a touch of inferiority?) with Emperor Prosek, to whom he always seems to fall a close second. He has hidden this well, but gets frustrated by the Emperor’s political maneuvering and tactics and returns the favors with “hardball” responses. His up-front, in-your-face attitude to the Emperor also, in part, comes from these emotions and is one factor that has led to the removal of Free Quebec from the Coalition. A move the Prime Minister had only recently come to realize. Still, he has turned this around and with the use of superb propaganda and his hypnotic charisma, to make it look as if the National Assembly had made their moves in anticipation of the secession. His social and economic programs have helped fuel the fire to this subtle change in the facts. A masterful tactician and politician, he knows full well the usefulness of propaganda and is nearly as skilled as the Emperor’s son.

The target for several assassination attempts (presumably instigated by the Coalition), Prime Minister Lorne has lived survived each, with no more than a few scars. His experience as an adventurer in his youth and combat skill has surprised more than one would-be assassin. As such, he has risen to a near god-like stature with the public. The *living symbol* of Free Quebec, with a powerful voice and quick mind that will lead them into the future.

Experience Level: 10th level Scholar/Politician/Leader.

Skills of Note: Literacy American and old French, Speaks American, Spanish, old French, Techno-can and Euro at 98%, Basic and Advanced Math 98%, Radio: Basic 98%, Computer Operations 98%, Pilot Automobile 95%, Pilot Hover Craft 98%, Lore Demons and Monsters, D-Bees and Magic at 97%, Writing 97%, Anthropology 82%, Intelligence 75%, Prowl 77%, Streetwise 56%, Land Navigation 72%, and Wilderness Survival 67%.

Magic Knowledge: Lore skill gives him a detailed understanding of magic, magic creatures and myths. He knows the types of magic that are conducted in North America, especially in Free Quebec. He is somewhat knowledgeable of an obelisk in the northern tundra, but clueless as to its purpose or origin.

Psionic Powers: None.

Combat Skills: Hand to Hand: Expert, 10th level.

Attacks per Melee: Eight.

Bonuses: +6 to initiative, +3 to strike, +5 to parry, +6 to dodge, +2 to roll with punch, fall or impact, +3 to damage, +7% to skills, +1 to save vs insanity/psionics, 70% to trust/intimidate, +3 to save vs Magic, +10% to save vs coma/death, critical strike on rolls of 18, 19, or 20. +2 to Perception Rolls.

Weapon Proficiencies: W.P. E-Pistol, W.P. Knife, W.P. E-Rifle, all at 10th level proficiency, W.P. Blunt at 3rd level.

Weapons: Always carries a Vibro-Knife in a hip-sheath, as well as a Wilk’s 320 Laser Pistol on his person. His favorite rifle is the Wilk’s 457, acquired shortly after he started adventuring. He has had the same one ever since (slightly superstitious).

Body Armor: He has an entire wardrobe of T-40 “Plain-Clothes” business and ultra-business suits and tuxedos, as well as several long coats and standard jackets for the harsh weather. The Prime Minister wears standard Quebec Military QEBA-10 Body Armor (80 M.D.C.) when in the field or giving speeches. Only the helmet is special and distinctive to denote his position.

Cybernetics: Amplified hearing and sound filtration, and toxic filter.

Description: A tall man, he looks much like a polished, city-bred administrator who is best suited behind a desk or in front of an audience, as well as veteran of several campaigns and adventures. His rugged looks and civil servant oriented mind have made him an icon in Quebecois minds. His hair is cut short, military-like, his physique like that of any mercenary. His eyes are a piercing blue that can stare anyone down or provide much needed support and comfort.

The National Assembly

The leadership of Free Quebec has fallen to the National Assembly. Formed from the elite membership of society, these aristocrats have all risen to positions of power in their respective fields of expertise or regional politics to represent their constituencies. For the past century and more, the National Assembly has endeavored to carry Free Quebec into the future. Ever since they confederated the many local city-states into the present Free Quebec, the Quebecois have looked to them for leadership.

The National Assembly is a collection of Ministers under the leadership of a *Prime Minister*. Each serves in the Assembly as

advisors to the Prime Minister in the areas of expertise in which they specialize. Their assistance in the implementation of decision and policy making has helped Prime Minister James Lorne rise to the status of an “enlightened elite” and one of the most powerful leaders in North America.

It was some of these selfsame advisors who advised the former Prime Ministers to forge an alliance with the Emperor and the Coalition States. That alliance provided an economic and political windfall to Free Quebec which they exploited to their fullest. Unfortunately all good things must come to an end. What seemed like the perfect alliance slowly turned into a social and political snake pit. Their zeal to do what was best for their nation and its private industry eventually came back to haunt them in a growing mutual animosity with the Coalition States. Irreconcilable differences would eventually divide them and push them apart. Political haranguing aside, the eventual secession from the Coalition States was probably inevitable and came from a unanimous vote of the Assembly.

The Executive Council

The ultimate leader within the State of Free Quebec, Prime Minister James Lorne has led his people in a vision he shares with those in power down to the common Quebecois. His decisions have helped Free Quebec prosper in a time of uncertainty. If there is any one individual to lead Free Quebec through war, it is this man. Right behind him is the **Executive Council**, formed from select members of the National Assembly who act as key advisors to the Prime Minister. These people are seen as the decision and law-makers as well as more influential people with political power in their own right. Their offices are typically located in the elite, wealthy sectors of the City of Free Quebec.

Vice-Prime Minister, Luc Maillet: He is head of the Executive Council and acts as a primary advisor and liaison to the Prime Minister. He has held this position since being elected with James Lorne and is nearly as zealous a patriot and statesman as his leader. Both men work well together and trust each other implicitly. It was VP Minister Maillet who pushed and lobbied for the technology trade with the NGR & Triax and helped to write the terms of the agreement. Attributes of note: I.Q. 14, M.A. 18, P.E. 17, all others average. Hit Points 53, S.D.C. 31; 8th level Politician/Leader, 6th level Operator. Alignment: Unprincipled. Luc Maillet sometimes questions the Prime Minister’s methods but never doubts his dedication to the welfare and freedom of their nation.

Prince Gerard Dupuis: The official representative from the Kingdom of the Saguenay and son of King Robert Dupuis, one of the founding kingdoms in the nation of Free Quebec. He has become one of the most trusted advisors to the Prime Minister. Attributes of note: I.Q. 17, M.E. 19, M.A. 21, P.P. 18, P.E. 15, all others average. Hit Points 49, S.D.C. 40; 7th level Freelance Spy. Alignment: Anarchist with leanings toward Miscreant.

Mayor Joseph Arsenaault: The elected mayor of the City of Free Quebec, he too has become a respected advisor to the Prime Minister. Attributes of note: I.Q. 12, M.A. 22. Hit Points 42, S.D.C. 21; 7th level Scholar/Politician. Alignment: Aberrant.

Minister of Foreign Affairs, Gilles Duseault: Head of the Foreign Relations Office, Minister Duseault is an accomplished

speaker, politician and diplomat. He was responsible for the actual negotiations between Free Quebec and the NGR. He is also the one in charge of detailing foreign affairs concurrent with the Prime Minister’s wishes. Attributes of note: I.Q. 15, M.E. 19, M.A. 18, P.S. 14, P.E. 15, Spd. 22, all others average. Hit Points 60, S.D.C. 57; 8th level Military Specialist. Alignment: Unprincipled.

Minister of Defense, General Patrick O’Neill: Five-Bar General in the Quebec Army. General O’Neill is a veteran of many campaigns and has much influence within the Council. A cool, confident tactician who knows what risks war places on a nation and its people, he has been instrumental in Free Quebec’s military preparations for armed conflict with the CS. He helped establish the Liberty Reserve and encouraged the development of new Glitter Boy designs. Attributes of note: I.Q. 14, M.E. 15, P.S. 22, P.E. 13, all others average. Hit Points 66, S.D.C. 40; Age: 71, 12th level Military Specialist. Alignment: Scrupulous.

Minister of Health, Dr. Erin Tremblay: Head of the Medical Sciences Division concerning health care technology, laws and services provided to the people of Free Quebec. Attributes of note: I.Q. 18, M.A. 17, P.P. 15, all others average. Hit Points 40, S.D.C. 24; 9th level Medical Doctor. Alignment: Principled.

Minister of Advanced Medicine, Dr. Robert Fugere: Head of the Medical Sciences dealing with human augmentation, specifically Juicers and bionics. He was responsible for creating the blueprints for the Shock Trooper Battalions, developing a humane Juicer program and procedures for creating cyborg troops and their reintegration into human society. Attributes of note: I.Q. 21, M.E. 20, P.P. 18, all others average. Hit Points 43, S.D.C. 22; 10th level Cyber-Doc. Alignment: Scrupulous.

Minister of Science & Technology, Maurice Fraser: Head of the Research sectors for science and technology, he advises on issues relating to advancement of technology, and most recently, the adaptation of acquired Triax technology. Attributes of note: I.Q. 21, M.E. 18, P.B. 17, all others average. Hit Points 39, S.D.C. 22; 10th level Scientist. Alignment: Anarchist.

Minister of Industry, Micheline Pilot: Head of the Industry, she reports on industrial affairs. Attributes of note: I.Q. 14, M.E. 23, P.S. 13, P.P. 15, all others average. Hit Points 45, S.D.C. 30; 11th level Operator. Alignment: Unprincipled.

Minister of Justice, Judge George Taylor: Head of the Justice Department. A retired General, he once headed the JAG Corps for the Quebec Military. He is responsible for enforcing and updating Free Quebec laws and policies. He has a reputation for being tough but fair. Attributes of note: I.Q. 14, M.E. 18, M.A. 19, P.B. 17. Hit Points 58, S.D.C. 48, age 77. 10th level Military Specialist, 8th level Judge. Alignment: Scrupulous.

Minister of Intelligence, Gen. Sandra Haley: Commander-in-Chief of le Sûreté. She is responsible for all non-military intelligence services whether they be internal or external. Attributes of note: I.Q. 17, M.A. 15, M.E. 22, P.S. 17, P.P. 20, P.E. 17, P.B. 20, Spd. 14. Hit Points 55, S.D.C. 52; 9th level I.S.S. Intel Specter. Alignment: Aberrant.

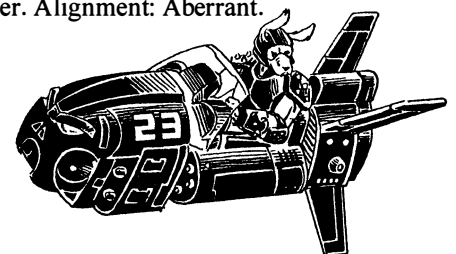

C.F.Q.C. Radio Free Quebec

"In the wake of the formation of the Coalition State of Free Quebec, we as a people have been at odds with Chi-Town. The inevitable breaking away of Free Quebec from the Coalition States was the result of years of bitterness and mutual frustration with policies, politics, views and ideologies that were suffocating us. What we see as our rightful way to live and grow as a nation has finally come to terms with the fascist rulers, the minions and followers of Emperor Prosek and his self-serving policies.

"So be it, I say. What does a self-made ruler down in the south know about our needs? Our dreams? How can he guide our destiny when he doesn't even know us? We are free, we are Quebecois and our place in this world's society is now ours, and ours alone. Freedom, my friends, is what this is all about! Freedom to pursue our own policies, our own way of life, and our own dreams without having to second guess ourselves and kowtow to big brother in the south.

"The time is ours. I ask you all to take charge, 'mes amis', there is no better time to be part of Free Quebec!"

— An excerpt from Sylvain Richard's program, "Vive la Quebec!"

The national radio station has become the unofficial voice of the public on affairs ranging from civil policy and recent events, all the way to foreign policy and military affairs. Ever since relations with the Coalition States began to seriously sour 15 years ago, the radio personalities of C.F.Q.C. have played an increasingly important role in winning the hearts and minds of the people. They began by incessantly promoting the idea of a "free state" and demanding the, then new, Prime Minister to do something about it. They screamed for a truly "free" Quebec that wasn't "ruled by a foreign Emperor." More times than one can count, Quebec diplomats had to go through official channels to smooth over comments made on the radio against Emperor Prosek and the Chi-Town leadership. However, Prime Minister Lorne refused to silence the station. And the people listened.

Several of the radio personalities quickly became veritable icons among Free Quebec society, speaking violently and vehemently against the Coalition States, the Coalition Military, Emperor Prosek, his family and CS policies, laws and society. Prime Minister Lorne recognized the value of this "free speech" and did little to curb them even when Chi-Town officials and diplomats screamed for the station to be shut down and the "rebellious dissidents" punished. His failure to respond to this "crisis" would be another one of many things to widen the divide between his nation and the CS. The fact of the matter is, the Prime Minister saw an opportunity and seized it. He carefully and subtly encouraged the radio programming without any obvious official support. His scheme, to make these sentiments appear as if they were a *grass-roots movement* started by the people and that anything he might do or endorse as Prime Minister was in response to "public sentiment," not his own machinations or the ranting of a maverick radio station.

The Prime Minister gave the radio station credibility (and quadrupled its audience overnight) by "innocently" stating in a

public address that C.F.Q.C. was "the voice of the people and the people can not be silenced." Within a few short years the Prime Minister had turned an independent radio station into his tool of propaganda and manipulation. A tool so cunningly crafted that to this day the owners and radio personalities do not realize it. He made his strongest move when he began making appearances on the program to address the concerns of his people, as well as giving speeches addressing Coalition injustice, the rights of Free Quebec, the loss of her national identity and crumbling personal freedoms under CS influence wherever and whenever he could. In fact it was Prime Minister Lorne who was the first to raise the issue of secession on C.F.Q.C. by innocently asking the audience, "What am I to do? To restore the kind of independence and national identity you seem to want, we would have to secede from the Coalition States? Does anybody really want that?" With that question, the campaign to secede from the States exploded into being. Over the years that followed, the C.F.Q.C. played a large (unwitting) roll in getting the 87.5% backing the Prime Minister needed to have Free Quebec secede from the Coalition.

Today, C.F.Q.C. is an integral part of the culture in Free Quebec, and the most popular radio station in the country. It has become a veritable way of life for those in Free Quebec and the surrounding countryside. Their broadcasts can be heard, via relay stations, across the nation, as far west as Iron Heart and northward into the tundra. Coalition broadcast units relay the messages on to Chi-Town where intelligence personnel listen, analyze and try to glean inside information about the "enemy." Never suspecting that C.F.Q.C. is, at least in part, the pawn of the Prime Minister and fed information that helps the cause for Free Quebec, misleads the CS and promotes his schemes. It helps him define Free Quebec for what it is: an independent state, unshackled from the damaging dreams of Emperor Prosek and the smothering influence of the Coalition States.

Sylvain Richard Radio Personality

Sylvain Richard is both a radio personality and partial owner of C.F.Q.C. Over the years, the Richard family has had an active hand in various radio operations, including rogue "Radio Cells" in Old Bones and elsewhere. The family was instrumental in the petition and work behind organizing and championing many liberal causes, including the secession of Free Quebec from the Coalition States. The family has benefitted from the success of their radio station and the politics which it has promoted. They are friends of Prime Minister Lorne whom they ardently support, and have benefitted as the "Voice of Free Quebec" in many ways, from advertiser dollars and public celebrity to a perception of having political clout and enjoying the rewards from a government sponsored construction of broadcasting facilities and relay stations across the nation. The Richard family has no idea the Prime Minister uses them as his pawns or that he has little regard for them whatsoever.

The C.F.Q.C. has very much come to allow differing opinions to be expressed, but for the most part the public remains fairly receptive to only a few personalities. These are people they have come to identify themselves with, particularly **Sylvain Richard**, a third generation radio personality, and **Julie Tremblay** the official government correspondent.

Sylvain has the edge in dealing with the Quebecois public in that he has a name that is instantly recognizable to more than four generations. His father and grandfather were both short-wave radio relays and members of the Broadcast Coordinators Network where they gave their opinions and pushed for national reform. Sylvain continues the tradition of these radio broadcasters, but is much more a celebrity than a politician or a reformer (which makes it all the easier for the Prime Minister to manipulate him).

The family has been placed on Chi-Town's most-wanted list, with Sylvain Richard somewhere in the top ten. This has only increased his "hero" status among his listeners and places him closer to the Prime Minister (and his charismatic influence) because the Prime Minister has personally taken it upon himself to insure Richard's safety. A calculated move that has seen Sylvain Richard and his family moved to the Prime Minister's estate and placed under Military protection. Sylvain loves it, because he is treated like a god, gets to hobnob with the leaders of the nation and (believes he) has the ear of the Prime Minister himself.

On the air, his outbursts and ranting concerning pro-Quebecois and anti-Chi-Town sentiments, crimes and atrocities (many fed to him by Prime Minister Lorne or one of his people) works to inflame the people and keep them stoked against the CS (and supportive of the Quebec Government with Lorne at the helm). His messages of independence, patriotism and hate get to an estimated three million or more people daily, inside and outside of Free Quebec. This gives him one of the most powerful vehicles to counteract and infuriate Emperor Prosek's carefully laid propaganda, brainwashing and bigotry in the country. Heard daily, people can get their dose of the "truth and righteousness" whenever they want it.

Sylvain takes this job seriously, honestly thinking that his work helps to keep his homeland free from the negative influence of Emperor Prosek and other outsiders. He even hopes that some day, the Coalition States will see the errors of their ways, follow Free Quebec's ideals, and overthrow the Prosek regime. A pro-humanist and as prejudiced against D-Bees as they come, he also preaches about racial purity and isolationism. His has the somewhat naive belief that Free Quebec (in part, thanks to him) is the perfect nation-state. This creates a natural bias against all other nations, especially Chi-Town. A bias that is transferred very much to the listening masses, which for now, is exactly what Prime Minister Lorne wants.

Sylvain Joseph Richard

Alignment: Anarchist with delusions of self-importance.

Attributes: I.Q. 14, M.A. 24, M.E. 12, P.S. 13, P.P. 19, P.E. 11, P.B. 17, Spd. 31.

Hit Points: 39, **S.D.C.:** 18, **Age:** 27

Size: 5 feet, 10 inches (1.78m), 160 lbs (72 kg), **P.P.E.:** 7

Disposition: Despite, or perhaps because of, his bombastic personality, rapier wit, obvious intelligence and intense sincerity (he honestly believes what he says and sees himself as a crusading patriot; as do his listeners), Sylvain is as impressive in-person as he is over the radio. He has a natural charm that seems to stretch out around him and captivate those who hear him, especially if they already share his views. He has a knack for recognizing and saying what people want to hear, and has learned to use it skillfully in all of his endeavors. His commanding voice is deep and keeps people's attention in an

almost magical way, making him all the more influential in what he says. The influence of his late father, a true visionary and crusader, has helped create the man that radiates this persona and now helps to identify what Free Quebec stands for.

Although his fame nearly rivals that of the Prime Minister and some members of the National Assembly of Free Quebec, Sylvain has no little real power and remains impotent in the world of politics. He is little more than a voice, manipulated to reflect the emotions of the people and the machinations of the Prime Minister. He is oblivious to this, thus his power to influence and make real change is diluted to nearly nothing. Being a true patriot who loves his country is part of his natural charm, but also limits his message. When the war is over and a different era begins, Sylvain may find other voices call to his listeners and that his fame may be fleeting.

He good-naturedly talks to everyone he meets until they prove themselves to not be worth talking or listening to. Always up for a good debate, he is perfectly content to argue out a minor point until it reaches universal significance. He has even been known to change his opinion during a few of these mammoth arguments. As it stands, Prime Minister Lorne and a couple others are the only ones who have been able to reverse or modify this hard-line young man's opinions or choice of what to say on the air.

Experience Level: 6th level City Rat.

Magic Knowledge: None.

Psionic Abilities: None.

Combat Skills: Hand to Hand: Martial Arts, 6th level.

Attacks per Melee: Seven.

Bonuses: +4 to strike, +6 to parry, +6 to dodge, +6 to roll with punch, fall or impact, critical strike on natural 18-20, 80% to trust/intimidate, 35% to charm/impress. +2 to Perception Rolls.

Weapon Proficiencies: W.P. Knife and W.P. Energy Pistol.

Weapons of Note: Always carries a Vibro-Knife and a C-18 Laser Pistol.

Armor: Plain-Clothes leather jacket with M.D.C. padding (A.R. 10; M.D.C. 12).

Skills of Note: Streetwise 60%, Speaks American 98%, Radio: Basic 80%, Pilot Motorcycle 95%, Pilot Automobile 80%, Basic Math 80%, Prowl 70%, Find Contraband, Weapons and Cybernetics 61%, Computer Operation 75%, Writing 60%, Literacy 65%, Acrobatics, Athletics, and Running.

Description: A tall, nice looking young man, Sylvain Richard would easily blend into a crowd of college students until his identity was revealed. He dresses in expensive clothing but it is his flamboyant gestures and voice that make people stand up and take notice. Except for special events, he almost always has a couple of days growth of facial hair.

Julie Tremblay

Official Radio Correspondent

When Prime Minister Lorne realized that C.F.Q.C. was an excellent propaganda vehicle, he decided to appoint a diplomatic liaison to be Sylvain Richard's direct link to the National Assembly to help get "their" message to the people. The result was the posting of **Julie Tremblay** as a Public Relations Officer to help shape Sylvain's opinions, feed him information and make sure it was the Prime Minister's message that was getting out. She is also to keep an eye out for subversives and trouble-



makers by assessing guest speakers and workers at the station. Sylvain Richard and Julie Tremblay hit it off so well that he offered her a position as radio personality to do interviews focusing on the issues and with members of the National Assembly and other powerful people. The change was not something she looked forward to, but it was decided that this would give her (and through her, the National Assembly) more influence over the station and the message it was delivering to millions of listeners.

Starting out, she was the shy, very reserved and soft-spoken voice of the government for two hours on Sunday evenings. Over the years she has honed her abilities and gathered her confidence. She now portrays the rulers as hard-nosed, public-oriented officials, who live to serve the people and make Free Quebec strong. In addition to her Sunday evening talk show (which is now 3 hours long), she does weekly special reports, and acts as the station's government news correspondent. Her newfound part-time career has led her to become famous (only the Prime Minister and Sylvain Richard are more recognized and adored). This has also led to increased risk. She has been branded by the Coalition propaganda machine as a traitor to the States, and the mistress of the Prime Minister (which is a blatant lie). There have been several attempts on her life which have only enhanced her image as a trusted and beloved patriot.

More importantly, from the Prime Minister's point of view, she earned the complete trust (and a certain amount of misplaced affection) of Sylvain Richard. Julie is one of the very few people who he actually listens to and who can change his mind on issues and positions. Sylvain is smitten by Julie but he is a

married man and there is no hankypanky going on between them. Personally, Julie finds Sylvain too full of himself to be attracted to him.

Full Name: Julie Marie Tremblay

Rank: Captain

Alignment: Scrupulous

Attributes: I.Q. 14, M.A. 24, M.E. 17, P.S. 15, P.P. 19, P.E. 12, P.B. 15, Spd. 14

Hit Points: 39, **S.D.C.:** 18, **Age:** 25. **P.P.E.:** 7

Size: 5 feet, 10 inches (1.78m), 150 lbs (all muscle; 67.5 kg),

Disposition: A very confident woman, she makes her presence known to a room of people just by being there and not saying a word. She radiates confidence and uses it to her advantage. As the unofficial "voice for the government," she is in a position of major influence and power, something she is acutely aware of. She feels pressured from both the public she speaks to as well as her superiors who constantly weigh and monitor her efforts to do what's best for the nation. Her job as the National Assembly's Correspondent has made her public career the success that it is, but it is something she knows can be taken away from her at any moment (an unlikely event), and it is not anything she sought. Julie is a career Military Officer who is simply doing her duty. She has always been something of a perfectionist, and she has worked hard at honing her radio style and image. She is annoyed by the amount of attention that the flashy and controversial Sylvain Richard gets, especially since half of what he spouts and thinks are ideas she has planted in his mind.

Julie carries herself tall and proud, pushing herself hard and accepting the rewards her efforts have brought her. She is known to be a very professional and capable soldier, even with her job as a radio personality. A trained light-infantry officer, she received the highest standing a woman has ever received in the airborne training course, graduating in the top 5%! With war erupting on the horizon, she can't help feel that she could better serve her country in the field of battle. The Military High Command deems otherwise.

Experience Level: 6th level CS Military Specialist.

Magic Knowledge: None.

Psionic Abilities: None.

Combat Skills: Hand to Hand: Expert, 5th level, Robot Combat: Elite (SAMAS), boxing, wrestling.

Attacks per Melee: Seven.

Bonuses: +6 to initiative, +4 to strike, +7 to parry, +9 to dodge, +2 to roll with punch, fall or impact, pin/incapacitate on natural 18-20, critical strike on natural 18-20, 80% to trust/intimidate.

Weapon Proficiencies: W.P. Energy Pistol, W.P. Energy Rifle, W.P. Knife.

Cybernetics: Amplified hearing and sound filtration system, toxic filter, and artificial spleen (bio-system replacement resulting from an accidental injury).

Weapons of Note: Wears a Vibro-Knife on her at all times. Her usual weapons include a C-18 Laser Pistol and C-12 Laser Rifle.

Armor: "Plain Clothes" Armor (28 M.D.C.), or standard Military body armor (80 M.D.C.)

Skills of Note: Radio Basic 80%, Literacy 65%, Speak American 98%, Computer Operations 85%, Intelligence 62%, Pilot Hover Craft 85%, Pilot Robots and Power Armor 71%, Read

Sensory Instruments 70%, Pick Locks 65%, Wilderness Survival 65%, Escape Artist 65%, Detect Ambush 65%, Parachuting 85%, Military Etiquette 80%, Play Musical Instrument 70% (clarinet; professional quality!).

Description: A taller than average woman, Julie Tremblay stands proud and confident in herself. Since her induction into the radio community, she has taken more care in her outer appearance. Her hair is cut to military standards but still remains stylish. She wears a dress uniform most of the time, military battle armor when on-duty away from the radio station, and wears a variety of "Plain Clothes" armor with civilian clothes when off-duty.

Note: There are other radio (and TV) personalities, but none are as recognized as Sylvain Richard or Julie Tremblay, both of which make increasingly frequent television appearances.

les Soldats de St. Jean (Soldiers of St. John)

The organization known as les Soldats de St. Jean is a vast group of people in and around Free Quebec who are hard-line human supremacists and pro-Quebecois, or anti-Coalition zealots. They are not like the typical gangs that operate within any one given urban center or several surrounding communities. They are a group of people covering the entire width and breadth of Free Quebec. Neither are they primarily into illegal operations or disreputable actions, although by their very nature they do consort with unsavory characters and condone violence. The government considers them violent, political activists who are barely tolerated by many, fully accepted by others.

Les Soldats have a membership which numbers into the tens of thousands (mostly rural folks). Their supporters are found in all walks of life from the farmers, loggers and trappers in the deep forests, to the grunger who lives in the slums of a 'Burb, to the business people and influential members of society, including corporate officers, government and military officials. For the most part they are collected into *Local Chapters* which organize and delegate their operations. There is at least one major Chapter within each major urban center, with hundreds of others scattered throughout the countryside. They are especially prominent within the Gaspé Peninsula and the western regions.

Intensely pro-Quebecois, they have a deep hatred for the Coalition States, especially for the Emperor and his extended family, including prominent government and military officials. With word of the Campaign of Unity and the preceding secession by Free Quebec from the Coalition States, les Soldats de St. Jean have become all the more fervent in expressing their ideology. As human supremacists, they will be satisfied to send the Coalition troops packing and live free of Chi-Town's influence. Their main target of hate is nonhumans. It is les Soldats de St. Jean who promote the methodical extermination of D-Bees and encourage citizens to take matters into their own hands and go on "D-Bee hunting parties." They are also ardent critics of the more accepting people in places like Lazlo. With some carefully laid and biased lessons in history and opinions, D-Bees and practitioners of magic are easily made the source of all the evil and danger in Free Quebec.

There is, however, a vast range of views and idealism within the organization. Views that cause discord and infighting, and divide the membership. Some factions focus entirely on eradicating D-Bees from the planet. Others are active against the D-Bees and practitioners of magic. The most extreme may also include *psychics* and mutants like *Psi-Stalkers* on their hit list. The most militant actively seek out and destroy any unfortunate victims who cross their paths and seem to be constantly spoiling for a fight. When D-Bees and magicians aren't available, they verbally attack the moderates in the organization, accusing them of being armchair generals and cowards who lack conviction.

Moderates within the group are often criticized and disliked by the militant factions because they don't usually take up arms against "the enemies of man." Instead they only "talk" about the need for preserving the human race and lobby the government to do their dirty work for them. Moderates are the most active in the political arena, pushing for further laws, sanctions and military action against D-Bees, and calling for another Northern Dynamo campaign to purge the surrounding land of D-Bees and magicians. These individuals are not likely to sully their own hands with the blood of the innocent, although they would ignore any pleas for help from nonhumans, spit on and threaten those incarcerated, and refuse to do business with any humans who use D-Bees as slaves or employees. The practice of slavery and employing D-Bees is outlawed throughout Free Quebec, but is allowed in **Old Bones** and neighboring communities outside its borders. Actually, some farms and wilderness communities, secretly and illegally keep D-Bee slaves or employ D-Bees at slave wages.

With the outbreak of war, the extremists in les Soldats de St. Jean are quick to take up arms to "defend their nation." In truth, it is an excuse to go on a killing spree, flushing out D-Bees and suspected sorcerers, spies and their sympathizers, and slaughtering them in the name of national patriotism. There are many "militias" already organized with scores of new ones popping up every day. Those in the wilderness areas are often experts in the local geography and skilled at guerrilla warfare and intelligence gathering (they have strong ties to the communities in the surrounding countryside if nothing else). The more established militant factions are reasonably organized groups with a military hierarchy. Most have stockpiles of weapons, foodstuffs, equipment and supplies scattered throughout the wilderness. Armed with energy pistols, energy rifles, rockets, rail guns, heavy weaponry and homemade explosives and land mines, they mobilize using cars, trucks, motorcycles and civilian hover vehicles.

Surplus military-style equipment such as jet packs and the occasional robot or suit of power armor also exists. The majority has been purchased from Northern Gun before the CS embargo, or "liberated" from D-Bee loving mercenaries, bandits or D-Bee gangs. It is important to note that so-called "D-Bee lovers" are anybody who is seen freely associating with D-Bees. Thus, a group of adventurers who may have only one nonhuman (D-Bee, dragon, etc.) in the group, or who are seen sharing food with a D-Bee child or trading goods with a D-Bee traveler, is regarded with the same hate and disdain as D-Bees themselves. In the eyes of these bigots, humans soft on D-Bees are fools and traitors to their race, and need to be purged along with the "monsters" themselves. All too often these sentiments are used



to mask reasons to intimidate, bully, rob, rape, get revenge and kill.

Breakdown of les Soldats de St. Jean

Total Number: Approximately 10,000 “soldiers” (huntmen/scouts and other mercenary O.C.C.s) and around another 40,000 rural villagers and townspeople who follow their ideals. This number does not take into account the thousands of urban followers they don’t know of or contact. There are about another 20,000 idealists within the urban centers, from all walks of life.

Racial Breakdown: 98% Human and 2% Psi-Stalkers.
Note: 65% male, 35% female.

Breakdown by Occupation:

- 41% Vagabond farmers, loggers, laborers, homesteaders living off the land.
- 12% Wilderness Scouts
- 20% Huntsmen/Trappers (see *Rifts@ Canada* for O.C.C.)
- 18% Mercs/Grunts and fighters of all kinds.
- 4% Headhunters/Partial Cyborgs
- 5% Other O.C.C.s

Typical level of experience for men of arms, thieves and other O.C.C.s is 1D4+2 (4th level average). Leaders of specific cells, and specialists and experts within the group tend to be 1D4 levels higher than the average (typically 6th or 7th level).

D-Bees in Free Quebec

There aren’t any. At least none that are “officially” tolerated, especially in or around human population centers. Since before joining the Coalition States, Free Quebec has been one of the most ruthless campaigners for human supremacy, their actions against D-Bees rivaling anything done by Chi-Town. The general consensus view is that D-Bees are monstrous, alien invaders and a threat to all human life. (People of magic are held in equal contempt, accused of actively cavorting with evil forces and assisting them to harm humans.) Moreover, Free Quebec’s history is filled with centuries of struggle and war against wave after wave of supernatural monsters and mortal alien invaders. This long history of strife, murder and mayhem suffered at the hands of nonhumans has forever colored their view and sown the seeds of deep-rooted hatred and prejudice.

Ever since the **Saguenay Campaign**, which pushed hordes of invading demons deep into the northern Badlands nearly a century ago, the people of Free Quebec have had no tolerance for nonhumans. Many are outright hostile and kill them on the spot. Others actively hunt them like obsessed exterminators bent on eliminating the “creatures” once and for all. Others hunt D-Bees for sport or to collect a modest bounty. Meanwhile, the **Northern Dynamo Campaign** less than a decade ago has only served to reinforce their disdain against both D-Bees and practitioners of magic. Never mind that the entire fiasco was instigated by a cadre of sorcerers so reviled that they were expelled

from the *Federation of Magic*, and as a result were testing Free Quebec to see if it might prove vulnerable to a takeover. These wicked mages and the D-Bees they recruited are not indicative of the nonhumans who inhabit eastern Canada or live in the peaceful kingdom of Lazlo to the west. Unfortunately, many people, especially those in the order of *les Soldats de St. Jean*, do not distinguish between evil invaders and peaceful settlers. To them, all D-Bees and magic practitioners are the same. All threaten human life. All must be destroyed.

The main difference between isolationist Free Quebec and the expansionist Coalition States is that the Quebec Government has no dreams of conquering the Americas. They simply want to hold onto the land they have claimed (primarily the old pre-Rifts Province of Quebec), live in peace and be left alone. A full 80% of the old province is undeveloped wilderness that will take centuries for Free Quebec to outgrow, if ever. Thus, if left to their own devices, they'll slowly develop their land, grow as a people and a nation and won't bother anybody. Of course attitudes *may* change, but this has been Free Quebec's position for over a century and there is no reason to think it will change any time soon. In fact, the nation's predilection toward isolationism versus the Coalition's imperialistic expansionist views has always been a source of consternation between the two, perhaps more so than anything else.

The D-Bee presence. Although D-Bees are not welcomed and are methodically hunted and killed, there is a vast population of them within the borders of Free Quebec, reaching upwards to an estimated 200,000 or more. For the most part they try to keep a low profile and avoid attracting attention to themselves. Most live in the remote wilderness areas as farmers, trappers, cheap labor (hired by unscrupulous humans who pay them slave wages) or mercenaries (again, cheap hired guns). Others live off the land as tribal nomads in small groups of 6-60. Some make a living as bandits, smugglers, and raiders, robbing, killing and pillaging to survive. Still others live their lives constantly on the run, drifting from one place to another and doing whatever it takes to endure. "Old Bones" is often considered a haven, but it is more of a lion's den where foolishly optimistic and naive D-Bees are chewed up, and only the lucky ones are spit out alive. Sadly, prejudice is a double edged sword, and many D-Bees have good reason to hate human beings and inflict grievous harm upon them out of revenge, anger or a sense of justice. Such is the dog-eat-dog world of Rifts Earth.

"Franko"

The unofficial leader of *les Soldats de St. Jean* is a man known to all only as "Franko." The Sûreté have been trying to track down this individual for years now, but have never gotten close enough to even know what he looks like. The best they have done is learn one of his many aliases or nicknames, "Franko." They have no physical description to go with the name, and some agents question whether or not he really exists. The name suggests the individual is male and this "Franko" is always referred to as "him," but they are willing to consider the possibility that "he" may be a she, or even a small group. It would seem there are few people who have actually seen Franko, but people all around the nation follow his lead as if he were the unofficial king of rural Free Quebec. This is one of the

reasons that Free Quebec is searching for this individual, for they fear he may one day lead a political insurrection against the sitting government. A more pressing reason is that this "Franko" is responsible for a number of atrocities. Not just against D-Bees (Who cares about that?), but against loyal human citizens of Free Quebec whom he has deemed to be D-Bee sympathizers and traitors to mankind. Prime Minister Lorne is one of the yet living "traitors" along with half of the Elite Council condemned by "Franko" for not being more active in the eradication of nonhumans and for allowing the "cesspool of filth and inhumanity at Old Bones" to exist for any reason.

"Franko" is in fact a man, but his motives are far from overthrowing the present rulership of Free Quebec. In fact, he commends their secession from the Coalition States, but sees their efforts as not going far enough. A hard-line advocate for the independence of Free Quebec, "Franko" has preached secession for years. He wanders the wilderness with a trusted inner cadre of scholar-warriors, and guides the people with a powerful message of fear and hate. He rarely ever does the actual speaking, but "spreads" his word through his "disciples" and those who "know the truth." In this regard, rumor and a confused jumble of "messages" filter down to the rural communities. His words often create suspicion and evoke violence. And frequently, innocent people suffer and die with a mere whisper from this deluded sociopath.

"Franko" is an educated man who speaks his mind and firmly believes the message he is spreading. And in places away from the protection of the Quebec Military or the safety of the cities, it is spreading like wildfire. He advocates armed resistance to the Coalition presence and the punishment of Chi-Town, but his main message is to destroy D-Bees. According to Franko, the D-Bees will try to "make their move" while the government and its Army are distracted with the Coalition Army. Thus, the people (those in the know) must be ready for the inhuman tide of creatures that are surely waiting to wash over their land. His advice. Don't wait, strike before they can make their move. See a D-Bee, hunt him down like a mad dog and kill him. End of story. He has organized many of the uneducated wilderness people to form local militias, and has armed several key cells to defend crucial positions. This talk of D-Bee invasion and his arming of the populace is another reason why the Free Quebec authorities want to rein this maniac in.

Undeterred by the looming threat of the Sûreté and the Free Quebec authorities, nor the onset of war with the Coalition, "Franko" continues to spread his "truths." Ironically, the war has helped him elude the authorities and provides him increased freedom as the government and military of Free Quebec have much more pressing problems and limited resources to waste dealing with this lunatic. For the moment, there remains a full dozen Sûreté operatives on the search for him, over half of whom he knows of and cunningly avoids. **Note:** Despite the influence and trouble he has caused in the rural two thirds of the nation, "Franko" represents one of the smallest and most extreme factions within *les Soldats de St. Jean*. Although credited for having founded the organization, and as such revered as a living legend by many, even the followers in his own organization consider him to be seriously unbalanced, delusional, and dangerous. Most are thrilled that he stays out in the wilderness consumed by his own insane crusade.

“Franko” — Lunatic Visionary

Real Name: Jean Desjardins

Alignment: Miscreant

Insanity: Jean is a mild schizophrenic who suffers from paranoia, as well as delusions and obsession. His delusions are many (and usually obvious), including the fact that he believes he is doing God’s work, and he is obsessed with protecting his country from D-Bees and demons in particular and all other invaders in general. He truly believes that D-Bees and those humans willing to tolerate them are a danger to all humanity and MUST be destroyed. He sees himself as a visionary and a prophet spreading truth and saving lives. He is dedicated to the destruction of all D-Bees in Free Quebec, but is already starting to expand that to all of Canada and preaches how Quebec will never be safe with a modern-day Sodom & Gomorrah like *Lazlo* as a neighbor. He honestly believes that bands of D-Bees are conspiring to swarm over the rural and wilderness regions of Free Quebec to steal the land for themselves and slaughter any humans in their path. That is why people must be warned and prepared!

Attributes: I.Q. 16, M.E. 20, M.A. 21, P.S. 14, P.P. 18, P.E. 16, P.B. 12, Spd. 19.

Hit Points: 52; **S.D.C.:** 54.

Height: 6 feet (1.8 m), **Weight:** 175 lbs (78.75 kg).

Age: 37

Horror/Awe Factor: 10 (15 to those in his organization).

Disposition: He is a passionate and powerful speaker. Once he gets going, he is hard to stop. He is, however, very select in the people he confides in or talks to. Rarely has he ever been in front of a group and done the actual speaking, choosing to join the crowd and whisper encouraging comments about the speaker he has personally chosen and trained. This is done for several reasons. First off, he wishes to keep the mystique of who he is a mystery, adding to the mystique of the message he spreads. The few times he makes himself known to verify people’s stories, he wears conflicting outfits and disguises but speaks the exact same messages. Secondly, he is trying to evade capture by a number of groups, least of which are the Coalition and Free Quebec’s leadership. Thirdly, it allows him to anonymously gather intelligence about how his message is spreading.

A patriot of the State, he doesn’t fear capture by the Free Quebec officials to avoid death; that honor is reserved for Coalition spies. He avoids detection for the benefit of his people and himself in the message he and his *soldats* have been telling.

Otherwise, he is a quiet man, capable of acting as a simple woodsman or an educated scholar passing through. He very often assumes various guises to better get an idea of the rural population and their views.

Experience Level: 9th level Wilderness Scout

Skills of Note: Cooking 80%, Climbing 98%/90%, Speaks American, Dragonese/Elven, Techno-can and Inuit all at 98%, Land Navigation 88%, Horsemanship 92%, Identify Plants 85%, Fishing 90%, Prowl 85%, Track Animals 80%, Wilderness Survival 90%, Boxing, Pilot Hover Vehicle 90%, Disguise 75%, and Sniper.

Weapon Proficiencies: W.P. Knife, W.P. Energy Rifle, W.P. Energy Pistol (all 9th level).

Combat Skills: Hand to Hand: Expert (9th level) and Boxing.

Number of Attacks: Nine.

Bonuses: +6 on initiative, +4 to strike, +9 to parry, +10 to dodge, +4 to roll with punch/impact, critical strike on rolls of 18-20, +3 to save vs psionic attack, 65% to trust/intimidate.

Magic Knowledge: None.

P.P.E.: 7

Psionic Knowledge: None.

Weapons and Equipment: L-20 laser pulse rifle, Wilk’s 320 Laser Pistol, Vibro-Knife (1D6 M.D.), survival knife, NG-S2 survival pack, infrared distancing binoculars, thermo-imaging scope for rifle, 2 smoke grenades, 2 fragmentation grenades. Wears Huntsman body armor (60 M.D.C.).

Description: “Franko” is a tall man with short brown hair and brown eyes who could easily blend into any crowd of rural people. He usually lets his beard grow and shaves infrequently, all the better to hide his true identity. He only wears body armor when he knows he’s going to be involved in violence/combat or when he knows his life is in danger or it is necessary to blend in with the surrounding populace. Otherwise, “Franko” is clad in buckskin and furs, and looks very much like a trapper/woodsman.

Free Quebec authorities, intelligence operatives, and Coalition troops have no idea of his true appearance, nor do they have any leads as to what he *may* look like. Remember, they aren’t even sure if “Franko” is a man! He is typically accompanied by a small group of six equally deranged followers who revere him as a god.

Bionics: Amplified hearing and sound filtration, gyro-compass & clock calendar.

Money: “Franko” has 1000 credits and 12,000 credits worth of Black Market equipment and supplies on his person for trade.

les Soldats de St. Jean

Chapter Colonel Robert Miller

As one of the more influential members of les Soldats, Robert Miller has been able to collect and gain the support of an unprecedented 1,200 members within the western areas of rural Free Quebec. The people under his influence aren’t restricted to those within the official boundaries either. A full 40% of his “troops” rest *outside* Free Quebec’s borders. Unofficial supporters and moderate members probably raise the total to nearly 4,000 people.

Colonel Miller has been a Free Quebec native his whole life, and sees the country as a proud nation unwilling to bend to foreign rule. He sees this pride in all the people around him and within the leadership of the National Assembly. It wasn’t until the first words and appearances of “Franko” that he thought of becoming a more active “patriot.” He was actually present when “Franko” made one of his earliest speeches and is an elite member of les Soldats. He is also one of a dozen people who know “Franko” and could provide an accurate description.

Colonel Miller is very good at motivating his people in the cause of les Soldats, but is not insane or quite the zealot that “Franko” and some others are. He recognizes and respects people’s decisions to either join or not to join, and be as active as they feel comfortable with. This benevolent attitude has made those that choose to join all that more effective and loyal to him and his views. It has even given some of those on the fence, and

even opposed to his views, time to rethink the matter — some of whom later decide to join or at least listen and consider what les Soldats has to say. Miller is a very thoughtful man who means well and looks to the betterment of the people in the western portion of Free Quebec. He believes D-Bees, creatures of magic, supernatural beings and practitioners of magic represent a real and present danger and must be ferreted out and destroyed or driven from the land. Actually, he and his followers are quite satisfied with driving D-Bees out of the nation rather than slaughtering them, and Col. Miller has been known to show mercy to D-Bee children and females, herding them past Free Quebec's borders and letting them go. Likewise, he is not in favor of killing psychics or mutants like Bursters and Psi-Stalkers, nor does he promote the murder of "humans" who innocently or misguidedly associate with nonhumans. He would rather try to "teach and rehabilitate" them. On the other hand, interracial marriages are not tolerated, and humans proven to be evil traitors to humanity are tortured and run out of town or killed as an example to others. Although compassionate, Colonel Miller is a "soldier" and is not afraid to kill when it is called for.

The southwestern portion of Free Quebec is actually one of the best prepared for the CS invasion, thanks in part to Colonel

Miller's efforts. Many cooperate with the Quebec Military in providing information about the area, report enemy activity, and some even freelance as Wilderness Scouts to help the war effort. Capable guerrilla fighters, they will gladly pitch in and lend a hand fighting CS troops if asked or if the situation dictates it.

Unbeknownst to Quebec Military forces, Colonel Miller leads nearly a brigade of armed civilians and another brigade of support personnel. It was also Colonel Miller's efforts that have enabled them to capture and repair two CS Scout Spider-Skull Walkers, one Hellfire and a couple dozen suits of "new" Dead Boy armor. A full third of their armaments are also "compliments" of the CS, as Colonel Miller and his men began to raid and rob CS troops near their border the moment they arrived (and months before the war actually began). The patriotic militiamen try to keep a low profile, their numbers unknown, and cheerfully engage in guerrilla warfare to defend their nation and help the Army. Most of their activity is in the southwestern part of the rural country.

Note: Although originally inspired by "Franko," Colonel Miller recognizes that the movement's leader is only a man, and a crazy one at that. He feels "Franko" is a dangerous hatemonger who has lost sight of the movement's real goals (and reality in general) and, these days, does more damage than good. He has had no direct contact with "Franko" in years and hopes to keep it that way. Although he dislikes and even fears for how "Franko" is hurting the movement and creating unreasoning terror among the northern wilderness people, Miller will not betray the man to the authorities.

"Colonel" Robert Miller

Real Name: Robert Miller

Alignment: Scrupulous (albeit a bit deluded).

Attributes: I.Q. 15, M.E. 18, M.A. 21, P.S. 14, P.P. 15, P.E. 17, P.B. 11, Spd. 14.

Hit Points: 52, **S.D.C.:** 54.

Height: 6 feet, 2 inches (1.88 m).

Weight: 175 lbs (78.75 kg).

Age: 41

Horror/Awe Factor: 8 (12 to his followers; none to "Franko" who sees Miller as a disappointment and weak).

Disposition: Robert Miller is a fairly quiet man, careful in what he says to most everyone he comes into contact with. He chooses his words carefully but gracefully, always getting the point across without any means of misinterpretation. He is a good motivator of his troops and gets along with all of them. He is seen somewhat as an icon by those not directly involved with les Soldats. He is cool under fire and an excellent tactician who knows the lay of the land in the local region as if it were his own backyard. In many ways, that is exactly the way he envisions most of the Free Quebec wilderness, as his own backyard.

The Colonel is as much a human supremacist as any other citizen of Free Quebec who has seen the death and destruction caused by inhuman invaders. Although he does not regard all D-Bees with the blanket accusation of being murderous monsters, he is extremely suspicious of them and does not want D-Bees in his country. At present, there are two Psi-Stalkers (6th and 8th level) in prominent positions within the unit, as well as an Inuit scout.

Experience Level: 7th level Wilderness Scout and something of a Rogue Scholar.

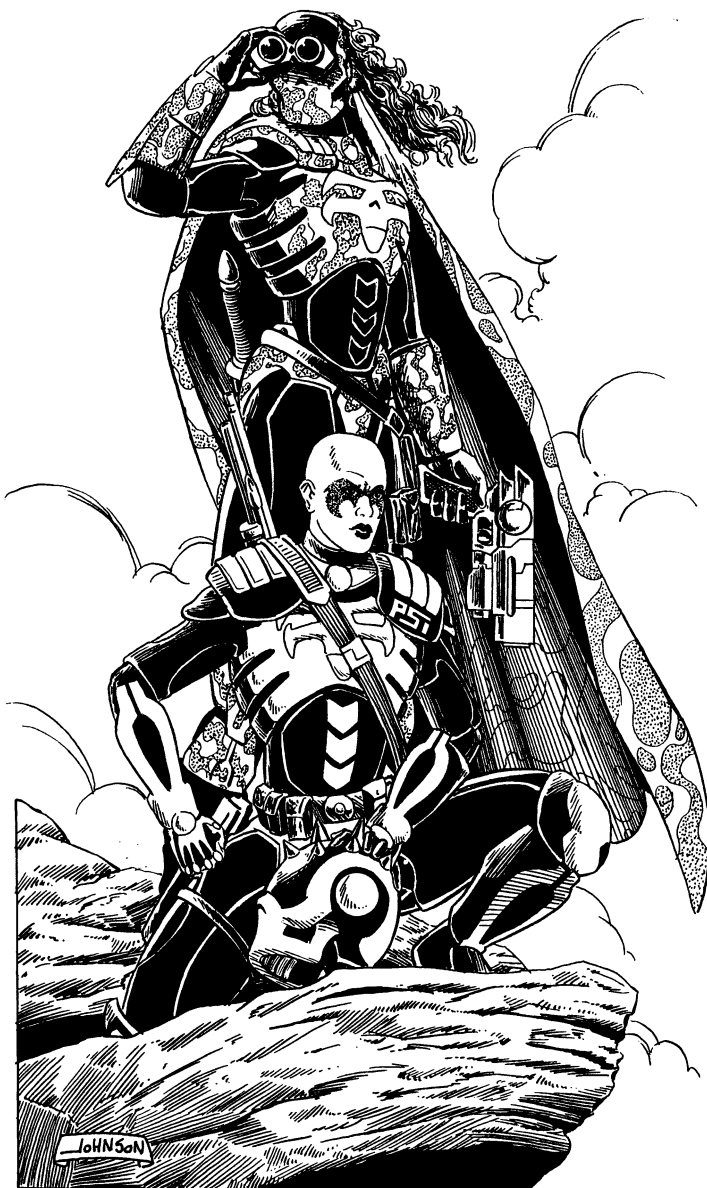

Skills of Note: Literacy, Speak American, Old French, and Inuit all at 98%, Basic Math 98%, Computer Operations 70%, Pilot Automobile 90%, Horsemanship 80%, Land Navigation 82%, Climbing, Hunting and Fishing.

Weapon Proficiencies: W.P. Energy Rifle, W.P. Energy Pistol, W.P. Bolt-Action Rifle and W.P. Knife, all at 7th level.

Combat Skills: Hand to Hand: Expert (7th level) and Boxing.

Number of Attacks: Eight.

Bonuses: +2 to strike, +3 to parry and dodge, +2 to roll with punch/impact, +2 to save vs psionic attacks, 65% to trust/intimidate, +5% to save vs coma/death, +1 to save vs magic, critical on roll of 18-20.

Magic Knowledge: None.

P.P.E.: 9

Psionic Knowledge: None.

Weapons and Equipment: Wilk's 457 energy rifle, F-18 laser

pistol, NG-S2 survival pack, 2 Vibro-Knives and full wilderness gear.

Description: Robert Miller stands over six feet tall, but does not put on an air of superiority over any of the people he commands. His thick, dirty-blond hair is often in slight disarray, caring about more important things. His physique also doesn't threaten others, although this more often than not fools people into thinking he can't care for himself. He normally dresses in buckskins or furs with Huntsman body armor most of the time. When expecting combat, he uses full environmental body armor of various sorts (has recently acquired and repainted a suit of new Dead Boy armor).

Bionics: None.

Money: Has access to over 500,000 credits worth of equipment, money and stores including weaponry, not counting the items noted previously stolen from the CS.

Old Bones

The ruins of old Quebec

By Kevin Siembieda

Old Bones is said to be what's left of the pre-Rifts city of old Quebec. Actually it has been rebuilt dozens of times. The fact that it is located near a series of ley lines has made it the target of many monster and magic attacks, dimensional disturbances and strange weather, and it seems to be a trouble magnet to this day. It was finally abandoned roughly 30 years before the start of the Post Apocalyptic calendar (i.e. roughly 135 years ago) and the new, great City of Free Quebec was built a hundred miles to the northeast on the *Saguenay River*.

Today old Quebec is known as **Old Bones**, a ragtag trader's town given special exempt status from Free Quebec. This means it is officially a self-governing community outside the jurisdiction of the Quebec government, or so the story goes. It is neither a kingdom or nation, but an independent and lawless city. The permanent population is about 70,000; a bit more than the 60,000 reported by Erin Tarn six years earlier. The work force is a mixture of occupations with farmers, fishermen, shipbuilders, laborers, merchants, and craftsmen, all predominately human (82%), representing the majority of residents. Not included is a high number of criminal and vice related occupations, including pirates, confidence artists, prostitutes, smugglers and thugs of all kinds. An additional 10,000-40,000 transient visitors are present in the eastern half of Old Bones at any given time. A high percentage of "visitors" include guns for hire, and the likes of mercenaries, adventurers, pirates, freebooters, thieves, bandits, Bounty Hunters, Wilderness Scouts, Headhunters, Juicers, Craziest, and other men at arms. This makes the atmosphere at Old Bones, particularly in the *Trade Center* and *Eastruins*, bawdy, raucous and untamed, with loud music, wild dancing, partying, shouting, shooting, gambling, and illicit pleasures going on around the clock.

Generally speaking, Old Bones has a dirty, unkempt look with poorly maintained and vandalized buildings and trash-littered streets. It is not quite the squalor one finds at most Chi-Town 'Burbs or some of the other disreputable border towns that dot the country, but it is far from the pristine streets

of Chi-Town, Iron Heart or the City of Free Quebec. All races and people are welcome to come to Old Bones to *do business*, but D-Bees and practitioners of magic are wise not to linger or make a spectacle of themselves. If they do stay for more than a day, it is best they keep a low profile, because such outsiders are known to meet with misfortune and regularly vanish without a trace.

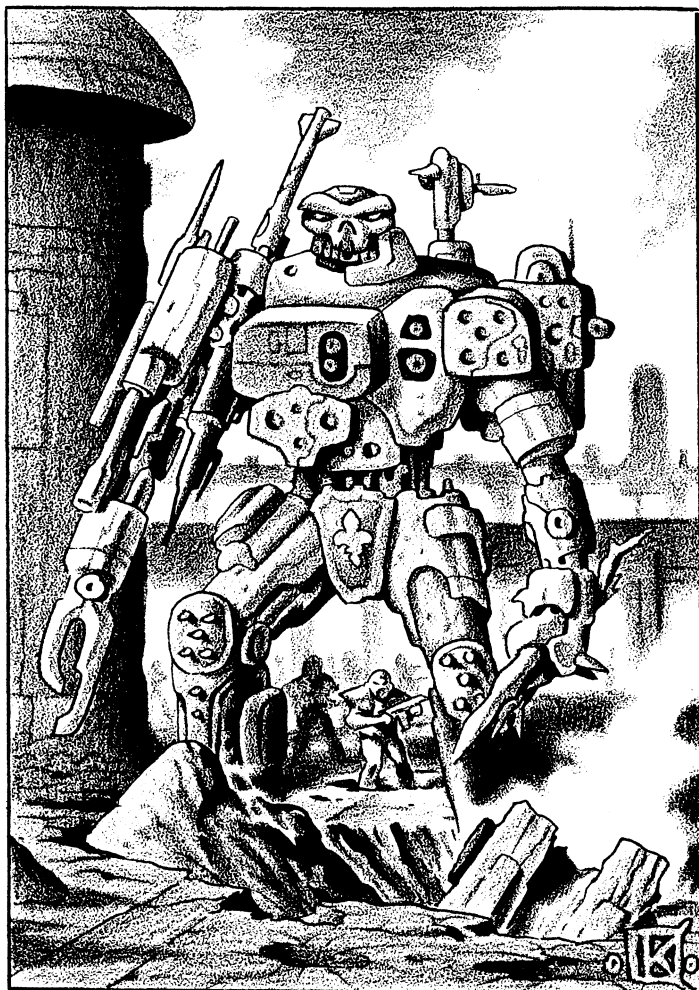

There *are* well kept and quiet neighborhoods in Old Bones (mostly in the northern part of town), but they are forgotten in the harsh light and excitement of the **Trade Center**. This is where most “visitors” come to sell or trade their wares, catches and booty and/or come to enjoy a bit of “city life” before going back into the wilderness or facing the trials of their professions as warriors and explorers. It is at the Trade Center where gamblers, adventurers, mercenaries, spies, smugglers, pirates, killers, criminals of all stripes, fugitives and deviants as well as the curious, desperate, hopeful and innocent all collect into a diverse pool of humanity. There is even a shocking number of *D-Bees* (shocking for Free Quebec, at any rate). Some *D-Bees* are residents, many are slaves, others traders and adventurers.

The majority of the shops are normal merchants trying to eke out a living the best they can. However, virtually all (85%) of the illicit establishments, the thieves’ guild, Body-Chop-Shops, Juicer augmentation clinics and Black Market traders are spy fronts for Free Quebec. The handful that are not, are either CS fronts or real Black Market operations.

What most people do not realize, including many residents, is that Free Quebec secretly “manages” *all* of Old Bones. It is a way for the Quebec authorities to keep a sharp eye on potential trouble and an ear to what is happening around them, especially from adventurers and brigands who may have valuable information, salvage, weapons, and ancient artifacts that the government can procure without anybody being the wiser. Free Quebec uses Old Bones as a giant “fly trap.” An easy way for the nation to lure out and spy upon the adventurers, mercenaries, criminals, *D-Bees* and practitioners of magic active in and around their nation. The city, particularly the *Trade Center*, offers so much that people just can not stay away, and it has become a haven for adventurers and mercenaries alike. Likewise, farmers, trappers, fishermen and visitors are attracted to come and do business and/or enjoy the sights, sounds and entertainment Old Bones has to offer. It is so enticing, and its illusion of being a free and open (mostly lawless) society is so entrenched, that Old Bones has become the base of operations, staging point, haven or hide-out for innumerable adventurer groups, mercenary outfits, pirates and bandits. This makes keeping tabs on these potentially dangerous rogues (and enemies) that much *easier* for Free Quebec. While many of these groups are smart enough to know or suspect this is the case, the benefits and allure of Old Bones is just too good to resist.

Old Bones was secretly established by Free Quebec as an intelligence web (and something of a sting operation) inspired by the idea that one should keep one’s friends close and enemies closer. It has worked like a charm. Many Quebec Military and le Sûreté spies are well positioned in the city and regularly learn about (and counter) many criminal plots, schemes of sabotage, planned raids, crimes already committed (and those responsible), the location of *D-Bee* activity within their borders, foreign spy operations, and so on, without anybody realizing it.

When necessary, special government operatives kidnap and interrogate or kill the most dangerous scoundrels as well as the occasional mage, *D-Bee* and fugitive. Hardly anybody notices such disappearances because so many “visitors” are constantly coming and going. Even long-time establishments sometimes pick up and leave without warning. When disappearances are noticed, most people don’t really care because Old Bones is no-

torious as a dangerous place — “enter at your own risk.” Likewise, rumors about Free Quebec and Coalition spies and assassins working undercover in the city have abounded for decades. Some are even notorious *suspects* with some locals and visitors convinced of their secret identities as “agents.” Whether these suspicions and rumors are true or not, is rarely proven, and “facts” tend to be elusive things at Old Bones. It is difficult to tell fact from fiction and those trying to find the truth may find themselves in a maze of contradictory and fictitious clues, or at the business end of an assault rifle.

Conspiracy theories and rumors of diabolical plots are constantly on the street. They are part of the atmosphere and charm of the city, so few locals and regular visitors pay much attention to them until they get embroiled in one. All of this makes Old Bones a lawless trading town, no-man’s zone and “neutral ground” all rolled into one. (Readers might think of it as a combination of “Dodge City” from the old American West, World War II’s Casablanca and the Star Wars cantina.)

At Old Bones one can buy and sell magic items, goods stolen from the CS or Quebec Army, trade furs for weapons, openly criticize the Quebec government, speak in support of or against the Coalition States, get drunk, brawl, wench and enjoy a little R&R. Of course, one never knows who he is really dealing with or who may be *listening*. Or how they will react. Is that merchant really a CS spy or a Free Quebec undercover agent? Is that mercenary just a loudmouthed punk or a CS plant looking to stir up trouble? Don’t be too quick to join in on bashing Free Quebec, because maybe those other guys are really agents or sympathizers, or paid informants. And God only knows who may be listening quietly in the shadows, taking notes and memorizing names and faces. As noted earlier, people have a nasty habit of disappearing in Old Bones.

The Old Bones Trading Center and its neighbor, Eastruins, are filled with seedy taverns, gambling halls, drug dens, pawnshops, brothels, hotels, merchants galore and establishments of questionable character. Thus, it is not surprising that a lot of “visitors” of questionable character and nonhuman species have a terrible knack for ending up *dead*. The cause of death ranges from apparent suicide to accidents, drug overdose, robbery and other misfortunes (like a gunshot in the back). Funny how the majority of these poor souls are *outsiders and nonhumans* who come to visit, seldom long-time residents. Then again, most residents know to stay away from the Trade Center and eastern part of town that caters to outsiders, thieves and inhuman monsters. Local business owners and residents make a point of keeping their noses out of the business of outsiders, but most are quick to come to the defense of their fellow citizens. It is one thing for roughnecks, *D-Bees* and mercenaries from out of town to assault, batter, rob and kill each other, but it is quite another to mess with the locals. It just isn’t condoned, and there always seems to be somebody willing to step forward and intercede before serious harm is done. That individual can be a shop owner or his staff, a good Samaritan passing by, a surprise appearance of Northtown Police or indignant citizens threatening to riot. Depending on the situation, these benefactors are sometimes suspected of being Free Quebec spies and undercover police subtly maintaining the peace, but more often than not they really are just fellow citizens and good-natured adventurers stepping forward to protect the innocent and see that justice pre-

vails. There is so much to do and see, and there are so many other targets to abuse, that most bullies, drunks and troublemakers back down when confronted. Of course, these thugs may seek revenge later on a dark street or turn their vengeance upon the good Samaritan who dared to interfere in their business. Most fights, ambushes and back alley duels take place at night; daylight brawls and gunfights in the streets are uncommon. Many are petty acts of revenge over an earlier incident or minor infraction that festers until the offended party feels compelled to save face and extract his pound of flesh.

The Quebec Military infrequently dispatches a small military force to “intervene” and “police” this neutral zone; mostly *Pale SAMAS* and *V-SAMs* on fly-by patrols to make sure things don’t get too out of hand and to deter serious crime from leaking into the “civilized” communities of Free Quebec. When necessary, a Glitter Boy squad accompanied by Side Kicks enters the community to root out and destroy the worst scum and send D-Bees running. (They may also be sent in to rescue an agent, cause a diversion or eliminate a problem.) While these “interventions” can cause quite a stir among visiting outsiders, many with something to hide or fear, the locals take it all in stride. The “official” government of Old Bones takes no action against such incursions, pointing out that they are an “island of free enterprise surrounded by the forces of Free Quebec” and that they exist only because of that nation’s “tolerance.” Indeed, if Free Quebec wanted Old Bones removed, its Armed Forces could obliterate the place in an afternoon and be planting daisies the next morning. Yet more proof that Free Quebec has an ulterior motive for letting Old Bones continue to exist. Old Bones alleged helplessness and complacency is also bought and paid for by Free Quebec, as all government officials enjoy secret, annual stipends that range into the hundreds of thousands of credits.

The Coalition Presence

Chi-Town, its Intelligence Division and its Propaganda Department are in on the secret that Free Quebec uses Old Bones as part of its Intelligence Network. It is a secret that it keeps even during its war on the nation, and hopes to utilize itself. Consequently, the Coalition Army has been given direct orders not to invade, harass or destroy Old Bones. A command that many CS officers can not understand, but obey nonetheless. The CS Intelligence Department has its own (comparatively small) deep cover network of spies, agents, observers and informers. About half are known to Free Quebec’s leaders due largely to the work of le Sûreté du Quebec (SQ), but the rest remain undiscovered and dangerous. Like Free Quebec, Coalition spies and informants watch and listen, collect information and act on it accordingly. Unlike Free Quebec, the CS is much more active in trying to manipulate events and public opinion by creating and spreading false rumors to further their cause and to create uneasiness and trouble for their enemy. Many an instigator of trouble, political unrest, criminal activity and derision is a Coalition agent.

In addition to causing unrest and trouble in the city of Old Bones itself, Coalition operatives also use it to recruit mercenaries and cutthroats to take direct action against the nation of Free Quebec, her military and her cities. Sometimes the secret agent reveals his connection with the CS and other times he maintains his false identity and simply manipulates others to serve the Coalition cause. These pawns may believe they are working for a



smuggler, crime lord, mercenary outfit, businessman or even for Free Quebec itself, that's how cunning and skilled these CS spies and instigators can be. Other CS operatives are hit men who sniff out, track down and assassinate Sûreté du Quebec agents and Quebec Military Intelligence officers, informants and allies to damage the Free Quebec Intelligence web and/or to extract revenge. These assassins and CS soldiers may also kidnap and torture individuals whom they believe have valuable information that will help the CS, or kill those who seem to present a threat. Sometimes loudmouths speaking against the Coalition States or Emperor Prosek, as well as practitioners of magic and D-Bees, suffer a similar fate out of spite or a sense of patriotism.

The original City of Quebec had always been a major port city and Old Bones remains so today. Shipments from Northern Gun and other merchants in the west arrive regularly, while fishermen and trappers arrive daily to sell or trade their goods. As a neutral zone acknowledged by both Free Quebec and the Coalition States, Old Bones has become a haven for pirates and river rats of all kinds, as well as adventurers, mercenaries, fishermen and trappers. With so many traders and potential customers, Old Bones' Trade Center and eastern port district is constantly swarming with people looking to buy, sell, and barter. **The Eastruins District** caters specifically to pirates, the fish trade, the poor and D-Bees, while those who have money to burn are attracted to the Trade Center District.

And so Old Bones continues to be the site of unchecked skullduggery, espionage and murder, thinly veiled behind political maneuvering and free enterprise.

Places of Note

Northtown District

This is where half of the residents of Old Bones live and work. It is composed mostly of homes and apartments, broken by clusters of stores and the occasional business.

OBC Broadcasting: The city operated radio and television network is located in Northtown. It offers three TV channels (news, entertainment and shopping) as well as two pirated stations pulled in from Free Quebec.

The Parliament and Economics Center: The seat of local government and commerce is located here. Most are do-nothing politicians who live off the bribes and hush money paid to them by Free Quebec and various criminal and covert factions operating in their city (including the CS). They live high on the hog and manage most of the affairs of the city around the Trade Center. Center affairs are left to other, less obvious powers.

Northtown Hydro: Hydroelectric power plant.

Northlake Park is a large, cared for park around a small lake and marks the southwest corner of Northtown and the beginning of New Town. It is shared by the residents of both districts.

Urban Sprawl: Much of Northtown is made up of homes and quiet neighborhoods, a stark contrast to the constant cacophony of noise and activity at the Trade Center and Eastruins. Most residents are members of the working middle class. Only about 5% are wealthy business people, city leaders and the politically connected — with their large estates and private guards

creating their own little island community. Small neighborhood businesses and shopping areas for the locals are also scattered throughout the community.

Transients are not tolerated in this part of town nor are travelers or outsiders. Such undesirables are politely asked to leave before the authorities are called to escort them out. **The Wall** is a series of fortified wall sections that partially encloses Northtown. The southern partition separates Northtown from the Trade Center.

Northtown Police. Northtown Police patrol The Wall to keep away the riffraff of the eastern half of Old Bones as well as maintain law, order and peace throughout Northtown and New Town.

Judging from the lawlessness of the Trade Center and Eastruins, one would scarcely know there is a police presence in Old Bones whatsoever. That's because the authorities have little business in the rough parts of town. When they are present in Trade Town, they keep a low profile, stepping forward only to protect business establishments owned by residents and occasionally to help a citizen being abused by outsiders.

It is a different story in Northtown and New Town. Here the police have a strong presence and brook no nonsense from outsiders. The Wall and Northlake Park help to divide the residential parts of Old Bones from the more squalid and dangerous southern half of the city-state. Visitors are gently nudged out of these quiet neighborhoods and back to the Trade Center. Those who resist are arrested and forcibly returned to the Trade Center or thrown out of town. Anybody who dares to draw a weapon or use magic, or is found committing a violent crime against the northern or western residents is beaten, stripped of his valuables and very likely killed. Police brutality is rampant against outsiders causing trouble in Northtown and New Town. Those who aren't robbed and killed by the Police are roughed up and threatened or fined. (**Note:** Outsiders who are beaten and robbed or killed and stripped of their belongings see half the money acquired this way going to the neighborhoods, a quarter to the government leaders and a quarter divided among the police responsible for the "bust".)

Justice in the "polite" sections of Old Bones rests almost completely in the hands of the police squad(s) who arrive on the scene. The authorities may ignore and allow corruption, crime and anarchy in the Trade Center and Eastruins, but that all stops "beyond The Wall" and in New Town. The police credo goes something like this: "Don't like it, then don't come here. Come looking for trouble, expect to pay for it with your life." This extreme attitude is widely publicized and well known, so most visitors stay out of the residential parts of town. Likewise, since Northtown authorities rarely venture into the Trade Center, most hoodlums spotted in the residential neighborhoods try to hightail it out to find sanctuary at the Trade Center. However, a number of the bodies found dead in the gutters of the Trade Center are victims of justice resulting from the long arm of the Northtown Police.

New Town (west)

This section of Old Bones is the most recently rebuilt part of town. It houses light industry and the lower middle class neighborhoods. It enjoys protection by the Northtown Police Department and has good relations with its northern neighbor.

Old Bones

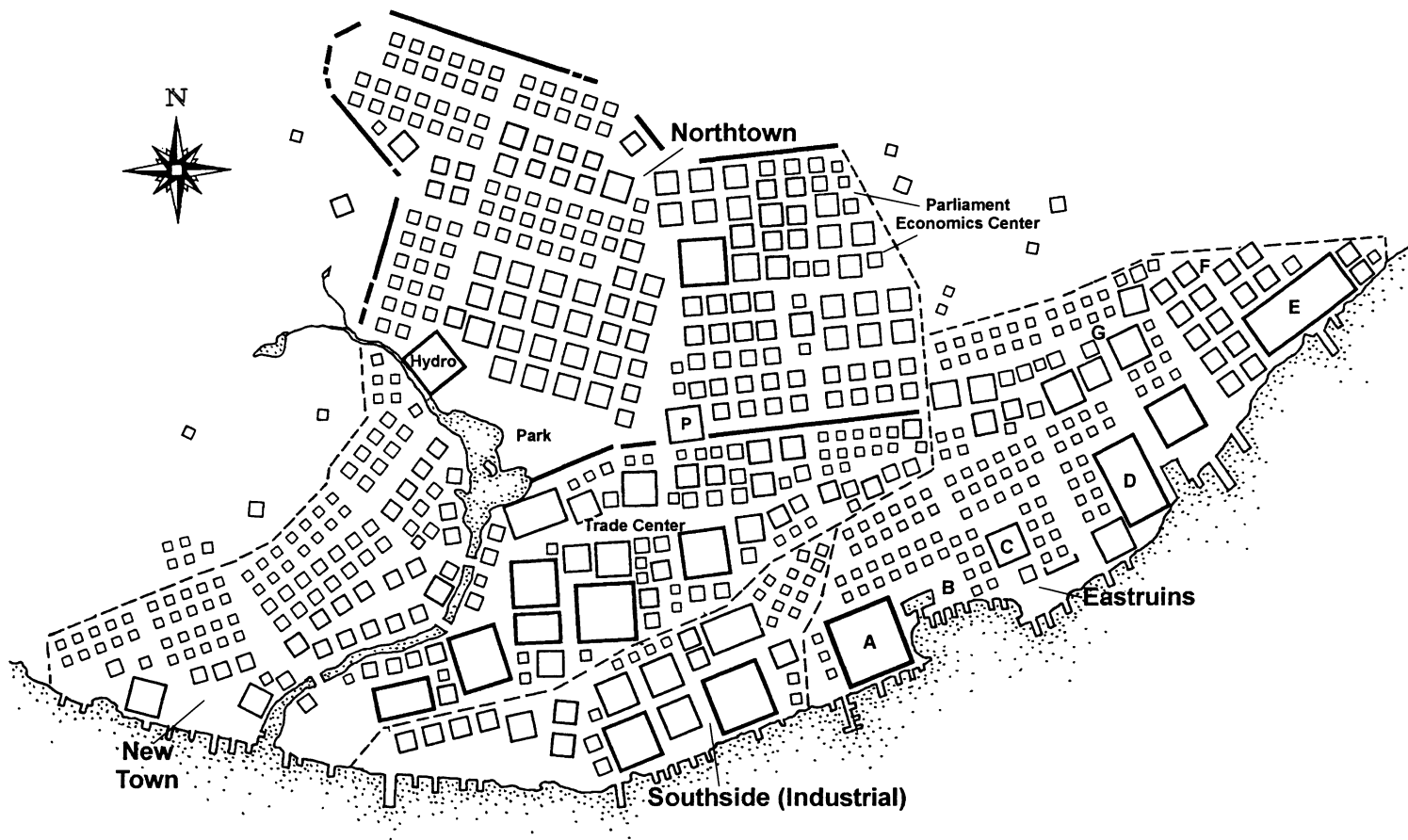

Shipyards, docks, yacht club, boat rental and fish markets are all found along the southern shores of the St. Lawrence. North River divides New Town from the Trade Center, although several bridges provide easy travel for residents who work in the heart of Old Bones.

Southside Factory District

This is the city's center for heavy industry. It represents 22% of the city's income and is also home to some of the poorest neighborhoods.

Eastruins

The poorest of the poor and the most loathsome live in or visit the ramshackle neighborhoods and crumbling buildings of Eastruins. Residents include poor laborers, the homeless, indigent squatters, the mentally ill, refugees, fugitives on the run, free D-Bees, D-Bee slaves, D-Bee slave owners, hermits, outcasts and those suspected of practicing the mystic arts. It is also the location of three ley lines, and as such is frequently plagued by poltergeists, demons, monsters, and creatures of magic, as well as visited by practitioners of magic both good and evil.

Most respectable residents of Old Bones avoid this part of town. However, there is a notable merchant district, hotels, and establishments that cater to down-on-their-luck mercenaries, adventurers, D-Bees, pirates and lowlifes. The place is squalid and

the quality of goods and services is terrible, but the prices are cheap and most people don't ask questions. Eastruins offers a hundred pawnshops and two hundred saloons, as well as several docks, fish markets, trading posts, shipyards, tattoo parlors, a dozen disease-ridden brothels, cheesy hotels with rates under 30 credits a night, filthy flophouses with rates under 10 credits a night, smoke filled gambling halls and two small arenas where duels and bloodsports take place (along with betting, of course).

Ironically, this was once the heart of pre-Rifts Quebec's tourist district with the famous *Chateau Frontenac* standing 200 feet (61 m) above the shores of the St. Lawrence. Today, nothing remains of the Chateau, although attempts to rebuild it had been attempted at least twice during the Dark Ages. Today the shipyard, lumbermill and fish market are the main sources of employment for honest folk. A full 30% of Eastruins is devoted to the "tourist" trade.

A) Port St. Pierre. Basically the harbor port authority of Old Bones. This is where all ships and their crews check in and get (or buy) their assigned docking space. 8% of Eastruins' residents are employed here.

B) Docks.

C) Fish Market. Docks, boats and marketplaces used by the poorest fishermen in the city.

D) Dockside Lumbermill. 17% of Eastruins' residents are employed here. Both building lumber and finished wood prod-

ucts can be purchased here. Skilled carpenters, woodworkers and craftsmen are available to work on special assignments.

E) Frontenac Shipyard. A huge facility that builds, repairs and sells water vessels large and small. Offers two ship-sized dry docks and ten smaller ones. 30% of Eastruins' residents are employed here.

F) Warehouse area.

G) Business District & Residences.

Trade Center District

The Trade Center District is the said to be the heart of the city, its life blood, and the cancer that threatens to destroy it. A full 55% of Old Bones' commerce is generated by the Trade District. Without it the city would shrivel and blow away. Yet it is also the snake pit where a full 70% of all crimes and 81% of all murders, suicides and disappearances occur (Eastruins is second). Ironically, the very place that breathes life into the city is also the thing that threatens to tear it apart. It represents a volcano of human emotion and aggression that, should it blow, could take half the city with it, but it is too valuable and important to do without.

The following are just a few of the most notable establishments out of hundreds of businesses found in the Trade Center area of Old Bones.

1. Riverside, the more posh, expensive and law-abiding shops, hotels, restaurants and riverboat businesses, interspersed with the homes of wealthy business people, are found along the banks of the North River. If there is a quiet and relatively safe part of the Trade Center, this is it.

2. Riverside Hydroelectric Power Plant. Supplies half the power used by the Trade Center.

3. Northlake Casino. This is the largest and most swank casino in town. Every game and slot machine imaginable is available here (and only half of them are fixed in the house's favor!).

4. Trade Crossing. A giant trading post and open market where fishermen, farmers, trappers, adventurers, pirates, freebooters, and travelling merchants can come to sell or trade their wares. Old Bones gets a 25% cut on all sales and booth space is limited to a first-come first-served basis. There is room for approximately 600 dealers. Which of these people *may* be crooks or spies is anyone's guess.

5. The Station is the main depot and largest of the underground rail stations. It is located in the Trade Center and has three concourses, each with a number of stores, shops and restaurants to accommodate travelers.

The Rails. This is Quebec's old mass transit system dug out and rebuilt (several times) since the Great Cataclysm. It is an underground rail system with a network of tunnels and stops throughout the Trade Center District and links to Northtown, Southside and Eastruins (it stops at the North River). The rails are not too dangerous during the day and rush hour when people are traveling to or from work, but in the early morning hours and during the night, they become a haven for drunks, gangs, crooks and the disenfranchised, most of whom are looking for trouble. Most rail travelers end up in the Trade Center and Eastruins Districts where the greatest number of shops, services, hotels, transient housing and entertainment are found. This

stretch of underground tunnels is also where crime and violence are at their highest. Most residents of the city avoid The Rails after seven in the evening, until morning rush hour at around seven a.m. Beaten victims of robberies and fights, as well as 1D4 corpses are found on the tracks or at the various stations every morning.

The Money-Maker Casino is found on the third level of The Station and is divided into a large, grungy 24 hour casino, restaurant and dance hall. It is a popular night spot and the scene of many brawls, drunkenness, and robberies.

Rumors: Word on the street is that Coalition and Free Quebec spies frequent The Money-Maker Casino in search of information and secrets whispered over drinks or revealed during the euphoria of winning or the despair of losing.

Unscrupulous recruiters for mercenary groups, crime lords, gangs, business people, and special interest groups (often unnamed and unidentified) frequently target men and women currently down on their luck (and often desperate) to hire for special jobs. Mercenaries, adventurers, psychics, Wilderness Scouts, Headhunters, Juicers, Crazies and sorcerers are chief among those recruited. "Jobs" may involve smuggling, gun-running, spying, theft, protection (i.e. working as a guard/protector or armed escort), delivery or pick-up of a person or property, to fighting raiders, pirates or D-Bees, and battling or slipping by soldiers of Free Quebec or the Coalition. Actually all kinds of schemes, jobs, and opportunities, legal and illegal, are pitched at and around casinos and gambling halls all over town.

Celebrity gambler **Pierre Champlain** is widely believed to be a deep cover agent of le Sûreté du Québec — a spy for Free Quebec. Other rumors suggest he is a kingpin in the Black Market (since he seems to lose more than he wins, this is where his money really comes from). Those who support the Black Market theory point to the fact that he frequently consorts with higher ups in the Black Market and other known criminals. However, Pierre's wealth and renown allows him to hobnob with the wealthy, influential, famous, and notorious of Old Bones from heads of state to criminals and adventurers. He is welcomed everywhere in the city from the halls of parliament to the back alleys of the Trade Center and gaming halls of Eastruins. This is why so many others are certain he is an SQ spy. Furthermore, Pierre lives in a mansion in Riverside, where he leads a surprisingly quiet life in the company of several woman servants and lady friends. His reclusive lifestyle is interrupted by high-profile "appearances" of his choosing. Events that some believe are staged to deliberately draw attention to himself and get close to powerful people. **Note:** Pierre Champlain is a 10th level Gambler and Lady's Man (playboy), with thieving, seduction, cardsharp, streetwise and intelligence skills. He is highly educated, confident, and well mannered, yet he seems to fit in comfortably with people from all walks of life, from the poor and uncultured to grunts and adventurers, as easily as he does the self-styled aristocracy of the city. He is a capable fighter (Expert) and marksman with energy pistols and Vibro-Knives, although he tries to avoid violence and dueling. Attributes of Note: I.Q. 17, M.E. 12, M.A. 22, P.S. 14, P.P. 18, P.E. 10, P.B. 19, Spd. 11; Anarchist alignment. Age 44, but looks 30, has a full head of light brown hair, sparkling blue eyes and a smile that makes women swoon.

6. **The Ice Palace** ice rink and arena is the home of old style hockey, Juicer hockey, ice-skating and other ice sports and special events. Old Bones loves its hockey. Juicers flock to the neighboring bars.



7. **Dreambuilder** is a hole-in-the-wall establishment next door to the Ice Palace that looks like a tiny, dingy, herb and drug store, but this is just a front. Beyond the dingy store is a state of the art Juicer conversion facility. The price of augmentation is high at 500,000 credits, but it is a safe, reliable place to “get juiced” without fear of complications and without having to pledge oneself into the service of a disreputable sponsor. Supposedly one gets access to the Juicer facility with a special password or when escorted by a known “associate,” however most locals know about this place, they just don’t talk about it.

Rumor: The Dreambuilder is a Free Quebec operation originally created as part of Operation: Liberty Station to undermine the CS edict that outlawed Juicer creation in the (then) State of Free Quebec. Today, it is said that those who seem trustworthy are approached by agents working for the Quebec Military and recruited into secret service for Free Quebec.

8. **The Bunker** is what’s left of an old Mega-Damage fortress built either before the Great Cataclysm or sometime early during the Dark Ages. One of its big attractions is a huge indoor arena where all manner of sporting events, concerts and spectacles take place (seats 30,000). The Bunker complex also offers a small arena (seats 4000) that can be rented by individuals, teams and groups for private duels, contests and games, the Warrior’s

Tavern (a large, friendly and safe watering hole), the Adventurer’s Inn (a huge restaurant), plus a gun range, armorer and weapons shop. Perhaps needless to say, The Bunker is extremely popular with visiting warriors and adventurers, but it is also popular with locals, particularly for sporting events.

The prices for weapons and armor are average on the high side, but this is one of the few places where goods are of high quality and guaranteed to work like new. Any second-hand items are completely refurbished and in sound working condition before sold. One can sell or trade weapons and equipment stolen from the Quebec Military at 20-30% of the standard Black Market price, but Quebec Military items are rarely sold at The Bunker.

Rumor: The reason why Quebec Military items are never sold here is because The Bunker is entirely operated by Free Quebec! Most locals who live or work in the Trade Center know or suspect as much, but most visitors, bandits and pirates, especially those new to the area, have no idea.

9. **Crazy Al’s Juicer Security:** A business that hires out Juicers and Crazies (average 5th and 6th level) as body guards, escorts and security teams. Psychics and Headhunters (average level 4th) are also available at 25% less than Juicers and Crazies. The going rate is 1,500 credits a day, plus expenses (typically another 200-500 credits), double for “Top Guns” who are 8-10th level.

Rumor: A Black Market operation heavily infiltrated by Free Quebec (Juicer) agents.

10. **Sylvette’s** is the only sign on the shop, but then the owner, Sylvette Jiroyan, doesn’t really need to advertise. This expansive weapons shop offers a huge variety of weapons and armor, including Northern Gun, Manistique Imperium, Wilk’s and old-style Coalition issue weapons. Word on the street is she can get anybody any weapon they want, including Bandito Arms and Black Market items, Triax weapons and body armor, and CS and Free Quebec weapons and even power armor, both old and new style! Of course the price must be right (and you can bet it will be plenty high) and neither Sylvette or her assistants ever offer such commodities, they must be asked first.

The arms shop is owned and operated by *Sylvette Jiroyan*, a seductive arms dealer who has worked out of Old Bones for the last 12 years. She is a sultry 40 year old beauty who looks like she’s 28 thanks to modern science. Attributes of note: I.Q. 20, M.A. 23, P.S. 21, P.P. 22, P.B. 20, Spd 15, all others are average.

Rumors: This mysterious beauty is the subject of numerous and conflicting rumors. Many believe she is a Coalition spy while others are convinced she is a Black Market kingpin. It is said that she is an assassin and a few have suggested she may even be a True Atlantean, because she has at least a half dozen tattoos. For a while it was circulating that Sylvette was once a top “hit man” for the Black Market, but the individual who started that rumor, a jilted lover, met with a freak accident. It is widely known she had a fling with the famous gambler, Pierre Champlain, shortly after she arrived in Old Bones. The affair was hot and short-lived. The two are cool but friendly toward each other, and some believe they are business partners.

(The truth? Who can say for certain when it comes to this woman. She is a 10th level Assassin of Miscreant alignment, but she is not a True Atlantean. Her left arm is bionic with two re-

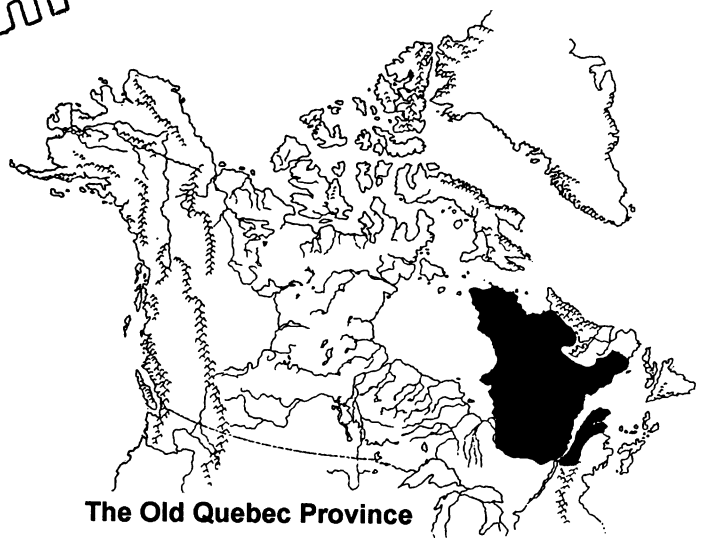
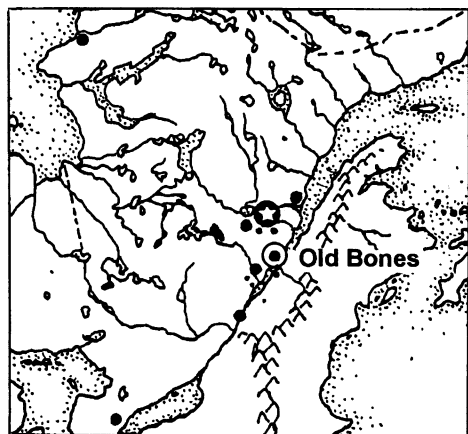
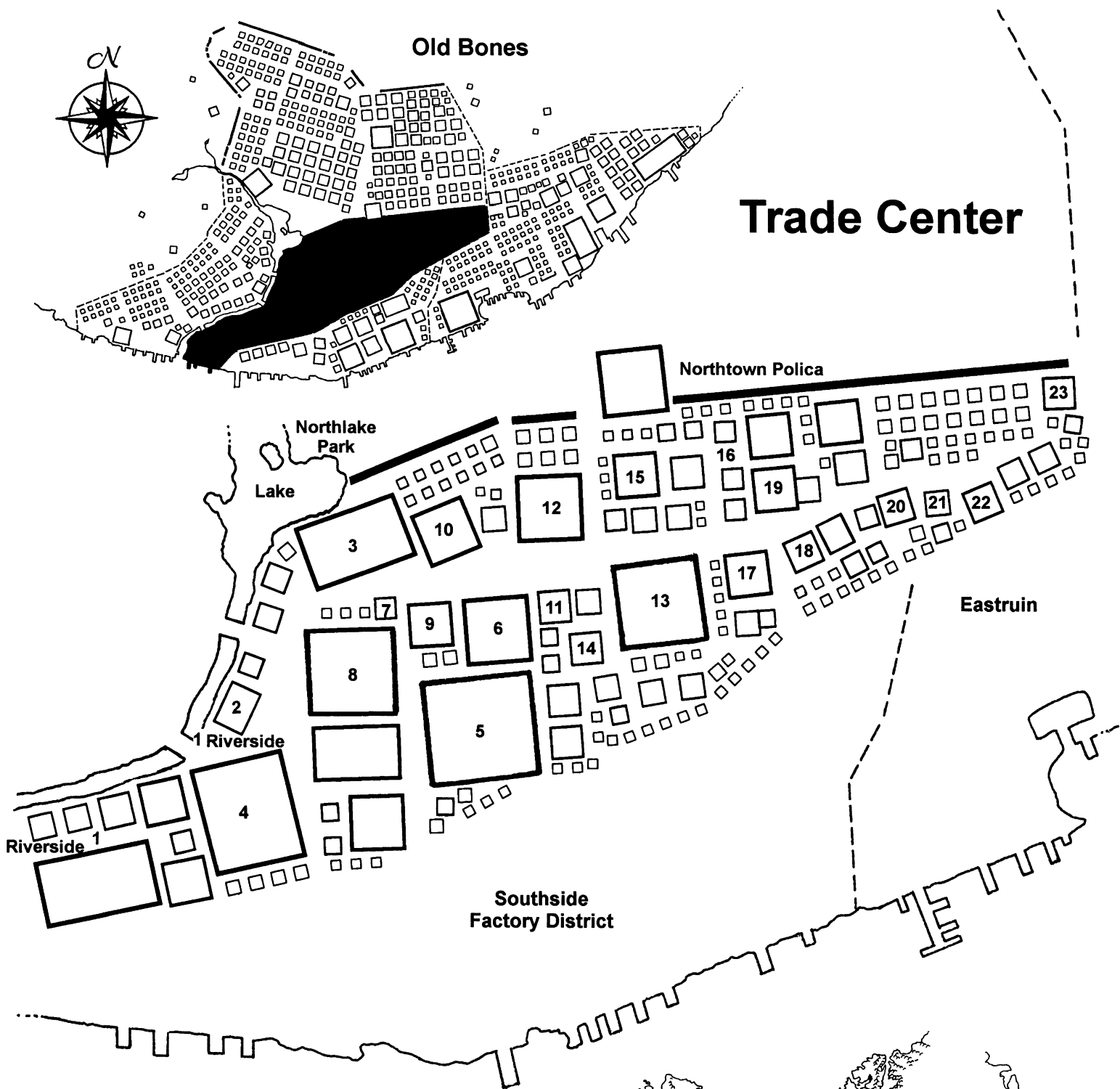

tractable finger blades, one finger camera, and a fingerjack in the pinky, but looks and feels completely human. The wrist contains a retractable wrist needle for injecting drugs and poisons into her unsuspecting victims. She also has the following cybernetic implants: a toxic gas lung filter, universal ear implant, amplified hearing, sound filtration system, and clock calendar. These days she rarely takes any assignments herself, preferring the intrigues of business and politics in Old Bones. Instead she hires out a small cadre of hand-picked assassins and spies, mostly female, for special assignments. Sylvette is a retired Black Market assassin and maintains strong connections with them, as well as a number of top spies, smugglers and traitors within the CS and Free Quebec who help her acquire her wares.)

11. Cyberware. A Body-Chop-Shop of questionable repute. It is a reasonably clean medical facility that specializes in cybernetic implants, cyber-disguises, bionic reconstruction, repair and up-grades, but can also do full bionic conversions. Prices are average on the high-side. Rumor: It is a Free Quebec front. (Truth is, it is a Black Market operation that often recruits Headhunters and 'Borgs as enforcers and hit men, caters to Black Market operatives and is trying to establish an assassins' guild).

12. Old Bones Garage. Actually a garage complex with a series of garages that rebuild, repair and modify giant robots and vehicles of all kinds. Prices are high, but the Operators who work here are all top-notch (5th-8th level).

13. Trade Center New and Used Vehicles. A dealer who sells all sorts of conventional and hover vehicles. He offers an especially large selection of motorcycles, hovercycles, and small watercraft.

14. Ye Old Tobacco Shop. A front for *Roland Desjardin*, a renowned Old Bones Black Marketeer who is said to have connections with everybody. He or his henchmen can arrange "jobs" (i.e. criminal activity), "hits" (i.e. assassinations), and the acquisition of rare commodities (i.e. stolen and illegal goods) through third parties for those who have the money and are vouched for by somebody in the Black Market. His front men can also provide most other Black Market services such as forged documents, I.D. papers, and so on. Attributes of Note: I.Q. 19, M.E. 14, all others average; Aberrant alignment.

15. Old Bones Cinema. A 24 theater multi-plex with new films imported from the Coalition States, Free Quebec, and Perez Productions and restored, old pre-Rifts classics. Ten credits per show.

16. The Theater District. A dozen playhouses, a large concert hall, open-air pavilion in a small park, and a score of nightclubs (with live entertainment) and sleazy strip joints with girly-shows dominate this area of town. Restaurants and small store are also located here. Rumors: The Old Liberty Theater is a Free Quebec front with one or more secret tunnels to The Rails. The Bang-Bang Club is a Coalition front and safe-house. The Cattle Club is a decadent hell-hole where D-Bees are tortured and killed for the thrills of its sick, human supremacist clientele — it is operated by a sadistic faction of Les Soldats de St. Jean.

17. Public Parking. A massive, six story parking structure for those who simply refuse to take The Rails.

18. The Foundation House. This is more like a lodge or fraternity house open to Operators. Prices for one of the 64 rooms are low, but only Operators are allowed (sorry, no friends). The

Foundation also offers a small library, lounge area and pub on the premises and a small but well stocked private garage next door. It is owned by *Cyreon Holst*, a wealthy and experienced Operator who made his fortune traveling with the renowned adventurer group, the *Terminal Headkick Foundation*. Attributes of note: I.Q. 17, P.P. 21, P.B. 18, all others average. Unprincipled alignment. 12th level Operator, age 56, human.

Rumors: One set of rumors suggests he is in league with the Black Market, another that he is a CS spy, and third that he is a retired Naruni salesman. Locals don't believe any of these are true. His Terminal Headkick Foundation buddies are still off adventuring somewhere, but visit from time to time. If anything suspicious should ever happen to Cyreon, they will investigate.

19. Liberty Inn. A sturdy old Mega-Damage hotel that caters to Juicers, Headhunters and cyborgs. It is really a front for the Free Quebec Liberty Station Operation and a safe-house for augmented Quebec Military Intelligence agents. Likewise, agents who get their cover blown can hide at Liberty Inn and be smuggled out of town. Special Forces working for the Quebec Military often use the Liberty Inn as a means to get introduced into the general public as mercenaries looking for work. A secret Juicer detox facility and small medical facility complete with Cyber-Docs and bionic installation and repair capabilities is located in a secret sub-basement.

20. Salmand Special Investigations: Located on the border of the Trade Center and Eastuins, it is a four person operation that seems to have been plucked right out of an old film noir movie, up to a point. This detective agency is located on the third floor of a shabby office building in the "bad part of town." A shady tavern and game hall is downstairs (Salmand and his crew are welcomed regulars who get special treatment along with food, drink and services at half price in exchange for helping the owners deal with particularly dangerous clientele and supernatural menaces), an accounting business is located next door, and a disreputable travel agent is across the hall. The rest of the building is either empty or used for storage by the owners. A blind pig (illegal gambling operation) takes place every weekend on the top (4th) floor.

Salmand Special Investigations Staff:

- *Shelly Winslow* runs the office. She is a brunette bombshell who works as receptionist, file clerk and Girl Friday. Attributes of Note: P.B. 24 (she is a knockout!), I.Q. 14, M.A. 12, M.E. 17, P.P. 15, all others average. Principled alignment. Rumor: She's Salmand's old girlfriend and still has a crush on the big dope which is the only reason a girl with these looks and brains stays at a place like this. (The rumor is true, but she is also a 4th level *Psi-Nullifier* — see page 66 of **Rifts® Psyscape™** for details — who sometimes helps her boss on special cases).
- *Martin Petit* is the office gopher, good natured assistant and researcher. He is an 8th level Rogue Scholar who handles research and maintains the office's computer and expansive data bases (all protected against hackers and viruses). Rumor: Petit dreams of becoming a real detective but doesn't have the disposition for it, at least not in Old Bones. He is smart and curious, but soft and unprepared for street-work. If someone is looking to get at Salmand, Petit is the weak link. Attributes of note: I.Q. 20, M.A. 18, P.S. 8, P.P. 7, Spd 14, all others average; Scrupulous alignment. (The rumor is true.

The eternally cheerful Mr. Petit always has a positive outlook, thinks the best of people, tends to be too trusting, gullible and a bit naive. Despite having worked with Salmand for years, he hasn't acquired any noticeable street smarts. He's just a loveable, hardworking sidekick who wants to help people.)

- *Philip Dushane* private investigator. Ex- 8th level NTSET Protector from Chi-Town no less (see page 188 of **Coalition War Campaign** for O.C.C. details). He is a square-jawed, hard-nosed, gruff investigator with the bedside manner of a pit bull. However, he is an excellent detective and specialist in dealing with the "supernatural and monsters." He and his boss are best friends and trust each other implicitly. Attributes of note: I.Q. 12, M.E. 17, P.S. 20, P.P. 15, Spd 23, all others average; Scrupulous Alignment. **Rumor:** Dushane is really a CS spy! I mean how much more obvious can you get? (The truth is Philip has some connections and contacts back home, but he's no spy. He left Chi-Town because he got fed up with the politics and lies. He bummed around as an adventurer for a few years before meeting Salmand and settling down at Old Bones.)
- *Salmand* is a man of mystery. He doesn't have a last name (or maybe that is his last name, who knows?). He has only been in Old Bones for three years, takes only the cases he chooses to take, and money does not seem to be an issue. He charges those who can afford him out the whazoo, but often takes jobs without pay or for pocket change when the individual is poor and truly needy. Consequently, he is loved by the poor people of Old Bones, particularly the honest folk stuck in Eastruins. Even the criminal element respects Salmand and sometimes provides him with tips, information and occasionally, a helping hand. Those who find themselves on his bad side know they are in trouble, because he is relentless and always sees a job through to its completion.

Salmand appears to be in his early thirties', stands six feet, six inches tall (1.95 m), has long black hair that is usually worn in a ponytail, and wears light body armor under a cloak. **Rumor:** He is known to consort with D-Bees, psychics and practitioners of magic, and often takes jobs that involve magic or the supernatural. This has led to the rumor that Salmand is really a Mystic or Shifter, or even a dragon in human guise (all are popular theories on the street). Another rumor is that he is an ex-Cyber-Knight or knight undercover. A few of his enemies have suggested he is a spy from Tolkeen, but hardly anybody believes that. (The truth is Salmand is a young, 98 year old, 7th level True Atlantean Nomad with a noble heart. He is Scrupulous in alignment and dedicated to helping the innocent and crushing supernatural evil, including vampires, demons, Necromancers and other practitioners of dark sorcery. If he has any other agenda, he keeps it to himself. He likes to work away from the limelight where he can use his magic tattoos without revealing his true nature. Loved by hundreds of poor, they will hide and help him and his staff should they ever need it. This also means that Salmand and Dushane have a multitude of friends on the street who provide them with accurate tips and information.)

21. Wonders Beyond Science is a small magic shop that specializes in herbs, components for magic and simple Techno-Wizard devices.

22. Shade of Atlantis. A large magic shop made in the shape of a three story stone pyramid that specializes in exotic and alien magic items, including symbiotes, parasites and a handful of (low power) magic items purportedly from the Splynn Dimensional Market of Atlantis! Despite its onerous reputation, no minions of Splugorth or monsters of any kind have been seen in or around the magic shop. It is a sparkling clean, bright place and packed with high-priced magic items, Bio-Wizard devices, symbiotes, herbs, poisons and magic components. Most people report feeling something sinister about the place. It is avoided by most locals, and visitors who don't know anything about magic also steer clear of it.

Rumors: According to word on the street, the owner is *Syd Lycrean*, a 9th level Bio-Wizard, and his partners, who are rarely seen, are *Mick Kilaan*, a 7th level Stone Mage, and *Kyrforge* (always concealed under bulky, hooded robes), an 8th level Splugorth Conservator! A monster (*Murvoma Metzla*) is said to guard the shop at night — the three live above it in the top of the pyramid. They are up to no good, gathering information about humans and the Coalition States in general, and Old Bones and Free Quebec specifically for purposes unknown. (The truth ... the rumors are right! Indeed, resting on an ley line, the shop has a dimensional portal that links it directly to the city of *Splynn*! A full third of the items sold here, for top dollar, come from Splynn.)

23. The Silver Cross Boarding House. A humble looking, three story building with 40 rooms. It is commonly frequented by travelers who reportedly dabble in magic. **Rumor:** It is run by

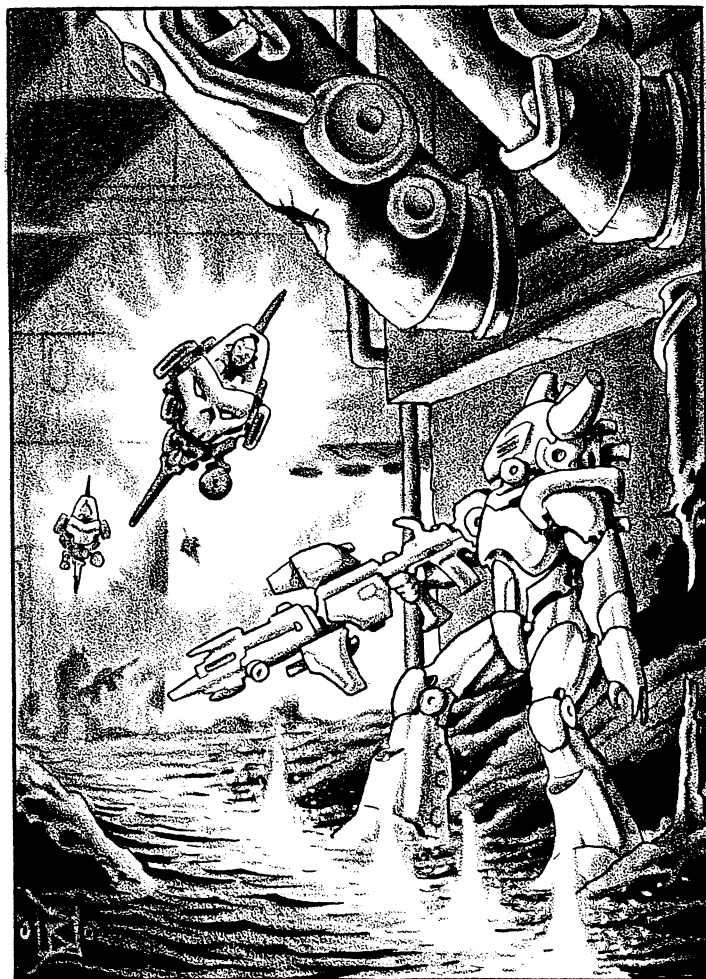

a little, dwarfish man, named Lamont Charlevoix who is said to be a dragon in human(ish) disguise. The building is said to be warded and protected by magic.

Note: Remember, these are just a few places of note. Countless shops, pubs, bars, stores, tattoo parlors, hotels, and places of entertainment are scattered throughout the Trade Center. Only 20% of this district is residential housing.

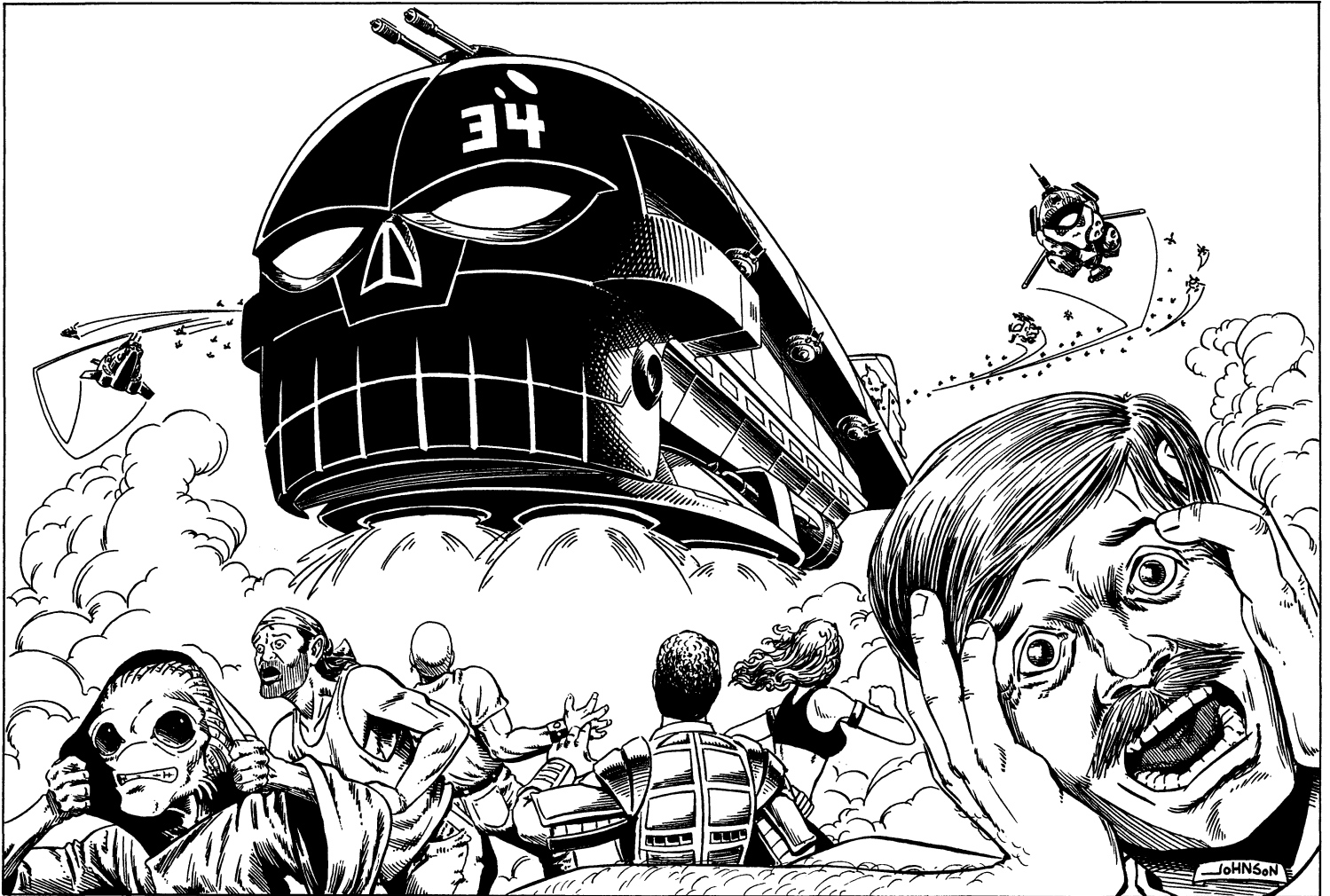

Old Bones Rumor Mill

Adventure note: Game Masters, use Old Bones as a vehicle to build adventures of all kinds. It is a wonderful setting for virtually any type of player characters, particularly unallied adventurers, mercenaries, freelance spies, freebooters and lawmen. Virtually any type of adventure can start at Old Bones. It is especially ideal for leaking clues and information as rumors and innuendo.

Conspiracy Theory Generator

By Bill Coffin

One of Old Bones' most time-honored exports has been shady information, dicey rumors, and conspiracy theories, the wilder the better. Locals know better than to believe everything they hear on the mean streets of Old Bones, but they also know not to turn a completely deaf ear, either. The rumors and scuttlebutt that swirl around in this town often (but not always) have

some kernel of truth in them. The challenge is figuring out what exactly it may be, if anything. Naturally, since just about anything is for sale in Old Bones, conspiracy theories have become a major commodity to adventurers looking for some action, mercenaries in search of a possible job, spies on the prowl for leads, and undercover military types trawling for covert intelligence.

In any given day's worth of shopping and carousing in Old Bones, an adventurer is likely to come across 1D4 various conspiracy theories, either overheard on the street, posted on some wall somewhere (when there is so much talk about, some folks throw discretion out the window), or given over for the price of a drink or other favors.

The accuracy of what somebody hears varies wildly; sometimes over the course of a day, folks will hear three different theories about the same thing, none of which even remotely re-

semble each other. That is the nature of the Old Bones rumor mill. While it may have some great nuggets of information, one must sort through a mountain of chaff to find them.

To get a sense of the kinds of stories one might hear in Old Bones, consult the **Rumor Generator** below. To come up with a bit of news, simply roll once on each of the tables below and splice the various components together. For example, say you roll the following: 31% (Who?), 60% (What?), 16% (Where?), 93% (When?), 82% (Why?), and 44% (How?). Consulting the tables below, we get the following:

31% (Who?): Franko, the mysterious leader of Les Soldats de St. Jean ...

60% (What?): ... knows the location of a pre-Rifts spaceship...

16% (Where?): ... in Montreal...

93% (When?): ... since the Coalition started hiring mercenaries to help them fight the Quebecois ...

82% (Why?): ... just to see what would happen ...

44% (How?): ... by the seat of his pants.

If you just string these together, they might not make much sense, but if you apply a little creative energy, the parts fall into place nicely. Using the example above, this is what a little creative editing and imagination can produce:

“Franko, the mysterious leader of Les Soldats de St. Jean has uncovered information for the location of a forgotten pre-Rifts spaceship hidden somewhere in Montreal! Word is, he plans to recover it. He’s been up to something big ever since the Coalition started hiring mercenaries to help them fight the Quebecois. He’s a ‘by the seat of his pants’ kind of guy so who knows what someone like him is going to do with it?”

Even once the story elements are pulled together, though, they might not make a particularly compelling or true story. “So what if Franko found an old spaceship?” Or they might lead to other wild speculation and rumor: “It’s not a spaceship. What would Franko want with a spaceship? It must be a pre-Rifts missile. Yeah, maybe a whole truckload of missiles. With nuclear warheads! That’s why the Quebec Military must be so interested in finding Franco, because they want the nuclear missiles!” If word reaches a CS spy, it could lead to an investigation or the CS looking for Franko too.

The trick to making this work is understanding a few of the Iron Laws of Rumor, observed throughout Old Bones. They are:

1) Everything you hear is important to somebody. Just because it means nothing to you makes it that much more dangerous, because you don’t actually realize that there may be people willing to kill to keep this information/story/rumor a secret.

2) Everything you hear is just the tip of the iceberg. For every secret that gets out into the open, there are 99 more that never get discovered. And those are always the best ones, too. The rumor that is being heard is just the doorway to a web of intrigue, secrecy and forbidden knowledge of potentially epic proportions. That’s why one rumor often spawns another — hence the term, rumor mill.

3) Everything you hear is connected. That is why to the folks on the streets of Old Bones, a rumor about Franko’s spaceship makes sense especially when compared to the one about Emperor Prosek being in love with some Quebecois woman he wants assassinated, and the one about Sylvain Richard recently becoming obsessed with scoring a load of uranium (“I’m telling

you, they’ve all got something to do with each other, and when I find it out, its going to change everything!”).

To make the story a full-blown conspiracy theory, either roll up a few different stories and find some way to tie them all together, or pick one or two of the story components (such as the “Who?” or “Why?” sections) and roll multiple times for those. Or just use logic and imagination to weave likely conclusions and wild speculation (as illustrated earlier). The best part about conspiracy theories is that they are often held together by conjecture, hypothesis and misinformation. When generating your own, just remember that these things are not meant to be watertight, so you can get away with making some “whoppers.” If they seem incredulous, then congratulations, it’s a genuine conspiracy theory!



Who?

01%-05%: Emperor Joseph Prosek, supreme commander of the Coalition States, Free Quebec’s public enemy #1 ...

06%-10%: Joseph Prosek II, heir apparent to the Coalition ...

11%-15%: General Marshall Cabot, Military Counsel to Emperor Prosek ...

16%-20%: General Ross Underhill, Legendary Coalition Hero and Commander of the 4th CS Mechanized Infantry Division...

21%-25%: Free Quebec Prime Minister James Lorne ...

26%-30%: General Sean Oulette, head of Free Quebec’s Tactical Administration and Intelligence Deployment Division ...

31%-35%: Franko, mysterious leader of Les Soldats de St. Jean...

36%-40%: Colonel Miller, charismatic leader of one of the largest rival factions within Les Soldats de St. Jean, Franco's one-time student and now sometimes adversary ...

41%-45%: Sylvain Richard, egotistical personality behind Radio Free Quebec, and willing pawn of Prime Minister Lorne ...

46%-50%: Julie Tremblay, decorated soldier and now radio personality and colleague of Sylvain Richard ...

51%-55%: Roland Desjardin, a renowned Old Bones black marketer ...

56%-60%: Clint Rundgren, a crusty old trapper who has lived on the outskirts of Free Quebec all his life and is a walking treasure trove of rumors, news, stories and lore ...

61%-65%: Cyrean Holst, a wealthy and experienced Operator who made his fortune traveling with the renowned adventurer group, the Terminal Headkick Foundation ...

66%-70%: Slick Willie, a fearsome Headhunter from the Chi-Town 'Burbs who has been operating in and around Free Quebec since hostilities began with the Coalition, and is supposedly on a kind of open-ended freelance contract with the CS ...

71%-75%: Oleg Skonch, a Coalition spy master and intelligence operator who defected to Free Quebec a year ago and has provided the Quebecois with much valuable CS intelligence ever since ...

76%-80%: Guillaume Tourniere, dashing rogue and one of Free Quebec's finest Glitter Boy pilots ...

81%-85%: Colonel Killian Hurricane Huxtable, a Coalition field officer notorious for having never lost a single engagement to Free Quebecois forces ...

86%-90%: Free Quebec Vice Prime Minister Luc Maillet ...

91%-95%: Sylvette Jiroyan, a seductive arms dealer from Old Bones who can get anybody any weapon any time, if the price is right ...

96%-97%: Pierre Champlain, gambler, playboy and suspected spy master ...

98%-00%: Emmanuel Moquet, a brilliant scientist and drunkard who is well known throughout Old Bones for constantly rambling about some discovery he has made that will render all Coalition weapons technology obsolete ...

What?

01%-05%: ... wants to organize an expedition to the northern reaches of Free Quebec ...

06%-10%: ... is looking for a professional assassin ...

11%-15%: ... has obtained Coalition military secrets ...

16%-20%: ... owes the wrong kind of people a lot of money...

21%-25%: ... has just left the country ...

26%-30%: ... found some kind of magical artifact ...

31%-35%: ... is in league with alien invaders ...

36%-40%: ... keeps finding crop circles in local farms ...

41%-45%: ... learned that a prominent Quebecois politician plans to defect to the Coalition ...

46%-50%: ... knows the real reason behind this war and what it has to do with an impending invasion from Atlantis ...

51%-55%: ... can't understand why members of the Old Bones bounty hunting guild, The Hundred Hands, want him/her dead ...

56%-60%: ... knows the location of a pre-Rifts (or alien) spaceship ...

61%-65%: ... has a secret brother nobody knows about ...

66%-70%: ... is the only witness to a heinous crime and cover-up ...

71%-75%: ... is having a love affair with somebody...

76%-80%: ... has awakened to incredible psychic powers...

81%-85%: ... just came into a huge shipment of illegal small arms (CS, Free Quebec or other) ...

86%-89%: ... could destroy all of Free Quebec with a flip of switch ...

90%-93%: ... commands (or possesses) magic beyond belief ...

94%-96%: ... is obsessed with obtaining twenty kilos of enriched uranium...

97%-00%: ... maintains constant communication with foreign agents ...

Where?

01%-05%: ... in Chi-Town ...

06%-10%: ... in Quebec City ...

11%-15%: ... in Old Bones ...

16%-20%: ... in Montreal ...

21%-25%: ... in Hudson Bay ...

26%-30%: ... in Tolkeen ...

31%-35%: ... in Lazlo ...

36%-40%: ... in New Lazlo ...

41%-45%: ... in Ottawa ...

46%-50%: ... the rural farmlands in northern Free Quebec (or the tundra) ...

51%-55%: ... along the river (fill in a name) ...

56%-60%: ... in the forested wilderness of western Quebec ...

61%-65%: ... in the pre-Rifts ruins just past the edge of southern Free Quebec ...

66%-70%: ... in Atlantis ...

71%-75%: ... in the New German Republic ...

76%-80%: ... in Dunscon ...

81%-85%: ... in Pyscape ...

86%-90%: ... in an alien dimension ...

91%-95%: ... somewhere in Ontario ...

96%-00%: ... on an island in the Atlantic ...

When?

01%-05%: ... for the last 20 years...

06%-10%: ... for the last 15 years...

11%-15%: ... for the last 10 years...

16%-20%: ... for the last 5 years...

21%-25%: ... for the last year...

26%-30%: ... for the past six months...

31%-35%: ... for the past three months...

36%-40%: ... for the past month...

41%-45%: ... for the past week...

46%-50%: ... for the past three days...

51%-55%: ... for a day or two...

56%-60%: ... since yesterday...

61%-65%: ... since this morning...

66%-70%: ... since this afternoon...

71%-75%: ... since this evening...

76%-80%: ... since about an hour ago...

81%-85%: ... since the war with the Coalition started...

86%-90%: ... since everybody started seeing those weird submarines in the St. Lawrence River ...

91%-95%: ... since the Coalition started hiring mercenaries to help them fight the Quebecois ...

96%-00%: ... since the Sasquatch (or other strange creature) started appearing on the edges of Free Quebec ...



RYAN BERES

101

Why?

- 01%-05%: ... for reasons only Prime Minister Lorne knows ...
- 06%-10%: ... to gain revenge ...
- 11%-15%: ... to make some money ...
- 16%-20%: ... to settle an old debt ...
- 21%-25%: ... because if not, they'll kill his/her family ...
- 26%-30%: ... because the voices tell him/her to ...
- 31%-35%: ... because he/she thinks it is his/her ticket out of Free Quebec ...
- 36%-40%: ... because he/she lost a bet...
- 41%-45%: ... to settle the debate on this issue once and for all ...
- 46%-50%: ... oh, come on! You know the reason why...
- 51%-55%: ... because he/she has suffered some kind of mental trauma ...
- 56%-60%: ... because he/she secretly is a spy for the other side ...
- 61%-65%: ... because he/she gets his/her thrills that way ...
- 66%-70%: ... because of the planetary alignment ...
- 71%-75%: ... to comply with ancient and long-forgotten traditions ...
- 76%-80%: ... to betray the Coalition/Free Quebec (whichever side they are on) ...
- 81%-85%: ... just to see what would happen ...
- 86%-89%: ... wouldn't you? ...

- 90%-93%: ... foretold by ancient (Indian?) legend ...
- 94%-96%: ... because he/she is bucking for a promotion or bonus payment ...
- 97%-00%: ... to satisfy a life-long ambition ...

How?

- 01%-05%: ... with a little help from some out of town friends.
- 06%-10%: ... by using his/her secret magical powers.
- 11%-15%: ... by calling upon a secret order of freedom fighters working in the deep wilderness of Quebec.
- 16%-20%: ... only after years and years of persistent effort.
- 21%-25%: .. after getting lucky on his/her first try.
- 26%-30%: ... by cheating.
- 31%-35%: ... through plenty of dirty tricks and subterfuge.
- 36%-40%: ... by way of a painstakingly detailed and carefully executed plan.
- 41%-45%: ... by the seat of his/her pants.
- 46%-50%: ... by doing what came naturally to him/her.
- 51%-55%: ... after going on a self-imposed hunger strike for 40 days and nights.
- 56%-60%: ... after killing whoever got in the way.
- 61%-65%: ... by paying plenty of bribes.
- 66%-70%: ... by setting that big fire on the other side of Old Bones that killed all those people.
- 71%-75%: ... by sending a letter bomb to Emperor Prosek.

- 76%-80%: ... after researching the topic for well over a year.
- 81%-85%: ... by riding somebody else's coattails.
- 86%-89%: .. only after groveling like a dog to the right people.
- 90%-93%: ... through pure dumb luck (or happenstance) ...
- 94%-96%: ... by contacting creatures not from this world.
- 97%-00%: ... by stealing what it was he/she was after.



Now, Don't Quote Me On This...

The overall accuracy of the rumors and conspiracy theories generated here is up to the Game Master. Are they the honest truth, flights of fantasy, or something in between? If you can't decide, then roll on the following table.

Rumor/Conspiracy Theory Accuracy

01%-20%: Balderdash! All six elements of the story are incorrect. This is some kind of joke, the rantings of a madman, or the end product of somebody drinking a full can of Sterno.

21%-35%: Give Me A Break! Five of the story elements are untrue; roll 1D6 to determine which one is the grain of truth among the lot. 1: Who? 2: What? 3: Where? 4: When? 5: Why?

6: How? Naturally, having only one correct story element doesn't give the player characters much to go on, but maybe if they keep their eyes and ears open, when that one element comes to the surface, they will suspect something is afoot. ("Hmm. I didn't know le Surete had arranged an ambush on Tuesday! I mean, I figured something was going to happen on Tuesday, but not that.")

Whether or not the player characters actually know which story element has the ring of truth to it is left to the G.M.'s discretion. A rule of thumb is that characters have a base 5% chance per point of I.Q. of knowing which element is the real McCoy. The maximum chance of separating truth from fiction is 98%. Thus, a character with an I.Q. of 11 has a 55% chance of knowing which story element of the six he has just heard is likely to be at least accurate, if not grossly out of context.

36%-50%: Quit Kidding Around! Two of the six story elements are true; roll 1D6 to determine which, and give those who know it a base 5% chance per point of I.Q. to see if they know which parts are true. A story with this many holes in it is hardly worth following ... or is it? For some people, those two parts that are correct might be enough to whet their appetite for the rest of the story.

51%-65%: You Don't Say? Half of the six elements are incorrect, which for the hardcore conspiracy theorist means this story is practically watertight. Determine the truthful elements as well as the chance for discovering them as above. With three points to base the story off of, those who hear this might very well get the feeling that they know the basic gist of the story but all of the important details are wrong.

66%-75%: Are You Serious? Four of the six elements are correct! Determine the truthful elements as well as the chance for discovering them as above. With only two holes in the story, this is probably the kind of thing that many adventurers would be willing to follow up on if there was the promise of some kind of reward to it. There is still enough unknown about it to make it exciting, but enough is reliable to give the story legitimacy and therefore, not a waste of time to investigate.

76%-85%: Tell Me More! Of the six elements, only one is incorrect. Determine the truthful elements as well as the chance for discovering them as above. The hole in the story could be a relatively minor detail the player characters do not need, or it might be that final piece of the puzzle they have been looking for but still can not find. In any case, the story is solid, and finding leads to follow it up with should not be difficult ... right?

86%-98%: I Just Heard the Weirdest Thing. The entire story as the player characters hear it is true! Now, the challenge is not verifying the rumor, but figuring out why it might be important, and how it could figure into the broader scenario of the war between the Coalition and Free Quebec.

99%-00%: You Can't Handle the Truth! Not only is the entire rumor/conspiracy theory 100% true, but the version the player characters have heard is actually more complete than what the actual participants of the rumor/conspiracy theory know themselves! Should those principals find out, they might seek out the heroes to get this information. Depending on who the principals are, that could be a good or bad thing. Wealthy Quebecois with a soft spot for adventurer types? Good thing. Psychopathic Coalition Special Forces officer with a penchant for torture? Bad thing.

Where Did You Hear This?

- 01%-05%: It's posted up on a few kiosks on the bad end of town.
- 06%-10%: Every year or so a rumor like this pops up. I really think it might be true this time, though.
- 11%-15%: I could tell you, but then I'd have to kill you.
- 16%-20%: Some important-looking guy, down at one of the drinking holes. He was pretty drunk and was just blabbing away. You might still be able to catch him, if you hurry.
- 21%-25%: I got an anonymous tip on this. Whoever gave it to me definitely wanted to make sure it got out into the open.
- 26%-30%: Somebody owed me some favors, so I took them out in trade for info.
- 31%-35%: Got it off some out-of-towners who didn't know enough to keep their mouths shut.
- 36%-40%: I got connections, see? I see all, I know all. Ever need some more info, come to me. I'll set you up.
- 41%-45%: What do you mean, where did I hear this? Man, it's the talk of the town! What rock have you been hiding under?
- 46%-50%: Some Glitter Boys (or other types of soldiers in the Quebec Military) just in from patrol were talking about it.
- 51%-55%: Some river traders were talking about it.
- 56%-60%: This is the word in the Coalition camps.
- 61%-65%: Secret communique from Prime Minister Lorne's office that got leaked accidentally.
- 66%-70%: Intercepted it off a shortwave transmission.
- 71%-75%: Don't know, actually (or, some drunk told me).
- 76%-80%: Sorry. I can't reveal my sources (mercenary, suspected spy, government official or Black Marketeer).
- 81%-85%: What, are you calling me a liar?
- 86%-90%: What do you care? The info's good, ain't it?
- 91%-95%: I overheard it on the street.
- 96%-00%: Some D-Bee told me.

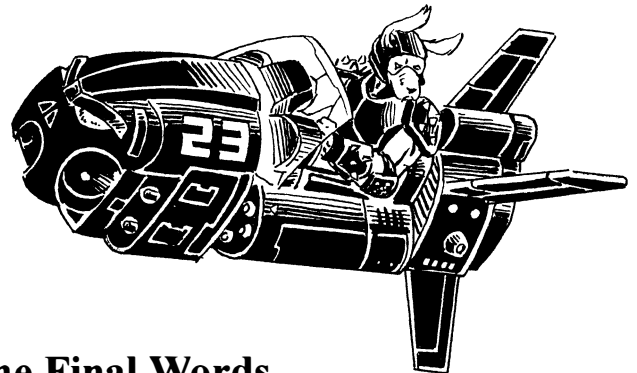

Some Final Words

Most of Old Bones' residents consider the town's overactive rumor mill to be just one of those things that comes with the territory. The vast majority of people here brush off the never-ending deluge of hearsay and scuttlebutt for what it usually is — implausible, inaccurate yarns that are hardly as important as they pretend to be.

That said, the rumor mill is considered the Old Bones *Employment Agency* by many of the adventurers in town, who routinely chase down the various rumors. Even if a rumor turns out to be untrue, following any leads will invariably result in adventure, and perhaps reward and glory. At the very least, chasing down old rumors provides a kind of high-risk entertainment for a town so wild and woolly that ordinary pastimes simply don't make the grade.

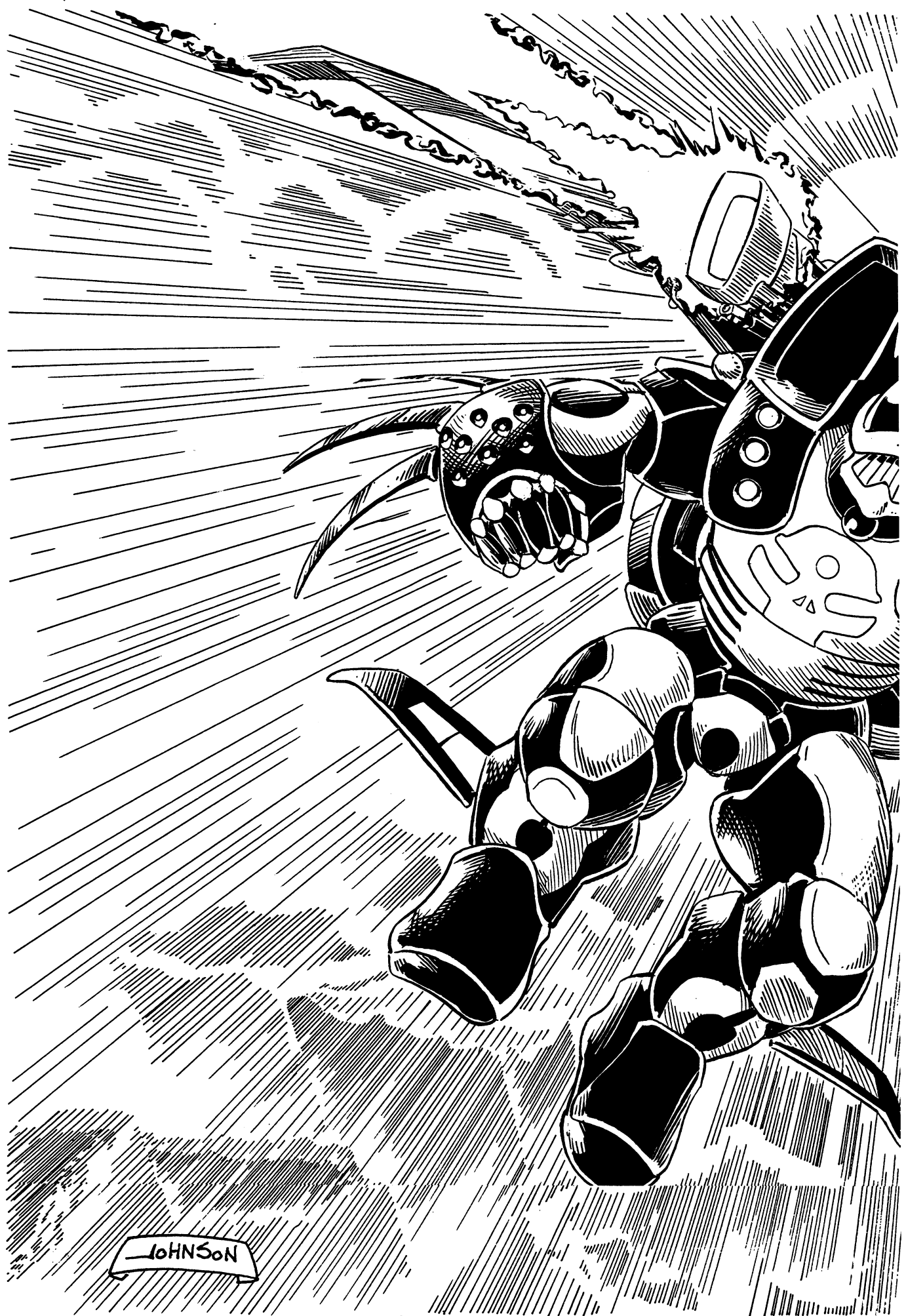

JOHNSON

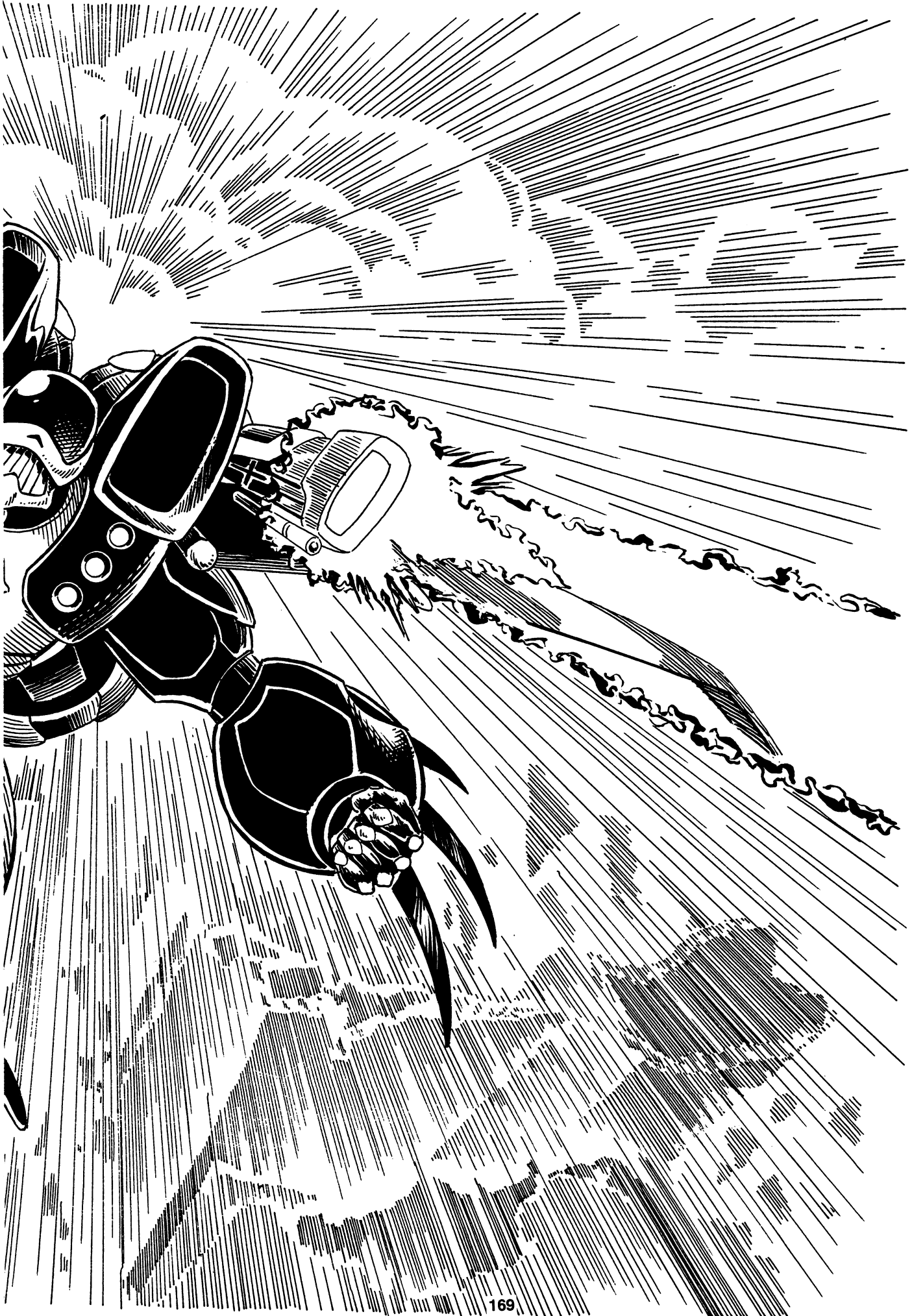





By Kevin Siembieda

Despite Erin Tarn's prayers for intervention to prevent the war between the Coalition States and Free Quebec, a bloody conflict is inevitable. Although the hearts of the soldiers on both sides may not be in this battle, emotions quickly boil over after the first shots are fired.

What ignites the war is an act of terrorism against the Coalition front-line combat troops by a previously unknown group of Free Quebec super-patriots. Ironically, these self-proclaimed "patriots" have no *official* connection with either the government or military of Free Quebec. They are a small group of zealots with under 200 members. However, among their devotees is a rogue cell within the Quebec Army. These fanatical operatives have illegally outfitted their compatriots with military issue armaments and armor. Worse, six Classic Glitter Boys, a dozen Violator SAMAS and 40 or 50 ground troops on hovercycles (and clad in official Quebec Military body armor) participated in an assault on the Coalition, making the incident seem like a military attack and any denial of complicity part of a cover-up.

And so it begins

In the few weeks before the incident, acts of theft, sabotage and vandalism exploded along the CS front-line north of the ruins of *old Ottawa* near a city of 38,000 called **New Pembroke** (across the Ottawa River from the ruins of pre-Rifts Pembroke). CS Field General Kasdan and his Commanders along the southwestern border of Free Quebec had been suffering from covert tactical transgressions for weeks, presumably at the hands of Black Ops teams sent in by the *Quebec Military*. However, the CS forces have suffered similar assaults from "unallied rebels" and independent operatives with a hate for the Coalition States from communities outside of Free Quebec. Not wanting to be the one responsible for the war, General Kasdan resists retaliation. Instead, he warns the city of **New Pembroke**, the cluster of tiny, surrounding communities and the government of Free Quebec to take action to prevent further "incidents."

A short time later, just before midnight, the village of **Riverbend**, CS sympathizers, just on the border of Quebec Territory, begins to *burn*. When CS troops, unprepared for combat, rush to the rescue of the innocent villagers, they are picked off by sniper fire. As more CS troops arrive they are shelled by mortar and mini-missile fire. When a SAMAS squad accompanied by a mixed platoon of Terror Troopers and Hellraisers arrive on the scene, they are ambushed by a squad of *Violator SAMAS* and Quebec Army ground troops. Seconds later, a half dozen *Glitter Boys* and a platoon of Quebec Soldiers (they were clad in standard military issue environmental armor) begin to blast away through the village.

When it was all over, the village laid in ruin. 183 civilians were dead. Another 62 injured were among the 93 villagers to survive. Coalition troops fared much better with only 14 dead and 30 injured, but it offered them no solace. They had been lured out into an ambush while trying to protect innocent lives. The enemy was both cowardly and ruthless.

Retribution was swift and devastating. Although reports of a fire and combat had reached the Quebec Army defense forces stationed at **New Pembroke**, they were unaware of any details, or that the Quebec Army had been implicated in the tragic event. Thus, they were caught completely by surprise when an entire, mechanized Coalition Field Army (over 20,000 troops) assailed the city at 0400 hours that morning. The Quebec troops suffered heavy casualties, over 1100 infantry troops were slain and 2024 captured. Civilian casualties approached 9,000 with twice that number suffering from injuries. The small city of 38,000 fell to the CS in only two hours — the first CS victory in a war Free Quebec had not known had started. Triumphant, the Field General claimed New Pembroke for the CS and magnanimously allowed all civilian patriots of Free Quebec (roughly 72% of the surviving population) to leave the city and go elsewhere to live in their "doomed nation." These battered refugees also carried with them this warning:

"The Quebec Army has shown its true, treacherous colors and the Coalition States will have its revenge. There will be no hesitation or mercy in the future. Death awaits all who oppose the Coalition States!"

The shadows of war

Word of Free Quebec's treachery spread throughout the CS forces within 24 hours of the **Riverbend Ambush**. The villainy of the attack, the Coalition's devastating retaliation and victory against New Pembroke would ignite heated skirmishes all along the western border of Free Quebec for weeks to come. However, the CS would not enjoy another easy victory like the one at Pembroke as the Quebec Army and its Glitter Boy Legions mobilized quickly to defend itself against what it perceived as unprovoked acts of aggression by the Coalition States.

Ironically, the Quebec government saw the Coalition's claims of a Free Quebec attack and the alleged slaughter of the innocent at Riverbend as more lies to cover up CS treachery. It sounded like classic Coalition propaganda, and Free Quebec fiercely denied all allegations. After all, it *knew* no such military operation had occurred. They in turn, pointed a righteous finger at the Coalition Army for starting the war by attacking unsuspecting New Pembroke in the middle of the night without provocation.

Free Quebec's leaders would be mortified when an unknown terrorist cell took credit for what they had done, complete with video documentation. At first they wanted to believe it all was a CS trick, but they had recently heard rumors about this group of zealots and there was corresponding evidence to support their claims. A platoon of Infantry soldiers under the command of Black Ops unit *Viper Delta* had gone AWOL, taking the power armor and equipment seen in the video.

The terrorists, calling themselves the **Children of Freedom**, would wait two weeks before stepping out of the shadows, making sure the war was in full swing before taking credit for their "patriotic" actions. The COF would justify the slaughter of the men, women and children of Riverbend as "*justice befitting any traitor who would accept the Coalition States over our independent nation.*"

In a video and audio statement transmitted from a secret, mobile video-station (as well as the computer and radio communications networks of most major cities in the region), a hooded terrorist leader claimed with pride the following:

“Today, we have struck a blow for Quebec’s independence, punishing the traitors of **Riverbend** and igniting the inevitable war our leaders were too cowardly to accept.

“The reluctance towards war had to end. It is Free Quebec’s destiny to stand proud, free and independent. Somebody had to muster the courage to send these invaders a fiery statement. Our leaders spit forth hard words but refused to follow them up with strong, decisive action. Their hesitance made us look weak and suggested reconciliation with the Emperor was a possibility. We speak for all patriots of Free Quebec when we say that returning to the Coalition as a member State is not an option! We will never serve a foreign power again. NEVER! No ‘true’ patriot will ever allow this. It is our destiny to be free of the Coalition’s tyranny. And though the price we must pay for our freedom will be with the blood of our people, it is a price well worth paying. This is the beginning of a great era for Free Quebec.”

Admittedly, the leaders of Free Quebec were hesitant to leap into war, but reconciling with Emperor Prosek and returning to the fold as a member State had never been entertained. The terrorists made dangerous assumptions and acted recklessly. Actions that have plunged Free Quebec and the Coalition States into war. What is to follow is best presented in the words of Erin Tarn:

“The war may have been ignited by a disenfranchised madman, but once started, it can not be easily stopped. Reluctance to do battle is washed away when one’s life is threatened and he sees his fellow soldiers — friends, comrades and respected leaders — cut down all around him, their fragile bodies vaporized when the temuous shells of their armor give way to a relentless assault. Reluctance and compassion are quickly replaced by hatred and righteous vengeance is justified. This is the madness of war. The battle for Free Quebec has begun, and I fear both sides will suffer dearly for it.”

War Days

As the old saying goes, “Once the genie is out of the bottle, it’s hard to put him back in.” So it is with war. The Riverbend Ambush and subsequent battles have sent the Coalition and Quebec Armies at each other’s throat. Each conflict has a snowball effect, creating bad will, hate and a lust for revenge on both sides, emotions that only motivate and promote more killing.

The Coalition States reject the notion that the Riverbend Ambush was a terrorist act done without the knowledge or consent of the Quebec High Command. Likewise they discount the video documentation and terrorist claims as an obvious and weak attempt by Free Quebec’s leaders to cover up their shameful plunge into war. Word is circulating through diplomatic and military channels (as well as the streets of Old Bones and western border communities) that the CS believes the Quebec Army sponsored the Riverbend Ambush and, only after New Pembroke fell so easily, have come to realize they can not withstand the might of the Coalition Army. As a result they are now back-peddling, concocting this terrorist “story” to get the CS to hesitate and back off. It won’t happen. Free Quebec will fall. The Coalition Military High Command is committed to it.

The Children of Freedom

These lunatics are as feared and hated by the leaders of Free Quebec as the CS. Because of them, a war that might have been averted intensifies with each passing week. Furthermore, these zealots are dangerous loose cannons who continue to undermine the plans of the Quebec government and its military, taking matters into their own hands time and time again, exacerbating an already explosive situation.

The leader of Viper Delta Squad is **Captain Elaine Jeunet**, a strong-willed misanthrope diagnosed as a mild sociopath with psychotic and paranoid tendencies. Ironically, these traits made her a ruthless and outstanding Special Operations Commando. Her track record for success is impressive to say the least, earning her a position as the youngest woman to be assigned Platoon Leader of any Black Ops operation. Capt. Jeunet and many of her platoon were more close-knit than usual. Many had adopted her radical view on the nation’s independence and were known to express extreme disappointment with the government and way the war was going (or not going as the case may be), but nobody ever thought they would act upon them. At least not like this. She and the other members of her squad are on a short-list of Quebec Military soldiers who have gone AWOL and have a history of antisocial behavior or a hate for the CS.

While Captain Jeunet and her Special Forces platoon are without question the muscle behind the Children of Freedom, and deadly in the extreme, the Quebec Military High Command does not believe she is the leader of this terrorist group. As good an espionage soldier and assassin as Captain Jeunet is, she is not a motivator. Rather, she is the perfect second-in-command and iron fist enforcer. That means there is somebody else pulling the strings. High Command suspects **Robert Carlye**, an outspoken dissident who was expelled from his position as Head of Sociology and Behavioral Science at the University of Free Quebec two years ago. His loss of tenure resulted from his increasingly inflammatory anti-government position and speech making, inciting violent student rallies and encouraging vigilantism. Elaine Jeunet was one of his students seven years ago, before she joined the Military Service. She has kept in touch with him over the years, frequently voiced his views and regarded him as a misunderstood visionary — “the greatest mind” she had ever known. Circumstantial evidence seems to support this theory. The current whereabouts of Robert Carlye are unknown (he disappeared about one month ago, shortly before the Riverbend Ambush incident), and the hooded terrorist in the video is a heavysset male with the same build as Carlye. Moreover, the dialogue had a very “Carlye” sound to it.

The problem is nobody knows where any of these individuals might be, or where their secret headquarters may be located. If Viper Delta doesn’t want to be found, they won’t be.

Viper Delta

All members of Viper Delta Platoon are dedicated to Captain Jeunet and, to a slightly lesser degree, Robert Carlye. However, if push comes to shove, they will follow their Captain’s lead. Ironically, that makes this strong, forceful woman the weak link in the terrorist group Children of Freedom, because the soldiers

under her will follow her lead, whatever it may be. So if somebody could convince her that Carlye is a madman or power-monger and she walks away from the group, they all walk. Without Capt. Jeunet and her troops, the Children of Freedom have no teeth. The few dozen militia-type supporters and mercenaries currently being recruited are likely to disband, realizing that while Robert Carlye is the brains of the COF, Capt. Jeunet is the heart and muscle.

Breakdown of Viper Delta Platoon:

- 10 V-SAMAS
- 6 Pale Death SAMAS
- 7 Classic Glitter Boys
- 1 Glitter Girl
- 2 Side Kick Power Armor
- 14 Infantry Troops (with 12 Bobcat Hovercycles and four Cougar Jeeps).

Note: Average level is 4th-6th. Average alignment: Anarchist and Aberrant, with a few others mixed in. All are well equipped and seasoned warriors who see themselves as super-patriots working their own agenda to save Free Quebec from Coalition domination. Most are merciless when it comes to battling the Coalition Army and protecting the COF, Capt. Jeunet and Professor Carlye. All will follow their Captain into hell and back.

Additional COF Forces:

In addition, the Platoon approached and convinced a Recce infantry squad (10 Infantry troops) to go AWOL with them and supplemented their initial forces with a band of Headhunters Viper Delta had worked with in the past and who hate the CS. Those forces include:

- 1 Crazy
- 2 Wilderness Scouts
- 2 Headhunter Assassins
- 2 Headhunter Anti-Robot Specialists
- 3 Headhunter Techno-Hounds
- 6 Standard Headhunter Techno-Warriors

Captain Jeunet

A huge part of Carlye's success in building and motivating the COF is the fiery dedication and fierce, intense commitment of Capt. Jeunet and Viper Delta, which contributes to an overall sense of excitement, importance, and power. An intensity and blind commitment that has them all caught up into the heat of the moment. A fire that burns in the pit of each of their stomachs and makes them feel as if they are part of something great. If that fire is ever doused by losing Capt. Jeunet's support through disillusionment or her death, the group will crumble.

Captain Elaine Jeunet sees herself as a patriot, and everything she does is for the good of Free Quebec. She does not covet fame, glory or power, and assumes she will die in obscurity on some field of battle. She does what she does for the greater good of the people, or so she believes. Carlye has her convinced that the leaders of Free Quebec were on the verge of signing a peace agreement with the Coalition States and handing over complete control of the government to Emperor Prosek. By pure coincidence while working undercover at Old Bones (where conspiracy theories abound), she heard a convincing theory that supported Carlye's. Horrified and confused, she turned to her



mentor for advice. He convinced her that unless somebody with her courage was willing to do something extreme, Free Quebec would soon be an extension of Chi-Town and the pawns of the Prosek family. That's when Carlye proposed the idea of staging a military raid that would lure the CS into battle and start the war. Between her and Carlye, Viper Delta Platoon, and a few other "patriots" known to Carlye, were suckered into an act of violence that would forever survive in infamy. Being a soldier of decisive action and fearing an imprisoning peace might be reached at any moment, she hatched the Riverbend Ambush and put it into place within a matter of days. Understanding the military and the CS, she knew the incident had to enrage the Coalition Army into crossing the border and attacking a Free Quebec city. The sacrifice of "innocent people" was for a greater cause. As usual, she did her job exceedingly well.

Captain Jeunet —

Renegade Soldier of the Quebec Army

Full Name: Elaine Marie Jeunet

Rank: Captain

Alignment: Aberrant, dedicated to her country, but has her own twisted view of what is best for it.

Attributes: I.Q. 18, M.A. 14, M.E. 11, P.S. 21, P.P. 20, P.E. 15, P.B. 14, Spd. 21

Hit Points: 37, **S.D.C.:** 51, **Age:** 24.

Size: 6 feet (1.8 m); 150 lbs (all muscle; 67.5 kg). **P.P.E.:** 9

Disposition: A very stern, confident woman who always seems to have a hatred for somebody or something. Capt. Jeunet is an excellent tactician and organizer who always tries to be prepared for every possible contingency. She is driven and intense, yet a very private person who keeps her feelings to herself and her mind focused on the mission at hand. The only person she opens up to is her confidant and mentor, Robert Carlye. If she ever feels that he has used and manipulated her for whatever reason, their relationship will be shattered forever (making her more paranoid, morose and violent than ever before).

Other than Carlye, Viper Delta and the COF, she has nothing. Capt. Jeunet has destroyed her military career and her parents died at the hands of D-Bee pirates when she was 13 years old. If she leaves the Children of Freedom it will be out of disillusionment and a sense of betrayal. Viper Delta is likely to go with her and the group will probably take to becoming mercenaries or bandits away from Free Quebec (Tolkeen, maybe?).

Experience Level: 6th level CS Special Forces.

Magic Knowledge: None.

Psionic Abilities: None.

Combat Skills: Hand to Hand: Assassin, 6th level, Robot Combat: Elite (SAMAS), boxing, and wrestling.

Attacks per Melee: Nine.

Bonuses: +3 to initiative, +5 to strike, +7 to parry and dodge, +10 to S.D.C. damage, +4 to roll with impact, +3 to pull punch, entangle, pin/incapacitate on natural 18-20, critical strike on natural 18-20, 80% to trust/intimidate.

Weapon Proficiencies: W.P. Energy Pistol, W.P. Energy Rifle, W.P. Heavy, W.P. Knife, Sniper, Demolitions, and Paired Weapons.

Cybernetics: Sensor Hand with fingerjack and gyro-compass; hand looks reasonably normal.

Weapons of Note: Fully loaded Violator SAMAS (all standard weapons and mini-missiles), pair of Vibro-Knives, Q1-02 "Stopper" ion pistol, Q2-20 laser and grenade launcher (with bayonet), a Q4-44 "Drummer" shotgun (carried even when in V-SAM), a crate of 144 plasma mini-missiles, a crate of 144 armor piercing missiles, and plenty of E-Clips for all weapons plus an E-Clip recharging unit (she is always prepared). She also has a variety of explosives and two Type-One Fusion Blocks.

Armor & Other Gear: V-SAM, plus a suit of standard military body armor (80 M.D.C.), and "Plain Clothes" Armor (28 M.D.C.); which one she uses depends on the operation. She also has a Bobcat Hovercycle, language translator, laser distancer, RMK and IRMS robot medical systems, first-aid kit, and all standard gear for a Special Forces field operative.

Skills of Note: Literacy (American) 69%, Language: American 98%, Basic Math 94%, Radio: Basic 89%, Radio: Scrambler 74%, Climbing 84/74%, Running, Wilderness Survival 74%, Land Navigation 70%, Intelligence 62%, Interrogation 64%, Streetwise 60%, Pilot Hovercycle 89%, Pilot Robots and Power Armor 85%, Pilot: Robot Combat Elite (SAMAS all), Lore: Demons and Monsters 64%, Read Sensory Instruments 74%, Detect Ambush 69%, Military Etiquette 79%, and Computer Operations 79%.

Description: Tall, lean, and mean. This attractive blonde is as tough as they come and looks it. For combat missions, she is

typically clad in her V-SAM power armor or military body armor.

Robert Carlye

The correctly suspected ringleader of the Children of Freedom is Professor Robert Carlye, Rogue Scholar. He is a devout anarchist who sees the current government of Free Quebec as weak, corrupt and ill-suited to lead the nation. He especially hates the charming Prime Minister James Lorne, whom Carlye believes is leading the nation into ruin. Ultimately, he believes the government must be toppled and a new Prime Minister, such as himself, elected. Carlye, a self-styled super-patriot, suffers from delusions and megalomania, believing only he has the vision to win the war against the Coalition States and lead Free Quebec to greatness. He sees Capt. Jeunet as a noble warrior, patriot and his means to power. Although he trusts her judgement, loyalty and combat abilities, she, like all people, can not see the full scope of his grand vision and is far from being his equal. While it is true that Carlye is using Capt. Jeunet and all others who follow him, it's not out of deliberate manipulation or some sick game. In fact, he doesn't see any manipulation involved at all. It is simply that they are all like children who look to him for guidance and comfort (which he is all too ready to provide). Consequently, Capt. Jeunet is a competent general in the *Army of Freedom* he dreams of building. An army of patriots who will share his vision for a better future and trust in his judgement to take them there. An army that will inspire the people of Free Quebec to rise up and topple the current government in favor of Carlye's unique brand of freedom.

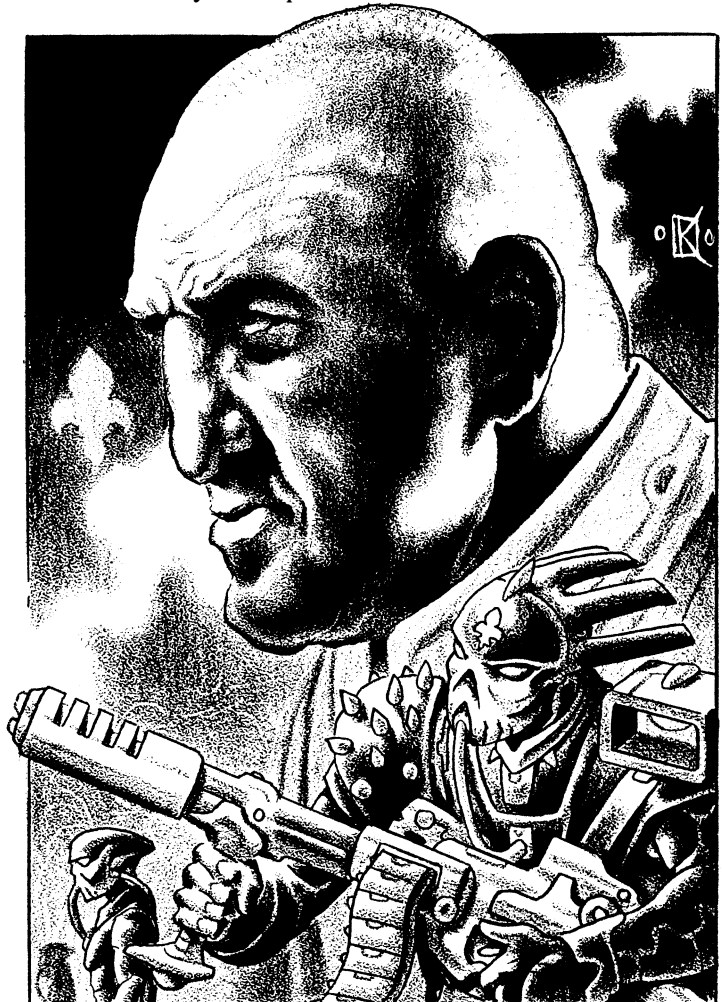

Professor Robert Carlye, leader of the COF

Real name: Robert Williams Carlye

Alignment: Miscreant. His first and only loyalty is to his twisted dreams for Free Quebec.

Hit Points: 46, **S.D.C.:** 22, **P.P.E.:** 4

Weight: 285 lbs (128 kg), **Height:** 6 feet, 2 inches (1.86 m).

Age: 51

Attributes: I.Q. 21, M.E. 8, M.A. 20, P.S. 14, P.P. 9, P.E. 10, P.B. 9, Spd. 9.

Disposition: Combination fire and brimstone preacher and soft-spoken scholar. He comes off as a man of knowledge, insight and vision. His words are full of conviction and supported by deep thought, good intentions, powerful conclusions and (often revised) history. Robert Carlye, although not a clergyman, radiates with a sort of god-inspired conviction and power that is both frightening and impressive. He knows he is right and acts accordingly. Carlye is an inspiring leader and impressive figure, but he is not well organized or particularly good at strategy and tactics. Nor does he truly care about his people whom he freely sacrifices for the “greater good of Free Quebec.” Compassion is an alien word to Carlye and both it and justice are colored by his all important “vision” for the future. Nothing else matters.

Experience Level: 10th level Scholar and Terrorist Leader.

Skills of Note: Literacy in American, Euro and old French, Speaks American, old French, Euro and Inuit (the common tongue) at 98%, Basic and Advanced Math, Anthropology, Computer Operations, Computer Programming, History (of Free Quebec and the CS), Law, Writing, Swim, Fish, Pilot Sail Boat and Pilot Hover Craft are all at 98%. Radio: Basic 90%, TV/Video 87%, Computer Hacking 67%, Dance 67%, Sing 92%, Art 77%, and Forgery 72%.

Magic Knowledge: Only from a historical and anthropological point of view with a detailed understanding of magic creatures, gods and myths of North America (and the people who worship them). He knows the types of magic that are conducted in North America, but nothing about how they work.

Psionic Powers: None.

Combat Skills: Hand to Hand: Basic, but only at 3rd level.

Attacks per Melee: Six.

Bonuses: +2 to parry and dodge, +2 to roll with punch, fall or impact, 60% to evoke trust/intimidate.

Weapon Proficiencies: W.P. Energy Pistol at 10th level proficiency, W.P. Blunt at 3rd level.

Weapons: Always carries a weighted walking stick made from M.D.C. material (not that he needs it, the cane is for show; does 2D4 S.D.C. damage as a weapon), Q1-01 Laser Pistol and a pocket knife (1D4 S.D.C.). Carlye counts on Capt. Jeunet and other henchmen to protect him.

Body Armor: T-40 “Plain-Clothes” business suits and robe (25 M.D.C. each). He can squeeze into a suit of specially made, non-environmental armor that has a helmet and 50 M.D.C.

Cybernetics: None.

Description: Carlye is an imposing man, tall and heavy, but solid. He is completely bald and has a rather flat nose like a boxer (it has been broken twice, once in a diving accident and a few years ago during a campus riot he caused). He has piercing eyes, a deep voice, and calm, confident demeanor. That calm is often replaced by fire and brimstone when giving motivational speeches, defending his actions and when

angry. He has never experienced combat although he thinks he understands it from his years of study and reading.

Note: Nobody knows exactly what the Children of Freedom (COF) plans on doing next. As militant terrorists who see the Quebec Military and Government as being as much a danger to the freedom, security and future of Free Quebec, they are just as likely to take action against them as much as Coalition forces. Capturing radio and television stations to spread their word, kidnapping and killing government and military leaders and undermining military holding actions (in lieu of more aggressive action) are all likely plots and campaigns.

At least for now, the COF will focus on continuing to instigate conflicts between the CS and Quebec Military, masquerading as genuine Army troops sanctioned by the leaders of Free Quebec. It will take months (if ever) before the Coalition Military may be willing to believe there is a group of rogue soldiers operating outside the Quebec Army. Consequently, the COF represents a very real and present danger to the war effort. Meanwhile, the COF is starting a recruiting drive to build an army. Capt. Jeunet would like to see a guerilla force of 160-240, Carlye imagines an army of tens of thousands.

CS vs Quebec Military

In a stand-up fight with the Coalition Army on one side and the Quebec Forces on the other, the CS is almost certain to eventually come out the winner. Such a fight would be bloody and costly for both sides, but the CS would win from sheer weight of numbers alone. Fortunately for Free Quebec, wars where both sides lined up on the field of battle to kick the hell out of each other vanished centuries ago. Although there may be some “field battles” and “skirmishes,” even pitched battles are not usually that linear. There are traditional infantry troops, tanks, and APCs battling alongside and/or against cyborgs, Dog Boys, Juicers, power armor troops, robots and all types of aerial adversaries high in the sky and swooping down to ground level. This is not the type of combat we knew in the 20th Century and the ages that came before it. This is a fast moving, ground and air battle between augmented humans, robots and fliers — most of whom are one-man units with the firepower of a light tank or the speed, flight capabilities and weapons of a pre-Rifts assault helicopter! The world before the Great Cataclysm has never seen anything like it. And truth be told, no such high-tech war of this potential magnitude has ever been fought on Rifts Earth!!

Yes, there have been stellar battles between man and monsters, war machines against magic or the supernatural — the ongoing war between the New German Republic and the Gargoyle Empire dwarfs anything experienced in North America in its scale, sheer numbers and years of conflict — but never have two technological giants like the Coalition States and Free Quebec ever gone at it tooth and claw.

The advantage Free Quebec has (and why it makes good role-playing) is that the Coalition States do NOT want to level the cities or obliterate their enemy. They want to *conquer* and *dominate* the enemy. There is no value, no reward in blasting one’s enemy to atoms and in the process destroying all the cities, land and resources they had to offer. War is usually about more than winning or killing, its about conquest, economics and politics. The CS wants and needs Free Quebec’s natural re-



sources, technology, manufacturing, cities and people. These things all represent prestige, value, opportunity, expansion and power. A smoking crater is nothing more than empty, blasted earth.

This means away from the border battles and guerilla warfare in the wilderness, the real war — the heart of the conflict — will take place in the cities where *both sides* will try to keep collateral damage and civilian casualties to a minimum. Sure the CS will crush the occasional town or city as an example, but overall, they need to *conquer and preserve* the urban centers. This is where the Quebec Army has a decided advantage. The entire Army is designed for one-on-one “urban” combat. That’s why its Army is composed of thousands upon thousands of (relatively small) power armor troops, cyborgs, Juicers, and small, fast, highly maneuverable one-man fliers from soldiers clad in body armor riding hovercycles and rocket bikes to Sky Cycles and a variety of SAMAS, all ideal for urban combat and guerilla warfare in and outside of the cities. These are troops that can swarm from the skies like angry hornets, appearing from out of the heavens without warning and joined by Glitter Boys and other ground troops emerging from their hiding places like ants, sniping from the ground, rooftops and air before vanishing to fight another day. Hit and run tactics and surgical strikes are the lifeblood and bread and butter of the Quebec Army. It’s what they are designed and trained for. These attacks are made all the more shattering by a strategy to cripple, frustrate and whittle the enemy down rather than destroy it in one fell swoop. Strategies that divide and weaken so that the enemy can be conquered

later, usually at a time and place of Free Quebec’s choosing, or which tire and frustrate the enemy to such a degree (“We’ll never beat these guys!”) that they give up and go home. Their most famous war cry is that “every man is an army” — at least when every man is wearing power armor like Glitter Boys and SAMAS.

Circumstances have made it so the Coalition must fight *Free Quebec’s* war. And it is a fight Quebec could successfully wage for years if not decades!

A unique approach

As noted elsewhere, the Free Quebec forces are not the mad-dogs bent on killing, something that can not be said about many of the Coalition forces. Generally speaking, the leaders and soldiers in the Quebec Military dislike the notion that humans are killing humans. Consequently, the Free Quebec forces are content with crippling warships, giant robots, CS vehicles, power armor, and war machines, cutting communications and blocking supply lines to force the enemy into retreat rather than sending them to their graves. This is especially true of the Free Quebec Navy which has become adept at scuttling and crippling ships while letting the majority of the CS crew survive and limp home from hostile territory. While the Quebec High Command realizes this “humanitarian” approach to war may cost them dearly in the long run, it is their hope that the CS will suffer such great losses in resources and equipment, suffer so many injuries and embarrassing setbacks, that they will give up. However, when push comes to shove, the Quebec troops are willing



to fight to kill. In fact, the air and ground war offers less leeway than the naval battles which usually take place away from inhabited areas and clearly defined lines of demarcation. Here the cost in lives and equipment is much higher in a back and forward battle to push the enemy from some strategic location, hold it as long as possible, lose it and return to take it back again.

Currently most of the fighting is taking place at sea, along the St. Lawrence, and in the vast wilderness that sweeps out all around the *City of Free Quebec*, the population center and heart of the nation. The city is heavily fortified and defended, as are the many smaller cities and towns around it. It is the wish of the Quebec Military to keep as much fighting away from the population centers as possible, so they are trying to wage their war and establish "beachheads" and strategic lines of defense in the remote regions of their country. So far, this has worked well, but these are the early days of the war and it is only a matter of time before the Coalition Army tries to take the City of Free Quebec (a smaller version of Chi-Town) or some other large city. Such an attack will constitute an entrenched battle. Most Military minds believe they can hold out under siege for months, perhaps years, but only time will tell.

Meanwhile, Free Quebec continues to take the war to the Coalition Forces scattered all around it, keeping them angry and off balance. Luring them to give chase to an elusive foe and wasting time, energy and resources.

Situation Critical

By Bill Coffin

Based on suggestions by Kevin Siembieda

Additional text and ideas by Kevin Siembieda

The war in Free Quebec has created various developments that are not in and of themselves theaters in the campaign, nor are they specific mission objectives of either side. They are merely interesting circumstances that have either been created or exaggerated by the war and provide some interesting possibilities to those who care to notice them. These can be the springboards for entire sub-campaigns within your playing of the war in Free Quebec, or they can merely be divergent threads of the larger story line involving the Quebecois' war for independence.

What follows here are brief overviews of some of these "sitcrit" scenarios, a slang term used by Coalition intelligence officers to describe the various quasi-military "situations critical" in and around Free Quebec. Following each overview will be a few **Hook, Line & Sinkers™**, a handy adventure format where only the barest elements for an adventure are provided. The rest of the development is left to the G.M.'s design. Hook, Line & Sinkers work well both as stand-alone adventures, or as stepping stones to a larger campaign.

The Hook is the current situation or location of the adventuring party.

The Line is an opportunity for adventure that presents itself to the player group. Think of this as the "bait" or enticement for the party to enter the adventure.

And finally,

The Sinker is the clincher to the Line. The Sinker presents the party with a dilemma or development that makes the situation a true adventure.

This section contains three Situations Critical: *The Privateers of Montreal*, *The Triax Witch Hunt*, and *Open Season*. These few examples provide a good look at the kinds of situations that are affecting the course of the war. Game Masters, hopefully after reading these you will be familiar enough with this to try designing some of your own. Good luck, and enjoy!

The Privateers of Montreal

First detailed in *Rifts Canada*, the **Island Kingdom of Montreal** is a haven for lawbreakers, smugglers, and other assorted ne'er-do-wells. But unlike Old Bones, it has not become a massive center of clandestine commerce. Instead, now that the war between the CS and Free Quebec has entered high gear, the island state has become a gathering spot for pirates and privateers, scoundrels and cutthroats, all looking for an opportunity to somehow profit from the war.

The two most active classes of brigands on the island are *Pirates* and *Privateers*. There is only a slight difference between the two. **Pirates** are bandits and raiders who use waterways to waylay passersby and relieve them of their goods (and sometimes, their lives). They are usually considered outlaws by every sovereign state they encounter and feared by travelers who may fall victim to them. After all, they are nothing more than common thieves and cutthroats. **Privateers**, on the other hand, enjoy some legitimacy, tenuous though it may be. They are basically pirates during war time who have been hired by one sovereign state to exclusively plunder the ships and coastal communities of another sovereign state. This thin *alliance* with a real nation or kingdom makes them quasi-legitimate war allies and gives them a license to steal, sabotage and destroy. As long as the "privateers" don't cause their ally any problems, stay out of their way, and harass and hurt the enemy (in this case Free Quebec), the "ally" (in this case the CS) is happy with them.

Free Quebec's dominance of the waterways of the north have made piracy there all but impossible. The skilled and tenacious Quebec Navy has fully deployed into the waters north of Old Bones, along the St. Lawrence River and the Atlantic coast, making any CS naval headway upriver impossible. This has stymied plans for a CS invasion of Quebec city (thereby cutting out a long and dangerous overland journey for the troops), and has also given Free Quebec a lane from which ships can pummel any land forces that have strayed too close to the shore. The Quebec Navy is, on average, much more experienced and skilled than the CS Navy, since most of the best and brightest of the CSN were in fact from Quebec before it seceded. As skilled as the Quebec Navy is, they have no problem detecting any CS land or naval incursions, and either withdraw to evade or ambush any forces out to get them. CS air strikes have only been moderately more successful (see the section on the **Quebec Navy** for more details about it and its operations).

Coalition High Command has decided that enough is enough. They need control of the St. Lawrence River for both defensive and offensive purposes, but they lack the experience to do it and

do not have the time to acquire the experience. Moreover, the Quebec Navy's assaults against them have been embarrassing and damaging to the Coalition's reputation for having an invincible military. Consequently, the CS has resorted to "buying" the naval experience and power they need. Enter the *Island Kingdom of Montreal*.

Situated south of the Free Quebec blockade, the swarm of pirates on the tiny Island Kingdom are easily as skilled (if not more so) than the Quebecois', and they also have formidable homebrew naval craft that are speedy, well armed, and ideally suited to high-speed riverine combat. Most of all, these "River Rats" are mercenaries at heart and will gladly fight for the handsome wages the Coalition is offering.

Standard pay for a Montreal River Rat is 3,500 credits a month for basic crewmen, 6,000 credits a month for officers, and 10,000 for captains. Bonus money is paid out for destroyed or captured Quebecois' vessels, personnel and supplies. The general rate is 500 credits for each Quebecois' captured or killed (a confirmed kill), and 20% of the value of any vessels captured or destroyed. **Note:** *Capturing things* is to the privateers' preference, since they can collect their Coalition bounty as well as skim off the top by removing and hiding select items before turning the vessel over to the CS, and then selling the stuff at Old Bones or to other pirates, mercs and adventurers for a hefty profit.

So far, the program has worked nicely, and many privateer crews that had been running dependable but dilapidated ships have cashed in their bonus money to buy new Northern Gun and Manistique Imperium built vessels (As Coalition allies, the CS has allowed the two weapon manufacturers to sell watercraft, weapons, armor and equipment to these otherwise unsavory River Rats at a 25%-50% discount). The CS has also sold its naval "allies" Coalition style Jet Skis and CS Wave Demons with a different paint job to distinguish them from true Coalition Navy troops. Rumor has it that one particularly successful River Rat crew has scored a CS Stingray Mini-Sub and patrol boat from the Coalition for a cool 100 million credits, although many find this difficult to believe. Where exactly these privateers may have gotten that much money is unknown, but they certainly did not get it from CS bounties. (**Note:** All of these craft are fully described in the Coalition Navy sourcebook.)

It is too early in the campaign for the Montreal Privateers to have made any serious impact on the Quebecois' forces in the St. Lawrence and Great Lakes region, but who knows? Perhaps over time, the gradual attrition from constant privateer attacks will erode the Quebecois' resolve to hold on to the river, in which case the Coalition will score a great victory. With their watery backyard left open, the Coalition could throw withering fire upon the Quebecois' at point blank range. Needless to say, this is a development the Quebecois' do not intend to let happen, so they will expend massive amounts of men and material to keep the CS privateers at bay. The way the privateers see it, the deadlock is good for business. If they somehow defeat the Quebecois' Navy — which they do not honestly see happening because the Quebecois' Navy is simply too large, well armed and well-organized (not to mention supported by a strong Air Force) — it would take away the best paying gig these pirates have ever seen. As far as they are concerned, keeping this situation as it is for as long as possible is their goal. As a result, they only do enough to make an impressive dent and keep their Co-

alition patrons happy (only the Coalition seems to think the Quebecois' could actually be driven from the river by these rogues). If by some miracle the Montreal River Rats were to push the Quebecois' back, they would probably ease off long enough to let Free Quebec catch its breath and field more forces. Hey, these privateers know a renewable resource when they see one.

The Mary Ellen Carter

Hook: The Montreal River Rats have scored their first major victory — the sinking of the Quebecois' cruiser Gaumont. Now the once great warship lies at the bottom of the St. Lawrence, where the majority of its arms are ripe for salvaging. The top prize among them are the ship's magazines of long- and medium-range missiles, which according to rumor, *may* have been tipped with nuclear warheads.

Line: For a prize this juicy, everybody in the area is getting involved. The Quebecois' have to get as much off the Gaumont as possible so they can redeploy the weapons to other combat ships. The missile stores in particular are valuable for their long striking distance; it has been weapons like these that make the Quebec Navy such a threatening presence to Coalition Army units inland. The Coalition Army, on the other hand, wants just as badly to deprive them of any useful salvage. In the middle is a small fleet of salvage seekers and treasure hunters who are all willing to take a chance and steal the items before either the Coalition or Free Quebec can get their hands on them. Very valuable booty, indeed.

Sinker: This adventure could be played from the point of view of any of the parties involved (Free Quebec, the CS, pirates, freebooters, mercenaries and adventurers). Regardless of the player characters' loyalty, they will face an uphill battle salvaging the cruiser and keeping other rivals away from it. The first thing is to actually get to it, which probably requires a submarine or power armor. Thankfully, the player characters have the connections to get a *CS Stingray Mini-Sub* on loan from either the CS, Tolkeen, or part of a very successful River Rat fleet. The sub is the intrepid **Mary Ellen Carter**, a rough and tumble combat sub that has been used for salvage operations before in the much deeper Great Lakes. The sub Commander is worried, however, that the relative depth of the St. Lawrence River will make it tough to avoid enemy depth charges or underwater boarding parties.

Once the sunken ship is located, the heroes will have to get out of their submarine and dive around the wreck of the Gaumont. As any experienced diver will attest, poking around shipwrecks can be very dangerous, so the heroes will have to be cautious as they strip the Gaumont of whatever weapons, gear and other valuables that may remain.

All the while, dangers abound. Other salvage craft will be in the area, as well as plenty of other divers. Underwater dog-fights and diver battles are highly likely, subjecting the player group to an unusual and challenging combat scenario. There is also the possibility that monsters in the area will come to investigate. Nothing better to liven up a river dive than the intervention of a Cadborosaurus, eh? Or maybe an aquatic demon or maybe the activity attracts a curious Splugorth Slaver?

After the player characters get what they can from the Gaumont, all they have to do is *fence* the stuff in Old Bones or use it themselves. Chances are, the heroes will be unable to take

more than 10-15% of the ship's salvageable resources and no more than a half a dozen missiles in one trip. By the time they are ready and willing and able to return, the sunken vessel is likely to have been stripped dry and infested with Quebec troops, CS forces, or pirate divers and underwater commandos. What do you say? Is it worth it for another shot at more treasure?

Barrett's Privateers

Hook: Michael Barrett has been the scourge of the lower St. Lawrence for years, sometimes hitting Quebecois' freighters, and sometimes running freelance escort duty for the very same ships only a few days later. Barrett has always survived by playing both sides of the fence, and taking advantage of Free Quebec's very tolerant policy towards riverine piracy. This policy makes it so that each time pirates protect/defend/help a Quebec ship, it earns them an amnesty towards one of their previous criminal acts. It is hardly a perfect system, but it has kept Free Quebec from having to crackdown on the pirates, and it bred an independent river militia that it hoped would be a buffer against the CS Navy. Unfortunately, things have not turned out that way, and Free Quebec would like to reverse that.

Line: The key is recruiting Capt. Barrett to the Quebecois' cause. Many of the St. Lawrence pirates and privateers follow his lead. If he were to weigh in on Free Quebec's side, many pirates who have not yet gotten involved in the war will do the same and work for Free Quebec. It is possible that some of those who currently work for the CS might very well switch sides without warning. A Barrett-led river militia would allow the Quebec Navy to send the privateers southwest past Lazlo and into the Great Lakes to keep a closer eye on Coalition activities. They might also be encouraged to launch missile strikes against Coalition formations far from the front, where they will be less prepared for an attack and more tightly grouped together. All in all, bringing Barrett on board would be a huge help to Free Quebec.

The only problem is, Barrett's retired. He sailed his last cruise some five years ago and now lives in seclusion somewhere on one of the *Prince Edward Islands*, a small Canadian archipelago inhabited only by the occasional sailor, some Faerie Folk, and every once in a while, Splugorth Slavers. Should the player group manage to get to the Isles and locate Barrett, there remains the issue of actually convincing him to return to a life of piracy and privateering. The last time he shipped out, it cost him both of his legs (he has bionic replacements below the knees), so he is not particularly eager to experience combat again. Should he return, it will take him a patrol or two to scrape the rust off his command skills, but he will once again fit easily into the role of riverine Captain and tactician; he is the equivalent of a 9th level Privateer (**Coalition Navy™**, page 117).

Sinker: Barrett is just as open to fighting for the Coalition States as Free Quebec, so it all depends on who presents him with the more attractive offer and most enticing pitch. (Maybe something will appeal to his sensibilities, likes or dislikes to weigh in as an intangible attraction. Money is not everything.) Regardless of whom the player group is working for, there will be representatives of the enemy arriving at Prince Edward slightly before or at the same time the player characters do. How they settle any rivalry (treachery, cheating and backstabbing may, or may not, abound) to win Barrett's support is left to

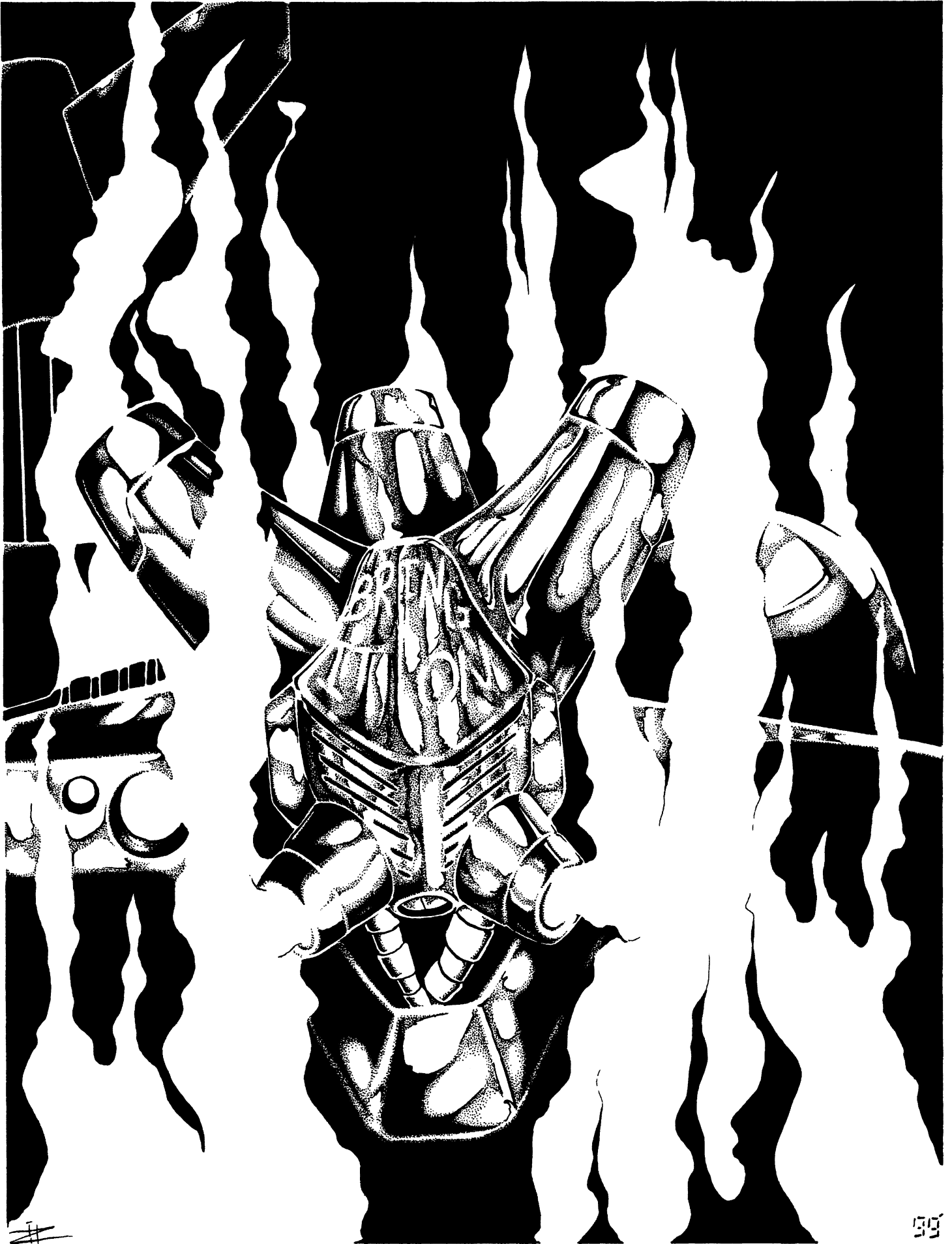

them. Of course, Barrett has his own way of dealing with these kinds of things: no armor and energy pistols at 20 paces!

Running the Blockade

Hook: The Quebec Navy has got the St. Lawrence River locked up for miles, preventing riverine access to the ocean, as well as for ocean vessels to get within 50 miles (80 km) miles of Quebec City (most don't get anywhere near that close). This has prevented the Coalition fleets from coming down the river and assaulting Free Quebec from the water, but it has also choked off a major supply route to and from Old Bones, and the city merchants there are not happy about it.

Line: To alleviate this burden, a cartel of black marketeers and other shady types have scrounged together the means to hire the player characters for a very special mission. The job, should they decide to accept it, is to assemble a fast blockade runner group and try to thread through the Quebecois' ships and establish a risky but profitable lane to the sea. The way will be long and hard, especially in and around the City of Free Quebec, where the heroes will hit a logjam. This stretch of the St. Lawrence (and again at the Gulf of St. Lawrence) is where the Quebec Navy has its strongest presence, supported by Glitter Boy ground forces and Violator SAMAS air wings. A virtual wall of naval firepower to stop anybody from moving up or down river. However, there are holes in the wall, and a good captain in a fast ship should be able to exploit them. If not, one had better be well armed, because after Quebecois' detection, one's only option is blasting his way out.

Sinker: Old Bones is run by Free Quebec, who knows everything about this plan, including who has been hired to execute it. The people in Old Bones who suggested the plan have already been dealt with, but Free Quebec is going to let their henchmen (i.e the player characters) continue their work because it will be a worthy "test" of the Navy's defenses. If the heroes manage to make it through, it will expose a dangerous blind spot in the river blockade. If the heroes do not make it through, they will either be sunk or what is more likely, they will be captured, imprisoned, and given a chance to work off their sentence in the service of Free Quebec, handling situations that require the characters' specialized talents.

The Triax Witch Hunt

Free Quebec does not conduct much business internationally. For the last decade, it has been focused on building up the strength to secede from the Coalition, so expanding its borders and establishing a major global presence are things that have never been priorities for this nascent state. One of the few countries outside of North America that the Quebec people do have extensive contact with, over the last five or six years, is the *New German Republic* and the *Triax* corporation, through which Free Quebec has purchased (non-military) supplies and equipment. This relationship is an offshoot from the Coalition's dealings with Triax/NGR. Triax Industries, being shrewd business people, first cut a trade agreement with Free Quebec (while it was still a member State, hoping to entice the rest of the CS to open themselves up to formal trade), and then decided not to cut off Free Quebec when it seceded. It has, however, stopped selling them military hardware in order to keep its relationship with the Coalition States (besides, Free Quebec really did not need more

weapons anyway). Triax and the New German Republic hope to build a diplomatic and trade relationship with the CS while maintaining their ties with Free Quebec. To this end, they have even offered to broker a cease-fire in which a lasting peace might be reached. So far the CS has declined this offer and their relations with the NGR and Triax are strained.

Despite clear evidence showing that Free Quebec is not currently procuring military hardware from Triax/NGR, the Coalition has always been afraid that such an arrangement is already in place, and any day now, large shipments of top-line Triax hardware will appear on the battlegrounds of Free Quebec. The very notion of this chills the CS High Command to the core. They are already having enough problems with the Quebecois' Glitter Boys and V-SAMs; adding even more advanced war machines to the mix will only make matters worse.

CS Intelligence spends a lot of time and effort tracking as much of Free Quebec's business dealings with Triax/NGR as possible. CS spies have placed themselves in numerous positions throughout Free Quebec's civilian populace at great risk to themselves in the search for any leads to prove Triax/NGR interference (above and beyond the notorious Glitter Boy trade agreement). Not surprisingly, little has turned up since there really are no secret military transactions to uncover! The NGR and Triax are honorable so they feel obligated to live up to their trade agreement with Free Quebec as well as acknowledge them as a sovereign nation. However, in a bid to maintain and even improve relations with the Coalition States, the NGR and Triax have agreed to trade only *non-military* goods to Free Quebec. Being suspicious of everybody, the CS does not believe they will be good to their word and has spent tremendous effort looking for treachery on the part of Triax and the NGR. In fact, the sheer size of the intelligence effort the CS is pouring into this has made their fears self-sustaining. With all those undercover operatives in and around Free Quebec, adventures and fiascos are bound to happen, and when they do, the paranoia of the CS twists what happens into further justification to investigate the Free Quebec-NGR/Triax link even further. In some circles of the CS this is called the "gravy train," since it is a perfectly self-contained series of never-ending crises that keeps the Coalition Intelligence Community busy, and will always receive generous funding (something other branches of the military are jealous of, since they all vie for a larger slice of the budget).

From Free Quebec's point of view, the Coalition spies that keep turning up in its midst are a troubling sign indeed. If Prime Minister Lorne only knew that these spies are just chasing dead ends, he would probably be considerably relieved. But he, like the rest of Free Quebec, does not know what it is that the Coalition spies are after, and until he finds out, security will remain as tight as possible around all import/export, storage, and manufacturing facilities. Predictably, this display of locking down only makes the Coalition more dedicated to discovering what the Quebecois' are hiding. It is a pointless, vicious circle that will eventually end with both sides realizing the irony of it all. But by that time, both will have created huge, powerful spy networks which *may* find other ways of waging silent war upon each other.

Putting the Boot In

Hook: The Coalition High Command has grown weary of the lack of results shown by its army of spies in Free Quebec.

High Command wants answers about Free Quebec's dealings with Triax/NGR, and they want them now! The time for subtlety is over. The time for results has begun. And the High Command knows just how to do it, too.

Line: In a gross violation of an unspoken treaty, the Coalition is sending in an entire Armored Company (160 soldiers, some clad in power armor and SAMAS) into Old Bones to shake down the entire town. One of the countless *rumors* currently floating around this den of iniquity is that Free Quebec has a secret trading depot where Triax drops off German military robots, power armor and weapons. A related rumor has it that Free Quebec is supposedly producing Triax military technology at some secret base in or around Old Bones. The CS is convinced the rumors are true and wants to find incriminating evidence that will expose the fiendish plot and use it as leverage to get the NGR to stop trading with Quebec entirely. Such an invasion by Coalition Forces is unheard of — Old Bones has always been considered a hands-off kind of place for decades. A "DMZ" (De-Militarized Zone) where both sides profit from the incredibly shady dealings going on there.

The reason why Old Bones exists at all is because it is being spared in the war. Were the town the site of constant attacks or threats, it would see business (legitimate and otherwise) reduced to a mere trickle of its current volume. Moreover, the city could be easily invaded or destroyed as it has no "official" army or defense. (On the other hand, the thousands of mercenaries, adventurers and criminals present at any given time tend to provide whatever chaotic and impromptu defenses the town needs. A force the CS troops may have severely underestimated.) The CS apparently does not care about the anarchy and destruction their mini-invasion will cause, or about the unspoken understanding between them and the Quebecois' that Old Bones is off-limits so long as no one side uses it for overtly military purposes (CS, SQ and spies from all over are present in the city). As far as the Coalition is concerned, Free Quebec has already broken their "understanding" by using Old Bones to buy, trade and build Triax hardware, which constitutes a military use. Free Quebec insists that the rumors are unfounded and point out that Triax hardware has never played an important role in their arsenal. After all, Free Quebec has tons of Coalition machinery, the Glitter Boys and more. They don't really need what Triax has to offer, even if Triax were offering it to the Quebecois'.

The Coalition force sent to storm Old Bones consists of 16 ten-man squads. Each squad has four standard Dead Boys (wearing CA-4 standard body armor with jet packs, and carrying CP-40 Pulse Laser Rifles, C-50 Dragonfires, or C-29 Hellfires), two specialists (usually a Juicer, 'Borg, Ranger or Special Forces Commando), three power armor troops (PA-100 Mauler, PA-200 Terror Trooper, PA-07A Light Assault SAMAS, PA-8A Special Forces Strike SAMAS or PA-09A Super SAMAS), and a squad leader wearing CA-6C or CA-6EX body armor and carrying standard infantry weaponry. Typically, a squad leader holds the rank of sergeant. Four squads make a platoon (40 troops), led by a 1st lieutenant. Four platoons make the company (160 troops), led by a captain. During the sweep of Old Bones, the company will split into platoons and sector off the city, then further split into squads if possible to cover as much of the settlement as quickly as they can. The forces going into Old Bones realize that they are too few to actually take over the

town or even do a thorough investigation, so they are focusing on the Trade Center which contains a few specific targets implicated by the rumors. Furthermore, they know there are so many well-armed militants here that any prolonged fighting will end with the destruction of their forces. Thus, the plan is to sweep in fast, disperse, search, and get out before anybody can organize any kind of serious resistance or counter-attack. Two platoons of Super SAMAS and a Death's Head Transport wait in the wings as backup for retreating troops. **Note:** The CS troops have no desire to destroy Old Bones, but won't take many precautions to avoid combat. Parts of the city could suffer if any mercenaries and visitors offer heavy resistance.

Sinker: Shortly after Coalition troops enter the town, all hell breaks loose. Despite the CS High Command's resolve that there is a nefarious plot going on, the rumors are completely false. There is no Triax or NGR presence here, nor any secret factory making Triax equipment. The Coalition has nothing to find here, so despite their searching, they will come up empty-handed, making this entire mess a wasteful exercise in paranoia and futility.

Initially, the Coalition troops will meet scattered resistance from the people of Old Bones. The soldiers are rough and tend to shoot first and ask questions later. Consequently, the level of brutality toward those who appear to be agents, spies or sympathizers for Free Quebec and other shady types is likely to be high. Likewise, casualties among those who offer resistance is also likely to be high.

After about an hour of mayhem, adventurers, black marketeers, bounty hunters, assassins, pirates, mercenaries, and all other manner of armed militants will come out of the woodwork to split up the Coalition invaders and hand them some pay back. That the Dead Boys are in their distinctive black-and-white armor does not help them at all once the time comes for them to cut and run — they are easy targets. By the end of the day, the Coalition Company will probably be decimated, parts of Old Bones will be in flames and 1D4x1000 people will have suffered personal injury or loss of property. Free Quebec will respond viciously due to this, since they see the incident as a dishonorable attack on a previously agreed non-aggression zone. The Coalition will see the operation's failure as further evidence of advanced Triax weaponry (how else were their forces so easily defeated?), but is likely to refrain from any further ill-conceived raids on the city. The drive to find evidence linking Free Quebec and Triax/NGR will remain, however.

Note: This CS raid can lead to all sorts of combat. Players are encouraged to have their characters take a side for this battle. Are they with the Coalition blitzkrieg unit who enter fast and suddenly must beat a life-or-death retreat? Or are they part of the Old Bones payback force that rises up to eject the Coalition from the town? Or, the adventurers might try to work whatever jobs they have or simply be trying to find a safe hiding place until all the craziness blows over, but get attacked or caught in a crossfire.

In addition to straight up combat against the invading Coalition soldiers, there can be any number of non-CS adventures/conflicts instigated by the CS raid. Mercenaries and/or criminals may use the distraction to get revenge on the player group or somebody the group happens to be visiting. Maybe criminals decide to rob a bank or business, or assassinate an en-

emy or rival, or try to get in good with the CS by helping them. Likewise, a spy may use this diversion to break into someplace to steal secrets, kidnap or kill, or get in good with the player characters by pretending to help them or by fighting the CS. Perhaps a group of bullies or human supremacists, fueled by the excitement of the raid, decide to go on a hunting spree and kill themselves some D-Bees trying to escape the carnage and find a safe hiding place or flushed out by the combat. (Do our heroes intercede to help the nonhumans?) Meanwhile, our heroes might find themselves trying to evacuate innocent people from a battle zone, rescue children from a burning building, protect or defend a church or other place or people, or find themselves fighting thieving scum who jump them (to steal what they have) or getting themselves caught in a riot, among other possibilities. By the way, such subplots are likely in any urban combat situation.

A Traitor Among Us

Hook: In their relentless pursuit of information about the non-existent Free Quebec-Triax/NGR arms trade, Coalition Intelligence has uncovered a shocking secret. It seems that *Colonel Alex Flint*, renowned Coalition field commander, has been conducting a weapons trade of his own with the Quebecois! For years before the current hostilities even started, Col. Flint was in a position to handle equipment transfers and acquisitions for the Quebec area. When Free Quebec seceded, he decided to become a private pipeline providing Coalition hardware to the renegade nation. Hacking into Coalition quartermaster inventories, Col. Flint manipulated accounting data throughout the chain of distribution, specifically inflating casualty figures so perfectly unused units could be written off as KIA and privately sold. The Colonel has this process down to a science, making millions of credits each year (which he has prudently socked away in a number of locations), and making many important friends within Free Quebec. He would never have been discovered if a *rookie* CS Intelligence Officer hadn't accidentally searched through one of Colonel Flint's personal accounting databases. Now that his "side enterprise" is blown, the Colonel is a marked man. He needs to get himself into Quebecois' custody, pronto!

Line: Before he goes, Colonel Flint has to make one last business deal, a BIG one that can help him to "retire" in luxury. Using his top-secret clearance codes and his extensive computer hacking knowledge, Col. Flint has commandeered an entire division of nearly 6,000 Skelebots, all recently arrived from the Iron Heart factories, and intends to deliver them to his friends in Free Quebec.

The division contains a total of 5,760 skelebots. On the lowest level, the Skelebots are divided into 10-unit squads, with nine units being new-model *FASSAR-30s* and the tenth unit being a *FASSAR-40 Skelebot Hunter* or less frequently, a *FASSAR-50 Hellion*. The Skelebot Hunters and Hellions are command units and the rest of the squad will follow their lead. Four of these squads make a 40-unit platoon. Four platoons make a company (160 units). Four companies make a battalion (640 units). Three battalions make a brigade (1,920 units). Three brigades make a division (5,760 units). (Statistics and descriptions for the various Skelebots can be found in the **Coalition War Campaign™** sourcebook, pages 122-133.)

Exactly how Colonel Flint gained control over so many combat units is unknown, but Coalition Intelligence suspects he used a little-known networking glitch in the Skelebots to network

them all and slave their robot brains to the units at the top of the division's command structure. In this case, those would be the three divisional command units. The Colonel then placed himself as the human Command Officer for those three units and programmed them so that his orders automatically filtered through the command to all subordinates. His commands are obeyed in unison by the entire Skelebot division!

Sinker: Colonel Flint is fleeing the Coalition front at this very moment, surrounded by what could be considered the largest personal retinue of bodyguards in recent history. He is taking the group through a moderately wooded area to avoid detection from the air so that Coalition Sky Cycles or jet fighters don't just bomb his group to smithereens. The group only has about 100 miles (160 km) to go before it can enter Quebecois' territory and expect some kind of reinforcement. At present, the group is moving at top speed (one of the Skelebots is carrying Col. Flint) and should cross over the border before long.

Both the CS and Free Quebec have scrambled forces to intercept this oncoming mass of Skelebots. Despite their huge number, they really do not present a very effective fighting force due to the way they have all been slaved together. If Col. Flint were to give the command for them to fire, all 5,760 of them would draw their rail guns and fire in the exact same direction, without regard for any *friendly units* in front of them. As a precaution, the Colonel commanded all of the Skelebots to turn off their weapon functions, so currently all they are is a huge group of runners, powerless to defend themselves.

For the player characters, the choice is to play as one of the many Coalition squads (or hirelings) sent in after Colonel Flint, or as agents for Free Quebec sent out to safely rescue Colonel Flint or to prevent the CS from capturing or killing him. Keep in mind that these Skelebots represent a huge material loss to the Coalition Army, and they would just as soon bomb the lot of them than watch them get turned over to Free Quebec. Of course, bombing them all will prove difficult, and doubtlessly some will get away. If Col. Flint makes it into Quebecois' custody alive, he will provide his liberators with a packet of computer CD-ROMs that contains reams upon reams of sensitive Coalition military data — the "real present" he wished to deliver to Free Quebec. (Maybe the player characters are working for a third party who wants this data, or who simply doesn't want it to fall into the hands of Free Quebec.) The Skelebots were really just an extravagant form of body armor for him to wear (hoping his pursuers would have to chew through thousands of skelebots before they could get to him) on his way out. Col. Flint knew that Free Quebec has little use for the mass combat tactics the Skelebots are designed for, and would probably only cannibalize these things for parts. By stealing so many of them, he hoped that the Coalition Army would have no choice but to destroy all of the robots, thereby dealing themselves a serious blow.

Why Col. Flint decided long ago to betray the Coalition is unknown and left to the G.M.'s discretion. Possible motivations might include a disillusionment with the Coalition's heavy-handed approach towards Quebecois' independence, pure greed (the Quebecois' pay well), revenge against military politics (i.e. he's been passed over for promotion so often he's turned traitor), or perhaps just for the thrill of it.

The Hard Sell

Hook: An NGR trade representative has been abducted from his room in Quebec City and both sides want to know where he is. The Coalition Army is convinced he has slipped away for a clandestine arms deal. The Quebecois' fear he has been kidnaped by Coalition operatives, a development that will only complicate Free Quebec's dealings with both Triax and the NGR. Both sides want a speedy resolution to what could become a major problem if left to snowball on its own. Naturally, the player characters are called in to help, or they hear about the situation and offer their unique services.

Line: After following a number of leads and rumors, the heroes learn that the NGR rep is indeed in the city and has been seen making preparations for some kind of secret meeting to take place later that evening. If the heroes spy on the meeting or crash it forcibly, they learn that the NGR rep was not dealing with any Quebecois', but with a *Naruni arms dealer!* It seems this gentleman had made separate contact with the Naruni during his visits to Free Quebec. The Naruni representative, it turns out, is simply furious that his people got forced out of the North American arms market by the Coalition States, and would like to flood the local Quebecois' market with cut-rate Naruni weaponry. At the very least, the rep thinks, they can both make a killing by dumping the weapons in Old Bones or by setting up a separate arms bazaar on the outskirts of Free Quebec. After all, who wouldn't like to get their hands on a Naruni peacemaker?

Sinker: This spells big trouble for both the Coalition and Free Quebec. The appearance of a Naruni (very rare these days) could tip the balance of power in the region for everybody. While the authorities at Free Quebec appreciate this could hurt the invading Coalition Army, the thought of alien arms dealers making back alley deals goes beyond disconcerting. The very fact that the Naruni wish to hurt the Coalition can only mean that the aliens will eventually turn on Free Quebec as well — and with good reason! The Quebecois' are as ardently anti-D-Bee as the Coalition States and they have absolutely no use for sneaky aliens trying to make money by nurturing human fear, hate and greed. Moreover, being strident human supremacists they don't want anything to do with these despicable *aliens* and would NEVER use their weapons or technology under any circumstance. The Naruni know this, so their presence can only undermine the nation of Free Quebec. The Quebec Military (as well as fanatics like the Soldiers of Saint John) doesn't want to see otherworldly beings, especially the Naruni, get even a toe-hold in or around their nation. Thus, the Quebec Military wants these alien troublemakers found and "neutralized" (a euphemism for obliterated) immediately!

The Coalition Army does not want to see more high-powered alien armaments fall into the hands of raiders and bandits already plundering CS supply lines and encampments. Likewise, any revenge plot by the Naruni must be taken with the utmost seriousness. The Naruni never just get one last parting shot in at their enemies; they lay the foundations for vast revenge mechanisms that will make their enemies' lives miserable for generations. That is the Naruni way, and like it or not, the Coalition States have definitely gotten on the Naruni's bad side. Now the High Command fears it is about to see what kind of dividend a Naruni vendetta pays out, unless they can nip this conspiracy in the bud. **Note:** The NGR has similar feelings toward aliens. This

makes the representative a dangerous rogue in direct defiance of NGR law and protocol. If he is uncovered he will be tried as a traitor to humankind and dealt with appropriately.

Exactly how the G.M. handles the Naruni's attempt to establish a sales department in the Quebec area hinges on how he wants to run the game and how the player characters want to handle it. It is very unlikely that the Naruni could establish a covert operation even in a place as corrupt as Old Bones without being discovered and shut down before it ever got going. While the arms meeting may be the immediate climax to the adventure, keep in mind that this situation is not over by a long shot. Even if this Naruni was a rogue solo operator (and he was, by the way), there are bound to be more like him, especially as the war drags on and both the Coalition and Free Quebec find it harder and harder to police their own lands. For the NGR, the death, apprehension or roughing up of their trade representative could have serious diplomatic repercussions for either Free Quebec or the Coalition States, unless it can be proven that he was consorting with alien monsters.

Open Season

Free Quebec's military is famous for its unconventional style of combat, favoring the speed and flexibility of small units and solo operators over the crushing firepower of large, massed formations of soldiers (like the Coalition Army). This unique fighting style, in which "every man is an army," has proven nearly difficult for the Coalition forces to counter simply because it is a way of battle they are not well prepared for. As one Coalition general was quoted as saying,

"The Quebecois' use guerilla tactics, speed and surprise so effectively that they have managed to stymie our every move. It's like a hammer ball opponent who's got a wicked serve on you. Even though you know you can beat him with one hand tied behind you, you still keep falling for that damned screwy serve point after bloody point. Eventually, after losing eight or nine points in a row, you realize that unless you learn to play like your opponent does or somehow counter that serve, you are going to lose the game. It doesn't matter how well you played in all the games before this one, or that your style was different. All that matters is you better figure out how your opponent is getting past you, or he will continue to beat you like a dog until you give up or he takes the game. It hardly takes a genius to see how this applies to our troubles in Free Quebec."

The Coalition has had its own successes with small unit tactics, but even small teams of elite Commandos and Special Forces can not match the sheer mobility, flexibility, and independence of the *average* Quebecois' soldier. It is one thing to pit special team against special team, but the entire Quebec Military fights in this style. The Coalition Military trains its Dead Boys in a more traditional manner. To load up with weapons and ammo, go out a short distance, fire it all, come home and reload, and repeat the process until victory is achieved. They usually use firepower, robots and numbers to win the day. Meanwhile, the average Quebecois' takes a light load into battle and hits the enemy at one place and moves on, hits him again, moves on, and keeps doing it until he has the enemy all tied up just trying to engage him. Forget about accomplishing your mission, for the Coalition soldiers on the front lines, every one Quebecois' soldier might as well be ten or one hundred in terms

of how well they manage to tie up much larger Coalition forces. And that's exactly what the Quebec Military wants to do. They know in the long run they cannot win a protracted stand-up fight against the Coalition's superior numbers and resources. Instead they use their tactics to slow the enemy's progress by creating confusion, crippling supply lines and communications, keeping them on edge and splintering enemy forces into smaller, more manageable groups, effectively *whittling* them down to size. The Quebecois' may not be slaughtering Coalition troops en masse, but they are preventing them from advancing any further into Free Quebec, and for now, that is enough.

Psychologically, the success Quebecois' soldiers have had in an accumulation of small victories over their enemy has been tremendous, keeping morale and confidence high. The Quebecois' rejoice in their victories and remain confident that they shall one day win the war and preserve their independent status. Meanwhile the Coalition Army must wrestle with frustration, a growing mountain of small (even tiny) losses that falsely creates a gloomy defeatist attitude and sense of helplessness combined with strong doubts over whether they should really be fighting their human brethren to begin with. This results in poor morale, self-doubt, self-loathing and festering anger that divides and conquers the enemy from within.

Some Coalition units are beginning to show signs of extreme stress from having to deal with Quebec's unconventional battle tactics. Perpetually frustrated in their attempts to engage the enemy, much less defeat him, many Coalition soldiers are showing serious signs of post-traumatic stress disorder even though they may not have been in close combat or wounded. It is the constant anticipation of coming under fire by an enemy who strikes and fades so quickly that there is nothing to retaliate against. And, when the Quebecois' do attack in force, it is with an amazing, well coordinated, mixed force of Glitter Boys, SAMAS, and other units that have been very successful in ripping apart Coalition front-line units and then retreating away from battle having scored yet another victory. The Coalition Army calls this "erosion warfare" for the gradually disintegrating effect it has on the Coalition soldiers' endurance and "will" to continue the war. Some fear that unless the Coalition Army figures out a way to counter the Quebecois' ingenious means of turning the Army's size against itself, the Coalition will find itself with a large and mostly undamaged army full of soldiers in no shape to fight anymore. A comparatively bloodless victory for Free Quebec, a shattering defeat for the Coalition.

Final Exam

Hook: Deep in the Hudson Forest on the western edges of Free Quebec, a huge Quebecois' force has gathered for a rare joint meeting and training session. This so-called "Sabotage School" is an annual opportunity for Quebecois' soldiers to share stories of their battlefield experiences so all might know what tactics work best against the Coalition Army, and where the enemy seems to be best adapting to the Free Quebec way of fighting. The Coalition has known about "Sabotage School" for a while and has been preparing to strike the next time it is held. High Command feels this event is a golden opportunity to hit an unusually high concentration of Quebecois' forces and score a major victory for the Dead Boys on the front-lines. The player characters in this adventure can be part of the attacking Coalition force, Quebec soldiers attending Sabotage School, or inde-

pendent friends or sympathizers of Free Quebec who were either invited to attend or were merely in the area, noticed the large Coalition build-up and thought to investigate.

Line: This year's attendance for Sabotage School is unusually high, with a force of some 10,000 Quebec soldiers gathered in a particularly remote area of Free Quebec. The soldiers range from simple infantry to Glitter Boy and SAMAS pilots, vehicle drivers, cyborgs, combat specialists, you name it. Virtually every aspect of the Quebec Military is in attendance. Should the Coalition Army strike here and now, it will strike a blow felt across the entire Quebec war machine. That is why the Coalition Army is taking no chances.

The CS ground forces sent to the area roughly equal the Quebecois' numbers, only they are receiving very heavy air support. A wing of 16 *Talon Stealth fighters* will make the first strike, hopefully capitalizing on the element of surprise and showering the area with long-range missiles and mini-missiles while *CSN Dagger Fighter-Bombers* move in to follow up by dropping their cluster bombs all over the area. The Coalition Army hopes that after the initial target area has been saturated, the remaining Quebecois' in the field will be in such a state of disarray that the incoming CS Infantry will be able to corral them for easy capture and circumvent their infamous strike-and-fade fighting style. More importantly, this would be an impressive victory for the CS and bolster sagging spirits among the troops.

Sinker: If the CS strike is a success, 40%-50% of the ten thousand will die in the bombing and thousands more (5D6x100) will be captured, interrogated and imprisoned. The loss will give CS forces confidence and hurt the Quebec Military with a highly publicized defeat and the loss of valuable manpower. That having been said, no battle plan ever survives more than the first few minutes of live fire, and this one will be no exception. The Coalition Army grossly overestimates its ability to simply bomb the Quebecois' into a stunned panic; if it were so easy, they would have been doing it by now, no? Moreover, once the Quebecois' get the *slightest hint* of incoming CS forces, they will scatter so fast and wide that the Coalition will swear that they missed out on Sabotage School altogether. That's where the *player characters* come in. If the Sabotage School can be warned - even given a five minute advance warning, they will scatter and the Coalition Army's plan will flop! Of course, they need to uncover the plot first and be able to warn the Quebec troops before it is too late (that should mean having to outsmart and outrun a squad of CS troops who learn that these characters are out to ruin their wonderful scheme).

Note that even in a spoiled CS attack, the field will favor the Coalition's air power and surprise. Several hundred Quebecois' are likely to die in the bombing or get captured in the ensuing ground attack, but casualties are likely to be minimal (under 1000) if given at least a 10 minute warning (double the casualties and captives if under that amount of time). While the CS may officially claim victory, unofficially they will be thwarted and frustrated again.

The question will be, can the Quebecois' scatter before the Coalition brings their big guns on them? And what happens afterward? The scattered Quebec soldiers will be pursued by CS troops at least until air support arrives, which might lead to an aerial dog-fight and another battle entirely. Many of the fleeing

soldiers will also have to spend 36-48 hours out in the wilderness until they can work their way back to the safety of a Free Quebec military base. While in the field they will need to worry about possible pursuing CS squads, enemy sympathizers, bandits and monsters.

If the Quebec soldiers have five minutes or less time to react, they will scatter, but probably close in for close combat with the CS ground troops to cause the CS air force to stop bombing for fear of killing their own troops (even the CS tries to avoid fratricide). At that point, will the Coalition really be up to fighting the elusive Quebecois' army on its own territory under circumstances it prefers? How well the Coalition performs here might be a sign of things to come for the war's foreseeable future.

See Jean Run

Hook: A Coalition brigade of over 1,000 men, power armor, assault robots and combat vehicles have finally flushed out *Les Jureaux Rouge*, the "Red Twins," a pair of platoon-sized battle groups who have been chewing away on Coalition forces in the field for months. Using the trademark hit-and-run fighting style that has been the bane of Coalition Commanders in this war, these two platoons have accounted for disproportionately high numbers of casualties, injury and damage against their Coalition adversaries. The psychological stress they are inflicting on CS Army personnel within the besieged Coalition units has been tremendous. One CS group, Fire Brigade Eager, has suffered a bizarre form of mass mental breakdown from the "Red Twins'" relentless assault on them. Eager's CO has suffered a kind of psychotic episode recently, and has become obsessed with destroying *Les Jureaux Rouge*, no matter what the cost. Pretty much every last man of Eager Brigade vigorously agrees, as if they have decided it is better to chance death than to endure the constant whittling away of *Les Jureaux Rouge*. No matter what it takes, the soldiers of Eager Brigade have sworn to destroy these Quebecois' units. Period.

Line: Two days ago, *Les Jureaux Rouge* engaged this brigade and retreated as usual, but this time, Eager Brigade successfully gave pursuit and managed to blast the Free Quebec Army units to Kingdom Come! Not pausing to celebrate this rare victory, Eager Brigade set itself to eradicating every member of *Les Jureaux Rouge*, regardless of their willingness to surrender or not. Those few members of *Jureaux Rouge* who did give up were executed on the spot by Eager's homicidal members, who are so bent on liquidating their hated enemies that they have forgotten even the most basic rules of war: not to execute prisoners. While the Coalition Army regularly exterminates practitioners of magic and D-Bees, it does extend this courtesy to other humans, such as those they are fighting in Free Quebec. Moreover, successful interrogation of members from this squad could prove invaluable to the CS war effort, but Eager Brigade doesn't care. They crave only bloody revenge.

Roughly twenty members of *Les Jureaux Rouge* are currently fleeing across the wilderness of Free Quebec, hoping to reach a safe haven where the insane CS troops will be afraid or unwilling to follow. The *Truffault Bridge* is an ideal spot, just nine or ten clicks away, so that is where the remaining *Jureaux Rouge* members are heading at top speed.

Meanwhile, Eager Brigade is giving chase and is trying its hardest to overtake its quarry. Should any *Jureaux Rouge* members fall behind, they are as good as dead. Worse, since there are

so few of these Quebec soldiers, everyone in Eager Brigade (about 1390 remaining troops) will want a piece of the ones they catch from now on. Any *Jureaux Rouge* caught by Eager Brigade will be tortured hideously before his execution. Likewise, anybody even suspected of helping these warriors will suffer a similar fate.

The rest of Able Division, the larger unit of which Eager Brigade is a part, has learned about this situation and is itself rushing to remedy it. The remaining two brigades, *Foxtrot* and *Giant*, are in pursuit of Eager Brigade in the hope of overtaking it and stopping the madness (their fear is that left unchecked, there's no telling what Eager Brigade might do, or how it might accelerate the fighting in that region). *Foxtrot* and *Giant*'s mission is to force Eager to call off the hunt for the shattered remains of *Jureaux Rouge*; better to let them go than to commit wholesale barbarity against the enemy and innocent people and lose what little dignity the Coalition Army has left in the eyes of its enemies. *Foxtrot* and *Giant* hope that by merely telling Eager to stand down, it will, but if they must fire on their CS brothers, then they will. In the Coalition Army, sometimes discipline must be maintained at a high cost.

Sinker: Ultimately, the outcome of this three-part chase depends on what happens at the *Truffault Bridge*, a bottleneck that if destroyed, will cut off one or more parties from the chase and bring the situation to some kind of resolution.

If the player characters are in league with *Les Jureaux Rouge*, then there will be a strong CS Commando force lying in ambush at the bridge with orders to destroy the fleeing *Jureaux Rouge* (player characters seen with them included). Failing that, they are to destroy the bridge to prevent the Quebec soldiers from escaping. That way, the fugitives will be caught between the commandos at the bridge and the fast-approaching Eager Brigade. At that point, suicide might be a good option if some way can't be found of battling their way through. Unfortunately for surviving members of *Les Jureaux Rouge*, none of them have flight capabilities, so getting across that bridge was paramount. The river gorge the bridge spans is easily a third of a mile wide and cuts a nearly vertical channel into the ground. Rappelling down the sides is possible but slow; and with CS Commandos in the area, anybody going down ropes will be at the mercy of CS troops. Should the refugees manage to get across the bridge, they will want to destroy it themselves to cut-off the pursuit of Eager Brigade. In fact, the heroes of *Les Jureaux Rouge* may want to blow the bridge and sacrifice themselves to stop the crazed CS Brigade from continuing its rampage even after they are dead. Thankfully, the CS Commandos have already set charges on the bridge, so all the Quebec soldiers or the player characters need to do is procure the detonators for the charges or install new ones and set them off. The loss of this bridge will be a serious development, however, since Quebecois' forces have used it frequently to ferry soldiers to and from the front. With the bridge gone, troop deployment will be hindered until a new bridge can be built somehow.

Player Notes: In the unlikely event that the player characters are part of Eager Brigade, their objective will be to send a small group ahead to secure the *Truffault bridge* and prevent *Les Jureaux Rouge* from escaping. In this case, the player characters' mission will be similar to that of the CS Commandos in the previous paragraph.

If the player characters are part of Foxtrot or Giant Brigades, then they will be sent ahead to confront and stop Eager Brigade with their orders to cease and desist. If Eager does not heed the order, the player characters will be authorized to use force against them.

Whether the player group is from Foxtrot or Giant, or adventurers trying to intercede to either save the surviving members of Les Jureaux Rouge or stop the rogue Eager Brigade from crossing the bridge where they may do more damage, they are most likely to confront the Commandos from Eager Brigade at the Truffault Bridge. This is a small group of 10 Commandos and the easiest for a small group to engage with any hope of victory. Of course, these madmen from Eager Brigade are not going to listen to reason or impassioned pleas, so this can easily turn into a small-scale fire-fight over who controls the bridge. The Eager Commandos would rather detonate the bridge prematurely and trap the Jureaux Rouge than risk having the player characters capture the bridge and the demolition charges attached to it.

All the while, Les Jureaux Rouge might very well be in the area, observing the confusion. If the heroes emerge from battle victorious but are in no shape to continue fighting, Les Jureaux Rouge will burst forth from their hiding places and try to rush the bridge. If the player characters are still a force to be reckoned with, Les Jureaux Rouge will help them if they are adventurers or unallied freedom fighters, or surrender to them if they are CS troops from one of the other Coalition Brigades. (Les Jureaux Rouge would rather become prisoners of honorable CS troops than risk the homicidal mania of Eager Brigade spilling into the countryside and slaughtering innocent people.) If it looks like they can cross the bridge unmolested by the player group they will do so with a show of mutual respect.

More likely than not, the player characters are adventurers who get embroiled in this because they dislike the CS and nobly try to help the Free Quebec soldiers on the run. This has two bad results; primarily it gets them permanently branded as members of Les Jureaux Rouge, something members of Eager Brigade will *NEVER* forget, and marks them for death. Even if they should abandon their efforts to help the fleeing soldiers, they will be hunted down by Eager Brigade and killed! If they escape, members of Eager Brigade will try to kill them if they are ever encountered again! Similarly, heroic adventurers may realize that they must, or even be asked by Les Jureaux Rouge to, blow the bridge — or prevent the blowing up of the bridge as circumstance dictates. As concerned “heroes,” they are likely to try to help people. If the heroes then blow the bridge, they will be cut off in Quebecois’ territory and could end up becoming Les Jureaux Rouge prisoners! More likely however, is that the grateful Quebecois’ will thank the heroes for their honorable intervention, and they will let them go, telling them of a light, auxiliary bridge twenty miles (32 km) upriver that they can use to cross and get back to their base. Or they may be recruited as mercenaries or special agents to work for the Quebec Military or SQ.

Explosives Note: To set the demolition charges, three successful Demolitions rolls must be made to set all of the charges properly. If all three rolls are not successful, then the bridge will not buckle. The infantry will definitely still be able to cross the bridge. Whether heavy vehicles, power armor or assault robots can cross is up to the G.M.

Eager Brigade Note: Sadly, there is a faction within the Eager Brigade, led by Eager’s psychotic Commanding Officer, Colonel Dirk Bledsoe, who will not back down even to CS Army superiors. After an intense argument, the CO will avoid murderous combat and pretend to comply, however, at the first opportunity he will present to his men his own private agenda of revenge and announce that he is leaving and any who wish to join him should grab their gear and join in his crusade. Roughly two companies (320 troops) will follow him. The rest will do nothing to stand in their way, letting them take whatever gear they need or want and claiming ignorance when later questioned by their superiors. Each of the 320 are AWOL — deserters from the CS Army — and worse, they are a rogue force that will continue to reap havoc on the countryside of Free Quebec. They will rename themselves **Revenge Battalion** with *Fist and Sword Companies*. Their main focus will remain hunting down the survivors of Les Jureaux Rouge, player characters included, as well as anybody who might support the group. Since Les Jureaux Rouge were two companies in the Quebec Army, that’s just about *everybody* living in Free Quebec! CS sympathizers and ambivalent wilderness people are just about the only exceptions. This rogue group of Coalition soldiers will resupply by raiding towns, villages, militia groups, the Quebec Army and travelers, as well as live off the land. They will adopt the guerilla tactics of their enemy, divide into small coordinated platoons and keep to the wilderness and outskirts of civilization where they will wage their own private war until they are stopped one way or another. The CS will be concerned and embarrassed at first, but will do nothing to stop these lunatics. As long as they are functioning within Free Quebec territory and do not attack CS troops, the Revenge Battalion is Quebec’s problem.

Hunters’ War

Hook: A Quebecois’ platoon calling itself Roland’s Revenge has just kicked the stuffing out of a CS company of 160 men that got cut off from its brigade. By the time the Quebecois’ onslaught ended, virtually no CS units were left intact. Many soldiers and power armor/robots/vehicles were *disabled* rather than destroyed, but the utter defeat of the unit demands some kind of retribution. The Quebecois’ have been making numerous radio transmissions from the edge of a nearby forest, apparently with the intention of having CS forces pick them up and triangulate their rough position. This is a typical Quebec Military challenge. They are, in essence, saying: “Now you know where we are. If you are not cowards, why not come in here and get us?” The remains of the Coalition Brigade (three more 160-man Companies) will be compelled to enter the forest, where the widely dispersed Quebec soldiers will hold a vast advantage. The Quebec troops know the terrain like the back of their hand and should have little difficulty dividing Coalition forces and leading them into ambushes or tricking them to fire upon each other. Despite the fact that the Coalition forces know what trouble awaits them in the woods, they will enter anyway. They have no choice, which is the way the Quebec Army likes it.

Line: Something the Coalition troops will not realize until they have entered the forest is that for reasons unknown, this woodland area suppresses radio transmissions of any sort, which is why locals call it the “Static Land.” CS troops will be forced to operate “blindly,” without the ability to call for air strikes or reinforcements. Patches of this kind of “dark territory” are

sprinkled throughout Free Quebec, and they are among the Quebec Army's favorite spots to pick fights because it so heavily favors their style of fighting. Quebec soldiers are used to operating under radio silence in small groups. The Coalition troops, on the other hand, are very dependent on large-formation combat, which requires heavy communications during field operations. Without that, the CS soldiers stand an excellent chance of getting split up and hit from every side by their mobile, fast moving, hit and run adversaries. This situation could become a massacre for the Coalition Companies if they are not careful.

Sinker: Before sending in the entire force, the CS Commander will send in a few "Hunter Groups," parties specifically skilled at small-scale combat who might be able to beat the Quebec soldiers at their own game. These Strike Teams generally consist of only 4-10 soldiers, all of whom are trained in Special Forces operations and operating under radio silence. Therefore the communications blackout of the Static Land will not affect them. These special units are also somewhat familiar with the territory and are used to fighting on unfamiliar ground, which will further even the playing field. Once the CS Hunter Groups enter the Static Land, the rest of the CS force will fan out to encircle the area of forest where the Quebec troops are believed to be located to, as much as possible, prevent them from escaping.

Inside the forest, the battle will boil down to squad and solo engagements as the CS troops and the Quebec forces engage each other. This is the kind of combat the player characters (regardless of what side they are fighting for) excel at. Their individual efforts here in the "Static Land" might determine whether or not the rest of the CS Brigade will have to enter the forest and rescue their teammates and engage the enemy. Ambushes, trap laying, sniping, stalking, counter-stalking, and every dirty trick in the book will be used by both sides as this "hunters' war" kicks into high gear. It could take days of tracking, stalking and combat before the two warring factions sort things out here. The CS brigade on the edge of the forest will wait 1D4+1 days before giving up on the Hunter Groups and coming in en masse. Should this happen, it will be a Quebecois' field day, since the brigade soldiers will exhibit none of the stealthy expertise of the CS Hunter Groups that preceded them. These comparatively clumsy units will be easy to isolate, ambush and destroy for the Quebec freedom fighters. The real question then is whether or not the CS forces will realize how badly they are getting whittled away before they decide to pull out and choose to fight another day, when they can tilt the field more in their favor.

Other Adventures

By Kevin Siembieda & Francois DesRochers

Other adventures can include skirmishes and incidents against the Coalition Army and/or Free Quebec, or have nothing to do with the war at all. Remember, many opportunists and cutthroats are taking advantage of the war and the chaos it creates. This means the player characters may stumble onto robberies, village raids, smugglers, smuggling opportunities, gun-runners and gun-running opportunities, despot mini-kingdoms, quests to find lost magic or treasure, acts of sacrifice, heroism, and all types of adventures. So cut that imagination loose and have fun. Here are just some possibilities.

A Man's Best Friend?

Hook: Players may either be adventuring in the northern forests or sent out as hired mercenaries working for either the CS or Free Quebec as scouts. Rumors of trouble in local villages vaguely speak of beasts howling at night and demonic hounds. The undeveloped Badlands are largely uninhabited and home to D-Bee squatters, woodsmen and a number of monsters. As of late, the northern forests and tundra have become increasingly troubled by strange, predatory canine creatures that "walk like a man." The question is whether these beasts are the legendary Loup Garou, canine D-Bees or something else. In the last few weeks, a dozen Soldiers of Saint John militia men have fallen to the beasts, the bodies of lone D-Bees have been found here and there, and a village of 32 D-Bees was decimated — all victims torn to shreds and sometimes partially eaten. In addition, there have been reports of these animals(?) chasing travelers, killing livestock and howling at the moon. Most attacks have come at night, but some have taken place during the day.

Line: The Coalition doesn't seem to care, but then their presence in the northern wilderness regions of Quebec is thin and spotty at best, so their troops have not yet been victimized by the canine creatures (although the CS troops have suffered plenty at the hands of supernatural beings and monsters of the wilderness). The Quebec Military is concerned, but these monsters in the backwoods are low priority compared to everything else going on. If the player characters are members of the Quebec Army, they may be assigned as a Recce or investigative team to look into the matter. Likewise, squads operating near farms or villages may seek out the problem to help the locals they have come to know, or to protect the innocent.

Adventurer player characters just passing through are besieged by locals who plead with them to "save them from the demon hounds." Unfortunately, they are poor and can not offer more than one thousand credits worth of trade (a fortune for them), along with a warm, dry place to stay and good, hearty food to eat. The G.M. may want to put some sweet children or nice people in harm's way to tug on the heartstrings of the players.

Sinker: The CS doesn't care about these "demon hounds" because they are the ones who unleashed the beasts. These canine predators are packs of **Kill Hounds** (see **Rifts® World Book 13: Lone Star**, page 43, for details). Over a thousand, along with a few other mutant creations, have been released to "soften up the locals" and help eliminate threats from D-Bees and monsters. Kill Hounds are a larger, more savage breed of Dog Boys genetically "designed" to love to hunt and kill, particularly D-Bees, supernatural beings and practitioners of magic. Most are operating in small squads or packs of 6-12 and keeping a low profile — one third have already perished in combat. The perpetrators of the atrocities that have branded them "demon hounds" are a *pack* of 12 Kill Hounds, two Ursa Warriors (see **Lone Star**, page 72), and a trio of Mutant Rats (see **Lone Star**, page 87), all of whom have "gone savage-feral." That's why they are so bloodthirsty, brutal, actually eat some of their victims and occasionally kill livestock just to kill. Although they have all become savage, animalistic predators who have forsaken most of their civilized ways, these mutants are incredibly skilled warriors and hunters equal to any Ranger/Wilderness Scout in the Quebec or CS Army (average 6th level experience;



the leader of the pack is a hulking Kill Hound named Brutus and he's 8th level). All are masters of surprise and guerilla warfare, making them difficult to track down and capture or kill. All are deranged and beyond rehabilitation. They must be destroyed. Good luck, 'cuz killing even one will bring the wrath of the entire group on the perpetrators' heads.

D-Bee Uprisings

Hook: The northern ruins of Old Bones have exploded with D-Bee and radical human supremacist acts of violence (possibly the handiwork of a faction of Soldiers of Saint John). These have boiled over into the city proper and have begun to attract the attention of the Coalition and Quebec Armies.

Line: Player characters who are soldiers or working with Free Quebec may be sent in to investigate the reasons for the unrest and quell the problems. Or the characters may be hired by local heads of business (perhaps secretly the Quebec authorities) to find out what's going on and put an end to the rabble-rousers one way or another (without implicating the government or military of Free Quebec). There should only be moderate amounts of support by the locals.

Although the suggested setting is Old Bones, this sort of trouble could take place in any border town where D-Bees are illegally kept as slaves or where nomadic D-Bees have a strong presence.

Sinker: The D-Bee uprisings may be fueled by one of the following:

01-25% A charismatic, "Spartacus-type" escaped D-Bee slave who is trying to inspire his fellow slaves to revolt, reclaim their freedom and escape.

26-50% Coalition undercover operatives stirring up trouble to ferret out Free Quebec spies or soldiers in order to pick them off, or as a diversion to cover some other nefarious plot.

51-75% An alien god or demon lord is worshipped by a secret D-Bee cult (slaves and free beings), and their god has given them some holy quest (good or evil) that has stirred up the locals, and maybe has attracted more D-Bees from the outside. Nobody yet knows what this is all about but it can't be good! (If evil, some D-Bees may be witches or practitioners of dark magic and may be trying to open a portal to let their "god" or his minions into Rifts Earth). **Note:** Depending on the magnitude of the danger such a cult may represent, Coalition troops might actually join in stopping supernatural evil. This could involve the player characters, adventurers, and Quebec soldiers fighting along side Coalition troops to destroy a common enemy before it destroys Old Bones or causes greater problems.

76-00% Something as simple as a revolt caused by mistreatment at the hands of cruel slave masters or a faction of human supremacists.

Dangerous Game

Hook: Both the Coalition and Quebec troops continue to engage in skirmishes and military exercises along a particular border region. Each side blames the other for being the aggressor.

A tense cat and mouse game is being played between the two sides, where patrols that encounter each other rattle their sabers and engage in increasingly bloody skirmishes. Each has heard rumors that the other will soon strike with the intent of destroying their enemy.

Line: Both sides have Intelligence reports that confirm a major assault will be launched soon, and both camps are armed for all-out war. Anything could ignite this powder keg.

Player characters can be on either side as official troops or as independent, freelance guns for hire, or as outsiders or spectators.

Sinker: The player group learns a crack group of mercenaries have either been hired by an outside force (the Federation of Magic, Tolkeen, A.R.C.H.I.E. Three, or others) to increase tensions between Chi-Town and Free Quebec, or who have no love for either side, and have instigated this battle as a “bit of sport.” They have taken bets among themselves and a few other groups on who will win the fight, and now all that needs to be done is light the fuse to start the “game,” sit back and enjoy the spectacle. If the player characters can uncover this scheme (the parties involved are proud of themselves and brag about it regularly) and get some kind of proof they can deliver to the two warring factions, they can stop, for now, a small war.

Rescue the CS?!

Hook: The player groups hears (and sees?) the sound of combat not too far off in the distance.

Line: A squad of Coalition Soldiers are locked in life and death combat against some powerful force other than Free Quebec troops. This can be an evil dragon, pack of Loup Garou, demons, monsters, bushwhacking bandits, evil sorcerers, and so on. The CS appears to be on the losing end of this fight. Do the player characters help save them or turn their backs?

Sinker: Is the group’s decision any different if the CS are fighting to protect a small band of innocent and terrified human civilians (woodsmen, fishermen, farmers, family, travelers or children)?

The Patrol

Hook: A squad of CS or Free Quebec soldiers (perhaps on border patrol or reconnaissance) stops the player group to question them.

Line: They are looking for suspicious characters who may be enemy agents or in league with the enemy.

Sinker: If the player characters stay cool and calm, don’t take any pushing, bullying tactics or insults to heart, and maintain their innocence, the soldiers will let them pass (“Look, we don’t want any trouble. It’s like Ryan said, we’re just passing through and don’t want any part of your war”). If the player group sasses back, makes a threat, or pushes back, a fire-fight will erupt then and there. The soldiers will genuinely believe they have uncovered the enemy and will fight to kill. Reinforcements (if available, only a 01-33% chance) may be summoned.

Militia Madness

Hook: A squad of human supremacists (Soldiers of St. John?) are on a tear.

Line: Any D-Bee or mage in the player group will mark the entire team as “D-Bee loving scum” to be exterminated.

Sinker: The player group can run but can not hide. These lunatics will follow them and fight to the death. Combat can not be avoided.

No Entry, Turn Back

Hook: Both the Coalition and Quebec Army have marked off areas as no-man zones. Posted “No Entry” signs (and sometimes barbed wire and land mines!) typically denote the borders of such “zones.”

Line: Anybody found within a zone of no entry is presumed to be an enemy or dangerous intruder and is gunned down, no questions asked.

Sinker: If travelers ignore the signs or don’t pay attention and accidentally wander into a no entry zone they *will* be attacked. *Skelebots* are frequently stationed in CS no entry zones (intruders will encounter 1D6 at a time) to supplement a small number of human troops, mostly snipers and Rangers. The only way to escape alive is to flee the zone. Sounds of combat will attract other forces in the area to join the battle. Typically, combat troops (and Skelebots) stationed in the these zones do not pursue intruders, content to have slain a few while in the zone or chase them away.

Bandits!

Hook: Cutthroats are taking advantage of the war, the chaos it brings and the lack of lawmen to protect civilians.

Line: Banditry in and around Free Quebec is at an all-time high, and guess what, the player group is under attack. This isn’t any act of revenge or hate crime, just good ol’ fashioned bushwhacking inspired by greed. The strong take from the weak. These scum-bags are inexperienced, mostly 1-3rd level bandits, Wilderness Scouts and Headhunters, but they outnumber the player group by two or three to one, so they figure they can win.

Sinker: Its time to show these punks who’s strong and who’s not. They will flee or surrender when half their number is defeated, captured or slain. Ironically, if our heroes are victorious “they” should be able to get some valuable *booty* (E-Clips, weapons, food, and info) from their would-be attackers.

Delivery

Hook: The adventurers are approached by a smuggler or member of the Black Market.

Line: He or she wants them to deliver a package to somebody behind Coalition lines (perhaps to Lazlo, Northern Gun, Iron Heart, or just about anywhere). The pay is excellent, 50,000 credits per man! 10% paid upon acceptance of the job, the rest upon delivery. Note that the smuggler won’t approach anybody who has a reputation for breaking contracts.

Sinker: The trick is slipping past Coalition troops and getting in and out alive to collect payment! A feat made all the more difficult by the fact that the tiny package contains either coded information or scrambled video footage that is incredibly damaging to the CS war effort or one of its top commanders. That means CS soldiers of all types (grunts and Dog Boys to Juicers, SAMAS and Robot squads) will be hot on their trail every step of the way. (That having been said, the CS troops encountered should never be more powerful than the player group, unless there is some easy avenue of escape left open to the adventurers).

If there is any good news it has to be one of the following:

1) If cornered or captured, the CS pursuers will be satisfied with getting the package (knowing the group couldn't read the data) and let them live (but only after confirming they have the right package/info).

2) If by some miracle the group manages to get to the drop point and meet with the agent they are to deliver the package to, they can argue for better pay (obviously the package is incredibly valuable). Each character can get as much as 100,000 Universal credits, but not a nickel more because the agent doesn't have any more funds available, and more CS troops will arrive at any minute. He may promise more, but they will never see him again. If they delay the hand-off, they miss the window of opportunity, and a platoon (yes, a platoon) of CS soldiers arrives and the player group must make a hasty retreat or be captured. Escape will save their necks, but the buyer is gone, there is nobody else who wants it, and the info (because it is time sensitive) becomes worthless. Greed does not pay.

Please help us, please

Hook: A town or village is being terrorized by bandits, a gang of mercenaries or D-Bees.

Line: They beg the player characters to liberate or save them from these cruel marauders.

Sinker: Walk away and innocent people, including families, will suffer terribly from these brigands. Time to take a stand?

D-Bee Warpath

Hook: With the Quebec Military spread out thin, there aren't enough defenders to adequately protect the wilderness settlements. **Line:** A small army of 1D4x100 evil D-Bees, divided into squads and platoons, have decided it is payback time and are raiding and burning down human farms and villages (they aren't bold enough to attack Quebec soldiers and avoid them). Innocent people are being raped, tortured, enslaved and butchered.

Sinker: Our heroes happen to stumble across such a raid leveled against a small village, town or farm. The D-Bees are winning but showing no mercy. People will die unless somebody intervenes. The problem is, while these brutes can probably be easily surprised and frightened into running away, they will return in 1D4 days with twice as many warriors. Worse, if they identify any members of the player characters' group, they will be remembered and marked for revenge. If things go badly, the player characters could find themselves on the run from the D-Bees' vengeful comrades and family members. **Note:** Most of the D-Bees are half the level of the player characters and poorly equipped.

D-Bees in Trouble

Hook: 1D4x12 D-Bees are being held prisoner.

Line: Their fate is obviously bleak; i.e. they are about to be sold into slavery, or tortured and eaten by something monstrous, or gunned down by CS, Quebec or other human supremacist forces.

Sinker: The villains harassing the D-Bees (men, women and children) are no bigger than the player group, but just as powerful (or slightly more so). However, if the player characters intervene they might be able to save a dozen or more innocent nonhumans.

Human Sacrifice

Hook: Rumors have been circulating for months that a Necromancer, evil Shifter/Summoner, Witch or other vile practitioner of the black arts is up to no good. A number of dead humans, clearly the victims of ritual sacrifice, have been found dumped in the woods. Nobody knows who is responsible, or why these murders are taking place.

Line: Surprise, you found the culprit! The player group accidentally stumbles onto a sacrificial ceremony in progress, or learns about an evil Sorcerer or Witch and tracks him down to his lair, with victims locked away, waiting to be sacrificed.

Hook: Player characters to the rescue? Exactly what the evil mage is up to we leave for the Game Master, but it is probably self-serving. Once defeated, any booty the villain (and his henchmen/servants or followers or minions) may have is up for grabs to the player characters. In addition, if the situation is handled bravely and the prisoners are treated with kindness, the group is likely to win the admiration and help of the victims' families or even an entire community.

Experience Points

Descended	Glitter "Girl" Pilot	Side Kick RPA & Reloader O.C.C.
1 0,000-2,150	1 0,000-2,150	1 0,000-1,950
2 2,151-4,300	2 2,151-4,500	2 1,951-3,900
3 4,301-8,400	3 4,501-8,800	3 3,901-7,450
4 8,401-17,500	4 8,801-18,000	4 7,451-14,600
5 17,501-25,600	5 18,001-26,000	5 14,601-21,800
6 25,601-35,700	6 26,001-36,300	6 21,801-30,200
7 35,701-52,800	7 36,301-53,500	7 30,201-40,200
8 52,801-72,900	8 53,501-74,500	8 40,201-53,200
9 72,901-98,500	9 74,501-100,000	9 53,201-73,200
10 98,501-132,500	10 100,001-135,000	10 73,201-103,200
11 132,501-183,500	11 135,001-185,500	11 103,201-138,200
12 183,501-235,000	12 185,501-237,500	12 138,201-190,000
13 235,001-285,000	13 237,501-297,500	13 190,001-242,000
14 285,001-345,000	14 297,501-357,500	14 242,001-292,000
15 345,001-410,000	15 357,501-417,000	15 292,001-352,000

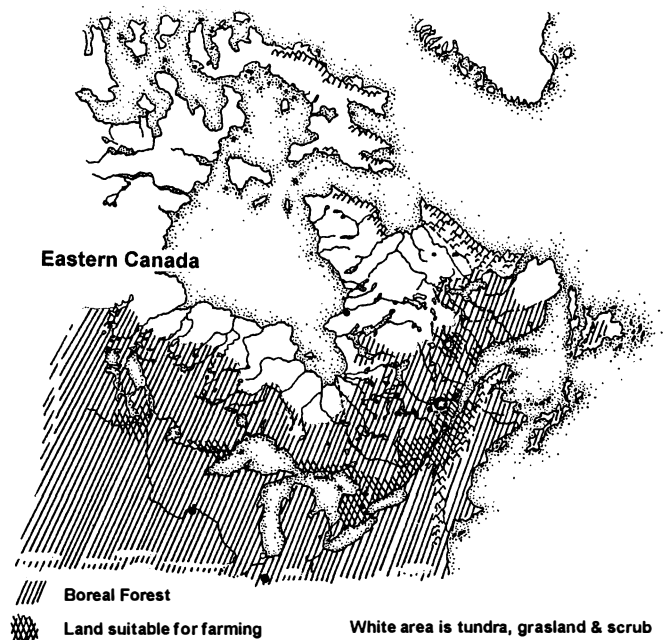



CS Battle Lines

Skirmishes and Incursions are currently taking place all along these areas.

The Quebec Army is positioned to engage these forces and protect population centers and places of strategic importance.

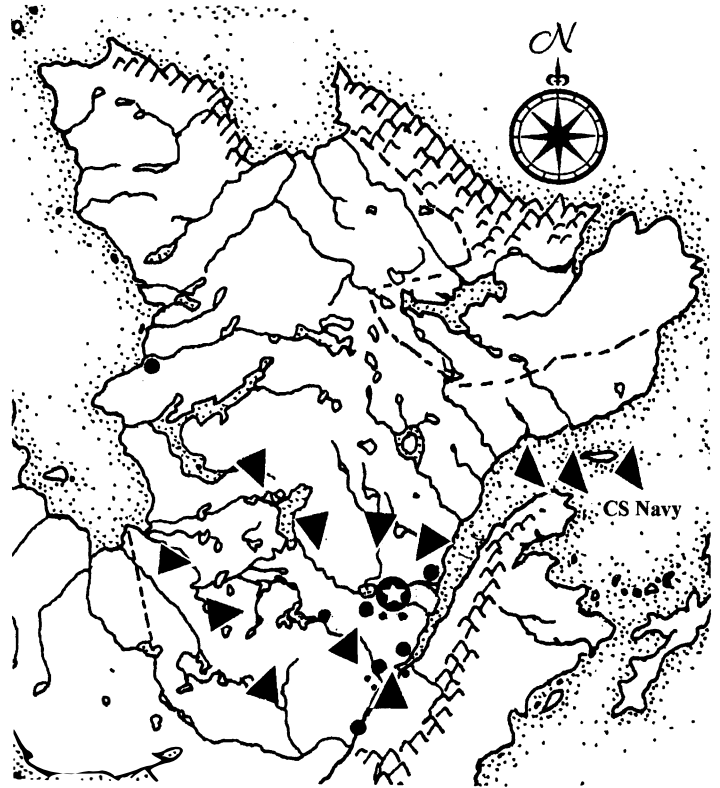

CS "Plan of Attack"

Over the next 2-4 years, the CS expects to encircle and over power Free Quebec.

However, this plan is not likely to succeed. All CS Navy and Northeast forces will be eliminated or contained by the Quebec Navy (with ground and air support). This means the Coalition's Strongest line of attack will be the West and Southwest.

CS Northern troops will continue to be plagued by monsters, bandits, militiamen and Quebec Recce and Rangers.

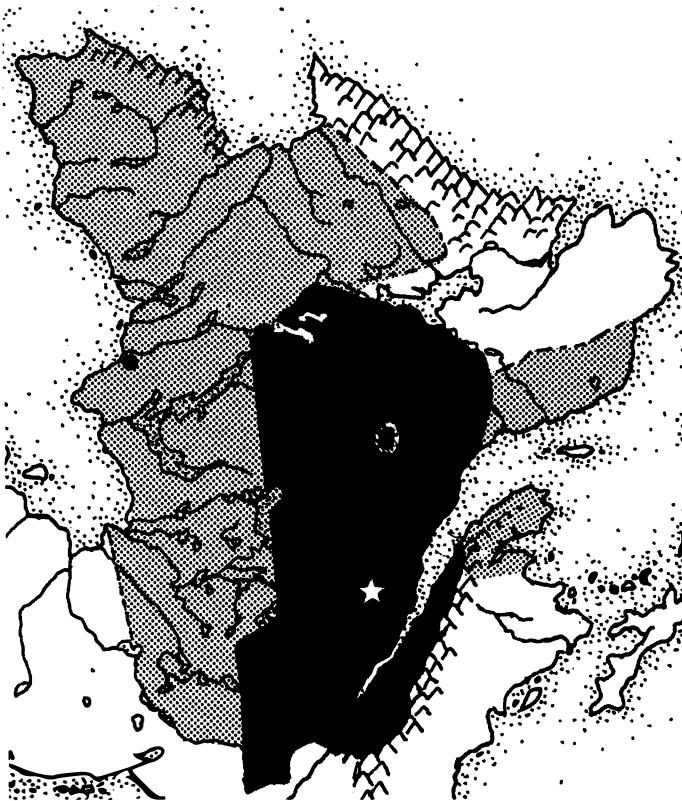

Free Quebec

The black area is the heartland Free Quebec and the most heavily populated region.

The grey area is all the land claimed by Free Quebec — The Old Province

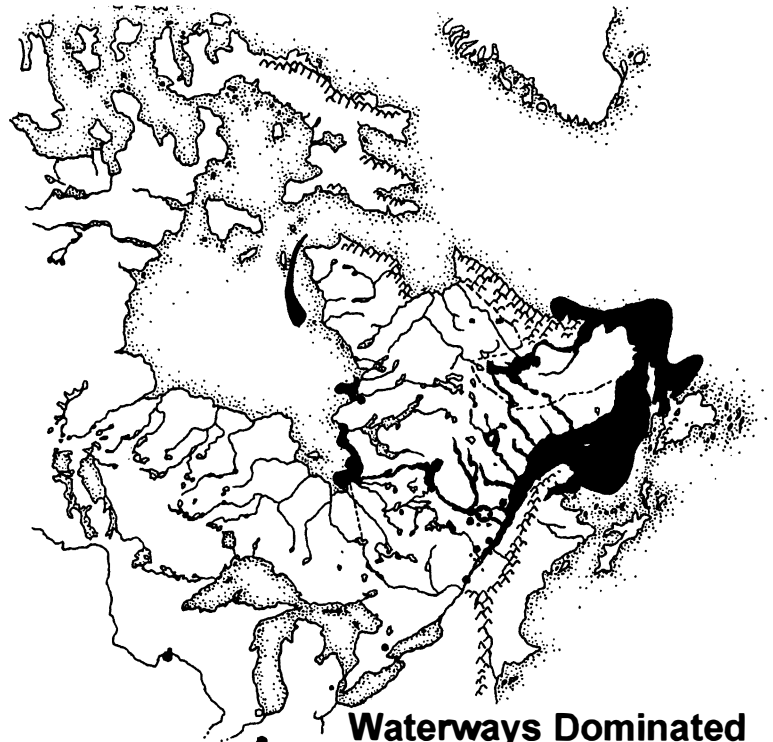

Waterways Dominated by the Quebec Navy



RIFTS®

- Imagine Earth transformed into an alien landscape.
- Humans exist – barely. And we are not alone.
- Aliens and monsters emerge from the Rifts – holes torn in the fabric of space and time, connected to countless worlds and realities.
- Ancient gods, demons and magic have returned.
- Magic and technology clash.
- Hundreds of character classes, many inhuman.
- *Rifts® Ultimate Edition* is the core RPG rule book.
- Expansive world setting with 90+ sourcebooks to draw upon.
- Rifts®, your portal to endless adventure.
- Limited only by your imagination.

www.palladiumbooks.com

© 2014 Palladium Books. Rifts®, Megaverse®, Nightbane® and other titles, slogans and likenesses are trademarks of Palladium Books, Inc. Palladium Books - 39074 Webb Court, Westland, MI 48185 USA - 734-271-2903 order line.

Other RPG Worlds from Palladium Books®:

- *Rifts®* – the ultimate role-playing experience.
- *Rifts® Chaos Earth®* – Play the apocalypse as it happens.
- *Splicers®* – Weird science. Bio-tech battles insane robot legions.
- *Robotech® RPG* – All eras of the TV show brought to life.
- *Dead Reign™ RPG* – Can you survive the Zombie Apocalypse?
- *Palladium Fantasy RPG®* – Unique world, monsters as player characters, magic and more.
- *Heroes Unlimited™ RPG* – Play any hero; mutants, aliens, cyborgs, superhumans, mages, immortals and more.
- *Nightbane® RPG* – Conspiracy, magic, horror and monsters.
- *Beyond the Supernatural™ RPG* – Modern horror and suspense.
- *Ninjas and Superspies™*, and more.

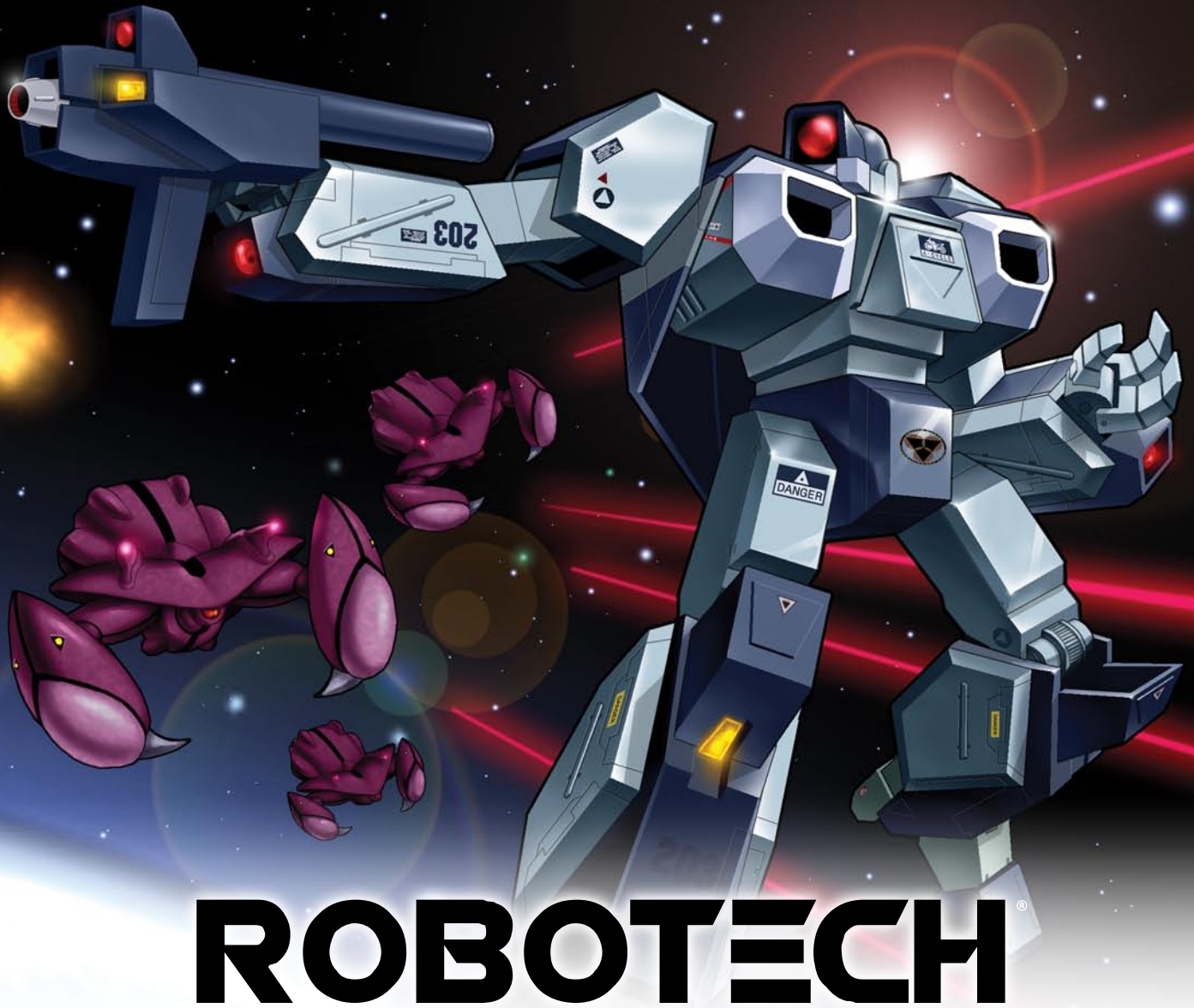

ROBOTECH®

Role-Playing Game and Sourcebooks

- **Four generations of heroes and mecha** • **Giant transformable robots** • **Alien invaders** • **Battle for control of the Earth** • **Combat takes to the stars** • **All presented in a core rule book and dynamic set of epic sourcebooks** • **Easy to learn** • **Fun to play** • **Quick character generation** • **Fast combat** • **Captures the action and adventure of the anime TV series** • **Isn't it time you joined the adventure?**

Robotech® "Core Rules" – Shadow Chronicles® RPG Hardcover

All the rules and information a player needs to start a Robotech® role-playing campaign with Admiral Rick Hunter and the United Earth Expeditionary Force trekking across the galaxy.

- Human mecha: Alphas, Betas, Cyclones & much more.
- Five character classes. 25 different Military Specialties.
- Invid mecha, Haydonites, and alien enemies.
- Quick roll character tables. Make a character in 15 minutes.
- A complete, stand-alone RPG.
- 224 pages. Cat. No. 550HC. 8½ x 11 size, hardcover.

Robotech®: The Macross® Saga Sourcebook – Cat. No. 551

A treasure chest packed with the iconic mecha, vehicles, weapons and characters that made Robotech® famous. Valkyries, Destroyers, ground vehicles, aircraft, spacecraft, weapons, Zentraedi soldiers, Zentraedi mecha, alien invaders, heroes, villains, and more.

- All the iconic Macross mecha, vehicles, weapons & characters.

www.palladiumbooks.com

Robotech®: The Masters Saga™ Sourcebook – Cat. No. 552

Tons of never before seen stats and descriptions for the many weapons, armor, mecha and robots of the Army of the Southern Cross.

- The Army of the Southern Cross™ – all 15 branches and their mecha!

Robotech®: New Generation™ Sourcebook – Cat. No. 554

The battle for the liberation of Earth starts here.

- Kit-bashed mecha combining parts from different mecha.
- Invid Hives, world overview, key characters and adventure ideas.

Robotech®: Genesis Pits™ Sourcebook – Cat. No. 555

The Invid Genesis Pits, their purpose, function.

- Inorganics and other war machines of the Invid Regent.
- Genesis Pit mutations and monsters.

Robotech®: Expeditionary Marines Sourcebook – Cat. No. 553

Join the UEEF (United Earth Expeditionary Force) led by Admiral Rick Hunter as they travel across the galaxy liberating planets from the bondage of the Invid Regent, the Robotech Masters and other tyrants.

- New mecha, weapons, and character classes of the UEEF Marines.
- New alien species and allies. Planet hopping and more.



ROBOTECH

RPG TACTICS™

Main Boxed Game – Cat. No. 55100 – Available Now!

A fast-paced, strategy battle game that captures the speed and action of Robotech®. Play Earth defenders or Zentraedi invaders.

- Scalable from small squad skirmishes to mass battles.
- Turn-based system of play and uses D6. Two or more players.
- 34 highly detailed game pieces. 6mm scale.
- 112 page color rule book with paint guide and index.
- 53 laminated, color game cards.
- 24 custom dice, two decal sheets and more.
- Assembly and painting required. Glue not included.
- \$99.95 retail – Cat. No. 55100 – shipping now!
- Available in North and South America, the EU, Australia & New Zealand.

Note: Each product contains plastic game pieces requiring assembly and painting. Glue not included. This is not a toy. Small parts, not suitable for children under the age of 13. Adult supervision advised. Images shown here are not to scale.



UEDF Valkyrie Wing™ – Cat. No. 55201

Build your fleet of Earth defenders with the Valkyrie Veritech Fighter; six game pieces total. **\$36.95 retail.**

- 2 Valkyries in Fighter mode.
- 2 Valkyries in Guardian mode.
- 2 Valkyries in Battloid mode.
- Multiple heads for making the VF-1A, VF-1J, VF-1R & VF-1S.



UEDF Tomahawk/Defender Destroids™ – Cat. No. 55202

Expand your Destroid squad with these formidable walking tanks; four game pieces total. **\$32.95 retail.**

- 2 Tomahawk Destroids – the main battle tank of Destroids, brimming with powerful particle beam cannons for arms, and wielding a battery of missiles and an array of other weapons.
- 2 Defender Destroids – a long-range, anti-aircraft juggernaut capable of shooting down incoming Zentraedi Battlepods and Gnerl Fighters.



UEDF Spartan/Phalanx Destroids™ – Cat. No. 55203

Add some long-range power and up-close punch to your army with these valuable Destroids; four game pieces total. **\$32.95 retail.**

- 2 Spartan Destroids – civil defense, riot control and deadly in hand to hand combat.
- 2 Phalanx Destroids – a walking, long-range missile artillery unit.



Zentraedi Regult Battlepods™ – Cat. No. 55401

Expand your Zentraedi forces with their main infantry battle mecha; six game pieces total. **\$36.95 retail.**

- 6 Regult Tactical Battlepods – the lightning quick Regults, armed with a pair of particle cannons and auto-cannons, attack in wave after wave.



Zentraedi Artillery Battlepods™ – Cat. No. 55402

Give your Zentraedi legion greater firepower with these artillery and support Battlepods; four game pieces total. **\$36.95 retail.**

- 4 Zentraedi Support Battlepods, each of which can be made into:
 - Gluuhaug-Regult – Light Artillery Battlepod
 - Serauhaug-Regult – Heavy Artillery Battlepod
 - Telnesta-Regult – Experimental Particle Beam Battlepod
- Four game pieces total.**



Zentraedi Glaug Command™ – Cat. No. 55403

This diverse pack provides your Zentraedi forces with greater tactical capabilities; three game pieces total. **\$36.95 retail.**

- 1 Glaug Officer's Battlepod – the fast and deadly mecha of Zentraedi field leaders.
- 1 Quel-Regult Scout Battlepod – the stealthy eyes and ears of your Zentraedi battle force; electronic warfare capabilities.
- 1 Quel-Gulnau Recovery Pod – enhances the Glaug's ability to bring in Battlepod reinforcements. **Note:** This figure has NEVER before been offered by any company.



Can YOU survive the Zombie Apocalypse?



Dead Reign™ RPG

It is the aftermath of the *zombie apocalypse*. Civilization is gone, the dead reign, and the living fight to survive against impossible odds. Tales of zombies, human survival and horror as a fast-paced, easy to learn game and sourcebooks.

- **Zombie combat rules, vehicles and equipment.**
- **Six iconic Apocalyptic Character Classes and Ordinary People with 40+ occupations to choose from.**
- **Seven types of zombies plus the Half-Living.**
- **Secrets of the Dead and tips on fighting zombies.**
- **Death Cults, their Priests, power over zombies and goals.**
- **101 Random Scenarios, Encounters and Settings.**
- **100 Random Corpse Searches and other tables.**
- **Quick Roll Character Creation tables (10 minutes).**
- **A complete role-playing game by Siembieda and others.**
- **\$22.95 retail – 224 pages – Cat. No. 230. Available now.**

Civilization Gone™

Dead Reign™ Sourcebook One

It has been months since the dead rose to attack the living. Civilization has crumbled. There is no army, no government, no help coming. You are on your own and things are only getting worse.

- **Madmen and Psychopaths including the *Zombie Master, Ghost Walker, Backstabber, Messianic Leader, Zombie Lover, Deathbringer* and others.**
- **Bandits and Raiders who prey upon other survivors.**
- **Street Gang Protectors and their mission to save lives.**
- **Phobia and Obsession tables. Many adventure ideas.**
- **House and home resource and encounter tables.**
- **Random encounter and survivor camp creation tables.**
- **Additional world information and survival advice.**
- **\$12.92 retail – 64 pages – Cat. No. 231. Available now.**

Dark Places™

Dead Reign™ Sourcebook Two

Secrets of survival, including using railroad tracks and the urban underground to travel unseen and undetected by zombies.

- **Worm Meat, Bug Boy, Sewer Crawler and Impersonator Zombies.**
- **“Live Bait” zombie lures with human beings as bait.**
- **Traveling the rails and boxcar encounter tables.**
- **Traveling sewer tunnels, steam tunnels & other dark places.**
- **The pitfalls and dangers of the urban underground.**
- **Diseases, infection and additional world information.**
- **Random encounter tables, boxcar content tables, and more.**
- **\$12.92 retail – 64 pages – Cat. No. 232. Available now.**

Endless Dead™

Dead Reign™ Sourcebook Three

The zombie hordes grow in number and strangeness. Can humankind survive? Where is the military?

- **New types of zombies like Fused Zombies and Walking Mass Grave.**
- **New O.C.C.s including Wheelman and Zombie Hunter.**
- **Info & tables for weaponizing vehicles and vehicle combat rules.**
- **Random encounter tables for military bases, police stations, gun stores, buildings, suburbs, industrial parks, small towns, farmland and wilderness.**
- **Tables to make Survivor caravans, hideouts, Safe Havens & more.**
- **Timetable for setting zombie campaigns & many adventure ideas.**
- **\$16.95 retail – 96 pages – Cat. No. 233. Available now.**



Other horror titles from Palladium Books®

Fear the Reaper™

Graveyard Earth™

Beyond the Supernatural™ RPG

Nightbane® RPG series

© Copyright 2012 Palladium Books Inc. All rights reserved. Rifts®, Palladium Books®, Megaverse®, Nightbane®, Heroes Unlimited, Dead Reign and other published book titles, names, slogans and likenesses are trademarks of Palladium Books Inc.

www.palladiumbooks.com

Palladium Books® Check List & Order Form

Dept. P-16, 39074 Webb Court, Westland, MI 48185

Name: _____ Address: _____

City: _____ State: _____ Zip/Postal Code: _____ Country: _____

Credit Card Number: _____ Expiration Date: _____ Visa MasterCard

Telephone Number: _____ Signature: _____ AMEX Other

The Rifter® Series

- ___ 090 Best of The Rifter® – \$12.95
- ___ 170 The Rifter® #70 – \$13.95
- ___ 171-172 The Rifter® #71 & 72 – \$24.95
- ___ 173 The Rifter® #73 – \$13.95
- ___ 174 The Rifter® #74 – \$13.95 (Spring)

Splicers®

- ___ 200 Splicers® RPG – \$23.95
- Note: Sourcebooks coming soon.

Dead Reign®

- ___ 230 Dead Reign® RPG – \$22.95
- ___ 231 SB 1: Civilization Gone™ – \$12.95
- ___ 232 SB 2: Dark Places™ – \$12.95
- ___ 233 SB 3: Endless Dead™ – \$16.95
- ___ 234 SB 4: Fear the Reaper™ – \$12.95
- ___ 235 SB 5: Graveyard Earth™ – \$12.95
- ___ 236 SB 6: Hell Followed™ – \$20.95 (coming)

Rifts® Novels

- ___ 301 Sonic Boom™ – \$9.95
- ___ 302 Deception's Web™ – \$9.95
- ___ 303 Treacherous Awakenings™ – \$9.95
- ___ 304 Tales of the Chi-Town 'Burbs™ – \$12.95
- ___ 305 Rifts® Path of the Storm™ – Screen-play & Sourcebook – \$12.95

Weapons Books

- ___ 401 Weapons and Armor™ – \$8.95
- ___ 402 Weapons and Castles™ – \$8.95
- ___ 403 Weapons and Assassins™ – \$8.95
- ___ 404 Weapons & Castles of the Orient™ – \$8.95

Palladium Fantasy RPG®

- ___ 450 The Palladium Fantasy RPG® – \$26.95
- ___ 4500HC Palladium Fantasy RPG® 30th Anniversary Hardcover – \$50.00
- ___ 451 Dragons & Gods™ – \$24.95
- ___ 453 Old Ones™ 2nd Ed. – \$24.95
- ___ 454 Monsters & Animals™ 2nd Ed. – \$24.95
- ___ 455 Adventures on the High Seas™ – \$24.95
- ___ 458 Island at the Edge of the World™ – \$20.95
- ___ 459 Yin-Sloth Jungles™ – \$20.95
- ___ 462 Western Empire™ – \$24.95
- ___ 463 Baalgor Wastelands™ – \$24.95
- ___ 464 Mount Nimro™ – \$20.95
- ___ 465 Eastern Territory™ – \$24.95
- ___ 466 Library of Bletherad™ – \$20.95
- ___ 467 Northern Hinterlands™ – \$24.95
- ___ 468 Land/Damned 1: Chaos Lands™ – \$24.95
- ___ 469 LoD 2: Eternal Torment™ – \$24.95
- ___ 470 LoD 3: The Citadel – \$24.95 (coming)
- ___ 471 Wolfen Empire™ – \$20.95
- ___ 472 Mysteries of Magic™ One: Heart of Magic – \$16.95
- ___ 474 Bizantium/Northern Islands™ – \$20.95
- ___ 475 Garden of the Gods™ – \$12.95 (coming)

Heroes Unlimited™ / After the Bomb®

- ___ 500-2 Heroes Unlimited™, 2nd Ed. – \$26.95
- ___ 5000HC Heroes Unlimited™ 30th Anniversary Hardcover – \$50.00
- ___ 501 Villains Unlimited™ Revised – \$24.95
- ___ 503 After the Bomb® RPG – \$22.95
- ___ 505 Road Hogs™ (After the Bomb® II) – \$9.95
- ___ 507 Mutants Down Under™ (AB III) – \$9.95
- ___ 511 Mutants of the Yucatan™ (AB IV) – \$9.95
- ___ 513 Mutants in Avalon™ (AB V) – \$16.95
- ___ 514 Mutants in Orbit™ (AB VI) – \$16.95
- ___ 515 Aliens Unlimited™ – \$24.95
- ___ 516 Heroes Unlimited™ G.M.'s Guide – \$24.95
- ___ 517 Century Station™ – \$24.95
- ___ 518 Gramercy Island™ – \$24.95
- ___ 519 Aliens Unlimited Galaxy Guide™ – \$24.95
- ___ 520 Mutant Underground™ – \$16.95
- ___ 521 Powers Unlimited® One – \$16.95
- ___ 522 Powers Unlimited® Two – \$16.95
- ___ 523 Powers Unlimited® Three – \$16.95
- ___ 525 Revised Ninjas & Superspies™ – \$20.95
- ___ 526 Mystic China™ – \$24.95
- ___ 527 Armageddon Unlimited™ – \$20.95

Robotech® RPG

- ___ 550 Robotech® The Shadow Chronicles® RPG (manga size) – \$16.95
- ___ 550HC Robotech® The Shadow Chronicles® Deluxe Hardcover RPG – \$30.95
- ___ 5500HC Robotech® The Shadow Chronicles® Gold Ed. Hardcover RPG – \$70.00
- ___ 551 Robotech® Macross® Saga Sourcebook – \$16.95
- ___ 552 Robotech® The Masters Saga™ Sourcebook (manga size) – \$16.95
- ___ 553 Robotech®: Expeditionary Force Marines Sourcebook – \$20.95
- ___ 554 Robotech® The New Generation™ Sourcebook – \$16.95
- ___ 555 Robotech® Genesis Pits Sourcebook – \$16.95

Robotech® RPG Tactics™ (New!)

- ___ 55100 Robotech® RPG Tactics™ – \$99.95
- ___ 55105 Robotech® RPG Tactics™ Rulebook – \$20.00
- ___ 55101 UEDF Dice Pack – \$12.00
- ___ 55102 Zentraedi Dice Pack – \$12.00
- ___ 55201 UEDF Valkyrie Wing – \$36.95
- ___ 55202 UEDF Destroid Pack – \$32.95
- ___ 55203 UEDF Spartan Pack – \$32.95
- ___ 55401 Zentraedi Regult Battlepods – \$36.95
- ___ 55402 Zentraedi Artillery Battlepods – \$36.95
- ___ 55403 Zentraedi Glaug Command – \$36.95

Rifts® Chaos Earth®

- ___ 660 Rifts® Chaos Earth® RPG – \$20.95
- ___ 661 Rifts® CE Creatures of Chaos™ – \$12.95
- ___ 662 Rifts® CE The Rise of Magic™ – \$12.95
- ___ 665 Rifts® Chaos Earth® First Responders™ – \$16.95 (coming)
- ___ 666 Rifts® Chaos Earth® Resurrection™ – \$20.95

Beyond the Supernatural™

- ___ 700 Beyond the Supernatural™, 2nd Ed. – \$24.95
- ___ 702 Tome Grotesque™ – \$20.95 (coming)
- ___ 703 Beyond Arcanum™ – \$24.95 (coming)

Nightbane®

- ___ 730 Nightbane® RPG – \$24.95
- ___ 731 Nightbane®: Between the Shadows™ – \$20.95
- ___ 732 Nightbane®: Nighlands™ – \$20.95
- ___ 733 Nightbane®: Through the Glass Darkly™ – \$20.95
- ___ 735 Nightbane® Survival Guide™ – \$20.95

Rifts®

- ___ 800HC Rifts® RPG Ultimate Edition – \$39.95
- ___ 801 Rifts® Sourcebook One Revised – \$20.95
- ___ 802-E Rifts® World Book 1: Vampire Kingdoms™, Revised – \$24.95
- ___ 803 Rifts® Conversion Book One™ – \$24.95
- ___ 804 Rifts® WB 2: Atlantis™ – \$20.95
- ___ 805 Rifts® Sourcebook 2: Mechanoids™ – \$16.95
- ___ 807 Rifts® WB 3: England™ – \$20.95
- ___ 808 Rifts® WB 4: Africa™ – \$20.95
- ___ 809 Rifts® Dimension Book 1: Wormwood™ – \$20.95
- ___ 810 Rifts® WB 5: Triax™ – \$24.95
- ___ 811 Rifts® Pantheons of the Megaverse® – \$24.95
- ___ 812 Rifts® Sourcebook 3: Mindwerks™ – \$16.95
- ___ 813 Rifts® Mercenaries™ – \$20.95
- ___ 814 Rifts® WB 6: South America™ – \$20.95
- ___ 815 Rifts® WB 7: Underseas™ – \$24.95
- ___ 816 Rifts® DB 2: Phase World® – \$24.95
- ___ 817 Rifts® DB 3: Phase World® Sourcebook – \$16.95
- ___ 818 Rifts® WB 8: Rifts® Japan™ – \$24.95
- ___ 819 Rifts® WB 9: South America Two™ – \$24.95
- ___ 820 Rifts® WB 10: Juicer Uprising™ – \$20.95
- ___ 821 Rifts® WB 11: Coalition War Campaign™ – \$24.95

- ___ 822 Rifts® WB 12: Psyscape™ – \$20.95
 ___ 825 Rifts® WB 13: Lone Star™ – \$20.95
 ___ 826 Rifts® WB 14: New West™ – \$24.95
 ___ 827 Rifts® WB 15: Spirit West™ – \$24.95
 ___ 828 Rifts® Sourcebook 4: Coalition Navy™ – \$16.95
 ___ 829 Rifts® WB 16: Federation of Magic™ – \$20.95
 ___ 830 Rifts® DB 4: Skraypers™ – \$20.95
 ___ 831 Rifts® Index Volume Two™ – \$16.95
 ___ 832 Rifts® WB 17: Warlords of Russia™ – \$24.95
 ___ 833 Rifts® WB 18: Mystic Russia™ – \$20.95
 ___ 834 Rifts® WB 19: Australia 1 – \$24.95
 ___ 835 Rifts® WB 20: Canada™ – \$24.95
 ___ 836 Rifts® WB 21: Splynn Dimensional Market™ – \$24.95
 ___ 837 Rifts® WB 22: Free Quebec™ – \$24.95
 ___ 838 Rifts® WB 23: Xiticix Invasion™ – \$20.95
 ___ 839 Rifts® Coalition Wars®: Sedition™ – \$20.95
 ___ 840 Rifts® Coalition Wars®: Coalition Overkill™ – \$16.95
 ___ 841 Rifts® Coalition Wars®: Sorcerers' Revenge™ – \$16.95
 ___ 842 Rifts® Coalition Wars®: Cyber-Knights™ – \$16.95
 ___ 843 Rifts® Coalition Wars®: Shadows of Evil™ – \$16.95
 ___ 844 Rifts® Coalition Wars®: Final Siege™ – \$24.95
 ___ 845 Rifts® Game Master Guide™ – \$26.95
 ___ 846 Rifts® Aftermath™ – \$24.95
 ___ 847 Rifts® DB5: Anvil Galaxy™ – \$20.95
 ___ 848 Rifts® Book of Magic™ – \$26.95
 ___ 849 Rifts® Adventure Guide™ – \$24.95
 ___ 850 Rifts® Bionics Sourcebook™ – \$16.95
 ___ 851 Rifts® DB 6: Three Galaxies™ – \$20.95
 ___ 852 Rifts® Dark Conversions™ – \$24.95
 ___ 853 Rifts® Chi-Town 'Burbs™ – \$9.95
 ___ 854 Rifts® The Tolkeen Crisis™ – \$12.95
 ___ 855 Rifts® The Black Vault™ – \$9.95
 ___ 856 Rifts® The Vanguard™ – \$9.95
 ___ 857 Rifts® WB 24: China One™ – \$20.95
 ___ 858 Rifts® WB 25: China Two™ – \$20.95
 ___ 859 Rifts® DB 7: Megaverse Builder™ – \$16.95
 ___ 860 Rifts® DB 8: Naruni Wave Two™ – \$16.95
 ___ 862 Rifts® WB 26: Dinosaur Swamp™ – \$20.95
 ___ 863 Rifts® MercTown™ – \$20.95
 ___ 865 Rifts® Merc Ops™ – \$20.95
 ___ 866 Rifts® WB 27: Adventures in Dinosaur Swamp™ – \$20.95
 ___ 867 Rifts® Mercenary Adventure Sourcebook – \$12.95
 ___ 868 Rifts® WB 28: Arzno™ – \$20.95
 ___ 869 Rifts® WB 29: Madhaven™ – \$16.95
 ___ 870 Rifts® John Zeleznik Coloring Book – \$5.95
 ___ 871 Rifts® Machinations of Doom™ – \$18.95
 ___ 872 Rifts® DB 10: Hades™ – \$24.95
 ___ 873 Rifts® DB 11: Dyval™ – \$24.95
 ___ 874 Rifts® WB 30: D-Bees of North America™ – \$24.95
 ___ 875 Rifts® DB12: Dimensional Outbreak – \$24.95
 ___ 876 Rifts® Megaverse® in Flames™ – \$24.95
 ___ 876HC Rifts® Megaverse® in Flames™ Gold Hardcover Edition – \$50.00
 ___ 877 Rifts® Heroes of the Megaverse® – \$16.95
 ___ 878 Rifts® Sourcebook: Shemarrian Nation™ – \$16.95
 ___ 880 Phase World®: Fleets of the Three Galaxies™ – \$16.95
 ___ 881 Rifts® WB 31: Triax™ Two – \$24.95
 ___ 883 Rifts® DB 14: Thundercloud Galaxy™ – \$20.95
 ___ 884 Rifts® Vampires Sourcebook™ – \$20.95
 ___ 885 Rifts® WB 32: Lemuria™ – \$24.95
 ___ 886 Rifts® Black Market™ – \$24.95
 ___ 887 Rifts® WB 33: Northern Gun™ One – \$24.95
 ___ 888 Rifts® WB 34: Northern Gun™ Two – \$26.95
 ___ 889 Rifts® Sourcebook: Heroes of Humanity™ – \$16.95 (coming)
 ___ 890 Rifts® World Book: Secrets of the Atlanteans™ – \$24.95 (coming)
 ___ 891 Rifts® World Book: Sovietski™ – \$24.95 (coming)
 ___ 892 Rifts® Sourcebook: The Disavowed™ – \$16.95 (coming)
 ___ 2510 Rifts® & The Megaverse® Art Book – \$22.95
 ___ 2510-HC Rifts® & The Megaverse® Art Book, Hardcover – \$50.00
 ___ 2510-CML Rifts® & The Megaverse® Art Book, Collector's Masterwork Edition – \$125.00
- Miscellaneous Products**
 ___ 600 Deluxe Revised RECON® RPG – \$22.95
 ___ 2536 Rifts® Coffee Mug – \$10.00
 ___ 2537 Gamer Coffee Mug – \$10.00
 ___ 2539 Rifts® Dice Bag – Black – \$8.00
 ___ 2545 Dead Reign™ Coffee Mug – \$10.00
 ___ 2554 Palladium Bookmarks, Set One – \$5.00
 ___ 2555 Palladium Bookmarks, Set Two – \$5.00
 ___ 2560 Palladium Fantasy® Coffee Mug – \$10.00
 ___ 2561 Property of Chi-Town Library Pencil – \$0.50 each
 ___ 2562 Future Visions™ – The Artistry of Charles Walton II – \$13.95
- Note:** T-shirts and other products can be found online: www.palladiumbooks.com
- Rifts® Miniatures**
 ___ MI8002 Xiticix Pack – \$18.00
 ___ MI8004 Coalition Dog Pack – \$18.00
 ___ MI8005 Men of Magic Pack #1 – \$18.00
 ___ MI8006 Cyborgs Pack #1 – \$18.00
 ___ MI8007 Simvan & Ostrosaurus Pack – \$18.00
 ___ MI8008 Coalition Skelebots Pack #1 – \$18.00
 ___ MI8009 Coalition SAMAS Pack #1 – \$22.00
 ___ MI8010 Coalition Sky Cycle Pack – \$22.00
 ___ MI8011 Coalition Dog Pack #2 – \$18.00
 ___ MI8015 Damaged Skelebots Pack #1 – \$12.00
 ___ MI8016 Cyber-Adventurers Pack – \$18.00
 ___ MI8017 Rogues & Scout Pack #1 – \$18.00
 ___ MI8018 Brodkil & Witchling Pack – \$18.00
 ___ MI8019 Damaged Skelebots Pack #2 – \$18.00
 ___ MI8020 Psi-Stalkers & Scouts Pack #1 – \$18.00
 ___ MI8021 Shadow Beast – \$12.00
 ___ MI8022 Mystic Knight – \$6.00
 ___ MI8023 Lord Magus – \$6.00
 ___ MI8024 High Magus – \$6.00
 ___ MI8025 Coalition Psi-Stalker – \$6.00
 ___ MI8026 Coalition Dog Boy in DPM-D1 Armor – \$6.00
 ___ MI8027 Coalition Dog Boy #2 – \$6.00
 ___ MI8028 Coalition Dog Boy #3 – \$6.00
 ___ MI8029 Coalition Dog Boy #4 – \$6.00
 ___ MI8030 Coalition Dog Boy #5 – \$6.00
 ___ MI8031 Glitter Boy – \$20.00
 ___ MI8032 Glitter Boy Pilot – \$6.00
 ___ MI8033 Kydian Overlord – \$20.00
 ___ MI8034 Dragonsaurus – \$10.00
 ___ MI8035 Slaver and Slave (Atlantis) Set – \$10.00
 ___ MI8036 Crazy – \$6.00
 ___ MI8037 Juicer #1 – \$6.00
 ___ MI8038 Juicer #2 – \$6.00
 ___ MI8039 Cyborg #1 – \$12.00
 ___ MI8040 Cyborg #2 – \$12.00
 ___ MI8041 Cyborg #3 – \$6.00
 ___ MI8042 Coalition Grunt #1 – \$6.00
 ___ MI8043 Coalition Grunt #1 – \$6.00
 ___ MI8044 Coalition Grunt #2 – \$6.00
 ___ MI8045 Coalition Grunt #3 – \$6.00

When placing an order by mail, please add money for shipping and handling. Add \$5.00 for orders totaling \$1-\$50, \$10.00 for orders totaling \$51-\$95, and for orders totaling \$96-\$200 please add \$15.00 US. Double the amount for Canada, and *quadruple* it for overseas orders. For more shipping options, order online at www.palladiumbooks.com.

Allow 2-4 weeks for delivery.
 Make checks and money orders payable to: *Palladium Books*

Check release dates for new products. If the book you order has not been released yet, your order will be held as a backorder until the product is available. Please note that prices are subject to change without notice.

Orders can also be placed by phone, at (734) 721-2903 (order line only). Please have your credit card information when you call.

www.palladiumbooks.com

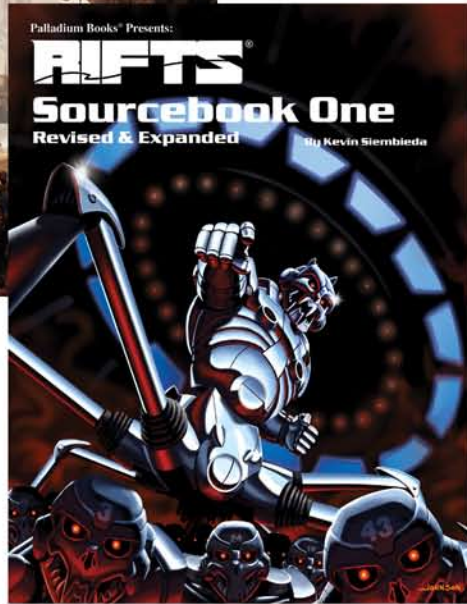

Also from Palladium Books®:

Rifts® World Book 28: Arzno™

- Mercenaries vs vampires.
- City of Arzno mapped & described.
- TW power armor, weapons & equipment.
- Fallen Cyber-Knights & Blood Cult.
- 160 pages – available now.

Rifts® World Book 29: Madhaven™

- The ruins of New York City.
- Mutants, monsters, ghosts & mystery.
- Mystic Knights of the White Rose.
- Encounter tables and adventure ideas.
- 128 pages – available now.

Rifts® Sourcebook One, Expanded™

- Robot creation rules.
- Power armor, robots, weapons and gear.
- A.R.C.H.I.E. Three and his madness.
- Monsters, adventures and more.
- 160 pages – available now.

Rifts® Dimension Book 10: Hades™

- The pits of Hades mapped and described.
- New demons, riding beasts, & monsters.
- New magic and mystic weapons.
- Key characters, adventure and the Minion War.
- 224 pages – available now.

Rifts® World Book 22: Free Quebec™

The line is drawn and the Coalition Army faces off against the Glitter Boy legions and warriors of Free Quebec.

- The war starts here!
- Emphasis on the Quebec Military.
- New Glitter Boys, V-SAM and other power armor.
- Combat vehicles and weapons exclusive to Free Quebec.
- Cyborgs unique to Free Quebec.
- Coalition and Free Quebec war plans.
- Background on the nation of Free Quebec and key figures.
- Old Bones, full of intrigue and treachery.
- Rumor & Conspiracy tables.
- Hints and information about the Siege on Tolkeen.
- By DesRochers & Siembieda.
- 192 pages.

Rifts®, endless possibilities limited
only by one's imagination!™

\$24.95

Cat. No. 837

ISBN-10: 1-57457-030-7

ISBN-13: 978-1-57457-030-4

**Palladium
Books Inc.**
www.palladiumbooks.com