

Palladium Books® Presents:

Rifts® World Book Ten

Juicer Uprising™

By C.J. Carella

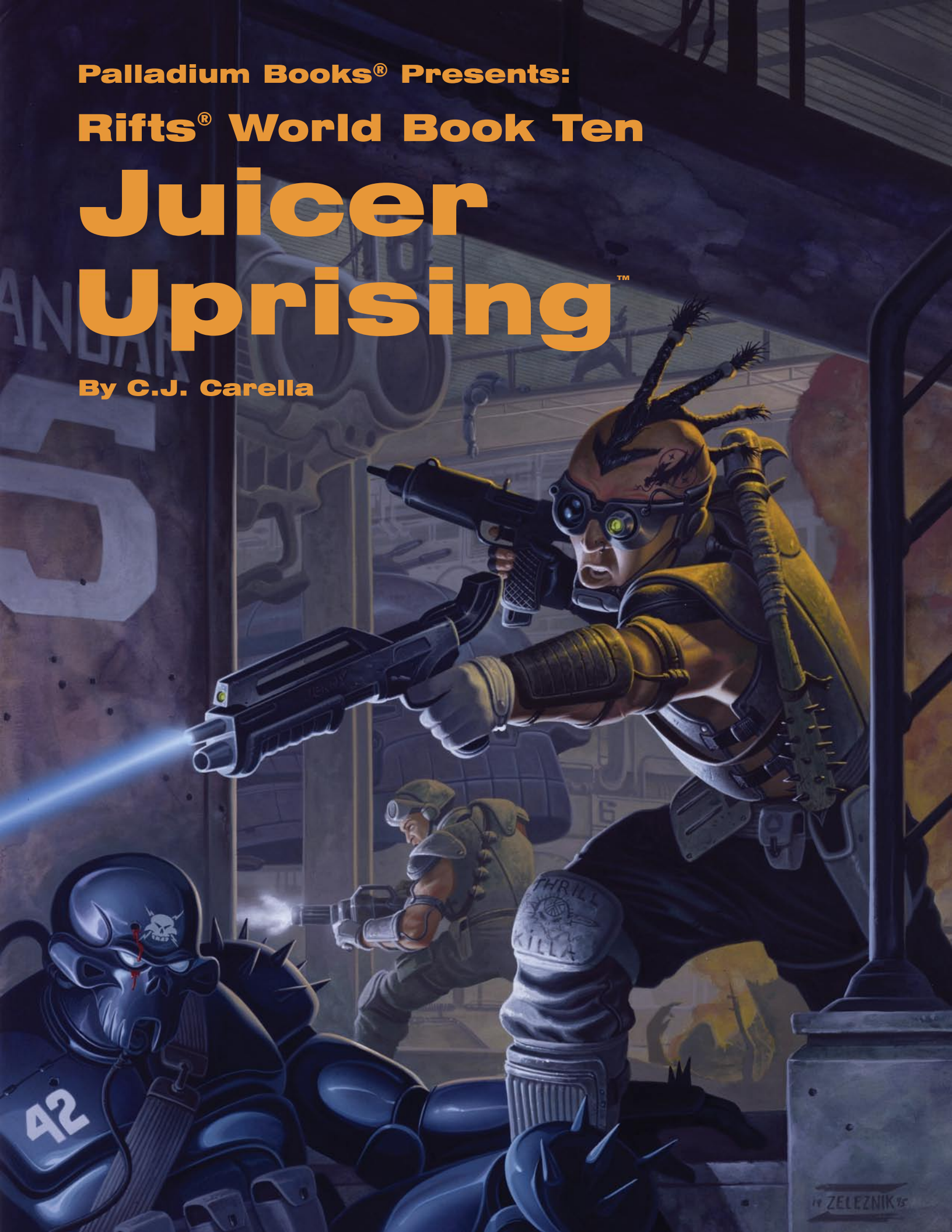

Warning!

Violence and the Supernatural

The fictional World of Rifts® is violent, deadly and filled with supernatural monsters. Other dimensional beings, often referred to as “demons,” torment, stalk and prey on humans. Other alien life forms, monsters, gods and demigod, as well as magic, insanity, and war are all elements in this book.

Some parents may find the violence and supernatural elements of the game inappropriate for young readers/players. We suggest parental discretion.

Please note that none of us at Palladium Books® condone or encourage the occult, the practice of magic, the use of drugs, or violence.

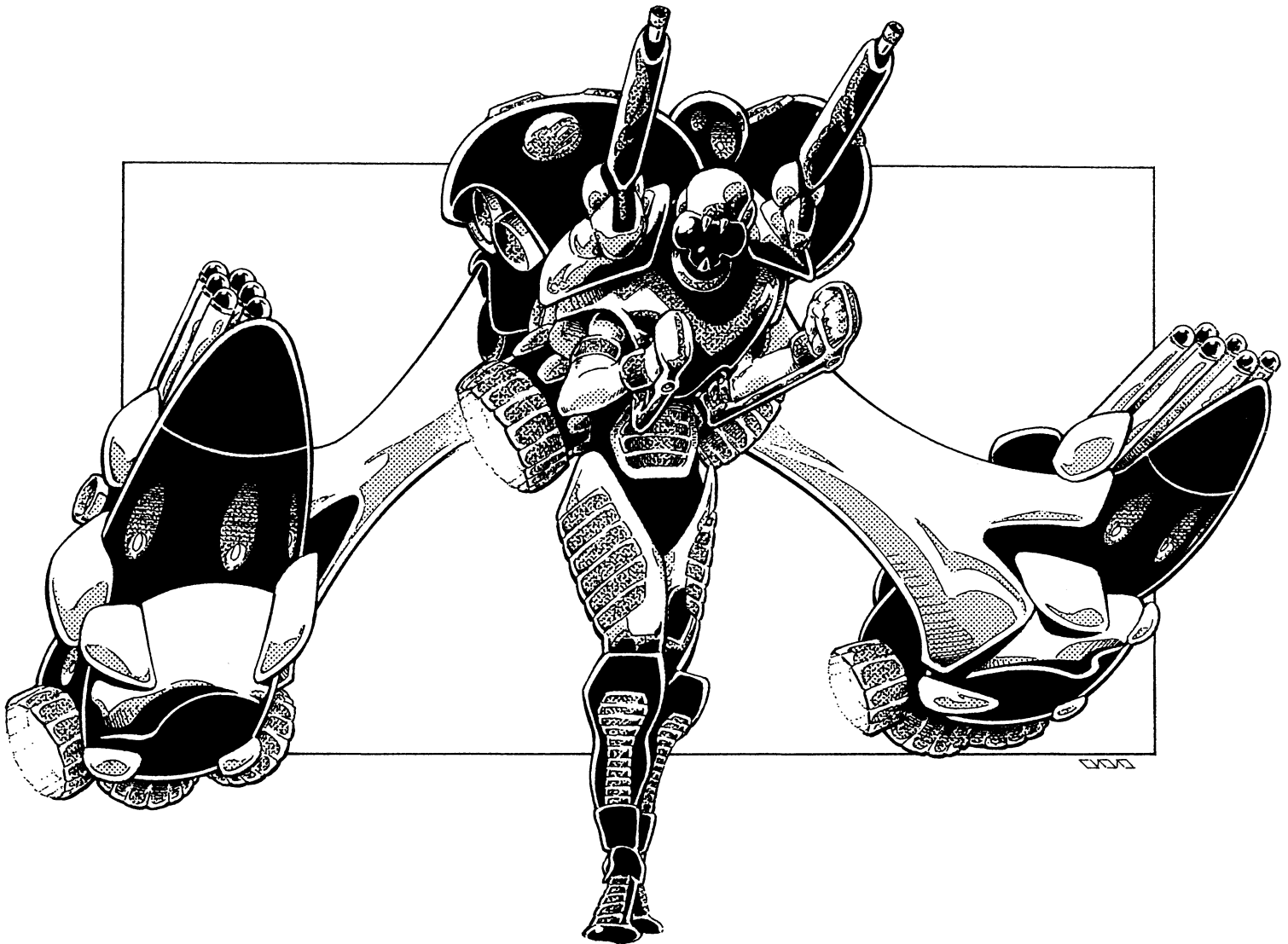

A supplement for the Rifts® RPG.

Compatible with the entire Palladium Books® Megaverse®!

Dedicated to All the Rifts Fans.

— Carlos J. Martijena-Carella

PDF Edition – January 2016

Copyright 1990, 1991, 1994, 1996 Palladium Books Inc.

Copyright 1996 by Kevin Siembieda

All rights reserved, world wide, under the Universal Copyright Convention. No part of this book may be reproduced in part or whole, in any form or by any means, without permission from the publisher, except for brief quotes for use in reviews. All incidents, situations, institutions, governments and people are fictional and any similarity, without satiric intent, of characters or persons living or dead, is strictly coincidental.

Palladium Books®, Rifts®, The Rifter®, Coalition Wars®, RECON®, Nightbane®, Splicers®, Palladium Fantasy Role-Playing Game®, The Mechanoids®, The Mechanoid Invasion®, After the Bomb®, Phase World®, and Megaverse® are registered trademarks owned and licensed by Kevin Siembieda and Palladium Books Inc.

Juicer Uprising, Juicer, Crazies, Cyber-Knight, Psi-Stalker, Coalition States, Erin Tarn, Triax, Mindwerks, NGR, Splugorth, Kittani, Naruni Enterprises, and other names and titles are trademarks owned by Kevin Siembieda and Palladium Books Inc.

Owner of trademarks Kevin Siembieda. Licensed user Palladium Books Inc.

Palladium Online www.palladiumbooks.com

Rifts® World Book Ten: Juicer Uprising™ is published by Palladium Books Inc., 39074 Webb Court, Westland, MI 48185.
Printed in the USA.

Palladium Books® Presents:

Rifts® World Book Ten

Juicer Uprising™

Written By: Carlos J. Carella

Inspired by the world of Rifts®, Juicers and other characters & concepts created by **Kevin Siembieda**.

Additional Text, Concepts & Editing: **Kevin Siembieda**

Editors: **Alex Marciniszyn**
James A. Osten
Kevin Kirsten
Julius Rosenstein

Cover Painting: **John Zeleznik**

Interior Artists:

Vince Martin
Wayne Breaux Jr.
R.K. Post

Art Direction & Keylining: **Kevin Siembieda**

Typography: **Maryann Siembieda**

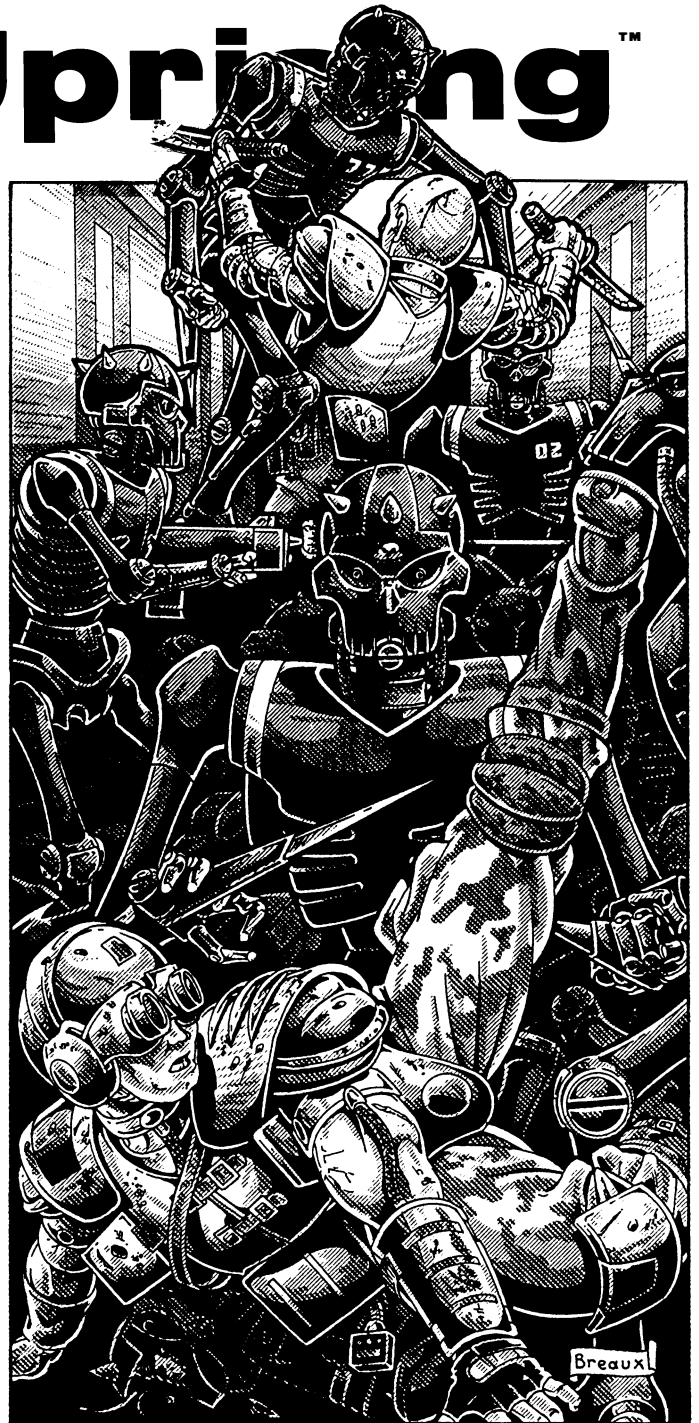

Special Thanks to C.J. for breathing fantastic life and color into the Juicers and more of Rifts® North America! To Vince for some great Juicer designs and some stunning artwork. Wayne Breaux and R.K. Post for their designs and atmospheric artwork. John for an action packed, guns and glory cover. Maryann, Jim, and Al for the extra hours they put in to get this baby done on time, and Julius, Kirsten, and Steve for their welcomed efforts and assistance — superhumans all.

— Kevin Siembieda

Prelude to Destruction	7
The Juicer Revisited	8
Pre-Rifts Origins	8
Early Juicers	9
Juicers Today: Circa 105 P.A.	11
Common Juicer Volunteer	11
The Juicer Procedure	12
Dangers & Side Effects	13
Non-Human Juicers	16
The Rise & Fall of the Juicer	17
Death	18
Juicers & The Law	18
Making a Living	19
The Juicer Culture	20
The Edge	20
Juicer Bars & Clubs	23
Juicer Wannabe	23
Juicer Sports	24
Non-Juicers in Juicer Sports	25
Deadball	26
Murderthon	27
Juicer Football	28
The JFL Championship	29
Other Sports	29
Juicer Lexicon	30
New Juicer Variants	30
Hyperion Juicer	30
Titan Juicer O.C.C.	32
Supernatural Strength	34
Phaeton Juicer O.C.C.	35
Mega-Juicer O.C.C.	36
Delphi Juicer O.C.C.	39
Coalition Juicers O.C.C.	41
Psycho-Stalker O.C.C.	45
Techno-Wizard Juicers	47
Dragon Juicer (a.k.a. The Blood Drinker)	47
Murder Wraith: Undead Juicer	50
Maxi-Killer: Bio-Wizard Juicer	53
Juicer Related O.C.C.s	55
Juicer Gladiator O.C.C.	55
Juicer Assassin O.C.C.	56

Juicer Scout O.C.C.	57
Gambler O.C.C.	58
Wannabe Juicer.	59
Designer Drugs	61
New Skills	64
Weapons & Equipment	66
Rocket Boots.	67
New Body Armor	68
Juicer Weapons	71
NG-45LP “Long Pistol”	73
Deadball Grenade	74
JA-12 Laser Rifle	76
Power Armor	77
Ground Vehicles	81
Aircraft	85
Icarus Flight System	86
Juicer Organizations	89
The Valkyri	89
The Society of Sages	92
Juicer Army of Liberation	94
The Grim Reapers	95
Places & Nations of Interest	100
Kingsdale	100
Kingsdale Armed Forces	104
The Forest Rangers	105
The Kingsdale City Guard	105
Places of Interest	105
Los Alamo	111
Juicers in Los Alamo	113
Los Alamo Armed Forces	115
Places of Interest	116
Notes Regarding Juicers & Other Kingdoms	118
The City of Newtown.	121
Crime & Gang Problems	123
Juicers in Newtown.	124
Armed Forces	124
The Border Wall	126
Fort El Dorado.	129
Armed Forces	130
Places of Interest	130
The Juicer Uprising	132
Prologue	132
Plans & Missions	133

Grim Discoveries	147
The Hidden Truth	147
Vallax/UTI Secret Complex	148
The Horrors of War	149
Juicer Techno-Zombies	150
Phoenix Juicer	151
New Comers	152
The Vallax O.C.C.	153
Truth & Consequences (Aftermath)	154
Experience Tables	156

Quick Find Table

Designer Drugs	61	Prometheus Treatment (prologue)	132
Fort El Dorado	129	Prometheus Treatment (CS plans)	133
Experience Table	156	Prometheus Treatment (Phoenix Rising)	133
Juicer: Blood Drinker (aka Dragon Juicer)	47	Splugorth Juicers	53
Juicer Bars & Clubs	23	Techno-Wizard Juicers	47
Juicer: Culture	20	Techno-Zombie (see Grim Discoveries)	147
Juicer: Death/Last Call	17	Techno-Zombie Juicer O.C.C./NPC	150
Juicer: Death Cult (Grim Reapers)	95	Techno-Zombie: Phoenix Juicer	151
Juicer: Early/Pre-Rifts	9	Undead Juicer (Murder Wraith)	50
Juicer Gluttony (MIV)	14	Vallax (the alien R.C.C.)	153
Juicer Lexicon (slang)	30	Vallax: Newcomer Android	152
Juicer: Non-Human Conversions	16	Vallax/UTI Secret Complex	148
Juicer Organizations: Army of Liberation	94	Vallax Weapons & Equipment	153
Juicer Organizations: Grim Reapers	95		
Juicer Organizations: Society of Sages	92	Juicer O.C.C.s	
Juicer Organizations: Valkyri	89	Coalition Juicers O.C.C.	41
Juicer Philosophies	21	Delphi Juicer O.C.C. (psychic)	39
Juicer Psychosis	14	Dragon Juicer/Blood Drinker O.C.C.	47
Juicer Related O.C.C.s	55	Gambler O.C.C. (Juicer Related)	58
Juicer Side Effects	13	Hyperion Juicer O.C.C.	30
Juicer Sports	24	Juicer Assassin O.C.C.	56
Juicer Uprising	132	Juicer Gladiator O.C.C.	55
Juicer Volunteers	11	Juicer Scout O.C.C.	57
Juicer Wannabes	23 & 59	Maxi-Killer (Splugorth bio-wizard Juicer)	53
Juicer Wannabe Gangs	60	Mega-Juicer O.C.C.	36
Juicer Weapons & Equipment	66	Murder Wraith N.P.C. Villain	50
Julian the First	138	Phaeton Juicer O.C.C.	35
Kingsdale	100	Psycho-Stalker O.C.C.	45
Kingsdale: Dregstown	110	Techno-Zombie O.C.C./N.P.C.	150
Kingsdale Magickal Guild (the Monolith)	108	Titan Juicer O.C.C.	32
Maps	157	Wannabe Juicer	59
Last Call	17		
Los Alamo	113	Tables	
Los Alamo: Armed Forces	115	Juicer: Dragon Juicer Insanities	49
Los Alamo: The Border	116	Juicer: Hyper-Strength Syndrome (HSS)	13
Los Alamo: Freaksville	117	Juicer: Last Call Symptoms	17
Newtown: Armed Forces	124	Juicer: Maxi-Killer Insanities	54
Newtown: Border Wall	126	Juicer: Metabolic-Induced Voracity (MIV)	14
Newtown: City of	121	Juicer Procedure: Success & Failure	13
Newtown: George Hornesby	128	Juicer: Psychosis	15
Newtown: Royal Casino	127	Supernatural Strength	34
Prometheus Treatment, The	134		

Prelude to Destruction

We who are about to die, salute you.

You fear us, as well you should. We have nothing to lose. We are the walking dead, and we won't mind at all if we send others on their way ahead of us. We kill and we die; it's all the same to us. Mess with us at your peril.

Your lords and masters made a terrible mistake. It's all right to fear us, vilify us, to call us psychopaths and pathetic thrill seekers. It's even okay to try to kill us — it's going to happen sooner or later, right?

But you should never have given us hope. Even worse, you shouldn't have taken that hope away.

You Coalition dogs tried to fool us with promises of long life and power. You thought we would become your cannon fodder, and kill and die in your name. Now we know your promises were lies. Big mistake, "Squishies."

This day, all the Juicers on the continent declare war on the Coalition States and all their allies. We hold the Prosek family, General Underhill and Lybock personally responsible for this betrayal. We are coming for you, Prosek. Think about it and tremble.

—Julian the First

Mega-Juicer, Commander of the Juicer Army for Liberation

Introduction

Welcome to **Rifts® World Book Ten: The Juicer Uprising™**. When presented with the challenge of writing a book about this major event in the history of Rifts Earth, I decided to concentrate on four major elements which I think are what you, kind readers, will be most interested in.

First of all, the Juicers. Always one of the most popular O.C.C.s in the Rifts® Megaverse®, Juicers can be tragic heroes, daredevils, or evil villains. This book tries to expand on the role-playing possibilities of this character, offer new Juicer variants and skill packages, and answer some of the questions about the lives, origins and ultimate ends of these super-human warriors. There are technological Juicers, mystical Juicers, even some Necromantic mixtures of technology and dark magic; use them as friends or foes as you will.

But the book is not just about Juicers. Several city-states and kingdoms of North America are described in varying detail. As the first in the new batch of **Rifts®** books concentrating on North America, **World Book Ten** will start exploring the continent in greater detail, followed by other information-rich books like *Rifts® World Book 11: The Coalition War Campaign™* (often referred to in this book as the *CS War Machine*), *Psyscape™*, *Lone Star™*, and the *New West™*

Additionally, more technology and equipment was included in this book. Although this is not a "hardware book" like **Triax™** and **Rifts® Mercenaries**, you will find a few, new exotic weapons and vehicles, most of them uniquely suited to the Juicer psychology and needs, but which can be of use to other adventurers as well.

Finally, the **Juicer Uprising** itself. Rather than an adventure, I have outlined some of the salient events and points of a major revolt aimed at the Coalition city of *Newtown*, and then described a number of possible scenarios and sub-plots for Game Masters to develop. This means any GM can easily blend the Uprising into his campaign, and develop this danger-fraught situation as he sees fit. Mercenaries or heroes, opportunists or saviors, any character may play a role in the Uprising, even to the point of changing the "history" of the world.

So strap on your armor and make sure your E-Clips are charged before you join the Uprising in World Book Ten, and enjoy!

—C.J. Carella

Proclamation transmitted on all Radio Frequencies:

"Hey, Killers!

"Y'all know the Coalition Dead-Heads been lyin' to us about the Prometheus Treatment. They ain't gonna give it to us. They's afraid of the likes of us. But the treatment exists! They were gonna hold out on us, help a few to show they weren't kiddin', and then send us to get killed at Tolkeen!

"But they screwed up. We've found where they been conducting the research to make their immortal Juicer army. Yeah, you heard me right. 'Immortal.' We can have all our powers, be the toughest bastards on the block, and we get to live a hundred, two hundred, three hundred years! We'll be the rulers of the world!

"The Prometheus Treatment is in Newtown! The Dead-Heads kept their labs hidden away from their big cities. Bad idea, 'cause now they's too far away to send enough help before we take the town and the secret of immortality for us. It's our chance to get back our lives.

"Let's get 'em!"

Graffiti Found on a bunker outside Newtown:

"I don't care who's right — Let's go kill something."

The Juicer Revisited

Juicers are a strange and unique group. Some are people who have sacrificed their lives for the sake of power, others are unwitting or unwilling victims, and many are desperate or driven people who do not care about the consequences of their actions. Avengers, psychos and misfits, they are feared by many people on Rifts Earth, often with good reason. After all, a person who does not care about whether or not he or she lives or dies has little regard for the lives of other people. The other side of the coin is the dedicated warrior, who has literally already sacrificed his life for some cause, be it revenge, the protection of the weak, or some obscure obsession.

In these pages, the history, lives and myths of the Juicer are explored.

Pre-Rifts Origins of the Juicer Procedure

The first Juicers were developed in Pre-Rifts Germany, during the tense period that preceded the Great Cataclysm. The search for the perfect super-soldier became a new type of “arms race” as dozens of researchers worked feverishly on one of the many avenues of research that might lead to a superior warrior. While companies like **Mindwerks** (see *Rifts® Sourcebook Two: Mindwerks™* for details) developed the M.O.M. (Crazy) conversion, and genetic research organizations like the **Tex-Am Complex** and the **Achilles Project** (see *Rifts® World Books Six & Nine: South America I and II*) worked on creating mutant animals with human intelligence, corporations like **Uberchem Incorporated** worked on the Juicer process. Uberchem was one of the pioneers in drug enhancements, and its patents and techniques were applied (and copied) in dozens of places worldwide.

At first, Juicers were only used by ruthless Third World dictators and other madmen who cared nothing for the lives of their soldiers. As the augmented soldiers started making an important contribution in the battlefield, however, more and more nations started keeping small forces made up of Juicer “volunteers”; often in secret to avoid public scrutiny.

Mindwerks’ research created an uproar regarding human augmentation utilizing brain implants (see *Rifts Sourcebook Two: Mindwerks*). Leaks reporting the 100% mortality rate of the Juicer Process on all volunteers in under eight years created a public furor regarding the inhumanity of augmentation experiments on human beings, volunteers or no. Outrage swept Germany and raised serious questions in other parts of the world, particularly in the United States and Japan. Mindwerks was the last company to knuckle under to the pressure. Uberchem, already on shaky financial grounds, collapsed almost immediately, “orphaning” dozens of advanced Juicer research projects. However, this was not the end of the projects. The U.S. government and some American corporations covertly purchased many of the patents and hired a number of former Uberchem employees.



The resurrected research did not last long before the Great Cataclysm all but obliterated civilization on Earth. Thus, the secrets were lost — for a while.

Early Juicers

The early pre-Rifts Juicers were not too different from their contemporary counterparts. Many of them did not undergo the full, terminal process, however, but instead used the less severe JAEP (Juicer Augmentation Enhancement Program) treatments which gave the users only a fraction of the Juicer's power, but did not kill the enhanced humans if they did not overindulge (described in *Rifts® World Book Five: Triax™ and the NGR*). The people of “civilized” nations, like Germany, considered the volunteers who underwent the fatal augmentation to be insane patriots or barbarians to be shunned by “right-thinking folk.” At the same time, however, many others, especially the young and members of the “counterculture,” were fascinated by the concept of men and women who accepted a short life in return for god-like powers.

Juicers were often romanticized in novels, movies and video-games. A few pre-Rifts relics have been preserved, and have greatly contributed to the prevailing Juicer “mythos.” Among them is Reginald Wallazek's novel trilogy, *The Deathdance Saga*. The *Deathdance Saga* chronicled the (utterly fictional) adventures of Julian Amici, a European mercenary and secret agent who used his Juicer powers to uncover evil government conspiracies. The novels spawned a myriad of sequels, movies, video-games, and even a worldwide chain of interactive game parks. Julian Amici became as popular in the 21st Century as *James Bond* had been in the 20th, particularly among young teenagers who loved the idea of a doomed, misunderstood, yet heroic character. The anxieties caused by the new “cold war” may have had something to do with the popularity of an avenging Juicer who was capable of defeating any foe but was helpless to stop his inevitable fate.

Copies of the *Deathdance Saga* have been found in many pre-Rifts ruins. Although these books and films, both on paper and disks (computer and video), are banned in the Coalition States, manufacturers in *Ishpeming (Northern Gun)*, *Lazlo, New Lazlo* and *Kingsdale* have produced a number of restored editions, as well as new, modern versions and spin-offs. Sales are huge and many copies have been smuggled into the Coalition States. Computer games and movies, mostly pirated from ancient copies from before the collapse, are also fairly popular among the technological elite. Outside major kingdoms and technological enclaves, books are almost unknown, however, an oral tradition based on these stories has been created after travelers and merchants shared their renditions of the novels or movies they had seen/read with local peasants and farmers. In some places where Juicers are not popular, Julian Amici is seen as an evil “bogy-man” which mothers used to scare their children: “If you're not good, Julian Amici will come for you!” At others, he is a symbol of justice and heroism, no less real than other mythological figures. In some villages, Julian Amici is believed to be a real person who has somehow managed to survive and is alive and well! More than one youngster who undergoes the lethal Juicer Process has been inspired by these legends.

It may be no coincidence that the self-proclaimed leader of the Juicer Uprising calls himself “Julian the First.”

Juicers After the Great Cataclysm

During the “Dark Ages” following the Great Cataclysm, most technology was lost. Most surviving groups of people did their best to unearth or rediscover as much knowledge as possible. Among the first priorities were weapons and armor; the threat of bandits, supernatural creatures and D-Bee marauders were the most important concerns. Unearthing tools and knowledge regarding building and manufacturing were next. Human augmentation quickly became another major priority; Juicers and similar “super-humans” had a much better chance of surviving fights involving monsters and alien beings. To protect their loved ones, many people willingly sacrificed their lives to become the enhanced warriors. After all, life was so hard that very few people had any certainty that they would survive five or six more years under any circumstances! Life expectancy, for the lucky, was age 26 — augmentation offered the augmented warriors the hope that those they protected had a fighting chance to survive and rebuild.

In most places, of course, the technology was utterly lost. The bio-comp systems necessary to create Juicers were complex, very advanced machines, far beyond the capabilities of most survivors. A few made do with pre-existing systems and models until the computers broke down or the drugs ran out. Others tried to make do without the bio-comp system, resulting in the deaths of many would-be Juicers through overdoses and other mishaps. Enclaves like the NGR in Europe, the Silver River Republics in South America, and the future nation of Ishpeming/Northern Gun in North America, were the only places where the knowledge was kept alive. As communities grew and dispersed, they carried with them some of this precious scientific heritage. In other places, desperate scavengers in the ruins of old cities unearthed books and computer files that would lead to the rediscovery of old technology. Even so, Juicers did not make their return in numbers until the first years of the Post-Apocalyptic (P.A.) era. It took that long (a Dark Age estimated to have lasted 300 years) for humankind to rebuild even a fraction of its former might.

As noted previously, most redevelopment focused on the military sciences; the tools of war were crucial for survival. As a result, many civilizations started creating Juicers, Crazies and mutants, or turned to magic or alien champions to protect them. The Coalition States were the main exception. Although at first they may have relied on at least some Juicer soldiers (since the official history of the Coalition is so thoroughly rewritten to reflect current propaganda, nobody knows for sure), the CS soon made it a point to turn its back on all forms of human alteration. Its leaders turned to power armor, armored vehicles, robots and trained mutant animals. Far more efficient, its leaders insisted, was to use (intelligent) mutant animals and robots to fight and die for Humankind than the needless sacrifice of human life. For the CS, the idea of putting human lives at risk was stupid and destructive. The preservation of humankind and what made them human was more precious than ever in this new world of mutants, aliens and monsters. As a result, they regarded most types of augmentation as deforming and dehumanizing, so such procedures were outlawed in CS territories.



Juicers Today

Circa 105 P.A.

Despite the Coalition's laws and persecution, Juicers are fairly numerous in many parts of North America. Kingdoms like Ishpeming make extensive use of these augmented warriors, and offer the conversion process for sale to those who can afford it. Unlike the "super-soldiers" of the past, most Juicers become what they are for selfish reasons, not patriotism or a just "cause." Some see themselves as heroes and heroines, but many others just want to enjoy life to the fullest while they can, regardless of the consequences.

Becoming A Juicer

The road to power and glory is not an easy one. People become Juicers for a multitude of reasons, and those who wish to become Juicers often fail to achieve their dreams. Some common patterns among those who choose the short life of the super-warrior are described below. They can be helpful for players wishing to develop a Juicer character, and for Game Masters who wish to treat Juicer non-player characters as something more than combat monsters to throw at the adventuring party.

Common Juicer Volunteers

"Are you nuts? You wanna die or something?"

"We all die, old man. I wanna live the good life first!"

— Conversation overheard outside a Body-Chop-Shop

Who wants to become a Juicer?

The shortcomings of the process are obvious and well-publicized; most notably, a very shortened life span and violent death. Coalition propaganda depicts Juicers as insane psychopaths who will die horribly in a few years and, thus, have no respect whatsoever for human life or decency (in many cases, true). Still, there are many for whom even these facts and dark reputation are no deterrent. Among them are the following:

The Young and the Stupid: Many people in their late teens and early twenties feel immortal, and think that nothing terrible is really going to happen to them. Most of these people have no combat experience and do not realize that death has no respect for age or youth. Also, despite the warnings, propaganda and cautionary tales, many people actually do not believe the process is lethal! Even if it is, they reason, they still have a chance to detox after three years (a long time in their minds). Their plan is simple, they tell themselves: undergo the process, make a pile of money and "retire" after three years. Easy and exciting, they figure. They are wrong.

Mercenary recruiters for independent kingdoms love this type of foolish "volunteer." They can hire them relatively cheaply (the cost of the Juicer conversion plus some form of stipend or salary), plus these new Juicers are likely to be loyal as long as they believe there is hope. Eventually, however, Juicers who hang around others of their kind see the price of power firsthand. They soon realize that they are probably doomed to die in the throes of a drug-induced bio-overdrive or blasted to atoms on

the battlefield. Even worse, most of them soon become totally addicted to both the enhancing drugs and, more importantly, to the feeling of super-human strength, speed and physical perfection. They get a rush when people whisper in fear, "Oh my god, a Juicer," and often mistake fear, hate and awe with respect and power. Their carefully crafted plans soon collapse and they become addicts with no way out, or bitter, often mentally twisted men and women who feel life has handed them a raw deal.

Most Juicers of this ilk end up with an anarchist, miscreant or diabolic alignment, always looking out for number one. Many of them start with unscrupulous or even good alignments, but the discovery of their predicament often leads them astray.

The Obsessed: Some people follow the Juicer's path with their eyes open, knowing full well the consequences, and not caring. Among them are those who want to be able to strike back at a former tormentor or oppressor. This enemy could be anybody, from an individual to an entire species. Many former victims of supernatural predators such as vampires or the minions of the Splugorth have undergone the Juicer conversion for a chance to get revenge on them. Some would-be revolutionaries or former enemies of the Coalition States have done the same, hoping that in the five to seven years they will have left to live, they will be able to do enough damage to compensate for their sacrifice. Personal conflicts are also a common motivation; many are the tales of Juicers who lived for the day when they could confront somebody who offended or brutalized them or their loved ones. Bullied children often dream of gaining the Juicer's powers so they can teach their tormentors a lesson.

The biggest problem these avengers have is the high cost of the Juicer process. Unlike the more mercenary Juicers, the obsessed do not want to spend two or more years of their lives working off their debt. Instead, they try to sell what little worldly goods they have, or raise the money through more illicit means. A few pretend to accept the terms of an employer, and then escape as soon as they undergo the Juicer conversion. These oath-breakers are often pursued by their angry ex-employers, beaten, enslaved and/or executed.

Most obsessed Juicers are anarchist, aberrant or diabolic; their driving goal has become so important that they will gladly sacrifice not only themselves but anybody or anything to achieve it. Some may hesitate before harming the innocent — after all, many of them were former victims themselves — but others simply don't care anymore.

The Insane: You don't have to be crazy to be a Juicer, but it helps. A significant percentage of these augmented warriors are indeed psychotic or delusional. Some think they will beat the odds and survive longer than the allotted five to seven years; others are so far removed from reality they only have a vague idea of what is happening to them. The worst of the lot are the true psychotics, people who have no respect whatsoever for human life, and who do not have normal emotions and feelings. These madmen have no remorse or compassion, and often kill for no good reason. Fortunately, psychopaths do not survive long in civilized areas; as soon as their true natures are revealed, they are often killed by lynch mobs, champions of justice like Cyber-Knights, and even their fellow Juicers. However, psycho-Juicers in the wilderness can indulge in their insanity without fear of reprisals, especially among the most brutal outlaw gangs that terrorize the countryside.

The Poor: The gap between the haves and the have-nots is much wider in the post-apocalyptic era than it has ever been. On one extreme are the wealthy and powerful, who own technological and magical conveniences that are far better than the most decadent 20th Century billionaire could have imagined. On the other, are the destitute people living in conditions that would not have been tolerated in 20th Century America — conditions, in fact, no better than those endured by medieval peasants, if not worse. The poor of Rifts Earth live in squalid villages or slums, eking a meager living and are constantly exposed to plagues, bandits, and supernatural predators. The life expectancy of these unfortunates is lower than it has been since the Industrial Age; surviving to age thirty when you are poor is an accomplishment. To these unfortunates, the poorest adventurer is incredibly wealthy. Owning an energy weapon and M.D.C. armor, each worth tens of thousands of credits, is an incredible achievement to people whose average income is often less than one thousand credits per year!

Faced with such a life, many people will do anything it takes to escape it. Even the Juicer's short life looks like a better option than what they have. So, many people will volunteer for the conversion. Some reason they can make their money and quit before the Juicer process kills them. Some have written off their own life as lost, but hope to make enough money to help their family to escape their life of poverty or subjugation under a foul ruler. Others simply don't think ahead.

Many of these Juicers feel a great deal of hatred for the wealthy; some become bandits and commit atrocities against anybody they consider to be rich. A number of them, on the other hand, embrace the decadent culture of the affluent and powerful, and do their best to forget their humble origins. Some never manage to acquire either wealth or glory and die an anonymous death. Very few actually manage to help those they left behind.

Unwilling Juicers: Not every Juicer chooses his fate. A significant number are forced into it. Unwilling Juicers are basically slave-warriors, pressed into service, made to endure the Juicer process, and used as cannon fodder by their enslavers. Although slavery is illegal in most of the larger kingdoms, a number of small nations and groups have no such qualms.

The largest slave market in the world is the monster-populated continent of Atlantis. There, the Splugorth and their minions use humans as anything from servants to food. Juicers are not an exception. Many slaves are turned into Juicers and used for labor or forced to fight in the arena for the entertainment of the masses. These Juicers are either the human technology variants or more powerful and grotesque bio-wizardry Juicers (for more information about bio-wizardry Juicers, refer to the **Splugorth Juicers section**; general information about bio-wizardry, alien symbiotes and other Splugorth technology can be found in *Rifts World Book Two: Atlantis*).

Slave Juicers are slightly better off than normal slaves and forced laborers, inasmuch as they have valuable skills and abilities — and also have a good chance to escape and maybe get revenge on their tormentors. Ex-slaves can make great tragic characters — doomed to die through no fault of their own, but willing and able to right some wrongs before their demise.

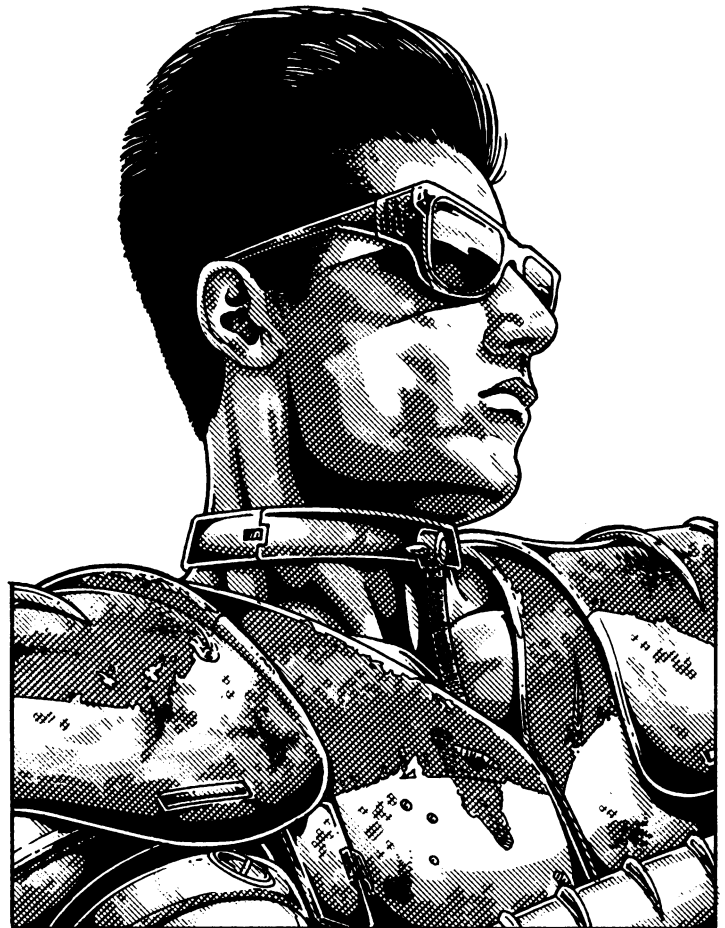

Breaux

The Juicer Procedure

"This Won't Hurt A Bit."

— Handwritten sign over a Body-Chop-Shop in Ishpeming.

Contrary to popular opinion, Juicer conversion is neither instantaneous or painless. It requires two surgical procedures, a period of adjustment, and often serious side-effects. Some people come out of the operations without Juicer powers, with reduced or altered forms of those powers, or as physical wrecks, weaker than when they started!

Undergoing the Juicer procedure can take as long as two months. First, the operations installing the bio-comp and the IRMSS internal housing each take 2-6 hours, and the patient must convalesce for at least two days in between the operations. Rushing the procedure increases the chance of a catastrophe by 15% (i.e., reduce the chance of success by 15%, or by 20% if both operations take place on the same day; see below). After the bio-comps and nano-machines are in place, the new Juicer must undergo a period of adjustment as his body is modified and enhanced by the drugs. Over the first week, the Juicer will get one half of his final bonuses. For example, a Juicer whose strength has been raised from 14 to 26 will only have a P.S. of 20 for the first week. Initial combat and initiative bonuses are likewise half those provided by the end of the procedure. It will take 2D4 weeks for the full benefits (bonuses) to manifest themselves. Sadly, many neophyte Juicers go out looking for trouble, relying on their abilities and often getting themselves killed be-

fore they are fully empowered and capable of handling themselves.

A competent doctor with the proper equipment can perform the procedure with a 98% chance of success without ill effects. This chance will decrease proportionally with the skill and shoddiness of most body-chop-shops. In an illegal “bodybuilding clinic” in the Coalition States, unscrupulous cyber-docs will use substandard techniques and implants, often “recycled” bio-comps and injection collars, usually taken from the corpses of dead Juicers! If characters undergo the Juicer conversion in the course of play, the Game Master might want to reduce the chance of success by 6% to 48% (giving a range of 50% to 92%), depending on the type and quality of body-chop-shop used by the would-be Juicer. Then roll percentile dice using the modified chance of success. If the roll succeeds, the Juicer process is performed normally, with only the common dangers and side effects listed under **Dangers and Side Effects**. If the roll fails, however, a mistake has been made! Roll on the following table:

01-30%: Reduced bonuses: Reduce one of the physical bonuses (P.E., P.S. or P.P.) by half! Everything else remains the same.

31-50%: Poorly calibrated bio-comp: The bio-comp system overdoses the Juicer, increasing his attributes but greatly decreasing his life span! Add 1D4 to any two physical attributes, but reduce the character’s life span by 1D4 years!

51-60%: Narcolepsies: This strange phenomenon is caused by a faulty bio-comp circuit in charge of monitoring the Juicer’s health level. Occasionally, the bio-comp will think the Juicer is severely injured, and will place the victim into a temporary healing coma! Consequently, the Juicer has a 1-5% chance of suffering Narcolepsies (sudden states of unconsciousness) for no apparent reason every day; this chance is reduced to 1% during combat or strenuous activity. Roll at the beginning of each day: 01-05% means the Juicer will suffer an attack of Narcolepsy during the day; roll 4D6 to get the time (military time; i.e. 400 to 2400 hours, or 4:00 a.m. to 12:00 a.m.) of day when the Juicer will, for no apparent reason, collapse into a coma. This period of unconsciousness will last 2D4 minutes. A sudden impact (being struck or attacked) has a 50% chance of snapping the character out of this state.

61-70%: HSS Syndrome: Roll on the HSS table.

76-85%: Metabolic-Induced Voracity: See the MIV entry below.

86-90%: Psychosis: Roll on the Random Insanity Table.

91-97%: Roll on the Last Call Effects Table. The Last Call Effects will affect the Juicer from the beginning of his new life, causing many people to think he or she is nearing death!

98-00%: Near-lethal backlash! The victim rejects the poorly-administered drugs. The bio-comp needs to be removed, and the patient suffers the effects of undergoing Detox! All physical attributes are reduced to 8+1D4 (or the original attribute -2, whichever is lower), and the victim is permanently weakened. The Juicer procedure can be attempted a second time, but also reduce the chances of success by an additional -10%!

Dangers and Side Effects

Even during their first 1-3 years of life, Juicers are not exempt from side effects, possible malfunctions in their bio-comps, and other dangers. Power always has a price, and the more powerful the Juicer is, the steeper — and more lethal — that price becomes. A significant percentage of Juicers are never able to lead a normal life, even by the standards of what is normal on Rifts Earth.

Among the most common side effects of the Juicer conversion are the following:

Hyper-Strength Syndrome (HSS)

This condition is common among Juicers with a P.S. of 30 or higher, or any Juicer variant with supernatural P.S. HSS sufferers are not always able to control their strength, and often end up breaking things and hurting people without meaning to. The condition comes about when the Juicer’s nervous system does not develop well enough to cope with the increased strength of his body. Symptoms include clumsiness when handling fragile objects, sudden bouts of trembling, muscle spasms, and jerky, uncoordinated movement. About 27% of all super-strong Juicers are afflicted with this syndrome, but among *Titan Juicers* (see the **Juicer Variant Section**), the chance is even greater: studies show a 40% chance of being afflicted with HSS.

During character creation, the Game Master or the player may roll (at the G.M.’s discretion) to determine if a super-strong Juicer (P.S. 30+, or any level of supernatural P.S.) suffers from HSS. A roll of 01-27% (or 01-40% for Titan Juicers) means the character is afflicted with that syndrome. In that case, roll on the following table.

HSS Symptoms Table:

01-20% Tremor/Spasms: The character is afflicted by occasional muscle spasms. His muscles start trembling uncontrollably, causing the character to drop objects, knock things down, etc. The spasms are not overwhelming or paralyzing. Furthermore, adrenaline seems to keep them under control, so the spasms do not affect the Juicer’s combat performance whatsoever; they tend to occur during quiet moments. Every day, there is a 5% chance that the Juicer will suffer the spasms at some point. To determine the time of the spasm, roll 4D6; a 4 is 4:00 a.m. and a 24 is 2400 military time (12:00 a.m.); however, if the character is in combat or physically active, the adrenal surge produced by the bio-comp suppresses any spasms. The episodes last 1D4 melee rounds, during which the Juicer is at -20% to any skill roll and will accidentally inflict 1D6 S.D.C. damage to any thing or person in his grasp (drop, crush, bump, knock over, etc.).

21-40% Severe Tremor/Spasms: As above, but the muscle spasms are more frequent and may happen any time, even in combat! Every day, there is a 15% chance the character will be afflicted by one or more spasms; roll four times a day (as many as four attacks each day)! To determine the time of each spasm, roll 4D6; a 4 is 4:00 a.m. and a 24 is 2400 military time (12:00 a.m.). Each episode lasts 2D4 melee rounds (30 seconds to 2 minutes). The effects are as above, except that if the Juicer is in combat, he is at -4 on all combat actions during the episode, and -30% on all skills.

41-55%: Clumsiness: When handling fragile objects, the character may accidentally break them or crush them between his fingers. The save roll is equal to the Juicer's P.S. bonuses to S.D.C. damage! So, a Juicer with P.S. 30 will need a 15 to save. The character adds M.E. bonuses (if any) to his saving roll. Also, if the player states that his character is very careful, taking two to three times the amount of time normally required to carry out a task, the Game Master may assign an additional bonus of +2 to +10, depending on circumstances. Fragile objects include glass cups or vials, ceramic plates, chopsticks, binoculars, books, etc. Metal objects, any M.D.C. object (includes most weapons) and other solid objects are not damaged by these spasms.

56-70% Major Clumsiness/Danger to Others: In addition to the clumsiness symptoms above, the Juicer also risks injuring people while hugging them, bumping into them or even showing affection. The save is the same as above, but the Juicer has a +2 bonus, although circumstances (a passionate embrace or similar display of affection, for instance) may reduce or even eliminate the bonus. If the save is failed, the "victim" can take 1D4 S.D.C. plus the Juicer's hand to hand damage bonus in accidental injury. M.D.C. creatures and S.D.C. creatures with a P.S. or P.E. of 22 or higher are tough enough to not take damage from such accidents, so no save is necessary. Characters in M.D.C. body armor are also safe.

71-80% Tremor/Spasms and Clumsiness: The Juicer is affected by both occasional muscle spasms and the clumsiness associated with HSS. Effects as per the two entries, above.

81-90% Severe Tremor/Spasms and Clumsiness: As above, but the tremors are more severe; see individual entries for details.

91-95% Tremor/Spasms and Major Clumsiness: Occasional spasms accompanied by a dangerous inability to control one's strength. See individual entries for details; reduce bonuses to save by half.

96-00% Severe Tremor/Spasms and Major Clumsiness: The Juicer is racked by severe spasms in addition to being a danger to others. Double the penalties and damage inflicted by these conditions.

Metabolic-Induced Voracity (MIV) — Juicer Gluttony

This condition is common among Juicers with exceptional speed and reflexes (Spd. 80+ and/or P.P. 26+); Juicers with such high attributes have a 20% chance (roll during character creation) to experience MIV symptoms. **Hyperion Juicers** (see the **New Juicer Variant Section**) have a 30% chance of developing MIV, regardless of their actual attributes.

Basically, MIV is caused by the bio-comp system's demands on the Juicer's metabolism. To keep up with the incredible energy demands on their body, MIV sufferers *must* consume a minimum of 10,000 calories a day, the equivalent of five or six meals, but will not feel satiated until they consume at least 20,000+ calories! The Juicer will be in an almost constant state of hunger unless he has something to eat almost every hour; meats, junk-food, nuts of all kinds and fatty foods are preferred, as they have a higher caloric value. Sights like Juicers spreading

butter over a cheese pizza, or eating chunks of fried lard are common, as the craving for fat takes over.

Despite the incredible amounts of food eaten, MIV Juicers (also known as "gluttons") never gain weight; in fact, many become rather thin (for a Juicer) despite eating three to ten times as much as a normal human.

If the MIV Juicer misses a day's meal (consumes under 10,000 calories), he experiences a feeling of coldness, light-headedness, and weakness. Reduce all combat bonuses and initiative by -1. The character will feel mild anxiety and be afflicted by pangs of hunger. If he sees food, he will feel a nearly irresistible urge to drop anything he's doing and consume a meal (usually not applicable to life threatening situations). If this occurs at a wholly inappropriate moment, like during combat, a save versus insanity (plus M.E. bonuses, if any) is necessary to resist the urge. The weakness passes as soon as the Juicer consumes enough food.

Eating less than 10,000 calories (but at least 2,000) a day will severely weaken the Juicer: reduce all combat bonuses by -1 (cumulative) per day. If the Juicer spends a day without eating *anything* (for a Juicer that's less than 500 calories), all his bonuses and melee attacks are *halved*, and the character will be racked with hunger pains. After a second day without food, the bio-comp will slow down the Juicer's metabolism to save the character's life. However, this means speed and P.P. are temporarily halved and all Juicer reflex bonuses are temporarily lost! The starving MIV Juicer must save versus insanity to avoid flying into a frenzy at the first sight of food. A failed roll means he charges in and devours whatever he can get his hands on (and will fight, perhaps kill, to get it)! This condition will continue until the Juicer has eaten enough to allow his metabolism to speed up again. There are stories of some MIV gluttons resorting to cannibalism to satisfy their urges!

Juicer Psychosis

Insanity is a common price for the power acquired by Juicers. The problem is, the so-called "Juicer Psychosis" is sometimes hard to differentiate from the overconfidence most Juicers (justifiably) feel. Added to this is the fact that many volunteers for the Juicer process were mentally ill to begin with, so it's difficult to establish a link between the Juicer conversion and inevitable insanity. However, kingdoms where Juicers are employed in great numbers have the statistics to prove that a significant number of them develop mental problems within a few years after their transformation. The "Juicer psychosis" can actually be one of many different mental disorders, ranging from delusions to a lack of conscience and remorse.

Some 15-25% of all Juicers develop mental or emotional disorders at some point in their lives. The chance of insanity increases over the years, to the point that almost a fourth of all Juicers in their last months are mentally ill. Game Masters wishing to add that risk into their games should make a percentile roll on the following table every "campaign year" (or so) of the Juicer's life, starting with the second year. In the second year, a roll of 01-05% means an insanity has developed; 06%+ means no insanity. Every year after that, add +5% to the chance; by the sixth year, the chance of random insanity becomes 25%.

Juicer Psychosis Table — By Kevin Siembieda

Note: Psychosis is a severe mental disorder characterized by deterioration of normal *intellectual* and *social* functioning, and by partial or complete withdrawal from reality.

01-10 Obsessed with death. This character loves to fight and likes to kill; it gives him a rush as good as any chemical release. Some even become serial killers or mass murderers who slaughter people without hesitation, as if trying to murder as many people as they can before their own end.

11-20 Fascination with death in all its forms. The Juicer examines and tends to study ways one can die (and kill), implementations of death, how the human (and nonhuman) body reacts/responds to the threat of death/fear reactions, tolerance to pain, survival responses, and even the philosophical concepts of death, the soul, life after death and so on. It's interesting to note that the character is not afraid of death and is not morbid about it, simply fascinated. Others may find him to be disturbingly callous and ghoulish.

21-40 Super-species syndrome: A common symptom is the belief that Juicers are a "separate, new species" or the "next step in human evolution" and that all non-augmented humans are inferior beings, not worthy of much, if any, respect or consideration. Regard for the life, laws and the needs of non-Juicers is minimal.

41-50 Superman syndrome: The Juicer thinks he's stronger, faster, smarter, and better than anybody else. He tends to respect only brute strength, power, ruthlessness and other Juicers. As a result, the character accepts foolish challenges, takes dangerous risks and always underestimates his opponent or the chance of failure/defeat. Crazyies are often seen as loud-mouthed rivals. If it's any consolation, the character is usually cheerful, helpful and positive.

51-55 God syndrome: The Juicer believes he is "god" and as such, above the law, judgement, and comprehension of all creatures. The least offensive are cocky, arrogant, bossy, condescending and trivialize everything that does not directly involve them (they are the center of their universe). The most extreme honestly believe they are truly a superhuman "god" and act accordingly as directed by their alignment, so some are reasonably benevolent "gods" while others are cruel, vengeful or malicious.

56-60 They're out to get me: The character believes that most people hate and fear him out of jealousy, because he's better than they are. As a result, he believes "they" are out to get him (torture, kill, imprison, cheat, discredit him, etc.). Blames all of his misfortunes on others and sees conspiracies everywhere. Tends to be a loner and distrusts everybody except fellow Juicers and the occasional comrade.

61-65 Ordinary laws are meant for "ordinary" men: The Juicer's sense of superiority is such that he ignores the laws of any place he visits. The character isn't necessarily mean about it, nor blatant or deliberate about breaking the law, he just doesn't think about them and refuses to pay the consequences when accused of breaking them.

66-70 Cocky daredevil — "I can do anything" The character is usually friendly and cheerful, but accepts any challenge, takes stupid risks, will fight at the drop of the hat to defend his honor or the honor of his friends and allies (even if they ask him not to), brags and showboats. His antics often get him in trouble and endangers those around him.

71-80 Manic depressive: Alternate severe depression one week (nobody loves him, he's a loser, and he's going to die in a few years; -10% on all skills, and reduce all combat bonuses by half) with manic episodes the next week (everything is great, he's the best there is, life is grand! +5% on all skills and +2 on initiative).

81-87 Hysterical aggressive reaction: The Juicer reacts in anger and violence to a particular thing or occurrence. This "trigger" is usually a response to accusations and criticisms about his character, such as being called a coward, sissy/wimp, cheater, ugly, stupid, crazy, etc. The reaction may also be a response to the actions of others, usually something that was traumatic to the character sometime in his youth. This can include things like a child being beaten, acts of torture or cruelty, seeing someone attacked by an animal, D-bee, CS trooper or monster, etc.

In most cases, the Juicer flies off the handle ranting and raving like a lunatic, shoving and threatening or challenging his accuser or the perpetrator of the "trigger" action — i.e. "How would you like it if I slapped you around like that, punk!" Shove. Shove. "You want to hit somebody? Huh? You want to hit me!? Come on, you bastard, hit me!! What's wrong? I'm not a helpless little kid (or woman, or D-bee, or dog, etc.), is that the problem? I should beat the snot out of you and see how you like it, huh? What do you think about that, huh? Get the ... out of here before I kick your ass!" The slightest act of antagonism, aggression or intolerance toward him, like a shove back, pushing him away, a smart remark, ignoring him, etc. will send the Juicer into a fury and he will attack the person or thing that set him off.

88-94 Hysterical aggressive reaction to fear/phobia: In this case, the "trigger" is something the character has a phobia about, except instead of cringing in fear, the Juicer lashes out to destroy whatever is the object of his fear. This is usually a tangible thing like spiders, snakes, a particular monster, etc. For example, if a Juicer has a phobia about spiders and sees an itty-bitty spider dangling from the shelf behind the bar in a saloon, he's likely to shout something like, "Oh my god! Look out! Get out of my way," and leap over the bar and karate kick or chop the spider, shouting, "Did I get it? Did I get it? God, I hate spiders." Of course, in the process he may have caused a panic (after all, it takes a lot to scare a Juicer) and caused damage by his extreme actions. If the phobia is something like a fear of the dark, he will fight (to the death) anybody who tries to put him someplace dark or who tries to take away his light, or do anything to get out of it.

Remember, this is an unreasoning response driven by terror. Consequently, the character's actions may not make sense. For example, the Juicer who is afraid of spiders will scream his battle cry and lunge into battle with a giant, monster spider even though it can be easily avoided (it may not have even seen him). Similarly, he may attack a spider-like D-bee or demon without the slightest provocation and kill without regret or reasoning (he can't help himself). Obviously, this can draw his fellow adventurers into some serious (and pointless) conflicts (and the reason why the phobia shouldn't be caused by intelligent beings that are too common, like practitioners of magic, cyborgs, CS troops, etc.)

95-00 Jekyll and Hyde: The Juicer hears a voice in his head and feels powerful emotions contrary to his original alignment.

There will be moments, especially when under stress, angry or drunk, that the voice speaks so loudly and convincingly and the contrary emotions are so strong, that the Juicer will respond to them. The response is the opposite of the character's normal, original personality and can be frightening, as if the Juicer is a completely different person. When he returns to normal, the character may regret his actions, but there is little he can do when his other personality takes over. Consequently, if the Juicer is a principled or scrupulous good character, his opposite, Hyde personality will be one of the evil alignments. As a result, in the heat of combat or under stress, the Hyde personality may surface and engage in acts of cruelty and intimidation, torture, belittling others, killing an unarmed foe out of anger or spite (or even sheer pleasure), and so on.

Non-Human Juicers

The Juicer Process is a human development. Although augmented soldiers, including cyborgs, exist in several parts of the Megaverse, Juicers (and Crazies) are relatively rare. As a result, very few methods to transform non-humans into Juicers are known to exist. The one major exception is Atlantis, where Splynnncryth's bio-wizards have experimented with their own versions of the Juicer Process and use magic and symbiotes to augment slave-warriors. Some examples include:

True Atlanteans: As a race of long-lived and generally wise people, most Atlanteans find the concept of "burning out" for the sake of a few years' worth of power to be utterly disgusting and downright stupid. Exceptions do exist, however, from Atlanteans who are forced or tricked into accepting such a modification to occasional unstable and insane individuals. Since their physiology is mostly human, True Atlanteans can undergo the Juicer Process. The physical bonuses of the Juicer conversion are gained in full. However, given the extremely long life spans of Atlanteans and their extremely powerful metabolisms, they tend to live longer than normal juicers. Typical Atlanteans can survive the Juicer Conversion for up to 10 +1D6 years. Atlantean Juicers who live as much as 15 or 16 years are not uncommon. However, given that their normal life span is 500 years or more, Atlanteans have a great deal more to lose.

True Atlanteans have a slightly better chance of surviving the detox process: add +25% (to a maximum success rate of 98%) to the **Detox Success Ratios** in *Rifts® Ultimate Edition*, page 80. In the seventh year, Atlantean Juicers still have a 25% chance to survive; in their eighth year it drops to 12%, the ninth year it is 5%, and on the tenth year it is 1%. Atlanteans who have been Juicers for more than ten years have no chance of surviving the Detox process. The consequences of a successful Detox are the same for Atlanteans as for humans.

Dwarves and Elves: Both of these races can undergo the Juicer Process. Dwarves can actually use the normal Juicer process used on humans, without undergoing any penalties. Elves require specially tailored drugs for their different metabolism; treatments have been developed in Kingsdale and New Lazlo, although in the latter nation, Juicer conversion is illegal (performed by underground body-chop-shops). Dwarves can undergo the regular conversion, and can be Titan Juicers (although

their height is "only" six to seven feet (1.8 to 2.1 m), Mega-Juicers and Dragon Blood Juicers; both the Phaeton and Hyperion Juicers require reflex enhancements that literally burn out the Dwarven nervous system! Elves can be of any Juicer type.

The big difference for elves and dwarves is their longer life spans. Regrettably, although they live two to six times as long as normal humans, both elves and dwarves do not, on the average, survive much longer than humans once they undergo the Juicer conversion. Dwarves add an additional 4D6 months to their life expectancy; Elves add 1D4x10 months, which means that at best they could survive a little over ten years as Juicers, a fraction of their normal life expectancy.

As a result, few Elves will willingly consent to the Juicer modification; only those who are driven by revenge, insanity or similar obsessive behavior will consent. Dwarves are only slightly less reluctant. In some Earth D-Bee communities, some Dwarven warriors form "berserk societies" and consent to the change to better protect their people. These berserkers are fear-some enemies.

Ogres: These Neanderthal-like humanoids are so close to humans that they can undergo any of the Juicer conversions.

Trolls, Orcs, Goblins and Giants: These D-Bees come primarily from the Palladium World and similar places of magic. So far, no variant of Juicer augmentation works on them.

Gargoyles and Brodkil: Although these beings have only minor supernatural attributes, the only place where a Juicer process that works for them has been developed is Atlantis (see the Bio-wizard Juicers described elsewhere). Human drugs and bio-comps will not work on these creatures, as their life signs and genetic structure are very different. Only the Splugorth bio-wizards have had enough experience in these matters to develop a comparable type of augmentation for these beings.

Dragons and other Shapeshifters: Most shapeshifting supernatural beings, including Changelings, Pleasurers, Nightbanes, Werebeasts and Dragons are unable to use the Juicer Process. Such beings are too alien for any bio-comp to work on them.

Supernatural Beings: So-called demons, vampires and other supernatural beings (and most alien life forms) cannot become Juicers! Such beings are too alien for any bio-comp to work on them.

Mutant Animals: Most mutants have a high chance of being allergic to the chemicals used for the Juicer Process. The dangers are so extreme that most places will not even try to experiment with the drugs; roughly 80% of all mutants exposed suffer lethal or near-lethal experiences; some of the drugs (and one can never be sure which one) cause some mutants to suffer from shock, inflames mucous membranes (including lung tissue, which causes death by suffocation), blindness, epileptic convulsions, and worse. In some cases, the mutants in question experience uncontrollable growth of muscle tissue, until they become unmoving blobs of flesh, too heavy to even walk.

After several failures, most places discontinued attempts to use the Juicer conversion on mutant animals. The one exception was Los Alamo, where a steady trickle of mutant animals (refugees from Lone Star) gave researchers the opportunity to experiment. Right now, dog humanoids (the Dog Pack/Psi-Hound R.C.C.) can be granted the Juicer conversion, but only in that

city-state. Even there, the failure rate is over 20%, so very few mutant animals willingly undergo the conversion. Only “regular” Juicer bonuses apply; none of the variant Juicer conversions has been successfully applied. However, the Juicer Psi-Hound/Dog Boy completely loses his sensitivity to magic and the supernatural (all mutant dog powers numbers 1-4)! Furthermore, mutant dogs who “get juiced” have a life span of only five years +2D4 months.

Other mutant animals are being experimented on at Los Alamo, but results are not promising. In particular, any mutant animal with supernatural powers (like many of the sub-species described in *Rifts South America One and Two*) cannot accept the Juicer process.

Wolfen: Los Alamo and Kingsdale have developed a combination of chemicals that will successfully transform Wolfen and

other canines like the Coyle and Kankoran into Juicers, but not mutant canines (see *Rifts Conversion Book One* for stats on Wolfen, Coyles and Kankoran). Kingsdale is the major center for this type of conversion in North America; Atlantis also has facilities for it. Besides the common Juicer process, the only variants that have been successfully applied to Wolfen include the Hyperion and the Titan Juicers. Attempts to create Phaeton and Mega-Juicers have so far, failed miserably. All other side effects, bonuses and penalties are the same (use the Wolfen stats normally, and then add in the Juicer bonuses).

Some Wolfen are attracted to the Juicer process because they feel it makes them ideal warriors, destined to die gloriously in combat. Even those who do not undergo the conversion will respect Juicers, even non-Wolfen ones. Others consider the process to be dishonorable and even obscene.



The Rise & Fall of the Juicer

Bright-burning candle

Soon embraces the darkness...

A Juicer lives life.

— Haiku written on the gravestone of Achilles Smith, Juicer

If a Juicer does not (and most don't) try the detox process (which is itself a painful and dangerous procedure with no guarantees of success), he is doomed to die. The end can come suddenly, or the dying man can linger painfully for several weeks. Sooner or later, the first warning signs that a character does not have long to live will start to appear. The symptoms might be

mere inconveniences (except for the fact they are reminders of one's coming death) or might cause the Juicer almost crippling agony. A Juicer exhibiting terminal side effects is said to be on his “Last Call.” Juicer's on Last Call can experience any of the symptoms below, starting in the last year of his/her life. Every month of the last year, roll percentiles; a 01-15% chance means one of the symptoms occurs; the roll is at +1% every month after the first. By the last month, there is a 26% chance of experiencing one of the following maladies.

Last Call Symptoms Table:

01-20% Headaches: Pounding migraine headaches are a common complaint of Juicers on Last Call. They can be the result of blood pressure problems, or, more often, the gradual death of brain cells (see memory loss, below). Whatever their cause, these headaches can be extremely intense (reduce all skills by -15%). Sufferers become short-tempered and easily provoked, sometimes lashing out at the slightest provocation. The migraines can occur as often as six times a day (roll 1D6 to determine how many episodes happen on a given day).

21-40% Memory Loss: As the Juicer starts to burn out, some sections of his brain may actually die; the most common areas are those that store memory, especially long-term memory. Commonly, Juicers start to forget details about their early lives, although 90% retain full memories of the last five to ten years of their lives until they die.

41-50% High Blood Pressure/Nosebleeds: As the bio-comp pushes the body well past its breaking point, many Juicers suffer from excessive blood pressure levels, enough to kill a normal man. Common symptoms include a lack of skin ruddiness, specially around the face, giving the Juicer a constantly flushed look. Nosebleeds often occur whenever the Juicer is upset or tense, as the high pressure actually bursts the delicate nasal blood vessels. Acrobatic and gymnastic skills are performed at -20%; they tend to make the character feel dizzy and faint.

51-60% The Shakes: As the body is pushed beyond its limits, the Juicer develops a slight, but constant body tremor. Reduce skills that require a delicate touch by -5% and aimed shots and targeting are -1 to strike.

61-70% Reduced Healing: The body just can't respond like it used to, even when pumped with augmenting drugs. As a re-

sult, the Juicer's healing factor is reduced by half (only heals two times faster than a normal human and is +10% to save vs coma).

71-80% Muscle Cramps: The stresses put on the Juicer's body will eventually destroy the muscle tissue, abused by the drugs that conferred the character super-human strength. The first symptom of this deterioration are muscle cramps, which can be extremely painful, although not overwhelming (the bio-comp releases drugs that block the pain, allowing the Juicer to carry on and continue destroying his body). All physical skills are -5% and reduce the speed attribute by 10%.

81-00% Addictions: Juicers nearing the end start acquiring immunities to some of the drugs that power their body. Drugs that used to enhance their reflexes, block pain and relieve boredom and tiredness start losing their effectiveness. The bio-comp responds by injecting ever-increasing dosages into the Juicer's bloodstream, but often the Juicer starts suffering withdrawal anyway. Many of them deal with the withdrawal symptoms (which include depression, sleepiness and listlessness) by using other drugs like tobacco, alcohol, barbiturates and others. The interactions between the Juicer chemical dispenser and these drugs are often unpredictable and dangerous. Roll on the *Effects of Drug Addiction Table* in **Rifts® Ultimate Edition**, page 21, to determine possible side effects.

Death

"I'll never forget how my best friend Gordon checked out. We were enjoying some down time after we did the Singapore job. He bought it in a brothel room in Bangkok. One second, he was just laughing at one of my jokes. The next, pink froth explodes out of his mouth. He grabbed his chest; I'll never forget the look of dumb surprise that came over his face. He must have known the end was near, but I guess he never really believed it until it happened. By the time I stood up, he was gone.

"I swear: I'm not going to wait for it to hit me. When the time is near, I'll pick a fight I cannot win and check out with both guns blazing..."

—From *Totentatz Comes to Town: A Julian Amici Novel*
Reprinted by New Lazlo Press, New Lazlo

After Last Call comes death, popularly known as "checking out." Most Juicers do not wait for the inevitable and instead, try to die in combat in as heroic a manner as possible. Unfortunately, the end can come suddenly and with little warning. A Juicer may be feeling perfectly well just before dropping dead.

Common causes of death include heart attacks, strokes, or total burnout, a state in which the Juicer's entire system shuts down. Some more exotic (and gruesome) ends include the "Juicer Meltdown," a curious phenomenon in which the Juicer's cells literally break down, with symptoms somewhat similar to the Ebola virus, resulting in the liquefying of the victim's internal organs, fatal in a matter of hours. Suicide is very common among those who feel what they think may be fatal symptoms. Drug overdoses, caused by either manipulating the bio-comp to provide excessive dosages, or by taking other drugs, is also a common way to "check out."

Juicers & the Law

North America is fragmented in over a hundred independent kingdoms, plus cities, towns and nomadic communities, so there is no such thing as "the law of the land." In most places, the law is what the largest group with the biggest guns say it is, regard less of right or wrong. However, in the more civilized places of Rifts Earth, governments and societies have passed their own bodies of law, and many if not most of them have made special provisions for Juicers.

In pre-Rifts nations, when the Juicers and Crazies first made their entry into world affairs, several laws were passed dealing with augmented humans. First, Juicers were considered to always be armed and dangerous, due to their incredible physical abilities, and any crimes committed by a Juicer, even without weapons, were treated as if the Juicer was armed, thereby having stiffer penalties. If a Juicer got into a fight with a normal human and killed him, he would be charged with murder, and self-defense could only be claimed if the normal human had military weapons! Similar laws apply in many kingdoms of Rifts Earth. Juicers who get into bar fights with non-augmented humans risk being tried for murder, attempted murder, or assault with a deadly weapon, even if they were only using their hands and feet.

In many places, the Juicer Conversion is banned outright. The Coalition States is the best known such nation. In the CS, captured Juicers can be executed on the spot or, more commonly, subjected to involuntary detox, a fate worse than death for most Juicers. Many an unfortunate Juicer has been captured, detoxified and then made into a "poster child" for anti-Juicer propaganda, with pictures and films of the weak, half-insane wretches paraded across Coalition cities as a living example of "the horrors of the Juicer Process." Other kingdoms have also outlawed Juicers, refusing to grant them entry or even shooting them on sight.

A few places have taken a middle road, requiring any Juicers entering their territories to report to the authorities, keep them informed about their whereabouts, and promise to obey the law. If the Juicer breaks any laws, he or she is expelled or worse, and suspicions will fall on him just because of who he is. A dispute involving a Juicer and a normal human will be usually resolved in favor of the latter, unless the Juicer in question has a good reputation.

Of course, there are also many towns and kingdoms where Juicers are all but the rulers of the land. In the more primitive communities, two or three Juicers, equipped with M.D.C. weapons and armor, would be a law unto themselves, able to do anything with impunity. Even in a larger and better-defended town, a group of Juicers and other riffraff can get away with a lot, provided they do not push the locals over the edge (if the inhabitants of a town feel they have nothing to lose, they may launch a suicidal attack on their tormentors). Of course, Juicers (and anybody else, for that matter) who abuse their power always risk retribution, from the arrival of a group of Cyber-Knights and other champions of good, to a vengeful villager poisoning the Juicers' food and water.



Making a Living

Becoming a Juicer is expensive; prices range from 50,000 credits (in the few kingdoms where the Juicer process is readily and legally available) to 400,000+ credits in areas like the Coalition States, where only underground labs can perform the necessary operations. Furthermore, the drugs needed to keep the Juicer in top shape are very expensive: although the dispensing system usually has enough "juicer" for 10-12 months of operations, refills cost 2,000 to 50,000 credits, depending on their legality and availability. Consequently, Juicers have to make more money than most people in North America ever see (a common farmer or unskilled worker makes less than 2,000 credits a year; a skilled worker may make as much as 10,000 credits; advanced cities can raise these averages by 100-200%, but most people live under much poorer conditions). Since Juicers are designed for combat, most of their occupations will be in the security/military fields. Among them are the following:

Mercenaries: Some 50%+ of all Juicers pay off their conversion by serving in a kingdom's army for 1-3 years. Many continue selling their services after their "tour of duty" is over. See *Rifts Mercenaries* for more information and ideas on the mercenary occupation. Juicers are considered to be elite soldiers, and command pay rates 100% to 300% as high as regular troops.

Adventurers: One might consider this a mercenary occupation, but while the Juicer and his comrades may occasionally hire themselves out to perform jobs for others, they are more often explorers, freebooters and opportunists in search of adventure and glory, as much as wealth. These characters make most of their money from the booty they acquire along the way.

Bodyguards: Rich merchants and landowners often hire these super-soldiers as house guards and/or bodyguards. In some places, a Juicer bodyguard is considered to be a status symbol, and a Juicer who knows how to handle himself can expect to make in excess of 100,000 credits a year. Such a job requires more than combat skills, however. Since the Juicer will be "mixing-in" with the rich and powerful, his/her manners will be almost as important as his skill with the gun or the knife. Trusted bodyguards are also used as troubleshooters (often literally) and sent out on missions similar to the ones assigned to spies/assassins (see below).

Spies and Assassins: Juicers in pre-Rifts times were almost always used as secret agents and assassins, and that tradition continues to the post-apocalyptic days, although with less frequency. A number of highly-trained Juicers hire their services for covert operations. Some wealthy kingdoms and city-states have a small group of Juicer secret agents (often partnered with Crazies, D-Bees, psychics or men of magic), used for missions where overt force would lead to war or worse. Some nations use them to deal with political enemies, rival kingdoms, and "security threats." Among their tasks are simple espionage (stealing national secrets, acquiring intelligence data on enemy troops, equipment or development), assassinations, kidnappings, etc.

In addition to kingdoms, some large corporations also use Juicers for their own secret purposes. Industrial espionage is common, although Juicers are most commonly used to sabotage the operations of rival corporations. In recent years, the rise of Naruni Enterprises, a transdimensional weapons dealer, has prompted several Earth weapon manufacturers to send spies,

saboteurs and assassins to steal Naruni's secrets, or, failing that, to weaken or destroy the company and its employees. For more information on Naruni Enterprises and their role in Earth's affairs, refer to *Rifts Mercenaries* and the *Rifts Dimension Book Two: Phase World*.

A well-trained spy (see the **Juicer Assassin O.C.C.**) can expect to make 120,000 to 200,000 credits a year, plus bonuses for dangerous or tricky missions and/or a percentage of booty. On the down side, if killed or captured, his employer will disavow any knowledge of the Juicer or his mission.

Crime: Why work for a living if one can just take what's needed from the weak and defenseless? Many evil and anarchist Juicers will do just that, resorting to a number of criminal activities to get money and other valuables. The most common Juicer-related crime is plain banditry. Gangs of Juicers and other outlaws prowl the countryside of many regions, robbing trading caravans or raiding villages and towns. The more daring bands venture into the Coalition States' territory; although there is more booty to be had in the CS, there is also a much greater risk of being captured and typically, executed on the spot. Other common crimes include "protection rackets" in which the Juicers threaten store owners into paying them a monthly fee in return for "protection." People who refuse to pay soon find themselves beaten, robbed, or worse. Some of these groups will actually try to honestly protect their "customers" from other criminal gangs, but many are just concerned with terrorizing their victims and taking their money. A few Juicers are also involved in the Black Market as bodyguards and enforcers. Linking with the Black Market is also a sure way to have access to the expensive and illegal chemicals they need to survive. Although it is said that crime does not pay, a successful criminal can make millions of credits — or he can get killed by the authorities, other criminals, or can vengeful victims.

Blood Sports: In some parts of North America, Juicer combat sports have become extremely popular. Many people now work off their frustration and anger by watching Juicers and other enhanced humans do battle like the gladiators of old. Blood sports like Deadball, Murderthon and Juicer Football are seen by large crowds in such kingdoms as Los Alamo, Fort El Dorado and Old Bones. Video disks of these events are also sold throughout the continent; they are illegal in the Coalition States, but can be purchased through the Black Market or in the 'Burbs. In fact, some Juicer sports are held in the 'Burbs of Chi-Town, right under the noses of the CS security officers (many of whom are bribed to look the other way). Occasionally, a Coalition officer will spearhead an attack against such places and practices, but only a few events are ever disturbed by police action. In other nations, like Lazlo, blood sports are also forbidden, and also still practiced in secret.

Fame and fortune are possible, as is an untimely (even for Juicers) death. A successful sports figure can earn hundreds of thousands of credits in salaries, purses, and even advertising endorsements. Successful gladiators are pampered and showered with praises and luxuries. They are still risking their lives, in some cases more often than a veteran mercenary, and the mortality rate among these athletes (many of whom are forced to compete without armor and other protection) is very high. For more information about Juicer sports and the people who participate in them, refer to the **Juicer Gladiator O.C.C.** and the **Juicer Sports Section**.

Others: Other occupations where Juicers participate include entertainers (in wandering carnivals, as described in *Rifts World Book One: Vampire Kingdoms*), test subjects used to experiment with the Juicer chemicals and to create new variants, scouts and guides (see the **Juicer Scout O.C.C.**), and almost any occupation that could benefit from the increased strength and reflexes common to most Juicers.

The Juicer Culture

"If it's dangerous, do it. If it's suicidal, do it NOW!"

— Graffiti painted outside a Juicer Bar

Tragic heroes or psychopathic villains, the Juicers have become a part of North American culture. The Juicers themselves have adopted their own "sub-culture," where toughness and recklessness are considered to be virtues, and living on the edge is seen as the only way to truly live. "You are not truly alive until you dance with Death" is a common Juicer saying. Taking chances is, for the Juicer, a form of self-expression.

Over the years, Juicers have developed their own group mystique and ideals. Among them is the desire to skirt on "the edge," constantly risking their lives for glory and money, the creation of an establishment that caters only to Juicers and other augmented beings, and even the growth of gangs of Juicer Wannabes who imitate their idols and often get themselves killed before managing to become Juicers themselves.

The Edge

It's like this.

Imagine you're walking down the street, minding your own business, and then two street scum decide to screw with you. Maybe they don't notice the drug harness — myself, I hide it under my cloak; I don't like to advertise — or maybe they are just high on something, or just plain crazy. They ask you for money, you tell them to go play with themselves, and one of them reaches for a gun or a vibro-blade.

That's when it starts to happen.

That little computer they built into you starts pumping chemicals into your bloodstream. The world slows down around you, and everything feels sharper, clearer, more real than anything you'll ever feel, before or after. You can count every hair in the young punk's face, you can smell his fear and anger, you are aware of everything around you. I guess that's how a god would feel.

You have all the time in the world. The punk's weapon is only halfway out of its holster, and you still have time to think of a battle plan, enjoy the scenery, and even think of a snappy joke, before you need to make your move.

Finally, you decide it's time to act. The punk is ten feet away. You close in. To the punk and his friends, it's like you just teleported. They are flies trying to swim through molasses, and you are a hawk soaring through the sky. What to do, what to do... You could draw your gun and drill the punk between his eyes, but you are feeling artistic, so you just wind-up and give him a good haymaker, powerful enough to dent ballistic armor. So the punk manages to clear his weapon, but you just batted his head

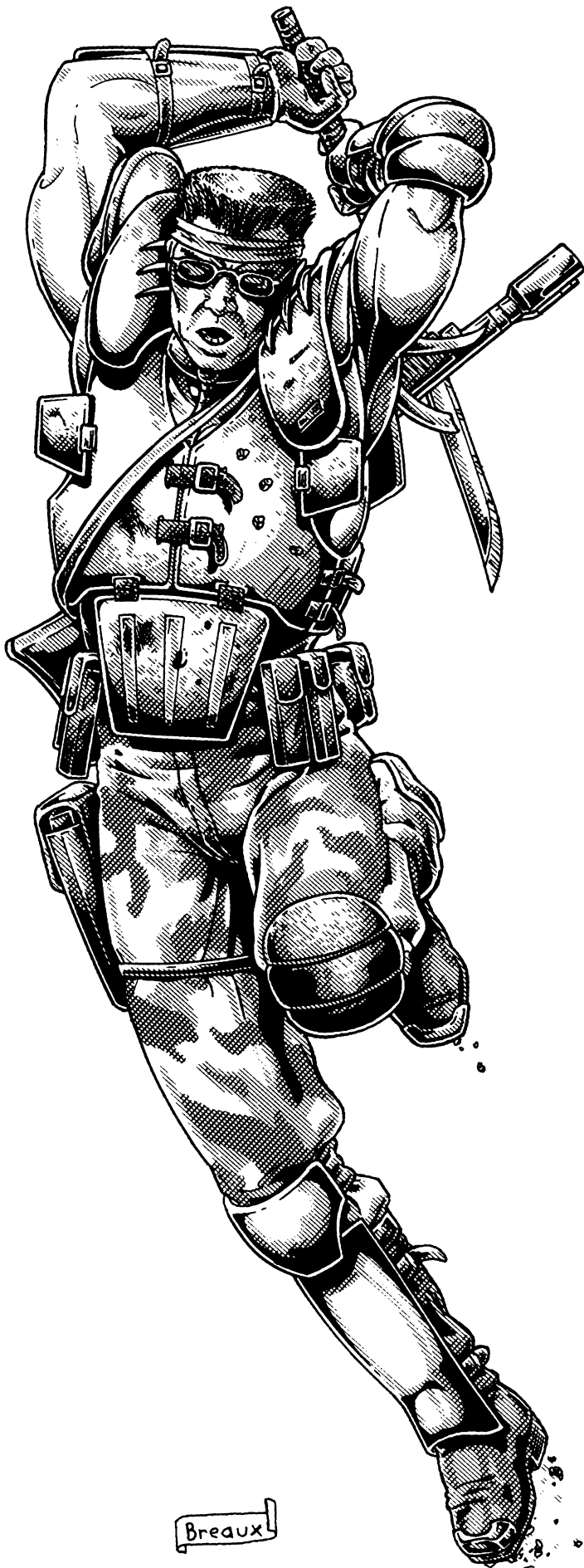

clean off his shoulders. The other punks try to run. You can catch them—they'd need a car to get away from you—or you can let them go, enjoying the high while it lasts.

Finally, the danger is over, and you come down. Things stop being so clear and beautiful anymore. You may even get the nagging suspicion you are back to being a human. Sometimes, I need to remind myself I'm not, and I have to leap off a building just to get the rush going again.

You never feel so alive until you spit into the face of Death.

—From *A Juicer's Diary*,
by Crazy Lou, Juicer. Printed by Kingsdale Books.

Since they have already sacrificed any reasonable chance of living a long life, Juicers have created an entire mythos around flirting with death. To them, the best way to truly feel alive is to put everything on the line, time and time again, to risk death.

The typical Juicer is the ultimate “adrenaline junkie”; living for the high they get when they are fighting for their lives. Their bio-comps, which increase adrenaline and pheromones (natural body chemicals that heighten pleasure or strong sensations), make this addiction worse: Juicers feel pleasure whenever they are exposed to danger: risking life is their ultimate “high.” And like all drug addicts, they will do stupid things to feel that high again and again. This state of being in danger, and the fear and excitement (natural and chemically-induced) it induces is craved by Juicers, so many of them make a point of living on the edge their entire lives. The stereotypical Juicer will do almost anything on a dare, from picking a fight against hopeless odds to attempting suicidal vehicular stunts, acrobatic maneuvers, and other dangerous challenges.

Juicer Philosophies: Over the years, a romantic image of the Juicer has become commonplace even among the Juicers themselves. In the eyes of some, a Juicer is somebody who has sacrificed his life in order to live life to the fullest, even if it's for a brief time. A common myth among Juicers is that they are the only ones who appreciate life, because they know how short their time really is. Many young and impressionable people actually seek Juicers for their “wisdom” about life. If the Juicer in question is feeling charitable (many questioners walk away with bruises and broken bones, and precious little wisdom), he may share his philosophy with the “squishy” (a Juicer term for non-augmented humans). Most of the time, this philosophy boils down to a disregard for consequences (“We all die sometime, so why give a crap about anything?”), and the search for immediate gratification (“Anything you wanna do, do it now, before it's too late.”). These beliefs are one more reason why many Juicers are often hated and feared, even outside the Coalition. More than one teenager has been seduced by the “Juicer philosophy” and become a criminal or worse. Many concerned parents will never allow their children to come near a Juicer.

Of course, not all Juicers buy into the nihilist philosophy. Some actually espouse the opposite viewpoint: To them, their short lives means they only have so much time before they can make a difference in the world. “Life is meaningless without a goal,” these Juicers will often say. Many of them actually envy “normals,” because they have, in the words of a heroic Juicer, “the time to learn from their mistakes, unlike us, who will rarely get a second chance.” Their belief is that friendships, kindness and good deeds are the only lasting legacy they can leave be-



hind, and they seek to live on in the memories of others. These characters have a high regard for life and never try to recklessly endanger others, or take life away without a thought.

Finally, a third group of Juicers makes no pretense in believing in any philosophy or meaning in life. They may be bitter about their inevitable doom, or they simply don't care about such things. Some may be good, others evil, but they completely reject any belief that their Juicer status gives them any insight into the deeper questions of life. They do what they have to do to live their life as they see fit before it's gone.

Juicer Bars & Clubs

The wannabe tries to smile grimly and look tough, but all he manages to do is look young and scared. Then he tries to come in. Lara, our bouncer, tries to be nice; she's got a soft spot for the young and stupid. "Juicers only, squishy."

"I'm a Juicer, and I can prove it," he says, and that's when I know there's gonna be trouble. I should have noticed the symptoms: the kid had dropped a tab of Crash. "Lara, he's..." I start to say.

"I'm gonna kick your ass!" the kid screams, and he tries to punch Lara in the face. Crash makes you stronger and faster than human; it also makes you dumb enough to think it's enough to take on a Juicer. The sad thing was, the kid moved fast enough to make Lara react as if he posed a real danger. Her reflexes take over her, and before I can get to the door the kid's gotten his neck broken.

Lara looks at me. Even under all the face paint, I can see her guilty expression. I shrug. "It don't mean nothin'."

—From *A Juicer's Diary*,
by Crazy Lou, Juicer. Printed by Kingsdale Books.

Some of the more tolerant cities and towns in North America have allowed the construction of a few establishments that cater exclusively to Juicers, or more commonly, to Juicers, Crazies, augmented humans and the occasional D-Bee. There, the super-humans can gather together to swap tales, relax among their kind, and keep track of any new rumors or news. Humans are only allowed if a Juicer is with them, and even then the "squishy" may get picked on, insulted or otherwise bothered by some customers. In some Juicer Bars, violence is a common occurrence; usually, the bar and stage (if any) are protected by M.D.C. mesh cages, and the furniture is either easily broken (to prevent major injuries) or made of M.D.C. materials (to keep the cost down).

In addition to Juicers, Crazies, and D-Bees of unusual size, strength or speed, supernatural creatures may be welcome to some of these bars. Few non-augmented humans manage to impress Juicers enough to be welcomed into their ranks, those who do have to be extraordinary individuals. Sometimes, the patrons demand a test of the newcomer's "worth." These tests can consist of a simple bout of arm-wrestling (often against a Titan Juicer or similar powerhouse), or a hand to hand duel (usually only a fistfight to first blood, but in some places it's a major brawl or a fight to the death!). Juicers respect strength and toughness.

Many of these bars have wall-mounted plaques in honor of famous Juicers. Only the most impressive deeds will entitle somebody to this honor. The acts do not have to be good (or evil) to qualify; there are plaques honoring people who saved entire cities from destruction, next to ones depicting notorious villains. There is always room for more plaques. Some Juicers hope to do something heroic (or foolish) enough to one day get their own metal plaque commemorating their name, birth and death, and a brief description of their deed(s). Some plaques are more sophisticated, and can project a holographic picture of the Juicer, or have a memento of the deed (weapon, horns, skull, etc.) mounted with it.

Juicer bars are a good place to get information and find employment, as long as the people asking the questions are Juicers themselves. People who may be deadly rivals outside the bar will often treat each other in a friendly, or at least polite manner, and may help each other with a quick bit of news or even a warning of some danger. These bars try to live by the ideal that Juicers should stick together.

Juicer Wannabes

Some people, especially in the 'Burbs, free towns and other lawless, violent areas of the world, admire and respect Juicers. There is even an ever-growing group of young people, usually in their teens, who pretend to be Juicers. They are the so-called "Wannabe Juicers," or Wannabes. Wannabes ape the dress, attitude and lifestyle of their role models. Some use drugs to give themselves temporary boosts, and most end up trying to become Juicers at some point in their lives. Wannabe gangs are a problem in some cities, because the would-be Juicers often terrorize and intimidate civilians, and wreak havoc for its own sake. Many end up getting killed in gang fights, commit suicide in ghoulish imitation of their short-lived "mentors" or end up as true Juicers.

Most Juicer Wannabes are City Rats or Vagabonds; the more dedicated ones spend so much time and money in their worship that they become, in effect, a class of their own (see the **Juicer Wannabe O.C.C.**). They often spend most of their money on designer drugs to enhance their physical abilities. If they have enough money and the resources, some will also try magic potions, herbal concoctions and alien substances. They try to get their hands on Juicer plate armor, or lacking that, they fashion crude copies of this armor, sometimes using S.D.C. materials (such a fake suit, made of ballistic plastic, Kevlar and other materials, will have an A.R. of 8+1D6 and 3D6x10 S.D.C.). Sometimes they also wear fake drug harnesses and Juicer goggles. To the inexperienced, the Wannabes can pass themselves off as real Juicers, at least until somebody who knows what's what comes along or the kid gets himself into trouble or killed.

The Coalition is particularly harsh on Wannabe gangs, many of which frequent the 'Burbs and other slums. In some cases, the Wannabes are killed on the spot; more frequently, they are imprisoned and made to work in chain gangs used to maintain roads, construct public buildings and similar hard labor.



Juicer Sports

Blood sports involving juicers have started becoming popular in some parts of the world. Although forbidden in most “civilized” city-states in North America, some kingdoms openly promote them, attracting jaded spectators from other nations. Criminal organizations also conduct such events in secret, often catering to the rich and powerful.

Sports-related gambling is a problem in all the kingdoms where any Juicer sport is played. Bets on who will win, the point spread, injuries and almost any possible event in a game are routinely placed by jaded spectators. Since gambling is legal in a number of kingdoms, there is no law-enforcement threat to the betting. In fact, in some places the kingdom’s government controls the gambling, and uses its guards and soldiers to collect any overdue debts.

The typical post-Rifts “bookie” is a gambler himself (see the **Gambler O.C.C.**), or a criminal type like a City Rat, Smuggler or Forger (see *Rifts RPG* and *Rifts Mercenaries*). Bets are made on every aspect of the game, with the odds determining the pay-off ratio. Attempts at fixing events are common, especially in the more lawless areas. Sometimes, players are bribed, threatened, blackmailed, drugged, injured or killed to ensure the outcome of a game. Likewise, Juicers and super-humans who aren’t sports figures nor want to participate in blood sports, are sometimes forced (threats and blackmail) or tricked into fighting or playing.

Among the people of the outlaw kingdoms and the ‘Burbs surrounding the Coalition cities, the exploits of these Juicer

sports figures often become legendary. The fame of these “stars” is even more short-lived than the Juicers themselves, often coming and going in a matter of months, or even weeks. New winners get a following of thousands of fans, while the losers are soon forgotten.

While some people decry the sport as brutal, very few places (except the Coalition, where Juicers themselves are outlawed) institute any outright bans on them. For one, people in Rifts Earth are a lot less sensitive to violence than 20th Century humans: the constant dangers and threats faced by the population has made many people relatively callous. Secondly, *Deadball* (and all other Juicer sports) is played by volunteers, so people have the attitude that “it’s their lives, and they can do whatever they want.” Still, there are some people who will protest the games and even try to have them shut down.

A number of kingdoms and city-states are havens for these sports; in some cases, the sports are not publicly condoned, or are actually illegal, but they thrive in the underworld controlled by rogues and criminals.

Los Alamo, Kingsdale and Fort El Dorado: These kingdoms’ openness to Juicers and overall lax laws have allowed many Juicer sports to develop there. *Deadball* in its current form, as well as *Murderthon*, both made their appearance in Los Alamo and were “exported” following the Open Door Policy of 102 P.A. (see the **Los Alamo section** for more information). Kingsdale and Fort El Dorado soon followed suit, and all three kingdoms have extensive facilities for most Juicer sports. These cities are fully described in this book (see individual entries elsewhere).

The Coalition States: Both Juicer Conversions and Juicer sports are outlawed in the CS. However, the ‘Burbs and other slums around the sprawling cities for the Coalition are secret havens of these sports. Small underground arenas host games of Deadball, and there is a lively trade of video chips of recent games of Murderthon, Combat Racing and Juicer Football played in cities outside the Coalition. Possession of those chips is a criminal offense, punishable with fines, arrest and hard labor, but many fans, including a significant percentage of the CS army, still love to watch the exploits of these athletes.

Sports-related gambling is also a problem in the big cities. The Black Market has recently taken control of this activity, although other criminal gangs and organizations sometimes try to “muscle in,” resulting in massive gang warfare. A study made in Chi-Town suggested that almost 15% of all the money paid to CS soldiers was spent on gambling. Needless to say, the study was suppressed and the researchers arrested on the charge of spreading “defeatist propaganda.”

There are rumors that some CS cities have secret arenas where prominent Coalition officers spend their money betting on the lives and deaths of these sports figures. Another rumor claims that none other than *Colonel Thaddius Lyboc* is a fan of Deadball, and he has pulled strings to protect his favorite underground arena, **The Red Sands**. Whether this is true or just a malicious rumor remains unknown.

Old Bones: This “free city” has some Juicer sports facilities, including a large arena for *Free-For-Alls*, the savage melee combats where as many as one hundred Juicers wade in, armed only with knives (see the **Free-For-All section**). However, the Coalition State of Free Quebec does not allow any organized sports (see the **Old Bones section** for more information).

Lazlo and New Lazlo: Juicer sports are outlawed in both communities, but illegal arenas can and do operate, as long as they are careful not to attract the notice of the authorities. Most of these arenas are located outside the cities’ borders, and are make-shift places that move from place to place, always one step ahead of the police.

El Paso and Ciudad Juarez: The two southernmost human enclaves in North America routinely engage in arena sports. In the last four years, Juicer sports brought from Los Alamo and Kingsdale have become all the rage. Both cities have their own Juicer Football teams, the *El Paso Maulers* and the *Juarez Juicers*, who compete in the Juicer Football League. The El Paso Maulers won the championship in 104 P.A.

The NGR: Juicer sports are controlled by the NGR authorities, and organized to be safe for participants. In most cases, contestants wear mega-damage body armor, and a game can be called off on account of an injury. Perhaps because of this, or simply because Juicer sports do not appeal to the German people, the popularity of these games is low compared to North America.

Atlantis: The Splugorth have adopted some Juicer sports and given them their own bloodthirsty twists. A version of Juicer Football is often played with supernatural beings, or, sometimes, with one team of supernatural beings playing against a team of normal (S.D.C.) humans, Juicers or other creatures. The second type of football game is designed to end up with the massacre of the human team, to the wild delight of the audience. Murderthon is another fan favorite, as well as Deadball, often played be-

tween Splugorth Conservators (see *Rifts World Book Two: Atlantis* for more information).

Non-Juicers in Juicer Sports

Although most of the sports described are dominated by Juicers, they are not always completely exclusive. The main criteria for allowing contestants to participate is whether or not they have a prayer to survive, or, whether or not they will make the game interesting. In some places, non-augmented humans are allowed to compete in Juicer sports, either against Juicers (which usually results in short, bloody games) or against other humans (longer-lasting, but often just as lethal). The most common non-Juicer competitors in these games is the Crazy and Headhunter, although practitioners of magic, psi-stalkers, dragons and D-bees are sometimes allowed.

Crazies are usually able to hold their own against Juicers in most physical contests. Although they are not quite as strong, fast or vigorous as Juicers, Crazies have psionic powers and the ability to regenerate from damage, and often that is just enough to equalize the combatants. On the average, however, a Juicer will beat a Crazy at most sports. In the more sophisticated places, like Los Alamo or Kingsdale, there have been attempts to establish a “Crazy League” but they have failed, both because of lack of interest and because it is difficult to rely on Crazies for any long-term activity (since they are, after all, insane).

Some D-Bee species have also managed to hold their own against Juicers. Minotaurs, Trolls, Wolfen, Psi-Stalkers, Simvan riding and/or commanding monsters, and giants have become regular attractions and other D-Bee challengers are frequently tested—they certainly stand a better chance than most humans in a contest against a Juicer, although most lack the reflexes to keep up with them in any game that involves speed, agility and reaction time. The one restriction put on most D-Bee races is that they must be S.D.C. beings (that is, they must be vulnerable to conventional weapons and attacks; no mega-damage beings). Also, the few Juicer variants that are actually impervious to conventional weapons (M.D.C. creatures) are not allowed to participate. If there is a question regarding the physical nature of a contestant, a low-caliber S.D.C. bullet (usually a .22 or .25 caliber bullet with a low powder charge, inflicting half damage) is fired into the unprotected contestant! If the round does not break the skin, the Juicer or D-Bee is disqualified. Medical facilities are available to treat the wound, but occasionally a would-be contestant dies from the gunshot.

Kingsdale is the only exception in North America to the above rule; the city-state has instituted an *Unlimited League* where any creature, including dragons, werebeasts, and supernatural beings are allowed to participate in the sport. Mega-Juicers and Dragon Juicers often find themselves competing against hatchling dragons, gargoyles, and other supernatural beings. Usually, if a contestant is a mega-damage creature and his opponent isn’t, the “weak” participant is allowed mega-damage body armor (not power armor) to compensate for the situation. Still, injuries and death are much more common in the Unlimited League than in any other (the UL games are among the most popular, in spite of or perhaps because of that fact).

Deadball

This savage sport bears some light resemblance to Jai Alai and racquetball, except death and injuries are extremely common. Deadball originated among the bandits of the so-called Pecos Empire, where they played the game using stones, which they could whip towards a goal post, or against the opposing player. At first, the game was played by non-augmented humans and D-Bees, but whenever Juicers or Crazies joined the game, the normal players would get slaughtered (often literally), so eventually the “sport” was dominated by Juicers and, in some cases, Crazies.

In the kingdom of Los Alamo, an enterprising businessman decided to set up a more sophisticated “arena” where Deadball could be played as a spectator sport. Instead of an open field (where a high-speed ball would be as dangerous for the audience as for the players), he built a room similar to those used in 20th Century racquetball, with transparent walls so people could see the game. To add spice to the game, a very elastic ball which would protrude spikes at random times was incorporated! Response was overwhelming: tickets to the 300 seat building where the bouts were held sold out in record times. Soon half a dozen Deadball establishments sprung up in Los Alamo, and copycats followed suit in other independent kingdoms in the west.

Deadball has a Professional Association that has chapters in Los Alamo, Kingsdale, Fort El Dorado and El Paso, as well as half a dozen lesser kingdoms. City championships are held annually, and “international” games are held once every two years (the first such championship was held in Fort El Dorado in 104 P.A.; the next one is due in 106 P.A.). The current champion is Diego McDonald from El Paso (9th level Juicer Gladiator), although since he’s in his fifth year of service, it is unlikely he will live to defend his title in the 106 championship. Rumor has it that McDonald is one of the Juicers participating in the Juicer Uprisings.

Deadball Rules: There are many variants of Deadball, depending on where the sport is being played. However, most forms of this sport are played in a 30x60 foot (9.1 x 18.3 m) room, either completely enclosed or with 30 foot (9.1 m) tall walls (most fans and players prefer a completely enclosed room to allow for bouncing action from the ceiling). A dividing line runs down the middle of the room; each player must remain within his/her half of the field. Sections of the wall are made of M.D.C. plexi-glass to allow the audience to see the game. The walls at each of the long ends of the room have a small (6 inch/0.15 m wide) hole. The objective of the game is to get the Deadball into the opposing hole; each time the player gets the ball in he gets one point. The opposing player can try to catch or deflect the ball, and if he catches it, he can toss it back, and so on. Additionally, if only one player is capable of continuing play, he wins automatically, regardless of the score.

Players cannot cross the middle of the court into the other side. They can toss the ball, using its high elasticity to bounce it off walls much like racquetball, aiming for the hole — or the other players. Players can strike at each other with the Deadball, but are forbidden from using hand to hand combat or using any weapons other than the Deadball itself.

The ball is a highly elastic sphere roughly the size of a baseball. Its name comes from the fact that, at random intervals, sharp metal spikes poke out of it! Not only do the spikes add to the lethality of a strike, there is a 40% chance that they will spring up when the player tries to catch or block the ball! As long as a player holds the ball, the spikes do not come out. By most sets of rules, players cannot hold onto the ball for more than six seconds; a few Deadballs are set up so that the spikes come out if they are held for more than the allotted time.

A thrown Deadball does 2D6 S.D.C. plus the character’s damage bonuses. When the spikes are out, this damage is raised to 4D6 S.D.C. plus P.S. bonuses. Trained Deadball players can do even more damage (see the New Skills section). A ricocheting ball does half damage (and half the P.S. bonuses), but it is harder to dodge (-4 to dodge or to catch). Catching the ball is a combat maneuver equivalent to a parry (-3 to catch); use the parry bonuses of the characters. The goal hole is a small target and requires a called shot to strike and a roll of 18 or higher to hit!

The players are not allowed to wear body armor or protection, so injuries are expected. “It’s not Deadball until blood starts to flow” is a common saying in places where this brutal game is played, and it’s a rare game where a player does not receive several lacerations from the spiked ball. Given the incredible endurance and recuperative powers of Juicers and/or Crazies, the injuries are seldom lethal. In a few places, humans and mutant animals are allowed to compete, but their death rates are much higher.

Before the game starts, lots are drawn to determine who gets the ball first. When a player scores a goal on his opponent, the opponent gets the ball next, the rest of the time, it’s up to the players to catch (or dodge) the ball while it is in their half of the court. Stumbling into the opponent’s area is penalized with one point, just as if the opponent had scored, and the ball is given to the opponent. The same applies with any attack on the opponent beyond throwing the ball at him. Otherwise, just about anything else goes (leaps, somersaults, back flips, name calling, spitting, etc.). Canny players use the ricochet action to get the ball past the opponent, or to strike him from behind or the sides. Others concentrate on crippling the opponent to slow him down. **Note:** Characters who lose 50% of their S.D.C./Hit Points will be at -2 to initiative and all combat rolls.

Purses and Prizes: A typical Deadball game in a city-state like El Paso or Fort El Dorado will have a victory purse of 1D4x500 credits every game, the loser gets 1D6x10 credits; amateur or “squishy” bouts generally pay 1D4x100 to the winner and nothing to the loser. A professional player can play 2-4 games a week, provided his injuries are not extensive. Professional Association games pay 2D6x1000 credits to the winner (for the elimination rounds) to 3D4x10,000 credits for a city championship; double for the International Championship! Fees for the loser are 1D4x1000 credits.

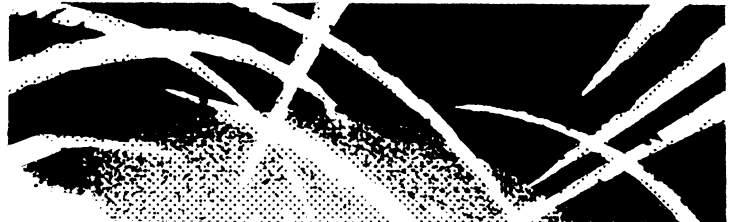

Murderthon

Murderthon is a competition sport with elements of track running and marathons, but adding combat to the mix! Typically, the game is run around a track (500-meters long) that can accommodate as many as ten participants, although most Murderthon games have 5-8 players. The objective is to cover the distance in the best time possible

Murderthon Rules: Contestants leave the starting line when a shot is fired into the air. They must run around a 500 meter (1640 ft) long track, consisting of two long, straight paths and two curves, for an oval shape, 20 times, for a total run of 10,000 meters (10 kilometers, a little over 6 miles). The participants can attack opponents as they run, but if they pause to fight for more than 15 seconds (one melee round), they are disqualified. Likewise, if a contestant is knocked off the field, he is also disqualified.

The key to winning this event is to either run so fast that the other contestants cannot outpace you, or to make quick “hit and run” attacks on one’s opponents.

Weapons are allowed! The limit is two throwing weapons no larger than a knife, and one hand weapon of choice (sword, etc.). Most contestants favor spiked gloves or forearm blades attached with ceramic bands (less likely to be dropped if attached), and throwing knives, bolas, or shurikens for their ranged weapons. The winner is the person who completes the 10,000 meters (10 km or roughly six miles) first.

The average Juicer (Speed 40) can run the course in under thirteen minutes (keeping a grueling pace that no human could match), and can complete a “lap” in less than a minute. The fastest Juicers (Speed 80+) can finish the entire run in less than seven minutes! The record time in the Los Alamo Annual Tournament dates from 101 P.A., and was 4 minutes and 30.2 seconds.

Speed is not the only determination in winning. Slow players often win by injuring the other contestants while continuing to run at a steady pace. There was a case where a Titan Juicer ran slowly and ponderously down the course, but every time a faster contestant tried to pass him, the Titan would clothesline him, knocking him down or even out! The Titan was the second place winner (the first place winner was a Hyperion who managed to dodge the Titan’s attacks). Shortly after that, Titans were banned from the sport; they were killing too many other contestants.

Murderthon Play in an RPG: The easiest way to play Murderthon is to use paper and pencil, and record each melee round the player(s) participates in, and write down how much distance each player covers during each round. Remember that the speed of a character, times 20, is the number of yards/meters covered in a minute. Every melee round, the Juicer covers five yards/meters for every point of speed. For example, a Juicer with speed 60 will cover 300 yards/meters in one melee round.

If a character is attacked while running, he can parry or dodge, but in either case he is slowed down; reduce Speed by -20% for each dodges or counterstrike, and 5% for a parry in which he parries and keeps going (-20% for a parry that misses; the shock of getting hit and hurt slows him down a bit) for that melee round. At the beginning of each melee round, we assume the character is moving at maximum speed.

Attacking while on the run is at -3 to all attack and defense rolls. Remember, characters cannot stop and fight for longer than 15 seconds (one melee round) or they are disqualified.

If a Juicer is hit and takes serious damage, 12 points or more, reduce his speed by 1 point for every such injurious attack, anything else is shrugged off, at least for the moment (consider effects from blood loss).

A team of 6-8 judges is watching the field to determine any penalties, and most games are recorded on a video chip and reviewed at the end of the run to double-check the judges’ decisions.

Every act of attacking (strike) reduces the character’s speed by -20% that melee round. For example, a Juicer who attacks four times during that melee will lose -80% of his speed; most Murderthon players will only attack once or twice per melee. A character can only attack the targets on either side or directly in front of him. To attack the guy behind you is pure folly.

Attacking is only possible if the target is within 30 feet (9.1 m) of the attacker; by keeping track of the distance covered, the Game Master knows where each contestant is. The faster runners will eventually overtake the slow ones as they gain “laps” on them; this is where most slow runners decide to attack and slow down their opponents. **The Quickie Way:** For Game Masters and players for whom a detailed Murderthon game feels like a tough SAT question, there is a quickie way to resolve the entire race in a matter of a couple of rolls. Roll as follows: Use the bonuses to strike or dodge (whichever is higher), add them together, and then add +1 for every twenty points of Speed. Then each player rolls 1D20 plus those bonuses; the highest roll wins the race, second highest wins second place, and so on. If there is a tie for first, second or third place, roll again to break it.

Special Attacks: Some special attacks and maneuvers include:

Attacking the Guy Behind You: This is usually a revenge move, because it can cost one the game to use it. To get the character running behind you, one must stop, roll to dodge oncoming contestants (-8 to dodge) and strike. This uses up three melee actions and gets a -60% speed penalty. Worse, if the attacking character fails to dodge, he is bumped and elbowed by 2D4 fellow contestants as they speed by him, suffers 4D6 damage and loses all remaining actions for that melee round (three of next melee if this was his last attack that melee).

Body Block Stop Action: The character suddenly stop and bends into a crouching position while covering his head; the move counts as two melee actions and there is a -40% speed penalty. 2D4 opponents behind him must roll a dodge at -6 to avoid him. Even a successful dodge costs them -20% reduction in speed for that melee. A failed dodge roll send them tumbling over the crouched character and they lose 1D4+1 melee actions (reduce speed 20% for each). The crouching character can safely resume running after six seconds/two melee actions.

Clothesline: This striking attack does 1D6 plus P.S. bonuses, and has a 1-50% chance of knocking one’s opponent down (he loses two melee actions/-40% on speed that melee).

Elbow Strike: This is a strike that does normal punch damage.

Sideswipe: The attacker bumps into the target, knocking him sideways. Instead of normal strike and parry/dodge bonuses, both the attacker and the defender roll 1D20 and add their P.S.

bonuses. If the attacker wins, the target is knocked sideways and loses -60% of his speed in that round. If the attacker's roll is over 10 points higher than the target, the victim is knocked down (loses -80% of his speed that round). On a tie or if the defender wins, nothing happens to the person being attacked but the move will cost the attacker -20% of his speed for that round.

Trip: This is resolved like a normal attack, but can only be dodged; if the attacker wins, the victim falls down (speed is reduced by -80% that melee round). If there is a tie, roll percentiles: 01-50% both the attacker and defender fall down, 51-00% both the attacker and defender are staggered and the speed of each is reduced by half for that melee round.

Example: The El Paso Championship Race has six contestants: Blue (Speed 110, can cover 550 meters/round), Zapper (Speed 97, 485 meters/round), Morgana (Speed 89, 445 meters/round), Larry (Speed 106, 530 meters/round), Lightning (Speed 131, 655 meters/round) and Sloan (Speed 78, 390 meters/round). The characters take off!

During the first round, nobody attacks anybody and everybody covers their maximum possible distance. During the second round, Lightning is actually passing Sloan for the second time, and Sloan decides to attack (this reduces his speed by -20%, from 78 to 63). He tries a *sideswipe*; his attack roll (with P.S. bonuses) is a 31; Lightning's defense roll is only a 20, which means Lightning is knocked down! Lightning gets up and keeps running, but his speed is down by -80%, to a mere Spd. 26 (130 meters); even so, Lightning manages to get up and pass Sloan. The Game Master also rules that Lightning's fall also affected Larry who was on his other side running neck and neck. Larry had to dodge Lightning's body, so he lost -20% of his Speed! So, at the end of the second round, the totals are as follows:

Blue: 1,100 meters; Zapper: 970 meters; Morgana: 890 meters; Larry: 790 meters; Lightning: 786 m.; Sloan: 705 m.

And so on.

Some rounds, nobody might attack anybody, while in others, people could attack opponents that are passing them. In any case, speed may not make a difference! If Sloan keeps attacking people as they overtake him, he might be the first one to cover 10,000 meters (10 km or a little under 6 miles).

Prizes and Pursues: Most arenas will charge 1D4x100 credits for somebody to participate in a Murderthon event. Prize moneys are paid to the first, second and third place winners. Typical prizes are 2D4x1,000 credits for first place, 3D4x100 for second, and 1D4x100 credits for third. Championships may pay even more, usually an additional 20% to 100%, depending on the size of the run and the wealth of the city or town sponsoring it. The sponsor makes most of his money from charging spectators, pay-for-view television, video sale rights and concession stands.

Juicer Football

Like its name indicates, this is the Juicer version of American football, with a few rules variations, such as allowing full-contact fighting! This sport is only beginning to become popular throughout North America (due to the expense necessary in

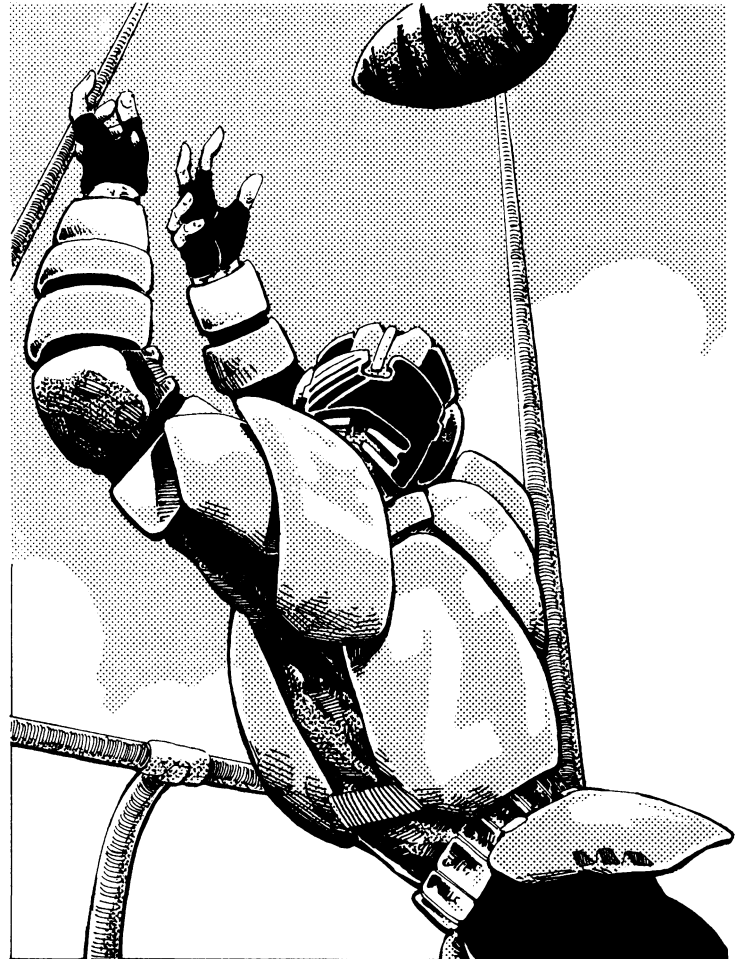

maintaining teams of Juicers and its newness), but in the last three years it has been catching on like wildfire.

The early versions of this sport were played purely for entertainment purposes by bored Juicers looking for some clean fun. Of course, their version of fun included getting clobbered with enough force to kill a normal human being. Eventually, their antics attracted attention and somebody thought of charging admission. The first "official" rules were devised in Los Alamo in 98 P.A., and soon the idea spread. Although more expensive than any other organized Juicer sports, it has earned a great deal of popularity. Betting on the outcome of the games has become a widespread vice even in the Coalition States, and videos of some games are a prized trade item. To reduce expenses, many team members also double as mercenaries, bodyguards and soldiers.

Rules for Juicer Football: Many of the rudimentaries of pre-Rifts football remain. The official game is played in a field 50 yards by 150 yards (150 feet/46 m by 450 feet/137 m); teams can have up to eleven people on the field. The objective is to carry the pigskin across the goal line; kicking the ball is not allowed, but passes are. No weapons are allowed.

The initial stages of the game are similar to pre-Rifts football, with quarterbacks, receivers, kickoffs (the only time the ball can be kicked; field goals are too easy for Juicers to make, so they were disallowed), etc. After the ball is in play, however, things get uglier, and a player is as likely to be drop-kicked in the face, clotheslined, punched and tripped as he is to be tackled.

The offense has four tries to carry the ball to the goal line, after which the ball passes on to the other team. Beyond that, there are few other rules. Both sides can attack the opposing players at

will. A common tactic is to clobber the receiver into submission and then take his ball away. The players are given plastic body armor with A.R. 14 and S.D.C. 200 (2 M.D.C.), but even so, injuries and the occasional death are very common. Titan Juicers are allowed to play, but will be removed from play if they use their full strength (restrained punches only).

Prizes and Purses: The average game of Juicer Football is played in a prosperous town or kingdom, and is usually played by “amateurs” whose real jobs include being mercenaries, soldiers, adventurers, bandits, guards, or similar occupations. In those contests, each player is paid 1D4x100 credits, plus a 200 credit bonus to each of the winning team’s players.

JFL players get a much higher salary, although not as high as their 20th Century counterparts. Average pay for a professional Juicer Football player is 40,000 credits, with bonuses that can add up to another 4,000 to 10,000 credits per season. Valuable players can make as much as five times this amount. The wealthier kingdoms often get into bidding wars for the best players.

The JFL League Championship

On 102 P.A., entrepreneurs in Los Alamo made a proposal to other kingdoms where Juicer sports were legal. The idea was to create an “international” league whose members would pit their teams against one another until a championship was won. Income would be earned by ticket sales, video sales, advertising and concessions. El Paso, Ciudad Juarez, Fort El Dorado and about half a dozen smaller kingdoms joined in.

The Championship games started in P.A. 102, in Los Alamo, and since then there have been two more Championships, in 103 (Ciudad Juarez, the Maulers won 7-3), and P.A. 105 (El Paso, the Assassins won 12-6). The 104 Championship was canceled when the convoy taking the Juarez Juicers to El Paso was ambushed by wild vampires: although the Juicers managed to beat off the attackers, they lost nearly one-third of their players, and had to forfeit the game.

Games are televised locally in the city or town where they are played if the technology is available; lack of communication satellites makes transmission beyond city borders impossible. After the game, recorded versions are taken and played in the other city participating in the League (takes anywhere from a few hours to several days, carried by courier, assuming nothing happens to the courier). Several large companies take the opportunity to pay for advertisement space, both in the live and recorded transmission. Afterwards, the tape is offered to other communities on a pay-for-view basis and later sold as a video disk, collector’s edition. Naruni Enterprises (see *Rifts Mercenaries*) produces the best commercials, selling anything from advanced weapon systems to toys and T-shirts featuring Naruni weapons and armor.

Other Sports

The three sports described previously are the most popular, but there are a few others that also have some support in certain areas.

Combat Racing: Several forms of combat racing have appeared in the more developed but less civilized city-states of North America. Rules vary from place to place, but it usually involves Juicers or other daredevils in fast motorcycles, cars or hover vehicles. In some cases, using weapons is allowed; in oth-

ers, vehicles can ram each other but weapons are not allowed. Prizes and purses vary, but often they are not enough to cover the cost of repairing vehicles after the grueling race, so pilots are usually sponsored by local millionaires or corporations, or are just crazy Juicers who do it for the fun and absorb the costs the best they can.

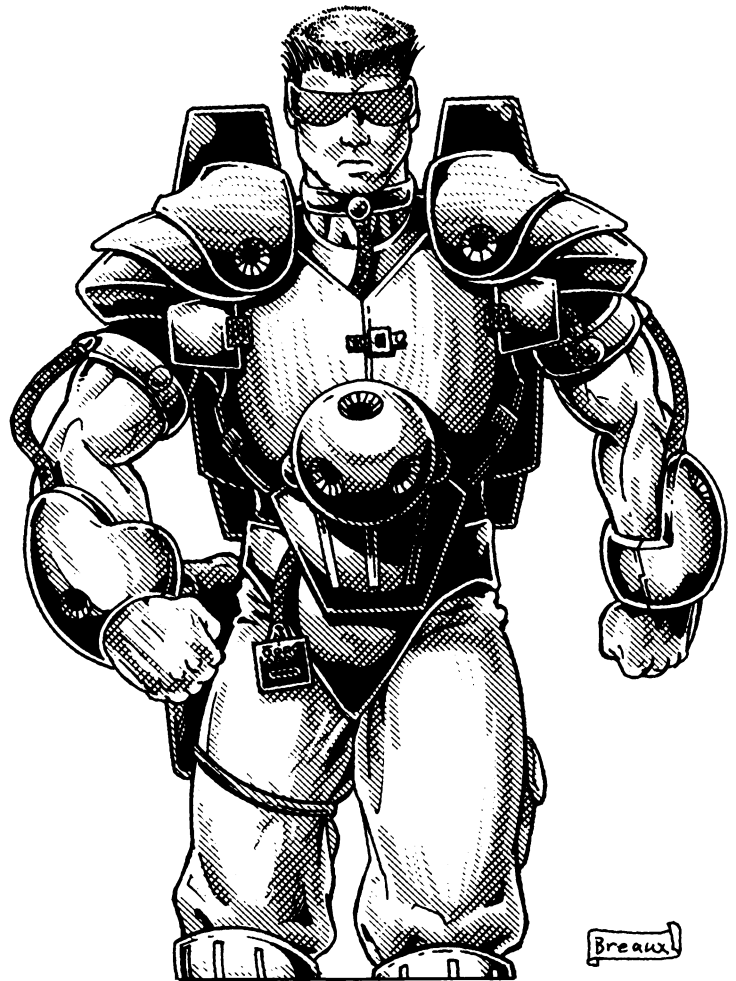

Free-For-All: The most brutal of all Juicer sports, Free-For-All is the Juicer version of the medieval Grand Melee; a fight between several Juicers, everyone against everyone, with the winner being the last man (or woman) left standing. The rules, such as they are, are simple and straightforward. The game is played in arenas of varying size, as small as a Deadball court or as large as a football field. The players (typically 4-24, but sometimes as many as 100) place themselves in a rough circle. When the starting shot is fired, they can attack at will. No weapons or armor are allowed, and tests are given to ensure that characters with supernatural strength are not allowed in the arena (Titan Juicers are not allowed to compete except in the Unlimited League). The last person left standing is the winner. The fighting is usually not the death. Juicers will go into a healing trance after taking extensive injuries (reduced to 5 Hit Points or less), so killings are less frequent than one might think, so long as only Juicers, Crazies and enhanced humans are the only contestants.

Free-For-Fall contestants are usually paid 1D6x100 credits for participating. Winners get a purse of 3D6x1000 credits. In some places, people who qualify get additional prizes: 2D6x100+250 credits for being the next-to-last person left standing, and 1D6x100 for being the third-to-last.

Juicer Lexicon

Achy Breaky: A normal human being, as in: “Two achy-breakys got in my way, so I greased them.” Also see Meat Boy, and Squishy.

Big’Un: Titan Juicers, or any Juicer who is over seven feet tall.

Black Lobsters: Nickname for Coalition troops, especially those in original Dead Boy armor (see *Rifts World Book 11: Coalition War Machine* for new CS armor, bots and weapons).

Checking Out: Dying, usually from the side effects of the Juicer process.

The Deathdance Saga: Series of pre-Rifts novels about the adventures of *Julian Amici*, a Juicer secret agent. Still in print, circulating (illegally) in the Coalition States and (legally) in Ishpeming, Kingsdale, the Lazlo republics and other parts of the world.

Doing a Juice: Getting away with something, usually a criminal act; originates in the Julian Amici novels.

Doing a Double-J: An impressive, death-defying feat or escape worthy of the fictional super-spy Julian Amici.

Getting Juiced: Getting the Juicer augmentation to become a Juicer.

Grease: To kill or destroy.

Grease Spot: A corpse that has been mangled by M.D. weapons, especially explosives or plasma weapons.

Julian Amici, Juicer (a.k.a. J.A., Deathdancer, the Double-J): Fictional character in a popular series of pre-Rifts novels, *The Deathdance Saga*, that survived the Great Cataclysm and are still published in such places as New Lazlo and Ishpeming. Also, a nickname for a tough guy: “Hey, you must be some sort of Deathdancer” or “Who do you think you are, the Double-J?”

Juiced: As in, “Be careful, he’s juiced,” means a juicer or someone high and empowered by drugs.

Last Call: The last year of a Juicer’s life, usually plagued with symptoms of his upcoming death.

Meat Boy/Girl: Normal, non-augmented human or D-bee. Also see Achy Breaky, Squishy.

Moron Boy/Girl: Juicer wannabe, anybody who admires and tries to emulate Juicers.

The Process: Juicer conversion. Becoming a Juicer is referred to as “going through the process.”

Squishy: Normal human.

Squishy in a Hard Shell: A human in M.D.C. body armor.

Tank or Tank o’ Juice: A supernatural/M.D.C. creature or person. M.D.C. Juicers (Mega-Juicers and Dragon Juicers mostly) are known as Tanks o’ Juice.

Wannabe: Anybody who admires Juicers and *pretends* to be one.

New Juicer Variants

Technology in the Post-Apocalyptic era has been improving gradually over the decades, with some of the technological powerhouses (Northern Gun, the Manistique Imperium, Iron Heart, the Coalition States, etc.) beginning to make some real advancements, particularly in the areas of weapons, robotics, cybernetics and human augmentation (and which many fear may lead to an arms race and eventually war). Consequently, a number of Juicer variants have been developed within the last few years, and are described below.

Juicer Demographics (North America):

“Standard” or “Normal” Juicers: 74%

Hyperions: 6%

Titans: 5%

Phaetons: 5%

Mega-Juicers: 2%

Coalition Juicers: 2% (and increasing)

Psycho-Stalkers 1%

Delphi Juicer: 1%

Dragon Juicers: 1%

Murder Wraiths: 1%

Others (Escaped Splugorth Juicers, and other exotic varieties, and experiments): 2%

Note: In the New German Republic, Juicer variants are even rarer, comprising about 10% of all Juicers (combined). They are unheard of in Japan and most other parts of the world.

The cost for “standard” Juicer augmentation is 65,000 to 100,000 credits. As a rule, the higher the cost, the better the success rate, but this is not always the case, and would-be Juicers should ask around about the quality and expertise of a body-chop-shop *before* they pay to be “juiced.”

Hyperion Juicer O.C.C.

Juicers are noted throughout the land for their speed and enhanced reflexes. The Hyperion variant expands those abilities to almost ludicrous levels. The fastest Hyperion Juicers are fast enough to keep up with some land vehicles, and their reaction times are blindingly fast. However, these enhanced reflexes and speed have a price. Hyperions are always restless and uncomfortable when not moving, have a short attention span, are bored easily, and worst of all, they require enormous amounts of food to stay alive.

Hyperions were first developed at Northern Gun in Ishpeming, the result of an accidental overdose of certain Juicer agents. The “first” Hyperion was a Juicer who tampered with his bio-

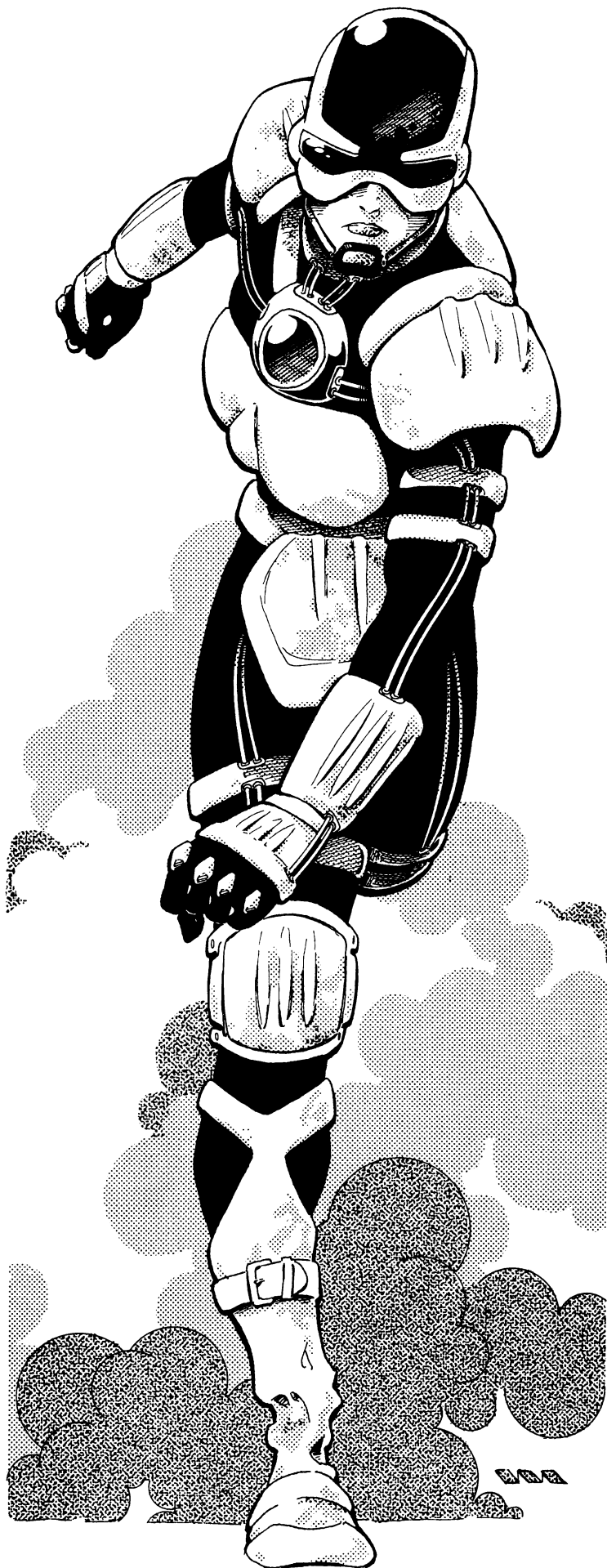

comp dispenser to get a bigger rush. The Juicer became incredibly fast, breaking previous Juicer records — and then collapsed from a heart attack three hours later. The medical researchers who performed the autopsy noted the results, both positive and negative, and engaged in more research to see if an even faster Juicer could somehow be developed. After a number of experiments, many of which resulted in the deaths of the test subjects, the Hyperion was developed. This juicer speed-demon is just one of the new “variant” Juicer augmentation conversions available on the market. Although not as accessible as the “standard” Juicer augmentation, it can be found at most large kingdoms that specialize in Juicer conversions.

The Hyperion Juicer O.C.C.

Attribute Requirements: None

O.C.C. Abilities and Bonuses:

1. Super Endurance: Add $4D6 \times 10$ to S.D.C., $3D6$ to Hit Points, and $2D4$ to P.E. attribute. Can lift and carry four times more than a normal person of equivalent strength, and can last five times longer before feeling the effects of exhaustion. Can remain alert and operate at full efficiency for up to four days without sleep (but needs to consume at least 4000 calories a day to function normally). Normally needs only four hours of sleep per day.

2. Super Strength: Add $1D4 + 2$ to P.S. attribute. Note: Minimum P.S. is 18, if lower adjust to 18.

3. Super Speed: This is where the Hyperion excels. Add $2D4 \times 10 + 40$ to Speed attribute. Minimum speed is 77; if lower adjust it to 77 (53 mph/85 km)! Can leap a distance of 50 feet (15.2 m) across/lengthwise after a short run (half that from a dead stop) and 25 feet (7.6 m) high (half without a short run). Kick attacks inflict $3D6$ S.D.C. plus P.S. bonuses, power kick (counts as two attacks) inflicts $1D6$ M.D.!

4. Super Reflexes and Reaction Time: The Hyperion is even faster than normal Juicers, but experiences more problems.

Bonuses: +6 on initiative, +1 to strike, parry and dodge, +4 to roll with punch, fall or impact, +2 to disarm, and may parry or dodge all attacks, even from behind/surprise. +3 to Auto-Dodge at level 1, +1 at levels 2, 4, 6, 8, 10, 12 and 14. +2 attacks per melee round and add $2D6$ to P.P. attribute. Minimum P.P. attribute is 22, if lower, adjust up. +4 to Perception Rolls.

Penalties: In addition to the normal Juicer problems (such as insomnia, impatience, etc.), Hyperions tend to overreact to any sudden moves or noises they hear. This means there is a 1-30% chance the Juicer will react with an instinctive punch or kick if somebody startles him or sneaks up from behind. Likewise, a loud noise within 20 feet (6.1 m) of the Juicer is likely to cause him to spin around, back flip, or dive on the ground, roll or somersault, and land/stop facing the direction of the noise, weapons drawn.

The worst side effect is that Hyperions need a lot more food to stay active than normal humans. The Juicer must consume twice as much as a normal person, or he will suffer from low blood sugar and energy levels with the following penalties: reduce all combat bonuses by half after one day (24 hours) without getting 4-6 hearty meals! Reduce them by half again for each subsequent day with less than one meal until zero. Also reduce speed by 10 points after the second day for each subsequent day of starvation and one melee attack for every four days. **Note:** Less than one normal-sized meal is starvation for the Hyperion.

Additionally, 1-30% of all Hyperions suffer from *Metabolic Induced Voracity (MIV)*, also known as Juicer Gluttony; see the *Juicer Side Effects* section for more information.

5. Saving Throw Bonuses: +4 to save versus psionics, +4 to save versus mind control (psionic and chemical), +9 to save versus disease, toxic gases, poisons, and other drugs (increased due to the high metabolism which burns off drugs and disease quickly; half the normal duration for symptoms and side effects).

6. Enhanced Healing: Heals four times faster than normal, +20% to save versus coma/death. Virtually impervious to pain, as per the normal Juicer.

7. Low Life Span: Hyperions tend to burn out even faster than common Juicers! The average life span of a Hyperion is 5 years and 3D6 months.

O.C.C. Skills:

- Acrobatics (+5%)
- Climbing (+5%)
- Gymnastics (+5%)
- Land Navigation (+15%)
- Radio: Basic (+10%)
- Wilderness Survival (+10%)
- Language (two of choice at +10%)
- W.P. Knife
- W.P. Energy Rifle
- W.P. one of choice

Hand to Hand: Expert

Hand to Hand: Expert can be changed to Martial Arts (or assassin if evil) at the cost of one "other" skill.

O.C.C. Related Skills: Select six other skills. Plus select two additional skills at level three, and one at levels six and nine. All new skills start at level one proficiency.

- Communications: Any
- Domestic: Any
- Electrical: Basic only.
- Espionage: Any (+5%)
- Mechanical: Automotive only.
- Medical: First aid only.
- Military: Any (+5%)
- Physical: Any (+5% where applicable)
- Pilot: Any
- Pilot Related: Any (+5%)
- Rogue: Any (+5%; +15% on prowl)
- Science: Basic math only.
- Technical: Any
- W.P.: Any
- Wilderness: Any

Secondary Skills: The character also gets to select five Secondary Skills from the Secondary Skills list in *Rifts® Ultimate Edition*, page 300. These are additional areas of knowledge that do not get the benefit of the bonuses listed in parentheses. All Secondary Skills start at the base skill level.

Standard Equipment: Bio-comp and bio-data implants, drug harness and drug supply (usually needs to be replenished once or twice a year), portable IRMS kit, set of fatigues, utility belt, backpack, sunglasses, canteen, compass, and personal items.

Weapons and armor include a suit of light body armor; favors Spike Armor or Vibro-Spike Armor (M.D.C. 50), and an energy rifle of choice, energy pistol of choice and 2D4 en-

ergy clips for each, one automatic weapon and choice of two melee weapons and a vibro-blade.

Money: 4D6×100 in credits and another 4D6×100 in black market items.

Cybernetics: None.

Hyperion Juicer Augmentation Cost: Typically 80,000-120,000 credits, sometimes more.

Titan Juicer O.C.C.

The Titan Juicer Conversion was developed in the kingdom of Los Alamo, near the ruins of the pre-Rifts city of Austin, Texas. The researchers in that kingdom were trying to create a Juicer strong enough to battle a supernatural monster or a robot vehicle. They first tried to use hormonal treatments to raise the subjects' strength to ultra-human levels, but after a certain point, test subjects had so much muscle tissue they could no longer support their own weight! Many unfortunates died after their bones were crushed by their hugely overdeveloped muscle mass. A method to strengthen bone beyond human (or any Earth animal's) limits needed to be discovered.

The perfected process involved the injection of a chemical solution laced with several types of metal particles (in quantities that would be poisonous under most circumstances). The metal particles were dissolved in a special binding substance that chemically sought and bonded with bone tissue. The process mixed metal and bone into a solid whole, greatly reinforcing the skeleton of the test subjects with bones as strong as tempered steel! The reinforced bone structure was now able to support a great deal more weight than normal bones. At the same time, growth hormones triggered a growth spurt similar to the one experienced during a human's first sixteen years of life, only in this case the growth occurred over a matter of weeks.

Juicers who undergo the eight week Titan treatment become 60% to 80% larger, and three to four times heavier (average weight is 600-700 pounds/270 to 315 kg). The smallest Titan can dead lift 3,000 pounds (1350 kg), with over two tons being the common limit. Their physical strength is the equivalent to a supernatural being, so Titans can punch through power armor plating and slug it out with mega-damage creatures. Despite the Titan Juicer's great strength and mass, it is recommended that armored gauntlets be worn to protect their flesh and bones — which are still not quite as tough as true supernatural beings and creatures of magic like dragons (or the psychically enhanced Mega-Juicer).

There is a price for this power, however. Titan Juicers put a lot more stress on their bodies, and the hormone treatments have serious side effects that appreciably shorten the average life span of these enhanced warriors. Despite this, the popularity of the Titan conversion process is on the rise.

Titan Juicer O.C.C.

Attribute Requirements: None

O.C.C. Abilities and Bonuses:

1. Super Endurance: Add 3D6×100 to S.D.C., 1D4×100 to Hit Points, and 3D4 to P.E. attribute. This makes the Titan the equivalent of a minor mega-damage being, with 4 to 22 M.D.C.

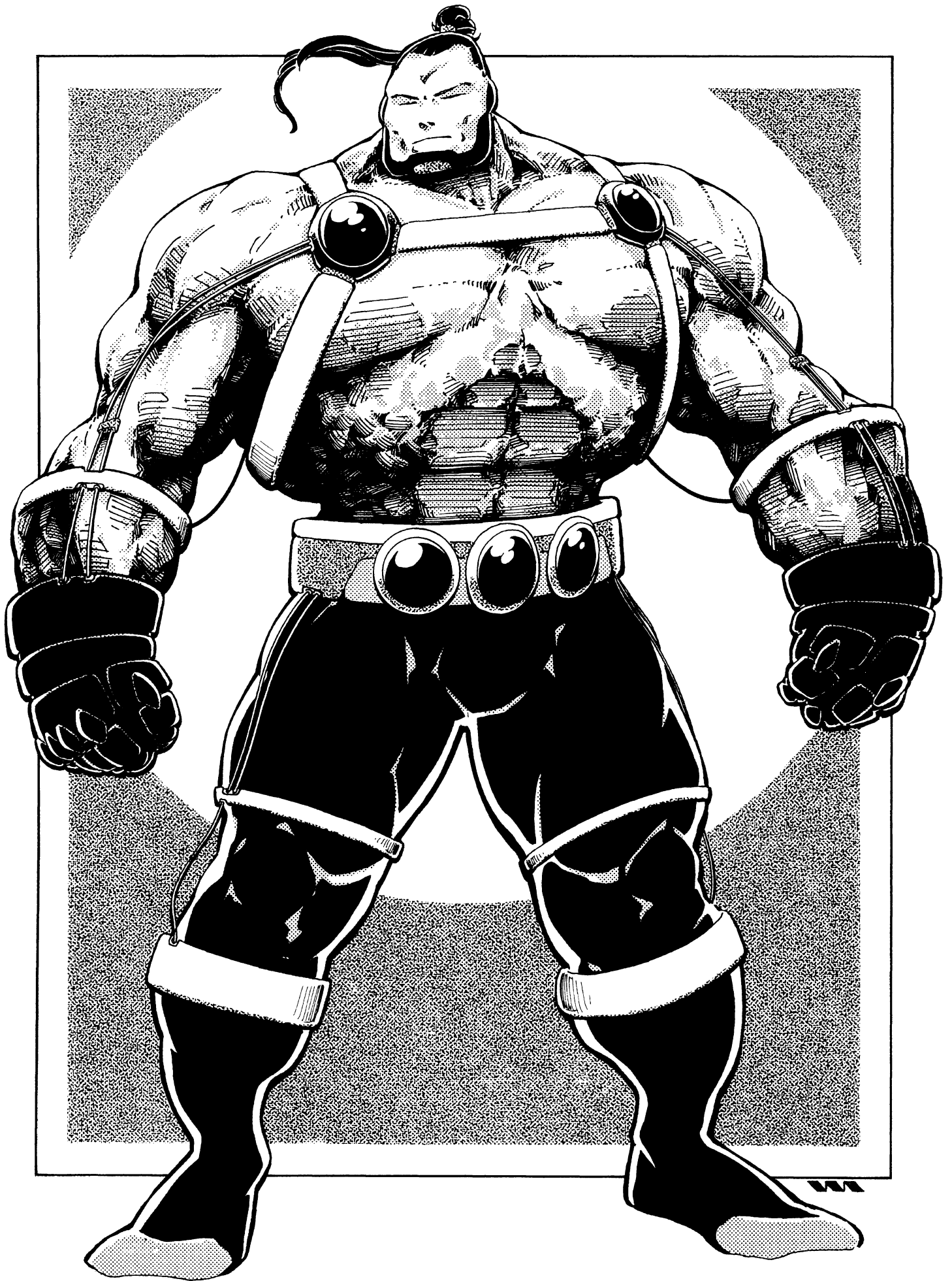

points (400 to 2200 S.D.C./Hit Points). Note that normal S.D.C. attacks will still hurt and can even kill the character, but a ton of S.D.C. damage needs to be inflicted. Even at an M.D.C. of 22, the character is vulnerable to a few well placed weapon blasts, so most wear some sort of body armor.

The Titan's strength is considered to be supernatural (can carry 50 times his P.S. in pounds and lift 100 times his P.S.). He can remain alert and operate at full efficiency for up to four days without sleep. Normally needs only four hours of sleep per day.

2. Super Strength: Add 2D6+8 to P.S. attribute. Note: Minimum P.S. is 30, if lower adjust to 30. This strength is supernatural, so the Titan inflicts damage as per the following table reprinted from *Rifts® Conversion Book One*.

A formula for determining the M.D. damage for supernatural strength in Rifts:

This table is applicable to most generic supernatural beings and creatures of magic from the **Palladium RPG, Beyond the Supernatural** and **Heroes Unlimited**. Note that specific monsters may contradict this **general** conversion list.

P.S. 15 or less: Only inflicts 1D6 S.D.C. on a restrained punch, 4D6 S.D.C. on a full strength punch or 1D4 M.D. on a power punch (counts as two melee attacks). P.S. bonuses are added to S.D.C. attacks.

P.S. 16 to 20: Inflicts 3D6 S.D.C. on a restrained punch, 1D6 M.D. on a full strength punch, or 2D6 M.D. on a power punch (counts as two melee attacks). P.S. bonuses are added to S.D.C. attacks.

P.S. 21 to 25: Inflicts 4D6 S.D.C. on a restrained punch, 2D6 M.D. on a full strength punch, or 4D6 M.D. on a power punch (counts as two melee attacks). P.S. bonuses are added to S.D.C. attacks.

P.S. 26 to 30: Inflicts 5D6 S.D.C. on a restrained punch, 3D6 M.D. on a full strength punch, or 6D6 M.D. on a power punch (counts as two melee attacks). P.S. bonuses are added to S.D.C. attacks.

P.S. 31 to 35: Inflicts 5D6 S.D.C. on a restrained punch, 4D6 M.D. on a full strength punch, or 1D4×10 M.D. on a power punch (counts as two melee attacks). P.S. bonuses are added only to S.D.C. attacks.

P.S. 36 to 40: Inflicts 6D6 S.D.C. on a restrained punch, 5D6 M.D. on a full strength punch, or 1D6×10 M.D. on a power punch (counts as two melee attacks). P.S. bonuses are added only to S.D.C. attacks.

P.S. 41 to 50: Inflicts 1D6×10 S.D.C. on a restrained punch, 6D6 M.D. on a full strength punch, or 2D4×10 M.D. on a power punch (counts as two melee attacks). P.S. bonuses are added only to S.D.C. attacks.

P.S. 51 to 60: Inflicts 1D6 M.D. on a restrained punch, 1D6×10 on a full strength punch, or 2D6×10 on a power punch (counts as two melee attacks). P.S. bonuses not applicable.

Note: If the Titan punches mega-damage structures barehanded, he will suffer one S.D.C. point of damage for every M.D. point it inflicts. If the character is wearing mega-damage armor, or at least mega-damage gloves or gauntlets, he can punch enemies with total impunity (no damage).

3. Super Speed: Although faster than a normal human, Titans are the slowest among the Juicers. Add 2D6 to Speed attribute. Can leap 20 feet (6.1 m) across after a short run (half that from a dead stop) and 20 feet (6.1 m) high (half without a short run). Leaping range is still good because of the Titan's supernatural strength.

4. Super Reflexes and Reaction Time: The Titan has enhanced dexterity, but only slightly. **Bonuses:** +1 on initiative, +1 to roll with punch, fall or impact, +2 to disarm, and gets an automatic parry or dodge on all attacks, even from behind/surprise. +1 to Auto-Dodge at levels 1, 3, 6, 9 and 12. +1 to Perception Rolls. Also add *one* attack per melee round, and add 1D4 to P.P. attribute. Minimum P.P. attribute is 17, if lower adjust it to 17. **Penalties:** Same as normal Juicers (insomnia, restlessness, impatience, etc.).

5. Saving Throw Bonuses: +5 to save versus psionics, +6 to save versus mind control (psionic and chemical), +8 to save versus toxic gases, poisons, and other drugs, and +4 to save vs horror factor.

6. Enhanced Healing: Heals one hit point or S.D.C. for every point of the P.E. attribute every hour! For instance, a Titan Juicer with P.E. 24 would heal 24 S.D.C. or hit points per hour, +25% to save versus coma/death. Virtually impervious to pain, as per the normal Juicer.

7. Low Life Span: Titans tend to burn out even faster than common Juicers! The average life span of a Titan is 5 years and 2D6 months.

O.C.C. Skills:

Radio: Basic (+5%)

Wilderness Survival (+5%)

Land Navigation (+5%)

Piloting (two of choice; +10%)

Language (two of choice; +10%)

W.P. Energy Rifle

W.P. Heavy or W.P. Heavy Energy Weapons

W.P. (one of choice)

Hand to Hand: Expert

Hand to Hand: Expert can be changed to Martial Arts (or Assassin, if evil) at the cost of one "other" skill.

O.C.C. Related Skills: Select seven other skills. Plus select two additional skills at level three, one at level six, one at level nine, and one at level twelve. All new skills start at level one proficiency.

Communications: Any

Domestic: Any

Electrical: Basic only.

Espionage: Intelligence, escape artist, detect ambush and detect concealment only (+5%).

Mechanical: Automotive only

Medical: None

Military: Any

Physical: Any except Acrobatics. Prowl has a penalty of -5%!

Pilot: Any

Pilot Related: Any, although the Titan may be too large for most conventional vehicles.

Rogue: Any (-5% to Prowl)

Science: Basic Math only.

Technical: Any

W.P.: Any

Wilderness: Any.

Secondary Skills: The character also gets to select six Secondary Skills from the Secondary Skills list in *Rifts® Ultimate Edition*, page 300. These are additional areas of knowledge that do not get the benefit of the bonuses listed in parentheses. All Secondary Skills start at the base skill level.

Standard Equipment: Bio-comp and bio-data implants, drug harness and drug supply (usually needs to be replenished once or twice a year), portable IRMSS kit, set of fatigues, utility belt, backpack, sunglasses, canteen, compass, and personal items.

Weapons and armor include a suit of Titan Plate Armor (180 M.D.C.), energy rifle of choice, energy pistol of choice and 2D4 energy clips for each, a vibro-blade and two non-energy weapons or melee weapons. Most Titans seem to have a fondness for rail guns and heavy weapons.

Money: 4D6×100 in cash and another 4D6×100 in trade items.

Cybernetics: Starts with none and rarely gets any.

Titan Juicer Augmentation Cost: Typically 100,000-150,000 credits, sometimes more.



Phaeton Juicer O.C.C.

Phaetons were developed by Ultra-Tech Industries (UTI). The first prototypes were “created” in the kingdom of Newtown, but the treatment didn’t become commercially available until Newtown joined the Coalition States. It would later become available at the free city of Fort El Dorado, an ally of the CS. The stated purpose of the Phaeton Variant was to create the ultimate combat pilot, able to withstand G-forces that would knock a normal

human unconscious, and to “push the envelope” of any vehicle’s performance to its ultimate level.

The project was very successful. Phaetons (named after the mythological character who dared pilot the sun chariot of the gods) are less well-developed in terms of strength and endurance, and they resemble the Hyperion Juicer in that they tend to be smaller and faster than the stronger, more hulking standard Juicer. However, put them in the cockpit of any vehicle and the Phaeton becomes one with the machine.

Since their inception, Phaetons have become very popular and conversions are offered in several cities and kingdoms in North America (pirated from New Town or Fort El Dorado; something that has made the Coalition very unhappy).

The Phaeton Juicer O.C.C — Master Pilot

Attribute Requirements: None.

O.C.C. Abilities and Bonuses:

1. Super Endurance: Add 1D4×100 to S.D.C., 4D6 to Hit Points, and 2D6 to P.E. attribute. Can lift and carry four times more than a normal person of equivalent strength, and can last five times longer before feeling the effects of exhaustion. Can remain alert and operate at full efficiency for up to four days without sleep. Normally needs only four hours of sleep per day.

2. Super Strength: Add 2D4 to P.S. attribute. Note: Minimum P.S. is 20, if lower adjust to 20.

3. Super Speed: Add 2D4×10 to Speed attribute. Can leap 30 feet (9.1 m) across after a short run (half that from a dead stop) and 20 feet (6.1 m) high (half without a short run).

4. Super Reflexes and Reaction Time: The Phaeton has most of the Juicer’s normal abilities, but where they excel is when they are piloting a light vehicle.

Bonuses: +3 on initiative when on the ground, +4 on initiative when piloting a light land or air vehicle; +4 to roll with punch, fall or impact. Gets an automatic parry or dodge on all attacks, even from behind/surprise. +1 to Auto-Dodge at levels 1, 2, 4, 6, 8, 10, 12 and 14. +2 to Perception Rolls. Add one extra melee attack/action per melee when on the ground, but two while in a vehicle. Also add 2D6 to P.P. attribute. Minimum P.P. attribute is 22, if lower adjust it up to 22.

+1 to strike and dodge when piloting any vehicle, +2 to dodge in the air, and can dodge even if piloting a vehicle that does not normally have a dodge, such as a tank! However, the vehicle must have a minimum speed of 60 mph (96 km). Also see #5.

Penalties: Same as normal Juicers (insomnia, restlessness, impatience, etc.), especially when kept waiting and when not behind the wheel of a vehicle.

5. Pushing the Envelope/Natural Piloting Ability: Phaetons have been physically and mentally conditioned to become “naturals” at piloting almost any vehicle. Furthermore, the Phaetons can perform maneuvers that would crush a normal pilot under the stresses of inertia. The character is at +15% to fly/pilot any vehicle he is trained with and +25% on his *two favorite* vehicle types of choice (usually aircraft). Furthermore, Phaetons get combat bonuses while in a vehicle (see #4, above).

When faced with an unfamiliar vehicle, the Phaeton has a base percentage of 40% plus 1% per level of experience, plus I.Q. bonus, if any, to pilot/fly it. If the vehicle is very alien and difficult to fly (some Splugorth models, for example), the Phaeton has a base chance of 25% plus 1% per level and I.Q. bonus.

Note that this ability does not allow the Phaeton to use alien weapon and sensor systems, just to pilot the vehicle. The Game Master may rule that some vehicles, especially those with psionic or magic controls, cannot be used even by this character.

6. Saving Throw Bonuses: +4 to save vs psionics, +4 to save vs mind control (psionic and chemical), +6 to save vs toxic gases, poisons, and other drugs, and +4 to save vs horror factor.

7. Enhanced Healing: Standard: Heals four times faster than normal, +20% to save versus coma/death. Virtually impervious to pain, as per the normal Juicer.

8. Low Life Span: Same as normal Juicers: 5 years plus 4D6 months.

O.C.C. Skills:

Basic Math (+20%)

Radio: Basic (+10%)

Land Navigation (+10%)

Navigation (+15%)

Piloting: Six of choice (+15% Phaeton Juicer bonus; 2 are +25%)

Weapon Systems (+15%)

Language (one of choice; +10%)

W.P. (one of choice)

Hand to Hand: Expert

Hand to Hand: Expert can be changed to Martial Arts (or Assassin, if evil) at the cost of one "other" skill.

O.C.C. Related Skills: Select seven other skills, but these should tend to reflect an affinity for machines or piloting. Plus select two additional skills at level three, one at level six, one at level nine, and one at level twelve. All new skills start at level one proficiency.

Communications: Any (+5%)

Domestic: Any

Electrical: Basic only.

Espionage: Intelligence, escape artist, and wilderness survival only (+5%).

Mechanical: Any (+5%)

Medical: None.

Military: Any (+5%)

Physical: Any (+5% where applicable)

Pilot: Any (+15% Juicer bonus; see #5)

Pilot Related: Any (+10%)

Rogue: Any (+10% to computer hacking only)

Science: Advanced Math and Astronomy only (+5%).

Technical: Any (+10% on computer operation and programming only)

W.P.: Any

Wilderness: Any.

Secondary Skills: The character also gets to select three Secondary Skills from the Secondary Skills list in **Rifts® Ultimate Edition**, page 300. These are additional areas of knowledge that do not get the benefit of the bonuses listed in parentheses. All Secondary Skills start at the base skill level.

Standard Equipment: Bio-comp, bio-data and PAS Helmet, drug harness and drug supply (usually needs to be replenished once or twice a year), portable IRMSS kit, set of fatigues, utility belt, backpack, sunglasses, canteen, compass, and personal items. Weapons and armor include a suit of light body

armor (usually Juicer Assassin flex-plate) and an energy rifle of choice, energy pistol of choice and 2D4 energy clips for each, a vibro-blade and two non-energy weapons of choice.

Money: 4D6×100 in credits and another 4D6×100 in black market items.

Cybernetics: None.

Phaeton Juicer Augmentation Cost: Typically 90,000-140,000 credits.

Mega-Juicer O.C.C.

"If you wanna be tough, become a Juicer. If you wanna be a GOD, become a Mega-Juicer."

— Sign outside an Ishpeming Body-Chop-Shop

This is the most advanced Juicer ever created, the so-called Mega-Juicer or "Super-Juicer." The only places where this expensive conversion is available are **Ishpeming** (a.k.a. Northern Gun) and recently, in **Kingsdale**. A research team unearthed some secret pre-Rifts "super-soldier" projects that combined elements from M.O.M. conversion and the Juicer process. The idea was to use volunteers with high levels of psychic energy (P.P.E. or I.S.P.) and then trigger that energy through drugs and electrical implants. The energy would then be channeled through the body of the patient, turning him/her into a being of incredible strength and endurance. Normal Juicer chemical enhancements were added to produce a nearly invincible warrior.

In the P.P.E. rich world of Rifts Earth, the Mega-Juicer process creates a minor supernatural creature. The triggering mechanism completely infuses the subject's body with psychic energies, giving his skin and muscle tissue the tensile strength of M.D.C. alloys while retaining the elasticity of normal human skin. In trial runs, 45 bullets were fired point-blank at Mega-Juicers without even bruising them. Even mega-damage weapons like laser pistols were used in the test, giving the Juicers painful but not lethal burns that healed in a matter of minutes. Only enough firepower to destroy a suit of mega-damage power armor was deemed enough to kill one of these enhanced humans.

Although the project had been an unqualified success, the Mega-Juicer could not replace more ordinary methods of human augmentation. For one, only latent psychics (estimated at representing less than 15% of all volunteers) would benefit from the drug treatments. Furthermore, the process is extremely expensive, two to three times as much as it takes to develop an ordinary Juicer. It also takes twice as long to recover from the operations, which involve regular Juicer surgery, followed by the implantation of electronic stimulators that enhance and channel psychic energy in a continual bio-feedback loop.

The other problem with Mega-Juicers was only discovered some five years after the first test subjects were first released. The bio-feedback energies released by the body will eventually produce an overload. At that point, the Juicer literally starts to "burn out," producing mega-damage levels of heat and light energies around him! Mega-Juicers in the terminal stages are a ter-

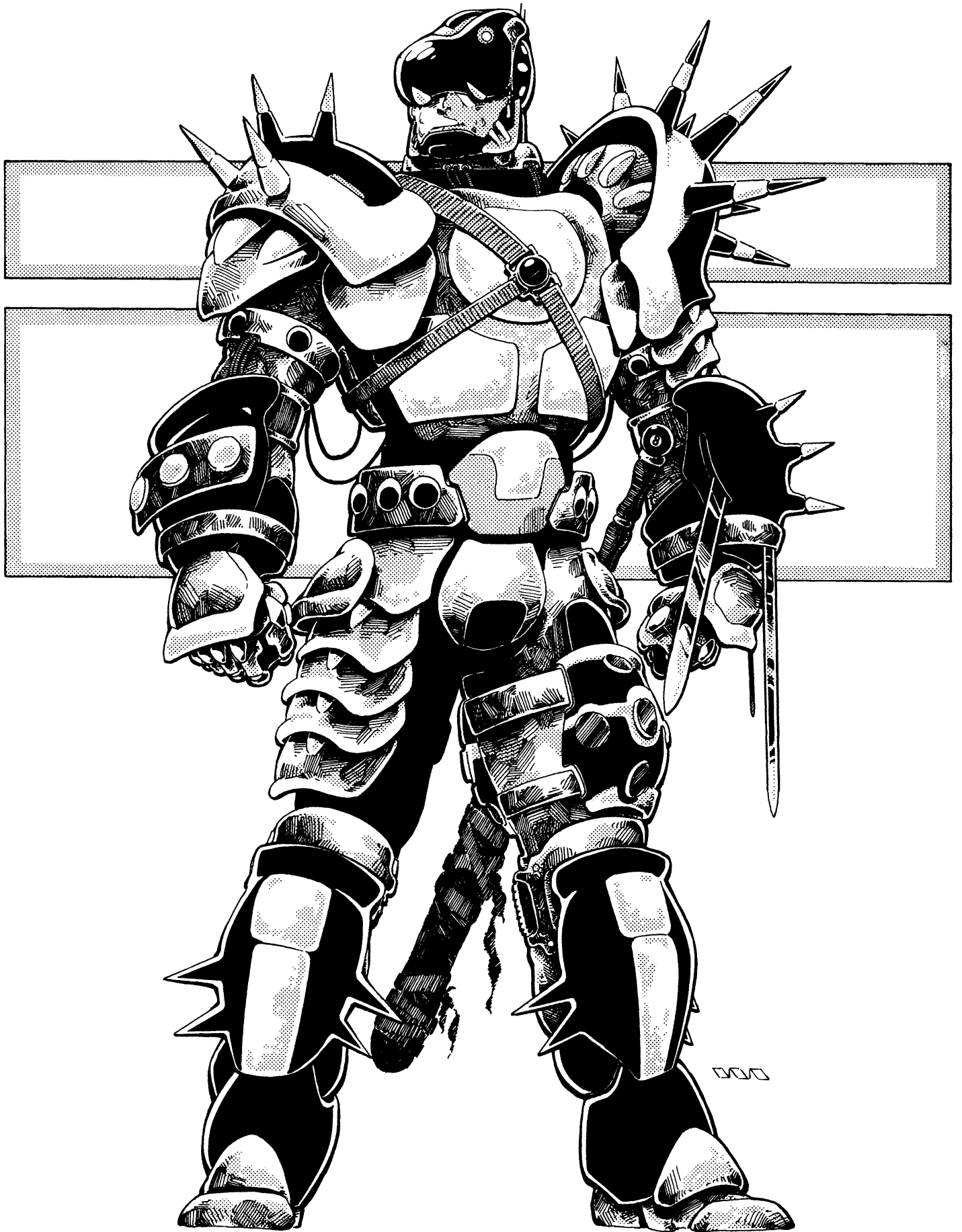

rible danger to themselves as well as others, and are often put to death or expelled from populated areas.

Mega-Juicer O.C.C.

Attribute Requirements: Minor, major or master psionics, or high P.P.E. (30 points or more).

O.C.C. Abilities and Bonuses:

1. Super Endurance: Add 2D6 to P.E. attribute, plus the Mega-Juicer becomes an M.D.C. being with P.E.x4 M.D.C.; add 2D4 M.D.C. per level of experience. The character's strength is considered to be supernatural (can carry 50 times his P.S. in pounds and lift 100 times his P.S.). The Juicer can remain alert and operate at full efficiency for up to seven days without sleep. Normally needs only three hours of sleep per day.

2. Super Strength: Add 2D6 to P.S. attribute. Note: Minimum P.S. is 25, if lower adjust to 25.

3. Super Speed: Add 2D4x10 to Speed attribute. Can leap 30 feet (9.1 m) across after a short run (half that from a dead stop) and 20 feet (6.1 m) high (half without a short run).

4. Super Reflexes and Reaction Time: Bonuses: +2 to pull punch, +4 to roll with punch, fall or impact; +4 on initiative, +3 to disarm, gets an automatic parry or dodge on all attacks, even from behind/surprise. +1 to Auto-Dodge at levels 1, 2, 4, 6, 8, 10, 12 and 14. +3 to Perception Rolls. Add two extra attacks per melee, and add 2D4 to P.P. attribute. Minimum P.P. attribute is 20, if lower adjust it to 20. **Penalties:** Same as normal Juicers (insomnia, restlessness, impatience, etc.).

5. Saving Throw Bonuses: +5 to save versus psionics, +6 to save versus mind control (psionic and chemical), +3 to save versus magic, +6 to save versus toxic gases, poisons, and other drugs, and +6 to save vs Horror Factor.

6. Enhanced Healing: Regenerates 2D6 M.D.C. every hour, +20% to save versus coma/death. Virtually impervious to pain, disease, and normal ranges of heat and cold.

7. Low Life Span: Burnout! Mega-Juicers have the same life span of normal Juicers, with one small difference. After the 5th year of service, there is a cumulative 15% chance per month that the Mega-Juicer will undergo a psychic overload. First, his eyes will start glowing so brightly that not even sunglasses or mirrored face plates will obscure them. Then, his entire skin will start to glow. In 1D4 weeks after these first symptoms, the glow will burn anybody or anything that comes into physical contact with the Juicer, inflicting 2D6 S.D.C. and igniting highly flammable materials.

1D4 weeks later, the energy aura will be hot enough to inflict 1D6 M.D.! The very earth will melt into lava, leaving flaming footsteps behind as the Juicer walks on it. At first, this fire will not harm the Juicer, but 1D6 days after the flames become Mega-Damage energies, the Juicer will start suffering damage every day (4D6 M.D. per day, which cannot be regenerated), until he is consumed by his own rampant energies! Even worse, if the Juicer is killed or dies at any of these stages, he will explode, inflicting 4D6x10 M.D. to a 30 foot (9.1 m) radius. There is no known cure for the burnout; most Mega-Juicers who start showing symptoms will be killed (from a safe distance) or exiled into the wilderness.

O.C.C. Skills:

- Radio: Basic (+5%)
- Wilderness Survival (+5%)
- Land Navigation (+5%)

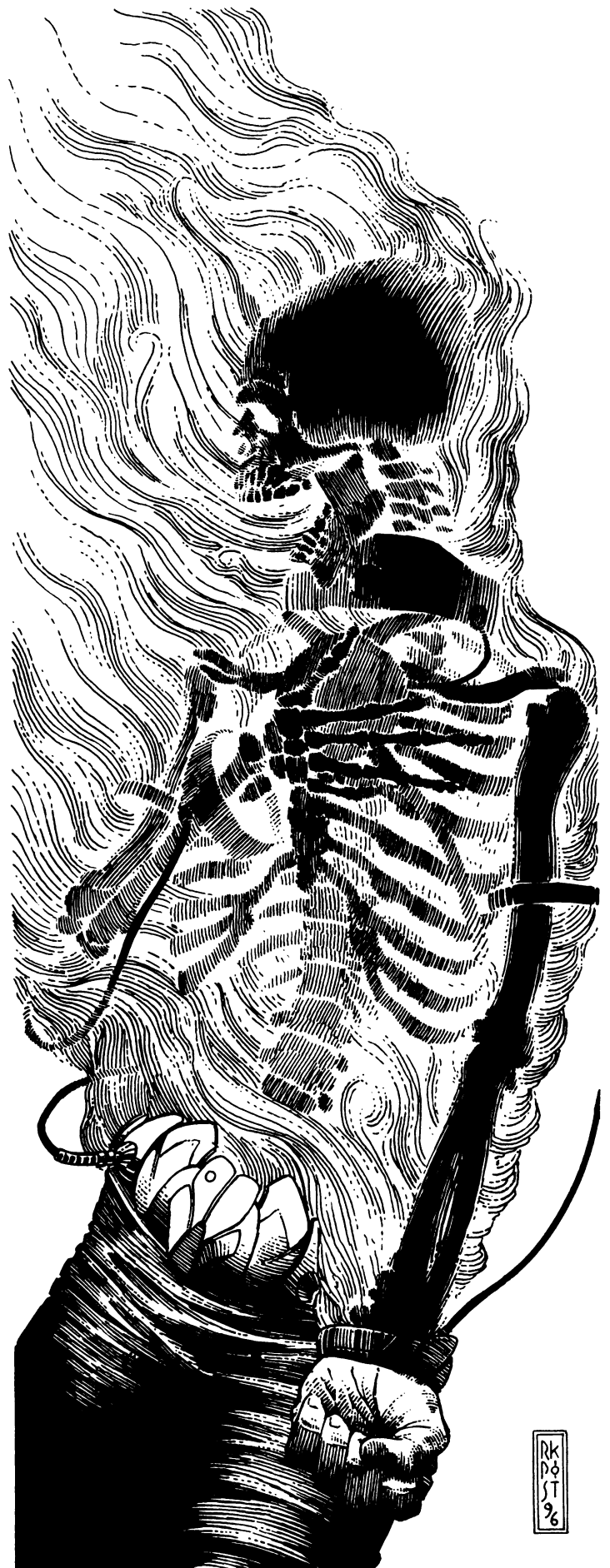

Piloting (two of choice; +10%)
Language (two of choice; +10%)
W.P. Energy Rifle
W.P. (two of choice)
Hand to Hand: Expert

Hand to Hand: Expert can be changed to Martial Arts (or Assassin, if evil) at the cost of one “other” skill.

O.C.C. Related Skills: Select five other skills. Plus select two additional skills at level three, and one at levels six, nine, and twelve. All new skills start at level one proficiency.

Communications: Any

Domestic: Any

Electrical: Basic only.

Espionage: Intelligence, escape artist, detect ambush and detect concealment only (+5%).

Mechanical: Automotive only

Medical: None

Military: Any

Physical: Any (+5% where applicable)

Pilot: Any

Pilot Related: Any

Rogue: Any (+10% to Prowl)

Science: Basic Math only.

Technical: Any

W.P.: Any

Wilderness: Any

Secondary Skills: The character also gets to select six Secondary Skills from the Secondary Skills list in *Rifts® Ultimate Edition*, page 300. These are additional areas of knowledge that do not get the benefit of the bonuses listed in parentheses. All Secondary Skills start at the base skill level.

Standard Equipment: Bio-comp, bio-data and bio-feedback implants, drug harness and drug supply (usually needs to be replenished once or twice a year), portable IRMSS kit, set of fatigues, utility belt, backpack, sunglasses, canteen, compass, and personal items. Weapons and armor include a suit of Mega-Juicer Combat Armor (130 M.D.C.), energy rifle of choice, energy pistol of choice and 2D4 energy clips for each, and choice of two other weapons.

Money: Mega-Juicers tend to make more money than regular Juicers. 5D6×100 in credits and another 1D4×1000 in black market items.

Cybernetics: None.

Mega-Juicer Augmentation Cost: Typically 200,000-400,000 credits.

Delphi Juicer O.C.C.

The Delphi Juicer is the creation of the mysterious Dr. Heinrich Rommel, an immigrant from the New German Republic who set up a body-chop-shop in Ishpeming sometime in the early 90's P.A. Rommel sometimes speaks of having worked with a mysterious woman called “Engel der Vernichtung” who had managed to mate psionics and machines in the strange science of *Psynetics* (for more information on this “Engel” and her creations, refer to the *Rifts® Sourcebook Three: Mindwerks*). According to some rumors, Rommel escaped the clutches of this “angel of death” after stealing some psynetic prototypes. He did not stop running until he and a small team of bodyguards (all of them Euro-Juicers) had reached the shores of North America, far enough to escape her vengeance (at least for the time being).

Once he was in America, Rommel set up shop in Ishpeming, where he partnered with a budding Juicer-creating company called the **Hyper-Science Corporation**. HSC was competing with Ultra-Tech Industries (see the UTI section for more information), but so far had only been able to offer normal Juicer conversions. Attempts to develop new variants had failed miserably, often killing test subjects in the process. Rommel offered HSC his expertise, and started a project to develop a Juicer with tremendous psionic powers. The research project took a long time, due mostly to the difficulty in finding enough latent psionics who wished to try the dangerous test; there are some rumors that Rommel and his cronies started kidnapping potential test subjects. It is possible that as many as a hundred Delphi Juicers were forced into involuntary conversion (and thereby condemned to an early death).

In any case, the result of these experiments was the creation of a psionically-adept Juicer, a lethal combination of incredible physical and mental powers, provided the character wears a spe-

cial Psychic Amplification Helmet. The helmet, developed by Rommel and his partners, uses stolen Psynetic technology, M.O.M. variants and other technological breakthroughs to increase the power of the wearer. The helmet is surgically attached to the wearer, increasing his mental abilities twofold or more. Delphi Juicers make ideal bodyguards, assassins and scouts; some kingdoms are beginning to create a high demand for these enhanced warriors. Regrettably, during the last months of their lives the Delphi Juicers are plagued by spontaneous activations of their powers, which can lead to dangerous and unpredictable situations.

The Delphi Juicer O.C.C. — Psychic Juicer

Attribute Requirements: M.E. 12 or higher and minor or major psionic powers.

O.C.C. Abilities and Bonuses:

1. Super Endurance: Add 4D6×10 to S.D.C., 5D6 to hit points, and 2D4 to P.E. attribute. Can lift and carry four times more than a normal person of equivalent strength, and can last five times longer before feeling the effects of exhaustion. Can remain alert and operate at full efficiency for up to four days without sleep. Normally needs only four hours of sleep per day.

2. Super Strength: Add 2D4 to P.S. attribute. Note: Minimum P.S. is 20, if lower adjust to 20.

3. Super Speed: Add 1D4×10+10 to Speed attribute. Can leap 20 feet (6.1 m) across after a short run (half that from a dead stop) and 20 feet (6.1 m) high (half without a short run).

4. Super Reflexes and Reaction Time: Bonuses: +3 to roll with punch, fall or impact, +2 to disarm, +3 on initiative, +3 to Perception Rolls, +1 to Automatic Dodge at levels one, two, four, six, eight, ten, twelve and fourteen; gets automatic parry



or dodge on all attacks, even from behind/surprise; add two extra attacks per melee and add 2D4 to P.P. attribute. Minimum P.P. attribute is 19, if lower adjust it to 19.

Penalties: In addition to the normal Juicer problems (such as insomnia, impatience, etc.), Delphi Juicers sometimes react violently to psychic flashes, especially precognitive visions. If an involuntary vision (as per the clairvoyance sensitive power or sense danger) is experienced, and is disturbing or frightening, the Juicer may lash out blindly (physically or psionically) at the nearest target before he even realizes what he's doing!

5. Psionic Powers: The conversion process turns the Delphi into a master psionic with the following abilities: Clairvoyance, presence sense, see aura, see the invisible and three powers from the physical category and one power from the super category (with the same restrictions as a Mind Melter). Each level after the first, the Delphi can select one power from the physical, sensitive or super categories. **I.S.P.:** M.E. attribute number plus 6D6. Add 8 I.S.P. per level of experience after the first. Also, the Psychic Amplification Helmet adds to the available I.S.P. energy.

6. Psychic Amplification System (PAS) Helmet: This helmet uses revolutionary Psynetic technology to increase the available I.S.P. of the Delphi Juicer. It increases the range of all powers by 10%, and doubles their duration! The helmet also provides a "pool" of 80 I.S.P., recovered at the rate of 8 I.S.P. per hour. The PAS Helmet is permanently linked to the Delphi Juicer (synchronized with the wearer's brain waves) and cannot be used by others. The helmet also protects the head with 30

M.D.C. and has an advanced optical system that includes low-light, infrared and thermal sights.

The helmet can only be removed surgically, forcibly torn off or blasted to smithereens (attackers are -5 to strike on a called shot). Regardless of how it is removed, the Delphi Juicer will instantly lose all the features listed above, plus is so psychologically dependent on it that he loses all combat bonuses, one melee attack, and is -20% on all skill performance until a new helmet can be acquired (costs 100,000+ credits; must be calibrated to his specific brain waves).

7. Saving Throw Bonuses: +4 to save versus psionics, +5 to save versus mind control (psionic and chemical), +7 to save versus toxic gases, poisons, and other drugs; half without the PAS helmet.

8. Enhanced Healing: Heals four times faster than normal, +20% to save versus coma/death. Virtually impervious to pain, as per the normal Juicer.

9. Low Life Span: Same life span as a normal Juicer. Special Terminal Effects: During Last Call (the last year of a Juicer's life), the character's psychic powers start going out of control! Every two hours, one of his powers (the G.M. rolls randomly or chooses one of the character's powers) activates itself for no reason! I.S.P. is spent normally and the power just does its thing (as the G.M. sees fit). This may be harmless (see aura), annoying (telepathic flashes from people around the Juicer), or downright dangerous like spontaneous combustion (pyrokinesis) or worse.

10. Special Detox Penalties: If the character undergoes detox and survives, most of his psionic abilities are lost forever! The character becomes a minor psionic, and is allowed to retain a total of four powers from any category except super (all super-psionics are lost). I.S.P. is reduced to 4D6 plus two per level of experience, and all other psionic bonuses (including the PAS helmet, which is unusable) are lost. If the detox (which involves the removal of the Psynetic brain implants and PAS helmet) is a failure, the Juicer dies or is left a mental vegetable; I.Q. 1D4, M.E. 1D4, M.A. 1D6 and can't remember any skills, the past, who he is/was, etc.

O.C.C. Skills:

Radio: Basic (+5%)
 Wilderness Survival (+5%)
 Land Navigation (+5%)
 Piloting (two of choice; +10%)
 Language (two of choice; +10%)
 W.P. Energy Rifle
 W.P. (two of choice)
 Hand to Hand: Expert

Hand to Hand: Expert can be changed to Martial Arts (or Assassin, if evil) at the cost of one "other" skill.

O.C.C. Related Skills: Select seven other skills. Plus select two additional skills at level three and one at levels six, nine, and twelve. All new skills start at level one proficiency.

Communications: Any
 Domestic: Any
 Electrical: Basic only.
 Espionage: Intelligence, escape artist, detect ambush and detect concealment only (+5%).
 Mechanical: Automotive only
 Medical: None.

Military: Any
Physical: Any (+5% where applicable)
Pilot: Any
Pilot Related: Any
Rogue: Any (+15% to Prowl)
Science: Basic Math only.
Technical: Any
W.P.: Any
Wilderness: Any.

Secondary Skills: The character also gets to select four Secondary Skills from the Secondary Skills list in **Rifts® Ultimate Edition**, page 300. These are additional areas of knowledge that do not get the benefit of the bonuses listed in parentheses. All Secondary Skills start at the base skill level.

Standard Equipment: Bio-comp, bio-data and PAS Helmet, drug harness and drug supply (usually needs to be replenished once or twice a year), portable IRMSS kit, set of fatigues, utility belt, backpack, sunglasses, canteen, compass, and personal items.

Weapons and armor include a suit of light body armor (usually Juicer Assassin flex-plate) and an energy rifle of choice, energy pistol of choice and 2D4 energy clips for each, plus two weapons of choice.

Money: Delphi Juicers tend to make more money than regular Juicers. 5D6×100 in credits and another 6D6×100 in black market items.

Cybernetics: None.

Delphi Juicer Augmentation Cost: Typically 150,000-200,000 credits and is currently available only at Ishpeming.

Coalition Juicers

By C.J. Carella and Kevin Siembieda

The Coalition States have long been vocal opponents of the Juicer process and all its implications. CS Propaganda has made it a point to show how stupid and dangerous tampering with one's body through chemicals is, and how counterproductive it is to condemn a healthy man or woman to an early grave by cursing him with this chemical addiction. In most cases, these beliefs are shared by the common people and most government officials. The Coalition has long held an official policy of exclusion of Juicers from their armies, forcing the member State of Quebec to abandon its use of Juicers, and declaring the very process to be *illegal*. For decades, the creation of Juicers was punishable by death.

However, supporters of Juicers for military use have existed in the CS military and government since the inception of the CS. Government leaders have sat on pre-Rifts Juicer technology for almost a hundred years! A few military analysts have argued the virtues of such augmented warriors and have shown that the combat performance of Juicers is more than double that of normal human beings. Their need for less sleep, increased endurance, low fatigue ratio, greater strength and agility, and other factors give these enhanced warriors a much greater chance of surviving actual combat than non-augmented soldiers. As the Coalition begins to gear up its campaign for expansion and prepares to fight nations that rely on magic, Juicers, and D-Bees (many of whom have superhuman attributes and powers), some strategists predict that some front-line CS combat units will suffer in excess of 80% casualties in the first few weeks of fighting. The same studies indicate that if such units were made up of Juicers, the casualties might be reduced to an astonishing 30% or even 20% in terms of personnel, and less than 20% in terms of equipment, since Juicers have less need for heavy equipment like tanks and robot vehicles. One often quoted study ran a cost comparison between a human and Juicer shock battalion, and found that the Juicer unit would actually cost 20% less money to outfit, including Juicer conversion costs, which the Coalition could do relatively cheaply, and would be 20-40% more combat efficient.

Another study showed that the average suit of power armor costs 1-5 million credits, while a fully outfitted Juicer, including the cost of his military training, body armor, weapons, equipment, and Juicer augmentation process would be no more than 250,000 credits, possibly less (remember, the CS produces things at cost). Thus, *four* (4) fully equipped Juicers could be created for the cost one basic suit of power armor, or *twenty* (20) Juicers for the cost of one five million dollar power armor suit like the Super SAMAS!

For years, these studies failed to sway the leading minds of the Coalition States. To **Emperor Prosek**, Juicers are an abomination. In the tradition of his father and grandfather, he had vowed that he would not sacrifice precious "human" life foolishly. Power armor, robots, and other alternatives (Psi-Hounds/Dog Boys, Skelebots, etc.) were the ideal alternatives despite their costs in credits and resources. His son (and heir apparent to the throne) **Joseph**, is more pragmatic. He would have problems condemning full citizens to the almost certain death that is the fate of most Juicers, but has no qualms in doing so to would-be citizens in the 'Burbs and wastelands, whom he sees as useless rabble anyway. An unsubstantiated rumor has it that young Prosek has submitted a plan in which a human volunteer can earn citizenship for himself and two members of his family, by submitting to Juicer augmentation and faithfully serving in the Coalition Military for no less than five years. Many of these impoverished and downtrodden people are so desperate that they would jump at the chance to get a couple of loved ones into the safety of a Coalition city.

General Marshall Cabot (see *Rifts® Sourcebook One*) has been quietly lobbying for the formation of a Juicer Division for over a decade, and has turned a blind eye to the secret Juicer projects conducted in Free Quebec by *General LeNoir* and in Chi-Town itself, by **Colonel Lyboc**. General Cabot's protege, the decorated war hero **Ross Underhill**, has been vocally opposed to the use of Juicers even if restricted exclusively to the military. To him, Juicers are overrated and certainly not equal to a well-trained human in power armor, or so he insists. He'd

much rather see money and effort spent in the development of advanced suits of power armor like the long heralded “Super SAMAS” and others (revealed in **Rifts® World Book 11: Coalition War Campaign**).

The situation remained a stalemate for years. It took the proposal of **Operation Phoenix** and several months of intrigue and political machinations before the Coalition States passed a law making the use of Juicers and Juicer technology legal under the *exclusive* jurisdiction of the military. For more information about Operation Phoenix and its consequences, see the **Uprising** section.

Juicers in Free Quebec

When Free Quebec became a Coalition State, it was forced by treaty to abandon the creation of Juicers and to discharge those serving in its army. It took five years for Quebec to comply and dismantle its Juicer Battalions; it had four such battalions, or some 8,000+ Juicers. By 40 P.A. there were no Juicers in Quebec’s Armed Forces — at least not on the official rosters and tables of organization.

In reality, the Quebec government secretly moved several augmentation facilities to the traders’ town of Old Bones, in the ruins of the pre-Rifts city of Quebec. Old Bones is allegedly an independent town, but is secretly under the control of the Free Quebec government, which uses the town as an intelligence-gathering resource (enemies of the Coalition often foolishly talk freely in Old Bones), and to maintain a small covert army of Juicers, Crazies and other special operatives. The code name for this secret operation is the **Liberty Reserve**.

The Liberty Reserve is an unofficial army covertly trained, assembled and maintained without the knowledge of the other Coalition States, especially Chi-Town. As its code name implies, the operation is meant to preserve Quebec’s freedom, both from the enemies of humankind and, if necessary, from the Coalition itself! The plan was drafted years ago, when Quebec was being pressured to abandon its Glitter Boy armed forces. The Quebecois leaders feared that civil war might erupt within the Coalition one day, and that their state must be prepared. If such a war started, Quebec would outfit an army of 10,000 volunteers with Juicer augmentation and use it against its former allies. Alternatively, the Liberty Reserve could also be called to duty if another enemy, such as a horde of D-Bees, threatened the survival of the State.

The current leader of the Liberty Reserve is *General Maurice LeNoir* (8th level CS Military Specialist). General LeNoir is a patriot who puts Quebec’s interests above all other things, including the rest of the Coalition States and even humanity at large. LeNoir operates from a hidden base built under Old Bones. At this base, a small army of 500 Juicers and about 1,000 other augmented soldiers, including ‘Borgs and Crazies, is constantly training. Occasionally, members of this army are sent out on covert missions, usually against bandits, D-Bees and monsters (and occasionally to spy on the other States). The Juicers do not wear Coalition uniforms and pretend to be independent adventurers or mercenaries. All of them are dedicated fanatics who serve for a period of two years and then accept the detox process and partial or full bionic reconstruction as a reward; most continue to operate in the service of their country. For every existing Juicer, there are twenty other candidates who

would, in an emergency, receive the bio-comp augmentation and fight for Quebec.

Free Quebec’s Juicers use the standard augmentation, but their training is usually more extensive and include the *Juicer Assassin* and *Juicer Scout O.C.C.s* among their forces.

Lyboc’s Secret Project

Colonel Thaddius Lyboc is an important spy master and security agent of the Chi-Town State. He is also an important man in the Chi-Town underground, where he co-owns three body-chop-shops and has multiple contacts with the Black Market, criminal organizations, and other underground elements, both Downside (the lower levels of the Chi-Town arcology) and in the surrounding ‘Burbs. In recent years, Lyboc initiated a secret project designed to create a small but highly trained army of Juicer spies, assassins and operatives. This secret unit has been operating for several months in the countryside surrounding the Coalition, without the “official” knowledge of the authorities. General Cabot knows of the operation (he personally authorized the personnel transfers that gave Lyboc his volunteers for the Secret Juicer project), and he has covered for it, although he has yet to give his blessing to Lyboc. This secret project would eventually play a major part in the Juicer Uprising. See the **Uprising** section for more details.

Secret CS Juicer

Coalition Special Trooper

These augmented soldiers are the result of Lyboc’s secret project. The “official” reports are that a new unit, the *Chi-Town 1st Special Forces Battalion*, was assembled by Lyboc to be used in counter-terrorist, anti-guerrilla and reconnaissance missions. The Special Forces Troopers were outfitted with a highly stylized Death’s Head pattern armor, decorated with spikes and equipped with a Forearm Integral Weapon System (FIWS, described in the New Weapons and Equipment section) and other heavy weapons. They have been used sparsely, so they are not widely recognized in the Coalition States, and in some places they are not even recognized as Coalition soldiers, which is how Lyboc likes it.

The typical Special Trooper is a highly dedicated and motivated Coalition soldier who has already undergone basic training before receiving the bio-comp augmentation. The Juicer operations are conducted in one of the three body-chop-shops partially owned by Lyboc (which means that he actually gets to pocket some of the military funds devoted to this secret project). The typical term of service as a Juicer is two years, after which the soldier undergoes detox; some volunteer for a third tour of duty, accepting the greater risk of death in return for another year as a Juicer powerhouse, and a few remain in service for the full 5-6 years, abandoning all hope in return for the chance to build a stronger human empire and destroy the enemies of mankind.

In addition to standard Juicer augmentation, Special Troopers are outfitted with a variety of bionic implants (many of them illegal). They include cyber-armor for greater protection, a bionic hand with concealed weapons, and (unknown to the soldiers) a



built-in bomb that will kill the Juicer if the right radio signal is sent out! The bomb is Lyboc's "insurance policy" in case a Juicer turns against the Coalition.

At the time of the Uprising, Lyboc's Special Forces Battalion had about 300 Juicers and some 200 'Borgs, as well as 100 of the highly experimental Psycho-Stalkers. When the Uprising exploded around the city of Newtown, the Battalion was mobilized and sent towards the front, to fight Juicers with Juicers.

Coalition Juicer Special Operative

Attribute Requirements: None.

O.C.C. Abilities and Bonuses:

1. Super Endurance: Add $1D4 \times 100$ to S.D.C., $1D4 \times 10$ to hit points, and $2D6$ to P.E. attribute. Can lift and carry four times more than a normal person of equivalent strength, and can last five times longer before feeling the effects of exhaustion. Can remain alert and operate at full efficiency for up to five days without sleep. Normally needs only three hours of sleep per day.

2. Super Strength: Add $2D6$ to P.S. attribute. Note: Minimum P.S. is 22, if lower adjust to 22.

3. Super Speed: Add $2D4 \times 10$ to Speed attribute. Can leap 30 feet (9.1 m) across after a short run (half that from a dead stop) and 20 feet (6 m) high (half without a short run).

4. Super Reflexes and Reaction Time: Bonuses: +4 on initiative, +2 to Perception Rolls, +2 to disarm, +2 to pull punch, +4 to roll with punch, fall or impact, +1 to Auto-Dodge at levels 1, 2, 4, 6, 8, 10, 12 and 14, automatic parry or dodge on all attacks, even from behind/surprise; add two extra attacks per melee round, and add $2D4$ to P.P. attribute. Minimum P.P. attribute is 20, if lower adjust it to 20. **Penalties:** Same as normal Juicers (insomnia, restlessness, impatience, etc.).

5. Bionic Implants: Unlike normal Juicers, the Coalition Juicer has a handful of bionic and cybernetic implants designed to make a better warrior, and also to better control him. The implants include *cyber-armor* (A.R. 16, 50 M.D.C.), a *bionic hand* (12 M.D.C.) with a *laser finger blaster* for assassination missions ($1D4$ M.D.; 300 foot/91 m range) and *climb cord* (30 feet/9 m length; wrist). Finally, a small *explosive device* is secretly implanted in their skulls. If the character goes AWOL the device is detonated, automatically killing the Juicer. Removing the device requires a roll on Medical Doctor (at -20%) or M.D. in Cybernetics skill (no penalty) and requires surgical facilities. A failure on the roll causes the device to detonate, killing the patient and inflicting $1D6$ M.D. to a 10 foot (3 m) radius!

6. Saving Throw Bonuses: +4 to save versus psionics, +4 to save vs mind control (psionic and chemical), +6 to save vs toxic gases, poisons, and other drugs, and +3 to save vs Horror Factor.

7. Enhanced Healing: Standard: Heals four times faster than normal, +20% to save versus coma/death. Virtually impervious to pain, as per the normal Juicer.

8. Low Life Span: Standard for Juicers: 5 years plus $4D6$ months.

O.C.C. Skills:

- Speaks American 98%
- Basic Math (+12%)
- Radio: Basic (+10%)
- Pilot Hovercraft (+15%)
- Pilot Tank & APC (+15%)
- Read Sensory Equipment (+10%)

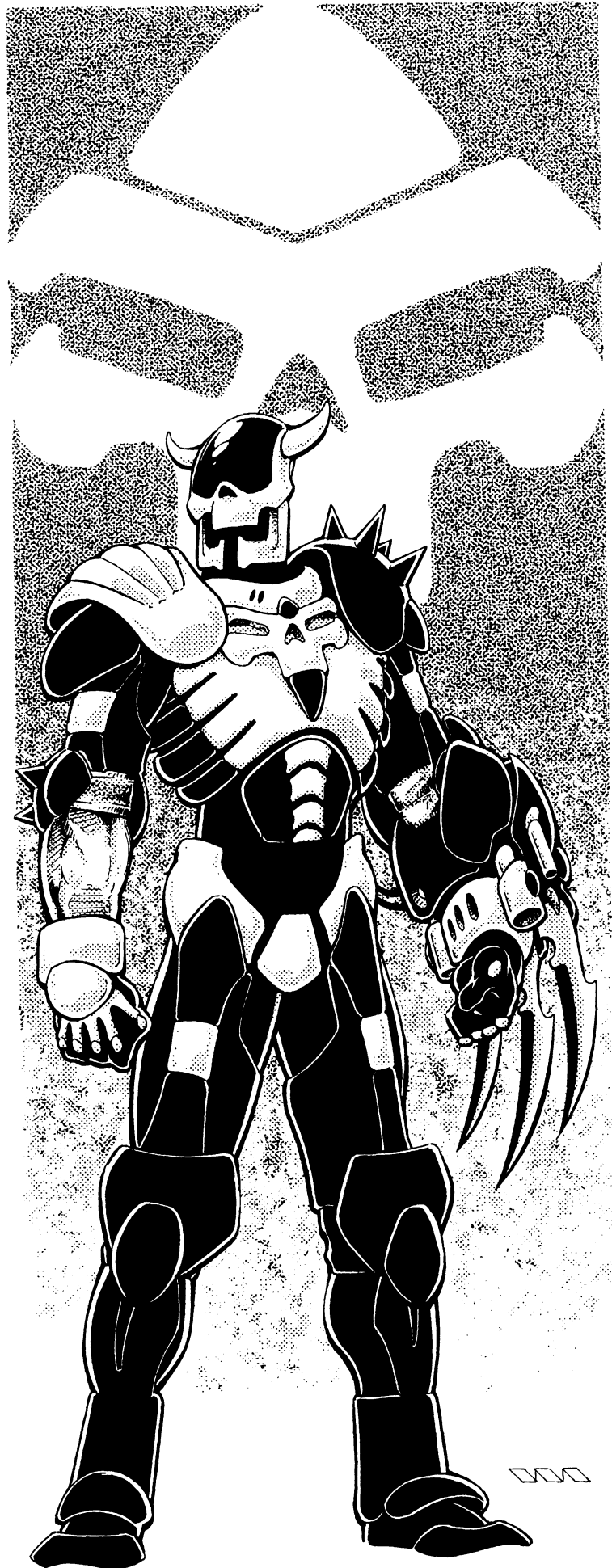

Intelligence (+10%)

W.P. Energy Pistol

W.P. Energy Rifle

W.P. Knife

Hand to Hand: Expert

Hand to Hand: Expert can be changed to Hand to Hand: Martial Arts at the cost of one "other" skill, or assassin, if evil.

O.C.C. Related Skills: Select seven other skills. Plus select one additional skill and a W.P. at level three, two at level six, and one at levels nine and twelve. All new skills start at level one proficiency.

Communications: Any (+5%)

Domestic: Any

Electrical: Basic Electronics only.

Espionage: Any (+10%)

Mechanical: Automotive only (+5%)

Medical: Paramedic only.

Military: Any (+15%)

Physical: Any.

Pilot: Any

Pilot Related: Any (+5%)

Rogue: Any

Science: Math and chemistry only.

Technical: Any (+5%)

W.P.: Any

Wilderness: Any.

Secondary Skills: The character also gets to select five Secondary Skills from the Secondary Skills list in **Rifts® Ultimate Edition**, page 300. These are additional areas of knowledge that do not get the benefit of the bonuses listed in parentheses. All Secondary Skills start at the base skill level.

Standard Equipment: Coalition Special Trooper Armor with FIWS weapon built into forearm (-5% prowl penalty, 115 M.D.C., 25 lbs with Forearm Integral Weapon System, very expensive, using special M.D.C. alloys; has all standard features). Standard issued weapons currently include C-14 Fire-Breather Rifle or C-27 Heavy Plasma Cannon, vibro-knife, C-18 pistol, 8-10 E-Clips per weapon (larger numbers if operating in the field), 4 reloads for the grenade launcher (48 grenades), three signal flares, survival knife, distancing binoculars, robot medical kit, pocket computer, utility belt, walkie-talkie, uniform, bio-comp and bio-monitor implants, drug harness (drugs must be added every 6-12 months), and food rations for two weeks. Troopers on missions may be assigned a vehicle, usually a light model and additional food and equipment.

Money: Food, clothing and basic services are provided for free, plus a monthly salary of 3,000 credits. Starts with one month's pay.

Cybernetics: In addition to the ones provided above, the character may have 1-3 additional cybernetic or bionic implants, although not everyone does. Many feel the addition of cybernetics demeans being a Juicer.

Coalition Juicer Special Operative Cost: Not applicable; available only to the CS military (CS cost is approximately half a million including bionics, body armor, weapons and equipment).

Psycho-Stalker O.C.C.

Juicer Psi-Stalkers

The CS Psycho-Stalker was an accidental creation, the result of a combination of circumstances, most notably, stupidity and the smarts to take advantage of the unexpected. During the early phases of the formation of the Chi-Town 1st Special Forces Battalion, a number of volunteers were transferred from other units to the Battalion to undergo the Juicer augmentation in one of Lyboc's chain of body-chop-shops. Not all the Battalion members were going to be Juicers, however. Lyboc wanted a mixed force of secret Juicers, 'Borgs, and a number of Psi-Stalkers, to get the best combination of firepower, mobility and anti-supernatural capabilities.

The Coalition bureaucracy, as bureaucracies are wont to do, screwed up in one of the transfer orders. A Psi-Stalker named *John Dow* was assigned to the Battalion, but his paperwork was mixed up with that of another soldier, a John Doe who was eligible for Juicer augmentation. The Psi-Stalker was sent to one of Lyboc's body-chop-shops to receive the augmentation. This was against regulations: not only was the augmentation of Psi-Stalkers and mutant animals still strictly forbidden, but every such attempt had invariably resulted in the death of the patient.

Standard operating procedure would have been to report the mistake and not perform the operation. However, the cyber-doc running that particular body-chop-shop was a brilliant madman called *Shane "Miracle Worker" Charleston*. Shane saw the whole situation as a challenge for his abilities, and instead of sending John Dow back to the base, he started conducting tests on the unfortunate volunteer. Shane had some theories as to why the standard Juicer treatment had not worked on the creatures. Some years earlier, he had made extensive studies on the strange metabolism of Psi-Stalkers, who require little food and water but live off the P.P.E. of living beings. Using this knowledge and some specially-prepared drugs, Shane was able to create a Juicer Psi-Stalker! The result exceeded everyone's expectations. The creature could channel his I.S.P. into his body to temporarily become an M.D.C. being! To Shane's chagrin, Joe Dow used that very power to punch through one of the walls of the shop and escape. The first Psycho-Stalker (as the result was called) has not been heard of ever since — the explosives and other cyber-implants had not been installed yet.

Despite the escape of the first Psycho-Stalker, Lyboc decided that converting several Psi-Stalkers into Psycho-Stalkers would be a great idea. There are currently about a hundred of these strange psychic beings under Lyboc's command, but the CS leaders are leery of continuing this particular augmentation on "D-Bees," even with the assurance of the bomb implant. This augmentation is top secret and carefully guarded — it will NOT fall into the hands of others!

Psycho-Stalker — Juicer Psi-Stalker

Attribute Requirements: None.

O.C.C. Abilities and Bonuses:

1. Super Endurance: Add 2D6×10 +100 to S.D.C., +40 to hit points, and 3D4 to P.E. attribute. Can lift and carry four times more than a normal person of equivalent strength, and can last 5

times longer before feeling the effects of exhaustion. Can remain alert and operate at full efficiency for up to five days without sleep. Normally needs only three hours of sleep per day.

Special Bio-Feedback Power: By refocusing psychic energy (I.S.P.) points, the Psycho-Stalker can temporarily become an M.D.C. creature! Change all S.D.C. and Hit Points to M.D.C. This process costs 25 I.S.P. and lasts one minute (4 melee rounds) per level of experience. However, during this period, the character cannot use any of its psychic abilities.

The transformation also burns up Potential Psychic Energy and makes the Stalker *hunger* for a minimum of 20 P.P.E. points. The hunger pangs/craving is intense and the mutant will be irritable and distracted (reduce initiative by 3) until he feeds.

2. Super Strength: Add 2D6 to P.S. attribute. Note: Minimum P.S. is 22, if lower adjust to 22. When using the Bio-Feedback Power (see #1 above), this strength becomes supernatural.

3. Super Speed: Add 3D4×10 to Speed attribute. Can leap 30 feet (9.1 m) across after a short run (half that from a dead stop) and 20 feet (6 m) high (half without a short run).

4. Super Reflexes and Reaction Time Bonuses (includes Juicer and Psi-Stalker bonuses): +5 on initiative, +3 to Perception Rolls, +2 to disarm, +2 to pull punch, +4 to roll with punch, fall or impact, +1 to Auto-Dodge at levels 1, 2, 4, 6, 8, 10, 12 and 14, automatic parry or dodge on all attacks, even from behind/surprise; add two extra attacks per melee round, and add 2D6 to P.P. attribute. Minimum P.P. attribute is 20, if lower adjust it to 20. **Penalties:** Same as normal Juicers, insomnia, restlessness, impatience, plus the range of natural Psi-Stalker powers are half.

5. Saving Throw Bonuses: +4 to save vs psionics (do not add M.E. bonuses), +5 to save vs mind control (psionic and chemical), +1 to save vs magic, +6 to save vs horror factor, and +6 to save vs toxic gases, poisons, and other drugs.

6. Psi-Stalker Powers: All the powers of the Psi-Stalker R.C.C. apply to the Psycho-Stalker, with the exceptions of physical and saving throw bonuses (already taken into account above). Among these powers are the ability to sense psychic and magic energy, sense supernatural beings, nourishment (lives on P.P.E., usually 50 to 100 P.P.E. a week; does not need food or water), and psionic empathy with animals. **Note:** Reduce the usual range for these powers by *half*. For reasons unknown to most researchers, the Juicer process seems to interfere with (sometimes completely destroy) psionic powers.

7. Psionic Powers: Choose six psi-powers from the Sensitive Category. I.S.P.: M.E. plus 1D6×10 I.S.P., plus 10 I.S.P. for each additional level of experience. Reduce range by half. Considered a master psionic for save purposes. Also, add 1D6 to the M.E. attribute.

8. Enhanced Healing: Standard: Heals four times faster than normal, +20% to save versus coma/death. Virtually impervious to pain, as per the normal Juicer.

9. Low Life Span: Same as normal Juicers: 5 years plus 4D6 months. During the last 2 years of life, the Psycho-Stalker becomes ravenously hungry for P.P.E., requiring as much as 150 to 250 P.P.E. per week to subsist. In addition, they lose *ALL* psionic powers, including their natural abilities to *sense* the supernatural and magic and empathy with animals! This is akin to a human losing his sense of sight or hearing. Many will go berserk and desperately seek to feed on (kill) supernatural beings or

other strong P.P.E. sources, like practitioners of magic. The worst become psychotic murderers consumed with hunting, killing and feeding, so the name is ironically appropriate.

O.C.C. Skills:

Radio: Basic (+10%)
Pilot Hovercraft (+10%)
Pilot Motorcycle (+10%)
Read Sensory Equipment (+5%)
Wilderness Survival (+15%)
Streetwise (+8%)
Prowl (+10%)
Climb (+10%)
W.P. Energy Rifle
W.P. two of choice
Hand to Hand Expert

Hand to Hand: Expert can be changed to Martial Arts (or Assassin if evil) at the cost of one "other" skill.

O.C.C. Related Skills: Select four other skills. Plus select one additional skill at levels four and eight. All new skills start at level one proficiency.

Communications: Any (+5%)
Domestic: Any (+5%)
Electrical: None
Espionage: Detect Ambush, Escape and Intelligence only (+5%).
Physical: Any
Mechanical: None
Pilot: Any (+5%)
Medical: First aid only.
Pilot Related: Any (+5%)
Military: Any (+5%)
Rogue: Any



Science: Basic and Advanced Math only (+10%).

Technical: Any (+5%)

W.P.: Any

Wilderness: Any (+10%)

Secondary Skills: The character also gets to select six Secondary Skills from the Secondary Skills list in *Rifts® Ultimate Edition*, page 300. These are additional areas of knowledge that do not get the benefit of the bonuses listed in parentheses. All Secondary Skills start at the base skill level.

Standard Equipment: Coalition Dead Boy armor (new or old; see *Coalition War Machine* for new equipment), uniform, survival kit, heavy energy rifle, energy weapon of choice and six E-Clips for each, a pair of vibro-blades of choice, air filter, sunglasses, canteen, backpack, and gas mask.

Money: Pay is 2,500 credits a month plus room and board. Starts with one month's pay.

Cybernetics: None, ever, except bio-systems if absolutely necessary.

Psycho-Stalker Juicer Conversion Cost: Not applicable; available only from the CS military.

Techno-Wizard Juicers

Rifts Earth is a place where magic and technology have been merged together to produce some unique devices. Techno-Wizardry has been used to produce vehicles and weapons that are often superior to the products of magic or technology alone. In such places as Kingsdale and Tolkeen, ambitious sorcerer-technocrats have experimented with would-be Juicers to create a superior form of enhanced human. Although these experiments have not proven to be as efficient (or long-lived) as Atlantis' **Bio-Wizardry Treatments** (see *Rifts® Atlantis* for more information), one particular alchemical and technological blend has been very successful, although it is highly expensive and dangerous — the so-called *Dragon Juicers*.

Another, even more sinister form of TW-Juicer is necromantic, rather than alchemical in nature. These sinister *Murder-Wraiths* are worshippers of the embodiment of Death itself and allow themselves to be transformed into undead monsters with no shred of humanity!

Dragon Juicer

a.k.a. the Blood Drinker

In 78 P.A., a band of adventurers slew an adult dragon who had been plaguing the outskirts of Kingsdale. Among them was a techno-wizard and amateur alchemist called Regius. The sorcerer had heard stories about the magical powers of *dragon's blood* and extracted several gallons of the precious liquid for his experiments. The techno-wizard conducted several tests on the blood, going so far as ingesting some of the liquid himself; the experience nearly killed him. It seems that dragon's blood can cause a lethal allergic reaction on some humans when imbibed or injected. Several years of research later, Regius presented his discoveries to a group of magicians and technocrats at Kingsdale. His experiments showed that when properly laced with some of the chemicals used on Juicers, dragon blood could grant humans supernatural powers.

The amazing powers of the Dragon Juicers had a high price, however. First of all, the "mundane" chemicals produced many of the same side effects that affect standard Juicers, including a low life expectancy. More importantly, the transformed people became terminally addicted to the blood of dragons. While the blood dosage necessary to maintain the powers is relatively small, going without it for even as little as a week can be deadly! And there was always the simple fact that most dragons will not part with their blood willingly.

Despite the serious shortcomings, Regius and several others in conjunction with one of the body-chop-shops, decided to create several Dragon Juicers. One of the sorcerers involved was a dragon herself, and she volunteered to donate some blood for the creation process. Highly individualistic and driven, she saw no moral dilemma in the creation of beings who might eventually need to hunt down and kill others of her kind. The first full Dragon Juicers, all volunteers, were created in 89 P.A. In 100 P.A., the Federation of Magic offered Regius and his associates

a fortune for the exclusive rights to his secrets. They accepted, on the condition that their Kingsdale shop could also continue to make Dragon Juicers. By 101 P.A., members of the Federation of Magic were creating Dragon Juicers beyond the borders of Kingsdale. There are rumors of an ancient dragon who has created a small army of bodyguards he "feeds" with his own blood! And one can only wonder what the Federation of Magic plans on doing with this knowledge.

Dragon Juicer — A Techno-Wizard Creation

Attribute Requirements: None.

O.C.C. Abilities and Bonuses:

1. Super Endurance: P.E. is increased by 2D6. The Juicer becomes a supernatural being with M.D.C. equal to his P.E. attribute plus 3D6×10. Add 10 M.D.C. per level of experience. Endurance is also considered to be supernatural.

2. Supernatural Strength: Add 2D6 to P.S. attribute. Note: Minimum P.S. is 20, if lower adjust to 20. See the *Titan Juicer* for the supernatural strength and damage chart.

3. Super Speed: Add 1D4×10 to Speed attribute. Can leap 40 feet (12.2 m) across after a short run (half that from a dead stop) and 20 feet (6.1 m) high (half without a short run).

4. Super Reflexes and Reaction Time: Bonuses: +1D4 on initiative, +2 to disarm, +2 to pull punch, +2 to roll with punch, fall or impact, +1 to Auto-Dodge at levels 1, 3, 6, 9, 12 and 15, automatic parry or dodge on all attacks, even from behind/surprise; add two extra attacks per melee, and add 1D6 to P.P. attribute. Minimum P.P. attribute is 18, if lower adjust it to 18. **Penalties:** Same as normal Juicers (insomnia, restlessness, impatience).

5. Supernatural Dragon Senses: Nightvision 100 feet (30.5m), see the invisible, perfect hawk-like vision, keen sense of smell and a base of 2D4×10 P.P.E. points (cannot learn magic or use psionic powers). +4 to Perception Rolls.

6. Saving Throw Bonuses: +2 to save vs psionics, +4 to save vs mind control (psionic and chemical), +6 to save vs toxic gases, poisons, and other drugs, +5 to save vs horror factor, and is impervious to disease, normal cold and heat.

7. Enhanced Healing: Regenerates 4D6 M.D.C. per minute (once every four melee rounds), +20% to save versus coma/death.

8. Low Life Span: Same as normal Juicers: 5 years plus 4D6 months, but the blood of an ancient dragon (5,000+ years old) will, if properly treated by an alchemist, extend the life of the Dragon Juicer by an additional 6D6 months! The alchemist needs at least a gallon of blood, the preparation process takes 1D6 months and costs 3D6×100,000 credits (one-quarter that amount if the Juicer provides the dragon blood).

9. Other penalties and effects: First, the cost is prohibitive. The Dragon Juicer process is typically 600,000 to one million credits, the initial augmentation process takes three months, and is very rare; only one shop in Kingsdale and select members of the Federation of Magic are known to create Dragon Juicers.



The need for more dragon's blood. After the initial conversion, blood from another dragon must be provided every six months. This typically costs another 10,000-40,000 credits. Soldiers for the Federation of Magic are provided the additional fluid free of charge as long as they serve them faithfully.

Dragon's Blood withdrawal is a debilitating and painful experience. If the Juicer can't get a new supply every six months, his M.D.C. and all combat bonuses drop by half, he loses two melee attacks/actions, and is racked by terrible bouts of stomach cramps and fever 1D4 times a day (each bout lasts 2D6 minutes; -6 on initiative and loses one more attack per melee round for the duration of the pain). Unless the character can get more dragon's blood within the next six months, he will die! Most of the time, Dragon Juicers never get the chance — as soon as word gets around that somebody is gunning after ancient dragons, one or more of these powerful beasts will take action.

Insanity. The typical Dragon Juicer has nightmares about dragons 1D4 times a week for the rest of his life. Sometimes the dreams are that the Juicer is a dragon himself (these can be good or bad), that body-chop-shops are after him and/or drain him of his blood, that he is hated and stalked by a dragon, and so on. After two years, roll on the following insanity table:

01-30 Paranoia and phobia: dragons are afraid that dragons are out to get him (perhaps for good reason).

31-60 Obsessed with fighting (and killing?) dragons and other supernatural beings.

61-90 Delusional. Thinks he or she *is* a dragon! Roll on the Juicer Psychosis table for the character's general disposition and outlook on life (roll again if either phobia is rolled).

91-00 Dragon vampire! The character drinks the untreated blood of slain dragons whenever he can. Strangely enough, this keeps him alive and prevents him from having to find an alchemist every six months to get more treated blood-based chemicals. It also adds another 1D6 months to his life. This may have something to do with the Juicer's large P.P.E. base and some latent magical property of the blood. Dragon vampires are usually quite mad (roll once on the neurosis table and once on the obsession table in the *Rifts® RPG*).

10. Dragon Vulnerabilities: Any weapon, magical attack or power that does extra damage to dragons will affect the Dragon Blood Drinker in the same fashion.

O.C.C. Skills:

- Radio: Basic (+5%)
- Wilderness Survival (+5%)
- Land Navigation (+5%)
- Piloting (one of choice; +10%)
- Demon and monster lore (+10%)
- Language (two of choice; +10%)
- W.P. Energy Rifle
- W.P. (two of choice)
- Hand to Hand: Expert
- Hand to Hand: Expert can be changed to Martial Arts (or Assassin, if evil) at the cost of one "other" skill.

O.C.C. Related Skills: Select five other skills. Plus select two additional skills at level three and one at levels six, nine, and twelve. All new skills start at level one proficiency.

- Communications: Any
- Domestic: Any
- Electrical: None

Espionage: Intelligence, escape artist, detect ambush and detect concealment only (+5%).

Mechanical: None

Medical: None

Military: Any

Physical: Any (+5% where applicable)

Pilot: Any

Pilot Related: Any

Rogue: Any (+5% to Prowl)

Science: Basic Math only.

Technical: Any

W.P.: Any

Wilderness: Any (+5%)

Secondary Skills: The character also gets to select four Secondary Skills from the Secondary Skills list in *Rifts® Ultimate Edition*, page 300. These are additional areas of knowledge that do not get the benefit of the bonuses listed in parentheses. All Secondary Skills start at the base skill level.

Standard Equipment: Techno-wizard bio-comp, bio-data and bio-feedback implants, drug harness and dragon blood supply (needs to be replenished twice a year), portable IRMS kit, set of fatigues, utility belt, backpack, sunglasses, canteen, compass, and personal items. Weapons and armor include a suit of Dragon Skin Combat Armor (100 M.D.C.), three weapons of choice and five E-Clips for each energy weapon.

Money: Dragon Juicers tend to make more money than regular Juicers. 6D6×100 in credits and another 1D6×1000 in black market items.

Cybernetics: None, ever.

Dragon Juicer Conversion Cost: 600,000 to one million credits! Very rare.

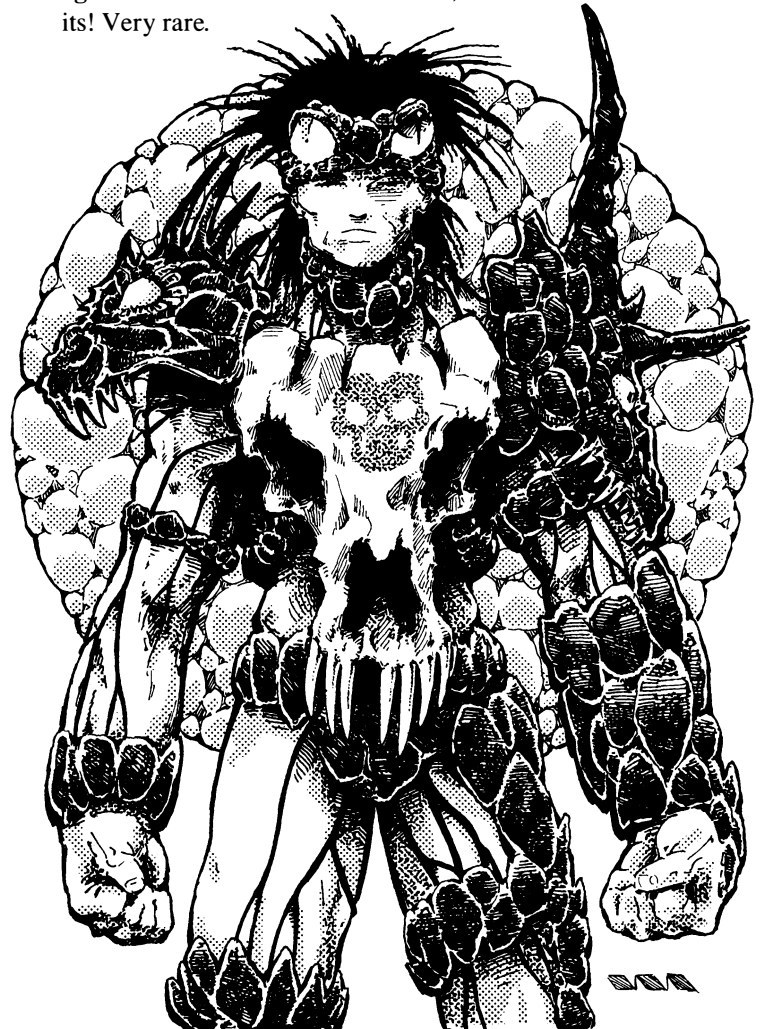

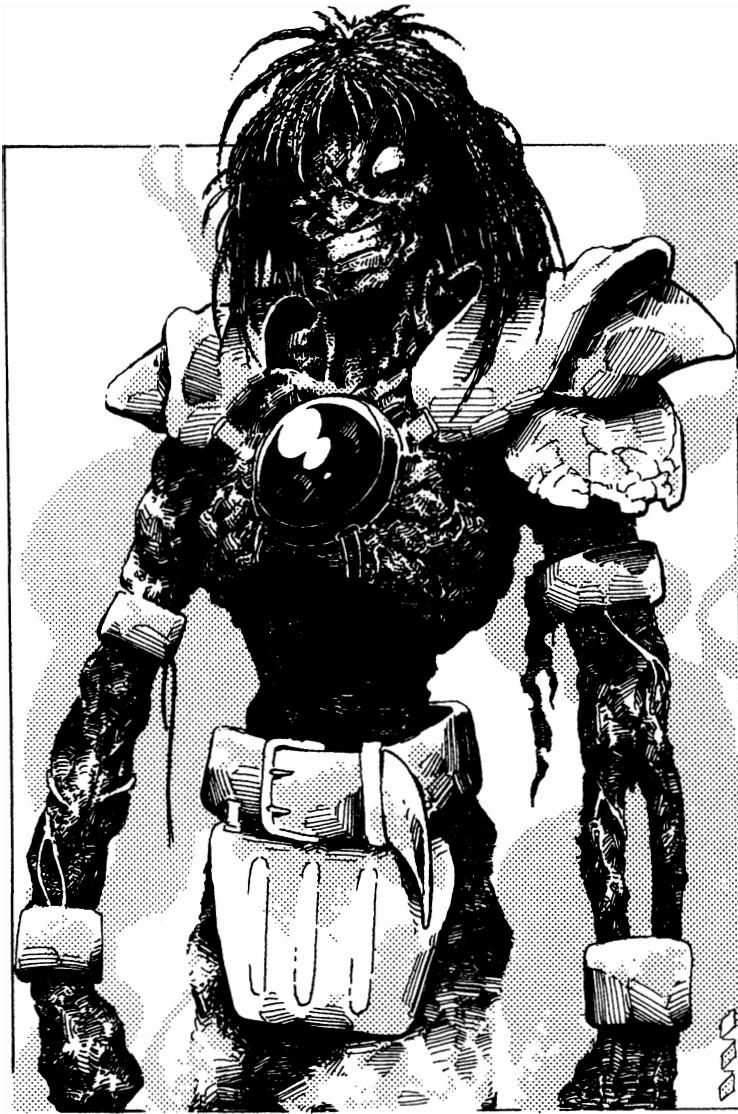

Murder-Wraith

Undead Juicer — NPC Villain

Dell kicked the door open and rolled into the room, gun ready. "You're dead, Max!" he shouted. Max had betrayed him, gone off to join some crazy cult, leaving Dell to fulfill a contract by himself. Not only had Dell failed in the mission, he'd made so many enemies that he was forced to leave Escanoba. It was time for some quick payback before skipping town.

Dell had tracked his former partner to this room in the worst section of town. He'd seen Max enter a few minutes before; the bastard looked drunk or hooked up on some new drug because his movements were jerky and uncoordinated, very strange for a Juicer. Dell was a Juicer himself, and he figured that if his ex-partner was under the influence, he'd be an easy kill.

Gun in hand, Dell looked around the room, his bio-comp enhanced senses absorbing every detail. The shades were drawn, shrouding the room in darkness. The first thing Dell noticed was the sickly-rich smell of death. The last time he had smelled something this foul was when he and Max kidnapped some rich merchant in Del Rio and left him in the trunk of their vehicle for three weeks under the merciless Texas sun. The utterly decomposed corpse they had found that day had this same rotten-to-mato stench.

Movement out of the corner of his eye! Dell spun expertly and fired a laser pulse-burst. Max, who had stepped out of the bathroom, was knocked backwards with three smoking holes in his chest; laser beams that went on to punch past the flimsy motel walls.

"What the..?" Dell said, blinking incredulously. In the flash of the laser lights, he had gotten a good look at his former friend. Max was ... rotting. He had been barely able to recognize Max's face; flaccid skin was blackened and sagging over fleshless cheeks, and his eyes were partially sunken in. The laser beams had cored through a near skeletal body. Dell had just shot a walking corpse!

"You're dead," Dell said. This time, the words were not a threat, but a tentative statement of fact.

"Yes, I am," Max replied, sitting up. He smiled, and two blackening teeth fell out of his mouth. "Long time no see, Dell."

Dell screamed and emptied the laser gun into Max. The corpse pushed on, oblivious to energies that could melt through tank armor. At the last second, Dell tried to run, but Max's reflexes were as good as always.

It didn't take long. The screams stopped after only a few minutes and blessed unconsciousness overcame Dell just after he saw Max's fingers descending towards his eyes. But it was enough time to find out there were much worse things than being dead.

Ever since the Juicer Process was developed in the 21st Century, many thinkers have wondered about the philosophical and spiritual implications of becoming a Juicer — to embrace death with little hope of escape. Since the Coming of the Rifts and magic, some of these thinkers have come to include men and woman who have long trafficked with forces beyond life and death. Many necromancers on Rifts Earth have watched these "walking dead" with growing fascination. A death cult from the Federation of Magic finally decided to try their hand in mixing their arts with technology. The result is the **Murder-Wraith**.

Murder-Wraiths are a form of undead, the combination of Juicer technology with the forbidden lore of the necromancer. Its creation is the ultimate consequence of magical corruption affecting both the body and soul of the subject. Unlike most types of undead, one does not become a Murder-Wraith unless one wishes to do so. Only the most insane and depraved cultists will undergo the foul rituals necessary to become one of these obscene creatures.

The mysterious cult known as the *Grim Reapers* holds the secret of Juicer Undeath. Those few Juicers who will do anything to escape death, or who become fascinated by it in all its forms, may seek out the Grim Reapers. Those who manage to join the group spend the last months or years of their lives serving the Horseman of Death (described in **Rifts® World Book Four: Africa**), murdering innocent people in the name of this dark god. A number of blood rituals prepare the Juicer's body for the transformations, even as his soul is thoroughly corrupted by his crimes. During the last year of the Juicer's human life, the chemicals of his bio-comp system are gradually replaced with noxious potions, products of dark alchemy. The last rite is conducted as the Juicer is about to die. The necromancers who lead these death-cults become mystically linked to the "candidates" and can sense the time when the Juicer's death is at hand. A final

ceremony, accompanied with more human sacrifice, is conducted as the candidate is in his death-throes. When it is over, an inhuman creature is unborn.

Undeath as a Murder-Wraith has its temptations. Those who emerge from the transformation are undying creatures who may exist for millennia. They are far more powerful than they were before, endowed with supernatural strength and endurance, while retaining their speed and reflexes as Juicers. The Undead Juicers are truly invulnerable to most forms of attack, harder to kill than vampires, and as powerful as demons. Only magic and the ancient bane of all undead, silver, will affect these beings; all other attacks, including the most powerful conventional explosives, will be useless.

The price for such power is the loss of every last shred of humanity. The Murder-Wraith must feed on the life force of others and consume their flesh to remain strong. Sunlight is painful (although not lethal) and most Undead Juicers only come out at night. Murder-Wraiths are controlled by their necromantic creators, and are bound to obey their every command. A few undead have managed to turn against their masters and slay them, but even then they remain evil monsters who must prey on all living things to survive.

Murder-Wraith, Undead Juicer

Note #1: Dragon Juicers, all other techno-wizard and bio-wizard variants, as well as Psycho-Stalkers, are the only Juicer variants that cannot be transformed into Murder-Wraiths. Their magical or psychic abilities somehow prevent the necromantic rituals that create the undead from taking effect.

Note #2: The Murder-Wraith is an NPC Villain. A creation of the most vile and extreme members of the Federation of Magic and other foul sorcerers. They are *not* recommended as a player character. Murder-Wraiths are men and women who voluntarily surrendered their humanity and committed horrible crimes to become what they are. For the most part, they are beyond redemption, as bad as a master vampire and other willing undead.

Requirements: Must have been an evil Juicer.

Alignment: Diabolic (90%) or miscreant (10%).

M.D.C.: By armor only, but is invulnerable to most conventional weapons (see Natural Abilities).

S.D.C./Hit Points: Murder-Wraiths have hit points equal to their former bodies' S.D.C. and hit points combined; most Juicers have hundreds of S.D.C. and 30+ hit points. Neither S.D.C. nor hit points increase by experience level after becoming an Undead; experience level is frozen from the moment the Juicer becomes the undead. In the case of Mega-Juicers, multiply their M.D.C. by two to get hit points.

Horror Factor: 14

P.P.E.: P.E. x2; also see Natural Abilities.

Average Life Span: Unknown; presumed to be eternal (or until destroyed).

R.C.C. Skills: As per the character's previous life, permanently frozen at those levels.

Alliances and Allies: Most Murder-Wraiths are in the service of a Necromancer and/or a Death Cult like the Grim Reapers. Through these masters, they often work with zombies, skeletons and other undead, as well as the occasional vampire, demon or supernatural predator.

Experience Level: The experience level of the creature is permanently frozen at the time of death.

Psionic Powers: None. If the Juicer had any psychic abilities before his death, they are lost.

Magic Powers: None.

Combat: As per hand to hand skill and Juicer bonuses.

Damage: As per supernatural P.S.

Bonuses: In addition to all Juicer bonuses, Murder-Wraiths are +2 to save versus magic and psionics, and +10 to save vs horror factor.

Weapons and Equipment: Usually basic Juicer stuff. The wraith can still wear armor (although many don't), and use energy weapons; vibro-blades remain a favorite.

Natural Abilities:

1. Juicer Powers: The Murder-Wraith retains all the Juicer powers, bonuses and abilities from his previous life. Their bio-comps become magically fused with their bodies, and the character does not need any new drugs or chemicals to maintain his abilities.

2. Supernatural Attributes: The character's strength and endurance become supernatural (if they weren't already). Use the attributes of the Juicer in question, and make the following changes: subtract 1D4 from I.Q., M.E. and M.A., and add 1D4+2 to P.S. Strength and endurance are considered to be supernatural. Physical Beauty is reduced by two-thirds! See the Titan O.C.C. for the *Supernatural P.S. and Damage Table*.

3. Invulnerability: With the exception of silver weapons and magic, non-magical weapons and attacks do no damage to Murder-Wraiths, including M.D. energy weapons and plasma bolts. Powerful explosions and M.D. attacks may knock the undead to the ground, but they suffer no damage.

4. Regeneration: Murder-Wraiths regenerate damage at the rate of 3D6 hit points at the end of each melee round! The only way to destroy the creature is to reduce it to negative 10 hit points, at which point the monster will crumble into dust and cease to exist.

5. Energy Vampirism and Cannibalism: The creatures need both P.P.E. energy and the flesh of sentient (thinking) beings such as humans and D-Bees to survive. P.P.E. is absorbed only when the Murder-Wraith is touching the victim and the victim is suffering pain. As a result, most Murder-Wraiths will torture their prey, or eat their flesh while the victim is still alive! Every round the victim is in pain, the monster will drain 1D6 P.P.E. points, up to the character's total available P.P.E. reserve. The P.P.E. drain is not permanent or lethal (unless the monster kills the victim to get the temporarily double release of life energy), but the process is so agonizing and horrible that survivors must make a save versus insanity or acquire a permanent derangement as a result of the encounter (01-33 Roll on the random insanity table in the **Rifts RPG**, 34-67 phobia/fear of Murder-Wraiths or all Undead, 68-00 obsession to destroy Murder-Wraiths or all Undead).

Murder-Wraiths need at least 10 P.P.E. and one pound of human (or D-Bee) flesh a week to survive. They can "store" up to 10 weeks of energy and flesh by consuming those amounts in the space of a day. If they miss either the flesh or the P.P.E., their own P.P.E. pool is reduced by one point for every day with-

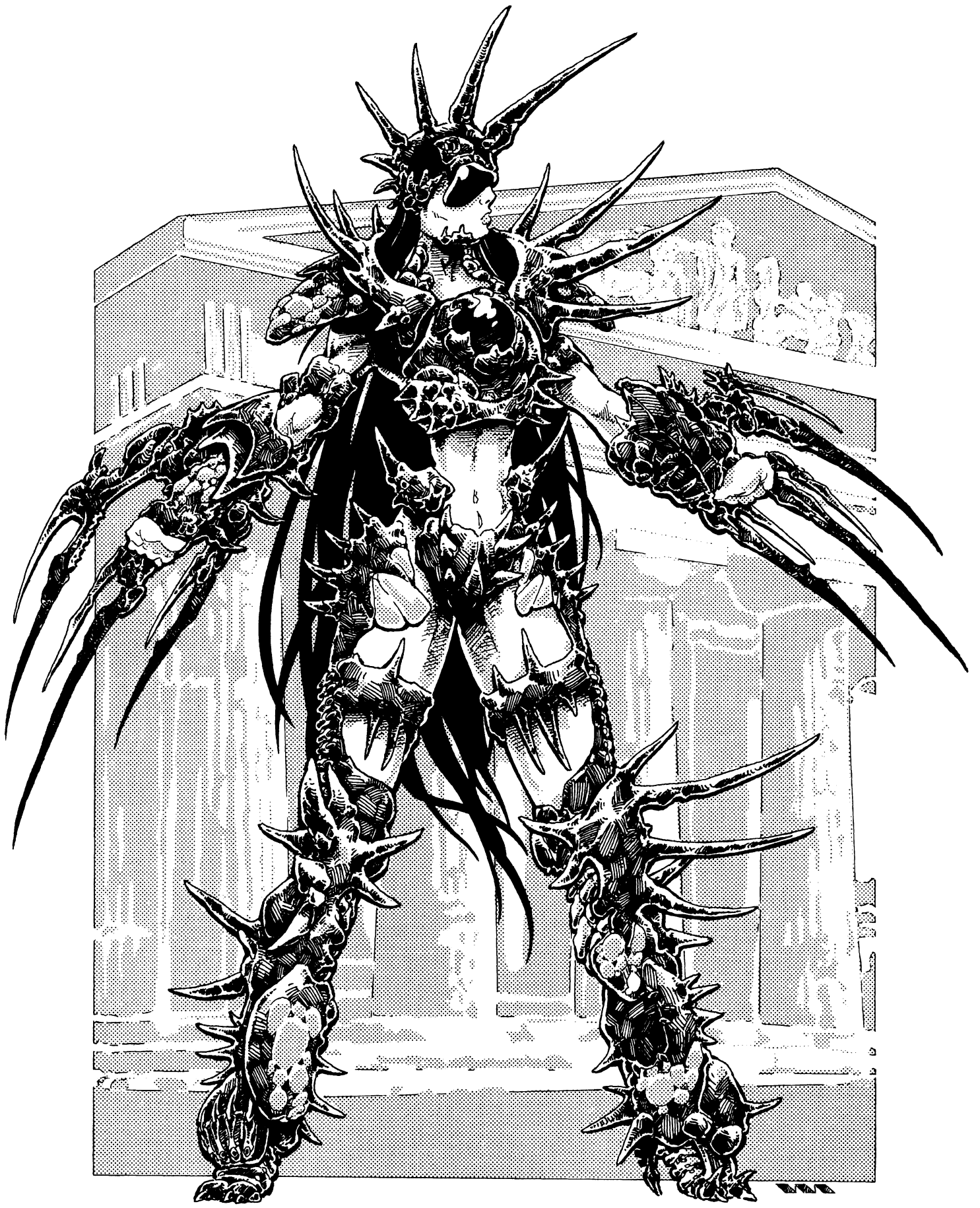

out sustenance. If their P.P.E. is exhausted through starvation, they dissolve in a pile of goo and cease to exist.

Vulnerabilities/Penalties:

1. Silver and Magical Weapons: Weapons made of or coated with silver do full damage. Mega-damage magic and magic weapons also do full damage. Hand to hand attacks from supernatural beings like vampires, dragons, etc., as well as magic weapons and magic spells, inflict hit point damage equivalent to their M.D. damage (i.e., one point of M.D. damage will inflict one hit point to the Murder-Wraith). S.D.C. magical attacks do half damage. Holy weapons and rune weapons that do extra damage to vampires do double damage (or the damage bonus against vampires/undead, whichever is higher).

2. Sunlight: Sunlight is painful and debilitating, but not lethal: The creature loses one melee attack per round and -2 points on all combat bonuses if forced to fight during the day, even if in the shade, indoors or during a cloudy, heavily overcast day. If forced to fight in sunlight, initiative is completely lost, and all melee attacks and bonuses are halved.

3. Bond of Servitude: Murder-Wraiths are under the control of the Necromancer who gave them unlife. To disobey or resist any order from its master, the creature must save versus insanity (add M.E. bonuses, if any). If the save is successful, the Murder-Wraith is free from mind control for one melee round (15 seconds). If its master is killed, the bond of servitude is broken and the monster is free to do as he pleases.

Splugorth Juicers

By C.J. Carella & Kevin Siembieda

For many years, Lord Splynncryth and his minions in Atlantis have been observing human developments with great interest. Although Atlantean technology is by and large superior to human equivalents, very few cultures in the Megaverse have had the incentive to develop new and more advanced technologies so quickly. Although still behind many pre-Rifts standards, some human developments rival anything produced during that age or by the Kittani, Splugorth and other cultures. The Juicer process is one of those developments. The Splugorth bio-wizards and technologists have been creating super-soldiers for thousands of years, primarily through magic tattoos, bio-wizardry and symbiotic unions. Recently, they have added the human's Juicer process to them (generally reserved for human and ogre slaves).

The "standard" Juicer conversion, as well as the Titan and Hyperion Juicers, are all available in Atlantis. The Mega-Juicer process is being researched and should be in Splugorth body-chop-shops by the end of 106 P.A. The Dragon Juicer process has been outlawed by decree, signed by Splynncryth himself! Dragons, especially those involved in the Pantheon of Dragonwright, are too highly respected and honored to be defiled in such a manner.

The "standard" Juicer process is designed to work only on humans. Recent variants have extended that augmentation to some humanoids. By trial and error, a few Juicer processing centers on Earth (including Kingsdale) have managed to develop

drugs that will work on the biology of a few nonhuman races, including Wolfen, Elves, Dwarves, Psi-Stalkers and Ogres (the latter two are nearly identical to humans). These treatments often cost 50% to 200% times more, due to the adjustments and different chemicals necessary, or because of the scarcity of such specialists (a matter of supply and demand). For the most part, supernatural, mega-damage beings and creatures of magic cannot make use of the Juicer process. However, the bio-wizards have combined their knowledge of symbiotes and Juicer augmentation to create their own super-juicer that can work on a wider range of nonhumans.

The Atlantean Juicer process combines high technology (much of it directly copied from human systems) with bio-wizardry. This Juicer is officially known as the *Bio-Wizard Juicer*, but is more commonly known as the **Maxi-Killer**. Instead of an actual bio-comp and harness, the Splugorth have developed a Juicer Symbiote that attaches itself to the flesh of the recipient, monitors the creature's biology, and then manipulates it to increase his strength, speed and reflexes.

Maxi-Killer — Bio-Wizard Juicer Inspired by Designs by Vince Martin

The symbiote used in the Bio-Wizard Juicer process is known as the Maxi-Inducer, is attached to the patient's back, and resembles the *chest amalgamate* minus a mouth or any sensory organs. Its "roots" grow inside the human's body as well as outside, wrapping its tendrils around the wearer's limbs and invading his internal organs. The symbiote both enhances and regulates the metabolism of its host, raising his attributes to supernatural levels. The human body is not meant to endure this heightened state for long, however, and death is as inevitable as with any other Juicer treatment.

Most Maxi-Killers are humans, ogres or elves raised in slavery (born to it or captured at an early age) and trained since early childhood in the arts of combat. Only the toughest and most ruthless among them are chosen for this enhancement, or similar "elite" gifts, like the Tattooed Maxi-Man. At age 16 or 17, the loyal slave is united with the Maxi-Inducer Symbiote, becoming a powerful warrior in the service of the Splugorth.

Maxi-Killers are often teamed up with Tattooed Men, Maxi-Men, Power Lords and other slave warriors and minions of the Splugorth. They have also become yet another popular attraction in the bloody arenas of Atlantis. Trusted servants are "rewarded" with as many as two additional bio-wizard implants or limbs (see **Rifts® World Book Two: Atlantis**). Kittani and Kydian (Overlords) volunteers can also become a Maxi-Killer and automatically get three bio-wizard additions.

Maxi-Killers are also being exported to other parts of the Megaverse. A few have made it to *Phase World* and other transdimensional markets, usually as slaves of a Splugorth High Lord or other powerful supernatural being, or as a gladiator.

A few slaves have managed to escape their masters, but are never able to lead a normal life, covered as they are by the inhuman symbiotes. Removing the symbiote is impossible without instantly killing the patient.

Bonuses & Benefits of Bio-Wizard Conversion:

1. Super Endurance: Becomes a Mega-Damage creature with $2D4 \times 10 + 60$ M.D.C. and an additional 10 M.D.C. per level of experience (also see #7, grafted armor). Also +1D4 to P.E. attribute, which is considered supernatural.

2. Supernatural Strength: Add +8 to P.S. attribute; minimum P.S. is 21 (supernatural).

3. Enhanced Speed: Add $1D6 \times 10$ to Spd attribute.

4. Super Reflexes and Reaction Time: +3 on initiative, +2 to Perception Rolls, +3 to roll with punch, fall and impact, and gets an automatic parry or dodge on all attacks, even those from behind and by surprise. +1 to Auto-Dodge at levels 1, 3, 6, 9, 12 and 15. Add one extra attack per melee round, and $1D4 + 1$ to P.P. attribute (no minimum).

5. Saving Throw Bonuses: +4 to save vs magic, +2 to save vs psionic attacks and possession, +4 to save vs poison and disease, and +4 to save vs Horror Factor.

6. Enhanced Healing: The Juicer regenerates $1D4 \times 10$ M.D.C. per hour, plus can regrow severed limbs and lost organs. +30% to save versus coma/death. Virtually impervious to pain.

7. Grafted Armor: Another symbiote linked to the Maxi-Inducer grows over the character like a living shell, providing him with grafted armor. This armor is alive and has 120 M.D.C. and regenerates damage at the rate of $1D4 \times 10$ M.D.C. per hour!

If the M.D.C. of the symbiote is reduced to zero, it disappears, its "roots" retreating into the body of the Maxi-Killer. Until it can regenerate 50 M.D.C., the Juicer cannot regenerate damage and suffers $3D6$ M.D. per hour as the symbiote feeds on his body to restore itself; every point the wearer suffers goes into the Maxi-Inducer symbiote. The severely injured symbiote's normal regenerative powers don't work until a minimum of 50 M.D.C. is restored, at which point both symbiote and its host body can regenerate normally. Armor reduced to zero will grow back completely 10 hours after hitting the 50 M.D.C. mark. **Note:** If the Maxi-Killer dies before the creature gets its 50 points, they both die!

The armor can also grow one forearm blade for each level of the Juicer's experience, up to a maximum of three per arm. Each sword-like blade is an M.D.C. structure that inflicts $2D6$ M.D. A dozen or so smaller protective spines typically cover the body armor and adds to its alien appearance.

8. Other Bio-Wizard Implants: If the character shows great loyalty and combat prowess (or is created specifically for a life in the arena), one or two additional Bio-Wizard implants or appendages may be granted (rarely before third level). Of course, player characters who have escaped Atlantis will not get any such "rewards."

9. Penalties: In addition to the usual anxieties, insomnia, restlessness, impatience, etc., of all Juicers, death remains inevitable and untimely. Recipients of the Bio-Wizard Juicer conversion face burning out after a number of years. The shortened life span of these creatures is figured by taking their average life span, dividing it by 20, and adding $4D6$ months to that number; that is how long the new "Juicer" has to live. Example: Splugorth High Lords (see **Rifts® World Book Two: Atlantis**) have a life span of 1200 years; an enhanced High Lord would live 60 years plus $4D6$ months after undergoing the process: a long time for humans, but a fraction of the normal lifetime for such a creature. The average human or Ogre lasts four years + $4D6$ months, True Atlanteans 25 years + $4D6$ months, and so on.

10. Possible Insanity: Maxi-Killers are not as traumatized as other Splugorth slaves, having been raised and conditioned to accept their lot in life. However, a significant percentage of these Bio-Juicers have some mental problems. Roll once on the following insanity table. Furthermore, roll every time a new bio-wizard enhancement is acquired.

Maxi-Killer Insanity Table:

01-60 No insanity

61-75 Obsessed with fighting and competition: loves it.

76-78 Obsession: Fighting; hates it and tries to avoid it.

79-84 Obsession: Danger — loves it; takes needless risks.

85-90 Tattoos: Not exactly a phobia but a slight fear and paranoia about them and those who have them — cannot stand to get any and distrust those who have even one; very suspicious of Tattooed Men.

91-95 Phobia: Splugorth

96-00 Phobia: High Lords

11. Racial Limitations: Among the species that can benefit from this augmentation are humans, True Atlanteans (but not Tattooed Men; must have less than six magic tattoos), Kittani, Kydians, Wolfen, Elves, Dwarves, Simvan, Hawrk-duhk, Hawrk-ka, Hawrk-ohl, and a variety of human-like D-Bees. Splugorth High Lords (not Conservators, because they have already been augmented via bio-wizardry) can also receive this treatment, but rarely do so. Shapeshifters, major or master psychics, practitioners of magic, creatures of magic and supernatural beings cannot undergo this treatment.

The Splugorth Bio-Wizard Juicer

Attribute Requirements: None.

O.C.C. Skills:

Radio: Basic (+5%)

Language: Dragonese/Elf and American (98%)

Intelligence (+10%)

Tracking (+10%)

Land Navigation (+10%)

Wilderness Survival (+10%)

Climbing (+10%)

Swimming (+5%)

W.P. Energy Rifle

W.P. Sword

W.P. (two weapons of choice)

Hand to Hand: Martial Arts or Assassin

O.C.C. Related Skills: Select four other skills, plus select one additional skill at levels four, eight, and twelve. All new skills start at level one proficiency.

Communications: Any (+5%)

Domestic: Any

Electrical: Basic Electronics only.

Espionage: Any (+5%)

Mechanical: Automotive only.

Medical: First Aid only.

Military: Any (+10%)

Physical: Any (+5%)

Pilot: Any except robot and power armor skills (+5%)

Pilot Related: Any

Rogue: Any (+2%)

Science: Math skills only (+10%)

Technical: Any, except computer (+5%).

W.P.: Any

Wilderness: Any (+5%)

Secondary Skills: The character also gets to select six Secondary Skills from the Secondary Skills list in *Rifts® Ultimate Edition*, page 300. These are additional areas of knowledge that do not get the benefit of the bonuses listed in parentheses. All Secondary Skills start at the base skill level.

Standard Equipment: Typically items are provided by the slave's owner on the basis of need. This includes access to

weapons, ammunition, field equipment, vehicle, money, and so on.

Money: None! Slaves are provided with everything they need. Some loyal slaves are given a monthly allowance at their master's discretion.

Cybernetics: None, ever.

Note: Available only to slaves and minions of the Splugorth.

Juicer-Related O.C.C.s

Juicers can pursue other areas of training and knowledge, but always as a Man of Arms. The O.C.C.s suggested on the following pages are really just some different areas of combat training that a Juicer of any variety might pursue. Each requires the character to be a Juicer. All Juicer bonuses and penalties remain the same, only the training/skill programs and some bonuses vary, as described in each entry. Use the experience table for the "standard" Juicer O.C.C. unless one of the new Juicer variants.

The Gambler and Juicer Wannabe are *not* Juicers, but characters who are often associated with them or are found at places where Juicers congregate.

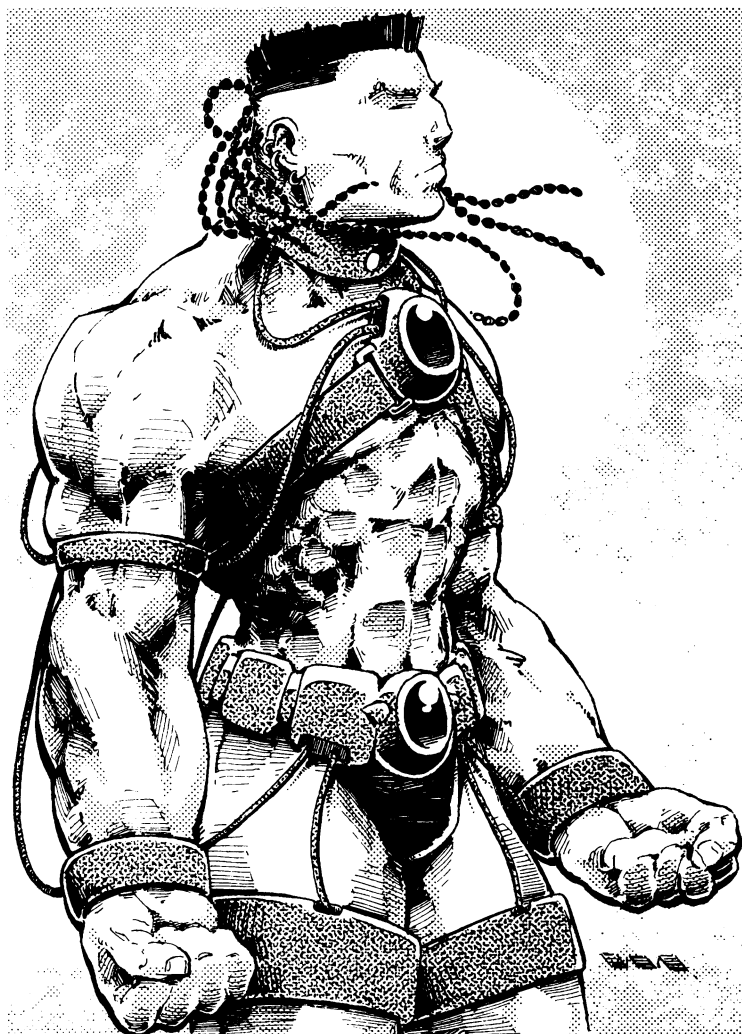

Juicer Gladiator O.C.C.

Not all Juicers use their abilities as warriors or assassins. A few, especially in areas where combat sports are popular, become sports stars, professionals who fight and die in hidden arenas for the entertainment of others, much like the gladiators of old. Juicer Gladiators are superbly trained athletes, but they are less experienced in actual combat than "regular" Juicers. Sports Juicers do not always stay in the sports profession or hang-around the arenas where they ply their trade. Some leave the cheering crowds and blood and glory behind and try their hand at other Juicer jobs. In those cases, their former fame can be a hindrance as well as a boon. Some people will be intimidated by their notoriety, while others will see it as a challenge. It is also difficult to remain anonymous when one's face has been broadcast on televisions and seen on video-tapes across the country.

Gladiators are expertly trained in hand to hand combat, athletics and acrobatics. They often lack a great deal of knowledge about on living in the wilderness, modern weapons, the Coalition States, and similar areas. This inexperience can often lead to their demise, due to overconfidence and foolish mistakes.

Juicer Gladiator O.C.C.

Attribute Requirements: None.

O.C.C. Abilities and Bonuses: Same bonuses as their Juicer type, with skills described below.

Sport Specialty: The character can select one sport in which he specializes. When practicing that sport, the Juicer is at +1 to strike, parry and dodge, and +10% to skill rolls specifically related to it; this is in addition to other O.C.C. or skill bonuses. These bonuses apply only to the sport in question, and will not help the character in the "real world" or when participating in another sport. The most common Juicer sports are Deadball, Juicer Football and Murderthon, as well as boxing, wrestling, swimming, fencing and archery.

O.C.C. Skills:

- Acrobatics (+5%)
- Athletics (General)
- Body Building and Weight Lifting
- Climbing (+10%)
- Gymnastics
- Running
- Two Languages of Choice (+10%)
- Performance (+10%)
- W.P. Ancient (two of choice) Hand to Hand: Martial Arts

O.C.C. Related Skills: Select six other skills. Plus select one additional skill at levels three, six, eight, eleven and thirteen.

All new skills start at level one proficiency.

Communications: Any

Domestic: Any (+5%)

Electrical: None.

Espionage: None.

Mechanical: Automotive only.

Medical: First aid only.

Military: None.

Physical: Any (+5%)

Pilot: Any (+5%), except robots and military vehicles.

Pilot Related: Any

Rogue: Any

Science: Math skills only.

Technical: Any (+5%)

W.P.: Any

Wilderness: Any

Secondary Skills: The character also gets to select five Secondary Skills from the Secondary Skills list in **Rifts® Ultimate Edition**, page 300. These are additional areas of knowledge that do not get the benefit of the bonuses listed in parentheses. All Secondary Skills start at the base skill level.

Money Bonus: 1D4×1000 credits.



Juicer Assassin O.C.C.

Not all Juicers are front-line warriors who dash madly into battle trusting on their enhanced strength and reflexes. A few specialize in the more subtle arts of espionage and assassination. The “Juicer Assassin” series of rifles was developed with this type of enhanced killer in mind. Most of these expert killers train extensively before undergoing the Juicer conversion. In fact, there is a growing number of professional assassins who see the entire conversion process as a business: train as an assassin, become a Juicer, make millions of credits for two years, and then undergo detox. An estimated 45% become addicted and live out their lives as chemically-enhanced spies and assassins, but enough manage to “kick the habit” and become rich doing it to inspire others to follow in their footsteps, even if the odds are against them.

Juicer Assassins are experts in the arts of moving silently, camouflage, evasion and guerrilla tactics. They are as likely to kill with a precise shot or stab in the dark as they are to go charging at an enemy with all guns blazing. They also tend to be more cold-blooded and less impulsive than their “gung-ho” brethren. Many of them pattern themselves after such mythological figures as James Bond or Julian Amici, dress in expensive clothes, and act in a refined and calculated manner.

Juicer Assassin O.C.C.

Attribute Requirements: None.

O.C.C. Abilities and Bonuses: Same bonuses as their Juicer type, with skills described below.

O.C.C. Skills:

- Radio: Basic (+10%)
- Language of choice (+10%)
- Detect Ambush (+10%)
- Detect Concealment (+10%)
- Demolitions (+10%)
- Prowl (+15%)
- Climbing (+10%)
- Streetwise (+10%)
- Sniper
- W.P. Energy Rifle
- W.P. Sharpshooting (Energy Rifle)
- W.P. Two of choice
- Hand to Hand: Assassin

O.C.C. Related Skills: Select six other skills. Plus select two additional skills at level three and one at levels six, nine, twelve and fifteen. All new skills start at level one proficiency.

- Communications: Any (+10%)
- Domestic: Any (+5%)
- Electrical: Basic only.
- Espionage: Any (+5%)
- Mechanical: Automotive only.
- Medical: First Aid only.
- Military: Any (+5%)
- Physical: Any (+5%)
- Pilot: Any (+5%)
- Pilot Related: Any
- Rogue: Any (+10%)
- Science: Math skills only.
- Technical: Any (+10%)
- W.P.: Any
- Wilderness: Any

Secondary Skills: The character also gets to select five Secondary Skills from the Secondary Skills list in **Rifts® Ultimate Edition**, page 300. These are additional areas of knowledge that do not get the benefit of the bonuses listed in parentheses. All Secondary Skills start at the base skill level.

Money Bonus: 1D6×1000 credits.

Juicer Scout O.C.C.

Not all Juicers are trained solely in combat. Some are taught the secrets of hunting, woodcraft, guerrilla warfare, camouflage and ambushes. The Juicer Scout combines some of the traits of a Wilderness Scout with the powers of a Juicer. These scouts work as special operation soldiers, messengers and in other occupations that take them away from the cities of Rifts Earth and into the dangerous wastelands surrounding them.

Juicer Scout O.C.C.

Attribute Requirements: None.

O.C.C. Abilities and Bonuses: Standard Juicer abilities, skills as below. Only normal Juicers, Mega-Juicers and Dragon Juicers can learn this skill program.

O.C.C. Skills:

- Radio: Basic (+10%)
- Language of choice (+10%)

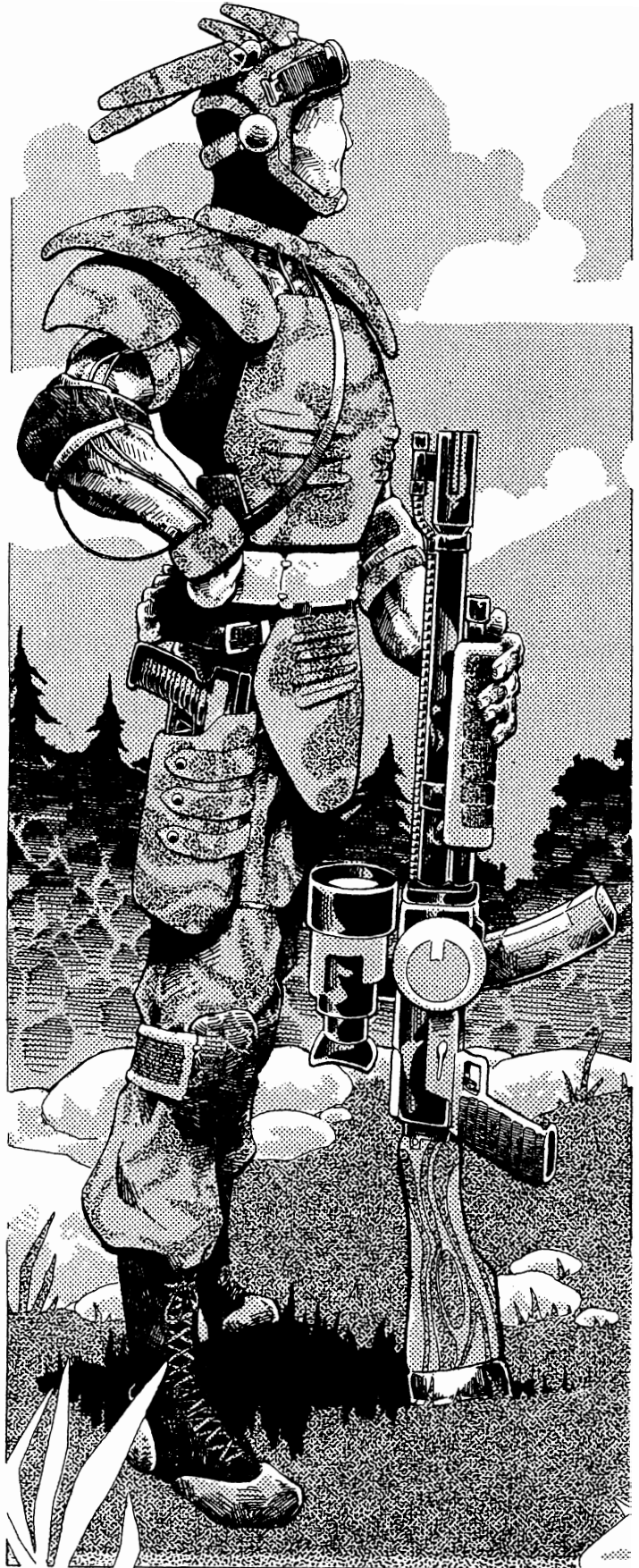

- Detect Ambush (+10%)
- Detect Concealment (+10%)
- Land Navigation (+10%)
- Wilderness Survival (+15%)

Prowl (+10%)
Track Humanoids (+10%)
Track Animals (+15%)
W.P. Energy Rifle
W.P. Two of choice.

Hand to Hand: Expert

Hand to Hand: Expert can be changed to Martial Arts (or assassin, if evil) for the cost of one "other" skill.

O.C.C. Related Skills: Select six other skills. Plus select two additional skills at level three and one at levels six, nine, twelve and fifteen. All new skills start at level one proficiency.

Communications: Any (+5%)

Domestic: Any (+5%)

Electrical: Basic only.

Espionage: Intelligence and Escape Artist only.

Mechanical: Automotive only.

Medical: First Aid only (+5%).

Military: Any (+5%)

Physical: Any

Pilot: Any (+5%)

Pilot Related: Any

Rogue: Any (+2%)

Science: Math skills only.

Technical: Any (+10%)

W.P.: Any

Wilderness: Any (+10%)

Secondary Skills: The character also gets to select five Secondary Skills from the Secondary Skills list in **Rifts® Ultimate Edition**, page 300. These are additional areas of knowledge that do not get the benefit of the bonuses listed in parentheses. All Secondary Skills start at the base skill level.

Money Bonus: 2D6×10 credits.

The Gambler O.C.C.

The Gambler O.C.C. is related to Juicer occupations, trades and Wannabes because these characters are often involved in Juicer sports and like to hang around their meal-tickets and heroes. The larger city-states of North America have grown enough to develop their own criminal and semi-criminal classes, including professional gamblers who spend most of their lives risking everything on the toss of the dice or the outcome of a game. Gamblers on Rifts Earth are a sub-set the City Rat and Vagabond O.C.C.s, a bit more experienced and sophisticated, but hampered by their fascination with games of chance and taking risks.

Most gamblers are adventurers and opportunists who spend much of their time in the shadowy underworld of large cities. They can be found in the 'Burbs enticing passers by to a shell game or dice, or in Downside, participating in a poker game where hundreds of thousands of credits are won and lost on the strength of a single hand of cards. To make money between games, most gamblers are willing to do any number of odd jobs, although they tend to shirk hard labor and "common work," preferring instead to do more glamorous and shady things. Some gamblers are also accomplished thieves, con-men and small-time

criminals. Those who operate in Coalition cities have little love for the government and often spend much of their time finding ways to cheat and steal from the CS and their Dead Boy lackeys.

Due to their living habits, gamblers spend a great deal of time mixing in with the underworld. As a result they are extremely knowledgeable about local crime figures and the authorities that persecute them. Furthermore, gamblers will establish a network of contacts in any city where they stay for more than six months; these contacts will be useful sources of information, warnings, and even help.

Gamblers are knowledgeable in a number of games of chance—as well as of ways to cheat at them. While they may or may not cheat, they will certainly be able to spot those who try to do so, and an angry gambler can be a dangerous enemy, especially if he has a hold-out weapon on his person. Sometimes, a gambler and a Juicer become partners, with the gambler frequently acting as the *manager* and troubleshooter for Juicer Gladiators and sports figures. A good partnership will multiply his and the Juicer's money by making smart bets (well, most of the time), offering "suckers" bets and odds on "his man" (which he knows he should win), collecting winnings, making sure people pay their debts on time and that nobody dares to try to cheat. These characters may also be able to help set up the bets in a street fight and even promote illegal competitions. Gambler player characters are particularly appropriate in a city-oriented game, although the character should be able to take care of himself even if he leaves the city behind.

Gambler O.C.C.

Attribute Requirements: I.Q. and M.A. 10 or higher; a high P.P. is also helpful but not a requirement.

O.C.C. Abilities and Bonuses:

1. Fast-Talk: Gamblers are good at making up stories on the spot, from tall tales to impress new acquaintances or excuses that get him out of a tough spot. Players should role-play this to the hilt. The better or more convincing the portrayal the more likely it is to be believed. Also take into consideration the character's M.A. and P.B. However, blatant lies or stories with obvious holes and inconsistencies in them won't fool anybody regardless of how charming the gambler may be.

2. Street Contacts: Most gamblers establish a network of contacts with other gamblers, sports figures, city rats, street urchins, small-time criminals, prostitutes, beggars and even local policemen and law-enforcers. When creating the character, the player (with the G.M.'s approval) can have up to one contact for every three points of Mental Affinity he has, rounded down (i.e., a gambler with M.A. 10 would have 3 Street Contacts, a gambler with M.A. 16 can have up to five, and so on). The player can tell the G.M. who/what these contacts are, how friendly they are, etc. Very powerful or influential Street Contacts, like a local crime boss, police chief, mayor, etc., are not likely or, if allowed, should count as two or more contacts.

Whenever the character needs to reach a contact, make a roll. **Base Chance of Success:** 35% plus 5% per level of experience, plus I.Q. bonuses. On a success, the character meets his contact. Whether or not the Non-Player Character has any information or can offer any help is up to the G.M. and the game history between the characters. As a rule, rumors, gossip and information about known street figures should be easy to find, while dark secrets and unusual bits of knowledge are not. Also, a contact can

spontaneously approach the character to warn him/her of any danger or problem that might involve him. **Note to G.M.s:** This can be a very useful role-playing and storytelling tool. A well-developed contact could be a great regular NPC for a street campaign.

O.C.C. Skills:

Basic Math (+20%)
Gambling (+20%)
Gambling: Dirty Tricks (+20%)
Palming (+10%)
Two Languages of Choice (+15%)
Literacy (+10%)
Streetwise (+14%)
Pilot: Motorcycle (+10%)
W.P. Knife
W.P. One of choice.
Hand to Hand: Basic
Hand to Hand: Basic can be changed to Expert at the cost of one "other" skill or to Martial Arts (or Assassin if any evil alignment) at the cost of two "other" skills.

O.C.C. Related Skills: Select 10 other skills, but at least two must be from rogue skills. Plus select two skills at level three, two at level six, and one at levels eight, ten, twelve and fourteen. All new skills start at level one proficiency.

Communications: Any (+5%)
Domestic: Any (+5%)
Electrical: Basic only.
Espionage: None
Mechanical: Automotive only.
Medical: First Aid only.
Military: None
Physical: Any
Pilot: Any (+5%)
Pilot Related: Any
Rogue: Any (+4%)
Science: Any
Technical: Any (+10%)
W.P.: Any
Wilderness: None

Secondary Skills: The character also gets to select six Secondary Skills from the Secondary Skills list in *Rifts® Ultimate Edition*, page 300. These are additional areas of knowledge that do not get the benefit of the bonuses listed in parentheses. All Secondary Skills start at the base skill level.

Standard Equipment: Two decks of cards (one used and probably marked; the other brand new), dice, sunglasses, hand computer, switchblade, one energy pistol (may or may not be a hold-out weapon), 1D4 extra E-Clips for it, one non-energy weapon of choice, a suit of light M.D.C. armor, four sets of clothes, a set of good shoes, traveling or work boots, a cloak or overcoat and a money belt.

Money: Starts with 6D6×10 in credit and 1D4×100 credits in salable black market items.

Cybernetics: Starts with none; may get some enhancements later, when/if he can afford them.



Wannabe Juicer O.C.C.

"You ready, fresh meat?"

"Ye..." I start to say when I get hit from behind. Hard. I stagger to my knees and somebody kicks me in the face. Something goes crunch inside my head, and I taste blood, lots of it. They work me over, boots and fists mostly, but along the way somebody decided a two-by-four is better. After a while, I stop feeling anything.

Cold water splashes my face. I blink and open one eye — the other is swollen shut. Through the red haze that seems to fill the good eye I see them standing over me.

"Wake up, fresh meat. You took your medicine like a man. I guess you're in."

I smile bloodily. I'm in the gang. Any day now, I'll be a Juicer, and nobody will ever mess with me again.

Somebody tosses me a leather jacket with the gang's colors on it. Despite the pain in my ribs, I put it on while they cheer me.

They offer to throw me a party, but I decline. Gotta go to a body fixer first.

For the most part, Wannabe Juicers are young men and women (age 13-20) who, for some reason or another, idolize the Juicer life style. Many of them want to be Juicers one day, or at least be as tough and feared as them. Wannabe gangs are a problem in several Coalition cities, as well as such places as Ishpeming, Los Alamo and Kingsdale. Some of these gangs are made up of hardened criminals involved in drug-dealing, cyber-snatching, protection rackets and other illegal activities. Others are formed to protect their neighborhood against other gangs (Wannabe or otherwise).

Among the things that distinguish Juicer Wannabes from other city rats is their reliance on designer drugs to (at least temporarily) get some of the power of their role models. At least 80% of all Wannabes will use one or more of these designer drugs, at least when they are about to get into a fight or other dangerous situation.

Besides the use of chemical augmentation, many Wannabes also try to emulate the daredevil attitudes of real Juicers. Thrill-seeking kids will dare each other into all kinds of dangers, from picking a fight with a Dog Boy patrol, to trying to jump from the rooftop of one building to the next, to “playing chicken” with incoming traffic. Many gang members also do their best to toughen themselves through exercise, martial arts, and weapons training; they realize that just relying on drugs is stupid and counter-productive. Besides, according to many rumors, people who over-indulge in drugs may not be able to accept the Juicer enhancement, or may suffer more side effects or live shorter lives (all true).

Some former Wannabes leave the slums where they lived out their childhoods and explore the wider world beyond, becoming adventurers, rogues and travelers. A few do actually grow up and abandon their fascination with Juicers and the use of drugs altogether. Many (35%) eventually get their wish and become Juicers by hook or by crook. Their knowledge about the Juicer life often allows them to make an easy transition from their former life into their new existence as enhanced super-soldiers. However, 35% die violently before their 21st birthdays.

Some Well-Known Wannabe Gangs

The Deadheads: The colors of this gang are red skull masks; some Deadheads actually steal Dead Boy’s armor (or at least the helmet) and paint it red. Their “tag” is a skull over two crossed daggers. There are Deadhead chapters in the **Chi-Town ‘Burbs** (heavily persecuted; seven members out of ten survive — there are hundreds of these misanthropes), **New Chillicothe** (a medium-sized gang with 1D4×10+50 members), **Fort El Dorado** (3D6×10+20 members) and **Ishpeming** (2D4×10+10 members). The Deadheads are thrill-seekers and rarely rob or molest people, except when the gang is looking for a fight. Sometimes the gang tries to sell its services as if they were mercenaries; their goal is for members to make enough money to undergo the Juicer treatment. Every year, 2D6 members of each gang “make it to the finals,” the gang’s term for becoming a Juicer; some continue to use the gang’s colors.

Drugs are only used when absolutely necessary; members are expected to work out, and every few weeks they compete against each other in all kinds of strenuous and dangerous activities.

The Juicer Disciples: Gang colors are black and white, with the letter JD in a white design as their main “tag.” This is a criminal gang involved in drug-dealing, body-snatching, kidnapping and murder-for-hire. They are big in **Ishpeming** and the **Manistique** Empire, especially the cities of *Escanoba* and *Manistique*. The authorities are trying very hard to destroy the gang, and to arrest or kill its leaders, but so far, they have not been successful.

The typical gang size is 2D4×10+10 members. Drug use is widespread among its members and the JDs often fight it out with other gangs of City Rats and Wannabes in ferocious shootouts that leave dozens of people dead. The Juicer Disciples have

contacts with the Black Market and often act as enforcers, bodyguards and couriers for that underworld organization. Very few members live long enough to become Juicers (1D4 per gang per year); many of those continue their criminal activities, sometimes within the gang or the Black Market, and sometimes on their own.

The Vigilantes: This gang is concerned mainly with defending its turf in the city of Kingsdale from criminal gangs, supernatural predators, and the like. About 40% of its members are Juicer Wannabes, and every year, 1D6+4 of its 1D6×10+40 members become Juicers, either by saving enough money (5%) or by becoming mercenaries in *Donner’s Division* (95%).

Gang colors are blue and red, and their symbol is a shield. Drug use is limited, with as many as 50% of the gang never using any drugs at all; 40% under emergencies and extreme circumstances, and 10% habitual users. Physical skills, combat training (50% of the gang has Hand to Hand: Martial Arts) and motorcycle driving are constantly practiced in or around the city. The Kingsdale authorities are very tolerant of the group, because its members rarely get in trouble and sometimes help the police and armed forces fight bandits, monsters and other threats.

Juicer Wannabe O.C.C.

Note: This character is best suited as a Non-Player Character (NPC) or villain/criminal, rather than a player character.

Alignment: Any, but most Wannabes are anarchist or miscreant.

Attribute Requirements: P.S., P.P. and P.E. 10 or higher.

O.C.C. Abilities and Bonuses:

1. Enhancing Drugs: All Wannabes have *access* to drugs. If appropriate, the character can start with 1D4 doses from any three of the designer drugs described at the end of this section. Players who don’t want their characters to use drugs get an additional 2D6×100 credits instead. Most Wannabes rationalize their use of designer drugs as only when they “need them” (such as engaging in combat). While a huge majority tend to use drugs regularly (and at least 30% become addicted, ironically never becoming Juicers), a good percentage (50%) avoid becoming addicted; statistics vary dramatically from gang to gang.

If the character becomes addicted to any designer drug, his becoming a Juicer is extremely dangerous. The chances of the operation being a failure are increased by 20% per each drug the character is addicted to! In other words, reduce the chance of success by 20% per drug addiction. So, for example, if a character was addicted to two designer drugs and submits to the Juicer process, the chances of success would be reduced by 40%! The best body-chop-shops (base chance of success 98%) would only have a 58% chance of performing the operations without complications (brain damage, epileptic seizure, shock, stroke, heart attack) and it goes downhill from there! Most reputable facilities will not accept a patient who is obviously an addict, regardless of the money offered (or threats made) to them.

2. Special: Becoming a Juicer: Wannabes are the only O.C.C. that can become Juicers without freezing their skills/previous O.C.C.; in effect, a 4th level Juicer Wannabe who manages to save enough money to undergo the Juicer augmentation will become a 4th level Juicer! Doing so means the character

will use the Juicer experience table from then on (which means they will progress more slowly in experience, but often start higher as a Juicer).

Note that they do not get any of the O.C.C. skills and bonuses of the Juicer character class; instead, keep using the skills of the Wannabe O.C.C., improving normally per additional level. New skills gained at higher levels can be chosen from either O.C.C.; when selecting skills at higher levels, use the most favorable bonuses and selections.

Example: The character Joey Blood started out play as a first level Juicer Wannabe. After several adventures (during which he rose to the fifth level of experience), Joey earned enough money to undergo the Juicer conversion. All his skills remain the same, and Joey does *not* get any new skills; he does, however, get all the physical bonuses of Juicer conversion and starts his Juicer as a 5th level character. A few game months later, Joey rises to the sixth level, using the *Juicer O.C.C.* experience point table. At sixth level, Joey gets to select a new skill. Before, when he was a Wannabe, he could not select any skills from the Espionage category, but now he's a Juicer, with access to military knowledge and training he did not have before, so he can now select escape artist (or any one available espionage skill), which starts at first level, but gets the Juicer's +5% bonus.

O.C.C. Skills:

Body Building
Boxing
Two Languages of Choice (+10%)
Streetwise (+10%)
Juicer Lore (+10%)
General Athletics
Running
W.P. Knife
W.P.: One of choice
Hand to Hand: Expert

Hand to Hand: Expert can be changed to Martial Arts (or assassin if an evil alignment) at the cost of one "other" skill.

O.C.C. Related Skills: Select eight other skills, but at least two must be selected from the Rogue category and two from the Physical category. Plus select two additional skills at level three, and one at levels six, nine and twelve. All new skills start at level one proficiency. **Note:** If the character becomes a Juicer during play, these new skills can be selected from the Juicer O.C.C. related skills, with the appropriate bonuses and limitations. Remember, only approximately 35% of all Wannabes become Juicers.

Communications: Any (+5%)
Domestic: Any
Electrical: Basic only.
Espionage: None
Mechanical: Automotive only.
Medical: First aid only.
Military: None
Physical: Any
Pilot: Any (+5%), except robot and military vehicles.
Pilot Related: Any
Rogue: Any (+6%)
Science: Math skills only.
Technical: Any (+10%)
W.P.: Any
Wilderness: None

Secondary Skills: The character also gets to select four Secondary Skills from the Secondary Skills list (**Rifts® Ultimate Edition**, page 300) at level one, and two more at levels three, six, nine and twelve. These are additional areas of knowledge that do not get the benefit of the bonuses listed in parentheses. All Secondary Skills start at the base skill level.

Standard Equipment: Two sets of gang colors (jackets, bannanas or other identifying marks), a fashionable wardrobe, located in a tiny apartment in the worst part of town, a knife, a handgun, energy pistol and two E-Clips, PDD player and recorder, a motorcycle (no hover bikes or heavy combat bikes), mega-damage suit of body armor (preferably Juicer style armor), Juicer style goggles, and fake drug harness (optional).

Money: 5D6×100 credits and 2D4×1000 credits in drugs or salable Black Market items.

Cybernetics: None; prefers to rely on their training and (occasionally) on designer drugs.

Designer Drugs

By Kevin Siembieda and C.J. Carella

These are the chemical stimulants used by Juicer Wannabes, City Rats, criminals and street toughs in an effort to be faster, stronger and more dangerous. Most of these drugs were first developed in the New German Republic (or at least "rediscovered" there; some were first created in pre-Rifts times), and have been imported to North America by the Black Market, at higher prices (20% higher than the average NGR street value).

Boing-go

A powerful stimulant that is roughly equal to drinking five pots of coffee and taking a hit of speed.

Duration: 24+2D6 hours per dose.

Bonuses: The user will not feel fatigued or the least bit sleepy and is +1 to initiative. The character is alert, energetic and will not (cannot) sleep for 24+2D6 hours. This means his level of productivity could be increased by three to four times when the character works for a full 24 hours.

Penalties: Hyper, fidgety and easily bored. Even if the character gets done with his work early and/or feels a need to sleep, he will be unable to do so until boing-go wears off. When the user finally comes off the high he will feel exhausted and need 10 hours of sleep. If forced to function without sleep, the character will be in a daze: all combat bonuses, melee attacks, speed and skill proficiencies are reduced by half!

Level of Addictiveness: High.

Prolonged use of boing-go (one or more times a week for over a month) or frequent use (three or more times in a single week) will lead to addiction, with the following penalties: inability to sleep, annoying hyper-activity and fidgeting, difficulty concentrating (reduce skills by 5%), and dramatic weight loss despite the fact the user has a voracious appetite (loses 5 pounds/2.3 kg per week).

After a few months, the boing-go junkie will have a thin, frail appearance with dark bags around his eyes, and a sickly pale complexion. After the fourth month, the character will collapse



from physical exhaustion and will require detox treatment. A reformed addict will become instantly hooked if the character ever takes the drug again.

Cost Per Dose: 30 to 60 credits.

Crash

This is a powerful combination of drugs that gives its user a feeling of power, strength and invincibility.

Duration: 1D4 hours

Bonuses while under the influence: +1D4×10+10 to S.D.C., +10 to P.E. (and all appropriate bonuses), +6 to P.S., +6 to speed, +1 attack/action per melee, +8 to save vs horror factor. In addition, the character is bold, fearless and aggressive.

Penalties: The character is so bold, fearless and aggressive that he or she is easily enticed into pointless brawls, dangerous challenges and taking stupid risks — acting without thinking. Furthermore, the character is likely to ignore pain, injury and blood loss, putting his life in jeopardy. Frequently, the crash user will also drink enough alcohol to kill the average man, but made possible from increased physical endurance. Of course, this only makes the crash after the high all the more painful.

While the drug is active, the user feels like a superman, but when the high is over the character feels like garbage in a trash compactor — he “crashes” hard. It is the crash after the high from which the drug gets its street name.

The crash, symptoms and penalties: The character feels nauseous and will vomit 1D4 times an hour for the next 2D4 hours. The slightest noise will make his head pound. The ears ring, eyes water, vision is blurred, the character feels dizzy, cannot walk (or crawl) in a straight line, and finds it impossible to concentrate. All he’ll want to do is crawl into a corner and sleep.

Penalties include -70% on skill performance, -6 on initiative, and speed, melee actions and combat bonuses are reduced by half. The symptoms and penalties last for 24 hours, double if the user was also drinking or taking other drugs. After the first and worst 24 to 48 hours, the crash penalties are reduced by half but last another 24 hours. The character may also suffer from bruises, broken bones and other injuries from stupid stunts and fights while high.

Level of Addictiveness: Minimum.

The crash after the high is so terrible that most intelligent people never touch the stuff again! Only the meanest or stupidest members of Wannabe gangs, bandits, bullies and addicts will use it on a regular basis. Even Juicer Wannabes will rarely use the drug more than once every two or three months, if ever.

Using crash more than twice a week will make the character an addict. Drug dependency makes the character use the drug on a daily basis, even when feeling terrible. After a while, the addict believes he is only useful when high. In some ways, this is true because when the addict crashes he is practically comatose! The penalties are -90% on skill performance, -10 on initiative, speed is reduced by 90%, melee actions reduced to one, and combat bonuses are reduced to zero. The symptoms and penalties last for 96 hours or until another hit of crash is taken. After six months the user can only function when high and the stress on the body is so great that the user could collapse from cardiac arrest (01-50%) or exhaustion (51-00%; roll once at the begin-

ning of every day). A cardiac arrest will mean coma and death unless the character receives immediate medical attention and at least six days of treatment in a hospital. Collapse from exhaustion will mean a coma-like sleep for 2D4 days (only a telepathic probe, mind link or psychic purification has any chance of waking him sooner). When the character finally awakens he craves food and a hit of crash.

A crash addict who manages to undergo the Juicer conversion has his life expectancy reduced by half (3 years or less!).

Cost Per Dose: 150 to 300 credits.

Juice

This is the preferred Wannabe Drug, a powerful stimulant cocktail that is advertised to make users “tough as juicers.”

Duration: 1D6 hours.

Bonuses while under the influence: +4D6 to S.D.C., +4 to P.S. and P.E., +3 to P.P., add one melee attack per round, +3D6 to Speed and +8 to save versus horror factor. The character does not feel pain, is unaffected by shock, and can fight until reduced to -5 hit points!

Penalties: The character is filled with unreasoning rage, and is likely to react violently to any provocation, no matter how small. Since the character does not feel pain, he is likely to get severely injured or killed, or to aggravate injuries; many a Juice addict has been crippled because he kept on fighting or running with broken bones and internal injuries!

When the drug’s effects wear off, the user will feel incredibly fatigued: -5 on initiative and all skills, combat bonuses and attacks per melee are reduced by half. Furthermore, the character will fall unconscious, in a coma-like state, 4D6 minutes after the drug stops working. The character will sleep for 2D4 hours and can only be awakened by strong psychic measures. Taking a second dose in the same day will work for only 3D6 minutes (all penalties are eliminated and all bonuses return for that time), at the end of which the character will collapse into unconsciousness of 4D6 hours.

Level of Addictiveness: Medium.

Taking Juice more than four times a week will make the user an addict. Addicts feel the need to take at least one dose of Juice every day. The character will always feel tense and short-tempered, even when not under the influence. When not under the influence, the character will be tired and depressed; all skills at -10%, -2 on initiative, reduce all combat bonuses by two and lose one melee attack.

Cost Per Dose: 250 to 500 credits.

Mega

Mega is a synthetic steroid that can increase the strength and toughness of the user. The drug must be taken for several weeks before it has an effect. The long-term effects of the drug are extremely dangerous.

Duration: Special. The drug must be taken for 1D4+3 days straight (one pill a day) before its effects are apparent. The results are so staggering, that the Wannabes who use this drug will *look* like they have undergone “the treatment” to become a Juicer. The character must take one pill every week to keep the added strength and endurance.

Bonuses while under the influence: +1D4×10 pounds in weight/muscle mass, +4D6+20 to S.D.C., +4 to P.S., and +2

to P.E. Minimum P.S. is 17, if lower raise it to 17. The character can lift twice as much as a normal person of equivalent strength and endurance, and can last 4 times longer before feeling the effects of exhaustion. Thus, he can remain alert and operate at full efficiency for up to three days (72 hours) without sleep. Typically needs only five hours of sleep a day.

Penalties: Every two weeks after the steroid treatment is completed (one pill a week thereafter), the character has to save versus lethal poison. If the save failed, roll on the following table:

01-40%: Lucked out: No consequences other than a feeling of sleeplessness for 1D6 days (finds it hard to sleep even a few hours a day). The character will be tired and is -1 to all combat actions and -5% to all skills during that period.

41-70%: Over-stressed: If the character performs any feat of strength or combat action during the following month, he will injure himself by over-stressing his body. This can result in torn muscle tissue, broken bones or other severe consequences of applying more strength than one's body can take. When attempting the strength feat, the character will automatically take 1D6 plus his P.S. bonus points of damage, directly to Hit Points! Furthermore, consult the *Pain Penalties table* in the *Rifts® Game Master Guide*, page 36, for an appropriate set of penalties (G.M.'s choice)! Effects will last 1-4 weeks. The occurrence will happen only once during that month.

71-90%: Chronic Stress: As above, but will happen 1D6 times over that month. The character is literally ripping his own body apart by pushing it beyond its limits.

91-00%: Heart Attack: The character suffers a heart attack by overexerting himself. This will occur at some point that month, when the character is in combat, running, lifting a heavy object, or performing similar strenuous activities. The character's hit points are reduced to zero, and he must make a save versus coma and death (add +30% to the Recovery Ratio in the *Rifts RPG*). If taken to a hospital, the character has a 100% chance of survival. If he survives, the character will require 1D4+1 weeks of recovery at a hospital or clinic and may begin to lose the bonuses from "mega" unless he continues to secretly take it in the hospital.

Level of Addictiveness: Low.

It is fairly easy to kick the habit; not taking Mega for a month will eliminate *all* side effects, bonuses, and will clean the character's body of the drug. However, many people, especially Juicer Wannabes, come to cherish the feeling of power and strength the drug provides so much that they often continue to take it even after suffering heart attacks and dangerous injuries.

Cost Per Dose: 300 to 600 credits.

Rush

Rush is another combination of drugs that heightens the user's senses, speed and reflexes.

Duration: 1D6×10 minutes.

Bonuses while under the influence: Add one additional melee attack, +3 on initiative, +1 to strike, +2 to parry and dodge, +3 to roll with impact, and +10 to speed attribute. General skill performance is increased by +5% and +10% on skills requiring dexterity and control such as surgery, forgery, lock picking, piloting, acrobatics, gymnastics, climbing and juggling. In addition, the character is keenly aware of his five senses, particularly smell, taste, hearing and touch.

Penalties: Bad and good smells are twice as potent, a lot of different sounds jangle the nerves and disrupts concentration (-10% on skill performance), and the character tends to be irritable and cranky.

Level of Addictiveness: Medium.

Using rush more than four times a week will make the character an addict. Drug dependency makes the character crave the drug 1D4 times daily! The addict will have all the bonuses listed while high, but becomes so emotionally dependent on it that he thinks he is clumsy and incompetent without it. When not high, the character is minus one melee attack, -3 on initiative, -2 to strike, -3 to parry and dodge, -3 to roll with impact, -10% on skill performance, and the speed attribute is reduced by 20%. In addition, the character's senses seem (it's all psychological) dulled. Food and drinks taste bland, the hands seem clumsy and cold, sounds seem muffled and odors smell unusual.

Cost Per Dose: 65 to 120 credits.

New Skills

Alphabetical List of New Skills by Category

Communications

Communications: Performance

Espionage

Espionage: Interrogation Techniques

Medical

Medical: Juicer Technology

Physical

Physical: Deadball

Physical: Juicer Football

Physical: Murderthon

Piloting

Piloting: Flight System Combat

Piloting: Jump Bike Combat

Rogue

Rogue: Gambling (Dirty Tricks)

Rogue: Gambling (Standard)

Technical

Technical: Juicer Lore

Weapon Proficiencies

W.P. Deadball

Communications

Communications: Performance: This ability is used by actors, gladiators, pro-wrestlers and politicians to impress and sway the public. A character with this skill knows how to do things with flair; if a skill roll is successful, it works like an attempt to charm or intimidate the audience. **Base Skill:** 30% +5% per level. **Note:** Obvious lies, inconsistencies and evidence to the contrary may ruin the effectiveness of the best performance. G.M.s, use your discretion.



Espionage

Espionage: Interrogation Techniques: This skill is learned by policemen, intelligence officers, etc. The character knows the techniques to get information from (typically unwilling) subjects. This includes such old methods as “good cop/bad cop” (one interrogator is threatening and intimidating, the other is sympathetic and friendly), deceiving and misleading the subject into giving away information, and similar. The character can also judge if the subject is lying (the Game Master might assess bonuses or penalties depending on how good a liar the subject is). This skill also includes some basic knowledge on methods of torture, from basic tactics like depriving the subject of sleep, to old “medieval” instruments and new, sophisticated techniques like sensory deprivation, partial electrocution, and drugs. **Note:** Only evil characters will engage in torture routinely. **Base Skill:** 30% +5% per level of experience.

Medical

Medical: Juicer Technology: This is a medical specialty dealing with the Juicer conversion. **Note:** A character needs this skill *and* an M.D. in Cybernetics or Medicine to install the bio-comp and other Juicer implants. This skill allows a doctor

to supply the right drugs to a Juicer, recognize Juicer variants, and diagnose most Juicer side effects and syndromes. **Base Skill:** 40%+5% per level of experience.

Physical

Physical: Deadball: This sports skill concentrates on dodging techniques, reaction speed, and general athletic abilities. A character with this skill automatically knows the Deadball Weapon Proficiency (see the new Weapons Proficiencies, below) and game rules.

- +1 on initiative
- +1 to dodge
- +1 to roll with fall or impact
- +1D6 to Speed attribute.
- +2D4 to S.D.C.

Physical: Juicer Football: This sports skill teaches the character the rules of the game, basic tactics and combat elements. A character with Juicer Football can use this skill for most of the game’s maneuvers, including throws and passes. **Base Skill:** 32%+4% per level of experience. This skill is not recommended for ordinary humans.

Body Block/Tackle: Knocks one’s opponent to the ground (90% chance if target is smaller than attacker, 60% if the same weight, 50% if target is up to 50% larger, 20% if 100% larger, no chance if target is over 100% larger). The tackled person loses initiative and one melee attack/action and suffers 1D4 S.D.C. plus P.S. bonus, per *each* person who tackles him.

Athletic Bonuses:

- +1 to roll with punch/fall
- +1 to P.S.
- +1 to P.E.
- +1D4 to Spd
- +3D6 to S.D.C.

Physical: Murderthon: Another sports skill usually reserved for Juicers. It teaches the character all the basic rules and combat maneuvers of the game. Plus it offers the following bonuses:

- +1 to strike
- +1 to dodge
- +1 to roll with punch or fall.
- +2D6 to Speed
- +2D4 to S.D.C.

Piloting

Piloting: Flight System Combat: This skill allows the character to use specialized flight packs like the *Icarus Flight System* at full efficiency and take advantage of all possible bonuses. The sophisticated control systems of the Icarus are as quick to react as the systems of a suit of power armor. Those without training do not get the following bonuses and the base skill level is reduced by half. **Base Skill:** 40% plus 5% per level of experience.

Bonuses:

- +1 attack/action per melee at levels 1, 3, 5, 8 and 11.
- +2 to dodge when flying.

If the pilot has auto-dodge, he can use it while flying!

Piloting: Jump Bike Combat: Another elite skill used for such advanced performance vehicles as the *Tarantula Jump Bike*. **Base Skill:** 45%+5% per level of experience.

Bonuses:

+1 attack per melee round with bike's weapon systems.

Automatic Dodge: +1 to dodge

Bike Jump Attack: This attack uses the rockets to have the bike jump in the air and then land on a target. The sensitive rocket controls require a special skill roll. **Base Skill:** 25% plus 5% per level of experience. If the skill roll is successful, the pilot can make a normal attack roll (at +1 to strike in addition to normal bonuses) to hit the target. Damage to his opponent is 3D6 M.D. **Note:** This attack can only be done if there is room to maneuver (open terrain only).

Rogue

Rogue: Gambling (Standard): This skill enables the character to skillfully play in several games of chance. The character knows the rules of 1D4 games, plus an additional game for every 2 points of the character's I.Q. (rounded up). In addition to rules, the character understands the theories of mathematical "odds" (+5% bonus to math skill), some basic strategies and tactics for winning consistently, when to hold them, fold them, etc. **Base Skill:** 30% +5% per level of experience.

Rogue: Gambling (Dirty Tricks): This is the other side of gambling in which the character is skilled at cheating in games of chance. This includes knowledge of dirty tricks

such as counting cards, how to use marked cards, using trick/loaded dice, stacking the deck (in one's favor), sleight of hand tricks to hide cards up sleeves or in the palm of the hand, dealing from the bottom of the deck, and other cheats (must have the palming skill for the latter two). **Base Skill:** 30% plus 4% per level of experience.

Technical

Technical: Juicer Lore: This skill covers all there is to know about Juicers, different Juicer variants, what powers they possess, Juicer lore and myths, drug side effects, etc. A character with this skill will recognize Juicers by their armor and abilities, as well as know the names of the most famous Juicers in history, current famous Juicer leaders, infamous gangs, and similar facts. **Base Skill:** 30% +5% per level of experience.

Weapon Proficiencies

W.P. Deadball: This skill allows the character to throw the spiked, ricocheting ball in the deadball game with great accuracy. A character with this skill can hit a target by ricocheting the ball off walls, ceilings and floors. This is a called shot, at -1 for every ricochet needed to strike the target. It is very hard to parry or dodge the ricocheting Deadball; the victim is at -2 to dodge, and at an additional -1 for every additional ricochet beyond the first.

Weapons & Equipment

Most of the weapons, equipment and vehicles described below are the preferred "toys" of the Juicer community, although many of them can be used by other characters, including Crazies, 'Borgs, and in many cases, normal humans as well.

Armor Accessories

Sensor Jammers

These "spoofers" can be built into a suit of light or medium M.D.C. armor (50 M.D.C. or less). They consist of several fiber-optic arrays and special insulating materials that jam and block thermal and radar signatures, and also diffuse laser targeting systems. When the Jammers are activated (they are powered by an E-Clip built into the armor), the character only has a 15% chance of being detected by standard thermal and radar detectors and optic systems. Furthermore, guided missiles are at -2 to strike, and even a volley of four or more missiles is -2 (roll once for entire volley). Laser aiming systems lose their targeting bonus when shooting at the wearer.

The Sensor Jammers are destroyed when over half the M.D.C. of the body armor has been depleted. The E-Clip operates the system for up to eight continuous hours; each activation of the jamming field depletes the equivalent of 10 minutes of charge, whether or not the jammers are active for that long. The system has been tried on power armor and vehicles, but found to

be ineffective due to the larger size, large energy supply, and much stronger heat signatures. The system is also useless for any creature who is over 10 feet/3.0 m tall.

Juicers, especially those who specialize in infiltration and cover operations, love this accessory.

Black Market Cost: 20,000 to install into a suit of armor.

Combat Gauntlets

These gauntlets have the same mechanical "muscles" used by 'Borgs and powered armor. While wearing them, the user can crush objects as if he had a robotic strength of 26 (1D6 M.D. crush/squeeze). Juicers and other augmented humans can inflict mega-damage with their punches while being protected by the gauntlets.

Besides being a weapon, the gauntlets are also useful as tools, allowing the wearer to grip objects with mechanical strength.

Weight: 4 lbs. (1.8 kg)

Mega-Damage: Crush/Squeeze does 1D6 M.D. Normal humans using it to punch inflict 2D6 S.D.C. plus P.S. bonuses. A Juicer, Crazy, 'Borg or other augmented human can inflict one M.D. on a normal punch using the gauntlets, or 1D6 M.D. on a power punch (counts as two attacks). Characters with supernatural P.S. add +4 M.D. to their hand to hand damage.

Penalties: While wearing the gauntlet, any fine manipulation skills using that hand are at -4 or -20%. Most guns cannot be fired by a hand fitted with the gauntlet.

Payload: Powered by a rechargeable battery with 20 hours of life.

Black Market Cost: 5,000 credits per gauntlet.

Combat Vambraces

This is a piece of power armor that entirely covers an arm and is either strapped to the body or built into a suit of environmental armor. The Vambrace uses the same mechanical systems of power armor, and has a robotic P.S. of 24. A Juicer or Crazy (normal humans cannot use this weapon without risking broken bones) can attack and inflict hand to hand damage as if he had that strength. Furthermore, the power armor piece can be fitted with bionic or power armor weapon systems (they must be purchased separately). Only one Vambrace can be built into a suit of non-powered armor.

Weight: 15 lbs./6.75 kg (this adds to the weight of the armor).

Mega-Damage: Hand to Hand: 6D6 S.D.C. plus P.S. bonus on a restrained punch, 1D4 M.D. on a full strength punch, and 2D4 M.D. on a power punch (counts as two melee attacks).

Payload: Powered by a rechargeable battery with an energy life of 8 hours.

Black Market Cost: 40,000 credits.

Grenade Bracers

This is an armor accessory, a built-in grenade bracer that holds 3 grenades on the forearm of the wearer (6 total if two of them are built into both arms). The grenades are stuck to magnetic clip holders; to grab a grenade, all the wearer has to do is hold it and twist it in a clockwise fashion, which automatically disables the magnetic clip.

Black Market Cost: 800 credits per Bracer. Can be built into normal body armor, or combat vambraces (see above), as well as into bionic limbs or power armor. Grenade cost not included.



Forearm Grenade-Launchers

This is a version of the Grenade Bracers (described above) that have electromagnetic launch systems added to the magnetic clips, as well as a laser targeting system. To shoot at a target, the wearer aims the laser beam and presses a firing stud; can be built into a glove, wrist, or computerized as a voice command grenade launcher! One, two or up to all three grenades will then be "shot" towards the target.

Weight: Adds 3 lbs (1.35 kg) to the armor weight.

Mega-Damage: Varies with grenade type.

Rate of Fire: One at a time or in "volleys" of two or three grenades.

Effective Range: 600 feet (183 m)

Payload: Three grenades per forearm.

Black Market Cost: 2,000 per forearm; 8,000 if a voice activated launch system is built into the armor.

Forearm Vibro-Blades (UTI)

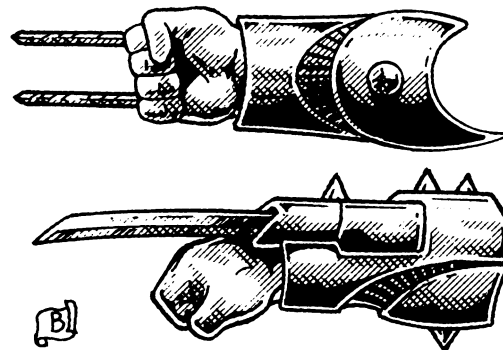

These weapons are mounted on the forearms of body armor. When activated, they extend two or three vibro-blades, which can be used in close combat. Juicers and Crazies are particularly fond of the weapon, since it allows them to engage in hand to hand combat, where their physical abilities give them a huge edge over normal humans.

Mega-Damage: Double Blade: 2D6 M.D. Tri-Blade: 3D6 M.D.

Black Market Cost: 4,000 for the double blade; 8,000 for the tri-blade.

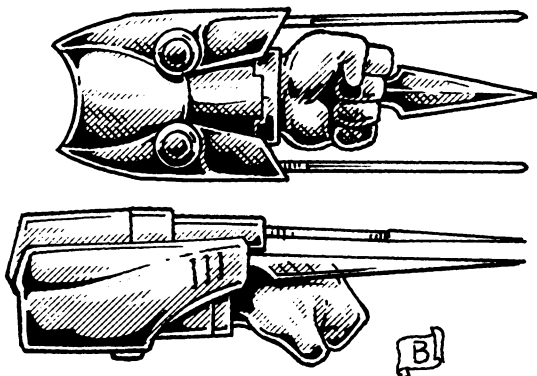

Rocket Boots

These bizarre accessories are the rage among Juicers and Crazies. As their name indicates, this footgear has focused explosive charges built into their soles; charges powerful enough to propel the wearer up to 60 feet (18.3 m) into the air! An acrobatics or gymnastics roll (equivalent to a back flip roll) will allow the wearer to do midair rolls, somersaults, back flips and cartwheels in two seconds and land on his feet. This maneuver enables the rocketing character to turn around, dodge (+1), land behind a person, or move 10-20 feet (3-6 m) in any lateral direction, or to land on a rooftop, tree branch, etc. Each rocket jump counts as one melee action.

Non-augmented humans and D-Bees who try to use rocket boots risk injury; each time the boot is used, the character must roll a 16 or higher to successfully execute the jump or maneuver

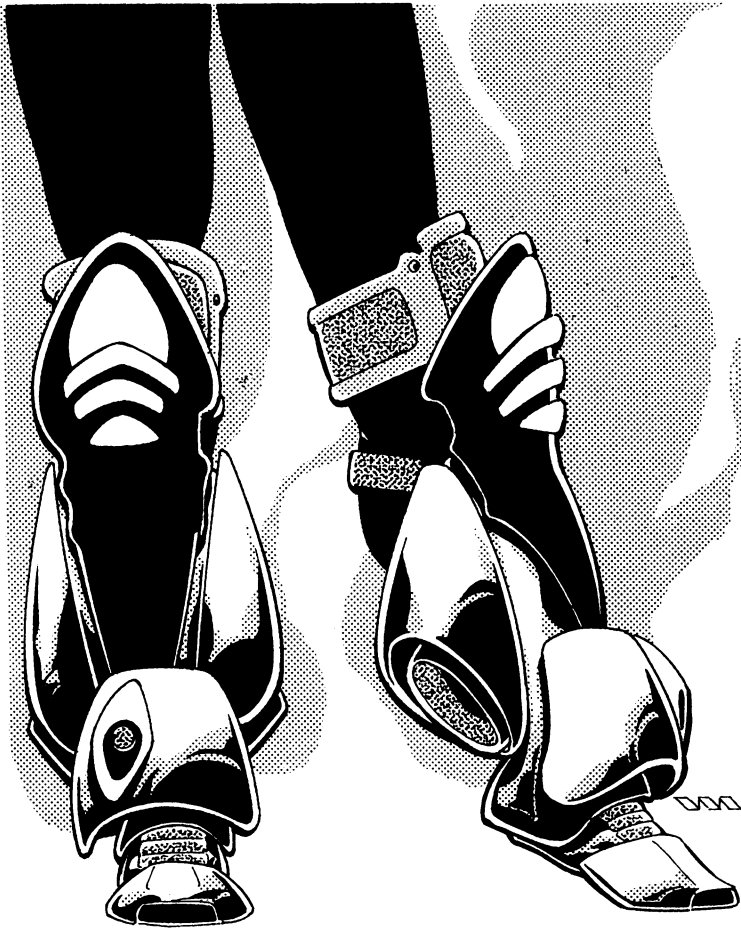

and land safely on his feet. A bad roll means failure to execute any special maneuver (back flip, etc.) and a bad landing: suffers 2D6 S.D.C. damage and loses initiative (if he had it); body armor does not protect against this injury. Broken legs, sprained ankles, and pulled ligaments from the stress of the rocket boots or nasty impacts and landings are very common. Even so, many Juicer Wannabes keep trying to use the boots. Characters with cybernetic or bionic legs can use the boots without penalties.

Payload: The boots are powered by an E-Clip and can make 20 jumps per standard E-Clip.

Black Market Cost: 30,000 credits. Can be built into a suit of mega-damage environmental armor for an additional 2,000 credits.

New Body Armor

Titan Plate Armor

This suit of armor is built by Ultra-Tech Incorporated for the Titan Juicer (see the *New Juicer Variants* section), although it can also be used by giant-sized D-Bees (8-12 feet/2.4 to 3.65 m tall). The armor consists of thick, heavy plates built with the same alloys used in power armor of cyborg body armor, and they offer massive protection at the cost of some mobility reduction. With this armor on, the Titan Juicers are almost as well armored as a soldier in power armor.

The minimum height to use this massive suit of armor is 7 feet (2.1 m), and a minimum P.S. of 24; it is not designed to accommodate smaller wearers. The smaller version of this armor, the Mega-Armor follows.

- M.D.C. 195
- Weight: 250 lbs. (112.5 kg).
- Variable Mobility: For wearers with a normal P.S. of 40+ or a supernatural P.S. of 25 or higher, the character is -15% to prowl, and -5% to climb, swim, or to the performance of acrobatics and gymnastics skills. Also, reduce speed by 10%. **Note:** Weaker characters (but no less than P.S. 25 normal or 20 supernatural) are -30% to prowl, and -15% to climb, swim, or to perform acrobatics and gymnastics skills. Also, reduce speed by 40%. Characters weaker than P.S. 25 normal or 20 P.S. supernatural cannot move while wearing the armor!
- Black Market Cost: 85,000 credits for the standard non-environmental version or 110,000 for the full environmental suit (and add 30 lbs/13.6 kg). **Note:** Northern Gun is developing a knock-off suit that is reportedly going to cost 10% less.

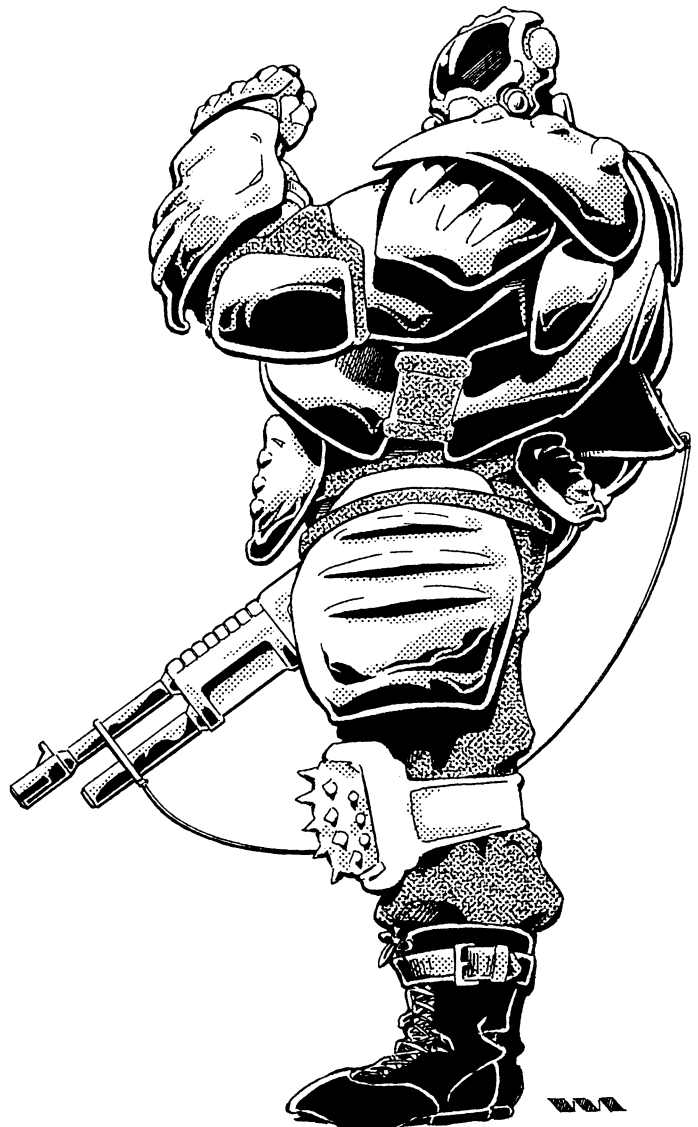

Mega-Juicer Combat Armor

(UTI and Northern Gun)

Both UTI and Northern Gun manufacture this type of armor (and both companies claim the other stole it from them). The design is very heavy, and only characters with supernatural strength (like the Mega-Juicer after which it is named) or a normal P.S. of 30 or higher can wear it without major penalties. Other than its weight, however, the armor is extremely flexible and offers excellent mobility for those who can wear it. See the *Mega-Juicer O.C.C.* for a picture of a Juicer wearing the armor.

- M.D.C. 130
- Weight: 80 lbs. (36.2 kg).
- Variable Mobility: For wearers with a normal P.S. of 30+ or a supernatural P.S. of 20 or higher, the character is -10% to prowl, and -5% to climb, swim, or to the performance of acrobatics and gymnastics skills. Also, reduce speed by 10%. **Note:** Weaker characters (but no less than P.S. 24 normal or 16 supernatural) are -25% to prowl, and -15% to climb, swim, or to perform acrobatic and gymnastics skills. Also, reduce speed by 30%. Characters weaker than P.S. 24 (normal) or 16 P.S. (supernatural) cannot move while wearing the armor!
- Black Market Cost: 55,000 credits for the standard non-environmental version, or 65,000 for the full environmental suit (and add 10 lbs/4.5 kg).

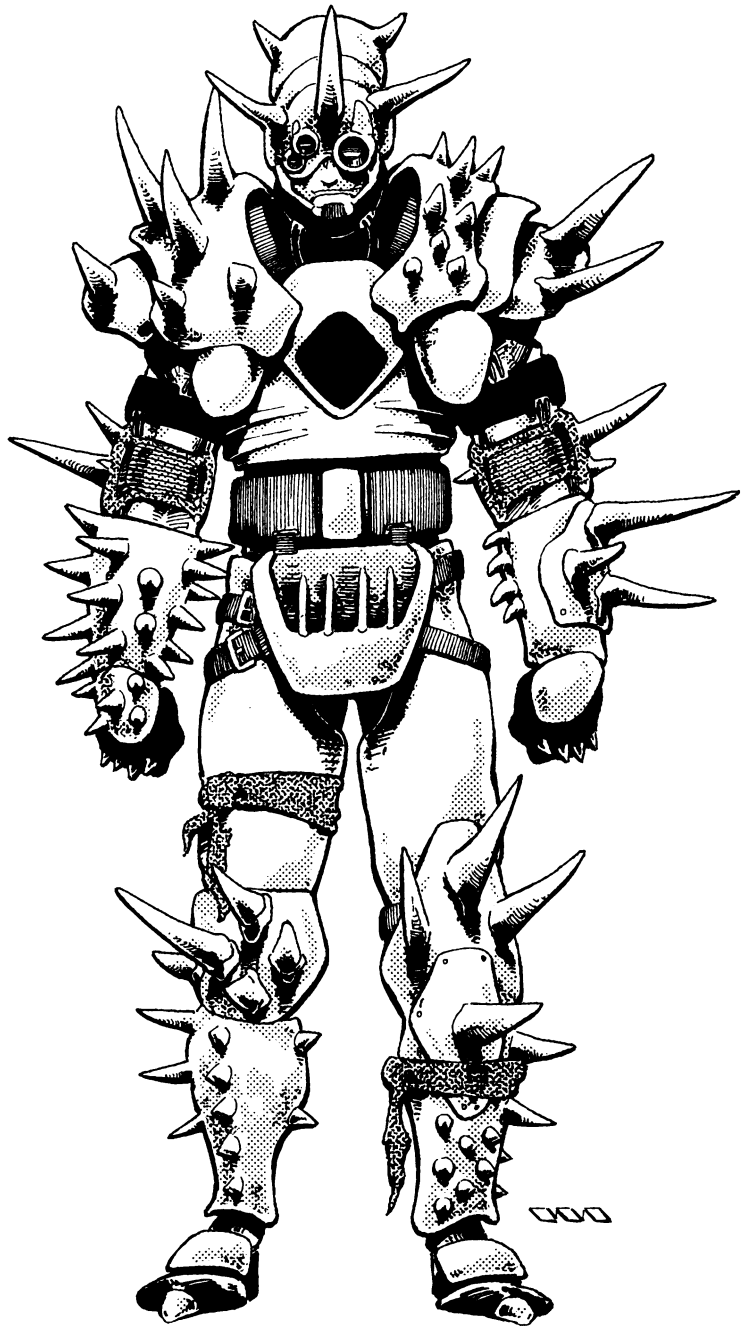

Spiked Armor

This type of armor is very popular with Juicers who participate in combat sports like Juicer Football and Murderthon. The spikes are made of mega-damage materials, which can actually chip away at M.D.C. alloys and even injure supernatural creatures.

A body slam or tackle with spiked armor will inflict 2D6 +P.S. damage on unarmored humans. If a Juicer with a P.S. 25+ body slams an opponent with M.D.C. armor or skin, the attack will inflict one point of mega-damage. A power slam (counts as two attacks) does 5D6 +P.S. damage bonus to S.D.C. targets and 1D6 M.D. to mega-damage structures and creatures. If used by a character with supernatural strength, the spikes add 1D6 M.D. to hand to hand damage; treat a body slam as a punch, and a power slam as a power punch, and add 1D6 M.D.

The armor is also very lightweight and allows a great deal of mobility, plus it offers better than average protection. Spiked armor is a favorite of Juicers, outlaws, and some adventurers and headhunters.

- M.D.C. 45
- Weight: 17 lbs. (7.65 kg).
- Good Mobility: -5% prowl penalty.
- Black Market Cost: 30,000 credits.

Vibro-Spike Armor

As above, but the spikes have vibro-fields, powered by an E-clip. A body slam will inflict 2D6 M.D. to all targets, and a power slam (counts as two attacks) does 4D6 M.D.!

Characters with supernatural strength add these damages to their basic hand to hand damage.

The E-Clip is inserted in a compartment on the lower torso of the armor. It will maintain the fields for up to 12 hours of continued use (each time the field is activated, it will drain the equivalent of one minute's worth of charge, even if used for less time). Although many Juicers and other warriors love the concept, wiser people are quick to point out that if the wearer is not careful, he can damage the armor or even injure himself by carelessly rubbing the activated spikes against other parts of his body. Every hour the spikes are activated continuously, there is a 01-22% chance that the user will accidentally harm himself.

- M.D.C. 50
- Weight: 18 lbs. (8.1 kg)
- Good Mobility: -8% prowl penalty.
- Black Market Cost: 55,000 credits; E-Clips not included.

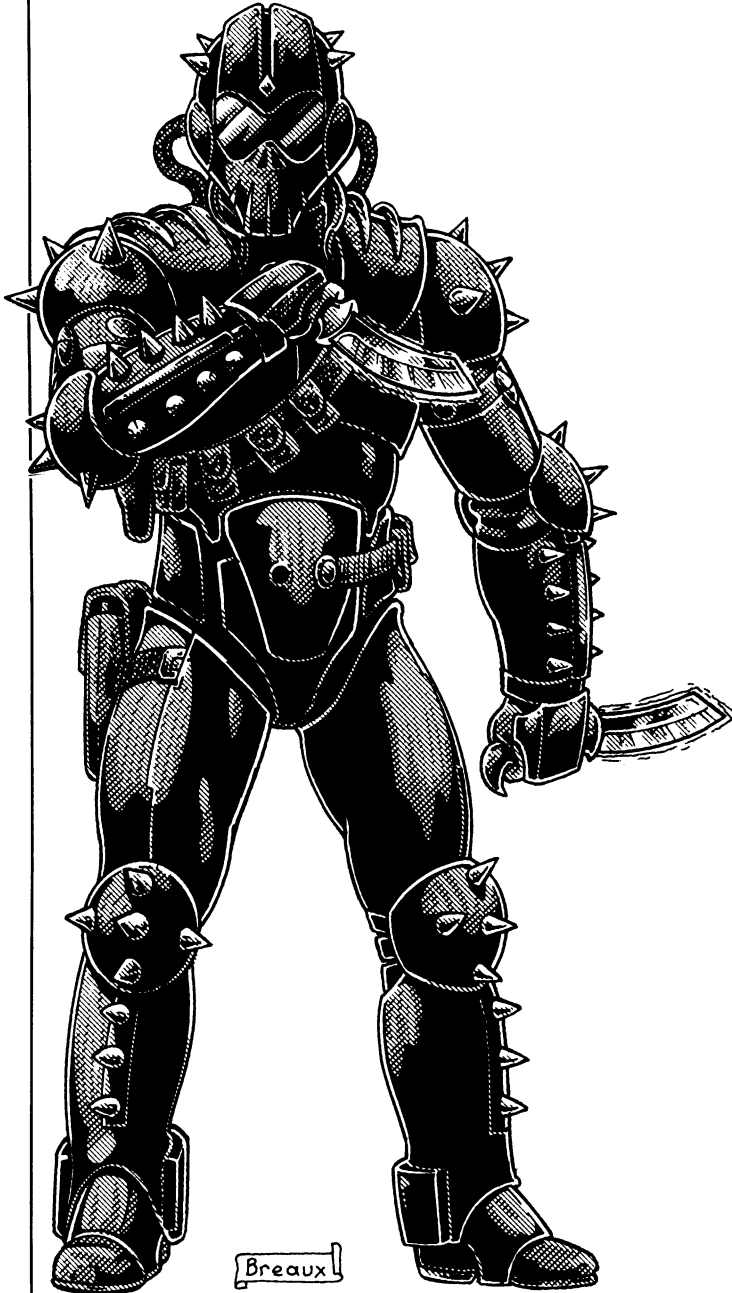

Man-Killer EBA

This heavy, environmental suit of armor is designed for maximum protection under the most lethal combat conditions. The armor sacrifices a measure of speed and agility, but provides superior mega-damage protection. Juicers who want to enter hand to hand combat with opponents in power armor or fight against supernatural foes will often wear this suit rather than the lightweight Juicer assassin armor and similar models.

The Man-Killer has spikes which can be used to harm M.D.C. materials and supernatural beings and which makes grabbing him painful. A body slam with spike armor will inflict 2D6 +P.S. S.D.C. damage on unarmored humans. If a Juicer with a P.S. 25+ body-slams an opponent with M.D.C. armor or skin, the attack will inflict one point of mega-damage. A power slam (counts as two attacks) does 4D6+P.S. damage bonus to S.D.C. targets and 1D6 M.D. to mega-damage structures and creatures. If used by a character with supernatural strength, the spikes add 1D6 M.D. to hand to hand damage (treat a body slam as a punch, and a power slam as a power punch, and add 1D6 M.D.).

The main drawback of the armor is its weight and poor mobility. Furthermore, "weak" Juicers with a P.S. of less than 24 will find the armor to be awkward, inhibiting movement and reducing speed.

- M.D.C. 110
- Weight: 40 lbs. (18 kg).
- Has all standard EBA features and can be used with a jet pack.
- Poor Mobility & Penalties: -20% prowling penalty, -5% to climb, swim, or to the performance of acrobatics and gymnastics skills. Also, reduce speed by 10%. **Note:** Characters with a P.S. of 23 or less also lose one attack per melee round, reduce their initiative roll by -1, and their speed is reduced by 30%.
- Black Market Cost: 60,000 credits.

Super-Hide Armor

Super-Hide armor, also known as the Dragon Scale or Dragon Skin armor, uses the hides of supernatural beings, properly treated and grafted onto a flexible articulated armor design. Each suit of armor is custom-made, often incorporating skulls, bones and other M.D.C. remains from dead monsters in their design. Claws are also often built into the armor; these claws are mega-damage weapons (can parry mega-damage attacks without penalty) that inflict 3D6 +P.S. bonus S.D.C. damage. Juicers and other augmented humans can do a mega-damage power claw attack (counts as two attacks) inflicting 1D6+1 M.D. Characters with supernatural strength add 1D6+1 M.D. to their normal hand to hand damage when striking with their claws.

Armor that actually has dragon hide among its building materials is very likely to stir anger among dragon hatchlings and adult dragons who see the character. Many dragons will attack anybody who dares to kill and skin their kind and wear it with such bold-faced audacity in public. Also, some good characters may find it reprehensible to use the skins of sentient beings, considering it barbaric and ghoulish.

Many Dragon Juicers get this type of armor after their techno-wizard conversion (they don't care what dragons or others think). In some places, this practice has led to people referring to it as Dragon Juicer Armor.

- M.D.C. Varies: Custom-made and uses diverse materials. The average suit has 70-100 M.D.C., but true "dragon" armor will have 110-140 M.D.C.!
- Weight: 20 lbs (9 kg) plus 10 lbs (4.5 kg) per 10 M.D.C. over 100 (a 130 M.D.C. suit would weigh 50 lbs./22.5 kg).
- Mobility Penalties (typical): A base prowl penalty of -15%, with -1% per 5 M.D.C. over 100 (a 130 M.D.C. suit would have a -21% prowl penalty). In addition, the wearer is -10% to climb, swim, or to perform acrobatics and gymnastics skills. Also, reduce speed by 10%.
- Black Market Cost: 80,000 credits plus 1D6×10,000 credits for "real" dragon scale armor. Poor availability outside Kingsdale or the Federation of Magic, and even at these places it is not common.



Juicer Weapons

Inspired by the designs of Wayne Breaux Jr.

FIWS

(Forearm Integral Weapon System)

— Chi-Town's Black Market

This weapon was developed for the use of the Chi-Town Special Forces Battalion (see the *Coalition Juicer* section). Colonel Lyboc, the officer in charge of the project, is always trying to make a buck, so the blueprints for the weapon were "stolen" by the Black Market and pirated FIWS are now on sale throughout North America.

The FIWS looks like a simple piece of armor at first, a thick, heavy forearm plate. Over and under the wrist are two thick-barreled particle beam projectors and a thinner targeting laser (+1 to strike). Additionally, three vibro-blades can spring into action at the flick of the wrist, providing the wearer with a lethal close as-

sault weapon. A long E-Clip powers the particle beam projectors. This fearsome weapon is meant for close assault; the particle beam weapons are very powerful, but relatively short-ranged. Combat trials have shown that a team of FIWS equipped Juicers who manage to get within 500 feet (152 m) of a tank will be able to destroy the vehicle before it can destroy them!

Weight: Adds 5 lbs. (2.25 kg) to the weight of the armor.

Mega-Damage: Particle Beam Weapons: 5D6 M.D. per single blast, or 1D6×10 M.D. per double blasts (counts as one attack but uses up two shots).

Vibro-Blades (3 per arm): 3D6 M.D.

Rate of Fire: Single shots only.

Effective Range: Particle Beam: 500 feet (152 m). Blades: hand to hand combat.

Payload: Particle Beam: 30 single shots or 15 double shots (long E-Clip).

Black Market Cost: 24,000 credits.

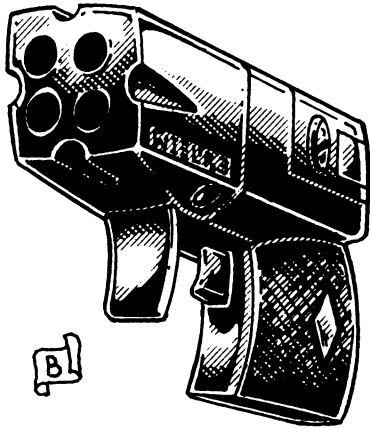

WI-LP3 Pepperbox Laser

A common holdout pistol, the Pepperbox is a small handgun whose four barrels are built into a solid block. The gun is small enough to conceal in a pocket or boot (+4% on concealment rolls). Instead of using an E-clip, the gun has four mini-batteries that prime and fire, one for each barrel. This gives the shooter four shots or any combination of multiple shots up to a single, powerful quadruple shot. The gun has a breakaway action that ejects the spent batteries when it is opened (changing batteries counts as one melee attack/action with a speedloader similar to

the one used in revolvers, or four melee actions if doing it one by one). The laser is relatively weak and short-ranged, but is quite capable of killing at up to 100 feet (30.5 m).

This gun is popular with City Rats, gang-bangers, gamblers, assassins and other undesirables. Although weapon detectors will pick up the presence of the gun, the Pepperbox can be hidden from cursory inspections or searches. Juicers like it as a backup weapon or to give enemies a nasty surprise. Assassins often use them in places where conspicuous weaponry would get them stopped and questioned.

Weight: Less than 1 lb. (0.45 kg)

Mega-Damage: 1D4 M.D. per shot. A double shot does 2D4 M.D., a triple shot does 3D4 M.D., and a quadruple shot inflicts 4D4 M.D. and empties the battery payload.

Rate of Fire: Can fire single, double, triple or quadruple shots (all count as one melee attack).

Effective Range: 100 feet (30.5 m)

Payload: Four shots; one shot per battery (each battery is roughly the size of a shotgun cell). Reloading the batteries takes four melee actions, or one if a speedloader is used.

Black Market Cost: 12,000 for the gun; each battery costs 100 credits. A special speedloader (loads all four batteries at once) cost 75 credits.

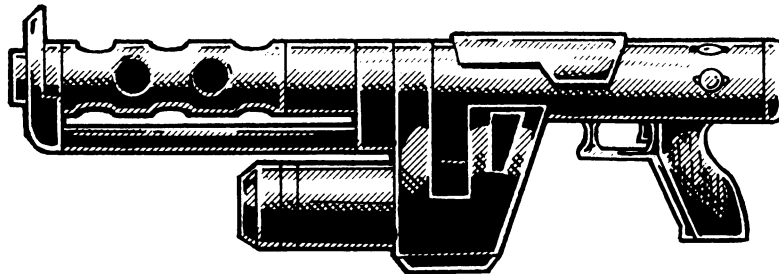

WI-FT1 Plasma Flamethrower (W.I.)

This fearsome weapon is the brainchild of a collaboration between *Golden Age Weaponsmiths* and Wellington Industries (W.I.; see *Rifts® Mercenaries* for details on both of these companies). Golden Age researchers recognized the flamethrower as an ideal shock weapon, and Wellington researchers adapted normal plasma weapon systems to produce a short-ranged, but continuous stream of mega-damage flames. A separate team working on the same project developed a form of plasma-based napalm that is used with another model of flamethrower (see the WI-NFT1, below).

Primarily a terrorist weapon, the flamethrower is also ideal for attacking certain monsters, lightly armored ground troops, vehicles, bunkers and other hardened positions.

Weight: 30 lbs (13.5 kg) or 45 lbs. (20.5 kg) with plasma tank.

Mega-Damage: A short plasma burst does 3D6 M.D. A concentrated plasma burst (counts as two attacks; 7 seconds) does 1D4×10+10 M.D. Or the attacker can cover an area with plasma: up to 10 feet (3.0 m) can be covered with each hand to hand melee attack/action, so a character with four hand to hand attacks could cover an area or length of 40 feet/12.2 m; everybody in the area affected takes 2D6 M.D.

Rate of Fire: Single shot or concentrated burst.

Effective Range: 500 feet (152 m).

Payload: Standard E-Clip holds 8 bursts, a long E-Clip holds 16 plasma bursts. A plasma tank holds 100 "shots."

Black Market Cost: 30,000 credits. A plasma tank costs 1,200 credits and is disposable.

WI-NFT-1

Napalm-P Flame Thrower

The NFT-1 is a research breakthrough for Wellington Industries. Using pre-Rifts technologies, the company's developers have created a weapon that projects "long-lived" plasma. This concentrated mega-damage fire does not dissipate within 10-20 seconds, but lasts for a period of 1D4 minutes. During this time, a target enveloped in the burning substance will continue to take damage. A well-placed shot of "Napalm-P," as this substance is called, will consume a man in light body armor in a matter of minutes. Only by wiping the sticky substance off, can the target hope to survive.

The NFT-1 uses specially designed fuel tanks that hold Napalm-P. If the tank is destroyed (called shot, and the tank has 15 M.D.C.), it will explode, inflicting 2D6×10 M.D. to a 30 foot (9.1 m) radius.

Weight: 45 lbs. (20.5 kg)

Mega-Damage: A plasma burst does 3D6 M.D. A concentrated plasma burst (counts as two attacks) does 1D4×10+10 M.D. Or the attacker can cover an area with plasma: up to 10 feet (3.0 m) can be covered with each hand to hand attack, so a character with four hand to hand attacks could affect an area of 40 feet (12.2 m); everybody in the area affected takes 2D6 M.D. Additionally, any target that is hit by the plasma will continue to take damage: 2D6 M.D. every melee round for 1D4 minutes! The only way to save oneself from the damage is to roll in dirt or sand (water will not extinguish the plasma) for one entire melee round (15 seconds), until the plasma is rubbed off.

Rate of Fire: Single shot or concentrated burst only.

Effective Range: 500 feet (152 m)

Payload: A Napalm-P tank holds 100 "shots."

Black Market Cost: 40,000 credits. A plasma tank costs 2,000 credits and is disposable.

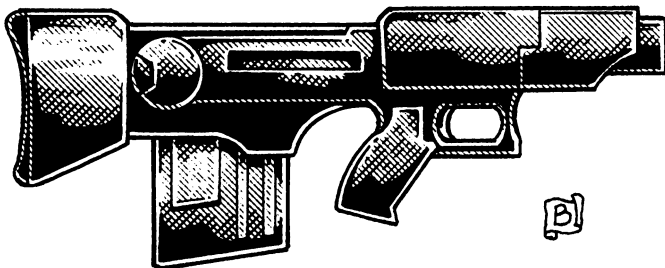

NG-IP7 Ion Pulse Rifle

A combat rifle that uses a shortened "bull-pup" design to make it compact and easy to carry and conceal. Liked by Juicers, security forces, and urban combat units.

Weight: 7 lbs. (3.15 kg).

Mega-Damage: Single shot 3D6 M.D. or multiple pulse burst 1D4×10 M.D. (counts as one attack but consumes three shots).

Rate of Fire: Standard.

Effective Range: 1600 feet (488 m)

Payload: 30 shots.

Black Market Cost: 20,000 credits

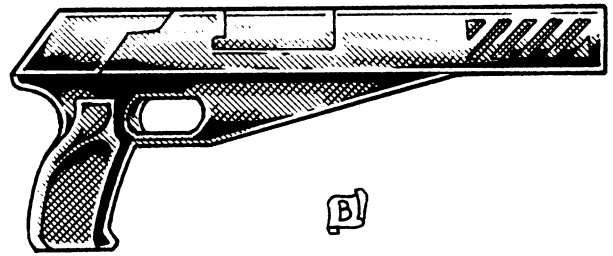

NG-45LP "Long Pistol"

The NG-45 is a long-barreled pistol that has nearly the range of a rifle and fires a powerful particle beam. Juicers like this weapon for the intimidation factor. It is also popular among pilots (small enough to fit into a weapons compartment, and yet almost as good as a rifle), outlaws and travelers. Of late, it has become a symbol of manhood and toughness.

Weight: 5 lbs. (2.25 kg).

Mega-Damage: 5D6 M.D. per shot.

Rate of Fire: Single shots only.

Effective Range: 1200 feet (365 m).

Payload: 8 shots.

Black Market Cost: 15,000 credits.

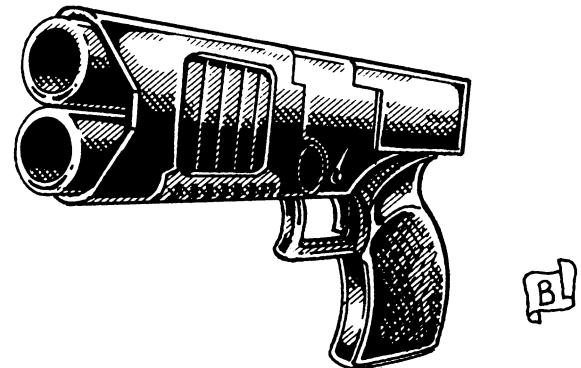

NG-11S "Sawed-Off"

This weapon resembles a double barreled sawed-off shotgun with a pistol grip. This .60 caliber smoothbore weapon can fire regular 12-gauge shotgun shells, but it can also fire special explosive rounds (equivalent to small grenades), as well as special ramjet rounds designed to crack open M.D.C. body armor. The ramjet rounds are fired from the gun like a normal bullet, but once they are in the air a secondary rocket booster kicks in, propelling the heavy M.D.C. slug at rail gun like speeds. The main drawback of the NG-11S is that it can only fire two-rounds at a time (reloading the gun takes one melee action). Juicers, bandits and adventurers like the gun nonetheless, and often carry 20 to 50 rounds in ammo belts/bandoleers. Some Juicers have adopted a "bandido" look, and walk around with crisscrossing ammo belts across their chests.

Weight: 3 lbs. (1.35 kg).

Mega-Damage: Varies with ammo type.

Shotgun Shell: 4D6 S.D.C. or 8D6 S.D.C. for a double blast at the same target (counts as one melee attack).

Solid Slugs: 5D6 S.D.C. or 1D6×10 S.D.C. for a double blast at the same target (counts as one melee attack).

Explosive Shell (Fragmentary): 2D6 M.D. to a 10 foot (3 m) diameter, or 3D6 M.D. to a 20 foot (6.1 m) diameter for a double blast (counts as one melee attack).

Explosive Shell (Plasma): 3D6 M.D. to a 6 foot (1.8 m) diameter area, or 5D6 M.D. to a 12 foot (3.6 m) diameter area for a double blast (counts as one melee attack).

APRJ (Armor-Piercing, Ramjet) Rounds: 3D6 M.D. per shot, or 6D6 M.D. for a double blast at the same target (counts as one melee attack).

Rate of Fire: Single or double shot only.

Effective Range: Shotgun shells or slugs: 300 feet (91.4 m). Explosive Shells and APRJ: 500 feet (152 m)

Payload: Two shots. Reloading the gun takes one melee round.

Black Market Cost: 4,000 credits. Explosive Shells cost 150 credits a piece; APRJ rounds cost 200 credits each.

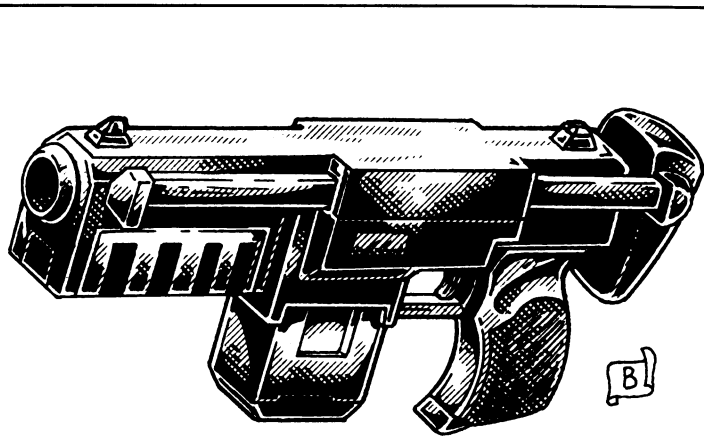

Zapper Gun (UTI)

The Zapper is the latest release from Ultra-Tech Incorporated. This bulky weapon has a short, stubby barrel and a retractable stock; it can be fired one-handed like a machine pistol or two-handed like a sub-machinegun. The weapon fires an ionizing beam that, when it touches an M.D.C. alloy, discharges a powerful electrical charge. The result is an arc of electricity that can melt M.D.C. materials, and furthermore, produces a stunning or even lethal shock to most living creatures.

The beams are -2 to dodge, because the ionizing beam is invisible until it touches the target, and then the electrical charge hits instantaneously.

Weight: 8 lbs. (3.6 kg).

Mega-Damage: 2D4 M.D. Additionally, humans and most humanoids have to make a save of 14 or higher or suffer 1D6 S.D.C. (or M.D.C. in the case of supernatural creatures) and lose initiative and are at -1 to all combat actions for 1D4 melee rounds. Supernatural beings who are immune to electricity take no damage; some powerful entities may have bonuses of +2 to +6 (in addition to P.E. bonuses) to save, at the G.M.'s discretion. This attack will affect people in body armor, and most types of light power armor. Vehicles and robots with a reinforced pilot's compartment, and heavy power armor will protect the pilot and crew completely.

Rate of Fire: Single shots only.

Effective Range: 1000 feet (305 m)

Payload: 15 shots with a standard E-clip

Black Market Cost: 30,000 credits

Deadball Grenade

Designed for players and fans of the Juicer sport Deadball, this grenade consists of an explosive charge surrounded by a highly elastic plastic sheathing, shaped like a ball (roughly the size of a baseball). Unlike true Deadballs, this sphere does not have spikes; instead, it can ricochet off almost any surface. The grenade's detonator can be set to explode after one, two, or more impacts (ricochets), to a maximum of five impacts/bounces. A trained Deadball player can bounce the ball around corners, into small holes, into a tank's crew compartment, etc. Characters without the Deadball W.P. (see the *New Skills* section) can attempt to do the same, but must make called shots at -4 to strike for each ricochet.

Weight: 1 lb. (0.45 kg)

Mega-Damage: 3D6 M.D. to a 20 foot (6.1 m) area.

Rate of Fire: One.

Effective Range: With the Deadball W.P., up to 200 feet (61 m); otherwise, 120 feet (36.5 m).

Black Market Cost: 1,000 credits per grenade.

Vibro-Deadball

Like the Deadball grenade, this weapon looks like the play ball of the popular Juicer game. Unlike a real Deadball, the spikes of this one always come out after a throw and they are surrounded by a vibro-field, inflicting mega-damage. A trained Deadball player can align the strike so it will hit a target, slash it, and ricochet back, at distances of up to 200 feet (61.0 m)! The spikes automatically retract after the first impact.

Weight: 1 lb. (0.45 kg).

Mega-Damage: 2D4 M.D.

Rate of Fire: A throw counts as one hand to hand attack.

Effective Range: 200 feet (61.0 m)

Black Market Cost: 4,000 credits

Holdout Speed Holsters Weapon Accessory

This is a holster equipped with a spring that, at the flick of a wrist, flings the gun into the character's hand. These holsters are typically worn on the forearm, allowing the wearer to be the first to draw a weapon.

At the beginning of a fight where no guns have been drawn, a character is at +3 to initiative to be the first to draw his weapon and fire. If the character is the one to initiate the attack, it counts as an ambush/sneak attack (automatically wins initiative).

Black Market Cost: 1500 credits.

Advanced Thermal Sights Weapon Accessory

Advanced thermal sights existed in pre-Rifts days and had many military applications, from night fighting to allowing the user to "see" inside buildings and other structures.

These advanced sights can sense heat signatures even through walls and other obstructions! Assassins often use them to locate a target and then shoot through often flimsy S.D.C. walls to hit him. Only thick (4 inches or thicker), reinforced M.D.C. walls will block thermal readings enough to foil the sights.

Black Market Cost: 15,000 credits for goggles, 30,000 to build them into armor.

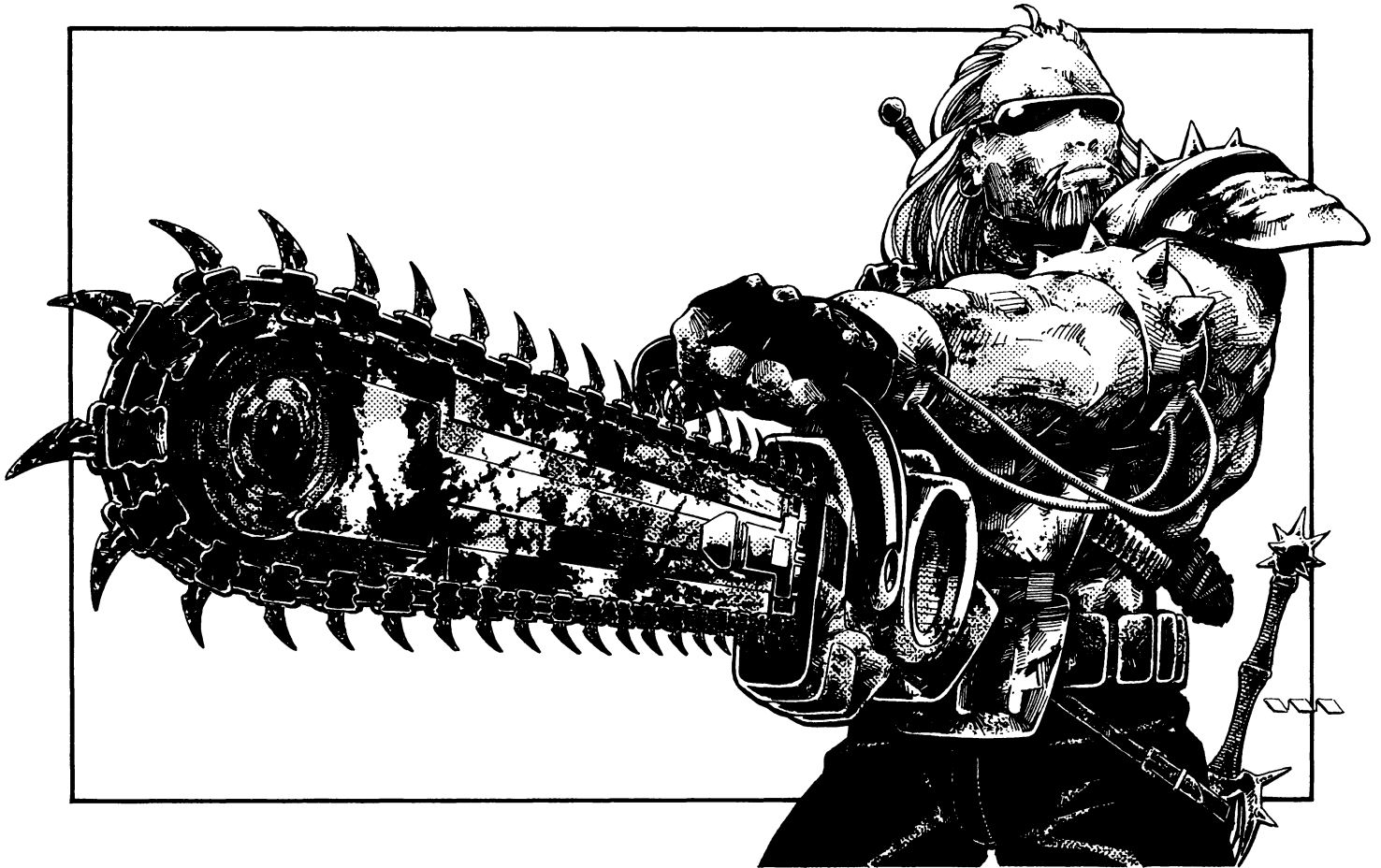

WI-C8 Close Combat Weapon System (W.I.) a.k.a. the Juicer Chainsaw

This Wellington Industries (W.I.) product is nothing more than a chainsaw with M.D.C. teeth, sharpened to a near-monomolecular edge. The saw bits use relatively cheap discarded or recycled M.D.C. alloys (often from damaged or destroyed power armor suits), but the sharpening process is very expensive. The chainsaw motor is powered by an E-clip, and is powerful enough to cut through almost any material if given enough time. The WI-C8 is very heavy and cumbersome, however. Normal humans who try to use it will be slow and clumsy with it. Juicers, however, have the strength and reflexes to use even this weapon without penalties.

Although somewhat archaic and useless in an era of ranged weapons, the chainsaw has a tremendous intimidation value and is a favorite in gladiatorial combat. The Juicer Army of Liberation has formed special shock troop groups armed exclusively with WI-C8's or WI-CL8's. In some encounters, CS detachments actually ran away when confronted with the sight of a charging mass of chainsaw-wielding maniacs.

Weight: 20 lbs. (9 kg).

Mega-Damage: When activated, the chainsaw inflicts 5D6 M.D.

Rate of Fire: Equal to hand to hand attacks.

Effective Range: Hand to hand combat only.

Payload: The E-Clip powers the chainsaw for one hour of continuous use. Every time the chainsaw is activated, it drains a minimum of one minute's worth of energy, even if used for less than a minute.

Penalties: Can only be used without penalties by characters with a P.S. 22 or higher or supernatural P.S. (any). Weaker characters will be at -4 to strike and -6 to parry.

Black Market Cost: 30,000 credits

WI-CL8 Multi-Purpose Weapon System (W.I.)

This variant on the Juicer Chainsaw mounts a laser rifle over the saw motor. This adds to the weapon's weight but gives its user a long-range attack. The heavy weapon requires a minimum P.S. of 24 to fire accurately, otherwise the user is at -4 to strike.

Weight: 28 lbs. (12.6 kg).

Mega-Damage: Chainsaw: 5D6 M.D. Laser: 3D6 M.D.

Rate of Fire: Each laser blast or saw strike uses one melee attack.

Effective Range: Laser: 2000 feet (610 m). Chainsaw: Hand to hand combat only.

Payload: Requires two E-Clips. The laser has 20 shots. The second E-Clip powers the chainsaw for one hour of continuous use. Every time the chainsaw is activated, it drains a minimum of one minute's worth of energy, even if used for less than a minute.

Penalties: -1 to strike with laser or chainsaw even by characters with a P.S. 24 or higher or supernatural P.S. (any). Weaker characters will be at -5 to strike and -7 to parry with the saw and -3 to strike with the laser (the weapon is heavy and unbalanced).

Black Market Cost: 45,000 credits.

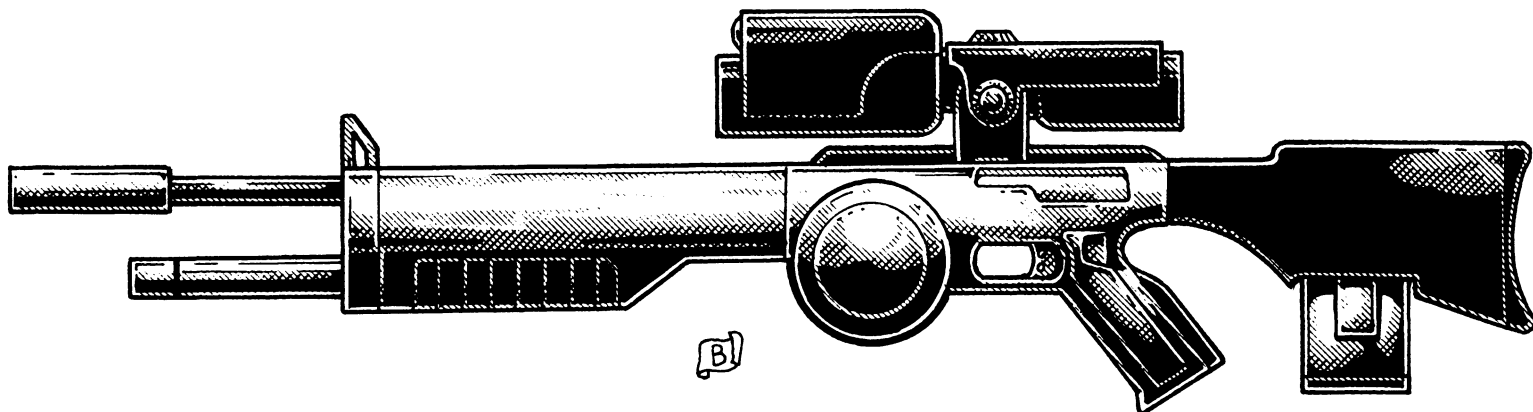

JA-12 Laser Rifle

Recently put into development, the JA-12 is a recreation of a pre-Rifts German design meant primarily for Juicers. The JA-12, like the JA-11, has an energy canister in addition to a normal E-Clip. More importantly, however, the weapon was optimized for both sniping and assault purposes. Not only can the laser fire accurate single shots, it can also fire multiple-pulse bursts (losing its targeting capabilities), and it also has a grenade launcher. Since it went into production, the JA-12 has been known as “the one-man-army rifle.”

The main shortcoming of the JA-12 is that it does not have a variable frequency setting (the multiple pulse system cannot be reset), making it less effective against Glitter Boys and similar laser resistant vehicles or robots.

Weight: 13 lbs. (5.85 kg).

Mega-Damage: A single shot inflicts 4D6 M.D. A triple-pulse shot does 1D6×10+10 M.D. (counts as one melee attack, but does not get the special targeting bonuses). Each grenade inflicts 3D6 M.D. to a 10 foot (3 m) radius.

Rate of Fire: Each single shot or burst uses one melee attack.

Effective Range: Laser: 4000 feet (1220 m); Grenade: 2000 feet (610 m).

Bonuses: +1 to strike on aimed/called shots, cumulative with other bonuses. No bonus for auto-pulse or grenades.

Payload: Standard E-Clip: 10 shots; long E-Clip: 30 shots. Energy canister (cannot be removed but is rechargeable) holds an additional 30 energy shots. The grenade launcher has a four-shot pump magazine and can be reloaded by hand.

Black Market Cost: 50,000 credits.

NG-H5 Holdout Ion Pistol

This weapon is manufactured by Northern Gun exclusively for its spy and security organizations. Its very existence was secret until the Black Market somehow got its hands on a shipment of several thousand NG-H5's. Knockoffs of the weapon can now be found for sale in many parts of North America. Use and possession of this weapon is illegal throughout most civilized parts of the continent, including the Coalition States. Finding such a weapon in the hands of anybody is usually grounds for imprisonment on the suspicion of being an assassin.

The NG-H5 is a Derringer-sized weapon that uses a specially manufactured mini-energy clip. The gun can fit in the palm of the hand and can be easily hidden in boots, hidden sleeve holsters, and even under light clothing (+6% to concealment rolls). More importantly, the original guns were built to foil most commonly-used weapons detectors, including most Coalition weapon detectors. Common systems (used at medium or low-level security areas) have no chance of detecting these weapons! More advanced systems (used at high-level security areas) have a 01-40% chance, depending on their complexity, at the G.M.'s discretion.

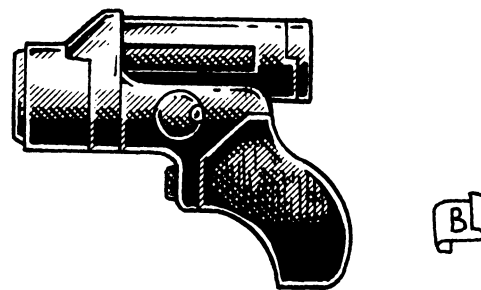

Juicer assassins love this highly concealable weapon; some even carry three or four of these guns, often putting two in sleeve/forearm speed holsters (see below) for maximum surprise and a spare in a boot or the small of the back.

Weight: Under one pound (0.45 kg).

Mega-Damage: 1D4+1 M.D. per shot.

Rate of Fire: Each laser blast uses one melee attack.

Effective Range: 200 feet (61.0 m)

Payload: 6 shots.

Black Market Cost: 50,000 credits.

Power Armor

NG-JK1A and 1B

Juicer Killer Power Armor

This armor suit marries a very light scout power armor with an advanced, “reflex” response system, increasing the speed and reflexes of the wearer, along with an advanced targeting computer tied to four energy weapons that can operate independent of the wearer!

The suit was designed to counter the tremendous speed and agility enjoyed by Juicers, other enhanced humans and many supernatural beings. For this purpose, an advanced computer system was built into the JK1A. The computer is tied to four weapons that operate in pairs, two lasers and two particle beam weapons. The computer is designed to follow and respond to (even predict) the movements of Juicers and other super-fast beings and compensate for it by “leading” the targets just enough to hit them despite their speed. The main result of this system is that Juicers, Crazies, etc., are not able to dance around gunfire with impunity, but must take evasive actions — effectively losing their automatic dodge against the special attacks of this weapon! When one on one, it’s as if the Juicer is facing three (3) foes, the computer with its two sets of weapons and eight attacks per melee, plus the pilot who can act independent of the computer (including performing other skills or attacking a different target).

Only a few hundred JK1A’s and B’s have been manufactured and sold. They are a rarity, expensive, and unproven in the field of combat. If they have a disadvantage, it’s that the armor is top heavy with the weapons clusters, missiles, and computer/sensors all being above the chest and shoulder like a giant collar. This makes running, leaping and quick hand to hand response difficult. The weapon collar also limits peripheral vision to about 90 degrees if the sensor systems and computer are knocked out. If the computer and its sensors are destroyed, the power armor pilot loses the extra eight attacks per melee round and is suddenly extremely vulnerable to enemy attacks, especially from the lightning quick enemy the suit is designed to combat. Still, as long as the computer is up and running and the four guns are intact, the JK1A and B are deadly in close and medium-range battles.

This Northern Gun specialty armor is popular in areas where Juicers and Crazies are outlawed or represent a serious problem. JK1A’s and B’s are in direct competition with the Defender Power Armor, a stolen Northern Gun design that is now being produced by the Black Market.

Model Type: NG-JK1: Models A or B. The “B” model is 10% larger with a little more armor protection and limited flight.

Class: Light Assault Exoskeleton

Crew: One

M.D.C. by Location: Numbers in parentheses are for the NG-JK1B, the more expensive and heavier armored model.

Chest Plates/Grenade Launchers (4) — 90 each (120 each)

Laser Guns (2, one on each side) — 25 each (30 each)

Particle Beam Guns (2, one on each side) — 30 each (40 each)

* Head — 60 (75)

Arms (2) — 90 each (120 each)

Forearm Mini-Rail Guns (2) — 40 each (60 each)

Legs (2) — 100 each (130 each)

*** Computer & Sensor Cluster (1, above head) — 80 (90)

** Main Body — 170 (210)

* Destroying the head of the power armor will eliminate all forms of optical enhancement and pilot sensory systems. The pilot must now rely on his own human vision and senses. No power armor combat bonuses to strike, parry and dodge, and reduce the computer’s number of attacks (8) to six, but the computer remains intact and operational. Striking the head requires a called shot at -4 to strike.

** Depleting the M.D.C. of the main body will shut the armor down completely, making it useless.

*** Destroying the targeting computer will nullify all the special anti-Juicers advantages, reducing the computer’s number of attacks per melee (8) to zero! The pilot must now control the four guns himself and each such use/attack counts as one of his own. The computer is a small target, requiring a called shot at -4 to strike.

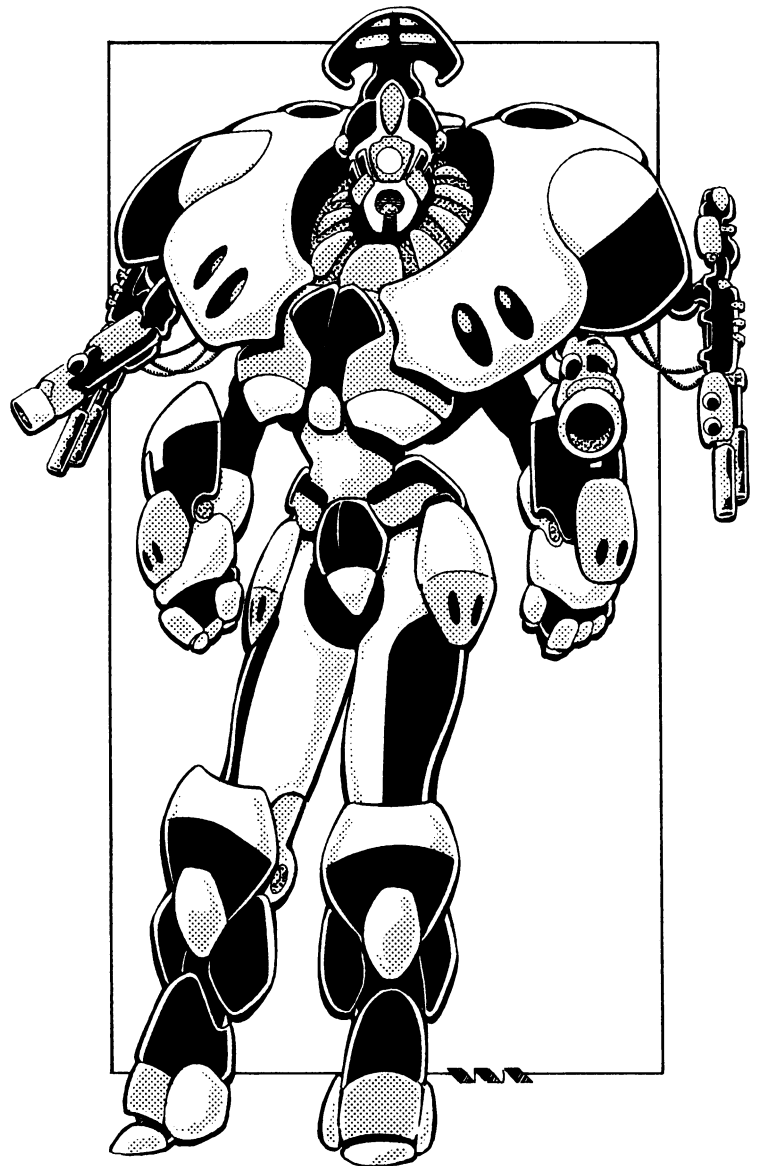

Speed:

Running: 90 mph (144.8 kmph) maximum. Note that the act of running does tire out its operator, but at 10% of the usual fatigue rate.

Flying: JK1A: None. Only the JK1B has thrusters built into the upper back, under the collar (70 M.D.C.), that enables the armor to fly in short bursts of five minutes. Maximum speed is 100 mph (160 kmph) and maximum altitude is a mere 300 feet (91.5 m).

Leaping: Unassisted leap reaches up to 25 feet (7.6 m) high or 30 feet (9.1 m) across. A jet booster assisted leap can propel the unit 100 feet (30.5 m) in any direction. This is applicable for both the A and B models.

Statistical Data:

Height: 7 feet (2.4 m)

Width: 4.5 feet (1.37 m)

Length: 4 feet (1.2 m)

Weight: 250 lbs. (112.5 kg).

Physical Strength: Equal to a P.S. 30

Cargo: None.

Power System: Nuclear; average energy life to 15 years.

Market Cost: 3.6 million credits for a new, undamaged suit of JK1A armor. The more advanced JK1B model costs 4.4 million credits. Drop the price by 2 million credits if the targeting computer is not included in the package.

Weapon Systems

1. Laser Guns (2): These two guns are mounted on the sides of the heavy shoulder plates. The lasers can be aimed by the computer system or the pilot.

Primary Purpose: Anti-personnel

Secondary Purpose: Defense

Mega-Damage: 3D6 M.D. per blast, or 6D6 M.D. per double blast (both lasers striking at the same target).

Rate of Fire: Equal to the number of hand to hand attacks of the pilot or the computer (4; two each). A double blast (both weapons firing simultaneously) counts as two melee attacks.

Effective Range: 4000 feet (1220 m)

Payload: Effectively unlimited.

2. Particle Beam Guns (2): These two weapons are on the lower section of the chest plates of the armor. They can also be controlled by the computer and provide more lethal power, but have a shorter range.

Primary Purpose: Anti-armor

Secondary Purpose: Defense

Mega-Damage: 5D6 M.D. per blast, or 1D6×10 M.D. per double blast (both particle beams striking at the same target).

Rate of Fire: Equal to the number of hand to hand attacks of the pilot or the computer (4; two each). A double blast (both weapons firing simultaneously) counts as two melee attacks.

Effective Range: 1600 feet (488 m)

Payload: Effectively unlimited.

3. Grenade Launchers (4): These four grenade launchers are built into the chest plates of the armor. They are used to clear out enemy infantry, to cover one's retreat with smoke, or with riot control/tear gas. This weapon can only be used by the pilot.

Primary Purpose: Anti-personnel

Secondary Purpose: Defense

Mega-Damage: Varies with grenade type.

Rate of Fire: One at a time, or volleys of two or four grenades.

Effective Range: 1200 feet (365 m)

Payload: 80 grenades total; 20 per launcher.

4. Forearm Mini-Rail Guns (2): Two double-barrelled mini-rail guns are built into each forearm. The pilot can fire one at a time, or aim both arms at a target and fire simultaneously, but such a tactic counts as two melee actions/attacks. These weapons can only be used by the pilot.

Primary Purpose: Anti-personnel

Secondary Purpose: Anti-armor

Mega-Damage: 2D6 M.D. per short burst (one arm) or 4D6 M.D. for both arms combined (counts as two melee attacks).

Rate of Fire: Short bursts only.

Effective Range: 2000 feet (610 m)

Payload: 40 short bursts per forearm.

5. Response Computer System (RCS): The most advanced system in the Juicer-Killer is a high-speed computerized sensor that reacts instantly to any movement and responds independently, as if by reflex, by shooting at the designated target. Furthermore, the computer will track a target relentlessly, focusing either two or four guns on it. The RCS only operates when the reflexes of the operator are not fast enough to deal with the situation, or when the pilot sets it on automatic assault or defense.

Against Juicers, the RCS neutralizes the Juicer's automatic dodge! The Juicer gets all his bonuses to dodge, but each dodge costs one melee attack/action. This is because the computer will relentlessly track and fire upon the target with two or four of its guns, forcing the Juicer to take evasive actions (thereby losing an attack/action) and allowing the pilot to concentrate on a different target, perform a skill, or to attack the same target!

Computer Combat Mode: The computer can track and attack two targets simultaneously (typically dividing the weapons in pairs). It is programmed to identify 3000 different enemy targets, including all known Juicer body armor and variant styling, Juicer gang insignias/colors, Crazies, vampires and several other dangerous beings and outlaws. Maximum sensor range is 5000 feet (1524 m).

Computer Attacks per Melee: Eight! Two per each of its four guns, per melee round. If a pair of weapons is aimed at the same target simultaneously (a standard tactic) the strike counts as *two* melee attacks (player can either roll one strike for both guns or one for each. He must announce his intentions before he rolls). The computer's independent actions frees the power armor pilot to engage in his own attacks/melee actions simultaneously.

Computer Combat Bonus: +2 on initiative and +1 to strike. These bonuses do not apply when the gun is under the control of the pilot. Each weapon can rotate 180 degrees up, down and sideways.

Glitches: If the computer and sensor array, located above and behind the head of the pilot, loses half or more of its M.D.C. one of the following may happen. Roll again for each additional 20 points of damage.

01-40 It loses one of the weapons and its two attacks per melee round (can't find it to shoot or to turn over control to the pilot).

41-60 Sensor damage, reduce strike bonuses by half.

61-80 Sensor damage, loses initiative entirely.

81-00 It forgets how to turn the weapons over to the pilot.

6. Pilot's weapon: The P.A. pilot can carry and use one or two hand-held weapons in addition to the weapon systems of the suit.

7. Hand to Hand Combat: Rather than use a weapon, the pilot can engage in mega-damage hand to hand combat.

Bonuses & Damage from NG-JK Hand to Hand Combat Training: Same for both Models.

- Restrained Punch: 1D4 M.D.
- Full Strength Punch: 1D6 M.D.
- Power Punch: 2D6 M.D.
- Kick: 1D6 M.D.
- Leap Kick: 2D6 M.D.
- +1 on initiative
- +2 to strike
- +1 to parry at levels one, three, six, ten and fourteen.
- No dodge due to the bulk and top-heaviness of the armor.
- +2 to roll with impact, punch or fall.
- +2 to pull punch.
- Body flip/throw is not possible because of the large weapon collar.
- Pilot gets +1 additional melee action/attack at levels one, five, and ten (plus the computer's additional 8 attacks per melee round!).

The Defender (J.A.P.E. II)

by Kevin Kirsten

The Juicer Apprehension Powered Exoskeleton system or J.A.P.E. was developed by Northern Gun to stem the growing tide of Juicer, M.O.M. and enhanced human crimes in the cities of the Midwest. The main goal of the project was to create a powered exoskeleton that could match the speed and strength of the chemically augmented super-humans, as well as to develop a method of non-lethal capture usable in both close-quarters and urban settings.

The prototype suit was built in 90 P.A., without any weapon systems. A year later, a number of non-lethal weapons were added to the suit. However, the project was shelved due to lack of interest, and Northern Gun turned its attention to developing more deadly types of armor like the JK1A & B Juicer-Killer. A decade later, the Black Market acquired the plans for the J.A.P.E. system during a raid on Northern Gun's R&D labs. The heads of the Black Market saw market potential for the suit with a few modifications. For the last six years, the J.A.P.E. II (commonly known as the Defender) has been sold by the Black Market at urban centers throughout North America.

The armor features a variety of non-lethal to lethal weapon systems, including a high-powered stun blaster, grenade launchers and variable frequency lasers. The stun system makes it desirable for the more humane law-enforcement agencies in such places as Lazlo (which has purchased several dozen), Laramy, and Kingsdale. By the same token, slavers and other criminals use the armor to kidnap people (using the stunner's non-lethal setting) and can substitute stun and riot control grenades for the more lethal varieties.

Model Type: BM-JAPEII

Class: Urban Assault & Capture Exoskeleton

Crew: One

M.D.C. by Location:

Arms (2) — 65 each

Neural Disrupter Rifle — 50

Forearm Mounted Variable Laser — 35 each

Shoulder Plates/Grenade Launchers (2) — 65 each

Capture Assault System — 20

Legs (2) — 120 each

Head — 100

* Main Body — 210

* Depleting the M.D.C. of the main body will shut the armor down, rendering it useless, and making the pilot vulnerable to attack.

Running: 120 mph (192 kmph) maximum! Note that the act of running does tire the operator, but at only 10% of the usual rate thanks to the robot exoskeleton.

Leaping: The powerful robot exoskeleton allows the operator to leap up to 30 feet (9.1 m) high or across unassisted by the jet boosters. A jet thruster assisted leap can propel the unit up to 120 feet (36.5 m) high and 200 feet (61.0 m) across. This is not flight, although the operator can maintain the thrusters to hover in place for up to 2D4×10 seconds before they begin to overheat.

Statistical Data:

Height: 8 feet (2.7 m)

Width: 2 feet, 8 inches (0.8 m)

Length: 4 feet (1.2 m)

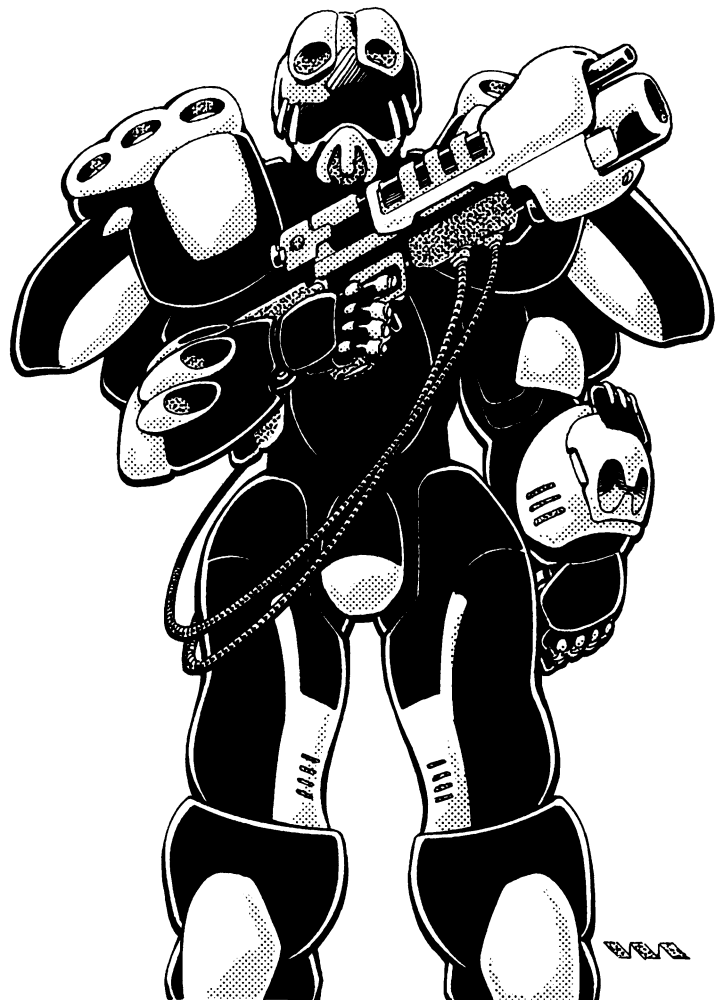

Weight: 800 lbs. (360 kg) without ammo or rifle, 1400 lbs. (630 kg) fully loaded.

Physical Strength: Equal to a P.S. of 30

Cargo: None

Power System: Nuclear with an average life of up to 10 years.

Black Market Cost: 1.1 million credits for a new, fully powered Defender complete with Neural Disrupter Rifle and a full complement of grenades.

Weapon Systems

1. Neural Disrupter Rifle: This marvel of modern weaponry was developed to be the ultimate answer to the chemically augmented humans running amok in the Midwest. The rifle fires a concentrated electrical pulse that disrupts the target's neural impulses, affecting all functions of the body, from cognitive thought to simple motor reflexes. The weapon has two settings. Setting one is meant to be used on unaugmented humanoids, while setting two is specifically geared towards Juicers and other augmented humans. The major advantage of the rifle is that the pulse blast will affect those in most light mega-damage body armor (50 M.D.C. or less). Those in armor with 51-80 M.D.C. are +6 to save. Those in heavier armor, power armor, vehicles, or robots or full conversion 'Borgs are impervious. Dragons, Mega-Juicers and most supernatural creatures are also impervious.

Primary Purpose: Anti-Juicer/Anti-personnel.

Secondary Purpose: Assault

Mega-Damage: Two types

Setting One: The pulse inflicts 2D6 S.D.C. and the victim must roll to save vs non-lethal poison (16 or higher to save). A successful *save* means that the victim is -3 to strike, parry and dodge and loses initiative and one melee attack for 1D4 rounds. A failed save means that the character is -7 to all actions, has no initiative, attacks/actions per melee are reduced to *one*, skill performance is -60%, and speed is reduced 90%, plus he suffers from painful seizures inflicting 1D6 S.D.C. per round for 2D4 rounds.

Setting Two: This setting is geared for augmented humans and will *kill* normal humans. The pulse inflicts 2D6x10 S.D.C. (roughly one M.D. point) and the victim must roll to save vs non-lethal poison (16 or higher to save). A successful save means that the augmented victim is -5 to strike, parry, and dodge, plus loses initiative and one melee attack for 1D4 rounds. A successful save by ordinary humans means the character is -10 to all actions, has no initiative, attacks/actions per melee are reduced to *one*, skill performance is -80%, and speed is reduced 95%, plus he suffers from painful seizures inflicting 1D6 S.D.C. per round for 2D4 minutes, if he survives at all!

A failed save by an augmented opponent (Juicer, Crazy, etc.) means that the character is -7 to all actions, has no initiative, attacks/actions per melee are reduced to *two*, skill performance is -60%, and speed is reduced 80%, plus he suffers from painful seizures inflicting 4D6 S.D.C. per round for 2D4 rounds.

Rate of Fire: Up to four blasts per melee.

Maximum Effective Range: 1200 feet (365 m)

Payload: Effectively unlimited; tied into the nuclear power supply of the power armor.

2. Shoulder Mounted Grenade Launchers (2): Two anti-personnel grenade launchers are set into the shoulders of the armor.

Primary Purpose: Anti-Personnel

Secondary Purpose: Defense

Mega-Damage: Any grenade type can be used but standard issue is *tear gas* (covers a 25 foot area/7.6 m and lasts for 3D4 minutes. Victims are -10 to strike, parry and dodge as well as -3 to initiative and one melee attack for 1D6 rounds), *concussion* (1D4 M.D. to a 20 foot area/6.1 m. Has a 01-75% chance to knock opponents off their feet and 01-60% to be stunned. Victims of a knockdown are -1 on all attacks for the first melee. Stunned victims are -10 on all actions and is the last to attack in a melee.), and *fragmentation* (2D6 M.D. to a 30 foot/9.1 m area).

Rate of Fire: One at a time, or in volleys of two, four or six.

Maximum Effective Range: 1200 feet (365 m)

Payload: 24 total; 12 per launcher. Typical mix is eight of each grenade type.

3. Forearm Mounted Variable Frequency Laser: This medium-power laser is built into the right forearm and serves as a backup weapon in case the other weapons were rendered inoperable. The targeting computer within the suit will adjust to an opponent's armor within 1D4 melees and recalibrate the laser's frequency to best penetrate his opponent's armor.

Primary Purpose: Assault

Secondary Purpose: Defense

Mega-Damage: 3D6 M.D. or 6D6 M.D.

Rate of Fire: Standard

Maximum Effective Range: 2000 feet (610 m)

Payload: Effectively unlimited; tied into the nuclear power supply.

4. Capture Assault System: The capture system works along the same lines as a rail gun or electro-magnetic mass driver. But instead of firing slugs or metal bearings the weapon fires mega-damage polymer bolas at rough speeds of up to 200 mph (320 kmph)! Victims of this attack are bound by a high tensile, polymer wire that is incredibly resistant to damage (M.D.C. of 10). Characters must have a supernatural strength of 20 or a robot strength of 30 to break free. Bound characters cannot run, lose initiative and all combat bonuses are reduced by half.

Primary Purpose: Capture

Secondary Purpose: Defense

Mega-Damage: 5D6 S.D.C.

Rate of Fire: Twice per melee.

Maximum Effective Range: 3000 feet (914 m)

Payload: 10 shots

5. Hand to Hand: Rather than use weapons, the pilot can engage in mega-damage hand to hand combat. See basic and Elite Power Armor Combat Training in the *Rifts RPG*, page 45. All abilities are the same except as follows:

Kick: 2D6 M.D.

Leap Kick: 4D6 M.D.; counts as two attacks.

An additional +1 to dodge and roll with punch at levels 2, 6 and 12.

Ground Vehicles

By Vince Martin,
with additional material by C.J. Carella

A specialty niche has developed in the vehicle industry over the last ten years in answer to the growing number of physically enhanced customers. Augmented humans like the Juicer and Crazy found the speed and reaction times of standard vehicles to be painfully sluggish. Previously, standard automobiles and motorcycles were modified by operators and amateur mechanics for higher overall performance and impromptu combat situations. When the vehicle manufacturers realized the potential for this sub-market, they began development of a variety of vehicles specifically for enhanced humans, with price tags reflecting the buyers' needs and greater ability to pay. To a Juicer, spending 100,000+ credits on a bike or jeep is worth it, considering that they do not really need to save money for the future.

The super-human population received these new designs with overwhelming enthusiasm, especially Phaeton Juicers and those with a passion for driving. Inevitably, boastful riders began to brag of their feats and vehicles. Always one to accept a challenge, Juicer drag and road races have become commonplace, from spontaneous duels to organized competitions. Furthermore, the added and enhanced capabilities of the new vehicles gives their riders additional avenues of debate and challenge, such as jumping and marksmanship while traveling at dizzying speeds.

The vehicle customizing industry booms as well. Customers longing for a car or motorbike more reflective of their personal tastes, line up at many garages scattered throughout the cities and villages that can give them what they want. In most cases, cash and discretion are all that is required for modifications ranging from a new paint job to the installation of a black market weapon system. These underground garages are particularly common in the West and Southwest, where the road systems that survived the Coming of the Rifts are in better shape and the land itself offers wide-open flatlands.

Because of the elevated sensitivity of the control inputs, normal humans find it very difficult to operate these specialty vehicles, and do not gain any of the skill bonuses they may provide augmented humans. In fact, if attempting any type of difficult maneuver, a non-augmented driver/rider must make a skill check at -30%.

Special note: Top speeds listed for the following wheeled vehicles assumes a perfect driving surface (i.e., a maintained concrete or asphalt road, salt flat, etc.) of at least one mile (1.6 km) in length, conditions seldom seen in the post-Rifts world, at the places that allow these vehicles. Over broken terrain, exceeding cruising speed always has a risk of loss of control and other catastrophes (-10% to piloting skill).

Tarantula Combat Jump Bike (UTI)

The Tarantula combat jump bike is a fast and highly maneuverable motorcycle developed specifically for riders with enhanced physical abilities. It is moderately armed, but lacks the structural integrity to withstand great amounts of damage.

Powering the Tarantula is a flex-fuel powerplant enabling it to operate on fossil fuels, propane, or compressed natural gas (CNG), depending on what is available. Sensors in the engine management system automatically detect which fuel is being administered. The bike may also rely on electric motors mounted in the wheel hubs and high-efficiency batteries for a limited time, but at the cost of overall performance (revised figures are in parentheses). The jump thrusters can use only CNG, which is stored in a separate tank with a five jump capacity.

The jump system provides the bike and a physically-enhanced rider with the ability to make extremely long airborne jumps/leaps. Jumping distance is calculated by tripling the current speed in Miles Per Hour (mph). This is the number of yards/meters the Tarantula remains airborne. Jump height is double the speed in inches.

Anti-lock braking, traction control, active aerodynamics, and solid rubber tires are all standard features on the tarantula, as well as a fully-active suspension, which detects irregularities in the surface ahead and automatically adjusts the ride height and firmness settings to provide optimum handling. Also included is an armored interface helmet, which is connected by fiber-optic cables to the bike and provides all the benefits of a Juicer optics helmet in addition to H.U.D. readouts of the Tarantula's vital statistics, including remaining jump fuel and E-Clip status.

Model Type: High performance motorcycle

Crew: One

M.D.C. by Location:

Main Body — 100

* Wheels (2) — 12 each

* Weapons — Pulse lasers (2) 15 each

* Thrusters (2) — (bottom) 25, (rear) 25

* A single asterisk indicates targets that are difficult to hit (-3 on a called shot).

Acceleration (0-60): 3.1 seconds (rocket assisted).

Top speed: 200 mph. (320 kmph) (150 mph/240 kmph with electrical battery).

Cruising Speed: 100 mph (160 kmph).

Braking (60-0 mph): 75 feet (23 m)

Jump Jet: The maximum length the bike can jump is equal to nine feet (2.7 m) for every mile (1.6 km) per hour being traveled; for example, a bike going at 100 mph (160 km) could jump as much as 900 feet (270 m)! The bike can jump up to five times before the jump tanks need to be refueled.

Range: 500 miles/800 km (12 hrs. continuous operation with electrical battery).

Statistical Data:

Height: 4 feet, 1 inch (1.2 m)

Width: 3 feet, 10 inches (1.18 m)

Length: 8 feet, 7 inches (2.6 m)

Weight: 1545 lbs. (695.25 kg)

Power System: Flex-fuel internal combustion, with electric backup.

Skill Bonus for Augmented Humans: +15% to piloting skill and execution of jumps, tricks, and special maneuvers.

Market Cost: 80,000 credits

Weapon System

1. Pulse Lasers: Mounted in the forward cowling of the tarantula are twin pulse lasers. They point in the same direction as

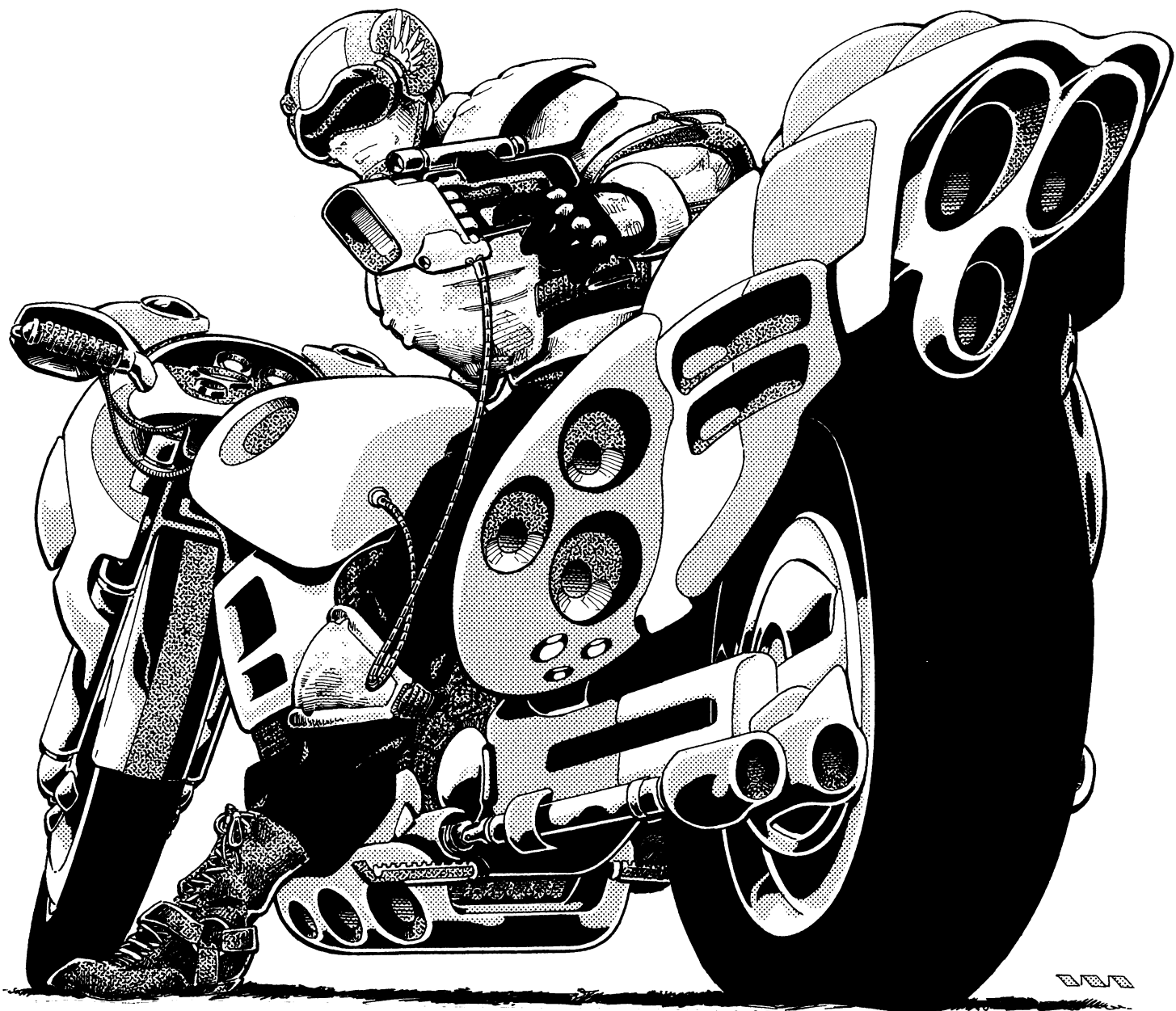

the front wheel, so it is possible for an augmented human to fire quick shots to the sides (30 degree angle/arc of fire) while the bike continues traveling straight. However, these side-shots do not gain the usual +1 bonus to strike for bursts, and the tarantula must be traveling no more than 120 mph (36.5 m). The weapons are powered by standard E-Clips inserted into two slots near the bike's controls.

Mega-Damage: 1D4×10 M.D. per simultaneous three shot burst.

Rate of Fire: Three shot bursts only

Effective Range: 1600 feet (488 m).

Payload: 30 triple shots bursts (short E-Clip only).

Road Boss Combat Chopper (W.I.)

The Road Boss heralds back to the pre-Rifts days of long, wide-open highways and heavy touring bikes designed to cruise mile after mile in relative comfort. Neither as fast or as nimble as most modern motorcycles, the Road Boss nonetheless requires a skilled pair of hands to fully extract every ounce of its formidable capabilities. Its low-slung, extended-fork design makes for a distinctive profile, a lower center of gravity, and promotes a retro "chopper" look popular in pre-Rifts days. Added to this is a heavily reinforced chassis and substantial armor, making the Road Boss combat chopper a menace to all who find themselves at the wrong end of her weapon systems. Juicers love the vehicle, which has spawned entire nomadic gangs of enhanced bikers.

Like the Tarantula, the Road Boss boasts a flex-fuel powerplant. However, while it does possess a larger capacity fuel cell, it does not have the electric backup motor in case of emergency. The heavily protected batteries are utilized solely for the vehicle management computer and its weapon systems.

The Road Boss is full-featured and boasts anti-lock brakes, traction-control, active suspension, and high-density, solid rubber tires, as well as a custom set of interface goggles or sunglasses that provide the same benefits as the Tarantula's interface helmet without the head protection.

Model Type: Motorcycle

Crew: One

M.D.C. by Location:

Main Body — 200

* Wheels (2) — 30 each

"Catapult" cannon — 75

* Mini-missile launchers (2) — 20 each

* Lasers — 5 each

* A single asterisk indicates targets that are difficult to hit (-3 on a called shot).

Top speed: 185 mph (296 kmph).

Acceleration (0-60): 4.4 seconds (rocket assisted).

Braking (60-0): 90 feet (27.4 m)

Range: 725 miles (1160 km)

Statistical Data:

Height: 3 feet, 10 inches (1.2 m)

Width: 4 feet, 4 inches (1.3 m)

Length: 16 feet (4.9 m)

Weight: 1850 lbs. (832.5 kg)

Power System: Flex-fuel internal combustion.

Skill Bonus for Augmented Humans: +10% to piloting skill and execution of jumps, tricks, and special maneuvers.

Market Cost: 200,000 credits with full weapon systems; 90,000 stripped of all weapon systems. Although originally produced by Wellington Industries, both Northern Gun and Golden Age Weaponsmiths offer comparable vehicles at comparable prices.

Weapon Systems

1. W.I. "Catapult" Assault Cannon: The Wellington Industries "Catapult" is a large-bore cannon that fires a high-explosive, armor-piercing shell. The cannon is mounted on either the

right or left side of the Road Boss to accommodate the rider's handedness, and is aligned over the shoulder similar to the Glitter Boy's "Boom Gun." Compensator thrusters dampen the cannon's recoil and the off-center adjustments to the bike's direction.

Mega-Damage: 1D6×10 M.D. (armor-piercing explosive) to a 3 foot (0.9 m) area.

Rate of Fire: Once per melee round; it takes the magazine some 10-12 second to "cycle" a new shell.

Effective Range: 4000 feet (1220 m).

Payload: 20 shells.

2. Mini-Missile Launchers (2): As a styling nod to the "choppers" of old, the Road Boss sports two pairs of mini-missile tubes along the sides of the bike that sweep to the rear and resemble exhaust pipes. The missiles fly up and then self-guide towards the designated target.

Mega-Damage: Varies with missile type.

Rate of Fire: One at a time, or volleys of two, three, or four.

Effective Range: One mile (1.6 km).

Payload: 16 total; eight per launcher.

3. Variable Lasers (3): A triple brace of light, variable-frequency lasers adorn the front cowling of the bike. They are typically fired in a forward position, but may be fired to the sides, the same as the Tarantula Jump Bike, but only at speeds of under 90 mph (144 kmph). An E-Clip slot points straight up beside the pilot seat, and can use a long or short clip.

Mega-Damage: 1D6+6 M.D. for center laser only; 4D6 M.D. for all three firing simultaneously.

Rate of Fire: Standard

Effective Range: 4000 feet (1220 m).

Payload: 30 single blasts, or 10 triple-blasts per long clip.

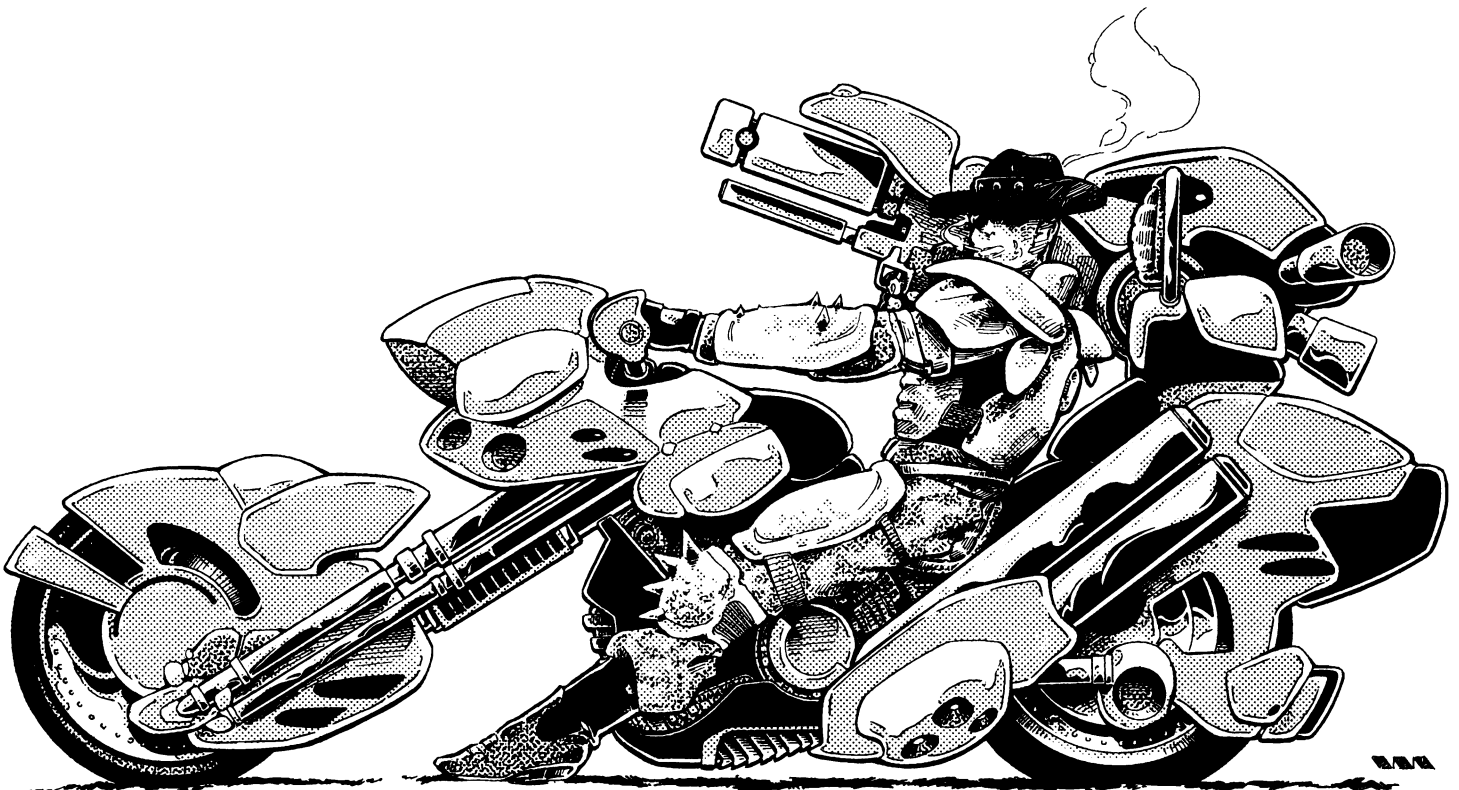

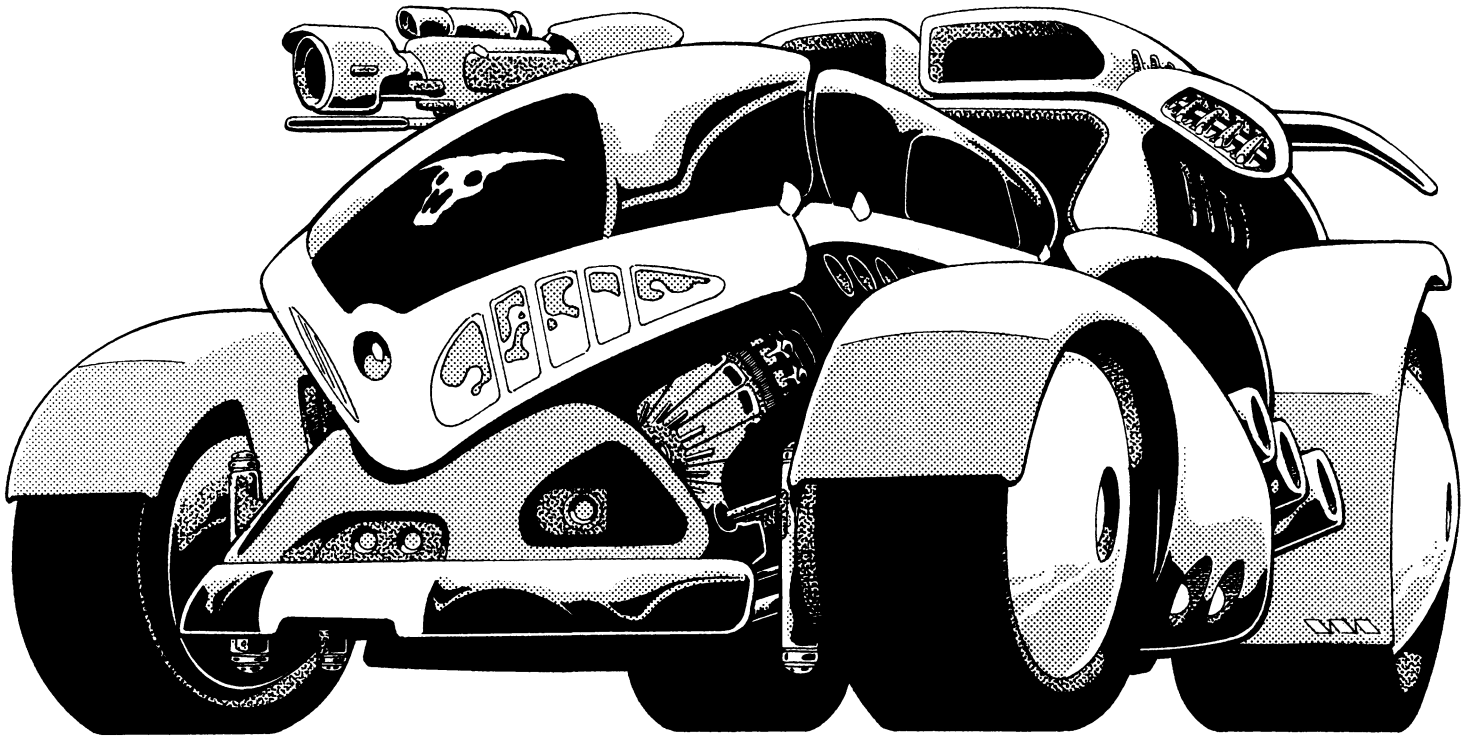

“Rolling Thunder”

All-Purpose Vehicle

The Rolling Thunder APV is equally at home on and off the road. It is a four-wheeled, open-cockpit vehicle featuring most of the same standard equipment as the two previous motorcycles, along with a few extras. The Thunder’s variable suspension, while fully-active, can be adjusted from 4 to 24 inches overall ground clearance for extremely adverse terrain. However, at ride heights over six inches (0.15 m), skill bonuses are negated due to the vehicle’s higher center of gravity. Anti-lock brakes, traction-control, solid-rubber tires, and a flex-fuel powerplant with electric backup are all standard fare. Vital vehicle statistics are projected onto the forward windshield via a colorful and detailed H.U.D. system.

The Rolling Thunder’s main weapon is the NG-202 Rail Gun provided by Northern Gun and mounted on the right side of the vehicle. It must be operated by a passenger/gunner. Other armaments include twin particle beams and a unique mobile mine deployment system. The mine system is particularly useful for discouraging pursuers, and to help block off an area, slowing reinforcements and invaders until the mines are cleared. The vehicle is a favorite of Juicer mercenaries.

Model Type: APV

Crew: One pilot and can accommodate three passengers comfortably.

M.D.C. by Location:

Main Body — 155

* Wheels (4) — 35 each

Rail Gun — 50

* Particle Beam Guns (2) — 20 each

* A single asterisk indicates targets that are difficult to hit (-2 on a called shot).

Acceleration (0-60): 5.7 seconds (6.5 with the battery system)

Top speed: 166 mph/265 kmph (142 mph./227 kmph with the battery system).

Braking (60-0): 100 feet (30.5 m)

Maximum Range: 525 miles/840 km (18 hrs. continuous operation with the battery system).

Statistical Data:

Height: 5 feet, 6 inches (1.65 m)

Width: 6 feet, 8 inches (2.0 m)

Length: 20 feet (6.1 m)

Weight: 2875 lbs. (1295 kg)

Power System: Flex-fuel internal combustion, electric back-up

Skill Bonus for Augmented Humans: +10% to piloting skill and execution of jumps, tricks, and special maneuvers.

Black Market Cost: 275,000 credits; manufactured by Wellington and Northern Gun.

Weapon Systems:

1. NG-202 Rail Gun: This weapon cannot be operated by the pilot while driving the vehicle. It features a laser tracking system, and gains a +1 bonus to strike.

Mega-Damage: Burst is 40 rounds and inflicts 1D4×10 M.D. One round does 1D4 M.D.

Rate of Fire: Standard

Effective Range: 4000 feet (1220 m).

Payload: As a machinegun: 300 round belt

2. Twin Particle Beams: These forward weapons are connected to the steering linkage, and can be fired to the sides as per the Tarantula rules. Standard E-Clips can be emptied into an energy reservoir cell, which provides a 50 shot storage capacity of ammunition.

Mega-Damage: 5D6 M.D. per single blast or 1D6×10 per double blast (counts as one melee attack).

Rate of Fire: Standard

Effective Range: 1200 feet (365 m).

Payload: 50 single shots or 25 double.

3. Mobile Mine Deployment System: This voice-activated weapon tracks pursuing vehicles (including robots and power-armor in excess of 7 feet/2.1 m tall), then releases one

of three grades of NG anti-vehicle plasma mines designated by the pilot: light, medium, or heavy. The system then detonates the mine by radio command. A built-in safety prevents a mine from being detonated within range of the Rolling Thunder. Pursuers may alter course to avoid the mines, but in so doing, lose considerable ground.

The mines can also be dropped and set to be activated when a target comes into range (30-70 feet/9.1 to 21.3 m). This feature allows the crew of the Jeep to spread their mines along a road to prepare an ambush.

Mega-Damage: Varies by mine type (carries all three types); ideal for blowing out tires and damaging the feet of robots.

Light: 6D6 M.D. to a 30 foot/9.1 m area.

Medium: 1D6×10 M.D. to a 30 foot/9.1 m area.

Heavy: 3D4×10 M.D. to a 70 foot/21.3 m. area.

Rate of Fire: One per melee round (15 seconds).

Effective Range: The radio transmitter has a roughly 3000 foot (914 m) range.

Payload: 12 total; four of each type. Mines cost 400 credits for light, 600 credits for medium, and 1000 credits for heavy.

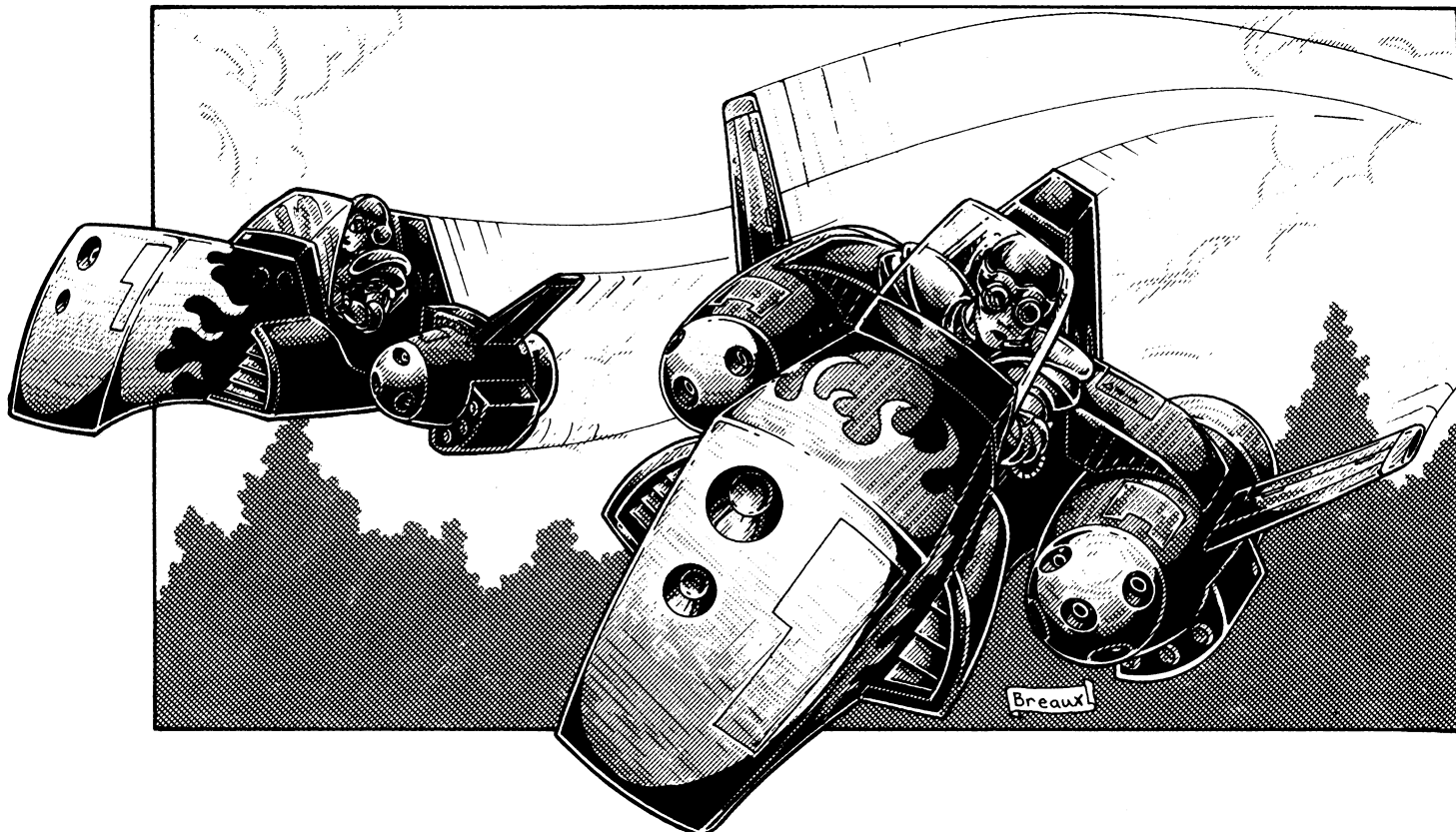

Aircraft

Assault Hover Bike (W.I.)

This combat vehicle is Wellington Industries' answer to Northern Gun's Sky King. This small hovercraft is slower and has a lower ceiling (5,000 feet/1524 m against 10,000 feet/3050 m for the Sky King), but it is more heavily armed and armored, with the firepower of an attack helicopter in a compact one-man vehicle. Since its creation, the AHB-2000 has been fairly popular among mercenaries and independent kingdoms, especially since its price tag is lower than the Sky King's.

Armed with two particle beam weapons, six lasers and six mini-missiles, the hover bike can "hose" an area and decimate infantry soldiers in the open. Furthermore, the vehicle has a very small profile, making it difficult to hit by normal hand weapons. Against other aircraft, or enemies with good anti-aircraft weapons, however, the AHB-2000 has proven to be something of a sitting duck and a disappointment. Still, there is a market for the vehicle, and hundreds of them have become involved in the uprising against the Coalition.

Model Type: AHB-2000

Class: Light Combat Hoverbike

Crew: One.

M.D.C. by Location:

Side-Mounted Laser Pods (2) — 65 each

* Side-Mounted Missile Launchers (2) — 35 each

* Forward P-Beam Guns (2) — 15 each

* Pilot's Windshield (1) — 25

Rear Thrusters (3) — 60 each

Main Body — 190

* A single asterisk indicates targets that are difficult to hit (-2 on a called shot). Reducing the M.D.C. of the main body destroys the aircraft. Destroying one thruster reduces speed by 33% and inflicts a -10% piloting penalty.

Speed:

Driving on the ground: Not possible.

Flying: The hover propulsion system enables the bike to hover stationary up to 1,000 feet (305 m) or fly. Maximum flying speed is 300 mph (480 kmph), but cruising speed is considered to range between 100 and 200 mph (160 to 320 kmph). Maximum altitude is about 5,000 feet (1524 m).

Range: The hover jets need to cool down after a maximum of 12 hours at speeds above cruising, and 24 hours at cruising speeds. By taking short rest periods and staying at cruising speed, the vehicle can fly almost indefinitely.

Statistical Data:

Height: 4 feet (1.2 m)

Width: 6 feet (1.8 m) counting the weapon pods on the sides.

Length: 9 feet (2.7 m)

Weight: 800 lbs. (360 kg) fully loaded.

Cargo: Small pilot's compartment, large enough for a hand weapon and a few possessions.

Power System: Nuclear; average energy life of 10 years.

Market Cost: 900,000 credits for a new, undamaged, fully equipped AHB-2000

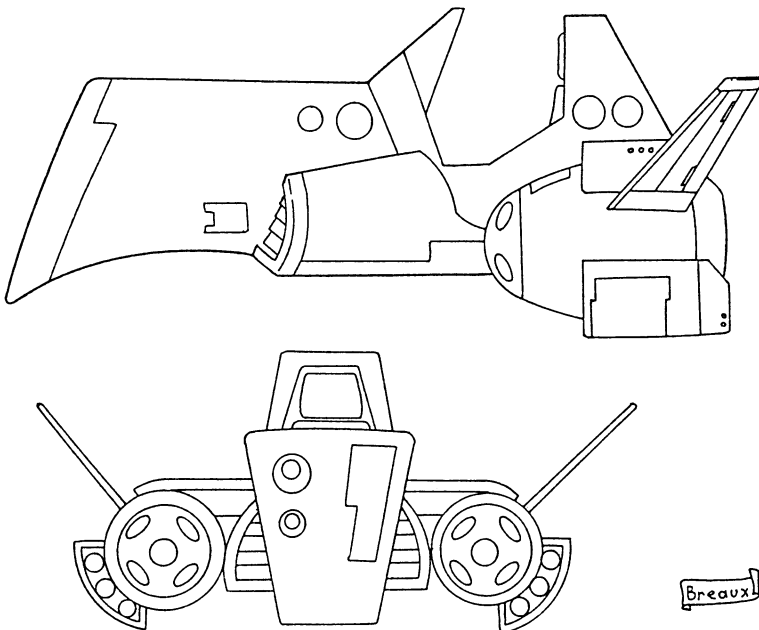

Weapon Systems

1. Particle Beam Guns (2): These “over and under” energy cannons are mounted in the nose of the vehicle. They are used in dogfights against other aircraft, or to strafe at close range.

Primary Purpose: Anti-aircraft.

Secondary Purpose: Anti-personnel.

Mega-Damage: A single blast from one gun inflicts 5D6 M.D.; a double blast (counts as one attack) inflicts 1D6×10 M.D.

Rate of Fire: Equal to the number of hand to hand attacks of the pilot.

Effective Range: 1600 feet (488 m)

Payload: Effectively unlimited.

2. Laser Pods (2): These side-mounted pods have five lasers each; the lasers can be focused to hit an area, or to strike a single target with as many as all ten laser beams!

Primary Purpose: Anti-personnel

Secondary Purpose: Defense

Mega-Damage: Each laser beam does 1D6 M.D. A refocused blast of five lasers does 5D6 M.D. and both pods can attack one target simultaneously for 1D6×10 M.D. When “hosing” an area, one attack roll “hits” all small targets in a 30 foot (9.1 m) diameter for 1D6 M.D. or one large (tank, truck, giant robot, dragon, etc.) for full 1D6×10 M.D. but peppers the entire body; targets are -3 to dodge.

Rate of Fire: Equal to the number of hand to hand attacks of the pilot.

Effective Range: 6000 feet (1830 m)

Payload: Effectively unlimited.

3. Mini-Missile Launchers (2): A mini-missile launcher is located on each side of the hover bike.

Primary Purpose: Anti-vehicle

Secondary Purpose: Defense and anti-personnel.

Mega-Damage: Varies with missile type.

Rate of Fire: One at a time, or in volleys of two, three or six missiles.

Effective Range: About one mile (1.6 km)

Payload: Six total; three per launcher.

Icarus Flight System (UTI)

This UTI vehicle is designed solely for Juicers or similarly augmented humans, especially the Phaeton Jucier. Part jet pack and part jet fighter, a fully assembled Icarus has a wingspan of about 12 feet (3.65 m) and has Vertical Take-Off and Landing capabilities as well as impressive jet propulsion. Its speed is enough to match some jets'. Only a Jucier, 'Borg or D-bee with superhuman strength and endurance can survive the G-forces generated by the vehicle.

The Flight Pack can be worn normally, or it can be controlled via remote control. Experienced pilots can direct the jet pack by remote control from the ground, ordering it to attack designated targets. The pack is attached to the pilot's armor by a special magnetic seal, and can be removed in a matter of seconds (detaching from the Icarus counts as one melee attack/action). Jucier pilots often have the IFS fly up first, and then they jump up and connect with the wings in mid-air, just to show off.

Disassembled, the modular vehicle can fit into the bed of a pickup truck or on the roof of a jeep, allowing a lightly-equipped group of adventurers to enjoy the resources of a jet fighter without needing hangars or heavy transport vehicles. The Icarus will become the core of the Juicers' “air force” during the Jucier Up-rising, destroying dozens of Coalition Jet Cycles and holding their own against jet fighters.

Model Type: IFS-1

Class: Combat Flight System

Crew: One

M.D.C. by Location:

*** Wings (2) — 120 each

Wing Thrusters (6; three per wing) — 35 each

Main Thrusters (3; rear, main body) — 45 each

Mini-Missile Launchers/Jet Systems (2) — 90 each

Forward Lasers (2) — 20 each

** Main Body — 120

* Pilot — As per body armor.

* The pilot of the Icarus is in the open, and can be targeted by a “called shot.” The pilot's M.D.C. body armor protects as normal. Killing the pilot will cause the Icarus to crash.

** Depleting the M.D.C. of the main body causes the aircraft to crash.

*** Destroying one wing will cause a loss of speed and control: reduce speed 33%, dodge bonus by half, and -30% to piloting skill. The missile launcher on that wing is also lost.

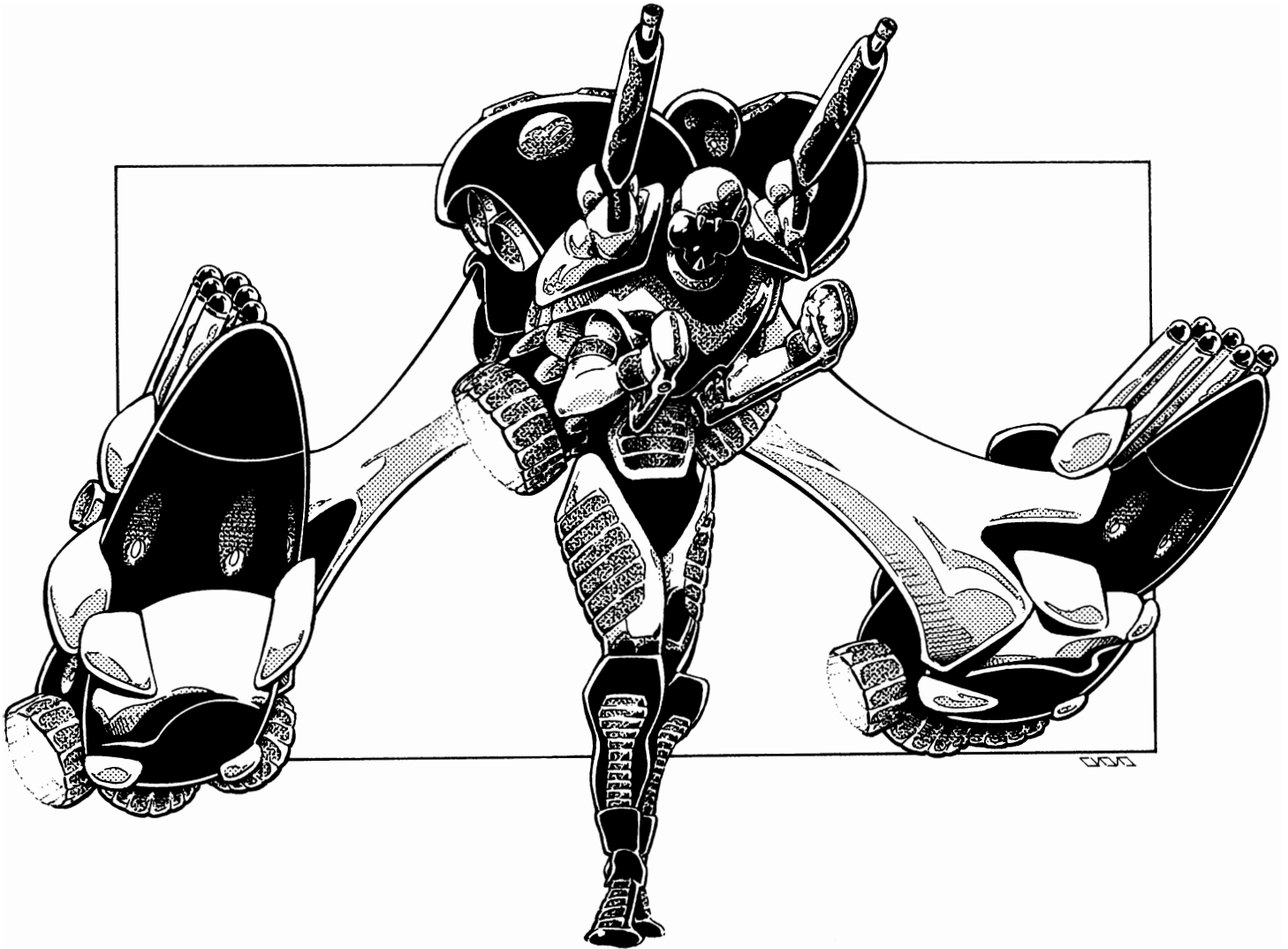

Note: The new skill *Flight Pack Combat* is needed to pilot this vehicle.

Speed:

Driving on the ground: Not possible.

Flying: Up to Mach One (670 mph/1078 kmph)! Only a Juicer, 'Borg or supernatural creature can survive the G-forces and stress placed on the pilot. Cruising speed is usually 300-400 mph (480-640 kmph); VTOL capable.

Range: Although the nuclear reactors operate for years, the jets need cooling off after 10 hours of continuous use at cruising speeds, or six hours at maximum speed. Maximum Altitude is 20,000 feet (6096 m)!

Statistical Data:

Height: 5 feet (1.5 m)

Width/Wingspan: 12 feet (3.6 m full wingspan).

Length: 4 feet (1.2 m)

Weight: 1000 lbs (450 kg); only a Juicer or super-strong being can stand up under the weight.

Cargo: None.

Power System: Nuclear; average energy life is five years.

Market Cost: 3.2 million credits. Fair to poor availability. The CS has outlawed this jet pack.

Weapon Systems

1. High-Powered Laser Guns (2): These weapons are mounted on the front end of the Icarus, but can rotate in a 90 degree arc in all directions. They can be used to strafe ground targets and engage in aerial combat.

Primary Purpose: Anti-aircraft

Secondary Purpose: Anti-personnel and ground vehicles.

Mega-Damage: 5D6 M.D. per single blast, 1D6x10 per double blast (counts as one melee attack).

Rate of Fire: Equal to the number of hand to hand attacks of the pilot.

Effective Range: 4000 feet (1220 m)

Payload: Effectively unlimited.

2. Mini-Missile Launchers (2): The tip of each wing holds six mini-missiles, usable against both ground and air targets.

Commonly used missiles include plasma and armor-piercing.

Primary Purpose: Anti-aircraft

Secondary Purpose: Defense

Mega-Damage: Varies with missile type.

Rate of Fire: One at a time, or in volleys of 2, 4, 6 or 12 mini-missiles.

Effective Range: About one mile (1.6 km).

Payload: 12 total; six per wing launcher.



Juicer Organizations

Described below are a few groups, organizations and mercenary companies where Juicers play an important role.

The Valkyri

“They was no ladies, that’s for sure.

“We was just doing a simple patrol mission. A D-Bee village had sprung up in the three weeks since we’d done a Search and Destroy, so the Lieutenant had us torch it. He had no problems with us helping ourselves to some loot beforehand — the Skelebots took care of running out the uglies, so it was no sweat. So we load up the Mark V with stuff — gold, jewels, booze — them D-Bees sure knew how to live — and we head back for HQ, with a little pre-planned stop at the ‘Burbs to sell the stuff.

“Then a land mine explodes under the front wheels and we figure things ain’t going according to plan no more.

“Four or five or us were on the outside, holding on to the turrets — it’s cooler, and we get to see around us. When the Mark V swerves, me and two other guys get knocked clear off. I musta bumped my head, ‘cause I blacked out for a few.

“When I come to, it’s all over but the shouting. The Mark V’s pilot compartment is burning, and the Skelebots are in pieces. The rest of the squad are all trussed up or dead, and all these chicks are unloading the loot and CS issue guns and E-Clips, and stuff. They was piling it on three ATVs, painted in camy.

“I ain’t kidding. All of ‘em were girls! Juicer chicks! They were having a big laugh as they drove away.

“Did I do anything? Umm. No. I mean, alls I’ve got is my service laser pistol an’ they’ve got grenade launchers, rocket launchers, rail guns, bazookas — and hell, they’re Juicers! Chicks or no. One grunt like me ain’t got a chance ‘gainst them! So ... I ... didn’t do anything. My head still felt a little woozy too. Did I mention that? Well, after they was gone, I got up and untied the others. I figured the Lieutenant would be pissed off, but turns out he tried to out shoot one of the Juicer girls. Guess who lost.

“Look. You can give me and the others latrine detail as our punishment. Beats going after ‘em.”

— Transcript of incident Report
from Private G.B. Sanders
CS Incident number 104-002312.

Note: The organization stats A-N are based on the rules for creating mercenary organizations as presented in **Rifts® Mercenaries**.

- A. Sponsorship: Criminal: Small-time bandits
- B. Outfits: Specialty Clothing: 20 pts.
- C. Equipment: Electronic supplies & good gear, medical clinic: 25 pts.
- D. Vehicles: Combat cars: 20 pts.
- E. Weapons: Extensive weaponry: 40 pts.

F. Communications: Full range system: 15 pts.

G. Internal Security: Tight: 10 pts.

H. Permanent Bases: None

I. Intelligence Resources: Scout detachment, Special Military Operatives, and Psionic and Magic Operatives: 35 pts.

J. Special Budget: Large Loans: 25 pts.

K: General alignment of personnel: Anarchist: 2 pts.

L. Criminal Activity: Cyber-doc, Expert Assassin, Special Forces, and Psychic Enforcer: 50 pts.

M. Reputation/Credentials: Known: 10 pts.

N. Salary: Good Salary: 10 pts.

Points Spent: 262 points

Size & Orientation: Large Company

The Valkyri are an all-female band of Juicer mercenaries and outlaws who are fast becoming legendary in the less civilized areas of the Midwest. They are a nomadic band, whom most authorities believe to be no more than one hundred members strong. In reality, their numbers are three to four times larger! The illusion that they are a smaller organization stems from the fact that they frequently divide their numbers into 3-6 smaller groups operating in different parts of the country, and because most people tend to underestimate them. Valkyri commonly sell their services to small independent kingdoms, city-states and towns, acting as mercenaries, temporary bodyguards, or carrying out short-term missions. Occasionally, they resort to banditry, but almost invariably, they attack Coalition States facilities, towns, and outposts. Most of these raids inflict minimal loss of life among the Valkyri, but the same can’t be said about their opponents who often suffer great injury and loss of government monies and equipment (particularly food, weapons and supplies). So far, the damage inflicted has not warranted an all-out hunt for them, but several Coalition officers have a personal grudge against the Valkyri and will do anything in their power to destroy them, if given the opportunity.

The group was formed some three years ago when two Hyperion Juicer sisters, known as the Redstone Twins, intervened in the lynching of a third female Juicer, Vanessa, falsely accused of murdering a local lawman. The three held off the lynch mob, escaped the town, and later proved Vanessa’s innocence. Of course, at that point they had killed several other townspeople, so they didn’t endear themselves to the locals, and all three were branded as outlaws. As they were leaving the town once and for all, two other women asked to join them; they had endured miserable lives in the town, and were willing to undergo the Juicer augmentation and accept an early death in order to escape their bleak existence.

Before they knew it, they had twenty female Juicers traveling with them. The high-spirits of most of the Juicer-reborn women, coupled with the success of the group, made it all worthwhile and prompted the ladies to consciously recruit more female members. Every time the Valkyri stop at a town or kingdom, they look for women who are being abused, rescue them

from their plight, and offer them membership into the group. A surprising amount accept and many (35%) become Juicers. Others (25%) have turned to partial bionic (Headhunters and 'Borgs) or Crazy augmentation, and a small percentage (5%) practice magic or possess psychic abilities. The rest don't get any augmentation whatsoever. Most stay with the Valkyri for a while, but after a while, some leave to find their own place in the world.

The Valkyri are experts at guerrilla and counter-guerrilla warfare. Although they lack the heavy equipment to fight a pitched battle against a large army, they are very proficient at luring enemies into ambushes, hit and run attacks, and infiltrating cities and camps (some women agents are very adept at looking harmless and helpless, or seductive, lulling guards' suspicions). The group has only a few heavy vehicles and power armor, but do have a lot of anti-armor weapons like bazookas, rocket launchers, and flame-throwers, which they use skillfully against better armed foes.

The company will commit acts of banditry when they cannot secure gainful employment, but they usually limit their crimes against the Coalition States, tyrannical kingdoms, and other "deserving" targets (like Naruni Enterprises). Many nations, including the CS, have put a price on their heads, and several other merc companies have tried to collect (and thus far, have failed every time).

A few weeks ago, the rumors of the **Prometheus Treatment** reached the Valkyri. They were intrigued enough to venture close to the Coalition territories to investigate for themselves. For more information about the role of the Valkyri in the Juicer revolt, see the **Uprising** section.

Vanessa Death-Giver Current Leader of the Valkyri

Vanessa was born in the Chi-Town 'Burbs amidst poverty and squalor. She never knew her father. He was killed when she was only months old, an innocent bystander in a shootout between a Dog Pack patrol and Black Market smugglers. Vanessa's mother died of tuberculosis ten years later, leaving the child alone and penniless. Many children in those circumstances would have died or suffered an even worse fate; fortunately for Vanessa, she was "adopted" by a kind-hearted female body-chop-shop operator. The girl grew up in the underground hospital, surrounded by tough men and women who came to the shop to get bionic or cybernetic implants or illegal Juicer or Crazy conversions.

When she was seventeen years old, Vanessa asked to become a Juicer. Her "aunt" refused, horrified at the prospect of condemning the girl she loved to die before her twenty-fourth birthday! She was very clear about the lethality of the procedure and how useless it was to throw away one's life. The lecture might have changed Vanessa's life if fate hadn't played a cruel joke on her. Not two days after the discussion, a corrupt Coalition officer and his Psi-Stalker lackey tried to extort money from Vanessa's adopted aunt. When the woman refused, the Psi-Stalker proceeded to rough her up, and his predatory instincts overcame him. Vanessa walked into the store to see the fiend crouching over the lifeless corpse of her aunt. The mutant then tried to kill the child, the only witness to the crime. Vanessa barely managed to escape. The ordeal awakening her latent minor psychic abilities.

A few days later, the young woman showed up at another body-chop-shop with enough black market trade items to pay for the Juicer conversion. After becoming a Juicer, Vanessa tracked down and executed both the Psi-Stalker and his boss, and then left Chi-Town with the authorities on her heels.

For two years, Vanessa worked as a single mercenary, sometimes with other "guns-for-hire," other times on her own. She had a number of relationships with other adventurers, but most of them ended badly (Game Masters and players: What if a player was one of Vanessa's flings?). Her experiences with men eventually made her lose respect for their entire gender, and she stopped working with male partners, preferring to go at it by herself. This lone wolf attitude almost cost her her life when she was falsely accused of murdering a local hero, a cyber-knight named Jason. Despite her skills, Vanessa was overpowered and would have been killed if the Redstone Twins, a team of Hyperion Juicers, had not intervened. Vanessa recognized that there was strength in numbers, and she vowed to spend the rest of her life building a mercenary organization for women and run by women.

Alignment: Aberrant with unscrupulous leanings.

M.D.C.: Special Juicer Plate Armor (55 M.D.C.) combined with a Splugorth's Blind Warrior Woman energy field (M.D.C. 100).

S.D.C./Hit Points: 327 S.D.C. and 82 Hit Points

Attributes: I.Q. 17, M.E. 15, M.A. 13, P.S. 28, P.P. 27, P.E. 29, P.B. 11, Spd. 95

Disposition: Very cold and aloof most of the time; quietly threatening when involved in a possible confrontation. Often acts as if she can read one's mind (which she can actually do; see her psionic powers). Although she no longer hates men as a gender, she still has very little use for "typical males," especially those who act condescendingly towards women, or who only see them as sex objects. She also hates the Coalition military which she blames for the deaths of everyone she cared for.

Horror Factor: None usually; in full battle gear and combat mask, she effectively has an H.F. of 8.

Natural Abilities: All Juicer abilities and powers (see *Rifts RPG*, page 69).

Level of Experience: 7th level Juicer (4th year)

O.C.C. Skills of Note: Radio: Basic (93%), Wilderness Survival (73%), Land Navigation (72%), Pilot Tank and APC (67%) and Motorcycle (98%), Prowl (73%), Combat Jump Bike (see the new skills section), and assorted W.P.s, including Sword and Paired Weapons.

Combat Skills: Hand to Hand: Assassin, Boxing, Wrestling and assorted W.P.s.

Attacks per Melee Round: Nine!

Bonuses: +4 on initiative, +3 to Perception Rolls, +8 to strike, +11 to parry and dodge, +10 to Auto-Dodge, +9 to roll/pull punch, +17 to S.D.C. damage, +7 to save vs magic.

Magical Knowledge: None, other than a general knowledge of anti-mage tactics. P.P.E.: 8

Psionic Powers: Minor psionic; Mind Block and Telepathy. I.S.P.: 43.

Vulnerabilities/Penalties: All common Juicer problems, plus she suffers from Metabolic Induced Voracity (MIV), and must eat 10,000-20,000 calories a day (roughly six full meals). This problem is very embarrassing to her, so she deals with it by flaunting it, eating disgusting amounts of food in front of everybody — and never gaining an ounce.

Alliances and Allies: Besides the Valkyri, Vanessa once worked with *Lieutenant Damian Crow*, from Crow's Commandoes (see *Rifts® Mercenaries*); the two became lovers for a brief period, and parted on bad terms, but each feels he/she owes the other a favor, and they both know they only need to ask to collect. Vanessa would only do this if she had no other choice.

Transportation: Vanessa has a personalized Iron Maiden APC, painted in camouflage pattern, with three long-range missile launchers (one missile in each launcher) built into each side of the vehicle. She most often rides into battle on a Tarantula Jump Bike.

Weapons: Her weapons of choice are swords. Recently, she came into possession of a lesser rune sword (evil alignment, does 5D6 M.D., has all the usual powers), and she also has three vibro-swords (2D6 M.D. each). For ranged combat, she carries a JA-12 laser rifle or a WI-GL4 revolving grenade launcher.

Body Armor: A specially designed suit of Juicer Plate Armor, with heightened protection (55 M.D.C.) and a painted face mask with an H.F. 7, and a stolen Blind Warrior Woman energy field (M.D.C. 100).

Money: Vanessa has over a million credits in her personal account, plus can get her hands on 1D4+2 million more through the mercenary company.

Description: A tall, athletic woman with red hair. Her face is almost always covered under a painted face mask.

The Redstone Twins

Born in a small village in the Manistique Imperium, Angel and Cherub Redstone were two adorable little girls, who despite their names, had a streak of devilish mischievousness that got them in trouble regularly. The two girls were incredibly willful and arrogant, adopting an attitude of "it's us against the world." At age sixteen, they ran away from their home and tried to make it in the large cities of the Manistique Imperium. The girls were just smart and tough enough to avoid most of the likely fates the young suffer in the rough streets of Escanoba. Until they fell into the hands of Moe "Headbreaker" Harris, that is. Moe was an evil headhunter who controlled a gang of smugglers and other criminals. Moe and his men kidnapped the young girls and kept them as their personal slaves for almost a year. During that period the girls suffered all manner of abuse and indignities. Eventually, the gang left the Manistique Imperium with the girls, in search of easier spoils. One night, on their tenth month of captivity, Angel managed to pick the lock on the chains holding her captive, and killed Moe in his sleep. Angel freed her sister and the two methodically killed every slaver in the band (twelve men), first ambushing two sentries and then using mega-damage weapons against the unarmed (and at first, sleeping) men.

The gang had set up camp on the outskirts of Kingsdale. The two sisters packed as much loot and money as they could in to a jeep, and made it to the kingdom, where they traded most of their wealth for the chance to become Juicers. The two sisters decided they would work as mercenaries for two to three years, and then go through detox and retire to a life of luxury. On their second year, however, a treacherous con-man managed to steal all their savings, effectively condemning them to death.

The twins no longer care about their future, and they now just want to enjoy life to the fullest, as well as to humiliate and destroy as many "deserving" people as possible. In the sisters' book, the deserving include anybody who lies or cheats people, steals from the poor and helpless, or tries to control people. When the sisters saw Vanessa about to be lynched, they felt obligated to intervene, and have never regretted their actions.

The Twins

Alignment: Both are anarchist with evil leanings.

M.D.C.: By body armor only.

S.D.C./Hit Points: Angel: 105 S.D.C. and 44 Hit Points.

Cherub: 98 S.D.C. and 50 Hit Points.

Attributes: Angel: I.Q. 14, M.E. 20, M.A. 17, P.S. 22, P.P. 28, P.E. 19, P.B. 17, Spd. 98

Attributes: Cherub: I.Q. 16, M.E. 14, M.A. 18, P.S. 24, P.P. 26, P.E. 21, P.B. 17, Spd. 103

Disposition: Angel: Of the two sisters, Angel has the stronger will. Despite the months of abuse, the Juicer was able to bounce back and is not afraid of men. She also has the nastier streak of the two (anarchist with evil leanings), and will sometimes go out of her way to destroy an enemy. She sees men as foolish playthings she can easily outsmart and defeat.

Cherub: In many ways, Cherub has never fully recovered from the abuse suffered at the hands of Moe and his men. She is afraid of men, although she will never show it; instead, her fear is expressed in anger and aggressiveness. Although not a weakling, she is easily swayed by people she respects, like Angel and Vanessa, and she will rarely argue with their decisions or orders.

Level of Experience: Both are 5th level Hyperion Juicers.

Natural Abilities: All Hyperion Juicer abilities.

O.C.C. Skills of Note: Wilderness Survival (65%), Motorcycle (90%), Prowl (+55%), Streetwise (45%), and assorted W.P.s.

Combat Abilities: Hand to Hand: Expert and Boxing.

Attacks per Melee Round: Eight.

Bonuses: Angel: +7 on initiative, +4 to Perception Rolls, +10 to strike, +14 to parry and dodge, +9 to Auto-Dodge, +8 to roll/pull punch, +2 save vs magic.

Cherub: +7 on initiative, +4 to Perception Rolls, +9 to strike, +13 to parry and dodge, +10 to Auto-Dodge, +8 to roll/pull punch, and +3 save to vs magic.

Magical Knowledge: None.

Psionic Powers: None.

Vulnerabilities/Penalties: Standard Juicer penalties.

Alliances and Allies: None, other than each other, Vanessa and their fellow Valkyri.

Transportation: They ride twin Highwayman motorcycles when they take a break; otherwise they prefer to run.

Weapons: Both favor laser rifles and have half a dozen different types, from pulse rifles to sniper rifles.

Description: Both sisters have elfin features, light brown hair, and green eyes.

Other Valkyri Personnel

In addition to the characters above, other important Valkyri include Janet "Howitzer" Rodriguez (Titan Juicer, 7th level), Debra Lee (Dragon Juicer, 5th level), Donna Doom (Mega-Juicer, 6th level), Leandra (Mind Melter, 4th level) and Esmeralda (Horned Dragon Hatchling, 7th level). Curiously enough,

Debra Lee and Esmeralda are best friends, despite the fact that Debra Lee wears armor taken from a Great Horned Dragon!

Total Members (105 P.A.): 350-400. Except where otherwise indicated, all the members are female.

Common Juicers: 100-120

Hyperion Juicers: 20-40

Titan Juicers: 20-40

Phaeton Juicers: 20-40

Mega-Juicers: 10-20

'Borgs: 10-20

Crazies: 10-20

Magicians (Line Walkers and Mystics for the most part): 10-15

Psychics (Bursters, Mind Melters, etc.): 15-20

Mutant Animals and D-Bees: 30-50 (80% female)

Bionic Augmented (Headhunters): 20-40 (80% female)

Non-Augmented Humans (vagabonds, wilderness scouts, city rats): 40-60 (90% female).

Camp Followers: An additional 2D4×100 people are distributed among the four main bands; these include children, relatives and loved ones (males are allowed among the camp followers), and young women training to become Juicers. Most

camp followers belong to a non-adventuring O.C.C. (average level 1D4); adults will have one W.P. and about 20% have Hand to Hand: Basic. **Note:** Each of the four war bands has 75-100 mercenary fighters (95% female) and 100-200 support personnel/camp followers.

Equipment:

16 Mountaineer ATVs (M.D.C. upgraded to 200, armed with a rail gun and a mini-missile launcher).

120 motorcycles of all makes, from Highway-Man and Wastelanders to jump-bikes and hover-bikes.

30 Big Boss ATVs (M.D.C. upgraded to 100 and equipped with at least two rail guns).

20 Racing Thunder Combat Cars.

20 Iron Maiden APCs

24 Sky Kings

16 Icarus Flight Systems

20 Samson Power Armor suits

15 Titan Combat Robots.

15 Titan Light Combat Robots.

About 150 assorted S.D.C. vehicles, light M.D.C. trucks (10 M.D.C.), and similar cargo vehicles for the camp followers.

The Society of Sages

a.k.a. The Dragon Hunters

This group of mages and alchemists operate in the neighborhood of the city-state of Kingsdale. The organization's harmless sounding name might indicate that the Society is only concerned with scholarly research with little impact on "the real world." Nothing could be further from the truth. While research is an important part of the Society's activities, its goal is the mastery of the secrets of magic and the accumulation of power. Much of its research involves Dragonkind; the Society considers dragons to be a potential danger to humankind, and its members are concerned about the influence of dragons in such places as Lazlo and Kingsdale itself, not to mention the ever-growing Cult of Dragonwright (see *Rifts® World Book Two: Atlantis* and *Rifts® World Book Six: South America*).

Although the Society of Sages operates in Kingsdale, it has contacts with other organizations and individuals on the continent, including the shadowy Federation of Magic. Several powerful sorcerers from the so-called "Federation" are full-time members of the society, communicating through the distance by arcane means. There are even tales of messengers braving the Bermuda Triangle and other dangers to bring communiques and messages to and from mysterious South American nations like the Voodoo worshippers of the Bahia Kingdom, or the Elven Biomancers of Maga Island (see *Rifts® World Book Six: South America One*). The Society is also rumored to have some contacts with a group of psychics in Ohio, the mysterious community known as "Psi-World" or "Psyscape" (more information about Psyscape is available in *Rifts® World Book Twelve: Psyscape™*).

The Sages were able to learn the secrets of making Dragon Juicers, thanks to a highly placed spy within the Federation of Magic, although the Federation blames the original Kingsdale inventor with the leak of its secrets. In a matter of months, the

Sages had "manufactured" over a dozen of these enhanced humans, and used them as secret agents and enforcers. Some of the Dragon Juicers were sent into the wilderness to hunt for dragons, especially those who were hostile to humans, although on at least two occasions, friendly or neutral dragons were killed without provocation. The Society did not condone those crimes and the agents responsible were executed, but most dragons and friends to dragons are suspicious or openly hostile to the Society of Sages, which has been nicknamed "The Dragon Hunters."

Membership: The actual number of full Society members is kept a secret from most, including its own members (with the exception of the leaders). The organization is believed to comprise no more than sixty powerful mages and alchemists, and perhaps another ten or so beings of supernatural power. Among them are at least three or four members of the Federation of Magic.

Agents: The Society of Sages employs about a hundred full-time agents and often hires as many as an additional two or three hundred mercenaries for some major projects. Of the current full-time agents, 22 are Dragon Juicers, some 30-35 are Juicers of various other types, and the rest are all manner of adventurers and creatures, including psychics, D-bees and other beings, including seven Poptalian Dragon Slayers.

Relations with Other Organizations: The Sages and the *Kingsdale Magickal Guild* have a tense relationship. The Guild is sure that several of its members and many candidates, are secretly members of the Society of Sages and serve the Society's interests above those of the Guild. Furthermore, several Guild masters are dragons who do not take kindly to a group who has been responsible for the deaths of no less than a dozen hatchlings. Any mage who is suspected of being a Sage is watched carefully. Three sorcerers who were found to

be Sages and guilty of betrayal have since disappeared without a trace. A game of cloak and dagger between the two groups is constantly played in the streets of Kingsdale. Agents of the Society are often caught in a web of intrigue and betrayal.

Outside Kingsdale and the Federation of Magic, the Sages keep a low profile, content with sending out agents and messengers to other magical enclaves.

Cagliostro Smith

Little is known about the man who calls himself Cagliostro Smith. He sometimes speaks of growing up in the ruins of Old Detroit, and of finding a cache of occult books which he used to train his talents for magic. Whether or not these tales are true is unknown, for the truth about his past is one of Cagliostro's most guarded secrets. He is well known as a former member of the Federation of Magic and the sorcerer even ruled his own petty kingdom until a more powerful rival defeated and exiled him. Rumors claim that this rival was a dragon or an inhuman creature, which might explain Cagliostro's hatred of D-Bees and dislike of dragons, but the sorcerer neither confirms nor denies these allegations.

Cagliostro is neither the most powerful nor the most influential member within the Society of Sages. He is the equivalent of a "middle management" guy, in charge of briefing and debriefing agents, contacting and dealing with outsiders, and taking care of any minor problems or threats that may arise. The sorcerer is particularly interested in the doings of the Cult of Dragonwright, and often sends agents to spy on or infiltrate major cult centers. He also has a couple of spies among the Federation of Magic and a contact at Tolkeen.

Cagliostro Smith:

Ley Line Walker and Human Supremacist

Alignment: Aberrant

M.D.C.: By armor or spell only.

S.D.C./Hit Points: 16 S.D.C. and 33 hit points.

Attributes: I.Q. 22, M.E. 13, M.A. 8, P.S. 13, P.P. 12, P.E. 10, P.B. 12, Spd. 14

Disposition: Cagliostro sees himself as a defender of Humankind. In many ways, there's little difference between him and Emperor Prosek or other human supremacists, except that unlike the Coalition's supporters, he believes magic is a useful tool, for good or ill. If the CS had not outlawed the practice of magic, he might have joined the military to gladly hunt down and destroy D-Bees and other non-humans. The sad part is that, for all his intolerance, the magician is an honorable man who will not break his word nor betray a friend. Since he would never give his word or befriend a non-human, he does not feel any guilt for anything he does to them.

When dealing with *human* underlings and new associates, Cagliostro is friendly and reasonable. He respects other people's opinions on almost any subject other than the rights of D-Bees, and genuinely cares about people and their problems. Any dealings he may enter into with nonhumans is done with great care and either out of perceived necessity or in a ploy to use, cheat or betray the poor fool. Most nonhumans who reside in or do business at Kingsdale know about his prejudice and respond appropriately (usually avoiding him or watching their backs). It was his intolerance for nonhumans that got him banished from the Federation of Magic.

Level of Experience: 10th level Ley Line Walker.

Natural Abilities: Read and Sense Ley Lines, Rifts and Magic Energy, Ley Line Transmission, Ley Line Phasing, Drifting and Rejuvenation, Create Ley Line Observation Ball, plus see magical abilities.

O.C.C. Skills of Note: Land Navigation (88%), Wilderness Survival (93%), Lore: Demons and Monsters (93%), Lore: Faeries (88%), American (98%), Spanish (98%), Dragonese/Elven (98%), W.P. Energy Pistol.

Combat abilities: Hand to Hand: Basic and Boxing.

Attacks per Melee Round: Seven.

Bonuses: +1 to strike, +2 to parry and dodge, +2 to roll/pull punch, +2 save vs magic, +2 to Spell Strength, and +4 to save vs Horror Factor. +4 to Perception Rolls.

Magical Knowledge: Thanks to his association with the Society of Sages and past dealings with the Federation of Magic, Cagliostro has learned all spells from levels 1-7, plus Anti-Magic Cloud, Commune with Spirits, Create Magic Scroll, Negate Magic, Talisman and Wards.

P.P.E.: 168

Psionic Powers: None.

Vulnerabilities/Penalties: None, other than his inability to trust or work closely with nonhumans.

Alliances and Allies: Besides the Society itself, Cagliostro is on good terms with several members of the Kingsdale Senate, including the Godling Arcadia.

Equipment: The magician has access to many weapons and vehicles. His favored sidearm is the Wilk's 320 laser pistol. He often wears Plastic-Man armor under his robes, but if he's expecting combat he dons a suit of stolen Dead Boy Armor (80 M.D.C.; old style), painted in a striped red and yellow pattern.

Money: He has 500,000 credits in personal funds and, through the Society of Sages, has reasonable access to approximately ten million credits.

The Slayer

Former Cyber-Knight, now a Dragon Juicer

Almost nobody knows the Slayer's real name, and only a handful of people have any idea of his background and history. That is the way this agent of the Society of Sages prefers it to be. Most only know him as a grim, dedicated warrior, and possibly one of the deadliest hand to hand fighters in the world.

The true story of the Slayer began seven years ago, when a very young and naive Cyber-Knight named Artorios and his four companions (two other Cyber-Knights, a renegade Dog Boy and a mystic) ventured into the wilds of the West. Artorios and his friends heard of a village being terrorized by a dragon. Tragically, the young Cyber-Knight and his friends had only fought hatchlings in the past, and had no conception of how powerful and deadly a full adult could be. Expecting a 20 foot (6.1 m) long creature, the band of heroes charged into the dragon's lair with all guns blazing. To their surprise, they found themselves facing a 60 foot (18.3 m) long Great Horned Dragon with enormous magical powers. The skulls of hundreds of its victims, human and otherwise, were strewn over the cave's floor; the monster used them as its bedding. Smoke belching from its nostrils, the monster smiled evilly at the newcomers and attacked.

For the first time in his life, Artorios was seized by panic. While his companions gallantly charged forward, knowing that their only hope lay in defeating the dragon, the Cyber-Knight froze in place. The act may have saved his life, or perhaps his help might have made the difference between victory and defeat (that question continues to haunt him). In any case, in a matter of minutes it was all over. Artorios collapsed to his knees, trembling, while the dragon slew his four companions. When it was over, the dragon loomed over the terrified knight. "Run, pup!" the beast hissed. "Run for your life!" Crying like a child, Artorios fled into the wilderness.

The Cyber-Knight Artorios disappeared from the face of the Earth. Two years later, an anonymous volunteer underwent the Dragon Juicer conversion and became an agent for the Society of Sages. The man, who calls himself the Slayer, serves the Society faithfully. Only once, two years ago, he took a leave of absence, hired a band of mercenaries, and with their help, went to a certain dragon's lair to exact a deadly revenge. When he came back, the Slayer was able to contribute several gallons' worth of dragon's blood.

The Slayer, Dragon Juicer

Alignment: Aberrant, although some of his formerly principled tendencies come to the surface once in a while. Overall, he will never harm an innocent, but his view of an innocent is somewhat different than that of most people.

M.D.C.: 198

Attributes: I.Q. 12, M.E. 17, M.A. 13, P.S. 35 (supernatural), P.P. 30, P.E. 28, P.B. 9, Spd. 53

Disposition: The Slayer is a man who looked into the face of evil and found himself unable to cope with it. His moment of cowardice cost him his self-respect and dignity. He has spent the rest of his life trying to make up for it. Above everything, he hates dragons and considers anybody who follows the Cult of Dragonwright to be a dangerous fool. In missions for the Dragon Hunters, the Slayer has killed five human followers of the cult. The circumstances were such that the Sages have let the killings pass. In one instance, three cultists tried to kill the Slayer when they saw his armor, and in the other, the cultists had betrayed him to the local authorities. However, his personal vendetta and outward hatred of dragons may threaten the Society's safety in the future.

A driven, obsessed man, he is humorless and quiet, and often appears to lack most emotions. In reality, he represses all such feelings, because he considers them to be distracting weaknesses. He respects courage and strength, and will come to the aid of a worthy warrior who is facing hopeless odds. The one thing he will not tolerate, from himself as well as anybody else, is cowardice. The Slayer will die rather than behave in a cowardly manner. Cagliostro is sure that it's only a matter of time before the Slayer meets his match (probably in the form of an ancient dragon) and dies in his endless quest to redeem himself.

Horror Factor: None.

Level of Experience: 3rd level Cyber-Knight and 9th level Dragon Juicer.

Natural Abilities: All Dragon Juicer abilities and Cyber-Knight powers except Psi-Sword.

O.C.C. Skills of Note: Speaks Dragonese/Elf and American at 98%, literate in American 98%, Lore: Demons and Monsters

and Lore: Juicers both at 98%; Gymnastics, Climb, Swim, Land Navigation, Horsemanship, W.P. Sword, W.P. Targeting, W.P. Energy Rifle and W.P. Heavy M.D. Weapons.

Combat Abilities: Hand to Hand: Martial Arts, Boxing and Wrestling.

Attacks per Melee Round: Ten!

Damage: As per Supernatural P.S. or weapon.

Bonuses: +4 on initiative, +6 to Perception Rolls, +10 to strike, +13 to parry and dodge, +9 to roll/pull punch, +7 to save vs magic, +4 to save vs psionics and mind control, +6 to save vs poison and +10 to save vs Horror Factor.

Magical Knowledge: None. P.P.E.: 31

Psionic Powers: The Slayer has lost his Psi-Sword and other psionic powers.

Vulnerabilities/Penalties: Affected by any and all anti-dragon powers, low life span, and Dragon Blood addiction.

Weapons: In his last mission for the Society of Sages, the Slayer acquired a lesser rune sword that inflicts 6D6 M.D. and has all the standard powers (see *Rifts® World Book Two: Atlantis*). Additionally, he favors vibro-blades and other melee weapons. His ranged weapon of choice is a Naruni Enterprise's Plasma Cartridge Rifles.

Body Armor: Dragon Skin Armor (M.D.C. 100).

Money: The Slayer has little use for his pay, so he has almost a million credits to his name, but he rarely bothers to use it, unless the money will make a mission easier. Expenses are usually provided by his employers.

The Juicer Army of Liberation

Since Juicers are for the most part, volunteers, the idea of an "army of liberation" for augmented humans would have been ludicrous under most circumstances. Even before the Uprising, however, the JAL had been operating for some years. According to their proclamations, often spray-painted on walls, despite the illiteracy common in their area of operations, the Juicer Army of Liberation fights against those who try to oppress, enslave, or deny Juicers their right to exist as free men. Places that have outlawed the Juicer process are the primary targets of the organization, particularly areas under Coalition control or influence. At first, most incidents involving the JAL were relatively harmless, mostly graffiti painting and other minor acts of vandalism. Apparently, many (perhaps most) members were not even Juicers, but young "Wannabes" who resented the persecution of their idols and role models.

All this changed in P.A. 103, when a Mega-Juicer who went by the name Julian seized control of the JAL and turned it into a militant, violent organization. Julian (who tacked the royal sounding title "the First" to his name) appears to have been the only survivor of a mercenary company that ran afoul of the Coalition States Armed Forces. A CS army unit wiped out the mercenary troop, and Julian swore revenge. He sought fellow Juicers who hated the Coalition, as well as those who sought to profit by plundering the richest nation in North America. This new, forceful leader was able to attract several hundred Juicers

to his banner by paying them generously with spoils taken from small Coalition villages, raided military depots, and other acts of banditry. Attracted by promises of loot, Juicers and other desperadoes, including Crazies, 'Borgs, Headhunters, a renegade mutant Dog Pack, D-Bees and even some normal humans all joined the growing band.

The Coalition has depicted the JAL as "terrorists" and "insane murderers," depending on which propaganda message one is listening to at the time. Although the JAL try to avoid injuring and killing the innocent (Coalition Soldiers are not considered "innocent"), their crimes have been greatly exaggerated and common people live in fear of the day the band of murderous Juicers will descend upon their towns or villages.

For the last few years, the JAL has conducted operations in small, highly mobile bands of 6-20 people, darting in and out of the Coalition's territories and taking refuge in the western wilderness. Most raids have occurred in the Missouri area, although the more daring bands venture as far as Iowa and a few have even made it as far as Chi-Town. Coalition patrols have always managed to kill or capture raiders who penetrated into Chi-Town territory before they could do much damage. It has become the unofficial CS policy to terminate all JAL groups whenever they are encountered.

Note: The aftermath of the Prometheus incident would have a profound influence on the JAL; see the **Uprising** section for more details.



The Grim Reapers

Surrender to Death, and Live Forever.

— Graffiti found on slum walls across North America.

The first rumors and tales about this mysterious and feared cult started appearing during the 80's P.A., at such Juicer havens as Ishpeming, Los Alamo and Kingsdale. The rumors spoke of a cult of Juicers who worshipped Death itself. Some of the wilder tales claimed that some Juicers had attained immortality by undergoing a dark magical ritual. Although these stories were never as widely believed as the *Prometheus Treatment* (for one, they didn't have the Coalition States' propaganda machine sup-

porting them), they have remained a persistent story for over two decades. Dozens, perhaps hundreds of Juicers try every year to make contact with the **Grim Reapers** and find out if the rumors of professed immortality are true. Most of these Juicers are in their fifth or sixth year of service and feel death approaching. These desperate men and women are ready to do anything to forestall their impending doom.

Juicers who desire to join the cult must venture into the worst slums of Juicer frequented cities and try to find somebody who knows something about the Grim Reapers. Most of them (the lucky ones) find nothing, or are deceived by con-men, slavers, or fanatical cultists who have no direct connection with the real Grim Reapers. The unlucky few who succeed are met one night by a group of cloaked men, hiding their faces beneath skull masks. What happens afterward is a mystery.

A Juicer mercenary called *Ramon Doodles* tried to infiltrate the organization. He was found in an alley in Ishpeming, horribly mutilated, but miraculously still alive. Mortally wounded, his last whispered words to the soldiers who found him is the only information people have about the Grim Reapers. According to the soldiers's account, Ramon said the cultists practiced human sacrifices and worse in hidden catacombs outside several cities. He insisted that their numbers were in the hundreds and that they were evil incarnate. They worshipped Death itself, and from the descriptions he gave of statues and drawings, some occult scholars believe their "deity" is none other than the fearsome leader of the Four Horsemen of Apocalypse! Ramon warned that Juicers who died in the service of the Grim Reapers were raised as undead warriors (see the *Murder-Wraith Juicers*). Monstrous mockeries of once human Juicers answering to insane cult leaders. He died without telling the soldiers the location of the catacombs.

The Ishpeming authorities took Ramon's last words seriously. Yet try as they might, they could not locate the cult or any subterranean lair. After several frustrating weeks without discovering a clue, the investigators finally decided to close the case and officially declared the Grim Reapers to be a minor cult of evil sorcerers with little or no presence in their territory. Nothing to be worried about. Whether this official declaration is true or not remains unknown. Rumors of undead Juicers continue to surface, especially near the Federation of Magic, Kingsdale and other non-aligned cities.

Aramis Knight Necromancer, Leader of the Grim Reapers

During the day, Aramis Knight is known to be a kind-hearted herbalist and alchemist in *Laramy*, a town associated with the city-state of Kingsdale. This middle-aged human opens his shop every day at 10:00 a.m., plies minor potions and medicinal herbal concoctions, and is considered by most to be a pillar of the community. Whenever somebody enters the store, Aramis walks out of the back with a smile and a kind word. Everybody speaks highly of the man and his soothing voice. Everybody, except for a handful of people who claim to have felt scared or uneasy in his presence. Those tales are always dismissed as sour grapes from people who envy the quiet success of the gentle herbalist.

At night, Aramis Knight closes up his shop, goes to the back and opens a secret passage leading to an ancient cavern beneath the town's foundations. He dons a black robe and a skull-shaped mask, and descends into the darkness. In the black depths of the underground catacomb, he leads a coven of seven cultists and three Murder-Wraiths in a dark ceremony dedicated to the Lord of Death. Later that night, he uses magic to communicate with his other minions. Aramis is the leader of the Grim Reapers, pulling the strings of the cult from the anonymity of the small town.

Very few people outside the cult have heard Aramis' story, and of these, only one is still alive. This survivor is **Ishmael Lord**, an Elven mystic now living in Lazlo, who thinks the man he knew as Arthur Night is dead and gone. If anybody showed Ishmael a photograph or video of Aramis Knight (very difficult to do, as the shop owner will always politely refuse to have his picture taken), the mystic would recoil in horror. The story he would tell would explain a great deal.

During the years 12-14 P.A., the Chi-Town armies under Joseph Prosek I (Karl Prosek's father) conducted a systematic campaign of genocide against the *Federation of Magic* (a brief account of the war can be found in the *Rifts® RPG*). Thousands of people, most of them innocent D-Bees, were massacred and entire towns and villages were laid waste by the relentless Chi-Town forces. Ishmael and Arthur were teenagers back then, apprentices to a mystic who had nothing to do with the Federation of Magic or their ill-advised attack on the Coalition. This did not save him, nor his pupils. Ishmael just barely managed to run into the forest when a Chi-Town patrol swooped over the magic school. Arthur, his teacher, and twenty other young men and women were taken out into a forest clearing, forced to dig their own graves, and mowed down by machine-guns. From his hiding place, the horrified Ishmael stood as the lone witness to the massacre.

The mystic remained in hiding the entire day. At nightfall, he walked over to the site of the mass grave, wishing to say good-bye to his friends before fleeing into the wilderness. As he was praying over the grave, a hand clawed its way out of the freshly-dug mound! Although he was terrified at first, Ishmael resisted his superstitious fear and helped pull out the survivor.

Arthur had survived that horrible night. A bullet had just grazed his head, knocking him unconscious. The young man had awoke found himself buried alive, and surrounded by the corpses of his fellow students. It had taken him hours to claw his way to the surface. He emerged a changed man — most likely



insane. According to Ishmael, Arthur had a vision while he was surrounded by the dead bodies of his former companions. In that vision, Death had spoken to him.

At first, Ishmael dismissed Arthur's ramblings as the product of shock. The two survivors traveled East, fleeing the Coalition patrols and making it to the outskirts of Lazlo. Ishmael stayed there, but Arthur claimed that he needed to go on. "Where to?" Ishmael asked, exasperated by the insane mutterings of his friend.

"Africa," Arthur replied. "That is where Death awaits."

That was the last Ishmael saw of Arthur. The young Elven acolyte learned the arcane arts in Lazlo, and would eventually become an experienced adventurer and hero. Decades later, he would be among the champions of light to travel to Africa for the momentous **Gathering of Heroes** in 103 P.A. (see *Rifts® World Book Four: Africa*). Ishmael was disturbed by the tales of the Horsemen of Apocalypse and their connection to Africa. Had Arthur's visions been actual prophetic dreams? He found his answer on a cold night on the outskirts of the Phoenix Empire, where he and his six companions were camping for the evening.

A wave of undead creatures rushed the camp. The seven champions managed to beat the first wave off of them, and the next. The heroes radioed for help, and they were told that a squadron of NGR aircraft was on its way to bomb the monsters into oblivion. Before that could happen, however, a much larger group of monsters surrounded the camp. Faced with hopeless odds, the adventurers prepared to die. Then, the crowd of monsters parted, letting their leader pass. Ishmael gasped when he recognized the grim cloaked man as Arthur!

Arthur also recognized his old school friend. "I told you Death awaited in Africa, Ishmael," he said. Then, instead of ordering a last attack, he led his monsters away from the camp. Ishmael does not know whether Arthur chose to spare his life in a moment of weakness, or whether some good still exists in the necromancer. In any case, a few minutes later the German aircraft dropped tons of explosives on the retreating undead horde. Ishmael believes to this day that Arthur died in the explosive bombardment.

Not so. Arthur survived not only the air strike but the fall of the Four Horsemen and the ensuing chaos. His master was banished from our reality, but it continued to "speak" to him. The necromancer made his way across the ocean, back to North America, the land of his birth. There he joined the society of evil sorcerers who led the Grim Reapers. In a matter of months, Arthur had intimidated or destroyed all the former leaders of the cult and taken their place as its ruler. Now, unknown to most, the headquarters of the Grim Reapers is located beneath the quiet town of Laramy where Arthur serves his dark lord by bringing chaos and death to the world.

Leader of the Grim Reaper Cult

Real Name: Arthur Night

Alignment: Diabolic and insane; a small part of him has scrupulous good elements, but it is very small and not likely to come to the surface often (see Disposition, below).

M.D.C.: By armor or spell, plus he can wear the skull of an ancient demon that provides him with an additional 40 M.D.C.

S.D.C./Hit Points: 21 S.D.C. and 71 Hit Points

Attributes: I.Q. 19, M.E. 11, M.A. 19, P.S. 13, P.P. 11, P.E. 17, P.B. 14, Spd. 16

Disposition: Aramis/Arthur has been utterly insane for over ninety years, ever since he was buried alive. His brush with death convinced him that there was no higher power, and that the only way to avoid the inevitable was to become a valuable servant of Death. He is one of the most accomplished sorcerers on the planet, and there is little he does not know about the occult arts. His warped sense of reality is his main drawback, although not much of one, since he is powerful enough (and crazy enough) to make his own reality!

During the daytime, Aramis makes extensive use of the Charismatic Aura spell to mute the quiet sense of menace that surrounds him. The spell and his excellent acting skills are what keep the illusion of normalcy going. The town's residents do not even suspect that Aramis and his cultists have been responsible for the disappearances (and subsequent deaths) of over a dozen town residents and nearly a hundred transients, visitors and other strangers.

Strangely enough, the Necromancer cherishes the double life he is leading. He likes to play the "character" of Aramis Knight, kind-hearted Herbalist. Sometimes he tells himself he is just enjoying fooling everybody — but sometimes he finds himself actually appreciating the occasional kindness and smiles he brings out in people. A small part of him, a part that was withered and nearly destroyed by the soldiers of Chi-Town, is being moved by the simple, joyful life he leads during the day.

Horror Factor: 13 unless he uses a spell to hide it.

Level of Experience: 15th level Necromancer.

Natural Abilities: Union with the Dead (can attach limbs and body parts of dead things to his own body), Animate and Control the Dead (up to 60 animated dead), and immune to vampire mind control and Slow Kill Bite. Longevity: Perhaps because of his strange association with Death, the Necromancer has only aged 30 years over a 90 year period, and that aging rate has continued to slow down with every passing year. It appears that Aramis Knight may live on for centuries!

O.C.C. Skills of Note: Lore: Demons and Monsters (98%), Holistic Medicine (98%), Wilderness Survival (98%), and W.P. Energy Rifle, Energy Pistol and Knife.

Combat abilities: Hand to Hand: Basic (15th level)

Attacks per Melee Round: Seven physical attacks or by magic.

Bonuses: 60% trust/intimidate, +4 to Perception Rolls, +2 to roll with punch/fall or impact, +2 to strike, +5 to parry & dodge, +3 to damage, critical strike on an 18-20, knock out/stun on an unmodified 18-20, critical strike from behind (triple damage) and death blow on a natural 20!

Magical Knowledge: Knows all Necromantic spells and all common spell magic, levels 1-13. **Note:** Many common spells cost the Necromancer twice the P.P.E. energy to cast. For G.M.s who do not have *Rifts® Africa*, assume that any spell that has nothing to do with death, Necromancy and spirit summoning has this increased power cost.

P.P.E.: 192 plus Death's Vessel (1,000 P.P.E.; see below).

Psionic Powers: None.

Alliances and Allies: Aramis is the leader of the Grim Reapers, a cult that has about 500 dedicated members and perhaps a thousand pawns (including paid mercenaries, assassins, and several hundred Juicers attracted by the idea of worshipping death). The other leaders of the cult include Alana Black (9th

level Necromancer), Otto Schroder (12th level Shifter), Memtar the Destroyer (8th level witch of the Death entity) and Overlord Wycleen (a renegade Splugorth High Lord, equivalent to an 8th level Shifter and 8th level tattoo master). Alana Black was married to Elrond Black, the former leader of the cult, whom Aramis destroyed in a sorcerous duel. She appears to strongly support the new ruler, but may be conspiring against him. Otto Schroder is a German sorcerer who contacted the Four Horsemen through the *Tree of Darkness* (see *Rifts Sourcebook Three: Mindwerks*), and Memtar is a devoted servant of the Death entity. Wycleen is a rarity, a High Lord who lost his mind and is now devoted to the destruction of all life.

Minions: The Grim Reapers hiding out near or beneath the town of Laramy include: Three Murder-Wraiths (including the Knight-Hunter, described below), two witches dedicated to the Death entity (6th and 4th level), three Necromancers (1st, 4th and 7th level, respectively), and two acolytes with no magical training (equivalent to 2nd level Vagabonds with no special powers).

Weapons and Equipment: Aramis' store is well-stocked with herbal medicines and a few minor potions and drugs. He keeps a vibro-knife and a laser pistol (1D6 M.D.) handy, but his vast magic powers are his real power. His truly valuable possessions include three powerful talismans which he keeps on his person at all times:

Bracelet of Protection: One of three gifts given to him by the death-cult of Africa, this bracelet creates a powerful combination of the Armor of Ithan and the Invulnerability spells that grant the wearer 300 M.D.C. for up to four hours per use. It can be activated four times a day.

Ring of the Elements: This is an ultra-powerful transplanar artifact, given to Aramis by Death itself. The ring appears to be an ornate silver band, carved with symbols for the four classical elements. Anyone wearing the ring can cast any warlock spell at sixth level strength, at no P.P.E. cost to the wearer! A total of four spells can be cast per 24 hours. Magical Guilds would kill to possess such a ring.

Death Vessel: This ornate gold amulet looks like a small urn, sculpted into the likeness of the Horseman of Death. The Death Vessel acts as a reservoir of energy, providing Aramis with an additional 1,000 P.P.E. that renews itself magically at the rate of 50 P.P.E. points per hour! Additionally, the vessel protects Aramis from all forms of possession and mind control, and grants him a +10 to save versus psionic attacks!

Body Armor: The mage wears a suit of Huntsman Armor (40 M.D.C.) when not using magic to protect himself or to “appear” normal and more helpless than he really is.

Money: Aramis has access to some 150 million credits through the cult.

Knight-Hunter A Hyperion Murder-Wraith

Sometimes, the rivalry between two brothers can lead to tragic consequences. In the case of Raphael and Armand Miller, it led to the death and destruction of an entire village.

The Miller Boys, as they were known, grew up in a tiny settlement in the untamed West. Two strong and healthy children, born little more than a year apart. Raphael (Ralph) was the eldest, a big kid who lacked the smarts to match his muscles. Armand was slightly smaller, but much smarter and he proved it by being the only member of the Miller family to learn to read, much to the delight of his parents. Ralph grew up being second-best at most things. Although his parents loved both brothers, Armand was the only one who seemed to have the potential to make something of himself. By the time the siblings were fourteen and thirteen, respectively, Armand was the obvious “darling” of not just the family, but the entire town. The kid seemed to be able to learn almost everything with amazing ease, and soon he was helping direct construction projects, devise defensive plans, and the like.

At age sixteen, Armand also developed minor psychic powers, further convincing Ralph that he would never be able to top his “little brother.” To make matters worse, at age seventeen Armand left the village to become a Cyber-knight! It was too much for Ralph. His brother was the local hero, while he was a simple “good old boy.” Ralph seemed doomed to spend his life toiling at the family farm while his kid brother saved the universe! The envious youngster decided to do something about it. Recognizing that he would never be able to become a cyber-knight, and too lazy for the hard work and training to become a warrior or mage, he decided to take the shortcut, and become a Juicer. Only a week after Armand left to become a Cyber-Knight, Ralph snuck out and became a Juicer mercenary for a nearby feudal kingdom.

Ralph was expecting a hero's welcome when he came back to his home after his term of service. Instead, his family and peers (who had no idea of where he'd been for the last two years) were horrified. “You are going to die in a few years, you fool!” his father screamed. Other villagers tried to convince him to undergo detox before it was too late. Enraged, Ralph started breaking things and punching people — until Armand showed up, a full-fledged Cyber-knight. For the first time since they'd been young children, the two brothers fought — and Armand won, using his brains and skill to overcome Ralph's strength and reflexes. The knight subdued Ralph, who was then expelled from the village.



Ralph found himself in a small city, drinking himself senseless and wishing he was dead. He must have said as much aloud, because another Juicer leaned over and whispered. "Death is not so bad ... after you get to know her." Intrigued and with nothing better to do, Ralph followed his "new friend" and met the Grim Reapers.

Armand Miller was found dead just outside the village of his birth five years later. His cyber-armor had been torn out of his body, and he had been horribly mutilated. Over the next few weeks, lone villagers were found killed in a similar fashion. Ralph, now an undead monster, killed almost one-third of his former neighbors and forced the rest to abandon their homes and risk the dangers of the wilderness to escape his relentless fury. Now the undead warrior serves the leader of the Grim Reapers, happy to belong to a group that appreciates him for what he is — a monster.



more successful and powerful than he currently is. He is haunted by feelings of guilt about the murder of his brother, and sometimes he has nightmares where Armand comes back from the dead to exact a terrible revenge. Occasionally he thinks of trying to kill his master, Aramis, but is too afraid to attempt it.

Ralph hates all Cyber-Knights or anybody who acts and behaves like one. He has adopted the nickname "Knight-Hunter" because he will attack any such warrior on sight, unless his master controls him. Under this insane hatred is a great deal of fear, both of Cyber-Knights and their Psi-Swords. Armand had injured Ralph severely with his Psi-Sword before the fiend was finally able to kill him; the Murder-Wraith has learned to respect those psychic powers.

Horror Factor: 13

Level of Experience: 5th level Juicer Murder-Wraith

Natural Abilities: See the Murder-Wraith described elsewhere.

O.C.C. Skills of Note: Wilderness Survival (60%), Prowl (65%), Detect Ambush (60%). Several W.P.s

Combat Abilities: Hand to Hand: Assassin and Boxing.

Attacks per Melee Round: Nine!

Damage: As per Supernatural P.S.

Bonuses: +4 on initiative, +6 to strike, parry and dodge, +5 to Auto-Dodge, +8 to roll/pull punch, +8 to save vs magic, +3 to save vs psionics, +10 to save vs Horror Factor.

Magical Knowledge: None. P.P.E.: 48

Psionic Powers: None.

Vulnerabilities/Penalties: See the Murder-Wraith description in the Juicer O.C.C. section.

Bond of Servitude: Ralph is under the control of the Necromancer who gave him unlife, Aramis Night. To disobey or resist any order from his master, the Murder-Wraith must save versus insanity (add M.E. bonuses, if any); if the save is successful, the Murder-Wraith is free from mind control for one melee round. If the Undead Juicer's master is killed, the bond of servitude is broken and the monster is free to do as he pleases.

Alliances and Allies: None, other than the Grim Reapers.

Money: Although he doesn't have any use for money, it pleases him to have amassed a fortune of items worth 50,000 credits. Aramis allows this to keep the monster happy.



Knight Hunter — Murder-Wraith

Real Name: Ralph Miller

Alignment: Diabolic

M.D.C.: By armor only, but usually doesn't wear any. As an undead he is impervious to normal weapons, even M.D. ones.

S.D.C./Hit Points: 329 S.D.C. and 61 Hit Points.

Attributes: I.Q. 8, M.E. 6, M.A. 4, P.S. 36, P.P. 23, P.E. 24, P.B. 3, Spd. 63

Disposition: Even after becoming an undead monster, Ralph is still a conniving, self-pitying loser. He is reasonably happy serving Aramis Night, but is still convinced he should be

Places & Nations of Interest

Described in the following pages are some areas and kingdoms where Juicers play an important role as defenders, mercenaries, and even dangers. The information in these city-states is not focused solely on Juicers, however, but has data that can be useful to any characters traveling through the regions in question.

Note: In some cases, the overall population, demographics and economic information about these places may differ slightly from the World Overview in other *Rifts*® titles. The reasons for these differences have to do with the time-line. *Rifts*® has an advancing time-line, which means as time passes, places change, populations may increase or decline, and the policies, economies, leadership and governments may also change. Secondly, new facts may come to light over time. Most of the following represents the state of things circa 105 P.A.

Kingsdale

Population Breakdown: 110,000 total

45% Human

15% Elves

10% Dwarves

5% Wolfen and other canine races (Coyles, Kankoran, etc.)

5% Goblin races (Goblins and Orcs)

20% Other races (includes mutant animals, Ogres, Dragons, exotic D-Bees, supernatural creatures, elementals, etc.)

Note: This does not include the transient population of visiting merchants, adventurers, mercenaries and Juicers (about 2D4×1000 total at any given time; it used to be three times that number before the trouble with Whykin and the CS).

Kingsdale is a place where magic and outlawed technology are given free rein. A free city-state, it is a gathering place of magicians, some of whom have connections with the mysterious *Federation of Magic*, and a place where Juicers, Crazies and 'Borgs can all be created.

The kingdom was born as a small village of refugees during the Dark Ages after the Great Cataclysm. No written records exist of its early history, or if they do, they have not been made public. Rumors suggest that some, if not all of the original villagers were practitioners of magic of some sort, and their powers helped to protect them from much of the chaos brought about by the return of magic to the world.

Kingsdale was a medium-sized town (pop. 5,000) by the early Post Apocalyptic years. It received a large influx of refugees during the years 12-15 P.A.; many of these immigrants may have been survivors from the first Federation of Magic (see *Rifts Ult. Ed.*, page 32) fleeing the wrath of the fledgling Coalition States. Among the refugees were also large numbers of D-Bees.

Among them was a contingent of some 3,000 Elves and Dwarves who claimed to come from another world, similar in some ways to the Palladium world, but where no humans existed and Elves and Dwarves co-existed peacefully. Their entire township had been suddenly Rifted to Earth, and Coalition soldiers had attacked them, decimating their numbers. Kingsdale welcomed the D-Bees, and the descendants of those Elves and Dwarves now make up a quarter of the city-state's population. The Elves had a large number of magicians among them, including Mystics, Diabolists and Warlocks (for the last two O.C.C.s, refer to *Rifts*® *Conversion Book One* and *Dark Conversions*). Their arrival, coupled with the large number of refugees from the Federation of Magic, increased the percentage of magic practitioners in the nation to 30%, one of the highest concentrations in North America.

Despite an ever-growing dependency on magic for its survival, Kingsdale did not abandon technology. Bands of scavengers scoured nearby cities in search of any scrap of scientific knowledge that could be found. In 30 P.A., a number of factories were built, allowing Kingsdale to make some simple machines, weapons, and E-Clips. In 45 P.A., the **Enhancement Clinic** opened, offering bionic, cybernetic and Juicer conversions. Many would-be Juicers agreed to serve in the Kingsdale armed forces for a period of two years in return for the operation. The kingdom took advantage of this offer and has relied heavily on (grateful and surprisingly loyal) Juicers for its defenses ever since.

Geography

Located South of the Missouri River, Kingsdale was built near the ruins of *White Plains*. Bordering the Ozark Plateau, the terrain surrounding the city is composed of low hills, covered with forests of mostly oak and hickory trees. Two main roads have been cut into the forest, connecting the city to the small town of **Laramy** (pop. 2,000) and then going all the way to the kingdom of **Whykin** (see *Rifts*® *Ultimate Edition*, page 25). The Laramy-Kingsdale road is a well-maintained packed-dirt road, good enough for most wheeled vehicles. The second road is of very low quality, little more than an enlarged game trail in some places, a dirt road in others. During the rainy season, the roads turn into muddy trails that will slow down wheeled and tracked vehicles, and even most robot vehicles. With tension growing between Whykin (CS sympathizers) and Kingsdale, the road is no longer being maintained, and is being overrun by the surrounding wilderness.

Animals in the area include deer, coyotes, foxes, puma, raccoons, rabbits, squirrels, beavers, owls and hawks. Several D-Bee species and monsters also prowl the wilderness, despite the best efforts of the **Forest Rangers**. Farms surround the city and the town of Laramy, and raise all kinds of domestic animals, including cattle, horses, pigs, sheep, chickens, turkeys and rabbits.

Government

Kingsdale is officially a dictatorship, but in this kingdom, the title of dictator does not have a negative connotation — it's a badge of office, much like "president" was in 20th Century America. The dictator is the commander of the armed forces, and the chief executive. He makes decrees regarding all military operations, major public works, holidays, and taxes. He is advised by a Senate made up of the wealthiest and most important citizens of the realm. New Senate members are elected by the vote of the existing members; there are no democratic elections whatsoever. The Dictator is also chosen by the Senate from among its ranks, although once he has been chosen he cannot be dismissed for a period of five years and can be reappointed without limit.

The current Dictator of Kingsdale is **Geoff Mercator** (11th level shifter and 6th level scholar), a self-professed dimensional traveler who claims to have been born on another world, although he appears to be a normal human. Mercator has ruled Kingsdale for the last twelve years, and has three more years to serve in his current term. A master of magic and politics, Mercator has managed to keep the peace in the kingdom, despite the looming presence of the Coalition States and the rabid hatred against D-Bees at Whykin. Mercator is also one of the most accomplished linguists on the continent, able to speak over a dozen languages fluently, including Dragonese/Elven and True Atlantean, as well as several tongues from other dimensions.

Other important figures in the government include **Arcadia** (6th level demigoddess), a strange woman who has served in the Kingsdale Senate for over ninety years, although she looks like somebody in her early twenties; **Desmond Donner** (9th level Special Forces soldier), commander of the mercenary army defending Kingsdale; **Ollaran** (14th level Elven mystic), the oldest member of the senate, who was already over 300 years old when he led his band of Elves and Dwarves into Kingsdale; **Lowell Grant** (8th level Coalition Military Specialist), a renegade Coalition officer in charge of the Kingsdale Police Department; and **Grodd** (9th level Dwarven Headhunter), a former adventurer and explorer who has since settled down and has chosen to pursue a life in public service.

Besides the Dictator and Senate, other public offices include the *Chief of Police and Public Safety*, in charge of dealing with crime, fire-fighting, disease control, etc. *The Magistrate of Magic*, which manages any dispute, conflict or problem involving both practitioners of magic and psychics, and the *Officer of Health and Public Works*, who manages most other city affairs. Taxes are collected by the *Treasurer*, a Senate member appointed for that purpose (taxation is relatively light: a 5% income tax supplemented with some tariffs on imported goods, and the sale of licenses and permits. In addition to paying taxes, all able-bodied citizens between the ages of 17 and 25 must spend at least two years in the military.).

The laws of the land are loosely based on the "codes" of 20th Century America. Trial by jury exists; judges are appointed by the Senate, and serve for three years before coming up for review and possible reappointment. Unlike 20th Century America, however, trials tend to be short and to the point, and the rules of evidence are a lot more relaxed; very few criminal cases are thrown out on technicalities, for example. Penalties are also harsher: Death for such crimes as murder, rape and kidnapping;

restitution and 1-10 years of hard labor for robbery; and confiscation and expulsion from the city (minus any valuable equipment) for carrying mega-damage weapons inside city limits (this rule is not applied inside *Dregtown* and other slums, however).

Society

Although many CS supporters accuse the government of being tyrannical, it has never been particularly repressive or evil. In fact, the government provides the citizens of Kingsdale with more liberty than the Coalition States offers to its own.

Kingsdale is a place where one in three adults can use magic, and humans and D-Bees can live together in relative harmony. Only Lazlo, New Lazlo and Tolkeen are known to be more tolerant of non-humans. However, it is by no means a perfect society. Those who have money and good paying jobs can enjoy a great deal of luxuries, from modern utilities to magical comforts. The city proper is relatively clean, peaceful and prosperous.

The lower classes, the poor, unskilled and unemployed, however, have as low a standard of living as the people of the Chitown 'Burbs. Other than a few private charities, there are no organizations trying to help the poor. While overall literacy is very high in Kingsdale (60% on the average), the illiteracy among the poorest one-tenth of the population is 80%. Violence and lawlessness is widespread in the poorer sections, especially in the so-called "Dregtown" (see *places of interest*, below). Driven by desperation, many people surrender their humanity and become Juicers, Crazies and 'Borgs to secure employment and a way out. Some of the poor, especially humans, feel a great deal of resentment toward D-Bees, especially Elves and Dwarves. This is due, partly because the two races have a strong sense of community and often help their less fortunate fellows. As a result, there are very few members of those races living in the slums and shantytowns surrounding the city proper. To some of the poor, this fact is "proof" that the D-Bees are thieving, greedy strangers whose conniving ways have made them prosper at the expense of "honest humans." Although this intolerance is not widespread (even among the poor, less than 20% are outright bigots), it is the source of the occasional hate crime, brawls and dissension.

Education and developing magical prowess are highly respected among the citizenship of Kingsdale. Although there is no mandatory public schooling, almost every family that can afford the expense (and some poor who can't, thanks to a few private grants and trust funds) send their children to school to learn at least the basics of literacy, mathematics and the sciences. As a result, most citizens of Kingsdale will have the skills Literacy (+15%) and Basic Math (+20%).

While in school, children are tested for any signs of aptitude in magic or the spark of psionic power. Those who do are selected for special training, both to benefit the community and to teach the children not to misuse their powers. This policy helps to maintain the high percentage of sorcerers in Kingsdale, which has remained steady at around 30% for the last five decades, as well as psychics and the occasional Mind Melter.

Technology

Kingsdale as a whole has a technology level comparable to that of 20th Century Earth. Three nuclear power plants (using cannibalized reactors from military vehicles) provide electrical



power for 60% of the population. The remaining 40% live in outlying farms and villages that do not enjoy modern utilities, or in the slums which lack running water, heat and electricity. The kingdom has fair manufacturing capabilities and can produce mega-damage body armor, E-Clips (although not enough to be self-sufficient), plastics, building materials, clothing, and some circuitry and computers (nothing more advanced than simple sensors and hand computers are produced locally). The city proper has facilities where mega-damage armor, bots and vehicles can be repaired. However, the city lacks the resources to manufacture nuclear power plants. One of the most famous “tech-centers” is the **Kingsdale Enhancement Clinic** (described in *Places of Interest*) which has “top of the line” bionic and cybernetic facilities, as well as Juicer and Crazy conversion equipment. As a result, Juicers are a common sight in and around the city and serve as part of the kingdom’s defense force and visitors. A number of body-chop-shops offering the Juicer Process operate openly in the city. Additionally, Kingsdale is a place where some techno-wizard versions of the Juicer conversion can be found, particularly the infamous Dragon Juicers: enhanced humans who use the alchemically-treated blood of dragons as one of the main ingredients.

The kingdom also has contact with such manufacturers as *Northern Gun* (Ishpeming) and *Wellington Industries* (the Manistique Imperium). A joint trading post from both manufacturers

actually operates in the city, and coordinates trade with other kingdoms and nations to the South. Adventurers seeking equipment and repairs will find a good level of variety in Kingsdale. Most Northern Gun and Wellington weapons, equipment and accessories can be found for sale here, although prices are typically 5-10% higher than elsewhere.

Magic at Kingsdale

Demographics: People with magical aptitude total over 27,000, according to the 103 P.A. census.

Ley line walkers: 30%

Mystics: 15%

Shifters: 10%

Techno-Wizards: 10%

Warlocks: 10%

Diabolists: 10%

Summoners: 5%

Others: 10% (includes Temporal Wizards, Necromancers, Sea Inquisitors, priests, herbologists, alchemists, dragons and others with magical skills, etc.).

Magic is an important part of Kingsdale’s everyday life. A sick person is as likely to go to an alchemy store or healer as to a pharmacy or doctor, and a home security system may combine electronic sensors with magical wards and protection circles! For the most part, magic is more expensive than technology, so magic items and services are usually the province of the well-to-

do. The only exception is when people have friends and family members who practice the mystic arts and get an occasional favor; remember, almost one in every three people has some degree of magic power (albeit often at a low level), so there is a good chance that a city dweller will know somebody who can help him or her with a couple of spells, potions or rituals.

This widespread use of magic is helped by a small network of minor ley lines (6 in total). Two ley lines cut across the city proper in two areas, and a minor nexus point is located some two miles away from the settlement. This nexus point has been converted into a small fortress, and a team of magically-adept militia members keeps watch on it to ensure no unwanted visitors emerge from a Rift.

Techno-Wizardry is acknowledged and used, but not to the degree seen at such places as Lazlo and Tolkeen. Any TW item described in the *Rifts® RPG* or *Rifts® World Book One: Vampire Kingdoms* can be found, and prices are 10-20% cheaper than Black Market rates. More advanced and sophisticated devices are much rarer and more expensive.

Alchemical potions and substances can be found in stores in the city and the slums, and they are cheaper than at most other places (lower prices by 15%). Magic weapons and items are rare and much more expensive, except for talismans (also cheaper by 15%). Rune weapons, Millennium Tree items and other exotica are all but unknown, and rarely, if ever for sale. Spell casters will find that most magic spells and rituals, levels 1-7, can be purchased/learned at Kingsdale. Prices are as per *Rifts® Ultimate Ed.*, page 190. Higher level magic is only available to **Magickal Guild Members** (see *Places of Interest* for more information).

Foreign Affairs

Kingsdale tends to mind its own business and not care about the affairs of other nations. However, tension between Kingsdale and its nearest neighbor, the kingdom of **Whykin**, has been rising in recent years. Whykin is populated mainly by humans, most of whom are rabidly opposed to magic and non-humans. Despite these differences, trade between the two cities has existed for over two decades. Kingsdale made it a point not to flaunt its own strengths, magic and liberal policies, and never acted in a belligerent way toward Whykin. The people of Whykin saw no point in picking a fight for no good reason, so as long as neither nation posed a threat to the other, a state of peace was maintained.

A number of incidents have disturbed this fragile truce, but three key events are as follows. First, in 101 P.A., a number of magically-adept raiders ambushed a trading caravan on the outskirts of Whykin, killing five citizens and injuring 16 others. Although no link to Kingsdale was ever proven, many people in Whykin blamed the “Witch Town,” as they sometimes call Kingsdale, for the incident. Trade between the two cities slowed down, and the authorities of both places started searching any newcomers thoroughly. A string of a dozen minor raids against small merchant caravans (two-bit copycats) annoyed merchants to the point that some decided to use alternate trade routes. This also inflamed the citizens of Whykin when the crooks were caught and discovered to be residents of the Dregtown slums in Kingsdale.

In 103 P.A., a group of terrorists planted a bomb in the hover car of Kingsdale Senate member Arcadia. The terrorists had not

counted on Arcadia’s supernatural toughness; the frail-looking woman survived the mega-damage explosives relatively unscathed. However, fifteen other people, including three school-children whose only sin was being near the car when it exploded, died in the incident. The terrorists were found, but were killed resisting arrest. An investigation as to their motives and supporters was inconclusive, but some leads did point to Whykin. After that incident, diplomatic relations and all trade between the two nations stopped altogether, and the **Kingsdale Forest Rangers** established a defense perimeter around all territories claimed by the city-state, stopping and questioning anybody who entered the area.

The third element has been the influence of the Coalition States. The CS has had a tenuous relationship with Whykin for years, but in the last few, they have increased the level of enticement for the city-state to “officially” join the Coalition States. To this end, the CS has been fanning the fires of hate, fear and distrust of Whykiners toward Kingsdale. The CS view the city-state of Kingsdale as an abomination and yet another target for “cleansing” once the CS has dealt with more immediate threats (see *Rifts® World Book 11: Coalition War Campaign* for more details). They are quick to point out that there is a shadowy and unofficial connection between Kingsdale and the new *Federation of Magic*. Although the Kingsdale government has no formal relations with any of the kingdoms of the so-called “federation,” several of the most powerful and prominent magicians of the city do have contacts with them. The Coalition has recently launched a propaganda campaign showing direct ties to the Federation and has suggested that Kingsdale is a front for



these vile terrorists and long-time enemies of the CS (of course these are all lies). They also condemn the use of “dangerous technologies,” such as the Juicer and Crazy conversions, and “nightmarish creations” of Techno-wizardry, as well as the harboring of non-humans and criminals.

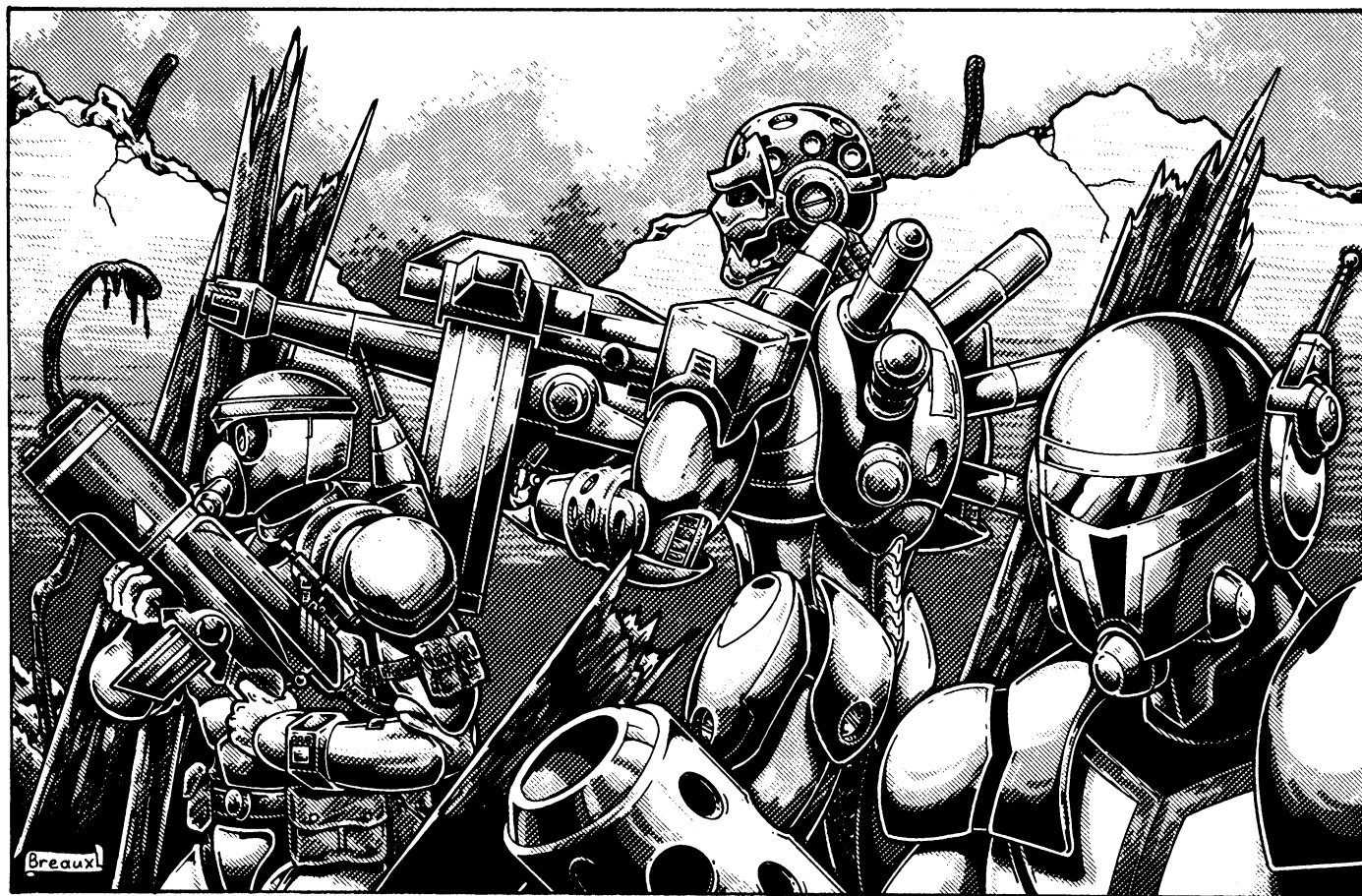

Kingsdale's Armed Forces

Kingsdale has about 12,000 troops at any given moment. Should war with Whykin or another force demand it, this number could be doubled or tripled in a relatively short time. The armed forces are divided among four major formations: Donner's Division, the Forest Rangers, the City Guard and the Magic Militia. All able-bodied citizens are expected to serve for two years in either the Forest Rangers or the City Guard.

Donner's Division

1920 Juicers (60% are conventional Juicers)

640 Crazies

640 Headhunters

320 'Borgs (full conversion)

160 Special Forces

640 Other men of arms (scouts, power armor pilots, grunts, etc.). Average level of experience: 15% 2nd level, 20% 3rd level, 15% 4th level, 30% 5th level, 10% 7th level and 10% 8th and higher. An estimated 1000-2000 Juicers, 200-400 Crazies, 200-600 'Borgs and 1000-2000 other men of arms can be raised in case of an emergency; possibly more depending on the circumstances (like a CS invasion).

The formal army consists of some 4320 troops under the command of **General Desmond Donner**, a former military officer of the Manistique Imperium who sold his services to Kingsdale fifteen years ago. General Donner has built a well-trained and organized army to serve as the main defense of the city. They are prepared for conflicts with both Whykin and the Coalition States. Donner realizes that an all-out attack by the Coalition will almost certainly succeed, so his defense plan calls for extensive guerrilla warfare, coordinated with the efforts of the **Forest Rangers** to deny the Coalition a secure foothold in their territory and to strike as a retaliatory underground army should the CS conquer Kingsdale.

Most soldiers in Donner's Division have medium to heavy body armor (50-70 M.D.C.), an energy rifle (long E-Clips are supplied routinely) and 1-4 personal weapons. Vehicles include a dozen medium and heavy Iron Heart tanks (see *Rifts Mercenaries*), over 1200 motorcycles, 600 hover vehicles, a small air squadron of some 24 fighter aircraft, 300 power armor suits and 50 giant robot vehicles (mostly Northern Gun product). These forces have sufficed to maintain the peace around the borders of Kingsdale and successfully defend against marauding bandits, dimensional raiders, and a powerful ancient dragon bent on usurping the rule of the kingdom. In case of a war, Donner would try to hire an additional two to four thousand mercenaries;

not enough to stop a full force siege by the Coalition, but enough to make it a very costly victory.

The Forest Rangers

This organization is the direct descendant of the pre-Rifts North American Forest Service (a division of the Department of Agriculture). A small group of rangers who survived the Great Cataclysm built a small community that kept alive the ideals of the Forest Service. Eventually, the Rangers joined with what would become Kingsdale; and now are the second largest armed force in that kingdom.

The Forest Rangers number about 2,000. 60% are wilderness scouts, 15% are Juicers, 10% Crazies (both with wilderness skills; see the *Juicer Scout O.C.C.*), and 15% are men of magic (mostly Ley Line Walkers and Mystics). A significant percentage of the Rangers are Psi-Stalkers (20%), Simvan (10%), Elves (30%), and Wolfen (15%); the members of the latter two races have exceptional woodcraft skills. They have few vehicles, mostly ATVs, motorcycles, and the occasional jet pack; Simvan Rangers ride a horse or monster. Most Rangers prefer to conduct foot patrols in teams of 3-18 (3D6) members. The Rangers are issued a pulse laser or ion rifle, an energy sidearm of choice, and a suit of Bushman body armor painted in a forest camouflage pattern. Some Rangers prefer to use bows and arrows, and usually have several arrows equipped with explosive or magical warheads. Magic is also used to travel (float, fly, levitate, swim, etc.), track, fight and protect.

The Rangers' main duty is to keep the surrounding wilderness free from bandits, monsters and other threats, as well fighting forest fires. They are also the first people travelers in the area are likely to encounter and are famous for helping humans and non-humans alike. They find and escort lost people to safety, help those stranded with a broken vehicle, offer directions and helpful information about the area and assist travelers in all types of distress. Although known for their courteous and helpful manner, they can be extremely relentless and tough when hunting down desperados and dealing with troublemakers. Suspicious looking travelers passing close to Kingsdale are often stopped by Ranger patrols and questioned about their destination, intentions and identity. They are especially suspicious of Whykiners and CS soldiers and citizens.

Rangers never travel in units smaller than three (typically three scouts or a pair of scouts and a Juicer or Psi-Stalker), and a typical "patrol" will consist of three to six wilderness scouts, one or two Juicers or Crazies, one or two others, and one practitioner of magic. Average level of experience is 1D4+3.

The Kingsdale City Guard

This organization provides the manpower for both the Kingsdale Police Department and the city's defense forces. The City Guard has some 4,000 effectives, divided into the Police Division (3,000) and the Militia (1,000). The Police Division is in charge of keeping the peace, investigating urban crimes, and doing similar routine police work. The standard issue for police officers is a suit of Plastic-Man armor with built-in radio, a laser pistol, and a neuro-mace or baton. A pulse laser rifle is often kept in their patrol car. Vehicles are limited to motorcycles, hover bikes, jet packs and hover cars. Average level of experience: 10% are 1st level, 20% 2nd, 20% 3rd, 30% 4th, and the rest are 1D6+4 level. 15% are Juicers, 15% Headhunters, 5%

'Borgs, 5% City Rats, 10% practitioners of magic, 10% are equivalents to the CS Military Specialist (officers) and 40% are the equivalent of CS grunts.

The Militia is equipped with medium or heavy body armor, and ion or laser pulse rifles, grenades, and other military equipment. The militia has a Robot Squadron (25 robots) and a Power Armor Division (30 suits), mostly relying on Northern Gun models. The militia's mission is to act as the city's garrison and provide support for the Magic Militia.

In case of war, the City Guard would also equip itself with heavy weapons and armor and be charged with civil defense, law enforcement and riot control.

The Magic Militia

Second in raw power to Donner's Division is the Magic Militia with its 2,000 troops; all practitioners of magic! Every single member is a sorcerer trained in basic combat (W.P. Energy Pistol, W.P. Energy Rifle and Hand to Hand: Basic). Ley Line Walkers, Shifters and any magician who can learn spells are taught the following combat spells, regardless of their level of experience: Armor of Ithan, call lightning, chameleon, fireball and heal wounds. Mystics, warlocks and similar magicians who cannot *learn* spells, are encouraged to "acquire" helpful combat magic when they have reached the appropriate plateau of advancement. Additionally, magicians are taught to fight in teams and in concert with "mundane" soldiers. Maneuvers with Donner's Division and the city Militia are common. The sorcerers are taught to use their powers to surprise the enemy, support infantry soldiers, and to act as medics, long-range artillery, shock troops, spies and special forces. **Note:** 40% are Ley Line Walkers, 20% Techno-Wizards, 10% Shifters, 10% Mystics, 10% Warlocks, and 10% other. 55% are humans, 40% are D-Bees and 5% are others (dragons, etc.)

Places of Interest

Kingsdale is located in a shallow valley, surrounded by low hillocks except on the river's side. The taller buildings can be seen in the distance, but most of the city is protected by the hills. A number of bunkers, manned by Donner's Division, protect all easy ways through the hills. These measures have sufficed to keep bandits and the occasional monster off the city proper. Two of the hills to the East are covered by the shabby dwellings of the Dregtown slums. Rangers patrol and protect the surrounding wilderness areas.

In addition to the places and stores described below, Kingsdale has half a dozen garages and maintenance centers capable of repairing and modifying mega-damage vehicles, bots and power armor, as well as four hotels with a tavern and restaurant, five body-chop-shops (prices are 10% lower, but failure rates are 12% greater) and a number of little shops and stores where one can purchase food, drinks, clothes, books, electronics, and other goods.

The Merchant's Plaza: This area is located near the center of the city proper. It is a large plaza with a small park in the north and an open courtyard decorated with statues of important figures in Kingsdale's history in the south. The rest is filled with

merchant stalls. Some are permanent structures of brick and mortar, while others are simple tents erected by traveling merchants staying in the city for only a short time (a few days to a few weeks). Clothing, computers, video and computer disks, books, machine parts and the like can be purchased here. Some S.D.C. weapons (especially melee and archaic weapons like knives, swords and bows and arrows) can also be purchased here. Most firearms and all energy and mega-damage weapons can only be found at the **Gunnery Trading Post**, mainly for security reasons.

Visitors to the Merchant's Plaza are quickly warned to watch out for cutpurses and pickpockets (city rats, levels 1-4) who routinely prowl the busy streets looking for easy marks. There are also a number of games of chance being run in the streets, from shell games to more legitimate card and dice games. The Plaza also has an entertainment area that offers fortunetelling, psychic counselling, ever popular pool and arcade games, nightclubs, dance halls (and saloons), "escort services," exotic dancers, and other sleazier services. During the summer, the *Best Freakin' Show*, a traveling circus, sets up shop at Kingsdale for an entire month. The show includes several magic acts, exotic animals, acrobats and similar good, clean fun (see *Rifts World Book One: Vampire Kingdoms* for travelling circus and freak show creation rules).

City Hall: The tallest building in Kingsdale is the City Hall, an imposing Gothic structure with elaborately decorated walls and fearsome gargoyles carved into each story. This 20 story building contains all the public offices, including the Senate Meeting Hall, the Judicial and Superior Courts, and the Dictator's office; only the Chief of Police has his offices at the Precinct House. While some might question the wisdom of putting almost every important person in the city in one building, where a bomb or some tragedy could take them all out, the fact is that City Hall is one of the best defended buildings on Rifts Earth and a mega-damage structure.

The Gothic architecture of the building conceals a myriad of incredibly powerful circles, wards and other mystical defenses. One of the defenses is a secret magic circle that prevents any energy discharge, explosion or detonation occurring from within the building or up to 100 feet (30.5 m) away! The "No Smoking" signs inside the building are utterly superfluous, as nobody can ever get a cigarette to light up, or to stay lit, while inside City Hall. The protective magic that is in place is obviously selective, allowing electricity and low-level burning (like the act of human breathing) to occur unimpeded, but preventing high-tech weapons, from slughtrowers to lasers, from working. Only the top sorcerers of the Kingsdale Magickal Guild know how to make this circle, which is said to require enormous magical expenditures and can only be performed over a ley line (one of which, not so coincidentally, runs right below the City Hall building). The walls of city hall are made of enchanted stone and concrete able to withstand 400 M.D.C. per 4 foot (1.2 m) section. Technological equipment (cameras, motion detectors and metal detectors) adds to the security.

Visitors to the place are searched, physically and magically, at every entry point. The head of security is an 8th level Mind Melter. He and his "Stealth Team," a beautiful Elven woman (P.B. 24, M.E. 22, 5th level Mind Melter) and four psi-stalkers (each is 6th level) use their psionic powers to further examine

suspicious looking characters and to sniff-out supernatural menaces. Once a visitor has been "cleared," he or she is free to go to their destination, be it the court for an important trial, or the Office of Permits to get a liquor license, and so on.

The Precinct House and City Jail: This large, grayish and drab structure fills an entire city block. This is the headquarters of the Police Division and where half of the entire police force is located (four smaller Precinct Houses collectively hold the other half). For the most part, this building looks like a typical police precinct from the 20th Century, except for the preponderance of body armor and the chance that the dispatcher, or the homicide detective will be a Wolfen, Elf, Psi-Stalker or other D-Bee.

The city jail is also in this building; there is only room for about 400 prisoners, because few people are ever imprisoned for long in Kingsdale. Convicts in for serious crimes are usually sent out to be executed by hanging or firing squad (prisoner's choice, unless he is a supernatural being immune to hanging), or taken to a labor camp where they will work off their debt to society. The commission of lesser crimes typically results in a stiff fine, a stern warning and freedom. The city jail's cells are sturdy: each wall has 300 M.D.C. and the bars on the door and windows have 100 M.D.C. each, plus they are constantly monitored by cameras. Dangerous prisoners and supernatural beings are further restrained by magical circles, wards, etc.

The Happy Days Inn: The largest lodging establishment in Kingsdale, the Happy Days Inn is a ten story building (the second largest building in Kingsdale) with an additional five subterranean levels. This 200 room hotel was built during the height of trade with Northern Gun, the Manistique Imperium and Whykin. Tension with Whykin has reduced trade and the number of visitors to the city by 30%. The increased presence of the Coalition in the territory has further reduced trade and visits from some of the D-Bee and smaller communities in the region. The hotel has suffered accordingly and finds that it can rarely fill more than half of its rooms at any given time.

Despite its problems, the hotel is quite beautiful, with a white and brick-red facade, a neon sign, and glass doors. Besides offering lodging, the Happy Days also has a nightclub, **The Nightingale**, where some of the best local talent and a few wandering musicians perform. The best restaurant in the city, **The Silver Fork**, and a small general store are also located at the Happy Days Inn. The standard rates are 30 credits a night for the "economy rooms" (a tiny room the size of a large closet, with a common bathroom located at the end of the hall, servicing ten other rooms), 80 credits a night for the "standard" (a one-bed room with a private bathroom, about the size and quality of a 20th Century motel room), 120 credits a night for the "first class" (a large room with a small living room and spacious closets and bathrooms), and 400 for the "imperial suites" (as luxurious and as large as a medium-sized apartment, beautifully decorated). Regular customers often get a 10 to 20% discount.

The hotel is owned and operated by the Gracci family, humans who have lived in Kingsdale for several generations. The patriarch of the family, Ramon Gracci, a retired Ley Line Walker (6th level Line Walker and 10th level merchant), is one of the wealthiest people in the city and a member of the Kingsdale Senate. The hotel is managed by his daughter, Corina Gracci, a middle-aged woman who is extremely gracious and courteous toward guests, but a total witch to her employees. The

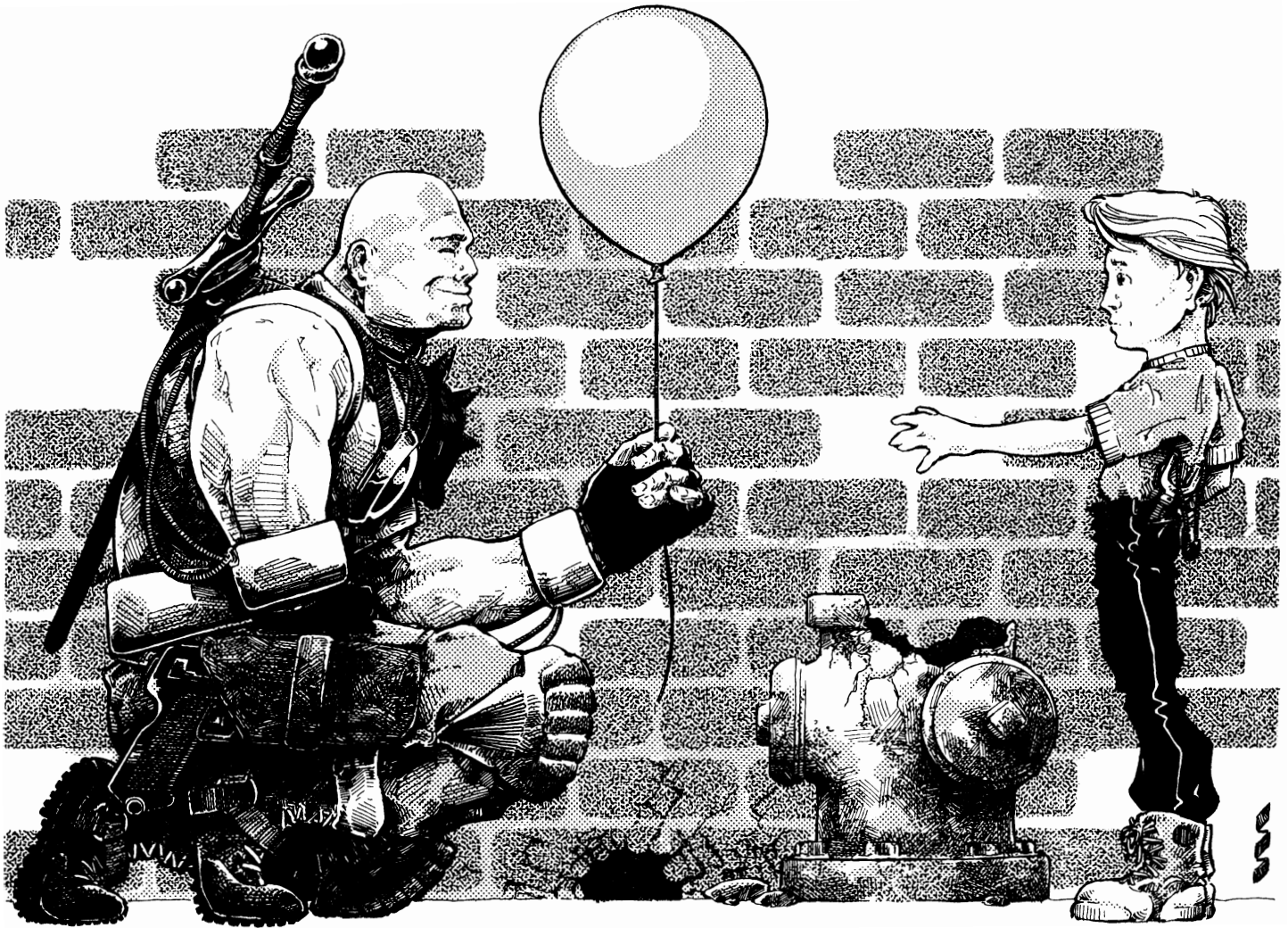

youngest Gracci is Manuel (7th level gambler), Ramon Gracci's grandson and Corina's nephew, a thirty-year old ne'er-do-well who often hangs around the nightclub trying to con some guests into joining him for a private poker game where the stakes are high and the cards are loaded. Corina wants Manuel expelled from the hotel (he has a lifetime Imperial Suite), but his grandfather does not have the heart to do so; it is rumored that Corina is scheming to have Manuel killed before he ruins the hotel's reputation.

The Laughing Skeleton Bar: This is a Juicer bar (see the *Juicer Culture* section) run by Kilroy Pig, a Titan Juicer (8th level, three years old) who inherited the bar in 103 P.A. after the previous owner (another Juicer) "checked out." Kilroy is one of the toughest Juicers around (3,000 S.D.C. and 240 Hit points, or a 32 M.D.C. equivalent, and a supernatural P.S. of 56)! When Kilroy tends the bar, his establishment gets very quiet and peaceful. Over the years, the Laughing Skeleton has accumulated pictures, trophies and mementos from famous Juicers throughout history, including a laser pistol reputed to have belonged to none other than Julian Amici himself (Kilroy will react angrily to any reminder that Julian Amici is a fictional character).

The bar has its own special tradition: Every Thursday night at midnight, Kilroy will get everybody a drink for free (and if you're not drinking, you get out of the bar right then and there),

and then has everyone stand up and join him in a toast: "To Death! We'll all get to see her sometime soon!" At the end of the toast, everyone has to empty his glass and throw it to the fireplace. A couple of mystically inclined customers find the entire process rather suspicious, almost smacking of Death worshiping, and some rumors claim that the basement of the Laughing Skeleton is a secret meeting place of the necromantic Grim Reapers (see the *Juicer Organizations* section for more information). So far, nobody has managed to uncover any information to prove or disprove this (and live to tell about it?).

The Kingsdale Enhancement Clinic (KEC): This is one of the best "chop-shops" in North America! It is a cyber-medicine clinic where the Juicer process as well as M.O.M. conversion, and bionic and cybernetic enhancements can be acquired. Juicer conversion is offered for a "mere" 70,000 credits, plus a 15,000 credit "license" purchased at City Hall; M.O.M./Crazy conversion costs twice as much. The license authorizes the carrier to receive Juicer (or Crazy) augmentation and operate with such conversion at Kingsdale for a period of up to 10 years (most Juicers die before then; Crazies need to renew for a cost of 30,000 credits). Cybernetics and bionics can also be had, at a 10% discount over common Black Market prices, but any weapons, bionics or combat-oriented enhancements require a government license that costs 5,000 to 20,000 credits, depending on how extensive or dangerous the implants or limbs are.

The Enhancement Clinic is run by *Doctor Douglas Welby, CMD*. Welby is a 14th level cyber-doc of almost supernatural skill (enhanced by the fact that he is a major psionic with the powers of deaden pain, healing touch, increased healing, psychic diagnosis, psychic purification and psychic surgery, among others). The good doctor is not only the best surgeon on the staff, but he is also an able administrator that has kept the Clinic running profitably for over seven years. Dr. Welby is in his mid-forties, slightly balding, with a kind expression and an intelligent, handsome face that has made more than one female patient, nurse and fellow doctor fall in love with him. To their dismay, Welby is happily married to a colleague, Dr. Mary Alt, an Elven physician and masterful surgeon. She is a stunning beauty, very charismatic and persuasive (10th level cyber-doc; I.Q. 19, M.A. 21, P.P. 23, P.B. 25; age 126 but looks 25). She is also a leading expert in bionics and cybernetics at Kingsdale and is currently dabbling in techno-wizardry. The couple, despite their inability to have children (being of different species), lead a happy, idyllic life.

The rest of the staff is courteous and highly skilled. All cyber-docs are at least 5th level, and all bionic and Juicer conversions are done with a 98% success rate. If a customer or patient becomes unruly, they are dealt with by the local security experts, which include four Wolfen Juicers (5th and 6th level), a full conversion 'borg (5th level) and a dwarven Headhunter (8th level), in addition to some 12 headhunters (levels 2-5).

The Enhancement Clinic offers full bionic conversion, all forms of bionic limbs, M.O.M. conversion, and in addition, the normal, "standard" Juicer conversion, the more exotic Hyperion, Titan, Phaeton, and (recently) Mega-Juicer types. Dr. Alt is trying to find a synthetic way to replicate dragon blood, which would allow the clinic to produce Dragon Blood Juicers, which is not currently offered by the clinic this research (although likely never to succeed) is causing some tension between the Clinic and the Kingsdale Magickal Guild.

The Kingsdale Magickal Guild (a.k.a. the Monolith) & Guild Store: The Kingsdale Magickal Guild is located in a strange-looking building half a block away from the Merchant's Plaza. The building appears to be a huge square made of a jet-black stone, and 40 feet tall (12.2 m). It is popularly known as "the Monolith" by the residents of Kingsdale. The stone appears to be completely impervious to all forms of attack, magical, technological and psionic. A human supremacist once fired a long-range missile with a nuclear warhead into the building, killing over twenty innocent bystanders on the street but not even scratching the surface (the terrorist was captured and taken into the Guild building; there are dozens of rumors concerning his fate, each more horrible than the last). A 20 foot (6.1 m) tall double door is the only entrance; there appear to be no windows.

Only magicians and a few supernatural creatures are allowed into the Guild building. Visitors report that the interior is never the same twice. Furthermore, the actual dimensions inside the Monolith seems to vary from time to time. Many witnesses claim the inside of the building is far bigger than should be possible, while others insist it is much smaller. The decor varies from a dark, cathedral-like structure to what appears to be an outdoor setting, sometimes a forest or meadow, sometimes a scorching desert over which shines a black sun. The meeting room of the Guild may look like a tent, or the nave of a church,

or a 20th Century office; it too is often different each time a visitor enters. Nobody seems to know whether this is done on purpose to keep newcomers off balance, or is some side effect of the building's nature.

All newcomers are greeted at the front door by a tall human-looking creature who registers as supernatural to most psychic and magical probes. The man, who calls himself "The Keeper", is always dressed in a black suit, reminiscent of the suits worn by 19th and 20th Century morticians. He has no hair whatsoever (including eyebrows and eyelashes), and his skin is extremely pale. The Keeper always meets visitors in a monotone, deep voice, with usually no more than a few words like, "Greetings. Enter as you will"; "The Masters are awaiting. Follow me"; or "Your presence is not required now. You may not enter." People who try to argue that last line have come to bad ends. The most famous incident involving The Keeper occurred in 98 P.A., when an ill-mannered hatchling dragon got mad at being refused entry and took a swing at the man. Nobody knows exactly what happened, but a couple of eye blinks later, the dragon was lying on the street in four or five pieces, quite dead, and The Keeper was calmly shutting the doors. Witnesses claim that for an instant, The Keeper seemed to change shape into something horrible and frightening; not even psychic probes and hypnotism have been able to make the witnesses remember exactly what the shape was.

The Guild has 793 official members as of 105 P.A. and about 1,000 candidates for membership. Entrance to the Kingsdale Guild is very limited. All members are at least sixth level and are accomplished scholars and adventurers as well as practitioners of magic. No member is allowed to reveal how they gained membership, but it is known that several of them completed a number of highly dangerous quests and missions, some of them on other worlds and dimensions. All who are accepted as members are also quite wealthy, and make donations of at least 100,000 credits every few years. *Candidates* for membership must be at least 6th level, and must be willing to undertake several missions over the course of years. Some candidates have been trying to earn admission for over a decade!

The *rewards of membership* are worth the price of admission. Guild magicians have access to any and all common spells, as well as Spells of Legend, and some new incantations unknown to the rest of the world. Additionally, the Guild Building has strange portals leading into several other dimensions, including the Guild's own Astral Kingdom (for information about astral kingdoms, consult *Nightbane World Book One: Between the Shadows*, or the upcoming *Rifts World Book Twelve: Psyscape*). The Guild will also help the magician in any research project; its libraries are among the most complete on the planet, surpassed only by such centers of learning as Atlantis, the Federation of Magic and Lazlo (the CS and NGR surpasses them only in the areas of technology, manufacturing and pre-Rifts era history and science).

The leaders of the Magickal Guild include Argo the Traveler (14th level Shifter), Menelaus Clotho (12th level True Atlantean Ley Line Walker), Irene LaRue (10th level Techno-Wizard) and Yolanda, (15th level Nightbane sorcerer — can be changed to a Sowki, Lizard Mage or Zembach if not familiar with the Nightbane™ RPG and characters).

Argo is reputed to have built the Monolith, although he claims to have found it on an alien world where, according to his story, “the gods would weep in horror.”

Menelaus is another experienced dimensional traveler, but rumor has it that he saw or did something that has permanently impaired his sanity. Rumors point to the mage having somehow reached the sleeping place of some creature or creatures known as the *Old Ones*. Since then, Menelaus is given to explosive bursts of insane laughter for no apparent reason, and most of the time it’s hard to have a rational conversation with the man.

Irene LaRue is the newest Guildmaster (or, more accurately, Guildmistress, although she insists on being called “master”); an ambitious and incredibly talented Techno-Wizard, she is credited with building a device that can open and close Rifts and dimensional portals with minimal P.P.E. costs! Some guild members and candidates suspect Irene’s ambition may lead her to attempt to remove one or more of the other Guildmasters by intrigue or outright treachery.

The woman who calls herself Yolanda has been the subject of a great deal of gossip since a team of assassins tried to murder her. According to an alleged witness, the assassins were somehow shielded from magical attacks, but Yolanda dealt with them by changing into the shape of a grotesque creature (a Nightbane™), part human, part feline, with bloody thorns protruding from her skin. The Yolanda-creature tore the would-be killers to shreds with terrifying ease. Coupled to this story are her occasional claims that she was alive (and already quite old) on Earth at the time of the Great Cataclysm; as a result, most people are uncomfortable in her presence.

Located across the street from the Monolith is the **Guild Store**, a perfectly normal looking shop that specializes in magical and Techno-Wizard items, components, scrolls and such. It even has a small section of alchemical components and herbs, although the store clerks admit that they cannot match the variety and quality of **Ye Alchemy Shoppe**. The store does have a wide selection of everything else, however, and at reasonable prices. It is managed by an ancient Wolfen called Numo (10th level scholar), whose brown fur coat is streaked with white and gray. Numo is extremely knowledgeable in all matters arcane, although he abandoned the pursuit of magic long before becoming a mage. The character will be glad to help identify and catalog any strange occult device or artifact, for a nominal fee of 50 to 1,000 credits (depending on how much research he has to do; he will not accept payment if he’s unable to identify the object). Although he will never betray the Guild, he will gladly share some of the rumors and gossip that are widely known in the city, prefacing them with “this is but a rumor, and may or may not be true.” He is also always hungry for new information, both about the world at large and any political intrigue or new developments in the sciences, arts, magic and the supernatural (he knows all lores). Of late, he has become highly interested in the continent of Atlantis and the Splugorth race, so he may pay well (as much as 100,000 credits) for any major piece of information or (non-magical) item. He may also purchase magic items (except rune weapons, which he will not even touch), paying between 10% and 30% of the “market price.” He has 2D6 million credits put aside for such knowledge and items at all times.

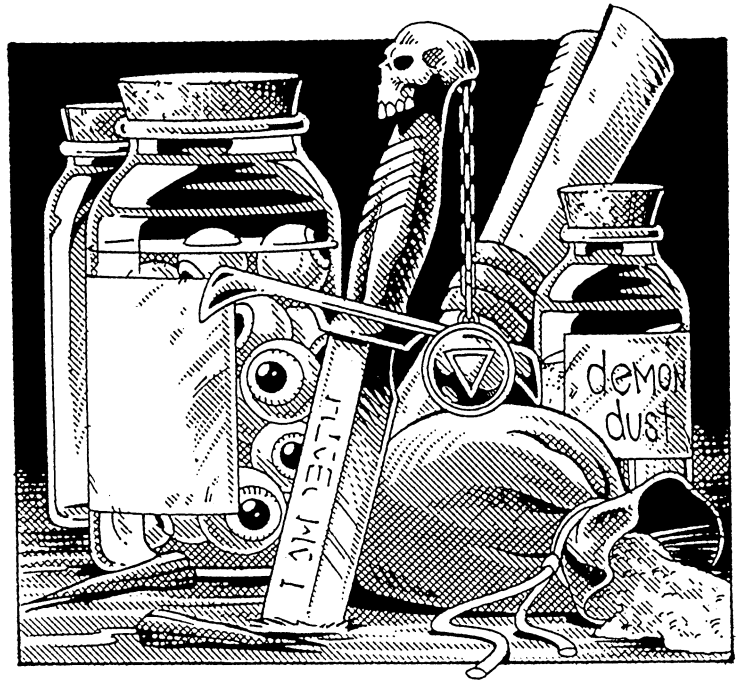

Ye Alchemy Shoppe: The second largest arcane shop in Kingsdale is operated and owned by members of the **Society of Sages** (for more information, refer to the *Juicer Organizations* section). The store has a good supply and wide range of magical potions, poisons, and even such exotic items as Faerie Foods and other strange items and substances, like bark from Millennium Trees and items that are not native to this part of the world (sometimes the Megaverse). Prices can range from the reasonable for relatively “common” alchemical substances to the outlandish for very rare and unique compounds.

The manager is none other than a Lizard Mage (see *Rifts Conversion Book One*) who goes by the name of Slither. Although most Lizard Mages are evil geniuses, Slither is neither. Once, he was indeed a powerful evil sorcerer and a dimensional raider, but he made the mistake of trying to steal from the Splugorth lord Splynncryth of Atlantis. The minions of the Splugorth discovered and captured the arrogant mage, and Splynncryth decided to have some fun with him. The Lizard Mage was cast into the strange dimensional portal at the city of Azlum (see *Rifts World Book Two: Atlantis*). A portal that opens into a dimension of light that has the effect of changing people’s alignments, powers, and even their physiology. Over a century later, the Lizard Mage was hurled through a Rift and was found, naked and unconscious, in the neighborhood of Kingsdale. Slither remembered most of his past, but could not recall anything about his experiences in the light-dimension. Whatever happened, his alignment changed from aberrant to scrupulous, and he lost all his P.P.E. and magical powers (although not his vast knowledge of magic).

The Society of Sages took pity on Slither and gave him his current position at Ye Alchemy Shoppe, where he serves as an expert in all alchemical substances and poisons. He also has the accumulated knowledge of over 5,000 years of dimensional traveling, and hires out his services as a consultant for a fee of 100 credits per hour, during which he will be happy to talk about such subjects as Phase World, Wormwood, the Palladium World and other places.

Note: Slither does not know a great deal about the Society of Sages' secret projects. People who want to know about the Dragon Juicer conversion will be told to speak with *Cagliostro Smith* (see the *Society of Sages* section).

The Gunnery Trading Emporium: This large store and warehouse fills two entire city blocks. It was established as a joint project by Wellington Industries (see *Rifts Mercenaries*) and Northern Gun, two of the largest arms manufacturers on the continent. The two companies agreed on this alliance to build a major trading post that would supply not only Kingsdale, but many other communities, as well as adventurers and mercenaries. The growing tension between Kingsdale and Whykin has slowed down trade, but the Emporium is still a major stopping point for mercenaries in the area and any merchant caravan coming to ply its wares in such places as Fort El Dorado, Los Alamo and El Paso.

The Emporium is a gun-lover's delight. The walls are decorated with hundreds of weapons, from "antique" .45's and M-16's to the latest weapons of the second century P.A. Although the emphasis is on products manufactured by Northern Gun and Wellington Industries, there is a sampling of other manufacturers, including Wilk's, Triax and Iron Heart Armaments. The only notable exception is Naruni Enterprises, a transdimensional arms dealer whose motives and methods are viewed with suspicion by most human-controlled companies. No Naruni products are sold in the Emporium, and clerks asked about Naruni products will be quick to point out how unreliable, alien and possibly dangerous they are (Naruni Enterprises is described in *Rifts Mercenaries* and *Rifts Dimension Book Two: Phase World*).

Given that there is a high concentration of Juicers in Kingsdale, many weapons and products in the Emporium are geared for the consumption of Juicers. Specialty weapons like flame-throwers, chainsaws, spiked armor, etc., are on display throughout the store. In addition to weapons, the Emporium has a small selection of vehicles, including several models of motorcycles and ATV's designed with the Juicers' incredible reflexes in mind. For more information on some of these weapons and vehicles, refer to the Equipment section of this book as well as **Rifts® Mercenaries**.

The Emporium is operated by *Carter Killigan*, a retired Juicer who survived detox and coped with it by acquiring massive bionic implants. Now more than half machine, he remains an expert in the arts of death-dealing and takes no lip from any Juicer who might think he "wimped out" by not accepting his fate. Most of the time, he's friendly enough, and has no problems with anybody who doesn't try to judge or insult him, Juicer or otherwise. In fact, most Juicers in Kingsdale have grudgingly come to respect the man, all the more so since Killigan helped round up a band of Juicer renegades who had been terrorizing the countryside. Killigan's posse was ambushed by the Juicers, and he was the only survivor. Alone and armed only with a vibro-blade, the 'Borg managed to take out three Juicers in hand to hand combat!

Dregtown: The poorest and most miserable citizens of Kingsdale have no choice but to make their homes on a couple of hills removed from the city proper. There, a chaotic jumble of tents, makeshift huts, and crudely built houses made with stolen construction materials litter the hills. Only a few "real" buildings have been built over the years.

Dregtown is essentially a lawless section of the city. The police only come here occasionally, and then they come in force (at least 50 officers, usually 100), and only when a "normal" citizen has gotten in trouble at Dregtown or some "Dregs" are conducting criminal activity in the city or surrounding wilderness.

This area is not just a place where the poor live, but a haven for criminals, spies, disreputable mercs, and organized crime. Over the years, the Black Market, other criminal organizations/gangs and greedy or evil individuals have used Dregtown as a den of drug trafficking, prostitution and forbidden pleasures.



Since the law rarely interferes with anything happening in Dregtown, it is the ideal place to set up shop for the criminally minded. So, despite the danger, many wealthy and spoiled people venture into the slums to “have fun.” Juicers often venture there, confident that their abilities will get them out of any trouble. A few Juicers have become leaders or enforcers for a criminal gang, merchant, drug operation, or other organization.

Besides normal humans and D-Bees, Dregtown is the hiding place of a number of supernatural creatures, including vampires (two nests of 1D6+2 vampires and a master vampire each hide there), werewolves (a pack of 7 hunt the homeless and destitute) and other monsters and predators. Sometimes the monsters attract enough attention to warrant a manhunt (so to speak) into Dregtown, but most of the time they can operate with impunity.

Los Alamo

By C.J. Carella with Kevin Siembieda.

Population Breakdown: 90,000 total

Humans: 75%

Mutant Animals (mostly Canine Humanoid): 10%

Others: 15% (assorted D-Bees, mostly humanoid).

Note: This does not include the population of New Austin (5,500), Greenestown (7,800), the population of the surrounding villages, farms and ranches (approx. 1,200) or the transient population of visitors (about 1D6×1000 at any given time). Freakville is part of Los Alamo.

This kingdom is located near the ruins of Austin, Texas. The community managed to survive the chaos of the Great Cataclysm and grew into a large, independent city-state with relatively high levels of technology (equivalent to 20th Century Earth, with a few advanced 21st Century techniques).

According to the local historians, a couple of units of the Texas National Guard were able to save a small group of people from the Cataclysm. In a matter of a decade, the survivors were able to loot the ruins of Austin and salvage much of its technology. This made them reasonably self-sufficient. To deal with the threat of marauding bandits and D-Bees, the people of this community built a string of forts around the city. Although usually outnumbered two to one, the humans persevered. This feeling of being outnumbered and besieged reminded people of the story of El Alamo, so they named their growing township in its memory, thus Los Alamo was born.

For many years, Los Alamo remained isolated from the world at large. They refused to admit strangers beyond their fortified walls and created a massive minefield in the wasteland around the city-state — a no-man’s zone they call “The Border.” By the late 50’s P.A., however, a number of trading caravans connected Los Alamo with other cities, and by 102 P.A., the city finally adopted a new “Open Door” policy and established diplomatic relations with such townships as El Paso, Ciudad Juarez, and Fort El Dorado, among others. The kingdom politely turned down an offer to join the Coalition States in 104 P.A., but it remains a bastion of humankind in the desolate Texas countryside.

Geography

The city is located by the shores of the Colorado river. A large hydroelectric plant produces enough power to maintain an impressive industrial complex, and to provide electrical lights and services for most of its 90,000 inhabitants (a luxury in most areas outside Coalition control). The kingdom is divided into four main sections. First is The Border, a no-man’s land that is the main defense against raiders and similar threats. **The Border** encloses a number of small agricultural villages and two towns, **Old Austin** and **Greenestown**, which in turn surround the city of **Los Alamo**; often referred to as “Downtown.”

Before the Coming of the Rifts, Texas was mostly arid, and the region around Los Alamo was no exception. During the great Cataclysm, however, a strange species of D-Bee tree appeared in the region, and has spread to cover an area of hundreds of square miles. This tree, known as **Purple Pine** (a completely unscientific name; the tree simply looks vaguely like a pine in the distance), has a dark purple trunk and straight branches covered with thin, spiny-looking leaves, with dark-green hues and purple “veins.” The tree seems to need very little water to survive, and can suck all the moisture it needs from the air around it. Still, most purple pine forests follow the Colorado river. Purple pines produce an edible fruit, known simply as “purple.” Purples look vaguely like large pine-cones or pineapples, and have a citrusy taste, although sweeter than most Earth fruits. Purples are now a staple in Los Alamo and are used in a variety of dishes, salads and deserts. A very strong liquor known as Purple Moonshine is also manufactured from the fruit.

Animals common to the region include the possum, armadillo, deer, and coyote. Wild cattle (survivors from pre-Rifts times) roam the plains, and are leaner and meaner than their domesticated cousins. Additionally, roving packs of *Ostrosaurus* (see *Rifts Sourcebook One*) prey on the local wildlife and have yet to learn to fear humans, so they remain a constant danger. Most of the wild creatures have learned to fear the Border, and tend to avoid the mined no-man’s land around the kingdom.

Government

The earliest members of the community amassed the greatest wealth by being the first to access all technology, weapons and other riches. They became the rich, elite, land barons and power-brokers of the territory. The average person was a poor farmer, cattle rancher, craftsman or laborer. They weren’t destitute like the people of Dregtown, but by comparison to the super-rich who ruled them, they were paupers. A few bitter people began to call these millionaires the “robber barons,” inspired by some fragments of a pre-Rifts book on the wealthy railroad “robber barons” of the 19th Century. Instead of being offended, however, the rulers of the community accepted the title as a compliment. Soon they started calling themselves the “barons,” and the name stuck. The governor of Los Alamo holds the title of Baron-in-Chief, shortened to B.I.C., or just “Bic” or “Baron.” The Bic is an inherited position, although the heir to the Baronial Seat is not necessarily a child or relative of the previous Baron.

The current Baron-in-Chief is *Morris Mellon*, a former soldier (7th level Headhunter) who married into a wealthy capitalist family and is now one of the twenty richest individuals in Los Alamo. Mellon was born in Los Alamo, but he struck out on his own and traveled through much of North America. He came

back convinced that the kingdom needed to form alliances with other human enclaves to survive. He was instrumental in creating the Open Door policy of 102 P.A., and he favors becoming an ally of the Coalition States, although not a full member, since the kingdom would then lose much of its independence. An able administrator and military commander, Mellon also prides himself on being a patron of the arts, although his taste is totally lacking — he is as likely to shower a third-rate painter with wealth as he is to reject a truly excellent work of art. His wife, *Ophelia Mellon* (5th level Merchant) is as influential in the running of the kingdom as he is.

Under the Baron-in-Chief are a number of appointed officials, including the Defense Minister, the Secretary of State, etc. Most of these posts are filled by cronies of Mellon, some of them former adventurers like himself. The Defense Minister, for example, is “Hammer” Jonesy, a full-conversion ‘borg (10th level) who prefers to lead the Los Alamo armies personally and enjoys engaging in combat whenever he can; he is a very “hands on” and “in your face” type of leader.

There is no such thing as elections for most government officials. The citizens get to elect twelve Councilmen, who are in charge of minor administrative tasks around the city. These include overseeing garbage collection, cleaning the streets, maintaining public buildings, dog catching, and other mundane tasks. Most people don’t even bother to vote, so most Councilmen are elected by their friends and relatives, and have very little power and influence. Most just live for the time when their achievements are noticed by the guys in real power and are given a more important position with greater power and opportunity (a rarity).

Justice is very straightforward, and is administered by local Sheriffs (70% Headhunters, 30% other men at arms), who act as the police, judge, jury and sometimes executioner (although usually a lynch mob takes care of that part). “Trials” typically last a couple of hours, unless no suspects have been caught. A person’s standing in the community is important, and strangers are more likely to be convicted of crimes than even the most notorious citizen. Most serious crimes carry a death sentence (including murder, rape, and grand theft — anything over 100,000 credits); other crimes have a 1-10 year sentence in jail or hard labor (15% of the Los Alamo labor force is convicted criminals). Repeat offenders of many crimes are executed or tossed out into the Border to try their luck in the minefields.

Technology

In most respects, Los Alamo has a standard of living comparable to 20th Century America, with electricity, hot water and other basic services (which are a luxury for many places on Rifts Earth). Street lights in the wealthier areas keep the darkness at bay at night and police patrol the streets, ever vigilant for predators from the Rifts, crooks and troublemakers. Factories produce a number of modern conveniences, from washing machines and electronics to vehicles and farm machinery, in addition to military gear. The main streets in Downtown are paved and wide enough to accommodate as many as four lanes of cars, robots and other vehicles. Furthermore, Los Alamo has revived an old form of transportation: the locomotive. A railroad system links Old Austin and Greenestown to Downtown. The train typically carries agricultural produce, cattle and passengers into Los

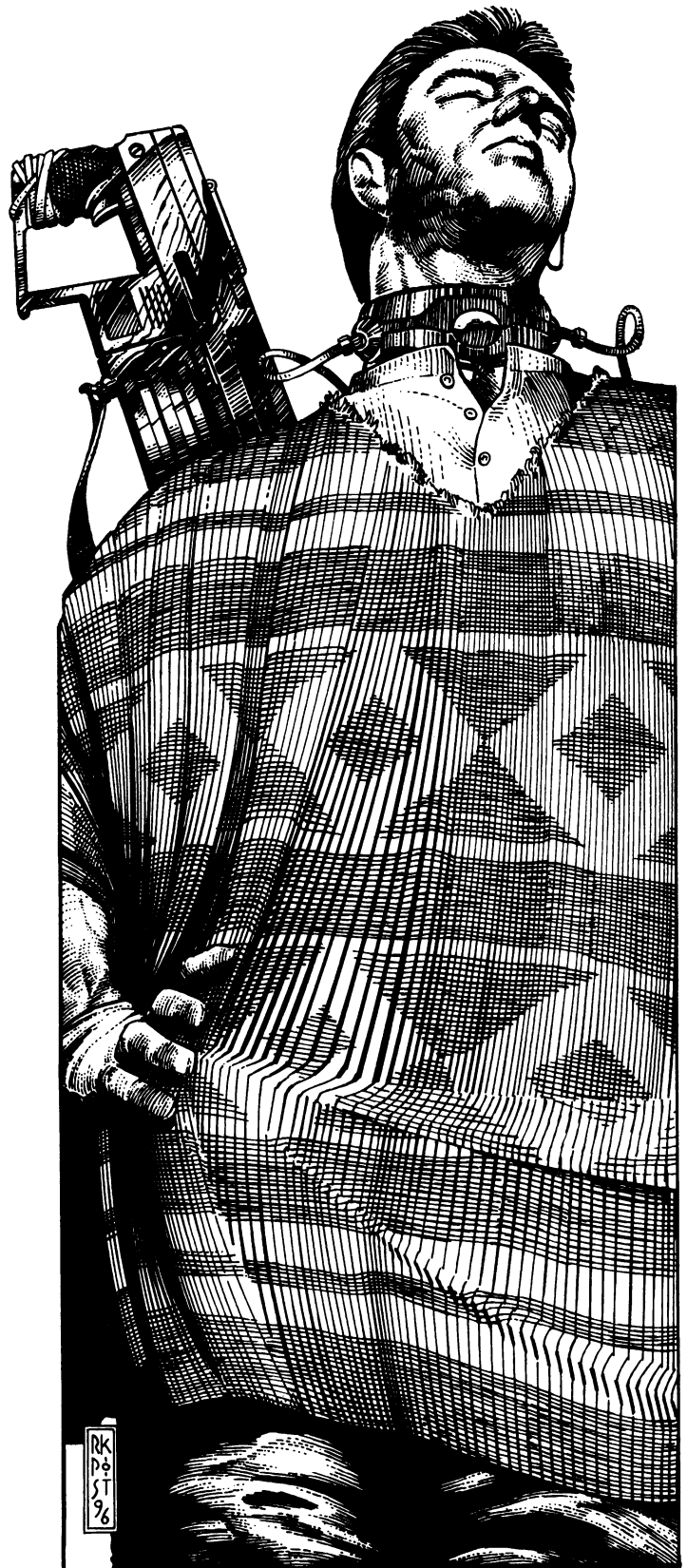

Alamo city proper (a.k.a. Downtown) and returns with processed foods, electronics, building materials, farming equipment, and consumer goods to be sold to the farming communities, as well as supplies for the Border Posts that protect the kingdom. The train also carries travelers, merchants, soldiers, and mercenaries to the various towns and outposts. The locomotives run on electrical, diesel and a few, steam combustion engines. They are protected by armored sidecars (M.D.C. 300) armed with medium-range missile launchers (each armored car has a turret with a 40 missile payload) and rail guns (NG-202's with 10,000 rounds in an expanded magazine). A typical 10-20 car train will have 2-4 armored cars for protection. Luxury passenger or military trains have an additional air and land escort of 4-8 light aircraft (similar to the Sky King) and 4-6 light land vehicles like the Big Boss ATV or the Racing Thunder. Additional air support is frequently available in six to ten minutes from one of the military outposts, towns or Los Alamo.

The weapons technology of Los Alamo is fairly advanced. Before the Open Door Policy established constant trade with other nations, the kingdom produced equivalents to many Wilk's and Northern Gun weapons (any non-Coalition weapon in the *Rifts RPG* has a Los Alamo equivalent costing 2D6 percent more than the listed price). Since 102 P.A., trade caravans have brought weapons and armor from all over North America and even several Triax models. The biggest arms purchase made by the kingdom in recent years was with Triax; 100 suits of *Predator Power Armor* were bought for the Los Alamo Army, with a final bill of 200 million credits (including shipping and handling).

In 104 P.A., a Naruni Enterprises trading delegation came to Los Alamo. It offered a very attractive sales and credit program that resulted in 40% of the Los Alamo armed forces being re-equipped with Naruni products. An estimated 100 million credits a year are being spent by the government on NE products. Private buyers spend an additional 50-75 million credits. This has led to a Naruni Trading Depot being built in Los Alamo, much to the chagrin of North American weapons manufacturers and the Coalition States. In fact, it was the Coalition's insistence that Los Alamo cut all ties with the alien arms dealer and "trade" all NE weapons and equipment for CS equivalents that caused them to decline the Coalition's invitation to join the States. A decision that has earned them the ire of the CS (in fact, they greatly underestimate the extent of the Coalition's feelings about this matter).

During its isolationist period, Los Alamo had very few cybernetic facilities, but this has changed thanks to trade with other technological enclaves, particularly the Naruni. Currently, two new facilities specialize in all kinds of bionics and cybernetics, up to full conversion, and half the body-chop-shops also offer some range of cybernetic augmentation and services. Unfortunately, prices at all these places are 15% higher than standard. Black market cybernetics are available, but cost double; they are not illegal, but highly taxed to prevent just anybody from getting them.

Juicers in Los Alamo

The Juicer process has been used in Los Alamo since the early apocalyptic era. The survivors of the Great Cataclysm, found a military facility near Austin that had the resources to

produce Juicers. In the early years following the Great Cataclysm these enhanced humans helped keep the fledgling community alive. Today, no less than *ten* body-chop-shops in Los Alamo offer Juicer conversion at prices ranging from 100,000 (for a 98% success rate) to 35,000 (71% success rate). *Titan Juicers* were first developed here as a countermeasure against such supernatural dangers as vampires, Brodkil and superhuman members of the Pecos Empire. Since 103 P.A., Hyperion and Phaeton Juicer conversions are also available at Los Alamo (see the *Juicer variants* for more information). Experiments with mutant animals have had limited success in developing Juicer conversion for canine humanoids, although at great risk for the recipients and some negative side effects.

Los Alamo is very tolerant of Juicers because they have a long history as courageous men and women who undertook the lethal augmentation to build and protect their community. Literally thousands of Juicers can be found on the monuments and lists of heroes and settlers who died building Los Alamo over the last 240+ years. Most local folks consider them to be valiant people who have sacrificed themselves to protect and defend humankind. This hero-worship has spawned a number of Juicer Wannabe gangs, some of which are a serious problem in the poorer sections of the city. Crimes committed by Juicers are not overlooked, but are not treated any more harshly than those committed by anybody else.

Ironically, the high regard Los Alamo citizens show Juicers, and the centuries long legacy of Juicer heroes, inspire even Juicer mercenaries and troublemakers to be on their best behavior when visiting the city and the neighboring towns and outposts. In some ways, Los Alamo has become a symbol of the "best" that Juicers can be, so these augmented warriors respond with an uncharacteristic display of restraint, respect, compassion and courtesy toward the inhabitants (a sort of mutual hero worship). Consequently, Juicers often police their own, putting a quick stop to the destructive antics of bad apples and roughhousing that might endanger "squishies." This only adds to the admiration the people of Los Alamo have for Juicers and continues the strange symbiotic relationship they share — many a citizen has risked his life to come to the aid of a Juicer, and many a Juicer has stood up to defend a Los Alamo farmer without considering personal risk or expecting a reward.

Society

Los Alamo is a veritable paradise compared to the lives led by most North Americans living outside the Coalition States. It is a place where one can enjoy such luxuries as running (and heated) water, electricity on demand, computers, and even radio and television stations that operate sixteen hours a day. The literacy rate is about 75% (95% among the wealthier one-third of the population), and several private and public schools operate in the city, although schooling is not mandatory. The life expectancy of people in Los Alamo is also higher than most places in North America, with the exception of the Coalition States and Lazlo. Plus, it is free of tyranny, organized crime, or strong CS influence.

Ironically, its very success is a problem for the city, because most people would rather live and work there than toil in the agricultural fields and cattle ranches that feed the community. To deal with this, the Baron-in-Chief has instituted strict "immigra-

tion” policies, and strong vagrancy laws. Basically, anybody who cannot prove he has a regular job or who does not have some important or at least well-to-do person to vouch for him is expelled from the Downtown area. On paper, this plan seems to work, but every year, hundreds of “illegals” move into the slums of the Downtown area, and try to make a living in the “big” city.

For the most part, Los Alamo’s population is pro-human and has little regard for D-Bees, especially inhuman-looking aliens. This prejudice arises out of decades of violent conflict with marauding D-Bees, the Pecos Empire, vampires and monstrous predators who have relentlessly tried to conquer them and continue to prey upon them. A small D-Bee community has grown in the Downtown area (see *Freaksville* in the Places of Interest section), but most of its inhabitants are humanoid-looking, so the majority can easily cover their inhuman features under hats, ponchos, capes and other coverings, allowing them to travel in relative safety. Fortunately, although most people at Los Alamo are prejudiced (i.e. they don’t like or trust D-Bees and wish they weren’t around), they are not overtly or violently racist. Consequently, outrageous acts of public persecution and abuse are rare. Still, some restaurants and other establishments refuse to serve D-Bees or treat them poorly by making them wait while human customers are served first, overcharging them, making snide remarks, and so on. A few establishments even have signs saying “Humans Only,” but this is relatively uncommon (less than 2%). Provoked beatings, lynchings, house burnings, and other acts of violence do not happen frequently, and when they do, they are not condoned — perhaps further influence of the Juicers’ heroic legacy at Los Alamo. Those who try to use the excuse that their D-Bee victims were somehow “asking for trouble” better be able to show concrete evidence that the D-Bees were the ones who started the trouble. This horrible and unfortunate prejudice may be far from idyllic, yet it is better than the treatment D-Bees can expect at most human dominated communities in North America. Mutant animals were equally distrusted at first, but over the years (and thanks in part to Coalition propaganda) they have become to be seen as friends and allies of humankind, especially mutant dogs (a.k.a. Psi-Hounds or Dog Boys or Dog Pack).

The attitude toward magic and its practitioners is roughly similar to their attitude toward D-Bees: they wish it didn’t exist and would go away, but since it won’t they try to tolerate it the best they can without actually encouraging its practice. While magic-users are not persecuted, magic can only be used within city limits in cases of emergency. Using magic in combat is considered aggravated assault, unless it was used in self-defense. Likewise, using magic to con/cheat or trick others, or in the commission of a criminal act, has strong penalties. Known magic-users are viewed with suspicion and tend to be treated as if they were D-Bees and are often the last to be served, etc. As a result, there are very few magic practitioners in Los Alamo.

Psychic powers are more widely accepted, since they are believed to be a “natural” ability that does not involve a “pact with transdimensional forces,” or that requires one to “command unnatural energy that has decimated our planet and allowed countless D-Bees and aliens to invade our lands”; two common Coalition accusations about magic-users which the people of Los Alamo believe. About 15% of the population has some minor psychic abilities and an additional 3% are major or master pson-



ics. Furthermore, Dog Boys and most mutant animals have some degree of psychic power which is also tolerated by the community. In fact, many mutant animals are hired as “psychic hunters” to locate supernatural enemies and threats.

Foreign Affairs

For many years, Los Alamo followed a policy of isolationism and separatism. Constant raids from the *Pecos Empire*, wild vampires and other dangers made them extremely wary of outsiders. For several decades, well into the early Post Apocalyptic (P.A.) years, most people of Los Alamo never ventured past “The Border,” and the only communication with outsiders came from the end of a gun.

As other kingdoms grew and prospered, trade started trickling in. The first weakening of the isolationist policy came after an openly friendly and peaceful merchant caravan approached The Border. When ordered to turn back, they did not try to pick a fight and left smiling and waving at the city’s defenders. A few years later, a similar caravan was allowed through The Border and allowed to sell its wares at the two outlying towns and villages. By 50 P.A., a few caravans were regularly trading in Los Alamo every few months, but their goods were so heavily taxed that profits were minimal. It wasn’t until 102 P.A. that the *Open Door Policy* was established and all tariffs on imported goods were removed. This has increased trade a hundredfold! Just before this, ambassadors from Los Alamo visited other kingdoms and city-states, including *El Paso*, *Fort El Dorado*, *Ciudad Juarez*, and one long journey to the famous Juicer haven *Kingsdale* (where they were shocked by the lawlessness and number of D-Bees and sorcerers). At the same time, Los Alamo also made their first contact with *Naruni Enterprises*, succumbed to their persuasive charm and good deals, and quickly made multi-million dollar arms purchases. For a kingdom that had resisted communication with the outside world for decades

and frowned upon their growing D-Bee population, they have embraced the Naruni with open arms.

A Coalition delegation arrived in early 104 P.A. The visit was prompted by reports of Los Alamo's pro-human and anti-magic policies, which were received favorably in Chi-Town. However, the kingdom's reliance on Juicers, and their unexpected "alliance" (or so the CS views their dealings with Naruni Enterprises) caused diplomatic relations to quickly deteriorate and is the source of some concern among Coalition diplomats and military analysts. Meanwhile, Los Alamo has no idea how "unhappy" the CS is with their rejection of a diplomatic union, and blissfully go about their business of developing their city-state and discovering the world around them.

Historically, Los Alamo's problems always seem to come from the South. **The Pecos Empire** has been trying to break through The Border for decades, and is responsible for raid after raid, banditry, cattle rustling and other crimes and assaults, including a massive attack in 99 P.A. The Pecos Invasion, as they call it, ended in a pitched battle involving over three thousand soldiers from each side. The Pecos raiders lost the battle and over half of their men in that encounter. Since then, the bandits have limited themselves to occasional attacks on travelers heading to or leaving Los Alamo, but have sworn that Los Alamo would one day belong to them!

Vampires are also a constant threat. Small bands of wild vampires and the occasional group of secondary vampires, as well as lone hunters, prey upon the residents of the city or neighboring towns, farms and ranches every 2D4 months. In 72 P.A., a large vampire coven was operating right in Downtown Los Alamo (two master vampires and over a hundred secondary vampires). The fiends were uncovered and destroyed thanks to the intervention of a pack of mutant dogs and three Juicers who warned the authorities of the danger and helped to hunt the "blood suckers" down and destroy them. The vampires' main hiding place in an abandoned mine tunnel was eventually found and flooded with water, utterly destroying most of the creatures. The clean-up operation took several weeks and cost over fifty lives (nearly twice as many suffered injuries). Since then, and after opening diplomatic relations with **Ciudad Juarez**, the Los Alamo government has noted an alarming number of rumors and reports indicating the existence of vampire kingdoms further South. If the Los Alamo government should become convinced that such horrific kingdoms exist, it would contact the Coalition States and propose an alliance to send an expeditionary force into Mexico, with Los Alamo offering as many as 5,000 mechanized troops to join with the Coalition's. Of course, the Coalition States may have other plans and refuse their gracious offer. See *Rifts® World Book One: Vampire Kingdoms* for details about Ciudad Juarez (a vampire haven), vampires and their kingdoms.

Los Alamo Armed Forces

Los Alamo has a standing army of about 10,000 troops and a volunteer militia 5,000 strong. Years of small-scale warfare have toughened both the civilians and soldiers of the kingdom, and almost every citizen knows how to take care of himself; 80% of all adults have some combat experience, know at least one W.P., 50% are trained in Hand to Hand: Basic (most 1D4 in experience) and 20% have Expert hand to hand training (1D4+2 levels in experience).

The Army: The Los Alamo Army is divided into five Motorized Battalions (640 soldiers each), five Light Infantry Battalions (640 men each), two Armored Companies (450 soldiers each), two Enhanced Soldier Battalions (640 men each; Juicers, Headhunters, etc.), and an Air Wing (320 soldiers). **Note:** Two of the motorized battalions and two light infantry battalions are in the city proper, where they double as the police force. The rest are in fortified bases located at strategic points around the city or at The Border.

A Motorized Battalion has 40 Armored Personnel Carriers (same stats as the Iron Maiden from *Rifts Mercenaries*; the Los Alamo equivalent, the LA-APC1, is almost identical), 200 combat motorcycles (see new weapons and equipment for some samples), 50 Big Boss ATV's, 50 robot vehicles and power armor suits (usually 25 of each; a mix of Triax, Northern Gun and Naruni models) and 640 troops. Soldiers are supplied with heavy body armor (65 M.D.C.), a laser rifle or plasma weapon (about 20% of the army is being re-equipped with Naruni Plasma Cartridge weapons and 20% with other Naruni M.D. weapons). These troops are in charge of patrolling and defending The Border and, more importantly, of reacting to any attack or invasion.

Light Infantry Battalions have comparatively few light vehicles: 10 APC's, 10 Big Boss ATV's, 50 combat motorcycles, 50 jet packs, and 20 Predator power armor suits. Its 640 foot soldiers are equipped with light body armor (30 M.D.C.), energy rifles and grenades. These troops are located mostly in the interior of the kingdom and at defensive outposts and bunkers. They primarily serve as garrison and defensive troops, fighting from heavily fortified positions.

Armored Companies consist of 60 tanks (a 50/50 mix of Wellington Industries equivalents and Naruni Enterprises hover tanks), 20 Iron Maiden APC's (Iron Heart), eight NG-V7 Hunter bot vehicles, six NG-M56 Multi-bots, and four Naruni Death-Knight Assault robots. Each of the two Armored Companies has 450 troops, including mechanics and support crews. These units are meant to fight side by side with and/or support the Motorized Infantry Battalions.

Enhanced Infantry Battalions are equipped just like Mechanized Battalions, but are made up of Juicers (60%), Crazies (5%), Headhunters (15%), full conversion 'Borgs (10%) and other enhanced humans (10%), including psychics and Dog Boys. Most of the EIB Juicers are volunteers paying for their conversions with military service. These units help in patrolling the border, fight vampires, and engage in reconnaissance, espionage and search and destroy missions against the Pecos Empire, demons and other enemies.

The Air Wing has almost 100 aircraft, including a number of fighters, Sky Kings, Juicer flying platforms (see the *New Equipment* section for Juicer aircraft), and a recent addition of a five-ship squadron of advanced Naruni fighters, the match of anything that flies the skies of Earth.

Note: About 10% of Los Alamo military units are made up of Psi-Hounds/Dog Boys, the Los Alamo version of the Coalition Dog Packs (many are refugees from the CS Lone Star Complex); 15% are Headhunters (partial conversion 'Borgs), 15% Juicers, 5% Crazies and 3% full conversion 'Borgs. See *Rifts® Mercenaries* for Naruni, Iron Heart and Wellington armor and armaments, among others.

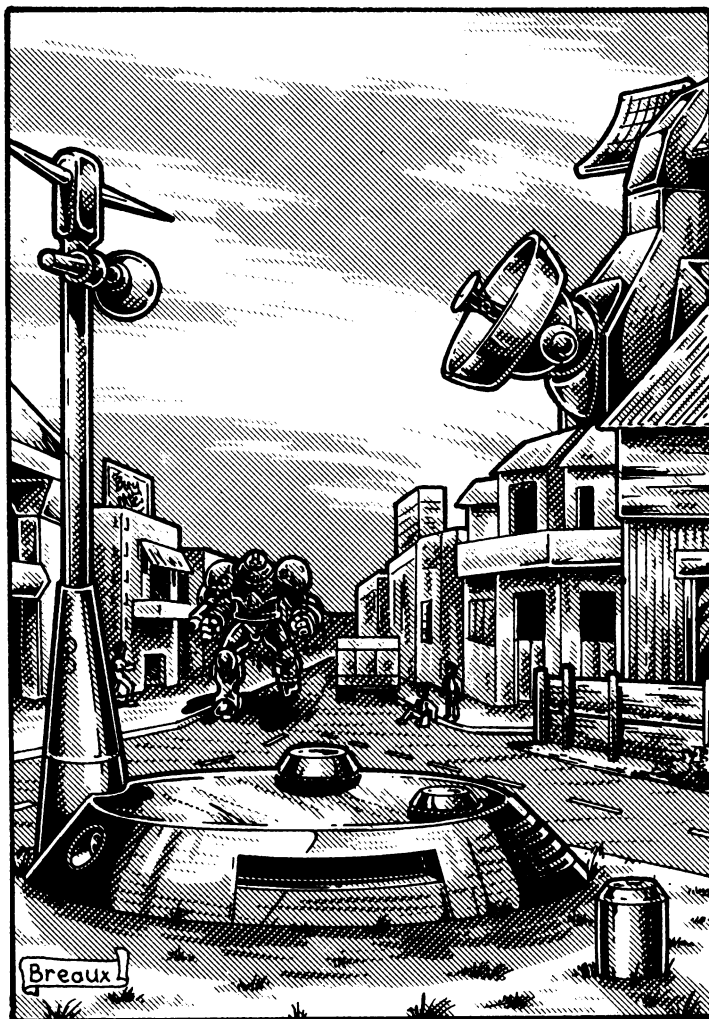

Places of Interest

The Border: People approaching Los Alamo will first discover a well-maintained road (one of four) that is paved for a 50 mile (80 km) stretch away from The Border, and then devolves into a dirt road, headed for El Paso to the South, Fort El Dorado to the North and towards Lone Star to the Northwest. Twenty-five miles (40 km) from The Border, the first signs appear, painted over ancient signposts: YOU ARE APPROACHING LOS ALAMO. SLOW TO 20 MPH (32 KMPH). STAY ON THE ROAD. Most signs are written in American (English) but 15% are written in Spanish. The illiterate are warned with graphic icons, but may not understand them which can lead to serious trouble.

People who follow the instructions will be met by a patrol, usually in one APC or on 6-12 motorcycles, occasionally by 2-4 suits of Predator power armor. The patrol will question the newcomers regarding their destination and business in the area. If the group is predominately monstrous looking D-Bees or suspected of being members of the Pecos Empire or other bandits, they will be turned back, forcibly if necessary. As long as the travelers are predominately human, not threatening and behave courteously, the soldiers will not give them any grief and allow them to continue. Acts of aggression and violence are usually met with deadly force! The people of Los Alamo have endured too many years of combat to take foolish chances. If combatants surrender after a brief fire-fight, and no Los Alamo soldier was

killed, the interlopers will be told to turn back and never return (if encountered in a fight later, they'll be slaughtered). If one or more soldiers are killed, the rest will assume the interlopers are bloodthirsty murderers and bandits and will fight until every last one is slain (or manages to escape). Note that reinforcements will arrive (in force if necessary) within 1D4+2 minutes.

Leaving the road is extremely dangerous. Land mines are scattered across the dusty landscape (Los Alamo's defenders know secret trails and other safe passageways through the no man's zone). The typical anti-personnel mine will inflict 4D6 M.D., while anti-vehicle mines do 3D6x10 M.D. Five miles (8 km) into The Border, hundreds of Sensor-Controlled Anti-Vehicle Weapon Systems (SAWS) are located at strategic points. SAWS are described in detail in *Rifts® Mercenaries*; basically, they are missile systems tied to a sensor suit, which can engage targets as far away as 6000 feet (1828 m) with short, medium and long range missiles. Furthermore, air patrols of 2D4 soldiers on hover-bikes or jet packs, or 1D4 suits of Predator power armor will sweep down on intruders and attack them with long-range weapons. Anybody who wanders off the road is assumed to be hostile and treated as such. Furthermore, there is a chance of encountering a monstrous predator, 1D4 Ostrasaurus or other animal or D-Bee predator(s), a small band of 1D4+1 wild vampires, 1D4+2 D-Bees, mutants or human bandits, 1D4+3 Pecos barbarians, or a supernatural monster or other danger. This 50 mile (80 km) buffer zone is not a safe place.

New Austin and Greenestown: These two towns have a population of under 8,000 each, and are the places where local farmers go to sell their produce. Trains carry this produce into the cities. There is very little of interest for visitors at either place. Each town has a mechanic facility that will handle most vehicle repairs, a general store carrying most basic provisions, and a weapons outlet that sells light hand weapons, and E-Clips, and offers E-Clip recharges.

The towns are also a check-out point, where travelers must leave all their heavy equipment, including robots, power armor and military vehicles, if they wish to proceed to the city proper (Downtown). Each town has a garrison of 1,200 soldiers, backed with tanks, bots, power armor, and Juicers. Two nearby military bases have an additional 2,000 soldiers each, so most adventurers find it wise to go along with these rules or get out of town. Personal hand weapons, nothing heavier than a laser pistol, as well as light to medium body armor (under 50 M.D.C.), may be retained for self-defense by *humans* and *Juicers* only. Nonhumans must surrender all mega-damage weapons and armor or turn back. Cyborgs, Headhunters, Crazies, and Juicers must register with the military/police and sign an agreement promising *not* to use their mega-damage equipment and features — failure to comply will result in stiff fines and long prison terms. Mutant animal soldiers will also be on the lookout for supernatural beings and aliens. Dragons and supernatural beings are not allowed into Los Alamo and are politely informed as such. Sneaking into Los Alamo will brand the character as a dangerous monster invader who will be hunted down and either driven from the territory or slain.

People who are cleared to go to the cities can continue on to Los Alamo (a 30 mile/48 km distance) in civilian vehicles, on foot, or they can get a train ticket (20 credits for a round trip; visitors are obligated to purchase a round-trip ticket).

Downtown: Most locals refer to the city of Los Alamo as “Downtown.” The skyline of Downtown resembles a small 20th century city. Buildings up to 30 stories tall are common, the main roads are all paved and well maintained, the train system goes from one end of town to the other (and back out to the two towns), streetlights and neon signs burn brightly at night (in most sections) and all the amenities one expects from a city are easily found. Hover vehicles and helicopters dart in-between buildings, and cars and motorcycles travel noisily through the streets. A time traveler from the 20th century would be quick to point out the differences, however. For one, there are far fewer buildings and vehicles than the average small city of that time, and only the main streets are paved, most side streets are either covered with gravel or dirt. Outside the heart of the city, most buildings are relatively small (under five stories tall) and primitive, even the main roads are covered with gravel or plain dirt, and people are as likely to be on foot or horseback as in a car.

The heart of Downtown is still a wonder to behold. This section fills about ten city blocks (and expanding). It houses the major businesses, government offices and corporate headquarters. Unlike a pre-Rifts city, most of the people in this section work and live there. The tall, 30-story buildings are half office space, half residential quarters. Well-to-do professionals wake up in the morning and take the elevator to their office, somewhere in the same building. Only low-ranking employees (janitors, secretaries, etc.) have to “commute” from the cheaper and low-quality houses surrounding Downtown to their jobs, often by foot or train.

Some 28,000 people live in the heart of the city, among them the wealthiest 10% of the population. The very rich (less than 1,000 total) live in manor houses on top of hills, and come to Downtown in luxury vehicles to enjoy themselves. The remaining 60,000 or so of the population make do in less affluent neighborhoods around the heart of the city; 60% of them still enjoy such luxuries as running water and electricity and represent the majority of the citizens of Los Alamo. Only the poorest 28% of the population lacks these luxuries.

Visitors to Downtown will find that prices tend to be higher (10-20% for most things, including food, clothing and other basic necessities), although of better quality than in most places, with the exception of the Coalition States, Lazlo and other major nations and kingdoms.

The Deathdancer Bar: Located in one of the Los Alamo neighborhoods, this bar caters to the Juicers and mercenaries who frequent the city. It is mostly a place to drink and relax. Excessive rowdiness, laughing, shouting and loud talking is okay, tossing people through plate glass windows is not and is discouraged strongly by the bouncers (both of whom are Titan Juicers, 5th and 7th level). The owner of the bar is a former Headhunter (5th level, retired) named Joe Hardaway. Joe was a friend to a famous Juicer, Crazy Lou, and he helped Lou write his memoirs, which are now a hot book in most non-Coalition areas. As a result, Joe was allowed to open a Juicer bar honoring his friends, and he is well-liked by the Juicer community.

The Remaker Body-Chop-Shop: This is the largest and best-equipped cybernetic hospital in Los Alamo, able to perform as many as 20 major operations simultaneously. The Remaker has a lucrative government contract, offering “free” Juicer and

bionic conversions in return for signing up for a three-year term of service in the Los Alamo Armed Forces. All Juicer conversions offered at Los Alamo are available here, as well as M.O.M. (Crazy) conversions, cybernetics and bionics (including Black Market versions). The regular price for Juicer conversions for those who do not want to serve in the Army is 65,000 credits; 100,000 for the Titan Juicer, and 85,000 for all other available variants. Prices for bionics are standard.

The owner of the Remaker is a grizzled, wiry old woman named Joelle Minelli (8th level cyber-doc). Dr. Minelli used to be an adventurer and rogue who operated under the street name of “Mama Scalpel”. According to some stories, Mama Scalpel used to work with Doctor Kenneth Reid, the mysterious leader of Reid’s Rangers (see *Rifts World Book One: Vampire Kingdoms*). Dr. Minelli will rarely discuss her adventures with Doc Reid and his necromancer ally, Planktal-Nakton, unless she has one drink too many. Some of her tales will make the toughest adventurer shiver. There are some who say that Dr. Minelli was somehow betrayed or hurt by Doc Reid, and she is quietly amassing enough money to put a “hit” on the saintly doctor or his necromancer partner, or both

Freaksville: The southern corner of the city proper is filled with simple houses and small buildings. Only 20% have electrical power or hot and cold running water. This section is where most of Los Alamo’s D-Bees live. The area has no official name, although it is sometimes referred to in official reports as the “D-Bee Quarter.” The slang term for the place is a lot more direct and degrading: “Freaksville, where the monsters live.”

Some 10,000 non-humans and 2,000 humans live in Freaksville. Although no walls or borders separate this section from the rest of the city, the change is apparent to anybody crossing the “invisible” line between Freaksville and the human-controlled city. For one, no streetlights shine there at night. Only a few lights were installed around the edges of the place, and vandals frequently break them; they are rarely fixed. There is a lot more graffiti, usually painted by bands of human toughs who wander there looking for a fight and disenchanting D-Bees. The streets are dirty and in disrepair. Calling the police is a waste of time, unless a serious fight is going on, or human lives are endangered, otherwise the cops rarely venture into the neighborhood.

Despite all this, most of the inhabitants of Freaksville live quiet, dignified lives, working hard and making money in productive endeavors. The per capita income in this area is actually slightly higher than in equivalent poor human neighborhoods, and the education level is generally higher as these people struggle to improve themselves and make a better life for their children. D-Bee volunteers keep several schools open and the Freaksville literacy rates are close to 80%, higher than the city’s average. Rejected by everyone else, the D-Bees (who belong to over thirty different races) have been forced to band together and help each other.

Attempts by criminal organizations to set up shop here have been stopped by a gang of D-Bees called the **Freak Fighters**. The gang is said to number 400+ individuals; some twenty or so are master psionics (including Bursters, Psi-Stalkers, and Mind Melters), and another dozen or more have super-powers or supernatural racial abilities (use *Heroes Unlimited*TM, *Villains & Aliens Unlimited*TM and *Rifts*TM *Conversion Book One* for possi-

ble powers). The Freak Fighters are also responsible for the most vicious attacks against human supremacists and supernatural predators (including vampires, werebeasts, dragons and others) who try to infiltrate the community. Although branded a “gang of criminals” by the Los Alamo authorities, most people living in Freaksville consider them to be courageous neighborhood defenders (at worst, well meaning vigilantes) and quietly support the organization with money, shelter and food.

The Naruni Trading Depot: The Depot was built by Naruni Enterprises on December of 104 P.A. The Naruni reps purchased an entire building in the best part of Downtown, converted the lower five floors into a large department store, and use the rest for office and living spaces. The Depot sells all kinds of products, from weapons, armor and accessories, to military and civilian vehicles, optic systems, entertainment systems, computer games, and dozens of other products, all tailored to fit the needs of the human population. Prices for weapons and equipment are reasonable (as listed in the *Rifts Mercenaries* book). Naruni Enterprises also sells their versions of hand computers, medical equipment and sensor systems at low prices (15% cheaper than the prices listed in the *Rifts RPG*). This practice has bankrupted some small businesses and generated a lot of ill will, especially among human supremacists who consider the Naruni to be transdimensional invaders.

So far, the Naruni have been very skillful in their maneuvering. For one, all Naruni representatives in Los Alamo are human, either Earth-born (25%) or from other parts of the Megaverse (such as Phase World). Although the latter group would be technically “D-Bees,” these salesmen are well trained to speak and behave just like locals, and are treated like “common people.” There are 120 Naruni employees in Los Alamo, including a security detail of 20 “Repo-Bots,” advanced full conversion ‘Borgs (see *Rifts Dimension Book Two: Phase World*; can be substituted for other bots or ‘Borgs if necessary). So far, there have been numerous threats and some acts of vandalism against the transdimensional corporation (some instigated by CS spies), but no violence yet. Many people fear it is only a matter of time.

The Black Market: Because Los Alamo was so tightly closed to outsiders and such a small market, the Black Market had ignored them. Since the kingdom has opened its borders and Naruni Enterprises has proven the Los Alamo market is much larger and wealthier than anyone had previously imagined, the Black Market has tried to make some inroads, but has failed to do so. Los Alamo has minimal crime and has successfully kept the Black Market and other criminal organizations out of its territory.

Notes Regarding Juicers & Other Kingdoms & Nations

The Pecos Empire & New Del Rio

The Pecos Empire has a good number of Juicers among their ranks, as well as Crazies, Headhunters, outlaws, D-Bees, supernatural beings, criminals and renegades. A couple of the larger towns under the “protection” of the Pecos Empire have Juicer conversion facilities (standard Juicers only). This so-called “Empire” is a motley collection of bandit gangs, adventurers and maniacs of predominantly evil and anarchist alignments who operate like barbarian hordes.

The semi-independent kingdom of **New Del Rio** has just (104 P.A.) opened up a medium-sized body-chop-shop where Juicer, Titan Juicer and Hyperion Juicer conversions can be performed, as well as most cybernetic and bionic implants, all at outrageous prices (100,000 for normal Juicer conversions, 200,000 for Titan Juicer, and 150,000 for Hyperions; double the price for any cybernetic and bionic implants or limbs).

Newtown & Fort El Dorado

These two cities are described with more detail in their own sections. Both places play an important role in the Juicer Uprising.

Ishpeming (Northern Gun)

Ishpeming is more commonly known as the mammoth weapons, armor, bot and combat vehicle manufacturer, *Northern Gun*.

It is also a major manufacturer of Juicers and the place where many Juicer variants have been developed. This powerful kingdom, its people and technologies will be described in more detail in a future world book.

Old Bones

This alleged “outlaw” haven is actually a puppet of the Coalition State of Free Quebec. This once independent nation made use of the Juicer conversion to augment volunteers for its army. When they originally joined the Coalition States, the creation and use of Juicers was illegal and Free Quebec grudgingly obeyed orders to ban it — at least on the surface. In reality, however, most Juicer facilities were transplanted to Old Bones where the nation continued to create Juicers and established a secret army. An army that after the unveiling of “Operation Phoenix” (the CS program to legalize Juicer augmentation for military use only) is now able to operate openly (see the *Coalition Juicer variant* for more information). However, Chi-Town’s leaders look suspiciously upon the “sudden” availability and size of the Quebec Juicer Corps.

Lazlo & New Lazlo

Both of these cities (Lazlo being the largest and most important) are havens of magic, technology and tolerance. Although the Juicer process is considered barbaric by the authorities of Lazlo, it is allowed and Juicers are welcomed. Those who volun-



tarily undergo Juicer conversion at both Lazlo and New Lazlo, must agree to counseling, a series of four one-hour meetings where a psychologist tries to change the volunteer's mind, or at least make him clearly understand the consequences of his actions and possible alternatives to satisfying the person's goals.

The Federation of Magic

This mysterious region is dominated by kingdoms and feudal baronies ruled by wizards, supernatural creatures and other peoples and beings of magic. Technology is not completely rejected by some of the larger kingdoms, and it is rumored that several places in the Federation have facilities for Juicer and Crazy conversions. Dragon Blood Juicers are definitely available from the Federation of Magic, usually by kingdoms who hate or fear Dragons. Some Necromantic Cults also make use of Murder-Wraiths, undead Juicers who serve them as undying warriors (see the *New Juicer Variants* section).

The New German Republic

Since Germany was where the Juicer conversion was first made available, it is not surprising that Juicers and chemically-augmented humans are fairly common in the New German Republic. Although most people find Juicers disturbing and fearsome, there are more than enough volunteers for the process to keep the body-chop-shops running. Most European Juicers act as mercenaries and assassins for hire; the NGR's armed forces rarely use them directly, distrusting the enhanced warriors.

In the last couple of years, some NGR laboratories have copied some of the new Juicer variants that first appeared in North America. Right now, the only variants available are the Titan, Hyperion and Phaeton, although a few researchers feel they are about to crack the secrets of creating the Mega-Juicer. As these "super-juicers" become more common, the temptation to make use of them in large numbers is growing among some military minds of the NGR. So far, cooler heads have prevailed — who wants to build an army of tens of thousands that will effectively suffer 100% casualties at the end of a six year period? Strong opposition from "right to life" groups also keeps the pressure on to avoid government use of Juicer technology. However, if the threat of the gargoyles and the brodkil becomes too immediate and overwhelming, the German people may resort to desperate tactics, including the raising of an army of short-lived but powerful warriors. Some unfounded studies suggest that if Juicers were used in massive numbers, victory would be likely but an entire generation of men and women would be sacrificed in the process.

For more information about the NGR and its desperate struggle, refer to *Rifts® World Book Five: Triax™ and the NGR*, and *Rifts® Sourcebook Three: Mindwerks™*.

Europe

Outside the New German Republic, Juicers are almost non-existent in Europe. England is too underpopulated and primitive for such things, and most of the rest of Europe is overrun by supernatural beings. The only major exception is the Poznan Collective (Poland). This nation is very large by North American standards (over 5 million inhabitants), and has access to high technology, including the Juicer conversion. Wannabe Juicer gangs have been a problem in Poznan, and Juicers are both a problem and a bulwark against the growing threat of the gargoyle and brodkil kingdoms. See *Rifts® World Book Five: Triax™ and the NGR* for more information.

Japan

Unknown to most people in North America, several pre-Rifts Japanese cities have reappeared in all their might in this strange and exotic land. The cities returned to our world while retaining all their technological knowledge, including the Juicer process. Although Juicer conversions are considered to be illegal throughout most of Japan, a number of underground organizations offer treatments for sale. Some high-tech underground organizations have created their own brand of super-assassin, the Ninja Juicer, but otherwise only the standard Juicer conversion is possible. For more information about Juicers in Japan, refer to *Rifts® World Book Eight: Japan*.

South America

Juicers are common in the Southern half of that continent, among the contending kingdoms collectively known as the Silver River Republics. Most Juicers are equivalent to the "normal" Juicer, although their training runs the whole gamut. For Juicers with different skills, see the new Juicer O.C.C.s described in this book. There are also many JAEP "pseudo-juicers" (see *Rifts® World Book Five: Triax and the NGR*) operating in South America. **Note:** The great distance between North and South America, a number of dimensional anomalies, and barriers like the Yucatan Peninsula and the Vampire Kingdoms of Mexico keep the nations, people and technology of this chaotic part of the world segregated from the rest. Most North Americans don't know a thing about Central or South America (if they did, they'd be frightened). For more information about the nations of South America, refer to *Rifts® World Books Six and Nine*.

The City of Newtown

Population: 70,000 (90% human, 5% mutant animals, 5% other D-Bees; see the *Newcomer R.C.C.* for more information). An additional 30,000 people live in neighboring villages, where they are engaged mostly in agriculture.

Located in the Northwest, in the former State of Arkansas, Newtown was a successful independent city-state that recently joined the Coalition. It is best known for a major weapons and cybernetics manufacturer, **Ultra-Tech Incorporated (UTI)**.

Newtown is built around the ruins of the pre-Rifts city of *Fort Smith, Arkansas*. At the time of the Great Cataclysm, the city and surrounding towns housed well over 200,000 people. Less than 5,000 survived the upheavals, which included floods from the nearby Arkansas river, as well as ley line storms and earthquakes that swallowed much of the city and the nearby *Fort Chaffee* military base. Survivors from that base formed the core around which Newtown was founded. Using what little remaining military equipment they could scrounge, the desperate humans fended off attacks from supernatural beings and managed to eke out a meager living. Eventually, the town grew into a small city.

Newtown remained just one more minor kingdom or city-state for centuries, and would have continued to be so if it hadn't been for the arrival of a group of "newcomers," in 83 P.A. These human settlers traveled in a large caravan of almost a hundred armored vehicles. There were over a thousand people in the caravan, mostly adult humans of both sexes. They claimed to be immigrants from the East, although without exception, none of the newcomers would volunteer any information about their lives or homes there. Their point of origin remains unclear to this day; the Coalition has no records of such a large group moving anywhere in or near territories under its control, and no scout reports (the Coalition routinely reconnoiters the surrounding "foreign" lands) mention a caravan of human refugees traveling south by southwest — a route that by rights, should have taken them past CS territory.

The newcomers appeared to be human and, more importantly, were immensely wealthy, both in terms of precious metals (the new arrivals paid with strangely-minted gold coins upon arriving in Newtown) and high technology. Although wary of the strangers, the people of Newtown, which at the time numbered less than 20,000, accepted the strangers and allowed them to settle in their midst.

In 85 P.A., a wealthy city native, *George Hornesby*, struck a deal with *Andrew Anderson*, the leader of the newcomers. Hornesby supplied the land and capital, and Anderson supplied the technology to launch a new manufacturing corporation, **Ultra-Tech Incorporated**.

The Rise of UTI

As the new manufacturer grew in size and power, it became clear that Andrew Anderson and other newcomers were highly skilled technocrats. In a few years, they took the handful of small machine shops in Newtown and turned them into cutting-edge factories and assembly lines. The first products included

farm equipment, power sources (including E-Clips) and simple M.D.C. alloys used for body armor and construction materials. By 90 P.A., the first advanced electronic factories went on line, producing computers, sensor systems and other sophisticated technologies usually limited to such enclaves as the Coalition States and Northern Gun. In 95 PA, simple power armor suits also went into production. That same year, a number of advanced Juicer conversions were first offered by UTI. Two years later, the company was producing a number of "knock-offs" of such manufacturers as Northern Gun, Wilk's and Wellington Industries.

The town, which had been a backward and rather poor place before, experienced an unprecedented bout of prosperity. Trade with nearby kingdoms and city-states grew by leaps and bounds, including the Coalition city of Chillicothe and the allied city of Fort El Dorado. Living standards increased accordingly, as the town residents started moving away from agriculture into high-tech manufacturing. Literacy increased as well, roughly equivalent to low 20th Century standards, but much higher than the Coalition's average.

It took well over a decade before UTI was noticed by the outside world, but by 97 P.A., the corporation and Newtown's manufacturing boom were famous beyond its borders. The Coalition States started paying particular attention to this fast-growing area. On June 12, 99 P.A., a Coalition Embassy met with George Hornesby (who by then was the wealthiest man in the town, owning nearly 40% of all the real state in and around Newtown) and other town notables, including Andrew Anderson. After several days of negotiations, membership to the Coalition States was granted, effective in 101 P.A.; the waiting period was necessary to meet some of the Coalition's terms, including the building of a fortified Western wall to protect against possible D-Bee threats, and the expulsion of any and all D-Bee "undesirables." An additional condition demanded that Juicer conversions stop being offered in Newtown. This was agreed to, but UTI simply moved most of its Juicer-related facilities to the free city of *Fort El Dorado*.

In the four years since its adoption into the Coalition, Newtown has become even more prosperous. UTI has secured a number of lucrative military contracts for the CS, mostly limited to non-vital accessories and spare parts (the Prosek government is too paranoid to allow a private company to produce strategic components). The recent increase of military readiness among Coalition Armed Forces (detailed in the upcoming *Coalition War Machine World Book*) has created a new economic bonanza for the city. Things couldn't have been any better, until the implementation of **Operation Phoenix Rising** (see the **Uprising section**).

Geography

Located at the confluence of the Arkansas and Poteau rivers, Newtown is surrounded by deciduous forests, covered in trees like oak, maple and chestnut, plus a few exotic transdimensional species. To the south lies the allied city of Fort El Dorado, and to the North is the CS city of New Chillicothe (population 100,000). Large tracts of land are now covered by wheat and corn fields to feed the city's growing population. Animals include pheasants and other game birds, rabbits, squirrels, deer, bears, foxes, and wolves (wild packs roam the countryside). The wolves compete with packs of wild dogs (the descendants of for-

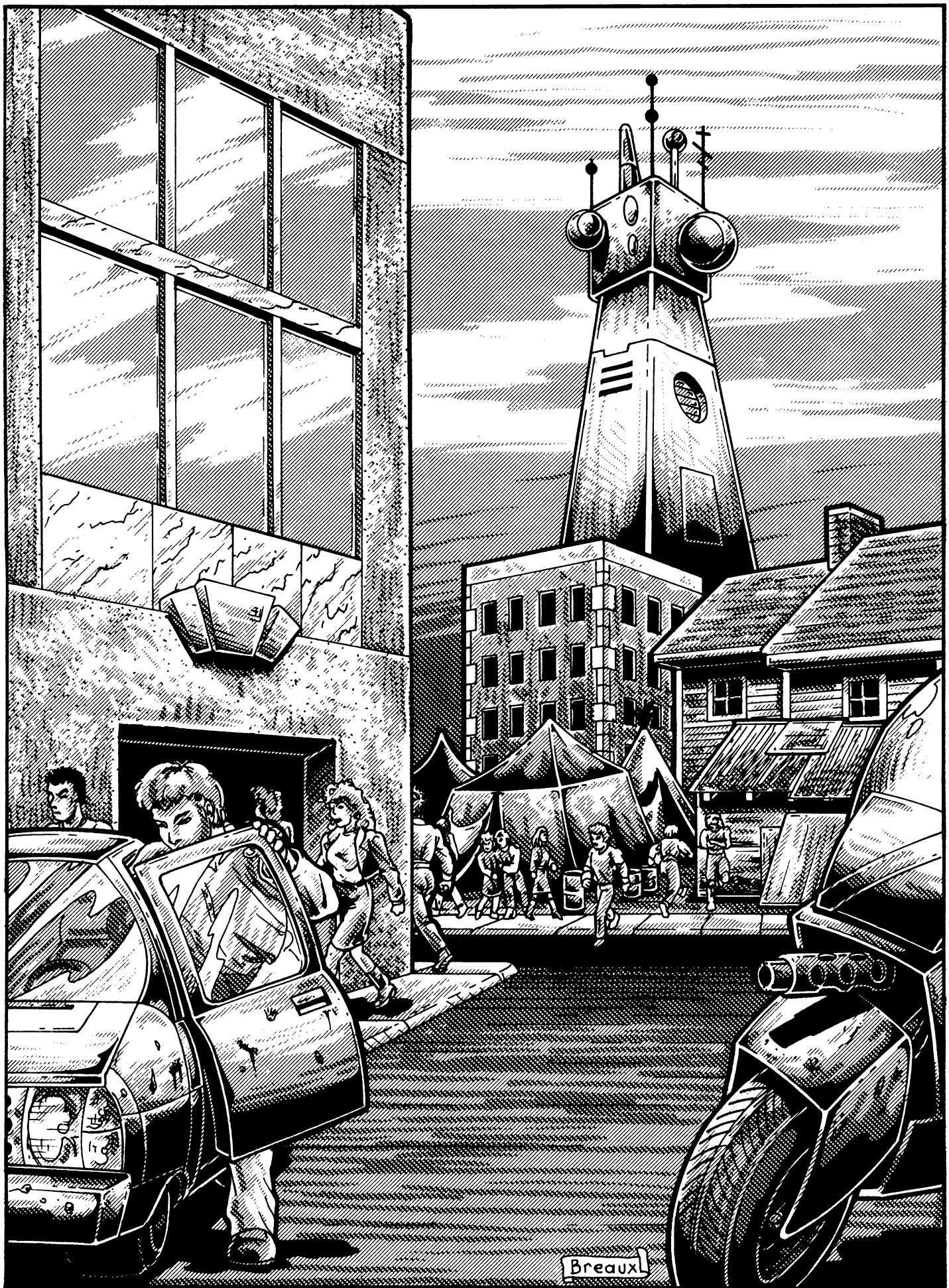

mer pets who became feral after the Great Cataclysm) as well as the occasional D-Bee animals and monsters.

Government

Before the arrival of Anderson and his band of travelers, Newtown was loosely organized into an oligarchy; basically a kingdom run by several wealthy landowners. The most powerful person in the town was George Hornesby, whose family owned numerous farms, not to mention over a dozen suits of power armor, including two Glitter Boys. Military and economic power were the main determinants of status in Newtown. In the last twenty years, however, the city's growth had made the old "feudal" system too inefficient, so when the Coalition States offered its invitation for membership, the city council, led by the old, powerful landowners and the newcomers' leader, Andrew Anderson, accepted.

Under the Coalition States, the government is even more formalized and "civilized." *George Hornesby* is now the Coalition District Governor of the city and the surrounding region. However, the real power is in the hands of **General Winston Orly**, the commander of the Coalition troops in and around Newtown. Although Hornesby takes care of most administrative duties, anything that affects security has to first be cleared by the General.

For the time being, Newtown is not a full-fledged Coalition State, but a "member city," loosely attached to the Coalition State of Missouri. If Fort El Dorado ever joins the CS, the two cities would be large enough to become the Coalition State of Arkansas, and they'd enjoy greater power and autonomy. Hornesby and the Newtown government answers to the Coalition State Governor of Missouri, and are ultimately subordinate to Emperor Prosek.

Society

Life had been good for the population of Newtown for nearly two decades. Before the uprising, the citizenship enjoyed one of the highest standards of living in the Coalition territories. Since joining the CS, raids from D-Bees and supernatural creatures, which were few and far between to begin with, had all but disappeared. **The Border Wall** blocks most likely routes for would-be invaders, and most attacks are dealt with at that locale. Peace and prosperity was the order of the day.

Within the city, most people enjoy a technological level roughly equivalent to 20th century Earth. Since the population was literate to begin with, Coalition laws against books have been relaxed, although several proscribed books (including all the writings of Erin Tarn) are still burned and their owners fined, imprisoned or worse. Laws against non-humans are in full effect, however, and very few D-Bees live in Newtown; those who do are watched carefully and deported, arrested or executed at the least provocation. The largest concentration of D-Bees is in the *Riverside neighborhood*.

The two major groups in Newtown are the "locals" and the "newcomers." Although the so-called newcomers have lived in the city for over twenty years, they remain a distinct group. The newcomers tend to keep to themselves, and do not often socialize with other people. They are rarely, if ever, seen in the bars and nightclubs enjoyed by wealthy professionals. This has led to the newcomers' reputation for being "stiff-necked puritans." In

the two decades since their arrival, there have been no marriages between newcomers and locals, although the newcomers have indeed married and borne children, but only among themselves. This makes many other Newtownians wary and suspicious of the strangers, although the wealth the immigrants have brought to the kingdom goes a long way in soothing their feelings. A persistent rumor, common among the poor of the city, is that the newcomers are D-Bees. Most people pay no mind to these wild tales.

Crime & Gang Problems

For all its wealth, poverty and crime are not unknown in Newtown. The poorest districts are located in the Northeast section of the city, known as **Riverside**. This is the older portion of the city; the original huts and crude brick buildings that were eventually sold for a song to poor immigrants and locals who had fallen into bad times. The unskilled and unemployed live in Riverside, which also houses a number of professional criminals and unwanted D-Bees. It is the place to go for illicit drugs, gambling, prostitution and other illegal activities. Muggings, cyber-snatching (the murder of people for their bionic or cybernetic implants), and similar crimes are common in the slums and often affect people outside the area.

Several gangs operate in Riverside and other localities in Newtown. The largest and most influential include:

The Rejects: This is a gathering of young men and women who lack the education, resources and contacts to make it out of the slums they grew up in. The Rejects wear their poverty as a badge of pride, and engage in stealing from the rich to give to the poor. This apparently "noble" goal is a lie, however, because the Rejects will steal from anybody and give to themselves. The gang has contacts with the Black Market and often tries to steal weapons and equipment from UTI (and lately, from the Coalition States) to sell in Newtown and elsewhere. The Rejects are 100% human, and number some 200 members, mostly City Rats, levels 1-5. The leader of the Rejects is *Liam McGregor* (8th level City Rat), a career criminal wanted for over a hundred major crimes, from kidnapping & extortion, to murder.

The Fighting Dead: This is a Juicer Wannabe gang who is constantly attacking Coalition personnel and facilities, because they blame the CS for the outlawing of the Juicer procedure. The Fighting Dead have some ties to the **Juicer Liberation Army** and is a constant thorn in the side of the authorities. In 104 P.A., however, the gang was dealt a crippling blow when a UTI security detail and a Coalition Special Ops team somehow located the main headquarters of the gang. A dozen gang members were killed, two dozen captured and imprisoned, and the leader of the Fighting Dead, a Juicer called Norm the Red, was captured and is currently in prison, awaiting execution (Norm only had about a year to live, in any case). A rumor claims that Norm and other imprisoned Juicers have been subjected to strange experiments by UTI researchers. The surviving Fighting Dead number some 60 members (mostly Juicer Wannabes and City Rats, levels 1-4, and a handful of Juicers, levels 1D4+2).

The Inhumans: A D-Bee gang that operates from **Ogretown**, a place dominated by Ogres, Orcs and similar non-humans, including a number of magicians and psychic mutants or aliens. The Inhumans keep a low profile outside Ogretown, but they literally run the place. Most of their crimes are committed

against other D-Bees, because those unfortunates cannot report them to the authorities, who couldn't care less about the plight of non-humans. A few of the most militant members have launched attacks against the Coalition States, but so far have been limited to a few minor acts (graffiti-tagging some CS buildings, beating up and robbing lone Coalition soldiers, etc.), but nothing that has warranted a major Coalition backlash. The Inhumans number 120 members (30% Ogres, 70% assorted D-Bees), led by Skull-Buster (7th level Ogre Tattooed Man), a refugee from Atlantis whose magical powers have allowed him to bully and intimidate the rest of his gang into following his orders.

Technology

The rise of UTI has caused the technology of Newtown to skyrocket in a matter of a few years. Before the arrival of the newcomers, Newtown had a low to average technological level, perhaps comparable to the *early* 20th Century. Its facilities could repair body armor and simple vehicles, and could recharge E-Clips, but could not manufacture any of them. Its most advanced equipment consisted of two privately-owned Glitter Boy suits and only half of its defense force was equipped with mega-damage armor and weapons (the rest had to make do with primitive body armor, if any, and use rifles and weak rocket launchers).

By 97 P.A., Newtown was manufacturing exact replicas of a large portion of the Northern Gun and Wilk's inventories, from lasers to power armor, at slightly cheaper prices (-10%). Juicer, M.O.M. and 'Borg conversions were also offered safely and at reasonable prices. Its seven factories were working three shifts a day, seven days a week, turning out hand computers, sensor systems, and medical equipment that matched anything produced by Northern Gun and, some say, the Coalition States as well. The how's and why's concerning this explosive growth and quantum leap in technology have yet to be adequately explained. The Coalition States seems to be unconcerned or unwilling to ask hard questions, for now. The reasons are twofold: Newtown is ardently pro-human, and its technological wealth will be an invaluable asset to the Coalition's imperialistic plans.

Since joining with the Coalition, Newtown has voluntarily divested itself from many illegal industries. The weapon factories are being phased out, or converted to produce Coalition parts and equipment. Additionally, Juicer and M.O.M. conversions are no longer offered (at least openly; see *Juicers in Newtown*, below). Even with these restrictions, almost every technological piece of equipment listed in the *Rifts RPG* can be found in this city at 5% to 10% lower prices.

Juicers in Newtown

Juicer enhancements are no longer offered in Newtown. Ultra-Tech Incorporated (UTI) moved its Juicer facilities to the free city of Fort El Dorado, with the grudging consent (if not blessing) of the Coalition States. However, this has done nothing to stop a number of *illegal* body-chop-shops from springing up in the slums of the city, especially the Riverside area. There are at least four illegal cybernetic/enhancement facilities where one can go to become a Juicer. Two of them are run by the Black Market and protected by *the Rejects* gang. One is a small-time operation run by a former UTI employee who went underground with a supply of drugs and bio-comps; this is a tiny shop, with minimal facilities, and those who go there have a high risk of

suffering from side effects and other problems (base chance of success is 65%).

The fourth facility is much more mysterious and less well-known. Its exact location is a well-kept secret, although it is believed to be an underground facility. According to the rumors, this body-chop-shop is run by UTI in defiance of Coalition laws. The few people who have undergone the Juicer process at this facility were drugged and kept unconscious for most of it, and have no knowledge of where it is located.

Armed Forces

When Newtown accepted the invitation to join the CS, it did so with the understanding that military bases would be built to accommodate a large force of soldiers. Additionally, the existing City Guard of Newtown was refitted with CS weapons and equipment, and renamed the **First Arkansas Brigade**. To ensure that the new military unit did not remain too loyal to the local government and citizens, over 30% of its 2,000 troops were reassigned to other Coalition posts and replaced with recruits from Illinois, Idaho, and Iron Heart. Arkansas soldiers now serve in Chi-Town, Canada and the border with Tolkeen.

At the time of the Juicer Uprising, there are over 3,000 CS troops in and around Newtown. The 1st Arkansas Brigade is reinforced with an armored battalion of Coalition regulars. Another battalion is stationed at the Border Wall. A smaller military outpost (400 infantry soldiers and two mechanized platoons) is located some 30 miles (48 kmph) south of the city proper, to provide support for bases near Fort El Dorado (see *Rifts RPG*). The table of organization and equipment of all these troops is detailed below.

In addition to the Coalition troops, Newtown has a militia of about 600 volunteer citizens. As far the CS government is concerned, these are worthless troops used mostly for support, garrison duty, and other unimportant missions. Unknown to most people, the militia is directly funded and equipped by Ultra-Tech Incorporated, and its members have a secret agenda.

1st Arkansas Brigade (Two infantry and one tank battalion):

1,200 medium and heavy infantry soldiers.
200 SAMAS (80% are recruits from other States).
50 Grinning Death Skull Main Battle Tanks (one Armored Battalion; see *Rifts Mercenaries*).
50 Mark V APC's (can transport almost the entire infantry complement).
100 Sky Cycles and pilots
100 Dog Pack soldiers and Psi-Stalkers

20th and 21st CS Mechanized Battalions: The 20th is located in Newtown, the 21st mans the Border Wall (see *Places of Interest*, below).

144 Heavy Infantry Soldiers
128 SAMAS
128 Skelebots (see *Rifts Sourcebook One*)
64 UAR-1 Enforcers
64 IAR-2 Abolishers (see *Rifts Sourcebook One*)
32 Spider Walkers
16 Mark V APC's

Additionally, the 21st CS battalion has an attached Dog Pack company (128 mutant soldiers) and 48 Sky Cycles and their pilots, all located on the Border Wall.

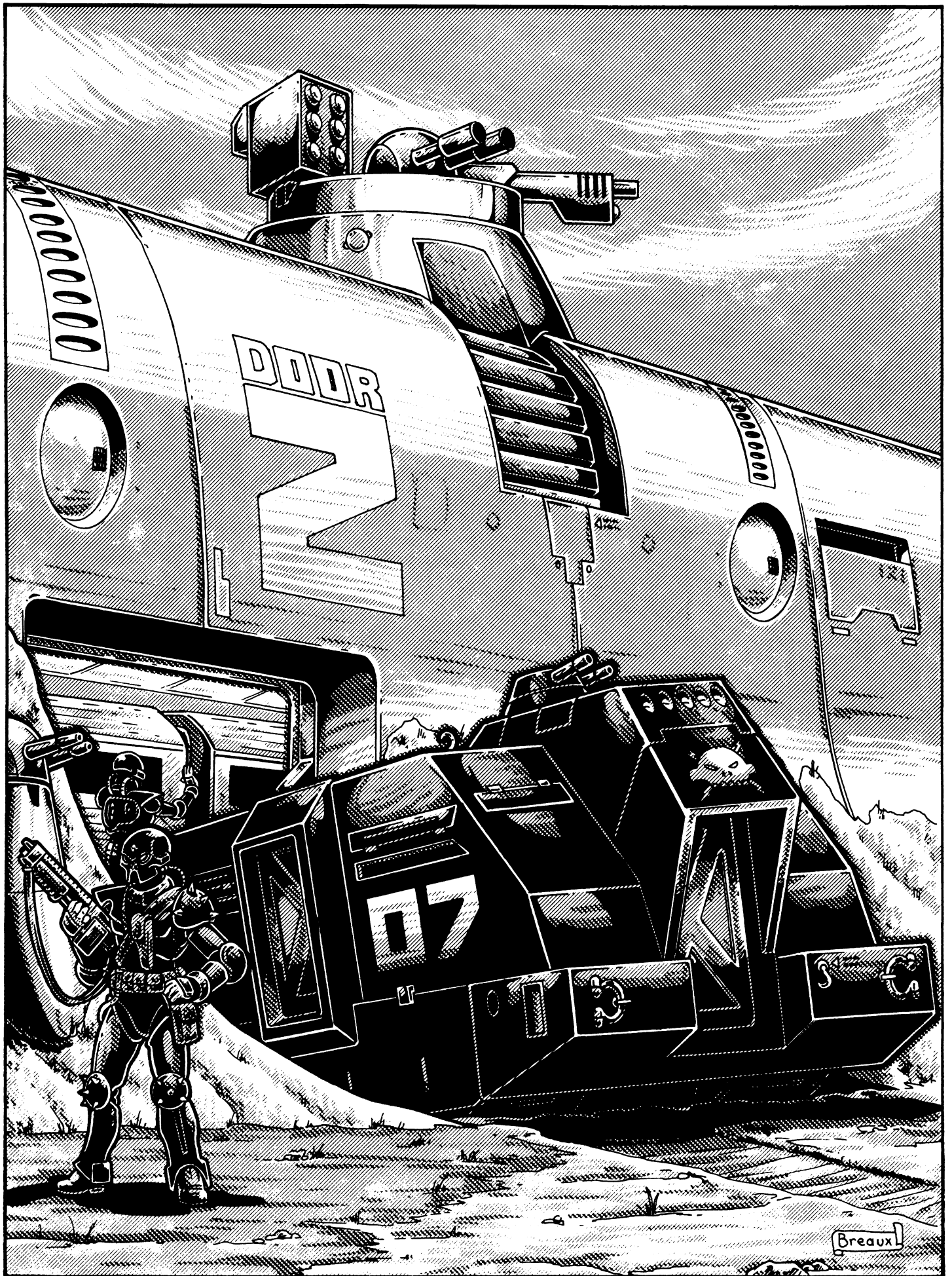

40th CS Regiment: Located 30 miles (48 km) south of Newtown, this force protects the trade routes between Newtown and Fort El Dorado.

400 infantry soldiers

16 SAMAS

32 Skelebots

32 Dog Pack soldiers

8 UAR-1 Enforcers

8 IAR-2 Abolishers

6 Mark V APC's

20 Sky Cycles

Newtown Militia: Allegedly an informal defense force, the militia is completely dominated by the mysterious "newcomers" who arrived in Newtown over two decades ago. The Newtown Militia is fully described in the *Juicer Uprising* section.

600 infantry soldiers

100 NG-EX10 Light Exoskeletons (see *Rifts Mercenaries*).

12 NG-V7 Hunter Mobile Guns (see *Rifts Sourcebook One*).

UTI's Security: This private security force is tolerated by the Coalition, although General Orly is not at all happy about it. The exact numbers of UTI's security force are believed to be in the hundreds, perhaps 300-500. They are lightly equipped with plastic-man body armor, and what appears to be Wilk's laser rifles and pistols; they have no vehicles. The true strengths and equipment of the UTI are fully described in the *Juicer Uprising* section.

The Border Wall

Located about one mile (1.6 km) away from the city proper, this fortification is somewhat similar to the Maginot Line that was built in France after World War I. Like the Maginot Line, the Border wall was designed to protect the city from possible invaders, and was laid out to block most ways of access to and from the uncivilized West. The Border Wall is about three miles (4.8 km) in length and consists of a high (60 feet/18.3 m) wall barrier. From the air, these walls appear to be over 200 feet (61.0 m) thick!

In reality, the "wall" is hollow, more like an elongated bunker. The interior of the border wall has a rail system with two monorail tracks, which allows reinforcements and supplies to travel the length of the fortification in a matter of minutes. Thirty-two turrets are spaced every 500 feet (152 m) or so, each holding a number of laser cannons, missile launchers and rail guns. Smaller firing points allow the defenders to engage enemies at any point along the wall.

At the time of the Juicer Uprising, the wall will be manned by only one oversized battalion (about 700 soldiers). Each of the 32 towers only had a detachment of 8-24 soldiers. For the last couple of years, this force had been more than enough to deal with what few raids or attacks came its way. The few times it required reinforcements, the soldiers were able to call upon the 2000+ soldiers in the city, only a mile (1.6 km) away.

Places of Interest

The Governor's Palace: The seat of government was built in 98 P.A. by George Hornesby, using some of his new wealth. It has been described by some as an "architectural monstrosity," a sprawling, eight story tall palace that fills three city blocks, built on top of the tallest hill in Newtown. It is a mixture of different

architectural styles, considered by many citizens to be an expensive eyesore, but loved by others who point at the size and expense of the Palace with great pride. The palace's major attraction is a giant clock built to resemble pre-Rift's London's Big Ben. Hornesby once saw a picture of that tower and fell in love with the idea of having a giant clock chiming every hour. Thus, a 12 story tower was built for just that purpose.

Since the incorporation of the city-state into the Coalition, a section of the palace has been converted into an armored building that houses two armored companies of Dead Boy soldiers. Additionally, dozens of Coalition emblems have been painted on the walls, and dozens of flags and posters with the symbols of the CS and pictures of Emperor Prosek now further distort the building.

UTI's Corporate Headquarters: UTI's main offices are located two blocks away from the Palace of Government, in the same building housing two of Newtown's major factories. This building covers as much area as the more imposing Palace, but only rises up five stories; this is because most of the offices and factories are located underground. Only the "newcomers" know exactly how extensive these underground facilities are, or how deep they run beneath the city. For more information about the underground section, refer to the UTI section in the *Juicer Uprising* section.

UTI's Electronics Division: This is a factory specializing in the manufacture of sophisticated electronics, including computer chips, guidance and sensor systems, and other expensive components. At first, theft used to be a major problem, with criminal gangs (the most notable being the Rejects) making several snatch-and-run raids in which a small band of 4-6 gang members would rush at a loading dock, scare or subdue any workers, and escape with a few boxes of valuable equipment. Some of the more daring gangs went so far as to hijack entire trucks as they were carrying products to other facilities.

As a result, security has been tightened to the point that the building looks more like a fortress than a factory. The last half dozen raids by gang members ended up with the would-be thieves getting mowed down, with only a couple managing to escape with their lives. The manufacturing facility has a "garrison" of at least 120 UTI security officers. Apparently, some of them are 'Borgs. According to one of the gang survivors of a failed raid, one of the guards was shot full in the face: beneath the flesh and bone appeared to be a metallic "skeleton!"

UTI's Biotech Division: This building is half a block away from the main UTI building. This is where the manufacture and research on medical equipment and technology are conducted. Until the treaty with the CS, this was also where Juicer enhancements were available, making the Biotech Building one of the largest body-chop-shops in North America. This is also where the **Prometheus Treatment**, the alleged "cure" for Juicer burn-out, was developed, which makes the Biotech Division the main target of the Juicer rebels.

In addition to developing medical technologies, it is rumored that the Biotech Division also conducts genetic experiments. A commonly told tale claims that UTI is breeding some sort of giant cockroach! According to some "semi-eyewitness accounts" (I knew a friend whose friend says he saw ...), human-sized insect beings have been spotted in or near the UTI Biotech build-

ings. The only documented case, reported by a local merchant and investigated by the authorities, turned out to be a lone Xiticix creature (see the *Rifts RPG*) that somehow had managed to wander into the city proper. More tall tales and urban myths about giant insects coming in and out of UTI facilities continue to be told, however.

The Royal Casino: This large bar, casino and nightclub was built in 99 P.A. to serve the needs of Newton's growing number of skilled workers and professionals. After the union with the Coalition, the Royal Casino also caters to CS officers and the occasional soldier who is prepared to blow one or two month's pay on the turn of the cards or other pleasures.

The Royal Casino is a very large establishment that can accommodate over six thousand people safely. It is built more like a shopping mall, with a center gaming court where all kinds of games of chance are played, surrounded by six bars and four showrooms. The showrooms feature singing, magic acts, and other forms of entertainment, including stand-up comedy (although jokes about the CS may get would-be comedians in trouble). The bars cater to different tastes, from a quiet pub for people looking for a break from gambling, to wild places where exotic dancers perform for the benefit of the patrons. Security cameras monitor all the bars and the casino floor, and a security team of 60 well-trained mercenaries (mostly headhunters levels 3-6) is at hand to respond to trouble.

General Orly has demanded the Royal Casino be shut down on a number of occasions, decrying the negative effect the place has on the morale of the city garrison. Governor Hornesby (who gets a generous kickback from the owner of the Casino) has always refused, reminding Orly that the Coalition treaty gives the local authorities discretion to conduct their affairs as they see fit, as long as certain broad and basic laws are respected, like outlawing non-humans and augmented humans.

The owner of the Royal Casino is Rowland Dublin (7th level gambler with a head for administration and business), a jovial, slender middle-aged man who often walks the floor of the Casino, trying his hand at the occasional game, and always ready to engage a patron in conversation. Unknown to almost everyone, Rowland is a D-Bee, a member of the Changeling race (see *Rifts Conversion Book One*) who arrived in Newtown over ten years ago to seek his fortune in a growing city. Dublin did not expect the CS to come here as well, and he is extremely paranoid about covering his tracks, especially since the CS commander already dislikes him and his establishment.

The Powder Keg: The Keg is the main civilian weapon store in Newtown. The entire UTI product line, as well as weapons from Northern Gun, Wilk's and Wellington Industries are available at the store. E-Clips of all types, clip recharging, weapon customization, accessories, and body armor of all types are also available.

This weapon store celebrated its 25th anniversary in 104 P.A. When it first opened, the Powder Keg was a tiny wooden shop whose inventory included two rusty laser pistols, a handful of E-Clips, a dozen hunting rifles, and a selection of S.D.C. bullets, knives, hatchets, bows and crossbows. Its owner was a 50 year old retired Wilderness Scout named Scott Schwartz. Scott's fortunes changed when he invested his hard-earned life's savings to become Newtown's exclusive UTI dealer. Two decades later,

the Powder Keg is one of the largest weapon stores on the continent.

Scott Schwartz, still going strong despite being in his seventies, continues to manage his store, ably helped by his granddaughter Felicia (7th level headhunter), herself a former adventurer who recently returned to the fold. Felicia is an expert shooter who will be happy to demonstrate the capabilities of any weapon system to a customer. The woman is not a friend of the Coalition States, having had her share of run-ins with it during her adventuring years, and is concerned about the CS influence in Newtown. She has taken no direct action against the new rulers of the city, but would not be heartbroken if something changed the current situation. Her brother Ethan (9th level merchant) and cousins Robert, Benjamin and Karen (all 4th and 5th level merchants) also help to run the store, along with 150 employees.

The Golden Delight: This is the largest bar (or, as Orly calls it, "den of iniquity") in the Riverside section. This is the place where mercenaries, adventurers, travelers and soldiers on leave, go to for a good time spiced with danger. Coalition soldiers who visit the Golden Delight are advised to travel in groups, or they risk being, at best, cheated and robbed, and at worst, made to disappear altogether. Several underworld figures frequent the bar, which is rumored to be the place to go if you are seeking anything illegal, from drugs to a body-chop-shop.

The bar is very large, with a capacity for over 500 patrons, and is divided into three large rooms. The first is known as the *Meat Rack*, and is where most visitors (including soldiers on leave and non-regulars) get to hang out. It is a loud, frenzied place where drinks are expensive and life is cheap. Fights are broken up by a heavy-set man called Cement-Head, a 4th level Vagabond with the super-powers of invulnerability and energy expulsion. He looks like a normal being but cannot be harmed by S.D.C. weapons and can take a lot of damage. The second room, the *Cool Saloon*, is reserved for regulars and "people who know people." The overall atmosphere is much more relaxed and friendly (less roughhousing). A number of card games go on regularly, with stakes of thousands of credits. Finally, the *Back Room* is where the "bigwigs" of the local underworld come to talk to each other and relax after a long day managing the Black Market, prostitution and drug rings, and other criminal activities.

People trying to get "connected" to the local underworld need to make several Streetwise rolls. If they are thought to be (rightly or wrongly) connected with the authorities, the bar regulars will take lethal action! If they are successful, however, characters will be able to hear any and all gossip circulating among the underworld. This is also the place to find Black Market items, forbidden books and other hard-to-find objects.

Ogretown: The local D-Bee quarter of Newtown is known as Ogretown, due to the fact that a significant number of the D-Bees there are Ogres (25%). Ogretown is run by the criminal gang known as the Inhumanes, who force all the people there to pay protection fees or risk being beaten up or worse. The Inhumanes have recently tried to "muscle in" on the drug trade controlled by the Black Market and the Rejects street gang. As a result, drive-by shootings and other flare-ups of gang warfare are sadly, common in the area.

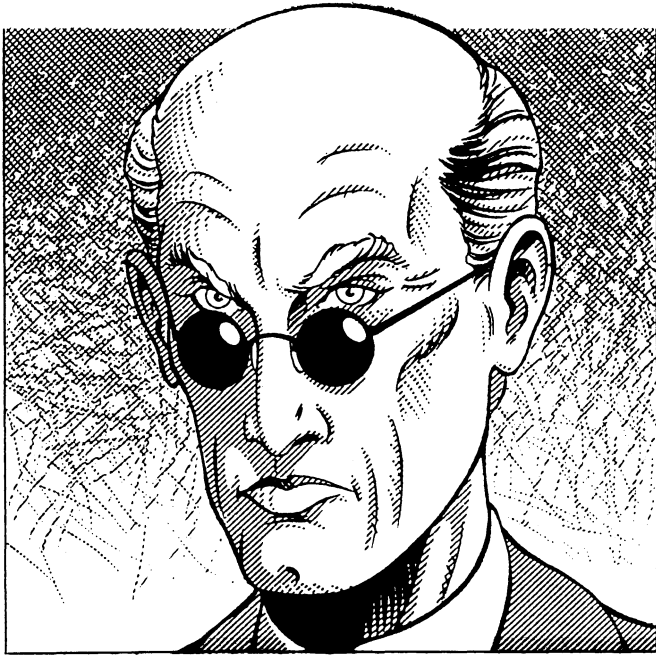

George Hornesby

Governor of Newtown

The Hornesbys were among the first people to claw their way out of the chaos and horror of the Great Cataclysm. George Hornesby can proudly point to a family tree whose members can be traced as far back as the Coming of the Rifts, to one Mark Hornesby, a shoe salesman by trade, a part-time National Guardsman by hobby. Mark Hornesby led a group of desperate people to a National Guard Depot, which they looted even as civilization collapsed all around them. Other Hornesbys carried on that tradition, discovering old ruins and taking everything of value from them as they could. By the time of George's birth in 43 P.A., his family was among the richest in Newtown, owning huge sections of farmland and several dozen military vehicles.

George built on his family's wealth. At age 18, he discovered a long-lost military cache containing, among other treasures, two Glitter Boy suits! George learned how to use one of the suits and spent several years working as a mercenary. By age 24, he had amassed over 15 million credits and his personal wealth exceeded that of his family's. At that point, he returned and became the Hornesby patriarch, marrying the daughter of another wealthy family (which, incidentally, brought her holdings under his control), and fathering seven children. Always an opportunist, George took advantage of the misfortune of others, buying out farms during times of drought, extending generous loans which he called in at the most unfavorable times (for the borrower, that is), and acquiring, by hook or by crook, more wealth and power.

Then the newcomers arrived in Newtown. George was suspicious of the quiet men and women, their advanced technology, and of a story that did not check out. Mamma Hornesby had raised no fool, and George quickly decided these people were obviously D-Bees from an advanced world. His second assumption, that they were desperate refugees, was wrong, but the strangers put up a good front and convinced him. George met with the leader of the "newcomers," Andrew Anderson to discuss their future in "his" town. At one point during the meeting, George cut off yet another of Anderson's lies. "Can the bull, pal," Hornesby said. "I know you don't come from the East. Per-

sonally, I don't care if you come from the East, West, or from Hades itself. I've got things you want, and you've got things I want, so let's talk business."

Anderson seemed quite satisfied by these words, and the two men have worked side by side, turning Newtown into the technological wonder it is today. When the Coalition States started showing interest in the city, George was alarmed, fearing that if the D-Bee nature of his partners were discovered, war might ensue. Anderson dispelled those fears, and convinced George that accepting membership to the Coalition on good terms would only lead to greater wealth and power. So far, he appears to have been right.

At the time of the Juicer Uprising, Hornesby is a happy man, a grandfather three times over, the leader of his own small empire, wealthy beyond his dreams. Little did he know he was about to lose it all.

George Hornesby

Alignment: Miscreant

M.D.C.: By armor; pilots a Glitter Boy suit (770 M.D.C.)

S.D.C./Hit Points: 39 S.D.C. and 49 Hit Points.

Attributes: I.Q. 17, M.E. 12, M.A. 22, P.S. 15, P.P. 16, P.E. 19, P.B. 13, Spd. 14

Disposition: A ruthless, conniving charmer, Hornesby is an expert at understanding people and taking advantage of them. An experienced ex-adventurer, he is still in excellent shape despite being in his fifties, and he's not afraid of violence. His "tough guy" attitude has made others back down, including General Orly. George Hornesby is afraid of very few things and does not let anything get in the way of his goals.

Level of Experience: 5th level Glitter Boy pilot and 12th level merchant.

Combat Abilities: Hand to Hand: Expert, Robot Combat: Elite, and Boxing.

Bonuses: 55% trust/intimidate, +4 to roll with punch/fall or impact, +2 to strike, +5 to parry & dodge, critical strike and knockout/stun on an unmodified 18-20, +2 to save vs magic and poison.

Attacks per Melee Round: Seven (Nine in a Glitter Boy).

Magical Knowledge: None. **P.P.E.:** 13

Psionic Powers: None.

Alliances and Allies: Hornesby's fate is tied to the well-being of UTI, and he will do everything in his power to protect the corporation. He is also on good terms with the Black Market, which owes him a few favors in return for his turning a blind eye to their activities in "his" town.

Minions: Has 20 personal retainers, including 10 Headhunters (levels 3-6), five Wilderness Scouts (levels 4-8), and five full conversion 'Borgs (levels 4-7), who act as his personal enforcers and bodyguards.

Weapons and Equipment: Hornesby is wealthy enough to buy any weapon manufactured in North America. His preferred combat tool is the Glitter Boy, which he still owns and maintains with exquisite care. On normal days, he wears a suit of light M.D. armor beneath his clothes (30 M.D.C.). He has access to all UTI products and any hand-gun or rifle ever made.

Money: He has a personal fortune of 150 million credits in cash and over a billion in personal property and landholdings, plus an income of 25 million credits a year from various business interests!

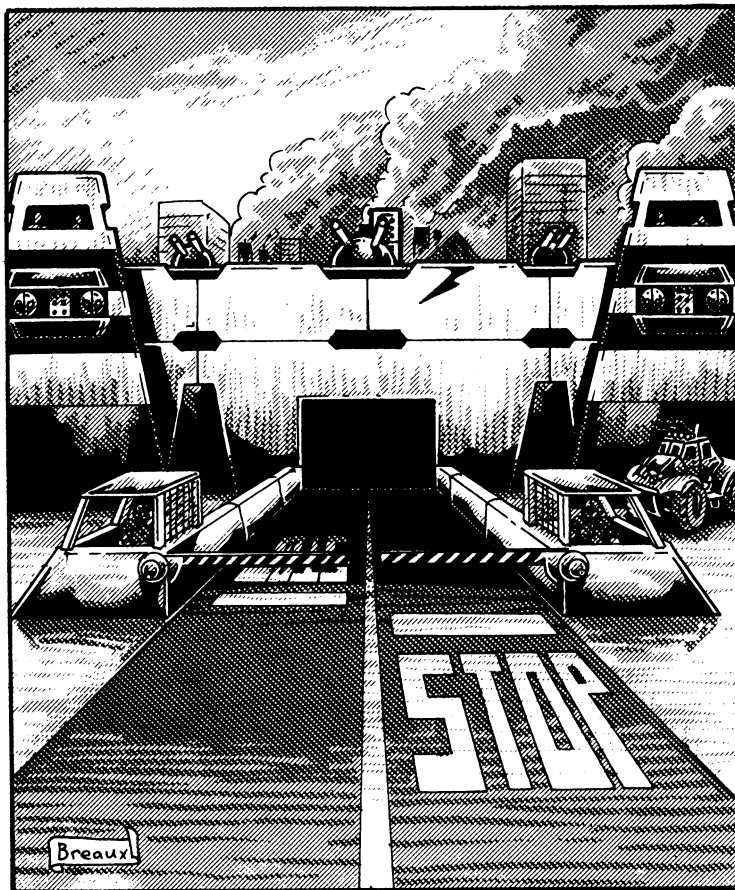

Fort El Dorado

Population: 135,000 (80% human, 15% D-Bees and 5% mutant animals). An additional 85,000 people live in small villages surrounding the city. An additional 2D4x1000 Juicers and as many would-be Juicers could be found in the city at any given time (up to the time of the Juicer Uprising anyway).

G.M.'s Note: Fort El Dorado has changed a great deal in the five years since Erin Tarn described the city in her book, *Traversing Our Modern World* (see *Rifts RPG*). Most of the changes are related to UTI's industrial investments in the city, and CS activity in the area.

Until 102 P.A., Fort El Dorado was an independent kingdom whose wealth was derived from producing raw materials for the Coalition States, mostly oil, cotton and natural gas. When their Northern neighbor, the free city-state of *Newtown*, became incorporated into the Coalition States, a delegation from Newtown established a thriving Juicer conversion business at Fort El Dorado; a business that now accounts for 10% of that kingdom's economy. What seemed like a great economic boon would seem to flirt with disaster a few years later, during the great Juicer Uprising.

Fort El Dorado was founded by the survivors of the former American state of Arkansas. The community managed to survive thanks to their access to strategic resources, especially natural gas and oil, and by the post apocalyptic years, it was one of the largest and wealthiest kingdoms not associated with the Coalition States. In the 50's P.A., a number of treaties between Fort El Dorado and the Coalition States were signed, and renewed in 85 P.A. Although the rulers of Fort El Dorado politely rejected offers to join the CS, the kingdom remains a strong ally, allow-

ing the CS army to establish two military outposts within its borders.

Among the reasons why Fort El Dorado did not join the Coalition were the kingdom's D-Bee population, which accounted for some 15% of its people, and its reliance on Juicer mercenaries for its defense. Although Fort El Dorado is extremely prejudiced against magic, non-supernatural D-Bees are allowed to live peacefully in the community, and a few have even become important citizens, something that would have clashed with CS policies. Furthermore, the Coalition would have forced the kingdom to give up their enhanced warriors, which at the time accounted for one-tenth of their defense force. So it seemed better for everyone to keep things as they were.

When Newtown agreed to divest itself from all Juicer technologies, UTI met with King Randall Stuart III and made him and his Congress a very attractive offer. At the time, Fort El Dorado only had minor Juicer facilities, certainly nothing compared to those in Ishpeming, Kingsdale and Los Alamo. UTI offered to move its entire human enhancement programs, lock, stock and barrel, to Fort El Dorado! A move that would add billions to the local economy!! In return, all UTI wanted was a guarantee that the kingdom would not outlaw the Juicer procedure for a period of at least fifteen years. Given that King Randall had no intention of restricting the creation of Juicers, he readily agreed to the plan. By 103 P.A., UTI had, in record time, built a large body-chop-shop that offered almost every Juicer conversion available. Since then, Fort El Dorado has become a major Juicer hang-out, which has only increased the city's wealth and reputation as the largest trade city in the area.

Government

Fort El Dorado is ruled by a constitutional monarchy. The King is an inherited position, controlled this last century and a half by the Stuart family, who claims to be descendants of time travelers from Earth's past; none other than members from the Stuart royal family from England (not likely). This century-old tale is cherished by the king's supporters and politely ignored by everyone else. Whatever its origins, the Stuart dynasty has produced its share of relatively capable leaders. The king commands the armies and rules by signing decrees. However, the financing of any government activity is in the hands of Congress, which controls taxation and public funds, unless the king pays for a government program out of his own pocket. This system gives Congress a great deal of power, although this elected body (whose members are selected by democratic vote once every six years) cannot rule on its own. In addition to the King and the Congress, there are a number of Directors nominated by the King and approved by the Congress. Directors are in charge of a number of government functions and take care of most administrative matters.

The current monarch is King Randall Stuart the Third, or Randall III, a thirty-year old man who loves to have fun a great deal more than is good for the government. Fortunately, the laziness and vices of the king (who has not married, but whose dalliances with actresses, performers and female adventurers have been the source of gossip for years) have not harmed the kingdom. Martin Clements, the Prime Director of Fort El Dorado, has made up for Randall's inadequacies, and is the kingdom's ruler in all but name. Under his able leadership, Fort El Dorado has prospered.

Technology

For the most part, Fort El Dorado's technology is comparable to the end of the 20th Century or early 21st Century. It has limited manufacturing capabilities, but trade with other nations, including the CS and the Black Market, more than makes up for it. Cybernetic facilities offer anything up to partial conversion bionics, M.O.M. and Juicer implants, and most energy weapons and equipment. As the only non-Coalition rest stop for hundreds of miles, it attracts trading caravans, travelers and adventurers from all over, and benefits from the trade and knowledge these visitors bring along.

Juicers at Fort El Dorado

Juicers are allowed within city limits, provided they do not carry any heavy weapons or wear heavy armor (power armor and giant robot vehicles are also outlawed and must be "checked" at the city's borders). Would-be Juicers have access to most forms of conversion with the exception of Mega-Juicers and Dragon Blood Juicers (which are outlawed because they rely on magic).

Juicer Sports are very popular in Fort El Dorado. King Randall himself is a fan of the sports and has spent a fortune outfitting Fort El Dorado's own Juicer Football team, the *Stuart Rhinos*. The Rhinos have not had a very distinguished career, but King Randall continues to spend money on them, sending talent scouts to find new talent at other kingdoms.

Society

Overall, Fort El Dorado's people are better educated and more tolerant of non-humans than the Coalition States. Their only major prejudices are against magic, psionics and other supernatural powers, due to bad experiences with supernatural creatures that arrived on Earth via one of the powerful Rifts that plague the so-called Magic Zone to the Northeast. Only mutant animals are allowed to use their abilities and only to help detect and hunt down anybody who is using illegal powers.

As long as somebody does not practice those "forbidden lores," he or she is welcome in Fort El Dorado, regardless of their species and appearance. D-Bees from all walks of the Megaverse reside and visit this city, without fear of being bothered as long as they don't bother others. There isn't a "D-Bee Quarter" or ghetto in the city; instead, people can live wherever they wish. These attitudes make travelers from the Coalition States and similar bastions of human supremacy extremely uncomfortable.

Foreign Relations

Fort El Dorado's main ally and trade partners are the Coalition States at large and the CS city of Newtown, respectively. The city is on relatively friendly terms with other independent communities, including Los Alamo, but for the most part, has little contact with them.

Armed Forces

The city-state has a standing army of 4,000, mostly infantry soldiers, with a contingent of 50 robots, 40 tanks, and 100 assorted light vehicles. The El Dorado Army also doubles as the police and security force. The soldiers are equipped with medium body armor (40-50 M.D.C.), energy rifles, 1D4 grenades and built-in radios; police units also have S.D.C. pistols and batons.

The city proper is surrounded by a heavy, fortified wall, 30 feet (9.1 m) high, made of reinforced M.D.C. concrete. A number of artillery pieces, rail guns and mortars are mounted on the wall's battlements, ready to engage any would-be invaders.

For several years, two Coalition military bases have been established in the environs of the city. The largest one consists of 650 soldiers (upgraded from 400), and is five miles (8 km) away from the city. A smaller outpost with 128 troopers (upgraded from the original 72) is assigned with protecting the natural gas plant, which is as valuable to the Coalition as to Fort El Dorado.

Places of Interest

The Post: The largest inn and hotel in Fort El Dorado, the Post was first used by travelers and messenger services who braved the wilds of North America to bring expensive or important packages or merchandise from one place to another. As civilization slowly grew, so did the number of travelers needing lodging, and the number of inns multiplied at Fort El Dorado. The Post, however, continues to be the largest and best known, and is usually the place well-to-do adventurers and travelers seek when they arrive in this kingdom. Good service, great food and comfortable rooms are the order of the day here. Rates range from 60 credits for a single room to 400 credits for the Crown's Suite, with the average single room ranging from 100-120 credits a night. The Post also provides high-security, so there is very little danger of being the victim of random robberies and other dangers that are common at the cheaper hotels and motels of Fort El Dorado.

This establishment is owned by Doris Sellers, a former traveling merchant (11th level Vagabond) who retired after amassing a considerable fortune. Still an attractive woman in her early fifties, she has many contacts among travelers, merchants, business people and adventurers, so she always seems to know what is going on before anybody else.

UTI's Superhuman Body-Chop-Shop: The largest body-chop-shop in the area, the UTI SBCS was established shortly after Newtown joined the Coalition States. UTI has managed to copy all technological Juicer variants except the Mega-Juicer and Dragon Juicer (and the secret Coalition versions), and can treat as many as 100 candidates at the same time.

The Los Alamo Clinic: The main competitor of UTI's establishment is the Los Alamo Clinic, a Juicer hospital established by a team of cyber-docs from Los Alamo. Conversions here are 10% cheaper, but there is usually a 1D4 week waiting list.

The Killing Ground: This weapon and vehicle store carries most of the common weapon lines available in North America, including a few models from Naruni Enterprises (bought from third parties; Naruni does not have a trading post in this city). Most items come from manufacturers like Northern Gun, UTI and Wellington Industries. A variety of off-road vehicles, power armor and robots are also on sale here.

The proprietor of the Killing Ground is a D-Bee who calls himself Pecos Hill. He claims to be the former leader of the Pecos Empire, an outrageous claim, but most people do not dare dispute it, because Pecos stands nearly nine feet tall and his scaly red skin has proven to be tough enough to resist anything smaller than a volley of heavy missiles. Pecos has lived at Fort El Dorado for over ten years, arriving at the city with about twenty million credits' worth of valuable merchandise. He used



the proceeds from the sale of the merchandise to buy into a local weapons store, and eventually, he bought out the previous owner (rumor says he didn't want to sell but Pecos was frighteningly insistent). Pecos Hill is believed to have contacts with the Black Market.

The Stuart Arena: This is the second largest arena dedicated to Juicer Sports in the area (the largest one is in Los Alamo). It is certainly one of the most luxurious. Built in 102 P.A. by King Randall Stuart, who used several million credits from his personal fortune, backed by a half dozen other investors (including UTI), to build a beautiful arena patterned after a Spanish bull-fighting coliseum. The structure can hold up to 30,000 spectators (it has yet to be filled to capacity), and the field in the center can be used for a variety of events, including Juicer Football, Murderthon and Juicer motorcycle races, with or without combat in-

volved. Ticket fees are very reasonable, 200 credits for season tickets, and 15-50 credits for most events. Located right next to the Arena is the **Arena Annex** where Deadball tournaments are held every day. The two establishments are responsible for the regular employment of no less than 300 Juicers, mostly Juicer Gladiators.

The most famous "local talent" of Fort El Dorado includes Maximillian Smith (Juicer Gladiator, 9th level, four years old), the undisputable champion of Deadball, who has yet to lose a game, with a record of 196 wins, 2 ties, and 34 wins because of fatalities! Groth "Pseudo-Titan" Crycher, a Troll Juicer (7th level, three years old), the MVP for the Stuart Rhinos; and Julienne "Atlanta" Vargas (8th level Hyperion Juicer, three years old), winner of the last two Annual Murderthon Championships.

The Juicer Uprising

By C.J. Carella

Additional text and ideas by Kevin Siembieda

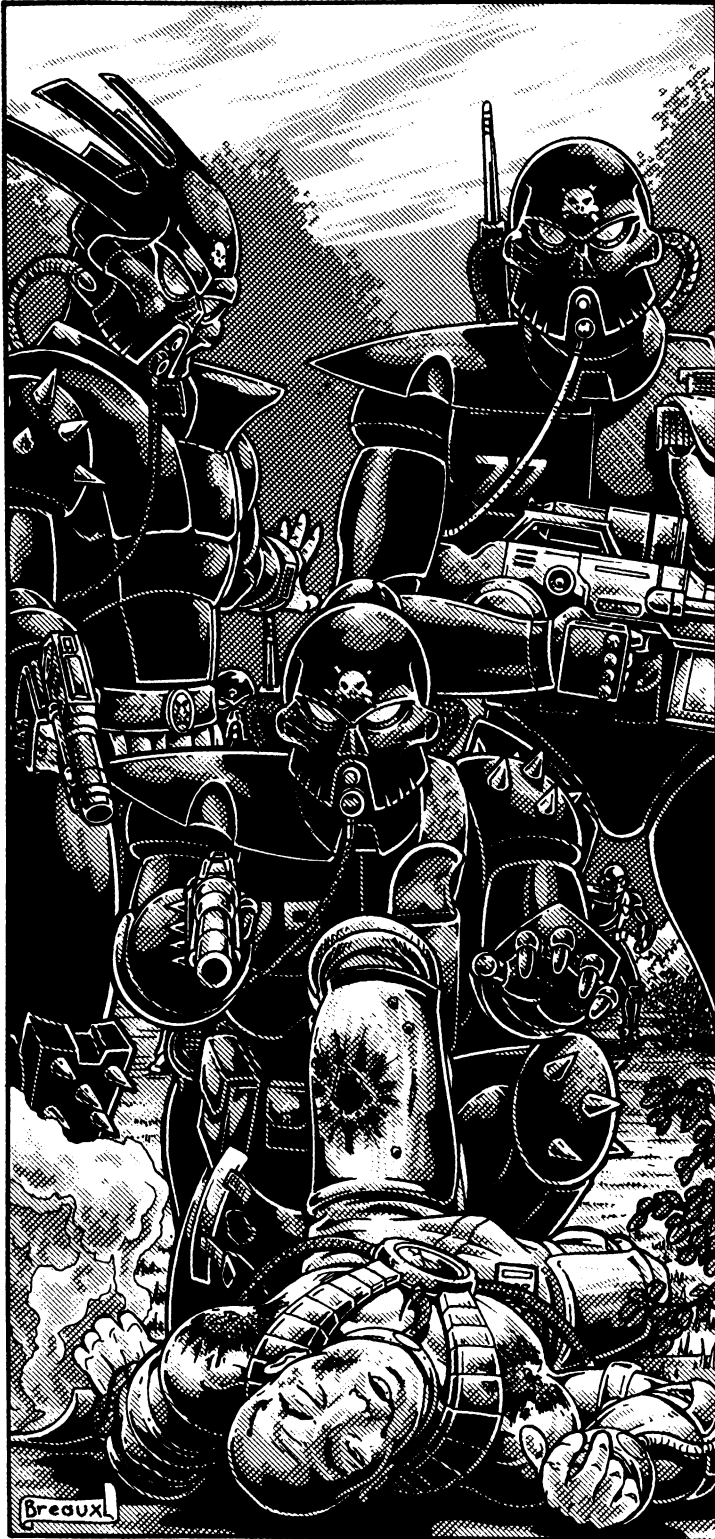

The Juicer Uprising is a major event in the history of Rifts Earth. For a period of several weeks, a violent conflict will rage through Arkansas and involve the Coalition States, several independent kingdoms, thousands of Juicers, Coalition troops, and a transdimensional power nobody even suspected existed. The result will affect North American politics for years to come. The information described below depicts the major incidents of this Uprising and some of the key forces involved.

The Game Master can modify, detail and expand the events and people involved in the Juicer Uprising as he or she sees fit. Throughout this section, adventure ideas and suggestions are provided to give Game Masters an outline for possible scenarios and ways to bring the player characters into the events leading to and following the Juicer Uprising. The characters' actions may influence the outcome of some of these events, so G.M.s should be flexible. Some ideas and suggestions on how to handle the aftermath of the Uprising are also presented, but G.M.s are encouraged to come up with their own consequences.

Prologue

The events that would lead to the deaths of thousands started with a simple breakfast on a balcony.

The balcony was on level 36, overlooking the man-made canyons of Chi-Town. Colonel Lyboc sipped his tea, not spiking it with rum for a change, while he listened to the stranger's plan. Occasionally, Lyboc stopped focusing on his future partner and let his glance oversee the depths below. It had taken him a great deal of work to make it here, near the top of the world. What the smiling man proposed might take him further up — or might cause him to plummet into the depths below, and lose everything.

"The enticement will be easy to provide," the stranger continued. "These are desperate men and women; they have nothing to lose, no?" The man's accent and inflections were unfamiliar to Lyboc, but he did not care. He had dealt with foreigners before, and even if this man was a D-Bee ... well, he had made deals with the enemy before, hadn't he?

"The problem lies in controlling them," Lyboc replied. "I've dealt with Juicers before. They are savages, many of them as insane as the Crazies. If your plan fails, we'll have several thousands of these barbarians running amok in Coalition territory, knocking on our very gates."

*"That is exactly why we are being careful. The plan will not fail. Once the Juicers receive the **Prometheus Treatment**, they will be under our complete control," the man insisted confidently. Lyboc frowned when the stranger spoke about "our" control, he did not seem to be including Lyboc — or the Coalition States for that matter. Despite his misgivings, Lyboc found himself nodding. The stranger was a civilian, but he came highly recommended by General Orly, commander of the Coalition*

Army of Arkansas. If the reports were correct, he had been instrumental in securing the wealthy city of Newtown for the Coalition States. And the plan made sense — perhaps dealing with the Tolkeen Problem once and for all, and, if he, Lyboc, was the man to bring it to the ears of the Emperor ...

Visions of grandeur danced in front of his eyes. To be elevated from a mere spy master to a man of true power ... General Lyboc. Yes, that had a nice ring to it.

“I will see what I can do, Mr. Anderson,” Lyboc said. “I believe I can convince the Emperor of the importance and value of this project.” Also a good time, he told himself, to unveil the other operation he had been working on. Another operation that involved Juicers. Those psychopathic killers had many uses.

Andrew Anderson stood and shook Lyboc’s hand. “The Coalition, all of Humankind — will never forget what you are about to do, Colonel Lyboc.”

Behind the smile, an inhuman mind that was pretending to be Andrew Anderson did not voice its true thoughts. Yes, they will never forget the day you handed us your lives on a platter, Lyboc.

Plans & Missions

On 102 P.A., only a year after the incorporation of the city-state of Newtown into the Coalition States, a delegation from that kingdom traveled to Chi-Town. It was led by Andrew Anderson, one of the most prominent members of Newtown as well as the major stockholder of Ultra-Tech Industries, a new weapons manufacturer whose quality products had already impressed Coalition technologists.

In Chi-Town, Anderson met with Colonel Lyboc from CS Intelligence. Somehow, Anderson knew that Lyboc had been using Juicers in secret Coalition missions (see the *Coalition Juicers* section). The civilian explained to Lyboc that he had a plan to use Juicers on a wider scale, as a “disposable army” that could be used in a suicidal attack against the Coalition’s enemies. Anderson said that he and Ultra-Tech Industries (UTI) had developed a way to artificially extend the life of Juicers for over two years, the so-called **Prometheus Treatment**. The Coalition could fool thousands of Juicers into fighting and dying for them by telling them the treatment could actually *cure* the degenerative Juicer augmentation process. Many Juicers would do just about anything to double their life span, if the CS could mislead them into thinking the process could give them 20, 30, or even more years of life as superhumans, they could get tens of thousands of Juicers begging to serve them in exchange for the treatment. Anderson pointed out that at least 50% would perish in battle before they learned the terrible lie. Furthermore, he revealed that Juicers who underwent the “treatment” would have a device implanted in their brains that could kill the subject by throwing a switch, thus saving the Coalition any trouble from the disillusioned. If the occasional “death chip” failed, the process really would extend the Juicer’s life for a few years, before he would experience an unexpected seizure and suddenly die, probably never realizing it was all a lie. How dangerous can dead men be?

Colonel Lyboc agreed to propose the idea to the Emperor, and **Operation Phoenix Rising** was born.

Operation Phoenix Rising

After some wheeling and dealing, and calling in a number of favors, Colonel Lyboc was able to secure an audience with Emperor Prosek to present the project. Operation Phoenix Rising was intended to destroy the city-state of Tolkeen. The plan called for the assemblage of a large army of Juicer mercenaries deceived into believing the reward for their services would be the *Prometheus Treatment*, a cure for the Juicer augmentation process. The army would be assembled on the outskirts of Newtown, where the volunteers would receive the “first stage” of the Prometheus Treatment in the form of a computerized chip implant that would (they’d be told) temporarily counteract the Juicer side effects without affecting their augmented attributes. The patients would also be told that a chemical regimen was also needed to keep the treatment working; this would ensure the Juicer mercenaries’ loyalty, at least until they had done their job.

The Juicers would then march North, to meet a Coalition Army Corps being organized at **New Chillicothe**. The Juicer army would spearhead the attack on Tolkeen, serving as *cannon fodder* against whom the sorcerers and dragons at Tolkeen would expend most of their energies, leaving them weak and nearly helpless against the Coalition troops following the Juicers. As the New Chillicothe CS Army moved in, a second army corps originating from Chi-Town would also strike, launching a two-pronged attack meant to sweep through Tolkeen and then continue North into the Xiticix territories, putting an end to three enemies of the Coalition States at the same time: Tolkeen, Xiticix along the border and the tens of thousands of Juicers (mercenaries and troublemakers) who would perish in the conflict.

The campaign, as outlined by Colonel Lyboc (and coached by Anderson), would last several months; by that time, the Juicers (those who had survived) would be destroyed when the “kill signal” built into the Prometheus Treatment’s Phoenix Chip was activated. The operation would not only conquer all of Minnesota, but would also wipe out an estimated 30,000 to 40,000 Juicers, reducing the North American population of these enhanced humans by at least 15% to 20%, if not more. Lyboc’s projections showed that this operation would be much less costly than a direct Coalition assault, and would also severely weaken several nations that relies on Juicers, including Los Alamo, Kingsdale and Ishpeming, who might lose as much as one third of their mercenary troops by the lure of the promise of salvation. This might actually enable the Coalition to absorb those annoying independent kingdoms. Lyboc waxed eloquent, promising the Emperor that his plan would deliver all of the Midwest into the hands of the Coalition States! And should things go wrong, early on, what did they have to lose. Thousands of Juicer rabble, with little risk or loss to CS troops who could be recalled at a moment’s notice.

Emperor Prosek listened without saying a word. At the end of the presentation, he dismissed Lyboc and met with his closest counselors and military analysts. At first, opinions were divided. General Ross Underhill and Emperor Prosek himself were unconvinced. Joseph Prosek the Second, the Emperor’s son, thought the plan would be an excellent idea. General Cabot wanted to do more research, but thought that if UTI could deliver a “treatment” that would deceive the Juicers and allow the CS to “terminate” their pawns at will, the operation was not only feasible, but enticing. He agreed that the plan would save thou-

sands of Coalition lives, not to mention accelerate the timetables of other military plans by several months, or even years.

After several hours of debate, Colonel Lyboc was recalled to the Emperor's presence. The Colonel was informed that the project would commence, covertly, and on a smaller scale than originally proposed, at least until the claims made by UTI were verified.

Adventure/Scenario Ideas: Player characters in the Chi-Town or Newtown areas may have a chance to find out something's going on. Information leaks are always possible — maybe it happens in a bar, when a drunken Coalition officer hints that a solution to “the Tolkeen problem” is close at hand, or a Juicer brags about his new lease on life via the Prometheus Treatment. Do the characters investigate? Over the course of other adventures, do more clues drop in their laps that will ultimately draw them into the conflict?

The Prometheus Treatment

Trial runs are conducted for several months. A number of Juicers in their terminal stages are kidnapped and exposed to the Prometheus Treatment, under the supervision of Coalition scientists. The results are carefully studied. UTI researchers are sent to Chi-Town to assist in the research.

The Treatment consists of the implantation of a micro-computer, the so-called “Phoenix Chip,” which assists the bio-comp in its task of regulating the Juicer's metabolism. The chip seizes control of the nano-machines used in all Juicer augmentation processes to help the Juicer's recuperative powers. The tests show that the Phoenix Chip does indeed manage to *delay* the onset of lethal body stress for as long as two and a half years, even if installed during what would normally be the last months of a Juicer's life. Additionally, the chip also reduces or completely eliminates many of the side effects most Juicers suffer even before their last days. The tests also conclusively confirm that the Phoenix Chip will not save a Juicer's life — it merely postpones the inevitable.

The second feature of the Phoenix Chip is a “kill signal” that is transmitted by radio. When a special code is fed into the chip, it uses the Juicer's own bio-comp and nano-machines to kill him! Drug overdoses or a sudden change in the victim's bio-rhythm does the job: death can be induced in a mere 5-15 minutes after the signal is received!

By the end of 104 P.A., the tests were completed. While most gave it their stamp of approval, some Coalition researchers had a few misgivings. According to some scientists, the Phoenix Chip appeared to somehow mutate the nano-machines in a Juicer's bloodstream. The tests did not show exactly what the changes were or how the mutations might affect the Juicer, only that they were there. This mutation was not deemed important, however, and the project was approved: an army of Juicers could be deceived, used, and when necessary, discarded with the push of a button.

Adventure/Scenario Ideas: Juicers start disappearing around the Chi-Town area; a player Juicer (or a Juicer friend/ally of the party) might be kidnapped and slated for a deadly experiment with the Phoenix Chip. Do the characters find him in time to save him from a certain death? The research facility is on the outskirts of Chi-Town, and lightly guarded, although a detach-

ment of Coalition Juicers is on watch there and could bring the player characters into a head-to-head confrontation with these deadly fighters.

Lies Within Lies

The first official proclamation about the *Prometheus Treatment* is made on December 13, 104 P.A. Joseph Prosek the Second, while addressing a crowd in Chi-Town, proclaims that a cure for the Juicers' terminal “condition” *appears* to be at hand (he is careful to make no promises or guarantees). His words are recorded and distributed throughout the Midwest and even parts of the west, east and Canada. Word-of-mouth carries the tale beyond the Coalition's borders. By the early part of 105 P.A., rumors about the apparent cure is known just about everywhere in North America. Many people dismiss them as lies and misinformation, but more than one Juicer listens and, in many cases, for the first time, dares to hope.

In March of 105 P.A., official messages are radioed throughout the Coalition borderlands and through Coalition communication aircraft directed at several independent towns, cities and kingdoms along its borders. An army of Juicers was being assembled at the city of Newtown (the job of this army or its target are not revealed; Tolkeen and the Federation of Magic are the two most common speculations). Enhanced humans who agree to serve in the CS army for a term of two years will be given their room and board, a 1500 credit monthly salary, and, most importantly, the *Prometheus Treatment*, which “should” prolong their life spans by tenfold! Hundreds of thousands of people hear the proclamation and the CS offer. Rumors soon begin to run amok. The Coalition's promises are distorted. In some places, the story goes that the treatment will add a hundred years to a Juicer's life and some even claim it will make a Juicer immortal! There are actually some cases where people become Juicers so they can enjoy the immortality they'll get after receiving the Treatment! Other stories claim the whole thing is a Coalition plot. Some even suggest the CS plans to assemble Juicers in one place so they can be exterminated, but this rumor is dispelled when the CS announces that it will be adding Juicers to its own Armed Forces within the next three years (actually, thousands of CS Juicers are being secretly created already).

When the Coalition offers proof of their claims, mania erupts. They produce dozens of Juicers who were on their “Last Call” and who, through the miracle of the Prometheus Treatment, are restored to health — strong, vital and already survivors months longer than they would have been normally. UTI parades a handful of Juicers who have allegedly undergone the treatment years ago and are still around to testify to its success more than two years after they should have died. Their televised and radioed interviews are broadcast in many areas, recorded and passed around in others. Some people continue to think it's all a trick or lies. Others refuse to fight for the Coalition States even if they really could offer immortality. However, thousands are utterly convinced and arrive in Newtown in droves. The attitude of many, perhaps most Juicers, was summed up by Lloyd “The Knife” Ballard, “If they's tellin' us the truth, we win. If they's lyin' to us — they lose.”

Adventure/Scenario Ideas: *Recruiting Drive:* If any of the player characters is a Juicer, this would be the best time to start an Uprising adventure/campaign. Wild rumors are flying around,

and many Juicers are dropping everything and heading to Newtown, Arkansas. Furthermore, word has it that the CS is also hiring scouts and mercenaries, should any of the characters be interested. The player characters might want to investigate the goings on in Arkansas, whether they're Juicers or not. Even those who despise the CS might feel compelled to "check things out" to get a better idea of what these fascists might have in store for the country. Or they may go to find work among the communities who fear Coalition reprisals, like Kingsdale, Tolkeen (the most likely target of a CS military campaign) or other nonhuman communities, freedom fighting organizations and non-allied kingdoms.

Any number of adventures involving the Coalition, Juicers, spies, bandits, and others can occur on the way to Newtown. If the G.M. wants the characters to play a role in the Uprising and its aftermath, this is a great way to get them involved.

Bring me the head of Diego McDonald: Diego McDonald, the international Deadball champion, has left El Paso, breaking numerous contracts for competitions, endorsements, and other lucrative activities, and a lot of people are unhappy about it. A group of mercenaries are hired to find McDonald and bring him back, alive if at all possible, dead otherwise. In addition, a 500,000 credit bounty is offered to anybody who can bring the Juicer back alive; 75,000 if he is killed — that would not help his employers' bottom line, but it would at least give them a measure of revenge.

Diego has heard about the Prometheus Treatment and has gone off to get it. He is desperate, starting to feel the symptoms of Last Call, and will do anything to cheat fate. He is traveling with his lover, Lynda Peterson (4th level Mega-Juicer), and a small band of four fans (Juicer Wannabes, all 3rd level). They are using a modified Mountaineer ATV with extra passenger space, armor (upped to 200 M.D.C.) and a few weapon systems.

The player characters can play a variety of roles. They can be the mercenaries hired to find McDonald (their job complicated by scores of other bounty hunters looking to beat them to him). If they are, will they be swayed by the Juicer's plight when they learn of it? Will they help him get the treatment? McDonald will fight to the death; he has nothing to lose. The only bargaining chip to use against him would be Lynda. He will comply with demands in order to protect her from harm.

Alternatively, our heroes can be fellow travelers who inadvertently meet (and befriend?) McDonald and get caught in the crossfire between the mercs and bounty hunters who are out to get McDonald — dead or alive! Do the characters intervene on either side's behalf?

The Chaos Months

The Coalition announcements create a great deal of excitement and apprehension, as well as chaos and death throughout the Midwest all by itself. In many kingdoms, from Ishpeming to Los Alamo and the Pecos Empire, the same drama plays out over and over. Thousands of Juicers, hired as mercenaries for a period of 2-4 years, either ask to be given a leave of absence or desert their posts. In Northern Gun/Ishpeming, over a thousand Juicer mercenaries just up and walk away, daring their employers to stop them. Caught by surprise, the authorities let the Juicers go, and then had to take measures to prevent the remaining 6,000 to 7,000 in the army from following suit! Desertions of

10-40 continue to occur on a weekly basis. In some cases, skirmishes between augmented humans and other soldiers have broken out when they tried to stop the deserters. In other cases, joyous (and drunken) Juicers have started riots, looting and pillaging in twisted acts of celebration. By mid-105, desertions and sporadic fighting has contributed to the deaths of over 2,000 people and countless injuries and acts of vandalism! A harbinger of things to come are reports of open rebellion at some of the border towns.

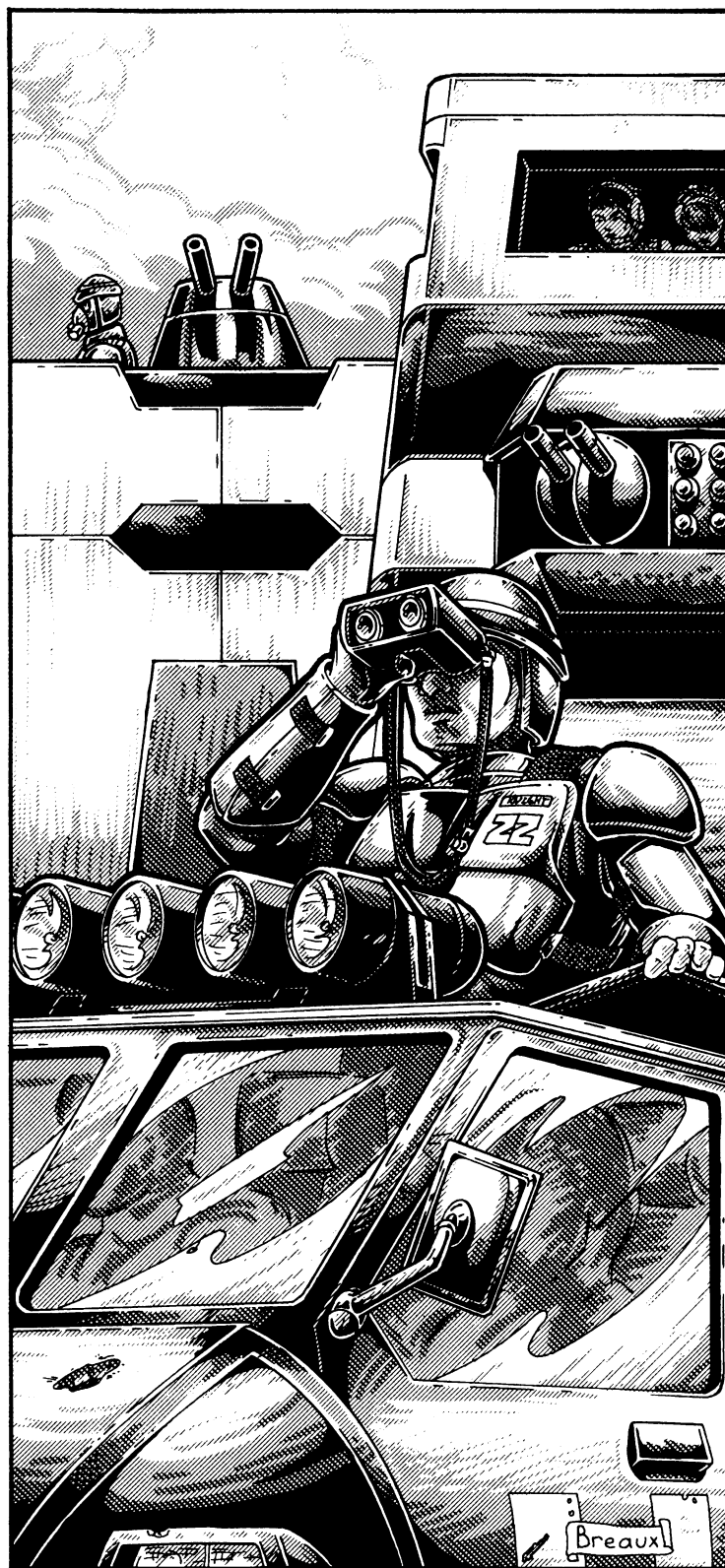

Meanwhile, the first Juicer contingents started arriving in Newtown. By the summertime, several thousand Juicers had arrived. The rulers of the city, Governor Hornsby and General Orly, agree for the first time in years, both concluding that to house the Juicers inside the city would be a tragic mistake. Instead, they establish a Juicer Camp on the outskirts of the city and start building a set of fortifications around Newtown itself. Before the arrival of the Juicers, the city did not have a defensive wall; for decades, heavy patrolling and other preventive measures had kept the community safe. Now, Orly had his engineers raise a set of temporary M.D.C. fortifications, just in case things get ugly.

Those first few months are chaotic and frantic. The tales of the cure are just being heard in the most remote corners of North America, places like the West and the far South. More and more Juicers hear the siren call promising normal years of life, and start heading toward Newtown — many of them without a good idea of where Newtown is. Hundreds of Juicers looking for the town are deceived by con-men, robbed and even killed along the way. Gangs of bandits start following Juicer bands, trying to take out any stragglers. In most cases, however, the enhanced warriors are more than able to take care of themselves, and many a bandit finds himself on the receiving end of his own brutality.

Adventure/Scenario Ideas: *Finding Newtown:* Player characters who decide to get the Prometheus Treatment or to check things out, will have to get there first. They can expect all manner of brigands and monsters to try to swindle, rob and attack them along the way.

Juicer Mutiny: The player characters are passing through the small kingdom of Farristown (or any number of places like it), a modestly successful settlement with perhaps 1,000-8,000 people living in mud huts and the occasional wooden house. The local defense force is made up of six headhunters, five Crazies, and a dozen Juicer mercenaries. When news of the treatment reaches Farristown, the Juicers walk out on their contracts. When the other mercs try to stop them, a shoot-out ensues, leaving five humans and Crazies dead, as well as four Juicers, before the deserters are able to make their escape. The town sends out messengers asking for help — not only has the community been left almost defenseless, but the deserters are burning and pillaging the countryside as they go. If the player characters agree to help, they have to find a way to stop eight Juicers (this may require a fight to the death, or could be worked out with diplomacy, or anything in between) and then have to help the town defend itself. A dragon, evil mage, a pair of demons, a group of powerful mercs or bandits may try to conquer, enslave or ravage the village and its people. Our heroes may find themselves momentarily stuck protecting these helpless folk from any manner of danger. Or the characters could train a local militia (equipped with weapons and armor taken from the dead Juicers and/or bandits), or even serve a stint as the town's defenders, but doing so might leave the characters out of the major events of the Uprising.

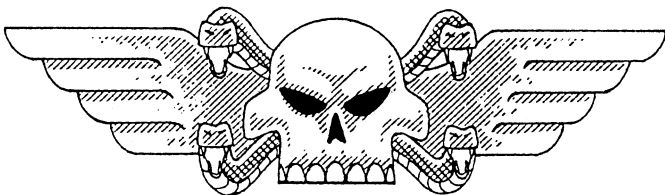

The Beginning of the End

The original Operation Phoenix Rising called for the assemblage of an army of 30,000 to 40,000 Juicers at Newtown. Both General Orly and Governor Hornesby (who feels betrayed by Ultra-Tech Incorporated and Andrew Anderson) protests this part of the plan. General Orly said that he would either need two entire divisions placed under his command, or he would not be responsible for what tens of thousands of Juicers might do to the city. The plan was then modified so that Juicers would be given the Prometheus Treatment and then sent towards New Chilli-cothe to the North in groups of 10,000, each group divided into two Juicer Divisions, under Coalition officers.

Regrettably, the Juicers arrive faster than anticipated, making the first few months total chaos. Teams of UTI scientists under Coalition escort go from the city to the Juicer Camp and establish a number of small Prometheus Treatment sites while the main Treatment Center in town is completed. Each Juicer is given a computerized card with an appointment date, coded to his fingerprints so the card cannot be stolen and used by more recent arrivals. There are occasional brawls and tension, but for the most part, the Juicers seem willing to cooperate.

Upon entering a Treatment Center, the Juicers are given an “explanation” of how the Prometheus Treatment works. They are told that the Treatment is experimental so nobody knows how long the life of a Juicer can be extended, but research suggests 20 to 40 years (all lies). The patients are told that a new chip must be inserted in their brains, a minor surgical procedure that will take an hour. After the chip is installed, the Juicers needs to take special tablets on a weekly basis (a falsehood; the tablets are harmless placebos), and that the tablets will be provided only if they continue to cooperate fully with the Coalition States’ military, whom they have committed to serve for the next two years. Most Juicers accept this in good faith and are cheerfully cooperative even in the cramped and chaotic surroundings of Newtown. Many who had been suffering the effects of Last Call and other problems come out of the operating rooms feeling better than ever. An atmosphere of joyful exuberance seems to fill the entire makeshift camp. On the first day of treatments, over 200 Juicers are given a new lease on life (or so they believe). Within the next few days, over five hundred Juicers receive “the treatment.”

Adventure/Scenario Ideas: *Arriving in Newtown:* The characters make it to the city and are treated to a strange spectacle. A beautiful settlement, surrounded by makeshift fortifications and further surrounded by a sea of tents and vehicles of every description. The first impression is that the city is (already) under siege.

For the time being, no Juicers (or any travelers) are admitted into Newtown. Ways to sneak in are possible, but risky; the Coalition soldiers have been ordered to shoot first and ask questions later. The characters have to make themselves at home on the open fields around the city, in rather unsanitary conditions, and surrounded by Juicers and mercenaries, some of whom are looking for trouble. Any Juicers in the party will get their appointment card to undergo the Prometheus Treatment. Unless the G.M. wants to condemn a character to death (or he wants a player character to become a renegade Phoenix Juicer), he should set things up so the Uprising erupts before he receives

“the treatment.” Any number of adventures and intrigue can take place while the characters wait.



The Devon Incident

The plan would have worked out perfectly, if it hadn't been for the Devon Incident. In some ways, such an incident was almost inevitable, given the impulsive and erratic behavior of the Juicers. Or perhaps the hand of Fate intervened. In any case, only a few thousand Juicers are treated before things fall apart.

The incident that precipitates the whole Uprising is one of those unforeseen events that can change history. Coalition investigators eventually piece together the chain of events, and can only find one person to blame, a young officer named Max Devon, thus the entire incident is named after him.

It all starts with a simple misunderstanding. One of the “sample” beneficiaries of the Prometheus Treatment, who has been paraded around the camp every day to prove the treatment works, is a Juicer veteran called Sam “The Dagger” Greenwood. Sam is fairly well known, having served in Ishpeming with distinction for several years, and has a well earned reputation. Furthermore, he had been converted over eight years ago by UTI and should, by rights, be already dead.

As luck would have it, another well known Juicer leader, a famous veteran named John Slaughter, had recently arrived at the camp, along with a fairly large mercenary band (90% Juicers). Slaughter had met a different Juicer who also went by the name

Sam “The Dagger.” The last names were different, but they are rarely used among mercenaries anyway. The day of the incident, Slaughter runs into the “sample” Juicer. Slaughter is introduced to Sam “The Dagger,” and when he doesn't recognize him, Slaughter starts shouting that the CS is using an impostor and trying to trick them! Ironically, the so-called impostor is the genuine article.

The incident might have blown over without a problem. In fact, another Juicer who knew both “Sams” was stepping forward to explain everything. Regrettably, the shouting match occurred at a temporary Treatment center, guarded by a Coalition platoon under the control of a young lieutenant, Max Devon. Lt. Devon was a recent transfer from Lyboc's intelligence division, and was perhaps the only CS soldier in the entire region who knew that the Prometheus Treatment was, indeed, a lie! Startled and scared by the outburst, the officer thought that the gig was up, and reacted without thinking, ordering his soldiers to fire into the crowd and kill Slaughter!

It proved to be a fatal mistake. Not only did the soldiers fail to shoot Slaughter (who nimbly somersaulted out of the way), but their laser beam volley cut down Sam “The Dagger” and the Juicer who could have explained away the misunderstanding. The startled Juicers in the camp found themselves being fired upon and instinctively fought back. A general melee broke out

around the Treatment Center and chaos rippled throughout the camp as the shooting and fighting spread to the surrounding area. Other Coalition guards tried to help by charging in with guns blazing, but this only made matters worse, as other Juicers thought they were being attacked and shot at them!

General Orly decided the only thing to do was to leave the Juicers alone to sort things out. He ordered all Coalition troops and UTI personnel to retreat behind the fortifications protecting the city. Since most Juicers did not know what was going on, they let most of the soldiers and researchers escape without incident.

The only serious casualties were taken at the site of the original fight. The Coalition platoon was wiped out with the exception of Lt. Max Devon, who was captured alive. Over a dozen Juicers were killed by stray gunfire during the fight. There were an additional dozen minor injuries on both sides. Things calmed down quickly as soon as the Coalition troops had left the camps, and Orly actually reported to his superiors that he thought this was a minor incident. Unknown to him, the damage was already done.

Under torture, Lieutenant Devon confessed everything he knew, which was plenty. He had overheard his superiors discussing the real implications of Operation Phoenix and had seen reports that the implant would only add a few years to the Juicers' life spans. Word of Devon's confession spread among the thousands of Juicers in the camp in a matter of hours. Anger and despair raged through it. Some Juicers called for a general attack on the city right then and there. Others decided it was time to pack it in and go home.

Adventure/Scenario Ideas: If the player group is in Newtown at the time, they get to witness the situation first-hand. Characters involved in the shoot-out will have to deal with trigger-happy CS soldiers. The player characters may contribute to the anarchy or play a role in defusing the situation, or they might seize the initiative and get the Uprising started even sooner!

The Robo-Doc: During the shoot-out, one of the characters (Juicer, friend of a Juicer, maybe even an innocent bystander) sees one of the UTI technicians get shot by a long burst of laser fire. The unarmored humanoid collapses — and the player character sees that beneath the human-looking flesh there is nothing but strange circuits and mechanical parts: the UTI employee is some sort of android! A few seconds later, the android explodes, leaving no trace of its body behind. Does the character tell the tale to other Juicers, or does he try to find out more about UTI?

The JAL Rises Again

Julian the First, leader of the Juicer Army of Liberation (see the *Juicer Organizations* section for more details) seizes the opportunity. Accepting Devon's confession as truth, he rallies the Juicers at the camp and works them into a frenzy against the Coalition. With the support of a grizzled veteran like Slaughter and others, he is able to convince about one-third of the Juicers to join him. A quarter are confused and undecided as to whether they should leave while the going is good or throw in with Julian the First. Another quarter believes the treatment really does exist, but that the Coalition would never admit it or give it to them. They plan to attack Newtown, take over UTI and get their answers (and perhaps the mythical cure), one way or another.

About one-tenth of the Juicers decide to go home. They leave with a lot more hatred for the Coalition, but with little desire to fight. Along the way, some will engage in a little banditry to pay for their troubles.

Hundreds of Juicers slipped out in the middle of the night. The rest, nearly 10,000 Juicers and thousands of their friends and allies, stay as they prepare to give the Coalition a nasty surprise the following day.

Adventure/Scenario Ideas: If any character is a skilled Juicer (level 6+) with a good reputation, he/she will get a chance to speak during the conclave. They may support or oppose Julian, or may propose their own plan of action. A sufficiently convincing character will have the chance to become one of the leaders of the Uprising! All kinds of rumors, speculation and plans can be made.

Julian the First Leader of the Juicer Army of Liberation

This charismatic leader is a Mega-Juicer with an axe to grind. Three years ago, he was a mercenary in a small group led by Diane "Lightning Strike" Danforth, a human mutant with electrical powers, and, incidentally, Julian's wife. Diane's band had the misfortune of running into a Coalition battalion on maneuvers. For no reason other than the fact that there were D-Bees among the band, the Coalition officer ordered an attack on the travelers. Only Julian was able to escape with his life.

The bitter Juicer took over the Juicer Army of Liberation and has used it to extract revenge on the Coalition time and time again, orchestrating a number of assassinations, acts of sabotage and raids against the CS. To Julian, the offer of the Prometheus Treatment seemed too good to be true, but he came to Newtown nonetheless, if only to see if he could throw a monkey wrench in the Coalition's plans. Now he has the chance of a lifetime: an entire army to jam down Prosek's throat! The first to fall will be Newtown.

Julian the First — Mega-Juicer

Alignment: Aberrant

M.D.C.: 143

Attributes: I.Q.: 16, M.E.: 14, M.A.: 23, P.S.: 32, P.P.: 21, P.E.: 28, P.B.: 12, Spd.: 87

Disposition: Julian's major goal in life is to pull the Coalition States down. He never dreamed he would get a chance before he died. Now that he has this opportunity, he wants to make the most of it. He knows he doesn't have long to live (some 10-13 months at best), and he wants to inflict as much damage as he can before he goes.

Despite this, Julian is not a berserker or a suicidal fanatic. He wants to win the war, not just go out with a bang. He will craft the best possible plans and will not send men to their deaths needlessly. However, he will reject any attempts to make a deal with the Coalition. He sees an opportunity to mount a noble crusade against the evil Empire. After he has razed Newtown to the ground, he will try to get Tolkeen, Kingsdale or other CS enemies to throw in with him and deal Emperor Prosek and his empire-building dreams a serious blow.

P.P.E.: 21

Level of Experience: 8th level Mega-Juicer

Natural Abilities: Supernatural strength and endurance, gets an automatic parry or dodge on all attacks, regenerates 2D6 M.D.C. every hour, virtually impervious to pain, as per the normal Juicer.

The First Battle

The next morning, when General Orly tries to reopen the Treatment Dispensation Centers, his soldiers find the Juicers waiting for them in full armor and gear. The surprised soldiers and doctors will be cut down by the dozen, and the Juicers will try to rush the fortification! Only a Spider Walker stands in their way. The robot vehicle stands in front of the main gates and its pilot will not hesitate to fire its rail guns point-blank into the advancing Juicers, killing scores of them and buying time for the CS troops to rally and close the gates ... leaving the Spider Walker outside, where it and its crew will fall into the hands of the rampaging Juicer army.

The initial battle will be disorganized, with bands of Juicers acting as they would, not bothering to obey commands from other leaders. Even so, their superhuman abilities and numbers are enough to overwhelm the Coalition troops and the city militia. After six hours of continual fighting, Newtown will hold, but stands on the verge of crumbling. Early in the fighting, General Orly does something that completely dooms him and the city. Despite Anderson's pleas to the contrary, Orly hits the Kill Signal on the Phoenix Chip! Three hundred and sixty-seven Juicers die amidst horrible convulsions, heart stoppage and worse. The Juicers soon realize that every Juicer still in the area who had submitted to the Prometheus Treatment had been killed — revealing the final treachery. Now more than ever, the Uprising is a war for revenge.

At the end of the initial battle, the Coalition had suffered 230 deaths, and the Juicers nearly 500 (mostly people killed by the Phoenix Chip). That left some 2,000+ Coalition soldiers surrounded by nearly five times their number in bloodthirsty Juicers.

Adventure/Scenario Ideas: This is an all-out fight. Rather than role-playing the entire battle, the G.M. should focus on the actions of the player characters. The party could spend the entire battle taking out a squad of Dead Boys, or squaring off against a robot vehicle. Maybe they manage to make it over the wall and into Newtown! When the assault is momentarily held at bay, they take cover and have the opportunity to do some investigating, or engage in sabotage or revenge seeking of their own. Maybe they can get more information about the Coalition States, the Prometheus Treatment, future CS plans (who was the Juicer army supposed to attack, etc.) and unravel the mystery behind UTI.

The Juicer Conclave

After the first battle, the Juicers retreat to lick their wounds and reorganize away from Newtown. They leave scouting parties to keep watch on the city and establish a defensive line just beyond the CS range of fire. The retreat is more a reaction to the shock of the CS treachery and the Juicers' realization of just how foolish they had been. Julian the First gathers the most powerful leaders among the Juicer contingent and explains "the facts of life" to them. First of all, the Juicer "army" was caught



between the city of Newtown and the Border Wall to the West and still almost took them out — they'll never survive a second assault.

Secondly, the Coalition should be sending reinforcements soon, unless they intend to write Newtown off as a lost investment (which isn't likely). Even if the Juicers try to escape by heading South, the CS will cut them off by sending troops to Fort El Dorado, a move the free city would probably accept without resistance. The only thing to do, Julian insists, is to take Newtown itself, and use it as a bargaining chip; an entire Coalition City held hostage to get concessions! Furthermore, if the tales of a cure are true, it would surely be found at Newtown. Julian does not believe there is any cure, but the wily leader is willing to use anything to convince the others to follow him and keep morale high.

The majority of the Juicer leaders decide that Julian has the guts and brains to lead them to victory, and agree to obey his orders. His plan is simple; divide the Juicer army (about 10,000 Juicers and about 2,000 mercenaries and D-Bees, all enemies of the Coalition, with more arriving every day) into three groups, each some 4,000 strong. The first group will surround the city and put it under siege, hopefully spreading its defenders and resources thin and creating openings that the assault force can charge and penetrate. Once the defensive wall is breached, the city will fall quickly. The second group will take the Border Wall and destroy the garrison there. The last army will move North and block any Coalition reinforcements coming to relieve the town; living off the land by despoiling any nearby villages and towns.

Adventure/Scenario Ideas: Another role-playing/diplomacy situation. The GM should allow charismatic or influential characters to speak and modify existing plans if they can come up with a better strategy. Or to lead a special strike force or undercover team into the city or against a strategic target. Julian will listen to a character who seems to know what he's doing, but will not be easily swayed from his own plans.

The Battle of the Wall

The second army group, led by John Slaughter, will move during the night and make it to the Border Wall during the wee hours of the morning. The CS reinforced battalion manning the wall knows the Juicers are up in arms near Newtown, and suspect an attack is imminent, so they have sent all their skelebots on perimeter patrol. The Juicers will be able to gain surprise despite these precautions, however. Small teams of sappers manage to get past the Skelebots on patrol and make it to the wall unnoticed. Once there, they set demolition charges against a large section of the wall, creating an opening. While about half of the army group uses heavy weapons against the defender's firing ports, the rest of the Juicers charge forward, overwhelming the Skelebots and heading towards the breach. At the same time, the commando teams who had blown the opening engage in savage hand to hand combat against Coalition soldiers in the tunnels inside the wall.

Even with covering fire, the Juicers running through the "kill zone" separating their hiding places from the wall will suffer horrible casualties as hundreds of them are mowed down by concentrated rail gun and laser fire, grenades and fragmentation missiles. Furthermore, the Coalition commander orders his 32

Spider Walkers and 128 combat robots (Abolishers and Enforcers) to block the advance of the Juicers should they survive the onslaught. Most of the Juicers only have light vehicles like jeeps and motorcycles. The security cameras mounted on the walls record the seemingly hopeless struggle, Juicers on foot or motorcycles charging metallic behemoths. Titan Juicers literally rip the arms and legs off the bots and mangle CS vehicles. Fast-moving Hyperions dodge gunfire and set satchel charges on the skelebots, blowing them to bits and crippling giant bot vehicles. Regular Juicers use vibro-blades, hand weapons and rocket launchers to disable or destroy the metal giants. And while some of them deal with the defensive lines, others rush on towards the

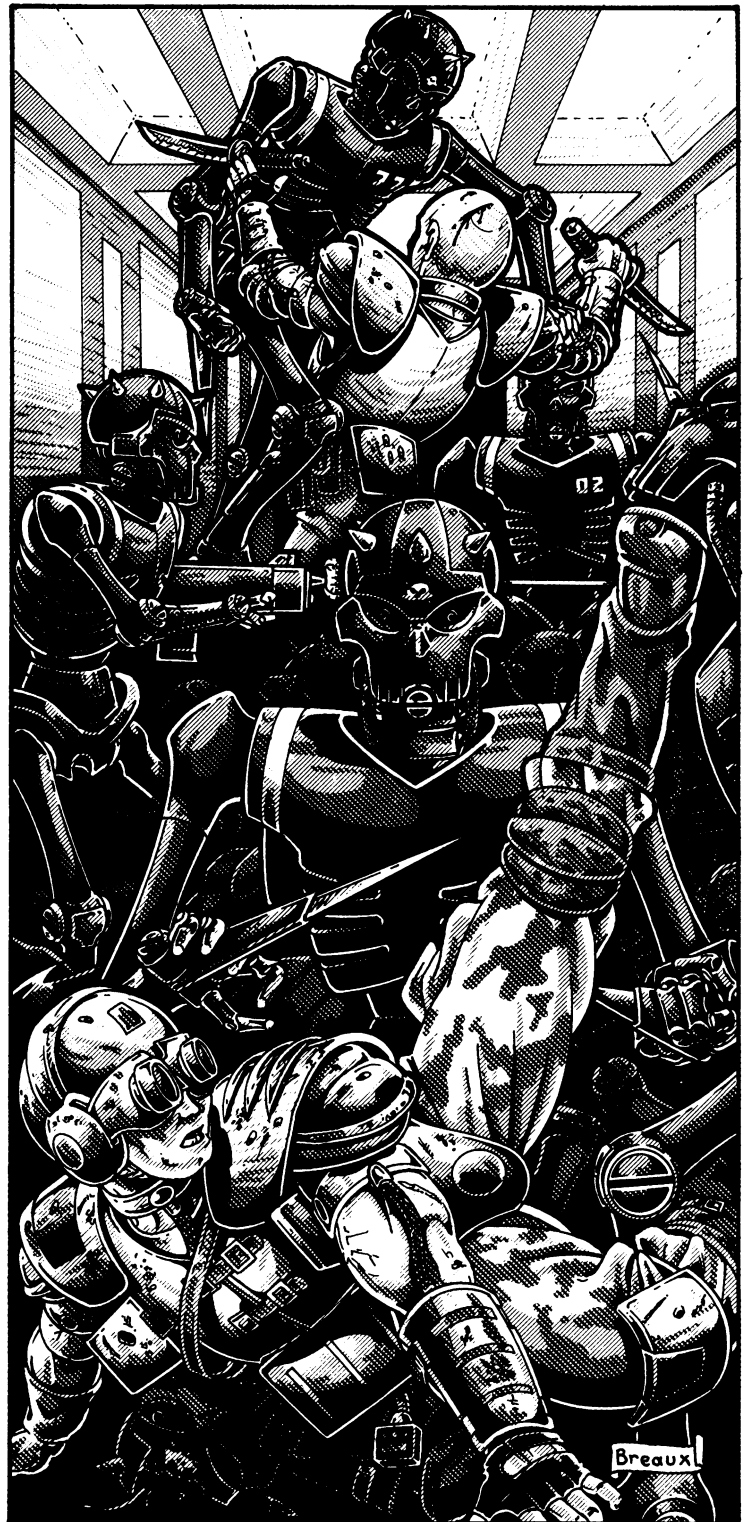

wall, close enough now that the defenders cannot fire on them without risking hitting their own robot vehicles and floundering troops.

Hundreds of Juicers reach the wall just as the decimated commando teams are about to be overwhelmed. The fight in the tunnels is close combat, the type of fighting that Juicers excel in; the advantage is theirs. Outnumbered, the humans and dog boys in the garrison fight heroically, but in vain. The commander uses Mark V APCs as “mobile fortresses” within the tunnels, firing heavy weapons into the advancing enemy. It is not enough. As the fighting inside the tunnels intensifies, the defenders can no longer fire on the Juicers outside. Once all the Coalition robot vehicles are destroyed or captured, the remaining Juicers charge the wall and open more breaches along its entire length. The surviving Coalition troopers are trapped in small pockets and methodically eradicated; no prisoners are taken.

There are no CS survivors, with the exception of a SAMAS and Jet Bike squadron that flee the area at flank speed, pursued by Juicers on hover bikes and flight packs (the squadron commander is later court-martialled for cowardice in the face of the enemy and executed; the rest of the squadron is not punished; they were following orders, after all).

Adventure/Scenario Ideas: If the player characters are involved in this siege, the best place for a party of elite warriors would be among the sapper teams who are sent out in small groups. The characters get to sneak past Skelebot guards (lots of prowl rolls), advance under the cover of darkness and battle towards the wall, blow a hole and then get into an extended fire-fight with desperate and angry Coalition troops. Do the reinforcements arrive before they are overwhelmed?

The CS Sortie

In the words of General Ross Underhill, “the events of the Juicer Uprising will go down in our military records as classic examples of incompetence and gross ineptitude.” Things looked extremely bad, at first.

Back in Newtown, General Orly falls prey to panic when he’s notified that the Border Wall has fallen. Claiming that saving his command (his army) is the most important thing, the General plans to abandon the city and break through the besieging forces. He does not consult on this move with his superiors, deciding that it would be “easier to get forgiveness than permission.”

Orly’s plans call for achieving air superiority with his “air force” of SAMAS and Sky-Cycles, and then leading the ground troops out, led by his tank company. His 200 SAMAS and 100 jet cycles attack the Juicer formations at 7:00 p.m. The Juicers react by scrambling their own hover vehicles, jet packs and the lethal Icarus Flight Systems, not to mention the occasional practitioner of magic among their allies. Outnumbered and outgunned, the Coalition flying troopers suffer over 20% casualties and fail to damage the Juicers’ heavy weapon emplacements. When Orly’s tank force tries to force a breakthrough, it is riddled with missile and grenade fire; in a matter of minutes, 13 of the 48 tanks are destroyed. Orly has to stop the attack, having achieved nothing but the destruction of much of his army.

Ironically enough, the Juicers don’t realize what Orly’s plans were; if they had known the CS commander wanted to abandon the city, they would have let him do it — after all, it is Newtown

they are after. Instead, Julian the First believes Orly was trying to do a “sortie,” a quick in-and-out attack to weaken the besiegers. Thus, in a way, Orly’s defeat worked against the rebels’ interests, as it keeps Newtown out of the Juicers’ hands a little while longer.

The First Relief Attempt

Had Orly communicated with his superiors, he would have known that help was on its way. Upon hearing of the Juicer Uprising at Newtown, the Coalition High Command ordered Norvell to use the troops slotted for the Tolkeen operation to relieve the city.

The relief force consists of three reinforced battalions (over 2,000 soldiers), an armored cavalry company (100 tanks), and one airborne regiment (three Coalition Death’s Head transports with full troop complements) and an air wing (24 jet fighters) to provide air support. In all, almost 4,000 soldiers and hundreds of vehicles leave New Chillicothe and are headed towards Newtown. Opposing them is a rag-tag force of some 3,000 Juicers and 2,000 mercenaries, outlaws, and D-Bees.

The battle would have ended in a decisive Coalition victory if it hadn’t been for the leader of the Juicer force, Captain Terror (9th level “standard” Juicer), an experienced veteran. Captain Terror has both the military training and the toughness necessary to make Juicers obey orders. Realizing that an open field battle would lead to the destruction of his forces, Captain Terror prepared a series of hit-and-run ambushes, and spent the next few days organizing a complex system of tunnels, trenches and hidden strong points as the Coalition troops in New Chillicothe gathered the supplies needed for their trip. The leader of the Juicer army made the best use of the weapons and equipment available, preparing a number of observation posts, sniper positions, and field fortifications to give his troops the best edge possible.

When the aerial scouts of the Coalition Army start probing south, they will be met by ground fire, mostly from light missile launchers. No aircraft will rise to challenge them, however. The scouts’ reports seem to indicate that a medium-sized body of infantry, estimated as less than 3,000 troops, is blocking the main paths toward Arkansas. General Norvell decided to strike and destroy this “helpless” formation before moving on towards Newtown. His plan is to place the airborne regiment behind the enemy formation, and then attack the Juicers from both sides, crushing them.

The three Death’s Head transports, protected by 18 jet fighters and 60 Sky Cycles, is sent out as the main force moves on the ground towards the Juicer formations. As the flying regiment approaches, Captain Terror orders his hidden air force to attack. 100 Icarus fliers and about as many assault hovercraft and Sky Kings take to the skies; previously kept hidden to better surprise the enemy, they do so admirably. One of the largest air battles in post-Rifts history follows. The light but agile Icarus fliers dart past the fighters and jet cycles, and head for their main target: the Death’s Head transports. Although the Coalition aircraft exact heavy casualties on the enemy, enough Juicers manage to reach the transports, destroying their flight systems and sending the heavy ships crashing to the ground. Of the 450 soldiers carried by the three transports, less than a dozen survive the fiery crashes. An additional twelve fighter jets and over twenty Sky



Cycles are destroyed or are heavily damaged through a combination of magic and daring. The Juicer pilots (many of them Phaeton Juicers) also suffer casualties; about forty aircraft are downed by the enemy. The airborne regiment has been shattered, however.

On the ground, things are not going much better for the Coalition. The troops are moving through dirt roads surrounded by heavy forests, ideal terrain for ambushes. The Juicers and their allies have placed hundreds of mines, deadfalls, barricades and other traps across the roads, and lay in wait in the woods. Coalition scouting parties, mostly made up of Dog Boys, fight lethal skirmishes with small Juicer bands. Meanwhile, Juicers and sorcerers in jeeps and motorcycles strike at the main formations and

flee before the enemy can counterattack. A common tactic consists of firing several short or medium-range missiles at the lead vehicle of a formation, disabling it and forcing the entire army to stop. Snipers let several vehicles go by and then shoot at officers and command vehicles. Whenever a Coalition platoon or squad falls behind or is isolated, dozens of Juicers come out of hiding and charge it, killing without mercy.

After two days, the Coalition force is unable to cover more than 20 miles (32 km). The Juicers have stopped the relief force dead on its tracks. General Norvell orders a withdrawal after suffering over 22% casualties in what he calls “the forest of death.” Little does he know that the Juicers forces have suffered nearly 40% casualties and could not fight successfully for more than another day.

Adventure/Scenario Ideas: Some possibilities include helping ambush a Coalition patrol. The G.M. could scale the size and composition of the CS troops to be challenging but not overwhelming; on the other hand, the player characters should realize they must use hit-and-run tactics. If they stay to slug it out with the Coalition army, they will surely be outgunned and outnumbered.

Battle In the Skies: If the player characters are pilot types, they could be part of the assault on the Coalition Death’s Head transports. They’ll get their chance to engage in dog-fights with the best the Coalition has to offer. If they succeed, they will be heroes.

Monster Munchies: The player group has just ambushed a CS patrol and they are making tracks — but the noise just awakened a huge monster, and it is hungry! The creature could be a Rhino-Buffalo (see *Rifts Sourcebook One*), a Worm of Taut (see *Conversion Book One*), or a similar large, fearsome non-intelligent monster. The characters have to deal with the monster and/or the pursuing CS force. If they play their cards right, they might turn one enemy against the other!

The Taking of Newtown

Without reinforcements, Newtown falls under the second assault just as Julian the First predicted. General Orly is captured and tortured, his troops crushed. Convinced that the CS will pay a healthy ransom, Julian manages to keep the troops he commands from looting and burning the city to the ground. Damage is relatively minor and for the moment, his men behave themselves, flush with victory and full of themselves. However, there are numerous civilian casualties and the destruction is great; just not as bad as it could be.

All ransom demands are ignored. No secret cure is uncovered at UTI. No CS troops come storming in. It’s like the calm before the storm.

The Coalition’s Reaction

The Juicer Uprising is a severe blow to the Coalition States on a psychological and publicity level. Although the casualties and physical damage are relatively small, the fact that their carefully crafted plans have exploded in their faces has made many prominent Coalition leaders furious. General Underhill is among the most outraged; he and his people had been planning a number of campaigns against Tolkeen and other “enemies” of the CS for years, and saw the entire Juicer recruitment as an un-

necessary diversion of resources. Now not only has he been proven right (although not in a way he had expected), but he has to do something about it. Joseph Prosek the Second is also furious, if only because he is implicated in such a boldfaced deception and callous act of treachery that it damages his credibility and image (he will, after all, be Emperor someday). The worst off among the Coalition leaders would appear to be Colonel Lyboc who has prudently made himself scarce during this debacle.

The Juicer Uprising is the first time in many years that a member of the Coalition States, even a minor city, was directly threatened with destruction. In the words of Emperor Prosek: "The Coalition's safety rests on the fact that its people *know* that the State will keep them safe from the chaos and violence that ravages the Earth. If the people stop knowing this truth, disaster will follow."

The military planners of the Coalition are faced with several challenges. Their intelligence reports show they are dealing with a force of 10,000 to 15,000 soldiers, at least half of whom are Juicers, and likely to grow larger by the day, as sympathizers and opportunists join their ranks. Sporadic acts of insurrection and rioting have already occurred at some border towns and the forces at Tolkeen seem to be preparing to mobilize. If the CS is not careful on how they respond to the crisis at Newtown, they could risk attacks from places like Tolkeen and the Federation of Magic or jeopardize other plans that have been in the works for a long time now — critical operations that could give them everything they want if their hand is not forced prematurely. Trying to balance the security needs of the entire nation, the planners spend several days arguing as to what force should be sent south. Emperor Prosek has reportedly said that he expects the entire matter to, "burn itself out in a few weeks. After all, nothing important is really at stake here. Is there? Not in the grand scheme of things. If they want Newtown, let them have it"

Rumors & Conspiracies

The Coalition States does its best to keep things quiet, but the Juicers' victory fills the airwaves and is spread by word of mouth, videotape and even by written messages. Soon, the "Great Deception" and the taking of Newtown is the talk of the day. It's on everybody's lips. But the Emperor is correct, the CS has lost nothing other than a minor resource in Newtown and has taken a public black eye.

Still, rumors fly faster than jet aircraft and soon the Juicers' victories are magnified a hundredfold. Characters not in the Arkansas or Missouri area may hear one or more of the following rumors:

- Newtown isn't even a real place. The entire conflict is propaganda created by the enemies of the Coalition States.
- The Prometheus Treatment really turns Juicers into undead monsters controlled by an alien intelligence.
- An army of 100,000 Juicers razed Newtown and New Chillicothe, and is even now, marching on Chi-Town.
- Emperor Prosek is leading twenty (or in some stories, forty, or a hundred) armored divisions to Arkansas to crush the rebellion.
- Every Juicer in the world is part of a mass conspiracy and is involved in the uprising! "Yer not a Juicer, are ya?"

- Not just Juicers, but 'Borgs and Crazies are in on it; all enhanced humans have decided it's time to end the reign of the "squishies." A number of 'Borgs and Crazies are buying this story and heading to Arkansas.
- A Juicer assassin has murdered Emperor Prosek and his son, Joseph. The CS is keeping this incident secret, for fear of mass revolts and civil war.
- The Juicers are being secretly supplied/helped/controlled by Atlantis, Naruni Enterprises, Tolkeen, Lazlo, the Mechanoids, the Xiticix ... insert your favorite enemy. Some stories claim all of the above at the same time!
- Larsen's Brigade (see *Rifts® Mercenaries*) is marching towards Arkansas to support/crush the revolt (pick one; both are false).
- The NGR is behind the revolt; the Germans are abandoning Europe to the Gargoyles and are planning a mass exodus to North America. The revolt is designed to soften up the Coalition for the invading German Navy.
- The armies of the demon worshippers of Tolkeen, Lazlo and the Federation of Magic will soon be joining forces with the 200,000+ Juicers and will soon be marching upon Chi-Town.

Adventure/Scenario Ideas: If the player characters are attracted to the uprising at this stage they can still get their licks in against the CS. Anybody who hates the Coalition may see this as a golden chance for some payback. Mercenaries (Juicers and otherwise) can sell their services to the highest bidders, and crusaders and heroes can travel to Arkansas to help protect the weak and defenseless from the horrors of war.

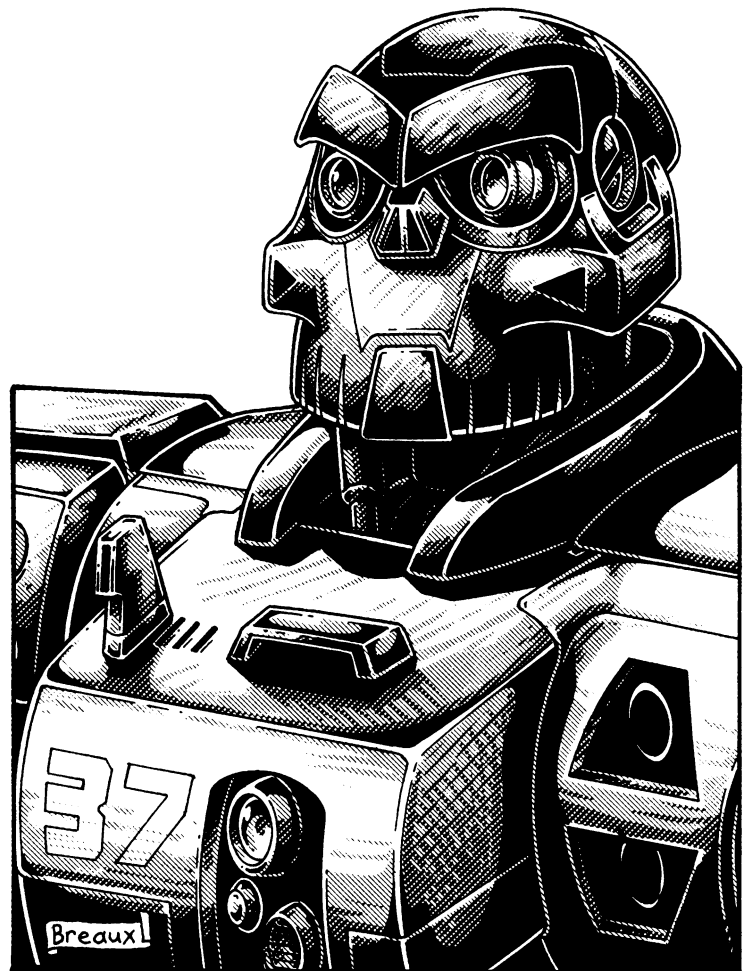

CS Note: The worst development for the CS is that the Newtown incident would seem to prove that it is not invincible; although there are other factors involved, behind the scenes, that has prevented the CS military from taking the extreme lethal action they are famous for. In fact, Joseph quips to his father that the incident at Newtown might actually work in their favor, giving the enemies of the CS “a false sense of security.” And is overheard saying, “Our enemies see the mighty giant as sleeping and vulnerable. Won’t they be surprised when he finally stirs and swats them away like the annoying bugs they are.”

Reinforcements

When the news and rumors hit the rest of the continent, thousands of Juicers decide to join the rebels. Many of these Juicers were already on their way, having abandoned their comrades and employers in hopes of finding the cure for their terminal condition. Over the following two weeks, over 5,000 additional Juicers from all parts of the country make it to Newtown, usually in small groups, but sometimes in full military squadrons, including a number of mercenary companies such as the Valkyris (see the *Juicer Organizations* section for details). Juicers are not the only ones, either. Many humans, D-Bees, ‘Borgs, Crazies, and mutants also start flocking to the Juicers’ cause. Most of them out of sheer hatred for the Coalition. To many of these adventurers and outlaws, this is a unique opportunity to, as a grizzled mercenary put it, “stick it to Prosek and his Dead Boyz once and for all!” Others are friends, relatives and loved ones who have followed the Juicers and want to help. These non-Juicers also number in the thousands (estimated at 4,000-6,000).

While the new arrivals provide a great deal more firepower and vehicles (including medium and large mercenary companies that brought in tanks, helicopters and robot vehicles), they also bring more mouths to feed, along with a number of other problems for Julian the First, and the other Juicer leaders. For one, the situation is a logistical nightmare; many, if not most of the arrivals have not bothered to bring enough food and supplies to sustain themselves for long, and lawlessness and disorder start to take its toll as boredom and confusion sets in. Without an enemy to fight the Juicer army is like a boat in dry dock — high and dry. Julian the First is a good general, but he is not prepared to run a city, especially a city of discontented Juicers, mercenaries and patriots spoiling for a war.

To deal with this problem, Julian the First organizes the newcomers into small groups and sends them off in foraging expeditions, as well as raids into the Coalition State of Missouri. However, the CS has pulled back and spoils are slim. Bored Juicers and others splinter into smaller groups that ravage the countryside. Many members of the Juicer rebels are little better than bandits, or fanatics motivated by pure hatred towards the Coalition. They sack villages, attack travelers, and ambush Coalition forces wherever they are found. A number of groups actually push deep into CS territory and engage in savage battles with Coalition forces, diverting troops from the Newtown forces and inevitably dying at the hands of the Coalition Army.

Adventure/Scenario Ideas: The player characters can be part of the roving bands, or may be travelers, heroes and crusaders who find themselves attacked by one of these groups, or who try to defend helpless villagers from such marauders. The enemies can be any combination of Juicers, from powerful Titans

and Mega-Juicers to nimble Hyperions; they may be accompanied by D-Bees, ‘Borgs, Crazies and other bandits. Coalition troops will also prowl the area, and may attack any armed group they believe is vulnerable or represents a threat to them (it might be a CS platoon or Company who tries to defend an innocent town or village).

Battle at Fort El Dorado

Not every Juicer who heard of the Newtown incident headed for that city. Many figured that Fort El Dorado, the new Mecca of Juicer conversion, might also have the Prometheus Treatment. Some 2,000 Juicers who were in or near El Dorado flocked toward that free city. At the same time, about 1,500 Juicers were already at the city, many of them young mercenaries who had just received the Juicer Process. As the first rumors started to fly, some tried to force UTI technicians to perform the Prometheus Treatment on them, or else! The local authorities tried to intervene, leading to a savage shoot-out in the streets of the city. Several hundred Juicers who had been minding their own business in the city suddenly found themselves shot at by scared city guards or private citizens. All this accomplished was to cause a riot.

The street fighting lasted several hours. King Randall radioed the nearby Coalition base (see the *Fort El Dorado* section), asking for help. The commander sent out 300 troops, and ordered the unit to march toward the city, but not to enter the city proper; the CS officer did not want to involve his force in a street battle, at least not until he received orders from his higher-ups.

Meanwhile, a few Juicers decided that a good fire would be just the thing to distract the city guards; less than an hour later, a lethal blaze ravaged through the poor sections of the city, where construction materials were highly flammable and fire-fighting equipment was almost non-existent. Under the cover of the flames and the screaming hordes of refugees fleeing the conflagration, hundreds of Juicers ran out of the city, using demolition charges to knock down large stretches of the city walls (incidentally, this quick action saved thousands of innocent people from dying in the fires or from being trampled at the narrow gates leading out of the cities).

When Juicers first came into sight of the Coalition troops outside the city, the commander of the force ordered the troops to open fire; mini-missile volleys from the force’s Mark V APCs cut into the Juicers like a scythe — and into the fleeing city people. Fortunately, the barrage did not last long, because the Juicers outnumbered the Coalition troops and forced a quick retreat.

The final tally of the battle for Fort El Dorado was catastrophic. Some four hundred Juicers, two hundred Coalition Soldiers, four hundred city guards and over a thousand innocent civilians were dead (final casualty numbers were never determined, as large sections of the city were reduced to rubble by the fires and explosions, burying many of the victims). Twice as many people suffered injuries. Fort El Dorado itself suffered billions of credits’ worth of property damage. The UTI Juicer facilities suffered heavy damage, as did many factories, warehouses and other facilities. A prosperous city had been devastated.

The Coalition survivors were routed; less than a hundred survivors (many of them wounded) returned to the CS base. The base commander was then warned by scouts that a force of at



least a thousand more Juicers was approaching the base! The commander did the only thing he thought he could accomplish. He abandoned the base and led his command to the outpost protecting the Red River natural gas plant. There, he and his troops dug in and prepared to withstand a siege, while sending desperate messages for help to Chi-Town.

Abandoned by the Coalition States, with an army of hateful Juicers already surrounding the city and another on the way, King Randall (who was privately sympathetic towards Juicers anyway) had no choice but to offer his surrender to the gathered Juicers. At first, this proved to be troublesome, because the Juicers at Fort El Dorado had no leaders; envoys could not find anybody who would claim to command the Juicers. Eventually, a five-year old Juicer called *Crush Durgan* gathered enough support to convince most of the thousand Juicers in the area to follow him. Crush talked to the envoy, and agreed to spare the city from attack, on a few conditions. Among them was to allow the Juicers to examine every UTI facility in the city to see if the Prometheus Treatment existed. Additionally, the city would have to provide food and supplies for the surrounding army, as well as a ransom of fifty million credits.

King Randall was forced to agree to all terms. The city walls had been destroyed, his defense forces were demoralized and decimated, and the Coalition was not hurrying to help. The ransom was paid (when divvied up, each Juicer got a little over 50,000 credits) and the Juicer "army" was given food, medicine and ammunition.

One event marred the victory; as soon as the order to examine the UTI Superhuman Body-Chop-Shop was made public, the building, which had been untouched by the previous night's fire, mysteriously exploded with all UTI employees inside! A search of the rubble did not reveal any recognizable bodies, and offered very little in the way of clues.

After that, the conquerors of Fort El Dorado went on their separate ways. Some decided to return to their former lives, while at least half marched towards Newtown in search of answers and revenge.

Adventure/Scenario Ideas: The player characters could be travelers staying at Fort El Dorado, minding their own business (or perhaps on their way to a different adventure) when the Juicer revolt explodes in the streets. Enemies could include angry Juicers, trigger-happy guards, terrified mobs, or the fire itself. Magicians and psychics may try to help quench the fire with their abilities, but they may trigger a violent response from the terrified citizenship, who hates and fears such powers.

Choosing Sides

As the weeks pass and Newtown remains under siege, some of the other nations of North America and beyond, start considering a course of action to take.

Tolkeen and the Federation of Magic: At this point, Tolkeen has the most to gain out of the uprising. Every soldier sent to Arkansas is no longer threatening Tolkeen's borders (al-

though the majority of the CS troops don't seem to be leaving). When they heard of the Coalition defeats, the leaders of that city-state discussed a course of action and thought about launching their own offensive, but thought better of it.

The Federation of Magic is also interested in anything that can harm their bitter enemy. They have so far contented themselves with sending small teams of scouts and spies South, to find out more and to covertly assist the uprising; some of these groups have Dragon Juicers among them.

Lazlo and New Lazlo: Both nations are not displeased by the Coalition's troubles, but regret the loss of life and property damage that warfare brings to any city. They fear this is a portent of things to come. Their hearts go out to the people of Newtown and the communities around them; the Juicers appear to be little more than bandits, and if the Coalition wins (as it is likely to do), it will exact a terrible revenge on any person or kingdom who helped the rebels.

The NGR: The New German Republic is sympathetic towards the Coalition cause, but can do little else besides offering moral support. The German government will tighten up its restrictions and laws against Juicers, and might even outlaw chemical enhancements altogether!

Atlantis: Although the Splugorth lord of Atlantis has little interest in North America, he may send a few spies there to discover what is going on.

Naruni Enterprises: Ever since UTI became a competitor, Naruni's local marketing teams have viewed the company with suspicion. According to rumors through the transdimensional pipeline, UTI is a puppet for a band of interdimensional conquerors! Naruni has dispatched its own spy teams into Arkansas to learn more.

The Pecos Empire: This bandit kingdom is biding its time. If Lone Star sends some of its troops north, it would be a golden opportunity to raid throughout Texas.

Adventure/Scenario Ideas: Player characters could be agents (willing or otherwise) of any of the above nations and organizations, or might cross paths with them.

Dangers in the Countryside

The first consequence of the uprising is an increase in lawlessness and chaos, not only in Arkansas, but in the adjacent regions. Among the new dangers encountered in the countryside are:

Bandits: Gangs of marauders, bandits and raiders roam freely through the countryside, and both the Coalition and the Juicer rebels are too busy fighting each other to do much about them (heck, rogue members from either side may *be* the marauders and bandits). Typical bandit gangs number 2D6 vagabonds, 1D6 wilderness scouts and/or 1D6 headhunters (with maybe a couple Juicers, Crazies or 'Borgs). Most are equipped with light and medium body armor, energy rifles and a few light vehicles. Well-armed bandits will have access to robots and power armor. Our heroes may come upon such a band tormenting a lone farmer and his family, attacking travelers, or even ambushing the party itself.

Coalition Juicers! As the main armies are slowly assembled in Missouri, Colonel Lyboc tries to redeem himself by sending his *Special Forces Battalion* (see the *Coalition Juicers* section) or *Special Forces Teams* out in force. These CS Juicers are on search-and-destroy missions, and will target any major leader of the uprising. At least once, Julian the First is attacked by two CS Juicers and one Psycho-Stalker, but he manages to hold the as-

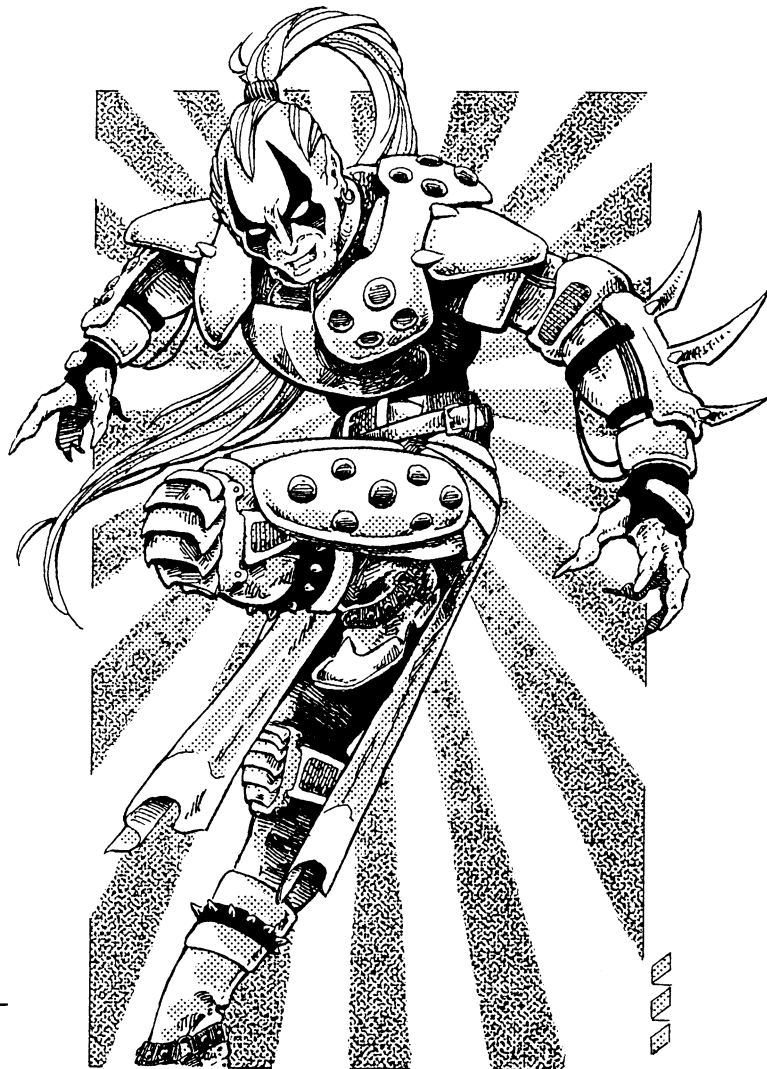

sassins off until other Juicers arrive and take care of them (the player characters could be involved in this assassination attempt, on either side of the conflict). A typical search and destroy team will have 1-2 Psycho-Stalkers, 1-4 CS Juicers and 1-4 Coalition 'Borgs. The team will usually try to attack from an ambush position. Characters who are well trained in guerrilla warfare could play a deadly game of cat and mouse with such a team.

Simvan Monster Riders: A large, nomadic gang of these cannibalistic D-Bees has been attracted by the war. Their goal is to sack villages and carry off weapons, valuables and live victims to be eaten at leisure! The player characters could be the only hope for kidnapped villagers, or might themselves be ambushed or captured.

Trouble with spies from the Federation of Magic: These guys aren't the nicest people around and can be involved in all sorts of foul deeds.

Grim Discoveries

By C.J. Carella & Kevin Siembieda

Shortly after the takeover of the Newtown, the Juicers make a disquieting discovery. Several hundred graves where they had buried their fallen comrades, have been disturbed. A few hundred Juicer corpses are missing. Somebody realizes that it appears that only the Juicers killed by the Phoenix Chip seem to be missing. Even more unsettling is the fact that it looks like the graves were dug from the inside out! Tracks leading away from the gravesites look as if many of the corpses dug themselves out and walked away, towards Newtown!

Attempts to follow the tracks fail after a few hundred yards/meters. Either the walking dead vanished or somebody covered their tracks. If a player character with a high tracking skill makes a roll at -30%, he will recognize that the tracks have been covered and might be able to follow a flimsy trail to their destination (see **the Hidden Truth**, below). The Coalition is the suspected graverobber. The theories are: they're either trying to cover up more lies by stealing the bodies (maybe there's more incriminating evidence still inside the dead bodies), or they're trying to use some kind of psychological trick to scare them — many Juicers are known to be superstitious.

In the following days, several Juicer patrols are destroyed by an unidentified enemy. In some cases, the entire patrol disappears without a trace; in others, burned and charred bodies are left behind. Nobody knows who this new enemy is, although the CS is the leading suspect.

The Hidden Truth

The terrible truth about the Prometheus Treatment is that it does indeed offer a measure of immortality — but as a Techno-Zombie controlled by an alien menace!

Unknown to both the Coalition and the Juicers, Operation Phoenix Rising was orchestrated by transdimensional aliens! The alien invaders are a disgusting insect-like race called the **Vallax**. It is the Vallax who *created* the “newcomers,” who are really advanced androids designed to look and act like humans. In fact, they are so perfect (covered in human flesh and built of organic and synthetic components and nano-machines) that a newcomer will pass most bio-scans! The Vallax are also the masterminds behind the phenomenal growth of Ultra-Tech Industries and the developers of the Phoenix Chip. Occasional sightings of these creatures gave rise to the rumors of giant insects running around UTI facilities.

Only a few dozen Vallax are trapped on Rifts Earth, the result of a dimensional space anomaly (they're not even sure where they are or how they got here). Trapped on a strange planet with no hope for escape, they decided to make the best of things. Realizing that humans would destroy them as monsters, the Vallax decided to remain in hiding and strike first. Being familiar with other humans, it was easy for them to create android fabrications

and program them to react like the natives of this world (well, mostly). This used up the last resources of their crippled spaceship which popped out of space from the other side of the universe and was dumped into a Louisiana swamp.

After a year of carefully studying the human “natives” and reconnaissance of the surrounding region, the Vallax felt confident that they could not only thrive on this world, but conquer parts of it as well. After destroying all evidence of their spaceship, they moved forward with their plan. Actually, it was standard invasion procedures for them, to quietly seize control of a suitable operations site (Newtown), undermine the indigenous population, create an army (Techno-Zombies), and expand in a circular radius from the operations center (Newtown) to the surrounding area (Fort El Dorado and neighboring towns and villages). They had already formulated plans to infiltrate the CS as well. An android look-alike of Emperor Prosek, Joseph Prosek II, and Colonel Lyboc can be found in one of the secret, subterranean chambers beneath UTI! Their most immediate problem (and delay) was to bring the primitive level of technology at Newtown/UTI to a level that would allow them to build more androids and create the Phoenix Chip (a recent accomplishment of the last year) to build their invasion force.

The Vallax standard invasion tactics are insidious. They subvert the population by turning members of it into robot-like minions or zombies through the use of microscopic nano-machines that enter the body and take control of it. Normal humans are too frail to survive the insurgent, transformation process and rebirth instigated by the nano-weapons, so the Vallax needed to focus on augmented humans. Cyborgs don't work well for a number of reasons, but Juicers were the ideal choice. They were more plentiful than Crazies and had implanted nano-machines that could be subverted and used by the Vallax already. Thus, the *Prometheus Treatment* ruse was developed. Juicers who underwent the procedure were not only implanted with the so-called *Phoenix Chip* (an ironic name the Vallax found very amusing), but also with thousands of microscopic nano-machines. The Phoenix Chip is the control center — a tiny computer brain — that directs the nano-machines to do their dirty work, as well as seizing control of the IRMSS (Internal Robot Medical Surgeon System) and using them to enslave the Juicers' bodies!

The microscopic devices immediately begin to carry out a complex program of seizing control of the mind and body of their victims. Once the process has begun, there is no turning back; only mechanical nano-viruses that could be introduced into the victim's body to hunt and destroy the others has any chance of combating the insidious and horrific nano-enslavers. However, the few civilizations who have tried such a remedy have found that 50% of the patients are permanently brain damaged to some degree and the rest don't survive the process!

At first, no apparent effects are noticeable, except that Juicers will feel somewhat more relaxed, less tense and “burned out.” This effect is particularly apparent among Juicers on their “Last Call”; many of the side effects and warning signs that their “time is up” disappear in a matter of days. Additionally, any chronic side effects the Juicer may have been suffering also disappear. This is the result of the nano-enslavers seizing control of the brain and nervous system. As the nano-enslavers take greater control, the memories of the living person, especially long-term memories, start to fade away. These Juicers start forgetting past experiences, acquaintances and other remembrances. After two months, this deterioration affects short-term memories, producing symptoms somewhat similar to Alzheimer’s Disease. The character may forget (temporarily or permanently) a friend, or not remember what he was doing a few days (or even hours) ago, etc. However, the basic intelligence and reasoning power of the victim can be kept functioning as long as desired by the Vallax. Of course, it’s only a matter of time before the Juicer realizes that something is terribly wrong with him. At any moment from that point forward, the Vallax can cue their nano-machines to take over completely; killing the human spirit and seizing complete control of the body. In this way, the Vallax can create an inexpensive army of “Techno-Zombies” from the very population they intend to conquer. A creation that is utterly obedient, with no other purpose in life than to serve its creators.

The description above is the slow, sure way of gaining complete and absolute control over one’s victim (99.6% success ratio). The Juicer Uprising has forced the Vallax to initiate a quick, “jump-start” of the process which only has a 72% success ratio — the Phoenix process is incomplete in the remaining 28%, which means the brain and personality of the victim are *NOT* under the complete control of the nano-enslavers or their alien masters. That’s what the “kill signal” really did. When the General activated it, the nano-machines went into overdrive, literally shutting the bodies down and making them appear dead while they engage in massive reconstruction (a 72 hour process).

Now that things are completely out of hand, the Vallax are using their *Techno-Zombies* to capture more Juicers to subject them to the Phoenix Chip conversion in order to build an army that might have a prayer of defending them. They can communicate with the nano-machines that now comprise the zombies’ brains via ultrasound transmissions (the Vallax also speak using ultrasonic frequencies that ordinary humans cannot hear without special mechanical augmentation or equipment, like ‘Borgs fitted with the *ultra ear*). The siege and taking of Newtown by the Juicers and the Coalition’s defensive line along the borders of their territory has effectively trapped the Vallax in Newtown with no means of escape. They realize it’s only a matter of time before they are discovered and destroyed.

Vallax/UTI Secret Complex

UTI built a network of catacombs underneath Newtown without the knowledge of the human inhabitants. These tunnels are filled with hot and steamy air because the Vallax come from a world with a higher average temperature than Earth’s. The lights are very bright, almost painfully so, another modification for the

benefit of the Vallax. There are a number of secret passages in several houses and UTI factories which open up to this tunnel system. Stumbling across one of them is highly unlikely, but characters with electrical engineer, locksmith or similar skills can, on a successful skill roll at -30%, find such a doorway if they are looking for it. Opening it will require a roll at -40%, or the use of psychic or magical abilities, or explosives. Making an opening will take a while; the doors and walls of the underground complex are made of very strong alloys with 500 M.D.C. per four foot (1.2 m section).

Characters who make it into the tunnels risk running into groups of 1D4 Vallax researchers and/or 1D6 newcomer security guards/androids (1-20% chance; roll every five to ten minutes). If they are stealthy and do not get discovered, the characters will see huge armories stocked with Vallax Force Rifles, grenades, rocket launchers and heavy weapons — enough to supply a large army. Attempts to use the weapons will fail (see the **Vallax section** for more information). They will also find a chamber full of transparent “coffins.” Several hundred of these coffins are filled with the bodies of Juicers (1D4×100) undergoing the “quick” conversion process; 2D4×10 Techno-Zombies will become activated every 24 hours. The Vallax and their newcomer servants have been kidnapping Juicers in small numbers for days now.

Adventure/Scenario Ideas: At this point, the discovery of the *real* truth behind Operation Phoenix Rising is about to be made. The player characters should have a good chance of making this discovery. The plot can be discovered in a number of ways. Each of them would be an adventure/scenario in itself. Described below are some possibilities; G.M.s can come up with alternatives that better suit their gaming group or style.

Outlined below are some possibilities:

Bug & Android Hunt: The player characters come across two Vallax invaders and four Newcomers, who are looking for an escaped renegade Techno-Zombie. The aliens will attack without warning; the Newcomers fight to the death, but if one of the Vallax is destroyed, the other will try to flee or, failing that, surrender. The alien will, if interrogated forcefully, reveal the secret of Newtown. Bringing the alien back will convince the Juicers (and eventually, the Coalition States) of what has really been going on.

Investigating UTI: There’s just something not right about these so-called “newcomers.” Our heroes can’t quite put their finger on it but these guys just seem suspicious. Other Juicers and Dog Boys feel it too. If a player character(s) was witness to the destruction of a newcomer during the Devon Incident, or heard about it, they may have additional reason (but no evidence) to suspect things are not right with these “squishies.”

Not so Friendly Fire: The player characters are on patrol or adventuring on their own (in or out of the city), when they are approached by a small group of Juicers (half as many as the player group). Other than a few looking a little spaced-out, there’s nothing out of the ordinary about them — until they attack without provocation! The attackers seem to move a “bit” slower than Juicers and don’t talk much. If the player group is captured they’ll learn **The Hidden Truth** (G.M.s, make sure they have a fair chance of escape later, to save the day). Or they

may be able to repel the attack and can 1) analyze any captives or slain (again) attackers, or 2) follow any who flee to the UTI complex and uncover **The Hidden Truth**.

Sometimes the Dead Can Talk: Our heroes are either on a scouting mission for the Juicer rebels, or are reconnoitering the Newtown area for their own reasons. In any case, they run into a **Techno-Zombie** (see below), one of the corpses that abandoned its grave! The Juicer has managed to partially overcome the mind control of the Phoenix Chip, mostly due to the fact that a laser shot damaged the chip, so the quickie conversion process is far from successful (only 60% but slowly continuing to take over the character at a rate of 2% per day). The Juicer offers to guide the characters to the place he was ordered to go to. He is in a desperate hurry; he can feel himself slipping away (long term memory is already gone). If the player characters dally too long, they will miss their opportunity.

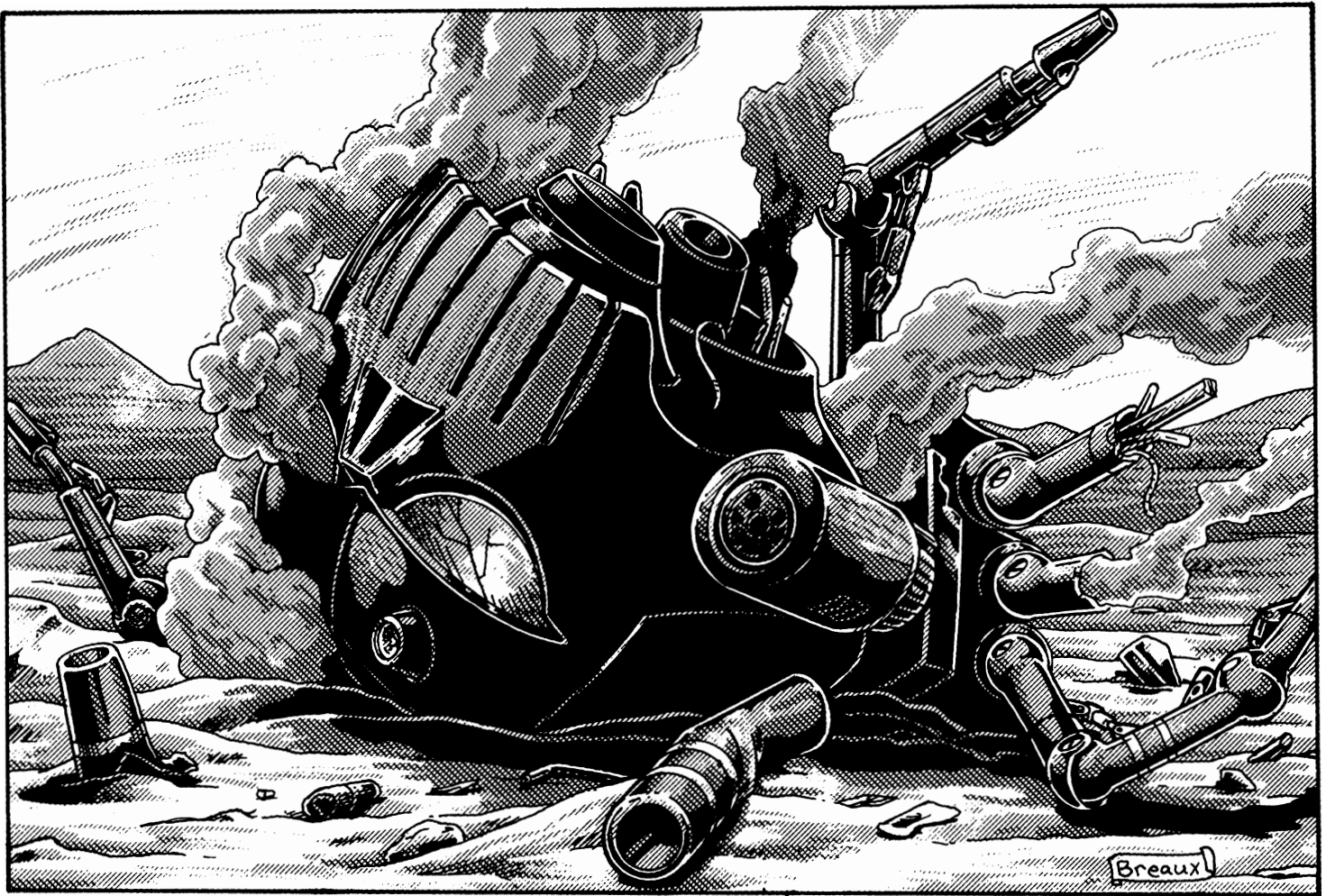

The Horrors of War

The terrible nano-devices can keep a *Techno-Zombie*, whose body does not get badly damaged, alive, though mindless, for decades! It can even simulate the stimulation and reactions of the Juicers by manipulating the brain and causing the release of natural chemicals created by the human body. Artificial stimuli

can also be continued through the bio-comp and Juicer augmentation already in place.

Even when the body is irreparably damaged and definitely dead, the nano-machines and the Phoenix chip can make “adjustments” to keep the body going as a rotting corpse! The creature that is left looks repulsive, but is still an ultra-fast and ultra-strong warrior; its body is as hard and strong as M.D.C.

plate armor (a nano-transformation on a molecular level). In short, a robot molded out of the flesh and bones of a once living human being. The Techno-Zombies and the walking corpses usually have a profound effect on the enemy, often causing psychological trauma, panic and confusion, which all works in the aliens' favor.

The Vallax had planned to create an army of 40,000+ zombie-like Juicers, equip it with highly advanced weapons, and use it in a surprise attack against the Coalition (perhaps duping CS enemies to join them in their attack against the Coalition). War prisoners would be turned into Juicers and subjected to the Prometheus Treatment to become Techno-Zombies and Phoenix Juicers, increasing the numbers of the army with every victory.

If it hadn't been for the Devon Incident, the alien creatures would have been able to move a huge army of Juicers right into the heart of Coalition territory! The uprising completely upset the aliens' plans, but even now they are trying to make the best out of their new situation.

Juicer Techno-Zombies

Most Techno-Zombies are human Juicers who have been turned into mindless living robots who obey and defend the Vallax. They are irrevocably alien monsters — the human behind the face is completely destroyed. Not the tiniest fragment of the person who once existed remains. Remember, only 28% of those who undergo the Prometheus Treatment will retain their humanity; that's only a few hundred total.

The Renegade Techno-Zombie as an Optional Player Character: A small percentage (28%) of the Techno-Zombies somehow manage to overcome the Phoenix Chip's mind control and actually retain some, but not all of their previous memories and personality. These renegades are free to pursue their own destiny. Keep in mind however, that the character's mental faculties are reduced and people who knew he had (seemingly) died, may regard him as a monster. Likewise, people who know the character has undergone even a partial alien transformation may regard the character with fear and/or suspicion. Furthermore, the Juicer may not trust himself, and may fear that he is less than human or a walking time bomb.

Alignment: Irrelevant; will follow its master's orders at any cost. **Note:** Renegades who cling to their mind and personality (failed "quickie" conversion) will have the alignment they had in life.

M.D.C.: As per body armor.

Attributes: Physical attributes are unchanged, but all mental ones are gone! The artificial intelligence in control is equivalent of an I.Q. of 8, but the zombies do not really think for themselves, they follow orders. **Note:** Those who resist the Techno-Zombie transformation will see all mental attributes reduced by half! **Horror Factor:** 11 (not applicable for those who are not zombies).

P.P.E.: None! No longer true "living" beings, but bio-mechanical constructs.

Average Life Span: The Phoenix Chip can function uninterrupted for 50 years and can keep a Techno-Zombie operating for at least that long. Also see the Phoenix Juicer (animated corpse). **Note:** Those who retain their humanity will live for 2D6 years longer than normal but will then burn-out and die.

Natural Abilities: All Juicer physical abilities with the following modifications: Reduce attacks per melee round by one, and all combat bonuses by two points. The Techno-Zombie isn't quite as fast and alert as the genuine article, but close.

Note that the alien nano-bots inside the character's body will repair injury and physical damage faster than ever; at the rate of 4D6 S.D.C. or hit points per minute (4 melee rounds)! **Note:** The increased healing applies to those who retain their humanity too.

R.C.C. Skills: Skills are frozen. **Note:** For characters who retain their humanity, skills continue to improve with level advancement, but they can never learn new skills and lose any skill bonuses.

Experience Level: Techno-Zombies are frozen at the level they were (preserved by the nano-machines — remember, the zombie is created to be a robot soldier so the limited skill range of the Juicer, focusing on combat, are all that it needs). **Note:** The character who retains his humanity progresses as a normal Juicer.

Combat: Relatively unchanged. See attributes and natural abilities.

Damage: Unchanged; same as the applicable Juicer O.C.C.

Bonuses: Relatively unchanged. See attributes and natural abilities.

Magic Powers: None.

Psionic Powers: None! Even if the character had psionic powers before, they are lost forever.

Insanities: Roll on the Random insanity table in the **Rifts® RPG** and on the *Juicer Psychosis Table* elsewhere in this book.

Alliances and Allies: None other than their Vallax masters. **Note:** Those who keep their humanity are free men, but can hear, though not understand, the Vallax ultrasonic transmissions and communications. Some fear the aliens will be able to eventually seize complete control of them, which contributes to their insanity.

Weapons: Any Juicer Weapon, or may use modified versions of the Vallax weapons and armor (the latter is not likely for renegades).

Note: There are approximately 400-500 Techno-Zombies currently available to the Vallax. Roughly 130 additional Juicers have kept their humanity and are not under the control of the Vallax.





The Phoenix Juicer

The terrible truth about the Prometheus Treatment is that it does indeed offer a measure of immortality — but as a Techno-Zombie or worse! The worst is the so-called *Phoenix Juicer*, a Techno-Zombie whose body has died, but is kept functioning as a rotting corpse!

Alignment: Irrelevant; will follow its master's orders at any cost.

M.D.C.: S.D.C Juicers take their combined S.D.C. and hit point total, halve it, and convert the remaining number to M.D.C. Juicers who are already M.D.C. beings experience no change.

Attributes: Physical attributes are unchanged, but all mental ones are gone! The artificial intelligence in control is equivalent to an I.Q. of 8, but the zombies do not really think for themselves, they follow orders.

Horror Factor: 14

P.P.E.: None! No longer true "living" beings, but bio-mechanical constructs.

Average Life Span: The Phoenix Chip and nano-machines keep the corpse-like Phoenix Juicer functioning for 50 years after its human body has died.

Natural Abilities: All Juicer physical abilities with the following modifications: Reduce attacks per melee round by one, and all combat bonuses by *three* points. The creature isn't

quite as fast and alert as the genuine article, but close. The nano-bots inside the monster's body will repair damage at the rate of 4D6 M.D.C. per every ten minutes; other healing powers and abilities are lost.

R.C.C. Skills: Skills are frozen at the moment the character became a zombie.

Experience Level: Frozen at the level they were when the Juicer became a Techno-Zombie (preserved by the nano-machines — remember, the zombie is created to be a robot soldier, so the limited skill range of the Juicer, focusing on combat, are all that it needs).

Combat: Relatively unchanged. See attributes and natural abilities.

Damage: Unchanged; same as the applicable Juicer O.C.C.

Bonuses: Relatively unchanged. See attributes and natural abilities.

Magic Powers: None.

Psionic Powers: None! Even if the character had psionic powers before, they are lost forever.

Alliances and Allies: None other than their Vallax masters.

Weapons: Any Juicer Weapon, or may use modified versions of the Vallax weapons and armor.

Note: There are only 1D4×10 Phoenix Juicers available.

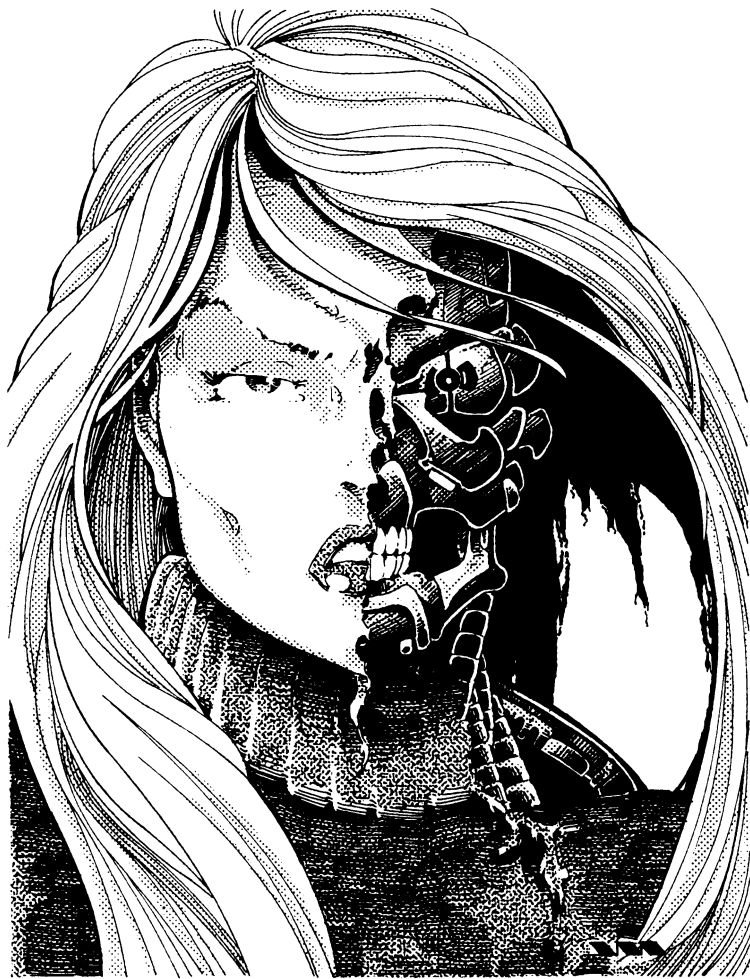

The Newcomers

Human-shaped Androids

The so-called “newcomers” of Newtown were strangers in the literal sense of the word, android servants of a transdimensional race of conquerors and slavers. These highly sophisticated androids are very expensive to produce (which is why the Vallax prefer to manufacture Techno-Zombies), and use advanced forms of artificial intelligence to simulate the thought processes of humans.

The Vallax studied humankind extensively before creating the 3,000 androids it would send into Newtown. Each model used a randomizing algorithm that actually created a complex personality, emotional make-up, and human-like characteristics. Each newcomer android behaves just like a human, except when it comes to serving the interests of the Vallax, which takes precedence over anything, including the androids’ self-preservation.

The androids have an outer layer of synthetic protein that simulates muscle, and living artificial skin and hair, which will fool almost every form of detection. Inflicting more than 30 S.D.C. points of damage will rip off parts of that sheathing, revealing the mechanical body underneath. The synthetic mind has

built-in psionic spoofers that will create an electromagnetic emanation that will fake-out those who can read minds or see auras to assume that the newcomer is using mind block or has a natural resistance to psionic probes. This is the only apparent clue that indicates newcomers may not be completely human.

The newcomers came in a multitude of shapes, from adult males and females to children and infants. Each is equally intelligent and ruthless, and will do everything in their power to carry out the commands of their masters.

Newcomer Androids

Note: NPC villains only.

Alignment: Aberrant; will serve their Vallax masters at any cost.

M.D.C. by Location: (Child models use the stats in parentheses):

Head — 40 (20)

Limbs — 35 each (15 each)

Main Body — 150 (75)

Flesh Sheath — 30 S.D.C. (same)

The android can function at full efficiency until the main body is destroyed. Destroying the head reduces but does not eliminate all its sensors (loses one attack per melee, and reduce all combat bonuses by 2 points).

Attributes: All attributes are the same, except for “children” models (use lower stats in parentheses). I.Q. 20, M.E. 18, M.A. 18, P.S. 30 (20), P.P. 21 (16), P.E. n/a, P.B. 5-20, Spd. 40 (20)

Horror Factor: None unless their true nature is revealed. At that point, H.F. is 8, or 10 for the children-shaped androids; its far more terrifying to see a child acting like an inhuman monster.

Average Life Span: Their energy capacitors provide power for 300 continuous years before requiring replacement.

Natural Abilities: Immune to pain, shock, disease, poison, psionic bio-manipulation and mental attacks; continue fighting until completely destroyed (reduced to zero M.D.C.).

R.C.C. Skills: Select five skills at +20%; five skills at +10%, and 10 skills at +5%. They do not benefit from any physical skill bonuses, but can “know” them.

Experience Level: 1D4+4; this “level” reflects the complexity of their programming.

Combat: Hand to Hand: Expert (security models) or Basic (all others).

Damage: As per Robot Strength (see *Rifts® Ultimate Edition*).

Bonuses (does not include attribute bonuses): +1 on initiative, +1 to Perception Rolls, +1 to strike, parry and dodge, immune to Horror Factor, most mental attacks and Bio-Manipulation.

Magic Powers: None. **P.P.E.:** Zero.

Psionic Powers: None.

Vulnerabilities/Penalties: None. Affected by all Mega-Damage weapons and most types of magic.

Alliances and Allies: The newcomers are machine slaves of the Vallax race, they serve no other.

Weapons and Armor: Androids masquerading as civilians often carry no weapons nor wear body armor (this is the vast majority; 95%). UTI security guards are equipped with Bushman Body Armor (M.D.C. 60), a Wilk’s 447 Laser Rifle and

a Wilk's 320 Laser Pistol. Guards (about 100) in the underground complex wear body armor, a personal force field (150 M.D.C.), and use a Vallax Force Rifle.

Note: There are a total of 4000 androids in Newtown; 500 can be found in the secret subterranean complex. Without the Vallax to lead them, the androids all self destruct (as will the UTI complex and all underground facilities. All traces of alien technology will be lost).



The Vallax R.C.C.

The Vallax are insect-like aliens from another part of the universe. The disgusting creatures have four legs, a long thorax, two arms equipped with two additional "armlets" that protrude from their forearms, and four thin vestigial limbs that may have been used to climb, but which no longer have any use. Two very large eyes are located toward the tip of the head, with two long, chain-like antennae located near the back. The creatures never wear armor or clothing of any kind; their tough carapaces allow them to withstand severe temperature extremes and injury that would kill a human. The creatures communicate via chemical secretions and ultra-sonic frequencies that humans (and even Dog Boys) can't hear. The chemicals produce a variety of smells, many of which are quite revolting to humans, who can sometimes smell a Vallax as far as 200 feet (61.0 m) away (triple for Dog Boys)!

The aliens on Rifts Earth are the survivors of a dimensional anomaly that sent their spacecraft crashing into a swamp. Aggressive conquerors, Vallax have been using androids created in the shape of the dominant indigenous life form as spies and infiltrators for centuries. Researchers developed the Techno-Zombie 250 years ago and have used it with terrifying efficiency. Consequently, their infiltration of Newtown and plans for conquest are standard operating procedure.

Alignment: Anarchist or evil only.

M.D.C.: By Force Field only.

S.D.C./Hit Points: Carapace adds 3D4×10 S.D.C. in addition to that gained by Physical skills. Hit Points: P.E. plus 1D6 per level of experience.

Attributes: I.Q. 3D6+6, M.E. 3D6, M.A. 3D6, P.S. 2D6, P.P. 3D4, P.E. 3D4, P.B. 1D6, Spd. 3D4.

Horror Factor: 10

P.P.E.: 3D6

Average Life Span: Thanks to their advanced technology, Vallax can live for 1,500 years. Apparently, however, the same anti-aging processes have reduced their fertility to the point that less than one in a hundred ever manages to procreate.

Natural Abilities: Communicate via chemical emanations (smells); can use a chemical "shout" that will nauseate humans not equipped with nose filters or gas mask (save versus non-lethal poison or racked by nausea: lose initiative, and halve bonuses and melee attacks); resistant to heat and cold extremes, up to 150 degrees Fahrenheit or -20 degrees Fahrenheit without ill effect.

R.C.C. Skills: Can select 10 skills from any category at +15% and 15 at +10%; the Vallax have the most extensive educational libraries in the Megaverse. Plus select 8 Secondary Skills.

Experience Level: Average 1D4+5

Combat: As per Hand to Hand skills.

Damage: Bite does 2D4 S.D.C. Claw strike does 1D6 S.D.C.

Bonuses: +2 save vs magic, +1 to save vs Horror Factor, +1 to Perception Rolls.

Magic Powers: None; Vallax understand some principles of magic, but never practice it, preferring to rely on their advanced technology.

Psionic Powers: Only 10% have psionic abilities (and then only minor psionics).

Vulnerabilities/Penalties: None.

Alliances and Allies: None on Rifts Earth; rely on android slaves or Techno-Zombies.

Note: There are only 12 Vallax aliens; eight are in the complex, four others are elsewhere in Newtown.

Vallax Weapons & Equipment

The Vallax technology is among the highest in the Megaverse; their weapons and equipment are incredibly sophisticated, centuries ahead of anything produced on Earth (or even such technological enclaves as Phase World). Fortunately, the aliens trapped on Earth had very limited resources available to them. Even what little alien technology that has been salvaged or recreated at the UTI complex and secret underground facility, will

be lost to the player characters and the people of Rifts Earth. As a precautionary measure, Vallax weapons and equipment have built in "safeties" that bio-scan anybody holding them; only Vallax, Newcomers, Techno-Zombies (under the control of the nano-enslavers) and Phoenix Juicers can use them. If an unrecognized user tries to operate the device, all systems shut down. If the unrecognized user tries to take the item apart, it self-destructs. Furthermore, the entire Vallax complex and all weapons and equipment have self-destruct mechanisms that will detonate and destroy absolutely all traces of the alien technology — this includes the Phoenix Chip and nano-enslavers (killing the beings who have them inside them)! The Vallax are very thorough.

Vallax Force Field

This defensive force field protects the wearer with 150 M.D.C., and regenerates damage at the rate of 2D6 M.D.C. per melee round. The field is generated by a small ring or bracelet that can be adjusted to fit over almost every wrist size; its charge lasts for 20 hours of continuous use.

Vallax Force Pistol

The Vallax weapons use a "variable energy" beam that can be modulated to produce almost any form of energy. The gun has a micro-computer that will analyze the effect of the first blast and will adjust the beam accordingly! After the first shot, the beam will affect targets protected by the invulnerable to energy spells, vampires, intangible entities, and even cosmo-knights!

Weight: 3 lbs. (1.35 kg).

Mega-Damage: 5D6 M.D. per shot; single shots only.

Rate of Fire: Single shot.

Effective Range: 1000 feet (305 m)

Payload: 30 shots.

Cost: Not available. Even the Splugorth have never heard of the Vallax.

Vallax Force Rifle

A larger version of the Force Pistol, with more power and range.

Weight: 5 lbs. (2.25 kg)

Mega-Damage: 1D6×10 M.D. per shot. Single shots only.

Rate of Fire: Single shot.

Effective Range: 2000 feet (610 m)

Payload: 40 shots.

Cost: Not available.

Truth & Consequences

If the Player Characters manage to infiltrate the facility, or capture a live Vallax alien, or somehow manage to uncover the entire alien plot, a number of things will/can happen. Again, it is up to the G.M. exactly how things unfold; follow the player characters' lead to determine how things turn out in the end. The player characters cannot possibly stop the Vallax themselves, but they have an entire army at their disposal.

The Juicers: The Juicers will not take kindly to learning that they have been played the fool by aliens from another world.

They will leave no stone unturned until they are certain that every single alien, newcomer/android, and Techno-Zombie is destroyed (a certainty if the UTI complex blows up). In the process, Newtown will be decimated and hundreds of innocent humans will be killed in the mad frenzy that will be part of this "purge."

Julian the First will lead the way. When his work is done, he will find that he still has some 6000+1D6×1000 Juicers and mercenaries looking to him for guidance. These forces are likely to decide to offer their services to Tolkeen (or other CS enemy) in their campaign against the Coalition. Julian and many of his men will never forget or forgive the Coalition States' attempt to use them with their lies (but mainly for giving so many hope and then taking it away). In his eyes, the CS is no better than the alien "bugs" they have destroyed. The others will resume their lives the best they can. In the end, an estimated 3000 Juicers will have perished as a result of the Prometheus Treatment and Juicer Uprising. Thousands of followers and innocent people will also perish.

Note: One way or another, the Juicers will find out about the Vallax and destroy them.

Newtown: Newtown is decimated. Hundreds will be slain, thousands injured, their industry (UTI) destroyed, and they will be forever branded as the pawns of ruthless alien invaders. The Juicers abandon the city, without ever getting a ransom.

The Coalition: Colonel Lyboc, through one of his Juicer spies in Newtown, is the first person in the Coalition States to learn of the involvement of the aliens. He uses this information to help the CS erase much of the tarnish to their image as a result of the Prometheus Treatment and Juicer Uprising debacles.

The CS formally announces that they were the victims of conniving, bloodthirsty and ruthless alien invaders. They place the blame entirely on the "dupes and traitors" at Newtown, who had unwittingly harbored and supported alien monsters for years. They are quick to point out that it was the Newtown aliens who had deceived the CS with their "human pawns" that the Prometheus Treatment was real. They insist they "honestly believed" the Prometheus Treatment was "a cure" for Juicers. Joseph Prosek the Second, actually apologizes to the Juicers who fell victim to this "insidious alien plot" and as proof of his sincerity, the CS gives all Juicers involved in the Newtown Uprising amnesty for any and all crimes "provoked by the aliens' deception." They are free to leave and return to their homes. The CS goes as far as to call the Juicers of the Uprising, "heroes who have saved us from yet another inhuman menace." As a result, the CS will keep its plans to add Juicers to its Armed Forces, and then turn the entire incident into a rousing campaign for the destruction of nonhumans, and the danger represented by such places as Tolkeen, Kingsdale and Lazlo who refuse to recognize the threat these "monsters" (all nonhumans) represent.

Furthermore, Colonel Lyboc is publicly proclaimed a hero and reveal how he was suspicious about Newtown and had sent "special agents" to investigate Ultra-Tech Industries. According to CS propaganda, Lyboc's spies had uncovered the alien plot and the CS was about to take action when the Juicers uncovered



it as well and took matters into their own hands. Privately, Colonel Lyboc is considered a fool and can forget about a promotion for the rest of his career. Most consider helping the CS to get out of the situation that “he” created was the least he could do.

For its own protection and the safety of all people, the CS has placed Newtown under military law — indefinitely. Over the next few years, Newtown will be turned into a major CS base with a small industrial city-complex to help fuel the Coalition War Machine.

The Player Characters: The adventurers have been on a roller-coaster ride as one thing after another changed at rapid pace. What seemed to be a new age for Juicers turned into betrayal by the Coalition States, sparking a riot that turns into a full-blown insurrection. After fighting Newtown’s defenders and Coalition troops, the enemy changes to alien invaders. If the CS can be believed (they live up to the promise of amnesty — there are no reprisals) the aliens were the bad guys the entire time!

In the end, our heroes probably have nothing to show for their troubles, except for having been part of a historic battle. A battle that ironically became a small war against monstrous invaders out to subjugate humankind. Amazing! But such is life on Rifts Earth.

Experience Tables

“Standard” Juicer & Gladiator Juicer

1	0,000-2,140
2	2,141-4,280
3	4,281-8,400
4	8,401-17,200
5	17,201-25,400
6	25,401-35,800
7	35,801-51,000
8	51,001-71,200
9	71,201-96,400
10	96,401-131,600
11	131,601-181,800
12	181,801-232,000
13	232,001-282,200
14	282,201-342,400
15	342,401-402,600

Juicer Scout

1	0,000-2,180
2	2,181-4,380
3	4,381-8,500
4	8,501-18,200
5	18,201-26,400
6	26,401-36,800
7	36,801-52,000
8	52,001-72,200
9	72,201-97,400
10	97,401-132,600
11	132,601-183,800
12	183,801-234,000
13	234,001-284,200
14	284,201-344,400
15	344,401-404,600

Titan Juicer, Hyperion Juicer, Delphi Juicer, Phaeton Juicer

1	0,000-2,250
2	2,251-4,500
3	4,501-9,000
4	9,001-18,000
5	18,001-26,500
6	26,501-36,000
7	36,001-52,000
8	52,001-75,000
9	75,001-100,000
10	100,001-140,000
11	140,001-200,000
12	200,001-260,000
13	260,001-320,000
14	320,001-400,000
15	400,001-500,000

Psycho-Stalker, Juicer Assassin, Coalition Juicer

1	0,000-2,200
2	2,201-4,400
3	4,401-8,900
4	8,901-17,000
5	17,001-25,000
6	25,001-35,000
7	35,001-51,000
8	51,001-75,000
9	75,001-100,000
10	100,001-150,000
11	150,001-200,000
12	200,001-250,000
13	250,001-325,000
14	325,001-400,000
15	400,001-500,000

Mega-Juicer, Maxi-Killer

1	0,000-2,600
2	2,601-5,000
3	5,001-10,000
4	10,001-20,000
5	20,001-30,000
6	30,001-49,000
7	49,001-62,000
8	62,001-80,000
9	80,001-110,000
10	110,001-150,000
11	150,001-200,000
12	200,001-250,000
13	250,001-310,000
14	310,001-370,000
15	370,001-520,000

Dragon Juicer,

1	0,000-3,000
2	3,001-5,000
3	5,001-10,000
4	10,001-20,000
5	20,001-30,000
6	30,001-50,000
7	50,001-80,000
8	80,001-120,000
9	120,001-170,000
10	170,001-250,000
11	250,001-325,000
12	325,001-400,000
13	400,001-525,000
14	525,001-650,000
15	650,001-900,000

Vallax (alien), Newcomer Android

1	0,000-2,400
2	2,401-4,600
3	4,601-9,200
4	9,201-18,400
5	18,401-28,300
6	28,301-48,000
7	48,001-78,000
8	78,001-110,000
9	110,001-150,000
10	150,001-200,000
11	200,001-250,000
12	250,001-310,000
13	310,001-380,000
14	380,001-470,000
15	470,001-600,000

Juicer Wannabe, and Gambler

1	0,000-1,875
2	1,876-3,750
3	3,751-7,250
4	7,251-14,100
5	14,100-21,200
6	21,201-31,200
7	31,201-41,200
8	41,201-51,200
9	51,201-71,200
10	71,201-101,500
11	101,501-136,500
12	136,501-186,500
13	186,001-236,500
14	236,501-286,500
15	286,001-326,500

Techno-Zombie: NPC Villain

Murder Wraith: NPC Villain

Newtown

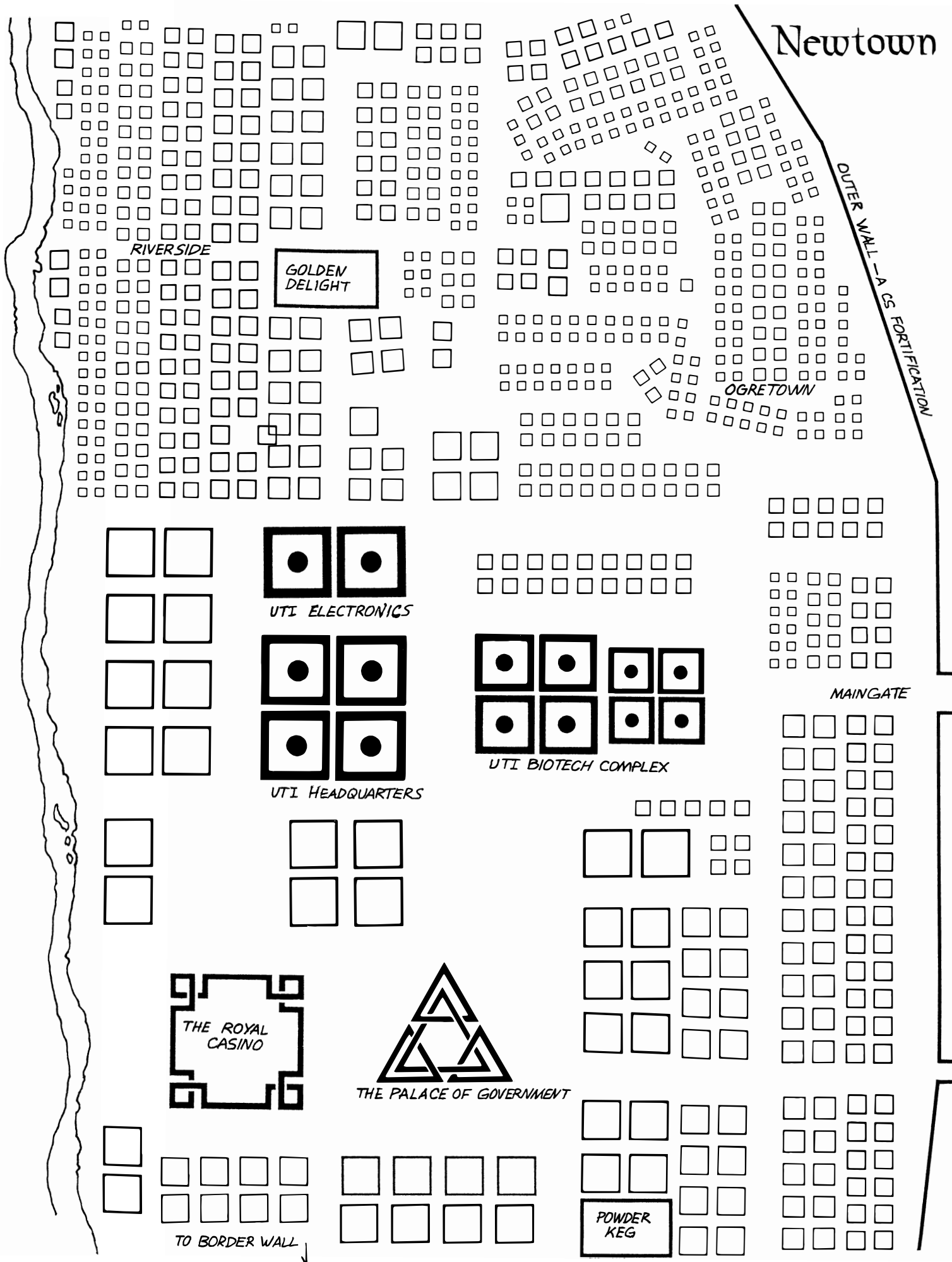

LARAMY 1

KINGSDALE RIVER

THE MONOLITH

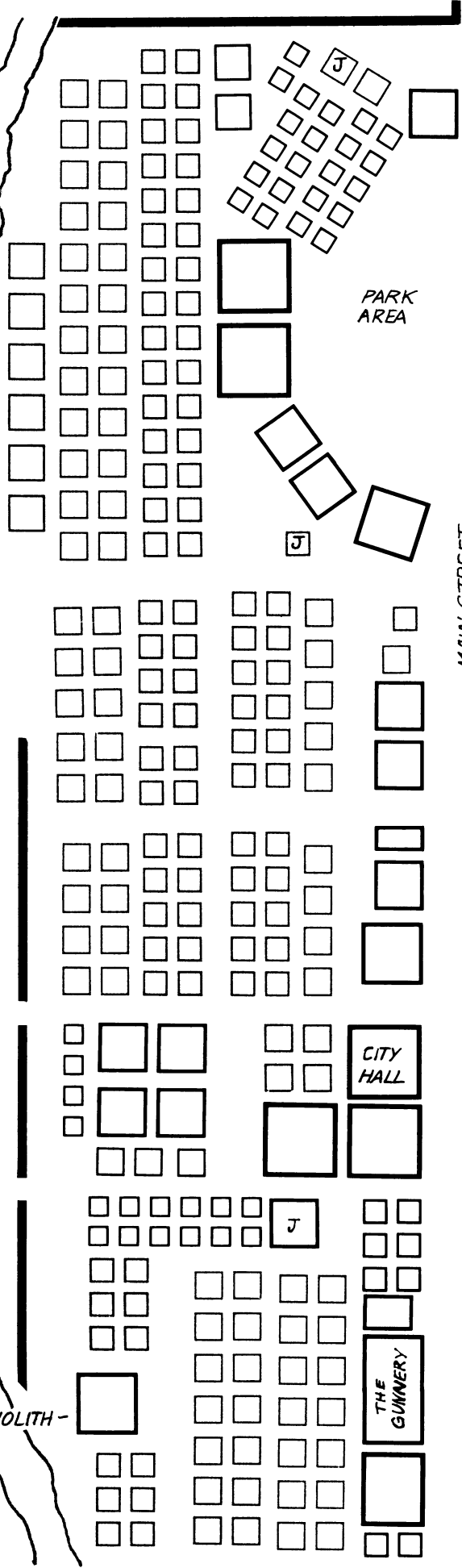

Kingsdale

"J" INDICATES A JUICER BAR.

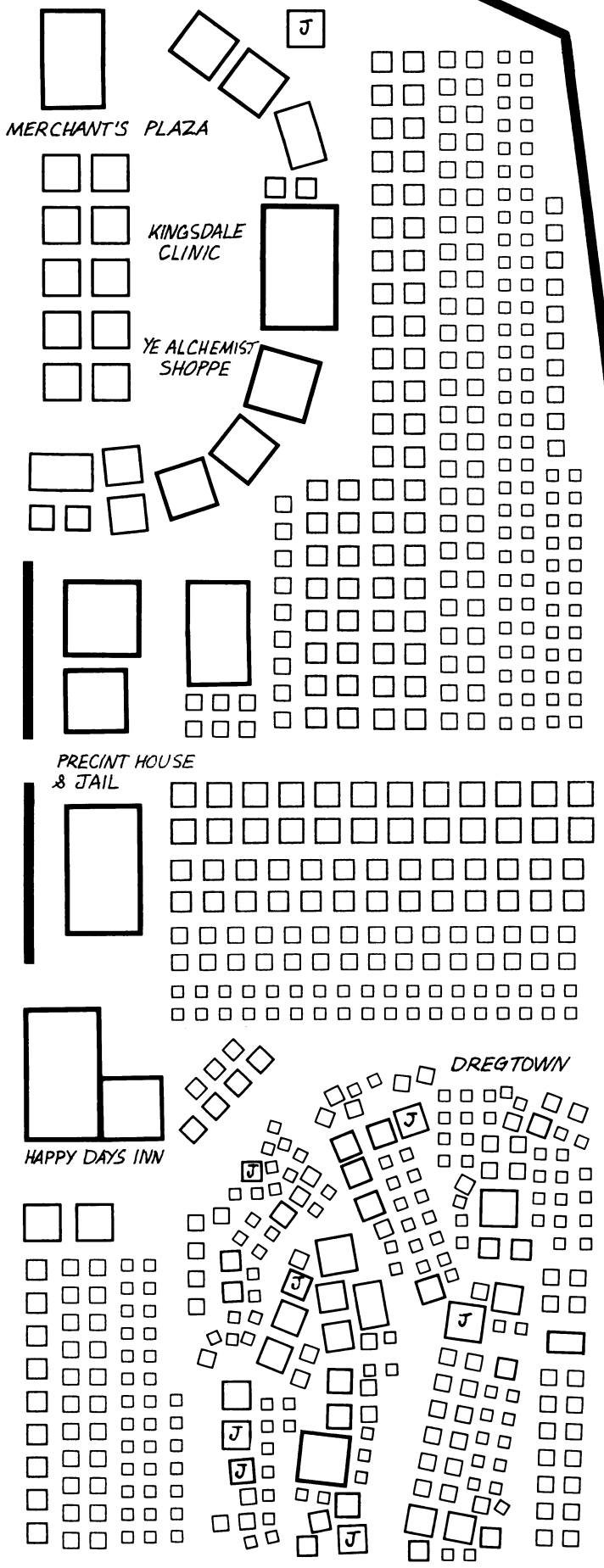

The Rifter® Subscription

The Rifter® is your doorway to unlimited imagination and numerous Palladium role-playing worlds. It offers new heroes, powers, weapons, magic and adventure for your games. It presents new villains, monsters and dangers to battle, and new ideas to consider.

It helps you unlock your imagination by showing you what gamers, just like *you*, have created. That's right, many of the articles and source material are written by ordinary gamers and fans like *you*. Other articles are by freelance writers and staff.

The Rifter® is made for *you*, our fans. Each issue presents unofficial (and sometimes official) source material, adventures, characters, monsters, villains, powers, weapons, equipment, ideas and fiction for **Rifts**®, **Chaos Earth**™, **Splicers**®, **Beyond the Supernatural**™, **Heroes Unlimited**™, **Ninjas & Superspies**™, **Palladium Fantasy RPG**®, **Nightbane**®, and/or any variety of other Palladium games and world settings. It's also a place where we test new ideas, and showcase new games, like *Dead Reign* and the upcoming *Mechanoids*® *Space*.

It is also a way to get the latest news, coming attractions, and sneak previews of upcoming Palladium products, events and secret projects.

Sourcebook

As a **sourcebook**, each issue of **The Rifter**® presents optional and/or official source material for a variety of Palladium's role-playing settings – **Rifts**®, **Phase World**®, **Palladium Fantasy RPG**®, **Heroes Unlimited**™, **Nightbane**®, **Beyond the Supernatural**™, and other titles such as **After the Bomb**®, **Ninjas & Superspies**™, **Rifts**® **Chaos Earth**™, **Splicers**®, and others. Every issue includes material for 3-6 different Palladium RPG lines.

Magazine

As a **magazine**, each issue includes the latest news and goings on at Palladium Books, information on new product, our schedule of releases, convention appearances, special offers, and even sneak previews and extra “official” material for new Palladium games or sourcebooks.

Talent Show

The Rifter is unlike anything on the market because it is a way for *you*, the fan, the unpublished writer and hopeful young artist to get published and break into the industry.

No other game company does that, so take advantage of the opportunity to see *your* work and *your* name in print! You'll get a small payment (about \$10 per printed page of text), four free copies of the issue your work appears in, and bragging rights to all your friends. Best of all, you get to share your ideas with thousands of other Palladium gamers.

Think it can't happen to you? Think again. Many of Palladium's artists and writers got started in **The Rifter**®, including *Apollo Okamura*, *Brian Manning*, *Mike Mumah*, *Carl Gleba*, *Todd Yoho*, *Brandon Aten*, *Taylor White*, *Jason Richards*, and *many others*.

Palladium is always looking for written material for **Rifts**®, **Chaos Earth**™, **Beyond the Supernatural**™, **Nightbane**®, **Palladium Fantasy RPG**®, **Heroes Unlimited**™, **Ninjas & Superspies**™, **After the Bomb**®, and all our game lines. We'd also like to see cartoons and comic strips.

Send your “article/source material” (5-30 pages) or art samples (photocopies, never original art), to *The Rifter*® *Submissions Dept*, 39074 Webb Court, Westland, MI 48185.

Subscribe Today

Lock in the current price and discount

The price of **The Rifter**® is \$13.95 retail (a steal for 96 pages of RPG source material and adventures), but a subscription saves you even more money, and you have the convenience of delivery right to your door. All prices are in U.S. dollars.

- **\$39.80 – that's only \$9.95 each**, a savings of \$16, and Palladium picks up the shipping cost. **Note:** This rate is *limited* to subscribers in the USA only.
- **\$61.80 – Canada.** Our apologies, but Palladium Books can no longer cover the increased cost of postage to other countries. We hope you understand.
- **\$75.80 – Overseas:** Overseas subscriptions *are* charged an additional fee for overseas shipping costs. Sorry. We are only passing along the additional postage costs, but it is hefty. Our apologies.
- **Free Shipping anywhere in the USA.**
- **Great Savings.**
- **A Megaverse® of adventure and fun.**
- **How to order.** *Send mail orders* with a check or money order (for \$39.80 in the USA) to:

The Rifter® **Subscription Dept.**
39074 Webb Court
Westland, MI 48185

Credit Card Orders: Can be made on our web site (www.palladiumbooks.com) or by telephone 734-271-2903 (this is an order line *only*).

Check or Money Orders: Send them to the address above with a note indicating which issue number you want your subscription to start.

Please indicate what issue number you'd like your subscription to start (i.e., last issue, current issue, next issue, or when your current subscription ends).

This offer is good till December 31, 2016.

© Copyright 2012 Palladium Books Inc.

www.palladiumbooks.com

Explore the Palladium Megaverse®

The Palladium “Fantasy” Role-Playing Game®

A world of epic fantasy, incredible magic and amazing beings including the shape-changing Changeling, ferocious Wolfen, monstrous Melech, dragons, giants, trolls, dragons and creatures that defy description. Players can create scores of human and inhuman characters.

Combat is fast and fun.

Magic is different! There is spell casting wizardry, the wards of the Diabolist, the circles of the Summoner, and the powers of Druidism. Plus the mind-powers of the Mind Mage, elemental magic, the enchantments of the Alchemists, the blessings of the priest, the dark magic of the witch and magic items and creatures galore.

Sourcebooks define the world, offer new types of player characters, different player races and monsters, adventures and/or adventure ideas. This line is currently Palladium's second best seller (behind *Rifts*® and just edging out *Heroes Unlimited*™). • \$26.95 — 336 pages.

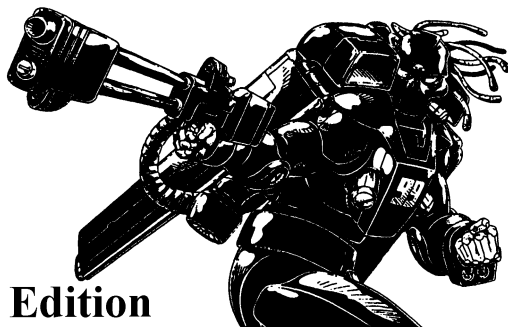

Rifts® Ultimate Edition

Dimensional *Rifts* are tears in the very fabric of space and time. Portals to other worlds. Doorways that allow the incredible, monstrous and magical to invade our world. Reshaping it into an alien landscape that is both frightening and wondrous, alien and yet strangely familiar.

Super-science, bionics, power armor and robots collide with the forces of magic, Techno-Wizardry, dragons and demons from the Rifts. Human-kind struggles on the brink of extinction, and the possibilities are endless.

Discover a world where anything is possible and you are limited only by your imagination. • \$39.95 – 376 page hardcover RPG.



Heroes Unlimited™ RPG, 2nd Ed.

Create any type of superhuman hero you can imagine.

Aliens, mutants, robots, cyborgs, super-soldiers, psychics, super-sleuths, martial arts masters, gun-toting vigilantes, super-geniuses, masters of magic, demigods, Mega-Heroes and more!

Over 100 super abilities, plus scores of sub-powers and 40+ psionic powers. Over 100 magic spells, plus enchanted weapons and objects.

Everything one needs to play other than dice and friends are in this complete role-playing game. Cover by Jim Steranko. Written by Kevin Siembieda • \$26.95 — 352 pages.

After the Bomb® RPG

Discover the world of mutant animals. Play it as a stand-alone game environment or combine it with *Heroes Unlimited*™, but check it out.

Mutant animal creation rules that make building your mutant characters fast, fun and challenging. Over 100 mutant animals presented. More than 40 animal powers and psionics; many more if you include weird abilities exclusive to certain animal species. • \$24.95 — 224 pages.

Ninjas & Superspies™ RPG

Over 40 different types of martial arts, oriental mysticism, and superhuman abilities combined with spies, gizmos, super-vehicles, cybernetic implants and disguises, and more to create the ultimate spy and combat game. A complete role-playing game with everything you need to play. A complete game in itself as well as completely interchangeable with *Heroes Unlimited*™. Written by Erick Wujcik. • \$20.95 – 176 pages.

Nightbane® RPG

The world has never been the same since Dark Day. Some say the world governments have been supplanted, taken over by ... god only knows what. That doppelgangers can steal one's identity and life, and that demons and monsters lurk in the shadows. Creatures of evil who serve the Nightlords.

But the lords of shadow are not unopposed. There are creatures of light as well as creatures born from darkness but champion the light. These are the Nightbane. Ordinary people, many teenagers, able to shed their human facade and assume a supernatural alter ego. A monstrous, inhuman visage imbued with superhuman power and the stuff of magic. Written by C.J. Carella. • \$24.95 – 240 pages.

Beyond the Supernatural™ RPG

A game of horror, mystery, & dark secrets

BTS-2™ is a stark, plausible reality where ghosts, demons, psychics, and magic are real, yet remain unknown to the world at large. Player characters are part of the secrets, part of the problems, and humanity's only true hope of dealing with the unexplained. Truly unique characters that will challenge and excite those who play them. New P.C.C.s include the Psychic Medium (and Spirit Guide), the Diviner and Autistic Psychic Savant, all with new and unique abilities. Characters like the Psychic Sensitive, Nega-Psychic and other original P.C.C.s get a face lift, new powers, and more details. The secrets of the supernatural, ESP, and magic revealed. • \$24.95 – 256 pages. Written by Kevin Siembieda and Randy McCall.

Splicers® RPG

Splicers® is a new science fiction RPG set on a devastated world where machines rule, and human beings are vermin who are hunted and exterminated. The human struggle is complicated by a nano-virus that instantly turns metal objects touched by human flesh into killing machines. Consequently, humans have been forced to turn to organic technology to battle the world-dominating machines if they hope to reclaim any portion of their planet for themselves. Mega-Damage System – compatible with *Rifts*®, *Phase World*®, *Chaos Earth*™ and *Mechanoid Space*™. • \$23.95 – 224 pages. Written by Carmen Bellaire.

Palladium Books Inc.
39074 Webb Court
Westland, MI 48185

www.palladiumbooks.com

Copyright 2014 Palladium Books Inc. All rights reserved, worldwide. Palladium Books®, Rifts®, Megaverse®, Nightbane®, The Mechanoids®, and After the Bomb® are registered trademarks of Palladium Books Inc. Heroes Unlimited, Ninjas & Superspies, Beyond the Supernatural, Splicers, and Rifts® Chaos Earth are trademarks owned and licensed by Palladium Books Inc.



RIFTS®

- Imagine Earth transformed into an alien landscape.
- Humans exist – barely. And we are not alone.
- Aliens and monsters emerge from the Rifts – holes torn in the fabric of space and time, connected to countless worlds and realities.
- Ancient gods, demons and magic have returned.
- Magic and technology clash.
- Hundreds of character classes, many inhuman.
- *Rifts® Ultimate Edition* is the core RPG rule book.
- Expansive world setting with 90+ sourcebooks to draw upon.
- Rifts®, your portal to endless adventure.
- Limited only by your imagination.

www.palladiumbooks.com

© 2014 Palladium Books. Rifts®, Megaverse®, Nightbane® and other titles, slogans and likenesses are trademarks of Palladium Books, Inc. Palladium Books - 39074 Webb Court, Westland, MI 48185 USA - 734-271-2903 order line.

Other RPG Worlds from Palladium Books®:

- **Rifts®** – the ultimate role-playing experience.
- **Rifts® Chaos Earth®** – Play the apocalypse as it happens.
- **Splicers®** – Weird science. Bio-tech battles insane robot legions.
- **Robotech® RPG** – All eras of the TV show brought to life.
- **Dead Reign™ RPG** – Can you survive the Zombie Apocalypse?
- **Palladium Fantasy RPG®** – Unique world, monsters as player characters, magic and more.
- **Heroes Unlimited™ RPG** – Play any hero; mutants, aliens, cyborgs, superhumans, mages, immortals and more.
- **Nightbane® RPG** – Conspiracy, magic, horror and monsters.
- **Beyond the Supernatural™ RPG** – Modern horror and suspense.
- **Ninjas and Superspies™**, and more.

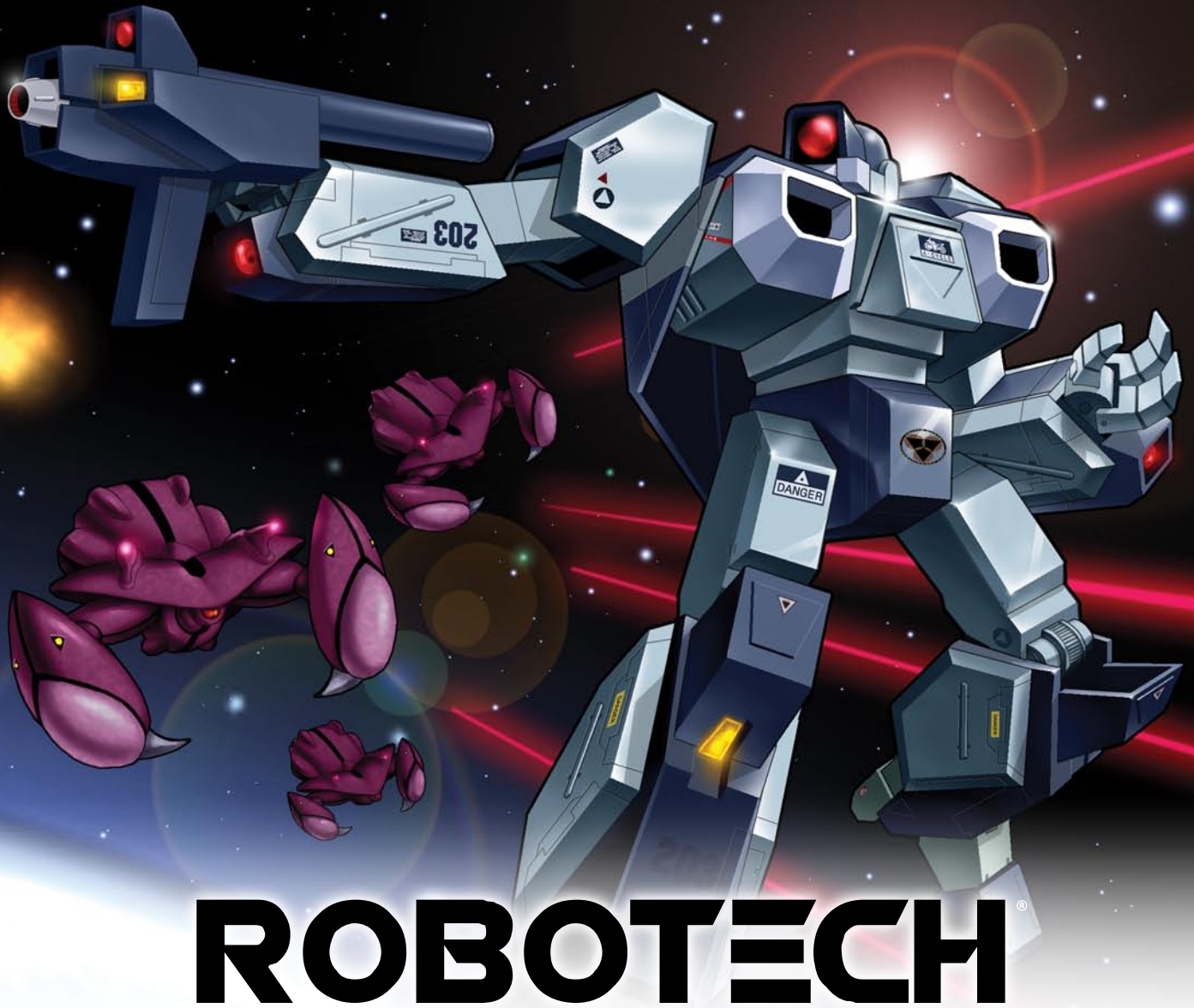

ROBOTECH®

Role-Playing Game and Sourcebooks

- **Four generations of heroes and mecha** • **Giant transformable robots** • **Alien invaders** • **Battle for control of the Earth** • **Combat takes to the stars** • **All presented in a core rule book and dynamic set of epic sourcebooks** • **Easy to learn** • **Fun to play** • **Quick character generation** • **Fast combat** • **Captures the action and adventure of the anime TV series** • **Isn't it time you joined the adventure?**

Robotech® "Core Rules" – Shadow Chronicles® RPG Hardcover

All the rules and information a player needs to start a Robotech® role-playing campaign with Admiral Rick Hunter and the United Earth Expeditionary Force trekking across the galaxy.

- Human mecha: Alphas, Betas, Cyclones & much more.
- Five character classes. 25 different Military Specialties.
- Invid mecha, Haydonites, and alien enemies.
- Quick roll character tables. Make a character in 15 minutes.
- A complete, stand-alone RPG.
- 224 pages. Cat. No. 550HC. 8½ x 11 size, hardcover.

Robotech®: The Macross® Saga Sourcebook – Cat. No. 551

A treasure chest packed with the iconic mecha, vehicles, weapons and characters that made Robotech® famous. Valkyries, Destroyers, ground vehicles, aircraft, spacecraft, weapons, Zentraedi soldiers, Zentraedi mecha, alien invaders, heroes, villains, and more.

- All the iconic Macross mecha, vehicles, weapons & characters.

www.palladiumbooks.com

Robotech®: The Masters Saga™ Sourcebook – Cat. No. 552

Tons of never before seen stats and descriptions for the many weapons, armor, mecha and robots of the Army of the Southern Cross.

- The Army of the Southern Cross™ – all 15 branches and their mecha!

Robotech®: New Generation™ Sourcebook – Cat. No. 554

The battle for the liberation of Earth starts here.

- Kit-bashed mecha combining parts from different mecha.
- Invid Hives, world overview, key characters and adventure ideas.

Robotech®: Genesis Pits™ Sourcebook – Cat. No. 555

The Invid Genesis Pits, their purpose, function.

- Inorganics and other war machines of the Invid Regent.
- Genesis Pit mutations and monsters.

Robotech®: Expeditionary Marines Sourcebook – Cat. No. 553

Join the UEEF (United Earth Expeditionary Force) led by Admiral Rick Hunter as they travel across the galaxy liberating planets from the bondage of the Invid Regent, the Robotech Masters and other tyrants.

- New mecha, weapons, and character classes of the UEEF Marines.
- New alien species and allies. Planet hopping and more.



ROBOTECH

R P G T A C T I C S

Main Boxed Game – Cat. No. 55100 – Available Now!

A fast-paced, strategy battle game that captures the speed and action of Robotech®. Play Earth defenders or Zentraedi invaders.

- Scalable from small squad skirmishes to mass battles.
- Turn-based system of play and uses D6. Two or more players.
- 34 highly detailed game pieces. 6mm scale.
- 112 page color rule book with paint guide and index.
- 53 laminated, color game cards.
- 24 custom dice, two decal sheets and more.
- Assembly and painting required. Glue not included.
- \$99.95 retail – Cat. No. 55100 – shipping now!
- Available in the USA, Canada, EU, Australia & New Zealand.

Note: Each product contains plastic game pieces requiring assembly and painting. Glue not included. This is not a toy. Small parts, not suitable for children under the age of 13. Adult supervision advised. Images shown here are not to scale.



UEDF Valkyrie Wing™ – Cat. No. 55201

Build your fleet of Earth defenders with the Valkyrie Veritech Fighter; six game pieces total. **\$36.95 retail.**

- 2 Valkyries in Fighter mode.
- 2 Valkyries in Guardian mode.
- 2 Valkyries in Battloid mode.
- Multiple heads for making the VF-1A, VF-1J, VF-1R & VF-1S.



UEDF Tomahawk/Defender Destroids™ – Cat. No. 55202

Expand your Destroid squad with these formidable walking tanks; four game pieces total. **\$32.95 retail.**

- 2 Tomahawk Destroids – the main battle tank of Destroids, brimming with powerful particle beam cannons for arms, and wielding a battery of missiles and an array of other weapons.
- 2 Defender Destroids – a long-range, anti-aircraft juggernaut capable of shooting down incoming Zentraedi Battlepods and Gnerl Fighters.



UEDF Spartan/Phalanx Destroids™ – Cat. No. 55203

Add some long-range power and up-close punch to your army with these valuable Destroids; four game pieces total. **\$32.95 retail.**

- 2 Spartan Destroids – civil defense, riot control and deadly in hand combat.
- 2 Phalanx Destroids – a walking, long-range missile artillery unit.



Zentraedi Regult Battlepods™ – Cat. No. 55401

Expand your Zentraedi forces with their main infantry battle mecha; six game pieces total. **\$36.95 retail.**

- 6 Regult Tactical Battlepods – the lightning quick Regults, armed with a pair of particle cannons and auto-cannons, attack in wave after wave.



Zentraedi Artillery Battlepods™ – Cat. No. 55402

Give your Zentraedi legion greater firepower with these artillery and support Battlepods; four game pieces total. **\$36.95 retail.**

- 4 Zentraedi Support Battlepods, each of which can be made into:
 - Gluuhaug-Regult – Light Artillery Battlepod
 - Serauhaug-Regult – Heavy Artillery Battlepod
 - Telnesta-Regult – Experimental Particle Beam Battlepod
- Four game pieces total.**



Zentraedi Glaug Command™ – Cat. No. 55403

This diverse pack provides your Zentraedi forces with greater tactical capabilities; three game pieces total. **\$36.95 retail.**

- 1 Glaug Officer's Battlepod – the fast and deadly mecha of Zentraedi field leaders.
- 1 Quel-Regult Scout Battlepod – the stealthy eyes and ears of your Zentraedi battle force; electronic warfare capabilities.
- 1 Quel-Gulnau Recovery Pod – enhances the Glaug's ability to bring in Battlepod reinforcements. **Note:** This figure has NEVER before been offered by any company.



Can YOU survive the Zombie Apocalypse?



Dead Reign™ RPG

It is the aftermath of the *zombie apocalypse*. Civilization is gone, the dead reign, and the living fight to survive against impossible odds. Tales of zombies, human survival and horror as a fast-paced, easy to learn game and sourcebooks.

- **Zombie combat rules, vehicles and equipment.**
- **Six iconic Apocalyptic Character Classes and Ordinary People with 40+ occupations to choose from.**
- **Seven types of zombies plus the Half-Living.**
- **Secrets of the Dead and tips on fighting zombies.**
- **Death Cults, their Priests, power over zombies and goals.**
- **101 Random Scenarios, Encounters and Settings.**
- **100 Random Corpse Searches and other tables.**
- **Quick Roll Character Creation tables (10 minutes).**
- **A complete role-playing game by Siembieda and others.**
- **\$22.95 retail – 224 pages – Cat. No. 230. Available now.**

Civilization Gone™

Dead Reign™ Sourcebook One

It has been months since the dead rose to attack the living. Civilization has crumbled. There is no army, no government, no help coming. You are on your own and things are only getting worse.

- **Madmen and Psychopaths including the *Zombie Master, Ghost Walker, Backstabber, Messianic Leader, Zombie Lover, Deathbringer* and others.**
- **Bandits and Raiders who prey upon other survivors.**
- **Street Gang Protectors and their mission to save lives.**
- **Phobia and Obsession tables. Many adventure ideas.**
- **House and home resource and encounter tables.**
- **Random encounter and survivor camp creation tables.**
- **Additional world information and survival advice.**
- **\$12.92 retail – 64 pages – Cat. No. 231. Available now.**

Dark Places™

Dead Reign™ Sourcebook Two

Secrets of survival, including using railroad tracks and the urban underground to travel unseen and undetected by zombies.

- **Worm Meat, Bug Boy, Sewer Crawler and Impersonator Zombies.**
- **“Live Bait” zombie lures with human beings as bait.**
- **Traveling the rails and boxcar encounter tables.**
- **Traveling sewer tunnels, steam tunnels & other dark places.**
- **The pitfalls and dangers of the urban underground.**
- **Diseases, infection and additional world information.**
- **Random encounter tables, boxcar content tables, and more.**
- **\$12.92 retail – 64 pages – Cat. No. 232. Available now.**

Endless Dead™

Dead Reign™ Sourcebook Three

The zombie hordes grow in number and strangeness. Can humankind survive? Where is the military?

- **New types of zombies like Fused Zombies and Walking Mass Grave.**
- **New O.C.C.s including Wheelman and Zombie Hunter.**
- **Info & tables for weaponizing vehicles and vehicle combat rules.**
- **Random encounter tables for military bases, police stations, gun stores, buildings, suburbs, industrial parks, small towns, farmland and wilderness.**
- **Tables to make Survivor caravans, hideouts, Safe Havens & more.**
- **Timetable for setting zombie campaigns & many adventure ideas.**
- **\$16.95 retail – 96 pages – Cat. No. 233. Available now.**



Other horror titles from Palladium Books®

Fear the Reaper™

Graveyard Earth™

Beyond the Supernatural™ RPG

Nightbane® RPG series

© Copyright 2012 Palladium Books Inc. All rights reserved. Rifts®, Palladium Books®, Megaverse®, Nightbane®, Heroes Unlimited, Dead Reign and other published book titles, names, slogans and likenesses are trademarks of Palladium Books Inc.

www.palladiumbooks.com

Palladium Books® Check List & Order Form

Dept. P-16, 39074 Webb Court, Westland, MI 48185

Name: _____ Address: _____

City: _____ State: _____ Zip/Postal Code: _____ Country: _____

Credit Card Number: _____ Expiration Date: _____ Visa MasterCard

Telephone Number: _____ Signature: _____ AMEX Other

The Rifter® Series

- ___ 090 Best of The Rifter® – \$12.95
- ___ 170 The Rifter® #70 – \$13.95
- ___ 171-172 The Rifter® #71 & 72 – \$24.95
- ___ 173 The Rifter® #73 – \$13.95
- ___ 174 The Rifter® #74 – \$13.95 (Spring)

Splicers®

- ___ 200 Splicers® RPG – \$23.95
- Note: Sourcebooks coming soon.

Dead Reign®

- ___ 230 Dead Reign® RPG – \$22.95
- ___ 231 SB 1: Civilization Gone™ – \$12.95
- ___ 232 SB 2: Dark Places™ – \$12.95
- ___ 233 SB 3: Endless Dead™ – \$16.95
- ___ 234 SB 4: Fear the Reaper™ – \$12.95
- ___ 235 SB 5: Graveyard Earth™ – \$12.95
- ___ 236 SB 6: Hell Followed™ – \$20.95 (coming)

Rifts® Novels

- ___ 301 Sonic Boom™ – \$9.95
- ___ 302 Deception's Web™ – \$9.95
- ___ 303 Treacherous Awakenings™ – \$9.95
- ___ 304 Tales of the Chi-Town 'Burbs™ – \$12.95
- ___ 305 Rifts® Path of the Storm™ – Screen-play & Sourcebook – \$12.95

Weapons Books

- ___ 401 Weapons and Armor™ – \$8.95
- ___ 402 Weapons and Castles™ – \$8.95
- ___ 403 Weapons and Assassins™ – \$8.95
- ___ 404 Weapons & Castles of the Orient™ – \$8.95

Palladium Fantasy RPG®

- ___ 450 The Palladium Fantasy RPG® – \$26.95
- ___ 4500HC Palladium Fantasy RPG® 30th Anniversary Hardcover – \$50.00
- ___ 451 Dragons & Gods™ – \$24.95
- ___ 453 Old Ones™ 2nd Ed. – \$24.95
- ___ 454 Monsters & Animals™ 2nd Ed. – \$24.95
- ___ 455 Adventures on the High Seas™ – \$24.95
- ___ 458 Island at the Edge of the World™ – \$20.95
- ___ 459 Yin-Sloth Jungles™ – \$20.95
- ___ 462 Western Empire™ – \$24.95
- ___ 463 Baalgor Wastelands™ – \$24.95
- ___ 464 Mount Nimro™ – \$20.95
- ___ 465 Eastern Territory™ – \$24.95
- ___ 466 Library of Bletherad™ – \$20.95
- ___ 467 Northern Hinterlands™ – \$24.95
- ___ 468 Land/Damned 1: Chaos Lands™ – \$24.95
- ___ 469 LoD 2: Eternal Torment™ – \$24.95
- ___ 470 LoD 3: The Citadel – \$24.95 (coming)
- ___ 471 Wolfen Empire™ – \$20.95
- ___ 472 Mysteries of Magic™ One: Heart of Magic – \$16.95
- ___ 474 Bizantium/Northern Islands™ – \$20.95
- ___ 475 Garden of the Gods™ – \$12.95 (coming)

Heroes Unlimited™ / After the Bomb®

- ___ 500-2 Heroes Unlimited™, 2nd Ed. – \$26.95
- ___ 5000HC Heroes Unlimited™ 30th Anniversary Hardcover – \$50.00
- ___ 501 Villains Unlimited™ Revised – \$24.95
- ___ 503 After the Bomb® RPG – \$22.95
- ___ 505 Road Hogs™ (After the Bomb® II) – \$9.95
- ___ 507 Mutants Down Under™ (AB III) – \$9.95
- ___ 511 Mutants of the Yucatan™ (AB IV) – \$9.95
- ___ 513 Mutants in Avalon™ (AB V) – \$16.95
- ___ 514 Mutants in Orbit™ (AB VI) – \$16.95
- ___ 515 Aliens Unlimited™ – \$24.95
- ___ 516 Heroes Unlimited™ G.M.'s Guide – \$24.95
- ___ 517 Century Station™ – \$24.95
- ___ 518 Gramercy Island™ – \$24.95
- ___ 519 Aliens Unlimited Galaxy Guide™ – \$24.95
- ___ 520 Mutant Underground™ – \$16.95
- ___ 521 Powers Unlimited® One – \$16.95
- ___ 522 Powers Unlimited® Two – \$16.95
- ___ 523 Powers Unlimited® Three – \$16.95
- ___ 525 Revised Ninjas & Superspies™ – \$20.95
- ___ 526 Mystic China™ – \$24.95
- ___ 527 Armageddon Unlimited™ – \$20.95

Robotech® RPG

- ___ 550 Robotech® The Shadow Chronicles® RPG (manga size) – \$16.95
- ___ 550HC Robotech® The Shadow Chronicles® Deluxe Hardcover RPG – \$30.95
- ___ 5500HC Robotech® The Shadow Chronicles® Gold Ed. Hardcover RPG – \$70.00
- ___ 551 Robotech® Macross® Saga Sourcebook – \$16.95
- ___ 552 Robotech® The Masters Saga™ Sourcebook (manga size) – \$16.95
- ___ 553 Robotech®: Expeditionary Force Marines Sourcebook – \$20.95
- ___ 554 Robotech® The New Generation™ Sourcebook – \$16.95
- ___ 555 Robotech® Genesis Pits Sourcebook – \$16.95

Robotech® RPG Tactics™ (New!)

- ___ 55100 Robotech® RPG Tactics™ – \$99.95
- ___ 55105 Robotech® RPG Tactics™ Rulebook – \$20.00
- ___ 55101 UEDF Dice Pack – \$12.00
- ___ 55102 Zentraedi Dice Pack – \$12.00
- ___ 55201 UEDF Valkyrie Wing – \$36.95
- ___ 55202 UEDF Destroid Pack – \$32.95
- ___ 55203 UEDF Spartan Pack – \$32.95
- ___ 55401 Zentraedi Regult Battlepods – \$36.95
- ___ 55402 Zentraedi Artillery Battlepods – \$36.95
- ___ 55403 Zentraedi Glaug Command – \$36.95

Rifts® Chaos Earth®

- ___ 660 Rifts® Chaos Earth® RPG – \$20.95
- ___ 661 Rifts® CE Creatures of Chaos™ – \$12.95
- ___ 662 Rifts® CE The Rise of Magic™ – \$12.95
- ___ 665 Rifts® Chaos Earth® First Responders™ – \$16.95 (coming)
- ___ 666 Rifts® Chaos Earth® Resurrection™ – \$20.95

Beyond the Supernatural™

- ___ 700 Beyond the Supernatural™, 2nd Ed. – \$24.95
- ___ 702 Tome Grotesque™ – \$20.95 (coming)
- ___ 703 Beyond Arcanum™ – \$24.95 (coming)

Nightbane®

- ___ 730 Nightbane® RPG – \$24.95
- ___ 731 Nightbane®: Between the Shadows™ – \$20.95
- ___ 732 Nightbane®: Nighlands™ – \$20.95
- ___ 733 Nightbane®: Through the Glass Darkly™ – \$20.95
- ___ 735 Nightbane® Survival Guide™ – \$20.95

Rifts®

- ___ 800HC Rifts® RPG Ultimate Edition – \$39.95
- ___ 801 Rifts® Sourcebook One Revised – \$20.95
- ___ 802-E Rifts® World Book 1: Vampire Kingdoms™, Revised – \$24.95
- ___ 803 Rifts® Conversion Book One™ – \$24.95
- ___ 804 Rifts® WB 2: Atlantis™ – \$20.95
- ___ 805 Rifts® Sourcebook 2: Mechanoids™ – \$16.95
- ___ 807 Rifts® WB 3: England™ – \$20.95
- ___ 808 Rifts® WB 4: Africa™ – \$20.95
- ___ 809 Rifts® Dimension Book 1: Wormwood™ – \$20.95
- ___ 810 Rifts® WB 5: Triax™ – \$24.95
- ___ 811 Rifts® Pantheons of the Megaverse® – \$24.95
- ___ 812 Rifts® Sourcebook 3: Mindwerks™ – \$16.95
- ___ 813 Rifts® Mercenaries™ – \$20.95
- ___ 814 Rifts® WB 6: South America™ – \$20.95
- ___ 815 Rifts® WB 7: Underseas™ – \$24.95
- ___ 816 Rifts® DB 2: Phase World® – \$24.95
- ___ 817 Rifts® DB 3: Phase World® Sourcebook – \$16.95
- ___ 818 Rifts® WB 8: Rifts® Japan™ – \$24.95
- ___ 819 Rifts® WB 9: South America Two™ – \$24.95
- ___ 820 Rifts® WB 10: Juicer Uprising™ – \$20.95
- ___ 821 Rifts® WB 11: Coalition War Campaign™ – \$24.95

- ___ 822 Rifts® WB 12: Psyscape™ – \$20.95
 ___ 825 Rifts® WB 13: Lone Star™ – \$20.95
 ___ 826 Rifts® WB 14: New West™ – \$24.95
 ___ 827 Rifts® WB 15: Spirit West™ – \$24.95
 ___ 828 Rifts® Sourcebook 4: Coalition Navy™ – \$16.95
 ___ 829 Rifts® WB 16: Federation of Magic™ – \$20.95
 ___ 830 Rifts® DB 4: Skraypers™ – \$20.95
 ___ 831 Rifts® Index Volume Two™ – \$16.95
 ___ 832 Rifts® WB 17: Warlords of Russia™ – \$24.95
 ___ 833 Rifts® WB 18: Mystic Russia™ – \$20.95
 ___ 834 Rifts® WB 19: Australia 1 – \$24.95
 ___ 835 Rifts® WB 20: Canada™ – \$24.95
 ___ 836 Rifts® WB 21: Splynn Dimensional Market™ – \$24.95
 ___ 837 Rifts® WB 22: Free Quebec™ – \$24.95
 ___ 838 Rifts® WB 23: Xiticix Invasion™ – \$20.95
 ___ 839 Rifts® Coalition Wars®: Sedition™ – \$20.95
 ___ 840 Rifts® Coalition Wars®: Coalition Overkill™ – \$16.95
 ___ 841 Rifts® Coalition Wars®: Sorcerers' Revenge™ – \$16.95
 ___ 842 Rifts® Coalition Wars®: Cyber-Knights™ – \$16.95
 ___ 843 Rifts® Coalition Wars®: Shadows of Evil™ – \$16.95
 ___ 844 Rifts® Coalition Wars®: Final Siege™ – \$24.95
 ___ 845 Rifts® Game Master Guide™ – \$26.95
 ___ 846 Rifts® Aftermath™ – \$24.95
 ___ 847 Rifts® DB5: Anvil Galaxy™ – \$20.95
 ___ 848 Rifts® Book of Magic™ – \$26.95
 ___ 849 Rifts® Adventure Guide™ – \$24.95
 ___ 850 Rifts® Bionics Sourcebook™ – \$16.95
 ___ 851 Rifts® DB 6: Three Galaxies™ – \$20.95
 ___ 852 Rifts® Dark Conversions™ – \$24.95
 ___ 853 Rifts® Chi-Town 'Burbs™ – \$9.95
 ___ 854 Rifts® The Tolkeen Crisis™ – \$12.95
 ___ 855 Rifts® The Black Vault™ – \$9.95
 ___ 856 Rifts® The Vanguard™ – \$9.95
 ___ 857 Rifts® WB 24: China One™ – \$20.95
 ___ 858 Rifts® WB 25: China Two™ – \$20.95
 ___ 859 Rifts® DB 7: Megaverse Builder™ – \$16.95
 ___ 860 Rifts® DB 8: Naruni Wave Two™ – \$16.95
 ___ 862 Rifts® WB 26: Dinosaur Swamp™ – \$20.95
 ___ 863 Rifts® MercTown™ – \$20.95
 ___ 865 Rifts® Merc Ops™ – \$20.95
 ___ 866 Rifts® WB 27: Adventures in Dinosaur Swamp™ – \$20.95
 ___ 867 Rifts® Mercenary Adventure Sourcebook – \$12.95
 ___ 868 Rifts® WB 28: Arzno™ – \$20.95
 ___ 869 Rifts® WB 29: Madhaven™ – \$16.95
 ___ 870 Rifts® John Zeleznik Coloring Book – \$5.95
 ___ 871 Rifts® Machinations of Doom™ – \$18.95
 ___ 872 Rifts® DB 10: Hades™ – \$24.95
 ___ 873 Rifts® DB 11: Dyval™ – \$24.95
 ___ 874 Rifts® WB 30: D-Bees of North America™ – \$24.95
 ___ 875 Rifts® DB12: Dimensional Outbreak – \$24.95
 ___ 876 Rifts® Megaverse® in Flames™ – \$24.95
 ___ 876HC Rifts® Megaverse® in Flames™ Gold Hardcover Edition – \$50.00
 ___ 877 Rifts® Heroes of the Megaverse® – \$16.95
 ___ 878 Rifts® Sourcebook: Shemarrian Nation™ – \$16.95
 ___ 880 Phase World®: Fleets of the Three Galaxies™ – \$16.95
 ___ 881 Rifts® WB 31: Triax™ Two – \$24.95
 ___ 883 Rifts® DB 14: Thundercloud Galaxy™ – \$20.95
 ___ 884 Rifts® Vampires Sourcebook™ – \$20.95
 ___ 885 Rifts® WB 32: Lemuria™ – \$24.95
 ___ 886 Rifts® Black Market™ – \$24.95
 ___ 887 Rifts® WB 33: Northern Gun™ One – \$24.95
 ___ 888 Rifts® WB 34: Northern Gun™ Two – \$26.95
 ___ 889 Rifts® Sourcebook: Heroes of Humanity™ – \$16.95 (coming)
 ___ 890 Rifts® World Book: Secrets of the Atlanteans™ – \$24.95 (coming)
 ___ 891 Rifts® World Book: Sovietski™ – \$24.95 (coming)
 ___ 892 Rifts® Sourcebook: The Disavowed™ – \$16.95 (coming)
 ___ 2510 Rifts® & The Megaverse® Art Book – \$22.95
 ___ 2510-HC Rifts® & The Megaverse® Art Book, Hardcover – \$50.00
 ___ 2510-CML Rifts® & The Megaverse® Art Book, Collector's Masterwork Edition – \$125.00
- Miscellaneous Products**
 ___ 600 Deluxe Revised RECON® RPG – \$22.95
 ___ 2536 Rifts® Coffee Mug – \$10.00
 ___ 2537 Gamer Coffee Mug – \$10.00
 ___ 2539 Rifts® Dice Bag – Black – \$8.00
 ___ 2545 Dead Reign™ Coffee Mug – \$10.00
 ___ 2554 Palladium Bookmarks, Set One – \$5.00
 ___ 2555 Palladium Bookmarks, Set Two – \$5.00
 ___ 2560 Palladium Fantasy® Coffee Mug – \$10.00
 ___ 2561 Property of Chi-Town Library Pencil – \$0.50 each
 ___ 2562 Future Visions™ – The Artistry of Charles Walton II – \$13.95
- Note:** T-shirts and other products can be found online: www.palladiumbooks.com
- Rifts® Miniatures**
 ___ MI8002 Xiticix Pack – \$18.00
 ___ MI8004 Coalition Dog Pack – \$18.00
 ___ MI8005 Men of Magic Pack #1 – \$18.00
 ___ MI8006 Cyborgs Pack #1 – \$18.00
 ___ MI8007 Simvan & Ostrosaurus Pack – \$18.00
 ___ MI8008 Coalition Skelebots Pack #1 – \$18.00
 ___ MI8009 Coalition SAMAS Pack #1 – \$22.00
 ___ MI8010 Coalition Sky Cycle Pack – \$22.00
 ___ MI8011 Coalition Dog Pack #2 – \$18.00
 ___ MI8015 Damaged Skelebots Pack #1 – \$12.00
 ___ MI8016 Cyber-Adventurers Pack – \$18.00
 ___ MI8017 Rogues & Scout Pack #1 – \$18.00
 ___ MI8018 Brodkil & Witchling Pack – \$18.00
 ___ MI8019 Damaged Skelebots Pack #2 – \$18.00
 ___ MI8020 Psi-Stalkers & Scouts Pack #1 – \$18.00
 ___ MI8021 Shadow Beast – \$12.00
 ___ MI8022 Mystic Knight – \$6.00
 ___ MI8023 Lord Magus – \$6.00
 ___ MI8024 High Magus – \$6.00
 ___ MI8025 Coalition Psi-Stalker – \$6.00
 ___ MI8026 Coalition Dog Boy in DPM-D1 Armor – \$6.00
 ___ MI8027 Coalition Dog Boy #2 – \$6.00
 ___ MI8028 Coalition Dog Boy #3 – \$6.00
 ___ MI8029 Coalition Dog Boy #4 – \$6.00
 ___ MI8030 Coalition Dog Boy #5 – \$6.00
 ___ MI8031 Glitter Boy – \$20.00
 ___ MI8032 Glitter Boy Pilot – \$6.00
 ___ MI8033 Kydian Overlord – \$20.00
 ___ MI8034 Dragonsaurus – \$10.00
 ___ MI8035 Slaver and Slave (Atlantis) Set – \$10.00
 ___ MI8036 Crazy – \$6.00
 ___ MI8037 Juicer #1 – \$6.00
 ___ MI8038 Juicer #2 – \$6.00
 ___ MI8039 Cyborg #1 – \$12.00
 ___ MI8040 Cyborg #2 – \$12.00
 ___ MI8041 Cyborg #3 – \$6.00
 ___ MI8042 Coalition Officer – \$6.00
 ___ MI8043 Coalition Grunt #1 – \$6.00
 ___ MI8044 Coalition Grunt #2 – \$6.00
 ___ MI8045 Coalition Grunt #3 – \$6.00

When placing an order by mail, please add money for shipping and handling. Add \$5.00 for orders totaling \$1-\$50, \$10.00 for orders totaling \$51-\$95, and for orders totaling \$96-\$200 please add \$15.00 US. Double the amount for Canada, and *quadruple* it for overseas orders. For more shipping options, order online at www.palladiumbooks.com.

Allow 2-4 weeks for delivery.

Make checks and money orders payable to: *Palladium Books*

Check release dates for new products. If the book you order has not been released yet, your order will be held as a backorder until the product is available. Please note that prices are subject to change without notice.

Orders can also be placed by phone, at (734) 721-2903 (order line only). Please have your credit card information when you call.

www.palladiumbooks.com



Also from Palladium Books®

Rifts® World Book Eleven:

Coalition War Campaign™

Highlights Include:

- CS troops with “new” and improved Dead Boy body armor, Light Assault SAMAS, Super SAMAS, Scout Spider Walker, UAR-3, bots, power armor, vehicles, weapons & equipment.
- CS cyborgs, Juicers, Special Forces, and other O.C.C.s.
- CS military activity, troop movement, build-ups, bases, and invasion plans (who will be the first to fall?).
- CS enemies: D-Bee strongholds, independent kingdoms, and other forces, mapped, outlined and briefly described — providing ideas and suggestions for countless adventures.
- The reactions of Tolkeen, Lazlo, the Federation of Magic, Free Quebec, mercenaries and other forces.
- World information and maps about the Coalition States and North America.
- Surprising alliances and invasion plans.
- Written by Kevin Siembieda. Art by Martin, Breaux, McKenna, Lawson, and Zeleznik.
- 224 pages.

Available at stores everywhere!

Palladium Books® Presents:

Rifts® World Book Ten:

Juicer Uprising™

- New types of Juicer O.C.C.s, including the Hyperion speed-demon, the mysterious Mega-Juicer, the giant super-strong Titan, the Mega-Damage Dragon Juicer (dependent on the blood of dragons to sustain his powers), Phaeton, Psycho-Stalker and others!
- The Juicer O.C.C., developed and expanded; the motivations behind these suicidal warriors, and the process and effects of being “juiced” completely described.
- Juicer Wannabes, side effects, quirks and insanity.
- New Juicer armor, weapons and equipment.
- The Prometheus Treatment: Immortality for the Juicers or another Coalition lie?
- More world information about North America, Newtown, Fort El Dorado, Death cults and hints of things to come.
- Written by C.J. Carella with concepts by Kevin Siembieda.
- 160 pages of epic adventure.

Discover the entire Palladium Megaverse®!

\$20.95

Cat. No. 820

ISBN-10: 0-916211-92-4

ISBN-13: 978-0-916211-92-9

**Palladium
Books Inc.**

www.palladiumbooks.com