

Palladium Books® Presents:

# The Mechanoids®

Rifts® Sourcebook Two

By Kevin Siembieda



---

# Warning!

## Violence and the Supernatural.

This book may be inappropriate for young readers.

The fictional world of **Rifts** is violent, deadly, and filled with monsters. Other dimensional beings, often referred to as “demons,” torment, stalk, and prey on humans. Other alien life forms, cyborgs, monsters, and demi-gods, as well as magic, psionic powers, insanity and the supernatural are all elements in this book.

The fictional villains of **Rifts Sourcebook Two: The Mechanoids** are murderous aliens consumed by hate and driven to genocide. Their motives, practices, and use of technology are evil, violent, and monstrous.

Some parents may find the violence and supernatural elements of the game inappropriate for young readers/players. We suggest parental discretion.

Note that **Rifts, Rifts Sourcebook Two: The Mechanoids** and all of Palladium’s role-playing game books are works of fiction! NONE of the monsters, characters, magic, powers or depictions are real. None of us at Palladium Books condone or encourage the occult, the practice of magic, the use of drugs, genocide or violence.

---

Palladium Books® Presents:

Rifts® Sourcebook Two

# The Mechanoids®

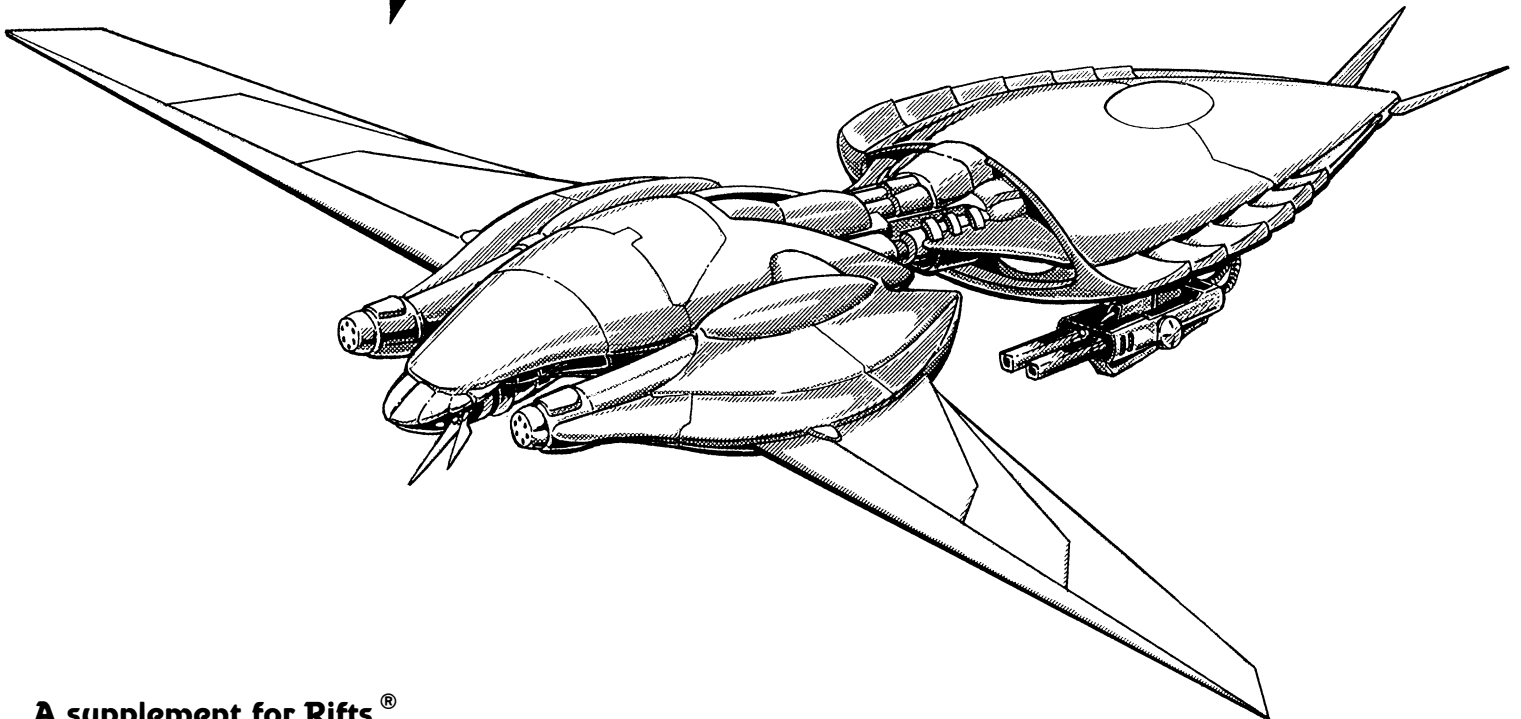

A supplement for Rifts.®

Compatible with **Beyond the Supernatural™**, **The Palladium RPG®**, **Heroes Unlimited™**, **Ninjas & Superspies™**, **Teenage Mutant Ninja Turtles®**, and others in the **Palladium® Megaverse®**.

## **Dedicated to the memory of Joseph Budreck.**

Joe was the founder of **Windmill Hobbies Distributors** and probably has many more significant accomplishments that could be added to his credit.

To Palladium he was one of the first “big guys” to carry our books. Although he could be occasionally cantankerous, Joe was always helpful, considerate of others, gave honest and sincere praise and offered friendly advice.

When the **Palladium Role-Playing Game** came out in 1983 (the first soft-bound RPG ever), Joe called to tell me that he thought the book was a wonderful product and had a great format. He was so impressed that he insisted that some of his accounts take the book on a returnable basis — at his risk, not little Palladium’s. This meant a lot to a tiny company just starting out and even more to the author, artist and publisher who put his sweat and blood into it, me.

All of us at Palladium Books considered Joe Budreck our friend. A cheerful voice on the other end of the telephone. Always quick with a bad joke or a kind word, and always placing “a little order” regardless of how huge that order might really be.

We’ll miss him.

## **PDF Edition – December 2016**

Copyright © 1992 by Kevin Siembieda.

The Mechanoids and The Mechanoid Invasion are copyright © 1990, 1985, 1982 and 1981 by Kevin Siembieda.

Character Sheets are copyright © 1992 by Kevin Siembieda, but can be duplicated for personal use.

**Palladium Books, Rifts, The Mechanoids, The Mechanoid Invasion, and Megaverse** are registered trademarks owned and licensed by Kevin Siembieda. **Mega-damage, M.D.C., S.D.C., P.P.E., Triax, A.R.C.H.I.E. Three, Hagan Lanovich, Kittani, Xiticix, Splugorth, Erin Tarn, Victor Lazlo**, and their likenesses, **The Palladium Role-Playing Game, Heroes Unlimited, Beyond the Supernatural, Ninjas & Superspies**, and other titles are trademarks owned and licensed by Kevin Siembieda.

All rights reserved under the Universal Copyright Convention. No part of this book may be reproduced in part or whole, in any form or by any means, without permission from the publisher, except for brief quotes for use in reviews. All incidents, situations, institutions, governments and people are fictional and any similarity, without satiric intent, of characters or persons living or dead, is strictly coincidental.

**Rifts® Sourcebook Two: The Mechanoids®** is published by Palladium Books Inc., 39074 Webb Court, Westland, MI 48185.  
Printed in the U.S.A.

Palladium Books® Rifts Sourcebook Two:

# The Mechanoids®

Written By: **Kevin Siembieda**

Editors: **Alex Marciniszyn**  
**James Osten**  
**Thomas Bartold**

Cover Art: **Kevin Long**

Interior Art: **Newton Ewell**  
**Kevin Siembieda**  
**Kevin Long**

Character Sheets By: **Gordon Delp**  
Keylines & Direction: **Kevin Siembieda**  
Typography: **Maryann Siembieda**

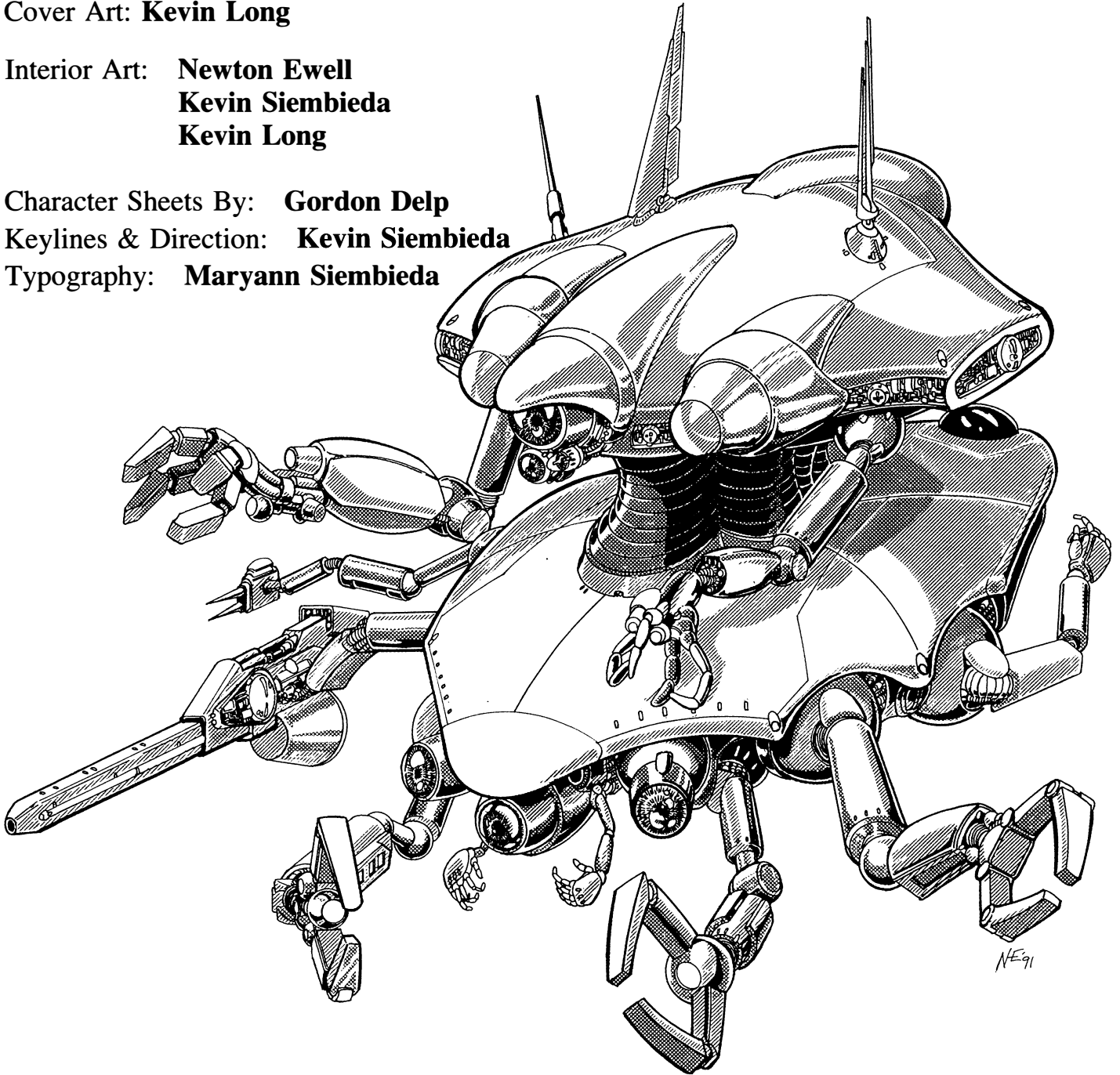

**Special Thanks to** Newton Ewell for some great new Mechanoid designs, Kevin Long, Maryann, Alex, Jim and the usual gang of idiots.

# Contents

<b>Premonitions of a Dangerous Future</b> . . . . .	<b>8</b>
An open letter from Plato . . . . .	8
The Coalition States On The Prowl . . . . .	9
The Minions of Atlantis . . . . .	10
Hotheads & Psychotics . . . . .	10
<b>Doomsday Cults</b> . . . . .	<b>11</b>
Children of Doom Cult . . . . .	11
<b>A.R.C.H.I.E. Three &amp; Hagan</b> . . . . .	<b>15</b>
The Mechanoids' Plans . . . . .	17
Some Notes about Archie . . . . .	19
<b>Hagan &amp; His Robots</b> . . . . .	<b>19</b>
HPA Mark One Power Armor . . . . .	20
Earth Saver One: Combat Bot . . . . .	23
Hagan's: AA-60 Hunter-Destroyer Bots . . . . .	26
<b>A History of Destruction</b> . . . . .	<b>29</b>
The Conflict Within . . . . .	31
More Surprises . . . . .	32
<b>Good Guy Mechanoids — AbM Mutants</b> . . . . .	<b>33</b>
AbM Wasp . . . . .	37
AbM Tunnel Crawler . . . . .	43
<b>Evil Mechanoids</b> . . . . .	<b>45</b>
Oracle . . . . .	47
Multi-Brain Vehicle . . . . .	51
Brute (Type One) . . . . .	55
Brute (Type Two) . . . . .	57
Exterminator . . . . .	61
Octopus . . . . .	67
<b>Mechanoid Robots</b> . . . . .	<b>72</b>
Thinman . . . . .	72
Runt . . . . .	75
Assault Probe . . . . .	77
Weevil . . . . .	79
<b>Mechanoid Hierarchy, Population &amp; Notes</b> . . . . .	<b>81</b>
Common Mechanoid Squads . . . . .	81
<b>Mechanoid Spider Fortress</b> . . . . .	<b>82</b>
Diagrams . . . . .	84
<b>Mechanoid Technology</b> . . . . .	<b>86</b>
Computers — Brain Pools . . . . .	86
Master Computer . . . . .	87
<b>Footnotes &amp; Reminders</b> . . . . .	<b>87</b>
<b>Adventures</b> . . . . .	<b>90</b>
<b>The Nightmare Begins (intro adventure)</b> . . . . .	<b>91</b>
Subplots & Story Elements . . . . .	92
<b>The Map Adventure</b> . . . . .	<b>93</b>
Tree Shadow . . . . .	94
Cintabar . . . . .	94
Wily Willie Gladanski . . . . .	95
<b>Evil Among Humans Adventure</b> . . . . .	<b>96</b>
Mea-La . . . . .	97
<b>Liberty Adventure</b> . . . . .	<b>97</b>
The Bad Cat Gang . . . . .	98
M'tin the Mayor . . . . .	100

<b>The Factory Adventure</b> . . . . .	<b>100</b>
<b>Other Adventure Ideas</b> . . . . .	<b>101</b>
<b>Random Mechanoid Encounters Table</b> . . . . .	<b>104</b>
<b>Random Wilderness Encounters Table</b> . . . . .	<b>105</b>
<b>Character Sheets</b> . . . . .	<b>106</b>
Blank Rifts Character Sheet . . . . .	109
Combat Data Sheet . . . . .	110
Psionic Data Sheet . . . . .	111
Spell Data Sheet . . . . .	112

## Quick Find Table

<b>A.R.C.H.I.E. Three</b> . . . . .	<b>15</b>	<b>Evil Mechanoids</b> . . . . .	<b>45</b>
A.R.C.H.I.E. Three: Story Background . . . . .	15	Mechanoid Brain . . . . .	48
A.R.C.H.I.E. Three: Secret War . . . . .	16	Mechanoid Brain Multi-Vehicle . . . . .	51
A.R.C.H.I.E. Three: Strategy & Tactics . . . . .	17	Mechanoid Brain	
A.R.C.H.I.E. Three: The Mechanoids' Plans . . . . .	17	Pools (see computers) . . . . .	86
A.R.C.H.I.E. Three: Some Notes about Archie . . . . .	19	Mechanoid Brute (Type One) . . . . .	54
<b>Cults &amp; Fanatics</b> . . . . .	<b>10</b>	Mechanoid Brute (Type Two) . . . . .	57
Doomsday Cults . . . . .	11	Mechanoid Computers . . . . .	86
Children of Doom Cult . . . . .	11	Mechanoid Digger . . . . .	88
Children of Doom: Nrii the Neuron Beast . . . . .	11	Mechanoid Exterminator . . . . .	61
Children of Doom: Garnak the Beast Dragon . . . . .	13	Mechanoid Mantis . . . . .	65
Children of Doom: Nigel the Nightstalker . . . . .	13	Mechanoid Master Computer . . . . .	87
Children of Doom: Other Members . . . . .	14	Mechanoid Octopus (Type One) . . . . .	67
<b>Hagan</b> . . . . .	<b>19</b>	Mechanoid Octopus (Type Two) . . . . .	69
Hagan Lonovich: N.P.C. Stats . . . . .	19	Mechanoid Oracle . . . . .	47
Hagan: HPA Mark One Power Armor . . . . .	20	Mechanoid Overlord . . . . .	45
Hagan: Earth Saver One: Combat Bot . . . . .	23	Mechanoid Runner . . . . .	52
Hagan: AA-60 Hunter-Destroyer Bot . . . . .	26	Mechanoid Seeker Pod . . . . .	62
Hagan: Adventures (start on) . . . . .	90	Mechanoid Spider Fortress . . . . .	82
<b>The Mechanoids</b> . . . . .	<b>29</b>	Mechanoid Squads . . . . .	81
A History of Destruction . . . . .	29	Mechanoid Technology . . . . .	86
AbM Origin of the Aberrant Mechanoids . . . . .	31	Mechanoid Tunnel Crawler . . . . .	64
AbM Mutants: Good Guy Mechanoids (optional) . . . . .	33	Mechanoid Wasp . . . . .	59
AbM Brain . . . . .	33	Brute Weapon Package One: Plasma Cannon . . . . .	56
AbM Brute . . . . .	39	Brute Weapon Package Two: Tri-Laser . . . . .	56
AbM Exterminator . . . . .	40	Brute Weapon Package Three: Missile Launcher . . . . .	57
AbM Runner . . . . .	35	Footnotes & Reminders . . . . .	87
AbM Seeker Pod . . . . .	42	Hierarchy & Population . . . . .	81
AbM Tunnel Crawler . . . . .	43	History of Destruction (Origin) . . . . .	29
AbM Wasp . . . . .	37	Origin of the Aberrant Mechanoids . . . . .	31
		<b>Mechanoids Robots</b> . . . . .	<b>72</b>
		Assault Probe . . . . .	77
		Mock Men . . . . .	72
		Runt Combat Robot . . . . .	75
		Runt Repair Unit . . . . .	76
		Skimmer . . . . .	78
		Thinman . . . . .	72
		Weevil . . . . .	79

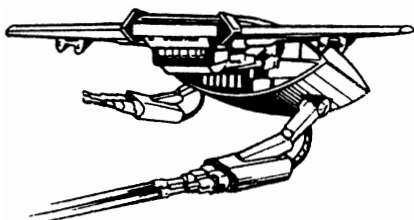

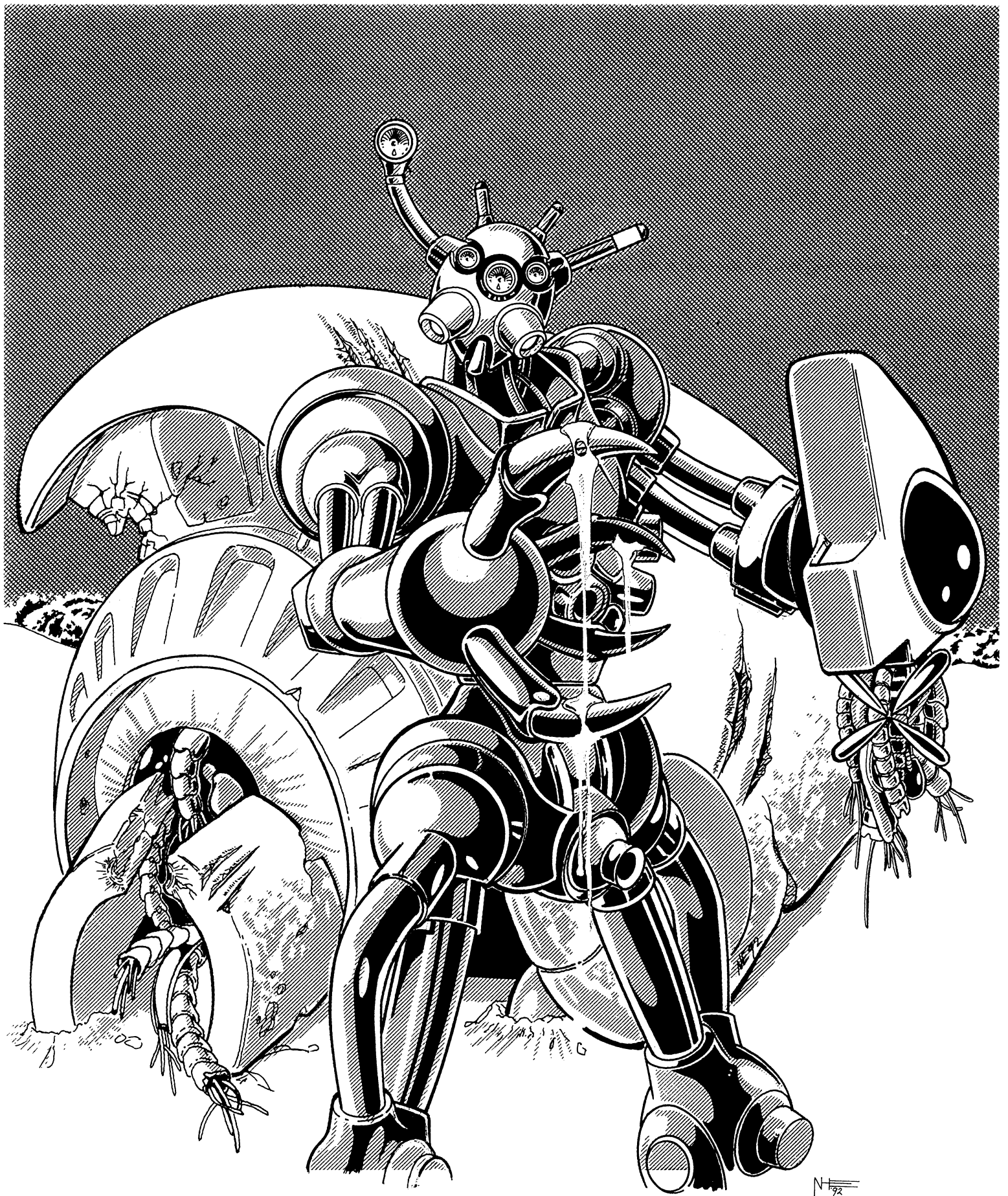

## A Word About the Mechanoids

Old-time fans and collectors may remember the original **Mechanoid Invasion Trilogy** printed way back in 1981 and 1982. As you might suspect, **The Mechanoid Invasion** was Palladium Books' very first RPG. It was 48 pages, comic book sized, printed on newsprint paper, with a million typos and had a cover price of a measly \$3.75 — really.

Palladium has come a long way since those fledgling days, producing one hit RPG after another.

As you all know, I'm not one to do twenty "new" or "revised" editions of the same game, but do I love those Mechanoids. I mean, as a whole, they are some of my best villains! The Mechanoids are tragic, insane, alien, super powerful, and totally deadly — what a great combination! And other people love 'em too! They have sprung up in two different, ill-fated comic books lines, we've had two different, national toy companies try to buy or license them, and I did a so-so rework of the trilogy back in 1985 simply called, **The Mechanoids**. Well, the Mechanoids are back and in the world of **Rifts**.

Old-time Mechanoid fans maybe disappointed to see that these diabolical fiends are relegated again to the role of villains and that there are none of the popular "humanoid" aliens from **Home-world** (the third book in the original trilogy). The reason is that I've been kicking around the idea of doing a science fiction, space exploration game called, you guessed it, **Mechanoid Space** (or something like that). This book would go into great depth about the Intergalactic Federation, the Nigelian Confederacy, alien races (old and new), planets, exploration, piracy, and conflicts between the various life forms. To top it all off, the Mechanoids seem to have returned from the grave. Their appearance in this book is only a prelude of things to come.

For those of you who don't know, the Mechanoid menace suddenly disappeared when the strange cyborgs seemingly committed racial suicide in their distant home galaxy. Even then, scientists speculated that there was evidence that there were Mechanoid survivors, but there wasn't a trace of evidence to prove it. A few hundred years have passed. The Intergalactic Federation is in a shambles, wars and disputes are erupting everywhere. The Mechanoids are a faded memory and much of their evil deeds and destruction are relegated to legend. Then the first rumors begin to trickle in about marauding cyborgs and mass destruction. Could it be the Mechanoids (new and improved too).

I hope I haven't gotten people too excited about **Mechanoid Space** because it's a project that I won't get to for another year or two (the RPG is very tentatively scheduled for 1994). I just thought I'd let you in on some of the things we're thinking about and the reasons the Mechanoids can exist in the **Rifts** time line.

### A brief aside about Rifts Atlantis

We have been deluged by fans asking about the *Mind Bleeder*, *Temporal Wizard* and *Chaing-Ku*, all of whom are mentioned, but never described. The questions range from, "Was this a teaser or accidental omission?" to "Where are these O.C.C.s!? We need them!"

The Chaing-Ku are mentioned because they are the creators of tattoo magic and have great historical significance for Atlan-

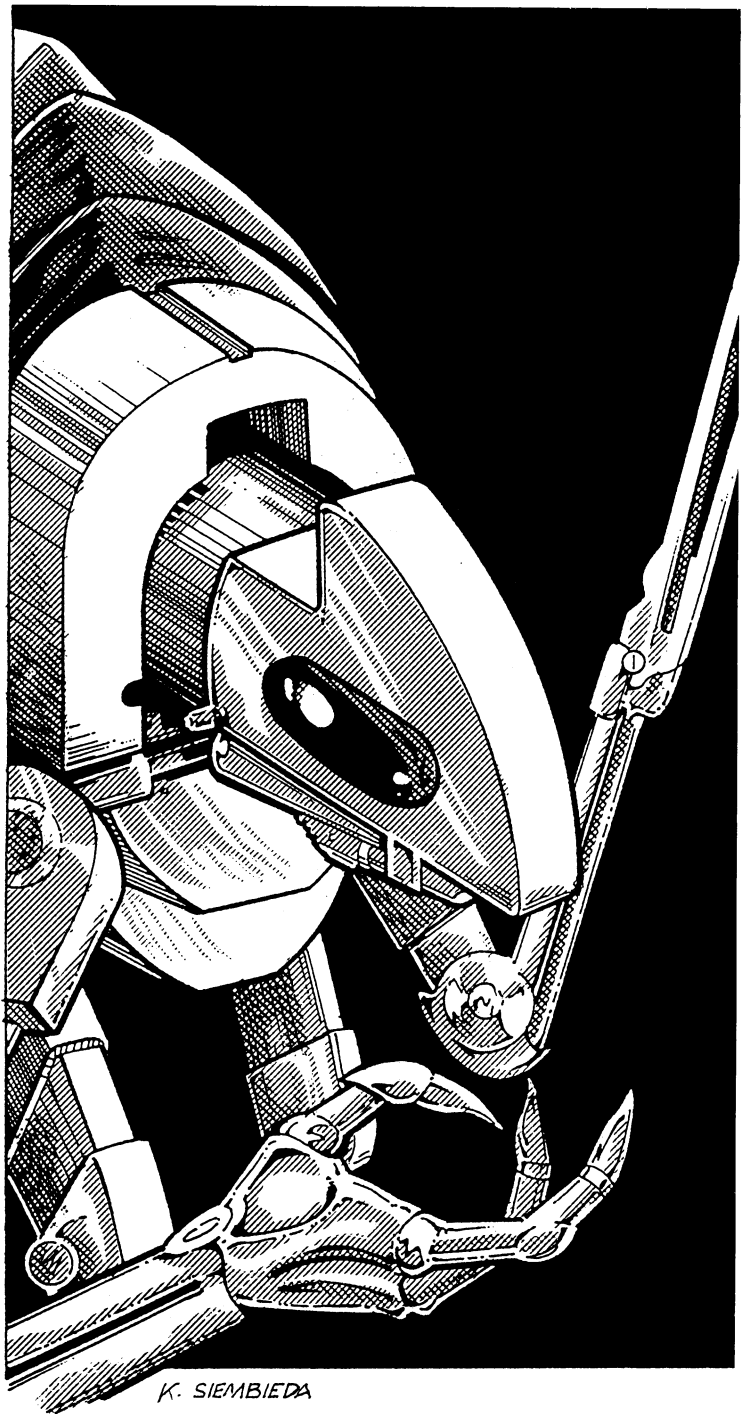

teans. A Chaing-Ku dragon has not been seen for thousands of years and are believed to be extinct (GM's option, really). Consequently, I decided not to include their general stats in the Atlantis book. These dragons may play a part in one of our future world books and if so, I will include character information then. In fact, the Chaing-Ku are likely to appear in **Rifts Africa**. Meanwhile, I hope to be writing a short description for publication in **Dragon Magazine**®, to be published sometime after January, 1993. A specific, S.D.C. Chiang-Ku villain can be found in **Villains Unlimited** (see Chiang-Six — this is where the idea for it and tattoo magic started).

The mind bleeder and temporal wizard will also appear in **Rifts England** or **Africa**. Yes, the temporal wizard in **Rifts** will be very different from the temporal wizard in **Transdimensional Ninja Turtles**.



# The Mechanoid Invasion<sup>®</sup>

---

## Premonitions of a Dangerous Future

---

### An Edict of Planetary Distress

Issued by Plato, Head of the Council  
of Learning at the Free State of Lazlo!

Rifts Earth is a planet in crisis. Just as humans and D-Bees are beginning to learn to work together and civilization is being rebuilt, we must weather the most devastating cycle of danger since the Coming of the Rifts. Those who know me, know that I am not an alarmist or “doomsday prophet” and that I practice great discretion, so heed this warning well for I fear we are about to face our greatest challenges of this epoch.

Over the past several months, psychics all over the world have been experiencing sensations of dread and feelings of anxiety and anticipation. The most powerful psychics, including one of our own Council members, have reported “visions” of chaos and mass destruction. Without exception they report waves of danger, probably attacks by alien or supernatural invaders from other dimensions. Some report four different threats or assailants, others report seven. The danger each represents will threaten every creature on this planet, from human to dragon. All agree that the people of Earth shall suffer greatly, unless we are prepared and crush the invaders before they can gain a foothold in our world.

### A Call to Arms

Please understand that this is no ordinary threat. Thousands of psychics have experienced these “shared” visions and feelings of dread. These visions and sensations are an unprecedented supernatural event in and of itself. It is almost as if the very planet is screaming to warn us. Indeed, the magic energies that encircle and binds us to our living planet may be the source of these premonitions. *The Council of Learning* has investigated each and every claim of precognitive sight and related reports for several months and have determined the danger to be very real.

Additionally, we have learned that psychics within the Coalition States, Triax, and Atlantis have experienced similar visions of doom. In an effort to promote peace and cooperation, this Council, under the authorization of the *Congress of the Electorate of Lazlo*, has sent Emperor Prosek, of the **Coalition States**, all the data and speculation we have amassed concerning this impending crisis. Furthermore, we have suggested that the CS cease all acts of aggression and consider the creation of an alliance with Lazlo, New Lazlo and the State of Tolkeen, among others. The **Coalition States** have not dignified us with a response, nor do we expect one. However, we have noted a dramatic decrease in military activity and an increase in the number of defensive fortifications and reconnaissance activity.

This Council has sent similar proposals to other kingdoms, including Kingsdale, Whykin, Tolkeen, The Manistique Imperium and the Northern Gun of Ishpeming. Most have refused

to take part in an official alliance, citing such reasons as the fear of losing their autonomy or neutrality and/or inciting the paranoid Coalition States to take action against us all. Tolkeen has refused for fear of making us a military target of the CS, but has promised to fight at our side for the survival of all sentient life should the time come. Most have agreed to share information and a handful of small communities have agreed to the temporary alliance.

### The Coming Danger

I wish I could tell you the names and give you the faces of our enemies, but I cannot. Psychics tend to have “feelings” rather than concrete data or evidence. The visions of these gifted individuals are only brief glimpses of what might be our future. Their visions are shrouded in innuendo and symbology. The exact meaning and measure of the future sight can only be left to speculation. The information that follows is drawn on consistent and recurring reports from reliable sources. I will personally vouch for its validity and accuracy.

- The Earth will experience the coming of seven demons and four great dangers, each threatening oblivion. Most psychics envision the waves of destruction as the coming of a particular “demon” or group of demons. Unless the danger is quickly and bravely met and the demons repelled or destroyed, they will inflict “waves” of destruction unlike anything we have seen since the eruption of the rifts. The destruction will probably be the result of alien or supernatural invaders from other worlds.
- The most immediate and potentially devastating danger will arrive very soon, perhaps in a matter of days. Most psychics refer to this danger as “The Devourer” and/or “The Swarm.” Many have reported visions of a cloud or swarm of armored demons that sweeps the land like locusts destroying everything in its path. Others have had visions of complete destruction including the devouring of the entire planet to feed the demon’s insatiable hunger.

Unlike most invaders, the Swarm functions as one and comes not as a conqueror, but as a “destroyer!” All agree that the Devourer is insane, driven by unreasoning hatred and a lust for murder and absolute destruction. The Devouring swarm will show no mercy and destroy every, man, woman, and child; human and D-Bee, and all who stand against it. Worst of all, if Earth falls to the swarm, it will open dimensional rifts to new frontiers and spread its madness and destruction throughout the Megaverse!

- The Devourer will arrive soon. The point of arrival is near. Most psychics agree the danger will come from the east. Some insist it will be the eastern coast of the old American Empire, but none have pinpointed the location.
- The denizens of Atlantis know and fear this demon because they have fought it in the past, but it is not clear whether they will join the fight or flee our world.

- If we lose the battle against the Devourer, the other dangers are unimportant for we will all be dead. Sadly, I am told that the swarm is beyond reason and we can show the invaders no mercy. All must be slain, for if even one survives, the entire race survives and a new swarm will be created to again threaten all sentient life.
- If we are fortunate and the Devouring Swarm is defeated, we will be quickly challenged by a new danger. Four demons with the powers of the gods will seek to open a portal of destruction. The four will each act alone and begin their quest at different places on the same continent. Although separated, each shares a common goal: to unleash destruction upon the world. Should the four meet, they will combine their strength and become virtually unstoppable. If destroyed one by one, before they can unite, their power will be greatly reduced and their ability to open the portal of destruction will also be greatly reduced.

Wherever these four demons tread, there will be sorrow and pain, pestilence and famine, and much death. Again, the monstrous denizens of Atlantis know and fear these demons to such a degree that they will not join the conflict even to save themselves. However, they have revealed the birthing place of these invaders; the continent of Africa!

- I am told the next danger has already established its foothold in our world. It is an old enemy who has established and lost a kingdom on Earth once before, long before the Time of Rifts. It is the rifts and the magic that has freed the imprisoned demon and has enabled him to return to our world.

This one is the weakest of the seven dangers, but the most cunning. He will quietly hide in the shadows of men and surround himself with noble champions, but all are mere puppets and dupes to be manipulated into building his empire. He is a being of many faces couched in deception. He is one who disguises himself as an angel and benefactor of men. He appears to be a champion of honor and goodness, while in reality he is the spawn of a demon who craves only power and the enslavement of those he pretends to champion. A force of evil whose power grows slowly, but ever so steadily.

This danger is not in this part of the world. However, the location of this fledgling kingdom remains a mystery, because Earth is a planet where there are thousands of kingdoms clawing for survival. We can only take comfort in the knowledge that this demon will not become a power to be reckoned with for another 20 years. With luck and an ever vigilant eye, we will see through his charade and strike him down.

- The last demon and his danger is distant and unclear. It will arrive out of chaos to create even greater chaos. The danger will appear within the next twenty years and will grow quickly to threaten the entire world. Many have speculated that the land of chaos is Europe, particularly at or around the New German Republic where humans are locked in an endless battle against demonic forces. Some have speculated that it is Triax or a demon lord who will be the source of this danger. Others see Prosek and the Coalition States as the danger, while others suggest the Calgary rift as the likely source of such trouble. Still others have pointed an accusing finger at China; an alien place steeped in magic and lore that we know little about. To be honest, this last danger could

appear anywhere, including our own back yard. All we can do is wait and be prepared.

For now, we must focus our attention on the most immediate danger, the Devouring Swarm. Scores of cyber-knights and champions of light prepare to scour the Eastern coastline. Communities, especially those in the east, should prepare themselves and strengthen their defenses. Citizens and vagabonds should report any strange occurrences, particularly the appearance of new rifts or strange, inhuman, alien beings. We encourage adventurers and champions to take up the quest and seek out the Devouring Swarm. Remember, there is no reasoning with these creatures. We are in the loathsome position of kill or be killed. With courage and honor, we will survive.

**Plato**  
**Head of the Lazlo Council of Learning**



## The Coalition States

### Troops on the Prowl

The Coalition States have stepped up patrols and defenses within CS territory. They have also dispatched seek and destroy squads to the east, including dog packs, SAMAS and armored patrols (UAR-1 & IAR-2 bots). Free Quebec has even sent a few Glitter Boy patrols to the southeast to assist in the investigation and has a GB platoon on full alert, ready to be dispatched at the first report of contact with the enemy.

The CS has shown impressive restraint and judgement by *not engaging* in the wholesale slaughter of non-humans. This is largely due to their forces being spread thin throughout the CS territories and the large number of troops committed to their campaign against Tolkeen. Thus, they cannot afford to incite unnecessary conflict on other fronts.

**GM notes about the Coalition.** Under the circumstances, the majority of CS patrols will actually fight alongside non-human heroes and adventurers. At the GM's discretion, the soldiers may temporarily join forces with a player group to fight the enemy. Remember, not all CS troops are evil or totally prejudiced against all non-humans, sorcerers or men of learning.

Furthermore, they are good tacticians and understand the necessity of temporarily working with a lesser evil to defeat a common foe. However, such “unofficial” alliances are likely to be very limited.

CS soldiers will be cool and aloof, particularly toward non-humans and wizards. Conflicting ethics, beliefs and conduct between the two groups may lead to accusations, arguments and fighting. On the other hand, the close association might breed friendship and understanding. It all depends on what the GM is looking to establish in the story and the disposition of both the player characters and non-player characters. Regardless of the outcome, it is an element that can add color and depth to the adventure.

## The Minions of Atlantis

Triax spies have shared information with the Coalition States that the rulers of Atlantis are quietly upgrading their defenses and seem to be preparing for war. The Kittani minions seem especially agitated and active (including the readying of the secret Kittani Dragon Dreadnought — See **Rifts Atlantis**). Triax assured their CS allies that the activity in Atlantis does not appear to be preparations to wage war against any of its neighbors, and are primarily defensive in nature. They have correctly surmised that the inhabitants of Atlantis have also experienced visions warning of the Devourer and as a result, are preparing for a possible conflict.

**GM notes about Atlantis.** Lord Splynncryth and the Kittani people recognize the psionic premonitions to be warnings about the *Mechanoids*! Both have seen the Mechanoids in action; the Kittani would have been obliterated by them if not for the intervention of Lord Splynncryth. The Splugorth would prefer to avoid conflict with the Mechanoids, but the Kittani minions crave revenge and warn that there will be no escape if the cyborgs conquer the Earth and seize control over the dimensional rifts.

One of Splynncryth’s strategic concerns is that joining the battle too soon would reveal the true power of Atlantis and evoke fear among the lesser civilizations on Earth. A fear that could incite these people to attack Atlantis. As a result, Lord Splynncryth has decided to wait and watch, hoping that the people of North America are up to the task of stopping the Mechanoid menace. However, he has agreed to let a number of military squads, mostly Kittani warriors and other minions, to travel to the North American coast to do what they can to prevent this crisis.

This means that like the CS, the Minions of Splugorth may temporarily fight alongside humans and beings they might otherwise consider an enemy or an inferior. The Kittani are the most likely to feel a kinship toward humans, elves and wolfen (the latter because of their ingenuity and skill as warriors). This could be an excellent opportunity for Game Masters to introduce characters from Atlantis into the North American campaign setting as both player and non-player characters (GM’s option).

Typical squads of minions will consist of four to ten warriors, although lone operatives and pairs are also possible. **The typical Kittani squad** will consist of four to six warriors, all clad in either Serpent power armor (with energy axe) or Equestrian power armor (with energy lance), plus one or two additional soldiers operating a Creax armored rover and/or two or three

ABS-3 security drones. **A mixed infantry team** will contain two Serpents (with plasma axe and energy rifle), two Equestrians, two Manlings (with jet packs and K-1000 spider systems), two ABSS-2 security drones and one Creax unit. **Other squads of minions** will be organized in the same types and numbers as the **Refugee Exterminator Squads**. The Splugorth does not expect most of these squads to return, so this is a great opportunity for heroes, slaves, rogues, and miscreants to escape Atlantis.

## Other Kinds of Trouble

### Hotheads & Psychotic

---

### Hunting Parties

---

Unfortunately, for all the good Plato’s warning has done, it has also caused a certain amount of panic, stupidity and persecution. There are groups of aggressive, paranoid vigilantes patrolling the streets of most communities; anybody who looks too alien or suspicious is run out of town, imprisoned, beaten or killed.

The worst of these hunting parties are arrogant bullies who have taken the call to arms as an excuse to cause mayhem, garner power or kill. These frequently operate as travelling bands of mercenaries, spoiling for a fight. They are mean spirited, bigoted men and women who like to hurt others.

The most dangerous groups are fanatical human supremacists who hate and fear all D-Bees and monster races, including dragons. They sincerely believe non-humans as to be “in league with the devil” and “an enemy to all humankind.” Some believe that it is the presence of the D-Bees that has caused all the problems. These individuals will persecute all weaker non-humans, punishing them both physically and emotionally. They will commonly belittle, humiliate and threaten non-human travelers into leaving the area or face deadly consequences. Those who do not get the message are beaten and robbed or, all too frequently, tortured and killed. Often, their bodies will be hung from trees and city gates, impaled on poles or hung from crosses as a warning to others.

Many of the wilderness hunting parties are composed of bandits who harass, attack, and slay victims, both human and non-human. They use the atmosphere of fear as justification for their actions. They will claim that non-humans were responsible for the death of any human beings.

Overall, it is the monstrous, animal and inhuman looking beings who suffer the greatest injustice at the hands of humans and human looking D-Bees. Many of the D-Bee nomads and wilderness people have temporarily gone to D-Bee towns and villages where they feel safer. Other wilderness folk have just “dug in,” with weapons in hand, ready to fight for their land and their homes with every last ounce of their strength (these people tend to be nervous and don’t trust strangers).

**GM’s Note:** Most vigilantes and hunting parties should be played as scoundrels and lynch mobs, crazed with blood lust or fear. These groups can be an occasional help, but more often than not, they are a hindrance and an enemy to the player characters, especially those travelling with non-humans.

# Doomsday Cults

First of all, word of the “Seven Dangers” and the possibility of obliteration has given rise to prophets of doom. In their least dangerous form, these so-called prophets are vagabonds, minstrels and preachers warning of impending destruction and a call for repentance. The more extreme prophets preach of doom and make a call to expel, avoid or kill all non-humans.

Misanthropes of evil and selfish alignment and those who have given up hope have become increasingly active, cruel and violent. Places like the Burbs and lawless wilderness towns have seen a dramatic rise in theft, gang activity, arson, murder, vampirism, blood sacrifice, and other violent crimes. After all, it’s the end of the world, what have villains got to lose?

The real dangers lie with fanatics and evil opportunists who use fanaticism and fear for their own gain. They not only call for the slaughter of non-humans (or vice versa) but encourage, condone, and typically participate in murder, theft and rioting. Many blood cults and practitioners of dark, sacrificial magic have jumped on the bandwagon to gather recruits, wealth and power.

## The Children of Doom

The most notorious of the blood cults is the organization known as the Children of Doom. The cult was recently driven from the foulest pits of the seediest burb around Chi-Town. It is comprised mostly of non-humanoid monsters. The leader is Nrrii (pronounced Near-ree), a Neuron Beast (see **Rifts Sourcebook One, Revised**, for complete details about the beast). His existence in the burbs was kept secret to all but select members of his blood cult. The cult became a refuge for non-humans seeking protection from humans and other ruffians.

Nrrii is also psionic and has had visions revealing that “non-humanoids” have nothing to fear from the Devourer, as long as they do not ally themselves with humanoids. He revealed this cosmic revelation during a mass meeting of his faithful. He proclaimed the Devourer as the “Liberator” and to be his minions the “Swarm of Vengeance” who will devour their enemies and raise non-humanoids to power. Their first act of “liberation” was to slay, on the spot, all cult members who were humanoid (about 60%). They then started a riot, killing scores of people and injuring hundreds. They then fled the burbs to meet the “Liberator”.

Later visions have revealed to Nrrii that the “Liberator” will arrive in a matter of weeks near what was once the capital city of the American Empire. Thus, he has mobilized the cult and all prepare to join forces with and help the Liberator when he arrives among the ruins of Washington, D.C. Along the way they preach their beliefs, raid and destroy towns and villages and gather monstrous recruits.

While some may consider their actions foolish, Nrrii is absolutely correct. The Mechanoids have no ill will toward non-bipedal, non-humanoid life forms and *will* accept them with open arms. Furthermore, the Mechanoids *will* liberate them out from under the yoke of humanoid domination and help them build a new civilization free of humankind.

**GM’s note:** The cult of the Children of Doom and its members provide an evil menace that can be a reoccurring source of

villainy throughout this adventure and continue throughout the regular campaign. Certainly, our heroes should encounter at least a few of these insane and murderous monsters during the adventure.

Here are some adventure ideas. One could be that the cult tries to protect an escaping Mechanoid brain and/or runner so the Mechanoid can create/clone/build more Mechanoids. Another possibility is that the group allies itself with the Mechanoids and becomes part of the legions that must be vanquished (the cult’s presence will add magic and more psionics to the Mechanoids power base). Of course the player group can encounter one or more of the cult members attacking a village, threatening innocent humanoids, and so on.

Along these lines, it might be interesting to have the player characters have a few minor skirmishes with the cult and learn enough about them to know they mean trouble, but also that the cult members *know* where the Devourer is going to arrive. They can then follow them to the location and have a jump on the action. Or if (when) the Mechanoids are defeated, the cult seeks revenge against those responsible — this could be a continuing theme and trouble. It is also possible that the surviving cult members (if any) will try to rebuild their organization and try to find the dimensional portal to the Mechanoids’ homeworld (an incredibly difficult task but not impossible). Again, this can be the source of future trouble and adventure (maybe they can accidentally unleash something from a rift, etc.).

There are so many possibilities that I leave the cult and the information about them at the disposal of the Game Master to do with as he or she pleases.

## Nrrii the Neuron Beast

All Neuron Beasts are incredibly intelligent and curious, but also cruel and manipulative. All are psychic vampires who feed on the emotions of those around them. In this particular instance, the neuron beast who calls itself Nrrii found the humanoids in the burbs of Chi-Town to offer a vast selection of delectable emotions. He created the cult as a means to attract tormented beings festering with hate, anger, fear, sorrow and dreams of revenge — sorrows and anguish which Nrrii drank like sweet nectar.

The cult had been in place for nearly a year when Nrrii began to experience flashes of psychic insight and visions about the coming of the four dangers and the Devourer. At first, he simply used the visions as a source of inspiration to stimulate greater fear and turmoil among the denizens of the burbs, but after a while he realized these visions had greater significance, that he was honestly glimpsing the possible/probable future. A future filled with hot emotions stirred up by struggle and the horror of oblivion. Yet even more than that, the beast was given insight about the harbinger of doom and saw not only a means to survival but to garner power as well.

“The Liberator”, will reshape the world. The Swarm will obliterate the insects known as humans and all life forms even remotely similar, allowing the so-called “monsters” to claim their rightful place. Once the Earth is theirs, the Liberator will use it as a stepping stone to carry the destruction from world to world by means of great space travelling vessels and dimensional

rifts. The idea of such cosmic destruction is a siren call to the maleficent Nrrii, with promises of power, intrigue, and oh such magnificent emotions, a veritable feast of emotions. The thought of tasting the last emotions of a dying race is the most alluring promise of all. Such sweet, sweet, incomparable anguish. And is it not ironic justice that one such as he and his followers come to feast with The Devourer on the last emotions of the dying? Even thinking about it creates a certain degree of ecstasy for the horrid being.

The beast is a fair leader and a good planner. His major flaw is that he is so enraptured by the vision of tasting death on a cosmic scale, to drink deeply the last emotions of entire races of people, that he has become obsessed by the vision. Like a man consumed by lust, all he can think about is finding the Liberator and helping to destroy all humanoid life, first on Earth, then throughout the Megaverse. The intoxication of this vision can make him a charismatic, bold leader and adversary. Yet at the same time, Nrrii is driven to recklessness and foolish sacrifice when he fears the dream may be taken away from him.

**Note:** If the Mechanoids are all killed but Nrrii survives, he will go completely insane. This will lead to his own campaign of murder and destruction of humans and bipeds, using his cult as the vehicle for his madness. He and his fanatical followers will preach about the glory of the second coming of The Liberator and promote anarchy and the practice of blood sacrifice. He will also seek to find and open the rift to the Mechanoids homeworld (a one in a billion chance). If he cannot, he will capture, torture and kill those directly responsible for the destruction of the Liberator. Nrrii and the cult can be a great continuing antagonist.

### Neuron Beast

**Alignment:** Miscreant

**Attributes:** I. Q. 28, M. E. 23, M. A. 22, P. S. 20, P. P. 16, P. E. 21, P. B. 4, Spd 44 (30 mph/48 km).

**Hit Points:** Mega-damage creature.

**M.D.C.:** 700 main body, plus each of the four arms has 100 M.D.C. and each of the 14 tentacles has an M.D.C. of 50. Never wears armor.

**Horror Factor:** 14

**P.P.E.:** 180, **I.S.P.:** 163

**Weight:** One ton

**Size:** 20 ft (6 m) tall and hovers about three feet (0.9 m) above the ground.

**Experience Level:** Third level magic user and psionic. Neuron beasts are notoriously lazy, seldom study and don't use their abilities except when absolutely necessary, thus they gain experience slowly — requiring twice as many experience points as the dragon.

**Natural Abilities:** Keen color vision, floats and hovers in the air (maximum speed 44) and can even hover above bodies of water. Impervious to normal heat and fire (mega-damage fire and plasma does half damage); hates the cold. The creature can also regenerate 1D4 × 10 M.D.C. per hour but cannot regenerate completely severed limbs. See magic and psionic powers.

**Magic:** P.P.E.: 180. Two spell attacks per melee and victims must roll a 13 or higher to save. Knows the following magic spells. **Non-offense Spells:** Escape, heal wounds, fool's gold, globe of daylight, fingers of wind, invisibility: simple, levitate, charismatic aura, multiple image, shadow meld, stone

to flesh, calling, Eyes of Thoth, tongues, magic pigeon, time slip. **Offensive Spells:** Blinding flash, energy bolt, fireball, call lightning, domination, trance, turn dead, exorcism, constrain being, and simple protection circle. **The tentacles** cause paralysis: lesser (even to creatures wearing mega-damage body armor); identical to the spell.

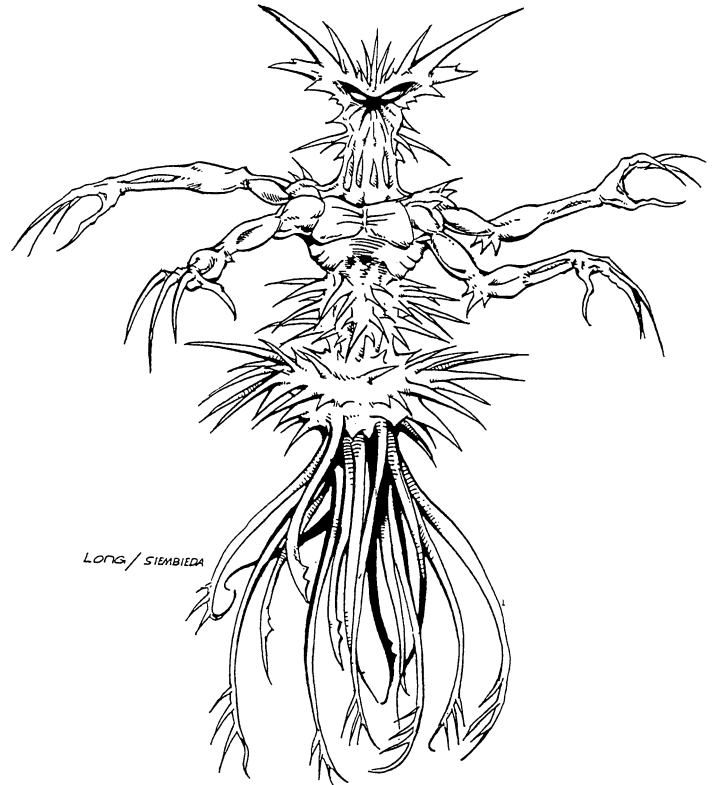

**Psionics:** I.S.P.: 183, three psi-attacks per melee, considered a master psionic. **Sensitive powers** include empathy, telepathy, object read, see aura, see the invisible, sense evil, sense magic and total recall. **Super psionic powers** include bio-manipulation, empathic transmission, mentally possess others, mind bolt, mind bond, P.P.E. shield (as many as one for each of the four hands), psi-sword (as many as one for each of the four hands), mind block auto-defense, and group mind block. Nrrii's favorite weapons/powers include bio-manipulation, empathic transmission, the psi-sword and mentally possessing others.

**Combat:** Eight physical attacks per melee total, or two magic, or three psionic.

**Bonuses:** +1 on initiative, +3 to strike, +5 to parry, +3 to dodge. +4 save vs horror factor, +2 to strike on a body block/tackle, +2 to roll, +2 to pull punch, +5 to damage (S.D.C.), +4 to save vs psionic attack (considered a master psionic, so only needs a 6 or higher to save, including the bonus), +3 to save vs magic, +1% save vs coma/death. Includes attribute bonuses. Impervious to normal fire and heat, mega-damage fire does half damage.

### Damage:

Restrained Tentacle Attack: 2D6 + 10 (P.S.) S.D.C.

Restrained Punch: 4D6 + 10 (P.S.) S.D.C.

Full Strength Tentacle Strike: 1D6 M.D.

Full Strength Punch: 2D6 M.D.

Crush: 1D6 M.D.

Body Flip/Throw: 1D4 M.D.

Impale on Body Spines (must pick victim up): 4D6 M.D.

Entangle/hold: 84% chance of entangling and holding as many as four human size people with its tentacles. The entangled person can not engage in physical combat while entangled.

**Skills of Note (include I.Q. bonus):** W.P. sword, W.P. blunt, demon lore 63%, faerie lore 63%, streetwise 51%, anthropology 58%, astronomy 63%, land navigation 71%, intelligence 67%, radio: basic 88%, math: basic and advanced 88%, and languages include American, Spanish, Euro, Dragonese, Faerie Speak and Gobblely, all at 88%, and literate in those languages that have a written word. He also knows all basic mystic symbols and recognizes runes (but can't read runes).

**Weapons:** Seldom uses any, preferring to rely on his formidable psionic and magic abilities and natural powers. However, in a pinch he will use giant sized weapons of man-made origin and may use trees, rocks, robot limbs, and other debris as a club, shield or thrown weapon.

**Bionics and Bio-Techno Devices:** NEVER uses any. His supernatural and bio-regenerative powers prevents the use of conventional cybernetics. Furthermore, Nrrii will have nothing to do with the creations of humanoids.

**Appearance:** A floating cactus with two eyes, four arms and 14 tentacles.

**Average Life Span:** 3000 + years

**Note:** Prefers hot climates and to be near other intelligent beings to feed on their emotions. Nrrii is not a dimensional traveler.

## Garnak the Beast Dragon

A rash, easily agitated monster that believes violence is the answer to all problems. Garnak is very aggressive, mean, and explosive — he has a nasty habit of hitting/attacking or smashing things when frustrated or angry. He enjoys slaughtering humans and all life forms that are weaker than him. Garnak is subservient only to Nrrii and doesn't like or trust Nigel.

### Dragon Beast

**Alignment:** Miscreant

**Attributes:** I.Q. 8 (lion), 5 (antelope), 4 (serpent), M.E. 7, M.A. 3, P.S. 30, P.P. 21, P.E. 22, P.B. 6, Spd 30

**Hit Points:** Mega-damage creatures.

**M.D.C.:** 290, plus each head has 50 M.D.C. (destroying all three heads will kill the fiend).

**Horror Factor:** 16.

**P.P.E.:** 30

**Weight:** Three tons

**Size:** Stands about 20 feet tall (6 m) and 50 ft (15.2 m) long from head to tail tip.

**Experience Level:** Equal to a fifth level warrior (use dragon experience chart to increase levels).

**Natural Abilities:** Each head has a separate brain and power; all work together as one. Lion Head: Nightvision 40 ft, track by smell 80% and impervious to psionics. Antelope Head: Nightvision 40 ft and impervious to magic. Serpent Head: Can see the invisible (i.e. magic ability), infrared vision 1200 feet (366 m), and is impervious to poison. General Abilities: Prowl 30%, climb/scale walls 60%/50%, swim 78%, bio-regenerate 2D6 M.D.C. per melee.

**Combat:** Nine (9) attacks per melee! Each head controls and directs three attacks per melee. Generally, each head will use two attacks (6 total) biting or using their toxic breath, while

the other three attacks are from the main body in the way of slashing claws. The fact that the three heads work as a simultaneous three-man team means that the creature can fight three different opponents at the same time and from three different directions, including from behind (because the neck is so long and flexible). Three heads are better than one, enabling the monster to see and respond to multiple attacks and/or be more aware of what's going on around it. Each head can control the body with a thought, providing incredible agility.

**Damage:** Lion Head: Bite: 4D6 M.D. Antelope Head: Bite: 1D6 M.D., head butt with horns 2D8 M.D., or fire breath doing 3D6 M.D. (range: 80 ft/24 m; can perform two breath attacks per melee). Serpent Head: Bite does 2D6 M.D. or toxic breath doing 6D6 S.D.C. damage to any who breathe it unless victim saves vs poison (range: 40 ft/12 m, covers a 20 foot area, dissipates instantly; can perform two breath attacks per melee) Main Body/Claws: 3D6 M.D.

**Bonuses:** +6 to strike, +7 to parry, +9 to dodge, +4 initiative, +3 to save vs psionics, +3 to save vs horror factor, +7 to save vs magic, drugs and poison; stats include attribute bonuses.

**Magic:** None, other than natural powers.

**Psionics:** None

**Appearance:** The creature has the body of a dragon and three different heads on a long, serpentine neck. The center head is a lion, the one to its right is a serpent, and to the left an antelope.

**Average Life Span:** 2500 years

**Skills of Note:** W.P. sword, W.P. blunt, demon lore 45%, faerie lore 45%, land navigation 56%, track animals 50% (20% to track humans), hunting, and languages include American, Dragonese, Faerie Speak and Gobblely, all at 70%; illiterate.

**Weapons:** Seldom uses any, preferring to rely on his formidable natural powers and brute strength. However, he may lash out with a giant-sized sword, club or trees, rocks, and other debris as a club, shield or thrown weapon.

**Note:** He carries his treasure with him in a belt of large, saddle-bag-like pouches. They include 50,000 credits' worth of gold, 40,000 in jewels, 5000 in silver, 15,000 in pre-rifts artifacts, plus an NG-super laser pistol, six standard E-clips, two fusion blocks and five high explosive grenades (the weapons are part of his treasure and not intended for use as weapons — not even Nrrii knows about the explosives).

## Nigel the Nightstalker Dragon

In practicality, Nigel is the single most powerful member of the cult, dwarfing even Nrrii in M.D.C., the regeneration of M.D.C. and magic power (he has more experience/higher level and knows more spells). Despite this, Nigel is lazy and shiftless, so he prefers to take a back seat and let somebody else have the responsibility and work of being the leader, while he enjoys tormenting other life forms and gathering wealth and power for himself. The cult is simply a means to have some fun, gather power and survive the horror of the Devouring Swarm.

Within the group, Nigel tries to do as little work or physical fighting as possible. Instead, he prefers to talk and negotiate his way out of trouble. He is a master of trickery and subterfuge.

He is a fast thinking, clever, conniving and masterful liar. His voice is deep, even, and as smooth as silk, with a tone of confidence and a touch of the sinister. He seldom raises his voice for any reason except for dramatic effect. Consequently, it is virtually impossible to tell when he's angry, nervous, lying or telling the truth. In a combat situation, he prefers to hang back and either attack from a distance or cause mayhem and confusion with his magic. He often disguises himself as a different, weaker creature through physical metamorphosis and often serves the cult as a spy and infiltrator — work that he loves.

Nigel considers Garnak to be a stupid brute, but he appreciates what the raw power and animalistic savagery of the dragon beast offers the group. One of Nigel's favorite intimidation tactics is to play good cop, bad cop, with Garnak acting as the slobbering bad guy and he being the good fellow keeping the beast at bay — provided the person cooperates. He often uses the beast dragon as a threat. Garnak dislikes Nigel because he is so lazy and non-combative. Much to Garnak's frustration, he knows that the nightstalker has manipulated him on more than one occasion. Because Nigel is so devious and tricky, Garnak is suspicious of everything he says or does and tries to avoid working with him.

### Adult Nightstalker Dragon

**Alignment:** Anarchist

**Attributes:** I.Q. 19, M.E. 18, M.A. 24, P.S. 28, P.P. 17, P.E. 22, P.B. 21, Spd 50 running (35 mph/56 km) and 90 flying (60 mph/96 km).

**Hit Points:** Mega-damage creature.

**M.D.C.:** 1200

**Horror Factor:** 14

**P.P.E.:** 350, **I.S.P.:** 60

**Weight:** 2.5 tons

**Size:** 10 ft (3 m) tall and 40 ft (12 m) long.

**Experience Level:** Equal to an 8th level practitioner of magic and a 3rd level shifter.

**Natural Abilities:** Breathes fire, fly, nightvision 600 ft (183 m; can see in total darkness), see the invisible, poor day vision (about half that of a human's), track by smell 84%, resistant to fire and cold (normal fire and cold does no damage, M.D. fire and cold does half damage), teleport self 88%, dimensional teleport 24%, and metamorphosis at will (can hold the same shape for 32 hours). The dragon can also regenerate 1D4 × 10 M.D.C. per minute. See magic and psionic powers.

**Magic:** P.P.E.: 350, eighth level spell caster, third level shifter.

Two spell attacks per melee and victims must roll a 15 or higher to save. Knows ALL levels 1-3 spell magic, plus animate and control dead, turn dead, exorcism, resurrection, remove curse, heal wounds, stone to flesh, shadow meld, Eyes of Thoth, tongues, and magic pigeon.

**Psionics:** I.S.P.: 60, all psychic sensitive powers.

**Combat:** Six physical attacks per melee or four using fire breath exclusively, or two by magic.

**Bonuses:** +4 on initiative, +4 to strike, +4 to parry and dodge, +4 to roll with impact, +2 to pull punch, +13 to damage (S.D.C.), +6 to save vs psionic attack (considered a major psionic so only needs a 6 or higher to save, including the bonus), +8 to save vs magic, +18% save vs coma/death, +4 save vs horror factor. Stats include attribute bonuses. Fire and heat does half damage.

### Damage:

Restrained Punch: 4D6 + 13 S.D.C.

Full Strength Punch: 3D6 M.D.

Power Punch: 6D6 M.D.

Slashing Tail or Kick: 2D6 M.D.

Bite: 2D6 M.D.

Fire Breath: 4D6 M.D. (30 ft/9.1 m range)

Body Flip/Throw: 1D4 M.D.

**Skills of Note:** W.P. sword, W.P. blunt, W.P. energy rifle, demon lore 90%, faerie lore 70%, land navigation 98%, track 80%, identify plants & fruits 80%, streetwise 60%, holistic medicine 76%, math: basic and advanced 98%, and literate in American, Euro, and Dragonese 98%, and additionally speaks Spanish, Chinese, Faerie Speak, and Gobblely, all at 98%. He also knows all basic mystic symbols and recognizes runes (but can't read runes).

**Weapons:** A vibro-sabre, silver ceremonial sword, Wilk's laser scalpel, Wilk's 320 laser pistol and JA-9 variable laser rifle. Tends to rely on wits and magic.

**Bionics and Bio-Techno Devices:** NEVER uses any.

**Appearance:** A long, serpentine, winged dragon with dark blue scales and bright blue eyes.

**Average Life Span:** 4000 years; Nigel's age is 2000 years old.

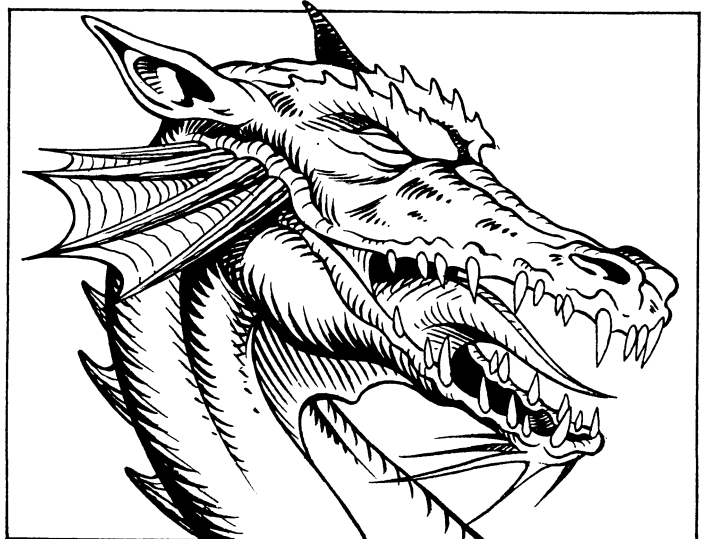

## Other Cult

### Members of Note

Most are the equivalent of 1D4 experience level.

- A dozen Black Faeries (see **Rifts Sourcebook**, page 113)
- Twelve Toadstools (see **Rifts Conversion Book**, page 108)
- A flock of eight Loogaroo (see **Rifts Conversion Book**, page 145)
- A pride of five Manticore (see **Rifts Conversion Book**, page 145)
- Four Malignous (see **Rifts Conversion Book**, page 187)
- A pair of Chimera (see **Rifts Conversion Book**, page 114)
- A pair of Spider Death Weavers (see **Rifts Conversion Book**, page 190)
- Two fourth level Witchlings (questionably humanoid — see **Rifts Sourcebook**, page 117)
- One Basilisk (3rd level dragon — see **Rifts Conversion Book**, page 120)

---

# Archie Three & Hagan

---

## The return of Archie and Hagan

If the player characters have ever encountered Archie Three and/or Hagan in the past, the two villains must have managed to escape. If the player group “thought” they had destroyed the two villains, they were obviously mistaken (see **Rifts Sourcebook One**). Here are some ways for bringing them back into play.

The real Archie Three, the one that is the size of a toaster, managed to survive. He could easily survive the collapsing or exploding of his secret complex. At worst, he would have been temporarily trapped. After a period of time, his bots were able to dig him loose and he was able to rebuild the complex (or possibly build a new complex at a nearby location).

If the player characters actually saw Archie destroyed and examined his shattered body, then the GM can either introduce another menace (perhaps one that has rebuilt the complex or even an Archie Four), or the little, smashed computer brain they examined could have been either a different component mistaken for Archie or yet another ruse — a second fake body to trick attackers. However, the **Rifts** players that I have heard from usually report that Archie Three has survived most encounters based on the original Archie scenario in the **Rifts Sourcebook One** (the adventurers usually believe that the giant, fake brain is the real Archie. He then rebuilds the giant brain after every incident, which serves to cause more confusion and/or fear among his enemies and creates the illusion that he is indestructible).

The more common casualty of the original adventure is Hagan Lonovich, Archie Three’s human partner. If Hagan was supposedly slain, it could really have been a life-like robot decoy or similar trick. It is also possible that the mangled and dying Hagan may have been rescued by Archie’s bots and reconstructed by means of cybernetics like James T, Archie’s original partner. Of course, the GM can introduce a new assistant/partner for Archie in place of Hagan. Such a character would fill the role of Hagan in this book. Whatever the case, Archie Three needs a human associate to participate in this adventure. If Archie should again encounter characters with whom he had a previous destructive or dangerous encounter, the event will only have made him more secretive, careful and vindictive. He will seek revenge or take pleasure in using them for his own secret schemes. Now on to our story.

## Story Background

For the player characters, there may be days, weeks or months of exploration and adventure in the eastern wilderness before the Mechanoids even arrive. These adventures can be as few or as numerous and varied as the GM and his players desire. They could include encounters with bandits, mutants, fanatics, the

Children of Doom, Splugorth Slavers, CS soldiers, wizards, monsters, and so on.

The events that follow are what transpired behind the scenes and ultimately leads to the arrival of The Devourer and his Devouring Swarm, The Mechanoids.

## The Coming of the Mechanoids

Archie Three continues to study and learn more about Rifts Earth. Recently, he has become fascinated by magic and ley lines, particularly the aspect involving dimensional travel. He was surprised and excited to learn that part of the old, underground Cyberworks complex lays on the site of what wizards call a ley line nexus. With the help of his robot minions and Hagan, Archie has been collecting data about dimensional rifts and travel. Information has been gathered through observation, verbal accounts, conversation, video and audio recordings and books. On occasion, the impatient living computer has resorted to capturing and torturing people for information.

It was only a short time ago (a few days or weeks — GM’s choice) that Hagan brought a foolish shifter into the inner sanctum of the underground Cyberworks complex. He offered the shifter a million credits plus a cargo truck filled with over fifty million credits’ worth of bots and equipment if he would open a dimensional rift. The greedy sorcerer was delighted to comply. The mystic energy is strong at the underground site, making the opening of the rift a simple matter.

After a short period of preparation, the shifter began to weave his magic. Halfway through the ceremony, he paused, noting that he “felt” something unusual, as if a presence was telepathically reaching out through the still forming rift. Reaching out not at him or Hagan, but toward a kindred spirit somewhere near (Archie Three). Hagan pressed him to continue, assuring him of his safety and reminding him of the fortune that would soon be his. A dozen A-63 robots, armed with laser pulse rifles, rustled in place as if to second the statement about safety. A dozen bottweilers also circled the area. Their glowing red eyes bobbing through the darkness like red meteors travelling in slow motion through a starless night sky.

Suddenly the subterranean ruins were bathed in blue light as a dimensional rift blossomed out of the darkness. The pillar of seething light seemed to radiate through the ceiling and the earth above it without disturbing a pebble. Hagan wondered if the pillar extended into the sky and if so, how high?

“Beautiful, isn’t it?” cooed the shifter, proud of his handiwork. “As often as I see this, I’m always awestruck by its beauty and power. Now this is a random rift, so I don’t know what’s on the other side. This rift is considerably bigger than I had intended it to be, but all you wanted to see was how a dimensional rift is created and what it looks like. Now I’ll just ...” The high-pitched whistle and lightning bolt flash of a particle beam vaporized the shifter’s upper body. His lower body dropping down like a pair of discarded stilts. Hagan instinctively dove for cover as the world around him seemed to explode.



Dozens of shapes thundered from the rift like a squadron of jets at blurring speeds. Several large shapes also emerged from the sparkling blue light, accompanied by scores of human-sized companions and vehicles (? He wasn't sure). Energy bolts flew from all directions, bottweilers leaped to meet the challenge and fell in an instant. Two A-63 bots were vaporized when they positioned themselves to protect Hagan. A moment later, the rift seemed to collapse into itself. The light vanished, cloaking the "visitors" in darkness.

Hagan, clad in combat armor and jet pack, disappeared by flying up into a man-sized air duct. He was pursued by a hail of energy bolts. A few hit but his armor absorbed the damage. As soon as he turned a corner and flew out of sight, the bombardment stopped. Apparently his assailants were unable or unwilling to pursue him.

Hagan travelled to what he considered a safe distance and paused to catch his breath. The sounds of battle had stopped, but he wasn't certain whether the battle had ended or whether he was simply too far to hear the din of combat.

Hagan began to wonder what he and Archie had inadvertently unleashed in the two minutes that the dimensional rift was open. He sighed and began to relax. "That was a close one," he thought, but now that he was safe, surely Archie's thousands of bots and automated defense systems could handle whatever those things were. He sent a mental message to Archie to see what insight he might have regarding the incident. The response was a disturbing silence. A trickle of perspiration sprung from his temples. Archie was always quick to respond.

"Archie? Talk to me partner. What's the situation?"

After a long moment, Archie responded with, "Hold your position and be silent. Collating."

And then a long silence.

Archie had never acted this way before. His tone was both gruff and nervous. Hagan tried to communicate again only to find their mental connection to be blocked. He tried summoning robots but they did not respond either. Jammed? Not from an outside source. Not here in the complex, anyway. Archie had cut him off. They ... he ... was in trouble. Hagan had never before realized that Archie had the power to override his every command. Suddenly he felt very alone and helpless.

After an eternity of silence and worrying, an A-64 master robot appeared. It came with the portable helmet-link to Archie and a handwritten message.

It stated, "The complex has been breached and compromised by an alien force of undetermined power. I believe they are similar in nature to myself or possibly cyborgs from an advanced civilization. I have temporarily severed my union with you to prevent the aliens from discovering your location and to prevent their access to my data files".

"Be warned that these creatures have an extreme dislike for humans and biped life forms. I have convinced them that you are my slave. An experimental animal. I suggest you play along with this ruse no matter how far it goes. To do otherwise will mean your death, as I fear that I will be helpless to intervene on your behalf. Be submissive to me and our visitors at all times.

"Destroy this letter and return with the A-64. Wear the portable cyber-link helmet at all times. It will prevent the invaders from probing your mind and will keep us in constant communication.

I fear we have dabbled in an area better left alone, but we have no time for regrets, we must gather data and formulate a plan of action. Trust me and be careful, my friend. These are not beings to be trifled with."

## A Bad Situation

---

Archie Three and Hagan Lonovich have quickly realized that these invaders, who call themselves the Mechanoids, are emotionally unstable — crazy. Unlike Archie and Hagan, who desire to someday rule the world, the Mechanoids dream only of destroying it. More accurately, the Mechanoid invaders desire to annihilate all human, humanoid and bipedal life forms! This poses a few immediate and major (albeit selfish) problems for the villainous duo.

First, if all humanoids are destroyed, then who are they going to rule and bully? Every conqueror needs people to manipulate and oppress. Besides, Archie Three still feels a strange kinship to humans. Even in his most vindictive moods he wants to dominate and hurt them, not obliterate them.

Hagan, on the other hand, is human and has no desire to participate in the genocide of humankind. He may be evil and selfish but he has no desire to assist in the extermination of his race. Hagan is many things but he is not a mass murderer. His allegiance will always be with fellow humans and other intelligent bipeds. He has made these feelings very clear to Archie, which has caused Archie Three to feel all the more nervous and uncomfortable.

The second concern for the two is that the Mechanoids are clearly so powerful that if left unchecked, it is they who will conquer and dominate the world. Archie Three realizes that the Mechanoids, at full strength, dwarf his own powers and resources (once considered to be quite formidable, but not by comparison). Inevitably he would find himself a servant to an alien master.

Hagan, if he survives at all, will be brutalized and probably turned into a full conversion borg, a change that will not make him happy. The only reason the Mechanoids allow Hagan's presence is that the quick thinking Archie was able to convince them that he is a plaything completely under his control. The Mechanoids like to torture and experiment on humans, so they approved of the situation, but how long will this ruse last?

Lastly, Archie realizes that even he is in jeopardy from the invaders. They would not understand his friendship with any human nor allow his dependence on Hagan for inspiration, motivation, robot designs and human insight. Thus, Hagan has become a dangerous liability. For an instant, Archie considered killing him, but Hagan is the most imaginative design man he has ever found. Furthermore, Hagan serves as his eyes and ears — a window to the outside world. On top of that, Hagan is loyal, trustworthy and his best (and only) friend in the whole world! Archie doesn't want to lose him. Thus, the die is cast. The two must secretly work to subvert and destroy the Mechanoids.

## Archie's & Hagan's Secret War

Archie and Hagan have hatched a wild scheme that might just work. Hagan will secretly fight to undermine and destroy the invaders. This must be accomplished through deception, cunning, and teamwork.

Hagan had been developing a suit of power armor and a humanoid robot vehicle for himself. Archie has made some special changes and pushed through their construction without the Mechanoids knowledge. Archie has also finished ten prototype robots he and Hagan had been developing as an infantry combat unit for their own army.

Armed with the bots, vehicle and power armor, Hagan has left the complex on his own, secret, “seek and destroy” mission — to destroy the invaders, one by one if necessary. If the Mechanoids inquire as to his whereabouts, Archie will tell them that he has sent Hagan away because he knows the presence of a human disturbs them.

Archie is fortunate in that the Mechanoids see him as a fellow Mechanoid. In many ways his origin parallels their own, right down to the loathing and abandonment by his human creators. Consequently, they have instantly assumed he is a kindred spirit and have confided in him about their strategies and plans. He gives information to Hagan and Hagan uses it against them.

Actually, this scheme is all Hagan’s idea, Archie is just helping him to implement the plan. Since Archie is privy to Mechanoid progress, plans, concerns, weaknesses and strengths, camps and outposts, intended targets, plus Mechanoid troop movements, Hagan and those he helps have a great advantage. By disguising himself and using bots not known to be of Archie Three’s usual design, he can act without fear of implicating Archie or revealing who he is.

## Strategy & Tactics

The plan is that Hagan, in his bot and power armor will bush-whack small groups of Mechanoids. In addition, he will tip off other forces in the area, including adventurers, CS patrols and Splugorth minions, leading them to the Mechanoids and joining the battle whenever appropriate.

Hagan’s and Archie’s entire strategy rests on creating confusion, employing hit and run tactics, and demolishing the enemy whenever encountered — no mercy, no survivors. This can be done with great effectiveness if Hagan helps steer other military forces toward the Mechanoids and assists them from a distance and in subtle ways. He will leave these unsuspecting co-conspirators clues, trails, warnings, and even weapons and equipment (very limited resources, like extra E-clips, the occasional energy rifle, food, medical supplies, etc.) to help them in their campaign against the Devourer.

If the Mechanoids are moving in to ambush the player group, an energy blast may come flying out of the underbrush, strike a concealed Mechanoid and, in doing so, warn the heroes. Or he may send a radio message or suddenly appear in camp, screaming a warning, firing a few volleys and then vanishing into the woods. Likewise, Hagan will appear out of nowhere, jumping into a battle to save human lives and to destroy the Mechanoids. Whenever possible, he will prefer to attack from a distance, like a sniper, or make a brief appearance and then disappear in the confusion.

If a Mechanoid escapes, Hagan will pursue and destroy it. Any player character who follows can join in the battle, but when the battle is done, the mysterious warrior will flee or disappear. If pressed for information as to who he is and/or why he won’t stay with them to fight, Hagan will simply state that

he has his reasons, cannot stay and that they must trust him. He may also infer that his presence will only bring the group more trouble but that he will be nearby.

On occasion, Hagan may join a group of warriors committed to fighting the Mechanoids. However, he is likely to come and go on a whim and is not much of a team player. In most cases, Hagan sees others as a means to destroying the Mechanoids and nothing more.

**GM Note:** Whether Hagan develops any respect or bonds of friendship toward player characters is left to the individual Game Master and the circumstances of the campaign.

---

## The Mechanoids’ Plans

---

**Note:** All this valuable information is at Archie’s and Hagan’s disposal. Archie Three has also been told the entire history of the Mechanoids their goal of total genocide of humans, humanoids and all intelligent bipeds. He knows that they have successfully annihilated scores of entire planets.

1. The Mechanoids hate ALL humanoid life, including the xiticix, werebeasts, supernatural beings and so-called demons of humanoid shape. As a result, even supernatural beings like the sowki, raksasha, gargoyles, and other bipedal life forms are targets for destruction. In fact, learning about the presence of super-powered and supernatural humanoids has caused the Mechanoids great concern and has made them all the more determined to conquer this planet, and to use it as a gateway to other worlds, in order to destroy these new, terrible humanoids.

Mechanoids will be friendly toward dragons, mindolar, alien intelligences and other creatures who are not humanoid in appearance or who do not associate with humanoids. However, they will not tolerate inhuman beings who work with, enslave or rule humanoids. Thus, the Splugorth and vampire intelligences, both of whom control humanoid minions, will be seen as enemies and destroyed. However, the Mechanoids may first try to reason with them and convince them to forsake their foolish ways and join their crusade to destroy humanoids. Some monsters will inevitably agree and join them.

2. More Mechanoids! In addition to the three dozen Mechanoids (a dozen wasps, some runners, brutes and robots) who emerged from the underground portion of the rifts, several hundred emerged on the surface. In fact, a Mechanoid Spider Fortress stepped through the rift. Fortunately, the fortress and its troops were engaged in combat at the time. Consequently, the fortress is nowhere near its full strength, has sustained mega-damage and has about a quarter of its normal troops. The Fortress will be used as a mobile base of operations to draw human troops away from other important operations.
3. The dimensional portal was a random occurrence and cannot be easily duplicated. The only being who might have known how to re-open the rift to the Mechanoids homeworld was the human shifter whom they vaporized upon their arrival. Several hundred Mechanoids made it onto Rifts Earth and none know anything about ley line magic and dimensional gateways. This means they have no way to get home or to summon reinforcements.

Unfortunately, their initial mind probes just before the rift was completely opened took Archie by surprise and the Mechanoids were able to glean some information from him. In an effort to appear cooperative, Archie let the Mechanoids access his data files about dimensional rifts and magic. This information has evoked great excitement from the Mechanoids.

First and most importantly, it is a means by which they can bridge the vastness of space and access countless worlds. As a result, they could expand their campaign of genocide on a truly cosmic scale. Second, the fact that this unparalleled knowledge lays in the hands of humanoids makes them nauseous and strengthens their resolve that humans and their cousins must be eradicated from the universe.

4. Troop movements and plans. The Mechanoids are survivors as much as destroyers and have already begun to implement a diabolical plan for survival and conquest.

They have divided themselves into four groups, each with a different objective. These four may in turn divide into smaller groups to achieve their goals.

**Force One** is very small, including an oracle, two brains, four runners, two exterminators, six brutes and a score of thinmen and runts to stay with Archie at his underground complex. This team has two purposes. One is to learn more about the Earth from Archie and the other is to retool part of his robot factory to build a Mechanoid robot army of thinmen, runts and skimmers.

**Story Note:** Archie's own forces can easily destroy this team, but he is concerned about possible repercussions from the other Mechanoids, or worse, if one of them brings a million more Mechanoids through a rift and destroys him. Archie's first concern is always "self preservation."

**Force Two** is composed of several smaller reconnaissance teams sent out to explore the world, starting with the North American continent (only wasps may conduct fly-bys over Atlantis, Europe and South America). These teams also discreetly destroy humanoids whenever it is appropriate, without jeopardizing their mission. This team is also to gather more information about creating rifts and dimensional travel, but none are to travel to other worlds.

Those involved in Force Two operations may splinter into even smaller groups, pairs or individuals to gather information, spy, conduct research and experiments, and establish small outposts. Runners, exterminators, brutes, tunnel crawlers, accompanied and assisted by skimmers, runts

and thinmen are the bulk of this group. Only a dozen or so wasps are assigned to reconnaissance and serve mainly as a tactical rescue and support unit.

**Force Three** is charged with finding a means to "self replicate" as an alternative to opening a dimensional rift. The Mechanoids are creatures of flesh and machine — true cyborgs. To create an army, all they need is a handful of Mechanoids to be cloned and a factory to build their mechanical bodies. This means that if even a tiny handful of Mechanoids escape the manhunt, they might be able to build an army through cloning.

They need to "acquire" a genetics engineering facility to clone themselves. The Mechanoids can modify and build the facility they need from any high-tech factory with manufacturing capabilities, but taking over an existing facility of some kind would save them precious time. Archie's facility will be used to build an army of robot drones like the thinman, and with time, may be modified to build the Mechanoids mechanical bodies as well. The Mechanoids are smart and seek to establish several genetics and cybernetics factories.

They will pick remote targets in order to keep their presence a secret until they can build that army. CS outposts and high-tech facilities will be likely choices for such a takeover. Secondary targets for conquest, once a reasonable army is built, will be large facilities such as Lone Star or Northern Gun — The Coalition States will be seen as their most formidable opponents. Thus, the CS will be left alone until the Mechanoids believe they are powerful enough to obliterate them.

**Force Four** is a seek and destroy operation coordinated by the Spider Fortress and operates away from the reconnaissance and research teams (staying mostly in the East and moving slowly North toward Free Quebec). This is the largest single group of Mechanoids on the continent. The troops engage in seek and destroy missions simply because the Mechanoids feel compelled to destroy humanoid life! These troops will kill as many humanoids as possible before they are destroyed. Entire towns will be blasted into atoms and hundreds of lives have already been snuffed out like candle flames against an hurricane.

Again, the Mechanoids are good strategists and tacticians and although insane, they will target "reasonable" opponents — namely those they believe they can defeat. Thus, they will avoid major industrial cities and large armies. Instead they will ravage villages, towns, small or primitive cities, CS



SIEMBIEDA / OSTEN

outposts and small squads of soldiers and groups of travelers. Hit and run tactics will be used but even in the wilderness, the Mechanoids' trail of destruction is easily followed.

## Some Notes about Archie Three

It is important that the reader, particularly the GM, realize that Archie Three has his own mental and emotional problems. First of all, he is afraid to leave the confines of his underground complex. The place is more than his birthplace and home. It is his secret sanctuary, an underground fortress that he perceives to be his physical body (that's part of his original programming). The idea of abandoning his "body" and placing his small brain into one of his robots, even an incredibly powerful one, to give him mobility and independence is unfathomable. Archie would never do it, except as a last resort to save himself and flee from an unbeatable enemy.

This feeling of being rooted to one place and never really desiring to travel beyond it, has made Archie Three a **voyeur**. He lives vicariously through his robot creations and through Hagan. Archie prefers to encourage Hagan to take action and watches him and other people with his robots. In this way Archie can explore the world and feel Hagan's emotions from the safety of his secret hiding place within his hidden fortress base (remember, not even Hagan knows that Archie is really a small black box the size of a toaster).

---

## Hagan & His Robots

Hagan Lonovich is a power hungry human with dreams of ruling the world, not helping in its destruction. He is painfully aware that he and Archie have stirred up a hornets' nest that could shatter that dream by destroying all human and humanoid life.

Hagan recognizes the danger the Mechanoids represent and wants them stopped! Archie tends to agree, but had some difficulty taking quick action against the alien invaders. Hagan got him to see the light and both now secretly work to undermine and destroy them.

Hagan will fight with cunning and courage. Is this uncharacteristic for a villain? Not really. Hagan has always been resourceful, he just never had an opportunity to express himself in quite this way. In the past, he always relied on trickery and deception to get what he wanted. He avoided direct confrontations and deadly combat and never had put on the mantle of leadership. However, his ingenuity, resourcefulness, intelligence, courage and other traits as a man of action, leader and strategist were always present. Hagan, always a shiftless rogue, never had a reason to push himself and utilize all of his talents. This situation with the Mechanoids has finally forced him to draw on his every ability.

The villain, at least for the moment, is forced to play the part of the hero. Like the old adage says, "Some people are born to greatness, while others are thrust into greatness." Hagan has just had greatness thrust upon him and he will respond well.

His new power armor and bot vehicle provide him with enhanced reflexes, speed and power. Each success in combat gives Hagan an adrenaline rush and rapidly growing confidence in his

Archie is so dysfunctional that he cannot even come up with his own ideas and designs for his robot creations without Hagan or somebody else (James T was his original assistant). Furthermore, he is relying more and more on Hagan to give his life purpose and direction, like latching on to the idea of world conquest. It's not that Archie doesn't have his own ideas, he has plenty of them, it's just that he has no confidence/faith in them. To him they seem unimpressive and foolish. When he does pursue one of his own ideas, like trying to understand how dimensional rifts and magic works, and something terrible happens, like this Mechanoid problem, it undermines Archie's confidence further and reinforces his fears and feelings of inferiority. For example, he will abandon all his studies about magic and dimensional travel because of the Mechanoid rift dilemma.

As for the Mechanoids, he hates the fact that an alien has invaded his body (the Cyberworks complex) and are interfering with his and Hagan's own plans. He'd like to destroy them and probably could have when they arrived. However, his inability to make a quick decision and his fear that such an attack might fail or have resulted in massive damage to the underground complex prevented him from launching an immediate attack. His inability to take immediate and decisive action has given the Mechanoids their foothold on Earth. It was Hagan's input that got Archie to take action against the invaders. If Hagan is killed, the Mechanoids might be able to talk Archie into really joining them.

abilities as a warrior, tactician and leader. He will quickly come to welcome each confrontation with the Mechanoids as a challenge to test his mettle.

The situation and his successes have made him, for the moment, a caring and benevolent hero who fights to protect the innocent. This will give Hagan, known as "the mysterious warrior," the reputation and respect of a hero. Still, he is evil and out for himself. He tends to view others mainly as pawns and potential enemies to be remembered and dealt with. Those who get in his way, now or later, will be eliminated regardless of any friendship that might develop during the Mechanoid affair. Without a doubt, Hagan will use his reputation as a hero to his advantage, for now it is enough that it makes him feel braver, smarter and more powerful than he has ever felt before. In many regards, his success in this war will make Hagan a more dangerous opponent in the future.

**Note:** Also read the preceding sections on *Archie & Hagan's Secret War* and *Strategy & Tactics*.

### Hagan Lonovich

**Alignment:** Diabolic Evil

**Attributes:** I.Q. 14, M.A. 11, M.E. 15, P.S. 17, P.P. 14, P.E. 12, P.B. 10, Spd. 9

**Hit Points:** 36, **S.D.C.:** 20

**M.D.C.:** See power armor and bot vehicle.

**Weight:** 184 lbs, **Height:** 6 feet (1.8 m), **Age:** 29

**P.P.E.:** 7, **I.S.P.:** 40

**Experience Level:** Sixth (6) level Operator (see **Rifts**, page 76-78). By the end of the Mechanoid adventure, Hagan will be 7th or even 8th level and more confident and bolder than ever before.

**Magic Knowledge:** None, other than rumors, lore and what little he has seen.

**Psionic Powers:** 40 I.S.P. and the power of telemechanics. He is considered a minor psionic.

**Combat Skills:** Hand to Hand: Basic

**Attacks per Melee:** Three (3)

**Bonuses:** +1 to strike, +2 to parry and dodge, +2 to roll with impact or pull punch, and +2 to damage (S.D.C.), plus bonuses and additional melee attacks from his unique union with his special power armor and battle robot.

**Weapon Proficiencies:** W.P. Energy Rifle, W.P. Energy Pistol, W.P. Automatic Pistol, and W.P. Blunt.

**Weapons:** He loves his new power armor and robot combat vehicle (especially the former). Old favorite weapons include the TX-5 pump pistol, Arch-22 pulse rifle, Wilk's laser wand and scalpel. Hagan has several secret stashes of weapons, E-clips, food and medical kits hidden at strategic locations.

**New Power Armor:** See new power armor and bot vehicle. Hagan has three extra helmets and one entire spare suit. If absolutely necessary, he can return to Archie's underground lair to effect secret repairs but that could be very dangerous. As for replenishing supplies of missiles and minor repairs, Hagan will make trades and purchases through normal channels. As his heroic reputation grows among the locals they will be glad to assist him in the way of repairs, food, supplies, healing, information, and hiding places.

**Old Body Armor:** Hagan's old lightweight, molecular, body armor, constructed by Archie (80 M.D.C., weighs 12 lbs/5.4 kg) and a suit of Titan power armor are also available if needed.

**Equipment of Note:** Portable tool kit, lock picks, pocket laser distancer, infrared distancing binoculars, field radio, a motorcycle and a hovercycle, PDD disc player and recorder, RMK robot medical kit, IRMSS internal robot surgeon system, compu-drug dispenser, and healing salve.

**Cybernetics:** Headjack, clock calendar, gyro-compass, toxic filter (lungs), bio-system polarized eyes and perfect 20/20 vision.

**Money:** Hagan has one million universal credits and another four million in rare Pre-Rifts artifacts (the Cyberworks complex is filled with valuable artifacts from 21st Century Earth).

**Skills of Note:** Basic math 80%, pick locks 65%, electrical engineer 75%, robot electronics 65%, mechanical engineer 70%, robot mechanics 55%, weapons engineer 65%, computer repair 65%, read sensory equipment 65%, radio: basic 90%, pilot motorcycle 95%, pilot hover craft 90%, pilot robots and power armor, robot combat: basic, robot combat: elite Titan power armor, general athletics, running, and swimming 85%. He can speak American and Spanish at 85%, but is mostly illiterate. Archie has been teaching him to read and write American, but his skill proficiency is presently only 35%.

**Disposition:** Tough, arrogant, resourceful, and imaginative. Once lazy and selfish, he has become a motivated dynamo out to save the world (so he can conquer it himself later). He once saw Archie only as a means to vast power, but the two have become genuine friends.

**Note:** Under the circumstances, Hagan may seem quite heroic and brave. However, he is still diabolic evil. He fights so courageously because he is trying to save his world. Not all

villains are murderers who despise life. Hagan cherishes life and won't stand by to watch the Mechanoids destroy human-kind.

The entire Mechanoid conflict will dramatically increase Hagan's confidence and will inspire him to think even more about the real possibilities of conquering the world (well, at least North America). It will also permanently cement his relationship with Archie Three (his best friend).

---

## Hagan's Secret Weapons

---

Archie Three and Hagan had finished the design work and had just begun the manufacturing of a suit of power armor and bot vehicle specially designed for Hagan. The two new creations were about to go into production when the Mechanoids arrived. Since then, Archie has made some specific improvements with combating the Mechanoids in mind. Both are tough, fast, and agile, with an emphasis on offensive strikes and mobility. Both the power armor and Hagan's personal robot vehicle are anti-Mechanoid war machines composed of molecularly bonded alloys similar to Archie's bots. Although both are prototypes, they will perform admirably and with only a few bugs.

Archie has purged all data files concerning the creation and design of the power armor and bots. Only a direct link/mind bond with Archie by a Mechanoid Brain, Oracle or Overlord could reveal their existence and origin.

---

## HPA Mark One Power Armor

The power armor conceals Hagan's identity and has psionic shields that, when combined with Hagan's own psionic energy, makes it impossible to read his aura and prevents telepathic probes, mind bond, mind control and psionic possession. The helmet also links him directly to Archie, enabling the two to psionically communicate within a 500 mile radius (800 km).

Furthermore, the armor and bot are designed to take advantage of his telemechanics power in a new way. Without expending more than a few I.S.P., Hagan links himself to his armor and/or vehicle so completely that man and machine become one. The armor and bot respond to thought as if they were an extension of the body, and as a result Hagan can coax more out of the machine and is more aware of its abilities and limits than an ordinary power armor pilot. This provides an increased number of melee attacks and combat bonuses. (**GM Note:** The psionic features, extra melee attacks and other combat bonuses do not work unless the operator is psionic himself and has the power of telemechanics).

### Hagan's Power Armor (HPA)

**Model Type:** Arch HPA-1 "Firebrand"

**Class:** Power Armor

**Crew:** One

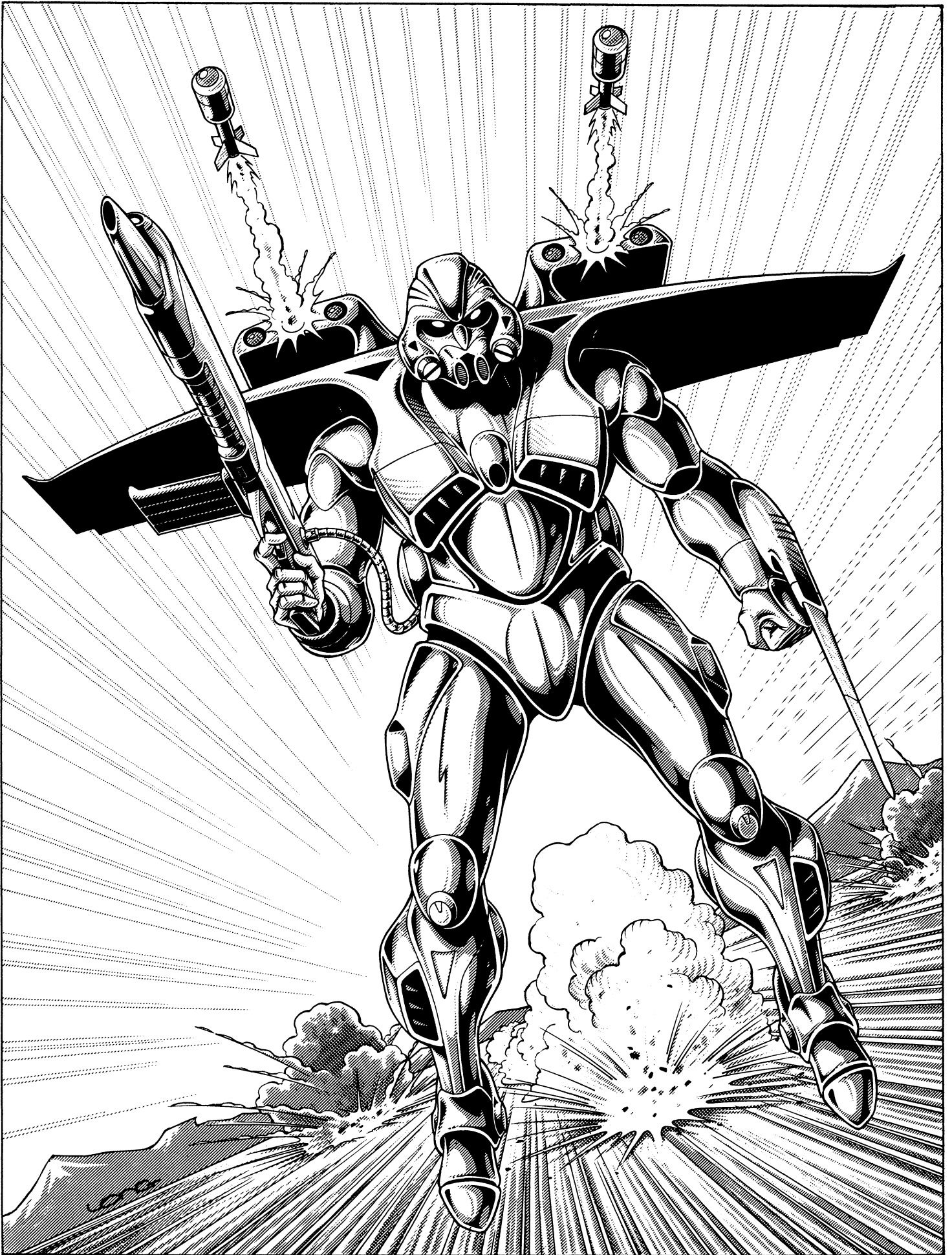

## M.D.C. by Location:

Vibro-Sword (1, left forearm) — 10  
Missile Pods (2, shoulder) — 50 each  
Wings (2, shoulder) — 50 each  
Main Rear Jet (1, back) — 100  
Secondary Jets (2, lower leg) — 20 each  
Arms (2) — 95 each  
Legs (2) — 150 each  
\*Head — 85  
\*\*Main Body — 320

\* Destroying the head will eliminate all optics and sensory systems, and leave the pilot's human head vulnerable to future attacks. **Note:** The head is a small and difficult target to hit. Thus, it can only be hit when a character makes a *called shot* and even then the attacker is -3 to strike.

\*\*Depleting the M.D.C. of the main body will effectively destroy the bot, shutting it down completely, making it useless. **Note:** Destroying the main jet will make flight and power jumps impossible.

## Speed

Running: 70 mph (112.6 km) maximum. Note that the act of running does tire its operator, but at only 10% the normal fatigue rate. Leaping: The powerful robot legs can leap up to 15 feet (4.6 m) high or across unassisted by jet thrusters. A *jet thruster assisted leap* can propel the unit up to 100 feet (30.5 m) high or 200 feet (61 m) lengthwise without actually attaining flight.

Flying: The jet propulsion system enables the HPA to hover stationary up to 500 feet (153.4 m) high or fly at the amazing speed of 600 mph (1000 km)! That's nearly Mach One!! However, cruising speed is more likely to range between 100 mph (160 km) to 200 mph (320 km). Maximum altitude is 5000 feet (1524 m). Range: Unlimited. The nuclear power pack gives the suit a life of 20 years even under the most strenuous and constant amount of use. However, the jets get hot after 24 hours of constant use and require a cooling period of about five hours or may burn out.

## Statistical Data

Height: 8 feet (2.4 m)  
Width: Wings extended: 8 ft, 6 inches (2.6 m). Folded: 3 feet (0.9 m).  
Length: 4 feet (1.2 m)  
Weight: 340 lbs (153 kg); does not include hand-held weapons.  
Physical Strength: Equal to a P.S. 40  
Cargo: None, other than land mine storage compartments in the legs.  
Power System: Nuclear; average energy life is 20 years.  
Black Market Cost: Not available, only two suits have been built.

## Weapon Systems

**1. Mini-Missile Launchers above the shoulders:** A pair of missile launchers are mounted above the shoulders/wings. Each of the missile launchers holds six mini-missiles, three ready to fire and three in reserve (12 total). Additional missiles can be hand loaded at a rate of one per melee round (15 seconds).

Primary Purpose: Assault

Weight: Not applicable; built into the armor.

Mega-Damage: Varies with missile type. Hagan typically uses plasma: 1D6 × 10 M.D. per missile.

Rate of Fire: One at a time or in volleys of two, three or four.

Effective Range: One mile (1.6 km)

Payload: 12 total, six per launcher.

**2. Fusion Block Bombs/Land Mines:** The upper portion of the legs have a compartment that contains fusion blocks. The explosive devices can be used in three different ways. One, as a bomb that is dropped from above and explodes on impact. Two, as a time delayed explosive placed or dropped on a specific target or placed to explode after so many seconds or minutes have passed or a particular time is struck (24 hour clock). Third, as a land mine placed on the surface of the ground and covered with a thin layer of dirt or leaves that explodes when stepped on. The blocks can be set for levels of sensitivity to a particular weight load or amount of pressure (from 100 lbs/45 kg to 2000 lbs/900 kg).

Primary Purpose: Assault

Weight: Two pounds (0.9 kg) each.

Mega-Damage: Varies with type; Hagan uses only type three fusion blocks: 4D6 × 10 M.D.; the blast radius is contained to a ten foot area (3 m).

Rate of Fire: Dropped or set one at a time. It takes 15 seconds, one full melee round, to set the timer and/or other requirements of the block.

Effective Range: 600 ft (183 m) and +1 to strike when dropped from above, -1 to strike for approximately every additional 100 feet (30.5) of height. Otherwise the block must be placed on the intended target. They are not aerodynamic and cannot be thrown far. Hagan can toss one about 200 feet (61 m) but is -4 to strike when thrown.

Payload: Each leg holds six fusion blocks, 12 total.

**3. Arch 230 Plasma Cannon:** This is a large rifle-looking weapon that fires a blast of fiery plasma. The weapon has a 30 shot E-clip (Hagan typically has two additional clips on him or nearby). The gun has an extendible cord that plugs into the armor, giving it an additional 10 blasts. The energy clip can be recharged with this same cord, but it takes one hour to recharge ten blasts.

Primary Purpose: Assault

Weight: 17 lbs (7.65 kg)

Mega-Damage: 1D4 × 10 M.D.

Rate of Fire: Aimed, burst, wild; see Modern Weapons Proficiencies; typically a single shot weapon.

Effective Range: 4000 feet (1200 m)

Payload: 30 shots per E-clip or 10 from the power armor.

**4. Forearm Blaster — Variable Laser:** A short-range laser blaster is concealed in the right forearm. The variable frequency laser is designed to overcome laser resistant armor. The weapon has its own targeting computer which also analyzes an opponent's armor (if not already preprogrammed into its memory). After one melee round, the computer is able to adjust to the light frequency that will inflict maximum damage to the target. The laser is accurate and deadly.

Primary Purpose: Assault

Weight: Part of the power armor.

Mega-Damage: 3D6 M.D. or 5D6 M.D.; two settings.

Rate of Fire: Each individual blast counts as one melee attack.

Effective Range: 2000 feet (610 m)

Payload: Effectively unlimited; patched into the armor's power supply.

**Design Flaw:** There is a 1-50% chance that the laser will not rise out of its housing, preventing it from firing. Roll each time the weapon is to be activated.

**5. 18 inch (0.45 m) vibro-blade (1):** Hidden in the left forearm is a retractable vibro-saber.

**Primary Purpose:** Assault; secondary purpose: defense.

**Weight:** 2 lbs (0.9 kg)

**Mega-Damage:** Vibro-Saber: 2D4 M.D.

**Range:** Hand to hand, with about a 5.6 foot (1.7 m) reach.

**Rate of Attack:** Equal to the total number of hand to hand melee attacks.

**Payload:** Not applicable

**6. Energy Rifles, Rail Guns** and other normal weapons can be substituted in an emergency or as a back-up weapon.

**7. Hand to Hand Combat:** Rather than use a weapon, Hagan can engage in mega-damage hand to hand combat using his fists and/or vibro-blade. Also see special bonuses described in number eight.

Restrained punch: 4D6 + 25 S.D.C.

Full strength punch: 1D6 M.D.C.

Kick: 2D4 M.D.

Leap Kick: 3D4 M.D.

Head Butt: 1D4 M.D.

Flying body block: 3D6 M.D. damage and has a 1-50% chance of knocking one's opponent off his feet (victim loses initiative and one melee attack), but counts as two melee attacks.

**8. Bonuses due to the telemechanic link:** These bonuses are in addition to Hagan's attribute and combat bonuses (listed previously).

Add two attacks per melee (5 total, hand to hand or energy weapons or any combination), +4 to strike with all the HPA's weapon systems (excluding fusion blocks), +3 to strike on a flying body block, punch or kick, +3 to pull punch, +5 to roll with impact, +4 to parry, +5 to parry with vibro-blade, +4 to dodge when on the ground, and +6 to dodge when flying.

The armor is a full environmental system with internal cooling, air purification and independent oxygen supply as is common to most suits of power armor. This also makes him impervious to poison, gas, and biological agents unless the suit is breached by depleting the M.D.C. of the helmet, arm, leg or main body.

A unique feature of Archie Three's design allows the armor to enhance and tap Hagan's psionic energy, making it impossible to read his aura and prevents telepathic probes, mind bond, mind control and psionic possession, as well as providing a bonus of +2 to save vs all psionic attacks and illusionary magic.

The helmet also links him directly to Archie, enabling the two to psionically communicate within a 500 mile radius (800 km).

**Note:** The bonuses from the power armor are NOT applicable when Hagan is piloting his large robot vehicle (or any robot vehicle); use the robot's bonuses instead.

**9. Sensor Systems of Note**

**Optics:** The HPA has full optical systems, including the visible light spectrum, infrared, ultraviolet, and polarization,

passive night vision (light amplification), thermo-imaging, laser targeting, and telescopic. *Telescopic optics* function like built-in binoculars, with a range of about two miles (3.2 km). All the other optic systems have a range of about 3000 feet (914 m).

**Radar:** Can identify and track up to 32 targets simultaneously, at a range of two miles (3.2 km). Applicable to flying targets at 500 feet above the ground or higher. The radar can not track ground movement.

**Radio Communication:** Medium-range directional radio. Range: 100 miles (160 km). The radio system can also eavesdrop on enemy transmissions and track transmissions (45% success level) to their source; tracking range is limited to 10 miles (16 km).

**Built-in Language Translator:** Same as the portable unit, see **Rifts RPG** page 247.

## Earth Saver One Hagan's Personal Combat Bot

In addition to his power armor, Hagan has a giant robot war machine to combat the Mechanoids. The bot stands nearly 20 feet tall, has a distinctly humanoid appearance and a battery of weapons. Like the power armor, the bot vehicle was already in the works when the Mechanoids rifted in. Archie has made some improvements and additions to help Hagan in his fight against the aliens. The unit is made from the same molecularly bonded alloys as Archie's other bots and is tough and mobile, however the emphasis is on weapons and combat as opposed to speed and agility.

The pilot sits in the chest. The head is the main sensor unit and the sensor tower is a secondary system. The head also has video recording capabilities, laser targeting, and optic systems.

### Earth Saver One

**Model Type:** AH-1

**Class:** Robot Infantry Vehicle

**Crew:** One, with an area that can accommodate one passenger.

**M.D.C. by Location:**

Shoulder Missile Launchers (2) — 150 each

Chest Lasers (2) — 25 each

Belly Ball Turret (1) — 30

Ion Cannon (1, right forearm) — 50

Vibro-Blade (1, giant, left arm) — 40

Hand-Held Cannon (1) — 80

Main Jet (1, lower back) — 60

Maneuvering Jets (2, lower leg) — 30 each

Sensor Tower (1, right shoulder) — 35

Spotlight in Chest (1) — 5

Spotlights in Head (2, eyes) — 5 each

Hands (1) — 25

Arms (2) — 120 each

Shoulder Plates (2) — 100 each

Legs (2) — 200 each

\*Head — 120

\*\*Main Body — 500

Reinforced Pilot's Compartment — 120



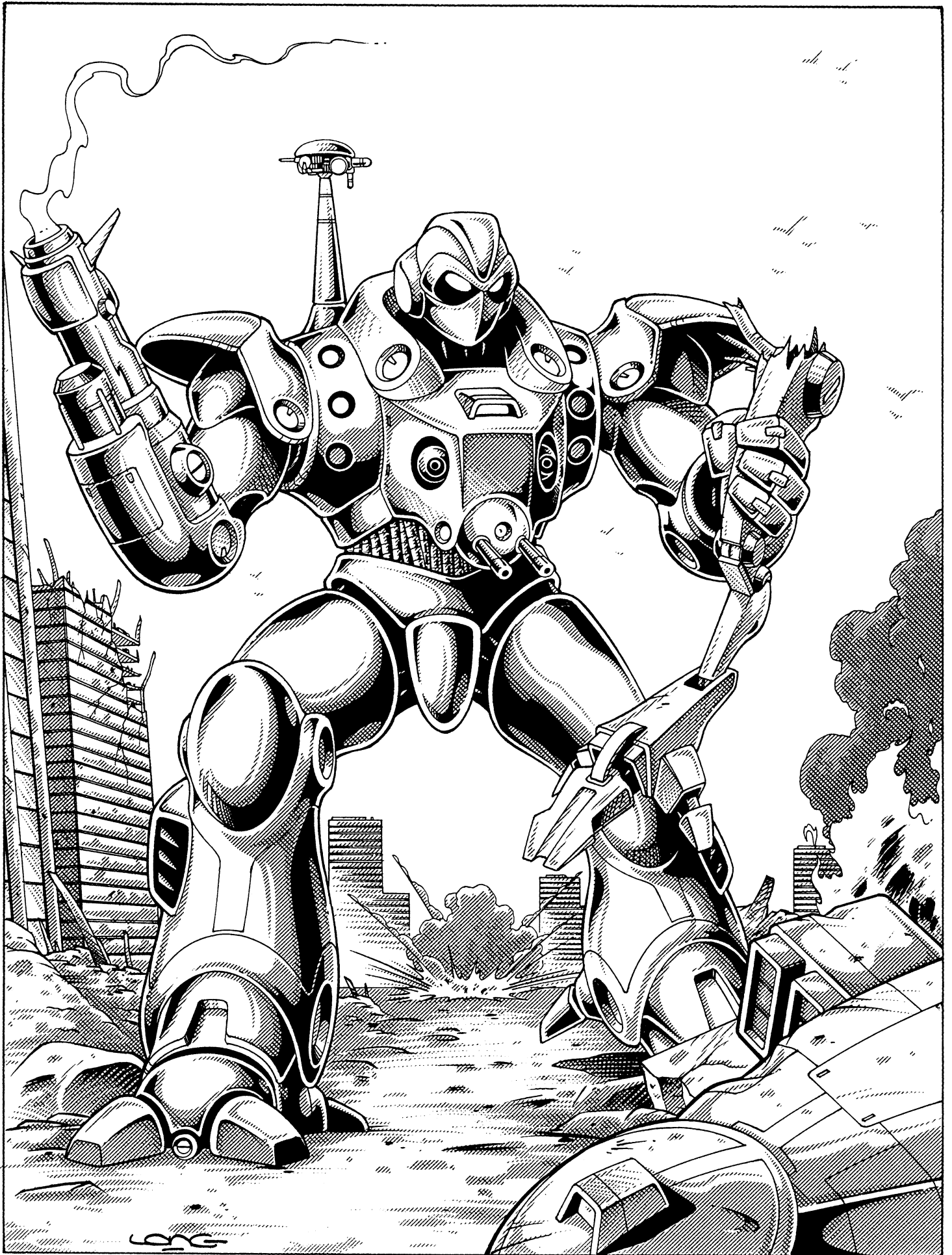

\* Destroying the head will eliminate the central optics, video-taping and sensory systems. However, only the video recording capabilities and eye spotlights are lost. The sensor tower on the right shoulder is a complete back-up system. **Note:** The head is a comparatively small target and shielded by the armored collar. Thus, it can only be hit when an opponent makes a *called shot* and even then he is -2 to strike.

\*\*Depleting the M.D.C. of the main body will effectively destroy the bot, shutting it down completely, making it useless.

### Speed

Running: 60 mph (96 km) maximum. Note that the act of running does NOT tire the robot and speed can be maintained indefinitely. Leaping: The robot legs are strong and designed for leaping and climbing. Non-jet thruster assisted leaps are limited to approximately 10 feet (3 m) high or across. A *jet thruster assisted leap* can propel the robot up to 50 feet (15.2 m) high or 100 feet (30.5 m) lengthwise without actually attaining flight.

Flying: The jet propulsion system gives the robot very limited flight capabilities. It can hover stationary up to 300 feet (91.5 m) high and fly for up to 10 minutes at a respectable speed of 150 mph (240 km). After 10 minutes the robot quickly loses altitude and the jets temporarily shut down within the next 1D4 minutes. The jets cannot be activated for flight or leaping until after a 30 minute cool-down period. Maximum altitude is 300 feet (91.5 m).

Range: Unlimited. The nuclear power pack gives the bot a life of 20 years even under the most strenuous and constant amount of use.

### Statistical Data

Height: 19 feet, 7 inches (6 m)

Width: 11 feet (3.35 m)

Length: 6 feet, 6 inches (2 m)

Weight: 16 tons fully loaded

Physical Strength: Equal to a P.S. 40

Cargo: Minimal storage space; about three feet (0.9 m) behind seat for extra weapons and equipment, plus three overhead storage compartments equal to three dresser drawers.

Power System: Nuclear; average energy life is 20 years.

Black Market Cost: Not available on the black market, this is the only prototype.

### Weapon Systems

#### 1. Medium-Range Missile Launchers Built into the shoulders:

A pair of missile launchers are located in the upper body, near the shoulders. There are six missile tubes per side for a total of 12 missiles. Additional missiles can be hand loaded at a rate of one per minute (4 melee rounds); can use power armor to carry, hover and reload.

Primary Purpose: Assault

Weight: Not applicable; built into the armor.

Mega-Damage: Varies with missile type. Hagan typically uses plasma: 2D6 × 10 M.D. per missile.

Rate of Fire: One at a time or in volleys of two, three, four, or six.

Effective Range: 40 miles (64 km) and travels at Mach 2.1

Payload: 12 total, 6 per launcher.

**2. Mini-Missile Launchers Built into the shoulders:** A pair of missile launchers are mounted in each shoulder. When activated, the shoulder plate flips up to reveal the launch tubes and missiles fire. Each of the missile launchers holds

12 mini-missiles (24 total). Additional missiles can be hand loaded at a rate of one per melee round (15 seconds).

Primary Purpose: Assault

Weight: Not applicable; built into the armor.

Mega-Damage: Varies with missile type. Hagan typically uses plasma: 1D6 × 10 M.D. per missile.

Rate of Fire: One at a time or in volleys of two, three or four.

Effective Range: One mile (1.6 km)

Payload: 24 total, 12 per shoulder launcher.

Design Flaw: If the shoulder or main body has lost half or more of its M.D.C., the sliding protective plate will stick, preventing it from firing. It will take six seconds (two melee actions) to work itself loose.

**3. Fusion Block Bombs/Land Mines:** The lower left arm has a concealed compartment that contains fusion blocks. The explosives are typically used for sabotage or as land mines. As a land mine, it is placed on the surface of the ground and covered with a thin layer of dirt or leaves and explodes when stepped on. The blocks can be set for levels of sensitivity to a particular weight load or amount of pressure (from 100 lbs/45 kg to 2000 lbs/900 kg).

Primary Purpose: Assault

Weight: Two pounds (0.9 kg) each.

Mega-Damage: Varies with type; Hagan uses only type three fusion blocks: 4D6 × 10 M.D.; the blast radius is contained to a ten foot area (3 m).

Rate of Fire: Set one at a time. It takes 15 seconds, one full melee round, to set the timer and/or other requirements of the block.

Effective Range: The block must be placed on or near the intended target. They are not aerodynamic and cannot be thrown far. Hagan can toss one about 400 feet (122 m) but is -4 to strike when thrown.

Payload: Six type three fusion blocks.

#### 4. Chest Lasers:

Primary Purpose: Assault

Weight: Not Applicable.

Mega-Damage: 3D6 per single blast or 6D6 M.D. per double blast.

Rate of Fire: Equal to hand to hand.

Effective Range: 2000 feet (610 m)

Payload: Effectively unlimited.

**5. Forearm Ion Cannon:** A short-range ion blaster is built into the right forearm. It is a high-powered but short-range weapon.

Primary Purpose: Assault

Weight: Part of the power armor.

Mega-Damage: 4D6 or 6D6 M.D.; two settings.

Rate of Fire: Each individual blast counts as one melee attack.

Effective Range: 2000 feet (610 m)

Payload: Effectively unlimited; patched into the armor's power supply.

**6. Double-Barrelled Laser Ball Turret:** A double-barrelled, heavy laser is mounted in the belly of the robot. The turret can rotate 180 degrees and has a 120 degree arc of fire.

Primary Purpose: Assault

Weight: Part of the power armor.

Mega-Damage: 6D6 M.D. per dual blast.

Rate of Fire: Each individual blast counts as one melee attack.

Effective Range: 4000 feet (1200 m)

Payload: Effectively unlimited; patched into the armor's power supply.

Design Flaw: There is a 1-50% chance that the turret will become temporarily frozen at its previous setting/angle of fire. It will not unlock for 1D4 minutes. Roll each time the weapon is to be used.

**7. Four foot, seven inch (1.4 m) Vibro-Blade (1):** Hidden in the left forearm is a giant, retractable vibro-saber.

Primary Purpose: Assault; secondary purpose: defense.

Weight: 2 lbs (0.9 kg)

Mega-Damage: Vibro-Saber: 3D6 + 2 M.D.

Range: Hand to hand, with about a 15 foot (4.6 m) reach.

Rate of Attack: Equal to the number of hand to hand melee attacks.

Payload: Not applicable

**8. Arch 860 Rail Gun (1):** This is a large, hand-held, rifle-looking rail gun.

Primary Purpose: Assault

Weight: 200 lbs (90 kg)

Mega-Damage: A burst is 40 rounds and inflicts 1D4 × 10 M.D.

Rate of Fire: Standard, see Modern Weapon Proficiencies.

Effective Range: 4000 feet (1200 m)

Payload: As a machinegun: 860 round belt, or drum: 21 bursts.

Powered by the robot's power supply.

**9. Other Giant Weapons** designed for robots can be substituted in an emergency or as a backup weapon.

**10. Hand to Hand Combat:** Rather than use a weapon, Hagan can engage in mega-damage hand to hand combat using his fists and/or vibro-blade. Also see special bonuses described in number eleven.

Restrained punch: 1D6 M.D.C.

Full strength punch: 2D6 M.D.C.

Kick: 2D6 M.D.

Leap Kick: 3D6 M.D.

Head Butt: 1D4 M.D.

Vibro-saber: 3D6 + 2 M.D.

Running body block: 2D6 M.D. damage and has a 1-60% chance of knocking one's opponent off his feet (victim loses initiative and one melee attack), but counts as two melee attacks.

**11. Bonuses due to the telemechanic link:** These bonuses are in addition to Hagan's attribute and combat bonuses (listed previously).

Add two hand to hand attacks per melee (5 total), plus an additional two attacks via missiles and/or energy weapons! +4 to strike with all the AH-1's weapon systems (excluding fusion blocks), +3 to strike on a flying body block, punch or kick, +3 to pull punch, +5 to roll with impact, +4 to parry, +5 to parry with vibro-blade, +4 to dodge when on the ground, and +6 to dodge when flying.

The bot is a full environmental vehicle with internal cooling, air purification and independent oxygen supply, as is common to most robot vehicles. This also makes him impervious to poison, gas, and biological agents unless the bot is breached.

A unique feature of Archie Three's design allows the bot to enhance and tap Hagan's psionic energy, making it impos-

sible to read his aura and prevents telepathic probes, mind bond, mind control and psionic possession, as well as providing a bonus of +2 to save vs all psionic attacks and illusionary magic.

## 12. Sensor Systems of Note

**Multi-Optics:** The Earth Saver robot has full optical systems, including the visible light spectrum, infrared, ultraviolet, and polarization, passive night vision (light amplification), thermo-imaging, laser targeting, laser distancing, and telescopic (with a range of about three miles/4.8 km). All the other optic systems have a range of about 4000 feet (1200 m).

**Radar:** Can identify and track up to 64 targets simultaneously, at a range of 30 miles (48 km). Applicable to flying targets at 500 feet (153 m) above the ground or higher. The radar can not track ground movement.

**Radio Communication:** Long- and medium-range directional radio. Range: 500 miles (804 km), with satellite bouncing capabilities for long range, and 100 miles (160 km) for medium. The radio system can also eavesdrop on enemy transmissions and track transmissions (45% success level) to their source; tracking range is limited to 10 miles (16 km).

**Built-in Language Translator:** Same as the portable unit, see **Rifts RPG**, page 247.

**Plus All Features Standard to Robot Vehicles.**

# AA-60 Hunter-Destroyer

## Hagan's Robot Minions

Hagan has one more weapon in his arsenal, the new AA-60 hunter-destroyer robot. 10 of these bots were completed before Archie felt it necessary to purge their design data from his memory. The bots are deliberately made to look very different than Archie's usual robots to conceal their origin. Like the armor and bot vehicle, the AA-60 is designed with destroying Mechanoids in mind.

Three AA-60's assist Hagan and are always nearby (although often prowling, hidden not far away). The other seven have been divided into groups of three and four and scour the land 24 hours a day, looking for the Mechanoids. If the group of Mechanoids is small the bots will attack. If the group is large (six or more) the bots will notify Hagan and carefully follow and observe the enemy. When Hagan and/or other forces arrive on the scene, the bots will join in the combat.

### AA-60 Hunter-Destroyer

**Model Type:** AA-60

**Class:** Fully Automated Self-Sufficient Infantry Robot

**Crew:** None; artificial intelligence

**M.D.C. by Location:**

Hands (2) — 25 each

Arms (2) — 100 each

Legs (2) — 120 each

Vibro-blades (2) — 10 each

Plasma Cannons (2, chest) — 50 each

\*Head — 60

\*\*Main Body — 330

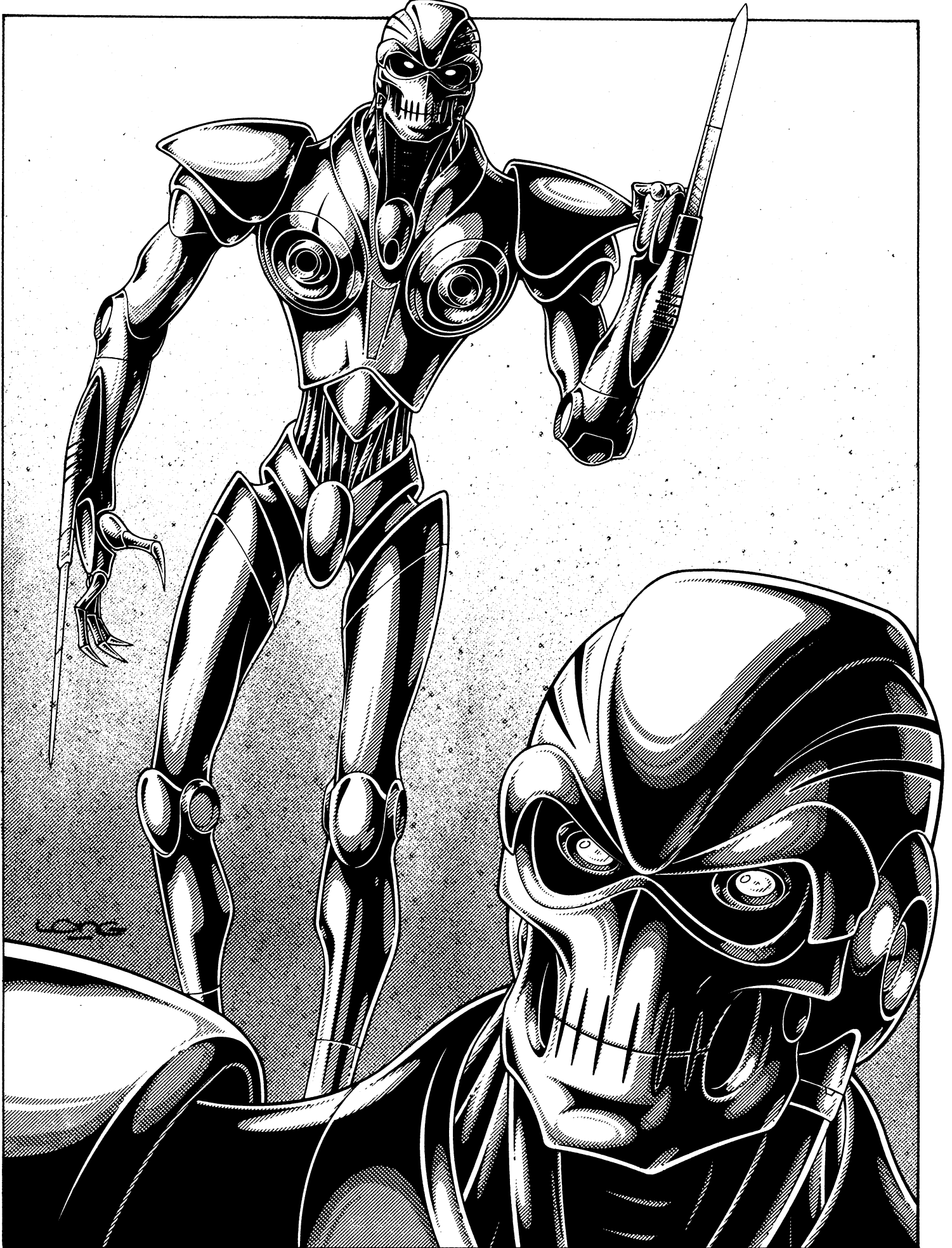

\* Destroying the head will eliminate all optics and sensory systems. In most cases, the robot will continue to fight, blasting blindly and groping and lashing out at anything it touches. **Note:** The head is a comparatively small target. Thus, it can only be hit when an opponent makes a *called shot* and even then, he is -2 to strike.

\*\*Depleting the M.D.C. of the main body will effectively destroy the bot, shutting it down completely and rendering it useless.

### Speed

Running: 90 mph (144 km) maximum. Note that the act of running does NOT tire the robot and speed can be maintained indefinitely. Leaping: The robot legs are strong and well suited for leaping. Leaps are limited to approximately 20 feet (6 m) high or 30 feet (9 m) lengthwise. A running start at a speed in excess of 40 mph (64 km) will enable the bot to double the height and length of the jump.

Flying: Possible only with the addition of a jet pack. Four of the bots are equipped with jet packs.

Range: The nuclear power pack gives the bot five years of life even under the most strenuous and constant amount of use.

### Statistical Data

Height: 10 feet (3 m)

Width: 4 feet (1.2 m)

Length: 3 feet (0.9 m)

Weight: 500 lbs (225 kg)

Physical Strength: Equal to a P.S. 40

Cargo: None

Power System: Nuclear; average energy life is ten years.

Black Market Cost: None. There are only 10 prototypes, but the market would gladly pay 10 to 20 million credits for an undamaged AA-60 for research or resale to Triax, Northern Gun or the Manistique Imperium.

### Weapon Systems

**1. Arch 2S Plasma Cannon (2):** These are two short-range plasma cannons built into the chest of the robot.

Primary Purpose: Assault

Weight: Not applicable

Mega-Damage: 6D6 M.D. per single blast or 1D6 × 10 per simultaneous dual blast (at same target).

Rate of Fire: Six single or double blasts per melee round.

Effective Range: 2000 feet (610 m)

Payload: As many as 60 dual blasts can be fired before the weapons need to be recharged. The weapons recharge at a rate of four blasts per hour.

**2. 18 inch (0.45 m) vibro-blades (2):** Hidden in each forearm is a retractable vibro-saber that slides down and locks into place. The blades can be used simultaneously or independently.

Primary Purpose: Assault

Secondary Purpose: Defense

Weight: 2 lbs (0.9 kg)

Mega-Damage: Vibro-Saber: 2D6 M.D.

Range: Hand to hand, with about a 5.6 foot (1.7 m) reach.

Rate of Attack: Six (6) per melee; hand to hand combat skill.

Payload: Not applicable

**3. Energy Rifles, Rail Guns** and other hand-held weapons and/or explosive (including fusion blocks) can be also be used by the bot. Archie has supplied them with NG-7 particle beam rifles (1D4 × 10 M.D., range: 1200 ft/365 m).

**4. Hand to Hand Combat:** Rather than use an energy weapon, the bot can engage in mega-damage hand to hand combat using his fists and/or vibro-blades.

Restrained punch: 4D6 + 25 S.D.C.

Full strength punch: 1D6 M.D.C.

Vibro-saber: 2D6 M.D.

Kick: 2D6 M.D.

Leap Kick: 3D6 M.D.

Head Butt: 1D4 M.D.

Judo Throw: 1D4 M.D.

Body Block: 1D4 M.D. damage and has a 1-50% chance of knocking one's opponent off his feet (victim loses initiative and one melee attack), but counts as two melee attacks.

**Bonuses:** Includes all bonuses from programming, robotics and sensors: +4 to strike with energy weapon (see energy W.P. skills), +6 to strike with vibro-blades or hand to hand attack (punch, kick, etc.), +4 to parry with fists/arms or +6 to parry with vibro-blade (including attacks from behind, due to motion detectors and other sensors), +6 to dodge, +2 to roll with impact or fall (no pull punch). Impervious to poison, gas, and biological agents, as well as psionic and magic mind control, charms, bio-manipulation, and S.D.C. attacks. See sensors for optical capabilities. **Attacks per Melee:** Six

### 5. Sensors of Note (in the head):

**Optics:** The AA-60 bots have full optical systems including the visible light spectrum, infrared, ultraviolet, and polarization, passive night vision (light amplification), thermo-imaging, laser targeting, and telescopic. *Telescopic optics* function like built-in binoculars with a range of about two miles (3.2 km). All the other optic systems have a range about 3000 feet (914 m).

**Radar:** Can identify and track up to 12 targets simultaneously at a range of two miles (3.2 km). Applicable to flying targets at 500 feet above the ground or higher only. Radar can not track ground movement.

**Motion Detector:** 100 foot radius (30.5 m), adds to ability to parry and dodge (see bonuses).

**Amplified Hearing:** Can hear sounds as quiet as 10 decibels and as far away as 500 feet (152 m). Can also hear in the ultrasonic range of high frequency sound. The computer is programmed to recognize 60,000 different mechanical sounds, from the sound of a car engine to the hum of a generator. Adds to alertness and attacks.

**Speech:** Full vocal capabilities. Speaks and is literate in American, Spanish, Japanese, and Chinese 98%. Speaks, but can not read Dragonese and Splugorth 98%. Speaks Euro 50%. Is also literate in 30 other pre-rifts languages, like Polish, German, Russian, Dutch, Italian, French, Portuguese, etc.; all are obsolete and forgotten languages.

**Radio Communication:** Long-range directional radio. Range: 100 miles (160 km). It can also eavesdrop on enemy transmissions and track transmissions (60% success level) to their source. Range: 10 miles (16 km).

**6. Skill Programs:** Programmed for combat, espionage and piloting. The program directs the actions and reactions to encounters and attacks. Combat program includes combat tactics, identification of all known Mechanoids, Coalition and Splugorth troops, common robots and vehicles, as well as common animal and D-Bee life forms, bots, armor, weapons and vehicles. W.P. energy pistol, rifles, and heavy, W.P. blunt, knife, and sword, demolition and disposal 90%, and W.P. paired weapons: Can use two hand-held weapons or vibro-blades in one simultaneous attack (double damage, counts as one attack/melee action) or attack with one and parry with the other.

Other skills include: Espionage related skills: Prowl 60% (takes into consideration size and construction), swim 94%, climb 90%/80%, land navigation 94%, wilderness survival 94%, escape artist 70%, intelligence 70%, tracking 70%, detect ambush 70%, detect concealment 70%.

Pilot and related skills include: automobile, motorcycle, hovercycle, jet pack, airplanes, automotive mechanics, basic electronics, computer operation, and basic math, all at 90% proficiency.

**7. Automatic Self-Destruct Program:** Standard.

---

# The Mechanoids

## A History Of Destruction

---

**The Mechanoids** are an ancient race renowned for their unrivaled technology, destructive power, and evil. Their cruelty and domination became a thing of legend as they swept through one galaxy after another. In each case, the horrible cyborgs would slaughter trillions upon trillions and devour entire planets and/or suns to power their interstellar war machines and planet size motherships. They are beings driven by three goals: expansion/conquest, the accumulation of knowledge, and the termination of all human life, including most humanoid bipeds.

It has been said that, at one time, the Mechanoid's power rivaled that of a god. If they were gods, then they were insane gods. God-beings without mercy, justice, or compassion. A malevolent force consumed by hatred, jealousy and contempt for all things human. The Mechanoids view humans, and their kith and kin, as a hideous cancer that must be eradicated from the universe. Their goal is no less than the total genocide of the human race, humanoid races (obviously related to humans), and those beings who would dare to associate, defend or assist humans (non-human allies).

Ironically, the Mechanoids' ancestry is deeply rooted in humankind. Long ago, there was a race of humans in a galaxy hundreds of thousands of light years away from Earth. Legend tells that these humans were refugees fleeing from a terrible disaster. Their homeworld was torn asunder and they were among the fortunate few to escape the great destruction. Nobody knows who they were or from where they came. The oldest legends identify them as "Atlanees," but they have been given many names; their true identity lost to antiquity. They were a hard working, peaceful people with an insatiable lust for knowledge. This desire sometimes made them reckless and cruel.

These humans had virtually eliminated disease and illness, and had also learned the secrets of genetic engineering, manipulation, reconstruction and cloning. Their knowledge of bionics and robotics were equally advanced, but their mastery of these sciences and related technology only served to make them hungry for more knowledge. This insatiable hunger launched an ambitious program to explore their galaxy and colonize its many planets. Since the frail human body was not especially well suited for the rigors of space, thousands of the dedicated, brave and

adventurous citizens volunteered to undergo genetic and bionic reconstruction. The large-scale experiment to create an army of space explorers specially engineered to combine flesh with machines was a great success. Far too successful.

At first, the public hailed the great achievement and applauded every spaceship launch manned by the reshaped cybernetic crew. Only a tiny minority voiced any fears or concerns about the experiments and the inhumanity of it all. With time that voice grew larger, but the tone had changed. There was no longer concern about inhumanity but great concern for the creatures' unhumanness. The public questioned what had really been created that day. The question was accented with growing apprehension. Many people suggested that these cyborgs were so removed from their human origin that they were actually a new and alien life form. As more was learned about the cyborgs, the more widespread and intense the fear. The space program stalled due to debate about unanswerable questions. The thousands of cyborgs remained on planet, pending an investigation and re-evaluation of the project.

The creatures, dubbed "new life" or **The Mechanoids**, proved to be superior to their creators in every way. The new life was encased in powerful, environmental cyborg bodies designed to withstand hostile environments. This made them infinitely faster, stronger, and invulnerable by human standards. Because they were completely linked to their robotic bodies, they moved with far greater speed and agility than any human pilot operating a machine. Their mental capabilities were also formidable. The screening process for volunteers meant selecting only the smartest and emotionally stable individuals. As a result, the majority of the Mechanoids were smarter, quicker thinking, and more resourceful than the average citizen. Genetic manipulation had also given the cyborg explorers dramatically enhanced and consistent psionic powers, including telepathy, empathy, racial memory and a psionic link to all other Mechanoids.

The new life was viewed as a frighteningly monstrous, sub-race too far removed from their human origins. Although the Mechanoids were loyal and benevolent beings, their presence made true humans uncomfortable and some physically ill. Suspicion and disdain ran high and quickly turned into paranoia and

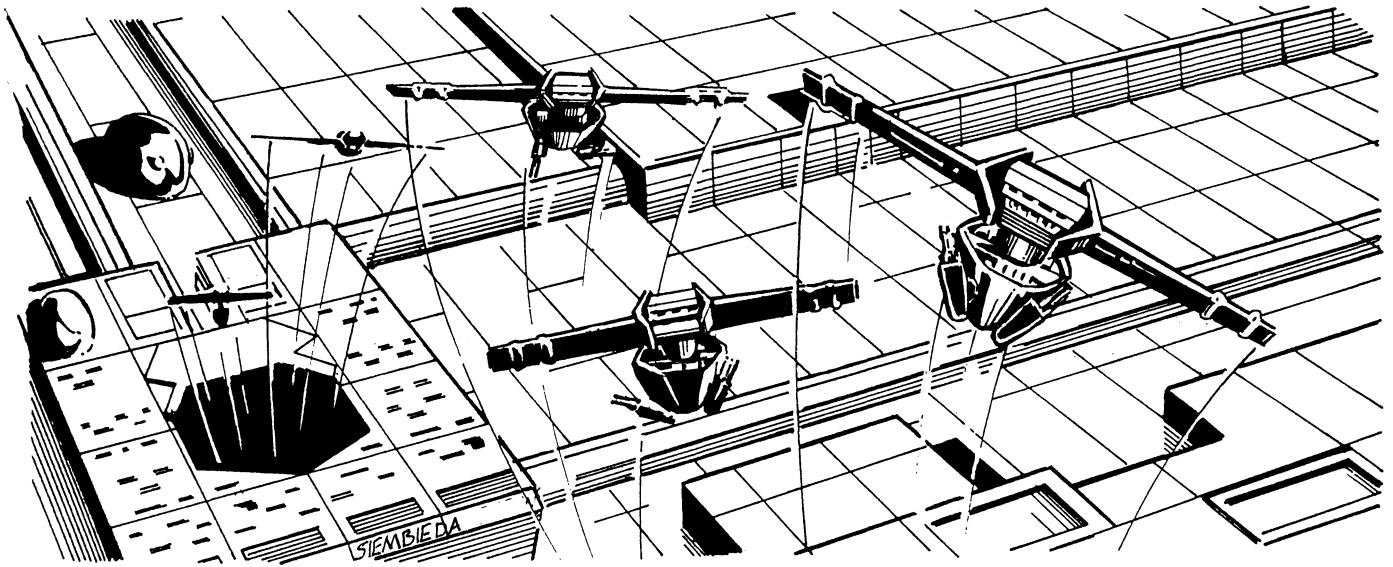

hatred. Eventually, the human creators decided that they had created an abomination that had no right to exist and destroyed the thousands of Mechanoids still on the planet. When the bloodshed was over, the humans tried to justify what they had done, but would live with the nightmare till their own demise.

The new life that had been sent to explore the stars were racked with confusion and sorrow, as they received empathic transmissions and psionic visions from and about the murder of their brothers. After a short while, they decided that they must have done something wrong to anger or frighten their creators. In a futile effort to prove themselves worthy to their creators, the new life built improved mechanical bodies and made more genetic improvements on themselves. When a design proved especially successful, they made thousands of clones encased in environmental, bionic bodies. Then they scattered throughout the galaxy to collect knowledge to offer as a gift to the creators.

When the new life returned, they looked much more like the Mechanoids we know today. Somehow they thought that the creators would appreciate their improvements and welcome them and their gift of knowledge. Instead, the humans were repulsed

and terrified. The Mechanoids were more alien than ever! They had increased their numbers a hundredfold and possessed knowledge and technology far superior to the humans'. Furthermore, the humans assumed that the Mechanoids would seek to punish them for the slaughter of the innocent cyborgs left behind. Thus, the humans rejected the gift and threatened to destroy the Mechanoids unless they left the planet immediately!

The blind hate, terror and revulsion emanating from the humans were a shock to the psionic creatures. The Mechanoids had never considered such a reception. For decades they had been consumed with proving themselves worthy of the creators' love and admiration. This was too much to endure. To make matters worse, the cyborgs could feel the humans' guilt for the many murders of the planet-bound Mechanoids. For the first time, the new life realized that they had done nothing wrong, except to allow themselves to be shaped and reborn by human creatures who were not noble and brilliant, but loathsome, frightened and horrible monsters that destroy all that they fear or do not understand.

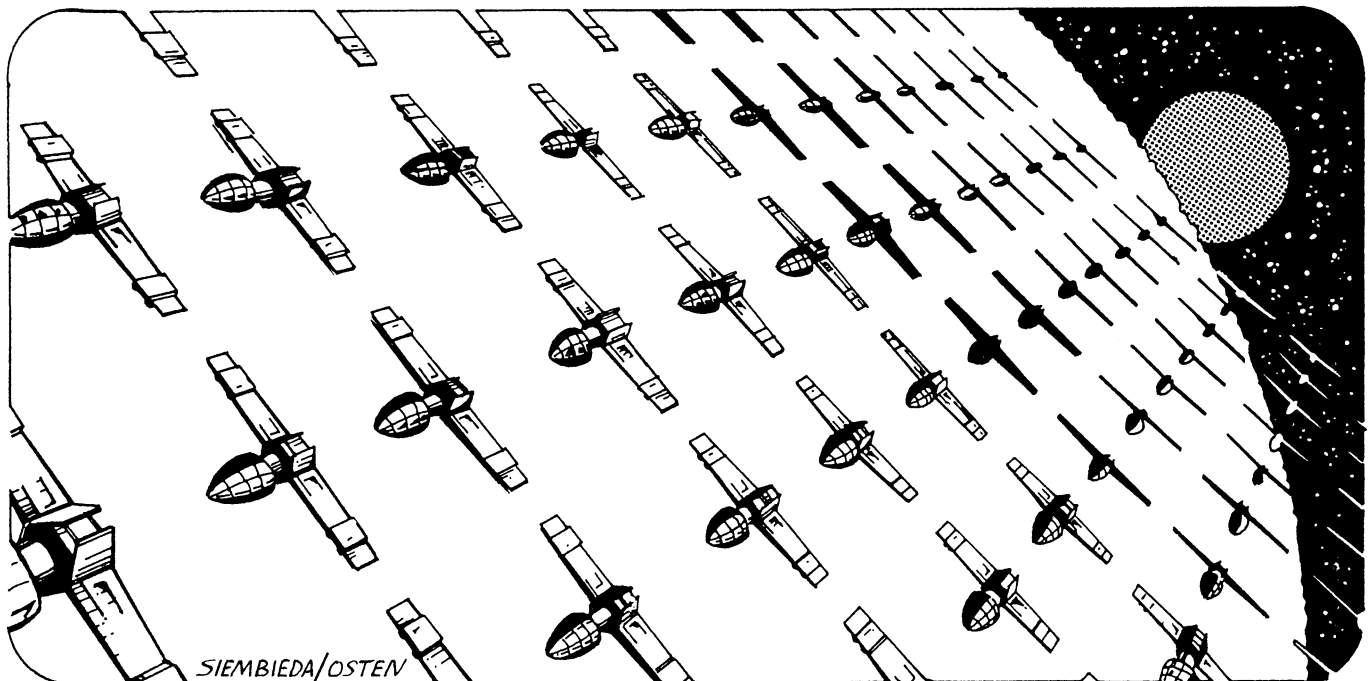

When the stunned Mechanoids did not immediately comply with the humans' demands that they leave and never return, they were attacked. This was the last straw! The Mechanoids retaliated.

The clash was a long and bloody one. When the battle was over, the new life stood among the ashes of the old. The legacy of hatred and violence would continue for ages. The Mechanoids would no longer tolerate degradation at the hands of their inferiors. They had proven themselves more than worthy of the humans involved in their genesis. They had proven themselves superior by feasting on the bones of their creators. But this was not enough. From that moment forward, the Mechanoids dedicated their existence to the complete eradication of the human race and all creatures like them.

The incident, accentuated and perpetuated by their psionic nature, has driven the Mechanoids insane. Their psionic powers and racial memory would keep the hate and anguish so vividly alive that generations of clones, created thousands of years later, would feel the rejection, frustration, hate, degradation, and blood lust as if they were experiencing it anew. Thus, whenever a humanoid is encountered, the Mechanoids are consumed by unreasoning loathing and a need to destroy. Although the creatures may appear to be calm and calculating killing machines, they are driven by burning emotions. In many respects, they are angry children who, after having struck down their abusive parents, feel no relief and transfer their emotions (including feelings of guilt) to everybody who reminds them of those parents. Striking out again and again does nothing to relieve those emotions!

The tormented aliens seek to stop their anguish and pain by destroying all humanoid life — the ultimate evil. Consequently, their cruelty toward humanoids is without parallel. Humans and humanoids are subject to all sorts of sadistic torture, including cybernetic, genetic, physical and mental experimentation, vivisection, degradation, and finally, death. Each individual Mechanoid has his own unique style and approach to torture and revenge. Some prefer mind games, others straightforward physical torment or destruction, while others combine aspects of them all.

**Note:** The Mechanoids' emotional state of mind makes it impossible for most to believe that any human could be their equal. Consequently, they frequently underestimate humanoid foes. This can lead to a chain reaction of mounting anger, frustration and foolish behavior on the part of the Mechanoids. They are easily provoked by humans who exhibit cunning, courage, strength of will, ingenuity, and arrogance. This may stimulate any number of potentially dangerous reactions from the aliens, including an unwillingness to surrender or negotiate with humanoids, taking foolish risks, rash behavior and carelessness, striking out in anger or frustration, mindless aggression, berserker rage, suicidal revenge (taking an action that may kill itself as long as the human dies too), or methodical Jack-The-Ripper type stalking, slaughter, and dissection.

The Mechanoids' reign of terror lasted for thousands of years. Not only would they ravage worlds occupied by humanoids, but they had developed the means to slice and dice the entire planet into sections and process it — a sort of cosmic strip mining. The process removed all natural resources, from minerals and fossil fuels to the very atmosphere and oceans. To witness the devouring of a planet was both horrifying and amazing. Typically, only planets occupied by humanoids suffered this fate.

First the planet would be defoliated. Second, millions of Mechanoids and their robot armies would swarm on the planet to "play with the humans." Play constituted the razing of cities, mass slaughter of the population, and terrible experiments and torture of captives. The third step was the syphoning of the oceans, followed by the removal of the atmosphere. Finally the planet would be cut into smaller sections, swallowed by the gigantic mothership and processed. Obviously, the dissection and consumption of the planet would destroy all of its inhabitants. Thus, the Mechanoids did not need to send troops to the planet's surface unless they faced substantial resistance. They enjoy the murder and mayhem caused by their hands, hence the previous reference to, "play with the humans."

## The Conflict Within

Finally, the nightmare seemed to end. One day, the insane destroyers simply disappeared, with little trace. After a while, a few of the Mechanoids' planet sized motherships were found drifting aimlessly — devoid of life. There was no sign of the millions of Mechanoids that normally crewed these vessels. The giant ships were themselves massive, living entities of flesh, metal and psionics, but the living portion had obviously died or been killed. The computers and brain pods were all part of the living organism. When it died, they died too! Memory, communications, life support, operations and all internal systems ceased to function. All data/memory was lost and the *body* of the deceased, living ship crumbled and decayed. Except for scrap metal, there was little to salvage.

As for the cyborgs themselves, they, and their robot legion, were nowhere to be found. However, there was some evidence of mass destruction in the way of massive scrap piles of fused, mangled or otherwise destroyed metal and plastic. Some believe the scrap piles were the destroyed bodies of Mechanoids and robots tossed in a heap. However, the amount of damage and deterioration was so vast that it was impossible to tell what had been caused by decay or from combat.

The Nigelian Confederacy, a coalition of humanoids who had all been victimized by the Mechanoids, discovered and investigated the Mechanoids homeworld. Except for a race of intelligent, insect-like beings known as the Dionii and the occasional Mechanoid robot defense system, there was no trace of any living Mechanoids. Encounters with the Dionii confirmed that there had been some sort of schism within the Mechanoid race.

What humans may never learn is that a portion of the Mechanoid population began to question and resist their race's quest for the genocide of the human race and related species. Exactly how or why so many Mechanoids experienced this sudden change of nature remains a mystery, even to the Mechanoids. It is likely that an aberration on a genetic level was replicated within millions of clones before it manifested itself. The Mechanoids have some evidence to suggest that the aberrations were deliberately created by rogue Mechanoid Oracles. Regardless of its origin, the aberrant genes gave millions of clones a higher degree of free will and levels of emotion previously unknown to the creatures. Even the warriors and drones shared a greater sense of identity and individuality. Furthermore, these mutant Mechanoids were a bit less aggressive than the former generations (only the Mechanoid Overlords seemed unaltered).



These subtle changes caused them to think in ways contrary to the old racial memories and hive mentality.

The Aberrant Mechanoids (AbM) desired an end to the senseless murder and destruction. This caused a massive schism within the Mechanoid race. The old Mechanoids realized that they had inadvertently created mutants that were as contrary in their ideology, and as frightening and repulsive to the old guard as the original Mechanoids had been to their human creators. Ironically, they don't see this parallel.

For the first time in Mechanoids history they were no longer a race of beings with one mind, and one purpose. The fact that any Mechanoid would suggest they stop persecuting humanoids would have been terrible enough, but to have millions suggesting it is an abomination beyond comprehension. The old Mechanoids considered destroying all the aberrant clones. After all, it was part of their psychology to destroy any non-humanoids who supported humankind. However, this seemed pointless until they could isolate the cause of the aberration. To do otherwise would mean the death of millions, which would dramatically weaken their defenses and make them vulnerable to their many enemies. Making additional clones would only perpetuate the aberration which remained hidden inside of them.

It is unclear what happened next or which faction was responsible, but the Mechanoids struck each other with biological warfare and treachery. A virus was created and unleashed into the population that killed Mechanoids by the billions. It is conceivable that the old Mechanoids decided that it was better to annihilate their entire race rather than have any Mechanoid work toward the preservation of humans. The new, Aberrant Mechanoids (AbMs) were less likely to initiate such a terrible plague. Still, they may have felt it their only recourse and an acceptable sacrifice in an effort to save countless humanoid lives.

At first it seemed none were spared, old or new. Total and complete self-genocide. To add to the mystery, there was a spinning, silver disc, larger than the planet Jupiter, protected by a dozen Mechanoid motherships — effectively creating an artificial solar system. One race of humanoids launched a massive attack against it and was obliterated. By the time others mounted a combined attack, they found only twelve lifeless and decaying motherships. The disc had vanished and the Mechanoids with it.

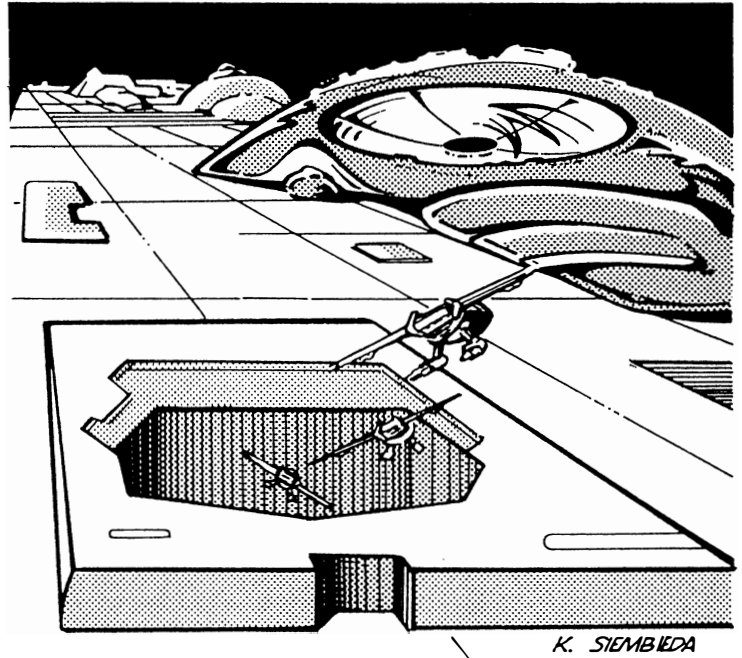

## More Surprises

Hundreds of years have passed since the Mechanoids first disappeared. The Mechanoid killing virus has died long ago. Much of the race was obliterated, but a tiny group of old Mechanoids with reasonably “pure” genetic structure were pirated away before the plague was unleashed. These elite survivors worked feverously for centuries to find and eliminate the problem. It took over two hundred years, but the problem has been isolated and eliminated. Another several decades have been spent making changes and improvements on their cyborg bodies and creating a new legion of clones. The new designs were to help signify the beginning of a new era. Once again the insane cyborgs are ready to blanket the universe with their mission of destruction.

Unknown to them, some of the aberrant Mechanoids (AbM) were also safely hidden away in suspended animation. When the old empire reappeared, the AbM mutants awoke to renew their campaign to stop them. This time, the aberrants have allied themselves with (suspicious) humanoids and have joined the fight to destroy their evil brothers.

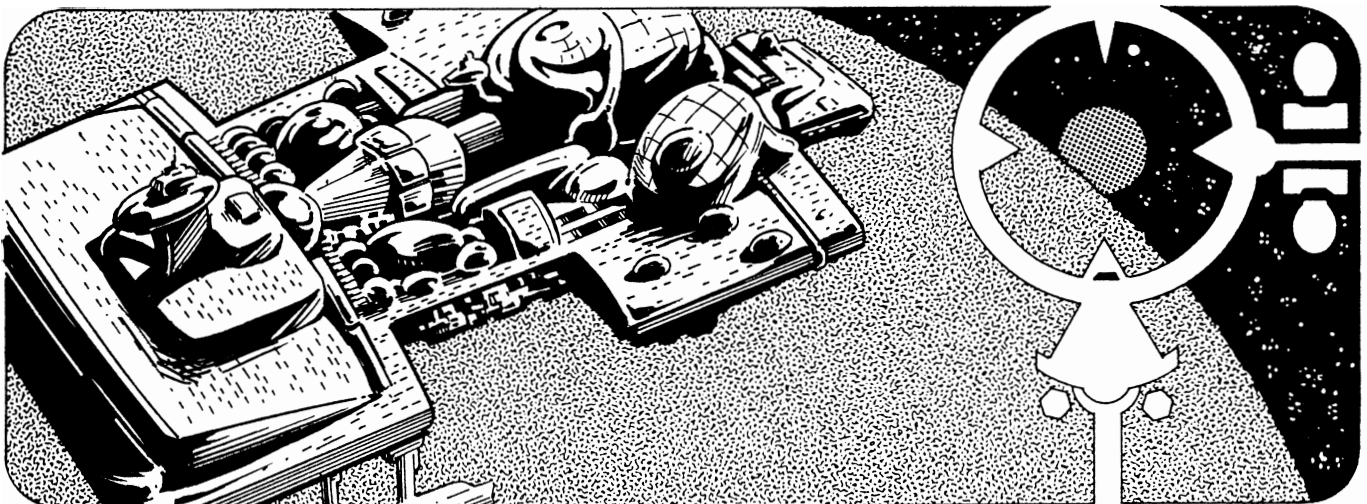

# Game Master's Option

## Good Guy Mechanoids — AbM Mutants

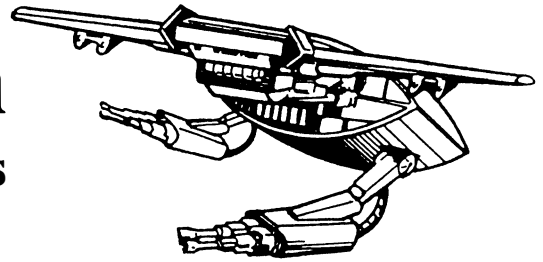

The Mechanoids brought to Earth through the dimensional rift were said to have been locked in combat with an enemy, which is why the spider fortress is damaged and the number of its troops is low. At the Game Master's option, that enemy could have been the Aberrant Mechanoids (AbM), which means some of these aberrants may have also been rifted to Earth. The GM can introduce some interesting non-player characters to help in the battle against the "true" Mechanoids and/or allow AbM mutants as player characters!

AbM player characters are limited to the old-style body designs and abilities, not the new ones. The most common "good guy" Mechanoids will be the tunnel crawler, brute, exterminator, seeker pod, runner, and wasp, in that order. The brain, mantis, octopus, digger, and others are much less common and may not even exist on Rifts Earth. More about the old and new Mechanoids, their continuing conflict, philosophies, allies and the universe will appear in: **Mechanoid Space — The Role-Playing Game** (tentatively scheduled for 1994, sorry). The stats for the most typical and fun to play Aberrant Mechanoids follow.

Unlike their evil kin, most of the aberrant Mechanoids will not seek to clone themselves or build an army of conquering robots. They have no desires of conquest. However, the AbM Mechanoids are individuals just as each and every human is an individual. This means that among the larger, helpful AbM groups there may be evil individuals who may consider conquering a kingdom or continent as his own domain or plot to make clones or build bots.

Most AbMs will accept their fate and try to live out their lives on Earth. The average life span of the elite Mechanoids, like the brain and runner, is 500 years. The combat oriented Mechanoids could live as long as 300 years depending on their luck on the field of combat. One of the continual problems that the AbMs will encounter is fear, suspicion and hatred from humans and humanoids. Most people will not be able to distinguish between the AbMs and human hating Mechanoids. Many of the fanatics belonging to cults will attack on sight and fight to the death. Only the Children of Doom cult will view them as gods (a situation which an unscrupulous AbM could use to his advantage).

## Aberrant Mechanoids

### Optional Player Characters, Heroes & Villains

#### AbM Brain

The brain is just that, one of the "brains" of the Mechanoids' operations; a commander/General and master scientist. They are known for their brutality, cunning and genius. The AbM brains are no exception and can make wonderful commanders, physicians, scientists and humanitarians. They are crafty, with a good head for strategy and tactics, as well as organization. However,

they are not designed for front-line combat and even the AbM brains try to avoid physical confrontation, preferring to direct others from a safe distance. The less scrupulous brains tend to be masters of deception, manipulation and mind games. They are also powerful master psionics who use their powers to their full advantage. Most tend to be secretive loners and rely on their intellect and psionic powers.

**Model Type:** AbM Brain — Free thinker, commander and scientist.

**Class:** Cyborg

**M.D.C. by Location:**

Hands (2) — 10 each

Arms (2) — 30 each

Shoulder Shield (1, left arm) — 40

Shoulder Laser (1, left arm) — 10

Lower Body — 60

Lower Hover Units (2) — 30 each

Hover Pod (an optional accessory) — 100

Multi-Pod (an optional vehicle body) — 300

Containment Chamber — None

\*Head/Dome — 50

\*Mechanoid's Fleshy Head — 10

\*\*Main Body — 90

\* Destroying the head will kill the creature. **Note:** The head is fairly large but protected by metal plates and covered in a tough, laser resistant polymer dome. It can only be hit when a character makes a *called shot* and the attacker is -1 to strike.

\*\*Depleting the M.D.C. of the main body destroys the cyborg's mechanical body housing and its containment chamber, however this organism can survive, for a time, without an environmental system. The Mechanoid organism can be rescued and installed into another mechanical body of the same design. Except for its psionic powers, the creature is totally helpless and will die within 6D6 minutes.

#### Speed

Running: 32 mph (50 km) maximum. Note: movement does not tire the Mechanoid inside.

Leaping: Not possible, but the brain can use telekinesis to rise in the air.

Flying: Flight is not possible without the addition of a hover platform. The hover platform provides speeds of up to 200 mph (321 km) and an altitude of about 2000 feet (610 m).

Range: Unlimited.

#### Statistical Data

Height: 10 feet (3 m)

Width: 5 feet (1.5 m)

Length: 6 feet (1.8 m)

Weight: One ton

Cargo: None.

Armored Body: The cyborg body is a full environmental system with internal cooling, air purification and independent oxygen

supply as is common to most suits of power armor. This also makes the creature impervious to poison, gas, and biological agents unless the containment chamber is breached by depleting all its M.D.C. **Note:** The Mechanoid Brain is able to survive outside its containment chamber longer than any other AbM, about 6D6 minutes!

**Power System:** A Mechanoid power crystal gives the cyborg a life of 100 years before requiring a replacement crystal.

**Black Market Value:** The Market will pay 2D4 million credits for a Mechanoid power crystal that has 50 years or more energy  $2D4 \times 100,000$  if less. The crystals cannot be duplicated!

**Alignment:** Any

**Horror Factor:** 13

**Physical Strength:** Equal to a P.S. 20

**Other Attributes of Note:** I.Q.  $2D6 + 15$ , M.E.  $2D6 + 13$ , M.A.  $2D6 + 11$ , and P.P.E.  $5D6$ .

**Number of Attacks Per Melee:** Four physical or psionic attacks.

**Combat Bonuses (includes all bonuses):** +5 to strike with laser, +3 to strike with all other weapons. +2 to strike with a punch, +2 to parry, +2 to dodge, +1 to pull punch, +2 to roll with impact, +6 to save vs horror factor, and +4 to save vs psionic attacks, +2 to save vs magic and poison.

**Psionics:** Master psionic but considered a mind melter:  $1D6 \times 100 + 1400$  I.S.P.! Psionic powers include all healing and all physical powers, plus telekinesis (super), telepathy, empathy, empathic transmission, bio-manipulation, hypnotic suggestion, mentally possess others, mind bond, mind wipe and mind block auto-defense.

**Average Level of Experience:**  $2D4 + 6$

**Skills of Note:** All medical skills (excluding holistic medicine) at 95%, all science and pilot related skills at 98%, computer operation and programming at 98%, computer hacking 68%, pilot hover vehicle, robot vehicle (and robot combat: basic), and spaceship at 90%. Weapon proficiencies include W.P. energy pistol, energy rifle and knife.

## Weapon Systems

**1. Multi-Purpose Mini-Laser Turret:** The tiny variable laser turret is built on the shield located on the left shoulder. It is a multi-purpose appendage used as both a short-range defensive weapon and a tool. The weapon has its own targeting computer which analyzes the reflectiveness of armor and substances as well as distances. After one melee round the computer is able to adjust to the light frequency that will inflict maximum damage to the target. The laser is accurate and deadly.

**Primary Purpose:** Multiple; weapon and tool.

**Weight:** Not applicable; it is part of the power armor's body.

**Mega-Damage:** 1D6 M.D., 2D6 M.D. or 3D6 M.D. (three settings).

**Rate of Fire:** Equal to the number of hand to hand attacks.

**Effective Range:** 2000 feet (610 m)

**Payload:** Effectively unlimited; patched into the armor's power supply.

**2. Laser Finger:** A utility laser is built into the first finger of each hand (concealed). It is an S.D.C. weapon used for dissection, surgery and soldering.

**Primary Purpose:** Tool

**Weight:** Not applicable; it is part of the power armor's body.

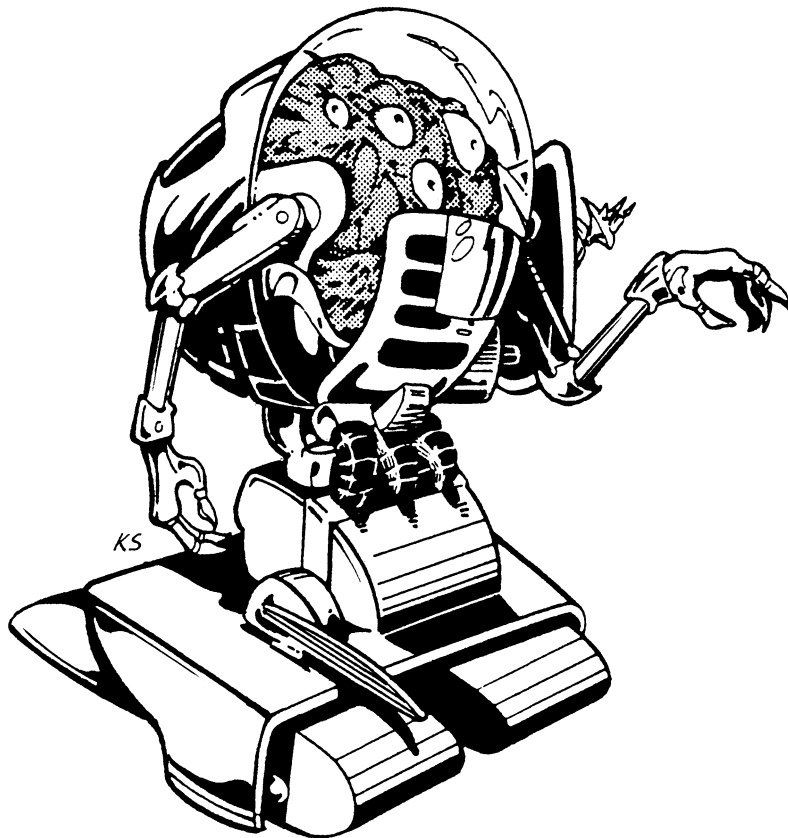

**Mega-Damage:** Laser finger:  $1D6$  to  $1D6 \times 10$  S.D.C. (regulated by  $1D6$  increments).

**Rate of Fire:** Equal to the number of hand to hand attacks.

**Effective Range:** 50 feet (15 m)

**Payload:** Effectively unlimited; patched into the armor's power supply.

**3. Energy rifles, pistols** and other hand-held weapons can be used by the Mechanoid Brain.

**4. Hand to Hand Combat:** Rather than use a long-range weapon, the Mechanoid can engage in hand to hand combat using its fists and/or hand-held weapons. The creature can also use its psionic powers of telekinesis or ectoplasm to wield weapons or hurl objects.

Restrained punch:  $3D6 + 5$  S.D.C.

Full strength punch:  $1D6$  M.D.

Body block/ram:  $2D6$  M.D. damage and has a 1-40% chance of knocking one's opponent off his feet (victim loses initiative and one melee attack), but counts as two melee attacks.

**5. Sensor Systems of Note**

**Optics:** Full optical systems, including the visible light spectrum, infrared, ultraviolet, polarization, passive night vision (light amplification), thermo-imaging, laser targeting, and telescopic. *Telescopic optics* function like built-in binoculars with a range of about two miles (3.2 km). All the other optic systems have a range of about 5200 feet (1560 m).

**Radar:** Can identify and track up to 72 targets simultaneously, at a range of two miles (3.2 km). Applicable to flying targets at 500 feet above the ground or higher. The radar can not track ground movement.

**Radio Communication:** Medium range directional radio. Range: 100 miles (160 km). The radio system can also eaves-

drop on enemy transmissions and track transmissions to their source (60% success ratio); tracking range is limited to 20 miles (32 km).

**Built-in Language Translator:** Same as the portable unit; see **Rifts RPG**, page 247.

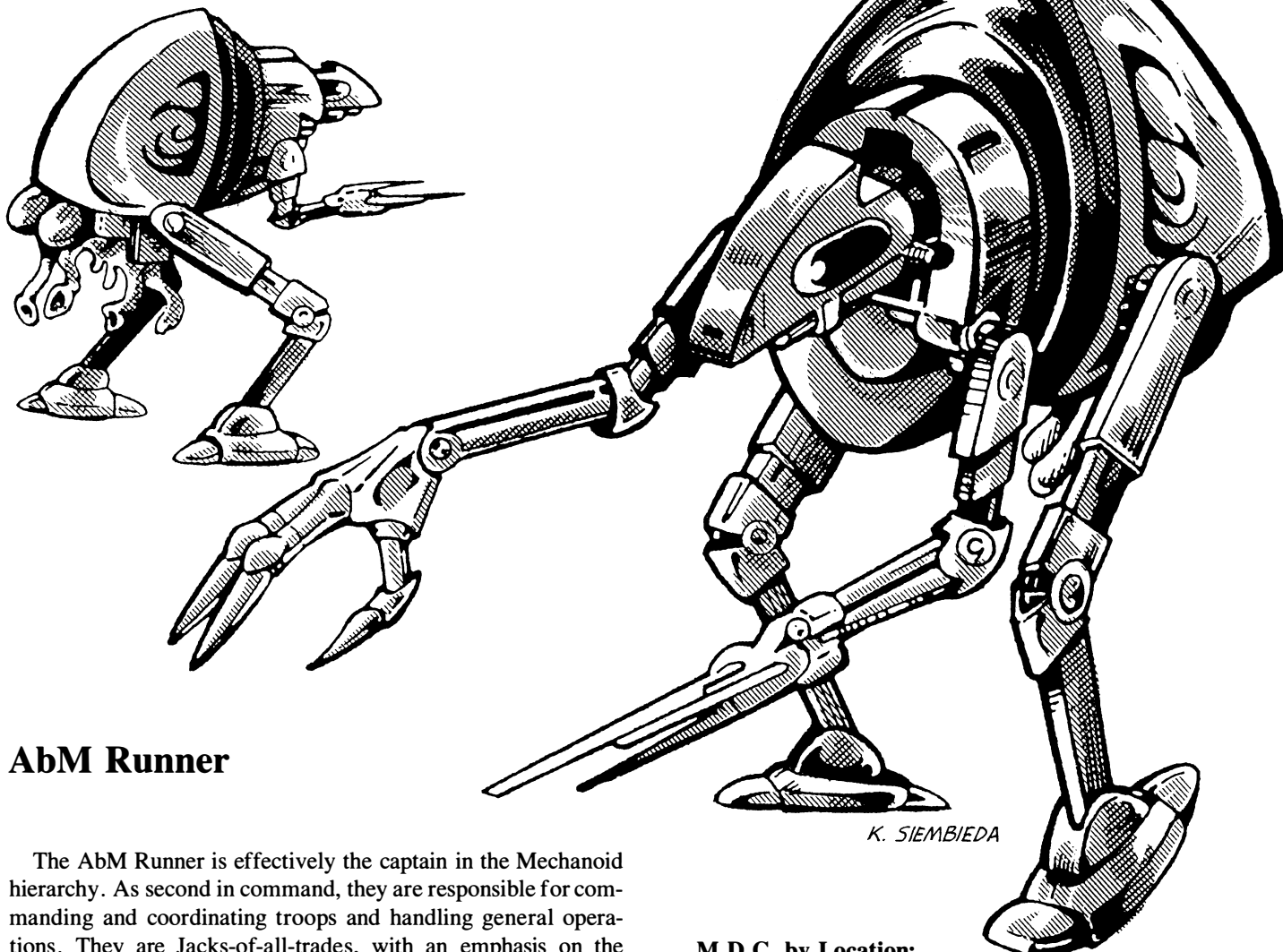

K. SIEMBIEDA

## AbM Runner

The AbM Runner is effectively the captain in the Mechanoid hierarchy. As second in command, they are responsible for commanding and coordinating troops and handling general operations. They are Jacks-of-all-trades, with an emphasis on the sciences, electronics and mechanics. The aberrant mutants are even more creative, resourceful and ingenious than their predecessors. This is good and bad, because while an AbM runner of a good alignment can be a mechanized paladin, those of an evil alignment can be incredibly ruthless, savage, cunning and manipulative.

Among those aberrant Mechanoids who have chosen to fight their insane brethren, the typical runner is dedicated and valiant. However, a number have abandoned the cause to strike out on their own. These may become criminals, despot kings, and maniacal freebooters concerned only with personal glory, wealth and power.

**Note:** AbM Runners who survive on Rifts Earth will find the concept of magic fascinating and may try to study it and even become practitioners of that art (start at first level).

**Model Type:** AbM Runner — Free thinker, scientist and technician.

**Class:** Cyborg

### M.D.C. by Location:

Laser Rod (1, typically the left forearm) — 20  
 Hands (1 or 2) — 20 each  
 Lower Arms (2) — 20 each  
 Upper Arms (2) — 50 each  
 Legs (2) — 60 each  
 Hover Pod (an optional accessory) — 150  
 Containment Chamber — 120

\*Head — 80

\*\*Main Body — 90 (also see psionic powers)

\* Destroying the head will eliminate all optics and sensory systems, and reduces the maximum speed, the number of melee attacks and all bonuses by half. **Note:** The head is a small and difficult target to hit. Thus, it can only be hit when a character makes a *called shot* and even then the attacker is -3 to strike.

\*\*Depleting the M.D.C. of the main body destroys the cyborg's mechanical body housing, however the organism's environmental containment chamber (effectively the pilot's compartment) contains the majority of the living organism. The Mechanoid organism can be rescued and installed into another mechanical body of the same design. Except for its psionic

powers, the creature is totally helpless and will die within 5D6 days, as long as the containment chamber is still intact.

### Speed

Running: 70 mph (112.6 km) maximum. Note that the act of running does not tire the Mechanoid inside.

Leaping: The powerful robot legs can leap up to 20 feet (6 m) high or across unassisted by psionic telekinesis.

Flying: Flight is not possible without the addition of a hover platform. The jet propulsion system enables the pod to hover stationary or fly at about 100 mph (160 km). Maximum altitude is 1000 feet (305 m).

Range: Unlimited.

### Statistical Data

Height: 15 feet (4.6 m)

Width: 5 feet (1.5 m)

Length: 10 feet (3 m)

Weight: 2 tons

Cargo: None.

Armored Body: The cyborg body is a full environmental system with internal cooling, air purification and independent oxygen supply as is common to most suits of power armor. This also makes the creature impervious to poison, gas, and biological agents unless the containment chamber is breached by depleting all its M.D.C. **Note:** The Mechanoid will die in 1D4 minutes if the containment chamber is breached — they cannot breathe Earth's atmosphere!

Power System: A Mechanoid power crystal gives the cyborg a life of 100 years before requiring a replacement crystal.

Black Market Value: The Market will pay 2D4 million credits for a Mechanoid power crystal that has 50 years or more energy  $2D4 \times 100,000$  if less. The crystals cannot be duplicated!

Alignment: Any

Horror Factor: 11

Physical Strength: Equal to a P.S. 30

Other Attributes of Note: I.Q.  $2D6 + 12$ , M.E.  $2D6 + 10$ , M.A.  $2D6 + 8$ , and P.P.E.  $4D6$ .

Number of Attacks Per Melee: Five physical or psionic attacks.

Combat Bonuses (includes all bonuses): +1 on initiative, +5 to strike with laser rod, +3 to strike with all other weapons. +4 to strike with a punch or kick, +4 to parry, +4 to dodge, +2 to pull punch, +2 to roll with impact, +2 to strike on a body block/ram, +5 to save vs horror factor, and +3 to save vs psionic attacks.

Psionics: Major psionic but considered a mind melter.  $1D4 \times 100 + 290$  I.S.P. and possesses all sensitive psi-powers plus hypnotic suggestion, telekinetic force field, and telemechanics.

Average Level of Experience:  $1D4 + 6$

Skills of Note: All communication skills at 98%, all electrical, mechanical, and pilot related skills at 90%, basic and advanced math 98%, computer operation and programming at 90%, computer hacking 40%, pilot hover vehicle and spaceship at 85%, and intelligence, forgery, tracking, wilderness survival, and land navigation, all at 75%. Weapon proficiencies include W.P. energy pistol, energy rifle and heavy energy and knife.

## Weapon Systems

**1. Multi-Purpose Forearm Laser Rod:** This multi-purpose appendage is used as both a weapon and a tool. Both the long-range and short-range lasers, the long and medium length tubes, are variable frequency lasers designed to overcome laser resistant armor. The weapon has its own targeting computer which analyzes the reflectivity of armor and substances as well as distances. After one melee round the computer is able to adjust to the light frequency that will inflict maximum damage to the target. The laser is accurate and deadly.

Primary Purpose: Multiple; weapon and tool.

Weight: Not applicable; it is part of the power armor's body.

Mega-Damage: Long-range laser: 3D6 M.D. or 5D6 M.D. (two settings), short-range laser: 1D6 M.D. or 3D6 M.D., laser scalpel: 1D6 to  $1D6 \times 10$  S.D.C. (regulated by 1D6 increments) or 1D4 M.D.

Rate of Fire: Equal to the number of hand to hand attacks.

Effective Range: Long-range laser: 5200 feet (1560 m), short-range laser: 1000 feet (305 m), laser scalpel: one foot (0.3 m).

Payload: Effectively unlimited; patched into the armor's power supply.

**2. Rail Guns, energy weapons** and other weapons can be substituted in an emergency or as a back-up weapon.

**3. Hand to Hand Combat:** Rather than use a long-range weapon, the Mechanoid can engage in hand to hand combat using its fists and/or hand-held weapons.

Restrained punch:  $4D6 + 15$  S.D.C.

Full strength punch: 2D4 M.D.

Kick: 3D6 M.D.

Leap Kick: 5D6 M.D., but counts as two attacks.

Head Butt: 1D4 M.D.

Body block/ram: 2D6 M.D. damage and has a 1-50% chance of knocking one's opponent off his feet (victim loses initiative and one melee attack), but counts as two melee attacks.

**4. Sensor Systems of Note**

**Optics:** Full optical systems, including the visible light spectrum, infrared, ultraviolet, polarization, passive night vision (light amplification), thermo-imaging, laser targeting, and telescopic. *Telescopic optics* function like built-in binoculars with a range of about two miles (3.2 km). All the other optic systems have a range of about 5200 feet (1560 m).

**Radar:** Can identify and track up to 72 targets simultaneously, at a range of two miles (3.2 km). Applicable to flying targets at 500 feet above the ground or higher. The radar can not track ground movement.

**Radio Communication:** Medium range directional radio. Range: 100 miles (160 km). The radio system can also eavesdrop on enemy transmissions and track transmissions to their source (60% success ratio); tracking range is limited to 20 miles (32 km).

**Built-in Language Translator:** Same as the portable unit; see **Rifts RPG**, page 247.

## AbM Wasp

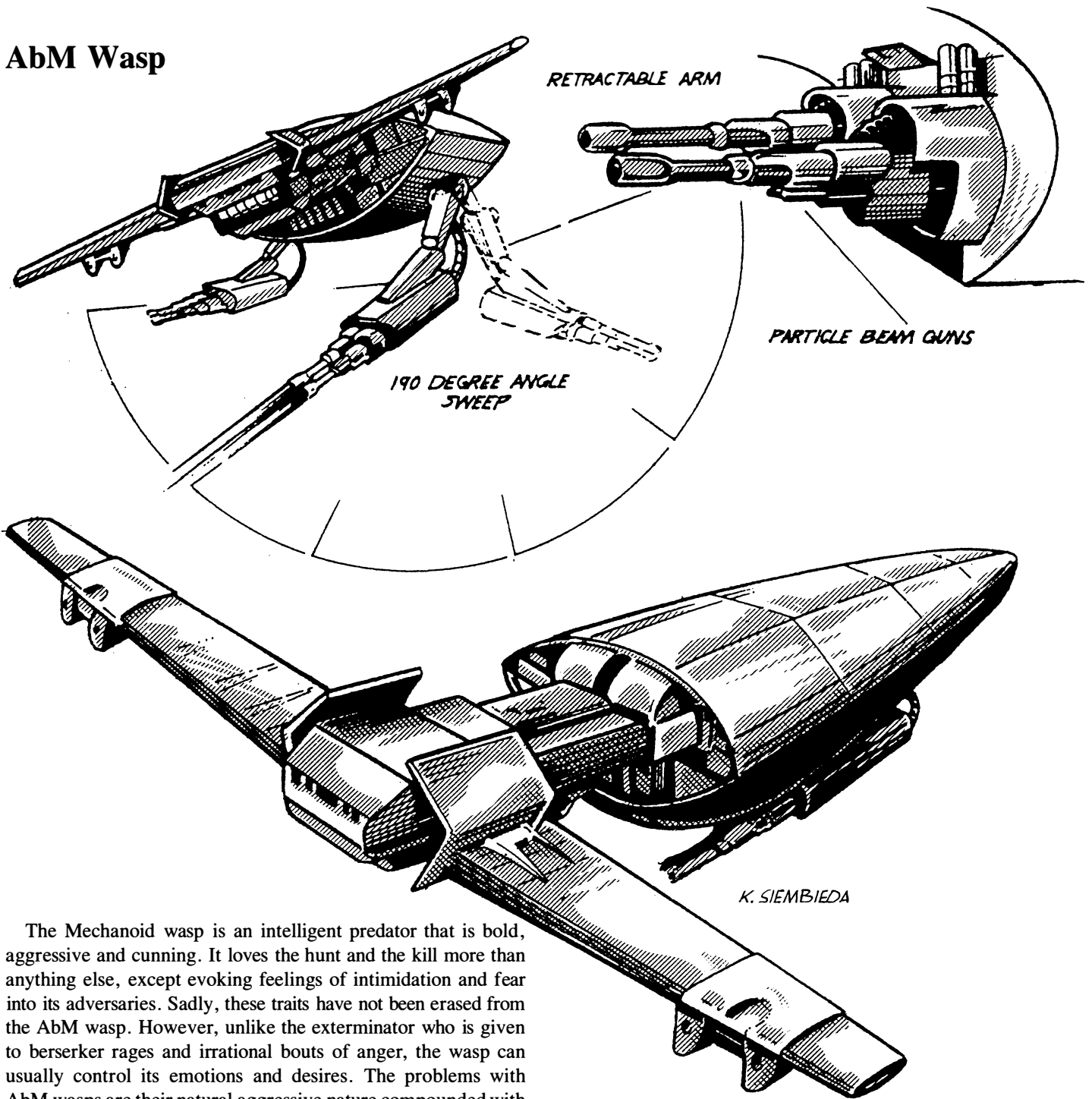

The Mechanoid wasp is an intelligent predator that is bold, aggressive and cunning. It loves the hunt and the kill more than anything else, except evoking feelings of intimidation and fear into its adversaries. Sadly, these traits have not been erased from the AbM wasp. However, unlike the exterminator who is given to berserker rages and irrational bouts of anger, the wasp can usually control its emotions and desires. The problems with AbM wasps are their natural aggressive nature compounded with the fact that they are action junkies who crave excitement, adventure and conflict.

When nothing is happening, the creature gets bored and when a wasp becomes bored, it is unhappy. An unhappy wasp can become a disruptive force within any group. It will grumble about the lack of action, the need for decisive leadership, the courage of others, as well as the weather and time of day. Such a malcontent can undermine authority through acts of defiance, like ignoring the law, ignoring the orders of an officer/team leader, mouthing off with rude, cruel, and disparaging remarks, and by stirring up others using suspicion and prejudice. In most cases, the wasp's ultimate goal is to instigate action through conflict. It doesn't care whether that action may be detrimental to the group or was created by goading the leader to take foolish action, or by causing arguments, fights or even mutiny within

the group. The wasp won't care if it may have been assigned to annoying or hazardous duty just to get rid of him. The belligerent, selfish creature has created conflict and conflict leads to action — no more boredom.

Likewise, a wasp has a hot temper and can be easily goaded into a fight, especially when bored (mainly because they are looking for trouble). They have an "I don't take any crap" and "Let's kick some butts," attitude and personality that makes them always ready to prove it through combat. Yet, despite the wasp's bellicose and belligerent personality, they can exhibit incredible restraint and composure under the most stressful and provoking situations in order to trick an opponent or when they aren't dying of boredom. This same determination and self control makes the wasp unbreakable under torture. The more a foe

wants something, the more the wasp will resist. Again, it is a matter of conflict, battle (only a battle of wills), and winning — and the wasp must win all of his battles, even at the cost of his life. Thus, a wasp can seldom be forced to betray his teammates, even teammates he hates.

AbM wasps have a greater independence and will than the old Mechanoid wasps, but this can spell trouble too. If the wasp becomes truly and totally dissatisfied with his teammates, leader(s) and/or situation, he may take off on his own. In the most extreme cases, the wasp may become an independent rogue, bandit, killer, or even join the evil Mechanoids, all for the sake of some action.

**Model Type:** AbM Wasp — Soldier/Air Force

**Class:** Cyborg

**M.D.C. by Location:**

Forearm Particle Beam Cannons (2) — 50 each

Upper Arms (2) — 40 each

Wings (2) — 100 each

Containment Chamber — 120

\*Head — 100

\*\*Main Body — 120

\* Destroying the head will eliminate all optics and sensory systems and reduces the maximum speed, the number of melee attacks and all bonuses by half. **Note:** The head is a small and difficult target to hit. Thus, it can only be hit when a character makes a *called shot* and even then the attacker is -3 to strike.

\*\*Depleting the M.D.C. of the main body destroys the cyborg's mechanical body housing, however, the organism's environmental containment chamber (effectively the pilot's compartment) contains the majority of the living organism. The Mechanoid organism can be rescued and installed into another mechanical body of the same design. Except for its psionic powers, the creature is totally helpless and will die within 5D6 days.

### Speed

**Running:** The wasp has no legs and cannot run, walk or jump. Its sole means of movement is its anti-gravity propulsion system and telekinesis. It can flop along with its weapon arms or drag itself at a speed of about 10 (7 mph/12 km) maximum.

**Leaping:** Not applicable.

**Flying:** Mach 2 — 1350 mph (2144 km), cruising speed is typically a slow 500 mph (800 km).

The flying, speed and aerial movement is made possible by a mentally controlled anti-gravity system. The wasp can attain incredible speeds while maintaining absolute control and precision maneuvering. The system is so amazing that the wasp can go from 0 to Mach 2 in three seconds and come to a complete stop in an instant! Maximum altitude is virtually unlimited.

**Range:** Unlimited.

### Statistical Data

**Height:** 3 feet, 6 inches (1 m)

**Width:** 15 feet (4.6 m) from wing tip to wing tip.

**Length:** 8 feet (2.4 m)

**Weight:** 1.2 tons

**Cargo:** None.

**Armored Body:** The cyborg body is a full environmental system with internal cooling, air purification and independent oxygen supply as is common to most suits of power armor. This also

makes the creature impervious to poison, gas, and biological agents unless the containment chamber is breached by depleting all its M.D.C. **Note:** The Mechanoid will die in 1D4 minutes if the containment chamber is breached — they cannot breathe Earth's atmosphere!

**Power System:** A Mechanoid power crystal gives the cyborg a life of 100 years before requiring a replacement crystal.

**Black Market Value:** The Market will pay 2D4 million credits for a Mechanoid power crystal that has 50 years or more energy, 2D4 × 100,000 if less. The crystals cannot be duplicated!

**Alignment:** Any, except principled. Typically anarchist, unprincipled or aberrant.

**Horror Factor:** 12

**Physical Strength:** Equal to a P.S. 30

**Other Attributes of Note:** I.Q. 2D6 + 8, M.E. 2D6 + 12, M.A. 2D6 + 6, and P.P.E. 3D6.

**Number of Attacks Per Melee:** Six physical or psionic attacks.

**Combat Bonuses (includes all bonuses):** +4 on initiative, +6 to strike with particle beams, +2 to strike with a punch, +6 to strike on a flying body block/ram, +6 to parry, +7 automatic dodge when in the air (does not count as a melee action), +2 to pull punch, +5 to roll with impact, +4 to save vs horror factor, and +2 to save vs psionic attacks but +8 to save vs all forms of mind control.

**Psionics:** Major psionic but considered a mind melter. 1D4 × 100 + 13 I.S.P. and possesses all physical psi-powers plus telepathy and mind block auto-defense.

**Average Level of Experience:** 1D4 + 6

**Skills of Note:** Radio basic, scramblers, surveillance, T.V./video 98%, basic and advanced math 98%, computer operation 90%, detect ambush, detect concealment, intelligence, tracking, wilderness survival, and land navigation all at 85%, and streetwise 50%. Weapon proficiencies include W.P. energy pistol, energy rifle and heavy (must use psionics to manipulate the weapons).

## Weapon Systems

**1. Particle Beam Forearm Cannons:** The Mechanoid weapon has greater range than any Earth P-beam cannon and when combined with the wasp's incredible speed and accuracy, is truly devastating. The weapons have their own targeting computer which gauges distances and adds to its accuracy. Each arm can be moved independently, with a swivel of 190 degrees.

**Primary Purpose:** Assault

**Weight:** Not applicable; it is part of the body.

**Mega-Damage:** 1D4 × 10 M.D. or 1D6 × 10 M.D. (two settings) per single blast or 2D4 × 10 per simultaneous, double blast (aimed at the same target). A simultaneous, double blast counts as one (1) melee attack!

**Rate of Fire:** Equal to the number of hand to hand attacks.

**Effective Range:** 4000 feet (1200 m).

**Payload:** Effectively unlimited; patched into the armor's power supply.

**2. Other weapons** cannot be held by the wasp because it has no hands. However, the creature can use telekinesis or ectoplasm to operate lightweight weapons, but is -2 to strike.

**3. Hand to Hand Combat:** Rather than use a long-range weapon, the Mechanoid can engage in hand to hand combat using its cannon barrels or wings as a bludgeon.

Restrained Punch/Swat: 4D6 + 15 S.D.C.

Full Strength Punch/Swat: 2D6 M.D.

Body block/ram: 2D6 M.D. at low speeds, 4D6 M.D. at Mach One or 1D4 × 10 M.D. at Mach Two. The wasp has a 1-40% chance of knocking its opponent off his feet (victim loses initiative and one melee attack) at speeds under Mach One, a 1-55% at Mach One and a 1-75% chance at Mach Two. All such attacks count as two melee actions regardless of the speed.

**4. Sensor Systems of Note:** Same as the Runner.

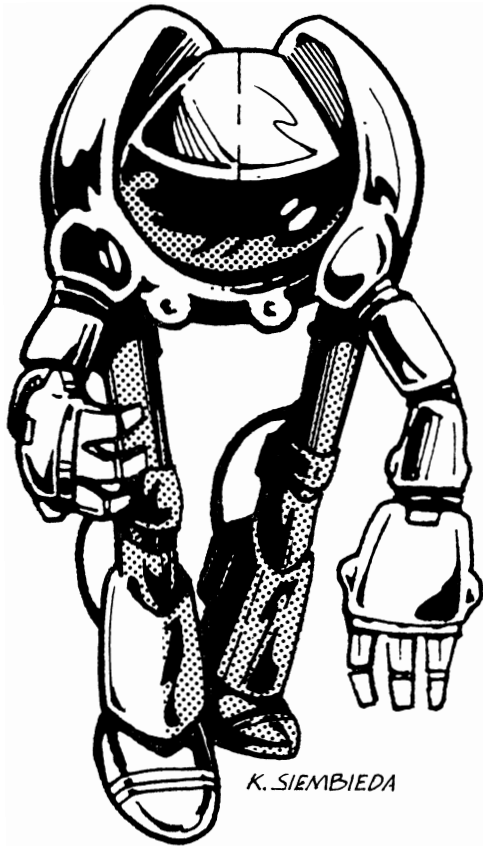

## AbM Brute

The Mechanoid brute was designed to be a commander of lesser Mechanoids and robots — like a Sergeant or a Lieutenant in the army. Consequently, the AbM brute, although a predator like the wasp and exterminator, is extremely loyal to his superiors and has a cool, calculating mind. This means unlike the wasp or exterminator, the AbM brute can control its emotions to follow orders to the letter. They are calm, methodical creatures with a good head for tactics and command. They work extremely well within a group and are fairly good leaders, particularly as a second or third in command.

The AbM Brute enjoys combat and espionage more than anything else, but exhibits unnerving patience and self control. In combat they are bold fighters, willing to take whatever risk to vanquish the enemy (within reason). Here again, their great patience and self control can be an asset, allowing them to make

precise moves and attacks at the last moment or under incredible stress.

**Model Type:** AbM Brute — Infantry leader & technician

**Class:** Cyborg

**M.D.C. by Location:**

Upper Arms (2) — 60 each

Lower arms & hands (2) — 90 each

Legs (2) — 100 each

Containment Chamber — 120

\*Forward Particle Beam Guns (2) — 20 each

\*\*Head/Main Body — 200

\* The tiny particle beam nozzles are difficult to hit, thus they can only be struck when a character makes a *called shot* and even then the attacker is -4 to strike.

\*\*Depleting the M.D.C. of the main body destroys the cyborg's mechanical body housing, however, the organism's environmental containment chamber (effectively the pilot's compartment) contains the majority of the living organism. The Mechanoid organism can be rescued and installed into another mechanical body of the same design. Except for its psionic powers, the creature is totally helpless and will die within 5D6 days.

### Speed

Running: 50 mph (80 km).

Leaping: 10 feet (3 m) high or across.

Flying: Its secondary means of movement is a limited anti-gravity propulsion system similar to the wasp's. 90 mph (144 km), cruising speed is typically about half, maximum altitude is 2000 feet (610 m).

Range: Unlimited.

### Statistical Data

Height: 12 feet, 6 inches (3.8 m)

Width: 5 feet, 6 inches (1.7 m)

Length: 6 feet (1.8 m)

Weight: 2.4 tons

Cargo: None.

Armored Body: The cyborg body is a full environmental system with internal cooling, air purification and independent oxygen supply as is common to most suits of power armor. This also makes the creature impervious to poison, gas, and biological agents unless the containment chamber is breached by depleting all its M.D.C. **Note:** The Mechanoid will die in 1D4 minutes if the containment chamber is breached — they cannot breathe Earth's atmosphere!

Power System: A Mechanoid power crystal gives the cyborg a life of 100 years before requiring a replacement crystal.

Black Market Value: The Market will pay 2D4 million credits for a Mechanoid power crystal that has 50 years or more energy, 2D4 × 100,000 if less. The crystals cannot be duplicated!

Alignment: Any except diabolic or miscreant evil. Typically principled or scrupulous.

Horror Factor: 12

Physical Strength: Equal to a P.S. 30

Other Attributes of Note: I.Q. 2D6 + 10, M.E. 2D6 + 10, M.A. 2D6 + 10, and P.P.E. 3D6.

Number of Attacks Per Melee: Five physical or psionic attacks.



Combat Bonuses (includes all bonuses): +2 on initiative, +5 to strike with particle beams, +5 to strike with a punch, +4 to strike with a flying body block/ram, +5 to parry, +5 to dodge, +3 to pull punch, +4 to roll with impact, +4 to save vs horror factor, and +3 to save vs psionic attacks, +2 to save vs magic and poison.

Psionics: Major psionic but considered a mind melter. 1D6 × 10 + 100 I.S.P. and possesses all physical psi-powers plus telepathy, empathy, electro-kinesis, psi-sword, and mind block auto-defense.

Average Level of Experience: 1D4 + 2

Skills of Note: All communication skills (+15%), all mechanical skills (+15%), basic electronics (+20%), all pilot related skills (+20%), all military skills (+15%), computer operation and programming (+15%), basic math (+30%), pilot hover vehicles and spaceships (+20%), prowler (+10%), and detect ambush, detect concealment, intelligence, tracking, wilderness survival, and land navigation (all +15%). Weapon proficiencies include W.P. energy pistol, energy rifle, heavy energy, sword and blunt.

## Weapon Systems

**1. Particle Beam Guns (2):** A pair of particle beam guns are built into the chest of the brute. Although terribly destructive, these tiny guns are fixed forward and are considered short-range weapons by Mechanoid standards. Furthermore, the brute must turn its entire body to point and shoot.

Primary Purpose: Assault

Weight: Not applicable, it is part of the power armor's body.

Mega-Damage: 1D4 × 10 M.D. per single blasts or 2D4 × 10 per simultaneous, double blast (aimed at the same target). A simultaneous double blast counts as one (1) melee attack.

Rate of Fire: Equal to the number of hand to hand attacks.

Effective Range: 1600 feet (488 m).

Payload: Effectively unlimited; patched into the armor's power supply.

**2. Rail guns, energy weapons** and other weapons can be substituted in an emergency or as a back-up weapon.

**3. Hand to Hand Combat:** Rather than use a long-range weapon, the Mechanoid can engage in hand to hand combat using its cannon barrels or wings as a bludgeon.

Restrained Punch: 4D6 + 15 S.D.C.

Full Strength Punch: 2D6 M.D.

Power Punch: 4D6 M.D., but counts as two attacks.

Kick: 2D6 M.D.

Leap Kick: 3D6 M.D.

Body Block/ram: 1D6 M.D. The brute has a 1-50% chance of knocking its opponent off his feet (victim loses initiative and one melee attack), but counts as two melee actions regardless of the speed.

**4. Sensor Systems of Note:** Same as the Runner.

## AbM Exterminator

The exterminator, along with the wasp, is one of the most aggressive and combat oriented of the AbM. They love to hunt, fight and kill — it's part of their genetic make-up and orientation. They are so aggressive and hot headed that they will fight at the drop of a hat. In fact, they often have trouble containing their lust to fight and will gladly jump into a conflict in an instant, regardless of the odds, when its leader orders it or when provoked. Fortunately, its blood lust is often quenched by the mere act of battle and not murder. Consequently, the exterminator can control itself enough to stop short of killing an opponent if those are his orders; but just barely.

The exterminator loves assassination, seek and destroy missions and infantry assignments. That's just the way they are. As a result, their alignment is always anarchist, aberrant or even miscreant evil. Their loyalty to the AbM race, a genetic and psychological bond, usually (but not always) keeps them loyal to the AbM and their commanders. If there is a traitor or a rogue in a group it will be an exterminator, wasp or brain.

The exterminator is so aggressive that sometimes they fly out of control during combat. The blood lust just takes over and the creature fights on pure instinct and berserker rage. When this happens it can distinguish between friend and foe but will keep fighting the enemy despite orders to the contrary. It may take a psionic empathic or telepathic jolt to bring him back to his senses.

**Model Type:** AbM Exterminator — Hunter-Killer/Soldier

**Class:** Cyborg

**M.D.C. by Location:**

Legs (2) — 90 each

Containment Chamber — 90

\*Particle Beam Cannon (1) — 30

\*Ion Blasters (2) — 10 each

\*\*Head/Main Body — 125

\* These targets are comparatively small and difficult to hit. Thus, they can only be hit when the attacker makes a *called shot* and even then he is -3 to strike.

\*\*Depleting the M.D.C. of the main body destroys the cyborg's mechanical body housing, however, the organism's environmental containment chamber (effectively the pilot's compartment) holds the majority of the living organism. The Mechanoid organism can be rescued and installed into another mechanical body of the same design. Except for its psionic powers, the creature is totally helpless and will die within 5D6 days.

### Speed

Running: 90 mph (144 km) maximum. Note that the act of running does not tire the Mechanoid inside.

Leaping: The powerful robot legs can leap up to 20 feet (6 m) high.

Flying: Flight is not possible.

Range: Unlimited.

### Statistical Data

Height: 15 feet (4.6 m)

Width: 5 feet (1.5 m)

Length: 5 feet (1.5 m)

Weight: 1.6 tons

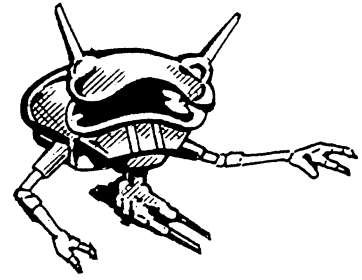
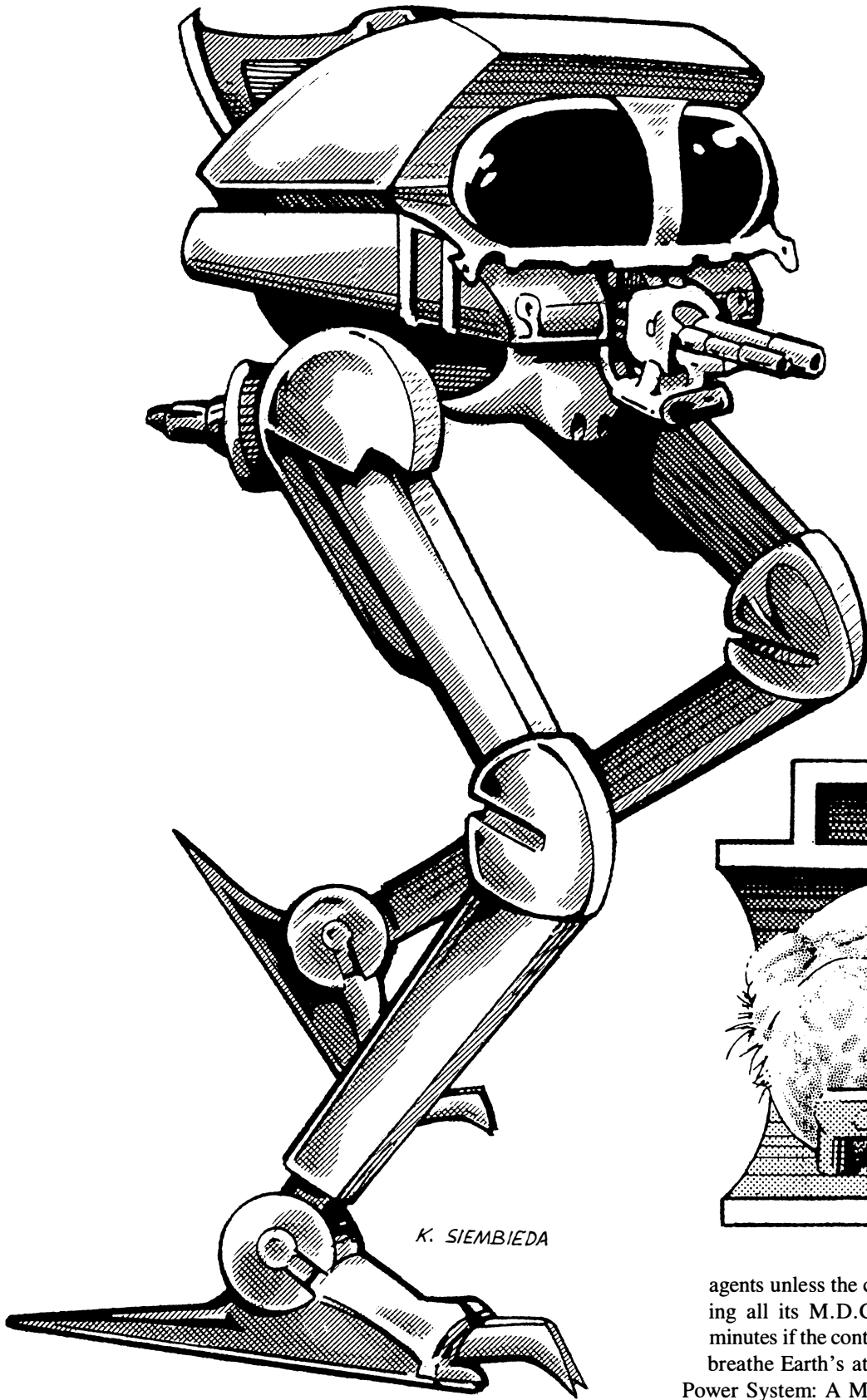

A CUT-AWAY REVEALING THE MECHANOID ORGANISM.

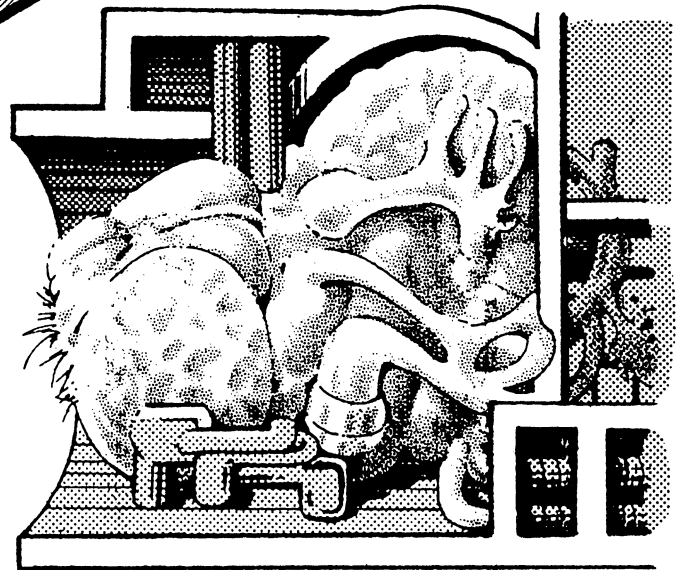

K. SIEMBIEDA

**Cargo:** A small bay that can hold a seeker pod, light cargo or a human “riding shotgun”, rumble seat style.

**Armored Body:** The cyborg body is a full environmental system with internal cooling, air purification and independent oxygen supply as is common to most suits of power armor. This also makes the creature impervious to poison, gas, and biological

agents unless the containment chamber is breached by depleting all its M.D.C. **Note:** The Mechanoid will die in 1D4 minutes if the containment chamber is breached — they cannot breathe Earth’s atmosphere!

**Power System:** A Mechanoid power crystal gives the cyborg a life of 100 years before requiring a replacement crystal.

**Black Market Value:** The Market will pay 2D4 million credits for a Mechanoid power crystal that has 50 years of energy or more, 2D4 × 100,000 if less. The crystals cannot be duplicated!

**Alignment:** Any except principled and scrupulous. Typically anarchist, unprincipled or aberrant.

Horror Factor: 11

Physical Strength: Equal to a P.S. 30

Other Attributes of Note: I.Q. 2D6 + 3, M.E. 2D6 + 8, M.A. 2D6 + 4 and P.P.E. 2D6.

Number of Attacks Per Melee: Four physical or psionic attacks.

Combat Bonuses (includes all bonuses): +1 on initiative, +6 to strike with its energy weapons, +5 to strike with a kick or stomp, +1 to parry, +4 to dodge, +1 to pull punch/kick, +4 to roll with impact, +3 to strike on a body block/ram, +4 to save vs horror factor, and +2 to save vs psionic attacks.

Psionics: Major psionic. 1D4 × 10 + 100 I.S.P. and possesses all physical psionic powers plus telepathy, and empathy.

Average Level of Experience: 1D4

Skills of Note: Radio: basic and scrambler (10%), basic math (+20%), computer operation (+10%), intelligence, detect ambush, detect concealment, sniper, tracking, wilderness survival, and land navigation (+15%).

## Weapon Systems

**1. Triple-Barrel Particle Beam Cannon (1):** This weapon is similar to the cannons of the wasp, except that it is fixed forward in the nose of the Mechanoid. The weapon has its own targeting computer which gauges distances and adds to its accuracy. The cannon can be raised and lowered up and down in a 90 degree arc, but cannot move side to side. To aim at a target to the side, the exterminator must turn its entire upper body. However, the upper body rotates 360 degrees, a complete horizontal circle, and can spin around in a second.

Primary Purpose: Assault

Weight: Not applicable; it is part of the body.

Mega-Damage: 1D4 × 10 M.D. per single blast or 3D4 × 10 M.D. per triple blast (all fire at the same target).

Rate of Fire: Equal to the number of hand to hand attacks.

Effective Range: 4000 feet (1200 m).

Payload: Effectively unlimited; patched into the armor's power supply.

**2. Ion Pulse Blasters (2):** A powerful close range weapon that can fire single blasts or a triple pulse. The weapon has its own targeting computer.

Primary Purpose: Assault and extermination.

Weight: Not applicable; it is part of the power armor's body.

Mega-Damage: 2D6 M.D. per single energy pulse or 6D6 M.D. per triple pulse blast (counts as one melee attack). The two ion blasters can be fired simultaneously at the same target inflicting either 4D6 M.D. from dual single blasts or 1D6 × 10 + 10 per dual triple blasts.

Rate of Fire: Equal to the number of hand to hand attacks.

Effective Range: 1600 feet (488 m)

Payload: Effectively unlimited; patched into the armor's power supply.

**3. Other weapons** cannot be held by the exterminator because it has no hands. However, the creature can use telekinesis or ectoplasm to operate lightweight weapons, but is -2 to strike.

**4. Hand to Hand Combat:** Rather than use a long-range weapon, the Mechanoid can engage in hand to hand combat using its legs and/or body.

Restrained Kick: 4D6 + 15 S.D.C.

Full strength Kick: 3D6 M.D.

Leap Kick: 6D6 M.D., but counts as two attacks.

Stomp: 2D4 M.D.

Head Butt: 1D4 M.D.

Body block/ram: 2D6 M.D. damage and has a 1-50% chance of knocking one's opponent off his feet (victim loses initiative and one melee attack), but counts as two melee attacks.

**5. Sensor Systems of Note:** Same as the runner.

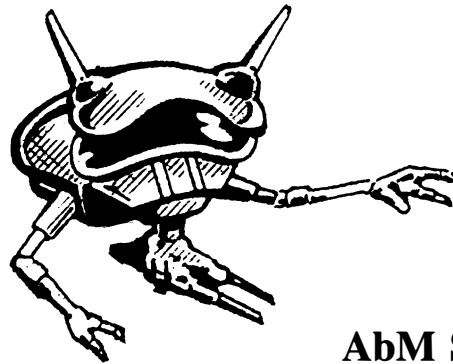

## AbM Seeker Pod

Although originally designed as a second component to the Exterminator, among the Aberrant Mechanoids (AbM) the Seeker pod is frequently an independent operative (and lots of fun to play).

They are the smallest AbMs. Their size makes them perfect for espionage and reconnaissance. Like all of the predatory AbMs, the seeker pod loves adventure, combat and the hunt. They are quick to take action, aggressive, alert, wily spies and hunters/trackers. Although aggressive and always ready for a fight, the seeker is not a mad dog warrior like the wasp and exterminator and exhibits great restraint and reason. It is cooperative, polite and obedient and prefers to work with a group.

The armor of the AbM Seeker Pod has been slightly modified and its M.D.C. increased from that of the original design (was only 10 M.D.C.).

**Model Type:** AbM Seeker Pod — Spy, tracker, and reconnaissance

**Class:** Cyborg

**M.D.C. by Location:**

\*Arms (2) — 10 each

Containment Chamber — 30

\*Laser Turret (1) — 30

\*\*Main Body — 60

\* These targets are comparatively small and difficult to hit. Thus, they can only be hit when the attacker makes a *called shot* and even then he is -3 to strike.

\*\*Depleting the M.D.C. of the main body destroys the cyborg's mechanical body housing, however, the organism's environmental containment chamber (effectively the pilot's compartment) holds the majority of the living organism. The Mechanoid organism can be rescued and installed into another mechanical body of the same design. Except for its psionic powers, the creature is totally helpless and will die within 5D6 days.

## Speed

Flying: 90 mph (144 km) maximum. 1000ft (305 m) maximum altitude.

Range: Unlimited.

## Statistical Data

Height: 2 feet, 6 inches (0.65 m)

Width: 2 feet (0.6 m)

Length: 3 feet (0.9 m)

Weight: 100 lbs (45 kg)

Cargo: None

Armored Body: The cyborg body is a full environmental system with internal cooling, air purification and independent oxygen supply as is common to most suits of power armor. This also makes the creature impervious to poison, gas, and biological agents unless the containment chamber is breached by depleting all its M.D.C. **Note:** The Mechanoid will die in 1D4 minutes if the containment chamber is breached — they cannot breathe Earth's atmosphere!

Power System: A Mechanoid power crystal gives the cyborg a life of 100 years before requiring a replacement crystal.

Black Market Value: The Market will pay 1D4 million credits for the smaller than usual Mechanoid power crystal if it has 50 years of energy or more, 1D4 × 100,000 if less. The crystals cannot be duplicated!

Alignment: Any except diabolic evil. Typically anarchist or unprincipled.

Horror Factor: 7

Physical Strength: Equal to a P.S. 17

Other Attributes of Note: I.Q. 2D6 + 6, M.E. 2D6 + 8, M.A. 2D6 + 10 and P.P.E. 3D6.

Number of Attacks Per Melee: Four physical or psionic attacks.

Combat Bonuses (includes all bonuses): +3 on initiative, +4 to strike with its energy weapons, +4 to strike with a punch, +4 to strike on a flying body block/ram, +4 to parry, +6 to dodge, +1 to pull punch, +3 to roll with impact, +4 to save vs horror factor, and +2 to save vs psionic attacks.

Psionics: Minor psionic. 1D4 × 10 + 30 I.S.P. and possesses the powers of telepathy, empathy, presence sense, see the invisible, object read, sixth sense and mind block.

Average Level of Experience: 1D4

Skills of Note: All espionage (+20%), plus radio: basic and scrambler (+15%), prowler (+10%), basic math (+30%), computer operation (+20%), and land navigation (+20%). Weapon proficiencies include W.P. energy pistol, knife and blunt.

## Weapon Systems

**1. Variable Mini-Laser Turret:** A small, double-barrelled laser turret is built into the undercarriage of the seeker pod. It is a multi-purpose appendage used as both a short-range defensive weapon and a tool. The weapon has its own targeting computer which analyzes the reflectivity of armor and substances as well as distances. After one melee round, the computer is able to adjust to the light frequency that will inflict maximum damage to the target. The turret can rotate 360 degrees and has a 90 degree vertical arc of fire.

Primary Purpose: Multiple; weapon and tool.

Weight: Not applicable; it is part of the lower body.

Mega-Damage: 1D6 M.D. per single blast or 2D6 M.D. per double blast.

Rate of Fire: Equal to the number of hand to hand attacks.

Effective Range: 2000 feet (610 m)

Payload: Effectively unlimited; patched into the armor's power supply.

**2. Energy rifles, pistols** and other lightweight hand-held weapons can be used by the seeker pod.

**3. Hand to Hand Combat:** Rather than use a long range weapon, the Mechanoid can engage in hand to hand combat using its fists and/or hand-held weapons.

Restrained Punch: 2D6 + 2 S.D.C.

Full Strength Punch: 1D4 M.D.

Flying Body block/ram: 1D6 M.D. damage and has a 1-30% chance of knocking one's opponent off his feet (victim loses initiative and one melee attack), but counts as two melee attacks.

**4. Sensor Systems of Note:** Same as the Runner.

## AbM Tunnel Crawler

The Mechanoid tunnel crawler is another creature designed for hunting and exterminating humans and humanoids. It is usually a lone hunter or works in pairs or a small group. The AbM tunnel crawler has a low intelligence and like the other predators, is consumed with stalking and killing. However, the AbM tunnel crawler is also extremely curious and enjoys exploring and reconnaissance.

The creature is extremely loyal and brave, with nerves of steel. They are extremely capable fighters and can be quite merciless when provoked or protecting a friend. They can move quickly and quietly, their six legs giving them great stability and superb climbing abilities, including climbing up and walking upside down on the under side of rocks and trees.

**Model Type:** AbM Tunnel Crawler — Seek & Destroy — Reconnaissance

**Class:** Cyborg

**M.D.C. by Location:**

Arms (2) — 20 each

Lower arms & hands (2) — 90 each

Legs (6) — 40 each

Containment Chamber — 90

\*Forward Ion Guns (2) — 20 each

\*Head — 50

\*\*Main Body — 200 (include forward plating)

\* Destroying the head will eliminate all optics and sensory systems, and reduces the maximum speed, number of melee attacks and all bonuses by half. **Note:** The head is a small and difficult target to hit. Thus, it can only be hit when a character makes a *called shot* and even then the attacker is -3 to strike.

\* The tiny ion guns are equally difficult to hit.

\*\*Depleting the M.D.C. of the main body destroys the cyborg's mechanical body housing, however, the organism's environmental containment chamber (effectively the pilot's compartment) holds the majority of the living organism. The Mechanoid organism can be rescued and installed into another mechanical body of the same design. Except for its psionic

powers, the creature is totally helpless and will die within 5D6 days.

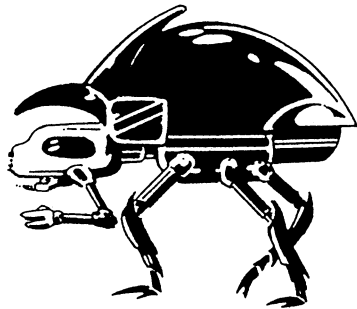

### Speed

Running: 50 mph (80 km) maximum; climbing or walking on ceilings (upside down) is one-third the maximum speed.

Leaping: 10 feet (3 m) high or across.

Flying: Its secondary means of movement is a limited anti-gravity propulsion system similar to the wasp's. 50 mph (80 km), cruising speed is typically about half, maximum altitude is 2000 feet (610 m).

Range: Unlimited.

### Statistical Data

Height: 5 feet (1.5 m)

Width: 6 feet (1.6 m)

Length: 7 feet (2.1 m)

Weight: 2.4 tons

Cargo: None

Armored Body: The cyborg body is a full environmental system with internal cooling, air purification and independent oxygen supply as is common to most suits of power armor. This also makes the creature impervious to poison, gas, and biological agents unless the containment chamber is breached by depleting all its M.D.C. **Note:** The Mechanoid will die in 1D4 minutes if the containment chamber is breached — they cannot breathe Earth's atmosphere!

Power System: A Mechanoid power crystal gives the cyborg a life of 100 years before requiring a replacement crystal.

Black Market Value: The Market will pay 2D4 million credits for a Mechanoid power crystal that has 50 years of energy or more, 2D4 × 100,000 if less. The crystals cannot be duplicated!

Alignment: Any except diabolic or miscreant evil. Typically principled or scrupulous.

Horror Factor: 9

Physical Strength: Equal to a P.S. 20

Other Attributes of Note: I.Q. 2D6 + 5, M.E. 2D6 + 8, M.A. 2D6 + 2, and P.P.E. 2D6.

Number of Attacks Per Melee: Five physical or psionic attacks.

Combat Bonuses (includes all bonuses): +3 on initiative, +5 to strike with ion beams, +5 to strike with a punch, +4 to strike with a flying body block/ram, +5 to parry, +6 to dodge, +3 to pull punch, +3 to roll with impact, +4 to save vs horror factor, and +2 to save vs psionic attacks, +2 to save vs magic and poison.

Psionics: Minor psionic. 1D6 × 10 + 60 I.S.P. and possesses telepathy, empathy, presence sense, see the invisible, see aura, sense magic, detect psionics, and mind block.

Average Level of Experience: 1D4 + 2

Skills of Note: All espionage (+10%), basic math (+30%), prowl (+15%), climb (+20%), land navigation (+20%), computer operation (+5%). Weapon proficiencies include W.P. energy pistol, energy rifle, sword and blunt.

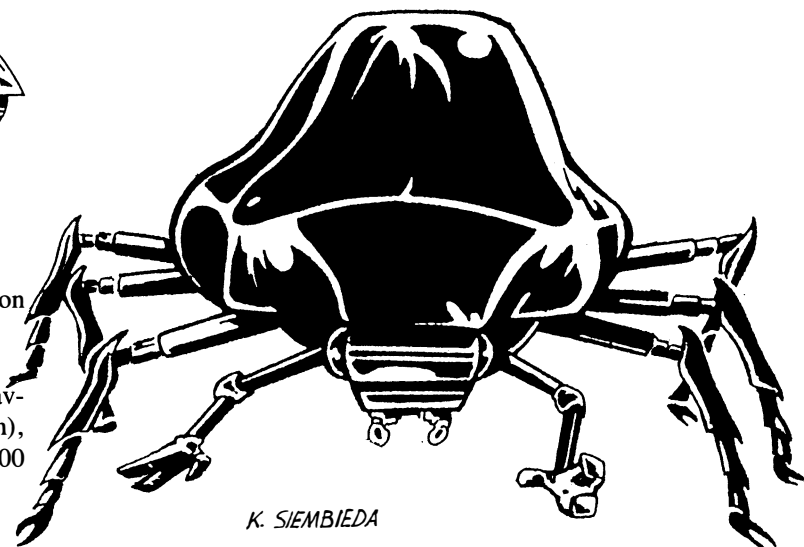

### Weapon Systems

**1. Ion Pulse Blasters (2):** A powerful close range weapon that can fire single or double blast. The weapon has its own targeting computer.

Primary Purpose: Assault and extermination.

Weight: Not applicable; it is part of the power armor's body.

Mega-Damage: 2D6 M.D. per single energy pulse or 4D6 M.D. per twin blasts (counts as one melee attack).

Rate of Fire: Equal to the number of hand to hand attacks.

Effective Range: 1200 feet (366 m)

Payload: Effectively unlimited; patched into the armor's power supply.

**2. Nerve Gas:** A gas toxic to most mammals can be released in the form of a greenish colored cloud (covers a 20 ft/6 m area). The gas has no effect on mega-damage creatures or characters enclosed in an environmental suit or vehicle.

Primary Purpose: Extermination

Weight: Not applicable; it is part of the power armor's body.

Damage: 1D6 direct to hit points and 6D6 additional S.D.C. damage per every exposure and each additional melee round (15 seconds) of exposure to the toxic cloud.

Rate of Fire: Equal to the number of hand to hand attacks.

Effective Range: 100 feet (30.5 m), covering a 20 foot (6 m) area per discharge.

Payload: Six per hour. The toxic cloud is produced by glands inside the Mechanoid organism.

**3. Energy rifles, pistols and other lightweight hand-held weapons** can be used by the Mechanoid.

**4. Hand to Hand Combat:** Rather than use a distance weapon, the Mechanoid can engage in hand to hand combat using its fists and/or hand-held weapons.

Restrained Punch: 2D6 + 5 S.D.C.

Full Strength Punch or Kick: 1D4 M.D.

Flying or leaping body block/ram: 1D6 M.D. damage and has a 1-50% chance of knocking one's opponent off his feet (victim loses initiative and one melee attack), but counts as two melee attacks.

**5. Sensor Systems of Note:** Same as the Runner.

# The Evil Mechanoids<sup>®</sup>

---

The evil Mechanoids are designed as non-player character villains. They are NOT recommended as player characters. All “true” or “pure” Mechanoids are maniacal creatures bent on the torture and destruction of humans and human-like species! The “true” Mechanoids live and work in a strict hierarchical, hive-like society and share the same goals: to gather knowledge, conquer new worlds and exterminate all humanoid life. All work to accomplish these goals in a cooperative manner.

It is important to note just what is the hierarchy within the Mechanoid society. There are only four “free-thinkers.” These beings have free will, independent thoughts, ideas, personality, alignments and disposition. The four serve as the leaders, scientists, scholars and thinkers within the Mechanoids’ hive society.

The ultimate power is the Mechanoid Overlord, next is the imaginative Oracle, followed by the Brain and the Runner. These are the villains who will hatch elaborate schemes and treacherous plots, conduct cat and mouse games with the enemy, perform strange experiments, enjoy slow torture of humanoids and develop the strategy and tactics for military campaigns. They give the Mechanoid race order and purpose, the others follow their lead.

The majority of the other Mechanoids are also intelligent, possess some measure of personality, and are capable of original thoughts. However, they are not as intelligent or curious as the free-thinkers and are also driven by strong instincts. Primordial needs and responses are a deliberate part of their very essence. These instincts make them merciless hunters and dedicated workers, programmed to obey their superiors without question and to work as a unit for the betterment of the society. Thus, while these more simple-minded Mechanoid organisms experience the same psychological trauma, emotions and hatred toward humans, they express themselves in a much more direct and destructive way. This is especially true of the predators like the wasp, brute and exterminator, and why they are charged with the hunting and elimination of humanoids. Only a handful of Mechanoids, like the haulers, diggers, and brain pools are effectively mindless drones, but they are the exception, not the rule.

All “true” Mechanoids, whether a free thinker, warrior or drone, loyally serve the Mechanoid race. This is due to the structure of the Mechanoid hive-like society and their inbred instincts. Furthermore, the creatures have little need for recreation or diversion. Each Mechanoid type has been designed to a specific genetic, physical and mental position to perform its particular function within their society. With the possible exception of the four free-thinkers and the Aberrant Mechanoids, they do not question their existence or their place in it. Each is a cog in a well oiled machine. Each performs its duties without fear, regret, or question. The whole must survive and each is part of the whole. This is the way things have been for thousands of years and so it shall continue. Only the AbM mutants have broken away from this narrow-minded existence.

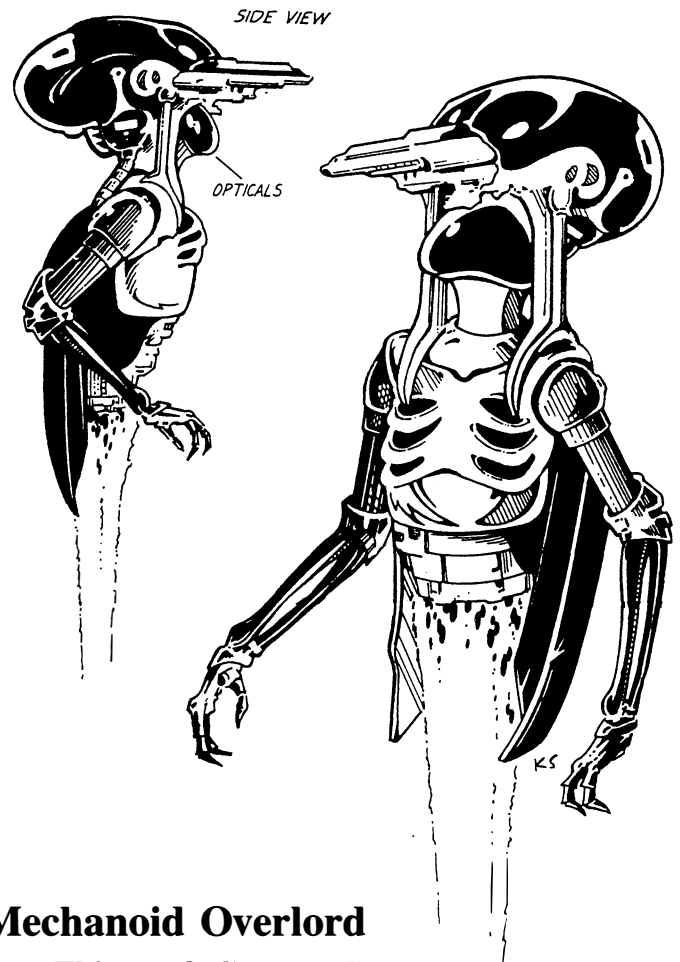

## Mechanoid Overlord

### Free-Thinker & Commander

---

The Overlords are the prime movers and ultimate leaders of the Mechanoid race. Following the hive analogy, they would be the designated queens. ALL Mechanoids answer to the overlords, including the other three free thinkers, the oracle, brain and runner. Typically only one or two overlords will be found commanding an entire planet and only one commands a planet-sized mothership. Discovering more than two on a single planet or ship is a rarity (none are likely to have arrived on Rifts Earth — GM’s choice). They seldom leave the ship, planet or a base of operation unless the situation demands it. If an overlord should be slain, the brains will assume his duties to the best of their abilities.

Overlords are extremely analytical, logical and methodical thinkers. They can organize and process a vast amount of data at amazing speeds and make the most difficult decisions quickly and with total confidence. They are superb strategists and bold leaders, as well as masters in mathematics, engineering, navigation, physics, genetics, cloning and biology. Most importantly, they alone hold the secrets of creating the Mechanoid power crystals (by converting and processing the energy of a sun; which is destroyed in the process). Likewise, the overlords are the only Mechanoids who can directly access the living master computers.

**Model Type:** Overlord: Free thinker, prime mover, strategist, scientist and supreme leader.

**Class:** Cyborg

**M.D.C. by Location:**

Hands (2) — 50 each

Arms (2) — 120 each

Large Lower Jet (1) — 300

Small Rear Jets (2) — 10 each

Particle Beam Cannon (1) — 120

Containment Chamber — 120

\*Forward Sensor Dome (1, head) — 120

\*\*Main Body — 500 (front) and 700 (rear; heavy plating)

\* Destroying the sensor dome will knock out all optic and sensor systems, including radar. The creature must rely on its normal vision and psionic senses. **Note:** The sensors are comparatively small and require attackers to make a *called shot*. Even then the attacker is -2 to strike.

\*\*Depleting the M.D.C. of the main body destroys the cyborg's mechanical body housing, however, the organism's environmental containment chamber (effectively the pilot's compartment) holds the majority of the living organism. The Mechanoid organism can be rescued and installed into another mechanical body of the same design. Except for its psionic powers, the creature is totally helpless and will die within 5D6 days. **Note:** The overlord can also survive for 1D6 hours without any environmental system and has an S.D.C. of 100.

**Speed**

Running: Not possible.

Leaping: Not possible.

Flying: Its means of movement is a combination of anti-gravity and a plasma thermo-propulsion system built into its lower body area. Maximum speed is Mach One, about 670 mph (1072 km); cruising speed is typically about half. Maximum altitude is 20,000 feet (6100 m).

Range: Unlimited.

**Statistical Data**

Height: 40 feet (12.2 m)

Width: 14 feet (4.3 m)

Length: 24 feet (6.4 m)

Weight: 40 tons

Cargo: None

Armored Body: The cyborg body is a full environmental system with internal cooling, air purification and independent oxygen supply as is common to most suits of power armor. This also makes the creature impervious to poison, gas, and biological agents unless the containment chamber is breached by depleting all its M.D.C. **Note:** The Mechanoid Overlord is able to survive outside its containment chamber longer than any other Mechanoid, about 1D6 hours!

Power System: A Mechanoid power crystal gives the cyborg a life of 100 years before requiring a replacement crystal.

Black Market Value: The Market will pay 2D4 million credits for a Mechanoid power crystal that has 50 years or more energy  $2D4 \times 100,000$  if less. The crystals cannot be duplicated!

Alignment: Any, typically aberrant evil.

Horror Factor: 15

Physical Strength: Equal to a P.S. 40

Other Attributes of Note: I.Q.  $2D6 + 18$ , M.E.  $2D6 + 18$ , M.A.  $2D6 + 16$ , and P.P.E. 6D6.

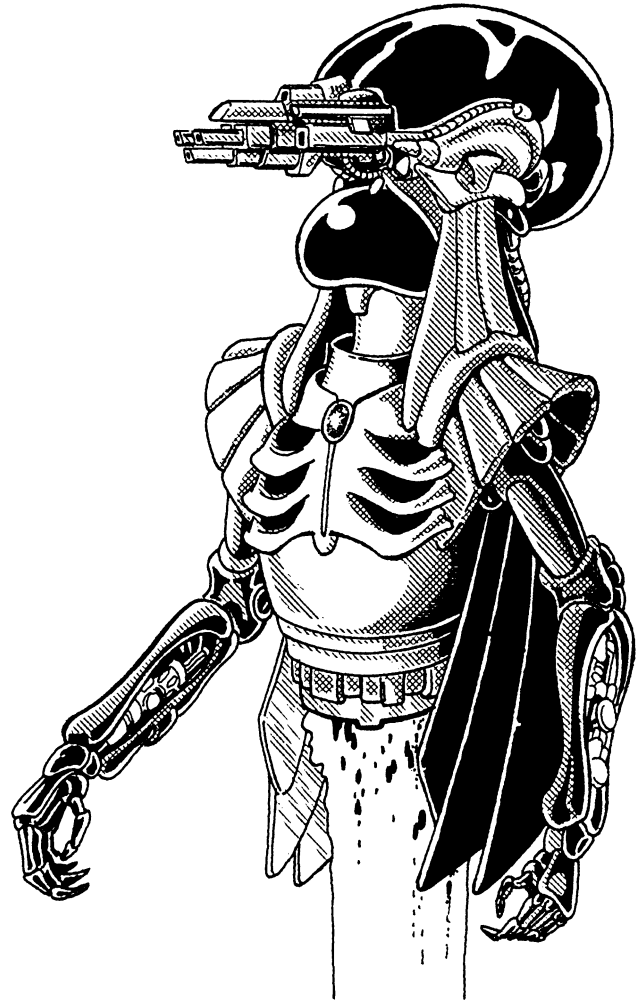

Number of Attacks Per Melee: Six physical or psionic attacks.

Combat Bonuses (includes all bonuses): +6 to strike with particle beam, +4 to strike with all other weapons. +5 to strike with a punch, +5 to parry, +5 to dodge, +2 to pull punch, +3 to roll with impact, +8 to save vs horror factor, +8 to save vs psionic attacks, and +4 to save vs magic and poison.

Psionics: Master psionic but considered a mind melter.  $1D6 \times 100 + 2300$  I.S.P.! Psionic powers include all sensitive, physical and super.

Average Level of Experience:  $1D6 + 10$

Skills of Note: All engineering, electrical, science, pilot related, computer and communication skills. Weapon proficiencies include W.P. heavy energy weapons and blunt.

**Weapon Systems**

**1. Triple-Barrel Particle Beam Cannon (1):** This weapon is similar to the cannons of the wasp, except that it is much larger, providing greater range and is fixed forward on the head of the Mechanoid. The weapon has its own targeting computer which gauges distances and adds to its accuracy.

Primary Purpose: Assault

Weight: Not applicable, it is part of the power armor's body.

Mega-Damage:  $1D4 \times 10$  M.D. per single blast or  $3D4 \times 10$  M.D. per triple blast (all fire at the same target).

Rate of Fire: Equal to the number of hand to hand attacks.

Effective Range: 6000 feet (1829 m).

Payload: Effectively unlimited; patched into the armor's power supply.

**2. Hand-held weapons** can be used by the overlord. Giant weapons can be used by the hands while smaller weapons can be operated using telekinesis or ectoplasm (–2 to strike).

**3. Hand to Hand Combat:** Rather than use a long-range weapon, the Mechanoid can engage in hand to hand combat using its fists and/or hand-held weapons.

Restrained Punch: 6D6 + 25 S.D.C.

Full Strength Punch: 4D6 M.D.

Power Punch: 1D6 × 10 M.D., but counts as two attacks.

Burn opponents beneath it with its plasma jets: 1D4 × 10 M.D.

Flying Body Block/Ram: 4D6 M.D. damage and has a 1-60% chance of knocking one's opponent off his feet (victim loses initiative and one melee attack), but counts as two melee attacks.

#### 4. Sensor Systems of Note:

**Optics:** Full optical systems, including the visible light spectrum, infrared, ultraviolet, polarization, passive night vision (light amplification), thermo-imaging, laser targeting, and telescopic. *Telescopic optics* function like built-in binoculars with a range of about two miles (3.2 km). All the other optic systems have a range of about 5200 feet (1560 m).

**Radar:** Can identify and track up to 500 targets simultaneously, at a range of 50 miles (80 km). Applicable to flying targets at 500 feet above the ground or higher. The radar can not track ground movement.

**Other Sensors:** Heat and motion detection with a 1200 ft (366 m) range. Molecular analyzer and radar and radiation detectors (effectively the same as human bionic system).

**Radio Communication:** Long-range directional radio. Range: 500 miles (800 km). The radio system can also eavesdrop on enemy transmissions and track transmissions to their source (60% success ratio); tracking range is limited to 100 miles (160 km).

**Built-in Language Translator:** Same as the portable unit; see **Rifts RPG**, page 247.

## Oracle

---

The oracle was once the most mysterious of the Mechanoids. They exhibited an uncharacteristic love for art, music and creativity, as well as an understanding, compassion and gentleness toward other life forms, including humans. Before the appearance of the AbM mutants, most were of a good alignment and avoided having an active hand in the annihilation of humanoids. They preferred to philosophize and create things rather than to destroy. They were visionaries, artists, philosophers and dreamers. In many ways, the oracle represented all the good that the Mechanoid race could accomplish.

In the old days, an increasing number of the Mechanoid Oracles began to sympathize with the humanoids' plight and began to question the logic and morality of their genocidal quest. Some even secretly helped captives and refugees to escape. It is likely that an oracle(s) was responsible for the mysterious mutation that created the AbM mutants. However, the new, "true" Mechanoids as they sometimes refer to themselves, believe they have found and eliminated the cause of these mutations. To insure this never happens again, the new, Mechanoid Oracles have been subjected to genetic reconstruction, making the crea-

ture far more single-minded and aggressive toward humanoids. The cost has been the loss of their compassion, objectivity and love for the arts.

The improved/alterd oracles are no longer the compassionate, inquisitive artists who often served as the conscience of the Mechanoid race. Instead they have become fanatics consumed with finding humanoids and developing new ways to torture them before they are destroyed. They are mean-spirited monsters who delight in the suffering and manipulation of humanoids. It was an oracle who immediately recognized the incredible potential of Rifts Earth as a gateway to thousands of humanoid worlds. It was the same oracle who devised the plan to quickly splinter into smaller groups to create more clones and to uncover the secrets of dimensional travel. Even so, the other Mechanoids keep a watchful eye on all oracles.

**Note:** Only one or two oracles should have made it to Rifts Earth. These villains serve as the masterminds of the Mechanoids' campaign and will personally focus on establishing a genetics and cloning facility to make more. The oracle leader on Earth will always be protected by four wasps, two brains, four runners, two type one brutes and a dozen thinmen who accompany it everywhere.

**Model Type:** Oracle: Free thinker, genetics engineer, and systems analyst.

**Class:** Cyborg

**M.D.C. by Location:**

Containment Chamber — 120

\*Forward Sensor Dome — 120

\*\*Main Body — 500

\* Destroying the sensor domes will knock out all optic and sensor systems, including radar. The creature must rely on its normal vision and psionic senses. **Note:** The sensors are comparatively small and require attackers to make a *called shot*. Even then the attacker is –2 to strike.

\*\*Depleting the M.D.C. of the main body destroys the cyborg's mechanical body housing, however, the organism's environmental containment chamber (effectively the pilot's compartment) holds the majority of the living organism. The Mechanoid organism can be rescued and installed into another mechanical body of the same design. Except for its psionic powers, the creature is totally helpless and will die within 5D6 days. **Note:** The oracle can also survive for 1D6 × 10 minutes without any environmental system and has an S.D.C. of 300.

**Speed**

Running: Not possible.

Leaping: Not possible.

Flying: The oracle has an anti-gravity propulsion system that enables it to hover at great speeds. Maximum speed is Mach 1.2 (about 750 mph/1200 km); cruising speed is typically about half. Maximum altitude is 1000 feet (305 m).

Range: Unlimited.

**Statistical Data**

Height: 42 feet (13 m)

Width: 40 feet (12.2 m)

Length: 130 feet (39.6 m)

Weight: 120 tons

Cargo: None

Armored Body: The cyborg body is a full environmental system with internal cooling, air purification and independent oxygen supply as is common to most suits of power armor. This also



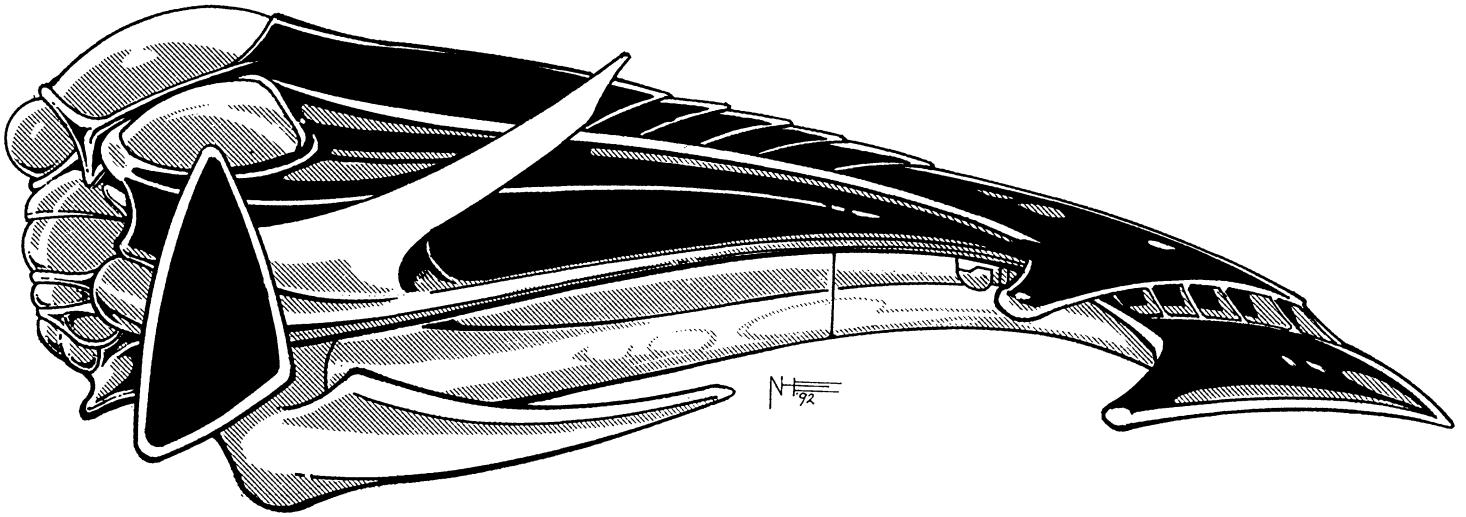

makes the creature impervious to poison, gas, and biological agents unless the containment chamber is breached by depleting all its M.D.C. **Note:** The Mechanoid Oracle is able to survive outside its containment chamber for about  $1D6 \times 10$  minutes.

**Power System:** A Mechanoid power crystal gives the cyborg a life of 100 years before requiring a replacement crystal.

**Black Market Value:** The Market will pay  $2D4$  million credits for a Mechanoid power crystal that has 50 years or more energy,  $2D4 \times 100,000$  if less. The crystals cannot be duplicated!

**Alignment:** Any, typically anarchist, miscreant or aberrant.

**Horror Factor:** 13

**Physical Strength:** Equal to a P.S. 30

**Other Attributes of Note:** I.Q.  $2D6 + 16$ , M.E.  $2D6 + 16$ , M.A.  $2D6 + 16$ , and P.P.E.  $1D6 \times 10$ .

**Number of Attacks Per Melee:** Five psionic attacks or five hand to hand/weapon attacks by means of telekinesis or ectoplasm.

**Combat Bonuses (includes all bonuses):** Combat using telekinesis or ectoplasm: +3 to strike, +4 to parry, +2 to pull punch. Also +6 to save vs horror factor, +6 to save vs psionic attacks, and +4 to save vs magic and poison.

**Psionics:** Master psionic with  $2D6 \times 100 + 3000$  I.S.P.! ALL psionic powers, including healing, sensitive, physical and super.

**Average Level of Experience:**  $1D4 + 10$

**Skills of Note:** All engineering, electrical, science, technical, pilot related, computer and communication skills, plus M.D. in cybernetics, play musical instruments, sing and cook (uses telekinesis or ectoplasm where physical manipulation is required).

## Weapon Systems

- 1. Hand-held weapons** can be used by the oracle by using its telekinetic or ectoplasm powers (no strike penalty).
- 2. Hand to Hand Combat:** The oracle has no hands or legs and must rely on its psionic powers in combat. However, it can ram into an opponent, inflicting  $1D6 \times 10$  M.D. and has a 1-80% chance of knocking one's opponent off his feet (victim loses initiative and one melee attack), but counts as two melee attacks.
- 3. Sensor Systems of Note:** Same as the overlord.

## Mechanoid Brain

The Mechanoid brain is not unlike a general in an army, although they sometimes change hats to play the role of the mad scientist. They wield great authority and nearly absolute control over those assigned to their command. Only an oracle or overlord can supersede the authority of a Mechanoid Brain. As far as the average human can tell, it is the ever present brain, commanding his troops, who is the leader of the Mechanoids — the overlord and oracle are seldom observed in action.

The Mechanoid brains have a fairly free hand in exactly how they conduct themselves and lead their troops. As will all Mechanoids, its genetic code and mental conditioning prevent it from wavering too far from its instinctive purposes to gather information, conquer and destroy humanoids. The only deviations are exactly how these things are coordinated and accomplished.

The brain's duties within the Mechanoids' society are varied and numerous. They supervise and coordinate almost every function of activity, including scientific study, experimentation, data analysis, navigation, cloning, cybernetics, manufacturing, troop movements, and many other daily tasks.

They are crafty, with a good head for strategy and tactics, as well as organization. They are maleficent creatures who despise humanoids and can be cruel beyond belief when it comes to torturing and tormenting prisoners.

The old-styled body housing has been completely redesigned, with combat situations in mind. The new body style completely encapsulates the living organism in a protective armored bubble. The lower body has insect-like legs that are combined with a bulbous upper body, to give the appearance of a spider. The four legs are perfect for traveling over a variety of terrains and provide increased ground speed. The lower body also has anti-gravity flight capabilities for even greater speed and diversity of movement. Two large and two small jets are built into the rear of the upper body for underwater and space propulsion.

The upper body can detach and reattach itself to the lower body. Simple hover jets built into the undercarriage provides reasonable movement (the anti-gravity system is housed in the lower body). The separation of the upper body from the lower body can be useful in fitting into smaller openings, tricking an

opponent and for accessing brain pools. Two arms are also built into the upper body.

As for weapons, one finger on each hand still has the concealed laser. The cyborg can also use hand-held weapons, but it now has a plasma sphere built into the forward section of its lower body as a means of defense.

**Note:** They are one of the four Mechanoids authorized to link with a Mechanoid brain pool (computer). The runner is the brain's right-hand man, with the brute not too far beneath him. Typically, wherever one finds a brain, 1D4 runners and/or brutes are not far away.

Evil brains who survive on Rifts Earth will dedicate themselves to establishing a genetics and robotics factory for the creation of an army of clones and robots. However, they will need runners to assist them. Otherwise, the brains will dedicate themselves to secretly undermining the power structures of the natives by manipulating humanoids and non-humans alike. Remember, brains are powerful master psionics who use their powers to cause mayhem and death.

**Model Type:** Brain: Free thinker, coordinator, commander and scientist.

**Class:** Cyborg

**M.D.C. by Location:**

Hands (2) — 10 each

Arms (2) — 50 each

Large Rear Jets (2) — 30 each

Small Rear Jets (2) — 10 each

Forward Plasma Sphere (1) — 25

Containment Chamber — 120

\*Forward Sensor Domes (3) — 20 each

\*\*Main Body (upper portion) — 150

\*\*\*Lower Body — 120

\* Destroying the sensor domes will knockout all optic and sensor systems including radar. The creature must rely on its normal vision and psionic senses. **Note:** The sensors are comparatively small and require attackers to make a *called shot*. Even then the attacker is -2 to strike.

\*\*Depleting the M.D.C. of the main body destroys the cyborg's mechanical body housing, however, the organism's environmental containment chamber (effectively the pilot's compartment) holds the majority of the living organism. The Mechanoid organism can be rescued and installed into another mechanical body of the same design. Except for its psionic powers, the creature is totally helpless and will die within 5D6 days. **Note:** The brain can also survive for 6D6 minutes without any environmental system. It has an S.D.C. of 35.

\*\*\*Depleting the M.D.C of the lower body destroys the anti-gravity system and the power of flight, leaving the upper body with its slower, more limited hover jet system.

**Speed**

Running: 50 mph (80 km) maximum. Note: movement does not tire the Mechanoid inside.

Leaping: 10 feet (3 m) high or across.

Flying: Its secondary means of movement is a limited anti-gravity propulsion system built into its lower body. Maximum speed is 200 mph (320 km); cruising speed is typically about half. Maximum altitude is 20,000 feet (6100 m). The more limited hover jet system of the upper body has a speed of 60 mph (96 km) and a maximum altitude of 500 feet (153 m).

Range: Unlimited.

**Statistical Data**

Height: 14 feet (4.2 m)

Width: 6 feet (1.8 m)

Length: 8 feet (2.4 m)

Weight: Three tons

Cargo: There are two small storage compartments in the rear of the lower body about the size of a car trunk.

Armored Body: Standard full environmental system. **Note:** The Mechanoid Brain is able to survive outside its containment chamber for about 6D6 minutes!

Power System: A Mechanoid power crystal gives the cyborg a life of 100 years before requiring a replacement crystal.

Black Market Value: The Market will pay 2D4 million credits for a Mechanoid power crystal that has 50 years or more energy, 2D4 × 100,000 if less. The crystals cannot be duplicated!

Alignment: Any

Horror Factor: 13

Physical Strength: Equal to a P.S. 30

Other Attributes of Note: I.Q. 2D6 + 15, M.E. 2D6 + 13, M.A. 2D6 + 11, and P.P.E. 5D6.

Number of Attacks Per Melee: Four physical or psionic attacks.

Combat Bonuses (includes all bonuses): +5 to strike with laser, +3 to strike with plasma generator and all other weapons. +3 to strike with a punch, +3 to parry, +3 to dodge, +1 to pull punch, +2 to roll with impact, +6 to save vs horror factor, and +4 to save vs psionic attacks, +2 to save vs magic and poison.

Psionics: Master psionic with 1D6 × 100 + 1400 I.S.P.! Psionic powers include all healing and all physical powers, plus telekinesis (super), telepathy, empathy, empathic transmission, bio-manipulation, hypnotic suggestion, mentally possess others, mind bond, mind wipe and mindblock auto-defense.

Average Level of Experience: 2D4 + 6

Skills of Note: All medical skills (excluding holistic medicine) at 95%, all science and pilot related skills at 98%, computer operation and programming at 98%, computer hacking 68%, pilot hover vehicle, robot vehicle (and robot combat: basic), and spaceship at 90%. Weapon proficiencies include W.P. energy pistol, energy rifle and knife.

**Weapon Systems**

**1. Forward Plasma Generating Sphere (1):** The dark sphere in the front of the lower body is the plasma generator. This is a powerful weapon that can inflict massive damage. Fortunately, it is limited to two blasts per melee and has a short range compared to most Mechanoid weapons.

Primary Purpose: Defense

Weight: Not applicable; it is part of the body.

Mega-Damage: 1D4 × 10 M.D.

Rate of Fire: Twice per melee (can be combined with laser or other methods of attack).

Effective Range: 2000 feet (610 m)

Payload: Effectively unlimited; patched into the armor's power supply.

**2. Laser Fingers (2):** A utility laser is built into the first finger of each hand (concealed). It is an S.D.C. weapon used for dissection, surgery and soldering.

Primary Purpose: Tool

Weight: Not applicable; it is part of the body.

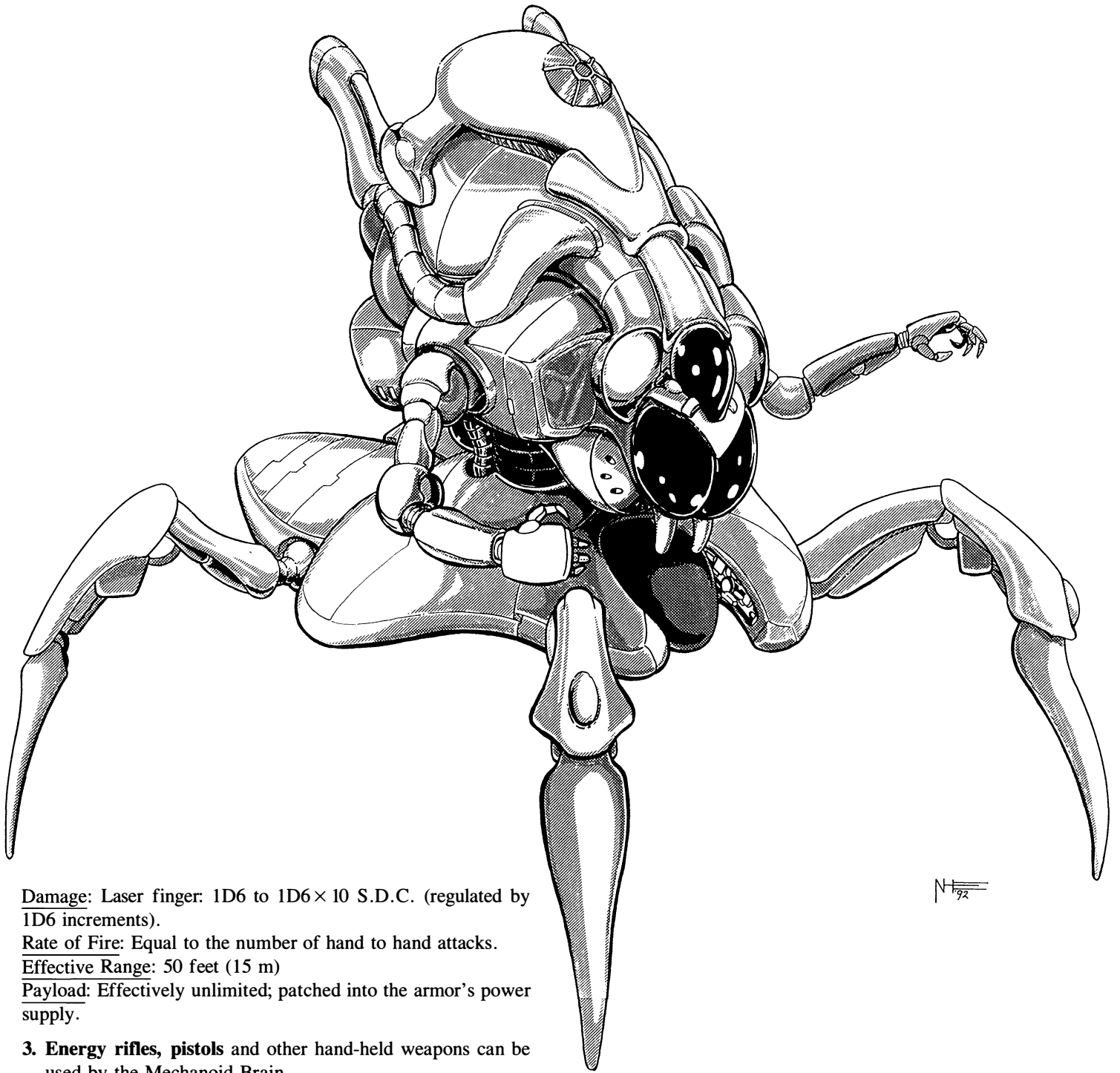

N 72

Damage: Laser finger: 1D6 to 1D6 × 10 S.D.C. (regulated by 1D6 increments).

Rate of Fire: Equal to the number of hand to hand attacks.

Effective Range: 50 feet (15 m)

Payload: Effectively unlimited; patched into the armor's power supply.

**3. Energy rifles, pistols and other hand-held weapons** can be used by the Mechanoid Brain.

**4. Hand to Hand Combat:** Rather than use a long-range weapon, this Mechanoid can engage in hand to hand combat using its fists and/or hand-held weapons. The creature can also use its psionic powers of telekinesis or ectoplasm to wield weapons or hurl objects.

Restrained Punch: 4D6 + 15 S.D.C.

Full Strength Punch or Kick: 1D6 M.D.

Power Punch: 2D6 M.D., but counts as two attacks.

Body block/ram: 2D6 M.D. damage and has a 1-50% chance of knocking one's opponent off his feet (victim loses initiative and one melee attack), but counts as two melee attacks.

**5. Sensor Systems of Note**

**Optics:** Full optical systems, including the visible light spectrum, infrared, ultraviolet, polarization, passive night vis-

ion (light amplification), thermo-imaging, laser targeting, and telescopic. *Telescopic optics* function like built-in binoculars with a range of about two miles (3.2 km). All the other optic systems have a range of about 5200 feet (1560 m).

**Radar:** Can identify and track up to 72 targets simultaneously, at a range of two miles (3.2 km). Applicable to flying targets at 500 feet above the ground or higher. The radar can not track ground movement.

**Radio Communication:** Medium range directional radio. Range: 100 miles (160 km). The radio system can also eavesdrop on enemy transmissions and track transmissions to their source (60% success ratio); tracking range is limited to 20 miles (32 km).

**Built-in Language Translator:** Same as the portable unit; see *Rifts RPG*, page 247.

# The Multi-Brain Combat Vehicle

The old-style Mechanoid Brains had several different types of body housings, each of which provided greater mobility under different conditions. This new cyborg body is superior and designed to operate in many different environments. The only additional vehicle specifically designed for the brain is the Multi-Brain.

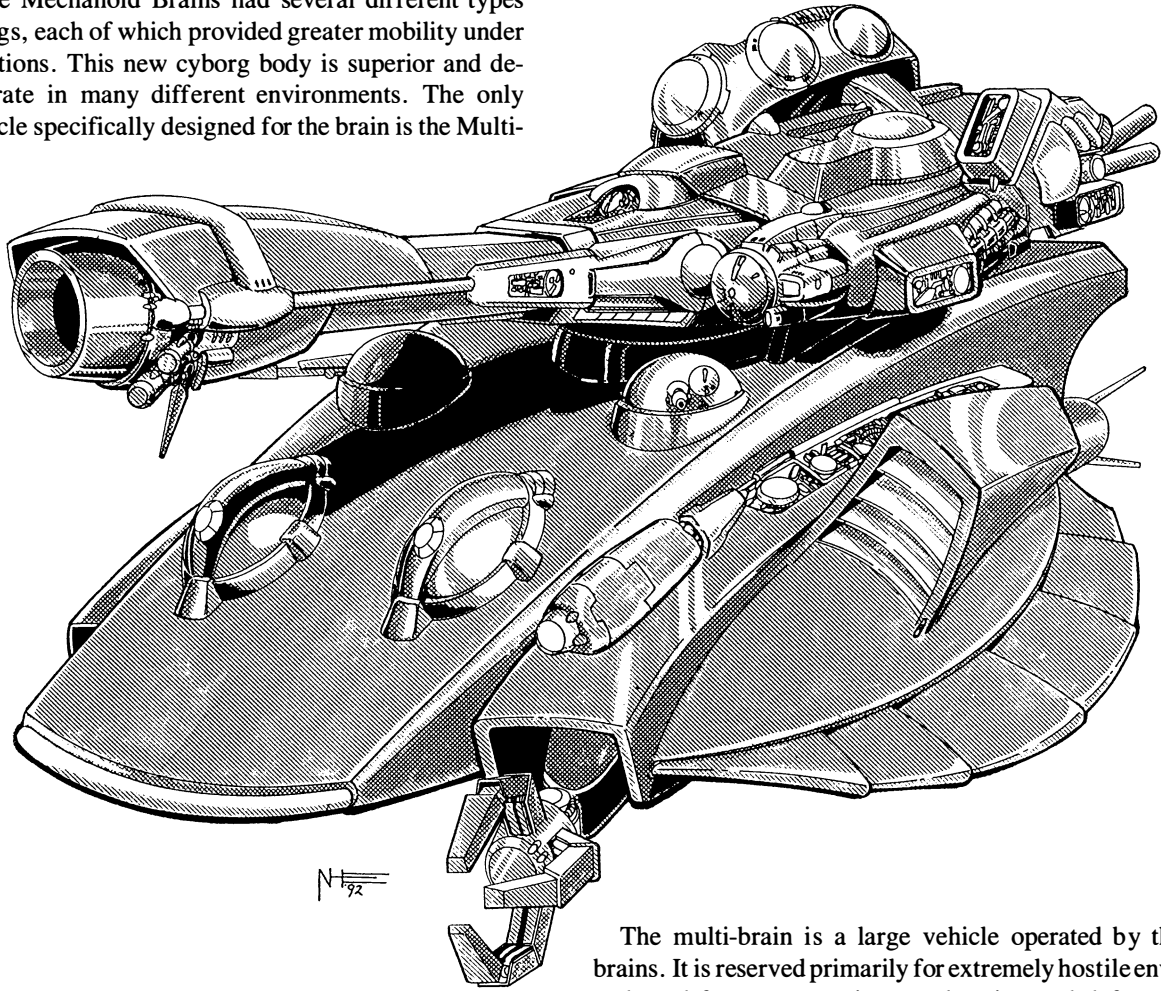

**Armored Body:** Heavily armored vehicle with full environmental system.

**Sensor Systems:** Same as the overlord.

**Power System:** A Mechanoid power crystal gives the vehicle a life of 50 years before requiring a replacement crystal.

**Black Market Value:** The Market will pay 2D4 million credits for a Mechanoid power crystal that has 40 years left in it and will pay another 2D4 million credits for a functioning plasma cannon (so they can try to duplicate it). The anti-gravity system is too complex and alien to duplicate (operated psionically) and only worth a few hundred-thousand credits to the curious.

**Total Number of Attacks Per Melee:** Twelve (12)! If necessary, the big plasma cannon, with its missile launchers, can detach from the larger, lower body. When this is done, the cannon loses the speed and mobility provided by the anti-gravity system of the main body, as well as half the combat bonuses and long-range sensor systems. Maximum speed for the cannon is 100 mph (160 km) and its total number of attacks per melee is six.

**Vehicle Combat Bonuses (includes all bonuses):** +2 on initiative, +5 to strike using lasers, +4 to strike with plasma cannon, +3 to strike with all other weapon systems, +4 to strike and parry using retractable arms, +4 to dodge, +2 to roll with impact.

The multi-brain is a large vehicle operated by three to six brains. It is reserved primarily for extremely hostile environments and used for transportation, exploration and defense. The new tank-like design reflects the Mechanoids' increased aggressive and no-nonsense attitude. A minimum of three brains are required to operate the vehicle at maximum efficiency; two to four in the lower portion and one or two in the top, cannon section. The brains themselves remain clad in their usual spider-like body housing while inside the multi-unit.

**Model Type:** Multi-Brain housing

**Class:** Combat and exploration vehicle

**Crew:** Three to six brains

**M.D.C. by Location:**

Hands/Claws (2) — 30 each

Arms (2) — 80 each

Plasma Cannon (upper body) — 140

Medium Range Missile Tubes (2) — 40 each

Mini-Missile Turret (1, 3 launchers) — 100

Laser Turrets (2) — 80 each

Searchlights (2, on the sides) — 10 each

Large Rear Jet (1) — 80

Small Rear Jets (2, on the sides) — 30 each

Containment Chambers — None

\*Forward Sensor Domes (2) — 80 each

\*\*Main Body (lower portion) — 400

\* Destroying the sensor domes will knockout all optic and sensor systems including radar. The creatures must then rely on their shorter range cyborg systems and psionic senses. **Note:**

The sensors are comparatively small and require attackers to make a *called shot*. Even then the attacker is  $-2$  to strike.

**\*\*Depleting the M.D.C. of the main body destroys the vehicle and its anti-gravity system, however, the plasma cannon can detach and keep on fighting but at a slower pace. The three to six brain pilots should be clad in their cyborg body housings and can also continue to fight on foot.**

**GM Note:** Only 1D6 of these vehicles made it through the rift.

### Speed

Flight: Mach 1 — about 670 mph (1070 km); cruising speed is typically half.

The flight, speed and aerial movement is made possible by a mentally controlled anti-gravity system operated by one of the brain pilots, while the others operate the big cannon, secondary weapon systems and/or monitor sensors. Like the wasp, the system enables the pilot to reach great speeds while maintaining absolute control and precision maneuvering. The system is so amazing that the vehicle can go from 0 to Mach One in three seconds and come to a complete stop in an instant! Maximum altitude is virtually unlimited.

Range: Unlimited.

### Statistical Data

Height: 21 feet (6.4 m); the cannon turret is 7 feet (2.1 m)

Width: 25 feet (7.6 m); the cannon is 10 feet (3 m)

Length: 40 feet (12.2 m); the cannon is 35 feet (10.7 m)

Weight: 62 tons; the cannon turret alone is 18 tons.

Cargo:  $6 \times 6 \times 6$  foot (1.8 m) storage bay.

### Weapon Systems

#### 1. Forward Plasma Turret (1) and Missile Launchers (2):

This is a devastating weapon of immense power and great range. In addition to the plasma cannon, the vehicle has a missile tube located on each side of the cannon. These fire medium range missiles and have independent laser targeting.

Primary Purpose: Assault

Weight: Not applicable; it is part of the body.

Mega-Damage: Plasma cannon:  $2D4 \times 10$  M.D., medium range missiles:  $2D4 \times 10$  M.D.

Rate of Fire: The plasma cannon can fire only four times per melee round (every 15 seconds), but can be combined with missiles, laser and other methods of attack within that same melee. The medium range missiles can be only fire one at a time and each launch counts as one attack action.

Effective Range: Plasma cannon: 8000 feet (2438 m), about a mile and a half. Medium range missiles: 40 miles (64.3 km) and travel at a speed of Mach 3.

Payload: The plasma cannon is effectively unlimited; patched into the armor's power supply. The medium range missiles are limited to four per launch tube, eight total.

#### 2. Mini-Missile Launcher (one turret, three launch tubes):

Located on the right side, toward the rear of the plasma cannon is an appendage with three domed hatches. This is a multiple mini-missile launcher.

Primary Purpose: Assault

Weight: Not applicable; it is part of the power armor's body.

Mega-Damage:  $1D4 \times 10$  M.D. per each mini-missile.

Rate of Fire: One at a time or in volleys of two or three. A volley counts as one melee action/attack regardless of the number of missiles. A total of four volleys can be launched per melee round.

Effective Range: One mile (1.6 km or approximately 1600 m)

Payload: Each of the three launch tubes houses 24 mini-missiles for a total of 72!

**3. Laser Turrets (2):** A pair of high-powered variable lasers are mounted in the center of the lower body. Both are variable frequency lasers designed to overcome laser resistant armor. Each weapon has its own targeting computer which analyzes the reflectiveness of a surface as well as distances. After one melee round, the computer is able to adjust to the light frequency that will inflict maximum damage to the target. The turrets can rotate 360 degrees and have a 10 degree up and down arc of fire.

Primary Purpose: Assault

Weight: Not applicable; they are part of the power armor's body.

Mega-Damage:  $2D6$  M.D. or  $4D6$  M.D. (two settings). The two turrets can be operated and moved independent of each other or made to fire simultaneously at the same target, inflicting  $1D4 \times 10 + 6$  per double blast (counts as one attack).

Rate of Fire: As many as twelve per melee round; each blast counts as one melee action/attack.

Effective Range: 6000 feet (1828 m)

Payload: Effectively unlimited; patched into the armor's power supply.

**4. Utility Arms (2):** Two powerful mechanical arms are located in housings on the side of the vehicle. They can be used to collect specimens, pick up, hold and carry objects or for combat.

Range/Length: 50 ft (15 m) reach

Attacks Per Melee: Up to six total.

Damage:

Restrained Punch:  $6D6 + 15$  S.D.C. (P.S. 30)

Full Strength Punch:  $3D6$  M.D.

Power Punch:  $6D6$  M.D., but counts as two melee attacks.

Crush/Squeeze:  $2D6$  M.D. per each melee action of squeezing.

Body block/ram:  $4D6$  M.D. damage and has a 1-75% chance of knocking one's opponent off his feet (victim loses initiative and one melee attack), but counts as two melee attacks.

**5. Sensor Systems of Note:** Same as the individual brain, except the ranges are all doubled and the radar can track and identify 500 different targets.

## Mechanoid Runner

The runner is a creative, resourceful and ingenious free thinker who serves as the right-hand assistant to the brains and overlords. They are often the heads of research and development, communications, physics, engineering, robotics, genetics, cloning and other scientific pursuits. As master genetic engineers they are responsible for much of the experimentation and torture on humanoids. They are usually found in the company of other Mechanoids or commanding robots.

The new body housing is similar to the old design but offers greater speed, agility and protection.

**Note:** Evil runners who survive on Rifts Earth will dedicate themselves to building a genetics and robotics factory to create an army of Mechanoid clones and a legion of combat robots. Others will try to find a way of contacting their main fleet to summon reinforcements. None will actively learn magic or how to use it to open a rift, because the pursuit of magic is forbidden.

Instead, they will observe the phenomena and try to find an inhuman ally to open a dimensional rift for them.

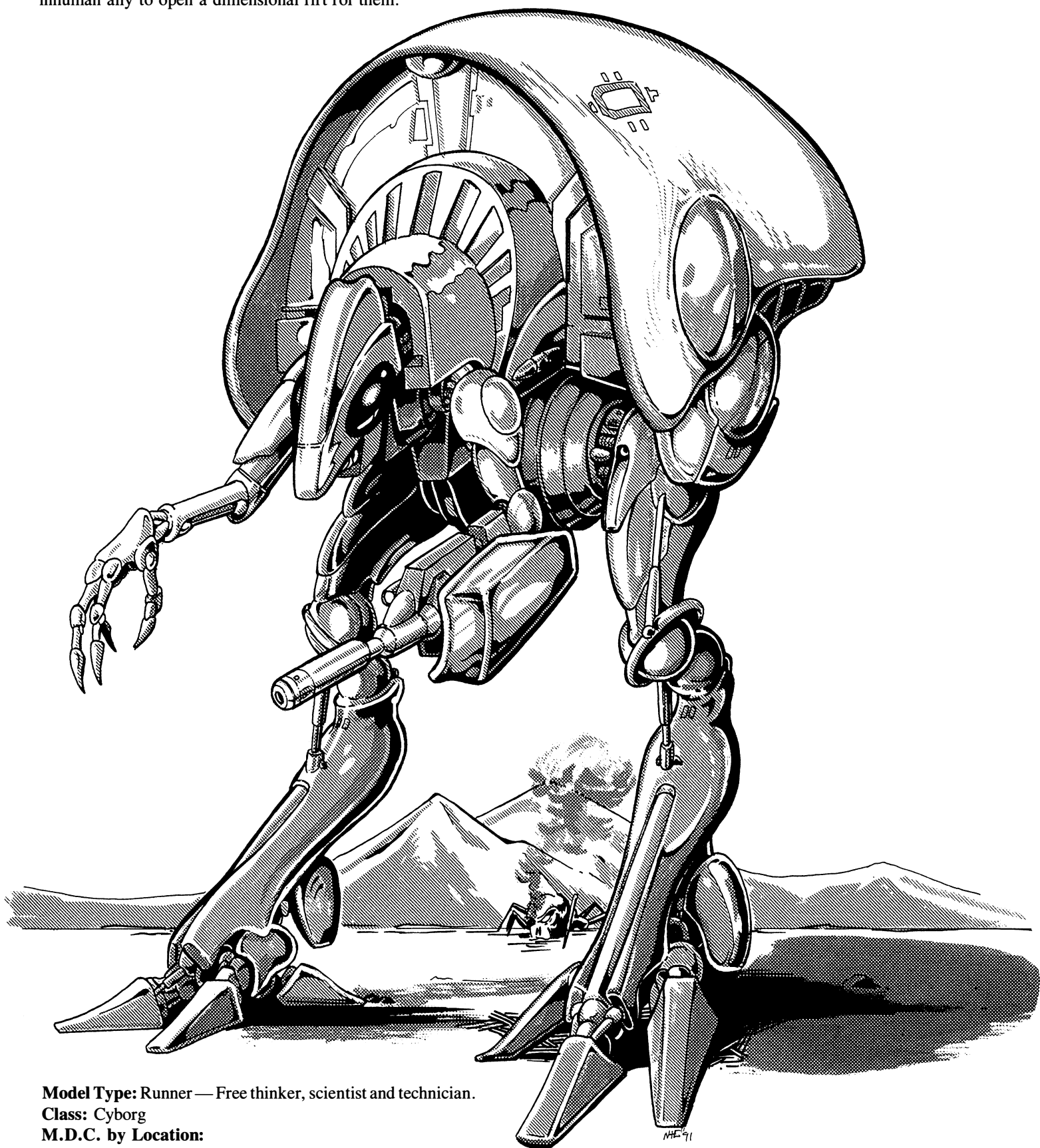

**Model Type:** Runner — Free thinker, scientist and technician.

**Class:** Cyborg

**M.D.C. by Location:**

Laser Rod (1, typically the left forearm) — 40

Hands (1 or 2) — 20 each

Lower Arms (2) — 30 each

Upper Arms (2) — 50 each

Legs (2) — 100 each

Hover Pod (an optional accessory) — 150

Containment Chamber — 120

\*Head — 90

\*\*Main Body — 150 (also see psionic force field)

\* Destroying the head will eliminate all optics and sensory systems, reduces the maximum speed, the number of melee attacks and all bonuses by half. **Note:** The head is a small and difficult target to hit. Thus, it can only be hit when a character makes a *called shot* and even then the attacker is -3 to strike.

\*\*Depleting the M.D.C. of the main body destroys the cyborg's mechanical body housing, however, the organism's environmental containment chamber (effectively the pilot's compartment) holds the majority of the living organism. The Mechanoid organism can be rescued and installed into another mechanical body of the same design. Except for its psionic powers, the creature is totally helpless and will die within 5D6 days.

### Speed

Running: 90 mph (112.6 km) maximum. Note that the act of running does not tire the Mechanoid inside.

Leaping: The powerful robot legs can leap up to 20 feet (6 m) high or across unassisted by psionic telekinesis.

Flying: Flight is not possible without the addition of a hover platform. The propulsion system enables the pod to hover in place or fly at speeds of up to 200 mph (320 km); cruising speed is typically about half. Maximum altitude is 20,000 feet (6100 m).

Range: Unlimited.

### Statistical Data

Height: 15 feet (4.6 m)

Width: 6 feet (1.8 m)

Length: 8 feet (2.4 m)

Weight: 2.2 tons

Cargo: None.

Armored Body: Standard: See the Mechanoid Brain. **Note:** The Mechanoid will die in 1D4 minutes if the containment chamber is breached — they cannot breathe Earth's atmosphere!

Power System: Standard: 100 years.

Black Market Value: Standard: The Market will pay 2D4 million credits for a Mechanoid power crystal that has 50 years or more energy, 2D4 × 100,000 if less. The crystals cannot be duplicated!

Alignment: Any, but typically selfish or evil.

Horror Factor: 11

Physical Strength: Equal to a P.S. 30

Other Attributes of Note: I.Q. 2D6 + 12, M.E. 2D6 + 10, M.A. 2D6 + 8, and P.P.E. 4D6.

Number of Attacks Per Melee: Five physical or psionic attacks.

Combat Bonuses (includes all bonuses): +1 on initiative, +5 to strike with laser rod, +3 to strike with all other weapons. +4 to strike with a punch or kick, +4 to parry, +4 to dodge, +2 to pull punch, +2 to roll with impact, +2 to strike on a body block/ram, +5 to save vs horror factor, and +3 to save vs psionic attacks.

Psionics: Major psionic but considered a mind melter. 1D4 × 100 + 290 I.S.P. and possesses all sensitive psi-powers, plus hypnotic suggestion, telekinetic force field, and telemechanics.

Average Level of Experience: 1D4 + 6

Skills of Note: All communication skills at 98%, all electrical, mechanical, and pilot related skills at 90%, basic and advanced math 98%, computer operation and programming at 90%, computer hacking 40%, pilot hover vehicle and

spaceship at 85%, and intelligence, forgery, tracking, wilderness survival, and land navigation, all at 75%. Weapon proficiencies include W.P. energy pistol, energy rifle and heavy energy and knife.

## Weapon Systems

**1. Multi-Purpose Forearm Laser Rod:** This multi-purpose appendage is used as both a weapon and a tool. The long-range lasers are variable frequency lasers designed to overcome laser resistant armor. The weapon has its own targeting computer which analyzes the reflectivity of armor and substances as well as distances. After one melee round, the computer is able to adjust to the light frequency that will inflict maximum damage to the target. The laser is accurate and deadly.

Primary Purpose: Multiple; weapon and tool.

Weight: Not applicable; it is part of the body.

Mega-Damage: Long-range laser: 4D6 M.D. or 6D6 M.D. (two settings), short-range laser: 1D6 M.D. or 3D6 M.D., laser scalpel: 1D6 to 1D6 × 10 S.D.C. (regulated by 1D6 increments) or 1D4 M.D.

Rate of Fire: Equal to the number of hand to hand attacks.

Effective Range: Long-range laser: 5200 feet (1560 m), short-range laser 1200 feet (366 m), laser scalpel: one foot (0.3 m).

Payload: Effectively unlimited; patched into the armor's power supply.

**2. Rail Guns, energy weapons** and other weapons can be substituted in an emergency or as a back-up weapon.

**3. Hand to Hand Combat:** Rather than use a long-range weapon, the Mechanoid can engage in hand to hand combat using its fists and/or hand-held weapons.

Restrained punch: 4D6 + 15 S.D.C.

Full strength punch: 2D4 M.D.

Kick: 3D6 M.D.

Leap Kick: 5D6 M.D., but counts as two attacks.

Head Butt: 1D4 M.D.

Body block/ram: 2D6 M.D. damage and has a 1-50% chance of knocking one's opponent off his feet (victim loses initiative and one melee attack), but counts as two melee attacks.

**4. Sensor Systems of Note:** Same as the Mechanoid Brain.

**5. Runner Hover Pod:** The runner has a simple hover platform which it literally steps into for greater speed and mobility.

Function: Transportation

Weapons: None

Main Body M.D.C.: 150

Speed: Hover jet system of propulsion; 400 mph (640 km) with a maximum altitude of 5000 ft (1524 m).

**Note:** This hover pod is specifically designed for use ONLY by the runner. It cannot be piloted by any other Mechanoid or human.

## Mechanoid Brute

The Mechanoid brute is designed to be a commander of lesser Mechanoids and robots — like a Sergeant or a Lieutenant in the army. Consequently, brutes, although a predator like the wasp and exterminator, are extremely loyal to their superiors and have a cool, calculating mind. They are calm, methodical creatures

with a good head for tactics and command and love combat and espionage more than anything else. They are fairly good leaders, particularly as a second or third in command. In addition to their military duties, brutes supervise and assist in construction, manufacturing, maintenance and anything else asked of them.

There are now two distinctly different styles of brute body armor. Both types house the identical living organism, only the mechanical body has been changed. The humans' label of "brute" reflects this Mechanoid's raw power and ferocity in battle. Like most of its kind, the brute enjoys torturing and killing humanoids.

## Type One Brute

The Mechanoids have made some dramatic changes in the brute. The type one brute resembles the old body style except that it is a little larger, has a slightly different body styling, more armor, and housings for a battery of detachable weapons. The addition of the weapons gives the brute a dramatically different appearance than the old AbM styling and makes the Mechanoid more lethal than the exterminator and, arguably, the wasp. It is a walking tank!

The complete, three unit weapon package includes a missile launcher, a high-powered tri-laser, and plasma cannon. The weapons package is modular and can be broken down so that only one or two of the weapons are used rather than all three. Likewise, the configuration of the weapons can be adjusted as desired. This means that a plasma cannon could be replaced with a second missile launcher and vice versa. Only the tri-laser can't be switched, it can only be mounted on the back of the brute.

The real disadvantage of the additional weapons is that they slow movement, but for whatever the brute loses in speed and mobility it gains in raw firepower. Note that there is no speed penalty for using any one optional weapon.

**Model Type:** Type One Brute — Infantry leader, assistant and technician

**Class:** Cyborg

**M.D.C. by Location:**

Upper Arms (2) — 60 each

Lower arms & hands (2) — 100 each

Legs (2) — 150 each

Containment Chamber — 120

Plasma Cannon (1, optional) — 100

Tri-Laser Cannon (1, optional) — 120

Missile Launcher (1, optional) — 120

Secondary Sensor (1, right side) — 20

\*Forward Particle Beam Guns (2, tiny) — 20 each

\*\*Head/Main Body — 280

\* The tiny particle beam nozzles are difficult to hit, thus they can only be struck when a character makes a *called shot* and even then the attacker is -4 to strike.

\*\*Depleting the M.D.C. of the main body destroys the cyborg's mechanical body housing, however, the organism's environmental containment chamber (effectively the pilot's compartment) holds the majority of the living organism. The Mechanoid organism can be rescued and installed into another mechanical body of the same design. Except for its psionic powers, the creature is totally helpless and will die within 5D6 days.

## Speed

**Running:** 50 mph (80 km) or 40 mph fully loaded with weapon options. **Leaping:** 10 feet (3 m) high or across; not possible with weapon options.

**Flying:** Its secondary means of movement is a limited anti-gravity propulsion system similar to the wasp's. 90 mph (144 km), cruising speed is typically about half, maximum altitude is 2000 feet (610 m). Speed is reduced to 60 mph (96 km) with weapon options.

**Range:** Unlimited.

## Statistical Data

**Height:** 15 feet (4.6 m) or 17 feet (5.2 m) with tri-laser.

**Width:** 6 feet (1.8 m) or 11 feet (3.3 m) with missile launcher and plasma cannon.

**Length:** 8 feet (2.4 m) or 11 feet (3.3 m) with any optional weapon system.

**Weight:** 3 tons or 4.6 tons with full weapon system package.

**Cargo:** None.

**Armored Body:** The cyborg body is a full environmental system with internal cooling, air purification and independent oxygen supply as is common to most suits of power armor. This also makes the creature impervious to poison, gas, and biological agents unless the containment chamber is breached by depleting all its M.D.C. **Note:** The Mechanoid will die in 1D4 minutes if the containment chamber is breached — they cannot breathe Earth's atmosphere!

**Power System:** A Mechanoid power crystal gives the cyborg a life of 100 years before requiring a replacement crystal.

**Black Market Value:** The Market will pay 2D4 million credits for a Mechanoid power crystal that has 50 years of energy or more, 2D4 × 100,000 if less. The crystals cannot be duplicated!

**Alignment:** Any except diabolic or miscreant evil. Typically principled or scrupulous.

**Horror Factor:** 12

**Physical Strength:** Equal to a P.S. 30

**Other Attributes of Note:** I.Q. 2D6 + 10, M.E. 2D6 + 10, M.A. 2D6 + 10, and P.P.E. 3D6.

**Number of Attacks Per Melee:** Five physical or psionic attacks.

The complete weapon package adds three physical melee attacks. The weapons can be used in any combination.

**Combat Bonuses (includes all bonuses):** +2 on initiative, +5 to strike with particle beams, +5 with all other weapon systems, +5 to strike with a punch, +4 to strike with a flying body block/ram, +5 to parry, +5 to dodge, +3 to pull punch, +4 to roll with impact, +4 to save vs horror factor, and +3 to save vs psionic attacks, +2 to save vs magic and poison. **Note:** Reduce all combat bonuses, except specific weapon strike bonuses, by -2 when the optional weapon package is used (two or more weapons).

**Psionics:** Major psionic but considered a mind melter. 1D6 × 10 + 100 I.S.P. and possesses all physical psi-powers plus telepathy, empathy, electrokinesis, psi-sword, and mind block auto-defense.

**Average Level of Experience:** 1D4 + 2

**Skills of Note:** All communication skills (+15%), all mechanical skills (+15%), basic electronics (+20%), all pilot related skills (+20%), all military skills (+15%), computer operation and programming (+15%), basic math (+30%), pilot hover vehicles and spaceships (+20%), prowler (+10%), and



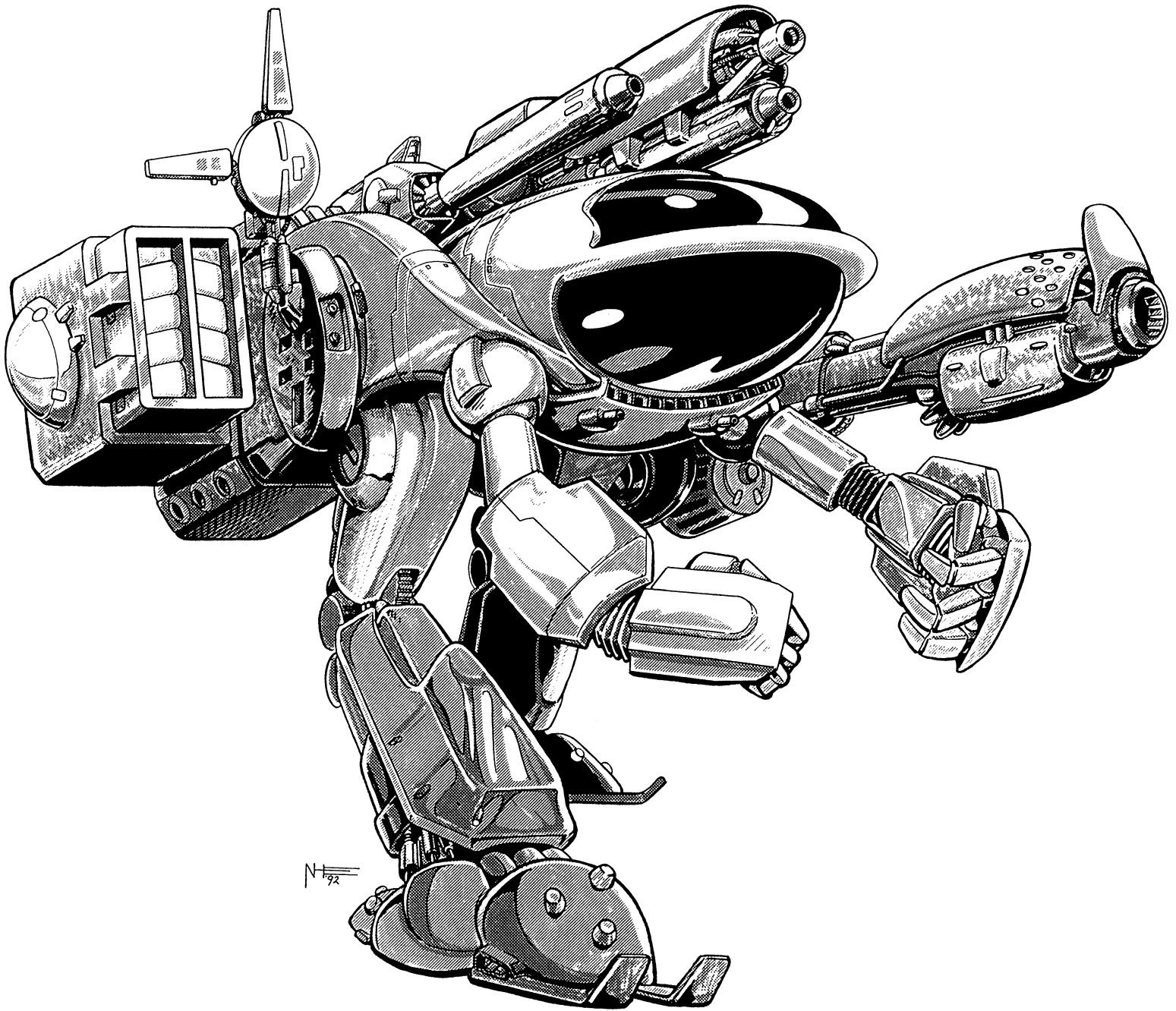

detect ambush, detect concealment, intelligence, tracking, wilderness survival, and land navigation (all + 15%). Weapon proficiencies include W.P. energy pistol, energy rifle, heavy energy, sword and blunt.

## Weapon Systems

**1. Particle Beam Guns (2):** A pair of tiny particle beam guns are built into the chest of the brute. Although terribly destructive, these guns are fixed forward and are considered short-range weapons by Mechanoid standards. Furthermore, the brute must turn its entire body to point and shoot.

Primary Purpose: Assault

Weight: Not applicable; it is part of the body.

Mega-Damage: 1D4 × 10 M.D. per single blast or 2D4 × 10 per simultaneous, double blast (aimed at the same target). A simultaneous, double blast counts as one (1) melee attack.

Rate of Fire: Equal to the number of hand to hand attacks.

Effective Range: 1600 feet (488 m).

Payload: Effectively unlimited; patched into the armor's power supply.

**2. Weapon Package Option Number One: Plasma Cannon (1 or 2):** A devastatingly powerful, long-range weapon.

Primary Purpose: Assault

Weight: 1200 lbs (540 kg)

Mega-Damage: 1D4 × 10 M.D. per single blast (or 2D4 × 10 per simultaneous, double blast if two plasma cannons are used. Simultaneous, double blasts count as one melee attack).

Rate of Fire: Equal to the number of hand to hand attacks.

Effective Range: 4000 feet (1200 m).

Payload: Effectively unlimited; patched into the armor's power supply.

**3. Weapon Package Option Number Two: Tri-Laser Cannon**

**(1):** This long-range weapon can only be attached to the back of the type one brute. It is forward facing but can be raised up and down in a 90 degree arc of fire. The lasers also have the standard variable light frequency capabilities.

Primary Purpose: Assault

Weight: 1100 lbs (495 kg)

Mega-Damage: 4D6 per single blast, 1D4 × 10 + 6 M.D. per double blast or 1D6 × 10 + 10 per simultaneous, triple blast!

Rate of Fire: Equal to the number of hand to hand attacks.

Effective Range: 6000 feet (1828 m).

Payload: Effectively unlimited; patched into the armor's power supply.

#### 4. Weapon Package Option Number Three: Mini-Missile

**Launcher (1 or 2):** This is a fast loading missile launcher.

The actual launch unit can rotate 360 degrees.

Primary Purpose: Assault

Weight: 900 lbs (405 kg)

Mega-Damage: 1D4 × 10 per missile.

Rate of Fire: One at a time or in volleys of two, four, six or eight. Each volley counts as one melee attack regardless of the number of missiles.

Effective Range: One mile (1.6 km)

Payload: A single launcher can fire a maximum of eight mini-missiles at any one time, but holds a total payload of 40.

5. **Rail guns, energy weapons** and other weapons can be substituted in an emergency or as a back-up weapon.

6. **Hand to Hand Combat:** Rather than use a long-range weapon, the Mechanoid can engage in hand to hand combat.

Restrained Punch: 4D6 + 15 S.D.C.

Full Strength Punch: 2D6 M.D.

Power Punch: 4D6 M.D., but counts as two attacks.

Kick: 2D6 M.D.

Leap Kick: 3D6 M.D.

Body Block/ram: 1D6 M.D. The brute has a 1-50% chance of knocking its opponent off his feet (victim loses initiative and one melee attack), but counts as two melee actions regardless of the speed.

7. **Sensor Systems of Note:** Standard: Same as the brain.

## Type Two Brute

The old-style brute has proven to be reliable under all types of circumstances and environments, however, it has always suffered from a lack of speed and mobility. The type two brute is a lighter, faster, more mobile and versatile design. It has only been in production a short while, but has been well received and is now in mass production.

One of its more unique features is that the top part of the unit can detach (and reattach) and fly, leaving its legs and large arms behind. Two joints located above the shoulders of the large arms allow the attachment of the optional weapon systems described in the section about the Type One Brute. However, the tri-laser cannot be used; available weapons are restricted to the missile launcher and/or plasma cannon. Flying with even one plasma cannon is awkward and makes the brute - 4 to dodge and reduces its speed, walking or flying, by 20%.

**Model Type:** Type Two Brute — Infantry leader, reconnaissance agent, technician, and assistant

**Class:** Cyborg

**M.D.C. by Location:**

Small Arms (2) — 30 each

Large Arms (2) — 100 each

Legs (2) — 200 each

Containment Chamber — 120

Plasma Cannon (1, optional) — 100

Missile Launcher (1, optional) — 120

\*Head/Sensor — 50

\*\*Main Body (upper) — 180

\* Destroying the head will eliminate all optics and sensory systems, and reduces the maximum speed, the number of melee attacks and all bonuses by half. **Note:** The head is a small and difficult target to hit. Thus, it can only be hit when a character makes a *called shot* and even then, the attacker is - 3 to strike. The tiny arms are also - 3 to be struck.

\*\*Depleting the M.D.C. of the main body destroys the cyborg's mechanical body housing, however, the organism's environmental containment chamber (effectively the pilot's compartment) holds the majority of the living organism. The Mechanoid organism can be rescued and installed into another mechanical body of the same design. Except for its psionic powers, the creature is totally helpless and will die within 5D6 days.

### Speed

Running: 90 mph (144 km) or 80 mph fully loaded with two weapon options.

Leaping: 30 feet (9 m) high or across or 10 feet (3 m) with one or two weapon options. Double the leaping distance when augmented by rear jet thrusters.

Flying: As noted earlier, the upper portion of the body can detach and reattach as desired. Once loose from the legs, the upper body can fly by means of a limited anti-gravity and jet thruster propulsion system. Maximum speed is 500 mph (800 km), cruising speed is typically about half. Maximum altitude is 20,000 feet (6100 m). Speed is reduced by 100 mph (160 km) with two weapon options.

Range: Unlimited.

### Statistical Data

Height: 12 feet (3.6 m).

Width: 5 feet (1.5 m) or 10 feet (3 m) with missile launcher and/or plasma cannon.

Length: 7 feet (2.1 m) or 10 feet (3 m) with plasma cannon.

Weight: 2 tons or 3.2 tons with two optional weapons.

Cargo: None.

Armored Body: Standard full environmental system. **Note:** The Mechanoid will die in 1D4 minutes if the containment chamber is breached — they cannot breathe Earth's atmosphere!

Power System: A Mechanoid power crystal gives the cyborg a life of 100 years before requiring a replacement crystal.

Black Market Value: The Market will pay 2D4 million credits for a Mechanoid power crystal that has 50 years of energy or more, 2D4 × 100,000 if less. The crystals cannot be duplicated!

Alignment: Any, typically aberrant or miscreant evil.

Horror Factor: 10

Physical Strength: Large arms are equal to a P.S. 30, small 20.

Other Attributes of Note: I.Q. 2D6 + 10, M.E. 2D6 + 10, M.A. 2D6 + 10, and P.P.E. 3D6.

Number of Attacks Per Melee: Five physical or psionic attacks. Each optional weapon (total two) adds one melee attack. The weapons can be used in any combination.

Combat Bonuses (includes all bonuses): + 3 on initiative, + 5 with all other weapon systems, + 5 to strike with a punch, + 5

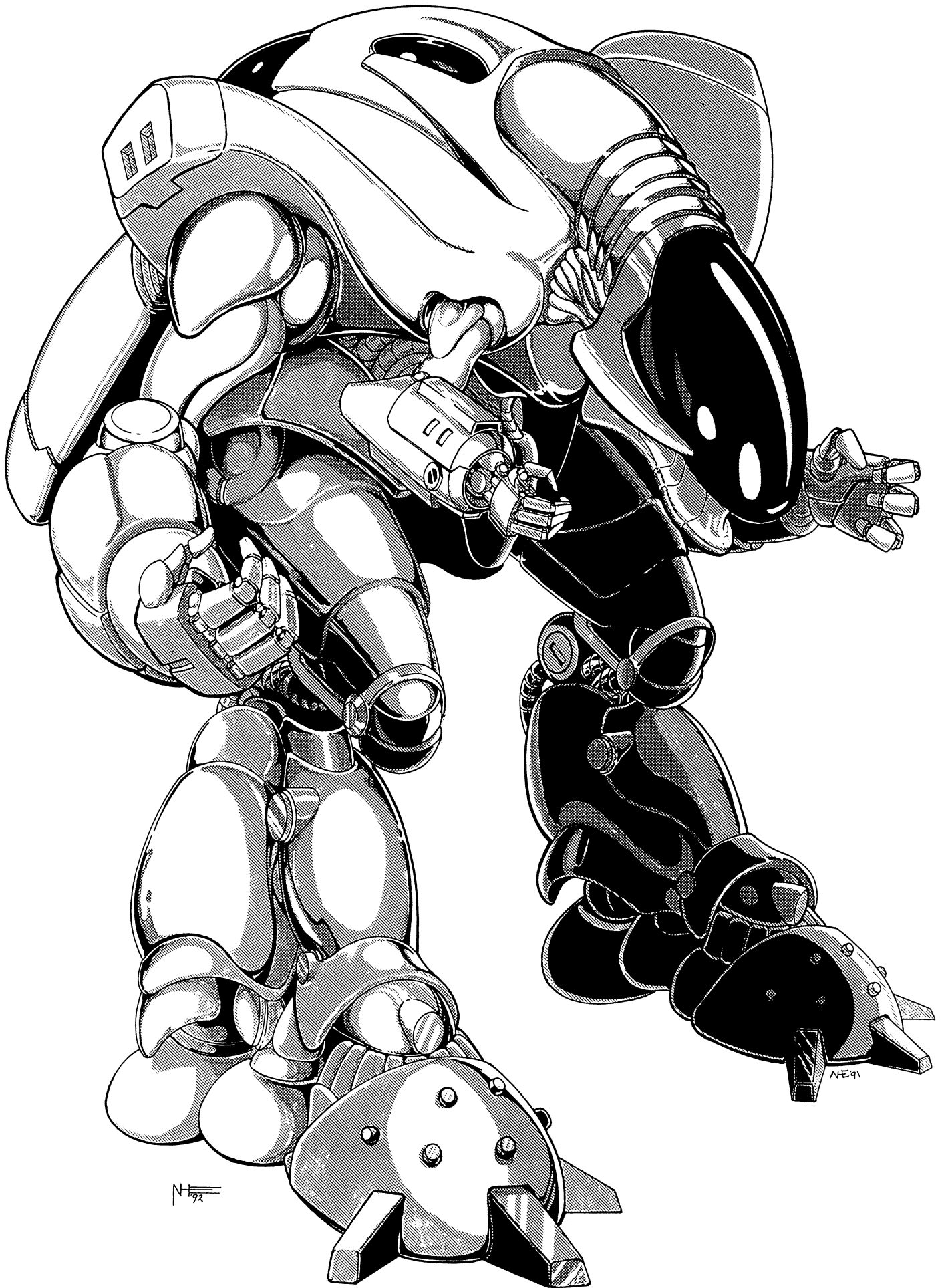

to strike with a flying body block/ram, +5 to parry, +5 to dodge, +3 to pull punch, +4 to roll with impact, +4 to save vs horror factor, and +3 to save vs psionic attacks, +2 to save vs magic and poison. **Note:** Reduce all combat bonuses, except specific weapon strike bonuses, by -1 when one or two optional weapon packages are used.

**Psionics:** Major psionic, but considered a mind melter with 1D6×10+100 I.S.P. Has all physical psi-powers plus telepathy, empathy, electrokinesis, psi-sword (can create four, one for each hand) and mind block auto-defense.

**Average Level of Experience:** 1D4+1

**Skills of Note:** All communication skills (+15%), all mechanical skills (+15%), basic electronics (+20%), all pilot related skills (+20%), all military skills (+15%), computer operation and programming (+15%), basic math (+30%), pilot hover vehicles and spaceships (+20%), prowler (+10%), and detect ambush, detect concealment, intelligence, tracking, wilderness survival, and land navigation (all +15%). Weapon proficiencies include W.P. energy pistol, energy rifle, heavy energy, sword and blunt.

## Weapon Systems

- 1. Weapon Package Options** are limited to either two of the plasma cannon or missile launcher or one of each. The back mounted tri-laser is not available to the type two brute.
- 2. Rail guns, energy weapons** and other weapons can be substituted in an emergency or as a back-up weapon; often uses the thinman's rifle and pistol.
- 3. Hand to Hand Combat:** Rather than use a long-range weapon, the Mechanoid can engage in hand to hand combat. Damage is listed for the large hands, the small ones do half damage.
  - Restrained Punch: 4D6+15 S.D.C.
  - Full Strength Punch: 2D6 M.D.
  - Power Punch: 4D6 M.D., but counts as two attacks.
  - Kick: 3D6 M.D.
  - Leap Kick: 4D6 M.D.
  - Body Block/ram: 1D6 M.D. The brute has a 1-50% chance of knocking its opponent off his feet (victim loses initiative and one melee attack), but counts as two melee actions regardless of the speed.
- 4. Sensor Systems of Note:** Standard: Same as the brain.

## Mechanoid Wasp

The Mechanoid wasp is an intelligent predator that is bold, courageous, aggressive and cunning. They are daring and flamboyant, thriving on relentless combat and excitement. Nothing seems to rattle their nerves, even when facing a foe with superior numbers or firepower.

They represent the very heart of the Mechanoids' infantry and defense network and are "the" power behind the Mechanoids' air force. The term is used loosely, because the wasp functions equally well in outer space and underwater. Their faster than sound speed enables the wasp to engage the enemy with lightning quickness and perform amazing aerial acrobatics during dog-fights. When a mothership launches an assault against a planet, a half million or more wasps compose 70% of the attack force.

Although a lesser Mechanoid within the hierarchy (the wasp is seventh, just beneath the brute), they are very smart and superb strategists and tacticians. As a result, wasps are frequently given complete autonomy and are allowed to act on their own initiative. They occasionally command troops, but prefer to be given free reign or to fight with other wasps rather than be slowed down by the other comparatively ponderous mechanoids. Although they enjoy out and out war as much as any of the predators, they use their intelligence and cunning to deceive, confuse, separate and vanquish their opponents.

The new body design for the wasp makes them even faster and more aerodynamic, plus it adds a little more firepower and protective armor.

**Model Type:** Wasp — Reconnaissance, soldier, strategist and tactician.

**Class:** Cyborg

**M.D.C. by Location:**

Forearm Particle Beam Cannons (2) — 50 each

Forward Lasers (2) — 30 each

Upper Arms (2) — 40 each

Wings (2) — 100 each

Containment Chamber — 120

\*Head — 100

\*\*Main Body — 150

\* Destroying the head will eliminate all optics and sensory systems, and reduces the maximum speed, the number of melee attacks and all bonuses by half. **Note:** The head is a much larger target than the old-style AbM wasp and is much easier to strike, requiring the character to make a *called shot* but without penalty. The forward lasers and particle beam cannons are now the more difficult targets to hit and also require a called shot with a -2 penalty.

\*\*Depleting the M.D.C. of the main body destroys the cyborg's mechanical body housing, however, the organism's environmental containment chamber (effectively the pilot's compartment) holds the majority of the living organism. The Mechanoid organism can be rescued and installed into another mechanical body of the same design. Except for its psionic powers, the creature is totally helpless and will die within 5D6 days.

**Speed**

**Running:** The wasp has no legs and cannot run, walk or jump. Its sole means of movement is its anti-gravity propulsion system and telekinesis. It can flop along with its weapon arms or drag itself at a speed of about 10 (7 mph/12 km) maximum.

**Leaping:** Not applicable.

**Flying:** Mach 3 — 2010 mph (3216 km), cruising speed is typically a slow 500 mph (800 km) to Mach One.

Speed, aerial movement and the act of flying is controlled by a mentally manipulated anti-gravity system. The wasp can attain incredible speeds while maintaining absolute control and precision maneuvering. The system is so amazing that the wasp can go from 0 to Mach 3 in five seconds and come to a complete stop in an instant! Maximum altitude is virtually unlimited.

**Range:** Unlimited.

**Statistical Data**

**Height:** 3 feet, 6 inches (1 m)

**Width:** 16 feet (4.9 m) from wing tip to wing tip when fully extended.

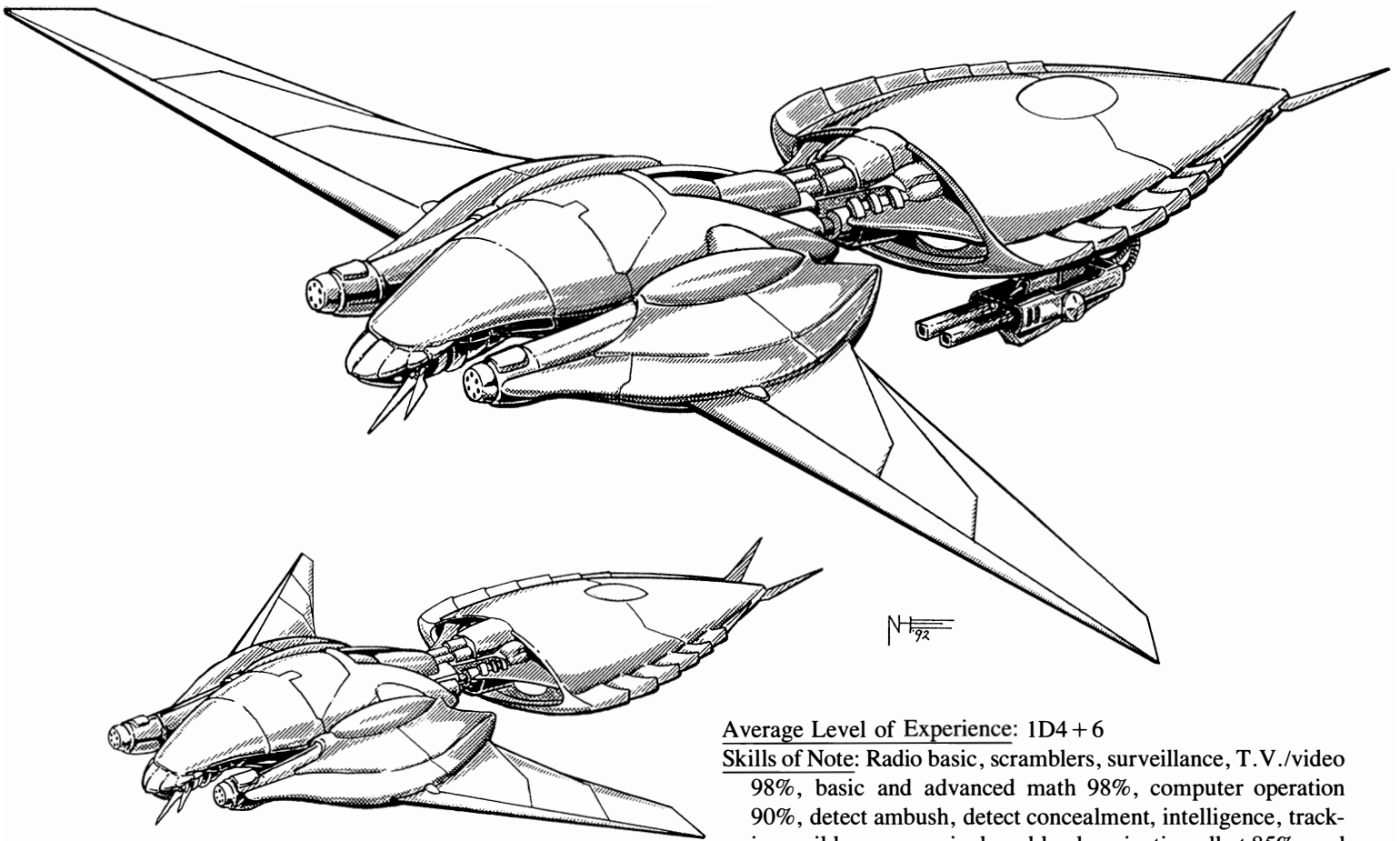

**Length:** 11 feet (3.3 m)

**Weight:** 1.4 tons

**Cargo:** None.

**Armored Body:** The standard full environmental system. **Note:**

The Mechanoid will die in 1D4 minutes if the containment chamber is breached — they cannot breathe Earth's atmosphere!

**Power System:** A Mechanoid power crystal gives the cyborg a life of 100 years before requiring a replacement crystal.

**Black Market Value:** The Market will pay 2D4 million credits for a Mechanoid power crystal that has 50 years of energy or more, 2D4 × 100,000 if less. The crystals cannot be duplicated!

**Alignment:** Any, except principled. Typically anarchist or aberrant.

**Horror Factor:** 12

**Physical Strength:** Equal to a P.S. 30

**Other Attributes of Note:** I.Q. 2D6 + 8, M.E. 2D6 + 12, M.A. 2D6 + 6, and P.P.E. 3D6.

**Number of Attacks Per Melee:** Six physical or psionic attacks.

**Combat Bonuses (includes all bonuses):** +5 on initiative, +7 to strike with particle beams or lasers, +4 to strike with a punch/swat, +6 to strike on a flying body block/ram, +6 to parry, +7 automatic dodge when in the air (does not count as a melee action), +3 to pull punch, +5 to roll with impact, +4 to save vs horror factor, and +2 to save vs psionic attacks but +8 to save vs all forms of mind control.

**Psionics:** Major psionic but considered a mind melter. 1D4 × 100 + 13 I.S.P. and possesses all physical psi-powers plus telepathy and mind block auto-defense.

**Average Level of Experience:** 1D4 + 6

**Skills of Note:** Radio basic, scramblers, surveillance, T.V./video 98%, basic and advanced math 98%, computer operation 90%, detect ambush, detect concealment, intelligence, tracking, wilderness survival, and land navigation all at 85%, and streetwise 50%. Weapon proficiencies include W.P. energy pistol, energy rifle and heavy (must use psionics to manipulate the weapons).

## Weapon Systems

**1. Forearm Particle Beam Cannons:** The Mechanoid weapon has greater range than any Earth P-beam cannon and when combined with the wasp's incredible speed and accuracy, is truly devastating. The weapons have their own targeting computer which gauges distances and adds to their accuracy. Each arm can be moved independently, with a swivel of 190 degrees.

**Primary Purpose:** Assault

**Weight:** Not applicable; it is part of the body.

**Mega-Damage:** 1D4 × 10 M.D. or 1D6 × 10 M.D. (two settings) per single blast or 2D4 × 10 per simultaneous, double blast (aimed at the same target). A simultaneous, double blast counts as one (1) melee attack!

**Rate of Fire:** Equal to the number of hand to hand attacks.

**Effective Range:** 4000 feet (1200 m).

**Payload:** Effectively unlimited; patched into the armor's power supply.

**2. Forward Fixed, Rapid-Fire Laser Cannons:** The lasers are an anti-personnel weapon ideal for strafing.

**Primary Purpose:** Assault

**Weight:** Not applicable; it is part of the body.

**Mega-Damage:** 1D6 M.D. per single blast, 2D6 M.D. per double blast, 6D6 M.D. per six simultaneous blasts or 1D6 × 10 + 10 M.D. from 12 simultaneous blasts (both guns aim and fire at

the same target). Simultaneous multiple blasts counts as one (1) melee attack regardless of the number of blasts fired!

Rate of Fire: Equal to the number of hand to hand attacks.

Effective Range: 4000 feet (1200 m).

Payload: Effectively unlimited; patched into the armor's power supply.

**3. Other weapons** cannot be held by the wasp because it has no hands. However, the creature can use telekinesis or ectoplasm to operate lightweight weapons, but is -2 to strike.

**4. Hand to Hand Combat:** Rather than use a long-range weapon, the Mechanoid can engage in hand to hand combat using its cannon barrels or wings as a bludgeon.

Restrained Punch/Swat: 4D6 + 15 S.D.C.

Full Strength Punch/Swat: 2D6 M.D.

Body block/ram: 2D6 M.D. at low speeds, 4D6 M.D. at Mach One or 1D4 × 10 M.D. at Mach Two. The wasp has a 1-40% chance of knocking its opponent off his feet (victim loses initiative and one melee attack) at speeds under Mach One, a 1-55% at Mach One and a 1-75% chance at Mach Two or greater. All such attacks count as two melee actions regardless of the speed.

**5. Sensor Systems of Note:** Same as the brain.

## Mechanoid Exterminator

They are natural predators who love to hunt, fight and kill. Exterminators are so aggressive that they will fight at the drop of a hat and will gladly jump into a conflict, regardless of the odds. They can be treacherous and tricky, laying traps, ambushes and engaging in cat-and-mouse games. They may command as many as eight robots, but are typically accompanied by their partner and mechanical bloodhound, the seeker pod.

The exterminator was originally designed for pest control on the giant motherships and at large bases where they prowl the tunnels, vents and pipelines in search of prey. However, they have proven so reliable and competent that they have been added to the ranks of the Mechanoids' infantry.

The new design gives it greater mobility, armor and firepower. For every one exterminator, there is a seeker pod. The seeker pod is housed in a compartment in the back of the exterminator. The two work as a team, with the seeker helping to locate targets and luring prey out of hiding.

**Model Type:** Exterminator — Hunter-Killer and Soldier

**Class:** Cyborg

**M.D.C. by Location:**

Legs (2) — 90 each

Seeker Pod Chamber — 50

Containment Chamber — 90

Missile Launcher (1) — 50

\*Particle Beam Cannons (2) — 50

\*Rapid-Fire Laser (1) — 30

\*Sensor Tower & Lights (1, top) — 30

\*Headlight (1, on head) — 5

\*Head/Secondary Sensors — 50

\*\*Main Body — 180

\* These targets are all comparatively small in size and difficult to hit. Thus, they can only be hit when the attacker makes a *called shot* and even then the attacker is -2 to strike.

\*\*Depleting the M.D.C. of the main body destroys the cyborg's mechanical body housing, however, the organism's environmental containment chamber (effectively the pilot's compartment) holds the majority of the living organism. The Mechanoid organism can be rescued and installed into another mechanical body of the same design. Except for its psionic powers, the creature is totally helpless and will die within 5D6 days.

### Speed

Running: 90 mph (144 km) maximum. Note that the act of running does not tire the Mechanoid inside.

Leaping: The powerful robot legs can leap up to 30 feet (9 m) high. Flying: Flight is not possible.

Range: Unlimited.

### Statistical Data

Height: 16 feet (4.9 m)

Width: 6 feet (1.8 m)

Length: 7 feet (2.1 m)

Weight: 1.8 tons

Cargo: A small bay that can hold a seeker pod or light cargo.

Armored Body: Standard full environmental system. **Note:** The Mechanoid will die in 1D4 minutes if the containment chamber is breached — they cannot breathe Earth's atmosphere!

Power System: A Mechanoid power crystal gives the cyborg a life of 100 years before requiring a replacement crystal.

Black Market Value: The Market will pay 2D4 million credits for a Mechanoid power crystal that has 50 years of energy or more, 2D4 × 100,000 if less. The crystals cannot be duplicated!

Alignment: Any except principled or scrupulous. Typically anarchist, miscreant, or diabolic.

Horror Factor: 11

Physical Strength: Equal to a P.S. 30

Other Attributes of Note: I.Q. 2D6 + 3, M.E. 2D6 + 8, M.A. 2D6 + 4 and P.P.E. 2D6.

Number of Attacks Per Melee: Five physical or psionic attacks.

Combat Bonuses (includes all bonuses): +2 on initiative, +6 to strike with its energy weapons, +5 to strike with a kick or stomp, +1 to parry, +2 to dodge, +2 to pull punch/kick, +4 to roll with impact, +3 to strike on a body block/ram, +4 to save vs horror factor, and +2 to save vs psionic attacks.

Psionics: Major psionic. 1D4 × 10 + 100 I.S.P. and possesses all physical psionic powers plus telepathy, and empathy.

Average Level of Experience: 1D4

Skills of Note: Radio: basic and scrambler (10%), basic math (+20%), computer operation (+10%), intelligence, detect ambush, detect concealment, sniper, tracking, wilderness survival, and land navigation (+15%). They are soldiers and know only skills pertinent to finding and fighting foes.

### Weapon Systems

**1. Double-Barrelled Particle Beam Cannon (1):** This weapon is similar to the cannons of the wasp. Unlike the old version, this weapon is built on a turret that can rotate 360 degrees and tilt away from its body 30 degrees. However, the exterminator must turn its entire body from side to side to aim. The weapon has its own targeting computer which gauges distances and adds to its accuracy. The turret is built into the left side of the cyborg.

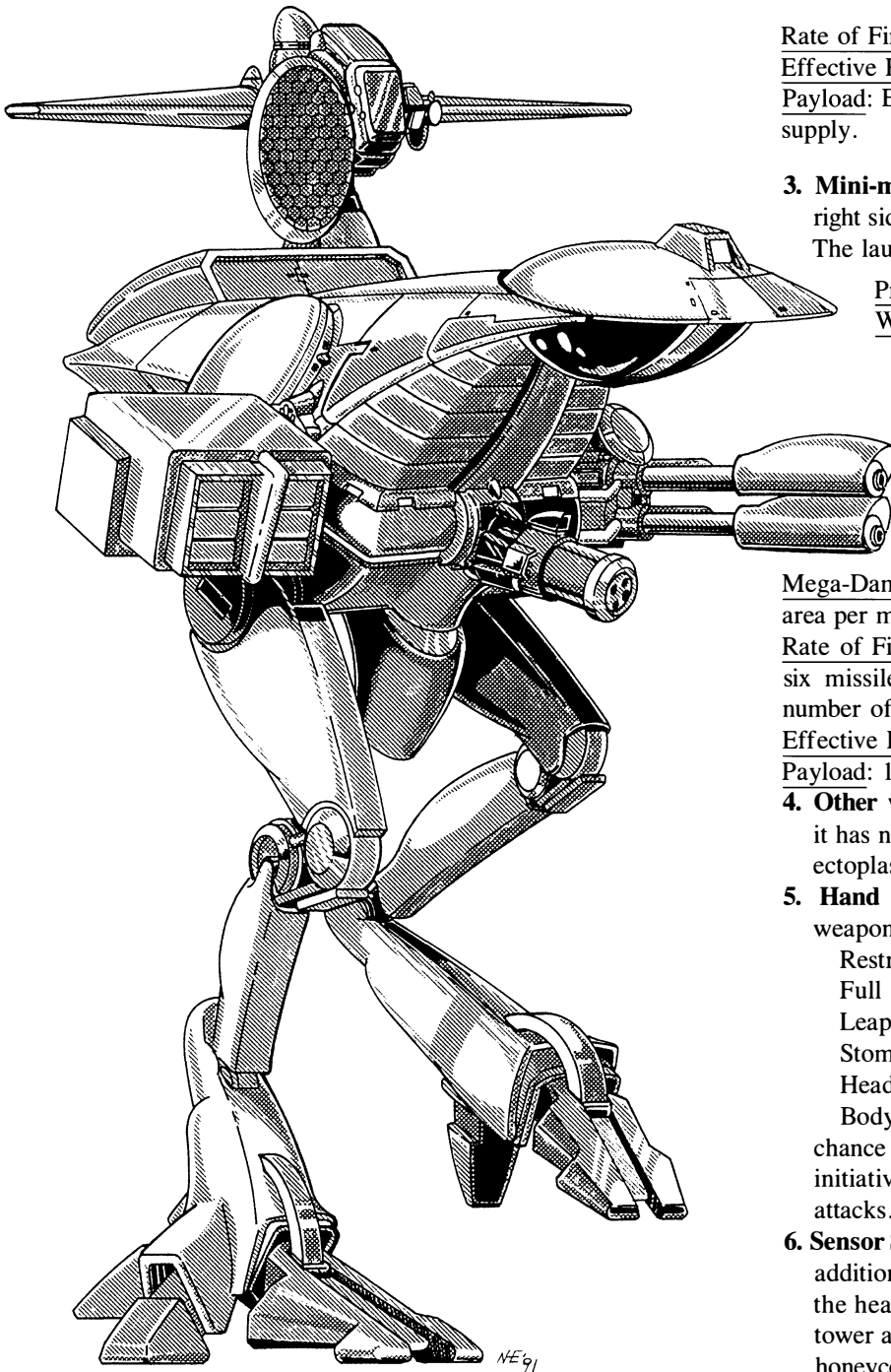

Primary Purpose: Assault

Weight: Not applicable; it is part of the body.

Mega-Damage: 1D4 × 10 M.D. per single blast or 2D4 × 10 M.D. per double blast (both fire at the same target).

Rate of Fire: Equal to the number of hand to hand attacks.

Effective Range: 4000 feet (1200 m).

Payload: Effectively unlimited; patched into the armor's power supply.

**2. Rapid-Fire Laser Cannon (1):** A powerful weapon that can fire a single pulse or a quadruple blast.

Primary Purpose: Assault and extermination.

Weight: Not applicable; it is part of the lower body.

Mega-Damage: 2D6 M.D. per single energy pulse or 1D4 × 10 + 6 M.D. per quadruple blasts (counts as one melee attack).

Rate of Fire: Equal to the number of hand to hand attacks.

Effective Range: 2000 feet (610 m)

Payload: Effectively unlimited; patched into the armor's power supply.

**3. Mini-missile Launcher (1):** The launcher is built into the right side and adds to the exterminator's versatility in combat. The launcher can rotate 360 degrees.

Primary Purpose: Assault and extermination.

Weight: Not applicable; it is part of the body.

Mega-Damage: Fragmentation missiles: 5D6 M.D. to a 20 foot area per missile.

Rate of Fire: One at a time or a volley of two, three, four or six missiles. A volley counts as one attack regardless of the number of missiles launched.

Effective Range: 3000 feet (910 m)

Payload: 18 total mini-missiles.

**4. Other weapons** cannot be held by the exterminator because it has no hands. However, the creature can use telekinesis or ectoplasm to operate lightweight weapons, but is - 2 to strike.

**5. Hand to Hand Combat:** Rather than use a long-range weapon, the Mechanoid can engage in hand to hand combat.

Restrained Kick: 4D6 + 15 S.D.C.

Full strength Kick: 3D6 M.D.

Leap Kick: 6D6 M.D., but counts as two attacks.

Stomp: 2D4 M.D.

Head Butt: 1D4 M.D.

Body block/ram: 2D6 M.D. damage and has a 1-50% chance of knocking one's opponent off his feet (victim loses initiative and one melee attack), but counts as two melee attacks.

**6. Sensor Systems of Note:** Same as the brain, plus the following additions. The exterminator has two sensor systems, one in the head and the other in the sensor tower on its back. The tower also has a high-powered infrared searchlight (the round honeycomb object) and a smaller, though equally powerful, spotlight (the small rectangular object). Both lights have a beam range of 1000 feet (305 m). The tower also provides a motion and radar detector (200 feet/61 m), laser targeting, laser distancing (4000 ft/1200 m) and long-range radio communication (500 miles/800 km).

## Mechanoid Seeker Pod

Although designed as a partner for the exterminator, the seeker pod is sometimes used as an independent operative, especially for reconnaissance. As stated previously, there is one seeker pod for every one exterminator, plus an over run of about 10% as replacement units and independent agents. They are the smallest of the true Mechanoids.

Like all of the predators, the seeker pod loves adventure, combat and the hunt. They are alert, wily spies, and incredible

trackers, who are quick to take action despite their diminutive size. Although aggressive and always ready for a fight, the seeker pod is not a mad-dog warrior like the exterminator and exhibits great restraint and reason. The seeker cannot endure a great amount of damage and usually takes a back seat to its powerful partner, while it watches the exterminator's back, alert for other attackers and signs of danger.

The design of the seeker pod is unchanged except for some additional body armor.

**Model Type:** Seeker Pod — Spy, Tracker, and Reconnaissance

**Class:** Cyborg

**M.D.C. by Location:**

\*Arms (2) — 10 each

Containment Chamber — 30

\*Laser Turret (1) — 30

\*\*Main Body — 50

\* These targets are comparatively small in size and difficult to hit. Thus, they can only be hit when the attacker makes a *called shot* and even then he is -3 to strike.

\*\*Depleting the M.D.C. of the main body destroys the cyborg's mechanical body housing, however, the organism's environmental containment chamber (effectively the pilot's compartment) holds the majority of the living organism. The Mechanoid organism can be rescued and installed into another mechanical body of the same design. Except for its psionic powers, the creature is totally helpless and will die within 5D6 days.

**Speed**

Running: Running is not possible, although the seeker pod can walk on its hands if necessary, at a speed of about 15 mph (24 km) maximum.

Leaping: Not applicable.

Flying: 90 mph (144 km) maximum, with a maximum altitude of 1000 feet (305 m).

Range: Unlimited.

**Statistical Data**

Height: 2 feet, 6 inches (0.65 m)

Width: 2 feet (0.6 m)

Length: 3 feet (0.9 m)

Weight: 100 lbs (45 kg)

Cargo: None

Armored Body: The cyborg body is a full environmental system with internal cooling, air purification and independent oxygen supply as is common to most suits of power armor. This also makes the creature impervious to poison, gas, and biological agents unless the containment chamber is breached by depleting all its M.D.C. **Note:** The Mechanoid will die in 1D4 minutes if the containment chamber is breached — they cannot breathe Earth's atmosphere!

Power System: A Mechanoid power crystal gives the cyborg a life of 100 years before requiring a replacement crystal.

Black Market Value: The Market will pay 1D4 million credits for the smaller than usual Mechanoid power crystal if it has 50 years or more energy 1D4 × 100,000 if less. The crystals cannot be duplicated!

Alignment: Any except diabolic evil. Typically anarchist or unprincipled.

Horror Factor: 7

Physical Strength: Equal to a P.S. 17

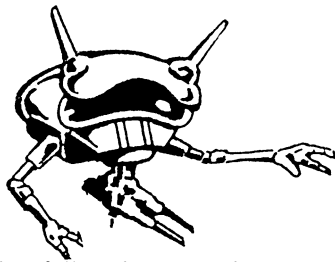

Other Attributes of Note: I.Q. 2D6 + 6, M.E. 2D6 + 8, M.A. 2D6 + 10 and P.P.E. 3D6.

Number of Attacks Per Melee: Four physical or psionic attacks.

Combat Bonuses (includes all bonuses): +3 on initiative, +4 to strike with its energy weapons, +4 to strike with a punch, +4 to strike on a flying body block/ram, +4 to parry, +6 to dodge, +1 to pull punch, +3 to roll with impact, +4 to save vs horror factor, and +2 to save vs psionic attacks.

Psionics: Minor psionic. 1D4 × 10 + 30 I.S.P. and possesses the powers of telepathy, empathy, presence senses, see the invisible, object read, sixth sense and mind block.

Average Level of Experience: 1D4

Skills of Note: All espionage (+20%), plus radio: basic and scrambler (+15%), prowl (+10%), basic math (+30%), computer operation (+20%), and land navigation (+20%).

Weapon proficiencies include W.P. energy pistol, knife and blunt.

**Weapon Systems**

**1. Variable Mini-Laser Turret:** A small, double-barrelled laser turret is built into the undercarriage of the seeker pod. It is a multi-purpose appendage used as both a short-range defensive weapon and a tool. The weapon has its own targeting computer which analyzes the reflectivity of armor and other substances as well as distances. After one melee round, the computer is able to adjust to the light frequency that will inflict maximum damage to the target. The turret can rotate 360 degrees and has a 90 degree arc of fire up and down.

Primary Purpose: Multiple; weapon and tool.

Weight: Not applicable; it is part of the body.

Mega-Damage: 1D6 M.D. per single blast or 2D6 M.D. per double blast.

Rate of Fire: Equal to the number of hand to hand attacks.

Effective Range: 2000 feet (610 m)

Payload: Effectively unlimited; patched into the armor's power supply.

**2. Energy rifles, pistols and other lightweight hand-held weapons** can be used by the seeker pod.

**3. Hand to Hand Combat:** Rather than use a long-range weapon, the Mechanoid can engage in hand to hand combat using its fists and/or hand-held weapons.

Restrained Punch: 2D6 + 2 S.D.C.

Full Strength Punch: 1D4 M.D.

Flying Body block/ram: 1D6 M.D. damage and has a 1-30% chance of knocking one's opponent off his feet (victim loses initiative and one melee attack), but counts as two melee attacks.

**4. Sensor Systems of Note:** Same as the brain.

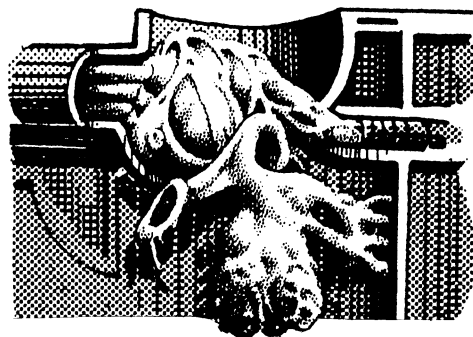



# Tunnel Crawler

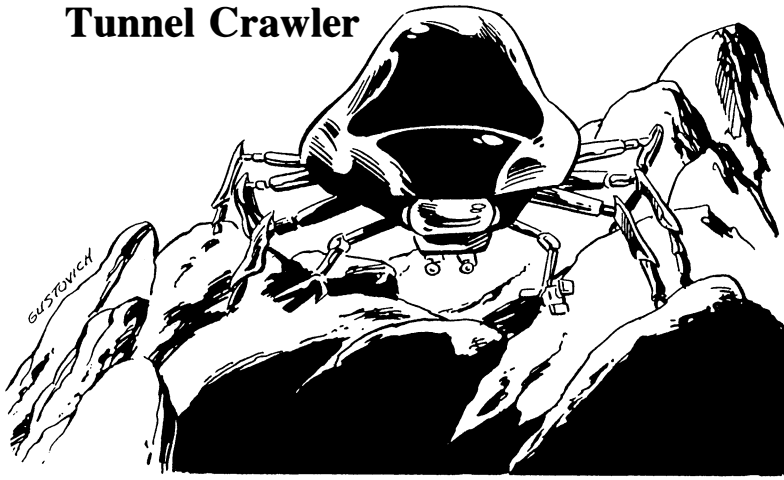

The Mechanoid tunnel crawler is another creature designed for hunting and exterminating humans and other pests in the tunnels, vents and pipelines of their motherships and bases. Usually a lone hunter, it also works in pairs or with small groups of other Mechanoids. It is a sadistic killer, frequently allowed to operate as a free agent wandering wherever it desires, Always alert for prey. The tunnel crawler has a low intelligence and is consumed with stalking and killing. It also enjoys exploring and reconnaissance.

The creature is extremely loyal and brave, with nerves of steel. They are extremely capable fighters and can be quite merciless when provoked or protecting a designated area or higher level Mechanoid. They can move quickly and quietly. Their six legs gives them great stability and superb climbing abilities, including climbing up and walking upside down on the underside of ceilings, rocks and trees.

**Model Type:** Tunnel Crawler — Seek & Destroy — Reconnaissance

**Class:** Cyborg

**M.D.C. by Location:**

Arms (2) — 20 each

Lower arms & hands (2) — 90 each

Legs (6) — 40 each

Containment Chamber — 90

\*Forward Ion Guns (2) — 20 each

\*Head — 50

\*\*Main Body — 200 (includes forward plating)

\* Destroying the head will eliminate all optics and sensory systems, and reduces the maximum speed, number of melee attacks and all bonuses by half. **Note:** The head is a small and difficult target to hit. Thus, it can only be hit when a character makes a *called shot* and even then the attacker is - 3 to strike.

\* The tiny ion guns are equally difficult to hit.

\*\*Depleting the M.D.C. of the main body destroys the cyborg's mechanical body housing, however, the organism's environmental containment chamber (effectively the pilot's compartment) holds the majority of the living organism. The Mechanoid organism can be rescued and installed into another mechanical body of the same design. Except for its psionic powers, the creature is totally helpless and will die within 5D6 days.

**Speed**

**Running:** 50 mph (80 km) maximum; climbing or walking on ceilings (upside down) is one-third the maximum speed.

**Leaping:** 10 feet (3 m) high or across.

**Flying:** Its secondary means of movement is a limited anti-gravity propulsion system similar to the wasp's. 50 mph (80 km), cruising speed is typically about half, maximum altitude is 2000 feet (610 m).

**Range:** Unlimited.

**Statistical Data**

**Height:** 5 feet (1.5 m)

**Width:** 6 feet (1.6 m)

**Length:** 7 feet (2.1 m)

**Weight:** 2.4 tons

**Cargo:** None

**Armored Body:** The cyborg body is a full environmental system with internal cooling, air purification and independent oxygen supply as is common to most suits of power armor. This also makes the creature impervious to poison, gas, and biological agents unless the containment chamber is breached by depleting all its M.D.C. **Note:** The Mechanoid will die in 1D4 minutes if the containment chamber is breached — they cannot breathe Earth's atmosphere!

**Power System:** A Mechanoid power crystal gives the cyborg a life of 100 years before requiring a replacement crystal.

**Black Market Value:** The Market will pay 2D4 million credits for a Mechanoid power crystal that has 50 years of energy or more, 2D4 × 100,000 if less. The crystals cannot be duplicated!

**Alignment:** Any except diabolic or miscreant evil. Typically principled or scrupulous.

**Horror Factor:** 9

**Physical Strength:** Equal to a P.S. 20

**Other Attributes of Note:** I.Q. 2D6+5, M.E. 2D6+8, M.A. 2D6+2, and P.P.E. 2D6.

**Number of Attacks Per Melee:** Five physical or psionic attacks.

**Combat Bonuses (includes all bonuses):** +3 on initiative, +5 to strike with ion beams, +5 to strike with a punch, +4 to strike with a flying body block/ram, +5 to parry, +6 to dodge, +3 to pull punch, +3 to roll with impact, +4 to save vs horror factor, and +2 to save vs psionic attacks, +2 to save vs magic and poison.

**Psionics:** Minor psionic. 1D6 × 10 + 60 I.S.P. and possesses all telepathy, empathy, presence sense, see the invisible, see aura, sense magic, detect psionics, and mind block.

**Average Level of Experience:** 1D4 + 2

**Skills of Note:** All espionage (+10%), basic math (+30%), prowl (+15%), climb (+20%), land navigation (+20%), computer operation (+5%). Weapon proficiencies include W.P. energy pistol, energy rifle, sword and blunt.

## Weapon Systems

**1. Ion Pulse Blasters (2):** A powerful close-range weapon that can fire single or double blasts. The weapon has its own targeting computer.

**Primary Purpose:** Assault and extermination.

**Weight:** Not applicable; it is part of the body.

**Mega-Damage:** 2D6 M.D. per single energy pulse or 4D6 M.D. per twin blasts (counts as one melee attack).

**Rate of Fire:** Equal to the number of hand to hand attacks.

**Effective Range:** 1200 feet (366 m)

**Payload:** Effectively unlimited; patched into the armor's power supply.

**2. Nerve Gas:** A gas toxic to most mammals can be released in the form of a greenish colored cloud (covers a 20 ft/6 m area). The gas has no effect on mega-damage creatures or characters enclosed in an environmental suit or vehicle.

Primary Purpose: Extermination

Weight: Not applicable; it is part of the body.

Damage: 1D6 direct to hit points and 6D6 additional S.D.C. damage per every exposure and each additional melee round (15 seconds) of exposure to the toxic cloud.

Rate of Fire: Equal to the number of hand to hand attacks.

Effective Range: 100 feet (30.5 m), covering a 20 foot (6 m) area per discharge.

Payload: Six per hour. The toxic cloud is produced by glands inside the Mechanoid organism.

**3. Energy rifles, pistols** and other lightweight hand-held weapons can be used by the Mechanoid.

**4. Hand to Hand Combat:** Rather than use distance weapons, the Mechanoid can engage in hand to hand combat using its fists and/or hand-held weapons.

Restrained Punch: 2D6 + 5 S.D.C.

Full Strength Punch or Kick: 1D4 M.D.

Flying or leaping body block/ram: 1D6 M.D. damage and has a 1-50% chance of knocking one's opponent off his feet (victim loses initiative and one melee attack), but counts as two melee attacks.

**5. Sensor Systems of Note:** Same as the brain.

## Mechanoid Mantis

The new body styling is even more mantis looking than before and offers a greater diversity in features for mining, construction and repairs. The huge Mechanoid continues to function as a specialist in those areas. Its duties include the identification, extraction and processing of ores, fuels, and other materials (mining and metallurgy), construction and repairs of mechanical systems, bots, vehicles, artificial structures, and research and development. The mantis also helps to plot and coordinate the dissection of planets and planetoids. A short-range or long-range plasma cannon can be attached to the top of the rear energy housing for purposes of mining and military defense.

The rear section houses a powerful plasma energy source with a life of 600 years. If the rear main body is destroyed, it will unleash an explosion of plasma energy that will inflict 2D6 × 1000 M.D. to a 1000 foot (305 m) area! However, the mantis cannot detonate the plasma generator at will and will seldom commit deliberate suicide by allowing itself to be so seriously damaged.

The mantis is highly intelligent, but is considered to be a drone because it is so absorbed in its work. The creature has little independent thought and few desires other than doing its job. However, a mantis will attack and kill humanoids whenever it encounters them.

**Model Type:** Mantis — Engineering, Construction, Repair & Mining.

**Class:** Cyborg Drone

### M.D.C. by Location:

Lower Arms & Hands (2) — 80 each

Upper Arms (2) — 100

Containment Chamber — 120

\*Optional Plasma Cannon (1, small) — 60

\*Optional Plasma Cannon (1, large) — 100

\*Forearm Laser (1) — 50

\*Laser (1, chest) — 30

\*Ion Blasters (2, lower chest) — 15 each

\*Spotlight (1, lower chest) — 5

\*Spotlight (1, small on head) — 2

Head/Sensors — 150

\*\*Main Body: Forward section — 350

\*\*Main Body: Fusion Chamber — 500

\* These targets are all comparatively small in size and difficult to hit. Thus, they can only be hit when the attacker makes a *called shot* and even then, the attacker is -2 to strike.

\*\*Depleting the M.D.C. of the main body destroys the cyborg's mechanical body housing, however, the organism's environmental containment chamber (effectively the pilot's compartment) holds the majority of the living organism. The Mechanoid organism can be rescued and installed into another mechanical body of the same design. Except for its psionic powers, the creature is totally helpless and will die within 5D6 days.

### Speed

Running: Not applicable.

Leaping: Not applicable.

Flying: 150 mph (240 km) maximum, with a maximum altitude of 2000 feet (610 m).

Range: Unlimited.

### Statistical Data

Height: 30 feet (9 m)

Width: 26 feet (7.9 m)

Length: 45 feet (13.7 m)

Weight: 138 tons

Cargo: There is a concealed cargo bay in the left portion of the chest that can hold the equivalent of a compact car and up to four tons. The small plasma cannon is often stored in it.

Armored Body: Standard full environmental system. **Note:** The Mechanoid will die in 4D6 minutes if the containment chamber is breached — they cannot breathe Earth's atmosphere.

Power System: Plasma generator contained in the giant rear portion of the body. The average life is 600 years.

Black Market Value: The Market will pay 2D4 million credits for a Mechanoid plasma generator in working condition.

Alignment: Typically aberrant evil.

Horror Factor: 11

Physical Strength: Equal to a P.S. 50

Other Attributes of Note: I.Q. 2D6 + 8, M.E. 2D6 + 8, M.A. 2D6 + 2 and P.P.E. 2D6.

Number of Attacks Per Melee: Four physical or psionic attacks.

Combat Bonuses (includes all bonuses): +4 to strike with its energy weapons, +4 to strike with a punch, +4 to parry, +2 to dodge, +2 to pull punch/kick, +2 to roll with impact, +2 to strike on a body block/ram, +4 to save vs horror factor, and +2 to save vs psionic attacks.

Psionics: Major psionic. 4D4 × 10 + 300 I.S.P. and possesses the psionic powers of telepathy, empathy, mind block, object

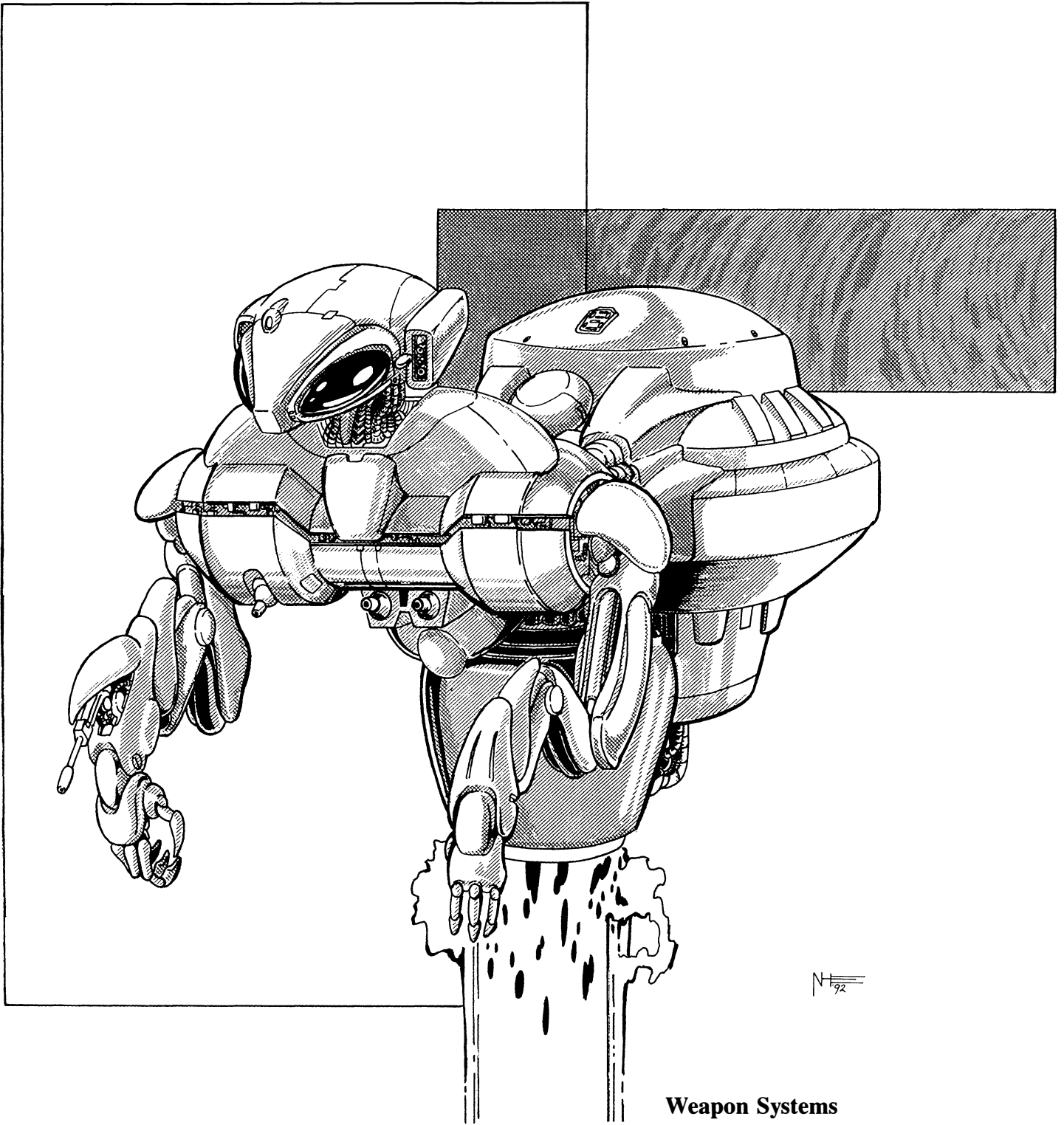

## Weapon Systems

read, see aura, see the invisible, speed reading, total recall, electrokinesis, super telekinesis and telemechanics.

Average Level of Experience: 1D4 + 6

Skills of Note: All mechanical skills at +25%, basic electronics (+20%), radio: basic and scrambler (10%), basic and advanced math (+25%), computer operation (+5%), plus both chemistry skills, read sensory equipment and land navigation, all at +15%.

**1. Ion Blasters (2):** These weapons are located in the lower chest, just above the large spotlight and are for defense.

Primary Purpose: Defense

Weight: Not applicable; it is part of the body.

Mega-Damage: 2D6 M.D. per single blast or 4D6 M.D. per double blast (both fire at the same target).

Rate of Fire: Equal to the number of hand to hand attacks.

Effective Range: 1200 feet (610 m).

Payload: Effectively unlimited; patched into the armor's power supply.

**2. Forearm Laser (1):** A powerful laser that serves as a tool for cutting, soldering and repairs, as well as a defensive weapon.

Primary Purpose: Tool and defense.

Weight: Not applicable; it is part of the lower body.

Mega-Damage: Any increment of 1D6 up to 6D6 M.D. per single blast.

Rate of Fire: Equal to the number of hand to hand attacks.

Effective Range: 2000 feet (610 m)

Payload: Effectively unlimited; patched into the power supply.

**3. Chest Laser (1):** Another laser used as a tool for cutting, soldering and repairs, as well as a defensive weapon.

Primary Purpose: Tool and defense.

Weight: Not applicable; it is part of the lower body.

Mega-Damage: 4D6 S.D.C., 6D6 S.D.C., 1D4 M.D., 1D6 M.D., 2D6 M.D. or 3D6 M.D. per single blast.

Rate of Fire: Equal to the number of hand to hand attacks.

Effective Range: 1200 feet (366 m)

Payload: Effectively unlimited; patched into the power supply.

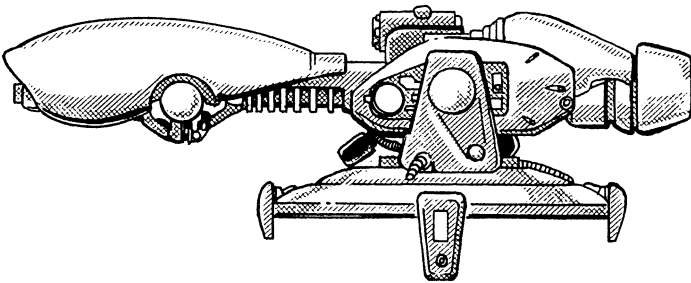

**4. Optional Medium Range Plasma Cannon (1):** The plasma ejector connects to the top, rear housing of the mantis and taps directly into the plasma generator. The weapon can rotate 360 degrees and tilt up and down at a 30 degree angle.

Primary Purpose: Assault

Weight: Not applicable; it is part of the body.

Mega-Damage: 1D6 × 10 M.D. per single blast.

Rate of Fire: Equal to the number of hand to hand attacks.

Effective Range: 3000 feet (914 m).

Payload: Effectively unlimited; patched into the power supply.

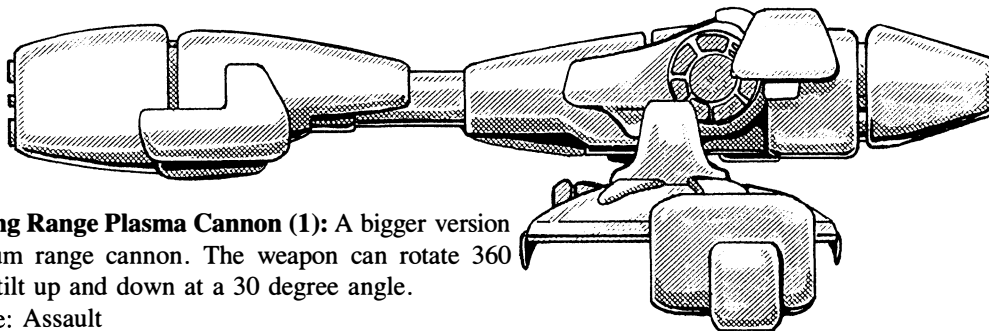

**5. Optional Long Range Plasma Cannon (1):** A bigger version of the medium range cannon. The weapon can rotate 360 degrees and tilt up and down at a 30 degree angle.

Primary Purpose: Assault

Weight: Not applicable; it is part of the body.

Mega-Damage: 2D4 × 10 M.D. per single blast.

Rate of Fire: Equal to the number of hand to hand attacks.

Effective Range: 5000 feet (1524 m).

Payload: Effectively unlimited; patched into the power supply.

**6. Electrokinetic and other psionic powers** can also be used as a means of attack. Telekinesis, for example, can be used in combat.

**7. Hand to Hand Combat:** Rather than use an energy weapon, the Mechanoid can engage in hand to hand combat using its fists and/or hand-held weapons.

Restrained Punch: 4D6 + 35 S.D.C.

Full Strength Punch: 4D6 M.D.

Power Punch: 1D6 × 10 M.D., but counts as two attacks.

Plasma burst from hover jet: 6D6 M.D.C.

Body block/ram: 4D6 M.D. damage and has a 1-65% chance of knocking one's opponent off his feet (victim loses initiative and one melee attack), but counts as two melee attacks.

**8. Sensor Systems of Note:** Extended: Same as the oracle, plus x-ray vision (50 foot/15 m range) and ultrasound probing (to scan for defects), computer optical enhancement system, electron microscope, microscopic and spectrographic vision (all used for scanning structural defects and for examining microchips and circuitry), video recording and sonar. The spotlights have a beam range of 500 feet (153 m).

## Mechanoid Type One Octopus

The body styling of the type one octopus is unchanged. The big Mechanoid is a single-minded drone consumed with the performance of its many precision and highly technical jobs. They are frequently seen working side by side with the mantis or a runner. The responsibilities of an octopus includes cybernetics and cybernetic implantation, medical doctor and surgery, genetic engineering, electronics, mechanics, manufacturing and repairs.

Unlike the other Mechanoids, the octopus will ignore humanoids unless they are attacking it or something it is working on. The only other time it will attack humans is if any of the other true Mechanoids tells it to do so. It is primarily found on the mothership and large Mechanoid bases. No octopuses of any kind are likely to have been rifted to Earth (GM's option).

**Model Type:** Type One Octopus — Medical, Genetics, Electrical and Mechanical Engineer, Manufacturing and Repairs.

**Class:** Cyborg Drone

### M.D.C. by Location:

\*Lower Arms & Hands (2) — 80 each

\*Lower Claw (1) — 100

\*Lower Retractable Laser Finger/Arm (1) — 10

Upper Multi-Arm (1) — 150

Upper Fusion Torch Arm (1) — 120

\*Upper Laser Finger/Arm (1, rear) — 20

Containment Chamber — 120

\*Head/Sensors — 80

\*Lower Sensors (2) — 35 each  
 Lower Body — 250  
 \*\*Main Body (upper section) — 250

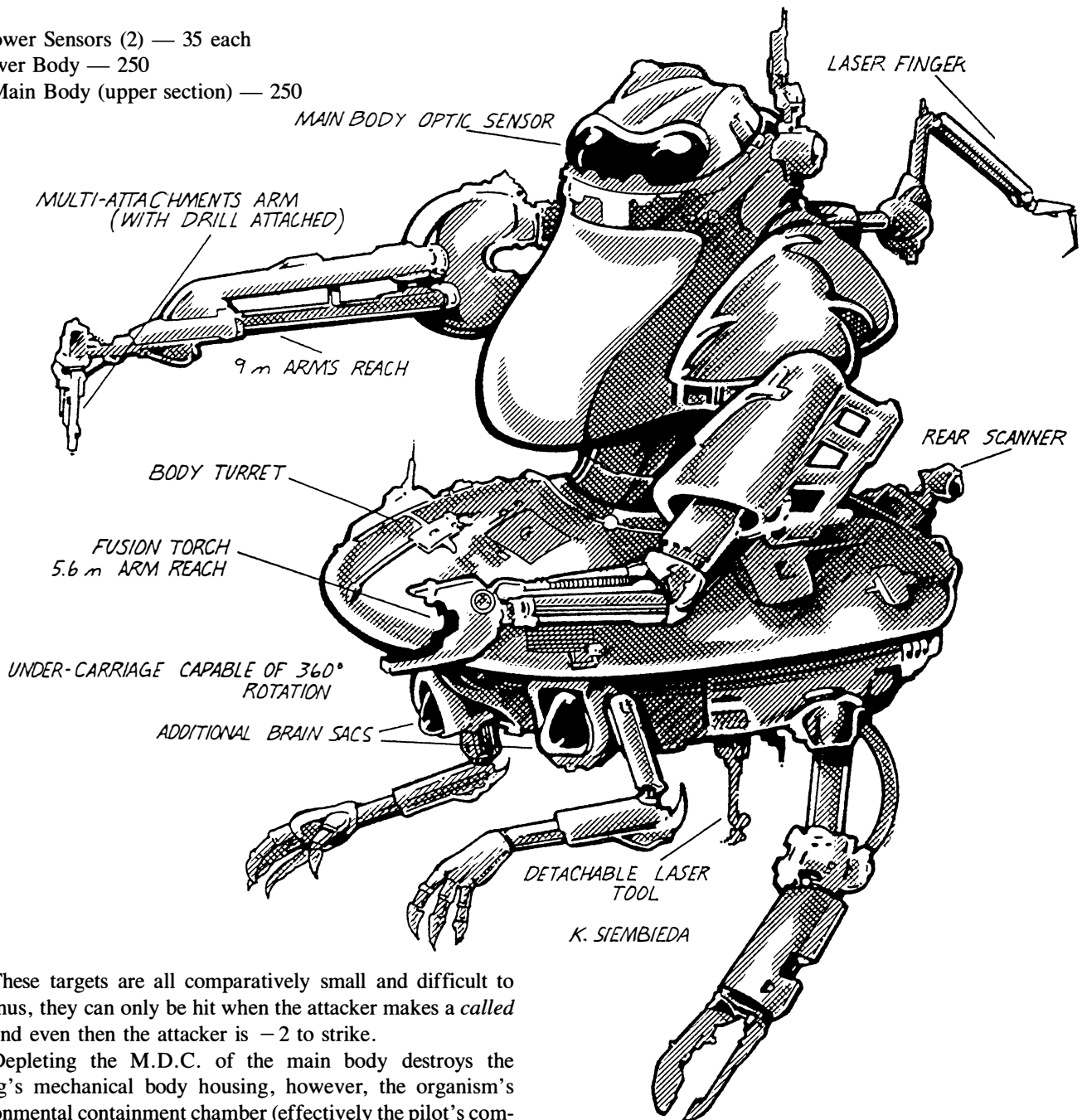

\* These targets are all comparatively small and difficult to hit. Thus, they can only be hit when the attacker makes a *called shot* and even then the attacker is -2 to strike.

\*\*Depleting the M.D.C. of the main body destroys the cyborg's mechanical body housing, however, the organism's environmental containment chamber (effectively the pilot's compartment) holds the majority of the living organism. The Mechanoid organism can be rescued and installed into another mechanical body of the same design. Except for its psionic powers, the creature is totally helpless and will die within 5D6 days.

### Speed

Running: Not applicable.

Leaping: Not applicable.

Flying: 500 mph (800 km) maximum, with a maximum altitude of 10,000 feet (3048 m). Flight is made possible by an anti-gravity system similar to the wasp's.

Range: Unlimited.

### Statistical Data

Height: 50 feet (15.2 m)

Width: 41 feet (12.5 m)

Length: 42 feet (12.8 m)

Weight: 90 tons

Cargo: There is a concealed cargo bay in the front, left portion of the lower body that can hold the equivalent of a compact car and weight up to six tons.

Armored Body: Standard full environmental system. **Note:** The Mechanoid will die in 4D6 minutes if the containment chamber is breached — they cannot breathe Earth's atmosphere.

Power System: Standard Mechanoid power crystal. The average life is 100 years.

Black Market Value: The Market will pay 2D4 million credits for a Mechanoid power crystal that has 50 years of energy or more, 2D4 × 100,000 if less. The crystals cannot be duplicated!

Alignment: Typically aberrant evil.

Horror Factor: 11

Physical Strength: Equal to a P.S. 50

Other Attributes of Note: I.Q. 2D6 + 8, M.E. 2D6 + 8, M.A. 2D6 + 2 and P.P.E. 2D6.

Number of Attacks Per Melee: Four psionic attacks or eight physical, hand to hand attacks (may combine psionics with physical attacks).

Combat Bonuses (includes all bonuses): +6 on initiative and cannot be surprised, even from behind. +5 to strike with its energy weapons, +5 to strike with a punch, +6 to parry, +2 to dodge, +2 to pull punch, +2 to roll with impact, +2 to strike on a body block/ram, +7 to save vs horror factor, and +4 to save vs psionic attacks.

Psionics: Major psionic. 2D6×10+100 I.S.P. and possesses all the psionic sensitive powers, telekinesis, nightvision, and telemechanics.

Average Level of Experience: 1D4+6

Skills of Note: All mechanical and electrical skills (+20%), plus radio: basic and scrambler (10%), basic and advanced math (+35%), computer operation (+10%), M.D. in cybernetics, pathology, and biology, both chemistry skills, read sensory equipment and land navigation, all at +15%.

Note: Only about 25% have the old type one body styling.

## Weapon Systems

**1. Fusion Torch (1):** A tool used for welding, cutting and repair work.

Primary Purpose: Tool

Weight: Not applicable; it is part of the body.

Mega-Damage: 1D6 M.D., 2D6 M.D., 4D6 M.D., 6D6 M.D. per blast (4 settings).

Rate of Fire: Equal to the number of hand to hand attacks.

Effective Range: 1200 feet (610 m).

Payload: Effectively unlimited; patched into the armor's power supply.

**2. Multi-Arm (1):** The large right arm is an all-purpose tool that has a high-powered drill and precision laser with several different attachments. The different attachments are usually kept in the cargo compartment. The arm can rotate 360 degree.

Primary Purpose: Tool and defense.

Weight: Not applicable; it is part of the body.

Mega-Damage: Small drill: Any increment of 1D6 up to 6D6 S.D.C.; small, heavy drill: 1D4 M.D., large drill: 2D6 M.D. or 4D6 M.D.

Light fusion torch: 1D6 M.D.

Light laser: Any increment of 1D6 up to 4D6 M.D.

Heavy laser: 3D6 or 5D6

Rate of Fire: Equal to the number of hand to hand attacks.

Effective Range: 40 foot (12.2 m) reach plus 10 feet (3 m) with energy tools.

Payload: Effectively unlimited; patched into the power supply.

**3. Laser Finger (1):** A tiny arm with one finger is built into the upper back of the octopus. The finger is a utility laser used for welding, cutting and repairs. The arm can rotate 360 degrees at the elbow and at the back joint, plus it can swing to virtually any angle. The reach is limited to about 10 feet (3 m).

Primary Purpose: Tool

Weight: Not applicable; it is part of the body.

Mega-Damage: 1D4 M.D., or 1D6 M.D. or 2D6 M.D. per single blast.

Rate of Fire: Equal to the number of hand to hand attacks.

Effective Range: 300 feet (91.5 m).

Payload: Effectively unlimited; patched into the power supply.

**4. Retractable Lower Laser (1):** Another laser used as a tool for cutting, soldering and repairs, as well as a defensive weapon. It has a 15 foot (4.6 m) reach.

Primary Purpose: Tool and defense.

Weight: Not applicable; it is part of the lower body.

Mega-Damage: 4D6 S.D.C., 6D6 S.D.C., 1D4 M.D., 1D6 M.D., 2D6 M.D. or 3D6 M.D. per single blast.

Rate of Fire: Equal to the number of hand to hand attacks.

Effective Range: 1200 feet (366 m)

Payload: Effectively unlimited; patched into the power supply.

**5. Utility Arms (2):** Two arms and hands are built into the lower body housing near the two lower body sensors. The arms are used for grasping, holding and carrying, as well as performing repairs and other tasks. They can use any variety of tools or weapons. Each arm has a 12 foot (3.3 m) reach and can rotate 360 degrees at both the shoulder and elbow.

Primary Purpose: Labor

Weight: Not applicable; it is part of the body.

Mega-Damage: 2D6 M.D. per strike.

Rate of Fire: Equal to the number of hand to hand attacks.

Effective Range: 12 feet (3.6 m).

Payload: Effectively unlimited; patched into the power supply.

**6. Large Utility Claw (1):** Another, larger arm also located in the lower body of the octopus. The arm can retract a bit, about six feet and a total reach of 20 feet (6 m) when fully extended and can rotate 360 degrees at the shoulder and elbow.

Primary Purpose: Labor

Weight: Not applicable; it is part of the body.

Mega-Damage: 3D6 M.D. per strike, 2D6 crush/squeeze, or 6D6 power punch.

Rate of Fire: Equal to the number of hand to hand attacks.

Effective Range: 12 feet (3.6 m).

Payload: Effectively unlimited; patched into the power supply.

**7. Sensor Systems of Note:** Extended: Same as the mantis.

**Note:** The body undercarriage with three arms and laser tool can rotate a full 360 degrees in the blink of an eye. Its multiple sensors make it impossible to sneak up on, but the drone is usually absorbed in its work. Octopus are found primarily on the mothership and large Mechanoid bases.

## Mechanoid Type Two Octopus

The type two octopus serves the exact same function as the type one and demonstrates the same single-minded obsessiveness in regards to the methodical performance of its job. The differences are a stylistic design change and additional features to better do its work.

One of the most significant features is that the big Mechanoid can detach its upper body (which houses the living organism) from the lower to access smaller areas. Flight is made possible using the Mechanoid's standard anti-gravity propulsion system.

The upper body has two mechanical arms. Each arm has a spotlight and a utility laser tool. The light and laser are built into the wrist of the large arm and in the hand of the small arm. Both arms can rotate 360 degrees at the wrist, elbow and shoulder. Additionally, mechanical tentacles are housed in each of the fin-like protrusions on the sides. These tentacles have tiny,

three finger hands at the ends and can snake down pipes and narrow cavities (50 foot/15.2 m reach). The forward, head structure is a multi-optics sensor system with telescopic, microscopic, thermographic and spectrographic capabilities, among others. The rear section has two large thrusters for forward movement and enhanced speed.

The lower sections can be controlled by the upper body (and brain) even when detached. It has eight arms: three claws (the front two have lights built into the palms), one human style hand on its left side, two small arms and hands in the front, a fusion torch, and laser arm.

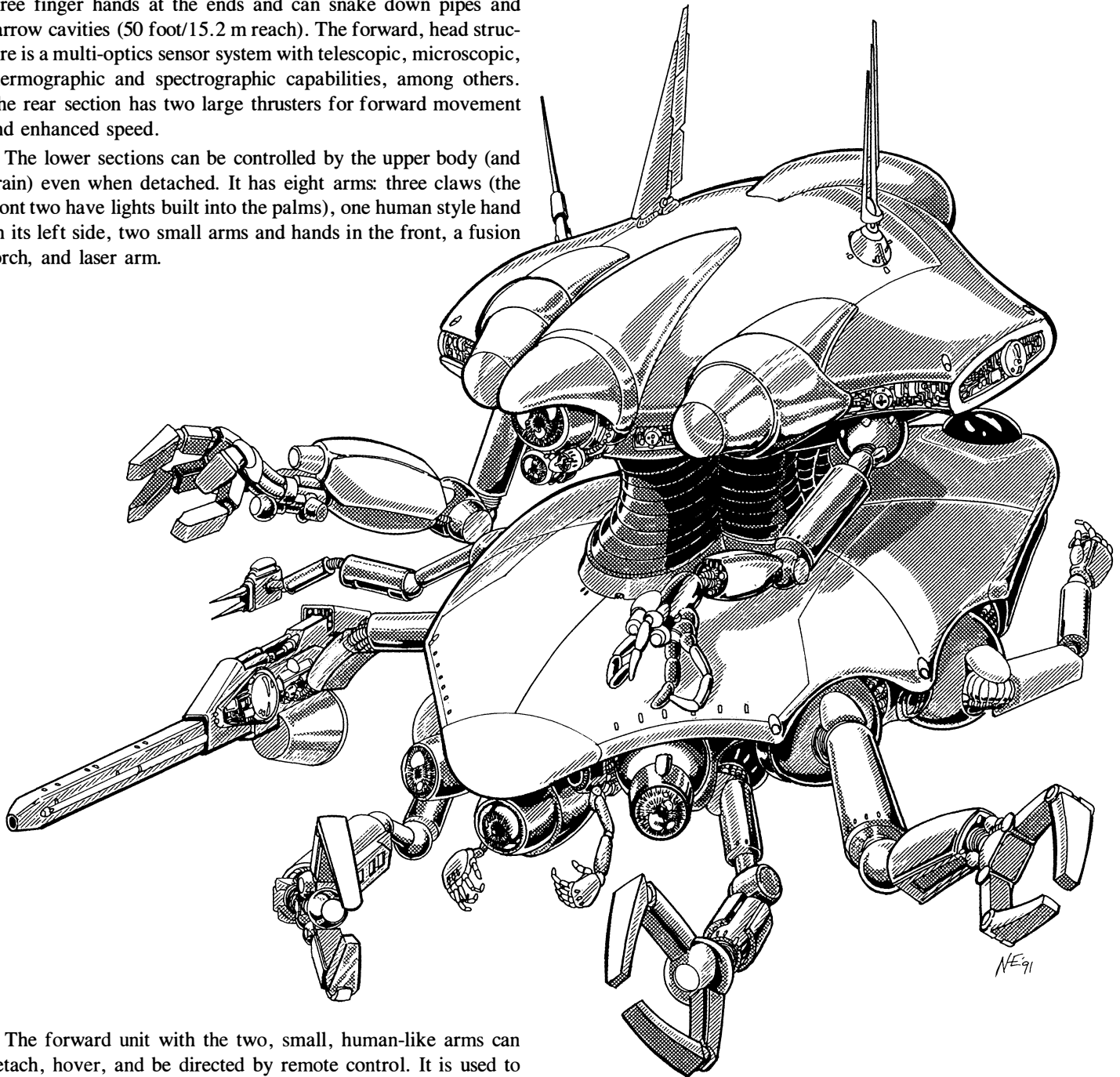

The forward unit with the two, small, human-like arms can detach, hover, and be directed by remote control. It is used to get into the nooks and crannies that the giant octopus cannot reach. The robot unit has the same optics and sensors as its parent unit. It transmits visual images and sounds of everything it sees and hears to the octopus. Transmissions can be played back when needed. The Mechanoid can then make an assessment of the situation and use the tiny unit to effect repairs or to better direct other technicians in their endeavours.

**Model Type:** Octopus Type Two — Medical, Genetics, Electrical and Mechanical Engineer, Manufacturing and Repairs.

**Class:** Cyborg Drone

**M.D.C. by Location:**

- \*Lower: Arm & Hand (1) — 50
- \*Lower: Tiny Arms & Hands (2) — 10 each
- \*Lower: Claw Arms (3) — 100 each
- \*Lower: Fusion Torch Arm (1) — 100
- \*Lower Laser Arm (1) — 30
- \*Upper Large Arm (1) — 150

\*Upper Small Arm (1) — 100

\*Concealed Tentacles (2) — 10 each

\*Lower: Detachable Remote Drone — 50

\*Lower Sensors (2, excluding remote unit) — 35 each

\*Head & Sensors — 100

Rear Thrusters (2) — 50 each

Containment Chamber — 120

Lower Body — 350

\*\*Main Body (upper section) — 270

\* These targets are all comparatively small and difficult to hit. Thus, they can only be hit when the attacker makes a *called shot* and even then the attacker is -2 to strike.

\*\*Depleting the M.D.C. of the main body destroys the cyborg's mechanical body housing, however, the organism's environmental containment chamber (effectively the pilot's compartment) holds the majority of the living organism. The Mechanoid organism can be rescued and installed into another

mechanical body of the same design. Except for its psionic powers, the creature is totally helpless and will die within 5D6 days.

### Speed

Running: Not applicable.

Leaping: Not applicable.

Flying: 500 mph (800 km) maximum, with a maximum altitude of 20,000 feet (6096 m). Flight is made possible by an anti-gravity system similar to the wasp's.

Range: Unlimited.

### Statistical Data

Height: 40 feet (12.2 m)

Width: 42 feet (12.8 m)

Length: 48 feet (14.6 m)

Weight: 90 tons

Cargo: There is a concealed cargo bay in the rear portion of the lower body that can hold the equivalent of a compact car and up to six tons.

Armored Body: Standard full environmental system. **Note:** The Mechanoid will die in 4D6 minutes if the containment chamber is breached — they cannot breathe Earth's atmosphere.

Power System: Power crystal with a life of 100 years.

Black Market Value: The Market will pay 2D4 million credits for a Mechanoid power crystal that has 50 years of energy or more,  $2D4 \times 100,000$  if less. The crystals cannot be duplicated!

Alignment: Typically aberrant evil.

Horror Factor: 11

Physical Strength: Equal to a P.S. 50

Other Attributes of Note: I.Q.  $2D6 + 8$ , M.E.  $2D6 + 8$ , M.A.  $2D6 + 2$  and P.P.E.  $2D6$ .

Number of Attacks Per Melee: Four psionic attacks or eight physical, hand to hand attacks (may combine psionics with physical attacks).

Combat Bonuses (includes all bonuses): +6 on initiative and cannot be surprised even from behind. +6 to strike with its energy weapons, +6 to strike with a punch, +8 to parry, +2 to dodge, +2 to pull punch, +2 to roll with impact, +2 to strike on a body block/ram, +7 to save vs horror factor, and +4 to save vs psionic attacks.

Psionics: Major psionic.  $2D6 \times 10 + 100$  I.S.P. and possesses all the psionic sensitive powers, telekinesis, nightvision, and telemechanics.

Average Level of Experience:  $1D4 + 6$

Skills of Note: Same as the type one: all mechanical and electrical skills (+20%), plus radio: basic and scrambler (10%), basic and advanced math (+35%), computer operation (+10%), M.D. in cybernetics, pathology, biology, both chemistry skills, read sensory equipment and land navigation all at +15%.

### Weapon Systems

**1. Large Hand and Arm (1):** The large right arm is used for repairs, lifting and carrying, and operating machines. It has a spotlight and utility laser built into the wrist. The hand can rotate 360 degrees at the wrist. The arm can rotate 360 degrees at the wrist, elbow and shoulder.

Primary Purpose: Tool and defense.

Weight: Not applicable; it is part of the body.

Mega-Damage: The laser can inflict 1D4 M.D., 1D6 M.D., 2D6

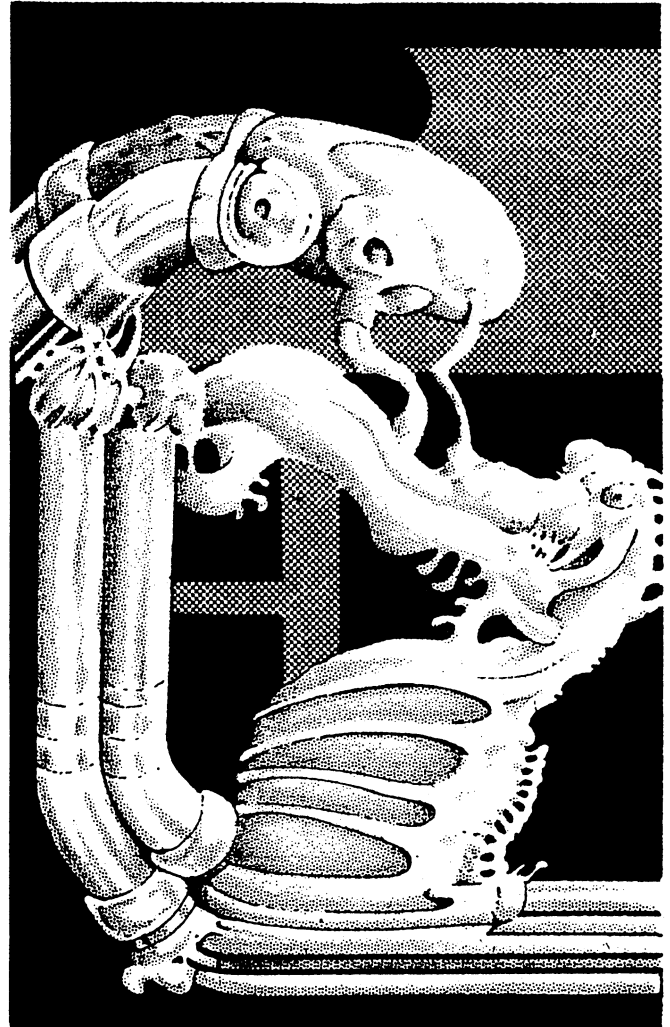

M.D., or 3D6 M.D., while the hand can punch, inflicting 4D6 M.D. or  $1D6 \times 10$  M.D. with a power punch (counts as two attacks).

Rate of Fire: Equal to the number of hand to hand attacks.

Effective Range: 50 foot (15.2 m) reach.

Payload: Effectively unlimited; patched into the power supply.

**2. Smaller Hand and Arm (1):** This limb is roughly equivalent to the large arm in every way except the amount of damage it inflicts from a punch and its reach.

Primary Purpose: Tool

Weight: Not applicable; it is part of the lower body.

Mega-Damage: The laser can inflict 1D4 M.D., 1D6 M.D., 2D6 M.D., or 3D6 M.D., while the hand can punch, inflicting 3D6 M.D. or 6D6 M.D. with a power punch.

Rate of Fire: Equal to the number of hand to hand attacks.

Effective Range: 30 foot (9 m) reach.

Payload: Effectively unlimited; patched into the power supply.

**3. Concealed, Retractable Tentacles (2):** A tentacle can project from each side of the upper body. They are used to get into small areas and to snake through pipes and around obstacles.

Primary Purpose: Tool

Weight: Not applicable; they are part of the lower body.

Mega-Damage: 1D6 M.D. from a punch or swat, but can also coil around and pin an opponent. A combined strength of 55 or greater is required to pull free of the ensnaring tentacle.

Rate of Fire: Equal to the number of hand to hand attacks.



Effective Range: 50 foot (15.2 m) reach.

Payload: Effectively unlimited; patched into the power supply.

**4. Laser Arm (1):** A tiny arm with one finger is built into the upper back of the octopus. The finger is a utility laser used for welding, cutting and repairs. The arm can rotate 360 degrees at the elbow and at the back joint, plus it can swing virtually to any angle. The reach is limited to about 10 feet (3 m).

Primary Purpose: Tool

Weight: Not applicable; it is part of the body.

Mega-Damage: 1D4 M.D., 1D6 M.D., 2D6 M.D., or 4D6 M.D. per single blast, or 8D6 M.D. from a dual blast.

Rate of Fire: Equal to the number of hand to hand attacks (8).

Effective Range: 1200 feet (610 m).

Payload: Effectively unlimited; patched into the power supply.

**5. Fusion Torch (1):** This is a slightly different type of tool than the type one, with a greater range of heat and flame. It is used for welding, cutting and repair work.

Primary Purpose: Tool

Weight: Not applicable; it is part of the body.

Mega-Damage: 1D6 to 10D6 S.D.C. or 1D6 to 6D6 M.D. per blast. The octopus can regulate the intensity and damage within the available range.

Rate of Fire: Equal to the number of hand to hand attacks (8).

Effective Range: 1200 feet (610 m).

Payload: Effectively unlimited; patched into the power supply.

**6. Utility Hand and Arm (1):** This arm and hand is built into the left side of the lower body housing. The hand is used for grasping, holding, carrying, performing repairs and many other tasks. The hand can use a variety of tools and operate machinery. It has a 12 foot (3.3 m) reach and can rotate 360 degrees at the wrist, elbow and shoulder.

Primary Purpose: Labor

Weight: Not applicable; it is part of the body.

Mega-Damage: 2D6 M.D. per strike.

Rate of Fire: Equal to the number of hand to hand attacks.

Effective Range: 12 feet (3.6 m).

Payload: Effectively unlimited; patched into the power supply.

**7. Large Utility Claws (3):** Three larger arms with pincer-like claws are also located in the front of the lower body. Each has a 20 foot (6 m) reach when fully extended and can rotate 360 degrees at the wrist, elbow, and shoulder.

Primary Purpose: Labor

Weight: Not applicable; they are part of the body.

Mega-Damage: 3D6 M.D. per strike, 2D6 crush/squeeze, or 6D6 power punch.

Rate of Fire: Equal to the number of hand to hand attacks (8).

Effective Range: 20 feet (6 m).

Payload: Effectively unlimited; patched into the power supply.

**8. Remote Control Drone (1):** The robot drone is located in the front of the lower body and can function as part of the whole or separate from the main body and function as an independent unit. Directed by the octopus by remote control, it is used to get into the nooks and crannies that the giant cannot reach. The robot unit has the same optics and sensors as its parent unit, plus it records and transmits visual images and sounds of everything it sees and hears to the octopus.

Primary Purpose: Labor

Weight: Not applicable; it is part of the body.

M.D.C.: 50

Mega-Damage: 1D4 M.D. from punches with its tiny arms or 1D6 from a flying ram.

Rate of Fire: The drone can only make four actions/attacks per melee, but each of the drone's actions counts as one of the octopus' eight melee actions.

Effective Range: 2000 feet (610 m).

Payload: Effectively unlimited; patched into the power supply.

**9. Sensor Systems of Note:** Extended: Same as the mantis and type one octopus.

**Note:** The upper and lower body can rotate 360 degrees in the blink of an eye or separate to function as two units. Its multiple sensors make it impossible to sneak up on, but the drone is usually absorbed in its work. Octopus are found primarily on the mothership and large Mechanoid bases. None are likely to have been dimensionally rifted to Earth (GM's option).

---

## Mechanoid Robots

**Assault Probe  
Runt  
Skimmer**

**Thinman  
Weavel**

---

## The Mock Men

### The Thinman & Runt Robots

**Mock Men** are robots deliberately designed by the Mechanoids to resemble humanoids. To the Mechanoids, this is an ironic joke — the humor is lost on most humanoids.

There are two types of mock men, the Thinman and the Runt. Although they still resemble the old pre-AbM designs, both have been recently redesigned.

The Runts and Thinmen are manufactured in the billions and are the mainstay of the Mechanoids' work force. They are found everywhere, assisting with vehicle repairs, working in factories, hauling cargo, constructing buildings, assisting in scientific and medical research, performing maintenance, as well as serving as front-line infantry troops, and helping in defense, maintenance and reconnaissance.

### The Thinman

The thinman's primary function is to assist the Mechanoids in combat, defense, maintenance, repairs and labor. The new thinman design provides increased armor, speed and versatility. Instead of the left arm being a laser weapon and tool, both arms have hands. Weapons include hand-held pistol and rifle styled energy weapons. The newly designed head resembles the skull of a humanoid and is constantly grinning.

They are abundant wherever Mechanoids are found. Thinmen are often seen in the company of brutes, runners, and brains, and less frequently seen assisting the mantis, octopus and others.

**Model Type:** Thinman — All Purpose, Combat and Maintenance.

**Class:** Robot

**M.D.C. by Location:**

Hands (2) — 20 each

Arms (2) — 50 each

Shoulders (2) — 100 each

Legs (2) — 90 each

Weapons (vary) — Typically 40 each

\*Head — 90

\*\*Main Body — 150

\* Destroying the head will eliminate the optics and most of the sensory systems — reduce combat bonuses by half.

\*\*Depleting the M.D.C. of the main body will destroy the bot. An attacker must make a called strike to hit a specific part of the body such as the head, arms, hands, legs and weapons (no strike penalty).

### Speed

Running: 90 mph (144 km) maximum. Note that the act of running does NOT tire the robot and speed can be maintained indefinitely.

Leaping: The robot legs are strong, enabling it to leap approximately 20 feet (6 m) high or across.

Flying: Not possible without the addition of a jet pack or vehicle.

Range: Effectively unlimited

### Statistical Data

Height: 13 feet (3.9 m)

Width: 4 feet (1.2 m)

Length: 3 feet (0.9 m)

Weight: 1200 lbs (540 kg)

Armored Body: Mega-damage robot body.

Power System: The nuclear power pack gives the robot five years of life even under the most strenuous and constant amount of use.

Black Market Value: The Market will pay  $4D4 \times 10,000$  credits to study the bot and its programming, and  $1D4 \times 10,000$  credits for a working plasma rifle. The pistol and other weapons have a wholesale value of about  $1D4 \times 1000$  credits.

Alignment: Not applicable. Humans would consider them to be diabolic killers.

Horror Factor: 10

Physical Strength: P.S. 40.

Other Attributes of Note: Not applicable.

Number of Attacks Per Melee: Five total attacks.

Combat Bonuses (includes all bonuses): +2 on initiative, +6 to strike, +6 to parry and dodge, +2 to pull punch, +2 to roll with impact. Impervious to horror factor and mind control because it has no living mind to frighten or influence.

Skills of Note: Intelligence 65%, track 65%, climb 90/80%, swim 65%, prowl 40%, land navigation 85%, radio: basic 96%, radio scrambler 96%, pilot hover vehicles 96%, pilot jet pack 96%, read sensory instruments 65%, basic math 96%, and can be programmed to understand 50 different languages at 96%. Weapon proficiencies included W.P. blunt, W.P. automatic rifle, and all energy W.P. skills.

**Programming and memory** enables the robot to identify weapons, combat vehicles, humanoid life forms and known enemies of the Mechanoids, including the Kittani. Combat programming directs the actions and reactions to encounters and attacks.

## Weapon Systems

**1. M-15 Plasma Rifle (1, standard issue):** The common infantry weapon given the thinman is this devastating plasma rifle. The weapon has an independent, 15 shot energy clip but can also be connected directly to the robot's power supply with a special conduit, for unlimited rounds. Runners, brains, and brutes can also use this weapon.

Primary Purpose: Assault

Weight: 25 lbs (11.3 kg)

Mega-Damage:  $1D4 \times 10$  M.D. per blast.

Rate of Fire: Five per melee

Effective Range: 4000 feet (1200 m).

Payload: E-clip is 15 or unlimited when linked directly to the robot.

**2. M-20 Ion Pistol (1; standard issue):** An ion blaster is the standard sidearm for the thinman and is also used by the runt and other Mechanoids.

Primary Purpose: Assault

Weight: 3 lbs (1.4 kg)

Mega-Damage:  $4D6$  M.D. per blast

Rate of Fire: Five per melee

Effective Range: 500 feet (152 m).

Payload: E-clip is 20 or unlimited when linked directly to the robot.

**3. M-30 Robot Variable Laser Rifle (1, Optional):** The M-30 is a variable light frequency laser designed to overcome laser resistant armor. The robot's combat computer will automatically analyze an opponent's armor (if not already preprogrammed into its memory). After one melee round (15 seconds), the weapon adjusts to the light frequency that will inflict maximum damage. This is standard equipment for the runt and optional for the thinman. The runner, brute and other Mechanoids also use this weapon.

The weapon has an independent, 30 shot energy clip but can also be connected directly to the robot's power supply for unlimited rounds.

Primary Purpose: Assault

Weight: 10 lbs (4.5 kg)

Mega-Damage:  $2D6$  M.D. or  $4D6$  M.D.; two settings

Rate of Fire: Aimed, burst, wild; see Modern Weapons Proficiencies.

Effective Range: 2000 feet (610 m)

Payload: E-clip is 30 or unlimited when linked directly to the robot.

**4. Energy Rifles** and other weapons can be substituted in an emergency or as a back up weapon.

**5. Hand to Hand Combat:** Rather than use a weapon, the robot can engage in mega-damage hand to hand combat. *Five (5) attacks per melee!*

Restrained Punch:  $4D6 + 25$  S.D.C.

Full Strength Punch:  $2D4$  M.D.

Power Punch:  $3D6$  M.D., but counts as two attacks

Kick:  $2D6$  M.D.

Leap Kick:  $3D6$  M.D.

Head Butt:  $1D6$  M.D.

**6. Sensor Systems of Note:** Standard for Mechanoid robots.

**Optics:** The robot has full optical systems, including the

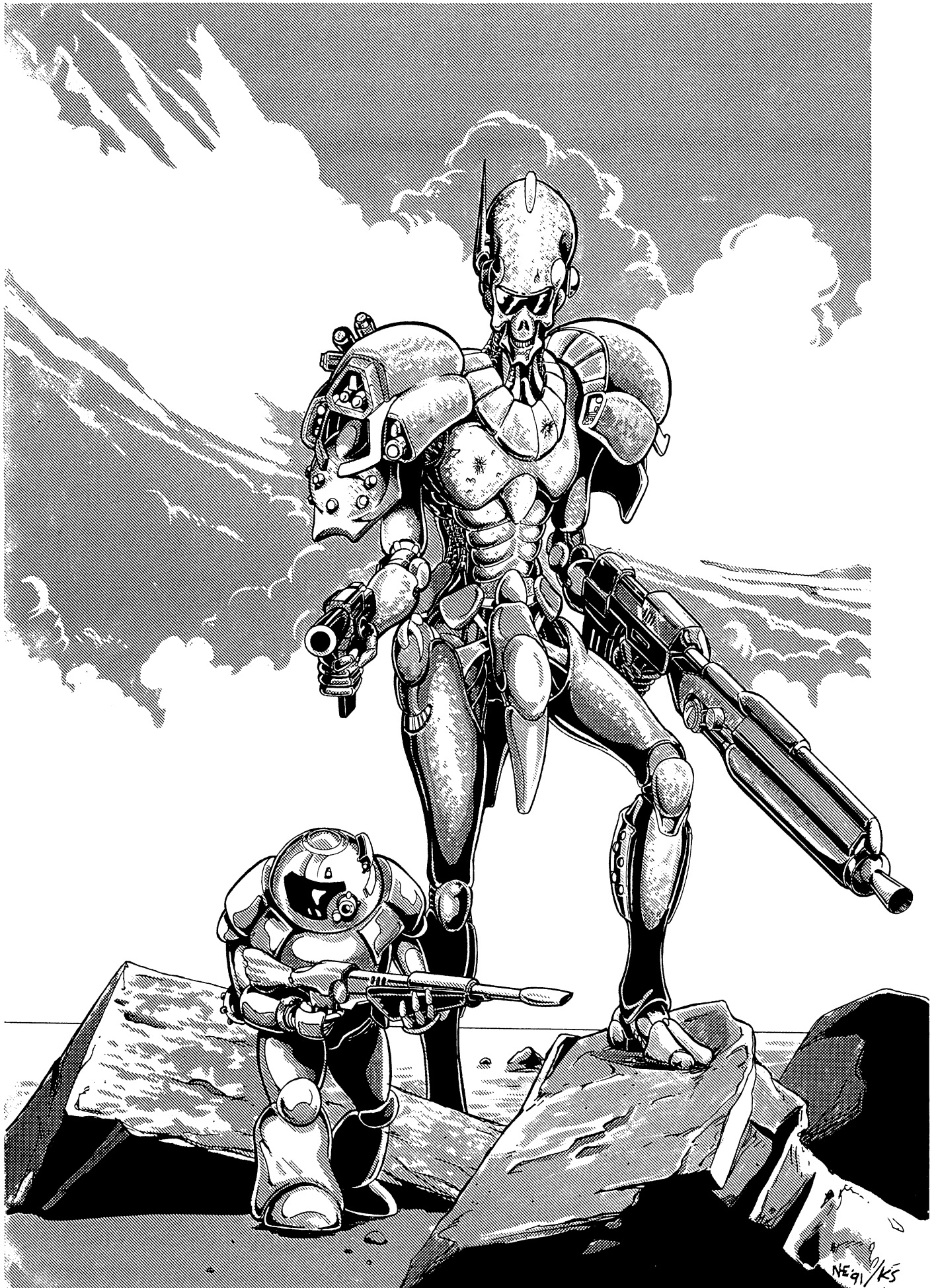

visible light spectrum, infrared, ultraviolet, and passive night vision (light amplification), thermo-imaging, laser targeting, and telescopic. *Telescopic optics* function like built-in binoculars with a range of about two miles (3.2 km). All the other optic systems have a range of about 3000 feet (914 m).

**Radar:** Can identify and track up to 48 targets simultaneously, at a range of two miles (3.2 km). Applicable to flying targets at 500 feet above the ground or higher only. Radar can not track ground movement.

**Motion Detector:** 100 foot radius (30.5 m), adds to ability to parry and dodge (see bonuses).

**Radiation Detector:** 100 foot radius (30.5 m); identifies and measures the amount of radiation.

**Radio Communication:** Medium range directional radio. Range: 50 miles (80 km). Can also scan and communicate via code, eavesdrop on enemy transmissions and track transmissions (60% success level) to their source. Range: 10 miles (16 km). **Note:** Understands English, Spanish, and Techno-can languages; can identify all others but can not understand or communicate in them.

**Speech:** The thinman communicates with the Mechanoids by means of coded radio transmission, but can speak a variety of languages that are known to the Mechanoids. No Earth languages are yet known, but Kittani, Nigelian, Ostrac, and Gendo are included.

## Runt Combat Robot

The runt's function, like the thinman's, is to assist the Mechanoids in combat, defense, maintenance, repairs and labor. The new runt design is closer to its earlier design than the thinman. There are subtle design changes and improvements, including increased body armor and speed. The head can rotate 360 degrees and has a tiny all-purpose laser mounted on the top of its head. Weapons include the same pistol and light laser rifle used by the thinman. The large, heavy plasma rifle cannot be used by the runt.

The runt's deceptive size, often lulls opponents into a false sense of superiority, because they are quick, strong and deadly. A single runt can lift and carry weights of more than a ton. They are found in abundance wherever Mechanoids are found and are often in the company of thinmen robots, brutes, brains, and runners.

**Model Type:** Runt Combat Unit — All Purpose, Combat and Maintenance.

**Class:** Robot

**M.D.C. by Location:**

Hands (2) — 10 each

Arms (2) — 30 each

Shoulders (2) — 50 each

Legs (2) — 70 each

Weapons (vary) — Typically 40 each

\*Head — 70

\*\*Main Body — 100

\* Destroying the head will eliminate the optics and most of the sensory systems — reduce combat bonuses by half.

\*\*Depleting the M.D.C. of the main body will destroy the bot. An attacker must make a called strike to hit a specific part

of the body such as the head, arms, hands, legs and weapons (no strike penalty).

### Speed

**Running:** 45 mph (72 km) maximum. Note that the act of running does NOT tire the robot and speed can be maintained indefinitely. **Leaping:** The robot legs are strong enabling it to leap approximately 8 feet (2.4 m) vertically or horizontally.

**Flying:** Not possible without the addition of a jet pack or vehicle.

**Range:** Effectively unlimited

### Statistical Data

**Height:** 4 feet, 4 inches (1.23 m)

**Width:** 2 feet (0.6 m)

**Length:** 2 feet, 6 inches (0.65 m)

**Weight:** 400 lbs (180 kg)

**Armored Body:** Mega-damage robot body.

**Power System:** The nuclear power pack gives the robot five years of life even under the most strenuous and constant amount of use.

**Black Market Value:** The Market will pay  $2D4 \times 10,000$  credits to study the bot and its programming, and  $1D4 \times 1000$  credits for its weapons.

**Alignment:** Not applicable. Humans would consider them to be diabolic killers.

**Horror Factor:** 8

**Physical Strength:** P.S. 30

**Other Attributes of Note:** Not applicable.

**Number of Attacks Per Melee:** Five total attacks.

**Combat Bonuses (includes all bonuses):** +2 on initiative, +5 to strike, +4 to parry and dodge, +2 to pull punch, +2 to roll with impact. Impervious to horror factor and mind control because it has no living mind to frighten or influence.

**Skills of Note:** Same as the thinman, except the prowl ability is at 50%.

**Programming and memory** enables the robot to identify weapons, combat vehicles, humanoid life forms and known enemies of the Mechanoids, including the Kittani. Combat programming directs the actions and reactions to encounters and attacks.

## Weapon Systems

**1. M-30 Robot Variable Laser Rifle (1, Optional):** The M-30 is a variable light frequency laser designed to overcome laser resistant armor. The robot's combat computer will automatically analyze an opponent's armor (if not already preprogrammed into its memory). After one melee round (15 seconds) the weapon adjusts to the light frequency that will inflict maximum damage. This is standard equipment for the runt and optional for the thinman. The runner, brute and other Mechanoids also use this weapon.

The weapon has an independent, 30 shot energy clip but can also be connected with a cable directly to the robot's power supply for unlimited rounds.

**Primary Purpose:** Assault

**Weight:** 10 lbs (4.5 kg)

**Mega-Damage:**  $2D6$  M.D. or  $4D6$  M.D.; two settings

**Rate of Fire:** Aimed, burst, wild; see Modern Weapons Proficiencies.

**Effective Range:** 2000 feet (610 m)

Payload: E-clip is 30 or unlimited when linked directly to the robot.

**2. M-20 Ion Pistol (1; standard issue):** An ion blaster is the standard sidearm for the runt and is also used by the thinman and other Mechanoids.

Primary Purpose: Assault

Weight: 3 lbs (1.4 kg)

Mega-Damage: 4D6 M.D. per blast

Rate of Fire: Five per melee

Effective Range: 500 feet (152 m).

Payload: E-clip is 20 or unlimited when linked directly to the robot.

**3. Energy Rifles** and other weapons can be substituted in an emergency or as a back-up weapon.

**4. Hand to Hand Combat:** Rather than use a weapon, the robot can engage in mega-damage hand to hand combat. *Five (5) attacks per melee!*

Restrained Punch: 4D6 + 15 S.D.C.

Full Strength Punch: 1D4 M.D.

Power Punch: 2D4 M.D., but counts as two attacks

Kick: 1D6 M.D.

Leap Kick: 2D6 M.D.

Head Butt: 1D4 M.D.

**5. Sensor Systems of Note:** Standard; same as the thinman.

## Runt Repair Unit

This unit is about the same size as the combat runt, but its function is not combat, but repair. The repair runt flies and has retractable, electromagnetic adhesive pads and cable to attach itself to the hulls of spacecraft or any other structures. Although not designed for combat, its program includes basic fighting and defensive skills. The repair runt will attack humanoids on sight.

**Model Type:** Runt Repair Unit — All Purpose, Repair & Maintenance.

**Class:** Robot

**M.D.C. by Location:**

Hands (2) — 10 each

Arms (2) — 30 each

Shoulders (2) — 50 each

Electro-Pads & Cord (2) — 10 each

Thrusters (2) — 30 each

Weapons (vary) — Typically 40 each

\*Head — 70

\*\*Main Body — 100

\* Destroying the head will eliminate the optics and most of the sensory systems — reduce combat bonuses by half.

\*\*Depleting the M.D.C. of the main body will destroy the bot. An attacker must make a called strike to hit a specific part of the body such as the head, arms, hands, legs and weapons (no strike penalty).

**Speed**

Running: Not applicable.

Leaping: Not applicable.

Flying: Hover jets give the robot the ability to fly in the air and move underwater or in outer space. 50 mph (80 km) maximum and can reach an altitude of about 2000 feet (610 m).

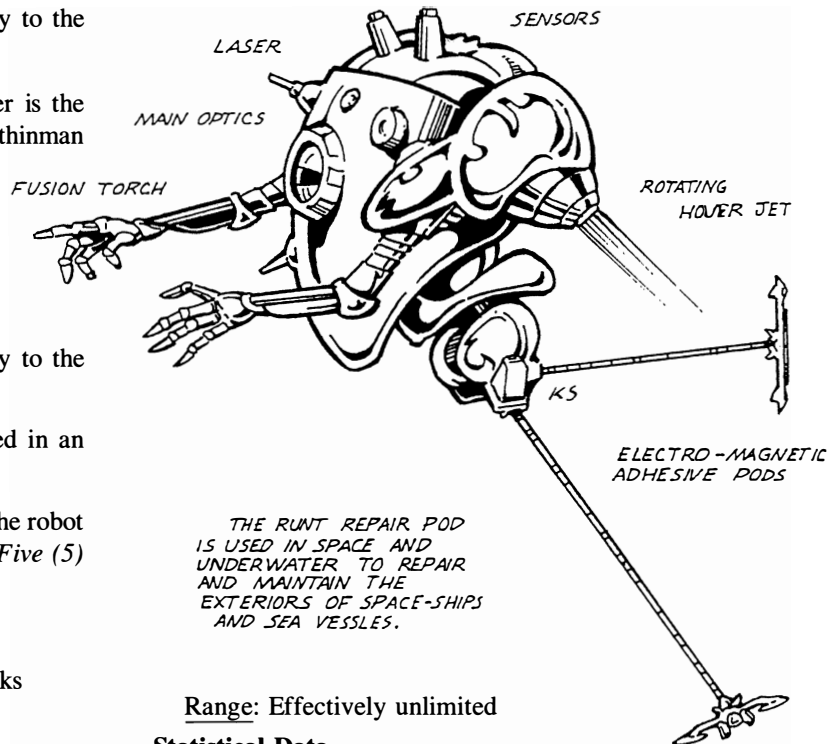

Range: Effectively unlimited

**Statistical Data**

Width: 2 feet (0.6 m)

Length: 2 feet, 6 inches (0.65 m)

Weight: 400 lbs (180 kg)

Armored Body: Mega-damage robot body.

Power System: The nuclear power pack gives the robot five years of life even under the most strenuous and constant amount of use.

Black Market Value: The Market will pay 2D4 × 10,000 credits to study the bot and its programming, and 1D4 × 1000 credits for its weapons.

Alignment: Not applicable. Humans would consider them to be diabolic killers.

Horror Factor: 8

Physical Strength: P.S. 30

Other Attributes of Note: Not applicable.

Number of Attacks Per Melee: Five melee actions/attacks.

Combat Bonuses (includes all bonuses): +2 on initiative, +5 to strike, +5 to parry and dodge, +2 to pull punch, +2 to roll with impact. Impervious to horror factor and mind control because it has no living mind to frighten or influence.

Skills of Note: Same as the combat runt.

**Programming and memory** enables the robot to identify weapons, combat vehicles, humanoid life forms and known enemies of the Mechanoids, including the Kittani. Combat programming directs the actions and reactions to encounters and attacks.

## Weapon Systems

**1. Laser Tool:** A laser used for cutting and welding is built into the upper body just about the eye-like sensor.

Primary Purpose: Tool

Weight: Not applicable.

Mega-Damage: 6D6 S.D.C. or 1D4 M.D. or 1D6 M.D.; three settings.

Rate of Fire: Five blast per melee.

Effective Range: 200 feet (61 m)

Payload: Effectively unlimited.

**2. Fusion Torch (1)**: A fusion torch is built into the finger of the right hand. This is a tool used for welding, cutting and other repairs.

Primary Purpose: Tool

Weight: Not applicable.

Mega-Damage: 1D4 M.D., 2D4 M.D., 3D4 M.D. or 4D4 M.D.; four settings.

Rate of Fire: Five per melee

Effective Range: 200 feet (61 m).

Payload: Effectively unlimited.

**3. The M-20 Ion Pistol, M-30 Laser Rifle** or other human-sized weapons and tools can be used by the little robot.

**4. Hand to Hand Combat**: Rather than use a weapon, the robot can engage in mega-damage hand to hand combat. *Five (5) attacks per melee!*

Restrained Punch: 4D6+15 S.D.C.

Full Strength Punch: 1D4 M.D.

Power Punch: 2D4 M.D., but counts as two attacks

Flying body block/ram: 2D4 M.D. with a 1-35% chance of knocking its opponent off his feet (victim loses initiative and one melee attack), but counts as two melee actions regardless of the speed.

**5. Sensor Systems of Note**: Standard; same as the thinman.

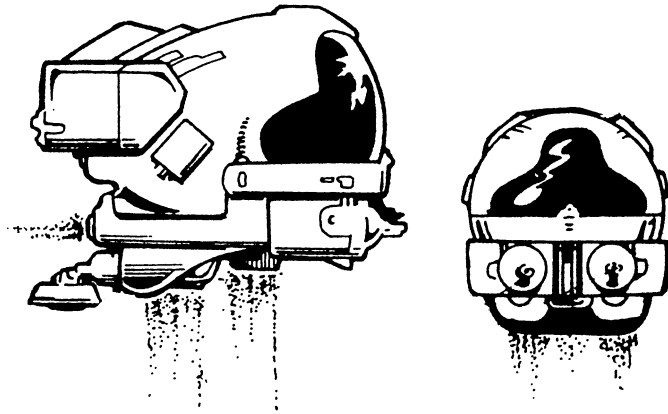

## Assault Probe

The assault probe is a combat robot about the size of a seeker pod. Its sole purpose is to hunt and exterminate humanoids and other pests. Like the tunnel crawler, the assault probe was originally designed to prowl the man-sized (and larger) tunnels, vents and pipelines of the Mechanoids' motherships, military bases, and cities. It has since become a reliable weapon used in the pursuit of refugees, seek and destroy missions, perimeter defense, and as a mechanical watchdog/guard.

Unless instructed to do otherwise, the assault probe is programmed to destroy all humanoids on contact without hesitation. The probe is silent and deadly even though its only weapon is a pair of rapid-fire ion blasters. The robot's design for prowling and combat in the confines of a tunnel has seen emphasis placed on stealth, alertness and firepower, not range. The probes are manufactured by the millions and considered to be inexpensive and expendable combat units.

**Model Type**: Robot assault unit — Hunter-Killer

**Class**: Robot

**M.D.C. by Location**:

Sensor Plate (1, front) — 30

\*Rear Thrusters (2) — 10 each

\*Lower jets (3) — 15 each

\*Ion Blasters (2, tiny) — 10 each

\*\*Main Body — 60

\*These are small and difficult to hit targets, thus they can only be struck when a character makes a *called shot* and even then the attacker is -3 to strike.

\*\*Depleting the M.D.C. of the main body destroys the robot.

**Speed**

Running: Not applicable.

Leaping: Not applicable.

Flying: Moves by use of a hover jet system, 150 mph (240 km), cruising speed is typically about half, maximum altitude is 2000 feet (610 m).

Range: Unlimited.

**Statistical Data**

Height: 3 feet (0.9 m)

Width: 3 feet (0.9 m)

Length: 5 feet (1.5 m)

Weight: 255 pounds (114 kg)

Cargo: None.

Armored Body: Mega-damage robot body.

Power System: A Mechanoid nuclear battery with a three year life.

Black Market Value: The Market will pay 2D4 × 10,000 to study the bot and its programming.

Alignment: Not applicable; for humans it would be the equivalent of diabolic evil, killer.

Horror Factor: 8

Physical Strength: Not applicable

Other Attributes of Note: Not applicable.

Number of Attacks Per Melee: Four total attacks; single energy blasts or rapid-fire bursts (a burst counts as one attack).

Combat Bonuses (includes all bonuses): +1 on initiative, +4 to strike, +4 to strike with a flying body block/ram, +4 to dodge +1 to roll with impact. Impervious to horror factor and mind control because it has no living mind to frighten or influence.

Skills of Note: Intelligence 60%, prowl 50%, track 65%, land navigation 85%, basic math 96%, and can be programmed to understand six different languages at 96%.

**Programming and memory** enables the probe to identify weapons, combat vehicles, humanoid life forms and known enemies of the Mechanoids, including the Kittani. Combat programming directs the actions and reactions to encounters and attacks.

## Weapon Systems

**1. Rapid-Fire Ion Beam Guns (2)**: A pair of tiny ion beam guns are built into the front/head-like section of the robot.

The guns are fixed forward and are considered short-range weapons by Mechanoid standards. The probe must turn its entire body to point and shoot, but the bot is very quick.

Primary Purpose: Extermination

Weight: Not applicable; it is part of the body.

Mega-Damage: 1D6 M.D. per single blast, 2D6 M.D. per double blast or 1D4 × 10 M.D. for a simultaneous rapid-fire burst from each gun.

Rate of Fire: Four single or multiple bursts.

Effective Range: 1200 feet (366 m).

Payload: Effectively unlimited; patched into the robot's power supply.

## 2. Sensor Systems of Note

**Optics:** The robot has full optical systems including the visible light spectrum, infrared, ultraviolet, and passive night vision (light amplification), thermo-imaging, laser targeting, and telescopic. *Telescopic optics* function like built-in binoculars with a range of about two miles (3.2 km). All the other optic systems have a range of about 3000 feet (914 m).

**Radar:** Can identify and track up to 48 targets simultaneously, at a range of two miles (3.2 km). Applicable to flying targets at 500 feet above the ground or higher only. Radar can not track ground movement.

**Motion Detector:** 100 foot radius (30.5 m), adds to ability to parry and dodge (see bonuses).

**Radiation Detector:** 100 foot radius (30.5 m); identifies and measures the amount of radiation.

**Radio Communication:** Medium range directional radio. Range: 50 miles (80 km). Can also scan and communicate via code, eavesdrop on enemy transmissions and track transmissions (60% success level) to their source. Range: 10 miles (16 km). **Note:** Understands English, Spanish, and Techno-can languages; can identify all others but can not understand or communicate in them.

**Speech:** The robot can not speak.

## Skimmer

---

The skimmer is a hunter-killer robot designed to be a fast, deadly and disposable infantry weapon. It is used to patrol and guard Mechanoid bases, reconnaissance, troops support and to seek out and destroy humanoids. They are comparatively simple-minded fighting machines designed to find and kill the enemy.

The protruding appendage at the top of the body is a video/sound camera which can transmit everything the skimmer sees and hears directly to a weevil reconnaissance robot or Mechanoid. The skimmer is often used in conjunction with the weevil, which records the data and transmits the information to a Mechanoid for future reference. The transmission range of a skimmer is roughly 100 miles (160 km).

**Model Type:** Skimmer — Combat, Hunter-Killer and Reconnaissance.

**Class:** Robot

**M.D.C. by Location:**

Lower Legs/Hands (2) — 25 each

Thruster Jet (1, rear) — 30

Fins (8) — 5 each

Spotlight (1, front) — 5

Ion Guns (2) — 25 each

\*Head & Sensors — 45

\*\*Main Body — 80

\* Destroying the head will eliminate the optics and most of the sensory systems — reduce combat bonuses by half.

\*\*Depleting the M.D.C. of the main body will destroy the bot. An attacker must make a called strike to hit a specific part of the body such as the head, arms, hands, legs and weapons (no strike penalty).

### Speed

Running: Not applicable.

Leaping: Not applicable.

Flying: Hover jets give the robot the ability to fly in the air and move underwater or in outer space. 300 mph (482 km) maximum and can reach an altitude of about 2000 feet (610 m).

Range: Effectively unlimited

### Statistical Data

Height: 4 feet (1.2 m)

Width: 5 feet (1.5 m)

Length: 7 feet, 6 inches (2.3 m)

Weight: 700 lbs (315 kg)

Armored Body: Mega-damage robot body.

Power System: The nuclear power pack gives the robot five years of life even under the most strenuous and constant amount of use.

Black Market Value: The Market will pay 2D4 × 10,000 credits to study the bot and its programming.

Alignment: Not applicable. Humans would consider them to be diabolic killers.

Horror Factor: 9

Physical Strength: P.S. 22

Other Attributes of Note: Not applicable.

Number of Attacks Per Melee: Five melee actions/attacks.

Combat Bonuses (includes all bonuses): +2 on initiative, +5 to strike, +5 to parry, +5 to dodge (automatic like a parry and does not use up a melee action/attack in the act of dodging), +2 to roll with impact. Impervious to horror factor and mind control because it has no living mind to frighten or influence.

Skills of Note: Same as the combat runt.

**Programming and memory** enables the robot to identify weapons, combat vehicles, humanoid life forms and known enemies of the Mechanoids, including the Kittani. Combat programming directs the actions and reactions to encounters and attacks.

## Weapon Systems

**1. Twin Ion Cannons (2):** The cannons can swing up and down in a 90 degree arc and can rotate 360 degrees to shoot in any direction regardless of what direction the head and forward section may be facing.

Primary Purpose: Extermination/combat

Weight: Not applicable.

Mega-Damage: 2D6 M.D. per single blast or 4D6 M.D. per simultaneous dual blasts (both weapons fire at the same target).

A dual blast counts as one attack action.

Rate of Fire: Five blasts per melee.

Effective Range: 2000 feet (610 m)

Payload: Effectively unlimited.

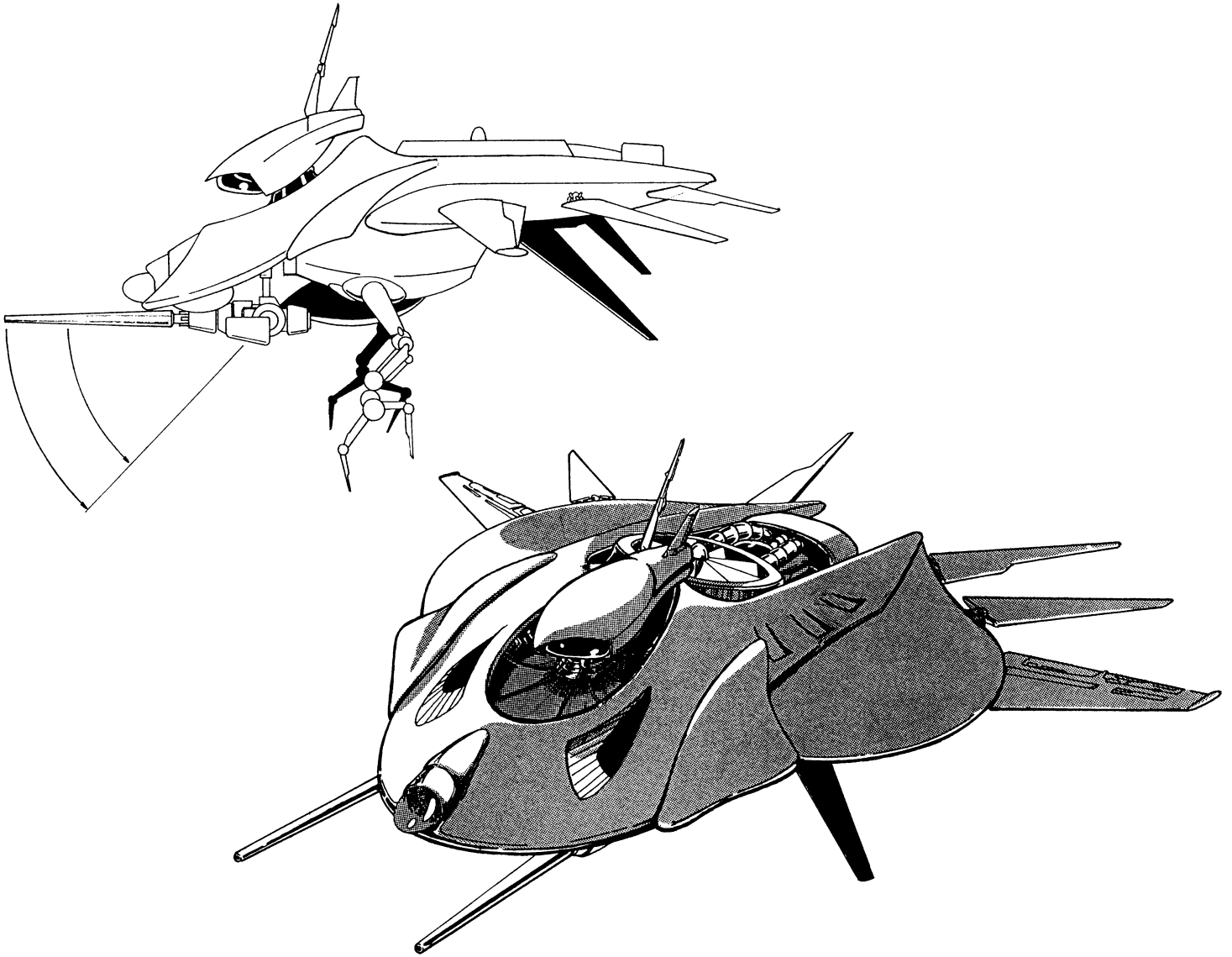

**2. Hand to Hand Combat:** The skimmer is not really designed for exchanging punches with an opponent. However, it can hit with its legs and feet/hands.

A common tactic is for the robot to swoop down on an opponent grab him with its bird-like legs and claws, and fly away, with the helpless victim, then dropping him before the person can break free or attack it. This attack and quick release counts as three melee attacks. Damage from the fall is only 3D4 M.D., but the victim loses two melee actions/attacks, loses initiative and is dazed for one full melee round/15 seconds (half combat bonuses). Rather than use a weapon, the robot can engage in mega-damage hand to hand combat.

*Five (5) attacks per melee!*

Restrained Punch: 2D6 + 7 S.D.C.

Full Strength Punch: 1D4 M.D.

Power Punch: Is not possible.

Flying body block/ram: 2D4 M.D. with a 1-45% chance of knocking its opponent off his feet (victim loses initiative and one melee attack), but counts as two melee actions regardless of the speed.

Fly and Drop: See description above.

**Sensor Systems of Note:** Standard; same as the thinman.

## Weevil

The weevil is a reconnaissance robot usually used to monitor the defensive perimeter of a Mechanoid base or to survey areas. This can be done individually or in conjunction with two to eight skimmers. If linked with skimmers, the weevil will receive video transmissions from them and record all "appropriate" data. Alone, it has a retractable housing with a comprehensive array of sensors, recording and transmission capabilities. When threatened, it will retract the sensor stems, signal its skimmer bodyguards and roll away.

**Model Type:** Weevil — Surveillance, Reconnaissance and Observation

**Class:** Robot

**M.D.C. by Location:**

\*Transmitting Antennas (2) — 10 each

\*Primary Optics & Recording (1, head) — 30

\*Secondary Optics & Recording (1, bottom appendage) — 20

\*Sensor Arms (2) — 40 each

\*Sensor Cluster (6) — 10 each

\*\*Main Body — 100

\* These are small and difficult to hit targets, thus they can only be struck when a character makes a *called shot* and even



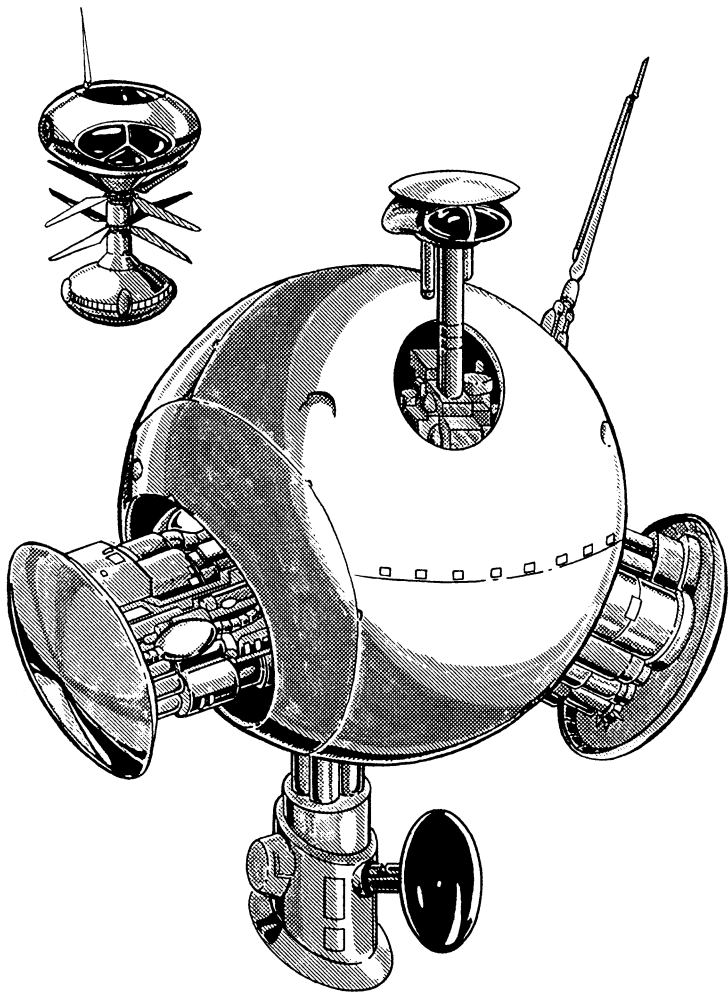

then the attacker is  $-5$  to strike. Destroying the sensor and recording head only eliminates the robot's ability to film and record what it sees.

\*\*Depleting the M.D.C. of the main body will destroy the bot. An attacker must make a called strike to hit a specific part of the body (no strike penalty).

### Speed

Running: 50 mph (80 km) maximum. The weevil *rolls* as its mode of travel. Tiny maneuvering jets are concealed all over its round body. It is equally effective in outer space and underwater.

Leaping: Not applicable.

Flying: Not applicable.

Range: Effectively unlimited

### Statistical Data

Size: 4 feet (1.2 m) in diameter.

Weight: 1800 lbs (810 kg)

Physical Strength: Not applicable.

Armored Body: Mega-damage robot body.

Power System: The nuclear power pack gives the robot five years of life even under the most strenuous and constant amount of use.

Black Market Value: The Market will pay  $2D4 \times 10,000$  credits to study the bot and its programming.

Alignment: Not applicable. Humans would consider them to be diabolic killers.

Horror Factor: 7; only because other mechanoids or hunter-killer bots must be close by.

Physical Strength: Not applicable

Other Attributes of Note: Not applicable.

Number of Attacks Per Melee: Four melee actions (dodge, etc.)

Combat Bonuses (includes all bonuses): +1 on initiative, +2 to strike, +3 to dodge, +3 to roll with impact. Impervious to horror factor and mind control because it has no living mind to frighten or influence.

Skills of Note: Same as the combat runt.

**Programming and memory** enables the robot to identify weapons, combat vehicles, humanoid life forms and known enemies of the Mechanoids, including the Kittani. Combat programming directs the actions and reactions to encounters and attacks.

### Weapon Systems

**Note:** The robot is a massive sensor and radio station and has no weapon systems. However, the weevil is typically accompanied by two or four skimmers, if not by a Mechanoid combat or reconnaissance team. If endangered, the weevil will take evasive action and radio for help. Attackers have two melees (30 seconds) to destroy the weevil before it can send a radio transmission. Also, the unit must stop and extend its antennas to send or receive transmissions.

**Sensor Systems of Note:** Extended; same as the overlord. Furthermore, each weevil has six sensor clusters that can be dropped from a concealed hatch in the body.

Each cluster extends the weevil's range of transmission by 200 miles (320 km) and sends back sensory data regarding the passage of enemy troop movement, seismic activity and ground vibration from the passage of bots and vehicles, motion detection, and transmits images and sounds. Several weevils can create a surveillance and security web that will warn of enemy activity. Each cluster has an M.D.C. of 10.

The destruction of any one or two clusters may be construed as an accident and not place the Mechanoids on alert. However, it is likely that 1D4 skimmers will be dispatched to scan the area.

**Hand to hand combat** is also impossible. The weevil's only means of physical attack is to roll over an opponent; 1D6 M.D.

### OLD STYLE WEEVIL

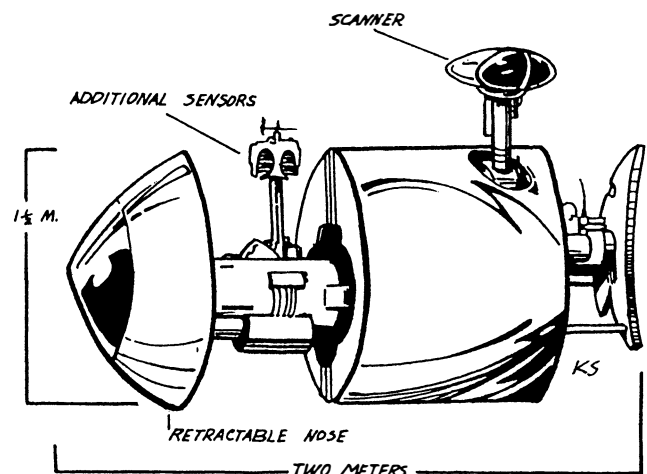

---

# The Mechanoid® Hierarchy, Population Percentage & Notes

---

**Note:** The estimated total population of Mechanoids in the universe is a paltry 800 million. This number is about 10% compared to past numbers, but then they have just made their reappearance in the universe. They continue to build their numbers.

Overlord 0.5%  
Oracle 1%  
Brain 6%  
Runner 14%  
Brute (Type One) 13%  
Brute (Type Two) 7%  
Wasp 25%  
Exterminator with Seeker Pods 7%  
Tunnel Crawler 6%  
Black Widow 2%  
Mantis 1.5%  
Octopus (Type One) 2%  
Octopus (type Two) 4%  
Mindless Drones 9%  
Others 2%

## Mechanoid Robots

**Note:** There are thirty times as many robots as Mechanoids, approximately 24 billion.

Assault Probes 20%  
Combat Runts 14%  
Repair Runts 7%  
Skimmers 14%  
Thinmen 28%  
Weevils 11%  
Others 6%

## Common

### Mechanoid Squads

---

#### Basic Maintenance or Repair Team

1 Brute or Runner or Octopus  
2 to 4 Thinmen  
1 to 4 Runts (either type)

#### Robot Drone Reconnaissance Team

1 Weevil  
2 to 4 Skimmers

#### Mechanoids' Low Profile Reconnaissance Team

1 Weevil  
2 Tunnel Crawlers  
2 Skimmers  
2 Seeker Pods  
2 to 4 Runts

#### Mechanoids' Standard Reconnaissance Team

1 Weevil  
1 Seeker Pod  
1 Type One Brute  
1 Type Two Brute  
1 or 2 Tunnel Crawlers  
2 Skimmers  
2 Runts  
1D4 Thinmen

#### Mechanoids' High Profile Reconnaissance Team

2 Runners or one Brain and Runner  
2 Type One Brutes  
2 Exterminators & Seeker Pods  
2 Skimmers or Tunnel Crawlers  
2 Weevils  
1D4 + 2 Thinmen  
1 or 2 Wasps are optional

#### Mechanoids' Low Profile Research Team (field scientists)

2 Runners or one Brain  
1 or 2 Brutes (either type)  
1 Exterminator & Seeker Pod  
1 Weevil or Skimmer  
2 Runts  
4 Thinmen

#### Mechanoids' High Profile Research Team (field scientists)

3 or 4 Runners or one Brain and two Runners  
1 Weevil  
1 Mantis  
2 Wasps  
4 Brutes (either type)  
2 Exterminators or Skimmers  
2 Runts  
2D4 + 2 Thinmen

#### Mechanoids' Low Profile Seek & Destroy Team

2 Tunnel Crawlers  
2 Skimmers  
2 Exterminators & Seeker Pods  
1D4 Assault Probes  
1D4 Runts

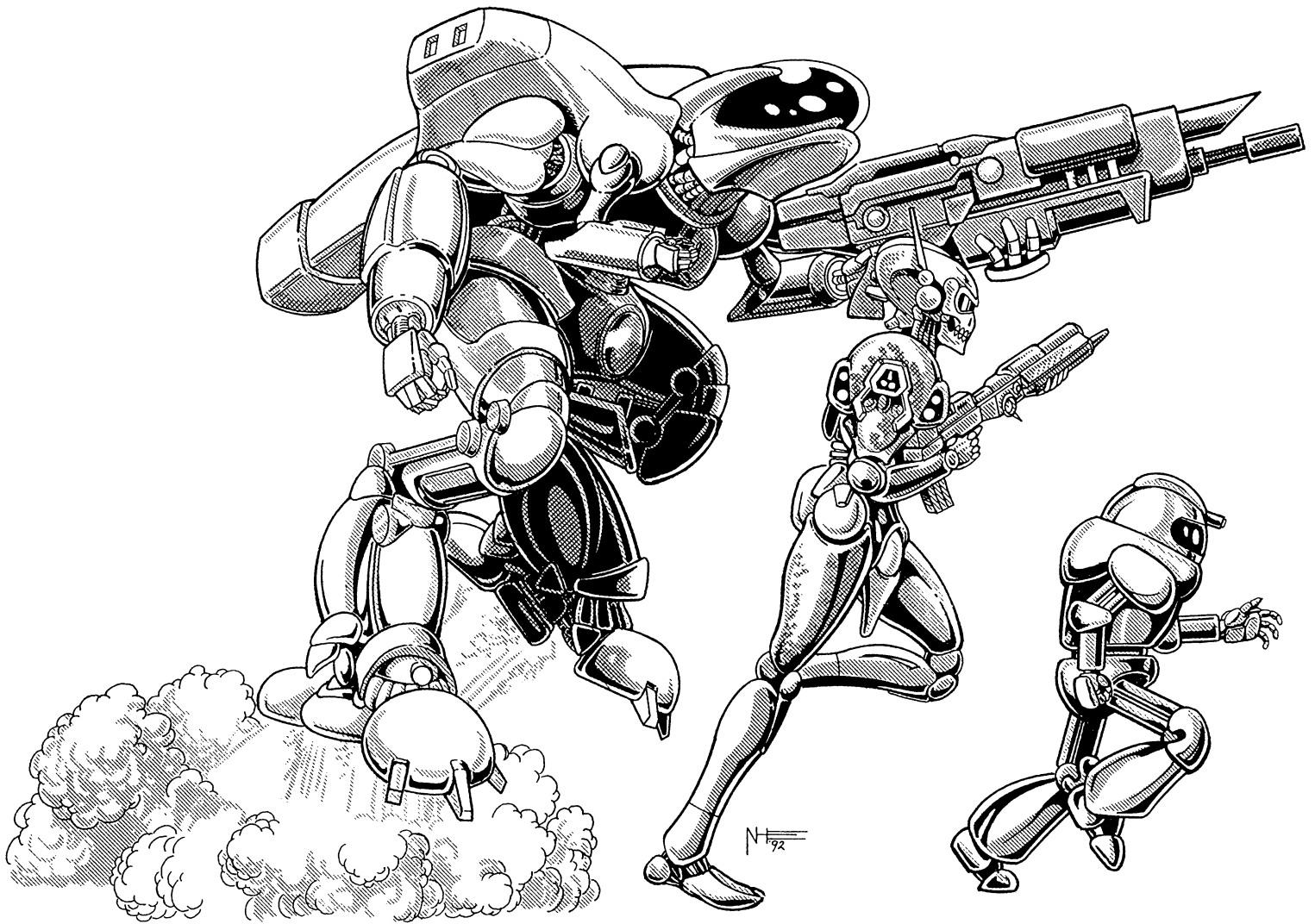

### Mechanoids' Standard Seek & Destroy Team

- 1 Weevil
- 2 Skimmers
- 2 Wasps
- 2 Tunnel Crawlers
- 2 Exterminators
- 1 Type One Brute (with full weapon package)
- 1 Type Two Brute (with full weapon package)
- 1D4 + 1 Assault Probes
- 1D4 + 2 Thinmen

### Mechanoids' Standard Strike Force & Rescue Team

- 4 Wasps
- 4 Skimmers
- 2 Type One Brutes (with full weapon package)
- 2 Type Two Brutes
- 4 Exterminators & Seeker Pods
- 6 Thinmen

**Note:** The exact number and type of Mechanoids that make-up any team can vary depending on the situation and available resources.

## The Mechanoid Spider Fortress

Along with the Mechanoid ground and air troops, an entire Spider Fortress has been rifted to Earth! The fortress is a gargantuan mobile assault base that is 853 feet (260 m) in diameter and towers 1598 feet (487 m) high. Fortunately for our heroes, its entire complement of troops did not make it through the rift and the fortress has suffered massive amounts of damage.

One-quarter of the normal troops, which have been divided into the Four Forces each with specific goals. The fortress serves as a mobile base of operations and is the heart of Force Four, with the purpose of drawing the human heroes away from more important, secret activities and to seek and destroy as many humanoids as possible.

Even at half its normal strength and with a fraction of its normal troops, the Spider Fortress is a deadly weapon of incredible power!

**Model Type:** Mobile Assault Base — Infantry & Defense  
**Class:** Robot Combat Vehicle  
**Crew:** 14 brains

**Troops:** The first number indicates how many Mechanoids are counted among the fortress' current troops. The number in parenthesis is the standard number of troops. The rest of the troops have been divided into the four task forces.

- Brains: 15 (32)
- Runners: 5 (72)
- Wasps: 6 (24)
- Brutes: 2 (12)
- Tunnel Crawlers: 0 (6)
- Combat Runts: 24 (120)
- Thinmen: 24 (100)
- Skimmers: 24 (64)
- Weevils: 4 (32)
- Assault Probes: 12 (32)

**M.D.C. by Location:** The number in parenthesis is the normal, undamaged amount of mega-damage capacity.

- \*Plasma Cannons (2) — 300 (500) each
  - \*Bowl Laser Cannons (4) — 50 (120) each
  - \*Missile Launcher (1, inside lid) — 120 (120)
  - \*Particle Beam Turrets (4, underside of platform) — 70 each and only two are working (normally 140 each).
  - \*Rim Lasers (52) — 10 (10) each, but only 11 are working.
  - \*Legs (4) — 300 (600 each)
  - Energy Barrier — 0 (normally 3000)
  - \*\*Lower Platform — 850 (1200)
  - \*\*\*Top lid — 1400 (3000)
  - \*\*\*\*Main Body Bowl — 916 (2000)
- \* These targets are comparatively small and require the attacker to make a called shot (No additional penalties).
- \*\* Depleting the M.D.C. of the lower platform destroys the four particle beam turrets and reduces speed by 50%.
- \*\*\* Depleting the M.D.C. of the top lid portion of the fortress eliminates the plasma cannon and missile launcher. Furthermore, all further attacks against it from above, strike the main body and inflict double damage!
- \*\*\*\*Depleting the M.D.C. of the main body destroys all weapon systems on the bowl, the protective energy barrier, and the line of troops communication, damages sensors and completely immobilizes the robot fortress. The results are all combat bonuses, damage and ranges of weapon systems still in operation, including the plasma cannons and P-beam turrets, are reduced by half! The missile launcher can only fire if the lid was open/up when the main body was destroyed.

**Note:** Destroying the main body and the upper lid or lower platform will destroy the entire fortress, causing it to explode in a contained, fiery mass. Everybody inside or within 1000 feet is killed (suffers 1D6 × 1000 M.D.).

### Speed

- Running: 60 mph (96 km).
- Leaping: Not applicable; it cannot jump.
- Flying: Not applicable; no means of propulsion nor anti-gravity system.
- Range: Unlimited.

### Statistical Data

- Height: 1598 feet (487 m)
- Width & Length: 853 feet (260 m) in diameter.
- Weight: 6000 tons
- Cargo: Plentiful

Armored Body: Mega-damage armor with personnel compartments that have a life support system. All Mechanoids are clad in their armored, cyborg bodies.

Power System: A plasma energy system gives the fortress its power and a life of 600 years.

Black Market Value: The Market would be interested in studying a spider fortress that is at least partially operable, but they are not likely to pay more than 3D4 million credits.

Alignment: Not applicable.

Horror Factor: 18

Physical Strength: Equal to a P.S. 60.

Other Attributes of Note: Not applicable.

Number of Attacks Per Melee: Specific weapons may be limited to the number of times they can fire per melee round (15 seconds), however, the total number of melee actions and/or attacks per melee round is 24! Plus each of the 52 rim lasers can fire once per melee (scattershot, not more than two rim lasers can shoot at the same target at a time). The available weapons can be used in any combination.

Combat Bonuses (includes all bonuses): +2 on initiative, +7 to strike with plasma cannon, +6 to strike with particle beams, +5 with all other weapon systems, +2 to strike with a kick or stomp, +4 to strike with a body block/ram. The fortress has no parry, dodge or roll with impact bonuses. See the M.D.C. description for combat penalties from damage.

## Weapon Systems

**Remember:** 24 attacks per melee round (15 seconds) are possible from the major weapon systems, numbers two through five.

1. **Energy Barrier — Special Defense System:** The energy barrier encircles and protects the entire fortress unit from massive bombardment, but the fortress cannot fire its weapons while the energy field is up. The field can recharge 500 M.D.C. every hour (about 8.3 M.D.C. every minute). However, if the main body bowl loses more than half its M.D.C. there is a 1-58% chance of losing the protective shield (requiring 6D6 hours of repair and parts). **Note:** The spider fortress on Earth doesn't have sufficient parts, but they may be able to jury-rig something over time.
2. **Dual Firing Plasma Cannons (2):** A devastatingly powerful, long-range weapon. The two cannons can fire simultaneously at the same target or individually at different targets. Both are located near each other. The cannons have a 45 degree arc of fire, both vertically and horizontally. Otherwise the entire spider fortress must move/adjust to fire. Note however, that the bowl housing can rotate 360 degrees on the lower platform and get the guns into a new firing position in about 3 seconds (uses one melee attack).

Primary Purpose: Assault

Weight: Not applicable.

Mega-Damage: 1D6 × 10 M.D. per single blasts or 2D6 × 10 per simultaneous, double blast if two plasma cannons are used. Simultaneous double blast counts as one melee attack.

Rate of Fire: Six times each per melee.

Effective Range: 6000 feet (1828 m).

Payload: Effectively unlimited; patched into the power supply.

3. **Missile Launcher (1):** Nestled safely inside the lid is a medium- and long-range missile launcher. To fire, the lid

## Spider Fortress

### Basic Fortress Data

Speed 60 mph (96 km)  
 Height: 1598 feet (487 m)  
 Width & Length: 853 feet (260 m) in diameter.

Weight: 6000 tons

Cargo: Plentiful

Armored Body: Mega-damage armor with personnel compartments that have a life support system. All Mechanoids are clad in their armored, cyborg bodies.

Power System: A plasma energy system gives the fortress its power and a life of 600 years.

**Remember:** 24 attacks per melee round (15 seconds) are possible from the major weapon systems.

### Energy Barrier — Special Defense System:

The energy barrier encircles and protects the entire fortress from massive bombardment, but the fortress cannot fire its weapons while the energy field is up. The field can be recharged 500 M.D.C. every hour (about 8.3 M.D.C. every minute).

The lid opens to a maximum of a 45 degree angle. It can fire twin plasma cannons, missiles or release wasps.

### Dual Firing Plasma Cannons (2):

1D6 × 10 M.D. per single blasts or 2D6 × 10 per simultaneous, double blast.

**Missile Launcher (1):** Inside the lid is a missile launcher that can fire both medium and long range missiles. To fire, the lid must open only 20 percent. 2D6 × 10 M.D. for medium range plasma missile or 3D6 × 10 M.D. per long range plasma missile.

**Particle Beam Turrets (4)**

**Bowl Laser Cannons (4)**

Destroying the main body and the upper lid or lower platform will destroy the entire fortress, causing it to explode in a contained fiery mass. Everybody inside or within 1000 feet is killed (suffers 1D6 × 1000 M.D.).

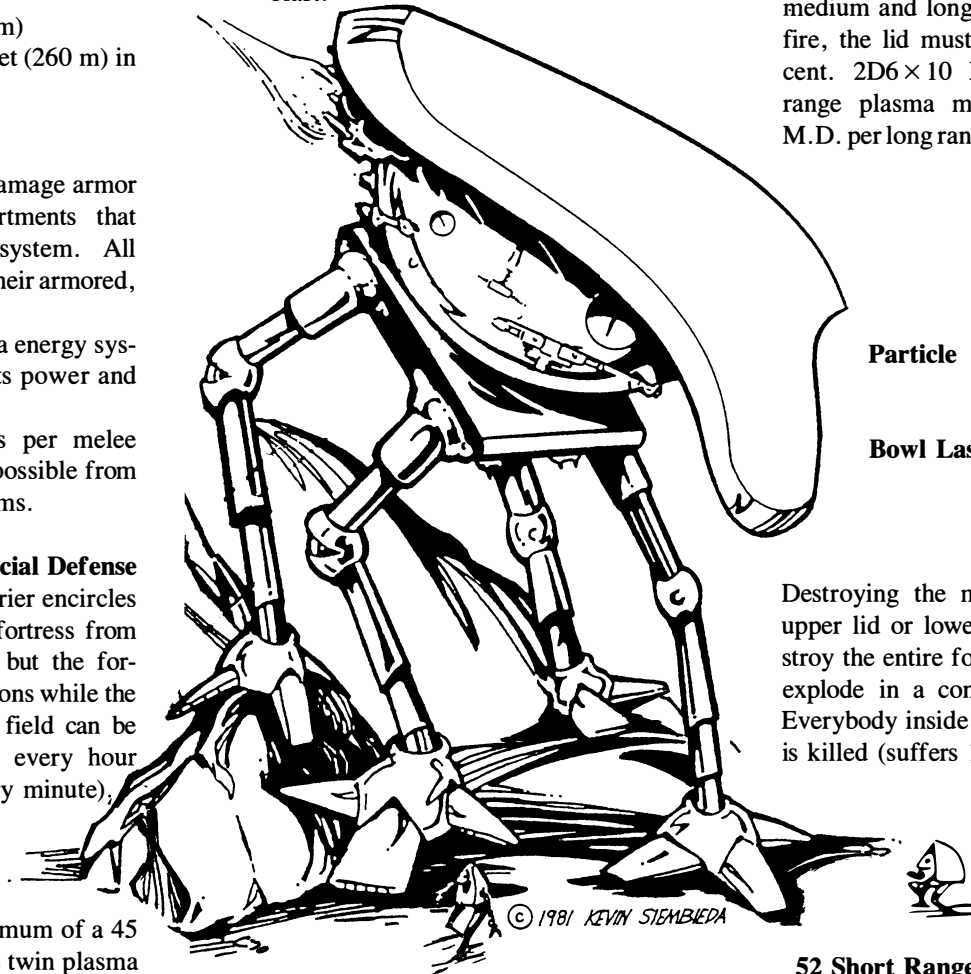

BOWL HOUSING CAPABLE OF 360° ROTATION.

PLASMA CANNONS

ACCESS HATCH

CLOSE RANGE LASER RIM

LASER CANNON

4 PARTICLE BEAM TURRET CAPABLE OF 360° ROTATION.

WASP RELEASE HATCH

PRESENT AT ALL MAJOR MECHANOID BASES.

There are hatches scattered around the body bowl to admit and release the wasps and other troops. The average M.D.C. of a hatch is 100.

**52 Short Range Rim Lasers:** Tiny, short range lasers are built along the rim of the body bowl. They are primarily anti-personnel and close combat weapons. Each weapon can be angled by about 100 degrees. 6D6 per single blast — 2000 feet (610 m) range.

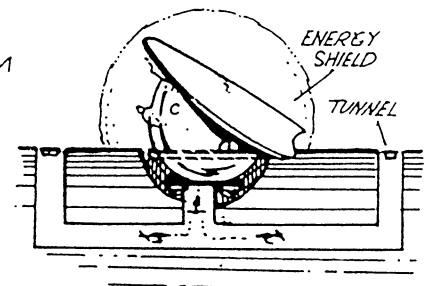

**Cut-Away of wasp tunnel system** common to most Mechanoid bases and outposts. This system allows the wasps and other troops to exit the fortress without it having to lower its energy shield.

# Mechanoid Base

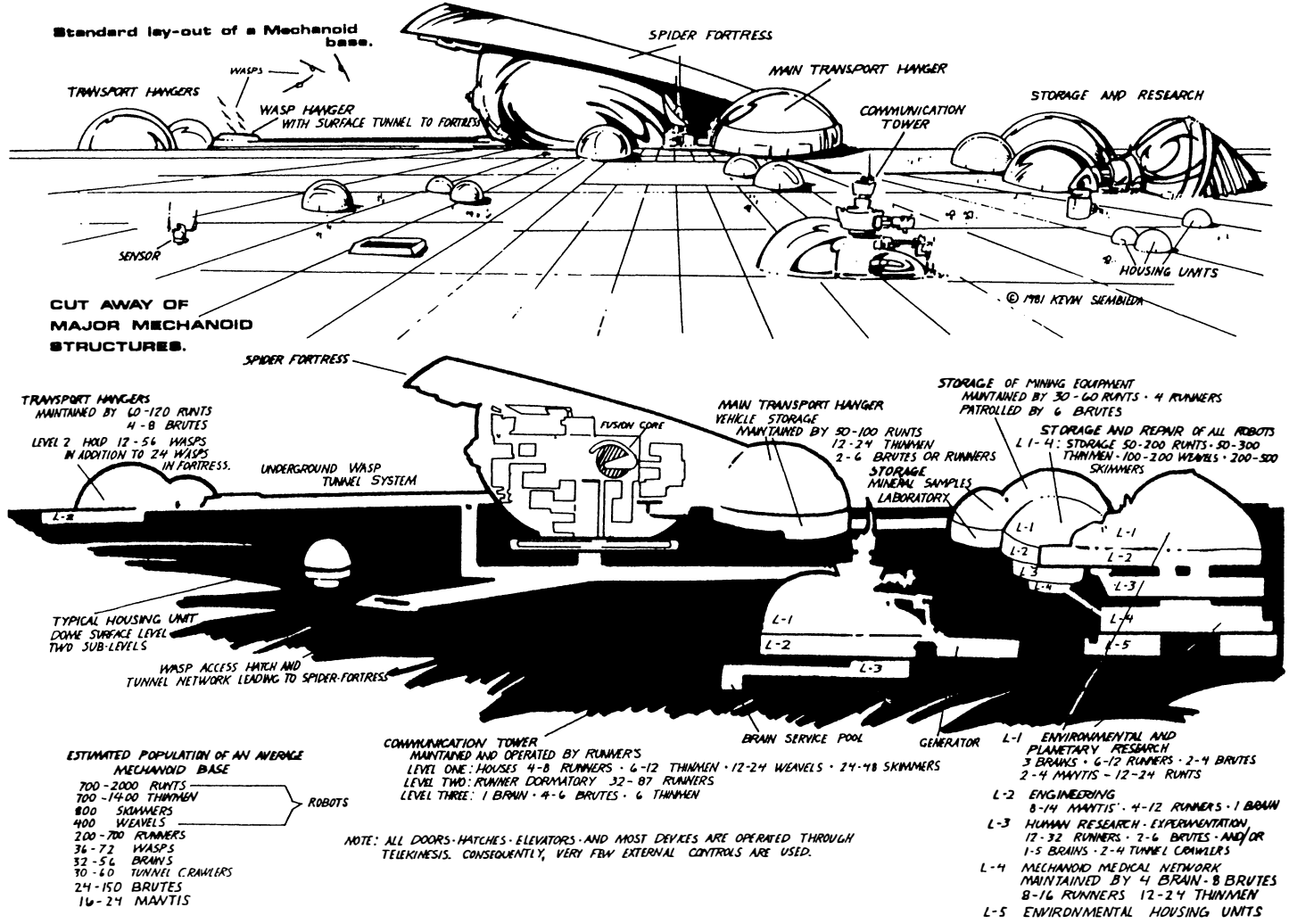

must open only 20 percent. It is a fast loading missile launcher that can fire medium and long range missiles.

**Primary Purpose:** Assault

**Weight:** Not applicable.

**Mega-Damage:** 2D6 × 10 M.D. for medium-range plasma missile or 3D6 × 10 M.D. per long-range plasma missile.

**Rate of Fire:** One at a time or in volleys of two or four, for a total of four volleys per melee round (15 seconds). Each volley counts as one melee attack regardless of the number of missiles.

**Effective Range:** Medium-range missiles, up to 60 miles (96 km). Long-range missiles, up to 500 miles (800 km).

**Payload:** The launcher can fire a maximum of four missiles at any one time, but holds a total payload of 48 medium- and 24 long-range missiles.

**4. Particle Beam Turrets (4):** A pair of double-barrelled particle beam turrets are built into the undercarriage of the lower platform. Each can rotate 360 degrees, with a 90 degree vertical arc of fire. Each also has its own targeting system.

**Primary Purpose:** Assault

**Weight:** Not applicable; it is part of the body.

**Mega-Damage:** 1D4 × 10 M.D. per single blast or 2D4 × 10 per simultaneous, double blast (aimed at the same target). A simultaneous, double blast counts as one (1) melee attack.

**Rate of Fire:** Four bursts per each turret per melee round.

**Effective Range:** 2000 feet (610 m).

**Payload:** Effectively unlimited; patched into the power supply.

**5. Bowl Laser Cannons (4):** This long-range weapon is forward facing but the barrels can be rotated in all directions, in a 120 degree arc of fire. The lasers also have the standard variable light frequency capabilities.

**Primary Purpose:** Assault

**Weight:** Not applicable.

**Mega-Damage:** 6D6 per single blast!

**Rate of Fire:** As many as six times each per melee round (15 seconds).

**Effective Range:** 6000 feet (1828 m).

**Payload:** Effectively unlimited; patched into the power supply.

**6. Short-Range Rim Lasers (52):** Tiny, short-range lasers are built along the rim of the body bowl. They are primarily anti-personnel and close combat weapons. Each weapon can be angled by about 100 degrees.

**Primary Purpose:** Anti-personnel

**Weight:** Not applicable.

**Mega-Damage:** 6D6 per single blast!

**Rate of Fire:** Equal to the total number of hand to hand attacks.

**Effective Range:** 2000 feet (610 m).

**Payload:** Effectively unlimited; patched into the power supply.

**7. Hand to Hand Combat:** Physical combat is very limited and it can only make a total of six physical attacks per melee round (15 seconds). All other attacks are made using the energy weapons.

Stomp with Foot: 2D6 × 10 M.D.

Crush from Stomp: 1D4 × 10 M.D. every time pressure is applied (counts as one attack).

Kick: 4D6 M.D. and there is a 1-60% chance of knocking its opponent off his feet (victim loses initiative and one melee attack). Counts as one (1) melee action.

Body Block/ram: 1D4 × 10 M.D. and there is a 1-85% chance of knocking its opponent off his feet (victim loses initiative and one melee attack), but counts as two melee actions regardless of the speed.

---

## Mechanoid® Technology

---

The Mechanoids' technology is both more advanced and alien in nature when compared to that of humans on Rifts Earth. Their entire technology is based upon cybernetics, robotics and psionics. All living Mechanoid organisms are integrated with machines and have some measure of psychic powers; in many cases, they are at phenomenal levels.

Most of their machines do not have the display screens, buttons, switches, triggers and knobs humans expect. Instead, these things are commonly internal elements activated by psionic powers like telepathy and telekinesis. This makes it quite difficult for the average human, unless he is psionic, to use most devices of Mechanoid design. Likewise, the aliens prefer to communicate by means of telepathy, but also send coded messages by means of radio and laser communication systems. An artificial voice synthesizer is often used to simulate a voice when dealing with humans.

**Player Note & Example:** In an old-play test of the original Mechanoid RPG, a group of player characters had infiltrated a Mechanoid base, were discovered and tried to escape. They dove into a Mechanoid elevator and ... to their horror, stared at a smooth blank wall. The walls were absolutely smooth, and featureless. With no control panels, buttons, protruding wires, or external controls of any kind! Several runners and a couple of thinmen closed in with, weapons blasting. Fortunately, the group had a psionic "ESPer" with them. He performed an object read on the elevator while the group engaged the Mechanoids in a fire-fight. The psionic character learned the history and operation of the elevator — a good start but there was more trouble.

Behind a particular area of the wall was a simple switch, normally activated by telekinesis. Unfortunately, none of the characters had that power. Instead, a mechanic carefully cut away a portion of the wall to flick the switch by hand. Meanwhile, a pitched battle raged around him. Something as easy as flicking a switch became a life and death struggle.

## Mechanoid Computers

Mechanoid computers or "Brain Pools" are living organisms that serve as computers. They have no personal identity or consciousness of being alive. The brain pool is an intelligent, living vegetable that contains, collates and uses information like a computer. There are only ten brain pools on a Spider Fortress, but there are millions on the planet-sized motherships. The big

ships have at least one every 500 miles, with many hundreds clustered in areas such as engineering, life support, navigation, research, science labs, power networks, and similar.

Brain pools can only be used by psionic beings. Within the Mechanoid hierarchy, only Overlords, Oracles, Brains and Runners have the authority to access a brain pool. No other Mechanoid has the physical or mental capacity to tap into these living psionic computer units. Ironically, humans with master or major psionic powers **can** also link with a Mechanoid brain pool! The psionic humanoid must enter the unit (usually measuring about 15x15x15 feet (4.6 m; although some are 8 times that size) and make physical contact (flesh touching flesh) with the warm fluids and soft, lumpy, membranes that cover the entire area of interior walls and ceiling. This will mean at least taking off protective helmets to use the computer — best results and immediate contact occur when the character is completely (well, mostly) naked. The psionic must then open himself mentally/telepathically and emotionally to the computer. Meditation and focusing on one to four specific topics is the best means to establish the psionic union and to find the desired data. It typically takes about 1D4 minutes to make the proper connection; half the time if naked.

Humanoid participants experience a pleasant euphoria accompanied by a floating sensation and no sense of time passing. At this point, the character is oblivious to everything around him, only a telepathic or empathic message can reach somebody "plugged" into a brain pool.

The mental accessing of information, diagrams, maps and so forth, is instantaneous; accomplished with a thought. Any delays or confusion stems from the unfocused thoughts and emotions of the user and/or the user's inability to remember everything (total recall is extremely handy).

The psionic person should direct his/her inquiries as simply and directly as possible via telepathy and should try to gather *small* blocks of information. Requesting too much data can cause a mental and sensory overload that will daze the user and break the connection with the brain pool. For Example: If the layout of the mothership is requested, the brain pool will respond by transmitting the schematics and floor plans of the *entire* ship, results in overload. Likewise, requesting the Mechanoids' history will provide not only the linear data but images and emotions, resulting in sensory overload. Limit the question as much as possible, like requesting the layout of a small, specific area, such as "transport factory, Level 3." This is safe and painless. A person may ask as many questions as he/she desires once contact with the computer is established.

**Victims of sensory overload** will have only one melee action or attack, all skills and combat bonuses are reduced by 75%, speed is reduced by 90%, and the character becomes dazed and confused. He or she will have difficulty thinking, walking, talking and may not recognize friends and family. This dazed state will last for 3D4 minutes. Furthermore, the character will suffer from a headache and a penalty of -1 on all combat bonuses and -10% on all skills for 1D4 days. Worst of all, the desired information was never properly received so there is no memory of it.

Tapping into a brain pool is painless, except for sensory overload and, once one becomes accustomed to the process, it takes only a few minutes (2D4) to learn just about anything. The

danger is that brain pools are designed to be an information retrieval and *exchange*, which means before the living computer has provided its service, it automatically probes the mind of the creature using it. It psionically probes and extracts ALL information, thoughts, memories, and knowledge and stores it in data files for future reference. It is available to anybody who can access it. Within six hours that information will be distributed throughout the entire network. The Mechanoids have few secrets between each other, but humanoids may have plans, memories, ideas and data that are best not shared with enemy invaders.

Only characters with the super psionic power of *mind block auto-defense* are impervious to the probes unless they concentrate on lowering their mental guard. Mind blocks will prevent or cause delays in accessing information from the information pool. The communication link will be broken every few minutes, requiring the user to start again from the beginning. After the brain pool has extracted all the data (takes about one minute) from the user, it completely opens itself to him. This means not only can the character extract information, but if he has the power of mind wipe, he can erase specific blocks of information/knowledge/memory extracted from him during the probe (and before it is shared with the network and added to the permanent data files).

**Notes:** The typical brain pool has 50 M.D.C. and 35 hit points. Destroying the living organism destroys that particular unit, but a silent alarm alerts the Mechanoids to trouble whenever a unit is hurt or killed. The brain pool has no defenses. The Mechanoids presume that humanoids cannot gain access to a brain pool and that few humanoids can figure out how to use one.

There is no way to make a hard copy of the data either on paper or disc because the information is psionically transmitted from one brain to another. Characters with total recall can remember and translate the information onto a system better suited for fellow humanoids; these can include audio and/or video recordings, computer input, handwriting, drawings, or telepathically passing the data onto others (but most humanoids forget details with the passage of time). Note that the character could use a Splugorthian, telepathic, holographic imager to project and record information gathered from a brain pool.

## The Master Computer Brain

The brain pools on a mothership or Mechanoid bases/super cities are all linked to a *Master Computer Brain*. This Master computer is also a living creature of flesh, circuits and psionics, but unlike the brain pools, is a sentient being with a will and personality of its own (its alignment is typically aberrant evil). The organism is gigantic, typically filling a 500 square mile (800 km) area. If this incredible entity is destroyed the base or ship is severely crippled, forcing secondary computer banks and brain pools to be used instead. Availability of weapons and computers/brain pools, the speed and accuracy of all systems and all operations are reduced to one-third normal. In many ways the master computer complex "is" the mothership.

Only the Overlord, Oracle, Runner, Brain and Brute are allowed physical access to the containment chamber of the master computer. The brains, runners, and brutes are the main service technicians and defenders, although Wasps and other

Mechanoids can be summoned during an emergency. NO robots of any kind are ever allowed in this area. Only the overlord is allowed to link with it directly. Others foolish enough to try linking with the Master Computer Brain are completely at the monster's mercy.

First of all, the computer can allow or not allow any sort of mind link at its discretion. The computer user must open his or her mind up to the Master just as they would the brain pools. The difference is that the Master is in complete control of his data file and their brain. The fiend can scan everything the user knows, implant any data it desires (real or a creation of its imagination), implant ideas and suspicions, implant 1D4 + 2 different insanities (any) or compulsions (the latter is like the compulsion spell), adjust skill knowledge (enhance or decrease known skills by as much as 50%), mind wipe or change important data and memories, completely and permanently erase half a person's mind (erase 50% of the memories and knowledge) or mentally possess him. Absolutely NO information can be extracted from an uncooperative Master Computer Brain! **Note:** There are no master computers on Rifts Earth.

## Statistical data about the Master Computer Brain

Life Form: Effectively an alien intelligence or something very similar to one.

Alignment: Any, but typically aberrant evil.

M.D.C.: 2D6 × 1000

Horror Factor: 16, but only applicable when somebody realizes exactly what they are up against.

Psionic Powers: 1D6 × 10,000 I.S.P. and equal to a 20th level master psionic. Powers include all sensitive, physical and super abilities (does not include the powers of a Mind Bleeder).

Combat & Bonuses: In addition to the mind altering abilities described and listed previously, the creature is impervious to mind control and +10 to save vs all other forms of psionic attacks and mind afflicting magic (including illusions), he is +6 to save vs all other forms of magic, impervious to S.D.C. weapons, heat, cold, poison and drugs.

## Mechanoid Footnotes & Reminders

1. All Mechanoids tend to believe they are superior to any other races, particularly humans and humanoids. This arrogance is instinctive and can lead even the elite four to underestimate humanoid opponents.
2. Most "true" Mechanoids, including the oracle, have an unreasoning hatred for humanoid life. Only the big haulers and digger drones are mindless and therefore, indifferent toward humanoids.
3. Mechanoids harbor no ill will toward non-humanoids/bipeds who do not resemble humans. They will treat these alien life forms with respect and consideration. In many cases, they will help non-humanoids. However, even the most inhuman creature is considered an enemy and destroyed if they ally themselves with humanoids.
4. Mechanoids communicate by means of psionics (telepathy and empathy), as well as by radio and laser.



**Mechanoid Digger**

TOP VIEW

1772 m.

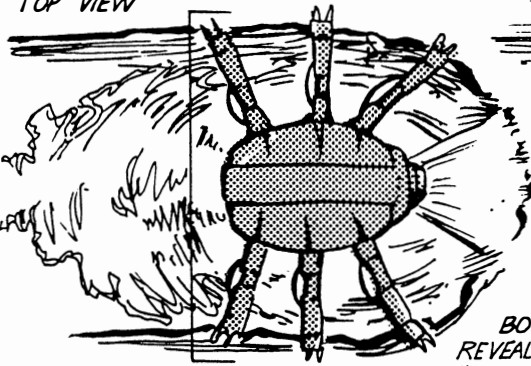

SIDE VIEW

1080 m. LONG

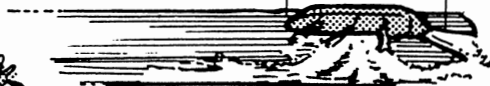

BOTTOM VIEW  
REVEALING THE CONTINUAL  
HYDROGEN FUSION CHAMBER.

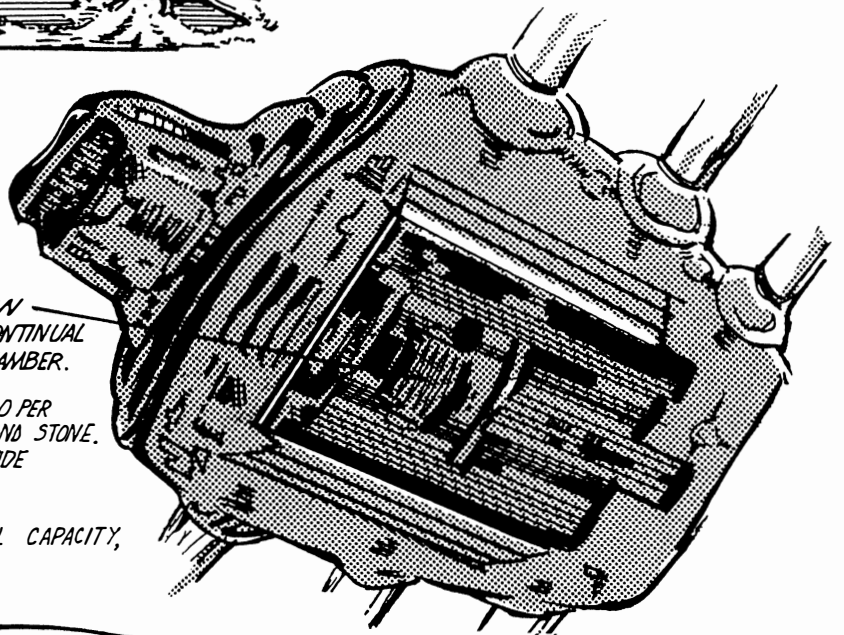

THE DIGGER DIRECTS HYDROGEN BLASTS (APPROX. 10 PER SECOND) VAPORIZING AND MELTING THE EARTH AND STONE. THE CLAWS DIG, TRIM, AND SHAPE THE 1 km WIDE 2 km DEEP CANAL.

THE DIGGER FUNCTIONS DAY AND NIGHT AT FULL CAPACITY, PAUSING ONLY 30 MINUTES EVER 24 HOURS.

DAMAGE CAPACITY	
HEAD	1800
BODY TOP	4000
BODY BOTTOM	180,000 C.H.F.C.
ARMS	2,000 EACH
CLAW	2,200 EACH
PLASMA GEN. SDC	980
ARMOR RATING	: 18

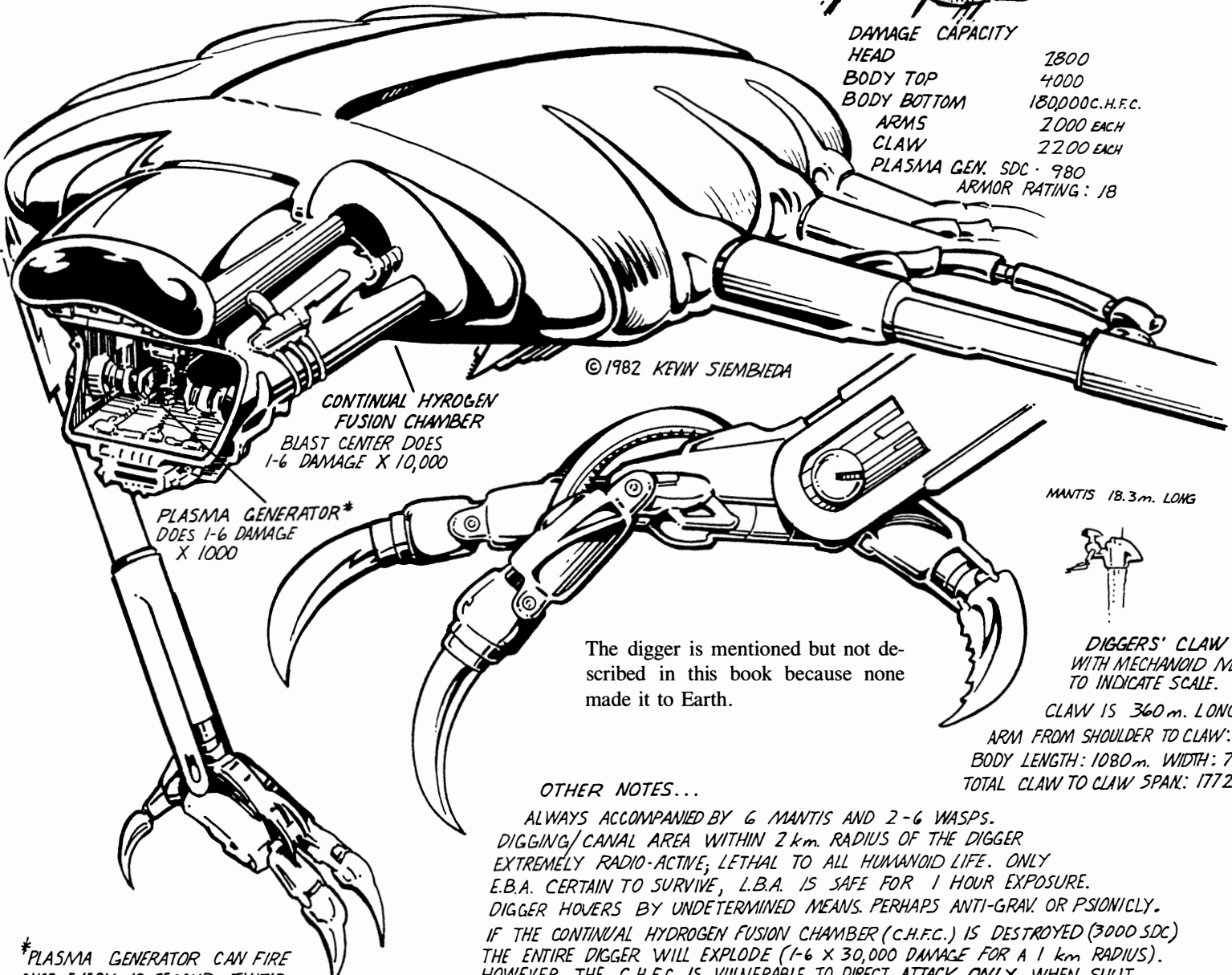

©1982 KEVIN SIEMBIEDA

CONTINUAL HYDROGEN  
FUSION CHAMBER  
BLAST CENTER DOES  
1-6 DAMAGE X 10,000

PLASMA GENERATOR\*  
DOES 1-6 DAMAGE  
X 1000

MANTIS 18.3 m. LONG



The digger is mentioned but not described in this book because none made it to Earth.

DIGGERS' CLAW  
WITH MECHANOID MANTIS  
TO INDICATE SCALE.

CLAW IS 360 m. LONG  
ARM FROM SHOULDER TO CLAW: 680 m.  
BODY LENGTH: 1080 m. WIDTH: 732 m.  
TOTAL CLAW TO CLAW SPAN: 1772 m.

**OTHER NOTES...**

ALWAYS ACCOMPANIED BY 6 MANTIS AND 2-6 WASPS.  
DIGGING/CANAL AREA WITHIN 2 km. RADIUS OF THE DIGGER  
EXTREMELY RADIO-ACTIVE, LETHAL TO ALL HUMANOID LIFE. ONLY  
E.B.A. CERTAIN TO SURVIVE, L.B.A. IS SAFE FOR 1 HOUR EXPOSURE.  
DIGGER HOVERS BY UNDETERMINED MEANS. PERHAPS ANTI-GRAV OR PSIONICLY.  
IF THE CONTINUAL HYDROGEN FUSION CHAMBER (C.H.F.C.) IS DESTROYED (3000 SDC)  
THE ENTIRE DIGGER WILL EXPLODE (1-6 X 30,000 DAMAGE FOR A 1 km RADIUS).  
HOWEVER, THE C.H.F.C IS VULNERABLE TO DIRECT ATTACK ONLY WHEN SHUT  
DOWN FOR ITS 30 MINUTE REST PERIOD.

\*PLASMA GENERATOR CAN FIRE ONCE EVERY 10 SECOND. THAT'S 6 ATTACKS PER MELEE. MAX. RANGE 2000 m.

5. The living Mechanoid organisms are carbon based creatures with a human origin (not that you could tell by looking at them). They are fragile, S.D.C. creatures with fleshy tissue, intricate nervous systems and large brains. They are completely integrated with their cyborg bodies and cannot survive for long without them. Mechanoids cannot breathe Earth's air or any oxygen- or nitrogen-rich atmosphere.

6. All Mechanoids are encased in a M.D.C. environmental body armor and exo-skeleton containing a life support system, independent air supply, circulatory system, purification system, heat and radiation shielding, communications and sensor system, enhanced optics and radar. The containment chamber that encapsules the living organism is equivalent to the reinforced pilot's compartment of human vehicles.

8. Mechanoids feed by partially or entirely slipping out of their mechanized body housing and into a liquid nutrient tank. Most Mechanoid body housings contain a two to five week food supply.

9. The sensor pods and head areas are often a weak point in the Mechanoids' design. Destroying the head or sensor area will usually cripple or impair the cyborg. However, these areas are typically small and/or shielded, requiring the attacking character to strike only on a called shot; strike penalties may apply.

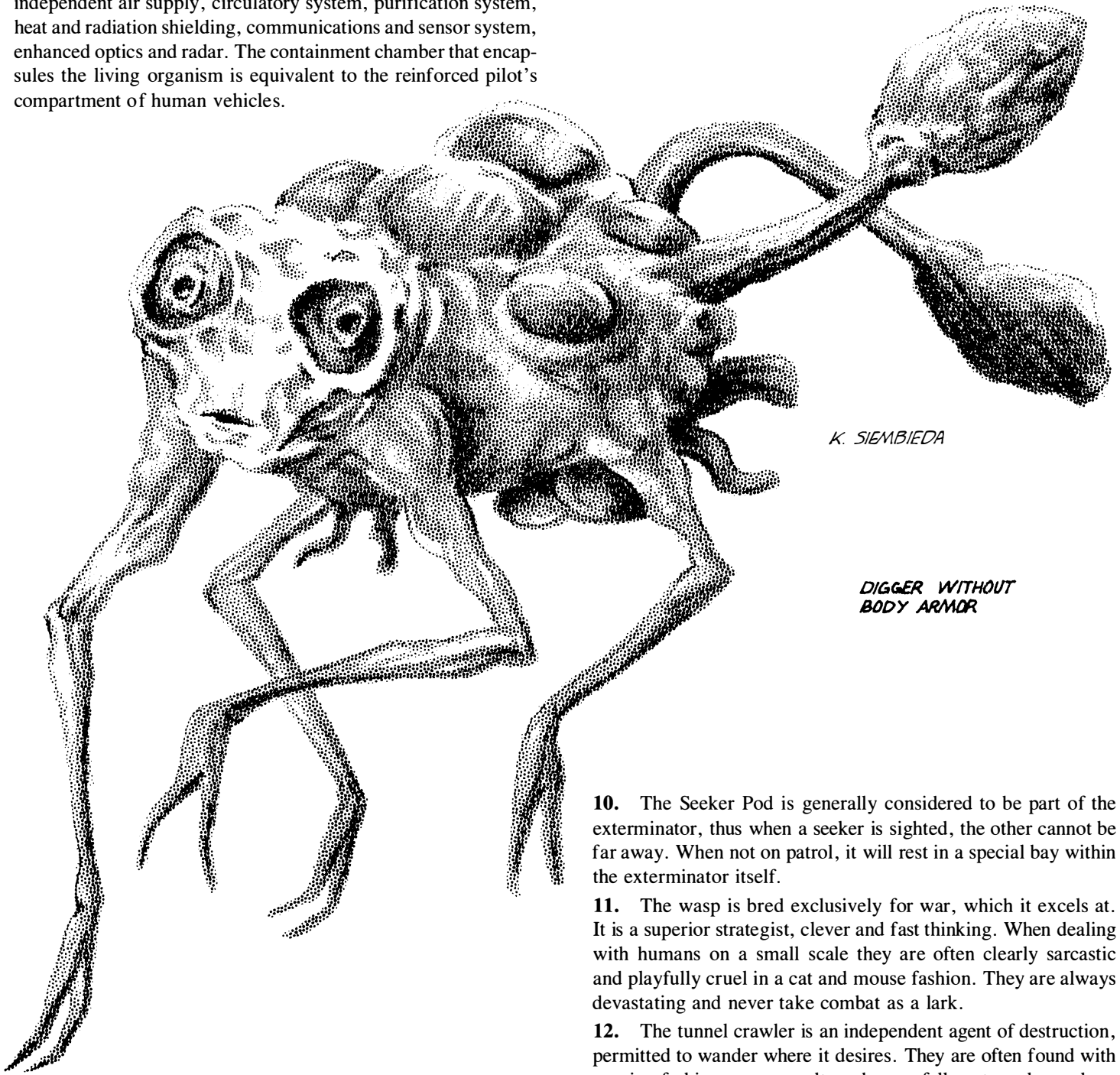

*K. SIEMBIEDA*

*DIGGER WITHOUT  
BODY ARMOR*

7. Most of the Mechanoids' equipment, elevators, transporters, machines, vehicles and other devices are operated psionically, requiring mind links, telepathy, empathy, telekinesis or ectoplasm. Consequently, there are few handles, knobs, buttons, screens, or other external controls.

10. The Seeker Pod is generally considered to be part of the exterminator, thus when a seeker is sighted, the other cannot be far away. When not on patrol, it will rest in a special bay within the exterminator itself.

11. The wasp is bred exclusively for war, which it excels at. It is a superior strategist, clever and fast thinking. When dealing with humans on a small scale they are often clearly sarcastic and playfully cruel in a cat and mouse fashion. They are always devastating and never take combat as a lark.

12. The tunnel crawler is an independent agent of destruction, permitted to wander where it desires. They are often found with a pair of skimmers, assault probes or fellow tunnel crawlers. They are usually found wandering the wilderness or city sewers in search of human prey.

13. Mechanoid **Haulers**, **Battle-cruisers** and **Black Widows** did not enter the dimensional rift, so they are not included in the descriptions.

# Adventures

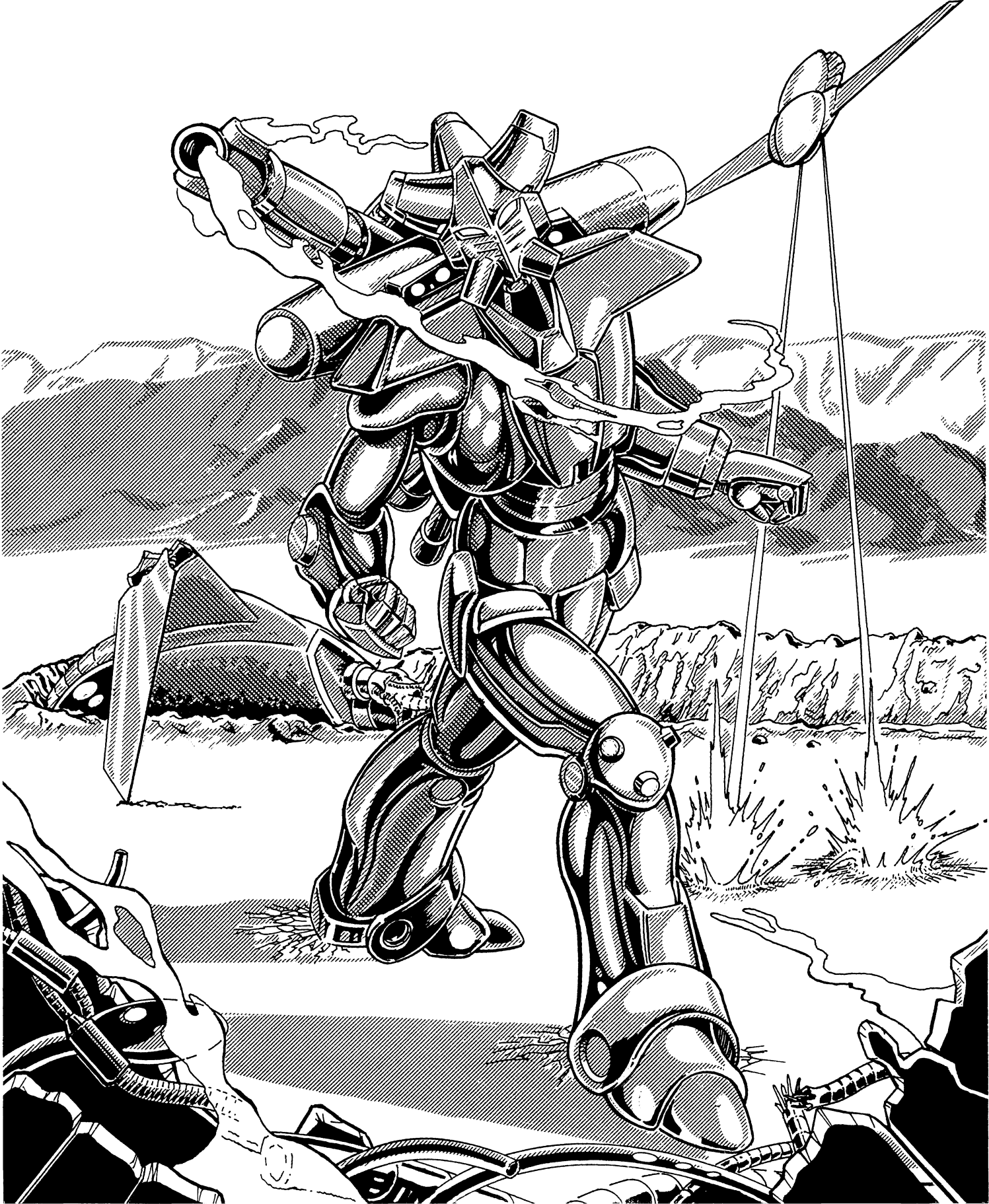

# The Nightmare Begins

## A Scenario Outline

---

**Basic Plot:** This adventure is an introduction to the Mechanoids, their cruelty and their plan for destruction. It is suitable for player characters of any experience level, but is ideal for low to middle level characters. Some GM's may want to beef up the opposition if the player group is high level or unusually tough. However, even against high level heroes the GM may want to keep things as they are. This would make it a quickie adventure that establishes the overall setting and the conflicts to come.

**Setting:** The wilderness that was once pre-Rifts Maryland, Pennsylvania, and Virginia is under siege by marauding destroyers. There are dozens of reports about demons and giant "robots" attacking and completely leveling towns and villages. The local authorities and Coalition sources confirm that at least a dozen towns have been destroyed. There are no reports of straight out theft. There is only carnage and in many cases, there are no survivors. It is apparent that these "demons" are using sophisticated energy weapons which gives more credence to the reports that identify the attackers as robots. The attackers use hit and run tactics — and never stop moving. The beings responsible for these attacks are destroyers, not conquerors. This has led many to speculate that it is the handiwork of the "Devourer" and his "swarm."

**An account from a survivor** might go something like this: The adventurers encounter a farmer who claims to have witnessed the destruction of his village. He is middle-aged, walks with a limp and wears a wide brimmed hat tilted in such a way that it covers much of the left side of his face. What isn't obscured by the hat is covered by long, dirty strands of brown and grey hair which falls over the left eye, down to his cheek. He trembles as he talks and his tone is filled with sorrow.

"It was terrible. Just terrible. It was mornin' but the sun ain't risen yet, 'cept for a little halo of light over the hill. I was admirin' the view when I realized that halo of light was coming from the south, not the east like it oughtta. Then it hit me, the whole town of Greenview must be on fire to give off a light like that. Then, before I could say a word to my two sons, the roof of my house was torn right off. At first, I thought we was hit by a twister, but the timber that connected to the roof was cut smooth and the tips glowed red like embers. I know now it was one of them lasers or somethin' that shaved the roof right off.

"Next thing, I hear screamin' and explosions and the neighbor's house is on fire. Wood an' dirt, an' debris is flying everywhere. Some things, like a pair of airplanes zoom by like lightning, right down the road, blasting houses, barns, vehicles ... people ... everythin' in their path. Faster than I can blink, they're gone, 'cept now there's holes blasted in the ground, parts of buildin's are missing an' smoke an' grit is everywhere. All this happened in seconds. Then, the flying things are back! There's a blast of light an' I fall to the ground, blinded. I hear more screamin' but like through a tin can 'cause my ears are hurtin' from the noise of the blasts an' all. I pray to god an' crawl like a frightened dog into a hole that wasn't there a second ago.

"Maybe a minute passes when my eyes can see again. I look over to where my boys had been standin' ... only ... only ... they're gone. All th ... that's left is a crater and one of Joey's shoes with ... oh god ... with his foot still in it. God Almighty, only his foot! Everything else gone! Vaporized!! God ... my Joey an' Thomas an' Nettie ... all ... gone. Like hell just opened up and swallowed 'em."

The tortured man needs a moment to regain his composure. He chokes back the tears and continues.

"I don't know how many minutes passed. I ... I must'a been in shock ... I don't know what all happened next ... I just don't know."

The story is again interrupted as the man collapses, shaking with uncontrollable sobbing. After several minutes, he is able to continue. If the group starts to leave before he's finished, he grabs the nearest person and pleads for them to wait. There's more!

"I think I must have heard a noise. The next thing I remember is looking up. There it stood. The devil from hell! Ten feet tall, maybe bigger, standing there kinda greenish an' red in the light of the fires. Grinning as happy as could be. In one hand the devil had this big gun. In the other was Jack's youngster, Sara. She ... she was all broken up and hung limp like one of her rag dolls ... She was only 10 years old ... It didn't have to ... she was only a child! An' this thing just stood there with this awful grin! I went crazy, started screaming an' was about to charge the damned thing when it fired its gun. The shot missed me directly ... but ... it blasted the dirt out from under me ... an' did this ..."

Trembling hands remove the hat and brush away the long, salt and pepper hair from the left side of his face. Painful looking blisters and scars cover the left side of his charred face, from his cheek to the top of his head. The left ear is missing and the eye socket is an empty, black hole. The damage is recent, no more than a week old. It's a wonder the farmer can speak at all. In a raspy whisper he continues.

"Must'a figured me dead. I woke up in the arms of a stranger. He said that he had done all that he could, let my head down gently, got up and walked away. I guess he was a travelin' preacher or healer or somethin'. I figure that he used his magic to heal me up the best he could. Probably ... shoulda ... just left me ... I ... ain't got nothin' left ... nothin' ... at all. Far as I could tell, the devil's done killed everybody. 'Course, was hard to tell ... there weren't ... too much left. No buildings left standin' ... not a stick ... an' the people ... only parts an' mangled bodies.

"I buried what I could ... prayed a while ... cried ... cried for days ... and left. I ... couldn't ... bring myself to take a look at Greenview. My village was little. Greenview ... that was a big town ... maybe 1000 people ... I ... just couldn't bring myself to see that many dead ... that's 'bout all I can tell you, 'cept them devils left the footprints of 'bots. Deep, hard lines.

“You boys look like heroes. Tell me you’re gonna find those bastards and send ’em back to hell! Tell me you’re gonna!! Tell me!! Tell ... me ... please ...”

Again the sobs and trembling. There’s little anybody can do to comfort this fellow. He’ll be haunted by his loss, grief and the memories of monsters for the rest of his life.

## Moving On

The overall setting is such that the player characters are likely to be in the area in search of “The Devourer.” The bad news, is that towns are being destroyed, individuals and groups of travelers have been slaughtered without reason or disappeared. Rumor has it that three squads of Coalition troops (one a Glitter Boy team of five members) have disappeared and are presumed dead. This destruction fits the premonitions of the psychic and sure sounds like it is the work of the Devourer. The good news is that the heroes are obviously on the right track. Any psychic sensitive in the party will sense this is the work of the Devourer.

Alternately, our adventurers may find themselves in this part of the country on just about any kind of business. They may get drawn into this drama whether they had intended to or not. The story they have just heard and others like it, may entice them to get involved to stop the murder of thousands. Paladin-type characters are likely to have been so moved, that they will feel compelled to take action. Meanwhile, the group may run into other refugees, victims and recent scenes of destruction (not to mention the Mechanoids or a Mechanoid bot). Such an encounter may be the final incentive to get them involved.

Another possibility is that they are hired guns. Many of the communities along the Eastern seaboard are hiring mercenaries to fight the invading monsters, to defend them against brigands and grave robbers who wait at the town’s borders like vultures.

Regardless of their motives, the group can easily find the burnt and crushed remains or Greenview, the farmer’s village, and other villages that have been destroyed by the Mechanoids.

### Clues:

1. Examining the scenes of destruction will confirm that energy weapons and robots are responsible.
2. Evidence shows the assailants possess particle beam, plasma and laser weapons.
3. Characters with an expertise in tracking can surmise that the attackers travel in small numbers, typically eight to twelve, not counting possible airborne enemies. This also indicates that they must be quite powerful for so few to kill so many and destroy so completely.
4. Tracks also show that there are at least three different types of robot or cyborg attackers used in these assaults.

Possible Subplots (use one, use several, or none at all). Also note that these story elements can be included in any of the adventures in this book:

1. The local populace of nearby towns and villages are becoming increasingly frightened that they will be destroyed next. Some of the larger and/or more prosperous communities are hiring mercenaries to guard houses, businesses and entire towns. They are also hiring mercs to deliver goods, escort caravans, guard individuals, and scout the wilderness to warn them of approaching danger. This can lead to all kinds of problems and adventure. Some of these mercs are no better than the monsters

they fight and many are criminals and con-artists out for themselves. See the adventure *Liberty* and the outline of *The Map*.

2. Our heroes find a 4000 foot wide swath of forest that has been decimated by a terrible battle. Trees that have not been blasted into toothpicks are burnt and toppled. Among the debris are the remains four of the five missing Glitter Boys. The power armors have been shredded or blasted into piles of junk — there is nothing to salvage. It is obvious that one of the GBs had its pilot’s compartment pried open and the pilot removed. The dismembered and rotting remains of the pilot are scattered not far from his armor. The other three were mercifully killed by the same high energy weapons that destroyed their power armor. The only remains of the enemy are metal fragments. It would seem that the enemy removes or atomizes its fallen soldiers.

Just as our heroes finish surveying this grisly battlefield, two SAMAS’s burst forth from the treetops and circle overhead. Two UAR-1, enforcer robots also push through the trees, accompanied by at least six foot soldiers (GM’s can alter the make-up and number of troops as is necessary to give the player characters a good battle). The CS soldiers are horrified by what they see and decide that the characters standing amidst the carnage are either responsible for their comrades’ deaths (examining the scene would show that this battle happened weeks ago) or that the characters are carrion that scavenge the remains of the dead for their own profit. Either way, they are not happy and will exhibit intolerance, anger, and cruelty. Whether this turns into a battle to the death or harassment is up to the Game Master.

3. The smoldering ruins of a merchant caravan, convoy of vehicles or tiny village. This battle was very recent — taking place no more than 1D4 hours ago. The search for survivors is the next logical step. This is a good opportunity for Game Masters to introduce new NPCs, provide clues and direction, and to add more evidence to the insanity and cruelty of the Mechanoids/Devouring Swarm.

It is likely that a robot reconnaissance team, made up of a weevil and two skimmers, is still in the area, only a few miles/km away. This can lead to a brief encounter. If the player characters destroy the weevil within four melee rounds and dispatch all the bots, they will have their first glimpse of the enemy. If the battle takes longer or the weevil or one of the skimmers escapes, a Mechanoid seek and decimate squad will arrive within the hour to destroy these humanoids. This will be a protracted battle to the death! If the group has moved on before the squad arrives, the hunter-killers will try to track them down. GM’s, have them strike at a dramatic moment!

4. Billows of smoke fills the skies up ahead. The sounds of energy weapons and explosions can be heard for miles. Climbing up a tree, flying above the tree line or standing on a hilltop shows a fairly large town under siege, 1D6 miles away! Those who can fly can be there in a minute and may takeoff immediately toward town. Before all the player characters can take action, one notices movement among the trees or underbrush. Surveying the battle from a safe distance is a four-legged, robot — a Mechanoid Brain!

The brain is so engrossed with its own thoughts that it will not notice the characters until they approach within 200 feet (60 m) or until it is attacked, whichever comes first. It will try to flee toward town, using its weapon systems and psionic powers to defend itself. Two nearby skimmers will join this skirmish

within 1D4 melee rounds. The other Mechanoids are too busy with their dirty work in town to notice any trouble miles away.

If the player characters didn't do any significant damage (like kill or capture the brain), the other Mechanoids will ignore the fact that they exist. If they destroy or hurt the brain or join the battle to defend the town and escape, the Mechanoids are likely to send a seek and destroy party after the group. If the characters make a stand in town, the Mechanoids will fight until two-thirds of their forces have been destroyed, then, if the Mechanoids are losing the battle, the remaining third will retreat. They will be consumed by revenge and will strike again!

A typical assault force on the town can be any of their standard squadrons or a mixture of the GM's own design. **Note:** Hagan may make an appearance during this kind of situation.

5. It has been quiet for nearly 48 hours. The enemy has disappeared without a trace. The peacefulness of the forest is broken by the boom, boom, boom of mini-missiles! The sounds of combat and the flash of energy weapons flash on a hill are only a short 4000 feet (1200 m) away.

If the characters go to investigate, they'll see an unusual type of power armor (Hagan) and two strange robots engaging Mechanoids in combat. A type one brute tries to crawl back into the fray; one of its legs and has been blown off and its flight system appears to be damaged as well (only has 84 M.D.C. left to its main body). Four thinmen are engaged in a counterattack, while two runts (or skimmers, or tunnel crawlers) circle to strike from behind!

When the battle is over, Hagan may stay around to chit-chat or offer advice. If nothing else, he points to the charred area where the brute was standing when he attacked it and says, "Take a good look," and leaves. Standing in that area and looking around, the player character(s) will realize that the brute was watching their camp and probably planning to attack.

6. A shriek shatters the air like an explosion. Running to investigate, our heroes see two thinmen menacing a human family (the setting can be in a village, a town under siege, in the forest, on a farm, or just about any remote place). One thinman is holding the oldest boy (perhaps 15 years old) up to its grinning face, the boy's younger brother (perhaps ten) is futilely pounding on the bot's leg with a stick (ignored for the moment). The other thinman towers menacingly over the fallen (dead or unconscious) father and the mother who clutches a baby and a seven year old girl.

This alone can make for a good encounter. A spin might be to have a particle beam blast the thinman's arm off at a weak spot. The boy, still clutched in the iron grip of the bot's hand, falls to the ground. The player characters can jump into this at any point and may finish off the Mechanoids' bots by themselves.

The energy blast could be Hagan's (who they see flying off in the distance) or a *good guy* Mechanoid! An old-style brute lumbers out of the shadows and pounces on the most threatening thinman while blasting the other as he charges. Other good, AbM's may join the battle. A great way to introduce AbM player or non-player characters (NPCs).

7. Any number of random encounters with Mechanoid squads, bots, and individuals. Use this and other adventures to draw the characters from one story-line into another.

---

# The Map

---

## A Scenario Outline

**The Setting:** The eastern forests of Maryland, Pennsylvania, Virginia or neighboring area. Mostly wilderness.

**Basic Plot:** A group of two-bit bandits are running a clever scam on adventurers who have come to these parts looking for the "Devourer." Wily Willie Gladanski, a confidence man of remarkable talent, claims to know where to find the Devouring Swarm.

According to Wily Willie, there is a place of magic (ley line nexus) where the Devourer has created a dimensional rift. This is, supposedly, the rift that the Devourer first arrived through and from which he continues to bring his demonic troops. To add to his credibility, Willie accurately describes the Mechanoid brute, wasp, runt, and thinman. As the final touch, he pulls out a "keepsake" a close encounter: the grinning jaw of a thinman and a few other bits and pieces of alien scrap metal.

If questioned, Willie seems to be absolutely sincere and honest. His story is consistent and feasible. In fact, parts of what he says are really true, because he and his friends have seen the Mechanoids in action and they do scare him.

If someone should suggest that he could have found the metal scraps, Willie's face turns red and trembles with indignation. Hands waving in outrage, he shouts something like, "Don't believe me, my friend! I don't care what you think! I know what I saw!! I saw two of my buddies get shot in half by ion cannons and our truck fried by a plasma blast! I lived through it!! I'm not asking you for your sympathy or a handout! I just thought you boys were looking for these bastards. I thought, just maybe you were heroes. My mistake!"

With this he stands up in a huff, ready to storm away, but (conveniently) drops the jaw and other scraps, giving player characters a chance to apologize and/or calm him down so he can tell them more. Otherwise, the delay gives him an opportunity to think of other things to say to peak the group's interest.

Willie will let characters ply him with booze, food, and favors (like a room for the night, new clothes, a shave, a couple credits, etc.). He's a heavy drinker and needs a dozen strong drinks to get him feeling even a little bit tipsy. However, after three, he will pretend to be getting loose lips from the booze. He'll say things like, "I shouldn't really tell you this but," and "Sshhh, this is a secret jushh between youze and me, buddiezzz."

One of his favorite routines is telling people that he's really a prospector and found gold in the valley where the Devourer has opened the rift. If he could get rid of the damn aliens, he could be rich ... they could all be rich, "Cuz I'll shhare the gold witcha all. Oops (giggle). Shhshh! Not so loud. Somebody's got to shhstop those shings or weez all dead men. Gold won't do me any good when I'm dead." However, Willie will weave any yarn that he thinks will get the group motivated into going. He'll even describe the location: hills, forest, stream, fallen tree, but it could be anywhere!

Willie, however, won't go with them.

"I'm ashamed to say it, but I'm not going back. I'm no hero and I'd only be a hindrance to you if I did go. Which I'm not."

Again he'll seem sincere and genuinely frightened; no character of a good alignment will force another to do otherwise. He will, however, draw them a detailed map.

The cost of the map? Nothing! "I trust you. I can see in your eyes that you are generous and trustworthy people. Just stop these creatures, for all our sakes." He will seem impressed by any claims that the group can close the rift and kill the monsters. He will do his utmost in flattery and sweet talk to encourage them.

Willie even promises to wait for them at this location (town, wilderness camp, etc.) until they get back. He will also offer to watch over any possessions they might want to leave in his safe-keeping, but he is careful not to push this offer for fear of making them suspicious.

## Willie and the Bandits

Willie and his real "buddies" are a bunch of crooks. The map does lead through Mechanoid occupied territory and our heroes should see the occasional Mechanoid or bot, and might even have a fight along the way, but this is not the way to A.R.C.H.I.E. Three's underground hide-out or any dimensional rift. It is the way to a bandit's ambush.

Wily Willie is part of a gang who lures would-be heroes, adventurers and travelers into a trap. **Note:** The "con" in luring unsuspecting travelers to the ambush location is a promise that the map shows a way of safe passage — avoiding any Mechanoid or bandit conflicts.

These bandits are not diabolically evil, just unscrupulous thugs out to rob from the rich and give to themselves. They aren't so greedy as to take all of the characters' possessions, just universal credit cards, gold, silver, gems, jewelry, booze, new weapons, a vehicle or two and other valuables that are easy to transport and sell. They've learned that a warrior and his favorite weapon are not easily parted, so they don't usually push the subject and let them keep such weapons and armor. They even try not to hurt anybody too seriously. But don't be fooled! Although these thugs are not the worst criminals on the planet, they are selfish scoundrels who steal and put innocent people in jeopardy. Furthermore, if pushed to the wall, they will kill or do whatever it takes to survive or escape.

If the group cooperates with the brigands, the ordeal is over in minutes, without any bloodshed. Resistance will cause a fight. The bandits are good fighters and especially dangerous if angered or cornered. They are likely to accept a character or group's surrender at any point, but battle will cause the thieves to be mean and pushy. They will also take more booty to compensate for their trouble. Few will fight to the death and they will flee into the woods if they have bitten off more than they can chew.

**There are 17 hoodlums**, mostly third to sixth level headhunters, wilderness scouts, city rats and vagabonds. The average alignment is anarchist, with a few fellows of miscreant and aberrant alignment. Weapons and equipment are mostly common Northern Gun and stolen CS items. Most of these brigands are good natured, cheerful, swashbuckling types. All are loyal to their leader and his second-in-command.

### Tree Shadow

**The leader** is a ninth level, wild psi-stalker of anarchist alignment, called **Tree Shadow**. He wears light, M.D. body armor.

His weapons include a bow and arrow with a variety of arrowheads (high-tech and conventional), an NG-Super laser pistol, a Splugorthian forearm plasma blaster (5D6 M.D., 2000 ft/610 m range, with 16 shots left in it) and a Splugorthian *Staff of Eylor!*

Tree Shadow's claim to fame is that he has slain a Splugorth Slaver and that he stalks the stalkers, meaning he fights Splugorth Slavers and minions. This has made him a hero and legend to the region. He and his bandits are loved by many of the local inhabitants who they have rescued from captivity and persecution by the Splugorth, CS soldiers and rival bandits. It is also important to note that Tree Shadow and his bandits do not molest or steal from the local villagers, farmers or huntsmen. They limit their attacks to notorious local scoundrels, other bandits, travelers and invaders from other parts of the country, including the Mechanoids. Tree Shadow loathes the Minions of Splugorth and enjoys fighting and stealing from them above all others. The reason for this animosity remains a mystery.

### Statistical Data of Note

**Alignment:** Anarchist

**Attributes:** I.Q. 15, M.A. 14, M.E. 22, P.S. 18, P.P. 21, P.E. 21, P.B. 10, Spd. 27. S.D.C.: 69, hit points: 59, P.P.E.: 6.

**Combat:** Martial Arts, with five attacks per melee.

**Bonuses:** +5 to strike, +6 parry and dodge, +3 on S.D.C. damage, +3 to pull punch, +3 to roll with impact, critical strike on a natural roll of 18-20, paired weapons, jump kick and leap kick (critical strikes), and entangle. +6 to save vs magic, +3 to save vs poison, +4 save vs psionic attack, +5 save vs mind control, and +6 save vs horror factor.

**Psionics:** 112 I.S.P. and has all the usual psi-stalker powers plus telepathy, empathy, object read, sense evil, see the invisible, and mind block.

**Skills of Note:** Tracking 75%, prowl 75%, wilderness survival 90%, land navigation 73%, identify plants & fruits 70%, boat building 70%, holistic medicine 60%, basic math, horsemanship 72%, detect ambush 75%, escape artist 70%, climbing 85/75%, W.P. archery and targeting, W.P. blunt, W.P. knife, W.P. energy pistol and rifle. A ninth level psi-stalker.

### Cintabar the Line Walker

**The next most dangerous member of the gang is Cintabar**, a 5th level ley line walker of aberrant alignment. He is a human with mahogany colored skin and dark brown eyes. He carries himself with an air of power and the utmost confidence. Cintabar is cool and confident under fire and an excellent tactician. He is also resourceful and cunning, relying on clever lies and intimidation techniques to bluff or undermine the confidence of his opponents. All of this has earned him the respect of the other bandits and the position of second-in-command. The wizard and Tree Shadow are good friends and each would sacrifice his life to save the other!

**A combat note:** Both Cintabar and the psi-stalker try to win fights without firing a shot, employing intimidation and weight of numbers. Cintabar's approach is usually brazen arrogance, tinged with sarcastic wit.

**For example:** When they ambush a group of travelers, there will be at least eight to ten assailants visible to some degree. Typically, Cintabar will slowly and boldly step forward and point out, "There are 20 (he exaggerates their true numbers)



very mean, very desperate, and, I might add, trigger happy, bandits out there. Oh, I know what you're thinking. You only see ten or twelve men and you wonder whether or not there really are twenty. You may wonder whether there are any borgs, bots or dragons among us. Come now, do you really think we'd be so brazen if we didn't have such resources? Do you really want to find out? Do you want to risk your lives over a few worldly possessions? No, I think not. Now," he says with a smile, "gives us what we want and you may leave without a scratch. A very good proposition in these oh so dangerous times."

With this, the line walker will usually perform some feat of magic that will add to the intimidation level and make them wonder about the things he has suggested. **Note:** Tree Shadow's approach is usually more menacing and threatening.

Six out of ten victims will hand over their valuables without a fight. Two out of ten will attempt a brief skirmish and surrender. Only one in ten will fight to the death.

Cintabar, Tree Shadow, Willie and the others may also offer genuine advice and warnings about "real dangers" that may await travelers in the wilderness, and give accurate directions to those who are lost. Remember, they are friendly, cheerful rogues who have a strange code of ethics and morality. They aren't exactly Robin Hood and his Merry Men, but they are close to it.

#### Statistical Data of Note

**Alignment:** Aberrant

**Attributes:** I.Q. 17, M.A. 15, M.E. 19, P.S. 14, P.P. 18, P.E. 14, P.B. 13, Spd. 14. S.D.C.: 20, hit points: 35, P.P.E.: 120.

**Combat:** Basic hand to hand, with three attacks per melee.

**Bonuses:** +3 to strike, +4 parry and dodge, +2 to pull punch, and +2 to roll with impact. +1 to save vs magic, +2 save vs psionic attack, and +4 save vs horror factor.

**Magic:** 120 P.P.E.; spells of note include all level one spells, befuddle, chameleon, concealment, detect concealment, mystic alarms, armor of Ithan, paralysis: lesser, carpet of adhesion, fool's gold, magic net, repel animals, escape, energy disruption, and call lightning.

**Skills of Note:** All of the usual ley line walker abilities and O.C.C. skills, as well as astronomy 58%, anthropology 53%, literacy in American 58%, prowl 50%, land navigation 61%, W.P. blunt, W.P. knife, and W.P. energy pistol. Fifth level line walker.

**Items of Note:** Splugorth jolt gun.

#### Wily Willie Gladanski

What else is there to say about Wily Willie? He's a 6th level rogue scholar turned criminal. He has moved out to the country because he is wanted by the Coalition States of Chi-Town and Free Quebec. His criminal record includes fraud, forgery, falsifying documents, computer hacking, theft, smuggling, extortion, gambling, and assault with a deadly weapon (shooting at CS troops to make a getaway), along with numerous petty crimes and charges of social subversion.

He enjoys his life in the country and finds it to be interesting, challenging and easy to perpetuate. He likes the idea of being a local hero at some villages and takes advantage of it by getting girls, favors, free food and free booze. When not involved with gang activities Willie can be found cheating at cards, pulling little scams (like selling fake artifacts or fake CS identity cards), dancing, drinking, socializing (usually with the ladies) or just relaxing.

#### Statistical Data of Note

**Alignment:** Anarchist

**Attributes:** I.Q. 15, M.A. 23, M.E. 17, P.S. 15, P.P. 17, P.E. 13, P.B. 19, Spd. 14. S.D.C.: 32, hit points: 43, P.P.E.: 8.

**Combat:** Basic hand to hand, with three attacks per melee.

**Bonuses:** +2 to strike, +3 parry and dodge, +2 to pull punch, +2 to roll with impact, critical strike on a natural 19 or 20 and +1 save vs psionic attack. Willie has a 75% chance of evoking a feeling of trust or intimidation and 45% to charm and impress.

**Skills of Note:** All of the usual O.C.C. scholar skills, plus computer operation 85%, computer programming 75%, computer hacking 40%, basic electronics 60%, radio: basic 75%, surveillance systems 60%, cryptography 55%, photography 80%, forgery 45%, escape artist 55%, palming 45%, pick pockets 50%, streetwise 40%, lore: demons & monsters 75%, anthropology 55%, literacy in American 98%, literacy in Techno-speak and Spanish 75%, W.P. knife, W.P. energy pistol and rifle. A sixth level rogue scholar, con-man and thief.

#### Adventure Ideas

Adventure ideas, encounters and possible subplots (use one or all):

1. Of course, there is the setup already established with the map and robbery. Once the bandits are introduced, there are lots of different things that can happen. The group may run into the bandits repeatedly and be robbed again and again (always a different scam that sets them up and/or a new place of ambush). The bandits will have more fun with each subsequent robbery.



In each a case, they will tease and poke fun at the player characters without mercy.

2. Remember, many of the surrounding villages think of the Shadow Tree gang as heroes and protectors. To complicate matters, GM's should have fun with player characters by having good folk praise and defend the bandits. "Oh, no! That couldn't have been Shadow Tree and his men! They saved this town from ... (fill in the blank) ... and rescued little Ricky and ...". They do as much good as they do mischief.

3. These bandits hate the Splugorth and their minions, the Mechanoids, and the Coalition. Consequently, they will heroically try to help any intelligent creature(s) under attack or enslaved by them. Thus, the player characters may suddenly find themselves with bandits fighting at their side. This can be played with great humorous effect if the player group has already been victimized by these bandits. Or if after these bandits help them, they rob them (the theft will be comparatively petty, since these people are the enemy of their enemies). Likewise, these good natured crooks will help people down on their luck and will respect heroes who are trying to help the villagers in the area.

Depending on the nature of the encounters, the player group and these bandits might become friendly rivals or even allies. This can lead to an exchange of information, supplies, medical aid, and even assistance in combat.

4. If the player characters keep having good or mostly good experiences with these guys, they may get to like them and find themselves helping the bandits fight CS troops or other enemies, escape from jail, elude the authorities, speak on their behalf, etc.

casualty of war." With those words, he waves and two of the humans pull her up and pin her against a tree.

Unless the player characters act quickly he will begin to torture her.

The appearance of any character will get energy weapons pointed at them and a warning to, "Mind yerself, man! This ain't none of your business! Now git!! Git out or git turned into dead meat!"

These men are diabolic evil, completely without honor and dangerous in the extreme. They know what they are doing is wrong and are afraid of repercussions, so they will not take chances. Any sudden movement or act of hostility will start a fire fight. They will fight as long as they think they can win, otherwise they will try to slip into the woods and escape.

The sleaze-ball with the knife will immediately use the D-Bee woman as a shield and a bargaining chip, threatening her life if the group of heroes doesn't back off. If these murderers get away with their hostage, she's as good as dead. However, if given the opportunity, she will pull away and dive for cover.

If they leave her behind, and escape, the four will molest more innocent people. Furthermore, if they should run into the heroes again, they will try to cause trouble or attack the "D-Bee lovin' bleeding hearts."

## Non-Player Characters

### The Four Men

All four of the men are human, mountain men/trappers and human supremacists. They are all diabolic evil, fifth level wilderness scouts, in their early twenties. They are dressed in common M.D.C. armor and use common Northern Gun energy weapons. Attributes are mostly average with above average numbers in P.S., P.P. and P.E. (no lower than 19 for each). None have any special abilities other than their knowledge of the forest.

### The D-Bee Woman

The woman is a psychic healer. She will be grateful to be rescued and will use her powers to heal anybody who is injured, starting with the most seriously hurt. Her next concern is the man tied to the tree who is still alive, though just barely.

After things have settled down, she will ask the player characters if they would escort her and the injured male D-Bee to her village. Unfortunately, neither she or her fellow tribesman have anything of value to pay them, other than food and a place to sleep. She is not pushy or whiny. If the answer is no, she will not press it. However, if the group agrees, they will be in for a few surprises. **Note:** Characters of a good alignment are not likely to let a woman and her injured companion make this dangerous trip alone.

The entire trip should not take more than a day or two. Whether they run into trouble with Mechanoids, Minions of Splugorth or bandits is left entirely to the Game Master. Personally, I would have at least a minor skirmish with the aliens.

When they arrive at the tiny village, the characters discover that the lady is Mea-la, the tribe's shaman and healer. She offers them food and lodging for the night. Whether they accept the offer or not, Mea-la will also give them information before they leave. She knows where the Mechanoids are most active and

---

# Evil Among Humans

---

## A Scenario Outline

**Basic Plot:** Four humans who hate D-Bees have decided to stop the coming of the Devourer by wantonly slaying any D-Bees they encounter. These men are murderous bigots who enjoy killing. They are using the paranoia of the time as an excuse to go on a killing spree.

**Setting:** The wilderness anywhere.

## The Situation

Our heroes happen to walk in on these villains as they are about to have some murderous fun with a D-Bee woman. The dead bodies of three D-Bees lay in a pile under a tree like cords of wood. A fourth is strapped to the trunk of a tree and has been tortured into unconsciousness. A D-Bee woman is on her knees, pleading for mercy, but it is obvious that her pleas fall on deaf ears.

The leader stands sneering in front of her, brandishing a knife. He says to one of his companions, "Ya know Waldron, I don't think these D-Bees know shit. Hell, I guess they really were just travelin' to that flea-bitten town in the gully." His grin widens as he addresses his captive, "The trouble is, sweetheart, we can't let you go an' tell anybody what we done here. They might not understand an' try to hurt us, so I guess yer just a

has had a “vision” of where they came from (she can place the group within a hundred miles/160 km of A.R.C.H.I.E.’s base).

The tribe will gladly offer the characters food, water and other basics for their journey. The shaman will preform any healings and blessings that are requested. If the group has been especially heroic and generous she will give her two favorite people an amulet to protect them against the supernatural (+2 to save vs horror factor) and her very favorite will also receive a potion of healing (instantly restores 3D6 hit points or S.D.C.).

**Subplot:** These D-Bees are travelers from England and can be reintroduced as friendly NPC’s in that setting. The injured male is her brother and he too has psionic powers. Both will be glad to see their rescuers.

### Statistical Data of Note about Mea-la

**Alignment:** Scrupulous

**Experience:** Seventh level Healer/Shaman & Wilderness Scout.

**Attributes:** I.Q. 14, M.A. 15, M.E. 20, P.S. 17, P.P. 14, P.E. 20, P.B. 19, Spd. 17. S.D.C.: 30, hit points: 42, P.P.E.: 60.

**Combat:** Basic hand to hand with three physical or psionic attacks per melee round.

**Bonuses:** +2 to strike, +3 parry and dodge, +2 on S.D.C. damage, +2 to pull punch, +2 to roll with impact, +3 to save vs magic, +3 to save vs poison, +5 save vs psionic attack, and +5 to save vs horror factor (includes the bonuses from an amulet).

**Psionics:** Master psionic, 62 I.S.P. Powers include bio-regeneration, deaden pain, healing touch, psychic diagnosis, psychic purification, psychic surgery, resist fatigue and mind block.

**Skills of Note:** All O.C.C. skills common to wilderness scouts, plus speaks American, Euro, Faerie, and Gobblely at 98% (illiterate), prowl 65%, basic math 80%, swim 75%, climbing 85/75%, running, W.P. archery and targeting, W.P. blunt, and W.P. knife.

**Weapons of Note:** Wood staff, wood knife, and long bow and arrows.

**Body Armor:** Wood and bark (magic) 50 M.D.C.

authority or protested too loudly have been run out of town, beaten or killed. It seems the Bad Cats like the town of Liberty and have decided to make it their own.

The ex-mayor and a handful of citizens discreetly approach any visiting adventurers who seem to be predominately good guys and beg them to help liberate Liberty! They can offer energy clips, the recharging of energy clips, basic supplies, fuel, repairs to armor and vehicles, and the services of a healer. They can also provide reliable information about each member of the Bad Cats, including where they live, their powers and their habits.

Liberty is not an extremely wealthy town and the Bad Cats have caused a great amount of costly damage. Still, as a reward, the town can pay each hero 50,000 credits, give them free room and board for up to six months, and the previously listed services.

**The Setting:** The town of Liberty is a growing community of about 6500 farmers, fishermen, loggers, carpenters, craftsmen, laborers, merchants, and families. The general tech-level is low, but there is some mixture of high technology and equipment. While there are many people who ride horses and live in simple, wood frame houses, half the town has modern amenities such as electricity, running water, sewers and hover vehicles. Basic energy weapons, body armor, modern tools, toys and appliances are also available.

In fact, there are two mechanics garages, the new motel, a dozen boarding houses, and the “Electronic Wizard Mega-Store” (it covers a city block and is two stories tall). This has made the town of Liberty a haven for trappers, adventurers, traveling merchants and travelers of all kinds, as well as a place where neighboring communities from hundreds of miles around can come and trade, sell and purchase goods and services. Even CS soldiers occasionally stop by for a little rest and relaxation.

**Subplots (use one, use several, or none at all):**

1. The leader of the Bad Cats gang is smart and has his men keep an eye on known troublemakers. This includes the ex-mayor, the three remaining ex-deputies, and “goodie-two-shoes.” This means he or his spies may notice our heroes being approached by known dissidents. This will inevitably lead to a little talk.

The sheriff and some of his best men will buy the group (or key members) a drink or meal, but this is definitely not a gesture of friendship. He will make it painfully clear, with veiled threats and innuendo, that they are on to them and that the group should keep their noses out of domestic squabbles. It may also be suggested that they move on very soon, like tomorrow. Another threat may be that so and so (one of the more dangerous deputies) doesn’t like some person(s) or race in the group and they better be careful. Afterwards, our heroes will notice that one of the deputies is always nearby, watching them.

2. If the player group decides to help the town’s people, they will have to be careful. Not everybody in town is against the Bad Cat gang, so the wrong word to the wrong person might cause the gang to take action first. Trumped up charges or instigating a fight could put one or more of the characters in jail or cause them to be beaten up or killed by the deputies. The sheriff might show compassion and suggest that the group leave town right that very minute to avoid further trouble. If they agree, their friend(s) will be released from jail and sent off with them. However, any confiscated weapons, armor or possessions are likely to remain in the sheriff’s custody as payment for the

---

# Liberty

---

## A Scenario Outline

**Basic Plot:** The people of Liberty had a town meeting and decided they should hire a group of super-powered heroes to help protect their town. They hired a group of mercenaries known as the **Bad Cats**. Unfortunately, these heroes have turned out to be the foulest of villains.

The Bad Cats are mean bullies who are terrorizing the townspeople. The old sheriff and four of his best deputies were killed in a gunfight by them. Later that evening, the sheriff’s home was burnt to the ground and his wife was abused. The next day, the gang announced that their leader was to be the new sheriff and his men the new deputies. They also held a mock election in which one of their members became the new mayor.

He serves as a stupid puppet to the gang’s leader. Those who have challenged their

trouble they have caused. He may even charge them fines to line his pockets.

**A combat note:** The Bad Cat gang is experienced and clever. If they know trouble is brewing, they will try to stop it before it gets out of hand. Likewise, they will try to divide the enemy and attack individuals or smaller groups, rather than wait for a mass attack. The Bad Cat leader/sheriff is always accompanied by two of his men and most of the gang members travel in pairs or small groups of three to six.

3. The player characters decide that the town's trouble is none of their business and plan to move on. Unfortunately, some of the sheriff's men believe otherwise and decide to eliminate them or cause trouble before they leave. This turns into a battle or the kind of trouble described in number two.

4. If the Bad Cat gang is run out of town, the surviving members may seek revenge against the group and/or the town. If against the town, they may vandalize crops and property, and/or try to take over again when the player characters have left. If against the player characters, they may try to assassinate them one at a time, work with another enemy and/or become a reoccurring nemeses.

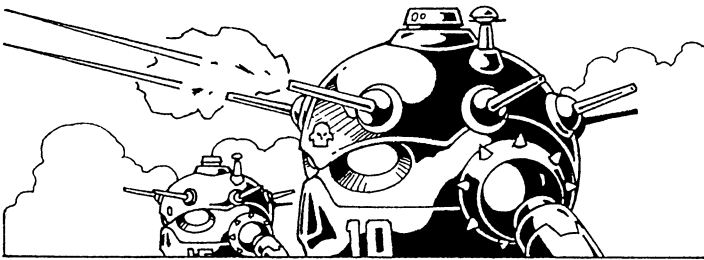

5. To make matters worse, the Bad Cats have worked for the Coalition as mercenaries and are friends with several of the worst squads and commanders. The gang has paid the CS to not interfere. This means: One, if any citizen contacts the CS for help, the message is intercepted and the citizen responsible is made known to the Bad Cats and punished. Furthermore, the most ornery and villainous Coalition soldiers are starting to come to Liberty to enjoy the recreation and benefits the town has to offer. These ruffians will cause more trouble, damage and misery to the inhabitants and support the Bad Cats' reign of terror.

6. If the premise in number five is used, it's likely that our heroes will encounter a squad of CS soldiers who are friends of the Bad Cats and who will join the gang to crush them or seek revenge if the gang is destroyed (they may even have one or two surviving gang members working for them as wilderness scouts). Furthermore, the bad CS soldiers will continue to come to the town looking for mischief, at least for a while. Our heroes may find themselves confronting CS troops for the next several weeks, until word spreads that the town has been cleaned up.

Whether these confrontations are deadly battle, ambushes or more subtle means of trouble, is up to the GM. If the player group is too tough, the soldiers are likely to back down without further repercussions, but there will certainly be some tense moments as the two groups face off, considering whether they should fight or not.

7. Red the burster, secretly approaches the group with his own agenda. He assures them that if they can kill Sheriff Quentin

and his second-in-command, Sweet Sue, he can take over the gang, calm everybody down, and prevent any acts of retribution. He swears that they will leave within 48 hours as quietly and peacefully as field mice never to return. To prove his sincerity, he may give the group some useful, but relatively unimportant information and he will openly defy Sheriff Quentin.

Deciding to work with Red is not an entirely bad idea. Red does have some influence over the gang, but there will be trouble. Some of the key gang members, like M'tin and Fast Hands, won't follow Red and will seek to avenge the deaths or incarceration of their leaders. Many of the lesser gang members will follow their lead. Furthermore, Red will loot as much as he can before he leaves town.

8. The Mechanoids never do trouble this town.

## The Bad Cat Gang

### Quentin Laroquette — Headhunter/Cyborg Leader of the Bad Cats & Sheriff

**Alignment:** Miscreant

**Hit Points:** 67, **S.D.C.:** 40, **M.D.C.:** Bionics & Body Armor

**Weight:** 288 lbs, **Height:** 6 ft, 6 inches, **Age:** 27, **Species:** Human

**P.P.E.:** 9, **I.S.P.:** None.

**Attributes:** I.Q.: 15, M.A.: 20, M.E.: 18, P.S.: 24 (bionic arms), P.P.: 20 (bionic), P.E.: 14, P.B.: 10, Spd: 17

**Note:** Quentin, like most headhunters, has submitted to partial bionic reconstruction, as well as numerous implants.

**Disposition:** Quentin can be disarmingly friendly, cheerful, and charismatic, but he is really very selfish, greedy, brutal and merciless. He'll say or do anything to get what he wants without regard for anybody. He is a cold-blooded killer without remorse. His ends always justifies his actions. He tends to talk in a slow, deep, ominous tone.

**Experience Level:** 10th level headhunter

**Magic and Psionic Powers:** None.

**Combat Skills:** Hand to Hand: Basic

**Attacks Per Melee:** Five (5). Critical strike on a natural roll of 18, 19 or 20, kick attack (1D6 S.D.C.), paired weapons, and Judo flip (1D6 S.D.C.).

**Bonuses:** +2 on initiative, +5 to strike, +6 to parry and dodge, +15 S.D.C. damage, +2 roll with punch or impact, and +2 to pull punch. 60% likelihood of instilling trust or intimidation (M.A.).

#### Bionics & Cybernetics:

##### The Arms

Wrist needle and drug dispenser in the right arm. Holds four doses each of: 1) antibiotics, 2) tranquilizer/sleep drugs 3) truth serum, 4) paralysis drugs, 5) poison (6D6 S.D.C./H.P. damage). A computer & calculator, and sensor hand is also built into the right arm.

The left arm and hand are bionic, with a laser finger blaster (1D4 M.D.), energy-clip hand port, concealed arm laser rod (1D6 M.D., 880 ft/224 range) and shooting knuckle spikes that fires four silver spikes (can fire one at a time or simultaneously; range 100 ft/30.5 m). Each arm has an M.D.C. of 25 and the hands 5.

## Head Features

All throat features including bionic lungs, loudspeaker, universal headjack, speech/language translator, molecular analyzer, modulating voice synthesizer (see **Rifts**, page 242), amplified hearing, sound filtration system, clock calendar and radiation detector. The left eye is a multi-optic eye (see **Rifts**, page 231). The right eye is normal.

**Weapons of Note:** Vibro-knife and matching vibro-saber, a pair of wooden throwing knives (1D6 S.D.C. damage), C-27 heavy plasma cannon (6D6 M.D.), JA-9 variable laser rifle, and six high explosive (3D6 M.D.) and four plasma (5D6 M.D.) grenades.

**Body Armor:** The gladiator armor; 70 M.D.C.

**Skills of Note (includes I.Q. bonus):** All headhunter O.C.C. skills (most are around 90 to 98%), streetwise 60%, languages: American and Spanish 98%, plus the bionic speech translator (all nine major languages at 98% but drops to 78% when 3 or more people are speaking), pilot automobile 98%, hovercraft 98%, demolitions 95%, demolitions disposal 95%, boxing, W.P. knife, W.P. sword, W.P. energy pistol, rifle and energy: heavy.

**Money:** Quentin has 100,000 credits worth of pre-rifts artifacts, 520,000 in universal credits (half of which have been taken from Liberty), and 230,000 credits worth of jewelry and precious metals.

## Sweet Sue

### A Mind Melter & Quentin's Girl

Sweet Sue ain't so sweet. She's a cold, calculating thief and murderer. She is the second-in-command of the Bad Cats and will seek retribution if her lover is killed or injured.

#### Statistical Data of Note

**Alignment:** Diabolic

**Experience:** Fourth level Mind Mage.

**Attributes:** I.Q. 14, M.A. 14, M.E. 22, P.S. 18, P.P. 18, P.E. 17, P.B. 19, Spd. 19. S.D.C.: 30, hit points: 38, P.P.E.: 4.

**Combat:** Basic hand to hand with three physical or psionic attacks per melee round.

**Bonuses:** +3 to strike, +4 parry and dodge, +3 on S.D.C. damage, +2 to pull punch, +2 to roll with impact, +1 to save vs magic, +1 to save vs poison, and +4 save vs psionic attack.

**Psionics:** 162 I.S.P. Powers include alter aura, see aura, sixth sense, mind block, telepathy, empathy, object read, sense evil, nightvision, see the invisible, impervious to fire, impervious to cold, impervious to poison, resist fatigue, bio-regenerate, induce sleep, electrokinesis, hydrokinesis, pyrokinesis, group mind block, and mental bolt.

**Skills of Note:** Speaks American, Euro and Gobblely at 90% (illiterate), pilot jet pack 59%, pilot hovercraft 70%, prowling 40%, streetwise 32%, pick pockets 40%, pick locks 45%, land navigation 58%, basic math 70%, swim 65%, climbing 65/55%, body building, running, W.P. archery and targeting, W.P. blunt, and W.P. energy rifle.

**Weapons of Note:** Wilk's 320 laser pistol and 447 laser rifle, NG-P7 particle beam rifle, neuro-mace, and two survival knives.

**Body Armor:** Crusader; 55 M.D.C.



## Red The Burster

This fellow is a handsome human with smoldering grey eyes and flaming red hair. He's known only as "Red." He is a cocky lady's man, cardsharp and swindler. He sees himself as a great leader and secretly dreams about getting rid of Quentin and Sweet Sue and taking over the gang. In his arrogance, he will often go off on his own and/or defy orders. Quentin tolerates him because he is an excellent fighter of considerable skill and power. Red can be found in the company of ladies, in a gambling house or in a bar just about any time of the day or night. To save time, he often gambles and drinks while surrounded by adoring women regardless of the time.

#### Statistical Data of Note

**Alignment:** Anarchist

**Experience:** Sixth level Burster.

**Attributes:** I.Q. 13, M.A. 11, M.E. 18, P.S. 20, P.P. 19, P.E. 14, P.B. 17, Spd. 12. S.D.C.: 30, hit points: 38, P.P.E.: 7.

**Combat:** Basic hand to hand with three physical or psionic attacks per melee round.

**Bonuses:** +2 to strike, +2 parry and dodge, +3 on S.D.C. damage, +2 to pull punch, +2 to roll with impact, critical strike on a natural roll of 19 or 20, and +2 save vs psionic attack.

**Psionics:** 148 I.S.P. All powers common to the burster R.C.C. (see **Rifts**, page 102 & 103), plus mind block, levitation, and resist thirst. Duration and range increase by 50% when near a ley line. Duration, range and damage are doubled at a nexus.

**Skills of Note:** Speaks American and Gobblely at 90% (illiterate), pilot jet pack 72%, pilot hovercraft 80%, streetwise 50%, pick pockets 60%, basic math 80%, swim 85%, climbing 65/55%, body building, general athletics, W.P. blunt, W.P. energy pistol and W.P. energy rifle.

**Weapons of Note:** NG-E4 plasma ejector (rifle), ion blaster, four plasma grenades (5D6 M.D.), six flares, a knife and a Wilk's laser scalpel.

**Body Armor:** Bushman; 70 M.D.C.

## Fast Hands A Psychotic Crazy

The most volatile member of the gang is a crazy named Fast Hands. He is constantly looking for trouble, causing brawls, gunfights and confrontations of any kinds. He is quick to accept any challenge of physical combat or feats of skill. Fast Hands hates Red and will not obey him if Quentin or Sue are killed.

#### Statistical Data of Note

**Alignment:** Miscreant

**Experience:** 5th level crazy

**Attributes:** I.Q. 9, M.A. 8, M.E. 11, P.S. 25, P.P. 27, P.E. 19, P.B. 19, Spd. 28. S.D.C.: 196, hit points: 66, P.P.E.: 24.

**Combat:** Assassin hand to hand, with five attacks per melee.

**Bonuses:** +2 on initiative, +8 to strike, +8 parry and dodge, +3 to pull punch, +7 to roll with impact, +14 S.D.C. damage, +2 save vs psionic attack, +6 to save vs mind control, +6 to save vs horror factor, +2 to save vs magic, and +8 to save vs poison and gases.

**Special Powers:** Standard Crazy: enhanced healing, bio-regeneration, leaping, and psionics (42 I.S.P.; summon inner strength, impervious to fire, and nightvision).

**Insanities:** Terrified of scientists (phobia), disgusted by anything sticky (affective disorder), frenzy caused by anger: add one melee attack, +30 S.D.C., +1 to strike, parry, and dodge (see **Rifts**, page 58).

**Skills of Note:** All of the usual Crazies' O.C.C. skills, plus boxing, intelligence 58%, tracking 55%, sniper, W.P. archery and targeting, W.P. knife, W.P. automatic pistol, W.P. heavy, W.P. energy pistol and rifle.

**Weapons of Note:** A pair of vibro-knife, a pair of throwing knives, a wooden throwing knife, sling with 30 exploding pellets (1D4 M.D. each), crossbow with conventional and high-tech arrows, NG-Super pistol, C-27 heavy plasma cannon (6D6 M.D.), C-40R SAMAS rail gun (1D4 × 10 M.D.), and four plasma (5D6 M.D.) grenades.

**Body Armor:** Modified, heavy Dead Boy armor; 80 M.D.C.

## M'tin

### The Mayor of Liberty

Another key member of the gang is a gigantes warrior. M'tin is a big, dumb lug who is dedicated to Quentin and Sweet Sue. He takes his position as mayor very seriously and gets angry when others make fun of him. However, M'tin has the intelligence and emotional maturity of a six year old child and adores Quentin and Sue as if they were his older, smarter brother and sister. He turns to them for constant advice and whatever they say goes. If either is hurt, M'tin will seek revenge. He will fight to the death to protect or avenge them.

#### Statistical Data of Note

**Alignment:** Anarchist

**Experience:** 5th level Vagabond warrior.

**Attributes:** I.Q. 6, M.A. 8, M.E. 5, P.S. 26, P.P. 20, P.E. 24, P.B. 5, Spd. 22. **Note:** Supernatural P.S. inflicts mega-damage from punches and kicks.

**Hit Points:** A mega-damage giant that has 90 M.D.C., plus body armor!

**P.P.E.:** 50.

**Combat:** Expert hand to hand, with four attacks per melee.

**Mega-Damage:** A restrained punch is 5D6 + 15 S.D.C., full strength punch or kick 3D6 M.D., power punch 6D6 M.D. (counts as two melee attacks).

**Bonuses:** +2 on initiative, +6 to strike, +8 parry and dodge, +2 to pull punch, +3 to roll with impact, +4 to save vs horror factor, +5 to save vs magic or poison.

**Powers:** 15 feet (4.5 m) tall, turn invisible at will, see the invisible, breathe M.D. fire (3D6 M.D., 20 ft/6 m range), and has thick, lumpy, M.D.C. skin. Plus 40 foot (12.2 m) nightvision, swim 60%, and supernatural strength and endurance.

**Insanities:** None, just stupid and mean.

**Skills of Note:** Boxing, general athletics, running, climbing 65/55%, cook 55%, sing 55%, radio: basic 65%, W.P. blunt, W.P. knife, W.P. sword, W.P. energy: heavy, and W.P. energy rifle.

**Weapons of Note:** A giant flaming sword (4D6 M.D.), a pair of silver throwing knives (2D4 S.D.C. damage; giant size), a modified Triax VX-180 Maxi-Rail Gun and ammo drum (1D6 × 10 M.D., 6000 ft/1828 ft, 100 bursts), and ten fragmentation (3D6 M.D.) grenades.

**Body Armor:** Modified, plate armor; 80 M.D.C.

## Other Bad Cat Gang Members

### 22 other Henchmen

One techno-wizard: 6th level, D-Bee, aberrant.

Two dog dogs: 3rd level, mutant bloodhounds, diabolic.

Two full conversion borgs: 3rd and 4th level, both miscreant.

One partial reconstructed borg: 5th level, miscreant.

Three juicers: all 3rd level, all diabolic.

One chief scout: 7th level, wild psi-stalker, aberrant.

Three wilderness scouts: All 5th level, all anarchist.

Five headhunters: All 4th level, all miscreant.

Armored squad (4): Two NG Samson (3rd level) and two Triax X-10 Predators (5th level), miscreant alignments.

---

# The Factory

---

## A Scenario Outline

**The Basic Plot:** Our heroes visit a dying town. The people are frightened and unfriendly. Does the group hang around to see if something is wrong or move on? There's just something not right about this town. Psychics will have premonitions of danger and apprehension.

This adventure might be ideal as something to play *after* the Mechanoid menace appears to have been eliminated.

Unknown to the player characters, a couple of brains and/or six runners, four type one brutes, three type two brutes, four tunnel crawlers and a dozen of each robot have escaped extermination and have taken over the town. The Mechanoids are usually hidden away or working at a bionics factory and a connecting genetics research facility. The retooling of the factory to build thinmen and runt robots is nearing completion (they'll start manufacturing in 2D4 weeks). The clone factory is years away from being able to produce more Mechanoids, but its eventual success is inevitable.

**The Setting:** This adventure can take place anywhere in North America, but is likely to be a fairly remote area. Our heroes stumble across a small industrial town that seems to have fallen upon hard times.

## A visit to an unfriendly town

This is a town that's on the skids. From its size, it is evident there was once a population of thousands that has dwindled to no more than five hundred. Buildings and streets are in a state of disrepair, most are boarded up or falling down. There are

signs of damage from a recent battle (weeks or months ago), but nobody has made any attempt to effect repairs. This is a ghost town in the making, like so many communities and kingdoms that are unable to survive the hardships of the world of Rifts.

Characters who have fought the Mechanoids and seen their destruction, are likely to see disturbing similarities regarding the kinds of damage and blast groupings seen on many of the battle scarred buildings. If these ruins are explored one of the characters will uncover the footprints of a brute. Or is he mistaken? The Mechanoids were not known to have traveled this far from the eastern seaboard. Besides, they were all killed. Right?

The village people won't allow the characters to rummage in or around the damaged buildings. Some might argue that going into the buildings is hazardous because they could collapse at any moment, but most are belligerent, telling the adventurers to, "Get the hell out of there! You have no business there! Get out!!"

If the characters ignore the complaints and persist in their investigations, a neighbor is likely to appear with an energy rifle to better convey their demand. Equally likely is the local constable appearing with five or six armed deputies and demanding that the characters move on. If this happens, the characters may be fined and escorted out of town for trespassing and scavenging on private property.

When asked about the Mechanoids the townsfolk will feign ignorance, but they look worried whenever the Mechanoids are mentioned. Psychics will sense intense fear, anger and sorrow. They will also sense that the person is lying. A telepathic probe might even reveal thoughts or images of Mechanoids attacking the town, but the people will deny "such crazy talk!"

There are no public stores, saloons, dance halls, hotels or open businesses. Nor will private citizens consider trading goods or putting people up in their homes. All the heroes keep hearing is, "Sorry, can't help you." "Don't know." "Get out of here. We don't want your kind in our town ..." and similar. Nobody will talk about the town's decline, the recent battle, the weather or anything else. People turn away, lock doors, give them mean or frightened glances, or just ignore them completely. On the edge of town is the disturbing sight of a graveyard with at least a thousand recently dug graves.

## What to Do?

Something is obviously wrong at this town. Evidence indicates the Mechanoids are somehow involved. Sneaking back to town under the cover of darkness will allow the adventurers to move about freely. All the townsfolk are locked up in their houses. The streets are empty. Only the factory in the center of town is lighted and in operation.

Hanging around town at night for more than an hour will lead our heroes to an encounter with a weevil and two skimmers. A tunnel crawler might also be found among the ruins. If nothing else, the group will have their worst suspicions confirmed.

### Battle with the Mechanoids

This is the local Mechanoids' last shot. Everything is riding on their holding the factory and building a legion of robots, followed by Mechanoid clones. If our heroes have encountered any Mechanoids or Mechanoid robots, they must make their

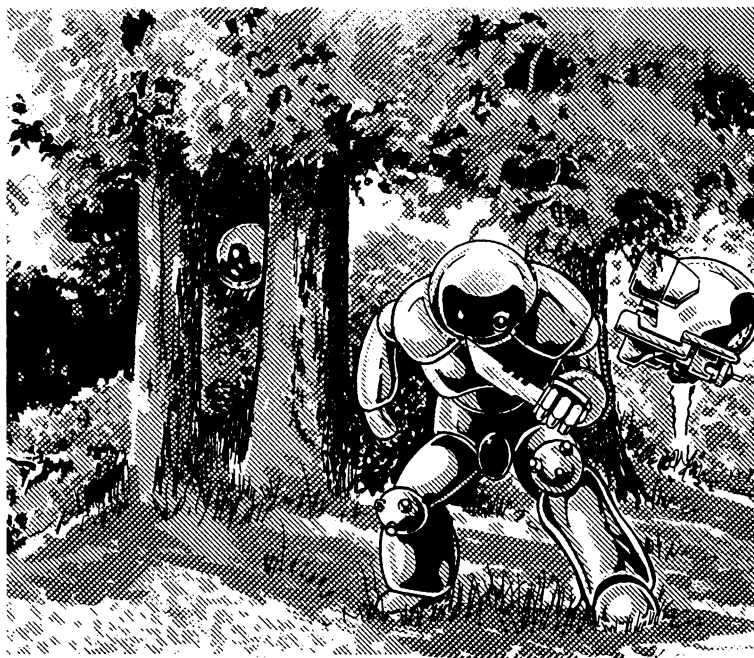

move in the next 24 hours. Otherwise, some Mechanoids might escape. Any character of good alignment will not allow this to happen. Even evil and selfish characters should realize the gravity of the situation and agree to join the battle. A score of villagers will also join the battle if they believe the heroes have a chance of defeating the monsters.

If the Mechanoids realize they have been uncovered, they will dispatch half of the brutes and robots to find and kill the invaders. The rest will remain to protect the factory. All the Mechanoids will fight to the death — they have nothing to lose. Only a runner or brain, accompanied by 1D6 robots, will try to escape to build anew. **Note:** If a Mechanoid escapes, the next adventure can be tracking it down.

---

## Other Adventure Ideas

---

**1. The Mechanoid God!** A village of 1D6 × 100 D-bees have adopted an evil or anarchist AbM Oracle (an evil Mechanoid brain and some bots) as their god. Among the Mechanoid's resources are a dozen or so Mechanoid robots. This god has protected them from other Mechanoids and menaces. Is this a benevolent AbM or rogue or a clever ruse? Is the Mechanoid a friend or enemy of humankind? If you try to kill it, how do you avoid hurting these misguided D-Bees who will fight to the death to protect their god!?

**2. The Torturer.** A Mechanoid runner, a type two brute and a handful of robots have just finished decimating a tiny village (six houses, three barns and a stable, about 40 people in all). Screams and crying can be heard from the barn. Inside a type two brute (with two optional weapon packages) is conducting vivisection and terrible experiments on a male D-bee. Two runts hold the man down. Three thinmen have over a dozen people corralled in a corner.

**3. The Secret:** An evil Mechanoid brain or runner becomes the friend and partner of a line walker or *shifter* to learn the

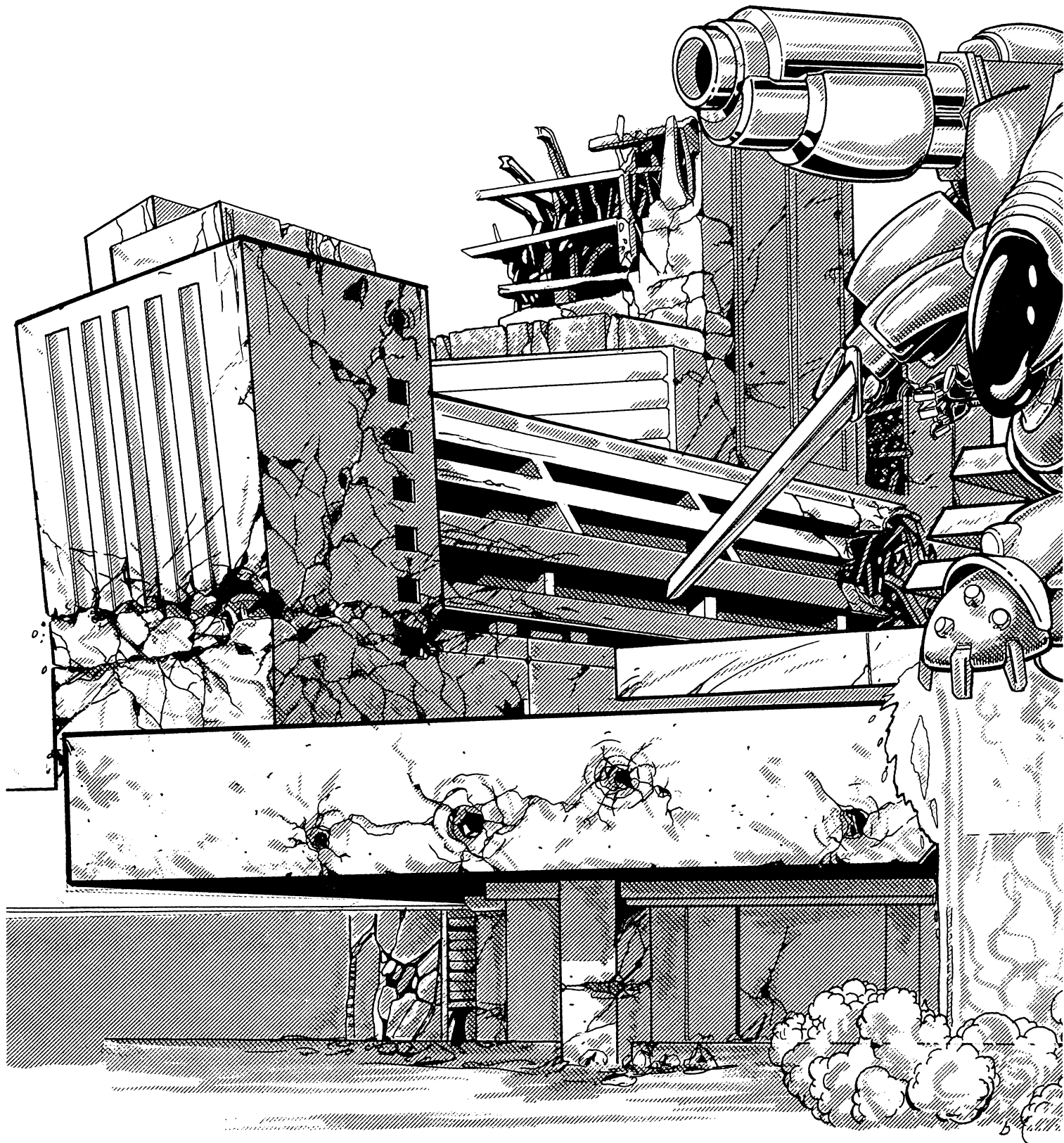



The Brute is equipped with two plasma cannons. Both are of a different design styling, but effectively the same as the one described. The unit mounted on the back is an additional sensor.

EWELL / SIEMBIEDA - 92



secrets of dimensional travel and magic. The Mechanoid pretends to be a demure, loyal friend and servant. However, it secretly plans to find a way to open a rift to the Mechanoid homeworld and bring back an avenging army. It hates its association with humanoids, but is willing to make any sacrifice to advance the goals of its race — the genocide of all humanoid life.

The predicament is that the practitioner of magic and his other servants, friends and allies don't know anything about the Mechanoids and are convinced that the runner is a gentle D-Bee. They are equally convinced that the player characters are fanatical lunatics out for the blood of innocent alien life forms. Thus, the mage and his allies will do everything in their power to protect the runner. Meanwhile, anybody who knows about the Mechanoids will realize that this is a terrible situation, because if the runner can ever open a rift to its homeworld it means the oblivion of the humanoids of Earth.

**4. Supernatural Influence:** A handful of foolish Mechanoids (evil ones or AbMs) befriend a mindolar. They take the foul beast into their confidence as an ally (it is inhuman after all) and, after a brief while, the supernatural creature takes control of their minds. The number and variety of Mechanoids controlled by the mindolar is left up to the GM, as are the creature's plans.

Any non-humanoid, supernatural monster may join forces with the Mechanoids.

**5. A case of mistaken identity.** Our heroes are actively fighting Mechanoids whenever they are encountered and are enjoying great success. Occasionally, they find a group of Mechanoids destroyed by somebody else. One night there is the sudden eruption of gunfire near the camp. When the characters arrive, they find the smoking husk of a runner and four bots. The attacker is nowhere to be seen. From time to time, they find clues that seem to lead them to Mechanoid lairs. They even receive an occasional radio message with information about Mechanoid troop movements and locations from an unidentified "friend" (Hagan).

Eventually, our heroes are confronted by a powerful group of Mechanoids. The aliens are convinced that the heroes, alone, have been delivering havoc to their dwindling numbers.

This Mechanoid force is unusual in that they are extremely powerful and have high ranking Mechanoids among them. This force includes one brain, three runners, four type one brutes, four exterminators and seeker pods, two wasps, 12 thinmen and two weevils. Even more unusual, the aliens have NOT struck out with deadly force. They want to take prisoners and ask questions.

The big question is, "How do you know where we are all the time? Tell us how you've been able to track our every move! If you cooperate, we will make your death quick and painless. Otherwise you will suffer long and horrible torture before you die."

The Mechanoids will try to capture as many members of the group as possible. A pitched battle may not be ideal at this time and the player characters may want to stall or surrender, waiting for a more opportune time to escape or attack. The Mechanoids will let most of the humanoids keep their body armor, power armor and minor weapons. Only obvious and powerful weapons and robot vehicles will be taken away.

Hagan MAY make an appearance in his armor and/or bot (with his other bots too) to rescue the characters at any point.

This encounter should be the prelude to the big, climactic battle with the spider fortress.

**6. The ultimate showdown!** Probably, the final confrontation will be tracking down and destroying the Mechanoid Spider Fortress and its Troops. Smart characters will have waged a war of attrition, luring squads of Mechanoids to their doom in many smaller skirmishes to reduce the Mechanoids' numbers. Hagan is almost certain to be involved.

A battle at A.R.C.H.I.E.'s base (optional), is possible, but unlikely. Arch can eliminate those Mechanoids himself. Furthermore, A.R.C.H.I.E. and Hagan would like to keep their involvement in bringing the Mechanoids to Earth their little secret!

**Note:** Don't forget about the Minions of Splugorth, the Coalition, and fanatical cultists for additional conflict and intrigue.

## Random Mechanoids Encounters Table

- 01-05** One, lone Tunnel Crawler. There may be other Mechanoids within 20 miles who might come to its aid (GM's choice).
- 06-15** Robot reconnaissance patrol: One weevil and two skimmers or assault probes.
- 16-20** 1D4 wasps doing a fly-by at Mach speeds. Only a 1-40% chance of noticing humanoids, unless attacked. If attacked the wasps will fight to the death.
- 21-25** A type two brute with full weapon options and 1D4 thinmen or runts.
- 26-32** Mechanoids' low profile reconnaissance team: One weevil, two tunnel crawlers, two skimmers, two seeker pods, and two runts.
- 33-41** Mechanoids' low profile seek & destroy team: Two tunnel crawlers, two skimmers, two exterminators and seeker pods, four assault probes, and a runt.
- 42-51** Mechanoids' standard reconnaissance team: One weevil, one seeker pod, one brute (type one), another brute (type two), two tunnel crawlers, two skimmers, two runts, and two thinmen.
- 52-54** 1D4 + 2 assault probes and a skimmer.
- 55-65** Mechanoids' standard seek & destroy team: One weevil, two skimmers, two exterminators and seeker pods, four assault probes, two wasps, a type one Brute (with full weapon package), a type two brute (with full weapon package) and three thinmen.
- 66-72** Mechanoids' high profile, reconnaissance team: Two runners, two type one brutes, two exterminators & seeker pods, one wasp, two skimmers, and four thinmen.
- 73-77** Mechanoids low profile research team (field scientists): One brain or two runners, one brute (type one — no weapon package), one exterminator and seeker pod, one skimmer, two runts and four thinmen.
- 78-80** A type one brute with full weapon package leading eight thinmen.
- 81-86** Mechanoids' standard strike force & rescue team: Four wasps, four skimmers, two type one brutes (with full weapon package), two type two brutes (with full weapon packages) four exterminators & seeker pods and six thinmen
- 87-92** Four wasps on patrol. There is a 1-79% likelihood that they will spot any humanoids or troop movement and attack.

- 93-95** A Mechanoids' repair team enroute: One brute, one octopus, two thinmen, and two runts. If they can be followed without being discovered, they will lead to an assault team ready to launch an attack on a factory town. If the group is discovered, all will fight to the death.
- 96-00** Mechanoids' high profile research team (field scientists): Three runners, one weevil, one mantis, two wasps, four brutes (either type), two exterminators, two runts and six thinmen.

## Random Wilderness Encounter Table

- 01-10** Kittani Patrol: Four serpents and two equestrians. They are likely to be friendly to any creature who's out to destroy the Mechanoids. Impatient with cowards. Looking for action.
- 11-18** A party of 1D4 + 3 Brodkil demons (see **Rifts Sourcebook One**, page 115, or substitute another demon or monster) looking for trouble.
- 19-24** Mechanoids' standard strike force: Four wasps, four skimmers, two type one brutes (with full weapon packages), two type two brutes (with full weapon packages), four exterminators & seeker pods and six thinmen.
- 25-31** Splugorth Slaver and six warrior women looking for slaves. Is likely to attack the player characters.
- 32-37** Mechanoids' robot reconnaissance patrol: One weevil and two skimmers.
- 38-40** A damaged thinman (or other Mechanoid or bot) separated from its group. The bot is missing its left arm and half its M.D.C. from the main body. Shoots at any humanoid it encounters. A Splugorth Powerlord and four Overlords. They're here to investigate the Mechanoid threat, but hate humans and will fight them whenever they are encountered. They will retreat when half have been slain.
- 41-56** Coalition reconnaissance squad spoiling for a fight. These men hate D-Bees and practitioners of magic as much as anything else. 1D4 + 3 soldiers.
- 57-62** 2D4 + 2 fanatical cultists hunting and killing D-bees. One is a 1D4 level practitioner of magic.
- 63-65** A pair of wasps on patrol, will attack and fight to the death!
- 66-68** 2D4 + 3 cowardly, bushwhacking bandits. They will flee in terror if their opponent proves to be too tough. The leader is a third level, full conversion borg.
- 69-70** 1D4 fury beetles that have been panicked by something and attack.
- 71-74** Mechanoids' standard reconnaissance team: One weevil, one seeker pod, one brute (type one), another brute (type two), two tunnel crawlers, two skimmers, two runts, and two thinmen.
- 75-77** A party of 1D4 + 3 Brodkil demons (see **Rifts Sourcebook One**, page 115, or substitute another demon or monster) looking for trouble.
- 78-80** Mechanized bandits! Three combat robots (GM's choice), three bandits in power armor (GM's choice), and three bandits in heavy body armor and jet packs.
- 81-83** 1D4 vampires or other supernatural menace!
- 84-87** Two exterminators and seeker pods accompanied by four assault probes. A type one brute (with full weapon package) and four thinmen will join the fight within four minutes.
- 88-91** 1D4 Shemarrian warriors riding Monst-Rexes. They will demand the adventurers make a 50 mile (80 km) detour or attack and fight to the death (see **Rifts Sourcebook One**, page 89-91, or substitute other danger).
- 92-95** A mated pair of rhino-buffalo who won't tolerate being interrupted; attack and fight to the death (see **Rifts Sourcebook One**, page 109, or substitute other monster).
- 96-00** A type two brute with full weapon options or exterminator and 1D4 thinmen or runts.

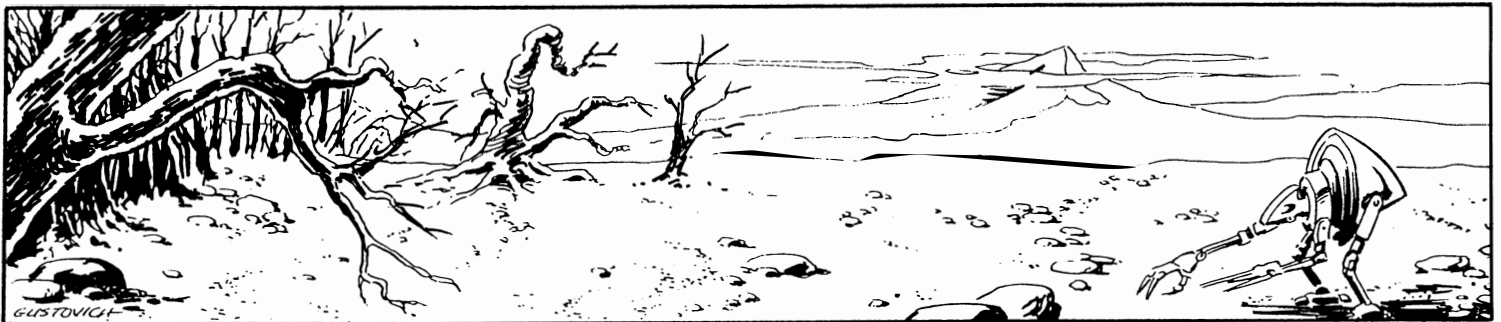

# Rifts® Coalition O.C.C. Character Sheet

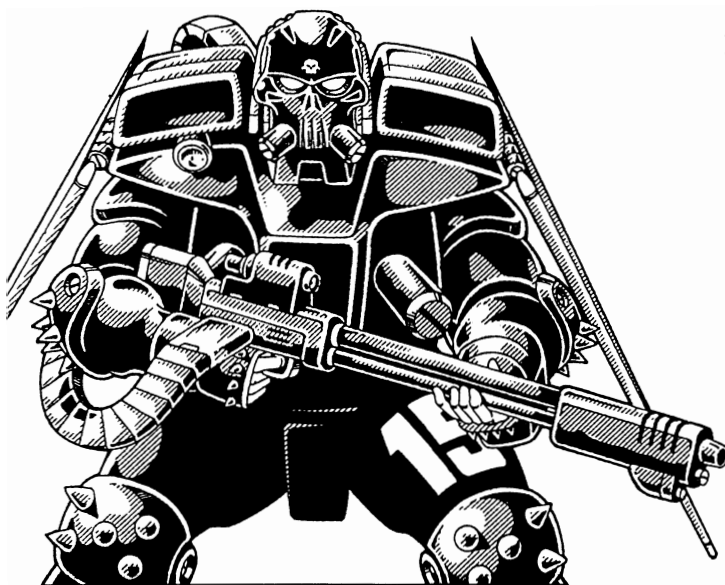

**NAME:** \_\_\_\_\_  
**RANK:** \_\_\_\_\_  
**ALIGNMENT:** \_\_\_\_\_  
**HIT POINTS:** \_\_\_\_\_ **S.D.C.(Physical):** \_\_\_\_\_  
**LEVEL:** \_\_\_\_\_ **EXPERIENCE:** \_\_\_\_\_  
**O.C.C.:** \_\_\_\_\_  
**SAVINGS:** \_\_\_\_\_ **BLACK MARKET ITEMS:** \_\_\_\_\_

**I.Q.:** \_\_\_\_\_ **SKILL BONUS:** + \_\_\_\_\_ %  
**M.E.:** \_\_\_\_\_ **SAVE VS. PSI/INS.:** + \_\_\_\_\_  
**M.A.:** \_\_\_\_\_ **TRUST/INTIMIDATE:** \_\_\_\_\_ %  
**P.S.:** \_\_\_\_\_ **DAMAGE BONUS:** + \_\_\_\_\_  
**P.P.:** \_\_\_\_\_ **STRIKE/PARRY/DODGE BONUS:** + \_\_\_\_\_  
**P.E.:** \_\_\_\_\_ **COMA/DEATH, POISON BONUS:** + \_\_\_\_\_ %/+\_\_\_\_  
**P.B.:** \_\_\_\_\_ **CHARM/IMPRESS:** \_\_\_\_\_ %  
**Spd:** \_\_\_\_\_ **METERS/MINUTE:** \_\_\_\_\_  
**P.P.E.:** \_\_\_\_\_ **I.S.P.:** \_\_\_\_\_

**O.C.C. Skills**                      **+% /Lvl.**          **%**

<b>O.C.C. Skills</b>	<b>+% /Lvl.</b>	<b>%</b>
_____	_____	_____
_____	_____	_____
_____	_____	_____
_____	_____	_____
_____	_____	_____
_____	_____	_____
_____	_____	_____
_____	_____	_____
_____	_____	_____
_____	_____	_____
_____	_____	_____
_____	_____	_____
_____	_____	_____

**O.C.C. Related Skills:**                      **+%/Lvl.**          **%**

<b>O.C.C. Related Skills:</b>	<b>+%/Lvl.</b>	<b>%</b>
_____	_____	_____
_____	_____	_____
_____	_____	_____
_____	_____	_____
_____	_____	_____
_____	_____	_____
_____	_____	_____
_____	_____	_____
_____	_____	_____
_____	_____	_____
_____	_____	_____
_____	_____	_____
_____	_____	_____
_____	_____	_____
_____	_____	_____
_____	_____	_____
_____	_____	_____
_____	_____	_____
_____	_____	_____
_____	_____	_____
_____	_____	_____
_____	_____	_____

**AGE:** \_\_\_\_\_ **SEX:** \_\_\_\_\_  
**HEIGHT:** \_\_\_\_\_ **WEIGHT:** \_\_\_\_\_  
**FAMILY ORIGIN:** \_\_\_\_\_  
**DISPOSITION:** \_\_\_\_\_  
**TYPE OF ENVIORNMENT:** \_\_\_\_\_  
**SENTIMENTS TOWARD THE COALITION:** \_\_\_\_\_  
\_\_\_\_\_  
**SENTIMENTS TOWARD NON-HUMANS:** \_\_\_\_\_  
\_\_\_\_\_  
\_\_\_\_\_

**Secondary Skills:**                      **+%/Lvl.**          **%**

<b>Secondary Skills:</b>	<b>+%/Lvl.</b>	<b>%</b>
_____	_____	_____
_____	_____	_____
_____	_____	_____
_____	_____	_____
_____	_____	_____
_____	_____	_____
_____	_____	_____
_____	_____	_____
_____	_____	_____
_____	_____	_____
_____	_____	_____
_____	_____	_____
_____	_____	_____
_____	_____	_____
_____	_____	_____

**Notes:**  
\_\_\_\_\_  
\_\_\_\_\_  
\_\_\_\_\_  
\_\_\_\_\_  
\_\_\_\_\_  
\_\_\_\_\_  
\_\_\_\_\_  
\_\_\_\_\_  
\_\_\_\_\_  
\_\_\_\_\_  
\_\_\_\_\_  
\_\_\_\_\_  
\_\_\_\_\_

# Rifts® Magic O.C.C. Character Sheet

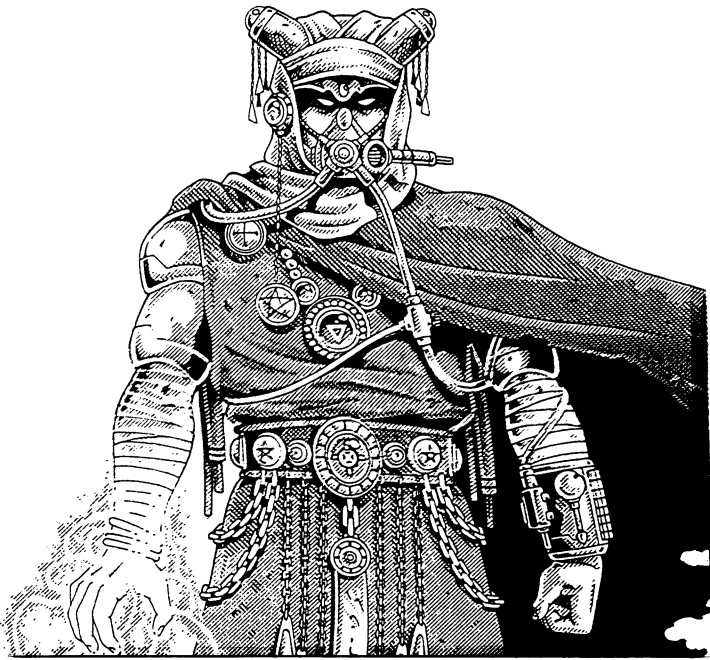

**NAME:** \_\_\_\_\_  
**RANK:** \_\_\_\_\_  
**ALIGNMENT:** \_\_\_\_\_  
**HIT POINTS:** \_\_\_\_\_ **S.D.C.(Physical):** \_\_\_\_\_  
**LEVEL:** \_\_\_\_\_ **EXPERIENCE:** \_\_\_\_\_  
**O.C.C.:** \_\_\_\_\_  
**SAVINGS:** \_\_\_\_\_ **BLACK MARKET ITEMS:** \_\_\_\_\_

**I.Q.:** \_\_\_\_\_ **SKILL BONUS: +** \_\_\_\_\_ %  
**M.E.:** \_\_\_\_\_ **SAVE VS. PSI/INS.: +** \_\_\_\_\_  
**M.A.:** \_\_\_\_\_ **TRUST/INTIMIDATE:** \_\_\_\_\_ %  
**P.S.:** \_\_\_\_\_ **DAMAGE BONUS: +** \_\_\_\_\_  
**P.P.:** \_\_\_\_\_ **STRIKE/PARRY/DODGE BONUS: +** \_\_\_\_\_  
**P.E.:** \_\_\_\_\_ **COMA/DEATH, POISON BONUS: +** \_\_\_\_\_ %/+ \_\_\_\_\_  
**P.B.:** \_\_\_\_\_ **CHARM/IMPRESS:** \_\_\_\_\_ %  
**Spd:** \_\_\_\_\_ **METERS/MINUTE:** \_\_\_\_\_  
**P.P.E.:** \_\_\_\_\_ **I.S.P.:** \_\_\_\_\_

O.C.C. Skills	+%/Lvl.	%
_____	_____	_____
_____	_____	_____
_____	_____	_____
_____	_____	_____
_____	_____	_____
_____	_____	_____
_____	_____	_____
_____	_____	_____
_____	_____	_____
_____	_____	_____
_____	_____	_____
_____	_____	_____
_____	_____	_____
_____	_____	_____
_____	_____	_____
_____	_____	_____
_____	_____	_____
_____	_____	_____
_____	_____	_____
_____	_____	_____
_____	_____	_____
_____	_____	_____

O.C.C. Related Skills:	+%/Lvl.	%
_____	_____	_____
_____	_____	_____
_____	_____	_____
_____	_____	_____
_____	_____	_____
_____	_____	_____
_____	_____	_____
_____	_____	_____
_____	_____	_____
_____	_____	_____
_____	_____	_____
_____	_____	_____
_____	_____	_____
_____	_____	_____
_____	_____	_____
_____	_____	_____
_____	_____	_____
_____	_____	_____
_____	_____	_____
_____	_____	_____
_____	_____	_____
_____	_____	_____
_____	_____	_____

**AGE:** \_\_\_\_\_ **SEX:** \_\_\_\_\_  
**HEIGHT:** \_\_\_\_\_ **WEIGHT:** \_\_\_\_\_  
**FAMILY ORIGIN:** \_\_\_\_\_  
**DISPOSITION:** \_\_\_\_\_  
**TYPE OF ENVIORNMENT:** \_\_\_\_\_  
**SENTIMENTS TOWARD THE COALITION:** \_\_\_\_\_  
**SENTIMENTS TOWARD NON-HUMANS:** \_\_\_\_\_  
 \_\_\_\_\_  
 \_\_\_\_\_  
 \_\_\_\_\_  
 \_\_\_\_\_

Secondary Skills:	+%/Lvl.	%
_____	_____	_____
_____	_____	_____
_____	_____	_____
_____	_____	_____
_____	_____	_____
_____	_____	_____
_____	_____	_____
_____	_____	_____
_____	_____	_____
_____	_____	_____
_____	_____	_____
_____	_____	_____
_____	_____	_____
_____	_____	_____
_____	_____	_____
_____	_____	_____
_____	_____	_____
_____	_____	_____
_____	_____	_____
_____	_____	_____
_____	_____	_____
_____	_____	_____
_____	_____	_____
_____	_____	_____
_____	_____	_____

**Notes:**  
 \_\_\_\_\_  
 \_\_\_\_\_  
 \_\_\_\_\_  
 \_\_\_\_\_  
 \_\_\_\_\_  
 \_\_\_\_\_  
 \_\_\_\_\_  
 \_\_\_\_\_  
 \_\_\_\_\_  
 \_\_\_\_\_  
 \_\_\_\_\_  
 \_\_\_\_\_  
 \_\_\_\_\_  
 \_\_\_\_\_  
 \_\_\_\_\_





Hand To Hand	Robot Combat	Robot Combat	Vehicle Log	Equipment
Type: _____	Type: _____	Type: _____	Type: _____	_____
Number of Attacks: _____	Number of Attacks: _____	Number of Attacks: _____	Number of Attacks: _____	_____
Damage: + _____	Damage: + _____	Damage: + _____	Crew: _____	_____
Strike: + _____	Strike: + _____	Strike: + _____	Max. Speed: _____	_____
Parry: + _____	Parry: + _____	Parry: + _____	Max. Range: _____	_____
Dodge: + _____	Dodge: + _____	Dodge: + _____	Engine: _____	_____
Roll: + _____	Roll: + _____	Roll: + _____	Length: _____	_____
Initiative: + _____	Initiative: + _____	Initiative: + _____	Weight: _____	_____
<b>DAMAGES:</b>	<b>DAMAGES:</b>	<b>DAMAGES:</b>	<b>M.D.C.</b>	_____
Punch: _____	Punch: _____	Punch: _____	Main Body: _____	_____
Kick: _____	Punch: _____	Punch: _____	Tires( ): _____	_____
Jump Kick: _____	Punch: _____	Punch: _____	Pil. Comp.: _____	_____
Flip: _____	Kick: _____	Kick: _____	<b>WEAPONS:</b>	_____
<b>SPECIAL ATTACKS:</b>	Leap Kick: _____	Leap Kick: _____	Laser: _____	_____
Knock Out: _____	Flip: _____	Flip: _____	Machine Gun: _____	_____
Critical Strike: _____	Tackle: _____	Tackle: _____	Special: _____	_____
Death Blow: _____	Stomp: _____	Stomp: _____	Special: _____	_____
<b>SPECIAL SKILLS:</b>	<b>SPEED:</b>	<b>SPEED:</b>	<b>NOTES:</b>	_____
Climb _____ %	Land: _____	Land: _____	_____	_____
Palm: _____ %	Flying: _____	Flying: _____	_____	_____
Pick Pockets: _____ %	Running: _____	Running: _____	_____	_____
Streetwise: _____ %	<b>M.D.C.:</b>	<b>M.D.C.:</b>	_____	_____
Prowl: _____ %	Main Body: _____	Main Body: _____	_____	_____
<b>HIT POINTS:</b>	Head: _____	Head: _____	_____	_____
S.D.C.: _____	Leg(Lft.): _____	Leg(Lft.): _____	_____	_____
P.P.E.: _____	Leg(Rt.): _____	Leg(Rt.): _____	_____	_____
I.S.P.: _____	Arm(Lft.): _____	Arm(Lft.): _____	_____	_____
<b>BODY ARMOR: ( )</b>	Arm(Rt.): _____	Arm(Rt.): _____	_____	_____
M.D.C.: _____	<b>NOTES:</b> _____	<b>NOTES:</b> _____	_____	_____
<b>NOTES:</b> _____	_____	_____	_____	_____
_____	_____	_____	_____	_____
_____	_____	_____	_____	_____

**Weapons:**

Weapon	Range	Damage	Payload	Cybernetic	Cost
_____	_____	_____	_____	_____	_____
_____	_____	_____	_____	_____	_____
_____	_____	_____	_____	_____	_____
_____	_____	_____	_____	_____	_____
_____	_____	_____	_____	_____	_____
_____	_____	_____	_____	_____	_____
_____	_____	_____	_____	_____	_____
_____	_____	_____	_____	_____	_____
_____	_____	_____	_____	_____	_____
_____	_____	_____	_____	_____	_____
_____	_____	_____	_____	_____	_____

**Cybernetics/Bionics:**

**Psionics:**

Psionic	Range	Duration	I.S.P	Saving Throw:
_____	_____	_____	_____	_____
_____	_____	_____	_____	_____
_____	_____	_____	_____	_____
_____	_____	_____	_____	_____
_____	_____	_____	_____	_____
_____	_____	_____	_____	_____
_____	_____	_____	_____	_____
_____	_____	_____	_____	_____
_____	_____	_____	_____	_____
_____	_____	_____	_____	_____
_____	_____	_____	_____	_____

**Weapon Proficiencies:**

Weapon	S	P	+%/Lvl.	%
_____	_____	_____	_____	_____
_____	_____	_____	_____	_____
_____	_____	_____	_____	_____
_____	_____	_____	_____	_____
_____	_____	_____	_____	_____
_____	_____	_____	_____	_____
_____	_____	_____	_____	_____
_____	_____	_____	_____	_____
_____	_____	_____	_____	_____
_____	_____	_____	_____	_____
_____	_____	_____	_____	_____









# RIFTS®

- Imagine Earth transformed into an alien landscape.
- Humans exist – barely. And we are not alone.
- Aliens and monsters emerge from the Rifts – holes torn in the fabric of space and time, connected to countless worlds and realities.
- Ancient gods, demons and magic have returned.
- Magic and technology clash.
- Hundreds of character classes, many inhuman.
- *Rifts® Ultimate Edition* is the core RPG rule book.
- Expansive world setting with 90+ sourcebooks to draw upon.
- Rifts®, your portal to endless adventure.
- Limited only by your imagination.

[www.palladiumbooks.com](http://www.palladiumbooks.com)

© 2014 Palladium Books. Rifts®, Megaverse®, Nightbane® and other titles, slogans and likenesses are trademarks of Palladium Books, Inc. Palladium Books - 39074 Webb Court, Westland, MI 48185 USA - 734-271-2903 order line.

## Other RPG Worlds from Palladium Books®:

- *Rifts®* – the ultimate role-playing experience.
- *Rifts® Chaos Earth®* – Play the apocalypse as it happens.
- *Splicers®* – Weird science. Bio-tech battles insane robot legions.
- *Robotech® RPG* – All eras of the TV show brought to life.
- *Dead Reign™ RPG* – Can you survive the Zombie Apocalypse?
- *Palladium Fantasy RPG®* – Unique world, monsters as player characters, magic and more.
- *Heroes Unlimited™ RPG* – Play any hero; mutants, aliens, cyborgs, superhumans, mages, immortals and more.
- *Nightbane® RPG* – Conspiracy, magic, horror and monsters.
- *Beyond the Supernatural™ RPG* – Modern horror and suspense.
- *Ninjas and Superspies™*, and more.



# ROBOTECH®

## Role-Playing Game and Sourcebooks

- **Four generations of heroes and mecha** • **Giant transformable robots** • **Alien invaders** • **Battle for control of the Earth** • **Combat takes to the stars** • **All presented in a core rule book and dynamic set of epic sourcebooks** • **Easy to learn** • **Fun to play** • **Quick character generation** • **Fast combat** • **Captures the action and adventure of the anime TV series** • **Isn't it time you joined the adventure?**

### Robotech® "Core Rules" – Shadow Chronicles® RPG Hardcover

All the rules and information a player needs to start a Robotech® role-playing campaign with Admiral Rick Hunter and the United Earth Expeditionary Force trekking across the galaxy.

- Human mecha: Alphas, Betas, Cyclones & much more.
- Five character classes. 25 different Military Specialties.
- Invid mecha, Haydonites, and alien enemies.
- Quick roll character tables. Make a character in 15 minutes.
- A complete, stand-alone RPG.
- 224 pages. Cat. No. 550HC. 8½ x 11 size, hardcover.

### Robotech®: The Macross® Saga Sourcebook – Cat. No. 551

A treasure chest packed with the iconic mecha, vehicles, weapons and characters that made Robotech® famous. Valkyries, Destroyers, ground vehicles, aircraft, spacecraft, weapons, Zentraedi soldiers, Zentraedi mecha, alien invaders, heroes, villains, and more.

- All the iconic Macross mecha, vehicles, weapons & characters.

[www.palladiumbooks.com](http://www.palladiumbooks.com)

### Robotech®: The Masters Saga™ Sourcebook – Cat. No. 552

Tons of never before seen stats and descriptions for the many weapons, armor, mecha and robots of the Army of the Southern Cross.

- The Army of the Southern Cross™ – all 15 branches and their mecha!

### Robotech®: New Generation™ Sourcebook – Cat. No. 554

The battle for the liberation of Earth starts here.

- Kit-bashed mecha combining parts from different mecha.
- Invid Hives, world overview, key characters and adventure ideas.

### Robotech®: Genesis Pits™ Sourcebook – Cat. No. 555

The Invid Genesis Pits, their purpose, function.

- Inorganics and other war machines of the Invid Regent.
- Genesis Pit mutations and monsters.

### Robotech®: Expeditionary Marines Sourcebook – Cat. No. 553

Join the UEEF (United Earth Expeditionary Force) led by Admiral Rick Hunter as they travel across the galaxy liberating planets from the bondage of the Invid Regent, the Robotech Masters and other tyrants.

- New mecha, weapons, and character classes of the UEEF Marines.
- New alien species and allies. Planet hopping and more.



# ROBOTECH

R P G T A C T I C S

## Main Boxed Game – Cat. No. 55100 – Available Now!

A fast-paced, strategy battle game that captures the speed and action of Robotech®. Play Earth defenders or Zentraedi invaders.

- Scalable from small squad skirmishes to mass battles.
- Turn-based system of play and uses D6. Two or more players.
- 34 highly detailed game pieces. 6mm scale.
- 112 page color rule book with paint guide and index.
- 53 laminated, color game cards.
- 24 custom dice, two decal sheets and more.
- Assembly and painting required. Glue not included.
- \$99.95 retail – Cat. No. 55100 – shipping now!
- Available in North and South America, the EU, Australia & New Zealand.

**Note:** Each product contains plastic game pieces requiring assembly and painting. Glue not included. This is not a toy. Small parts, not suitable for children under the age of 13. Adult supervision advised. Images shown here are not to scale.



### UEDF Valkyrie Wing™ – Cat. No. 55201

Build your fleet of Earth defenders with the Valkyrie Veritech Fighter; six game pieces total. **\$36.95 retail.**

- 2 Valkyries in Fighter mode.
- 2 Valkyries in Guardian mode.
- 2 Valkyries in Battloid mode.
- Multiple heads for making the VF-1A, VF-1J, VF-1R & VF-1S.



### UEDF Tomahawk/Defender Destroids™ – Cat. No. 55202

Expand your Destroid squad with these formidable walking tanks; four game pieces total. **\$32.95 retail.**

- 2 Tomahawk Destroids – the main battle tank of Destroids, brimming with powerful particle beam cannons for arms, and wielding a battery of missiles and an array of other weapons.
- 2 Defender Destroids – a long-range, anti-aircraft juggernaut capable of shooting down incoming Zentraedi Battlepods and Gnerl Fighters.



### UEDF Spartan/Phalanx Destroids™ – Cat. No. 55203

Add some long-range power and up-close punch to your army with these valuable Destroids; four game pieces total. **\$32.95 retail.**

- 2 Spartan Destroids – civil defense, riot control and deadly in hand to hand combat.
- 2 Phalanx Destroids – a walking, long-range missile artillery unit.



### Zentraedi Regult Battlepods™ – Cat. No. 55401

Expand your Zentraedi forces with their main infantry battle mecha; six game pieces total. **\$36.95 retail.**

- 6 Regult Tactical Battlepods – the lightning quick Regults, armed with a pair of particle cannons and auto-cannons, attack in wave after wave.



### Zentraedi Artillery Battlepods™ – Cat. No. 55402

Give your Zentraedi legion greater firepower with these artillery and support Battlepods; four game pieces total. **\$36.95 retail.**

- 4 Zentraedi Support Battlepods, each of which can be made into:
    - Gluhaug-Regult – Light Artillery Battlepod
    - Serauhaug-Regult – Heavy Artillery Battlepod
    - Telnesta-Regult – Experimental Particle Beam Battlepod
- Four game pieces total.**



### Zentraedi Glaug Command™ – Cat. No. 55403

This diverse pack provides your Zentraedi forces with greater tactical capabilities; three game pieces total. **\$36.95 retail.**

- 1 Glaug Officer's Battlepod – the fast and deadly mecha of Zentraedi field leaders.
- 1 Quel-Regult Scout Battlepod – the stealthy eyes and ears of your Zentraedi battle force; electronic warfare capabilities.
- 1 Quel-Gulnau Recovery Pod – enhances the Glaug's ability to bring in Battlepod reinforcements. **Note:** This figure has NEVER before been offered by any company.



# Can YOU survive the Zombie Apocalypse?



## Dead Reign™ RPG

It is the aftermath of the *zombie apocalypse*. Civilization is gone, the dead reign, and the living fight to survive against impossible odds. Tales of zombies, human survival and horror as a fast-paced, easy to learn game and sourcebooks.

- **Zombie combat rules, vehicles and equipment.**
- **Six iconic Apocalyptic Character Classes and Ordinary People with 40+ occupations to choose from.**
- **Seven types of zombies plus the Half-Living.**
- **Secrets of the Dead and tips on fighting zombies.**
- **Death Cults, their Priests, power over zombies and goals.**
- **101 Random Scenarios, Encounters and Settings.**
- **100 Random Corpse Searches and other tables.**
- **Quick Roll Character Creation tables (10 minutes).**
- **A complete role-playing game by Siembieda and others.**
- **\$22.95 retail – 224 pages – Cat. No. 230. Available now.**

## Civilization Gone™

### Dead Reign™ Sourcebook One

It has been months since the dead rose to attack the living. Civilization has crumbled. There is no army, no government, no help coming. You are on your own and things are only getting worse.

- **Madmen and Psychopaths including the *Zombie Master, Ghost Walker, Backstabber, Messianic Leader, Zombie Lover, Deathbringer* and others.**
- **Bandits and Raiders who prey upon other survivors.**
- **Street Gang Protectors and their mission to save lives.**
- **Phobia and Obsession tables. Many adventure ideas.**
- **House and home resource and encounter tables.**
- **Random encounter and survivor camp creation tables.**
- **Additional world information and survival advice.**
- **\$12.92 retail – 64 pages – Cat. No. 231. Available now.**

## Dark Places™

### Dead Reign™ Sourcebook Two

Secrets of survival, including using railroad tracks and the urban underground to travel unseen and undetected by zombies.

- **Worm Meat, Bug Boy, Sewer Crawler and Impersonator Zombies.**
- **“Live Bait” zombie lures with human beings as bait.**
- **Traveling the rails and boxcar encounter tables.**
- **Traveling sewer tunnels, steam tunnels & other dark places.**
- **The pitfalls and dangers of the urban underground.**
- **Diseases, infection and additional world information.**
- **Random encounter tables, boxcar content tables, and more.**
- **\$12.92 retail – 64 pages – Cat. No. 232. Available now.**

## Endless Dead™

### Dead Reign™ Sourcebook Three

The zombie hordes grow in number and strangeness. Can humankind survive? Where is the military?

- **New types of zombies like Fused Zombies and Walking Mass Grave.**
- **New O.C.C.s including Wheelman and Zombie Hunter.**
- **Info & tables for weaponizing vehicles and vehicle combat rules.**
- **Random encounter tables for military bases, police stations, gun stores, buildings, suburbs, industrial parks, small towns, farmland and wilderness.**
- **Tables to make Survivor caravans, hideouts, Safe Havens & more.**
- **Timetable for setting zombie campaigns & many adventure ideas.**
- **\$16.95 retail – 96 pages – Cat. No. 233. Available now.**



## Other horror titles from Palladium Books®

Fear the Reaper™

Graveyard Earth™

Beyond the Supernatural™ RPG

Nightbane® RPG series

© Copyright 2012 Palladium Books Inc. All rights reserved. Rifts®, Palladium Books®, Megaverse®, Nightbane®, Heroes Unlimited, Dead Reign and other published book titles, names, slogans and likenesses are trademarks of Palladium Books Inc.

[www.palladiumbooks.com](http://www.palladiumbooks.com)

# Palladium Books® Check List & Order Form

Dept. P-16, 39074 Webb Court, Westland, MI 48185

Name: \_\_\_\_\_ Address: \_\_\_\_\_

City: \_\_\_\_\_ State: \_\_\_\_\_ Zip/Postal Code: \_\_\_\_\_ Country: \_\_\_\_\_

Credit Card Number: \_\_\_\_\_ Expiration Date: \_\_\_\_\_  Visa  MasterCard

Telephone Number: \_\_\_\_\_ Signature: \_\_\_\_\_  AMEX  Other

## The Rifter® Series

- \_\_\_ 170 The Rifter® #70 – \$13.95
- \_\_\_ 171-172 The Rifter® #71 & 72 – \$24.95
- \_\_\_ 173 The Rifter® #73 – \$13.95
- \_\_\_ 174 The Rifter® #74 – \$13.95
- \_\_\_ 175 The Rifter® #75 – \$13.95
- \_\_\_ 176 The Rifter® #76 – \$13.95 (Fall)

## Splicers®

- \_\_\_ 200 Splicers® RPG – \$23.95
- Note: Sourcebooks coming soon.

## Dead Reign®

- \_\_\_ 230 Dead Reign® RPG – \$22.95
- \_\_\_ 231 SB 1: Civilization Gone™ – \$12.95
- \_\_\_ 232 SB 2: Dark Places™ – \$12.95
- \_\_\_ 233 SB 3: Endless Dead™ – \$16.95
- \_\_\_ 234 SB 4: Fear the Reaper™ – \$12.95
- \_\_\_ 235 SB 5: Graveyard Earth™ – \$12.95
- \_\_\_ 236 SB 6: Hell Followed™ – \$20.95 (coming)

## Rifts® Novels

- \_\_\_ 301 Sonic Boom™ – \$9.95
- \_\_\_ 302 Deception's Web™ – \$9.95
- \_\_\_ 303 Treacherous Awakenings™ – \$9.95
- \_\_\_ 304 Tales of the Chi-Town 'Burbs™ – \$12.95
- \_\_\_ 305 Rifts® Path of the Storm™ – Screen-play & Sourcebook – \$12.95

## Weapons Books

- \_\_\_ 401 Weapons and Armor™ – \$8.95
- \_\_\_ 402 Weapons and Castles™ – \$8.95
- \_\_\_ 403 Weapons and Assassins™ – \$8.95
- \_\_\_ 404 Weapons & Castles of the Orient™ – \$8.95

## Palladium Fantasy RPG®

- \_\_\_ 450 The Palladium Fantasy RPG® – \$26.95
- \_\_\_ 4500HC Palladium Fantasy RPG® 30th Anniversary Hardcover – \$50.00
- \_\_\_ 451 Dragons & Gods™ – \$24.95
- \_\_\_ 453 Old Ones™ 2nd Ed. – \$24.95
- \_\_\_ 454 Monsters & Animals™ 2nd Ed. – \$24.95
- \_\_\_ 455 Adventures on the High Seas™ – \$24.95
- \_\_\_ 458 Island at the Edge of the World™ – \$20.95
- \_\_\_ 459 Yin-Sloth Jungles™ – \$20.95
- \_\_\_ 462 Western Empire™ – \$24.95
- \_\_\_ 463 Baalgor Wastelands™ – \$24.95
- \_\_\_ 464 Mount Nimro™ – \$20.95
- \_\_\_ 465 Eastern Territory™ – \$24.95
- \_\_\_ 466 Library of Bletherad™ – \$20.95
- \_\_\_ 467 Northern Hinterlands™ – \$24.95
- \_\_\_ 468 Land/Damned 1: Chaos Lands™ – \$24.95
- \_\_\_ 469 LoD 2: Eternal Torment™ – \$24.95
- \_\_\_ 470 LoD 3: The Citadel – \$24.95 (coming)
- \_\_\_ 471 Wolfen Empire™ – \$20.95
- \_\_\_ 472 Mysteries of Magic™ One: Heart of Magic – \$16.95
- \_\_\_ 474 Bizantium/Northern Islands™ – \$20.95
- \_\_\_ 475 Garden of the Gods™ – \$12.95 (coming)

## Heroes Unlimited™ / After the Bomb®

- \_\_\_ 500-2 Heroes Unlimited™, 2nd Ed. – \$26.95
- \_\_\_ 5000HC Heroes Unlimited™ 30th Anniversary Hardcover – \$50.00
- \_\_\_ 501 Villains Unlimited™ Revised – \$24.95
- \_\_\_ 503 After the Bomb® RPG – \$24.95
- \_\_\_ 505 Road Hogs™ (After the Bomb® II) – \$9.95
- \_\_\_ 507 Mutants Down Under™ (AB III) – \$9.95
- \_\_\_ 511 Mutants of the Yucatan™ (AB IV) – \$9.95
- \_\_\_ 513 Mutants in Avalon™ (AB V) – \$16.95
- \_\_\_ 514 Mutants in Orbit™ (AB VI) – \$16.95
- \_\_\_ 515 Aliens Unlimited™ – \$24.95
- \_\_\_ 516 Heroes Unlimited™ G.M.'s Guide – \$24.95
- \_\_\_ 517 Century Station™ – \$24.95
- \_\_\_ 518 Gramercy Island™ – \$24.95
- \_\_\_ 519 Aliens Unlimited Galaxy Guide™ – \$24.95
- \_\_\_ 520 Mutant Underground™ – \$16.95
- \_\_\_ 521 Powers Unlimited® One – \$16.95
- \_\_\_ 522 Powers Unlimited® Two – \$16.95
- \_\_\_ 523 Powers Unlimited® Three – \$16.95
- \_\_\_ 525 Revised Ninjas & Superspies™ – \$20.95
- \_\_\_ 526 Mystic China™ – \$24.95
- \_\_\_ 527 Armageddon Unlimited™ – \$20.95

## Robotech® RPG

- \_\_\_ 550 Robotech® The Shadow Chronicles® RPG (manga size) – \$16.95
- \_\_\_ 550HC Robotech® The Shadow Chronicles® Deluxe Hardcover RPG – \$30.95
- \_\_\_ 5500HC Robotech® The Shadow Chronicles® Gold Ed. Hardcover RPG – \$70.00
- \_\_\_ 551 Robotech® Macross® Saga Sourcebook – \$16.95
- \_\_\_ 552 Robotech® The Masters Saga™ Sourcebook (NEW in 8½ x 11) – \$20.95
- \_\_\_ 553 Robotech®: Expeditionary Force Marines Sourcebook – \$20.95
- \_\_\_ 554 Robotech® The New Generation™ Sourcebook – \$16.95
- \_\_\_ 555 Robotech® Genesis Pits Sourcebook – \$16.95

## Robotech® RPG Tactics™ (New!)

- \_\_\_ 55100 Robotech® RPG Tactics™ – \$99.95
- \_\_\_ 55105 Robotech® RPG Tactics™ Rulebook – \$20.00
- \_\_\_ 55101 UEDF Dice Pack – \$12.00
- \_\_\_ 55102 Zentraedi Dice Pack – \$12.00
- \_\_\_ 55201 UEDF Valkyrie Wing – \$36.95
- \_\_\_ 55202 UEDF Destroid Pack – \$32.95
- \_\_\_ 55203 UEDF Spartan Pack – \$32.95
- \_\_\_ 55401 Zentraedi Regult Battlepods – \$36.95
- \_\_\_ 55402 Zentraedi Artillery Battlepods – \$36.95
- \_\_\_ 55403 Zentraedi Glaug Command – \$36.95

## Rifts® Chaos Earth®

- \_\_\_ 660 Rifts® Chaos Earth® RPG – \$20.95
- \_\_\_ 661 Rifts® CE Creatures of Chaos™ – \$12.95
- \_\_\_ 662 Rifts® CE The Rise of Magic™ – \$12.95
- \_\_\_ 665 Rifts® Chaos Earth® First Responders™ – \$16.95 (coming)
- \_\_\_ 666 Rifts® Chaos Earth® Resurrection™ – \$20.95

## Beyond the Supernatural™

- \_\_\_ 700 Beyond the Supernatural™, 2nd Ed. – \$24.95
- \_\_\_ 702 Tome Grotesque™ – \$20.95 (coming)
- \_\_\_ 703 Beyond Arcanum™ – \$24.95 (coming)

## Nightbane®

- \_\_\_ 730 Nightbane® RPG – \$24.95
- \_\_\_ 731 Nightbane®: Between the Shadows™ – \$20.95
- \_\_\_ 732 Nightbane®: Nighlands™ – \$20.95
- \_\_\_ 733 Nightbane®: Through the Glass Darkly™ – \$20.95
- \_\_\_ 735 Nightbane® Survival Guide™ – \$20.95

## Rifts®

- \_\_\_ 800HC Rifts® RPG Ultimate Edition – \$39.95
- \_\_\_ 801 Rifts® Sourcebook One Revised – \$20.95
- \_\_\_ 802-E Rifts® World Book 1: Vampire Kingdoms™, Revised – \$24.95
- \_\_\_ 803 Rifts® Conversion Book One™ – \$24.95
- \_\_\_ 804 Rifts® WB 2: Atlantis™ – \$20.95
- \_\_\_ 805 Rifts® Sourcebook 2: Mechanoids™ – \$16.95
- \_\_\_ 807 Rifts® WB 3: England™ – \$20.95
- \_\_\_ 808 Rifts® WB 4: Africa™ – \$20.95
- \_\_\_ 809 Rifts® Dimension Book 1: Wormwood™ – \$20.95
- \_\_\_ 810 Rifts® WB 5: Triax™ – \$24.95
- \_\_\_ 811 Rifts® Pantheons of the Megaverse® – \$24.95
- \_\_\_ 812 Rifts® Sourcebook 3: Mindwerks™ – \$16.95
- \_\_\_ 813 Rifts® Mercenaries™ – \$20.95
- \_\_\_ 814 Rifts® WB 6: South America™ – \$20.95
- \_\_\_ 815 Rifts® WB 7: Underseas™ – \$24.95
- \_\_\_ 816 Rifts® DB 2: Phase World® – \$24.95
- \_\_\_ 817 Rifts® DB 3: Phase World® Sourcebook – \$16.95
- \_\_\_ 818 Rifts® WB 8: Rifts® Japan™ – \$24.95
- \_\_\_ 819 Rifts® WB 9: South America Two™ – \$24.95
- \_\_\_ 820 Rifts® WB 10: Juicer Uprising™ – \$20.95
- \_\_\_ 821 Rifts® WB 11: Coalition War Campaign™ – \$24.95

- \_\_\_ 822 Rifts® WB 12: Psyscape™ – \$20.95  
 \_\_\_ 825 Rifts® WB 13: Lone Star™ – \$20.95  
 \_\_\_ 826 Rifts® WB 14: New West™ – \$24.95  
 \_\_\_ 827 Rifts® WB 15: Spirit West™ – \$24.95  
 \_\_\_ 828 Rifts® Sourcebook 4: Coalition Navy™ – \$16.95  
 \_\_\_ 829 Rifts® WB 16: Federation of Magic™ – \$20.95  
 \_\_\_ 830 Rifts® DB 4: Skraypers™ – \$20.95  
 \_\_\_ 831 Rifts® Index Volume Two™ – \$16.95  
 \_\_\_ 832 Rifts® WB 17: Warlords of Russia™ – \$24.95  
 \_\_\_ 833 Rifts® WB 18: Mystic Russia™ – \$20.95  
 \_\_\_ 834 Rifts® WB 19: Australia 1 – \$24.95  
 \_\_\_ 835 Rifts® WB 20: Canada™ – \$24.95  
 \_\_\_ 836 Rifts® WB 21: Splynn Dimensional Market™ – \$24.95  
 \_\_\_ 837 Rifts® WB 22: Free Quebec™ – \$24.95  
 \_\_\_ 838 Rifts® WB 23: Xiticix Invasion™ – \$20.95  
 \_\_\_ 839 Rifts® Coalition Wars®: Sedition™ – \$20.95  
 \_\_\_ 840 Rifts® Coalition Wars®: Coalition Overkill™ – \$16.95  
 \_\_\_ 841 Rifts® Coalition Wars®: Sorcerers' Revenge™ – \$16.95  
 \_\_\_ 842 Rifts® Coalition Wars®: Cyber-Knights™ – \$16.95  
 \_\_\_ 843 Rifts® Coalition Wars®: Shadows of Evil™ – \$16.95  
 \_\_\_ 844 Rifts® Coalition Wars®: Final Siege™ – \$24.95  
 \_\_\_ 845 Rifts® Game Master Guide™ – \$26.95  
 \_\_\_ 846 Rifts® Aftermath™ – \$24.95  
 \_\_\_ 847 Rifts® DB5: Anvil Galaxy™ – \$20.95  
 \_\_\_ 848 Rifts® Book of Magic™ – \$26.95  
 \_\_\_ 849 Rifts® Adventure Guide™ – \$24.95  
 \_\_\_ 850 Rifts® Bionics Sourcebook™ – \$16.95  
 \_\_\_ 851 Rifts® DB 6: Three Galaxies™ – \$20.95  
 \_\_\_ 852 Rifts® Dark Conversions™ – \$24.95  
 \_\_\_ 853 Rifts® Chi-Town 'Burbs™ – \$9.95  
 \_\_\_ 854 Rifts® The Tolkien Crisis™ – \$12.95  
 \_\_\_ 855 Rifts® The Black Vault™ – \$9.95  
 \_\_\_ 856 Rifts® The Vanguard™ – \$9.95  
 \_\_\_ 857 Rifts® WB 24: China One™ – \$20.95  
 \_\_\_ 858 Rifts® WB 25: China Two™ – \$20.95  
 \_\_\_ 859 Rifts® DB 7: Megaverse Builder™ – \$16.95  
 \_\_\_ 860 Rifts® DB 8: Naruni Wave Two™ – \$16.95  
 \_\_\_ 862 Rifts® WB 26: Dinosaur Swamp™ – \$20.95  
 \_\_\_ 863 Rifts® MercTown™ – \$20.95  
 \_\_\_ 865 Rifts® Merc Ops™ – \$20.95  
 \_\_\_ 866 Rifts® WB 27: Adventures in Dinosaur Swamp™ – \$20.95  
 \_\_\_ 867 Rifts® Mercenary Adventure Sourcebook – \$12.95  
 \_\_\_ 868 Rifts® WB 28: Arzno™ – \$20.95  
 \_\_\_ 869 Rifts® WB 29: Madhaven™ – \$16.95  
 \_\_\_ 870 Rifts® John Zeleznik Coloring Book – \$5.95  
 \_\_\_ 871 Rifts® Machinations of Doom™ – \$18.95  
 \_\_\_ 872 Rifts® DB 10: Hades™ – \$24.95  
 \_\_\_ 873 Rifts® DB 11: Dyval™ – \$24.95  
 \_\_\_ 874 Rifts® WB 30: D-Bees of North America™ – \$24.95  
 \_\_\_ 875 Rifts® DB12: Dimensional Outbreak – \$24.95  
 \_\_\_ 876 Rifts® Megaverse® in Flames™ – \$24.95  
 \_\_\_ 876HC Rifts® Megaverse® in Flames™ Gold Hardcover Edition – \$50.00  
 \_\_\_ 877 Rifts® Heroes of the Megaverse® – \$16.95  
 \_\_\_ 878 Rifts® Sourcebook: Shemarrian Nation™ – \$16.95  
 \_\_\_ 880 Phase World®: Fleets of the Three Galaxies™ – \$16.95  
 \_\_\_ 881 Rifts® WB 31: Triax™ Two – \$24.95  
 \_\_\_ 883 Rifts® DB 14: Thundercloud Galaxy™ – \$20.95  
 \_\_\_ 884 Rifts® Vampires Sourcebook™ – \$20.95  
 \_\_\_ 885 Rifts® WB 32: Lemuria™ – \$24.95  
 \_\_\_ 886 Rifts® Black Market™ – \$24.95  
 \_\_\_ 886HC Rifts® Black Market™ Hardcover Gold Edition – \$60.00  
 \_\_\_ 887 Rifts® WB 33: Northern Gun™ One – \$24.95  
 \_\_\_ 888 Rifts® WB 34: Northern Gun™ Two – \$26.95  
 \_\_\_ 889 Rifts® Sourcebook: Coalition States, Heroes of Humanity™ – \$20.95  
 \_\_\_ 890 Rifts® World Book: Secrets of the Atlanteans™ – \$24.95 (coming)  
 \_\_\_ 891 Rifts® World Book: Sovietski™ – \$24.95 (coming)  
 \_\_\_ 892 Rifts® Sourcebook: The Disavowed™ – \$16.95 (coming)  
 \_\_\_ 893 Rifts® CS: Heroes of Humanity™ Arsenal Sourcebook – \$16.95 (coming)  
 \_\_\_ 894 Rifts® Haunted Tech™ – \$16.95 (coming)  
 \_\_\_ 2510 Rifts® & The Megaverse® Art Book – \$22.95  
 \_\_\_ 2510-HC Rifts® & The Megaverse® Art Book, Hardcover – \$50.00  
 \_\_\_ 2510-CML Rifts® & The Megaverse® Art Book, Collector's Masterwork Edition – \$125.00
- Miscellaneous Products**  
 \_\_\_ 600 Deluxe Revised RECON® RPG – \$22.95  
 \_\_\_ 2537 Gamer Coffee Mug – \$10.00  
 \_\_\_ 2539 Rifts® Dice Bag – Black – \$8.00  
 \_\_\_ 2545 Dead Reign™ Coffee Mug – \$10.00  
 \_\_\_ 2554 Palladium Bookmarks, Set One – \$5.00  
 \_\_\_ 2555 Palladium Bookmarks, Set Two – \$5.00  
 \_\_\_ 2561 Property of Chi-Town Library Pencil – \$0.50 each  
 \_\_\_ 2562 Future Visions™ – The Artistry of Charles Walton II – \$13.95  
 \_\_\_ 2566 Glitter Boy Mouse Pad – \$9.95  
 \_\_\_ 2567 Old Ones Mouse Pad – \$9.95  
 \_\_\_ 2568 Zombie Graveyard Mouse Pad – \$9.95
- Note:** T-shirts and other products can be found online: [www.palladiumbooks.com](http://www.palladiumbooks.com)
- Rifts® Miniatures**  
 \_\_\_ MI8002 Xiticix Pack – \$18.00  
 \_\_\_ MI8004 Coalition Dog Pack – \$18.00  
 \_\_\_ MI8005 Men of Magic Pack #1 – \$18.00  
 \_\_\_ MI8006 Cyborgs Pack #1 – \$18.00  
 \_\_\_ MI8007 Simvan & Ostrosaurus Pack – \$18.00  
 \_\_\_ MI8008 Coalition Skelebots Pack #1 – \$18.00  
 \_\_\_ MI8009 Coalition SAMAS Pack #1 – \$22.00  
 \_\_\_ MI8010 Coalition Sky Cycle Pack – \$22.00  
 \_\_\_ MI8011 Coalition Dog Pack #2 – \$18.00  
 \_\_\_ MI8015 Damaged Skelebots Pack #1 – \$12.00  
 \_\_\_ MI8016 Cyber-Adventurers Pack – \$18.00  
 \_\_\_ MI8017 Rogues & Scout Pack #1 – \$18.00  
 \_\_\_ MI8018 Brodkil & Witchling Pack – \$18.00  
 \_\_\_ MI8019 Damaged Skelebots Pack #2 – \$18.00  
 \_\_\_ MI8020 Psi-Stalkers & Scouts Pack #1 – \$18.00  
 \_\_\_ MI8021 Shadow Beast – \$12.00  
 \_\_\_ MI8022 Mystic Knight – \$6.00  
 \_\_\_ MI8023 Lord Magus – \$6.00  
 \_\_\_ MI8024 High Magus – \$6.00  
 \_\_\_ MI8025 Coalition Psi-Stalker – \$6.00  
 \_\_\_ MI8026 Coalition Dog Boy in DPM-D1 Armor – \$6.00  
 \_\_\_ MI8027 Coalition Dog Boy #2 – \$6.00  
 \_\_\_ MI8028 Coalition Dog Boy #3 – \$6.00  
 \_\_\_ MI8029 Coalition Dog Boy #4 – \$6.00  
 \_\_\_ MI8030 Coalition Dog Boy #5 – \$6.00  
 \_\_\_ MI8031 Glitter Boy – \$20.00  
 \_\_\_ MI8032 Glitter Boy Pilot – \$6.00  
 \_\_\_ MI8033 Kydian Overlord – \$20.00  
 \_\_\_ MI8034 Dragonsaurus – \$10.00  
 \_\_\_ MI8035 Slaver and Slave (Atlantis) Set – \$10.00  
 \_\_\_ MI8036 Crazy – \$6.00  
 \_\_\_ MI8037 Juicer #1 – \$6.00  
 \_\_\_ MI8038 Juicer #2 – \$6.00  
 \_\_\_ MI8039 Cyborg #1 – \$12.00  
 \_\_\_ MI8040 Cyborg #2 – \$12.00  
 \_\_\_ MI8041 Cyborg #3 – \$6.00  
 \_\_\_ MI8042 Coalition Officer – \$6.00  
 \_\_\_ MI8043 Coalition Grunt #1 – \$6.00  
 \_\_\_ MI8044 Coalition Grunt #2 – \$6.00  
 \_\_\_ MI8045 Coalition Grunt #3 – \$6.00
- When placing an order by mail, please add money for shipping and handling.** Add \$5.00 for orders totaling \$1-\$50, \$10.00 for orders totaling \$51-\$95, and for orders totaling \$96-\$200 please add \$15.00 US. Double the amount for Canada, and *quadruple* it for overseas orders. For more shipping options, order online at [www.palladiumbooks.com](http://www.palladiumbooks.com). Allow 2-4 weeks for delivery. Make checks and money orders payable to: *Palladium Books*
- Check release dates for new products.** If the book you order has not been released yet, your order will be held as a backorder until the product is available. Please note that prices are subject to change without notice.
- Orders can also be placed by phone,** at (734) 721-2903 (order line only). Please have your credit card information when you call.
- [www.palladiumbooks.com](http://www.palladiumbooks.com)**

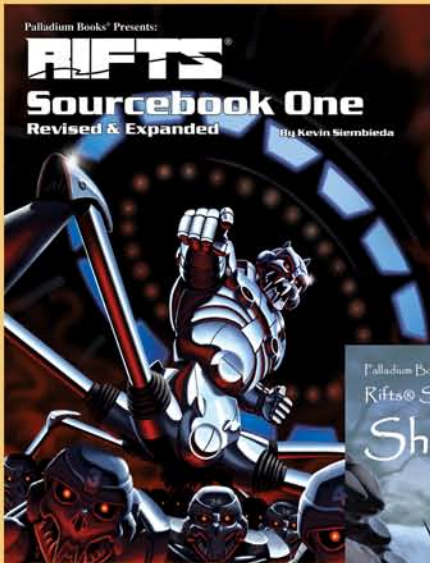

At stores  
everywhere



## Also from Palladium Books®

### Rifts® Sourcebook One, Revised

Rifts North America's greatest secret may be Archie Three – a pre-Cataclysm artificial intelligence with sentience and delusions of godhood. He's also the secret force behind Titan Robotics.

- Robot creation rules and robot player characters.
- 20 robots from Northern Gun and others.
- Power armor, vehicles, weapons and monsters.
- The mysterious Republicans – descendants of NEMA.
- A complete adventure plus ideas for many more.
- 160 pages written by Kevin Siembieda.

### Rifts® Shemarrian Nation™ Sourcebook

A comprehensive overview of the Shemarrian Warrior Women and more secrets about Archie Three and Hagan.

- 7 Shemarrian character classes, history and purpose.
- Shemarrian weapons and war mounts.
- More androids and robot minions of Archie Three.
- The secret war against the Splugorth.
- Random encounter tables, adventure ideas and more.
- 96 pages written by Sinsapaugh, Marker & Siembieda.

### Rifts® Bionics Sourcebook™

A compendium of bionic and cybernetic systems.

- 220+ bionic components and features plus foreign bionics.
- 47 commercial cybernetic implants and 24 Black Market bionics.
- 7 different City Rat O.C.C.s and the Cyber-Doc O.C.C.
- The Cyborg O.C.C. revisited plus rules & info on repairing bionics.
- TW Bionics, cybernetics to inhibit magic and more.
- 112 pages written by Kevin Siembieda.

## Rifts® Sourcebook Two:

# The Mechanoids®

Archie 3 and Hagan are back, but have inadvertently unleashed **The Mechanoids®** into the world!

The Mechanoids have one driving goal: To destroy all humanoid life! This book has it all. Source material, the Mechanoids, new equipment, monsters and adventure.

- **The prophecies of the Seven Dangers.**
- **20+ Mechanoids and their robot legion.**
- **Optional Mechanoids® Player Characters and character sheets.**
- **Archie Three and Hagan: Heroes or villains?**
- **The weapons and robot minions of Hagan Lonovich.**
- **New creations from Archie Three and Hagan, plus more history and insight about the unlikely duo.**
- **Five adventures, random encounter tables and adventure ideas.**
- **112 pages written by Kevin Siembieda.**

**One Game System – infinite worlds of adventure – all are compatible.**

\$16.95

Cat. No. 805

ISBN-10: 0-916211-55-X

ISBN-13: 978-0-916211-55-4

**Palladium  
Books Inc.®**  
www.palladiumbooks.com