

Palladium Books® Presents:

# RIFTS®

## Game Master Guide

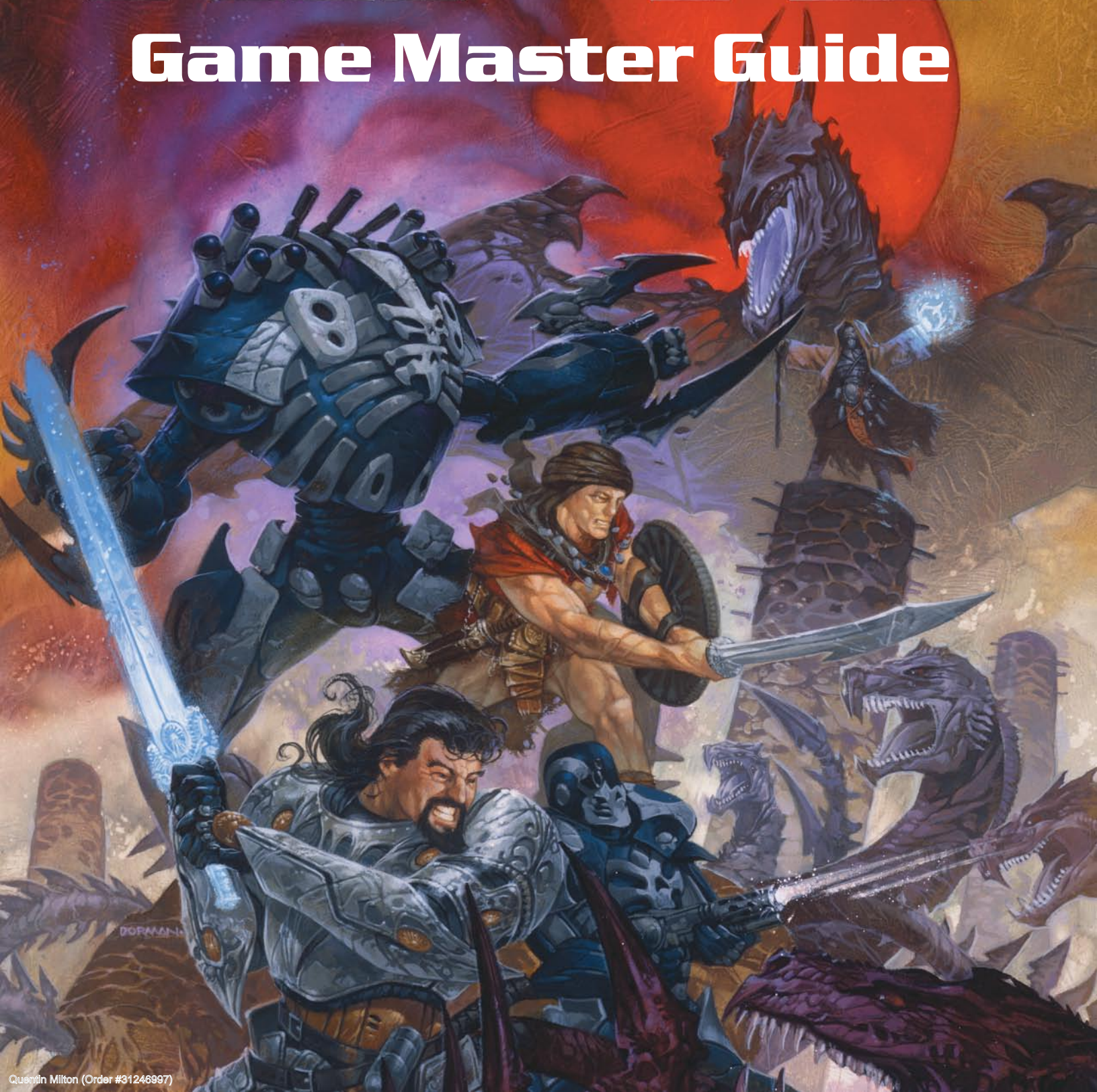

DORMAN

# Warning!

## Violence, War, Magic & the Supernatural

The fictional world of Rifts® is violent, deadly and filled with supernatural monsters. Other-dimensional beings often referred to as “demons,” torment, stalk and prey on humans. Other alien life forms, monsters, gods and demigods, as well as magic, insanity, and war are all elements in this book.

Some parents may find the violence, magic and supernatural elements of the game inappropriate for young readers/players. We suggest parental discretion.

Please note that none of us at Palladium Books® condone or encourage the occult, the practice of magic, the use of drugs, or violence.



p é r e z . 0 1

**An giant reference and sourcebook  
for the Rifts® RPG series**

# Dedication

I want to thank and dedicate this book to those who have helped me to *build* Palladium Books Inc. and kept it running for these many years. A lot of these good folks are hidden behind the scenes. People who offer me advice and lend me their trust and their spirit. Listed in no particular order, they include, Alex Marciniszyn, Steve Sheiring, Thom Bartold, Ken Bartold, Kay Kozora, Erick Wujcik, Larry Jordan, Cheryl Corey, Jill Esch, Wayne Smith, Julius Rosenstein and Henry Siembieda.

Last but certainly not least, is my partner, my wife and my love, Maryann. At Palladium she is always thinking about the fans and the business, and what will make people enjoy the hobby all that much more. At home we work to survive life and family and have a little fun in between.

Thank you everyone, for all you have given me over the years. I appreciate it more than you may know.

– Kevin Siembieda, 2001

To Kevin Siembieda, who gave me the go-ahead to do this crazy thing.

To my wife Alli, for putting up with my many sleepless nights.

To all of the **Rifts®** authors who built a Megaverse so big it took forever to compile!

And to all of the **Rifts®** fans, who breathed life into this mad endeavor. Thanks so much for making **Rifts®** a part of your imagination's landscape for the past decade. May your adventures bring only glory, friendship, riches and fame.

– Bill Coffin, 2001

**The cover:** Is what artist Dave Dorman thinks when he thinks *Rifts®*.

## PDF Edition – April 2017

### First Printing – September 2001

No part of this publication may be scanned, OCR'd or reproduced in any way for electronic publication on the web/internet or any other medium.

Copyright 2001, 2000, 1999, 1998, 1997, 1996, 1995, 1994, 1993, 1992, 1991, and 1990 Palladium Books Inc. & Kevin Siembieda

All rights reserved, worldwide, under the Universal Copyright Convention. No part of this book may be reproduced in part or whole, in any form or by any means, without permission from the publisher, except for brief quotes for use in reviews. All incidents, situations, institutions, governments and people are fictional and any similarity, without satiric intent, of characters or persons living or dead, is strictly coincidental.

**Rifts®**, **The Rifter®**, **Megaverse®**, **The Mechanoids®**, **The Mechanoid Invasion®**, **After the Bomb®**, **Phase World®**, and **Palladium Books®** are registered trademarks owned and licensed by Palladium Books Inc. and Kevin Siembieda.

Coalition Wars, Coalition War Campaign, Coalition Navy, Cyber-Knights, Dragons & Gods, Federation of Magic, Free Quebec, Juicer Uprising, Lone Star, Mindwerks, Mutants in Orbit, Mystic Russia, New West, Psyscape, **Rifts®** Book of Magic, **Rifts®** Conversion Book, **Rifts®** Game Master Guide, **Rifts®** Mercenaries, **Rifts®** Underseas, Skraypers, Sorcerers' Revenge, Spirit West, Splynn Dimensional Market, Triax & the NGR, Vampire Kingdoms, Warlords of Russia, Wormwood, Xiticix Invasion, Coalition States, Chi-Town, Free Quebec, Old Bones, Lazlo, Tolkeen, Freehold, Northern Gun, Manistique Imperium, Iron Heart, Golden Age Weaponsmiths, Naruni, Naruni Enterprises, Wellington, Triax, Ulti-max, Glitter Boy, Skelebots, Xiticix, Dog Boy, Dog Pack, Wolfen, Bio-Wizardry, Techno-Wizard, Temporal Raider, Ley Line Walker, Shifter, Tattooed Man, Headhunter, Psi-Stalker, Simvan, Mind Melter, Burster, Zapper, Psi-Slayer, Psi-Ghost, Juicer, Mega-Juicer, Titan Juicer, Deadball, Crazy, 'Borg, 'Bot, 'Burb, D-Bee, Cyber-Doc, Dragon Kings, Shadow Dragons, Emperor Karl Prosek, Joseph Prosek the First, Joseph Prosek II, Erin Tarn, Sir Thorpe, Lord Coake, The Defilers, Robert Creed, Corin Scard, Splugorth, Splugorth Slaver, Splynncryth, Splynn, Kittani, Metztlá, Sunaj, Iron Juggernauts, Daemonix, Larmac, Brodkil, Black Faerie, Witchling, Wind-Water Sail Ray, and other names, titles, character names, character likenesses and slogans are trademarks owned by Kevin Siembieda and Palladium Books Inc.

Palladium On-Line: [www.palladiumbooks.com](http://www.palladiumbooks.com) – also see us at [Facebook.com/PalladiumBooks](https://www.facebook.com/PalladiumBooks)

**Rifts® Game Master Guide** is published by Palladium Books Inc., 39074 Webb Court, Westland, MI 48185. Printed in the USA.

**Palladium Books® Presents:**

# **Rifts®**

## **Game Master Guide**

Rifts® Creator, Designer & Chief Writer: **Kevin Siembieda**

G.M. Guide Compiled by: **Bill Coffin**

G.M. Guide Organization, Additional Compiling & Rules by: **Kevin Siembieda**

Additional Text & Ideas: **Kevin Siembieda & Bill Coffin**

Additional Writers (includes material taken from various Rifts® titles written by): **Wayne Breaux Jr., C.J. Carella, Bill Coffin, Christopher R. Kornmann, Michael Leonard, Ben Cassin Lucas, Peter Murphy, Patrick Nowak, Francois DesRochers, Kevin Siembieda, Mark Sumimoto, and Erick Wujcik.**

Editors: **Alex Marciniszyn**

**Wayne Smith**

**Kevin Siembieda**

Proofreaders: **Julius Rosenstein**

**Maryann Siembieda**

Cover Painting: **Dave Dorman**

Interior Artists: **Wayne Breaux Jr.**

**Kent Burles**

**Scott Johnson**

**Kevin Long**

**Apollo Okamura**

**Ramon Perez**

**Freddie Williams**

**Michael Wilson**

Art Direction, Maps & Keylining: **Kevin Siembieda**

Typography: **Maryann Siembieda**

**Special Thanks** to Shawn Merrow, Rodney Stott, Maryann Siembieda, Wayne Smith and everybody who offered ideas and suggestions for what should go into this reference book. To Bill Coffin for sorting through the thousands of pages of material, gather it up and boiling it down. And to the artists and Palladium's stalwart staff. Thank you one and all.

– Kevin Siembieda, 2001

# Contents

The Ultimate Reference	9
The Beauty of Role-Playing	9
<b>The Rifts® Lexicon</b>	<b>10</b>
P.A. (Time-line)	12
Universal Credits	13
<b>Designer Notes</b>	<b>14</b>
Laying the groundwork for adventure	15
How to set up the basics	15
The bottom line	15
The plot (seven classics)	15
The twist	16
How many players?	16
That reminds me	17
An RPG campaign is a continuing epic	17
Defeat	17
The returning villain	17
Tricks of running a large group	18
The cliffhanger tactic	18
Comedy	18
<b>Game Mechanics</b>	<b>19</b>
Experience	19
Why an experience “level” system	19
Experience is its own reward	19
Experience Points Table	20
Other game elements and rewards	20
Playing in Character	21
NPCs are a valuable tool	21
Balance does not mean equality	21
Then there is common sense	22
<b>Physical Combat</b>	<b>23</b>
Attribute Bonus Chart	23
Speed Chart	23
<b>Rules &amp; Clarifications</b>	<b>24</b>
Attributes Beyond 30 (expanded)	24
Augmented Humans, Mutants & Cyborg P.S.	24
Power Punch	24
Supernatural Physical Strength	25
Weight & Movement	26
A Note about M.D. Creatures	26
Robot Strength & Damage	26
<b>Combat Terms</b>	<b>27</b>
Automatic Dodge	27
Blind	27
Hand Strikes	28
Death Blow	29
Knockdown	30
Paired Weapons	30
Simultaneous Attack	31
Some common combat questions & answers	31
M.D.C. Armor	31
Hand to Hand Skills	32
Simultaneous Attack (how it works)	32
The Dodge	32
Used up all attacks	32
Auto-Dodge	33
Dodging bullets and energy blasts	33
The Combat Sequence	34
Grappling	34
The Knockout	34
The Knock “down”	34
Optional Humanoid Knockdown Table	35
Optional Bots, Borgs and Supernatural Knockdown	35
<b>S.D.C. and Combat</b>	<b>35</b>
Some Common Sense Rules Regarding Physical S.D.C.	35
Blood Loss	36
Pain Penalties	36
Damage at Point-Blank Range	36
Side Effects from S.D.C. Damage	37
S.D.C. & Explosives	37
<b>Ranged Combat Revisited</b>	<b>38</b>
The problems with modern combat	38
Kev’s Quick & Dirty Rules for modern combat	39
No W.P.	39
Called Shot	39
Burst	39
Range and Targeting	39
Understanding High-Tech Weapons	40
Radar Notes	41
Suiting up in Body Armor	41
Definitive Dodging Rules vs Ranged Weapons	41
Parrying Energy Blasts	41
Optional Robot Combat Damage Tables	42
<b>Hand to Hand Combat</b>	<b>44</b>
No Hand to Hand Combat Skill	44
Hand to Hand: Basic	45
Hand to Hand: Assassin	45
Hand to Hand: Commando	46
Hand to Hand: Various Japanese Arts	46
Skills (opening info to the section)	48
<b>Skill Compendium</b>	<b>49</b>
Skill List & Percentiles	50
Skill Descriptions	52
Communications Skills	52
Cowboy Skills	52
Domestic Skills	53
Electrical Skills	54
Espionage Skills	55
Horsemanship Skills	56
Mechanical Skills	58
Medical Skills	59
Military Skills	61
Physical Skills	65
Physical Space Skills	67
Pilot Skills	67
Pilot Related Skills	70
Rogue Skills	71
Science Skills	72
Technical Skills	74
Weapon Proficiencies	78
Ancient Weapon Proficiencies	79
Modern Weapon Proficiencies	81
Wilderness Skills	82
<b>Psionics</b>	<b>85</b>
Psionic Powers Checklist	85
A few Notes on Psionics	85
Psionic Summary	86
<b>Psionic Descriptions Begin</b>	<b>87</b>
Healing Psionics	87
Physical Psionics	88
Sensitive Psionics	92
Super-Psionics	98
Mind Bleeder Powers	106
<b>Personal Weaponry</b>	<b>109</b>
The Availability of Weapons	109
Limiting Availability	110
A Few Weapon Notes	111
Lasers are completely silent	111
Black Market Prices for E-Clips	111
Self-Charging Power Packs	111
Knock-Off Weapons	111
Costs for Conventional S.D.C. Rounds	112
Balancing South America	112
Known Arms Manufacturers of Rifts Earth	113

<b>Weapon Descriptions</b> . . . . .	<b>113</b>	Triax E-Clips . . . . .	166
Arkhone Weapons (South America) . . . . .	113	Uranium Rounds . . . . .	166
Australian Weapons . . . . .	115	Triax Pistols . . . . .	167
Australian High-Tech Weaponry . . . . .	116	Triax Rifles . . . . .	168
<i>Bandito Arms</i> . . . . .	119	Triax Underwater Weapons . . . . .	170
<i>Coalition States Weapons</i> . . . . .	120	Tritonian Weapons (Underwater) . . . . .	171
Missile Chart . . . . .	123	<i>Wellington Industries</i> . . . . .	171
CS Grenades . . . . .	124	Ramjet Rounds . . . . .	171
CS Vibro-Blades . . . . .	124	Caseless Pistol . . . . .	172
CS Underwater Weapons . . . . .	125	Flame Throwers . . . . .	172
Colombian Weapons . . . . .	126	Automatic Grenade Launcher . . . . .	173
Colorado Baronies . . . . .	127	<i>Wilk's Laser Technologies</i> . . . . .	174
<i>Conventional S.D.C. Weapons</i> . . . . .	127	Laser Pistols . . . . .	175
Modifying Conventional Weapons . . . . .	127	Laser Rifles . . . . .	175
Weapon Deterioration Rules . . . . .	127	Derringer . . . . .	176
Weapon Condition Table . . . . .	127	CFT Cartridge Weapons . . . . .	177
Common Conventional S.D.C. Weapons . . . . .	128	Xiticix Weapons (Alien/North America) . . . . .	178
Empire of the Sun Weapons (South America) . . . . .	129	Weapon Notes . . . . .	178
<i>Free Quebec Weapons (Canada)</i> . . . . .	130	Known Xiticix Weapons . . . . .	180
Gargoyle Weapons of Europe . . . . .	132	<b>Equipment</b> . . . . .	<b>181</b>
Horune Weapons (Ocean Pirates) . . . . .	133	Adventuring & Camping Equipment . . . . .	181
Japanese Weapons . . . . .	134	Containers . . . . .	182
Traditional Japanese S.D.C. Weapons . . . . .	135	Clothing of Note . . . . .	182
Japanese Vibro-Blades . . . . .	136	Clothes: General Purpose . . . . .	182
H-Brand Vibro-Blades . . . . .	136	Communications Equipment . . . . .	183
Japanese Energy Weapons . . . . .	136	Medical Equipment . . . . .	184
Japanese Missiles . . . . .	141	First Aid Kit . . . . .	184
Japanese Land Mines . . . . .	142	Robot Medical Systems . . . . .	185
<i>Juicer Weapons</i> . . . . .	143	Miscellaneous Equipment . . . . .	186
<i>Kittani Weapons (Atlantis)</i> . . . . .	145	Computers . . . . .	186
Plasma Axe . . . . .	145	Basic Survival Pack . . . . .	187
K-1000 Spider Defense System . . . . .	146	Short-Range Radar . . . . .	187
Kittani Jolt Gun (TW) . . . . .	146	Winter Survival Kit . . . . .	188
Plasma Sword . . . . .	147	Optics, Goggles & Binoculars . . . . .	188
Slaver's Net Gun (TW) . . . . .	147	Optics for Guns . . . . .	189
Kittani Underwater Weapons . . . . .	147	Sensor Equipment . . . . .	189
Megaversal Legion (South America) . . . . .	148	Ecto-Sensor . . . . .	189
Inertia Beams (I-Beams) . . . . .	148	Radar . . . . .	190
Mindwerks Weapons (Europe) . . . . .	149	Surveillance Equipment . . . . .	190
Miscellaneous Weapons (North America) . . . . .	150	<b>Body Armor</b> . . . . .	<b>191</b>
L-20 Pulse Rifle . . . . .	150	List by Manufacturer . . . . .	191
Zapper Gun . . . . .	150	Descriptions Start . . . . .	192
High-Tech Arrows . . . . .	150	Australian . . . . .	192
Naruni Enterprises Weapons (Alien Imports) . . . . .	150	Black Market, Bandito Arms & Generic . . . . .	192
Native American Weapons . . . . .	154	Coalition States Military Armor . . . . .	193
Naut'Yll Weapons (Ocean Pirates) . . . . .	154	Juicer Armor . . . . .	194
Energy Net . . . . .	154	Cyborg Armor . . . . .	194
Energy Trident . . . . .	154	Dog Boy . . . . .	195
Harpoon Rifle . . . . .	154	Free Quebec Body Armor . . . . .	195
Sonic Wand & Rifle (TW) . . . . .	155	Japanese Body Armor . . . . .	196
New Navy (survivors of US Navy) . . . . .	155	Juicer Body Armor . . . . .	196
NGR Weapons (Europe) . . . . .	156	Naruni Enterprises Armor . . . . .	198
See Triax . . . . .	166	New Navy (Aquatic Body Armor) . . . . .	198
<i>Northern Gun Weapons</i> . . . . .	156	Northern Gun Body Armor . . . . .	199
Energy Clips . . . . .	156	Poland Body Armor . . . . .	199
NG-11S Sawed-Off . . . . .	157	Russian Body Armor . . . . .	199
NG Explosives . . . . .	158	South American Body Armor . . . . .	200
Phase World & Space Technology . . . . .	159	Triax Body Armor . . . . .	201
<i>Russian Weapons (Europe &amp; Asia)</i> . . . . .	159	Tritonia Body Armor . . . . .	202
Servo-Harness . . . . .	160	Tundra Rangers Body Armor . . . . .	202
Razor Disk Cannon . . . . .	161	Used & Reconditioned Body Armor . . . . .	202
Cyborg Missile launcher . . . . .	161	<b>Power Armor</b> . . . . .	<b>203</b>
Big Bear Plasma Rifle . . . . .	162	General Power Armor Notes . . . . .	203
Silver River Weapons (South America) . . . . .	163	List by Manufacturers . . . . .	203
Splynn Dimensional Market (Atlantis; Alien Imports) . . . . .	164	Coalition States Power Armor . . . . .	204
Kizh Merchandise . . . . .	164	SAMAS . . . . .	204
<i>Tolkeen Weapons (TW)</i> . . . . .	165	Free Quebec Power Armor . . . . .	206
<i>Triax Weapons (NGR/Europe)</i> . . . . .	166	Glitter Boys (various) . . . . .	206

Violator SAMAS	207
Japan Power Armor	208
Kittani	210
Miscellaneous Power Armor	211
Bandito Arms Power Armor	212
Chipwell Power Armor	212
Native American	212
New Navy	213
Samson	213
Naruni Enterprises Power Armor	214
South America Body Armor	214
Columbia	215
Silver River	216
Titan Flying Power Armor	217
Triax Power Armor	217
Tritonia Power Armor	219
<b>Robot Vehicles</b>	<b>220</b>
Robot Vehicle Basics	220
Listing of Robots Worldwide	221
Coalition States	221
Japan Robot Vehicles	223
Miscellaneous Robot Vehicles	225
Free Quebec	225
Kittani	226
Native American	227
Northern Gun	227
Naruni Enterprises	228
South America Robot Vehicles	229
Titan Robotics	230
Triax Robot Vehicles	231
Predator	231
Ulti-Max	232
Dragonwing	233
<b>Vehicles</b>	<b>234</b>
Vehicles listed by Type or National Powers	235
Aircraft	236
Boats & Water Vessels	239
New Navy	240
Poland/Tarnow Boats	241
CS Aircraft	243
Sky Cycles	243
Scout Rocket Bike	245
CS Helicopters	245
CS Boats	247
CS APCs & Tanks	250
Heavy Commercial Ground Vehicles	251
Bandito Arms	252
Kittani	252
Hovercycles & Rocket Bikes	253
Northern Gun Hovercycles	254
Jet Packs	256
Military Vehicles	256
Free Quebec: Cougar Jeep	257
Iron Heart Tanks	257
Motorcycles	259
New German Republic	260
See Triax	263
Russian Vehicles	260
Snow-Jetsled	261
'Borgbike	262
Triax Vehicles	263
Mechanic's Hover Pod	264
Jet Fighters	265
Triax Combat Ground Vehicles	265
Adventuring Vehicles	266
<b>Bionic Notes</b>	<b>268</b>
The psychological impact	268
Availability and markups	268

Additional & material costs	269
Surgical Recovery	270
Back-Street Doctors & Side Effects Table	270
Adjusting to New Bionics	270
Bionic Insanity Table	271
Bionics Index for Rifts®	271
Bionic "Arm" Weapons & Tools	272
Bionic Ear & Head Implants	273
Cyborg Body Armor	274
Psionic Enhancements	275
<b>Character Compendium</b>	<b>276</b>
Alphabetical Character Index	276
Men at Arms	277
Scholars & Adventurers	280
Practitioners of Magic	281
Racial Character Classes (R.C.C.s)	285
Psychic Character Classes (P.C.C.s)	288
<b>Monster Index</b>	<b>289</b>
Alphabetical Index	290
<b>Experience Tables</b>	<b>293</b>
Coalition O.C.C.s	293
Juicer O.C.C.s	295
Men of Magic O.C.C.s	295
Men of Arms O.C.C.s	299
Psychic O.C.C.s	305
Scholars & Adventurers	306
R.C.C.s (Racial Character Classes)	308
<b>Running the Game</b>	<b>316</b>
Game Master tips for running adventures	316
The Seven Deadly Sins	317
Motley Crews	322
Player vs. Player	322
<b>Adventures &amp; Campaigns</b>	<b>323</b>
Nuts & Bolts	323
<b>100 Rifts Adventure Ideas</b>	<b>325</b>
<b>Mini-Atlas of Rifts Earth</b>	<b>332</b>

## Quick Find

Aquatic Body Armor (New Navy)	198
Alignments as a character guide	21
Atlantis: Kittani Aircraft	238
Atlantis: Kittani Boats	240
Atlantis: Kittani Dreadnaught	257
Atlantis: Kittani Hovercycle/Pod	253
Atlantis: Kittani Power Armor	210
Atlantis: Kittani Robot Vehicles	226
Atlantis: Kittani Vehicles	252
Atlantis: Kittani Weapons	145
Atlantis: Splynn Weapons	164
Arrows: High-Tech	150
Arrows: Native American	154
Arrows & Ranges (see W.P. Archery)	79
Attribute Bonus Chart	23
Attributes Beyond Thirty	24
Black Market: All Equipment Section	181
Black Market: Body Armor	192
Black Market: Knock-Offs	192
Black Market: Power Armor (Bandito)	212
Black Market: Robot Vehicles (Bandito; Tarantula)	252
Black Market: Ground Vehicles (misc. & Contraband)	252
Black Market Weapons (Bandito & Misc.)	119 & 150
Blindness & Penalties	27
Coalition Aircraft	243
Coalition APCs & Tanks	250
Coalition Boats	247
Coalition Body Armor	193
Coalition Explosives	124
Coalition Power Armor	204

Coalition Robot Vehicles	221
Coalition Vibro-Blades	124
Coalition Weapons	120
Coalition States (see Lexicon)	10
Combat: Attributes Beyond Thirty	24
Combat: Balancing South America	112
Combat: Dodging Bullets & Energy Blasts	41
Combat: Parrying Energy Blasts	41
Combat Q&A	31
Combat: Modern Weapons	38
Combat: Radar	41
Combat: Rules & Clarifications	24
Combat Sequence	34
Combat: Special Ammunition	112
Combat Terms	27
Combat: Weapon Notes	111
Creatures of Magic (see Lexicon)	10
Credits: Black Market	14
Credits: E-Clip Cost	111
Credits: Universal	13
Cyborg Motorcycle	262
Cyborg Weapons (see Russian Weapons)	161
Demons (see Lexicon)	11
Dynamite	158
E-Clip Adaptors (Russian)	159
E-Clips: Cost	111
E-Clips: Northern Gun	156
E-Clips: Triax	166
E-Power Packs	111
Electro-Mace (Giant)	170
Energy Cartridge (CFT; Wilk's)	177
Experience, The Level System	19
Experience Point Table	20
Experience as a reward	19
Experience Tables for O.C.C.s./R.C.C.s	293
Explosives: CS Fusion Blocks	124
Explosives: Japan	142
Explosives: Naruni	152
Explosives: Northern Gun	158
Explosives: Triax Fusion Blocks	170
Flame Throwers (Wellington)	172
Flares	124
G-Clips (Russian)	159
G.M. Tips by Siembieda (Designer Notes)	14
G.M. Tips by Coffin (Running the Game)	316
Grenades: Coalition	124
Grenades: Japanese	142
Grenades: Kittani (mini-rockets)	147
Grenades: K-Hex Explosives	152
Grenades: Naruni	153
Grenades: Naruni Micro-Grenades	153
Grenades: Northern Gun	158
Grenades: Triax	170
Grenades: Wilk's Laser Grenades	177
Hit Location Tables for Robots	42
Juicer Body Armor	196
Juicer CS Body Armor	194
Juicer (assault) Hover Bike	255
Juicer Icarus Flight System	238
Juicer Motorcycle	260
Juicer Weapons	143
Mines: Northern Gun	159
Mines: Wellington	174
Missiles: CS	123
Missiles: Japanese	141
Missiles: Naruni	153
Money (see Lexicon)	12
Money: Universal Credits (see Lexicon)	13
Naruni Body Armor	198
Naruni Force Fields	198
Naruni Guns	150
Naruni Power Armor	214
Naruni Robot Vehicles	228
Naruni Tanks	258
Neural Mace (CS & Triax)	125
Northern Gun Aircraft	239
Northern Gun Body Armor	199
Northern Gun Power Armor	213
Northern Gun Robot Vehicles	227
Northern Gun Tank (Cavalry War Wagon)	258
Northern Gun Weapons	156
Plot devices	15
Plots for returning villains	17
P.S.: Augmented Humans (i.e. Juicers)	24
P.S.: Cyborg (Augmented Humans)	24
P.S.: Light Exoskeletons	24
P.S.: Ordinary Physical Strength	24
P.S.: Power Punch	24
P.S.: Robotic Strength	26
P.S.: Supernatural Strength	25
P.S.: Throwing Heavy Objects	26
P.S.: Weight & Movement	26
Psionics	85
Psionics: Mind Bleeder Powers	106
Psionics: Super	98
S.D.C. Ammunition	112
S.D.C. Australian Ancient Weapons	115
S.D.C. Combat Rules	35
S.D.C. Japanese Ancient Weapons	135
S.D.C. Weapons/Guns	127
S.D.C. Weapons (also see ancient W.P.s)	79
Skill Descriptions	52
Skill List & Percentiles	50
Skill: New Description: Bioware Mechanics	58
Skill: New Description: Brewing	59
Skill: New Description: Entomological Medicine	60
Skill: New Description: Pilot Robots & Power Armor	69
Skill: New Description: Pilot Robots & Power Armor Elite	69
Skill: New Description: Artificial Intelligence	73
Speed Chart	23
Time it takes to suit up in armor	41
Time-line: Coming of the Rifts (see Lexicon)	10
Time-line: P.A./A.D.	12
Triax Body Armor	201
Triax Power Armor	217
Triax Weapons	166
U-Rounds (Uranium Rounds)	166
Universal Credits (see Lexicon)	13
Vibro-Blades: Coalition	124
Vibro-Blades: Native American	154
Weapon Availability	109
Weapon Descriptions Begin	113
Weapons: Giant-Sized (Mindwerks)	149
Weapons: Howitzer Hand Cannon	148
Weapons: Juicer	143
Weapons: NG Shotgun slugs (see Sawed-Off)	157
Weapons: Ramjet Rounds	171
Weapons: Uranium Rounds	166
Weapons: Wilk's CFT Energy Cartridge	177





WILSON '01

# The Ultimate Rifts® Reference

The ultimate Rifts® reference. That is the idea behind this book. That's what you, our fans, have requested. Of course, putting it all together was not an easy task. The Rifts Megaverse® is infinite. Limited only by one's imagination. The Rifts® world, war, dimension, conversion and sourcebooks already in print only touch upon a fraction of those possibilities and number over 40 titles. Rifts® is a rich, exciting and expansive playing environment the likes of which have never quite been seen in gaming, but it has also gotten a bit unwieldy.

The **Rifts® Game Master Guide** is designed to make the Rifts Earth environment more manageable. How?

By presenting the *crucial data and information* in one easy to manage reference book. This means we have collected all the skills, weapons, equipment, power armor, robots, vehicles, bionics, psionics, experience tables, combat and other data into ONE big reference book. We could not squeeze everything we wanted to include into this tome, even after going with nine point type and 350 pages! But it *does* have the essentials.

Magic is so huge it has gotten its own, equally big book – The **Rifts® Book of Magic**. Likewise, we could only provide an “index” of the hundreds of different O.C.C.s, R.C.C.s and monsters. And equipment from the *Rifts® Dimension Books* (alien worlds) had to be left out too, but at least there are only four of those with another 2-4 in the development stages.

Still, the **Rifts® Game Master's Guide** is the ultimate reference to Rifts Earth, and reduces the need to lug around two dozen world books to run or play a **Rifts®** campaign to just a handful.

## Exploring the Rifts® Megaverse®

**Rifts®**, by its very nature, is an expansive gaming environment with truly endless possibilities.

The hundreds of characters, concepts and places presented in **Rifts®** are impossible to contain or condense in one or two tomes. That's a good thing, because we don't want to be hamstrung or limited in our adventuring. We *want* ALL the options. However, that does not mean one can thoroughly play all of those options. The Megaverse is just too darn big. But that's okay.

Think about it. Even a world traveler like my wife, Maryann, can not claim to have seen or experienced the *entire* world. Soon, she'll be able to proudly claim she has visited *every* continent on Earth. Quite a feat. While that claim will be true, she can NOT claim to have seen every country or city on Earth. Nor can she say that she has seen every culture or society. Heck, she can't even claim to have seen a tenth of them, and Maryann has been traveling the world for something like twenty years now. Even if she spent the majority of her time traveling around the world, she could *never* see every place.

The point is, our tiny blue planet is just too big, and life too short, to honestly see and experience it all. The same applies to the *game world* of **Rifts®**. And the **Rifts®** role-playing environment is even worse, because the characters can travel to virtually *anywhere* in the infinite Megaverse®! As exciting and dynamic as that concept is, the reality means making choices.

The *Game Master* and his/her *players* must *pick and choose* which characters to play and what part of Rifts Earth and/or the Megaverse® to play in today.

The reality of *infinite choices* is a certain amount of indecision, frustration and a flat out impossibility to see and do it all. Like Maryann in her world travels, all one can hope for is to enjoy exciting snippets of

the greater Megaverse. That may leave some players with a sense of missing out on something cool and fun. When there are hundreds of characters to choose from and dozens and dozens of cool adventure settings presented in books, it can be hard to pick the “right one.” Just remember, the decision is tough because there are so many alluring and fun *possibilities* – endless possibilities. But that doesn't mean you are missing out if you don't explore them all! It means that you should pick one or two or ten (as the case may be) and have a blast with it! When you get tired of that one or want a change of pace, there are scores of new and different possibilities to explore. That is the beauty of **Rifts®**. You really are limited only by the imagination.

That is also the beauty of role-playing.

## The Beauty of Role-Playing

You see, in this day of amazing technology, lightning fast communications and constant, exciting innovation, there is *nothing* that comes close to role-playing. That's because we utilize the ultimate computer, the one that can think for itself, imagine and dream – the human mind.

No machine can match it. No machine can “imagine” and “create” fictional characters, places, and ideas that exist only in the mind of that individual and share it with others. No machine can read words and “see” them as pictures and events as if watching a motion picture. Computers can not imagine brave and noble heroes, exotic D-Bees, fabulous aliens, terrifying monsters, treacherous villains, alien worlds or magic or super abilities that defy logic. But we can. We human beings can unleash the power of the imagination to create incredible works of art, vision, and imagination. We can use that power to cure disease, build, bridge impossible barriers, travel to the moon, and see ourselves as something more than animals. That amazing power is what we tap when we role-play.

We role-playing gamers use our power of imagination to create and tell stories. Stories each and every player in the group helps to mold through his or her character's actions and interaction with others in the gaming group. Together, we create a *shared experience* visualized in our heads. Together we shape an epic story of adventure and heroism. We remember it the same as we would a great movie or a book, only the memories are sharper and much more personal because we, through our fictional characters and bold imaginations, were part of the story. Our interaction, camaraderie, quick thinking, and a little luck of the dice saved the day. Heck, maybe even saved a world! And the only place this epic battle took place and is recorded, is in the minds and hearts of the participants. Man, oh man, you can not get any more unique, special and personal than that.

Our imaginations beat the best computer graphics or Hollywood special effects hands down, because the human mind can think of and visualize ANYTHING! And the suspense, excitement and action can't get any more vivid, because you are there – through your fictional character. You are the “actor” playing the knight, thief, cyborg, Juicer, spell weaving Line Walker, dragon or D-Bee. More than an actor, you are helping to *write* the script – to build the story. You, the player, through your character, your imaginary playing piece, can change events as they unfold. Together, working with the Game Master (the architect and director of our adventuring), you and your fellow players can be the hero or the goat. And if one falters, his buddy (another fictional character under another player's complete control) is there to lend a hand, sword or magic spell. It doesn't get any more interactive than that!

In case you can't tell, I love role-playing games. To me it is the ultimate gaming experience. It is *storytelling* taken to the max. It is pure, unbridled imagination, adrenaline, friendship, laughs, fun, cleverness, acting, writing and art all rolled into one explosive shared experience.

It is magic.

Magic, because you turn words and ideas into adventure. Magic because every group of players can take the same game and concepts, and run in a million *different* directions. It doesn't matter if the group plays the game serious and dramatic or lighthearted, full of humor and silliness, or as power-crazed "hack n' slash" maniacs kicking down doors and smashing the bad guys into oblivion. It doesn't matter as long as the players are having fun.

That's the beauty of role-playing, it can be tweaked to satisfy every taste. While you or I might not play "hack 'n slash," it doesn't matter that thousands of others do. What matters is that the imagination is unleashed and everybody is having fun. Everything else is a matter of personal taste.

If a gaming group loves to power game, go for it.

If you love drama and pseudo-realism, go for it.

If you prefer puzzles and mystery, enjoy them.

If your thing is military drama, that's good too.

If you prefer strong, character-based action adventures, or comic book style stories, or love stories, or sword and sorcery, or a combination of it all ... or something completely different, go for it. It is all perfectly acceptable.

Of course, there are general "styles of" and approaches to play, as well as "schools of thought" who tend to think their particular approach is the best (hey, don't we all?). I have come to realize that is just human nature. Hence the constant debate and sometimes name calling between self-proclaimed *serious* or *sophisticated gamers* and the so-called *power gamers* or *twitchers*. But in the end, neither is right or wrong. It all comes down to FUN. Fun and *unleashing the imagination* to have a night or afternoon of *fun* with your friends. What brand of fun, action and zaniness a particular group of gamers takes to is up to them. There is no WRONG way to play. Not if everybody in the gaming group is having fun. At least from my point of view as the game designer.

So if you had *fun* exploring one of Palladium's worlds, whether you wove your way through some clever, dramatic plot, or shot up monsters and villains in an orgy of butt-kicking action; if you unleashed your imagination and enjoyed things you never imagined before, and had fun doing it – welcome to my world. My Megaverse. OUR Megaverse. I hope you come back to enjoy it many, many times.

– Kevin Siembieda, 2001

---

## Rifts® Lexicon

---

The following is an alphabetical listing of select names, terms and slang common to Rifts Earth. Scattered among them are a few notable "game" terms as well.

**'Borg:** Slang for "cyborg." Usually refers to a full conversion cyborg.

**'Bot:** Slang for "robot." Usually referring to robots with a computer brain or artificial intelligence rather than the giant robot vehicles piloted by a living being.

**'Burb or 'Burls:** Slang referring to the tent cities, shanty towns and more formal and nice communities (from towns and cities to farms) that inevitably crop up around major metropolises, especially the great walled tech-cities of places like *Chi-Town*, *Iron Heart* and *Quebec City*.

**Burster:** A type of psychic with pyrokinetic powers above and beyond the normal range for that psionic ability. Basically they can burst into flame and manipulate fire. See the *Rifts® RPG* for details, and see *Rifts® World Book 12: Psyscape™* for a range of other types of psychic characters.

**Coalition States:** The greatest human technological power in North America. Free Quebec comes in second. Chi-Town (northern Illinois and Missouri) is the Capital.

**Coming of the Rifts:** The mythical time in which *magic* returned, the ley lines surged with renewed energy at unprecedented power levels and the planet Earth was forever transformed. The Dark Ages followed, lasting for about 200 years before human civilization began to rise again in 2287 A.D. (1 P.A.). See **P.A.** for a brief, but more complete time-line.

**Cowboy:** The Cowboy, Gunslinger, Gunfighter, Sheriff and other Old West style Occupational Character Classes (O.C.C.s) with a distinctive Rifts flavor are common to the region known as the *New West*. See the World Book of the same name for complete details.

**Crazy:** Crazies are those who have undergone M.O.M. (Mind Over Matter) conversion. Mental and physical *augmentation* via cybernetic brain implants to make them physically stronger and faster. It also usually gives the Crazy some psionic powers. One of the unfortunate side effects is that it also makes the character a thrill junkie, hyper and usually more than a little bit crazy, hence the moniker. Roughly comparable to a Juicer.

**Creatures of Magic:** Some players seem to have trouble making the distinction between *creatures of magic* and the *supernatural*. Creatures of magic are long-lived life forms that have human-like intelligence, personalities, and foibles, but to whom *magic* is an innate, sometimes instinctual ability. That is to say, magic is as much a natural ability to them as the five senses are to humans. Such creatures of magic include all types of *dragons*, *Faeries* and *Faerie Folk*, the *sphinx*, the *unicorn* and similar life forms. All creatures of flesh and blood (even if M.D.C. flesh and blood) rooted in the physical world.

By comparison, supernatural beings have very little in common with humans. Most are immortal and primordial beings whose bodies are either ethereal/spirit-like or energy in nature. Even those trapped in a physical body possess unnatural powers in that body and may shape change or fire or channel energy (whether that energy be fire/heat, magic or emotions, etc.). Most are also creatures driven by instinct and base emotions, and who possess natural "supernatural powers." In fact, many are the embodiment of one or more base and vile emotions such as hate, greed, envy, etc., and are instinctively driven to torment, hurt and kill "mortals."

**Credits:** The common designation for money and monetary units. One credit is roughly equivalent to one dollar. It is an electronic monetary unit placed on a credit or debit card. Also see *Money* and *Universal Credits* in this section.

**D-Bee:** Slang for "dimensional being," typically referring to a human-like (or at least bi-pedal) alien from another world. A D-Bee is typically "humanoid" in appearance, meaning a basic human body shape – one head, 2-4 human-like arms and hands, two legs, etc. Those who look extremely alien or monstrous are generally considered, well, alien or monstrous, although sometimes any *intelligent* alien being is lumped into the category of "D-Bee."

Most D-Bees (95%) are Hit Point and S.D.C. creatures. Only a few have Mega-Damage hides or supernatural strength. None are supernatural beings. Having supernatural P.S. or P.E. does not automatically make one supernatural. A "true" supernatural being is a demon, demigod, godling, god, alien intelligence or similar inhuman being that defies our understanding of biology and the laws of physics. They are more than mere *mortal* humans or D-Bees.

**Dead Boys:** Slang for *Coalition Soldiers*. They got this dubious nickname because they dress in black, the standard body armor has a

skeletal appearance, the CS army uses the death's head motif on everything, and because they deal out "death" to D-Bees, practitioners of magic and anybody who opposes them. See the *Rifts® RPG* and *Rifts® World Book 11: Coalition War Campaign* for information about the Coalition Army. Sourcebook Four, to learn about the *Coalition Navy*.



**Demons:** So-called "demons" and devils and Deevils are *evil* supernatural beings. Some are attractive, but most look monstrous and frightening. Many can disguise their appearance (but not their vile nature) through metamorphosis and other shapechanging abilities or magical powers. Most seek out mortals (humans and D-Bees) for their own sadistic pleasures or prey upon them like cattle.

*Sub-Demons* are the weakest and most downtrodden of their kind. Brodkil, Gargoyles, Gurgoyles, and Imps are all sub-demons.

*Lesser Demons* are the rank and file of demonkind. The foot soldiers, if you will, of the more powerful demons who command them. Most have a low to average intelligence, are extremely aggressive and war-like.

*Greater Demons* are much fewer in number than Lesser Demons. For every hundred lesser demons there is only one greater. These are the lieutenants and commanders of demonkind. Most are more intelligent and much more powerful than their "lesser" brethren.

*Demon Lords* are the deific powers who rule the less powerful demonic hordes beneath them.

*Alien Intelligences* are generally acknowledged as the most powerful of demonic lords and are often powers unto themselves. Many are conquerors and invaders, commanding great legions of demons and/or mortal minions to conquer and enslave an entire world, sometimes hundreds of worlds. While others are enigmatic figures who keep to themselves while they loose some secret conspiracy for their own amusement or simply to undermine a competitor or to have fun at the expense of others. They are the worst of the worst, and incredibly powerful.

Also see the supernatural.

**Dog Boys:** The humanoid, canine mutants created by the Coalition States via genetic manipulation of dogs. Dog Boys are engineered, grown and conditioned to fight on the side of the CS as loyal soldiers, police and rescue operatives. See *Rifts World Book 13: Lone Star* for complete details on these and other CS mutants.

**E-Clip:** Traditional automatic weapons have an ammo-clip. A cartridge that holds bullets and is slapped into the weapon to supply its ammunition. An "E-Clip" is the equivalent for energy weapons like laser guns, ion blasters, particle beam rifles, and plasma ejectors, among others. Instead of feeding the weapon bullets, an E-Clip is effectively a powerful *battery* that feeds the weapon energy to fire X number of energy blasts. Typically, the more powerful the blast (i.e. the more damage it inflicts) the fewer shots are available from that weapon. See the *Weapons* section of this book for more data and details on E-Clips and E-Power Packs.

**Erin Tarn:** Arguably the most famous and beloved celebrity in North America, perhaps the world! Famed historian, scholar and outspoken critic of the CS and injustice everywhere.

**Great Cataclysm:** The cataclysm that destroyed most of human civilization marked by the Coming of the Rifts. The Great Cataclysm caused worldwide, and literally earthshattering calamities: Earthquakes, storms, floods, fires and mass destruction on a biblical level, followed by plagues, starvation, war and dimensional anomalies and distortions, and the appearance of invading demons, monsters and D-Bees. Sea level rose, civilization collapsed (in many cases, wiped from the face of the planet) and Earth was reborn as an alien environment, place of magic and dimensional nexus to countless alien worlds. Also see P.A. for more time-line data.

**Humanoid:** In *Rifts®* the term is used broadly to include any non-human/D-Bee who is rather "human-like" in appearance; bipedal, stands upright, intelligent, and social. In other words, an alien being with "human characteristics."

**Juicer:** A Juicer is a character who has undergone physical *augmentation* via chemical means to make them more alert, physically stronger and faster. Unfortunately, the character becomes reliant on his "juice" (the drugs) and literally "burns out" in under ten years, and dies! A tragic figure that can be a hero or fiend. See the *Rifts® RPG* and *World Book 10: Juicer Uprising™* for more on this O.C.C. Roughly comparable to a Crazy, although both are strikingly unique.

**Ley Lines:** Natural lines of energy that radiate from the very planet and run in a straight line. That energy is the stuff of magic and can be drawn upon by practitioners of magic to power magic spells, magic rituals and to open dimensional portals. A ley line can run a few thousand feet/meters, a few miles or several thousand miles long. Most are about a half mile to a mile wide, with an additional two miles (3.2 km) of magical influence (i.e. a mage can draw on the ley line up to two miles/3.2 km away). They radiate a faint blue energy that can barely be seen during daylight, but can be clearly seen on heavily overcast days and at night. Where one or more intersect (a nexus point) the ley line is most powerful.

**M & M:** Slang for "metal and man" or "metal man," usually referring to a *Headhunter* because these warrior adventurers are usually a partial cyborg or heavily augmented with bionics. But can refer to any partial cyborg.

**Mega-Damage (M.D.):** In the *Rifts®* setting, humans and most D-Bees are Hit Point/S.D.C., but they wield such advanced technology and/or powerful magic, that they have weapons and armor that is measured in Mega-Damage. Handguns, body armor and vehicles with the firepower and armor of a 21st Century tank. Likewise, supernatural beings, creatures of magic and some D-Bees are Mega-Damage beings with skin like the armor of a battleship and supernatural strength.

**Mist (or "to mist"):** A grim term used by high-tech soldiers, mercenaries and warriors that refers to "killing and vaporizing" an opponent/enemy with an energy weapon; i.e. "Mist him" (kill him), or "mist the bodies" (vaporize them, leaving no or minimal evidence), or "mist

the truck” (vaporize it). Particle Beam and ion weapons are especially good at *vaporizing* things, but actually, *any* Mega-Damage weapon atomizes S.D.C. materials, including living beings.

**Money:** The most common unit of money on Rifts Earth (and, conveniently, the entire Megaverse) is the “credit.” One credit is effectively the same as one dollar. However, there is no paper or coin denominations. Instead, electronic credits are monetary units placed on a debit card. One hands the retailer the debit card and the appropriate number of “credits” is electronically subtracted. Payments to an individual are electronically input onto the plastic debit card.

A number of nations/kingdoms have their own brand of credits backed by their own, independent banking institution. These “local” credits are often redeemable only at the sponsoring kingdom/nation or business, forcing the individual to spend his money in that community. Sometimes a neighboring kingdom or national merchant operation (like the Black Market) will accept a rival’s credits, especially if the two do a lot of trade with one another. However, most “civilized” places and businesses will accept Universal Credits. **Note:** A number of electronic and DNA based measures are in place to prevent illegal use, robbery and fraud. For example, cards encoded with the owner’s genetic code can only be used by that individual and all transactions must require his direct involvement and approval.

*Universal Credits* are electronic currency accepted at most places throughout Rifts Earth and by the Splugorth, Naruni, Phase World, the Three Galaxies and most people and places associated with them.

*Gold & Gems.* Some merchants and communities prefer, quite literally, “cold, hard cash” in the form of precious metals and stones, such as gold and diamonds. Likewise, most banks and worldly businesses will accept precious stones and metals and turn them into “Universal (or other) Credits,” taking 10% of the value as their service fee. Typically, when gold, gems or jewelry are used as currency, the item will be ascribed a value in “credits.” Thus, a diamond worth 6,000 credits is treated as 6,000 credits, and any “change” is likely to be given to the character in the form of a debit card with “x” number of credits.

*Trade and Barter.* Much of Rifts Earth is a desolate wasteland with pockets of habitation. Many places are low-tech and have little or no use for “credits” and perhaps not even technology. Here, one can trade goods (furs, the meat of a freshly killed animal, a bolt of fabric, a gun, etc.) and services (labor, healing, cooking, hunting, ridding one of a problem, etc.) for another item or service. Sometimes an item offered or wanted in trade has no practical purpose (a piece of jewelry, artwork, animal’s tooth, etc.) and other times it is very practical (shovel, gun, clothes, etc.); it all depends on the wants and needs of the buyer and seller. Moreover, some item or service that has worth in one community may have no value (or need) at another. While *magic* and *psionic powers* can often win one favor and trade goods, it is unwelcome in some areas and can get the individual using it or offering it locked up in jail or much worse.

**Natural Twenty:** A game term that means a “20” is rolled for a combat action without the use of bonuses and other modifiers. A “modified twenty” would be a roll of a number less than 20 on the actual die, say an 18, which becomes a 20 or higher thanks to a bonus. Thus, 18 +2 to strike equals a twenty, but NOT a “natural 20.”

A natural 20 is the best one can roll in combat and is an automatic strike or success. It can only be dodged or parried if the opposing character also happens to get a “natural 20” (hey, it does happen). At Palladium, we usually let a natural 20 accomplish exactly what the player wants for his character on that combat action with *perfect* execution or precision (i.e. he shoots exactly what he was aiming at, even if it is a one in a million chance, or the perfect and/or effortless parry, dodge, disarm, knockout punch, roll to save, etc.). And a natural twenty is always impressive to spectators and may impress lowly villains to surrender or flee, especially if there are several powerful or impressive combat actions.

**Non-Player Character (NPC):** A game term that refers to any “character” NOT created and played by one of the “players.” Hence, it is a “non” player character. Such characters are typically played by the Game Master and include villains, store clerks, bartenders, the fair damsel in distress, and all incidental characters who are encountered by and *interact* with the “player characters.”

**O.C.C.:** The acronym for Occupational Character Class. An O.C.C. is a character class based on an occupation and orientation. The O.C.C., the skills selected, and alignment all define the character and his or her abilities.

---

**P.A.:** Short for Post Apocalyptic calendar. The P.A. dating system started in North America about 109 years ago and marks the end of the Dark Age that followed the Great Cataclysm. The Dark Ages lasted for nearly 200 years.

Once and for all, here is the time-line for the Coming of the Rifts and the Great Cataclysm:

*December 22, 2098 A.D.* marks the *Coming of the Rifts* and the beginning of the *Great Cataclysm*. **Note:** Most people in the world do not know exactly when the Great Cataclysm began nor how it began or how long the Dark Age lasted. Conventional wisdom is that the Dark Age continued for roughly 200 years. Some believe it was as long as three hundred.

*2099 A.D. to 2286 A.D.* is the actual 188 year long Dark Age that engulfed North America and most of the planet following the Great Cataclysm.

*1 P.A. (2287 A.D.):* Human civilization emerges from the long Dark Age in North America with the rise of Chi-Town and other notable “civilized” city-states, kingdoms and communities. Human civilization also rises from barbarism and begins to make its presence known around this point in other parts of the world. However, many parts of the world remain in barbarism or have been taken over by D-Bees or monsters to this day. A few other places, like the New German Republic and Republic of Japan, have been civilized nations for years, even decades before North America. **Note:** Chi-Town created the Apocalyptic calendar, but it was quickly adopted throughout the continent, and later, in other parts of the world.

*12 P.A. (2298 A.D.):* Chi-Town’s Bloody Campaign against the Federation of Magic.

*33 P.A. (2320 A.D.):* The Coalition States are formed.

*101 P.A. (2387 A.D.):* The year the **Rifts® RPG** opens up with the saga of Rifts Earth.

*106 P.A. (2392 A.D.):* The Coalition States declares war on the Kingdom of Tolkeen and Free Quebec.

*109 P.A. (2395 A.D.):* The Coalition Wars and its Siege on Tolkeen ends early July, 109 P.A.; peace with Free Quebec is reached a month or so earlier.

---

**Player Character:** This game term refers to the character created and “played” by one of the flesh and blood participants (i.e. “players”) in the gaming group. A typical group is 3-8 players and the Game Master (who sets up and directs the story and action). Each player creates and “plays” or portrays an imaginary, fictional character. This character is effectively his playing piece and “character” in the game/story. The Game Master (G.M.) portrays all the Non-Player Characters.

**R.C.C.:** Racial Character Class. Creatures of Magic and certain aliens, D-Bees and nonhumans often possess instinctive, innate or sociologically mandated occupations or skills. When this is the case, the character is *usually* limited to a particular Racial Character Class with a limited range of skill and occupation options. Some *nonhumans/aliens/D-Bees* can select an O.C.C., but most can not.

**Rift (or “Rifting”):** “Rift” is slang for *dimensional rift* – a tear in space and time that is effectively a two-way portal to another world that could be hundred to trillions of light years away, or in another dimen-

sion (realm of existence) entirely. “To Rift” or “Rifting” means to travel to another world or dimension via a dimensional portal or “Rift.”

**Rifter:** Archaic slang for a dimensional traveler who uses Rifts to travel to other worlds and dimensions in search of knowledge and adventure.

*The Rifter*® is Palladium’s quarterly sourcebook series for the entire Palladium Megaverse®, i.e. Rifts® and all our various games. Also features fan fiction and the occasional comic strip. Check it out.

**Fun Fact:** “The Rifter” appeared as character along with a “Rift Entity.” Both debuted in the same *Hook, Line and Sinker*™ adventure featured in the *Rifts*® *Index Volume One*, page 77. In this case, The Rifter was a Shifter who had linked himself to the Rift Entity trapped in an energy limbo in a Rift. A strange tale to be sure..

**Supernatural Beings:** Demons, Deevils, sub-demons, vampires/the undead, demigods, godlings, gods, spirits, angels, Elementals and Alien Intelligences are all supernatural creatures. Some, like demons and the undead, are instinctive predators and wicked creatures who delight in tormenting, hurting and killing humans and other mortals (creatures of magic too). The most animalistic are predators that hunt and prey upon humans, actually devouring their prey like a hungry lion or draining them of their life energy/essence, magic powers (P.P.E.) or emotions. Some are so primitive that they are little more than animals, using what intelligence or cunning they have to trick, frighten and torture their victims before devouring them. Others are highly, even supremely, intelligent, but may be as wicked and vicious as any demonic predator. Many are worse, choosing to incite treachery and cause chaos, suffering, and death en masse.

Creatures that are supernatural in nature are typically immortals spawned in some alien dimension. They have very little in common with humans or any mortal creature, and defy normal biology and laws of physics. They all possess some range of “supernatural powers” which typically included supernatural strength and endurance, the ability to fly (without wings), to magically understand all languages or possess some specific skill (prowl, climb, etc.) without the need to learn and study it, and wield such powers as bio-regeneration, metamorphosis, turn invisible at will, teleport, dimensional teleport, and natural spell casting abilities. In the latter case, most supernatural beings do not need to study magic, nor can they learn new magic, for they do not truly understand it, they simply possess the ability to do X, Y and Z.

Most supernatural beings, even those with high intelligence, are primordial creatures driven by instinct and powerful emotions. In fact, many are the embodiment of one or several base and vile emotion and desires such as hate, greed, envy, lust, revenge, etc. They are instinctively driven to torment, hurt and kill “mortals.” Because of this, most *are* what they are, and can not change. They do not pursue a profession like humans nor study to learn skills, magic, or develop talents. Instead they live to prey upon mortals, cause torment, kill and create chaos. Their cruel and savage outlook on life and foul, self-serving behavior is a reflection of their inhuman and barbaric essences. Their wickedness and low regard of mortals (often envy in disguise) probably results from the fact that they are so very different from mortals – both more than human and at the same time less; at least in regard to intellect, learning, emotions and choice. For as creatures not of the physical world and born from instinct, supernatural beings do not have freedom of choice in the same way as the fragile humans and D-Bees.

Furthermore, the majority of supernatural beings are alien to humans in their physiology as well. Many are energy beings and spirits who can manifest themselves in physical form, sometimes only by possessing a mortal being. These supernatural creatures include entities, ghost, Elementals and a host of so-called “spirits.” Even those demons and supernatural beings born in a physical body have figures and forms that are definitely *not* human. Some combine the human with the animalistic, others some elemental force, or are completely alien and monstrous.

**Universal Credits:** The currency of the modern, civilized world of Rifts Earth is “credits” – electronic money kept and accounted for by a

sophisticated, computerized banking system. Credits can be wired transferred in the Coalition State including small cities, towns, the Burbs, outposts, and independent communities *affiliated* with or who do a lot of trade with the CS, as well as *Northern Gun*, *Wilk’s*, and most merchants. Credits are electronic money encoded on a “debit card;” small sturdy, plastic cards very similar to pre-Rifts credit cards or telephone cards. Each time the “debit” card is used, the appropriate amount of *credits* is deducted from or added to the card. When all the credits are used up, the card can be thrown away or saved and taken to an appropriate banking institution, money lender, or merchant to have credits from a savings account or sale of property transferred onto the card for future use. Similarly, many businesses, banks, money lenders and even the Black Market and some traveling merchants can place additional credits into the card, by transferring real and hard cash from their account into the card.

The government of the *Coalition States* (representing 73% of all trade on the continent) is the one responsible for creating this system of money exchange and accounting. It prevents counterfeiting and enables the government (who controls the banking) to monitor the flow of money and commerce. For this reason, the Black Market, arms dealers, smugglers and many operating in the sale and purchase of *illegal* goods and services prefer to “trade” goods for goods rather than issue “credits” as an effective way to pay and trade people “under the table.” However, most do accept Universal Credits as well as the credit of other smaller kingdoms and, in some cases, issue their own credits.

*Universal Credits* are the most common, favored and popular form of credits in North America, as well as in the *New German Republic* and many independent kingdoms, nations and business including *Northern Gun*, *the Manistique Imperium*, *Wellington Industries*, *Wilk’s*, *Iron Heart Armaments*, *Golden Age Weaponsmiths*, *Free Quebec*, *Whykin*, *Lazlo*, *New Lazlo*, and most mid-West and eastern communities, including the *Black Market* (although front companies and cover identities are necessary for the latter). Most mercenaries, adventurers, bandits and people of North America will accept Universal Credits as a viable currency! Universal Credits *is* the main currency of North America.

Since the Coalition States are strong and stable, there is little danger of the credits becoming devalued or of the banks going out of business. Furthermore, because the system is based on “redeemable” Universal Credits typically available to the “bearer” of the card, it is safe to put thousands even millions of credits on one or more cards and use the money/credits freely, just about anywhere, without question. In this regard, the CS is unbelievably tolerant in its dealings with questionable businesses. For this system of banking and money exchange to collapse, the Coalition States would have to completely change its banking and monetary system (a monumental and disruptive task), or be destroyed. Ironically, this creates a subtle and bizarre interdependence and symbiotic relationship with both the supporters and enemies of the States!

Marked or Personalized debit cards in which the funds are available only to one or two specific individuals can also be issued, but each transaction with that card will be recorded, identifying the user, what he or she purchased, and where, giving the Coalition watchdogs potentially incriminating information.

Some independent nations, kingdoms, organizations (like the Black Market) and businesses with numerous outlets throughout the land issue their *own* form of “credits” on debit cards via an independent banking institution. Individuals who despise the Coalition may elect to use these instead of the CS Universal Credits. Likewise, citizens and supporter of that community or institution may also prefer to use their own credit system, however there are problems with this. First, the security of the credits is based entirely on the stability of the kingdom or organization that issued them. Obviously, such places are much more unstable and vulnerable to disaster than the CS. Second, since the CS will not recognize most other nations and never accepts *foreign* credits, these money cards have an extremely limited value. In many cases these in-

dependent debit cards are only accepted in the kingdom that it is issued and worthless everywhere else (and another reason the CS Universal Credits are so popular).

Lazlo and New Lazlo, Tolkeen, and a handful of other independent kingdoms and cities have their own form of credit system, but only the joint efforts of Northern Gun and the Manistique Imperium have managed to establish a banking and credits/debit system that is accepted and used at many locations through the country. Typically, any seller of Northern Gun (NG) and Imperium (MI) weapons and equipment (both using the same credits system and debit cards) will usually accept NGMI debit cards redeemable for credits that can be used at these Upper Michigan kingdoms and with all of NG and MI "authorized" gun shops, merchants and traders, as well as most 'Burbs. Furthermore, a handful of other independent towns, cities, merchants and traveling shows use or accept NGMI cards, including *Colorado Bar-*

*onies, Silvereno, Bandito Arms, Lazlo, New Lazlo, Kingsdale, Ciudad Juarez,* and scattered towns in the *Pecos Empire, Lone Star, New West and Magic Zone.*

The only credit-debit system to rival the NGMI and challenge the CS Universal Credits is that of the **Black Market**. Their debit card is a simple, encoded *black* plastic card. It is good at virtually *all* Black Market operations scattered throughout the world, including the Coalition States, and accepted by all official Black Market agents, operatives and freelancers, as well as by most Juicers, Crazies, Gunslingers, Bounty Hunters, mercenaries, spies, smugglers, bandits and criminals of all kind. *Black Credits*, as this illegal, underground system of banking and debit cards are known, is welcome at Coalition Burbs, most Body-Chop-Shops, the Pecos Empire, Bandito Arms, and many (not all) merchants and businesses at *Tolkeen, New Lazlo, Whykin, Kingsdale, Free Quebec, Lone Star* and scattered town in the *New West.*



# Designer Notes

By Kevin Siembieda

I am often asked about how and why I have designed **Rifts®** and the Palladium Game system the way I did, and/or how I run my games.

I hope to answer some of those questions, shed some light on my thought processes and offer some of my experiences and thoughts on role-playing and being a Game Master. I hope it helps give gamers and G.M.s insight, ideas and inspiration for their own games and helps to make running Rifts easier and more enjoyable.

I had trouble figuring out exactly where to start, and as I was writing this section, one part often (at least for me) segued into another. So here goes, in no particular order.

The roots of my game system and my style of play grew out of the fact that I was running my game at the long defunct, **Detroit Gaming Center**. I think of the DGC as a rain forest environment. A hothouse of ideas filled with zillions of people anxious to share their thoughts and games. Every role-playing game product that hit the store shelves appeared at the DGC that very same day and was absorbed like magic. Having hundreds of victims ... um ... I mean players at one's disposal gave a Game Master a crash course in running RPGs. We could try out anything on anybody and see what works and what does not. We also had a chance to try *everything* and see what worked best for us. This

group environment showed me that EVERY Game Master has his or her own style. It showed me that anything goes if it works for that Game Master and his players.

We had G.M.s who ran their games like a general marshaling his troops and the players acting with teamwork and almost military precision. We had G.M.s who ran fast and chaotic and whose players seemed to spend more time spending money, hanging around at saloons and backstabbing each other than actual adventuring. We had G.M.s like Erick Wujcik who weaved elaborate plots and loved mazes, puzzles and mysteries (lots of clues, false leads, dead ends and figuring things out). Some G.M.s loved dungeon crawls and simple plots. Others preferred complicated plots that went on for months (even years) before being resolved. Some folks liked mysteries, others, shoot 'em up games or a combination of everything. I knew one masterful G.M. who could not create an adventure on his own, but could take the worst piece of garbage adventure or adventure outline and weave it into a masterpiece. Others were power gamers (my 20<sup>th</sup> level this or that does ...) and still others were "hack 'n slashers" – crush, kill, destroy, and get rewarded. One such hack n' slash group playing an old, post-apocalyptic game called *Morrow Project*, thought nothing of a player character shooting an innocent farmer working in his field, because the game rules provided points for every kill, and by killing this fictional farmer his character got the last few points to reach the next plateau! (It was an event that helped to get me to develop my system for *Alignments*. To my thinking, a good guy just doesn't kill for his own personal advancement.)

Many styles of gaming I didn't personally like, but seeing dozens and dozens of different approaches, methods and practices showed me one very important thing: if everybody is having fun, there really isn't a wrong way to play. Role-playing games are unique and personal. The rules flexible. The idea is to create a story as a team. All stories have a beginning, middle and end.

## Laying the groundwork for adventure

Personally, I like fast moving, loose, flexible, character driven games where the players can go in whatever direction they want, and with me, as Game Master, gently or subtly drawing them in the direction I want or need for the adventure. That having been said, there has been many a time where the group spins off into areas I never expected and digresses from "my" plans for them completely. I like to improvise and go with the flow so that is okay, but I know it flusters some Game Masters. That is how and why I developed my "environmental" approach to creating and building adventures.

**How I set up the basics of an adventure.** I like to run fast and loose, focusing on the characters (player and non-player), the villains and the big picture. I like to set up my *playing environment* – the history of the area, the town and the key people are all known to me. I know in the town there is the wishy-washy Mayor (and who the real local power is), the corrupt Sheriff, the bartender with connections to the Black Market, the barmaid who dislikes him (and will warn innocent characters or offer info to thwart the bartender's schemes), the Shifter conducting dangerous experiments in the basement of his home, the mysterious vandalism happening lately, etc. I also figure out the *neighboring wilderness* and the various good and bad things about it, like the band of crooks, Juicers or Simvan that operate in it, raiding travelers, and who know things that will help the player group. As well as the Coalition spy team and the towns relationship with the CS and other powers in the region. My playing environment may also include neighboring places, people and monsters.

*Then there are the Villains.* My reading and loving comic books for something like 42 years has made me good at making *villains*. Real good. In fact, Erick Wujcik says I make some of the most delightful and memorable villains (and other select Non-Player Characters) he has ever seen.

**The bottom line.** The idea, for me, is if I know the environment and how the people (NPCs) in that environment live, think, and interact, I know how they will act and react. This enables me to let the player characters go off in other directions and do things I didn't plan for because I know how the Non-Player Characters (NPCs) will respond. That makes everything else easy. The corrupt Sheriff will look the other way if the right bribe comes his way, and he may know about criminal activities, gangs, and Black Market outlets; all things he might reveal for a price, or favor, or if gotten drunk. Likewise, if he takes a disliking to any one character in the group, he is likely to cause trouble for that individual, which in turn, is likely to draw the entire group into trouble (jail break, getting framed, used as pawns, robbed with the Sheriff doing nothing about it, etc.). When I need a scoundrel or innocent character for something, I know who I can draw on. Likewise, with the villains, I can move them around and have the villain make an appearance anywhere, rather than waiting for the player characters to find them. Ultimately, it all adds to and builds on the actions and reactions of the player characters and takes on a life of its own.

By knowing the Non-Player Characters, I respond to anything the players do, want or need. I can also use the NPCs to provide clues, encouragement, and inspiration to motivate the player characters and keep them on track. This includes facts and rumors that might get their blood boiling and ideas clicking.

**The plot.** I then present the players with one or two "goals." This is *their mission*, their overall purpose and the motivating plot for this night of adventuring. I often start small and simple, even obvious and cliché. But you know what? They are cliché because they work and people love 'em. That simple goal may be as basic as any of the following, among others.

1) The damsel in distress: "Please, please. You have to help rescue my sweet Amanda. The Coalition (or whoever/whatever) has her and god only knows what ... what they might ... oh, please help me."

2) The missing child. "Little seven year old Benny is gone" (wandered off and is lost, kidnaped, last seen talking to a stranger or D-Bee, etc.).

3) The terrible monster. Now, for me, a "monster" can be literally a monster (vampire, Xiticix, demon, etc.) or a vile, monstrous fiend (foul practitioner of magic, dragon, D-Bee, supernatural being, the CS, the Federation of Magic, pretty much any evil or despicable character). **Note:** In #1-3, Heroic characters may accept the challenge out of a sense of duty, morality or compassion. Self-serving characters may need additional reward to get them involved.

4) Hired protection. The player characters are hired to escort, guard and protect somebody, something or some place.

5) Money and power. This is the classic hire the player group to get something of immense value or power. Inevitably the payoff for their efforts is BIG in the way of money and/or fame, always with the underlying question of whether or not they should keep this item for themselves if they can get it. Which leads into the subplot of the classic double-cross, if not by the player group against their employer then the other way around.

6) The great race – or free-for-all. The player group "hears" about some immensely valuable or powerful artifact and either decide to try to get it for themselves or are hired by some rich dude to get it for him (of course, they will be paid handsomely for their troubles). The thing is, it is all hearsay. Rumor. This item may *not* actually even exist! Still, the characters are off with at least two or three *competing* groups (all or most bad guys) after the same thing. This pits our heroes against them and who or what may actually hold or guard the desired item.

7) Coercion. Personally, I love coercion. You know, when the characters are tricked, black-mailed or otherwise "forced" to go on some mission. This can be a pardon for past crimes (i.e. do this for me and you get out of jail), or do this thing otherwise these innocent people will suffer or die, or the good ol' Escape from New York: You have "X" days or hours before you die (or something terrible will happen to somebody), and so on.



There are others, but you get the idea.

**What next? Adventure.** Everything takes off from this one central starting point. This starting point is the launch for things to come. The adventure can move forward from this point in a linear, predictable fashion (sometimes those are the most fun) or take a twist or ten.

**The twist.** This is where the complications, obstacles, surprise turn of events, treachery, and subplots come into play. Such elements can be challenges and obstacles to be overcome or carry the players into completely unexpected directions and lead to entirely different side-adventures or different outcomes than expected. The fair maiden in distress ain't so fair or so innocent. She hasn't been abducted, she's really a Witch or Shifter or demon off on some nefarious plot (perhaps to enslave, hurt or kill the very people worried about her). The search for the lost child could turn into almost anything. Yes, Benny just happened to wander off, but he has since captured by — god only knows what. Or is being used as some unwitting pawn in some nefarious plot (is really the son of a King or Warlord and the villagers were the ones holding him hostage, and he's just trying to get home to Mommy and Daddy. Or the kid has some other significance. Or he's just a sweet child who wants to go home who come across these nice men, Slavers, and is now in a cage and heading for someplace called Splynn). The employer is worse than the villain who has the item the group has been hired to get. Or there is no valuable relic, it was all a ploy to find so and so in order for the group's employer to extract some terrible revenge. And so on. There's a million ways one can go. Draw upon things you have experienced yourself or hope you never have to. Draw ideas from the news, television shows, books, comic books, films, other role-playing games, etc.

## How many players should be in a typical group?

Gosh, I'm asked that question all the time. And I fear my answer sounds like an easy out, but it is not.

Whatever the G.M. feels comfortable with.

Most gamers I talk to have a group of 3-6 players plus the Game Master; so 4-7 total players in their group. About 10% are smaller and 20% are larger. You really can't play with fewer than three people (the G.M. and two players) and I have found most G.M.s feel most comfortable "running" 4-6 players. That is a good number in that most G.M.s can give a good amount of attention to each player and keep the story/adventure moving along at a good pace.

*Personally*, I like to run larger groups. For me, the "perfect" size is 8-12 players. Anything over twelve starts to get more unwieldy and the G.M. has to really work hard at his storytelling, pacing and theatrics to keep EVERYBODY involved and entertained. Inevitably, some faction of players get less attention and time to shine than others. However, if the adventure was entertaining, they don't mind, provided it is their chance to shine in next week's adventure. But then, I'm used to running a lot of people.

During my *Detroit Gaming Center* days, I used to run a regular Saturday night group of 26 people (The Defilers), with extra folk joining in sometimes bringing that number up to as many as 32 (which is almost impossible to run, even for a one-shot night of epic combat and adventure). I don't like to run more than 21 maximum, and much prefer 8-14 for my ideal comfort level. *And it is very important the Game Master feels comfortable.* He or she is the person orchestrating the set-



ting and adventure. The G.M. has to keep the action going and deal with a hundred different aspects of the game, from rules things like keeping track of Experience Points and making sure he and the players are using magic, psionics, equipment and game rules correctly, to the job of the referee to make sure the gamers are playing “in character,” as well as handling the story elements like creating suspense, presenting clues and pacing, to playing the villains and NPCs and weaving it all into a fun adventure. Hey, it ain’t easy! It is a ton of fun, but it is also a lot of work. So cut your Game Master some slack and try to work *with* him.

**That reminds me,** role-playing should NEVER be a *contest* between the players and the Game Master, with one side trying to outsmart or get the upper hand on the other. I’ve seen G.M.s who think it is their job to keep players confused, in the dark, and down. Meanwhile, I have players who think it is their job to outwit and/or trick or show up the Game Master, or to disrupt and ruin the G.M.’s plans. Both suck and are inappropriate behavior.

Remember, the *Game Master* is like the co-writer and director of a movie. This is the person who is setting the plot and “directing” the scenes. The G.M. moves the story along and presents many different story elements, obstacles and antagonists. *The players* are the actors and *co-writers* in our little drama (or comedy as the case may be). Their actions, insight and interaction with each other and with the “director/G.M.” help to *create, develop and move* the story along. EVERYBODY should be working together to the same end, to build the story and reach its climactic conclusion. In that regard, everybody, G.M. included, all part of the same “team.” If there is a “them or us” attitude in a playing group on either the part of the G.M. or the players, there is going to be friction, conflict and bad feelings that will tarnish the enjoyment of the game.

That is not to say there can not be a certain amount of competition or opposing views. And certainly, the players should be competing hard against the fictional *villains and obstacles* the G.M. has placed before them in the adventure. Indeed, it is the players goal to outsmart and thwart the bad guys. The G.M. can throw them some curve balls and surprises, just as the players should do the same thing to the Game Master. Personally, I love it when the players come up with a plan or find a loophole that I did not imagine in order to win the day (or the moment). It makes the adventure unpredictable, unique and that much more dramatic.

The idea is for the Game Master and players to challenge one another in a friendly, cooperative way. If done right, this creates the same kind of suspense and excitement one gets from reading a mystery novel or watching a movie. Halfway through, you have been given enough clues to figure out who the mystery murderer really is, and you can hardly wait to get to the end to find out if you are right (maybe changing your opinion as you learn more). The same thing is true in a good role-playing game adventure, only it is even more exciting because you, *the players*, are helping to create the story and reach that ending. There is a tremendous sense of exhilaration as one’s character actively fights to reveal the truth and confront the villain. There is even more excitement when there is a sudden, surprise twist, treachery or deadly turn of events, because your character is in the thick of things. And when the climax comes, and one’s character (with the rest of the group) helps to win the day and defeat the villain – man oh man, does it feel good. One feels a sense of camaraderie, accomplishment and exhilaration that is akin to winning the big high school football game! I’ve seen games where the players high-five each other, jump up and down and cheer. That’s what role-playing should be all about. Not competition between each other or the player group against the Game Master, but a creative team.

And it is most important that the Game Master remember this. Ultimately, as G.M., you want and need to help the characters reach their goals. Every obstacle you throw at the group is to challenge them, not crush them. It is to test their mettle, provide clues, keep them on the right track and build the dynamic tension of the story. NOT to belittle

and defeat them. Although *defeat* with the chance to escape, regroup, and return to challenge the villain again in a fantastic two or more part adventure will always be memorable. Check out this next section.

## An RPG campaign is a continuing epic

### Returning villains are fantastic

A regular campaign is typically a series of games/adventures involving the same characters over a period of time. Getting together every Tuesday or Saturday to play with the same characters and players in the same setting, provides fabulous storytelling opportunities and will create a sense of continuity and adventure even if every night is a different adventure. (Personally, I like both one-shot/one-night and continuing two and three part stories, always careful to end with a cliffhanger or an appropriate lull.)

For one thing, a continuing adventure/campaign allows the player characters to suffer defeat, while giving them the chance to return to succeed at a future point.

For another, it offers the opportunity to create returning villains.

Anybody who has ever read comic books knows how important and fun these two adventure elements can be. Use them!!! You won’t be sorry.

**Defeat.** I don’t care how smart or powerful a team is, they *cannot* always win. In fact, if they do always win, the story/adventuring gets boring. I’m not saying to set the players up for defeat, but if they are having an off night, making mistakes or the roll of the dice just goes bad for them (I’ve seen it happen), let them *lose*. Sometimes the real test of heroes is how they handle defeat.

Now, I’m not saying to kill them all. Heck, no. I’m saying whip their butts, but give them an *out*. This can be an opportunity to escape or something as comic book theatrical as the head villain laughing at them and mocking them for being “weak losers,” beneath his notice. “You are the best champions these people can find? Ha, ha, ha. Then we have nothing to fear. Begone before I destroy you. You are nothing before the power of Grandal the Destroyer.” And the scum bag turns his back and leaves, his minions chuckling and adding more insults as they follow his lead, but also to cover their leader’s back and perhaps get in a few last licks on our heroes.

Let me tell you, nobody likes getting their butt handed to them and then laughed at and dismissed as worthless, insignificant losers. It makes ‘em mad and spoiling for a rematch. Go for it, next week. Or maybe give the characters a *chance* to find out more about their opposition, uncover some weakness, develop a better attack plan, or to get some powerful weapon that will help them defeat these rats – a side adventure perhaps, that could last for one or more nights of gaming before the rematch.

Besides, it is the stuff of adventure. How many times have the good guys been defeated in comic books or movies only for the heroes to regroup and come back better, stronger, with more resolve than ever. It happened to Indiana Jones. It happened to Luke Skywalker (heck, the Jedi were almost completely destroyed before Luke came around). It has happened to Superman and Spider-Man, and Hercules, and every hero since people began telling adventure stories. And it is awesome.

**The returning villain.** Likewise, people love to have and hate their favorite villains. In *Rifts*®, that may be the Coalition States or Emperor Prosek personally, or the Federation of Magic, or some specific character from one of the world or sourcebooks, or one of your own dynamic creations. In comics, there is Lex Luthor, the Joker, the Green Goblin, Doctor Doom and a host of others. In film, there is Hannibal Lector, Darth Vader, and many more. Man, your mouth just starts to water and your pulse quicken the minute one of those *recognized* villains steps out of the shadows or claims responsibility for some delightfully terrible or insidious act. In this case, familiarity breeds anticipation and excitement. It creates history and builds suspense and emotion. Use that in your games.



Staying with the scenario presented under Defeat, above, let's say our heroes return for a rematch. This time they are prepared for their adversaries and have a few surprises of their own up their sleeves. Ultimately they win, defeating 98% of the bad guys and save the day. HOWEVER, the head villain, or one of his secondary, but memorable evil henchmen, escapes. The player group rejoices for winning the big picture, but all the loose ends are not tied up. They may even go looking for the escaped villain (or villains), but fail to find him (or her or them). Maybe the bad guy(s) fell off a cliff but the body was never found. Or maybe just slipped away during the action and has gone into hiding. The player characters still savor their victory, and maybe even forget all about this villain.

Then, a month later, six months later, a year, the villain reappears. He may be gunning for the heroes out of revenge or just up to more nefarious schemes and evil-doing. However, when the villain(s) and heroes clash again, it is more *personal* this time, because they have history. Both sides are out to defeat the other with increased gusto and resolve. Certainly the villain is out to show them up and get some satisfying revenge now that they are pitted against each other again. The revenge may involve the death of the group leader, a specific character who hurt the villain most in the past, or the entire team. Or it may be to embarrass them and hurt their reputation, or to hurt and infuriate the heroes by harming the innocent. Or simply a game of win or lose, to prove who is better, them or the villain. Whatever the case, it is all good stuff.

To really make for a good and regularly *returning villain*, do not kill the antagonist off this second time either. Let him get turned over to the authorities or escape again, or appear to be killed only to return later somehow (via bionic reconstruction or other lifesaving augmentation, magic, a pact with a demon lord, it was really a clone who died, or who knows what else). If captured, the scum bag manages to escape (again), bribes his way out, or an unlikely twist of fate liberates him. At some point, the group and this scoundrel clash again. This can be another out and out battle or quest for revenge, or it can be a couple other fun classic story ideas.

One of my favorites is pitting the group and the bad guy (and his henchmen) in a situation where they must work together to get out alive or to save the innocent. The villain works with them at least for awhile, but inevitably has his own agenda (escape, get the magic item or money, get revenge, etc.) and when the moment comes, betrays, attacks or abandons the group (or two out of the three, sometimes all three). It makes for great adventuring.

*Another is the race.* The heroes and the villain are both racing against time and each other to get or do something before the other. In the case of the heroes, their actions and winning the race will ultimately save lives, help people or prevent something terrible from happening (or stop the villain from getting more powerful). For the villain it is a matter of winner takes all and perhaps revenge.

Another is the, "I have turned over a new leaf." You know, the good old, "I have seen the error of my ways and have given up evil to be a champion of good," or even a preacher, healer, wise man, mayor, protector of the people, etc. The big question is always, "Is this guy for real?" Is he legitimate, or is this one of his scams?" And if it is a scam, what the heck is he up to this time? The answers to those questions we leave to the Game Master.

## Tricks of running a large group

**When a player group is small**, 2-6 players, they are more likely to bond naturally and tend to work as a team. Even if the characters splinter off in pairs or alone (and you know they do), they are easy to keep track of and even the most independent and chaotic players inevitably work as a team when they really have to. This is why it is more comfortable to run a group of 2-6 players.

**Running a large group**, however, has similar dynamics on a larger scale. Inevitably, when there are eight or more players, the group fractions into smaller *sub-groups* or teams within the larger group. This is a natural occurrence where *players* with a similar outlook and playing style or whose *characters* share some bond, camaraderie or sense of purpose will naturally gravitate to one another. Ultimately, these splinter groups are handled as a separate team or unit, so even though you have say, ten players, they are functioning together as two or three distinct units, not ten individuals.

**The cliffhanger tactic:** To keep everybody involved in the action and events transpiring, even those that do not involve them, I use the cliffhanger approach. That is to say I work with one group up until a tense or dramatic moment ("You hear soft footsteps ...") Like somebody trying to prowlf? asks one of the players, "Could be, maybe yes. And you also hear a faint raspy breathing. The door handle begins to turn ...") – and then I turn to one of the other groups and say, "Okay, what are you guys doing?" This keeps the player unit at the door tense and riveted to their events while watching and enjoying the actions of the other units. It also gives the players some time to think about what they are going to do next. Thus, when I turn my attention back to them, "Okay, you hear the click of the bolt and the door starts to open." The players can jump in and say, "I'm using my spell to turn invisible (or throw up an Armor of Ithan or some such). The Headhunter says, "My gun is drawn and I'm ready for anything." The Juicer says, "Yeah, me too, but if it is something too bad my character will back flip out of the way and then open fire."

Of course, you break at a dramatic pause also, like after the one unit has just defeated their opponents (and before they loot their victims or engage in interrogation, or make a run for it).

**Comedy.** I like humor in my games. It relieves tension and adds to the fun. Using the setting above, under cliffhanger tactics, I might, if appropriate, have the door open up to reveal a little girl (hence the soft footsteps) with a bad cold (hence the raspy breathing). It's cute. It's funny. And it keeps the players on their toes. Of course, she could be the servant of a powerful dragon, mage or monster that appears on the scene a moment later (right after they let their guard down).

---

# Game Mechanics

---

## Experience

### Why an experience “level” point system?

Because I like it.

As the game designer, I like the Experience Point system because I feel it is a more realistic simulation. I’ve known many brilliant people in my lifetime, and some, despite their high I.Q. and natural talents, just don’t do anything with it. Or they go to school, learn the basics and move on to something completely different. I also know from personal experience (no pun intended) that doing and learning through experience is how a person grows. I’ve seen artists and writers, sports figures and others hit a “new plateau” at a particular point in their career (often at several points in their career). To me, that’s hitting a new experience level. To reach a new level of understanding and skill that makes one better at what he or she is doing. It’s real, and I think an experience system recreates that.

In the Palladium Experience Level system, one’s character tends to grow more quickly in the early stages of experience, which is also true to life. At first, everything is new and exciting and one learns rapidly. However, with each new level of experience, attaining a new height (the next level) becomes more complex and difficult. It takes more subtly, more practice, and most importantly, more time. That is why after Seventh or Eighth level, it may take a character a year or two to reach the next level and two or more to attain the next. Typically by 10th level, most player characters (unless several years old) not likely to advance much for several years at a time. Which is realistic too.

### When does the use of a skill count toward experience?

I always go with the “clever” or “critical” use of a skill as the criteria for experience. Reading a computer screen, plugging in a battery or driving the car to the market is not worthy of any experience. Ordinary skill performance in an ordinary setting does not count. The higher the level of the character (and therefore, the easier it is to perform the skill) the less significant it is too.

Hacking into a computer or trying to reprogram it to stop a deadly virus, get vital information or to trick a villain – now that’s worth experience points. Likewise, driving a vehicle in such a way as to draw the attention of the bad guys away from innocent children, or to rescue innocent characters or to engage in a stunt driving-filled getaway or chase to capture or follow bad guys – now that’s worth counting for experience. But even with these examples, we are seeing the use of a skill combined with *ingenuity*, *daring* and *heroics*. This is, after all, an “adventure” game, so I always feel the greatest experience points should come from doing something that is smart, cunning, surprising, bold and heroic. If it saves lives (Non-Player Characters or fellow player characters), helps others, or contributes to saving the day, then those actions should count for something and contribute to the character’s experience points (not to mention the excitement of the gaming experience).

The greater the risk, the greater the level of (potential) self-sacrifice and the more people saved, the more experience that should be given out. Especially if the rescue was particularly brave and/or brilliant. Likewise, if doing something represented a moral dilemma for the character, but in the end, the character did the “right thing,” that too is worthy of a little experience.

Here again it is a matter of *subjective judgement* on the part of the G.M. A rescue in and of itself does not warrant a big experience point

reward if it does not truly *challenge* the player characters. If it is easy, the experience is minimal. If it is difficult the experience is greater. If it was death defying or nearly impossible to accomplish (at least without teamwork and cunning) the experience should be considerably more impressive. For example: The player group could rescue 50,000 people trapped in a football stadium and get 50-100 experience points each player character because all they had to do was battle some wimpy guards, the battle took only a few minutes and only two player characters even got scratched. Big deal. Low E.P.

On the other hand, a battle against a superior force – or even against one, lone villain, but one with great power and who almost kills half the group and/or where one of the player *characters* genuinely puts his or her life on the line – now that is courage, cunning and heroics worthy of 500-1000 experience points to each of those characters who almost died or saved the day. That includes the weak or injured character who came up with the brilliant plan or strategy but did not actually participate in the battle itself. Again, depending on the circumstances, level of opposition and who is being rescued (a pivotal NPC like a king, hero, godling, a lot of people, even one person, etc.) and exactly how events unfold could have an impact on the number of experience points handed out, low or high.

**This is easier than it may sound.** If you and/or the rest of the players are *impressed* or *surprised* by the character’s cleverness, self-sacrifice, heroics and actions (they don’t always have to be heroic actions) then that was probably something worthy of an Experience Point reward. If you find yourself as G.M. thinking, “I never thought of that,” or “That is exactly right, she’s got the right idea,” or “Wow,” for any reason, **it deserves Experience Points.**

Actually, I use what I call the “Wow Factor” for everything, from designing and running my gaming adventures to the writing of my role-playing games and sourcebooks. If something “wows” me or those around me, it is an important factor worthy of note. The more “wow” and even tingles of “ooh, that’s good,” and that little smile that curls one’s lips as a reaction to something someone said or did, are all signals to me, as Game Master, of a *significant* event or action to be noted, remembered and rewarded. And I make a point to mark down the experience as it hits me. NEVER wait till later and figure you will remember it, because you won’t. I sometimes even stop the game for a minute to jot it all down.

On the other hand, a thief picking a lock when nobody is looking, a mage casting an obvious or simple spell without any pressure, a man at arms standing guard, a Juicer leaping from rooftop to rooftop, a scholar buying and reading a book, a City Rat sneaking around or hacking into a computer to be nosy, an Operator cleaning his gun or maintaining the group’s vehicle or any character doing anything that is normal, typical, *expected* under the circumstances – or just a plain stupid thing NOT to do – big deal. **No Experience Points.**

### Experience Points are their own reward

Remember, in a game context, one of the tangible accomplishments and rewards the *player* receives is Experience Points for playing his or her fictional alter ego “in character,” and cleverly. Yeah, his or her character or the player group as a whole getting money, treasure, powerful weapons or rare artifacts is cool too, and is certainly a “reward” for the characters, but Experience Points are the real achievement for the individual player.

I have run many a game where the player characters got the snot kicked out of them, lost valuable equipment and got no or little financial reward, but the players were tickled pink because they saved the day (even if it was to save one lone orphan), because they worked as a team, had fun doing it and *won* – stopped the latest “unspeakable evil” and had the Experience Points (and self-satisfaction) to prove their heroic efforts were worth the trouble and pain for their fictional characters. That is the other beautiful aspect of the Experience Point system. You are rewarded for your character’s accomplishments and not some dopey points to make him or her more powerful.

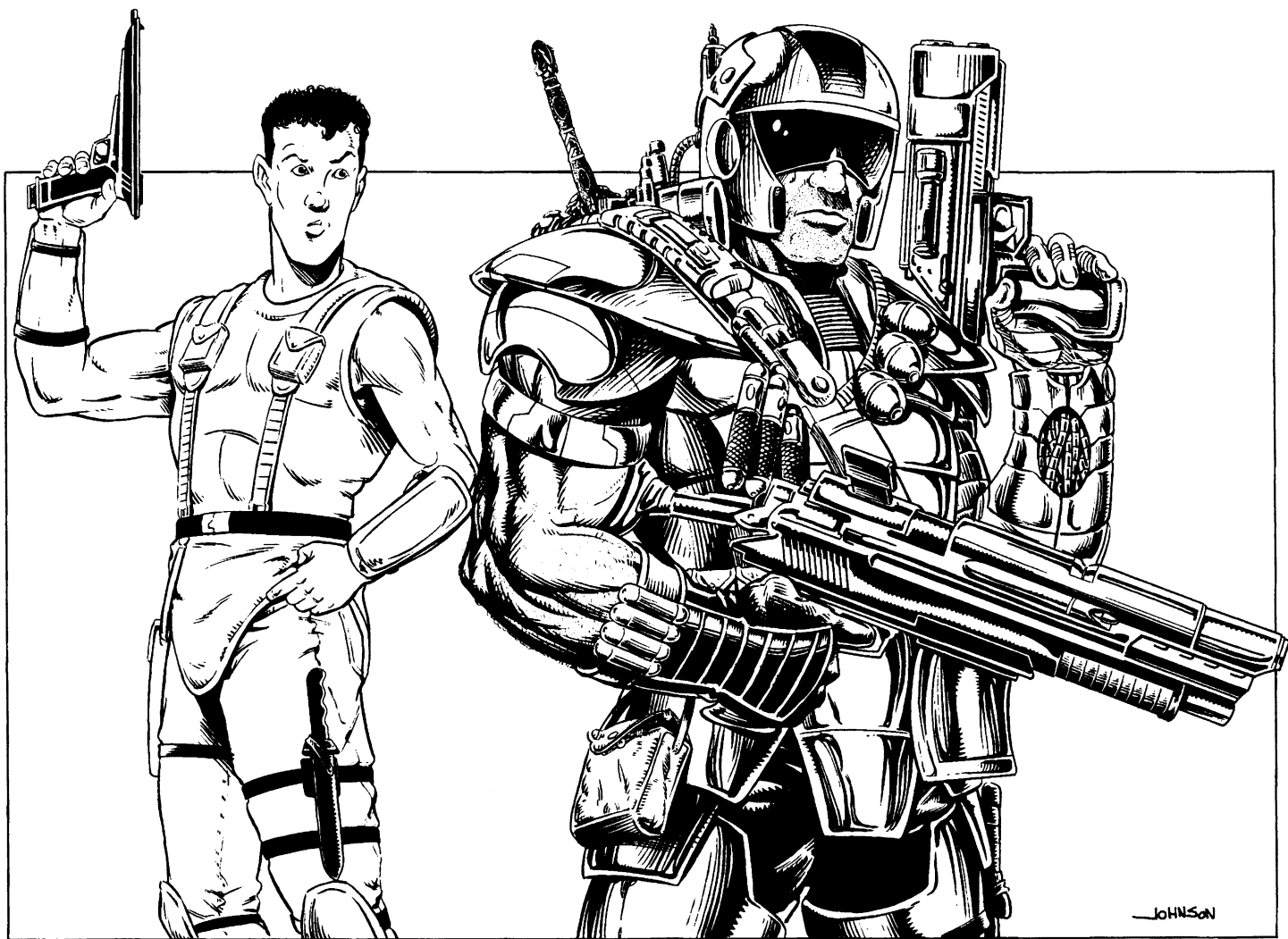

## EXPERIENCE POINTS TABLE

### Awarding Experience Points

Experience Points	Action
25	Performing a skill (successful or not).
25	Clever, but futile idea.
100	Clever, useful idea or action.
100	Quick-thinking idea or action.
200	A critical plan or action that saves the character's life and/or a few comrades.
400-1000	A critical plan or action that saves the entire group or many people.
100-300	Endangering the character's own life to help others.
500-700	Self-sacrifice (or potential self-sacrifice) in a <b>life and death</b> situation (like leaping in front of a fireball meant for someone else to save that person, even though he/she is likely to die, or offering his/her own life to save the group or another).
100	Avoiding unnecessary violence.
100-200	Deductive reasoning and/or insight.
50	Good judgment.
50	Playing in character bonus.
50-100	Daring (clever or not).
25-50	Killing or subduing a minor menace.
75-100	Killing or subduing a major menace.
150-300	Killing or subduing a great menace.

## Other game elements and rewards

Speaking of “intangible” rewards, don’t underestimate the power of a tearful **thank you** from the parents of the child the group just rescued and the good feeling that the players get when the NPC parents offer the group three chickens, a cow and a gold watch – almost EVERYTHING of value these peasants own! And/or the pledge of **undying gratitude** from these parents or the tribe or town, and **little things** like free room and board or healing and other small gestures of kindness and appreciation. Or the **warmth** from a gaggle of children embracing and playing with an ugly/monstrous player character and sincerely calling him their friend (a level of compassion and acceptance “monsters” do not often enjoy, especially from humans and other attractive races).

**Notoriety** or outright **fame** is another reward. To have the character or the entire player group treated like heroes and celebrities is a nice reward for the players. Another measure of their characters’ accomplishments even if it is in a one-horse town.

Of course, fame is a two-edged sword that cuts both ways, good and bad. Praise and prestige can turn into disdain and dislike if the characters wear out their welcome by using their celebrity to cheat or take advantage of those who embraced them. This can happen if one or more of the characters in the player group prove to be a low-life or scoundrel, or if he or the group do not “live up” to the townspeople’s *expectations* of them as “heroes.” For many people have unrealistic expectations or false impressions of what a hero should be, and become disillusioned and feel tricked or cheated when they come to realize the truth.

Worse, fame brings **notoriety**, and notoriety inevitably brings trouble. My old Defiler campaign brought the characters fame and fortune. They had gigantic statues of them erected by the townspeople. They

were all treated with love, affection and respect (even the inhuman ones). They got steep discounts (20-50% off most non-magical items, 10-20% off magic and rarities), were bought meals and drinks and one went on to rule the town (which thanks to the Defilers, now prospered and its people lived free and independent). That's the good part.

*On the other hand*, the Defilers were constantly being petitioned to help somebody or another. The more powerful, high level and *famous* they became, the more petitions for help they received – and the more difficult the opposition. They were once whisked away to an alien dimension against their will to save the king and his kingdom. They were attacked by villains looking to make a name for themselves by being able to claim, “I (or we) killed the famous Lord Coake,” to prove how powerful they were. The friends, families and associates of enemies the group had defeated or destroyed came looking for revenge (“Hello. My name is Inigo Montoya. You killed my father. Prepare to die.”). Even worse, world leaders and powerful sorcerers, dragons and beings began to approach them (how does one say no to a God of Light?). While good powers would approach them for good deeds, less scrupulous powers tried to manipulate them into doing things he/she/it wanted done for self-serving or evil purposes. Of course, that never worked, and the Defilers would figure out what was going on and turn the tables on the scoundrel or villain (with everything ending well). Once, toward the end of their careers (and nearly three years of playing the same characters in the same campaign), the group was attacked by a Genghis Khan character, his most powerful henchmen and half his army. Why? Because the fellow planned to conquer half the region. And when assessing the obstacles he would have to face, he decided that the Defilers would intercede on the behalf of those being conquered. Thus, he sought to eliminate them first (his only real opposition), so everything else would be easy!

## Playing in Character – Alignments are your guide

For me, one of the best guides for creating and playing “in character” whether the G.M. or a player, is the Alignments. These stereotypes serve as a broad template and guide for playing one's character. It is a moral barometer that will affect the character's judgement, choices and everything that fictional character does.

I could and probably should go on at great length about alignments and playing in character, but the above paragraph really says it all, and this book is running over pages already, so I'm keeping it short.

As a Game Master, there have been many, many times where I pause the game action to announce to a player. “A Scrupulous (or whatever) character would not do that. I think your character should reconsider. Now, you can continue, but your character's alignment is going to drop to Anarchist (or Miscreant or whatever is appropriate depending on the deed). You won't be a good guy any more.” And then I let the player think about it for a minute. Maybe turning to a different player and his character for a little bit. I always let the player do whatever he wants for “his” character, but there are consequences. And not just a drop/change in alignment. Let's say the character murders someone in cold blood or engages in torture. First, I announce how all the other good characters are shocked and horrified. (They would be, wouldn't you?) Then I announce as a reminder that any other good character in the group will try to stop this terrible or cruel action. This may give the first character a moment of pause and cause the player to reconsider his action, and may also pit one or more players against another. While I don't encourage inciting trouble between characters, a moral dilemma is a moral dilemma and will cause tension and even divide the group unless the character responsible makes amends. Moreover, any Non-Player Character (NPC) will react (negatively or positively depending on the character) to the event, which may drive home a point and get characters to respond in a more appropriate manner. Sometimes it takes that kind of nudge to get the players thinking.

## NPCs are a valuable tool

Not only is my adventuring world populated by countless Non-Player Characters, but I ALWAYS include one or two in the player group. Always.

Why? Because it gives me, as Game Master, a direct influence on the group. Not to overpower, manipulate or lead the group, but to influence in subtle ways. In fact, I NEVER make the group NPC a leader or a powerhouse. Often the NPC is young, weak, naive, and innocent, first to third level. This way, I can use the NPC to point out a clue or ideas the group missed (to get them going on the right track; sometimes the wrong track), to illustrate the fear or injustice or moral outrage of a situation, to get the group into mischief by his actions and for comic relief. In the situation earlier, where a player character is about to do something out of character or just plain evil, the NPC can show his shock and horror of it, and/or try to intercede to stop it. The NPC's comments, reaction and action should get the other players thinking and their characters reacting. It is a nice, subtle way to nudge things along and stimulate action and adventure. Along those lines, one can use the NPC to generate conflict. The kid gets the group in trouble by shooting off his mouth (“Oh, yeah, well my friends here can kick your ...”) or by making an accidental noise to alert the antagonists to the group's presence and so on.

NPCs in this capacity are the Game Master's greatest tool. Use them wisely.

## Balance does not mean equality

It surprises me every time I hear somebody say the Mega-Damage system is not balanced because unless a character is wearing M.D.C. armor or has Mega-Damage skin, he can not face a Mega-Damage opponent. These individuals usually go on to lament on how a lone gunman armed with an M.D. laser pistol and clad in (comparatively) flimsy Plastic Man body armor (with 30 M.D.C.) can wipe out an entire town of ordinary Hit Point/S.D.C. people! Well, maybe in theory, but not likely.

Such statements tell me two things. One, the individual does not understand Mega-Damage and two, has not logically thought through the game system or the setting.

On the surface, the above complaint sounds legitimate. Technically, Hit Points and S.D.C. do not stand a chance against Mega-Damage. Even a dude in light Mega-Damage armor wielding a Mega-Damage laser pistol is something of a “superman” against S.D.C. folks.

This is where story, setting and game rules merge and one must stop and *think* about the world environment in which he or she is playing.

**Rifts®** is a future Earth that has not only developed advanced weapons and technology, but has been transformed by magic and alien energies. Technology (whether based on science, magic or the supernatural) has changed and improved to the point that a lone individual equipped with a Mega-Damage rifle is the equivalent of a 20th Century “tank.”

Real world history is filled with moments where an era is changed forever. When guns, for example, made the bow and arrow obsolete, when the Iron Clads of the Civil War (i.e. the Monitor and the Merrimac warships) brought an abrupt end to the era of *wooden war ships* and brought about the age of the metal ships and the modern navy. And there are countless other real world events. The machine-gun, airplanes, mustard gas, germ warfare, guerilla warfare, terrorism, etc., all changed the way war was fought. Technology always advanced rapidly during major wars, for the one with the superior weapons had the distinct advantage.

The same is true in **Rifts®**. That's why there are all kinds of competing technologies to counter, overcome or overpower different types of Mega-Damage war machines and supernatural (M.D.C.) creatures. There are Juicers, Crazies, cyborgs, Headhunters, Mind Mages, Practitioners of Magic, and all sorts of magical, psychic, and mechanical countermeasures, alternatives and M.D. equivalents. All have their ad-

vantages and disadvantages. All work best under certain specific conditions, not ALL combat situations. Some are not better than most, they are just different, or a competing technology.



#### Then there is common sense.

Yes, a Mega-Damage character is vastly superior to his Hit Point/S.D.C. opponents.

No, this is NOT unbalanced or unrealistic.

Yes, to face one M.D.C. clad assailant armed with a rifle that punches a hole through a car and concrete is suicide. If facing him head on and one to one. But to do that is just plain stupid.

That's why in war, tanks tend to face other tanks or bunkers and other fortified positions. If a crowd of civilians try to take on the tank barehanded (and our M.D.C. character is a walking tank) or even with assault rifles, they'll be chopped to ribbons while having little if any impact on the tank.

Staying with this analogy, a civilian armed with an *anti-tank weapon* like a bazooka or LAW rocket launcher has a "chance" of stopping or damaging the tank, but the playing field is not even. The two opponents are not equal. The civilian character does NOT have the armor of the tank and can not face it one on one or he is a dead man! He must use cunning and stealth. Attack from a hiding place and hope the shot hits and does serious damage. Perhaps shoot out the treads to cripple it. Worse, one shot is not likely to destroy the tank, although it might impair its movement or knockout one of its weapon systems. (Yes, in real life, a lucky or extremely well placed shot *might* stop the tank, but it is still only a chance, and this is not real life. It is a game.) On the other hand, a tank has its limitations. It is slow and big, preventing it from going everywhere or functioning 100% in all situations. Tanks are notorious for getting stuck in mud and ditches and don't work well in urban situations or dense forests where their size and bulk limit their capabilities. The same holds true of characters, power armor, giant robots and monsters in **Rifts**®.

Moreover, it is this inequality of S.D.C. vs M.D.C. that has spawned people like the player characters, augmented humans, mutants, cyborgs,

power armor clad, and magic wielding characters who do possess *some level* of power to stand and fight for those who do not. Sadly, whenever some people have power, they use it to bully, harass, hurt, enslave and conquer those who do not. These are our misguided misanthropes, psychopaths and evil menaces – our villains – that the player characters do battle against.

And yes, the opposition is usually more powerful than the heroes. That is deliberate too. One or two dragons, demons, or other monster or giant robot can take on the entire group. Why? Because role-playing is a "group" sport, people. Thus, the "team," the player group, is expected to take the one menace, not one of the characters taking him on toe to toe. Of course, less powerful threats (other Juicers, cyborgs, mages, D-Bees, etc.) can be handled one on one, but not all opposition. This is part of storytelling and the sense of the grand scheme of things. It is up to the Game Master to parcel out the opposition in a logical and manageable way. On the other hand, I've seen players take on ridiculous odds and take amazing (sometimes spectacularly impressive and other times spectacularly stupid) risks. If they get themselves in a jam, let them pay the consequence. Try not to kill them out of hand (something can intervene on their behalf even if it's the bad guys leaving them for dead or taking them captive), but you know what, sometimes characters get killed. And it has been my experience that a "good" G.M. never kills them, they die one of two ways: giving up their life as a hero to protect/save a friend or innocent, or by doing something stupid. In the hundreds of (maybe a thousand plus) games I must have played over the years, I have seen four or five die a hero's death (always impressive) and I have seen at least 20 die from stupidity; only one in perished in a coincidental accident. In fact, one notable Defiler (no I won't name names) was one of these maverick, lone wolf, crazy seat of your pants kind of players who always had his character run off on his own. Well, in the high action adventure of the Defiler's campaign, not working as a team player and using one's head was a death sentence. This player burned through five different characters in six nights of gaming before

he got the message. And I wasn't trying to teach him any lesson, he just did such dumb or daring things that he would die. (More than one of my players learned the hard way, never to run off with a hot babe character without telling your companions who you are with and where you are going.) To this player's credit, he went on to become an impressive and inventive player, and a valued asset to the group. In the Rifts Earth setting, one needs to think, work as a team or die.

Another reason all characters are not created equal is that every player has different tastes. Role-playing is very personal, remember, so some players like to run powerhouse characters and some don't. Some like more thoughtful, less combat oriented character and for them there are City Rats, Rogue Scholars, Scientists, Operators, and a number of others. Others just love magic, and on and on. Each of these characters has their strengths and weaknesses, and it is up to the G.M. who has a diverse group to present situations where their character can shine and have his moment in the sun figuring out a strategy, uncovering a mystery, figuring out how to use some particular device, and so on.

I find it is power gamers who have the most difficulty with the concept of weaker and diverse characters or characters with flaws (which in my opinion are the most fun to play) because they are only interested

in playing the toughest bad ass around. And Rifts® has plenty of opportunities for grand adventures of shoot 'em up and butt kicking. That's okay. Power gaming is as fun and valid as anything else, but realize everybody is *not* you.

Besides, if the G.M. is thinking out the entire spectrum of adventures, situations and the world, there *should* be moments when being the strongest and having the biggest gun means squat! A Juicer or Glitter Boy pilot who can't read, can not use a computer or read simple instructions, or read a magic spell scroll. Moreover, the gun-toting brute is likely to frighten many people and incite violence, sometimes by the character's very appearance. Meanwhile, less threatening, less overtly powerful and more clever characters can be subtle, sneaky and get information the brute can not. They simply have other strengths than the warrior. It is up to the player to find and exploit those strengths, and the G.M. to present opportunities where the character can use them to the benefit of the entire group.

**The ultimate solution.** If you truly hate *Mega-Damage* change it to Hit Points and S.D.C. It is not that difficult. Really. No, this is not a cop-out, it is a legitimate solution. Do it. I give you my blessing.

# Physical Combat

## ATTRIBUTE BONUS CHART

	17	18	19	20	21	22	23	24	25	26	27	28	29	30
I.Q. add to all skills. One time bonus.	+3%	+4%	+5%	+6%	+7%	+8%	+9%	+10%	+11%	+12%	+13%	+14%	+15%	+16%
M.E. save vs. psychic attack/insanity	+1	+2	+2	+3	+3	+4	+4	+5	+5	+6	+6	+7	+7	+8
M.A. trust/intimidate	45%	50%	55%	60%	65%	70%	75%	80%	84%	88%	92%	94%	96%	97%
P.S. Hand to Hand Combat: Damage	+2	+3	+4	+5	+6	+7	+8	+9	+10	+11	+12	+13	+14	+15
P.P. parry, dodge and strike bonus	+1	+2	+2	+3	+3	+4	+4	+5	+5	+6	+6	+7	+7	+8
P.E. save vs. coma/death	+5%	+6%	+8%	+10%	+12%	+14%	+16%	+18%	+20%	+22%	+24%	+26%	+28%	+30%
save vs. poison & Magic	+1	+2	+2	+3	+3	+4	+4	+5	+5	+6	+6	+7	+7	+8
P.B. charm/impress	35%	40%	45%	50%	55%	60%	65%	70%	75%	80%	83%	86%	90%	92%

Spd: No special bonuses other than the raw, natural ability to run.

## SPEED CHART

The following is a simple conversion table of speed factors into *approximate* miles per hour (mph) and kilometer equivalents.

Speed Factor	Approx. MPH	Kilometers Per Hour
5	3½	5.6
11	7½	12
22	15	24
27	18½	29.7
33	22½	36
44	30	48
50	35	56
55	37½	60
58	40	64
66	45	72
77	53	85
88	60	96
110	75	120
132	90	148
220	150	241
293	200	321

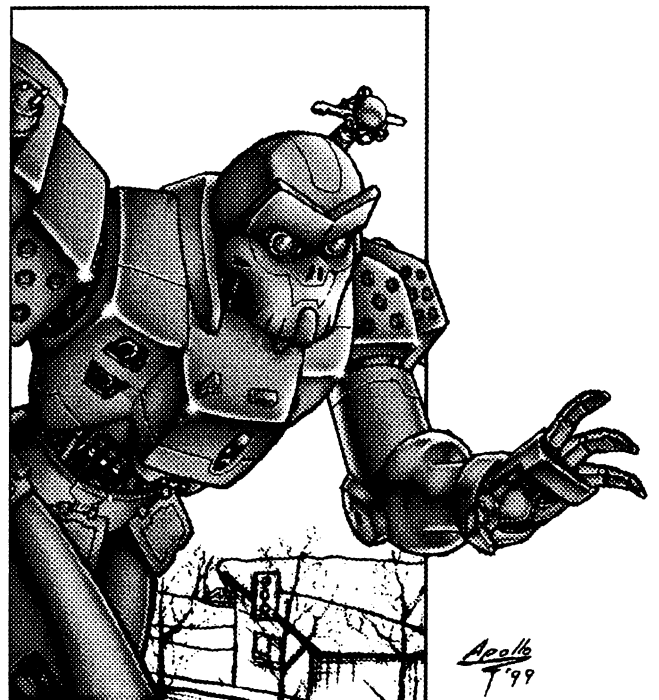



# Rules & Clarifications

By Kevin Siembieda (with a little help from some friends)

## Attributes Beyond 30 (expanded)

**Intelligence (I.Q.):** Bonuses stop on the chart at 30, but the bonuses continue.

I.Q. skill bonus beyond 30: +2 for every five additional I.Q. points, so I.Q. 35: +18%. I.Q. 40: +20, I.Q. 45: +22%, I.Q. 50: +24%, I.Q. 55: +26% and I.Q. 60: +28% and so on.

Moreover, characters with an I.Q. greater than 30 points have sharp memories, tend to notice details and are more likely to see through illusions. This translates into the following:

Save vs Illusion: I.Q. 30-33: +1, I.Q. 34-36: +2, I.Q. 37-39: +3, I.Q. 40-42: +4, I.Q. 43-45: +5, I.Q. 46-48: +6 and 49 or higher +7.

**Mental Affinity:** Any number *beyond 30* means a dynamic, charismatic person with a commanding and/or delightful presence. When the character enters the room, most people take notice. The individual can be very persuasive (in a charming or intimidating way).

M.E. of more than 30 provides select skill bonuses: +5% to Seduction, Gambling, Find Contraband, and Intelligence (gathering) skills; +10% to Interrogation and Performance.

**Mental Endurance (M.E.),** taps out at 30. Bonuses do not increase should the character have a number higher than thirty. The only exception might be a god. But for those rare individuals, demigods, godlings, gods, demon lords and other supernatural beings who might hit M.E. 30 or beyond, they get a bonus to save vs possession of all kind.

Save vs Possession: M.E. 30: +1, M.E. 40: +2, M.E. 50: +3, M.E. 60: +4.

**Ordinary Physical Strength (P.S.):** The higher the number, the stronger the character and the more damage with his punches (as indicated in the standard table). This strength applies to "ordinary" mortal men and women, so the damage is always Hit Point/S.D.C. damage even if it is beyond P.S. 30 or 40. **Note:** P.S. damage bonuses are always added to the physical damage done by *melee weapons* such as clubs, maces, knives, swords, and spears, but does not apply to arrows and guns.

Damage Bonus Continues: +1 point of Hit Point/S.D.C. per digit beyond 30. Thus a character with a P.S. of 31 does +16, P.S. 32 does +17, a P.S. of 40 does +25, and so on.

Throwing Bonus: For every five points above 30 (round down), the character can hurl a rock, ball or throwing weapon (dagger, spear, sling, etc.) or shoot an arrow an extra 30 feet (9.1 m) without losing accuracy (no penalties for the greater distance).

Lifting and Carrying Bonus: For every five points above 30 (round down), the strong character can lift or carry 30% more than usual.

**Physical Prowess (P.P.):** The bonus to strike, parry and dodge, stops at 30.

Initiative Bonus: However, for every three P.P. points beyond 30, the character gets a bonus on his *initiative roll*. P.P. 33-35: +1 on initiative, P.P. 36-38: +2, P.P. 39-41: +3, P.P. 42-44: +4, P.P. 45-47: +5, P.P. 48 and higher: +6.

**Physical Endurance (P.E.):** The bonus to save vs poison and magic stops at 30.

Save vs Coma & Death: However, the percentage to *save vs coma* continues at an increment of one point per each additional point beyond 30. Thus, a P.E. of 31 provides a 31% chance to save vs coma, 32 is 32%, and so on. Additionally, a character with a P.E. of 30 or higher fatigues at half the normal rate.

Impervious to disease: Additionally, any character with a P.E. of 30 or higher is effectively impervious to disease. Only the most virulent virus (or designer bug) has a chance of affecting this character.

**Physical Beauty (P.B.):** Any number beyond 30 is divine perfection. A beauty beyond compare, angelic.

P.B. of more than 30 provides select skill bonuses: +5% to Cardsharp, Concealment, Palming, Pick Pockets and Performance skills (observers are so distracted by the beauty they don't notice any trickery or flaws in performance); +13% to Seduction. Penalty: -10% to Prowl (all eyes are on the beauty).

**Speed (Spd.):** Indicates the rate of speed at which a character can run and/or fly. Most ordinary humans never exceed 30. However, Juicers, Crazies, cyborgs, robots, mutants, D-Bees, supernatural beings and others *may* achieve mind-boggling running speeds. The Speed Chart continues on and on, with the listing at a Spd of 293 or 200 mph (320 km). Running fast is its own reward and ability.

## “Augmented” Humans (Juicers & Crazies), Mutants, Cyborgs & Exoskeletons

Characters who possess an enhanced or increased P.S. because of unusual genetic mutation, chemical augmentation (Juicer), brain implants (Crazy), bionics (full conversion cyborgs), superhumans (Extraordinary or Superhuman P.S.) or exoskeleton (light power armor or mechanically enhanced body armor, android or very light robots) can inflict Mega-Damage, but only when they use a *power punch*.

This type of enhanced strength is typically the result of mechanical augmentation. This table applies only when specific damage stats are *not* provided.

- **Augmented P.S. 24** inflicts one point of Mega-Damage when delivered as a power punch or power kick; counts as two melee attacks.
- **Augmented P.S. 25 to 27** inflicts 1D4 M.D. with a power punch or power kick; counts as two melee attacks.
- **Augmented P.S. 28 to 30** inflicts 1D6 M.D. with a power punch or power kick; counts as two melee attacks.
- **Augmented P.S. 31 to 40** inflicts 2D4 M.D. with a power punch or power kick; counts as two melee attacks.
- **Augmented P.S. 41 or 50** (not likely to exist) inflicts 3D4 M.D. with a power punch or power kick; counts as two melee attacks.
- **Augmented P.S. 51 or higher** (not likely to exist) inflicts 4D4 M.D. with a power punch or power kick; counts as two melee attacks.

### Power Punch Notes:

1. A power punch is a roundhouse punch in which the character winds up and punches with all of his might. In all cases, the power punch attack counts as two (2) melee attacks/actions whether the punch strikes or not. The player must announce that he is trying a *power punch/kick/attack* before he rolls to strike.

2. A *power bite* is not possible! The only exceptions may be select supernatural beings or giant robots, in which case it will be noted in the character stats. Likewise, a power head butt, elbow, knee, body throw/flip or body block/ram is not possible except as noted above and where specifically listed for that particular character or equipment.

3. *Cyborgs*, although mechanical and robot-like, do not generally possess the same physical strength and power as a complete (or giant) robot. Consequently, they do not usually deliver Mega-Damage punches except as power punches. Most *partial reconstruction 'Borgs* can only have a maximum P.S. of 20 and inflict no Mega-Damage. *Full conversion 'Borgs* of great strength can deliver a Mega-Damage power punch or kick if they have a P.S. of 24 or higher! Use the table above.

4. In all cases, a power punch/kick/attack counts as two melee attacks/actions.

## “Supernatural” Physical Strength

Most S.D.C./Hit Point beings, whether human, monster, or otherwise, inflict Hit Point/S.D.C. damage even when they have an incredible strength of 30 or higher. On the other hand, even scrawny *supernatural beings* like Vampires, Gargoyles, Brodkiel, and demons, as well as “most” *creatures of magic*, such as dragons and Elementals, inflict *Mega-Damage*.

One might wonder why a strong human inflicts S.D.C. damage while these others, with a seemingly equivalent P.S., inflict Mega-Damage (M.D.)?

The answer is simple. Whether a being inflicts S.D.C. damage or M.D. depends on the nature of the creature.

Simply put, *supernatural beings* and *creatures of magic* are NOT human. They are something else. Creatures that defy the laws of physics and draw upon arcane forces and energies (like magic) as part of their innate essence. Thus, they are more than human. More powerful physically and magically (and sometimes psionically as well). Their supernatural aspect gives them Mega-Damage strength, endurance, and, in many instances, makes them natural M.D.C. creatures (i.e. flesh like Mega-Damage steel). Thus, in addition to their incredible supernatural strength, they usually have bodies with skin like the armor of a tank, are impervious or resistant to ordinary cold, heat and fire, impervious to disease, and heal much more quickly (most practically regenerate and heal before one’s eyes), because they are not human. **Note:** In an S.D.C. environment where magic energy is weak, these beings are often Hit Point/S.D.C. creatures, although they will still usually have plenty of H.P. and S.D.C. points.

- **Supernatural P.S. 15 or less:** Only inflicts 1D6 S.D.C. on a restrained punch, 4D6 S.D.C. on a full strength punch or 1D4 M.D. on a power punch (counts as two melee attacks). P.S. bonuses are added to S.D.C. attacks.
- **Supernatural P.S. 16 to 20:** Inflicts 3D6 S.D.C. on a restrained punch, 1D6 M.D. on a full strength punch, or 2D6 M.D. on a power punch (counts as two melee attacks). P.S. bonuses are added to S.D.C. attacks.
- **Supernatural P.S. 21 to 25:** Inflicts 4D6 S.D.C. on a restrained punch, 2D6 M.D. on a full strength punch, or 4D6 M.D. on a power punch (counts as two melee attacks). P.S. bonuses are added to S.D.C. attacks.
- **Supernatural P.S. 26 to 30:** Inflicts 5D6 S.D.C. on a restrained punch, 3D6 M.D. on a full strength punch, or 6D6 M.D. on a power punch (counts as two melee attacks). P.S. bonuses are added to S.D.C. attacks.
- **Supernatural P.S. 31 to 35:** Inflicts 5D6 S.D.C. on a restrained punch, 4D6 M.D. on a full strength punch, or 1D4x10 M.D. on a power punch (counts as two melee attacks). P.S. bonuses are added only to S.D.C. attacks.
- **P.S. 36 to 40:** Inflicts 6D6 S.D.C. on a restrained punch, 5D6 M.D. on a full strength punch, or 1D6x10 M.D. on a power punch (counts as two melee attacks). P.S. bonuses are added only to S.D.C. attacks.
- **Supernatural P.S. 41 to 50:** Inflicts 1D6x10 S.D.C. on a restrained punch, 6D6 M.D. on a full strength punch, or 2D4x10 M.D. on a power punch (counts as two melee attacks). P.S. bonuses are added only to S.D.C. attacks.
- **Supernatural P.S. 51 to 60:** Inflicts 1D6 M.D. on a restrained punch, 1D6x10 on a full strength punch, or 2D6x10 on a power punch (counts as two melee attacks). P.S. bonuses not applicable.

**Note:** Some supernatural creatures will have a greater or weaker damage than the above table provides. These are exceptions to the general rule and will be evident in the descriptions of specific creatures. Biting attacks typically inflict half the M.D. as a punch unless the maw is especially large or powerful, then a bite could inflict the same dam-



age or more. Tails and tentacles frequently inflict half to the same amount of M.D. as a punch. Power punches are not usually possible with a tail, but are possible with a tentacle. Kicks usually inflict the same M.D. as a punch, but in some cases the kick may inflict 1D6 more Mega-Damage.

**Supernatural Damage and Hand Weapons:** When wielding a hand weapon, such as swords, clubs and knives, supernatural beings inflict either the weapon damage plus P.S. damage bonus or their basic hand to hand damage (see previous table) plus P.S. damage bonus, whichever is greater. **Optional Rule:** Normal weapons are in danger of breaking when wielded by somebody with supernatural strength. A good rule of thumb is to assume a weapon is in danger of breaking whenever total damage inflicted exceeds more than *three times* the weapon's maximum base damage — in the case of a 2D4 sword, more than 24 points of damage might break it. Every time that much damage is inflicted, there is a 01-30% chance that the weapon will break. Heavy, sturdy weapons, and very well-crafted blades (a master smith's katana, for example) can withstand more damage, so do not roll unless damage exceeds *five times* the weapon's maximum damage. Magical weapons and artifacts are basically indestructible and are at no risk of breaking.



## Weight & Movement

Normal characters, with a P.S. of 3 to 16, can carry 10 times their P.S. in pounds (P.S.x10 = total in pounds). For Example: A character with a P.S. of 9 can carry 90 pounds (40.5 kg). A character with a P.S. of 15 can carry 150 pounds (67.5 kg).

Strong characters, with a P.S. of 17 or higher, can carry 20 times their P.S. in pounds. This means a character with a P.S. of 18 can carry 360 pounds (162 kg).

**Supernatural creatures** including dragons, Deevils and demons are even stronger than extraordinary humans. Supernatural beings and creatures of magic with a P.S. of 18 or higher can carry 50 times their P.S. Thus, a creature with a P.S. of 24 can actually carry over half a ton, 1200 pounds! Creatures with a strength of 17 or less are equal to humans; P.S.x10 in pounds (x20 for P.S. 17).

**Lifting weight** is a little different than carrying weight. You may have noticed, yourself, that you can usually lift up a heavier amount than you can carry. I'm not talking about weight-lifting in a body build-

ing sense, nor lifting a heavy weight above the chest. Simply the ability to bend over and lift something that weighs more than you can carry. The simple rule is that a character can lift **TWICE** as much as he/she could carry. This means that the character with a P.S. of 9 can carry 90 pounds, but can lift 180 pounds. Meanwhile, the supernaturally strong creature, with a P.S. of 24, can lift over one ton (2400 pounds).

**Throwing Heavy or Awkward Objects:** A character can not throw more than he can carry.

Add one foot (0.3 m) to the effective range for every P.S. point listed; e.g., P.S. 24, add 24 feet (7.3 m).

Objects such as bricks, bottles, and swords are not designed for throwing. Consequently, the effective range is limited regardless of the strength behind it.

Darts, knives and throwing axes are designed for throwing, but don't have the weight or balance for great distances. The same is true of most objects weighing less than half a pound. Javelins, more so than spears, are designed for distance throwing.

Miscellaneous items weighing over a pound (0.45 kg) and less than 10 pounds (4.5 kg), such as chairs, stools, and lanterns, can be thrown about *half* as far as the one pound (0.45 kg) object.

**Normal and extraordinarily strong characters** can hurl a weight equal to the weight he can carry four inches (0.1 m) per each P.S. point. This means the person with a P.S. 9 can toss 90 lbs (40.5 kg) up to 3 feet (0.9 m) away. The hero with a P.S. of 17 can toss 340 lbs (153 kg) up to 5 feet, 6 inches away (1.7 m).

**Supernatural characters** can hurl their maximum carrying weight one foot (0.3 m) per P.S. point. So a supernatural character with a P.S. of 24 can hurl an incredibly heavy object (up to 1200 pounds/540 kg) a whopping 24 feet (7.3m). Damage from these heavy thrown objects is 1D6 + 1D6 S.D.C. points per every 20 pounds (9 kg), so a 100 pound (45 kg) item will inflict 6D6 points of damage! A thousand pound (450 kg) object 6D6 x10 (or 3 M.D. , 4 M.D. if you round up).

## A Note about M.D. Creatures

Mega-Damage creatures are different from creatures of human flesh and blood. M.D.C. flesh is a special armor-like skin that is resistant even to most point-blank attacks. They can use their bodies to smother an M.D.C. grenade or withstand damage from a particle beam the same as M.D.C. power armor or a tank. While the blast will hurt, it will not kill until all Mega-Damage points have been depleted. The only possible exception may be a direct and powerful point-blank shot to the head; G.M.'s discretion. See S.D.C. Point-Blank rules and modify them to M.D.C creatures as is appropriate.

## Robot Strength & Damage

The robots created by the super-technology in Rifts usually have Mega-Damage armor and super-powerful hydraulics and mechanical systems that give them greater physical strength than bionic limbs or cybernetic prosthetics. This means that robots can frequently deliver Mega-Damage attacks. Power armor, especially full robot suits like the Glitter Boy, SAMAS and Ulti-Max, also inflict significant amounts of Mega-Damage due to their robotic nature. However, the power armor and 'bots mechanically enhanced strength is not as powerful as supernatural beings. Remember, 'Borgs are not as powerful as bots either.

Robots created in a more primitive environment, such as our own 20th Century, are not likely to be Mega-Damage bots and do not magically transform when brought into a Mega-Damage environment like **Rifts®**. To become an M.D. machine, the comparatively primitive bot will have to undergo a complete conversion into a new M.D.C. robot body. In such instances, the only thing likely to be preserved from the original robot is its physical brain, memory, and programs; possibly other internal systems within the Mega-Damage shell.

Robots with a P.S. of 18+ can lift and carry 25 times their P.S. attribute. Thus, a robot with a P.S. of 40 can lift and carry 1,000 lbs (450

kg) (25x40=1,000). Robot P.S. below 18 is equivalent to normal human strength for purposes of lifting, pulling and pushing: P.S.x10 in lbs.

- **Robot P.S. 15 or less:** Inflicts 1D6 S.D.C. on a restrained punch, 2D6 S.D.C. on a full strength punch and 4D6 S.D.C. on a power punch (counts as two melee attacks). P.S. bonuses are added to S.D.C. attacks. Kicks do 2D6 S.D.C., leap kicks 3D6 S.D.C. (Counts as two melee attacks); these robots are roughly equal to a human. Mega-Damage attacks are not possible.
- **Robot P.S. 16 to 20:** Inflicts 2D6 S.D.C. on a restrained punch, one M.D. point on a full strength punch, 1D6 M.D. on a power punch (counts as two melee attacks). P.S. bonuses are added to S.D.C. attacks. Kicks do 1D4 M.D. and leap kicks 2D4 M.D.
- **Robot P.S. 21 to 25:** Inflicts 6D6 S.D.C. on a restrained punch, 1D4 M.D. on a full strength punch, 2D4 M.D. on a power punch (counts as two melee attacks). Kicks do 1D6 M.D. and leap kicks 2D4 M.D. (counts as two melee attacks).
- **Robot P.S. 26 to 30:** Inflicts 1D4 M.D. on a restrained punch, 1D6 on a full strength punch, 2D6 M.D. on a power punch (counts as two melee attacks). Kicks do 2D4 M.D. and leap kicks 2D8 M.D. (counts as two melee attacks).
- **Robot P.S. 31 to 35:** Inflicts 1D4 M.D. on a restrained punch, 1D6 M.D. on a full strength punch, 4D4 M.D. on a power punch (counts as two melee attacks). Kicks do 2D8 M.D. and leap kicks 4D8 M.D. (counts as two melee attacks).
- **Robot P.S. 36 to 40:** Inflicts 1D4 M.D. on a restrained punch, 2D6 M.D. on a full strength punch, 4D6 M.D. on a power punch (counts as two melee attacks). Kicks do 3D8 M.D. and leap kicks 5D8 M.D. (counts as two melee attacks).

- **Robot P.S. 41 to 50:** Inflicts 1D6 M.D. on a restrained punch, 3D6 M.D. on a full strength punch, or 1D6x10 M.D. on a power punch (counts as two melee attacks). Kicks do 5D8 M.D. and leap kicks 1D8x10 M.D. (counts as two melee attacks).
- **Robot P.S. 51 to 60:** Inflicts 2D6 M.D. on a restrained punch, 6D6 M.D. on a full strength punch, or 2D6x10 M.D. on a power punch (counts as two melee attacks). Kicks do 6D8 M.D. and leap kicks 2D6x10 M.D. (counts as two melee attacks).

### Notes:

1. There are many different design and mechanical elements for every robot and suit of power armor, so there is a great deal of variation from one design to another. Some may have features that make a particular 'bot stronger or weaker than the above table suggests. The general rules, above, apply to robots and P.S. when a specific damage rating is not provided in its stats, and when adapting robots from other game books, settings and dimensions to the Mega-Damage world of **Rifts**.

2. Combat moves: Body blocks and tackles typically inflict half the M.D. of a normal punch. Stomp attacks are applicable only to robots that are 18 feet (5.5 m) or larger and commonly inflict 1D4 or 1D6 M.D., seldom more. Tear or Pry attacks are possible only if the mechanism is designed for that purpose. Such attacks usually deliver half the damage of a full strength punch.

3. Power Armor is generally smaller and lighter than a true, 100% robot. In many cases, power armor is little more than an armored exo-skeleton. As a result, a suit of power armor with an equivalent P.S. will frequently inflict less damage than a robot, especially giant robots. Power armor seldom exceeds a P.S. of 40.

---

## Combat Terms (Revised)

---

The following combat terms have been collected from various sources in the Megaverse with some new material added and some old information rewritten for greater clarity or updating.

**Attacks per Melee:** Characters with no hand to hand combat training get only *one* attack/action per melee at levels 1, 6, and 12. No automatic parry or dodge; each attempt counts as one melee action. P.P. and W.P. bonuses will apply. See pg 44 for complete details.

Characters with any kind of formal hand to hand combat training (Hand to Hand: Basic, Expert, etc.) automatically get two attacks plus those acquired from their hand to hand skill(s).

**Automatic Body Flip/Throw:** Certain martial artists can do a body flip/throw in place of a parry. This means that instead of blocking or deflecting the blow, the character attempts to leverage the attacker's own force into a flip. Success requires beating the attacker's roll to strike, just like a parry, but using the bonuses for body flip (not parry). Failure means taking full damage from the attack, without a chance to roll with punch/fall/impact. A successful roll means the character has grabbed his opponent and sent him flying in a judo-style throw.

**Automatic Dodge:** Certain O.C.C.s, R.C.C.s, and forms of combat enable the character to automatically dodge an attack without using up a melee attack/action. It is purely a defensive move. Roll for a dodge as normal (the dodge is not an "automatic" success), but the automatic dodge does not count as a melee attack or action.

**Attribute Bonuses:** Combat and saving bonuses gained through physical or mental strengths that give a character an extra added degree of agility, strength, endurance, etc. (See the eight attributes.)

**Back Flip:** The back flip involves throwing oneself backwards with the arms and shoulders, flipping the legs completely up, over, and back down on the ground into a standing position. The result is that one quickly moves backwards by a full body length. Doing a back flip counts as one melee attack/action and can be used as a dodge or for entertainment.

If used in place of a dodge, the character must roll higher than his opponent's strike roll using only the natural die roll (do not include any dodge bonuses). Failure to beat the strike means taking full damage *without a chance to Roll with Punch*. Success means avoiding the attack like a dodge.

**Back Flip: Escape.** If used in place of a strike (when it's the back-flipping character's turn to strike) this removes the character from combat and requires the opponent to use up an attack/action to move into range. This also gives the back-flipping character the initiative.

**Back Flip: Attack.** This is especially useful against someone attempting some kind of back strike. Once the opponent is detected in the rear, the back flip moves the character back into combat range. A back flip can also be used as a combined Strike against an opponent to the rear of the character. Use with either an axe kick, snap kick, or back-hand strike. If striking with a back flip, use only the bonus to back flip (not strike). Cannot be used with death blow or knock out/stun.

**Blind:** Once and for all, here are the definitive penalties and conditions for being blinded or fighting in absolute darkness without optical systems to see.

**Penalties:** Ignore all of the character's normal combat bonus (they don't count; natural rolls only, minus the penalties) and the blind character is -10 to strike, parry and dodge, disarm, pull punch and similar combat moves! Speed is reduced by 30-50% (or should be) only because the blind character is unsure of himself and running or moving quickly is likely to cause him to stumble or trip something and fall down (lose initiative and one melee attack/action), slam into a wall (1D6 S.D.C. damage, triple that if running) or run right into the arms of his opponent or some other danger. Obviously any skills requiring *vision* are impossible to perform.

Attacks per melee round and initiative are unchanged, but the character is lashing out wildly and guessing where his opponent is. This means the blind character has a good chance of accidentally striking a friend or innocent bystander with his wild flailing about or "blind shooting."

**Body Block/Tackle:** This is a combination of moves that involves a body block and a knockdown attack (counts as two melee attacks). A successful body block strike does 1D4 damage plus P.S. damage bonuses, and the opponent is likely to be knocked down. A successful strike always inflicts damage (from a shoulder, elbow, or tucked head), unless his opponent dodges (no damage and no knockdown), but the victim who is hit can avoid being knocked down only by trying to his maintain balance; roll percentile dice, characters with no special balancing abilities must roll above 80% or be knocked down. Those with a special balancing ability like those from Acrobatics or Gymnastics must roll under their current skill level (if 45% they must roll 45 or lower, if 80% they must roll 80 or lower). A successful maintain balance means the victim is not knocked down but loses one melee attack, and takes full damage.

Being knocked down causes the character struck to lose initiative (if he had it) and one attack/action for that melee round, plus he is knocked 1D6 feet away from where he was standing at the moment of the attack. A fall with impact can reduce damage by half, but counts as one melee action.

**Body Flip/Throw:** A judo style throw or flip that uses an attacker's own momentum and leverage to "flip" or "throw" him off his feet and onto the ground. Damage is 1D6 points plus P.S. damage bonus (if any), and the victim also loses initiative (if he had it) and one melee attack. A body flip/throw counts as one melee attack. A victim of a throw can try to *roll with impact/fall* to diminish the damage (half if successful), but other penalties are unchanged.

**Body Flip/Throw: Critical:** Characters with this attack inflict double damage; typically 2D6 + P.S. bonuses by rolling a certain "natural" die roll (a high number not modified with bonuses). The victim of a critical body throw loses initiative and two melee actions/attacks as a result of being thrown. This move cannot be done with an automatic body flip/throw because it is an attack, while the latter is a defensive move.

**Break Fall:** Also known as "ukemi," this is an advanced version of roll with punch/fall/impact. The character takes no damage if the break fall is successful, and only half damage if the roll for break fall fails! It can also be used against a knock out attack. A successful roll against knock out means the character takes normal damage, but is not stunned or unconscious. **Note:** The break fall uses up one melee attack each time it is used.

**Cartwheel (Attack):** Holding the body rigidly extended, the character rolls like a wheel by using the arms and legs as spokes. This maneuver can be used to move quickly into combat range. A cartwheel can also be used as part of a combined strike against an opponent to the rear of the character when used with either an Axe kick, Wheel kick or Knife Hand. If striking with a cartwheel, use only the cartwheel bonus. Must be used as the first attack in a melee round. **Note:** Cannot be used with death blow or knock out/stun.

**Combat Bonuses:** All appropriate bonuses available to the character are added to the various fighting abilities such as strike, parry or dodge, as well as initiative and saving throws. High physical attributes, certain physical skills, weapon proficiencies (W.P.), the occasional O.C.C. bonus, racial bonus, and magic *may* provide one or more combat bonuses. All applicable bonuses are combined and added to the character's dice rolls. Do not combine the strike bonus with the parry bonus, and so on; each combat maneuver is considered a separate category, so only the various bonuses to strike are added to the strike roll, bonuses to parry added to the parry roll and so forth.

**Critical Strike:** A powerful, special or nerve shattering strike that inflicts double the usual amount of damage. Critical strike/damage can be inflicted with bare hands or with a weapon.

**Damage:** The following are some of the typical damage amounts inflicted by the various types of punches and kicks. Each inflicts roughly the same equivalent S.D.C. or M.D. damage depending on whether the attacker is an S.D.C. being (like humans) or a Mega-Dam-

age being (like power armor, bots, oni, dragons and supernatural beings). Remember to add P.S. attribute bonuses to damage.



#### **Hand Strikes:**

Backhand Strike: 1D6

Body Flip: 1D6

Human Fist (punch): 1D4

Knife Hand: 2D4

Karate Strike: 2D4

Palm Strike: 2D4

Elbow/Forearm: 1D6

Power Punch: Does double damage + any other damage bonuses, but counts as two melee attacks. Applicable to all hand strikes.

#### **Foot Strikes:**

Kick Attack: 2D4

Karate Kick Attack: 2D6

Jump Kick: 3D6x2

Roundhouse Kick: 3D6

Snap Kick: 1D6

Wheel Kick: 2D6

Knee: 1D6

Backward Sweep: No damage, but knocks down opponent if strike is successful (he loses one melee action and initiative).

Tripping/Leg Hook: No damage, but knocks down opponent if the strike is successful (he loses one melee action and initiative).

Power Kick: Does double damage, but counts as two melee attacks. Applicable to all kick/foot strikes that inflict damage, except leap and jump kicks.

#### **Miscellaneous:**

Thrown/Dropped Small Objects: 1D4 or 1D6

Thrown/Dropped Large Objects: 3D6 per 100 lbs (45 kg) +10 per 40 feet (12.2 m). Falling: 1D6 per 10 feet (3 m).

Collision: 2D4 per 10 mph (16 km).

**Death Blow:** A special attack designed to kill an opponent in one or two strikes! This attack is often limited in hand to hand combat to the roll of a “natural” high strike number; i.e. death blow on a natural 18-20. Whenever the words “death blow” are presented without limitation, the character can use a death strike whenever he desires; however, such a devastating attack counts as two melee attacks/actions.

**Human vs Human:** Against humans and S.D.C. creatures, the attack does double the normal damage, plus P.S. bonuses direct to Hit Points. This attack can be used with punches and kicks or hand-held weapons such as swords, clubs, etc. It is not applicable to guns and does not work through armor; the armor must be removed or penetrated.

**Mega-Damage creature vs Mega-Damage creature:** The attack does double normal damage, plus P.S. bonuses, and it is so devastating to the creature’s body that it cannot bio-regenerate injury from a death blow for 1D4 hours! This attack is not applicable against M.D.C. ‘bots, ‘borgs and power armor, unless the M.D.C. attacker is making a called shot to the head or power supply, in which case double damage is inflicted to that part of the robot or armor.

**Disarm:** The act of disarming is simply getting rid of the opponent’s weapon; it does no damage. It can be used as a defensive move in place of a dodge or parry, or can be done as an attack/strike.

The disarm move is a strike, hold or grappling maneuver that causes an opponent to drop his weapon or whatever he’s holding. Counts as one melee attack/action. Disarm does not give the weapon to the character making the disarm move. True, the item is forced out of the victim’s grasp, but it is either knocked away or falls to the ground.

Typically an opponent is disarmed on a roll of a natural 19 or 20 when used as a defensive move. Roll a disarming strike to attack as usual; high roll wins. A failed disarming attack does no damage and means one’s opponent remains armed, and is probably mad, and ready to strike.

**Dodge:** A character dodges by moving out of the way of the attack. Dodging always takes up one attack/action per melee round. To dodge, the defender must roll higher than the attacker’s strike roll on a twenty-sided die.

**Drop Kick:** This is the combination of falling to the ground, a dodge and a kick. The kick can be either a kick attack, a snap kick or a crescent kick. It’s done in place of a dodge (or as an attack) as a defensive move. First, make the roll to dodge. If successful, then roll to kick. The opponent can defend nominally. No bonuses to dodge, strike, kick or damage apply for this move. Uses up one melee attack/action.

**Entangle:** A defender can attempt to trap the weapon or arm of an attacker. This is done instead of parrying or dodging, and takes up one attack per melee. An entangle is successful if the defender rolls above the attacker’s strike roll. It takes one attack and a roll to entangle to keep an opponent’s arm or weapon entangled every melee round. In order to get free, the entangled opponent must roll a dodge against the entangle roll.

**Hand to Hand Combat:** Fighting skills that provide the characters with attacks per melee, bonuses, and techniques. Characters without combat training have only one attack per melee and have no automatic chance to parry.

**Hit Points:** This is the number of points of damage a character can take before dying. Characters generally don’t lose Hit Points until their S.D.C. is down to zero. A character’s base Hit Points is the P.E. plus 1D6. Another 1D6 of Hit Points is gained every time the character advances an experience level. Lost Hit Points are not recovered without medical attention.

**Holds:** Using both hands, the attacker grabs on to some part of the opponent’s body and attempts to immobilize him. If the strike is successful, then the victim is helpless until released. Holds do no damage. Neither the attacker nor the victim can attack, parry or dodge while the hold is working. It’s easy for the attacker to hold the victim so that some third character can attack unopposed or attack from the rear.

Getting out of a hold requires agility. Both the victim and attacker roll twenty-sided dice and add in their P.P. attribute scores. The person doing the hold also gets to add in all his bonuses to hold and from the P.P. attribute (if any). High roll wins! If the attacker wins, then the hold continues. If the victim wins, then the hold is released and combat can continue.

Types of Holds Include:

**Arm Hold:** This involves twisting the arm around to the victim’s back. Any items in the hand of the arm being held can be easily removed.

**Leg Hold:** The victim is on the ground with his leg held up. There’s no way for him to get up until the hold is released.

**Body Hold:** Any number of wrestling holds. The victim can be held on the ground or in a standing position.

**Neck Hold:** The victim is held around the neck from behind. This leaves the victim totally vulnerable to attacks from any other character.

**Initiative:** Whoever gets to attack first is considered to have the initiative and is the “attacker.” Initiative is automatic in sneak attacks and long-range attacks. In most other cases, each opponent rolls a twenty-sided die, highest roll gets the initiative. Rolling for initiative takes place at the beginning of each melee round of combat.



**Kick Attack:** This is a karate-style kick. It is a normal attack that does 1D4 damage for the untrained, or higher with hand to hand skills (1D6, 1D8, 2D4, 2D6). Anyone trained in hand to hand combat can do a kick attack.

**Kick Attacks & Flying Jump Kicks:** There are a whole range of foot-based attacks. Each kick attack works differently and does different amounts of damage.

**Kick Attack:** This is a conventional, karate-style kick. It starts with bringing the knee, folded, up to chest level, then the foot is completely extended. Does 2D4 damage.

**Snap Kick:** A very short, very fast kick. Usually delivered low, striking the opponent somewhere below the waist. It works well in confined spaces and in grappling range but does relatively little damage; only 1D6 damage.

**Roundhouse Kick:** By turning the body and swiveling the hips, there's tremendous power packed into this kick. Can be used only once per melee round, and no other kicks can be used in that melee round. Does 3D6 damage.

**Wheel Kick:** A damaging kick that involves sweeping the leg completely around the body. Cannot come right before or right after another kick. Does 2D6 damage.

**Crescent Kick:** A swivel-hipped kick that sends the foot out on a sweeping arc. Does 2D4+2 damage.

**Axe Kick:** A very high kick that goes up and over the opponent, coming down on the neck or shoulder. Can't be used in the same melee round with any other kicks. Does 2D6 damage.

**Backward Sweep:** Used only against opponents coming up behind the character. Does no damage, it's purely a knock-down attack. Cannot be parried.

**Tripping/Leg Hook:** An attack on the opponent's legs. Does no damage, it's purely a knock-down attack. Cannot be parried.

**Jump Kicks:** A Jump Kick is performed by leaping completely off the ground and attempting to land foot-first on an opponent. Jump kicks can be used only by those skilled in hand to hand, martial arts. The advantage of a jump kick is that it works as a critical strike and doubles the normal damage inflicted. The disadvantage of a jump kick is that no other attack may be performed in that melee round (all attacks for that melee are used up in the kick). The jump kick must be the character's first attack of that melee round. For the rest of the melee round, the character can only parry, dodge or move into position.

**Jump Kick:** Critical strike inflicting 6D6 damage!

**Flying Jump Kick:** Must be made from long range. The character launches into the air, taking a position that will smash one foot into the opponent. Does 4D6 damage but counts as two melee attacks.

**Flying Reverse Turning Kick:** Must be made from long range. The extra twisting and turning of the body adds power and does 4D6 damage but counts as two melee attacks.

**Knockdown:** Getting knocked down, falling or getting struck by a fast, heavy vehicle, or explosion, or falling or getting knocked back dozens of yards/meters (30 feet/9 m or more) will even cause a character inside to take damage from the force of the impact. While most armors are padded, they only provide so much protection.

**Damage:** Inflict 1D6 Hit Point/S.D.C. damage for every 20 feet (6 m) one falls or is knocked back. And figure 1D6 points of damage for every 20 M.D. in an explosion. Round down. If the fall/knockback is 100 feet (30.5 m) or more, there is a 01-65% chance of being temporarily knocked out for 1D6 melee rounds.

**Penalties:** In ALL cases, when a character is knocked down or off his feet, he automatically loses initiative and one melee attack/action. This is true even if the character is knocked down right where he was standing or only a few feet/meters.

**Knockout/Stun:** Anyone hit by a knockout or stun attack will be temporarily incapacitated. The victim is not necessarily unconscious, just dazed.

**Leap Attack:** An airborne assault where the weapons and/or fists are wielded in mid-leap. A leap attack must be made only at the beginning of a melee round and, like the jump kick, uses up all attacks for that melee. Usually, only a single strike can be made during a leap at-

tack. However, if two opponents are close together, the attacker can leap between them and strike both of them at the same time; roll to strike for each character. After the leap, the character may not attack again until the next melee round, but can parry or dodge or move into position. Automatic parries work in mid-leap, but dodges are impossible. A successful leap attack is a critical strike and does double damage.

**Long-Range Attack:** By using a long-range weapon from a distance, an attacker can perform an undetected, first strike. Provided the attacker is not seen, the defender automatically loses initiative and may not dodge the first attack that melee round.

**Maintain Balance:** When some kind of knockdown attack has succeeded, while the character is starting to fall over, this is his last chance to attempt to recover. A successful roll (over the opponent's strike roll) means that the character will immediately regain his balance and remain standing. He can continue to fight but the act of retaining balance means he used up one melee attack/action. When maintain balance is used, then roll with punch/fall/impact or break fall can't be used, even if it fails.

**Melee or Melee Round:** Exactly 15 seconds. The segment of time combatants have to strike, counter and/or return strike. Generally, playing characters have two or more attacks per melee.

**Multiple Attackers:** Takes place when an opponent is faced by more than one attacker. Characters with hand to hand combat skills can attempt to parry any attacks within their line of sight. The defender from multiple attackers can strike at only one target at a time (see leap attack for a rare exception).

**Natural Twenty:** This is the result of 20 when rolling a twenty-sided die. A strike with a natural twenty will always be a critical strike. If someone with a strike bonus of +2 rolls an 18, then they have an attack roll of 18 plus unnatural, bonus modification; NOT a natural twenty, and is not a critical strike. A natural twenty beats all other rolls and can only be parried or dodged by another natural twenty.

**Paired Weapons:** Certain kinds of weapons, such as sais, nunchaku, daisho, knives, clubs and swords, can be used as paired weapons. Users of paired weapons can strike and parry simultaneously, can do twin strikes against a single target or against a pair of targets, and can parry two different opponents at the same time. In other words, warriors skilled in paired weapons often can do two actions for every one of their melee attacks (i.e. strike and parry). However, a twin, simultaneous strike with both weapons means losing the automatic parry and leaves the character open to his opponent's next attack without benefit of a parry (dodge is optional but uses up a melee action).

**Parry:** A defender can attempt to parry most physical attacks. This is done by blocking the attacker's blow with a weapon or hand. Characters trained in hand to hand combat can parry without losing melee attacks. Bullets and energy attacks cannot be parried!

**Power Punch:** A haymaker thrown with everything the character has, his every last ounce of strength. A power punch ALWAYS counts as two melee actions. A power kick can also be done. For characters with normal P.S., it does double damage in Hit Points and S.D.C. (normal punch damage of 1D4 times two plus any possible P.S. or Hand to Hand Combat damage bonus on top of that). Characters with extraordinary augmented P.S. or Supernatural Strength clearly indicate the damage inflicted in the listings presented at the beginning of this section.

**Punch:** A normal punch does 1D4 damage. A karate style punch or chop does 1D6 damage. A power punch does double damage (1D4 or 1D6 damage x2 or 2D4 or 2D6 damage) plus any damage bonuses on top of that. Hand to hand combat skills provide additional bonuses to damage as does having a high P.S. attribute.

**Pull Punch:** The ability to control the force of a hand to hand attack, whether it be a punch, kick or with a hand weapon. Usually used to reduce the blow to less than killing force. The character can choose to do half damage, quarter damage, a single point or no damage at all. A character must declare a pulled punch, and the player must roll 11 or

better on a twenty-sided die (1D20) to successfully pull his punch. A failed roll to pull means full damage is accidentally inflicted. **Note:** A normal kick does 1D6 damage, a Karate style kick does 1D8 (or 2D4) damage.

**Roll with Punch/Fall:** Hand to hand combat fighters can reduce the damage from blows and falls by rolling. If the defender is successful, then only half damage is taken. Roll with punch/fall does not work against energy blasts, bullets, fire, bladed weapons, psionics or radiation. Victims must roll higher than the attacker's roll. Falling characters must roll a 14 or higher, on a twenty-sided die, to roll with the fall.

**Saving Throws:** Occasionally, characters must roll to save against exotic attacks like poison, gas, insanity, psionics, etc.

Disease: 14 or better.

Lethal Poison: 14 or better.

Non-lethal Poison: 16 or better.

Harmful Drugs: 15 or better.

Acids: No save possible – dodge!

Insanity: 12 or better (sometimes higher).

Psionics: 12 for Major & Minor psionics; 10 for Master, 15 for ordinary folks.

Magic: 12 vs basic spell magic; 16 vs ritual magic. The save against magic will be higher (13, 14, 15, and even 16) if the spell caster is high level.

**S.D.C.:** This stands for Structural Damage Capacity, which is the amount of damage an object can absorb before breaking. Living creatures also have S.D.C.; it represents their physical resistance to damage. All the S.D.C. of a living thing must be reduced to zero before the Hit Points can be affected. **Note:** A cousin to S.D.C. is M.D.C. Or Mega-Damage Capacity. M.D.C. Applies to robots, and is explained in the Robot Combat section which follows shortly.



**Simultaneous Attack:** Instead of defending with a parry, dodge or entangle, a character can choose to do a simultaneous attack. In this case, the character does not defend (“Go ahead, hit me; I can take it!”) and simply attacks in response. The advantage of a simultaneous attack is that neither opponent can parry, dodge or entangle. In all probability, both will take damage. Exception: An opponent with paired weapons can engage in simultaneous attack (with one weapon) AND parry (with the other), OR, both the paired weapons can be used to strike with NO parry.

**Sneak Attack:** An attacker may lie in wait (ambush), attack from behind, or sneak up (prowl) on an opponent. If the foe does not discover the attacker, then the sneak attack is successful. The sneak attacker always has initiative, and the defender is not able to parry or dodge the sneak attack.

**Strike:** Anyone attempting to hit an opponent must roll to strike. As with all combat rolls, a roll to strike is made with a twenty-sided die.

**Throw:** Simply, this means throwing a weapon. Rolling to throw is exactly the same as rolling to strike, except that there are different bonuses per weapon type. See Weapon Proficiency. **Note:** A character may use *any* type of weapon, but gets no combat bonuses, such as strike or parry, unless he has a Weapon Proficiency (W.P.) in that particular weapon. This applies to modern and ancient weapons.

## Some common combat questions & answers

By Kevin Siembieda, Shawn Merrow & Rodney Stott

**What are the rules for using S.D.C. weapons against opponents in “partial” M.D.C. body armor?**

There are two possible sets of rules that could be used in this case.

The first is to require called shots only to target openings in the body armor. 12 or better is required to strike a stationary target. 15 or higher to hit a moving target and 17 or higher to hit a fast moving target. If the opponent knows the attack is coming, he gets to dodge as normal; high roll wins, defender wins ties (which means the dodging character successfully dodges and escapes his S.D.C. parts getting hit).

If the called shot is successful then the M.D.C. armor has been bypassed through the gap in the armor and the character takes the damage. **Note:** Without the called shot, strikes are presumed to hit the main body which would be covered by the M.D.C. armor.

The second option is to assign the armor an Armor Rating (A.R.), and to hit the character wearing the armor the attacker needs to roll above the A.R. of the target. Rolling below it means the armor takes the damage. **Note:** Ignore the A.R. if the attacker is using M.D. weapons as the lethality aspect will blast right through the armor, although the armor takes damage first. There are rare cases where S.D.C. armor that numbers into the hundreds of S.D.C. absorb a low intensity M.D. blast. In this case every 100 S.D.C. points equals one M.D. point.

Both sets of options are considered to be equivalent, though coming from different points of view.

**Can a person in body armor be knocked down or injured while wearing M.D. armor?**

Yes, it is possible. Attacks designed to trip, knockdown or pin/hold will work normally, although any serious damage inflicted is likely to be prevented by the body armor.

Likewise, getting struck by a fast, heavy vehicle, explosion or falling or getting knocked back dozens of yards/meters (30 feet/9 m or more) will cause the character inside to take damage from the force of the impact. While most armors are padded, they only provide so much protection.

**Damage:** Inflict 1D6 Hit Point/S.D.C. damage for every 20 feet (6 m) one falls or is knocked back. And figure 1D6 points of damage for every 20 M.D. in an explosion. Round down. If the fall/knockback is 100 feet (30.5 m) or more, there is a 01-65% chance of being temporarily knocked out for 1D6 melee rounds (double if the damage or distance is significantly greater).

**Penalties:** In ALL cases, when a character is knocked down or off his feet, he automatically loses initiative and one melee attack/action. This is true even if the character is knocked down right where he was standing or only a few feet/meters.



**What is the difference between the Paired Weapons Skill and the Paired Weapons Ability that one may get as one advances in hand to hand level?**

None. Just one is taken as an immediate ability and the other comes with time and training in a particular combat style of fighting.

**Are there any bonuses or penalties to strike small objects? (I.e. My Titan punching or kicking that annoying Gnome.)**

There are no bonuses listed, however striking small targets may require a "called shot" with a penalty to strike, or the character or animal may get an extra bonus to dodge. However, in most cases the penalties must be determined on the fly.

Using the above example, the Titan unless it is kneeling, or on much lower ground than the Gnome, might not even be able to punch him since the Gnome is way too small and likewise some weapons may be too short to reach the Gnome, but kicking will still be effective.

However, if two warriors are facing off against each other, and one attempts to rip the magical amulet from the other's neck using his hand, the G.M. might rule that a called shot and a -3 or -4 penalty to strike might be required. Failing to make this called shot will still be considered a hit on the target, but not in the location where they wanted to hit.

**What about large objects? Are there any bonuses to strike them?**

Generally, there are no bonuses to strike extra-large objects, though if the large object is not very mobile, the G.M. may allow bonuses to hit. Immobile objects (including unconscious characters) can usually be hit without any strike roll at close range. After all, the attacker is standing right in front of it.

**Can characters have more than one Hand to Hand skill? If so, are the bonuses cumulative, or are only the best bonuses chosen?**

Yes, conditionally. Other physical skills like Boxing and Wrestling offer additional bonuses to attributes, S.D.C. and combat bonuses (strike, parry, dodge, etc.). ALL these bonuses are cumulative.

However, all **Rifts®** characters only get *ONE* Hand to Hand Combat skill. (In fact, the only exceptions are characters in the *Ninjas & Superspies RPG* where some martial artists characters can select multiple forms of hand to hand combat training. This is NOT recommended for **Rifts®** as it may unbalance the game. **Rifts®** is not designed for the Ninja & Superspies style of play.)

**Are Hand to Hand bonuses combined with Weapon Proficiencies?**

*Yes, for melee weapons* like clubs, swords, spears, bow and arrow, etc. So if you have +1 to strike from the Hand to Hand: Basic combat skill and +1 with W.P. Sword and +2 from the P.P. attribute, the character will be +4 to strike.

*No, for modern weapons;* i.e. guns and missiles. The W.P. itself presents the only applicable shooting/strike bonus.

**What is a melee attack? How much time approx. is one? Could a Ninja Juicer (or just a Mystic Ninja) draw his sword and strike in one attack?**

A melee attack is an action during a melee round. Melee rounds are 15 seconds long; during that time, some characters can perform 3 to 5 actions while others can perform several more (6-10). Drawing a sword *is* one action and striking is a second action.

**Do Hand to Hand P.S. damage bonuses apply to energy melee weapons?**

No damage bonuses apply to the use of energy melee weapons unless there is a physical damage component to the weapon involved. Not even if the attacker has Supernatural Strength.

For example, with a Psi-Sword, Flaming Sword or Energy Sword, only the weapon damage applies, any P.S. damage (supernatural or otherwise) is not added.

However, a Vibro-Sword uses a physical core and so damage bonuses can be applied to this weapon. The same is true of rune weapons and TW weapons which have an actual cutting blade and such.

**Can you pick the same W.P. twice to double the bonuses?**

Absolutely not! NO! You can not take the same W.P. multiple times to get improved bonuses. However, some different W.P.s may offer an accumulated bonus for the same type of weapon, like Archery and Targeting, or Sharpshooting, but these are very rare.

**One of the players in my group & I were having a disagreement about Simultaneous Attacks. My friend thinks that if he is fighting something with more attacks per round than himself he can call Simultaneous and attack the same way he would be able to parry.**

No. Doing a simultaneous attack still counts as one attack, and will use the character's attack up like normal. All he is doing is skipping any opportunity to parry his opponent's attack and to strike the same time his attack is. What this does is enable the character who would normally be the defender to be the aggressor at the same instant. The advantage is unless he rolls a 1-4 to strike, his attack *will* hit, because the attacker is busy attacking and can NOT dodge. But then, neither can he!

The combat continues as normal. The aggressive defender can continue to simultaneously attack, each combatant hammering at one another without parrying or dodging, or he can try to parry and counterstrike. However, this does NOT give the defender extra attacks. When all of his attacks are used up, and if his attacker still has a few attacks left, the attacker continues to strike and all the other character can do is parry or dodge. A parry does not use up an attack. A dodge will use up attacks the defender character would have the next melee round.

## The Dodge

---

**When you roll to dodge, does a roll of 4 (before dodge bonuses are added in) mean you failed?**

There is no automatic failure for dodge rolls. The only time a dodge fails is when the roll to dodge is below the opponent's roll to strike.

**If a character has used up all of his attacks, is dodging still allowed (I assume so)?**

Yes, dodging *is* still allowed. HOWEVER, each dodge this melee round uses up one of the character's attacks from the next round. For example: Let's say the defender has 4 attacks per melee round and his opponent has six. In the first combat round, the defender uses up his attacks, but his opponent still has two left. The smart thing to do (if circumstances allow) is to parry the attack because a parry does not use up a melee attack or action. However, one can not parry bullets or energy blasts, so a character may be forced to dodge. In this example, the defender can *dodge* the attack but each "extra" dodge uses up one of his attacks next round. Next melee round, his opponent starts again with six melee attacks, while the defender now only has *TWO!*

Consequently, many warriors will stand and take the damage rather than try to dodge, especially if they *know* the incoming attack is low damaging and/or their body armor will take all (or most) of the damage..

The Exception: Characters with an *Automatic Dodge* can dodge all day long without burning up an attack. The Automatic Dodge is usually reserved to very fast and agile characters and combat masters. If it is available it will be listed in the O.C.C./R.C.C. or combat skill.



### How does an Auto-Dodge Work?

An Automatic Dodge works just like an automatic parry in that it does *not* use up any attacks to perform. Bonuses to Auto-Dodge comes from the character P.P. attribute and any special Auto-Dodge bonuses from O.C.C. or Hand to Hand Combat skill (it will say Automatic Dodge). Unless it specifically says a character has an Automatic Dodge, he or she does NOT.

**I have a question regarding automatic dodges. Ok, if I am in a fight and I roll for automatic dodge and miss the roll, do I automat-**

**ically divert to a normal dodge for that action, or does the failure at the automatic dodge just mean that I am hit with no chance for a normal dodge that action?**

It is the latter. An Automatic Dodge is the character's defensive counter-maneuver to the incoming attack. If he fails at it, he is hit, just like a failed parry.

**Are there any types of physical attacks you cannot parry? Like a dragon's bite?**

Definitely. A parry is generally used to *deflect* or physically *block* an attack, so if an attack can not be deflected or blocked, it cannot be parried. This means that falling boulders, energy blasts, bullets, etc., cannot be parried. Likewise, if you have no shield, hand weapon, or arm guards to parry with, one can not parry a sword strike or other attack, unless the character can get in close and is actually able to parry the attacker's arms (in this case, rendering the longer weapons useless). For example, in a knife fight, parrying the opponent's arms is possible and is more often done than parrying the knife itself.

**Why can't energy blasts, bullets or arrows be parried or dodged?**

Generally, these types of attacks come in too fast for the character to parry or dodge. It is just impossible even if the character is superhuman (at least in most cases). Moreover, even the super-rare character who can dodge an arrow, bullet or bolt of energy (like the Samurai and Mystic Ninja of Rifts Japan) must know the attack is coming; i.e. must see his shooter and realize he is the intended target. Any multiple blasts from two or more opponents can not be dodged no matter what! One simultaneous blast, maybe, all, never.

The Typical Character: Including Juicers, Crazies, and most superhumans and supernatural beings can *try* to dodge an arrow, bullet, or energy bolt, but must roll an unmodified dodge. That's right, NO bonuses of any kind and -10 to dodge! -12 to dodge a rail gun "burst."

Rifts® Traditional Samurai: -2 to dodge arrows, -4 to dodge gunfire or energy blasts.

Rifts® Mystic Ninja: -3 to dodge arrows, -6 to dodge gunfire or energy blasts.

**Can one attempt to parry an attack directed at someone else?**

Yes, but it will count as one of the character's melee attacks to do so, because he must move in or lunge to protect the other character, thus it is no longer an automatic action.

**So how do I leap in front of the fireball aimed at the one-armed, blind little orphan Timmy.... or how can one get in the way of an attack directed at someone else?**

It will count as a single action, and as always, you must roll to strike – in this case the strike being to hurl oneself in the path of destruction. High roll wins. The defender (i.e. the guy diving in front of the blast, sword or whatever the attack is) wins ties. So if both attacker and defender roll a 14 to strike, the defender wins and takes the damage meant for Timmy. Yes, success means the heroic character (now a human shield) will take the damage, and cannot attempt to Parry or Dodge that attack. A *failed roll* means the blast misses the heroic character and Timmy is struck.

If the circumstances dictate, the character could perform a leap that is basically a Simultaneous Strike in which the character tries to tackle the child and successfully knock of them out of harm's way. In this case, first roll to strike/hit the child/target (may miss the kid) and then roll to dodge. It is the dodge roll that will determine whether the hero manages to knock them both out of the way of his attacker's roll to strike. This heroic effort uses up two melee actions/attacks. If the G.M. is nice, he or she will let the hero take damage even if the dodge part of the roll fails so the child is saved (and the hero injured).

**Does rolling with a punch take an attack from the defending character? And if so, does it take his very next attack, leaving him on the defensive for his attacker's next strike? Or does the lost attack/action come off the defender's total number of attacks, letting him counter-strike?**

A roll with punch or impact will always count as a melee attack/action, and yes, it will be the character's next attack that is lost as he recovers from the attack that he rolled with.

**When it states that "the victim loses initiative and one attack," does this mean that he loses his very next attack? Or just one from his total.**

The victim will lose their *next attack* and no matter where they were in the combat order they will be moved to last in the order.

For example: If two characters (A, B) are fighting in that order of initiative, and B manages to strike "A," causing him to fall, or stagger back, "A" loses one attack and initiative. "A" will not be able to strike back until the third set of attacks and will be last in the order (effectively putting "B" into the advantage position as aggressor and probably with one attack option more than "A.")

**The sequence of combat** goes like this.

Let us assume "A" has initiative and five attacks per melee round.

"B" also has five attacks per melee, but since he lost the initiative roll, he is on the defensive.

**Attack One (A):** "A" strikes first (his first melee attack). Roll D20 to strike.

"B" can parry (no loss of attack) or dodge (counts as one melee attack/action). "B" elects to parry (roll D20), preserving his number of attacks.

**Attack One (B):** Now it is "B's" turn to retaliate. He strikes back. Just once (his first melee attack; roll D20).

"A" can parry or dodge, but elects to parry. However, "B" gets a lucky shot. A natural 20 maybe, or some other circumstance that the G.M. says knocks down (like rolling a 1 to parry and the attacker rolling a 20 or higher with bonuses, or having Supernatural P.S.). Getting knocked down means "A" just lost the initiative and one melee attack.

**Attack Two (A):** Gone. Lost due to the knock down. So is initiative.

**Attack Two (B):** In this case, "B" comes in with his next attack, because "A" lost his. All "A" can do is try to parry or dodge. He attempts a parry. "B" enjoys a free shot since he now has the initiative and "A" lost one attack.

**Attack Three (B):** Since "B" now has the initiative, he strikes at "A" again. Strikes in rapid succession (one-two strike) which could be all it takes to defeat "A." If not, the battle continues. "A" can parry or dodge. He goes for parry to avoid losing another attack.

**Attack Three (A):** Now it is "A" who can finally strike back.

**Attack Four (B):** "B's" turn to strike at "A."

**Attack Four (A):** Counterstrike.

**Attack Five (B):** This is the last strike of the melee round for "B." He goes first because he has initiative.

**Attack Five (A):** If "A" is still standing, he gets in his last shot of the melee round. "B" parries.

**Next round:** Starts fresh. Each has five melee attacks. Unless there is a pause in the battle, I (KS) usually keep the *initiative established in the first round*. In this example, "B" still has initiative and strikes first. If there is a pause and the battle is rejoined a round or more later, or a new opponent is faced, roll again to determine who has initiative.

Hand to Hand combat is based on the concept of back and forth, give and take. He who has initiative is the Attacker and strikes first, the Defender returns the favor and strikes immediately after. The Attacker then strikes again and the Defender strikes back (after a parry or dodge). Boom, boom, boom.

If the Attacker has fewer attacks than his Defending opponent, after he has expended his attacks, the Defender gets to get in a couple of good licks before the next melee round starts, leaving the Attacker to parry or dodge this last flurry. Next round, the Attacker from the onset of the battle still has initiative and the combat sequence repeats. If a G.M. prefers, he can roll initiative each and every round. I usually do not.

## Grappling

Occasionally, one may encounter a being that cannot be easily hurt, but can be constrained or distracted. A constant attack, e.g. an unrelenting battery of punches, kicks, and grappling, can keep the thing too busy and off balance to attack anybody else. Super strong characters protected by Mega-Damage power armor, bionics, or body armor can also grapple, pin, entangle, or crush/squeeze (bear hug) such a creature. As long as the character hangs on or keeps the fiend unbalanced, the monster's attacks are limited to that one individual and it cannot attack others. Or the ability to grapple, pin/hold or otherwise incapacitate can sometimes be a more effective assault than brute force.

Similarly, an opponent can be entangled, which usually means he falls or is easily knocked down and loses initiative and one melee attack.

## The Knockout

Unless a called shot is made, the strike from most attacks will fall on the main body. The called shot also applies to knockout/stun attacks. The Game Master can only assume that a combatant is trying to hurt or kill his opponent unless told otherwise. If the attacker "announces" that he is trying to render his opponent unconscious, that is a different story. Then if the character rolls at or above his Hand to Hand combat skill to Knockout/Stun, or rolls a natural 20, his opponent is knocked unconscious rather than killed. A knockout punch inflicts minimal physical damage but knocks the victim unconscious or dazed/stunned/incapacitated.

An opponent is also knocked unconscious when his Hit Points are reduced to zero. Anything below zero knocks the victim into unconsciousness and a coma, with death a likely prospect unless he soon receives medical treatment.

The Game Master can also allow obviously more powerful characters to knockout far inferior characters, even though the character does not yet have the hand to hand skill to do so. This should not be abused and I generally require the player character to have to strike with a roll of 19 or 20. Unlike detective movies, it can be difficult to knock somebody out. Some people are beaten to a pulp before they lose consciousness or never lose consciousness until they lapse into a coma.

In one play-test, a well meaning, but overzealous Juicer desired to knockout a captured security guard. "I'm going to knock this guy out so he won't be any trouble." I, being the G.M., said, "Fine, but you need a roll of 19 or 20, strike bonuses are included." Pow! A terrible low roll. "Lousy punch," I said with a wince. "You inflict normal damage and he's still conscious." The Juicer frowned and said, "I try it again." BAM!! Same results. "I try it again." Crunch!!! Same result! He pummeled that poor security guard in the head three times and was winding up for a fourth try.

Each roll for the knockout punch was terrible, a roll under 10 every time, so instead of knocking him out, the Juicer was inflicting great amounts of S.D.C. and hit point damage. As he readied himself to punch this poor, battered, and bleeding fellow for a fourth time, one of his teammates stopped him and pointed out that he was literally beating the guard to death (down to 9 Hit Points). The embarrassed Juicer apologized to the battered guard and to his teammates, tied the guard up, gagged him and stuck him in the corner instead of trying to knock him out. "Hey, how come you can always knock these guys out in the movies, but I couldn't?" My response as G.M., "Hey, this isn't the movies and based on your rolls, you couldn't knockout a fly." That's how it goes sometimes.

## Knockdown

The impact from an explosion, parrying a powerful energy blast, or a powerful punch/impact from a robot or supernatural creature, tackle, ram, Wind Rush, Telekinetic Push and other types of attacks may knock a character off his feet, even if the damage from the attack is minimal or successfully parried. It is the *force* of the attack that is likely to knock the individual off his feet.

**Penalty:** Being knocked down or off one's feet means losing initiative and one melee attack/action that melee round.

The optional Humanoid Knockdown Table can be applied to most human-sized characters, even in body armor, but is usually not applicable to dragons, characters in power armor, robots, powerful supernatural beings, and characters with a P.S. of 30 or higher. But even these characters may be knocked down from impacts that inflict 31 M.D. or more.

The chance of being knocked down from *impact or explosive force* is measured by the amount of damage the impact inflicts. The greater the damage, the more likely one is momentarily knocked off his feet (losing one melee attack). Note: This table is strictly optional and its use and/or modification is left solely to the Game Master. Also note that this table is a bit different from the vampire knockdown table found in the **Rifts: Vampire Kingdoms** Book. Why? Because this take into consideration the inclusion of body armor and combat experience.

### Optional: Humanoid Knockdown Table by Damage from Impact or Explosions

1-10 M.D.: No chance. Withstands the blow.  
11-20 M.D.: 01-20% chance of being knocked off feet.  
21-30 M.D.: 01-30% chance of being knocked off feet.  
31-40 M.D.: 01-50% chance of being knocked off feet.  
41-50 M.D.: 01-70% chance of being knocked off feet.  
51-60 M.D.: 01-90% chance of being knocked off feet.  
61 or more M.D.: 100%! Knocked off feet and stunned! The impact is so strong that, in this case, the character loses all attacks/actions that entire melee round (15 seconds).

### 'Bots, 'Borgs & the Supernatural: Knockdown Impact Table (optional)

Applicable to dragons, characters in power armor, full conversion cyborgs, robots, supernatural beings and characters with an M.D.C. of 500 or higher. These characters may be knocked down from impacts that inflict 31 M.D. or more.

1-30 M.D.: No chance. Withstands the blow.  
31-50 M.D.: 01-10% chance of being knocked off feet.  
51-70 M.D.: 01-20% chance of being knocked off feet.  
71-100 M.D.: 01-40% chance of being knocked off feet.  
101-150 M.D.: 01-60% chance of being knocked off feet.  
151-200 M.D.: 01-80% chance of being knocked off feet.  
201 or more M.D.: 100%! Knocked off feet and stunned; loses all attacks/actions that entire melee round (15 seconds).



## S.D.C. and Combat

Over the years I've heard some pretty silly and outrageous incidents regarding players abusing the concept behind S.D.C. for player characters. Fortunately, these incidents seem to occur mostly in Palladium Books' super-hero RPGs where the outrageous is more common, however, I still want to set a few things straight.

First of all, most RPG characters are larger than life heroes, whether they are set in the world of Rifts or Heroes Unlimited. This means the player characters, and most of their antagonists, are not the average guy off the street. They are "heroes" (and villains) and therefore, stronger, braver, and often endowed with superhuman abilities. The inclusion of personal S.D.C. defines one of the ways that the player characters are different than you or I. Like a boxer or any professional athlete, these characters are stronger and tougher than us average city folk.

In the case of Rifts, most player characters are all warriors or adventurers of some kind, augmented by technology or magic. They are struggling against alien and supernatural foes and explore a nightmare world of changing realities. Their training has made them physically stronger and skilled in the ways of combat. But while they may possess powers and abilities beyond the norm, they too are subject to scientific logic and common sense rules.

S.D.C. will come into play when the character engages in non-Mega-Damage combat outside the protective confines of his M.D.C. armor. Such confrontations may not happen often, but a character can't live inside a suit of armor all the time.

Fans have told me stories about other players whose characters charge gunmen without fear, because the bullet damage is first subtracted from their S.D.C. points and they know they can defeat the gunmen before their character gets shot more than four or five times and may not even suffer hit point damage. One character even jumped on a live grenade, took the full blast, got up, dusted himself off and said, "Heck, it's only 40 S.D.C., I'm fine." Another player's character would shoot himself in the temple to show the bad guys how tough he was.

Now, while the idea is that a character can endure more physical damage than a normal person, this is ridiculous!! Yes, this is also an example of poor Game Mastering, but I've heard these horror stories often enough that I feel I should address this problem along with everything else in this section.

### Some Common Sense Rules Regarding Physical S.D.C.

Come on guys, think about the situation and use some common sense. Let's tackle this gunmen scenario. The character may suffer only S.D.C. damage, and that's good, because he's not fatally wounded. However, what that means is that, while the wound is not immediately life threatening, the character is hurt! Do not underestimate pain. Even if he may be able to shrug off the pain and impact of a bullet wound and keep on fighting, he's a hero after all, it does not change the fact that the character is hurt and suffering.

The immediate problems for the wounded character are pain, further blood loss, and treating the wound. Unless each wound is correctly bandaged (roll on the appropriate medical skill), the character will continue to lose blood, which causes further physical damage. After the bleeding has been stopped, the hero must still have surgery to remove the bullets and get cuts sutured. The wound is also very painful and may impair further movement and/or the performance of skills. Think about how little you can do when you cut your hand or even cut or injure a finger. Something as simple as writing your name or opening a jar may be impossible or, at best, difficult and painful.

The following rules are some simple and realistic ways to play physical damage.

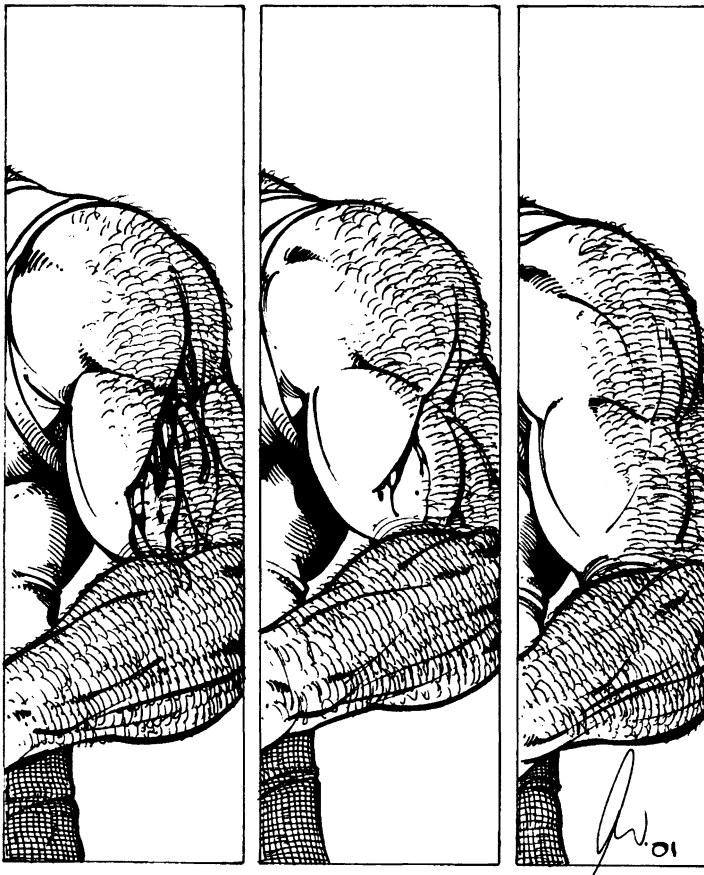

## Blood Loss

A character loses blood from every wound that has penetrated the body. This includes cuts, stab wounds, and gunshots. The injured character will suffer one point of damage for every wound, every minute (4 melees). Three gunshots means three points of damage every minute (60 seconds/4 melees). The damage is first subtracted from the S.D.C.

When all the S.D.C. points are gone, the damage is subtracted from the character's Hit Points.

Only first-aid or paramedic techniques that bind the wounds will prevent further blood loss and the wounded character can often perform medical treatment on himself. Yes, a character can function without medical treatment while losing blood and taking more damage every minute, but he will pass out when he reaches less than five Hit Points. This would be the classic John Wayne: nobody knows I'm hurt, keep on moving/fighting, and then collapses or dies. This happens all the time in heroic fiction.

When a character is severely hurt, down to only 15% of his Hit Points, he will suffer from internal bleeding. Only a medical doctor and surgery can save him. First-aid and paramedic skills can only be used to make the injured character more comfortable; they will not save him. Without the appropriate medical aid, the person will continue to lose blood and take one point of damage every minute (4 melees). When the injured character's Hit Points fall below zero, he has lapsed into a coma. See coma recovery rules in the *Rifts* RPG, pages 10 & 11. Game Masters may find it useful to use the Optional Damage Rules, in *Rifts*, (Table #1) as temporary side effects, even from S.D.C. damage. Or use the table as a guide for side effects resulting from damage to specific body parts (the random roll may not be appropriate).

## Pain Penalties (optional)

Penalties are cumulative. This makes sense when you think about it. How many times do we see a hero in the movies who's all banged up by the end, and can't fight nearly as well as he could in the beginning of the story? These optional rules are to simulate that effect.

## Leg

- Minor damage to a leg will reduce speed by 20%.
- Significant damage to a leg will reduce speed by 50%; -1 on initiative, -10% on skill performance.
- Major damage to a leg will reduce speed by 75%; -2 on initiative, to roll and to dodge, -20% on skill performance.

## Head, Hand or Arm

- Minor damage to head, hand or arm will reduce skill performance by 10%.
- Significant damage to head, hand or arm will reduce skill performance by 30%; -1 to strike or parry.
- Major damage to head, hand or arm will reduce skill performance by 60%; -2 to strike, parry, dodge and roll.

## Main Body

- Minor damage to the main body: -1 on initiative.
- Significant damage to main body: -1 on initiative, -1 to strike, parry, dodge and -10% on skill performance.
- Major damage to main body: -3 on initiative, -3 to strike, parry, dodge, and roll; -20% on skill performance. Double rate of blood loss.

## Damage at Point-Blank Range (optional rules)

There can be a big difference between getting shot from 300 yards away (about 270 m) or at a range of 10 feet (3 m). For one thing, the assailant will be less accurate and for another, the bullet will have less impact at the greater distance. Of course, both can kill.

We will define point-blank range as approximately 10 feet (3 m) or closer. At ten feet away the assailant has a better chance to hit his target (especially a human size target), the bullet or energy bolt will have greater impact (inflicting more damage), and the attack is more likely to hit a vital organ.

The following rules take into consideration the damage and effects of point-blank attacks.

1. If the target is immobile, such as an unconscious person or somebody who is tied up, the attacker will automatically strike his target at point-blank range (10 feet/3 m or closer). No roll to strike is necessary unless the target/victim can dodge or unless the attacker is shooting wild. However, without the strike roll, a critical strike (double damage) is impossible. On the other hand, damage is automatically much greater.

2. Damage at point-blank range is full S.D.C. damage and half hit point damage. For example: Your character is shot at point-blank range and suffers 12 S.D.C. points of damage. The full 12 points are subtracted from the S.D.C. and another 6 points (half of 12) are subtracted from the character's Hit Points as well. When all S.D.C. points are gone, the full damage is subtracted from the Hit Points. Yes, this does mean that a character may survive a point-blank attack, but that's because this is possible in real life.

3. Additional effects from point-blank attack! The force of this brutal attack will always momentarily impair its victim, even if it is only S.D.C. damage. Roll on the following table whenever a character is shot at point-blank range. Game Masters who want a more realistic game can have players roll on the following table whenever a character is shot from any distance. Of course, these rules do not apply to Mega-Damage structures, 'bots, 'Borgs, and body armor.

## Additional Side Effects Table from S.D.C. attacks, projectile and energy (optional)

**01-20%:** Momentarily stunned: Victim loses one attack that melee (or one the following melee if he has no attacks left that melee).

**21-40%:** Stunned and knocked down: Victim is knocked to the ground by the blast; loses two melee attacks, loses initiative, and is -1 to strike for the rest of that one melee round.

**41-60%:** Severely stunned and knocked down: Victim is in terrible pain and is knocked to the ground by the blast, loses all melee attacks/actions for one full melee and is -2 to strike, parry and dodge for that melee.

**61-80%:** Momentarily knocked unconscious: The shock to the nervous system temporarily renders the victim unconscious for 1D4 melees (15 to 60 seconds). While unconscious, the character can not move, think, or plan, nor is he aware of events happening around him. The unconscious individual is completely helpless and open to attack. He may appear dead to his attacker.

**81-96%:** Knocked unconscious: The victim is knocked out for 1D6 minutes. While unconscious, the character can not move, think, or plan, nor is he aware of events happening around him. The unconscious character is completely helpless and open to attack.

**97-00%:** Momentarily stunned: Victim loses one attack that melee (or one attack the following melee if he has no attacks left).

**NOTE:** Roll for each gunshot.

## Point-Blank Head and Heart Table (optional)

Damage from a point-blank shot to the head or heart inflicts full damage to the S.D.C. plus half damage directly to Hit Points. However, the side effects are much more deadly. Roll on the following table.

**01-35%:** Lucked out! Missed all vital organs; however, the blast knocks its victim unconscious for 3D4 minutes and covers the character in his own blood. Looks bad and feels worse; throbbing headache, terrible pain, shortness of breath, and experience difficulty concentrating; woozy. Penalties: Reduce speed by half, -30% on all skills, -10% on initiative, -3 to strike, -3 to parry and dodge, and the character is still losing blood (see rules for blood loss). The penalties apply for 24 hours.

**36-70%:** Knocked unconscious! The victim's condition is bad, but could be worse. In addition to the physical damage, the character is unconscious for 2D6 hours and requires immediate treatment to stop the bleeding and may need hospital treatment. Penalties: Reduce speed by half, -40% on all skills, -10% on initiative, -4 to strike, -4 to parry and dodge. The penalties apply for 72 hours, then reduce them by half for another 72 hours. Afterwards, return to normal.

**71-00%:** Coma! The shock to the nervous system is too much and/or caused serious internal damage. The character lapses into a coma. This automatically reduces the character's Hit Points to zero, regardless of the damage die roll. From all outward appearances, the character will seem to be dead. Only a careful examination will reveal life signs. Under these special circumstances the character can survive in a coma state three times as many hours as normal. See *Surviving Coma and Death*, *Rifts Ultimate*, page 354. The victim is +6% to save vs coma. Penalties are the same as #36-70 Knocked Unconscious, but the duration is twice as long.

**Note:** Depending on the situation, the victim of a point-blank attack may be automatically killed too. But this is left up to the Game Master's discretion. The general rules presented here are to be applied in non-lethal situations. Likewise, similar effects can be implemented for Mega-Damage inflicted to M.D. creatures, such as the dragon, when exposed to massive point-blank damage to the head; G.M.'s option.



## S.D.C. & Explosives

Again, I must say, use some common sense. A character can not survive a point-blank confrontation with a grenade or dynamite no matter how much S.D.C. or Hit Points he might have. If your character leaps on top of a grenade to save others, that's great, but he's dead. And I mean DEAD! There is no chance of survival, because he was laying right on the grenade. At the risk of being gory, his guts were blown to smithereens.

At the GM's discretion, the character might survive, but a limb or two will be blown off, like a hand, or hand and arm, or leg(s), et cetera. That's the only realistic way to play explosives vs the human body.

A basic rule of thumb when using explosives is that they inflict double damage directly to Hit Points when at point-blank range (10 ft/3 m). Point-blank range could be increased to cover double (or more) the normal area depending on the power of the explosive.

If the character is not caught in the point-blank range of an explosion then the normal damage is subtracted first from S.D.C. and then Hit Points. In the latter case, the character could walk away with just a few scratches; no serious damage. Of course, M.D.C. armor would absorb all S.D.C. damage without injury to the character.

**Note:** The same basic concept applies to M.D. explosives and M.D.C. creatures and structures.

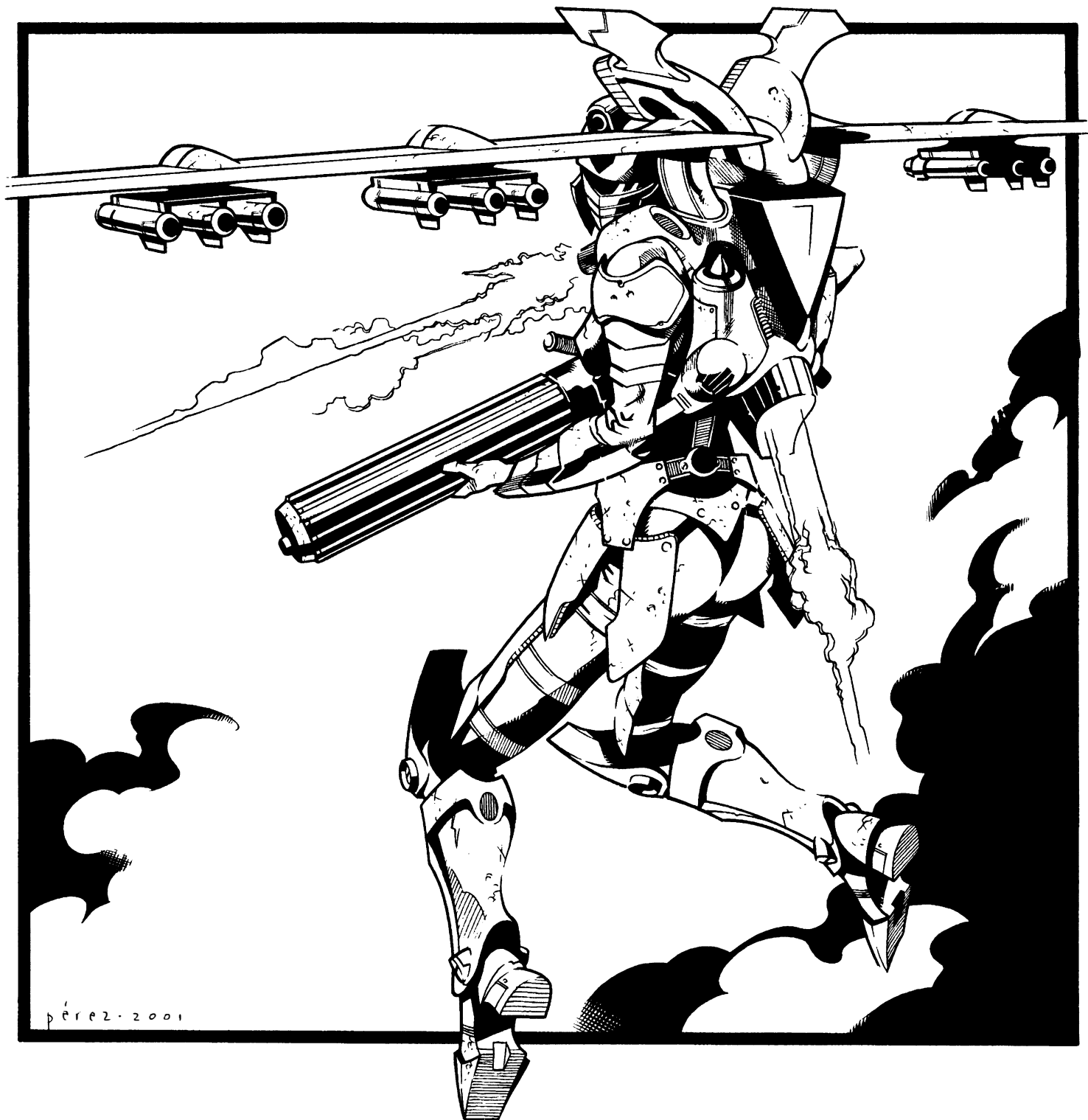

## New Ranged Combat Rules

The following are new, simplified rules involving *guns*, *lasers* and other *modern weapons* in Rifts®. These rules first appeared in the *Splicers™ RPG*, but were actually developed for *Beyond The Supernatural™ Two*, and will probably be adapted to all Palladium RPGs in the future.

Why the change?

A few reasons.

One, I heard the gamers' complaints about the notorious *-10 rule*. Two, I didn't really care much for the rule myself. I created it in response to what (at the time) seemed like a multitude of Game Masters who complained that guns had lost their significance because characters could easily dodge out of their way. While the *-10 rule* took care of that problem, the "fix" took away some of the fun of the role-playing experience. I mean, everyone wants to have a character who has at least a *chance* of dodging a gun shot. I certainly allowed characters to dodge bullets in my own games (without problems) for . . . ever. Lastly, I have never been satisfied with the rules for modern weapons. Looking back, I had surrounded myself with gun experts, and I think I listened too closely and tried too hard to simulate *real* gunplay (which is pretty damn deadly in the real world, folks). In doing so, I think some of

smoothness of play (and in the case of the -10 rule, some of the “fun”) got lost in the simulation. Realizing this, I worked up a new, simplified set of rules for gunplay in **Beyond the Supernatural™ Two**, and it has worked so well in play tests that I’m probably going to incorporate them in all or our games. I think you’ll find these rules are fun, fast and easy to use while simulating gunplay in a reasonably realistic way.

Military enthusiasts and long-time players may want to keep using the original rules with a few tweaks here and there. Everyone else should give these new rules a try.

## No Weapon Proficiency (W.P.)

Anybody who does not have a W.P. in a particular weapon type *CAN* pick up a gun of any kind and use it, but does so without benefit of any bonuses. The bonuses that follow do not apply to this *unskilled* character, but a weapon can still be deadly in his hands. P.P. attribute bonuses and Hand to Hand combat bonuses do *NOT* apply to modern weapons when used by the *unskilled* character.

Furthermore, the untrained shooter does *not* know how to reload or clean the weapon, or the gun’s kick, how to use a gun sight to aim accurately, or anything about guns, different types of ammunition or gun safety – all he can do is pick it up, aim as best he can and pull the trigger. **Penalties for the unskilled:** A character with no gun proficiency rolls 1D20 with *no* bonuses to strike, can *NOT* make an *aimed shot* or a *Called Shot*, and suffers a penalty of -3 to strike with burst attacks, -5 to strike when shooting a machine-gun or other heavy weapon, and -6 when shooting wild. A single shot is a straight, unmodified D20 roll.



## Modern Weapon Proficiencies (W.P.s)

There is more to shooting a revolver, pistol, rifle and other weapons than pointing and squeezing the trigger. Even taking careful aim requires practice with the weapon, and different categories of weapons have different applications, quirks and considerations one needs to know to get the optimum performance out of the weapon. A Modern Weapon Proficiency in a particular type of weapon gives the character a good understanding of all of these things, at least in that particular *type* of weapon. The character will know how to handle the weapon safely and how to use and reload it, disassemble, unjam, clean and otherwise maintain the weapon. He also knows the basic specifications/capabilities of the weapon, such as the type of ammunition it takes, maximum effective range, approximate damage, special accessories for the weapon (gun sights, silencers, etc.), and the weapon’s quirks, strengths and weaknesses.

The character has also had hours (perhaps years) of training with the weapon and continues to work with it on a regular basis. This means target practice and practical experience with it in the field and, as a result, he has a good *feel* for the weapon; its weight, its kick when fired, the sound of gunfire, and performance/exactly what it can do. A character with a Modern W.P. can make aimed and “Called Shots” (aimed at a specific location within a larger target, such as shooting a gun out of an opponent’s hands, shooting the hand, shooting an antenna, or tire, or whatever). His penalties are also *less* when shooting *bursts* or *wild*.

## New Weapon Proficiency Skills and Bonuses

**W.P. Handguns:** A familiarity with all types of handguns including revolvers and pistols. Revolvers are the classic cylinder-based “six shooter.” Pistols are “automatic” weapons, which means the gun keeps firing while the trigger is depressed and doesn’t stop until the trigger is released or the ammunition is spent.

**Damage:** Light caliber guns: 2D6 to 3D6 S.D.C. Medium caliber guns: 3D6 to 4D6 S.D.C. Heavy/large caliber handguns: 4D6 (.45 automatic) to 6D6 S.D.C. (Magnum revolvers). *Double damage* for a standard *short burst* (three rounds/bullets fired), but only pistols (not revolvers) can fire in bursts.

**Average Range:** 140 feet (42.7 m).

**Typical Payload:** Revolver: Six bullets. Automatic Pistol: 8-16 rounds.

**W.P. Bonuses:** +1 to strike at levels 2, 4, 6, 8, 10, 12, and 14.

**W.P. Rifles:** A familiarity with the very accurate, single shot bolt-action style of rifles used for hunting and sniping, and automatic and semi-automatic, military assault rifles like the M-16 and AK-47.

**Damage:** Light caliber rifles: 5D6 per single round. Medium caliber rifles: 6D6 S.D.C. per single bullet. Heavy/large caliber rifles: 7D6 to 1D6x10+3 S.D.C. per single round. *Double damage* for a standard *short burst* (three rounds/bullets fired). *Triple damage* for a *long burst* (six rounds/bullets fired) but counts as two melee attacks. **Note:** Only semi-automatic and automatic rifles can fire a three round burst. Only bolt-action and semi-automatic rifles can be used for sniping and firing a *single* bullet.

**Average Range:** 1300 feet (396 m), +500 feet (152 m; that’s 1800 feet/548.6 m total) for precision bolt-action rifles.

**Typical Payload:** Revolver: Six bullets. Automatic Pistol: 8-16 rounds.

**W.P. Bonuses:** +1 to strike at levels 1, 3, 5, 7, 9, 11 and 13.

**W.P. Shotgun:** A familiarity with the classic double-barrel shotgun and police and military versions of shotguns with ammo drums.

**Damage:** Buckshot: 2D6 S.D.C. (half damage for rock salt) to a 10 foot (3 m) radius; two S.D.C. (stings like the dickens) for riot control rubber bullets. Light Shot: 3D6 S.D.C. Medium Shots: 4D6 to 5D6, Heavy Shot/Large Bore: 6D6 S.D.C. **Note:** In all examples listed above damage is for a single round, double the damage if both barrels are fired simultaneously.

**Average Range:** Sawed-Off: 60 feet (18.3 m), Hunting: 200 feet (61 m), and Police/Military Shotgun: 300 feet (91.5 m).

**Typical Payload:** 2-6 in common shotguns, 20, 50 and 100 round ammo drums for police and military style (each single blast counts as one melee attack; can’t fire two simultaneous blasts but has rapid-fire and larger payload).

**W.P. Bonuses:** +1 to strike at levels 1, 3, 6, 10, and 14.

**W.P. Submachine-Gun:** A familiarity with small arms automatic weapons like the Uzi.

**Damage:** 4D6 S.D.C. per single round or 1D4x10 S.D.C. per three round burst.

**Average Range:** 500-600 feet (152 to 183 m; an Uzi is the latter range).

**Typical Payload:** Fires pistol rounds. A single bullet does 3D6+1 S.D.C., 6D6+3 for a three round burst, 1D6x10+4 for a *long burst* (six rounds/bullets fired) but counts as two melee attacks. **Note:** Can only fire in bursts.



**W.P. Bonuses:** +1 to strike at levels 1, 3, 6, 9, 12 and 15.

**W.P. Heavy Military Weapons:** Familiarity with military hardware, including grenade launchers, mortars, machine-guns, and mini-guns.

**Damage:** *Light or Medium Caliber Machine-Gun:* 5D6 S.D.C. per single round or 1D6x10 per short burst (12 rounds/bullets fired; counts as one melee attack) or 2D6x10+20 S.D.C. per long burst (36 rounds fired), but counts as three melee attacks. **Note:** Can only fire bursts.

*Heavy Caliber Machine-Guns and Mini-Guns:* 7D6 S.D.C. per single bullet, or 1D8x10 S.D.C. per short burst (10 rounds/bullets fired; counts as one melee attack) or 2D8x10+20 S.D.C. per long burst (30 rounds fired), but counts as three melee attacks. **Note:** Can only fire bursts and is so large, bulky and heavy that it must be mounted on a tripod, vehicle or supported on a stone or other strong support to use.

*Grenade Launcher Rifle:* 1D6x10 S.D.C. per grenade to everything in a 10 foot (3 m) radius. Can only fire one at time, each shot counts as one melee attack/action. A grenade launcher may also be mounted on an assault rifle, but has a reduced range and ammo capacity; pump action.

*Portable Mortar/Rocket Launcher:* 2D4x10 S.D.C. per explosive round to everything in a 15 foot (4.6 m) radius, but each shot counts as two melee attacks.

**Average Range:** Light Machine-Guns: 3000 feet (914 m) and Heavy Machine-Guns: 5000 feet (1524 m). Grenade Launcher: 1200 feet (366 m), only 800 (244 m) when part of an over and under assault rifle. Mortar or Rocket Launcher: 4000 feet (1219 m).

**Typical Payload:** Machine-Guns: 100 short bursts (3000-3600 round belts). Grenade Launcher Rifles: 2 hand loaded or 24 grenade drum or six shot, pump-action on a rifle. Mortar: One hand-loaded round at a time.

**W.P. Bonuses:** +1 to strike at levels 1, 3, 6, 10, and 14.

**W.P. Military Flamethrowers:** Familiarity with different types of flame casting weapons used by the military and mercenaries.

**Damage:** 5D6 S.D.C. per burst of flame (counts as one melee attack) with a 01-75% likelihood of anything flammable catching fire.

**Average Range:** 60 feet (18.3 m).

**Typical Payload:** 20 fire blasts per single canister of fuel, 40 per double canisters.

**W.P. Bonuses:** +1 to strike at levels 2, 5, 10 and 15.

**W.P. Energy Pistols:** A familiarity with all types of handguns that fire energy blasts. Includes laser tools and fusion torch.

**Specific Stats:** Varies with each individual weapon.

**W.P. Bonuses:** +1 to strike at levels 1, 3, 5, 7, 9, 11, 13 and 15.

**W.P. Energy Rifles:** A familiarity with all types of rifles and long range weapons that fire energy blasts. Including combination weapons such as grenade launcher and laser rifle.

**Specific Stats:** Varies with each individual weapon.

**W.P. Bonuses:** +1 to strike at levels 1, 3, 6, 9, 12, and 15.

**W.P. Heavy Energy Weapons:** Includes plasma, ejectors, rail guns, flame throwers, rocket launchers, cannons and similar high-tech, long-range weapons designed to inflict heavy amounts of damage.

**Specific Stats:** Varies with each individual weapon.

**W.P. Bonuses:** +1 to strike at levels 1, 3, 6, 10, and 13.

## Weapon Modifiers

### Bonuses & Penalties Depending on Circumstance

To shoot something the attacker must roll 1D20 and needs an 8 or higher to strike. HOWEVER, the shooter may also have *bonuses* to hit from Weapon Proficiency skills, but suffer mitigating *penalties* from conditions and circumstances.

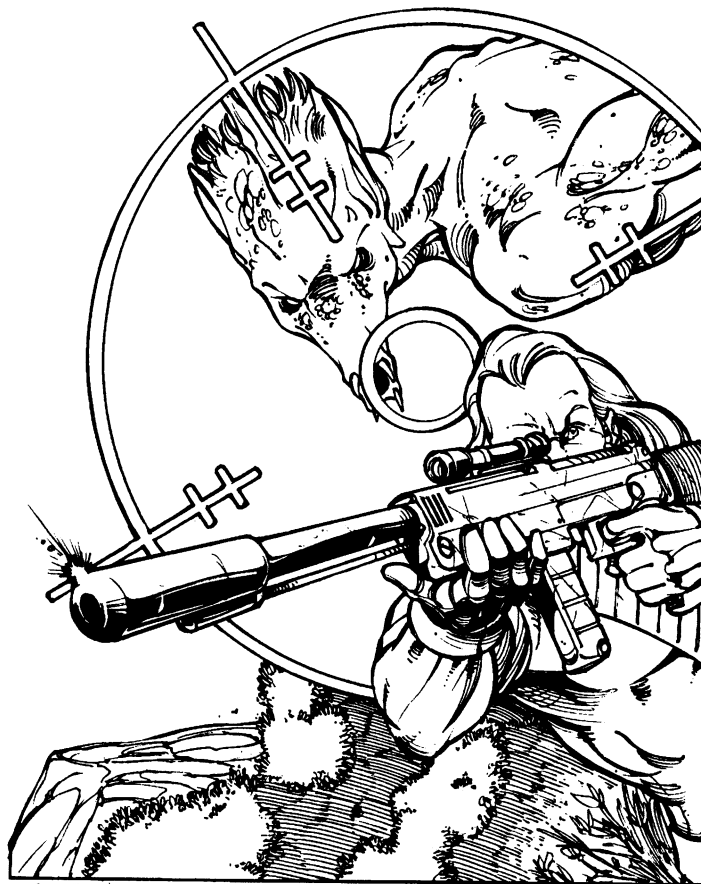

**Bonuses:** The only bonuses that apply to using guns and other ranged weapons are the specific *Weapon Proficiency skill*, *Sniping skill bonus* (if the character has that skill), any applicable bonus from the *weapon itself* (especially in the case of weapons built into power armor), and the ones that follow . . .

**Aimed Shot Bonus:** Only a single shot can be accurately “aimed” (no bursts or shooting wild). The skilled shooter is +2 to strike, but the attack counts as two melee attacks/actions (about 6 seconds), because he is taking time to aim and make a marksman style shot. An aimed shot can be made from any weapon that can fire a single round or energy bolt, including most energy pistols and rifles, revolvers, pistols, bolt-action rifles, semi-automatic rifles, shotguns and grenade launchers. **Note:** An “aimed shot” can only be performed with a single “sniper-style” shot, not a burst nor when shooting wild.

**A “Called Shot” target specification.** This is an aimed shot that homes in on a specific part of a larger target, such as a bull’s-eye, an opponent’s head, hand, gun, radio, radio antenna, sensor cluster, spotlight, tires, the sensor eye of a robot, etc., but counts as two melee attacks.

To make a “Called Shot,” the player must “call” or “announce” his character’s intention; i.e. “I’m going to shoot the gun from his hand,” aim and shoot. A carefully *aimed and Called Shot* gets the benefit of the +2 bonus to aim but counts as *three melee attacks/actions*. On the other hand, a quickly aimed Called Shot only counts as two melee attacks, but does not count as a true aimed shot and does NOT get the +2 bonus to strike.

**Penalties on a Called Shot:** Furthermore, a bull’s-eye or any small target is always a difficult to shot to make, and even with an “aimed Called Shot,” the shooter suffers a penalty of -3 or -4 to strike (sometimes more depending on the target). **Note:** A “Called Shot” can only be tried with a single “sniper-style” shot, not a burst or when shooting wild.

**Rolling a Natural Twenty to Strike** always hits its target and does double damage (critical strike). On top of that, the shooter can then

pick the location on the target where the shot hit. The only way it can miss is if the defender rolls a Natural Twenty to dodge!

**Single Shot:** The standard, non-Aimed, non-Burst, single firing of a ranged weapon counts as one melee attack. No additional bonuses or penalties apply beyond those gained from W.P. skills and situational modifiers below.

## Penalties

Penalties are *accumulative*, so if a character with an energy rifle is firing a burst or pulse weapon and shooting wild, he'd be firing the burst weapon at half his usual bonuses as well as suffering a penalty of -6 to strike for shooting wild!

**Shooting Blind:** -10 to strike what you cannot see, including shooting into ground cover without actually seeing a specific target. The same is true of shooting around corners without looking.

**Shooting Bursts:** Automatic firing, bursts, and rapid-fire pulses are not intended for accuracy: reduce the shooter's normal W.P. bonuses to strike by half. If the character does not have a W.P. for the weapon he is -3 to strike with a burst or pulse attack.

**Shooting Wild:** Has a penalty of -6 to strike and applies even to trained weapons experts when the character is terrified, angry/enraged, panicked, off balance, drunk, shooting from a moving vehicle/platform/horseback, spraying an area, shooting while under heavy fire himself, and while running, leaping, dodging, falling or hanging upside down.

**Shooting at a Moving Target:** -1 to strike someone running (under 20 mph/32 km), -1 to strike for each additional 50 mph (80 km) of speed the target is traveling, and an additional -1 to strike if the target is taking evasive action (zig-zag, leaping behind cover, etc.).

**Shooting at Someone Behind Cover:** If the target is completely covered/concealed there is no hope of hitting him from a distance, and the shooter will need to find a different vantage point where he can see the character or move in on the place of protection and concealment. If the target is hiding but part of him/it can be seen or if the target periodically pops its head or arm out to shoot back, curse or peek out, the shooter must make a *Called Shot* to shoot him/it and either shoot what little is seen or wait until he pops into the open for a couple of seconds.

**Shooting Beyond the Effective Range:** One may attempt a shot that is as much as 30% farther than the Maximum Effective Range of any given weapon, but the shooter suffers a penalty of -5 to strike.

## Dodging Bullets & Energy Blasts

A character may try to dodge gunfire and energy beams on the condition he knows they are coming and he can *see* his attacker.

The only applicable bonuses for dodging gunfire or energy beams are the character's P.P. attribute bonus, any O.C.C./R.C.C. bonus to dodge, and any dodge bonus from Power Armor or special ability. The defender trying to dodge must match or better the shooter's roll to strike to make a successful dodge. Each dodging action, whether successful or not, uses up one of the dodger's melee attacks/actions.

### Dodging Penalties:

-10 to dodge at *point-blank range*; within 4 feet (1.2 m) of the shooter.

-5 to dodge at *close range*, within 15 feet (4.6 m) of the shooter.

-3 to dodge at *near range*, within 60 feet (18.3 m) of the shooter.

-2 to dodge at any other distance (it's just not easy to dodge a speeding bullet or a light beam).

**Note:** A character with an M.D.C. shield, force field, or special ability *may* attempt to "parry" an energy blast or bullet under the same penalties as noted above with an additional penalty of -2 applied to each range (-12 to -4). HOWEVER, since the blast is *randomly deflected* it may hit an innocent bystander, comrade, piece of equipment, etc., and

inflicts full damage to whomever or whatever is struck. G.M.s, use your discretion.

## Quick Reference – Bonuses & Penalties

**All Ranged Attacks:** Requires a roll of 8 to strike (including W.P. & Sniping bonuses).

**Aimed Shot:** +2 to strike (takes 2 attacks).

**Called Shot:** No bonus, but enables the character to get a bead on very small or difficult specific targets; counts as two melee attacks (possible penalties for small targets).

**"Aimed" Called Shot:** +2 to strike, but can target very small, specific items and areas (takes *three* attacks; possible penalties for small targets).

**Shooting Blind:** -10 to strike.

**Shooting Bursts:** Strike bonuses reduced by ½ (-3 to strike without W.P.).

**Shooting Wild:** -6 to strike.

**Shooting 30% Beyond Normal Range:** -5 to strike.

**Target is Moving:** -1 to strike, -1 additional per 50 mph (80 km) beyond 20 mph (32 km), and -1 for evasive action.

**Target is Behind Cover:** Requires Called Shot, impossible if complete cover.

**Dodging gunfire, within 4 feet (1.2 m):** -10 to dodge.

**Dodging gunfire, within 15 feet (4.6 m):** -5 to dodge.

**Dodging gunfire, within 60 feet (18.3 m):** -3 to dodge.

**Dodging gunfire from a greater distance:** -2 to dodge.

## Gun Terms

**Attacks per Melee:** Each individual blast/bullet/energy beam counts as one melee attack. Firing a short burst also counts as one melee attack, but is less accurate. Long bursts and bursts from certain weapons (will be indicated in the weapon's description) may count as two (sometimes more) attacks/actions. Thus, if the character has five attacks per melee round, he can shoot five single blasts or short bursts, or two long bursts and one single shot or one short burst. If firing a machine-gun, only two short bursts and one attack with a different weapon or one other type of action.

For energy weapons a "pulse" is typically the equivalent of a short burst and counts as one melee attack, but suffers the usual burst penalty (reduce the bonus to strike by half).

**Damage:** The amount of S.D.C./Hit Point damage or Mega-Damage (M.D.) the weapon inflicts.

**Main Body:** The "main body" of robots, vehicles and power armor is typically the largest area of body mass offered by the target. On people that is the upper torso (chest and waist). The main body of an automobile is the large body mass that covers the frame. Parts not considered to be part of the main body include the tires/wheels/hover jets, legs, arms, hands, sensor cluster, mirrors, headlights, radiator grille, weapon turrets, and so on. Each full description of robots, vehicles, power armor, and body armor indicates what is the main body and what is not. To strike something other than the main body, the attacker must make a "Called Shot," or roll a *Natural Twenty*. (A Natural 20 always hits its mark, unless an opponent attempting to dodge also rolls a Natural 20.)

**Payload:** How many shots the weapon has, calculated by how much ammunition or what amount of energy the weapon holds before the ammo or E-Clip is empty and must be reloaded. "Unlimited" means the weapon draws from a larger power source, and an Energy-Clip and reloading are unnecessary. Most conventional and energy weapons, however, use bullets/ammo clips or Energy-Clips with a finite payload. E-Clips can be recharged, but not usually on the field of combat, they need to be taken back to base.

# Understanding High-Tech Weapons

**Pulse Weapons:** Many high-technology weapons, automatic weapons and energy weapons can fire multiple simultaneous rounds or bursts. Some high-tech weapons, like the *pulse rifle*, are designed to automatically release three rapid-fire energy pulses, instead of one shot, every time the trigger is pulled. The three energy pulses are so quick that they appear as one blast and only *one roll to strike* is required. Pulse weapons are *burst weapons* and the burst rule applies even to “aimed pulse” blasts (i.e. reduce the normal strike bonus by half).

**Weapons capable of aimed shots** are often considered to be “assassin,” “sniper” or “sharpshooter” weapons. Some have a switch that allows them to fire either a single shot or a burst/pulse. The aimed shot is always a careful and deliberate act of targeting and the shooting of *one* round/bullet or a *single* energy blast. The act of carefully aiming provides far greater accuracy but takes a bit of extra time and counts as two melee attacks per each aimed shot.

**Sniper rifles** are multipurpose weapons for use in field combat, sniping and assassination. Some can only fire one single shot per attack, others have the dual capability of firing a single shot or squeezing off automatic burst fire or a pulse energy blast. These rifles are designed for accuracy and usually enjoy an additional bonus to strike on a “Called Shot,” or an aimed, single blast. Not all rifles can fire a single shot and many of those that can do not necessarily get a special strike bonus from the weapon itself. Weapons that are expertly balanced will indicate what the strike bonus is in its description (typically +1). Even amateurs get this bonus if it is built into the weapon itself.

**Reloading.** Most conventional and energy automatic weapons require little time to reload. The process is a simple matter of retrieving a new, loaded ammo clip from its storage belt or compartment, removing the empty clip and slapping in the new, loaded clip. Except for extenuating combat conditions, the reloading takes a few seconds and counts as ONE melee attack/action.

Manually reloading grenade launchers, mini-missiles, shotguns, bolt-action rifles, revolvers and similar weapons requires more time because, typically, the spent cartridges must be removed and each new round must be loaded, by hand, one at a time. Even so, a revolver can be reloaded in about six to eight seconds and counts as two melee actions if the character has a W.P. in the weapon being loaded. Characters without a W.P. will need a full melee round or four melee attacks (whichever is shorter) to manually reload. Revolvers can be loaded in the time of one melee attack/action when a speed loader is used. Cost of the speed loader is 100 credits. The speed loader must be hand loaded in advance.

**A Character's P.P. Bonuses** do *NOT* count when shooting an automatic weapon, rail gun, shotgun, energy weapon, or any modern weapon. The mechanical design and capability of the weapon makes its use and abilities quite standard. The only exception is Natural Energy Blasts.

**Natural Energy Blasts.** Characters, aliens and supernatural beings who can generate energy blasts do so with natural ease. The firing mechanism is a natural extension of the character's own body, so add in bonuses to strike from a high *P.P. attribute* and any special bonus from the *ability* itself and/or applicable O.C.C./R.C.C. bonus (i.e., +2 to strike with energy bolts, or dragon breath, and so on). Each blast counts as one melee attack.

**Suiting up in Body Armor** by a practiced man of arms takes 1D4+4 *melee rounds* (about a minute and a half to two minutes). All others need 1D4+4 *minutes* to suit up. Both can strip down in about half that time.

**Suiting up in Power Armor** is about the same as body armor. The pilots who work for an army or military outfit usually have their power armor prepared and ready to go at a moment's notice and have a team of technicians to do prep work for them and to help them suit up. They can suit up in about *one minute*. Body armor still takes the 1D4+4 *melee rounds* because there are more pieces and dressing up to do.

Here are some optional hit location and damage tables for 'bots, robot vehicles and power armor. Rather than make the tables a completely random hit location and side effect table, I have opted for a table of side effects measured by the amount of damage the machine has endured. Obviously, if a 'bot's hand is blown off he loses the use of that hand.

## Side Effects by Location

The following optional tables can be rolled on when a specific hit location has suffered major damage (a loss of 60% of the M.D.C. in that location/limb).

## Hands

**01-30%:** Paralysis! Cannot flex fingers or pick up and carry or hold an object. The hand is in an opened position, the fingers spread slightly apart. Cannot make a fist, punch does half damage.

**31-50%:** Frozen in one position. The hand and fingers are locked in the configuration it was in when the damaging blast struck. This may mean locked in a fist, or clutching a weapon, etc. Punch does half damage unless in a clenched fist or karate style open fist.

**51-75%:** Structurally weakened. Cannot lift, carry or hold more than 200 pounds (90 kg). Punch does half damage.

**76-00%:** Joints lock at random times without warning. Roll every time the hand is used. 01-50% chance that the hand will suddenly lock-up/ freeze and cannot perform the desired function (pick up, hold, etc. ). Stays frozen for 1D4 melees.

## Arms

**01-20%:** Paralysis! Cannot move. Just dangles uselessly at the side of the bot. Cannot strike or parry with that arm.

**21-30%:** Frozen in one position. The arm is locked in the configuration it was in when the damaging blast struck. This may mean locked in a raised, outstretched or other position. Cannot make strike or parry with that arm unless the bot moves its entire upper body to do so. Damage is half.

**31-50%:** Sluggish response. Penalty: -1 hand to hand attack per melee and - 1 to parry.

**51-60%:** Structurally weakened. Cannot lift, carry or hold more than 300 pounds (90 kg). Punch does half damage.

**61-80%:** Joints lock at random times without warning. Roll every time the arm is used. 01-50% chance that the arm will suddenly lockup/ freeze and cannot perform the desired function (punch, move, etc.). Stays frozen for 1D4 melees.

**81-00%:** Any special weapon or sensor features built into the hand, arm, and shoulder do NOT respond. Special systems are completely inoperable; requires 1D6 hours of repairs.

## Legs

**01-20%:** Frozen in one position. The leg is stiff and unmoving. Cannot bend, reducing speed by 50%, and making leaps impossible. Climbing ability is also reduced by 25% and the bot is -1 to dodge.

**21-40%:** Sluggish response. Penalty: -1 to dodge and reduce speed and length of leaps by 25%.

**41-60%:** Structurally weakened. Kick attacks do half damage. 1-50% chance that the leg will buckle each time the bot is hit by more than 20 M.D.C. (anywhere on its body), dropping to one knee and losing one melee attack.

**61-80%:** Joints lock at random times without warning. Roll every time the leg is used to make a kick or leap, or is running at 45 mph (72 km) or higher (roll once for every five minutes of sustained running). 1-65% chance that the leg will suddenly lockup/freeze and cannot perform the desired function. Same penalties as frozen in one position, number 01-20. Stays locked up for 1D6 melees.

**81%-00%:** Any special weapon or sensor features built into the foot, leg, and hip do NOT respond. Special systems are completely inoperable; requires 1D6 hours of repairs.

## Main Body

The damage to the main body can be accumulative. Roll once when the main body has had 60% of its M.D.C. depleted. Roll again for every additional 40 M.D.C. points of damage.

**01-10%:** Dual images on radar screen showing twice as many radar blips as really exists; impossible to distinguish between real targets and ghost images. Penalty: - 8 to strike without visual confirmation.

**11-15%:** Radar and sonar are lost; require 1D6 hours of repairs. Pilot must rely on visual contact.

**16-20%:** Spotlights/headlights lost; must be replaced.

**21-30%:** Laser targeting system lost. Penalty: - 2 to strike; requires 1D6 hours to repair.

**31-40%:** Communications damaged; reduce range by half, requires 1D4 hours to repair.

**41-50%:** Communications and audio system lost; effectively deaf. Require 2D6 hours to repair.

**51-60%:** Electrical system damage. Secondary control panels catch on fire, knocking out personal computer(s); emergency back-up system engages, but not before the pilot's compartment is filled with smoke. Penalty: Lose two attacks that one melee round, - 4 to strike, parry and dodge until the smoke clears in 2D6 melees.

**61-70%:** Severe internal damage. Reduce speed by half, -I attack per melee, - 2 on initiative, - 2 to dodge.

**71-80%:** Computer memory damage! Cannot remember how to perform one of the following (roll or G.M.'s choice):

**01-20%:** Flight if robot vehicle, one skill program if a fully automated bot.

**21-40%:** Life Control: Includes temperature control and air recycling and circulation. About six hours of breathable air in a very hot and stuffy compartment. Penalty: -1 on initiative, strike and parry (pilot is distracted). If a fully automated bot, the unit smells of burning rubber and rotten eggs.

**41-60%:** Weapon systems: One weapon system is completely forgotten and therefore, unusable.

**61-80%:** Target identification is lost. Cannot distinguish between friend and foe, weapon systems must be manually operated and are -1 to strike and -1 on initiative. If a fully automated bot it cannot decide who is friend or foe and suffers a -3 initiative roll and usually will not attack until attacked first.

**81-00%:** Voice actuated access system does not recognize any voices or spoken codes. Access hatches, locks, and command functions must be handled manually. Furthermore, it cannot remember how to turn the self-destruct system on or off. If a fully automated robot it does not recognize, acknowledge or obey its master (if any) and suffers a - 10% skill penalty to all skills.

**81-90%:** Engine damage! Cannot engage any jet thrusters, fly or perform jet thrust leaps, and there is a minor radiation leak if nuclear powered (not yet life threatening).

**91-00%:** Sensor system is down (88% dead) and all combat bonuses are lost. Requires 3D6 hours to repair.



# Hand to Hand Combat

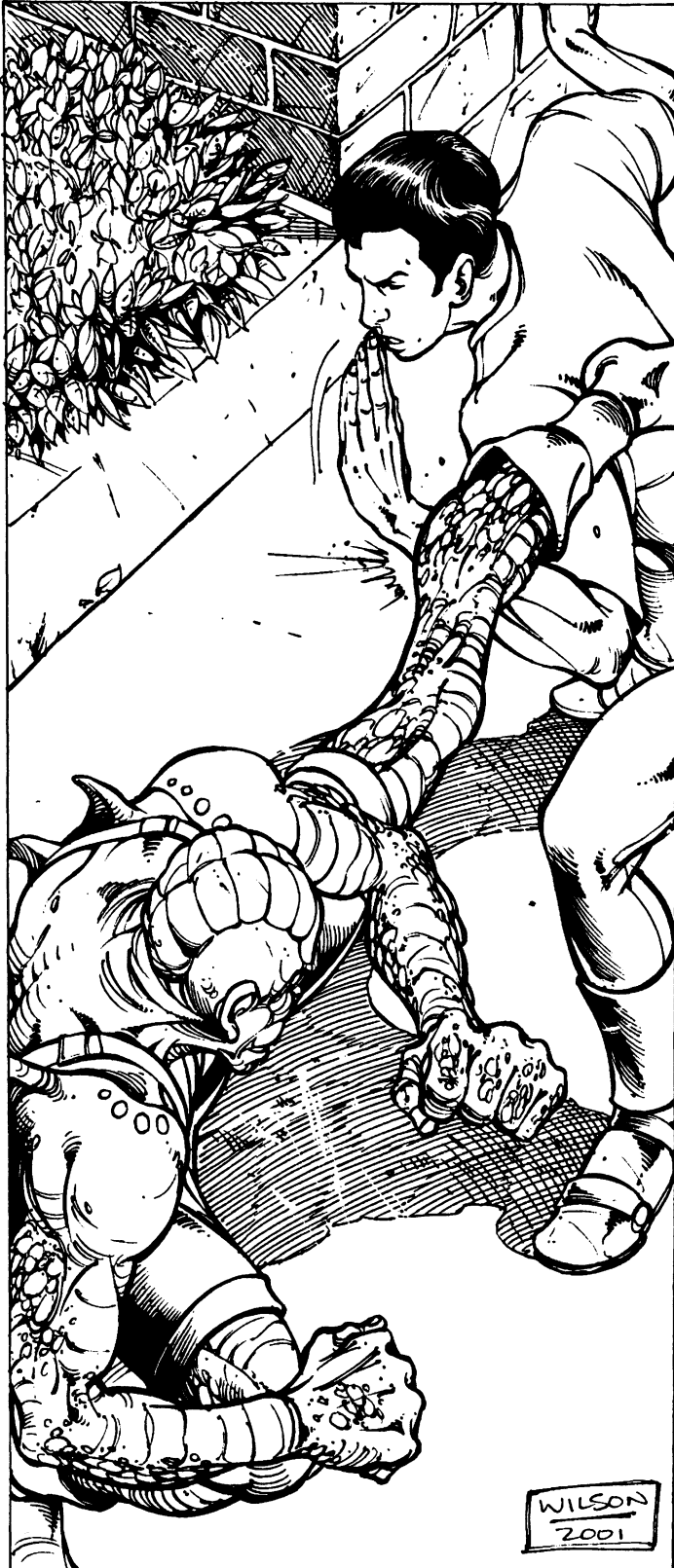

These are the standard level by level tables that present the *accumulative bonuses* offered by every form of hand to hand fighting currently known to be available on Rifts Earth. When characters advance a level, the player can come to this section to see what new bonuses apply to the character.

**Note:** ALL bonuses are accumulative. That means each new level offers new bonuses and combat capabilities that are *added* to those previously acquired. Certain Hand to Hand fighting styles also impart bonuses to one's physical attributes as well as perfection of the fighting form. Also see Boxing and Wrestling in the *Skill* section. Japanese martial arts are not usually known outside of Japan and the Orient; i.e. characters in the Americas, Europe, Africa and elsewhere will not know them.

**Number of attacks per melee:** In the RPG and other books, it states that a character has "TWO attacks per melee to start." However, this does not include the two attacks per round any character with hand to hand training is supposed to start with. Yeah, we know that is confusing, that's why we post in these combat lists that the character starts with FOUR. So please do NOT add another two to this starting number. Sheesh, I hope this helps and does not cause more confusion. **Example:** A character with *Hand to Hand: Basic* starts off with four melee attacks, but has a total of 5 at level four, 6 at level nine, and 7 at level 15. If the Boxing skill is also taken, the character would have one more than those listed here. Also note that some O.C.C.s and R.C.C.s, like the Juicer and Cyber-Knight, provide additional attacks per melee round and combat bonuses.

---

## Characters with No Hand to Hand Combat Skill

**Level 1:** Starts with one hand to hand attack per melee round. This reflects the character's pitiful fighting skills.

HOWEVER, the character can instead perform *TWO non-combat melee actions* at first level. A *non-combat action* involves some activity other than fighting (operating a machine, driving, locking a door, running, hiding, helping others, etc.).

For example, a ninth level character with no Hand to Hand Combat skill has three attacks, OR *six non-combat melee actions*. The character can perform both types of actions in the same melee round, but for each attack, he uses up *TWO non-combat actions*. So he could punch an opponent (1 *attack*), run inside a building (1 *non-combat action*), lock the door behind him (1 *non-combat action*), and then dodge out of harm's way when he sees his opponent getting ready to shoot at him through the door (uses 1 *attack*). That's two *attacks* and two *non-combat actions*, totaling six *non-combat actions*.

**Level 3:** +1 attack per melee round and +1 to dodge. +1 *non-combat melee action*.

**Level 6:** 2 *non-combat melee action*.

**Level 9:** +1 attack per melee round, for a total of three "attacks" per round (each attack counts as two *melee actions* for this character). +1 *non-combat melee action* for a total of six *melee "actions"*. That's it.

---

## Hand to Hand: Basic

This is an elementary form of hand to hand combat training available. Though it hardly stacks up against some of the more advanced forms of fighting, one who has trained in Hand to Hand: Basic still fights with combat knowledge skill compared to the simple, uneducated folk who populate Rifts Earth.

- 1: Starts with four attacks/actions per melee round; +2 to pull punch and +2 to roll with punch, fall or impact.
- 2: +2 to parry and dodge.
- 3: Kick attack does 1D6 points damage.
- 4: +1 additional attack/action per melee round.
- 5: +1 to strike.
- 6: Critical strike on an unmodified roll of 19 or 20.
- 7: +2 to damage.
- 8: Judo-style body throw/flip; does 1D6 damage, and victim loses initiative and one attack per melee.
- 9: +1 additional attack/action per melee round.
- 10: +2 to pull punch and +2 to roll with punch, fall or impact.
- 11: +1 to parry and dodge.
- 12: +1 to strike.
- 13: Critical strike or knockout from behind.
- 14: +2 to damage.
- 15: +1 additional attack/action per melee round.

## Hand to Hand: Expert

This fighting style is often taught to soldiers, bodyguards, thieves, and anybody else who will be expected to live by violence. While it lacks the mastery of the Martial Arts, an Expert fighter knows how to scrap quickly and efficiently. At high levels, especially, those with this skill can often hold their own against dedicated masters of the martial artists.

- 1: Starts with four attacks/actions per melee to start; +2 to pull punch, and +2 to roll with punch, fall or impact.
- 2: +3 to parry and dodge.
- 3: +2 to strike.
- 4: +1 additional attack/action per melee round.
- 5: Kick attack does 1D6 damage.
- 6: Critical strike on an unmodified roll of 18, 19 or 20.
- 7: W.P. Paired Weapons.
- 8: Judo-style body throw/flip; does 1D6 damage, and victim loses initiative and one attack.
- 9: +1 additional attack/action per melee.
- 10: +3 to damage.
- 11: Knockout/stun on an unmodified roll of 18, 19 or 20.
- 12: +2 to parry and dodge.
- 13: Critical strike or knockout from behind (triple damage).
- 14: +1 additional attack/action per melee round.
- 15: Death blow on a roll of natural 20.

## Hand to Hand: Assassin

This style of fighting is a specialized science of killing generally taught by secret organizations such as organized crime cartels, secret government "wet working" bureaus, and so on. **Note:** This hand to hand fighting style has been updated to include W.P. Paired Weapons at Level One, +1 on initiative at Levels Four, Eight and Nine, and the total of three attacks per melee round at Level One.

- 1: Starts with three attacks/actions per melee round; +2 to strike, W.P. Paired Weapons.
- 2: +2 additional attacks/actions per melee round.
- 3: +3 to pull/roll with punch/fall.
- 4: +4 to damage. +1 on initiative.



## Hand to Hand: Martial Arts

Considered to be a generic form of martial arts, taking techniques from many sources. **Note:** This hand to hand fighting style has been updated with initiative at level three, +2 to disarm at level seven, and the total of four attacks per melee to start.

- 1: Starts with four attacks/actions per melee to start; +3 to pull punch and +3 to roll with punch, fall or impact.
- 2: +3 to parry and dodge; +2 to strike.
- 3: +1 on initiative. Karate-style kick does 1D8 (or 2D4) damage.
- 4: +1 additional attack/action per melee round.
- 5: Jump Kick (critical strike) and Entangle (+1).
- 6: Critical strike on an unmodified roll of 18, 19 or 20.
- 7: W.P. Paired Weapons and +2 to disarm.
- 8: Leap Attack (critical strike).
- 9: +1 additional attack/action per melee round.
- 10: Judo style body throw/flip; does 1D6 damage, victim loses initiative and one attack.
- 11: +4 to damage.
- 12: +2 to parry and dodge.
- 13: Knock out/stun on an unmodified roll of 18, 19 or 20.
- 14: +1 additional attack/action per melee round.
- 15: Death blow on a roll of a natural 20.

- 5: +1 additional attack/action per melee round.
- 6: +3 to parry/dodge. Entangle (+2).
- 7: Knock out/stun on an unmodified roll of 17-20.
- 8: +1 additional attack/action per melee round. +1 on initiative.
- 9: +1 on initiative. Kick attack does 1D6 damage.
- 10: Critical strike on an unmodified roll of 19 or 20.
- 11: +2 to strike.
- 12: Death blow on a roll of a natural 20.
- 13: +1 additional attack/action per melee round.
- 14: +2 to damage.
- 15: +2 to strike.

## Cyber-Knight Zen Combat

Most Cyber-Knights have *Hand to Hand: Martial Arts* for their combat skill, but also get additional training, abilities and powers. Cyber-Knight Zen Combat training (exclusive to Cyber-Knights) is one of them. See page 27 of *Coalition Wars 4: Cyber-Knights* for details.



## Hand to Hand: Commando

This style of combat is a quick and dirty form of martial arts available only to the Commando and Special Forces O.C.C.s. **Note:** Remember, the Commando O.C.C. receives a one-time bonus of +2D6 S.D.C. and +1 to M.E. (focus and concentration), while the Special Forces O.C.C. does not (those are O.C.C. bonuses; not part of Hand to Hand: Commando). This hand to hand fighting style has been updated to include an additional +1 on initiative bonus at Level Three.

- 1: Starts with Four attacks/actions per melee round; W.P. Paired Weapons, body flip/throw, body block/tackle and +2 to save vs Horror Factor.
- 2: +1 on initiative, +1 to strike, +2 to parry and dodge, +3 to roll with punch/fall/impact, and +3 to pull punch. Backward sweep kick: Used only against opponents coming up behind the character. Does no damage; it is purely a knock down attack (same penalties as body flip) but cannot be parried (an opponent can try to dodge it but is -2 to do so).
- 3: Disarm (+1), +1 to automatic body flip, +1 on initiative.
- 4: +1 additional attack/action per melee and Karate kick attack. This is a conventional, karate-style kick. It starts with bringing the knee, folded, up to chest level, then the foot is completely extended. Does 2D6 damage.
- 5: Automatic dodge and critical body flip/throw.
- 6: +2 on initiative, +1 to strike, parry and dodge, and +1 to body flip/throw.
- 7: +2 to damage, +1 to save vs Horror Factor, +1 to disarm, +1 to automatic dodge and +2 to pull punch.
- 8: +1 additional attack per melee, jump kick, +1 to body flip/throw, and +1 to roll with punch/fall/impact.
- 9: Death blow on a natural 18-20!
- 10: +2 to save vs Horror Factor, +1 on initiative and +1 to strike.
- 11: +1 to disarm, +1 to pull punch and +1 to body flip/throw.
- 12: +2 to damage, +1 to parry and dodge, +2 to automatic dodge.
- 13: +1 additional attack/action per melee.
- 14: Automatic body flip/throw.
- 15: Critical strike on a natural 17-20.

## Hand to Hand: Aikido

Aikido is a martial arts form known to the modern characters living in the Republic of Japan and elsewhere on the islands of Japan. Its focus is entirely on defense, with absolutely no offensive maneuvers (other than body flip and pinning moves). Aikido was created in the 20th century, by drawing on techniques from *Jujitsu*, *Judo*, *Karate* and *Kendo*.

The Aikido martial artist can fend off the attacks of any and all who approach. Their goal in combat is to subdue opponents as quickly as possible. To do this, they seize the leading part of the attacker's body, usually right at the wrist or ankle. At this point, one can either use the attacker's momentum in a flip/throw, or, by applying a joint lock, one can lead the attacker around into a helpless position on the ground.

**Attribute Bonuses:** +2D6 S.D.C., +1D4 to M.E., +1 to P.P., and +1 to P.E.

- 1: Four attacks/actions per melee round; +3 to break fall, +2 to roll with punch/fall/impact, +2 to body flip/throw, and +2 to pull punch. **Basic Moves and Special Techniques:** Body block/tackle, body flip/throw, break fall, disarm, holds, roll with punch/fall/impact, pull punch, kick attack (2D4 damage), and the usual, strike, parry and dodge.
- 2: +1 on initiative, +2 to parry and dodge.
- 3: Automatic dodge and +1 to disarm.
- 4: +1 attack/action per melee round and +1 to body flip/throw.
- 5: Critical body flip/throw on Natural 18-20 (double damage).
- 6: +1 to parry/dodge and +1 to body flip/throw.
- 7: Automatic flip/throw and +2 to pull punch.
- 8: +1 additional attack/action per melee round.
- 9: +1 on initiative and +1 to strike, parry and dodge.
- 10: Double existing P.P.E. (inner spirit) and +1 to disarm.
- 11: +1 to parry, +2 to dodge, and +1 to body flip/throw.
- 12: +1 additional attack/action per melee round.
- 13: +1 on initiative and +2 to body block/tackle.
- 14: Critical strike on a natural 18, 19, 20.
- 15: +1 additional attack/action per melee round.

## Hand to Hand: Judo

This is a basic, modern style of martial arts common among the high-tech communities like the Republic of Japan, Ichto and Takamatsu. This is typically the *basic hand to hand* combat used by the Armed Forces and police of the Republic.

**Attribute Bonuses:** +2D4 S.D.C., +1 to M.E., and +1 to P.P.

- 1: Starts with four attacks/actions per melee round; +3 to roll with punch/fall/impact, +3 to pull punch. **Basic & Special Moves:** Body block/tackle, body flip/throw, break fall, disarm, roll with punch/fall/impact, strike, parry, dodge, and pull punch are available at first level. All bonuses are cumulative.
- 2: +2 to parry and dodge, +1 to strike.
- 3: +1 to body flip/throw and body tackle; +1 to disarm.
- 4: +1 additional attack/action per melee round and Karate-style kick (2D6 damage).
- 5: Critical body flip/throw on natural 19 or 20 (double damage).
- 6: +1 to strike, parry and dodge; +1 to body flip/throw.
- 7: W.P. Paired Weapons and +2 to damage.
- 8: Jump kick and +1 to roll with punch/fall/impact.
- 9: +1 additional attack/action per melee round.
- 10: +2 on initiative and +1 to parry and dodge.
- 11: +1 to break fall and +1 to disarm.
- 12: Critical strike on a natural 18, 19, 20.
- 13: +2 to damage and knock out/stun on a natural 19 or 20.
- 14: +1 additional attack per melee round.
- 15: Automatic body flip/throw.

## Hand to Hand: Jujitsu

This combat style is very pragmatic, using the philosophy of “what-ever works.” Techniques range from the assault of vital points, joint locks and throwing techniques. A trained master can reduce his or her victims into helplessness even if armed with daggers, sticks and guns. Any advantage that can be gained will be used by a Jujitsu practitioner without a second thought of fairness.

**Limitation:** Characters of an honorable alignment can not select this skill (i.e. can't be Principled or Aberrant).

**Attribute Bonuses:** +3D6 S.D.C., +2 to P.S., +1 to P.P.

**1:** Four attacks/actions per melee round to start; snap kick (1D6 damage), knife hand (2D4 damage), +3 to roll with punch/fall/impact, +2 parry and dodge, and +2 to pull punch. Basic and Special Moves: Maintain balance, break fall, disarm, body block/tackle, body flip/throw, holds, roll with punch/fall/impact, pull punch, kick attack (2D4 damage), knee and elbow strikes (1D6 damage), and the usual strike, parry and dodge.

**2:** +1 to strike, tripping/leg hook and backward sweep kicks.

**3:** +1 on initiative and critical strike from behind.

**4:** +1 additional attack/action per melee round and +2 to damage.

**5:** Palm strike (2D4 damage) and drop kick.

**6:** Critical strike on a natural 18-20.

**7:** +1 to strike, +1 on body flip/throw and +1 to disarm.

**8:** +1 additional attack/action per melee round and +1 to maintain balance.

**9:** Critical body flip/throw on natural 17-20.

**10:** Jump kick and leap attacks.

**11:** +1 additional attack/action per melee round and +2 to pull punch.

**12:** +1 on initiative, +1 to parry and dodge, and +1 to strike.

**13:** +2 to damage, +2 to pull punch, and +2 to break fall.

**14:** +1 additional attack/action per melee round.

**15:** Death blow!

## Hand to Hand: Karate

There are a variety of different styles of karate. What follows is a variation of Japanese *Kyokushinkai Karate*, or “the School of Ultimate Truth.” The focus of this martial art is on aggressive combat and striking power, especially the power to break through solid objects, as well as an emphasis on rapid strikes and speed. Training is very hard and competitive.

**Attribute Bonuses:** +3D6 S.D.C., +1D4 to P.S., +2 P.E., and +2 to Spd.

**1:** Four attacks/actions per melee round to start; snap kick (1D6 damage), knife hand (2D4 damage); +1 on initiative, +2 to roll with punch/fall/impact, +2 to parry, +1 to dodge, +1 to break fall and +2 to pull punch. Basic Moves and Special Techniques: Break fall, body block/tackle, roll with punch/fall/impact, pull punch, kick attack (2D4 damage), karate kick (2D6 damage), karate punch (2D4 damage), knees and elbow strikes (1D6 damage), and the usual strike, parry and dodge.

**2:** +1 to strike, tripping/leg hook and backward sweep kicks.

**3:** +1 additional attack/action per melee round and +2 to damage.

**4:** +1 on initiative, +1 to disarm, and roundhouse kick (3D6 damage).

**5:** Power punch and palm strike (2D4 damage).

**6:** +1 additional attack/action per melee round and +2 to pull punch.

**7:** Power kick, wheel kick, and +1 to strike, parry and break fall.

**8:** Critical strike on a natural 18-20, critical strike from behind and death blow on a natural 20.

**9:** +1 additional attack/action per melee round and +2 to damage.

**10:** Jump kick and leap attacks.

**11:** +1 on initiative, +1 to parry and dodge, and +1 to strike.

**12:** +1 additional attack/action per melee and +2 to pull punch.

**13:** Death Blow!

**14:** +2 to damage, +2 to pull punch, and +2 to break fall.

**15:** +1 additional attack/action per melee round.

## Hand to Hand: Kendo

Kendo is a martial art developed around the art of swordsmanship. Consequently, it deals with balance, striking, parrying and slashing.

**Attribute Bonuses:** +2D4 S.D.C., +1 to P.S., +1 to P.P. and +2 to Spd.

**1:** Four attacks/actions per melee round to start; knife hand (2D4 damage); +1 on initiative, +2 to roll with punch/fall/impact, +1 to disarm, +1 parry (punch attacks), +2 to parry with sword or staff (in addition to W.P. bonuses), +1 to dodge, +1 to break fall and +2 to pull punch. Basic Moves and Special Techniques: Disarm, break fall, roll with punch/fall/impact, pull punch, karate punch (2D4 damage), kick attack (2D4), knees and elbow strikes (1D6 damage), and the usual strike, parry and dodge.

**2:** +1 to strike and paired weapons.

**3:** +1 additional attack/action per melee round and +2 to damage.

**4:** +1 on initiative, +1 to disarm, and +1 to parry.

**5:** Tripping/leg hook and backward sweep kicks.

**6:** Power punch and palm strike (2D4 damage).

**7:** +1 additional attack/action per melee round and +2 to pull punch.

**8:** Critical strike on a natural 18-20, critical strike from behind and death blow on a natural 19-20.

**9:** +1 additional attack/action per melee and +4 to damage.

**10:** Automatic dodge.

**11:** +1 on initiative, +1 to strike, and +2 to break fall.

**12:** + One additional attack per melee and +2 to pull punch.

**13:** Jump kick and leap attacks.

**14:** Death Blow!

**15:** +1 additional attack/action per melee.

## Hand to Hand: Ninjitsu/Tai-Jutsu

The art of Ninjitsu has come to be identified as the art of the Japanese assassin.

**Attribute Bonuses:** +2 to M.A., +1 to P.S., +1 to P.E., +1 to P.P. and +4 to Spd.

**1:** Four attacks/actions per melee round to start; snap kick (1D6 damage), knife hand (2D4 damage); +2 to roll with punch/fall/impact, +2 on initiative, +1 parry, +2 to dodge, and +2 to pull punch. Paired Weapons: Training in the use of two weapons, one in each hand, to strike and parry simultaneously. Basic Moves and Special Techniques: Maintain balance, back flip, body block/tackle, body flip/throw, holds, roll with punch/fall/impact, pull punch, drop kick, kick attack (2D4 damage), knee and elbow strikes (1D6 damage), paired weapons, and the usual strike, parry and dodge. Also see Samurai Hand to Hand combat.

**2:** +1 to strike, cartwheel (attack), back flip (escape), back flip (defensive), and back flip (attack).

**3:** +1 additional attack/action per melee and palm strike (2D4 damage).

**4:** Leap attack, axe kick, and +2 to strike when performing any back flip or cartwheel.

**5:** Tripping/leg hook and backward sweep kicks and +2 to damage.

**6:** +1 additional attack/action per melee and roundhouse kick (3D6).

**7:** Critical Strike on the roll of a natural 18-20, or from an attack from behind; death blow on a natural 20.

**8:** +1 on initiative, +1 to strike and parry, +1 to roll with punch/fall/impact and +2 to maintain balance.

**9:** Death blow!

**10:** +1 additional attack/action per melee round and +2 to pull punch.

**11:** Double existing P.P.E. (inner spirit)!

**12:** +1 on initiative and +2 to roll with punch/fall/impact.

**13:** +2 to damage and +1 to disarm.

**14:** Jump kick, +2 to back flip/cartwheel, and +2 to damage.

**15:** +1 additional attack/action per melee round.



## Hand to Hand: Samurai (Zanji Shinjinken-Ryu)

Zanji Shinjinken-Ryu is an ancient school of samurai swordsmanship *exclusive* to the Samurai O.C.C. Unlike some other forms of martial arts that incapacitate an opponent, Zanji is designed to kill. Not wound, not injure, not knockout, but kill! A sword is an instrument of death, but also an extension of the swordsman. The secret of sword mastery is rooted in the ability of being able to respond instantly, without reflection, without hesitation, to anything that might happen. No amount of technical skill can benefit a samurai whose mind inhibits spontaneous response to the environment around him. In this sense, the sword and the man are of one mind and one spirit; a living extension of each other.

A samurai swordsman will carefully evaluate any opponent. Standing motionless, he will wait until the exact moment when, without thought or direction, he can instantly strike.

**Attribute Bonuses:** +3D6 S.D.C., +2 to M.E., +2 to P.P. and +1 to P.E.

- 1:** Four attacks/actions per melee to start; knife hand (2D4 damage); paired weapons, +2 on initiative, +2 to roll with punch/fall/impact, +2 to parry with sword or staff (in addition to W.P. bonuses), +3 to dodge, +2 to damage, and +2 to pull punch. Basic Moves and Special Techniques: Disarm, maintain balance, roll with punch/fall/impact, pull punch, Karate punch (2D4 damage), kick attack (2D4), knee and elbow strikes (1D6 damage), and the usual strike, parry and dodge.
- 2:** +1 additional attack/action per melee round, +1 to disarm, +1 to maintain balance.
- 3:** +1 on initiative, +1 to strike, +1 to parry, critical strike from behind, and death blow on natural 20.
- 4:** +1 additional attack/action per melee round and +2 to damage
- 5:** Critical strike on a natural 18-20 and +1 to maintain balance.
- 6:** +1 to roll with punch/fall/impact, +1 to dodge, +1 to maintain balance.
- 7:** Power punch/stab (with hand or sword), jump kick and backward sweep kick.
- 8:** + One additional attack per melee and +1 to dodge.
- 9:** Death Blow!
- 10:** +1 on initiative, +1 to save vs Horror Factor, and +1 to maintain balance.
- 11:** +1 additional attack/action per melee round.
- 12:** +2 to damage, +1 to save vs Horror Factor, and the knowledge and skill to create a "true" samurai sword.
- 13:** +1 additional attack/action per melee round.
- 14:** Double existing P.P.E. (inner spirit) and +1 to disarm.
- 15:** +1 additional attack/action per melee round.

## Hand to Hand: Teng-Jutsu

Rarely practiced among humans, this unusual martial art can only be learned from a *Tengu*, a kind of Japanese mountain spirit, or from a human practitioner of the art who is 12th level or higher.

In addition to the many bonuses and special moves Teng-Jutsu offers, *all* of its practitioners automatically know *all* of the Tengu Special Mystic Martial Art Powers (*Tengu acrobatics*, *Tengu leap*, *Tengu automatic leap dodge*, *Tengu timed leap*, *Tengu kick attack*, *Tengu power kick*, and *Tengu power punch*). These powers are learned at first level, and the bonuses they impart have been factored in below. The descriptions of these abilities can be found in *Rifts Japan*, page 69.

- 1:** Four attacks/actions per melee round and all special powers of this style of martial arts. Also +2 to dodge (normal), +2 to pull punch or kick, +1 to disarm, +1 to roll with punch/fall/impact, +3 to maintain balance, and +1 to break fall. Can perform Karate style kick, jump kick, leap kick/attack and all other types of kicks. Moves and Special Techniques: Break fall, roll with punch/fall/impact, maintain balance, back flip escape, back flip attack, cartwheel (attack), body

block/tackle, pull punch, kick attack (2D4 damage), karate kick (2D6 damage), karate punch (2D4 damage), knees and elbow strikes (1D6 damage), and the usual strike, parry and dodge, plus the Tengu special mystic martial art powers.

- 2:** Drop kick, +1 on initiative, and +2 on all back flips.
- 3:** +1 to strike, +1 to disarm, and +1 to leap dodge.
- 4:** +1 additional attack/action per melee round.
- 5:** Critical strike from all kicks (double damage) and jump kick and leap attacks.
- 6:** +1 to roll with punch/fall/impact, +2 to pull punch or kick, and +1 to leap dodge.
- 7:** +1 on initiative, tripping/leg hook and backward sweep kicks.
- 8:** +1 additional attack/action per melee round.
- 9:** +2 to disarm, +1 on all back flips, and +1 on cartwheel attack.
- 10:** Axe kick and +1 on initiative and +1 to parry.
- 11:** +1 additional attack/action per melee round.
- 12:** +1 to leap dodge and +1 to disarm.
- 13:** Snap kick and wheel kick.
- 14:** +1 to pull punch and +1 to leap dodge.
- 15:** +1 additional attack/action per melee round.

## Skills

One of the great features about a **Rifts**® character is the many different ways in which players can customize them. Skills play a big part in that, for they let each member of the party develop his or her own speciality. The problem, though, is that there are about a gazillion of the darn things spread out over the course of the **Rifts**® RPG game line. And it is even worse for Game Masters. Having created thousands of NPCs for various Palladium RPG books, ourselves, as well as our own games, we know that generating NPCs is one of the most time-intensive things to do. It can be loads of fun for the players, but it can become a tiring task for the G.M. who may have to roll up a dozen or more Non-Player Characters (NPCs) for just that night's adventure. We hope the chart-like lists and compilation in the pages that follow will make that creation process faster and simpler.

This section contains two presentations for skills.

**1. Skills List.** A comprehensive "list" of the names of every skill by category, followed by the skill's *base percentage* and the *additional percentage per level of experience*. Making this list a quick and easy visual reference for picking skills and determining their percentage.

Cryptography, for example, has a "base" success ratio of 25%, with an additional 5% per level of experience and appears as: Cryptography – 25%+5%.

**2. Skills Descriptions.** Every skill is described in full. No more flipping through a dozen sourcebooks to find the skill description you're looking for, because they're all right here!

Well, not quite *all* skills. This section does *NOT* include skills that are particular to a specific O.C.C. or R.C.C. Nor are the various specialized skills of the *Ley Line Walker O.C.C.* and others. Skills of that nature are more akin to *special powers* or *secrets of the trade or brotherhood* and generally are not available to other Occupational Character Classes (O.C.C.s). Thus, they are not included.

*Updates and clarifications.* Some skills have been modified, tweaked or rewritten by Kevin Siembieda in order to clarify who a skill works. A few new skill have been added.

**Note:** Skills with an asterisk \* are *NOT* common to most people of Rifts Earth, and certainly not in North America. Such rare or limited skills are typically limited to a particular *geographic location* like Australia, Japan and Africa, or *outer space*. Space skills are *not* normally available to characters on Rifts Earth, but are applicable to characters in a space or alien setting, including **Mutants in Orbit**™ and various Dimension Books like **Phase World**®, **The Anvil Galaxy**™, **The Three Galaxies**™, **Cosmo-Knights**™ and **Skrappers**™ (not to mention adapting games like *Aliens Unlimited*™, *The Mechanoid Trilogy*®, *Mechanoid*® Space and other space settings).

# Skill Compendium



# Skill List

## Communications

Cryptography – 25%+5%  
Electronic Countermeasures – 30%+5%  
Laser – 30%+5%  
Optic Systems – 30%+5%  
Performance – 30%+5%  
Radio: Basic – 45%+5%  
Radio: Scramblers – 35%+5%  
Surveillance Systems – 30%+5%  
T.V./Video – 25%+4%

## Cowboy Skills

Branding – 50%+5%  
Breaking/Taming Wild Horse – 20%+5%  
Herding Cattle – 30%+5%  
Horsemanship: Cowboy – 66%/50%+3%  
Roping – 20%+5%  
Trick Riding (SPECIAL)  
(Also see Exotic Horsemanship & Related Technical Skills)

## Domestic Skills

Bonsai – 50%+4%  
Brewing – 25%/30%+5%  
Cook – 35%+5%  
\*Corroboree (Australia) – 30%+4%  
Dance – 30%+5%  
Fishing – 40%+5%  
Floral Arrangement (Ikebana) – 30%+3%  
Gardening – 35%+5%  
Go – 30%+5%  
Play Musical Instrument – 35%+5%  
Poetry (Haiku) – 35%+5%  
Recycle – 30%+5%  
\*Rock Painting and Engraving (Australia) – 36%+4%  
Sewing – 40%+5%  
Sing – 35%+5%

## Electrical Skills

Basic Electronics – 30%+5%  
Computer Repair – 25%+5%  
Electrical Engineer – 30%+5%  
Electricity Generation – 50%+5%  
Robot Electronics – 30%+5%

## Espionage Skills

Detect Ambush – 30%+5%  
Detect Concealment – 25%+5%  
Disguise – 25%+5%  
Escape Artist – 30%+5%  
Forgery – 20%+5%  
Imitate Voices & Impersonation – 36%/16%+4%  
Intelligence – 32%+4%  
Interrogation Techniques – 30%+5%  
Pick Locks – 30%+5%  
Pick Pockets – 25%+5%  
Sniper (+2 to strike on an aimed shot)  
Tracking (people) – 25%+5%  
Wilderness Survival – 30%+5%

## Horsemanship Skills

Horsemanship: General – 40%/20%+4%

Horsemanship: Cowboy – 66%/50%+3%  
Horsemanship: Knight & Cossack – 40%/30%+5%  
Horsemanship: Cyber-Knight – 70%/50%+3%  
Horsemanship: Exotic Animals – 30%/20%+5%

## Mechanical Skills

Aircraft Mechanics – 25%+5%  
Armorer/Field Armorer – 40%+5%  
Automotive Mechanics – 25%+5%  
Basic Mechanics – 30%+5%  
Bioware Mechanics – 30%+5%  
Locksmith – 25%+5%  
Mechanical Engineer – 25%+5%  
Robot Mechanics – 20%+5%  
\*Space: Drive Repair – 30%+5%  
\*Space: Satellite Systems – 30%+5%  
\*Spaceship Mechanics – 22%+5%  
Submersible Vehicle Mechanics – 25%+5%  
Vehicle Armorer – 30%+5%  
Weapons Engineer – 25%+5%

## Medical Skills

Animal Husbandry – 35%+5%  
Brewing – 25%/30%+5%  
Criminal Science & Forensics – 35%+5%  
Entomological Medicine – 40%/20%+5%  
Field Surgery – 16%+4%  
First Aid – 45%+5%  
Holistic Medicine – 20%+5%  
Juicer Technology – 40%+5%  
Paramedic – 40%+5%  
Medical Doctor – 60%/50%+5%  
M.D. in Cybernetics – 40%/60%+5%  
Pathology – 40%+5%  
Sea Holistic Medicine – 20%+5%

## Military Skills

Armorer/Field Armorer – 40%+5%  
Camouflage – 20%+5%  
Demolitions – 60%+3%  
Demolitions Disposal – 60%+3%  
Demolitions: Underwater – 56%+4%  
Find Contraband, Weapons & Cybernetics – 26%+4%  
Military Etiquette – 35%+5%  
Military Fortification – 30%+5%  
Nuclear, Biological & Chemical (NBC) Warfare – 35%+5%  
Parachuting – 40%+5%  
Recognize Weapon Quality – 25%+5%  
Ship to Ship Combat – 25%+5%  
Space Defense Systems – 30%+5%  
Trap Construction – 20%+4%  
Trap/Mine Detection – 20%+5%

## Physical Skills

Hand to Hand: Basic  
Hand to Hand: Expert  
Hand to Hand: Martial Arts  
Hand to Hand: Assassin  
Hand to Hand: Commando  
\*Hand to Hand: Aikido (Japan)  
\*Hand to Hand: Judo (Japan)  
\*Hand to Hand: Jujitsu (Japan)

\*Hand to Hand: Karate (Japan)  
\*Hand to Hand: Kendo (Japan)  
\*Hand to Hand: Ninjitsu/Tai-Jutsu (Japan)  
\*Hand to Hand: Teng-Jutsu (Japan)  
\*Hand to Hand: ZANJI Shinjinken-Ryu (Japan)  
Acrobatics (varies)  
Aerobic Athletics  
Athletics (General)  
Body Building & Weight Lifting  
Boxing  
Climbing – 40%/30%+5%  
Deadball  
Gymnastics (varies)  
Juicer Football – 32%+4%  
\*Juicer Murderthon  
Prowl – 25%+5%  
Running  
\*Space Combat: Zero Gravity (Basic)  
\*Space Combat: Zero Gravity (Advanced)  
\*Space: Depressurization Training  
\*Space: Movement in Zero Gravity (P.P. multiplied by 5%, +4% per level of experience)  
\*Space: Oxygen Conservation – 30%+5%  
Swimming – 50%+5%  
S.C.U.B.A. – 50%+5%  
Wrestling

## Pilot Skills (Ground, Air & Water)

Advanced Deep Sea Diving – 40%+5%  
Airplane – 50%+4%  
Automobile – 60%+2%  
Bicycling – 44%+4%  
Boat: Motor & Hydrofoil – 55%+5%  
Boat: Sail Type – 60%+5%  
Boat: Ships – 45%+5%/44%+4%  
Boat: Warships & Patrol Boats – 40%+4%  
\*Combat Driving (Special; Australia)  
\*Combat Pod (Special Vehicle) – 40%+4%  
\* Contragravity Pack (Special Vehicle) – 42%+4%  
\*EVA – 40%+5%  
\*Flight System Combat (Juicer: Special Vehicle) – 40%+5%  
Helicopter – 35%+5%  
Hover Craft (Ground) – 50%+5%  
Hovercycle – 70%+3%  
Jet Aircraft – 40%+4%  
Jet Fighters – 40%+4%  
Jet Packs – 42%+4%  
\*Jump Bike Combat (Juicer: Special Vehicle) – 45%+5%  
Kayaking – 50%+5%  
Motorcycle – 60%+4%  
\*Road Train (Australia) – 40%+4%  
Robots & Power Armor – 56%+3%  
Robot Combat: Basic (SPECIAL)  
Robot Combat: Elite (SPECIAL)  
\*Spacecraft, Small – 60%+3%  
\*Spacecraft, General – 50%+4%  
\*Spacecraft, Advanced – 40%+4%  
\*Space Fighter – 50%+3%  
\*Space Yacht – 44%+4%  
\*Starships – 36%+4%

Submersibles – 40%+4%  
 Tracked Vehicles – 40%+4%  
 Truck – 40%+4%  
 Tanks & APCs – 36%+4%  
 Water Scooters – 50%+5%  
 Water Skiing & Surfing – 40%+4%  
 \*Wingrider Flying Wing (Russia)– 15%+5%

## Pilot Related Skills

Navigation – 40%+5%  
 \*Navigation: Interplanetary – 45%+5%  
 \*Navigation: Orbital – 50%+5%  
 \*Navigation: Space – 40%+5%  
 Read (& Operate) Sensory Equipment – 30%+5%  
 Weapon Systems – 40%+5%

## Rogue Skills

Cardsharp – 24%+4%  
 Computer Hacking – 15%+5%  
 Concealment – 20%+4%  
 Find Contraband, Weapons & Cybernetics – 26%+4%  
 Gambling (Standard) – 30%+5%  
 Gambling (Dirty Tricks) – 20%+4%  
 Palming – 20%+5%  
 Pick Locks – 30%+5%  
 Pick Pockets – 25%+5%  
 Prowl – 25%+5%  
 Safe-Cracking – 20%+4%  
 Seduction – 20%+3%, plus attribute bonuses.  
 Streetwise – 20%+4%  
 Streetwise: Drugs – 25%+5%  
 Ventriloquism – 16%+4%

## Science Skills

Anthropology – 20%+5%  
 Archaeology – 20%+5%  
 \*Artificial Intelligence – 30%+3%  
 Astrology – 8%+M.E. number and +3%  
 Astronomy – 25%+5%  
 \*Astrophysics – 30%+5%  
 Biology – 30%+5%  
 Botany – 25%+5%  
 Chemistry – 30%+5%  
 Chemistry: Analytical – 25%+5%  
 Marine Biology – 35%/25%+5%  
 Mathematics: Basic – 45%+5%  
 Mathematics: Advanced – 45%+5%  
 \*Oceanographic Surveying – 15%+5%  
 \*Oxygen Systems – 58%+4%  
 \*Undersea Farming – 35%+5%  
 \*Xenology – 30%+5%

## Technical Skills

Advanced Fishing – 30%+5%  
 Art – 35%+5%  
 Breed Dogs – 40%/20%+5%  
 Calligraphy – 35%+5%  
 Computer Operation – 40%+5%  
 Computer Programming – 30%+5%  
 \*Cyberjacking (Criminals only) – 50+3%  
 Falconry – 30%+5%  
 Gemology – 25%+5%  
 General Repair & Maintenance – 35%+5%  
 History – 30%+5%  
 Jury-Rig – 25%+5%  
 Language – 50%+5%  
 Law (General) – 25%+5%  
 \*Law (Space; CCW/Phase World) – 30%+5%  
 Literacy – 30%+5%  
 \*Lore: Aborigines (Australia) – 25%+5%  
 Lore: Cattle & Animals – 30%+5%  
 \*Lore: The Cities (Australia) – 20%+5%  
 Lore: D-Bee – 25%+5%  
 Lore: Demons & Monsters – 25%+5%  
 \*Lore: Dreamtime Culture (Australia) – 20%+5%  
 Lore: Faerie – 25%+5%  
 \*Lore: Galactic/Alien – 25%+5%  
 Lore: Juicer – 30%+5%  
 Lore: Indians – 25%+5%  
 Lore: Magic – 25%+5%  
 Lore: Psychic & Psionics – 25%+5%  
 Lore: Religion – 30%+5%  
 Masonry – 30%+5%  
 Mining – 35%+5%  
 Mythology – 30%+5%  
 Photography – 35%+5%  
 Prospecting – 20%+5%  
 Research – 40%+5%  
 Rope Works – 30%+5%  
 Salvage – 35%+5%  
 \*Space Contacts – 6%+2%  
 Undersea Salvage – 30%+5%  
 Whittling & Sculpting – 30%+5%  
 Writing – 25%+5%

## Weapon Proficiencies (Ancient)

W.P. Archery & Targeting  
 W.P. Battle Axe  
 W.P. Blunt  
 W.P. Bola  
 W.P. Boomerang  
 W.P. Bow  
 W.P. Chain  
 W.P. Crossbow  
 W.P. Deadball  
 W.P. Forked  
 W.P. Grappling Hook  
 W.P. Knife  
 W.P. Mouth Weapons  
 W.P. Net  
 W.P. Paired Weapons  
 W.P. Pole Arm  
 W.P. Shield  
 W.P. Siege Weapons  
 W.P. Slingshot  
 W.P. Small Thrown Weapons  
 W.P. Spear  
 W.P. Staff  
 W.P. Sword  
 W.P. Trident  
 W.P. Whip

## Weapon Proficiencies (Modern)

W.P. Revolver  
 W.P. Automatic Pistol  
 W.P. Bolt-Action Rifle  
 W.P. Automatic and Semiautomatic Rifles  
 W.P. Submachine-gun  
 W.P. Flamethrower  
 W.P. Grenade Launcher  
 W.P. Harpoon & Spear Gun  
 W.P. Heavy Weapons  
 W.P. Torpedo  
 W.P. Energy Pistol  
 W.P. Energy Rifle  
 W.P. Heavy Energy Weapons  
 W.P. Sharpshooting

## Wilderness Skills

\*Blend – 14%+4%  
 Boat Building – 25%+5%  
 Carpentry – 25%+5%  
 Dowsing – 20%+5%  
 Hunting (SPECIAL)  
 Identify Plants & Fruits – 25%+5%  
 Land Navigation – 36%+4%  
 \*Outback Survival (Australia) – 58%+2%  
 Preserve Food – 25%+5%  
 \*Roadwise (Australia) – 26%+4%  
 Skin & Prepare Animal Hides – 30%+5%  
 Spelunking – 35%+5%  
 Track Animals – 20%+5%  
 \*Track & Hunt Sea Animals – 35%/25%+5%  
 Undersea & Sea Survival – 25%+5%  
 Underwater Navigation – 30%+4%  
 \*Use Songlines – 20%+2%  
 Wilderness Survival – 30%+5%

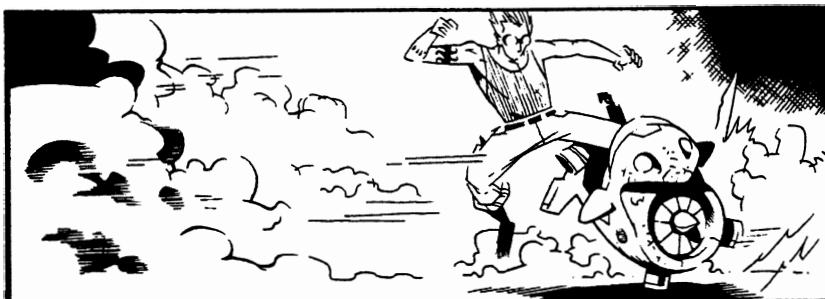

# Skill Descriptions



## Communications Skills

**Cryptography:** Skill in recognizing, designing, and cracking secret codes and messages. The character must study the code for two hours to attempt to break it successfully. A failed roll means the individual must study the code for an additional two hours before he can try to break it again. The character may attempt to break the code sooner, after only 10 minutes of study, but suffers a penalty of -30%. **Base Skill:** 25% +5% per level of experience. **Requires:** Literacy.

**Electronic Countermeasures (Jamming):** Useful for preventing the enemy's communications from working. Since all armor, power armor and robot vehicles are linked by radio transmissions, jamming can cause unit confusion and disrupt communications. Military organization breaks down, causing a loss of effectiveness for all but the best to units.

Just about any high-powered radio can be used for jamming. Armed with a radio, a small guerrilla unit can completely disrupt the maneuvers of large enemy groups. This skill also enables the radio operator to "follow" the enemy's attempted transmissions over jammed frequencies to trace their general location, a specific building, or direction. This tactic is extremely useful in finding and eliminating lone power-armor troopers. **Base Skill:** 30% +5% per level of experience. **Note:** If the G.M. likes, he can make this part of the *Radio: Scramblers* skill, but still with a base of 30%.

**Laser:** This skill provides the character with an in-depth knowledge of sophisticated laser communication systems and fiber optic communications. **Base Skill:** 30% +5% per level of experience. **Requires:** The Radio: Basic, Electrical Engineer, and Computer Operation skills.

**Optic Systems:** Provides expert training in the use of special optical enhancement equipment such as telescopic lenses, laser targeting, thermo-imagers, passive light intensifiers, infrared and ultraviolet systems, polarization, light filters, optical scanners, video cameras and related devices. **Base Skill:** 30% +5% per level of experience. Adds a special one-time bonus of +5% to T.V./Video skill if both are selected.

**Performance:** This ability is used by the likes of entertainers, gladiators, pro-wrestlers and politicians to impress and sway the public. A character with this skill knows how to do things with *flair*; if a skill roll is successful, it works like an attempt to charm or intimidate the audience. **Base Skill:** 30% +5% per level. **Note:** Obvious lies, inconsistencies and evidence to the contrary may ruin the effectiveness of the best performance. G.M.s, use your discretion.

**Radio: Basic:** This is the rudimentary knowledge of the operation and maintenance of field radios and walkie-talkies, wire laying, installation, radio procedure, communication security and visual signs/communications, as well as Morse code. It does not include the ability to make repairs. **Base Skill:** 45% +5% per level of experience.

**Radio: Scramblers:** This is training in the use of electronic masking, scrambling and unscrambling equipment, and codes to help foil the detection, interception and interpretation of radio transmissions by the enemy. **Base Skill:** 35% +5% per level of experience.

**Surveillance Systems:** This is the study and understanding of the operation, methods, and techniques in the use of surveillance systems. Includes motion detectors, simple and complex alarm systems, audio/visual recording and display equipment, recording methods, amplified sound systems, miniature listening devices (bugs, line tapping), and some optical enhancement systems (specifically as they relate to camera lenses).

*Tailing*, or following someone without their knowledge, is another form of surveillance. This also includes stake-out procedures. A failed surveillance roll indicates that the subject has spotted "the tail" and is aware that he is being followed/observed.

A failed roll in the use of surveillance equipment means that the equipment does not function as desired, impairing or preventing surveillance; i.e., bug does not transmit, recording garbled, film blurred or fails to record, etc.

A failed roll when hiding listening devices means the bug does not function and is easily discovered through the course of casual activity. **Base Skill:** 30% +5% per level of experience. **Requires:** Electronics: Basic or Electrical Engineering and Computer Operation and Literacy (the latter two are needed only for complex, high-tech systems).

**TV/Video:** In-depth training in the use of video and audio recording equipment, filming, editing, dubbing, title making, duplication, and transmission. Includes the use of field equipment; i.e., portable video camera and studio equipment. **Base Skill:** 25% +4% per level of experience.

## Cowboy Skills

**Branding:** The techniques and methods for tethering, controlling and marking, or "branding," animals. A brand is a mark burned on the skin to identify and show ownership of an animal; typically used on horses and cattle, sometimes on human and D-Bee slaves. This skill also includes a basic knowledge of common and notable insignias and emblems. **Base Skill:** 50% +5% per level of experience.

**Breaking/Taming a Wild Horse:** To "break" a horse, first the trainer must get the horse used to being around people, then used to having a saddle on its back (this takes 3D4 days), and then you "bit" train it (gets used to having a bit in its mouth and reins). Finally, the trainer must get the horse used to having a rider on its back. Depending on the horse, this can take a couple weeks (making an attempt every day) to several weeks with moderate success. It takes a lot of skill to stay on a wild horse when the animal wants you off. Some horses are never completely tame, and some will allow certain people to ride it, while bucking and throwing other riders. During this initial training period the rider must hang on for dear life while the horse does everything in its power to throw him. This battle of wills can last hours and take up to 12 weeks. **Base Skill:** 20% +5% per level of experience; -10% when breaking exotic and alien animals. Also includes riding wild bulls (cannot be broken), wild broncos, and other wild animals, as well as steer wrestling, but all at -15%.

**Herdng Cattle:** The techniques and methods of leading, directing and controlling cattle in a contained and orderly herd. Also includes keeping animals calm, basic care and feeding, how to tend cattle, recognize disease and illness, give birth to young, how to survive and regain control of a stampede, gather strays, how best to pen and corral livestock, mend fences, etc. **Base Skill:** 30% +5% per level of experience.

**Horsemanship: Cowboy:** See description under Horsemanship Skills.

**Horsemanship: Exotic:** See description under Horsemanship Skills.

**Lore: Cattle/Animals:** See description under Technical Skills

**Lore: Indians/Aborigines:** See description under Technical Skills.



**Roping:** The rope is the cowboy's most important and famous tool. Characters with the roping skill can expertly throw a rope to snare/lasso a cow's horns, a horse's neck, or the hoofs of either, to enable a 140 pound (63 kg) man to capture and subdue a half ton animal! Hitched around the saddle horn, a lariat can be used to pull a mired animal out of a bog, mud or river, as well as keep a hobbled horse or other animal from straying away in the night or rain, and the rope can even be used to create an instant, makeshift corral, when stretched taut by several men, to contain and hold a herd of animals, and even for quick justice at the end of a hangman's noose.

The roping skill includes knowledge and training in how to use a lariat, lasso, tie knots, expertly handle roped animals after they are snared, bring them to a stop by taking quick turns of the lariat around the saddle horn (known as "dally" or "da la vuelta"), tethering animals, and how to "hog-tie" animals (after the animal has been lassoed, the horse backs up to make the rope taut while the cowboy "tips" over the animal and ties three legs with a half shank; used in separating stubborn animals from the herd, capturing wild animals, and branding). The rope/lariat can be used for the roping and tying of animals, including cattle, horses, similar alien animals, and even small dinosaurs and people. This skill with a lariat can be executed standing on the ground, but is designed and intended to be done from horseback (or hovercycle).

A failed roll to tie a knot means that it is loose, sloppy and easy to untie, slip out of, or likely to unravel or snap when strained. A failed roll to lasso an animal or stationary target, means it misses its mark or slips off.

Against human and intelligent opponents, roll to lasso as if it were a combat attack to strike and ensnare. The intended victim can try to dodge; parry is not applicable. A successful strike means the character is caught in the lasso. *Ensnaring* a foot, leg or hand means the victim can be tripped, knocked down and pulled/dragged by hand or horse. Ensnaring the upper body means one arm is pinned (useless). Two or

more lassoes around the upper body means both arms are pinned and attacks requiring the use of one's hands are impossible, and the lassoed individual can be pulled off his feet and dragged. Multiple lassoes can also be used to snare each limb and "spread-eagle" the character. It takes 1D4 melee actions to cut through a lasso, but it is impossible to draw a weapon and cut oneself loose if both arms are pinned or while being dragged. In this combat usage, the roping character is +1 to strike and entangle for every 20 points of skill, so a skill of 65% means +3 to strike/ensnare/entangle. **Base Skill:** 20% +5% per level of experience.

**Trick Riding:** Riding bareback, standing on the animal's back, hanging from the side, or under its belly (usually for rodeo tricks or to hide from enemies), side saddle, as well as quick mounts and dismounts, mounting a horse by leaping down from above or with a running start, leaping from the back of a horse onto another horse or wagon, and similar. **Skill Requirement:** Must know one of the Horsemanship skills, or Trick Riding can not be selected. **Base Skill (Special):** The Trick Riding character can attempt all tricks and stunts without penalty; roll on the first/greater of the Horsemanship skill percentages for success. **Note:** Characters without this skill can try any of these tricks, but must roll on the second percentage number of their Horsemanship skill after reducing it by half. Roll for each attempt. Likewise, these stunts can be tried while riding mounts other than a horse, but reduce the skill by half, unless the character also has the skill Horsemanship: Exotic Animals.

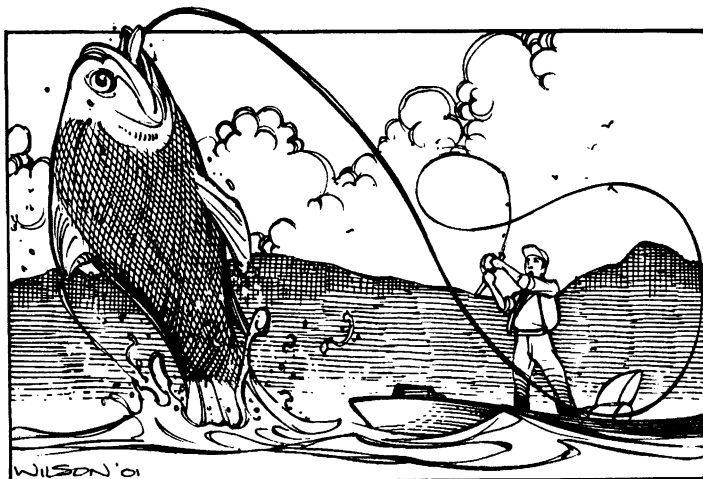

## Domestic Skills

**Note:** Characters can attain professional quality by selecting the same domestic skill twice. Add a one time bonus of +10% and note that the end result is of superior quality.

**Bonsai:** Tending, trimming and growing tiny miniature trees known as the "Bonsai." Experts can tell the difference between new (under 50 years old) and truly ancient bonsai (hundreds of years old). The character can also estimate the value and quality of the miniature tree. Bonsai is a common pastime of the noble castes in the New Empire of Japan and is unlikely to be practiced by anybody outside of the Japanese Islands. **Base Skill:** 50% +4% per level of experience.

**Brewing:** The understanding and methods of making fermented alcoholic beverages from grains and fruits. This specifically includes wine, mead, ale, beer and moonshine. Stronger alcohol, such as brandy, rum, and whiskey, is not included, nor are champagnes or fine wines. The first percentile number indicates the chance of success (a failed roll means an undrinkable batch of booze). The second indicates the quality of the brew; the lower the number rolled the tastier the drink. **Base Skill:** 25%/30% +5% per level of experience.

**Cook:** Skill in selecting, planning, and preparing meals. A cooking roll failure means that the cooked food is not properly prepared. It is edible but tastes bad (greasy, too spicy, sour, burnt, leaves a bad after-taste in mouth, etc.). **Base Skill:** 35% +5% per level of experience.

**Corroboree (Australian Dance):** This is perhaps the most important skill to any Australian Aboriginal character who believes in his people and his culture. The Corroboree is more than just a dance, it is a way to interact with the spirits and contact the Dreamtime. It requires at least 10 minutes or more of stomping, dancing and singing on a clear patch of earth. Without the Corroboree, Aboriginal society would crumble.

A successful Corroboree dance away from a ley line will earn respect from elders and other tribe members and bring peace of mind to the dancer/singer. In the latter capacity, the Corroboree functions as the equivalent of Meditation and can be used for increased healing and recuperation of P.P.E. and/or I.S.P. Aborigines may perform the dance for themselves as a way to calm their nerves as well as to commune with the world. It is unlikely to be practiced by anybody outside of Australia. **Note:** When performed on a Songline (the Aboriginal name for *ley lines*), the Corroboree provides all sorts of mystical knowledge about the land and the line; see Use Songlines in the *Wilderness Skill Category* for details. Available ONLY to Aboriginal characters in Australia. Nowhere else. **Base Skill:** 30% +4% per level of experience.

**Dance:** A practiced skill in the art of dancing. The character is especially smooth and graceful, a joy to dance with. Can learn new dance steps/moves much more quickly than somebody who can not dance. **Base Skill:** 30% +5% per level of experience.

**Fishing:** The fundamental methods and enjoyment of the relaxing sport of fishing. Areas of knowledge include the use of lures, bait, poles, hooks, lines, and the cleaning and preparation of fish for eating. Also includes a basic knowledge of freshwater fish, their habits and taste. **Base Skill:** 40% +5% per level of experience.

**Floral Arrangement (Ikebana):** The artful and creative arrangement of flowers appreciated by everyone throughout the orient. A painstakingly difficult art that takes years to really master. The creation of a good floral arrangement is a matter of honor to those who practice Ikebana; a bad job will be scorned even if done by the most heroic of warriors. This “art” is appreciated in modern and traditional Japan. It is unlikely to be practiced by anybody outside of the Japanese Islands. **Base Skill:** 30% +3% per level of experience.

**Gardening:** This skill offers a basic understanding of plant care and garden design. It can be both the ability to grow enough food to eat well, and/or the skill at creating beautiful, decorative gardens (with flowers, and other plants and rocks). This can be practiced by anyone.

The “art” of *Zen Gardening* creates a feeling of tranquility and harmony with nature that is greatly appreciated in modern and traditional Japan and by Druids of all kinds. **Base Skill:** 35% +5% per level of experience. (Zen Gardening is 34% +4% per level of experience).

**Go:** As chess is the most widely accepted intellectual game of the west, so Go is accepted as the most “enlightening” game of the eastern world. In many cases one’s skill at Go is seen as much more important than ability in the fighting arts. A victory at the intelligent game of Go easily outweighs any ten wins in single combat. It is unlikely to be practiced by anybody outside of the Japanese Islands. North American characters can substitute *Chess*. **Base Skill:** 30% +5% per level of experience.

**Play Musical Instrument:** The individual has learned to play a particular musical instrument with a fair amount of skill. The sound is generally pleasant (except when a bad roll is made). Note that each specific instrument requires the selection of this skill. For example: A character who can play the guitar, violin, and harmonica must select the play musical instrument skill three different times, once for each instrument. **Base Skill:** 35% +5% per level of experience. There is a -10% modifier (at the G.M.’s discretion) when the character tries to learn a musical instrument indigenous to a particular region and the character himself is not from that region (e.g., somebody from North America trying to learn a uniquely Australian instrument, like the didgeridoo). Likewise, particularly difficult instruments might also get a -10% modifier to play them.

**Poetry (Haiku):** Creating good, and sometimes inspirational, poetry. “Haiku” are short, three line, seventeen syllable poems that are the national poetry of Japan but whose style and rhythm is known around the world. Poetry often accompanies important events in Japanese society. For example, a samurai compelled to commit ritual suicide is expected to compose a “death poem.” In North America, *City Rats* have taken to writing Haiku and other forms of poetry. **Base Skill:** 35% +5% per level of experience.

**Recycle:** Recycling covers everything. In space that includes oxygen, but more typically includes paper, lumber, scrap metal and plastic. In a post-Apocalyptic world, recycling and rebuilding old and used items and material is commonplace. This is not like the Jury-Rig skill; a character with Recycle cannot make something out of odd components but, given some time and equipment, he can reduce the components to their *basic elements* for reuse to build something new. Has a rudimentary understanding of metallurgy. **Base Skill:** 30% +5% per level of experience.

**Rock Painting and Engraving (Australia):** Aboriginal art is very unique and special to them. They decorate bark, skins and rocks with pigments. Each painting tells a story and describes a myth in a way that only a character with this skill can interpret or read. Elders and Mabarn are the most common painters, and they take great pleasure in describing their works to those who wish to listen. Outbackers nickname this “X-ray painting” because the depictions of people and animals are stylized to show what looks like their bones. This skill is unlikely to be practiced by anybody outside of Australia. Some American Indians also engage in rock painting, but not to the same degree. **Base Skill:** 36% +4% per level of experience.

**Sewing:** The practiced skill with the needle and thread to mend clothing, do minor alterations, and layout, cut and sew simple patterns. This is not a tailoring ability, but can become tailoring if the player selects this skill twice. **Base Skill:** 40% +5% per level of experience.

**Sing:** The simple ability to read music and carry a pleasant tune. **Base Skill:** 35% +5% per level of experience.

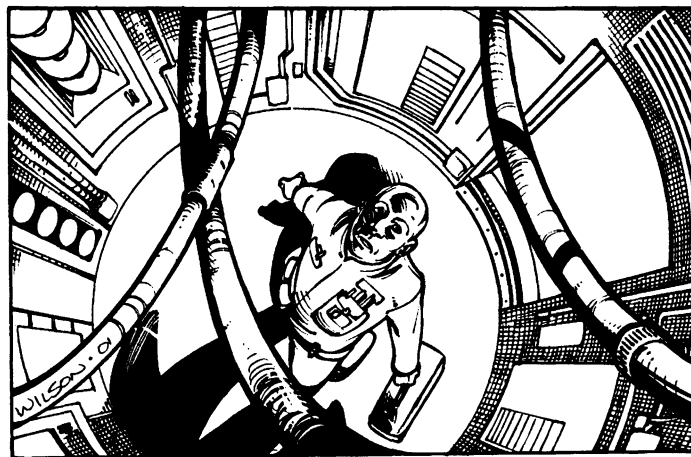

## Electrical Skills

**Basic Electronics:** This is a rudimentary understanding of the principles of electricity, simple circuits, wiring, and so on. This person can do basic wiring, repair appliances, and read schematics as well as assist electrical engineers. **Base Skill:** 30% +5% per level of experience.

**Computer Repair:** Knowledge of the internal electronics of computers and related devices (terminals, printers, modems, circuit boards, etc.). The character can attempt to repair or sabotage computers. Note that figuring out the repair or sabotage procedure counts as one roll, and the actual repair is a second roll. A failed roll means the repair is faulty and does not work (try again). No computer operation or programming skills are included nor required to fix computers. Many computer repair personnel don’t even know how to turn the computer on! **Base Skill:** 25% +5% per level of experience.

**Electrical Engineer:** Knowledge of electricity. Characters can diagnose and locate electrical problems, repair complex electrical devices, wire entire buildings or vehicles, and build electrical equipment. The character can also attempt to bypass security systems, alarms, and surveillance systems, but at a penalty of -20% for simple systems and -50% for complex systems (reduce these penalties by half if the character also has the surveillance systems skill). **Base Skill:** 30% +5% per level of experience. **Requires:** Advanced Mathematics skill and Literacy. **Note:** There is a -30% penalty when working on alien or extremely unfamiliar electronics. This includes Techno-Wizard devices. The electrician may be able to puzzle out some of the basic aspects of a device created by Techno-Wizardry, and may be able to figure out how to operate the machine, but will not be able to fully fathom how it works or how to repair it.

**Electricity Generation:** Electricity is generated in from a variety of ways: from sunlight, wind and hydro systems (using solar panels, wind mills and water turbines) to batteries, combustion engines and generators. This skill gives the character the understanding of how and why these generation systems work and he is able to use, link and repair such motors, turbines and generator systems, but not to build them from scratch. He can even install small nuclear energy systems like those used in power armor and vehicles, as well as hook up a means to "recharge" E-Clips and E-Packs from generators. **Base Skill:** 50% +5% per level of experience. **Requires:** Basic Math and at least Basic Electronics and *Basic Mechanic*. -40% skill penalty when working on alien or magical systems, including Techno-Wizard devices.

**Robot Electronics:** This is the complex and specialized study of robotics and robot/military engineering, micro-circuitry, and artificial intelligence. It includes knowledge of the Coalition robot assault units, exoskeletons, and robot systems. **Base Skill:** 30% +5% per level of experience. **Requires:** Electrical Engineering and Computer Programming. There is a -40% penalty when working on alien or extremely unfamiliar robot electronics.



## Espionage Skills

**Detect Ambush:** Training which develops an eye for spotting locations and terrains suitable for ambushes and being ambushed. It also provides a rudimentary knowledge of guerilla tactics used by the enemy. **Base Skill:** 30% +5% per level of experience.

**Detect Concealment:** This is a skill which enables the individual to spot and recognize camouflage, concealed structures/buildings and vehicles, as well as the ability to construct unobtrusive shelters, use camouflage and blend into the environment. **Base Skill:** 25% +5% per level of experience.

**Disguise:** The character knows how to apply make-up, wigs, skin putty, dyes, and other special effects in order to alter his appearance or that of somebody else. **Base Skill:** 25% +5% per level of experience. Also see Imitate Voices & Impersonation.

**Escape Artist:** The methods, principles, and tricks of escape artists. Includes muscle control (tensing and relaxing muscles), flexing and popping joints, knowledge of knots, and the ability to conceal tiny objects on the person. The character can try slipping out of handcuffs, ropes, straightjacket, etc. **Note:** Picking locks is a separate and distinct skill. **Base Skill:** 30% +5% per level of experience.

**Forgery:** The techniques of making false copies of official documents, signatures, passports, I.D.s, and other printed material. The forger must have an original or photocopy to work from in order to make an accurate copy. Skilled forgers can recognize other counterfeits but with a skill penalty of -10%. **Base Skill:** 20%+5% per level of experience; +5% if the Art skill is also known to the forger and +2% if he is also literate.

**Imitate Voices & Impersonation:** The ability to imitate the voice, accent and expressions of another person or geographic region. This skill is common among ninja, spies, and smugglers (in Japan, priests as well as tengu and oni). The first number indicates the character's ability to change his voice and imitate accents, inflections and expressions from other regions. A successful roll means he has disguised his normal/true speaking voice and accent, and convincingly sounds like he is from another region or part of the world.

The second number indicates the character's ability to accurately imitate the voice, inflections and attitude of a specific person! This is much more difficult, and the character will either need to know the person being imitated very well or have spent hours studying him/her. **Base Skill:** 36%/16% +4% per level of experience.

**Impersonation Note:** When combined with the Disguise and Intelligence skills, the character is able to completely *impersonate* another person or type of occupation (soldier, ninja, priest, etc.). This is likely to include a knowledge of the enemy/subject of impersonation, military procedure, dress, command, rank, and will usually require speaking the language fluently. This means the character can convincingly impersonate a general type of person, soldier, advisor, etc., with accurate disguise, proper action, and language. **Base Skill:** 16% +4% per level of experience; +12% to impersonate general personnel and occupations.

**Intelligence:** This is the specific training in the practices and principles of recognizing and analyzing sources of information about the enemy, observation techniques, counterintelligence measures and proper procedure. This includes the practical assessment of sights and sounds, estimation of ranges, what to report, handling prisoners of war, and handling captured documents and equipment (tagging and reporting to group leader or proper authority). This means the character will be able to accurately estimate ranges, the number of enemies, direction, purpose, and assess the importance of specific information.

Further intelligence training includes a working knowledge of indigenous guerilla warfare, enemy practices, appearance, and current activities. This enables the intelligence officer to recognize suspicious activity as guerilla actions and identify guerilla operatives. For Example: A particular booby trap, or weapon, or mode of operation, may be indicative of guerilla activity in the area. It may be up to the character to confirm the existence of the enemy and their strength, number, and location.

Another area of training made available to intelligence is the identification of enemy troops, officers, and foreign advisors. This means the person learns the many distinguishing ranks and marks that identify specific military units, special forces, groups, and leaders of the enemy. Such identification can pinpoint and confirm enemy operations, goals, and movement, as well as confirm outside intervention/aid.

**Note:** A failed roll in any of the areas of intelligence means that evidence is inconclusive, or that the character has incorrectly assessed the information/situation and is uncertain. A failed roll involving individual clues may mean the person has dismissed it entirely as being meaningless (G.M.s, use your discretion). **Base Skill:** 32% +4% per level of experience.



**Interrogation Techniques:** This skill is common among policemen, intelligence officers, and assassins/spies/bounty hunters. The character knows the techniques to get information from (typically unwilling) subjects. This includes such old methods as “good cop, bad cop” (one interrogator is threatening and intimidating, the other is sympathetic and friendly), deceiving and misleading the subject into giving away information, and similar. The character can also judge if the subject is lying (the Game Master might assess bonuses and penalties depending on how good a liar the subject is, and/or on the victim’s M.E., M.A. and/or P.B.; the higher any or each of these attributes, the more convincing the lies). This skill also includes some basic knowledge on methods of torture, from basic tactics like depriving the subject of sleep, to the use of “medieval” instruments, drugs and psionics. **Note:** Only evil characters will engage in actual torture. **Base Skill:** 30% +5% per level of experience.

**Pick Locks:** The character knows the methods and tools for picking/opening key and basic tumbler type locks. This does not include sophisticated computer or electronic locks.

It takes 1D6 melee rounds for each attempt to pick a lock. A failed roll means the lock holds; try again. **Base Skill:** 30% +5% per level of experience.

**Pick Pockets:** An ability to remove items from a person without their being aware of it. If a pick pocket attempt fails, the item has *not* been removed and there is a 67% likelihood of the intended victim recognizing the intent of the action. **Base Skill:** 25% +5% per level of experience.

**Sniper:** This skill represents special training in long-range rifle firing and marksmanship. Only rifles that can be made to fire a single round or blast can be used for sniping (no automatic/multi-firing rifles).

**Bonuses:** +2 to strike on an aimed shot.

**Tracking:** Visual tracking is the identification of tracks, and following the path of men or animals by the signs they leave on the ground and vegetation. Tracking is a precise art, requiring much practice. The skill includes the evaluation of tracks, indicating whether the person being tracked is loaded down with equipment, running, moving slowly (by measuring the space between steps), and so on. By this means, the tracker can estimate the person’s rate of movement, apparent direction, the number of persons in the party, and whether the person knows he is being followed. Other methods of tracking require recognizing other telltale signs, such as blood and other stains, broken and displaced vegetation, overturned rocks, litter (such as cigarette butts, ration cans, candy wrappers, soiled bandages and campfire remains), and even odors carried by the wind.

Tracking also includes the recognizing of dangerous animals by their tracks, habits, and feces. Likewise, tire tracks made by vehicles can reveal much, such as size and type of the vehicle, the weight of its load, etc.

Counter-Tracking techniques are also known, such as covering one’s trail, misdirection, parallel trails, avoiding obvious pitfalls like littering and others.

A failed roll means that the signs are inconclusive, vague or misleading. Additional signs must be found to verify or clarify (roll again). Three consecutive failed rolls means the tracker has completely lost the trail. Roll once every 40 yards/meters when following a trail. Persons attempting to follow a skilled tracker are -25% when following his trail if he is deliberately trying to conceal that trail (however, his rate of travel is reduced by half). **Base Skill:** 25% +5% per level of experience.

**Wilderness Survival:** Techniques for finding and getting water, food, shelter, and help when stranded in wild forests, deserts, or mountains. Characters without this skill will not be able to stay healthy for more than a few days in the wilderness once their supplies run out. **Base Skill:** 30% +5% per level of experience.



## Horsemanship Skills

In the devastated and mutated land of Rifts Earth, the horse (and other riding animals) has become a popular means of transportation. The skill includes the basic principles of riding, the care and feeding of the animal, recognizing breed and quality, charging, and jumps. The percentile number is used whenever the character tries to determine breed, quality, and when performing special jumps or maneuvers.

Originally, Horsemanship skills were part of the Piloting Skills section. As more and more Horsemanship skills were introduced, it became necessary to break them all off into their own skill section. For older O.C.C.s whose skill selections do not reference a Horsemanship section, simply know that the Horsemanship: General and Exotic Animal skills are available choices in place of a Piloting skill.

There are several levels and styles of horsemanship skills. Each indicates a certain degree of training and expertise. The individual O.C.C. will indicate which of these applies to that occupation (general knowledge is most common).

There are four main types of horseback riding skills. **General/Standard** (the typical skill known by most civilized people and CS citizens), **Cowboy, Knight/Cossack, Cyber-Knight** and **Exotic Animals** (the ability to ride alien and monstrous animals from other worlds). Unless stated otherwise, a character can only select *Horsemanship: General* and/or *Exotic Animals*. Cowboy and the others are generally restricted to special O.C.C.s and R.C.C.s.

Trick Riding and Roping skills can augment and complement one’s riding abilities, but are not riding skills in and of themselves. Each *Horsemanship skill* indicates a certain degree of training and expertise in riding and handling horses. Each type of horsemanship has the following skills and areas of knowledge. The higher the skill percentage the better the skill or ability. Tricks and stunts (without the Trick Riding skill) are performed at half the rider’s normal riding skill. **Note:** To avoid being thrown from the horse when jumping, charging, kicking or performing some other difficult maneuver or trick, the character must roll under his second percentage to remain in the saddle and in

control of his animal. Also note that the *American Cowboy* is arguably, the most skilled and versatile horseman in the world, with skills such as roping and herding as part of his repertoire of horsemanship related skills; all elements that are not usually available to other horsemen in the world (the Cossack being an exception).

**Riding & Care of Horses:** The first percentile number indicates the character's riding ability and a fundamental knowledge of feeding, caring, and grooming of horses.

**Recognize quality/breed:** The first percentile number also indicates the success ratio of recognizing the breed quality, age, strength, speed, health, and general attributes/capabilities (race horse, workhorse, warhorse, etc.) of the animal.

**Breed Horses:** The second percentile number indicates the knowledge in the raising, breaking, training and breeding of horses. It includes shoeing horses, giving birth, and curing minor ailments and injuries.

**Jumping:** The second percentile number also indicates the success ratio of NOT being thrown from the horse when jumping, charging, kicking or performing some other difficult maneuver or trick. The character must roll under his percentage to remain in the saddle and in control of his animal. Damage from being thrown off a horse is typically 1D6.

**Racing:** The second percentile number also indicates the success ratio of maintaining control and getting maximum speed while racing at full gallop. A failed roll means the horse runs quickly but 10% short of its maximum speed, but the rider can coax that little extra spirit and speed out of the animal. Once every four minutes, the rider can get the horse to kick into overdrive and run at 25% faster than its normal maximum. However, this speed can only be maintained for one minute at a time and cannot be done more than three times in a 15 minute period. Maximum running speed can be maintained for a period of minutes equal to the horse's P.E. attribute. Pushing the horse beyond its endurance will cause it to slow down by 30% and after 4D4 minutes, collapse from exhaustion (requires at least a half hour rest and light activity for another hour).

**Combat:** All bonuses are in addition to other combat skills, weapon proficiencies, or attribute bonuses. Applies to the rider, not the horse. The rider gains a combat advantage from the height and speed of being mounted. This provides the following bonuses when charging on horseback, regardless of what horsemanship skill the character has chosen: +1 to parry and dodge, +4 damage for melee attacks. Note that a person can not shoot a projectile weapon of any kind (bow and arrow or gun) with any degree of accuracy. An aimed shot is impossible on a moving animal! Bursts are possible if the horse is moving quickly, but not at a full gallop. At full gallop, the shooter can fire only as wild.

**A general note about horses:** The horse attack skill reference indicates that the rider is skilled enough to remain saddled while he attacks and has his horse rearing or kicking in simultaneous attack (roll under second percentile number).

**Attribute Notes:** Horses have a fairly high animal intelligence, roughly equal to that of a dog, and can generally carry or pull 500 pounds (225 kg). A war- or work-horse can carry about 600 pounds (270 kg) but pull up to five tons, and a pair of work-horses can pull up to 15 tons (but speed of working is a mere 15 mph/24 km).

**Speed:** Work-Horses, Mules & Donkeys: Spd 22 or 15 mph (24 km). Ponies: Spd 36+3D4 or approx. 25-30 mph (40-48 km). Riding Horse: Spd 48+1D6 or approx. 35 mph (56 km). Warhorse: Spd 48+1D4 or approx. 35 mph (56 km). Race Horse: Spd 57+1D6 or approximately 40 mph (64 km) with a short burst (1D4 minutes long) of up to 50 mph (80 km), but cannot handle the hardships of the wilderness (reduce H.P. & S.D.C. by 20% for every month forced to function in the wilderness or as a work-horse).

**Average P.P.E.:** 5D6; sensitive to the supernatural, ley lines and strong magic.

**Average Life Span:** 7-9 years as a work or strong riding animal, after which the horse is worn out (reduce H.P., S.D.C. and Speed by one third), but can continue to be used for light work, light to medium riding and/or put out to stud for several years to follow; total average life span is 12-15 years.

**Hit Points & S.D.C.:** The typical riding and race horse has 4D6+6 Hit Points and 5D6+12 S.D.C. Warhorse: 5D6+10 H.P. and 6D6+16 S.D.C. Work-Horses and Mules: 4D6+10 H.P. and 4D6+20 S.D.C. Pony and Donkey: 4D6 H.P. and 2D6+12 S.D.C. M.D.C. Horse Barding: Light offers 40-50 M.D.C. without penalty, Heavy: 110 M.D.C. but reduce the animal's speed by 5%.

**Damage from Horse Attacks:** The exact damage from a horse's kick will vary with the size and breed of the animal; generally 2D6 S.D.C. from the front legs and 4D6 from the rear legs; +6 damage from warhorses.

**Attacks per melee round:** 2 or 3.

**Cost:** Donkey: 600-1000 credits. Mule: 800-2000 credits. Work-Horse: 1000-2200 credits. Ponies: 800-2000 credits. Riding Horse: 2000-4000 credits. Warhorse: 3000-6000 credits untrained; 15,000-30,000 credits for a trained animal. Race Horse (for sport & gambling): 20,000-300,000 credits.

**Horsemanship: General:** All the basic skills as noted above. **Base Skill:** 40%/20% +4% per level of experience.

**Combat:** All bonuses are in addition to other combat skills, weapon proficiencies, or attribute bonuses. Applies to the rider, not the horse. The rider gains a combat advantage from the height and speed of being mounted.

+1 to parry or dodge while on horseback.

Inflicts +1D4 S.D.C. damage when on horseback.

Charge attack (running horse) with a pole-arm or spear: +1D6 damage. The attacker must roll under the second percentile number to avoid being dismounted. Charge attacks count as two melee actions/attacks.

Horse attack: This indicates that the rider is skilled enough to remain saddled while he attacks and has his horse rearing or kicking in simultaneous attack (roll under second percentile number). Damage from the kick of a horse will vary with the size and breed of the animal; generally 2D6 from the front legs and 4D6 from the rear legs; +6 damage from warhorses.

**Horsemanship: Cowboy:** Not available to most O.C.C.s. **Base Skill:** 66%/50% +3% per level of experience.

**Combat:** All bonuses are in addition to other combat skills, weapon proficiencies, or attribute bonuses. Applies to the rider, not the horse. The rider gains a combat advantage from the height and speed of being mounted.

+1 on initiative when on horseback at levels 2, 5, 10 & 15.

+2 to roll with fall or impact when knocked from a horse.

+2 to parry, dodge and rope/ensnare/entangle while on horseback.

Inflicts +1D4 S.D.C. or M.D. when on horseback, depending on the weapon (M.D. weapons like Vibro-Blades get the M.D. bonus; not applicable to ranged weapons like rifles and blasters).

Charge attack (running horse) with a pole-arm or spear: +2D6 S.D.C. damage. The attacker must roll under the second percentile number to avoid being dismounted. Charge attacks count as two melee actions/attacks.

Horse attack; see details under stats for horses.

**Horsemanship: Knight or Cossack:** All the basic skills as previously noted. **Base Skill:** 40%/30% +5% per level of experience.

**Knight Combat:** All bonuses are in addition to other combat skills, weapon proficiencies, or attribute bonuses. They apply to the rider, not the horse. The rider gains a combat advantage from the height and speed of being mounted.

+1 on initiative when on horseback.

+1 to roll with fall or impact when knocked from a horse.

+2 to parry or dodge while on horseback.

Inflicts +1D6 to damage when on horseback.

Charge attack (running horse) with a lance, pole-arm or spear: +2D6 damage. The attacker must roll under the second percentile number to avoid being dismounted. Charge attacks count as two melee actions/attacks.

Horse attack: This indicates that the rider is skilled enough to remain saddled while he attacks and has his horse rearing or kicking in simultaneous attack (roll under second percent) number). Damage from the kick of a horse will vary with the size and breed of the animal; generally 2D6 from the front legs and 4D6 from the rear legs.

**Horsemanship: Cyber-Knight:** Exclusive to the Cyber-Knight O.C.C. **Base Skill:** 70%/50% +3% per level of experience.

**Combat:** All bonuses are in addition to other combat skills, weapon proficiencies, or attribute bonuses. Applies to the rider, not the horse. The rider gains a combat advantage from the height and speed of being mounted.

+1 on initiative when on horseback at levels 1, 5, 9 & 14.

+2 to roll with fall or impact when knocked from a horse.

+2 to parry or dodge while on horseback.

Inflicts +6 S.D.C. or M.D. when on horseback, depending on the weapon (M.D. weapons like Vibro-Blades get the M.D. bonus; not applicable to ranged weapons).

Charge attack (running horse) with a lance, pole-arm or spear: +3D6 damage. The attacker must roll under the second percentile number to avoid being dismounted. Charge attacks count as two melee actions/attacks.

Horse attack; see details under stats for horses.

**Horsemanship: Exotic Animals:** Basically the same as the general horsemanship skill, except that the character is experienced in riding "tame" animals other than the horse. This can include elephants, camels, lamas, pegasus, gryphons, dinosaurs, giant insects, and other monstrous beasts trained (or willing) to be riding animals. Wild, untamed creatures cannot be ridden, except by Simvan and others with special animal skills or powers. **Base Skill:** 30%/20% +5% per level of experience. **Note:** Characters with the traditional "horsemanship" skill for riding horses and other very horse-like animals can quickly figure out how to ride exotic animals and alien riding beasts, but at a skill penalty of -12% to ride ground/running animals and -16% to ride flying or tree climbing and leaping animals. Similarly, beings from other dimensions not familiar with riding the fast and sleek Earth horse are -10% to ride them.

## Mechanical Skills

**Aircraft Mechanics:** The understanding of aerodynamics and the training to repair, rebuild, modify, and redesign conventional aircraft, including single engines, twin engine airplanes, jets, helicopters and hovercraft. Robot body armors and high-tech military vehicles are not included (see robot mechanics). **Base Skill:** 25% +5% per level of experience.

**Armorer/Field Armorer:** This is a somewhat simplistic and basic version of the weapons engineer skill as it applies to infantry weapons. A competent armorer character can maintain, fix, modify, mount, reload/charge ammunition, and figure out most small arms. The armorer can repair all types of pistols and rifles, repair minor damage to body armor (20 M.D. maximum), adjust targeting sights, use and repair optical enhancements, reload missiles and ammo drums, recharge E-Clips, install/mount a rail gun or machine-gun on a vehicle, and even fix most simple robot and bionic weapons like forearm blasters and retractable blades, as well as make arrows and arrowheads, sharpen blades/weapons, make horseshoes and basic metal items (including nails, spikes,

and chain links). He can also deactivate, reset and fix simple traps (roll for each attempt). **Base Skill:** 40% +5% per level of experience. **Note:** Automatically gets the Basic Mechanics skill at 30% +5% per level as part of this package.

**Automotive Mechanics:** The ability to repair, rebuild, modify, and redesign conventional vehicles with internal combustion (gas) engines. It also includes body work, turbine engines, methanol, ethanol and diesel truck engines. Working on hover jet systems for ground vehicles is possible, but with a -20% penalty. Working on reactor engines there is a -40% penalty. **Base Skill:** 25% +5% per level of experience.

**Basic Mechanics:** A general familiarity and understanding of basic mechanics. This character can fix a toaster, repair a bicycle, replace a belt on a motor, repair or replace a switch, handle or knob, replace a spark plug, change oil, assist in automobile repairs, maintain machinery, read a schematic and similar fundamental tasks. **Base Skill:** 30% +5% per level of experience.

**Bioware Mechanics:** "Bioware" is *cybernetics*. A character with this skill can identify, service and repair all cybernetic and bionic systems, from the simplest data plug to the most sophisticated of the artificial eyes. This, however, is limited to the actual *machine* and electronics of the cybernetics, not any actual designing or building of bionic components (unless part of a kit to be assembled) nor work on "bio-system" components like artificial skin, organic eyes or internal organs. However, when it comes to a cybernetic or even bionic machine part – hand, arm, leg, mechanical implant, and similar, this character can work on it. In fact, he can even assist a Medical Doctor or Cyber-Doc to install, add, remove or help transplant bioware fittings and cyber-implants. **Note:** The character can *not* perform surgery, or design or build new cybernetic items nor change the function of an existing piece. **Base Skill:** 30% +5% per level of experience. -20% when working with sophisticated bionic systems including bionic weaponry or alien mechanisms. **Requires:** Mechanical Engineering and Basic Math skills.

**Locksmith:** The study of lock designs and the ability to repair, build, modify and open locks. The methods, techniques, and tools of lock picking include the old-style key and tumbler, combination, and modern electrical locking systems. **Time requirements:** 1D4 melees to open an antiquated key type lock or simple tumbler/combination type, 1D4 minutes to open an elaborate tumbler type, 2D4 minutes to open a simple electronic lock (usually by patching in a bypass system), and 1D4 hours to break a complex, state-of-the-art electronic lock system such as those used in high security and restricted areas. Super high-tech systems, such as those used by the Coalition's military and government, will require 3D4 hours and have a skill penalty of -20%.

If an unsuccessful skill roll is made, the lock is not opened and the process must be repeated. If an attempt to open an electronic lock fails, roll again. A second failed roll means that the lock is irreparably damaged and can not be opened! **Base Skill:** 25% +5% per level of experience. **Requires:** At least Basic Electronics skill (-5% penalty when working on complex or high-tech locks) or Electrical Engineer (+5% bonus).

**Mechanical Engineer:** Training, understanding, and knowledge of how machinery is designed, operated, built, and maintained. Characters can attempt to redesign, modify, repair, construct, or sabotage mechanical devices (includes nuclear reactor driven turbines and atomic engines). The player must first roll to see if his character can figure out how to operate, analyze and design a machine. When a successful diagnostic roll has been made, roll again to determine when the character can fix/change/build the mechanism. **Base Skill:** 25% +5% per level of experience. **Special Bonus:** Add a one time bonus of 5% to the Locksmith and Surveillance Systems skills if Mechanical Engineering is also known. There is a -30% penalty when working on alien or extremely unfamiliar mechanics. This includes Techno-Wizard mechanics. The mechanic may be able to puzzle out some of the basic aspects of a device created by Techno-Wizardry, and may be able to figure out how to operate the machine, but will not be able to fully fathom how it

works nor how to repair it. **Requires:** Basic or Advanced Mathematics, at least Basic Electronics, and Literacy.

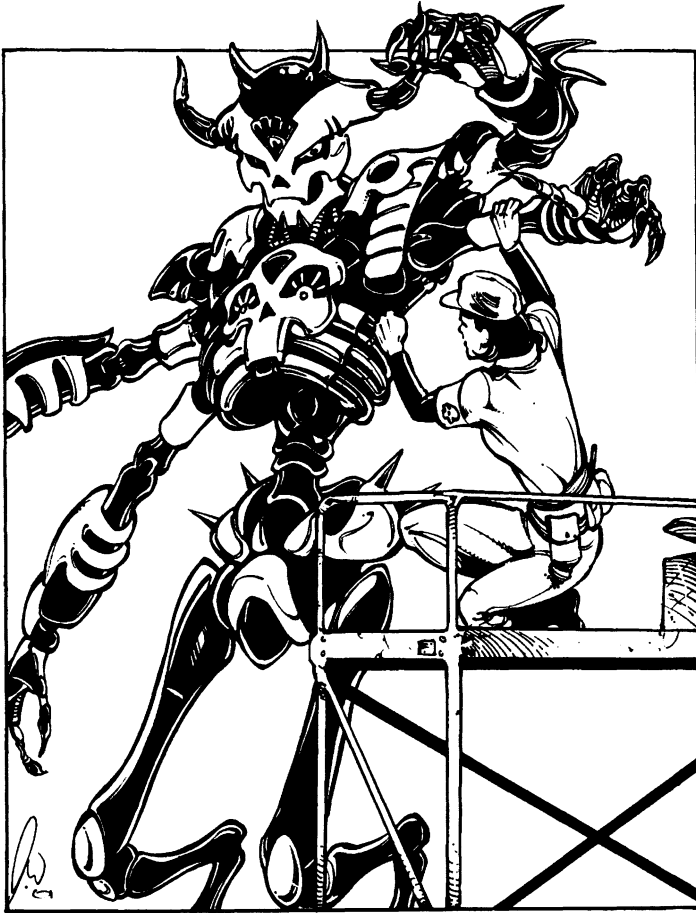

**Robot Mechanics:** This is the specific study of advanced mechanics as it applies to robotics. Those skilled in this discipline can repair, modify, build, and sabotage robots, including the creations of the Coalition, power armor, and exoskeletons. There is a -30% penalty when working with alien or extremely unfamiliar mechanics. **Base Skill:** 20% +5% per level of experience. **Requires:** Mechanical Engineer skill and related requirements.

**Space: Drive Repair:** There are four basic kinds of spacecraft drive systems: *chemical drives*, *ion drives*, *plasma drives* and *traction drives*. Each of these processes is radically different from the others and requires mechanics to take this skill separately for each kind of drive they want to be able to fix. Thus, to be able to repair all four main drive types, one must take this skill four times. Likewise, if the mechanic ever encounters a new and exotic type of drive system, he will have to take this skill one more time to familiarize himself with the new drive type. The four kinds of space drives used in **Mutants in Orbit** are all different and work on totally different scientific principles. A character with Drive Repair: chemical drive will have a complete knowledge of how these drives work, to the extent that they can build one if given time and enough spare parts, but their knowledge of ion drives, plasma drives or traction drives will be minimal. A character can attempt to repair other types of drives, but at a penalty of -40%. **Base Skill:** 30% +5% per level of experience.

**Space: Satellite Systems:** A space technology not appropriate for 99.9% of those on Rifts Earth, but which is common knowledge on *Phase World*® and other space settings. Satellites range from communication models to navigation beacons, spy systems, burnt-out husks with salvageable parts and military killer satellites. This skill allows a character to identify, strip down and repair any of them. **Base Skill:** 30% +5% per level of experience. **Requires:** Mechanical Engineering and at least Basic Electronics.

**Spaceship Mechanics:** A space technology not appropriate for 99.9% of those on Rifts Earth, but which is common knowledge on *Phase World*® and other space settings. The ability to repair, rebuild, modify and redesign conventional vehicles. This skill covers a basic understanding of gravitonic systems, but only includes the most rudimentary knowledge of *Phase technology*, and no skills on Rift drives. Conventional ship systems (communications, hull, life support) are pretty much the same everywhere. **Base Skill:** 22% +5% per level of experience. **Requires:** Mechanical Engineer & at least Basic Electronics skills. -30% penalty on alien systems.

**Submersible Vehicle Mechanics:** Training in the diagnosis and repair of submersible vehicles, including submarines, underwater robots, probes and stations. **Base Skill:** 25% +5% per level of experience. **Note:** Mechanical engineers can also effect repairs but at -15% and aircraft mechanics are at -40%.

**Vehicle Armorer:** A specialized skill in which the character can do more than just tinker with the mechanics of a vehicle. He can add (and often conceal) vehicle armor, modify or completely reconfigure the body/housing of a vehicle, add weapon mounts and turrets, add ram prows and shielding, soup-up with heavy-duty shock absorbers, extend and shorten wheelbases, as well as operate, repair and modify weapons for mounting and use on vehicles; typically large caliber weapons, such as vehicle-mounted flame throwers, machine-guns and mortars, etc. Various other skills may relate to this skill. This skill appeals to scavengers and mercenaries who often have to “find” and acquire the correct parts and pieces. In fact, finding the correct parts may be half the adventure (see the Find Contraband skill). This skill is practiced most commonly in Australia but an equivalent skill is practiced in low-tech, war-torn and wilderness areas where technology is scarce and salvage, refitting and reuse are a necessary part of life. In Australia those with this skill are known as “Outback Armorers” or “tank makers.” **Basic Skill:** 30% +5% per level of experience. **Note:** Automatically gets the Basic Mechanics skill at +20% as part of this package. Taking this skill in conjunction with Automotive Mechanics provides a +10% bonus to the automotive skill.

**Weapons Engineer:** This skill is usually reserved for military personnel. The character can maintain, repair, modify, mount, and figure out most weapon systems, including rail guns, energy weapons, and atomic power systems. He can repair an assault rifle and recharge E-Clips and E-Packs as well as repair and install a missile system into a vehicle. The engineer can also add and repair body armor and is an expert welder. **Base Skill:** 25% +5% per level of experience. **Requires:** Mechanical Engineering and Basic Electronics. -30% when working on TW or very alien weapon systems or vehicles.

## Medical Skills

**Animal Husbandry:** This area of study provides the character with a knowledge in the care, feeding, breeding, reproduction, treatment and behavior of domestic animals, as well as very basic veterinary skills for minor illnesses, setting a broken leg and giving birth. The animals included under this skill are cattle, sheep, goats, horses, mules, donkeys, ducks, chickens, and similar livestock and domesticated animals like dogs. (See Horsemanship skills for breeding horses). The percentile number indicates the degree of knowledge and skill one has about animals and their care. Reduce the skill ability by half when caring for captive or injured wild animals. **Base Skill:** 35% +5% per level of experience.

**Brewing:** The understanding and methods of making fermented alcoholic beverages from grains and fruits. This specifically includes wine, mead, ale, beer and moonshine, as well as teas, elixirs, tonics and other “brews” for *medicinal* purposes. Stronger alcohol, such as brandy, rum, and whiskey, is not included, nor are champagnes or fine wines. The first percentile number indicates the chance of success (a failed roll means an undrinkable concoction). The second indicates the quality of the brew; the lower the number rolled the tastier the drink.

**Base Skill:** 25%/30% +5% per level of experience. Adds +5% bonus to the Holistic Medicine skill if both skills are known.

**Criminal Sciences & Forensics:** Basic knowledge of police skills including basic criminal law, fingerprinting, ballistics (matching bullets to weapons and angles of impact), and general investigative techniques. Forensic medicine is the methods and techniques which enable the character to find evidence regarding the cause of death, time of death, and other details when examining a corpse. **Base Skill:** 35% +5% per level of experience. **Requires:** Biology, Chemistry, Chemistry: Analytical, Advanced Mathematics, and Literacy.

**Entomological Medicine:** This skill involves the unique *specialization* in insect biology and its applications to medicine and science. It is an uncommon skill (that originally appeared in *Mutants in Orbit*), but it does have applications on Rifts Earth and alien worlds.

In its simplest form, Entomological Medicine gives the scientist/doctor an in-depth understanding of insect biology, physiology and, most importantly, its chemical aspects. This means the character knows how and why the insect (from ordinary bugs to giants and intelligent insectoids) functions, its physiological strengths and weaknesses, types of natural weapons, and chemical weapons and chemical properties. Thus, the character is familiar with secreted poisons, acids, resins, chemical sprays, and other chemical and biological aspects of the insect, including where the chemical is secreted from, what its exact properties and effects on humans are, and any applications in medicine for those insect chemicals. Those with this skill will also know the *anti-toxin* and treatment to insect poisons and chemicals.

In its more advanced application, the character understands and can treat "insectoids" — intelligent, humanoid insects like the *Xiticix*. A character with this skill who is also trained in First Aid or Paramedics can help a wounded giant insect, *Xiticix*, or mutant or alien insectoid but does so with a -20% penalty. Any treatment more complex than that will require assistance from a doctor who has this skill. Body Fixers/Doctors versed in Entomological Medicine will be able to cure most insect complaints and injury, from diseases to broken limbs and cracked chitin, but even they work at a -10% skill penalty.

Obviously, this is a unique specialization completely different from the normal medical skills of doctors and requires a separate skill selection. **Note:** Characters based in North America have the equivalent of *Lore: Xiticix* if they take this skill, at the proficiency level listed here. Those in South America have *Lore: The Gatherer & Pincer Warriors*. The first percentage number is the level of knowledge and understanding, the second is the ability to treat insectoids and create anti-venoms and drugs using insect chemicals (This aspect of the skill requires Basic Math and Chemistry, if not Chemistry: Analytical). **Base Skill:** 40%/20% +5% per level of experience.

**Field Surgery:** This skill reflects training in emergency, life-saving surgical procedures that can be performed "in the field" to keep critically wounded individuals alive. Given the proper tools, the field surgeon can perform amputations, suture torn arteries, check internal bleeding, cauterize wounds, give blood transfusions and even install cybernetic implants (the latter is done with a penalty of -15% unless the character has basic cybernetics skill). Field expedient surgery is a dangerous proposition that all too often results in the death of the patient. Because of the risk involved, field surgery is attempted only when it is the only chance the wounded character has for survival! If the operation is successful the patient lives and can be evacuated to a hospital, but a failed roll results in the immediate death of the patient. **Base Skill:** 16% +4% per level of experience; +14% if the character is also an M.D.

**Optional Guidelines for Fatal Injury Treatment:** In the violent world of Rifts, regular humans and similar non-Mega-Damage beings are at an extreme disadvantage. Once a human's body armor is destroyed, a single M.D. blast will usually obliterate him/her. These guidelines are provided to give player characters a chance, however slight, to survive a blast that would normally evaporate the character. If the G.M. agrees,

the character can survive a Mega-Damage intensity wound if a trained medic makes a successful Field Surgery skill roll.

Unless the attacker made a called shot or rolled an unmodified 19 or higher, the character has the chance to live. The basic idea is that the M.D. blast was partially absorbed by nearby cover, body armor or merely sheared off a limb (G.M.s, give some reasonable explanation). Within 1D4 melee rounds after the character's being hit, a medic character must attend to his/her injuries. If the field surgeon makes a successful skill roll the character is incapacitated but survives the attack, though just barely (reduce S.D.C. to zero and Hit Points are at 1D6 above zero). A failed roll means the injured character was beyond saving and dies an instant later. Even if the field operation succeeds, the wounded character is in shock, crippled, may require additional extensive surgery, as well as require cybernetic or bionic reconstruction and a long recovery period before he is able to adventure again (2D4+2 weeks). It may be appropriate to also determine an insanity and permanent physical side effects from the injury. **Note:** This optional survival rule is also applicable to Medical Doctors and Cyber-Docs.

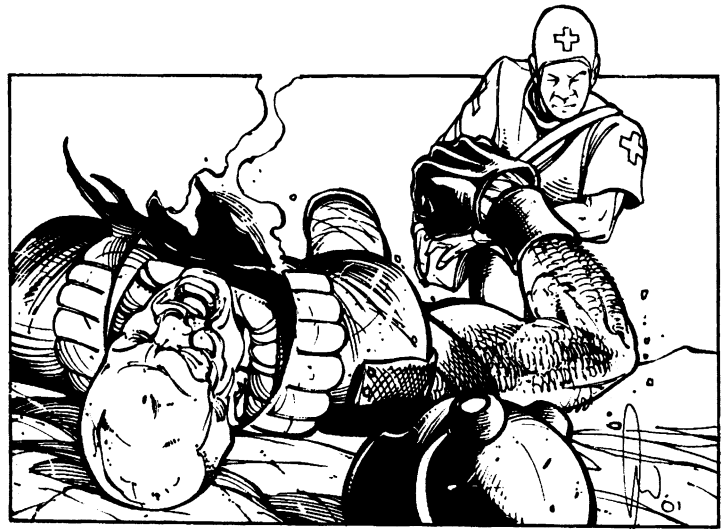

**First Aid:** Rudimentary medical treatment which includes how to bandage wounds, stop bleeding, administer CPR, artificial respiration, and use antiseptics and common anti-inflammatory drugs and painkillers. **Base Skill:** 45% +5% per level of experience.

**Holistic Medicine:** Training in the recognition, preparation, and application of natural medicines usually made from whole plants and/or their parts (roots, leaves, fruit). The Holistic Doctor is basically a pharmacist and naturalist who creates drugs from herbs and vegetation, as well as studies and treats common ailments. He can find and use plants to create salves, balms, ointments, and lotions to soothe burns, boils, rashes, and insect bites, reduce swelling, as well as create local anesthetics, and to heal wounds faster (twice as quick as normal). Potions and tonics are created to settle upset stomachs, induce drowsiness, or hallucinations. The individual can also make alcohol and poison (hemlock and mandrake for example).

The student of herbology also has a good knowledge of plant lore and when and where to find healing plants, edible fruit, roots, and bark, as well as how to use and/or avoid dangerous flora. The character can also preserve foods and knows how to set and mend bones, bandage cuts, and suture cuts. **Note:** Plants are seasonal and the right root or leaf may not be readily available in certain times of the year/season, or may be found exclusively in remote regions. Game Masters should use a certain amount of common sense and drama with this skill. **Base Skill:** 20% +5% per level of experience. A failed roll means the treatment or concoction did not work.

**Juicer Technology:** This is a medical specialty dealing with the Juicer! **Note:** A character needs this skill and an M.D. in Medicine or Cybernetics to install the bio-comp and other Juicer implants. This skill allows a doctor to supply and administer the right drugs to a Juicer, rec-

ognize Juicer variants, diagnose most Juicer side effects and syndromes, tell if the Juicer is beyond detoxification, administer detox, and assist in the Juicer creation process at a Juicer Augmentation facility. **Base Skill:** 40%+5% per level of experience.

**Paramedic:** An advanced form of emergency medical treatment which includes all first-aid techniques, the setting of broken bones, suturing of wounds, use of oxygen and emergency medical equipment, administering of drugs, knowledge of how to move a critically injured person, the removal of cybernetic prosthetics, and other life-saving techniques.

*A failed roll* means the patient has not responded to treatment or that the treatment has been improperly administered. **Note:** For serious injury or coma, roll three times, consecutively, on percentile dice. A roll of two successful out of three means the wound has been properly treated or that the patient's condition has been *stabilized*. Failure means the patient's condition is unchanged and getting worse. Another character can immediately attempt to apply medical aid or the same player can try again, but the first character must spend 1D6 minutes of reexamination and/or concentration on the problem before he can try again. **Base Skill:** 40% +5% per level of experience.

**Medical Doctor:** The medical doctor is a trained surgeon and has a doctorate in the medical sciences. Areas of training include: clinical skills, medical discipline, code of ethics, physiology (muscle, respiratory, blood, body fluids), pathology (diseases, their structure and function), rudimentary pharmacology (use, reaction, and interaction of drugs), laboratory skills, and techniques and methods of data collection. The medical doctor (M.D.) is also a trained surgeon and has a basic knowledge regarding cybernetics. This means the M.D. can remove and attach most cybernetic mechanisms (although at a penalty of -10%, and -40% on bionics). **Base Skill:** 60%/50% +5% per level of experience. The first percentage number is the doctor's ability to accurately diagnose the problem. The second percentage number is the doctor's skill at successfully treating the problem. **Requires:** Biology, Pathology, Chemistry, Basic or Advanced Mathematics and Literacy.

**M.D. in Cybernetics:** This doctor is a specialist in the science of cybernetics and a master surgeon. The character has all the basic knowledge and requirements of the regular M.D., although his diagnostic skills are nowhere near as honed, but is a specialist in surgery and the removal of limbs and internal organs and the surgical attachment of cybernetic replacements (artificial organs and prosthetics). He can also repair cybernetic prosthetics (if not too badly damaged). **Base Skill:** 40%/60%+5% per level of experience. The first percentage number is the "Cyber-Doc's" ability to accurately diagnose and treat a non-surgical problem/illness. The second percentage number is the doctor's ability to perform complex surgery, remove and install all types of cybernetic organs and devices. The Cyber-Doc can also work on bionic implants and systems but suffers a -15% skill penalty. Bionic science is much more complex and machine oriented than cybernetics. **M.D. Note:** An M.D. in Cybernetics can become a bionics surgeon (M.D.B. in cybernetics) by selecting this cybernetics skill twice and Electrical Engineering (and must have all the M.D. requirements). This will make him a master in all of the cybernetic and bionic sciences. There is now no penalty for installing bionics and there is a special bonus of +10% added to the character's surgery skill. The M.D.B. can also repair, modify, design, and build bionic and cybernetic devices. **Bionics Note:** One can not create a bionic implant in a garage. The character will need access to a cybernetics or bionics laboratory and parts to build or modify an artificial implant. Even a high-tech medical facility will not have the necessary components to create a cybernetic or bionic mechanism, although it may have access to them.

**Pathology:** This branch of medicine deals with the nature of diseases, their cause, and symptoms, and the functional and structural changes caused by disease. Training includes anatomy, physiology, cell biology, manifestation of disease, tissue injury and repair, abnormal cell structure, metabolism, diagnosis of human diseases, tissue culture methods and applications, analysis of drugs in biological samples and

laboratory research, investigative methods, and use of instruments and equipment. **Base Skill:** 40% +5% per level of experience. **Requires:** Biology, chemistry, and Literacy skills.

**Sea Holistic Medicine:** This skill is rarely known to characters living on the mainland. It is most common among seafaring folk and those who live on islands or along an ocean coastline.

The skill includes training in the recognition, preparation, and applications of natural medicines derived from aquatic plants/seaweed and sea animals, including ink, blood, poisons, glands and other secretions and chemicals. This skill also includes the knowledge of where to find the necessary plants or animals, how to extract the necessary components and some knowledge of legends as they pertain to the healing properties of the sea and sea animals. Otherwise, the skill is fundamentally the same as the standard Holistic Medicine skill. **Note:** The standard skill does NOT include medicines derived from the oceans and seas, likewise, the Sea Holistic knowledge does NOT include most of the land herbs and plants; only a handful of the very most common and basic ones. **Base Skill:** 20% +5% per level of experience. A failed roll means the treatment or concoction did not work.



## Military Skills

**Armorer/Field Armorer:** This is a somewhat simplistic and basic version of the weapons engineer skill as it applies to infantry weapons. A competent armorer character can maintain, fix, modify, mount, reload/charge ammunition, and figure out most small arms. The armorer can repair all types of pistols and rifles, repair minor damage to body armor (20 M.D. maximum), adjust targeting sights, use and repair optical enhancements, reload missiles and ammo drums, recharge E-Clips, install/mount a rail gun or machine-gun on a vehicle, and even fix most simple robot and bionic weapons like forearm blasters and retractable blades, as well as make arrows and arrowheads, sharpen blades/weapons, make horseshoes and basic metal items (including nails, spikes, and chain links). He can also deactivate, reset and fix simple traps (roll for each attempt). **Base Skill:** 40% +5% per level of experience. **Note:** Automatically gets the Basic Mechanics skill at 30% +5% per level as part of this package.

**Camouflage:** The skill of concealing a fixed base position, vehicle, bot, equipment or individual, using natural and/or artificial materials. A fair amount of time is involved in the preparation of a larger position. Large cargo nets, cut branches or underbrush are used most often in camouflage. This skill is also used to conceal traps. **Base Skill:** 20% +5% per level of experience.

**Demolitions:** Demolitions provides the person with an advanced knowledge in the use and workings of explosives and detonation devices for the purpose of blowing up bridges, buildings, and sabotage. This includes all types of explosives, such as mines, dynamite, plastics, nitro, blasting caps, etc. It also includes a basic understanding of the strategic placement of mines and booby traps. This will increase the

character's awareness of suspicious rope, string, and wire. **Base Skill:** 60%+3% per level of experience. A failed roll means a dud; no explosion.

**Demolitions Disposal:** This skill enables the character to safely defuse unexploded mines, bombs, explosive booby traps, dud artillery rounds, dud explosive charges, or any other explosive device. **Base Skill:** 60% +3% per level of experience.

**Demolitions Underwater:** Fundamentally the same basic skills and training as demolitions, but with an emphasis on using explosives in an underwater environment, including underwater techniques, area affect, sound wave damage, different types of explosives, as well as arming, disarming and repairing torpedoes and depth charges. **Base Skill:** 56% +4% per level of experience. **Note:** Any character with the demolitions skill can use explosives underwater, but is -10%.

**Find Contraband, Weapons & Cybernetics:** The character with this skill knows where to find arms dealers, the Black Market, smugglers, thieves, M.O.M. and Juicer conversions, body chop-shops, cyber-snatchers, criminal Cyber-Docs and illegal medical treatment, as well as how to spot them. He is also familiar with their hang-outs, gang or criminal ties, general practices, codes of conduct, pricing structures and modes of operation. Likewise, the character has a good idea of what Black Market weapons and cybernetics should cost and what these people pay for contraband items (typically only 20% of the retail market price). The character also knows the penalty for being caught with an illegal weapon, implant or bionics. In all CS cities and most societies, any M.D. weapons, concealed weapons and sidearms are forbidden inside large population centers.

This skill is especially appropriate in the modern cities of the Coalition States, as well as in the large cities of the NGR, Atlantis, Japan, and other large, urban communities. **Base Skill:** 26% +4% per level of experience. **Note:** This skill should be considered separate and apart from streetwise.

*A variation of this skill* is known as **Find Contraband, Parts & Relics**. This skill can be substituted for the one above, or if the G.M. allows it, as part of the above skill. As a separate skill, it is available to the military, mercenaries and the Operator O.C.C., as well to those who spend their lives scratching a living in the harsh wilderness as salvagers picking through the ruins of ancient cities. (This practically describes 98% of the Australian population!) This is a valuable "scavenger" or "scrounger" skill that enables the character to recognize contraband, machine and weapon parts, and electrical components, as well as a variety of other valuable parts and components. The character also knows where to find arms dealers, Operators/mechanics, gangs, smugglers, scavengers, bandits, illegal automotive garages, body chop-shops, and criminals who buy and sell such items. As always, he is familiar with their hangouts, gang or criminal ties, general practices, codes of conduct, general value of items, scarcity, pricing structures and modes of operation. Likewise, the character has a good idea of what black market weapons, parts and cybernetics should cost and what these people pay for valuable parts, relics, and contraband items (prices vary greatly depending on the item, location and buyer). The character also knows the penalty for being caught with a stolen, rare or illegal weapon or item. **Base Skill:** 26% +4% per level of experience. **Note:** This skill is separate and apart from Streetwise.

**Military Etiquette:** This skill grants a clear understanding of the way the military works, including rules of behavior (when to salute, how to address superiors/subalterns, etc.), military procedures and routines, standard issue of equipment, special ordering procedures, proper display of rank and medals, advancement in rank (and the duties that come with it), proper troop formations, how to deal with military bureaucracy, the chain of command, proper channels, who to contact to get things done, and other useful information in matters of military protocol and bureaucracy. **Base Skill:** 35% +5% per level of experience. **Note:** All soldiers have a fundamental knowledge of military etiquette (base skill 30% with no improvement), but this skill is much more complete with a strong knowledge of what is expected, correct and the formal approach (e.g. by the book knowledge).

**Military Fortification:** This is the skill of designing and building defensive fortifications suitable for modern Mega-Damage combat. If provided with the proper time and materials, the character can greatly increase the defensive value of natural terrain with murderous defenses that include obstacles to impede movement and protective structures to shield friendly forces from enemy fire. The character is trained to prepare mine fields, barbed wire, tank obstacles, tanglefoot wire, booby traps, trenches, tank ditches, foxholes/shell scrapes, reinforced concrete or earthen walls, bunker complexes, rail gun/mortar emplacements, tunnel systems and similar defensive constructions.

Even with the advent of Mega-Damage warfare the old standby fortifications listed above have useful applications. Obstacles like ditches and mine fields slow the advance of robots, infantry and tanks, exposing them for longer periods to defender firepower. Earthen walls and foxholes, made from S.D.C. materials, still afford soldiers some protection and can disperse energy blasts or deflect shrapnel from explosives. If these protective structures are built with Mega-Damage concrete and alloys they provide defenders with as much protection as any robot vehicle or tank! **Base Skill:** 30% +5% per level of experience.

**Nuclear, Biological, & Chemical (NBC) Warfare:** This is the knowledge of safety precautions to protect oneself and others from the effects of nuclear, biological or chemical warfare, waste and contamination. The character is also knowledgeable in the safe handling and "clean-up" and containment of such hazardous materials. **Base Skill:** 35% +5% per level of experience.

**Parachuting (uncommon):** The skill of parachuting includes the methods, procedures, and techniques of parachuting, packing the chute, skydiving techniques, precision landing, landing without injury, and practice of jumping from a high altitude aircraft. The advantage of parachuting is secrecy, since the troopers' insertion into enemy territory is silent and often goes unnoticed. The following three methods are the ones most commonly used by modern paratroopers:

High-Altitude-High-Opening (HAHO) jumps take place from a height of 25,000 to 30,000 feet (7620 to 9144 m). As the paratroopers drop they travel laterally to the desired drop zone (DZ) where they wish to land. This technique is used to "throw off" enemy units since they will probably search for paratroopers directly beneath the path of the aircraft.

High-Altitude-Low-Opening (HALO) operations also begin at 25,000 to 30,000 feet (7620 to 9144 m) but the paratrooper does not pop the chute until an altitude of 4,000 ft (1220 m), or even less. The jump takes place so rapidly that there is little chance for the paratroopers to be viewed after the chutes open.

The most dangerous method is Low-Altitude-Low-Opening (LALO) drops. The jump is made at the mere height of 300 to 500 ft (91.4 to 152 m). If there are any complications (a failed roll) the paratrooper is likely to be injured (broken bones) or killed (30% chance)! Even if the jump goes without a hitch, there is a 20% chance of taking 6D6 S.D.C. from an awkward landing, even if wearing M.D. armor.

Failure on a parachuting roll indicates that there are complications somewhere along the jump. This might mean an improperly packed chute, tangling of lines, etc. On a high altitude jump, the character gets a second roll for their reserve chute. If the second roll also fails then the character falls to his death! There is not enough time on a low altitude drop to use a reserve chute, so a failed roll means the character hits the ground (humans die!) without a second chance. Parachuting can be selected as a Military or Pilot Related skill. **Base Skill:** 40% +5% per level of experience.

**Recognize Weapon Quality:** The ability to accurately determine a weapon's durability, reliability, and quality by physically examining it. This includes knowing which manufacturers are reputed to make the best weapons, the ability to recognize damage or signs of misuse, modifications/customization or wear and tear, whether the weapon can be made as good as new with a little repair work and/or cleaning, whether it is a cheap (or quality) "knock-off" (copy/imitation), and so on. The

character can also recognize if the weapon is stolen (serial numbers filed away, etc.), new, old, and if it has any other special features or properties as well as what the fair price should be. **Base Skill:** 25% +5% per level of experience. Note: Reduce the skill ability by half if the item is not actually handled (seen but not touched/examined).

**Space Ship-to-Ship Combat:** A space technology not appropriate for 99.9% of those on Rifts Earth, but which is common knowledge on *Phase World®* and other space settings. This is the specific skill of flying a spacecraft in combat. While the *Pilot Spacecraft: Advanced* skill lets a character fly in these situations, this skill allows the pilot to use a ship's weapons and defense systems at the same time. The character also understands the theory and tactics of spatial dog-fighting, rather than relying on gut instinct. If, during combat, a character with this skill is only operating a ship's weapons systems, then they receive a +1 to strike. **Base Skill:** 25% +5% per level of experience

**Space Defense Systems:** A space technology not appropriate for 99.9% of those on Rifts Earth, but which is common knowledge on *Phase World®* and other space settings. Since the climate of space is somewhat hostile, every large base, including all orbital stations, the moon bases, asteroid outposts and even some large ships, is equipped with systems designed to detect and, if necessary, destroy incoming ships or attacks. A character with the defense systems skill will have a full understanding of the defenses of their home station. They will know how it works, how to arm, aim and fire the weapons, and how to repair the system in case of damage. They will also have a rough knowledge of the systems used by the other stations, which may help them evade detection or destruction, or even to work out how to destroy the enemy's defenses in a raid; +1 to strike bonus when using cannons and their likes. **Base Skill:** 30% +5% per level of experience.

**Trap Construction:** Training in the design and application of traps and mines used in anti-personnel and defense tactics. With readily available materials and simple tools, including shovels, knives, sticks, wire and rope, the character can build fiendish traps. Any who would scoff at the effectiveness of traps in modern Mega-Damage combat should reconsider. It is true that traps cannot be made to destroy or even damage M.D. equipment, unless explosives and the demolitions skill are used, but these traps can hamper or disable enemy robots and vehicles, and injure or kill unarmored or lightly armored soldiers! Traps can also be used as an alarm to alert the trap maker to the presence of intruders or the enemy (fires a flare, activates a video camera and transmission, makes noise, etc.).

The greatest drawback of traps lies in the amount of time required to prepare them—it can take hours to prepare rock slides, large pits and similar traps, but even this time can be shortened with help from others since only one character needs the skill to successfully direct workers. Ingeniously prepared traps can, and often do, shift the advantage of a battle to the side that prepared the field for combat. **Base Skill:** 20% +4% per level of experience.

The following are some examples of traps, complete with their effects, a character can build using the trap construction skill. All damage, penalties and considerations are based on a human-sized victim unless stated otherwise.

**Pit, Man-Sized:** Typically a simple pit/hole 7-14 feet (2.1 to 4.2 m) deep and concealed with twigs and leaves. Pits can slow an enemy advance by delaying troop movement (must pause to climb out of pit or to help comrade out of the pit), injuring the victim (typically twist, pull or bruise and sometimes break a leg or arm), damaging light (S.D.C.) equipment, trapping unfortunate soldiers and disabling robots (at least temporarily).

A person blundering into a pit trap falls, taking 1D6 S.D.C./Hit Point damage per every seven feet (2.1 m) of depth, even if wearing M.D. body armor (the impact has an effect on the person inside; no damage to power armor pilots)! The same damage is applied to fragile S.D.C. items that tumble into the pit. The character also loses one melee attack/action in that act of falling and 1D4 melee actions gathering his wits and getting back on his feet; stun effect.

To climb out of the hole unassisted requires 1D6 melee actions. An especially deep pit will require a climbing skill roll or somebody to give the character a hand. Robot vehicles that step into the hole have a 01-70% likelihood of tripping and falling. Crew members suffer 1D4 S.D.C. damage and must spend 1D4 melee rounds to right the vehicle. While trapped and/or while the victim(s) are attempting to recover, the trap maker and his allies usually launch a vicious attack or surround the victim. The pit trap is very common in the wilds of North America.

**Monster Pit:** In some instances, the trap designer will place a small (or large), vicious creature inside the pit. The creature will be terrified and/or angry and attacks anything that falls into the pit. These creatures typically fight until slain. Lasae, Worms of Taut and M.D. monsters of similar size are often used in this capacity, as well as wild canines, felines, bears and snakes.

**Snake Pit:** A shallow pit, 4 or 5 feet deep (1.2 to 1.5 m), filled with poisonous snakes or small Worms of Taut. Characters who fall or stumble into the pit receive 1D4 bites. Regular snake bites inflict 1D4 S.D.C. damage plus 3D6 S.D.C. from poison if the creatures bite unprotected flesh. Creatures like Worms of Taut and other alien "crawly things" may inflict Mega-Damage. The trap is rarely used in North American and Europe, but is frequently used in the jungles of South America and Asia.

**Tank Trap/Giant Pit:** Basically the same as a man-sized pit but dug to a depth of 18 to 30 feet (5.4 to 9 m). Infantry ground troops who blunder into the hole suffer 1D6 S.D.C. for every seven feet (2.1 m) of depth from falling and need 2D4+2 melee attacks/actions to climb out, unless helped out by people outside the pit with rope and such.

Robot vehicles and tanks can also fall victim to these deep and often wide pits. The crew suffers 2D4 S.D.C. damage from getting jostled around. Humanoid robots and power armor suits can climb or pull themselves out of the pit with relative ease; must spend one or two full melee rounds (15-30 seconds) unless the vehicle or power armor can fly or leap out (counts as one melee action).

Tanks, trucks and other ground vehicles may have part or all of the vehicle stuck or wedged in the pit and require a crane or giant robot(s) or several power armor troops to pull it out. Just how stuck and immobilized the vehicle is will depend on the size and depth of the pit.

**Mined Pit:** A pit with land mines or other explosive device(s) dug into or placed on the floor of the pit. It detonates when one or more victims hit the bottom.

**Punji Stake Pit:** Typically a pit 8-10 feet (2.4 to 3 m) deep, concealed with twigs and leaves. The bottom of the pit is lined with a bed of sharp wooden stakes. Roll 1D6 to see how many stakes the falling character lands on; each inflicts 1D6 S.D.C. damage plus damage and penalties from the fall (see the man-sized pit description). Vibro-Blades and special M.D.C. materials can be used to inflict Mega-Damage; roll 1D6 to see how many stakes the falling character lands on; each inflicts 1D6 M.D. plus possible damage and penalties from the fall.

Punji pits are extraordinarily effective against vampires and are found throughout Mexico! They are often used (camouflaged and open) as countermeasures along defensive perimeters and dug-in fortifications.

**Punji Sticks:** Sharp wooden stakes stuck into the base of trees, in tree branches, or on the ground at strategic locations, near settlements, defensive perimeters, off to the sides of paths and so on. People who stray off the path or go where they don't belong, may step on, stumble, trip, fall or lean into 1D4 stakes/spikes.

Each stake inflicts 1D6 points of S.D.C. damage. Wood and S.D.C. material punji stakes do no damage to characters in M.D. body armor and are rarely used for that reason.

As noted previously, Vibro-Blades and other Mega-Damage materials may be used, but are not as effective; Vibro-Blades tend to hum, tipping off their location, and M.D.C. materials scrape but seldom puncture M.D.C. armor unless the victim falls on or drives across them with some force. Punji sticks are a form of guerilla warfare designed



for use against humanoid enemies. Traveling slowly and carefully, they are easy to detect and avoid, but if reckless or running, the character is likely to run into them headlong.

**Punji-Stick Drop-Fall Trap:** A large weight bristling with sharp, wood stakes is suspended in a tree. It is released by a trip wire and either drops down or swings across the target area. Characters can try to dodge but are -3 to do so. This trap inflicts 6D6 S.D.C. damage to unarmored victims. Those wearing M.D. body armor suffer 2D4 S.D.C. damage from the impact and are knocked off their feet; lose initiative and one melee action!

**Swinging Log:** A huge log or piece of debris (cannon barrels and the legs from a giant robot are also used) is suspended in a tree. When released by a trip wire or pressure plate, it swings across the target area. All characters in the path of its swing are struck and suffer damage unless they successfully dodge at a -3 penalty. Characters wearing M.D. body armor suffer 6D6 S.D.C. damage from impact, unarmored victims suffer 2D6x10 S.D.C. (or one M.D. point)! Individuals struck by the log are knocked out cold by the tremendous impact for 3D4 melee rounds. The trap is a favorite for attacking groups of soldiers walking in single file, as well as against power armor.

Robot vehicles struck by the huge weight have a 01-50% likelihood of being knocked off their feet; vehicles knocked off their path. The vehicle crew suffers 1D4 S.D.C. damage from being thrown around the cockpit.

**Barbed Wire Barrier:** Cords or rolls of barbed wire are laid across a pathway, entrance or particular area (concealed or not) to bar its path. While the wire will not hurt Mega-Damage body armor, it still hooks and entangles the feet and snags any fabric, thus impairing movement (the wire must be cut or pulled away) and makes noise. Power armor units and 'bots can often tear right through it or stomp it down with no penalties, but their passage will still make some noise.

**Rock Slide/Log Fall:** Rocks or massive logs or debris piled at the top of an incline are released to tumble into the target area. Every foot soldier, 'bot or vehicle in the area suffers 1D4 M.D. from the impact of rocks or M.D. debris or 1D6x10 S.D.C. from logs. Unless the victims make a successful dodge at -8 and are able to dive for cover, they are struck and carried away by the tumbling rocks, logs or debris. Most will become pinned in or trapped beneath the fallen materials until rescued by companions.

Even those individuals who dodged successfully are trapped at the edge of the pile and need 3D4 melee rounds to work themselves free. Robots and vehicles, who are often targeted by this trap, have no chance to dodge and a 01-90% likelihood of getting knocked down or pushed 1D6x10 feet off the path. Furthermore, they are struck by more of the falling debris, suffer triple damage and are likely (01-75%) to need a crane, giant robot or several power armor troops to pull them free. The crew of the vehicle suffers 2D6 S.D.C. damage. During this time, the designers of the trap typically swarm the helpless vehicles, bots or soldiers, attacking or taking prisoners. In addition, the debris covered road/area is more difficult to travel over. This trap is very popular in hilly and mountainous regions.

**Crossbow Trap:** A crossbow attached to a tree or in a pit that shoots when a trip wire is pressed or broken. The bolt strikes the target on a 1D20 roll of 14 or higher. Damage from an ordinary bow and arrow is 2D6 S.D.C., but any of the high-tech types can be used. Often the crossbow will be loaded with an explosive high-tech bolt that inflicts 3D6 M.D. rather than a conventional projectile. Fairly common.

A variation can use an S D.C. or energy pistol (typically fires only a single shot) by having the wire press the trigger on the gun. However, this is a rarity because of the waste and cost of using a more sophisticated and high-tech weapon.

**Trip Snare:** Causes the character to trip. No damage, but the fall is embarrassing, the character loses initiative, two melee actions, and makes a loud noise that will alert nearby enemies and predators to the character's location. Usually the snare is set as part of an ambush, leav-

ing the fallen character vulnerable to the opening volley of an attack. This type of trap is extremely common.

Variations include trip flares, in which in addition to the above, a rocket flare is shot into the sky and explodes. The flare indicates the exact location of the intrusion and, at night, illuminates the immediate area of the snare.

**Animal Snare:** A simple snare designed to catch or lasso the animal's foot or head. This is typically used to capture small animals.

**Rope Snare:** This is a concealed, lasso-style snare tied to a tree. When the snare is triggered, the lasso snares the foot or feet and whips the character or animal up and suspends it, dangling from a tree, usually 5-10 feet (1.5 to 3 m) above the ground. No damage, but the character loses two melee actions and needs another melee action or two to cut himself down. It is most effective in forested areas.

**Net Trap:** Rather than using a lasso-style snare, a net can be used in the above rope snare trap. The net is spread on the ground and camouflaged, but wraps around the target when triggered. The character or animal is whipped up and suspended from the tree 10 feet (3 m) above the ground. There is no damage caused by the trap but the character loses two melee actions and needs a further three melee actions to cut himself loose.

**Bear Trap:** A pair of large, clamping metal jaws that snap shut when the prey steps on the pressure plate. The metal jaws are typically chained to a tree or stake and require a combined P.S. of 24 to pry them open; a hand activated release switch will also open and reset the trap. Damage is 4D6 S.D.C., but holds its prey in place until the jaws are opened or the prey literally tears itself free; animals often bleed to death. This trap is effective against animals and unarmored humanoid prey. It is sometimes combined with a snare to trigger flares or drop a grenade.

**Naruni Bullet Mine:** A crippling trap design which employs a Naruni plasma cartridge or small explosive. The cartridge is placed in a small hole in the ground atop a nail or firing pin, then covered by a camouflaged wooden slat. When someone steps on the slat, the cartridge is pressed down on the firing pin, triggering a plasma blast that inflicts 1D4x10 M.D. to the victim's foot. Uncommon, due to the generally poor availability of Naruni ammunition. Hand grenades and other explosives are sometimes substituted.

**Grenade Trap:** A regular grenade, with its pin removed, is attached to a trip wire and placed in a can hanging from a tree. When the trip wire is pulled, the grenade falls from the can and explodes on or near the unfortunate victim. The explosion causes regular damage by grenade type, fragmentation (2D6 M.D.) and plasma grenades (5D6 M.D.) are typically used. This is a fairly common trap. Variations include the use of riot control flash/stun grenades, tear gas and smoke grenades. Fusion blocks, plastique charges and land mines are all frequently used in booby traps throughout the world. However, the character must have the demolitions skill to use them.

**Mini-Missile Trap:** Typically a snare that triggers the launch mechanism of a mini-missile! Fairly uncommon; another guerilla tactic.

**Trap & Mine Detection:** Knowledge of the strategic placement of booby traps and mines, the telltale trademarks and indications of traps and mines, how to avoid them, and the use of mine and explosive detection equipment. The character has been trained to watch for suspicious objects, dirt mounds, trip wires and camouflaging materials that may denote the presence of a trap. Simple snare traps and trip wires can be easily disarmed by the character, but the Demolitions Disposal skill is required to *disarm* mines, explosives or complex traps. **Base Skill:** 20% +5% per level of experience on visuals alone. Add +50% when using special detection equipment to locate *mines/explosives* or +10% to locate other types of traps with detection equipment. **Note:** Psi-Hounds/Dog Boys who are of the Bloodhound and German Shepherd/Alsatian breeds have a base skill of 35% +5% per level of experience to literally "sniff-out" explosives, magic traps, and "sense" other types of traps without benefit of special equipment! However, these

“Sniffers” must undergo special training, and this special focus reduces their other sensing abilities by -10%. The ordinary Bloodhound or Shepherd Dog Boy does not get any special bonus or ability and must use mechanical equipment and his ordinary senses to locate mines and traps.

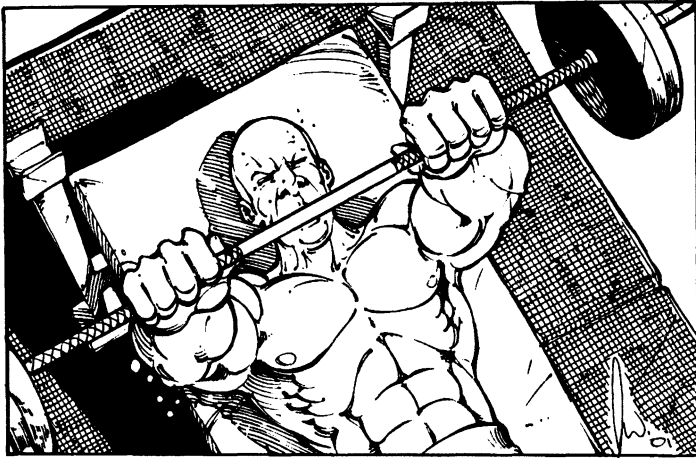

## Physical Skills

**Special Note:** One of the unique aspects of this RPG is that the player can increase his or her character’s physical attributes (P.S., P.P., P.E., Spd., S.D.C.) by selecting physical skills that build and develop the body. ALL attribute and skill bonuses are accumulative. However, a specific physical skill may only be chosen *once*, including hand to hand skills.

There are four major kinds of fighting techniques available to most characters in the Americas and Europe. They are: *Basic*, *Expert*, *Martial Arts*, and *Assassin*. Boxing and Wrestling *add* to the techniques and power of a specific hand to hand training.

*Commando* is a specialized style of hand to hand combat known to Coalition Commandos and Special Forces. Only a handful of O.C.C.s can select Hand to Hand Commando.

In Japan (and China and Asia), a number of the old martial arts have survived. The most notable *Japanese* martial arts of Rifts Earth are presented in this comprehensive G.M.’s Guide for the G.M.’s convenience. These forms and styles of combat are NOT known outside the Orient.

**No Hand to Hand:** Characters *without* combat training have one hand to hand attack at level one and get a second attack at level three, and a third at level nine.

**Hand to Hand: Basic:** Provides elementary fighting techniques and methods of attack and self-defense as taught in military basic training or in self-defense classes. See the Hand to Hand Combat section for a listing of bonuses and special abilities.

**Hand to Hand: Expert:** An advanced form of self-defense and unarmed combat taught to professionals and the military elite. See the Hand to Hand Combat section for a listing of bonuses and special abilities.

**Hand to Hand: Martial Arts:** This is some form of general oriental fighting skill (karate, kung-fu, etc.) that teaches advanced hand to hand combat. See the Hand to Hand Combat section for a listing of bonuses and special abilities.

**Hand to Hand: Assassin:** This is an advanced form of combat with an emphasis on immobilizing or killing one’s opponent quickly. See the Hand to Hand Combat section for a listing of bonuses and special abilities.

**Hand to Hand CS Commando:** A quick-and-dirty form of martial arts that stresses maximum damage and minimum finesse. See the Hand to Hand Combat section for a listing of bonuses and special abilities.

**The Japanese Arts of Combat:** Not available outside of Japan or Asia.

**Hand to Hand: Aikido:** A Japanese martial art that stresses evasion and counterstrikes. Generally unavailable to characters outside of the *Japanese Islands* unless the character has had extensive contact with one who has mastered this martial art and might have studied it from that person. See the Hand to Hand Combat section for a listing of bonuses and special abilities.

**Hand to Hand: Judo:** A Japanese martial art akin to grappling or wrestling. Generally unavailable to characters outside of the *Japanese Islands* unless they have had extensive contact with one who has mastered this martial art and might have studied it from that person. See the Hand to Hand Combat section for a listing of bonuses and special abilities.

**Hand to Hand: Jujitsu:** A Japanese martial art originally designed to give samurai a simple but effective means of unarmed combat should they ever lose their sword in battle. Generally unavailable to characters outside of the *Japanese Islands* unless they have had extensive contact with one who has mastered this martial art and might have studied it from that person. See the Hand to Hand Combat section for a listing of bonuses and special abilities.

**Hand to Hand: Karate:** A highly effective Japanese martial art that means “empty hand.” Generally unavailable to characters outside of the *Japanese Islands* unless they have had extensive contact with one who has mastered this martial art and might have studied it from that person. (Actually, Karate was very widely practiced throughout the world prior to the Rifts, so of *all* the Japanese martial arts, this one is perhaps the most likely to turn up far from its land of origin. G.M.’s discretion.) See the Hand to Hand Combat section for a listing of bonuses and special abilities.

**Hand to Hand: Kendo:** Considered by some to be more sport than martial art, Kendo teaches fundamental swordsmanship skills as well as all-around combat readiness. *Unavailable* to characters outside of the *Japanese Islands*. See the Hand to Hand Combat section for a listing of bonuses and special abilities.

**Hand to Hand: Ninjutsu/Tai-Jutsu:** The secret fighting style of the Japanese ninja assassins. *Unavailable* to characters outside of the *Japanese Islands*. See the Hand to Hand Combat section for a listing of bonuses and special abilities.

**Hand to Hand: Teng-Jutsu:** A peculiar style of fighting mastered by the *Tengu*, Japanese winged goblins. Extremely rare even in Japan, and *unavailable* outside of the *Japanese Islands*. See the Hand to Hand Combat section for a listing of bonuses and special abilities.

**Hand to Hand: Zanji Shinjinken-Ryu:** A specialized and deadly martial art of samurai swordsmanship. *Unavailable* to characters outside of the *Japanese Islands*. See the Hand to Hand Combat section for a listing of bonuses and special abilities.

## The rest of the Physical Skills:

**Acrobatics:** Aerial feats of agility and strength, such as walking a tightrope, high wire, trapeze, and stunts performed above ground. Other physical abilities include rolls, somersaults, leaps, and falls. Provides all of the following:

Automatic kick attack at first level; 1D8 (or 2D4) damage.

Sense of Balance (60% +5% per level of experience)

Walk Tightrope/High Wire (60% +3% per level of experience)

Climbing (40% or adds +15% to Climb skill)

Prowl (30% or adds +5% to Prowl skill)

Climbing (40% or +15%)

Prowl (30% or +5%)

+2 bonus to roll with punch or fall

+1 to P.S.                    +1 to P.E.

+1 to P.P.                    +1D6 to S.D.C.

**Aerobic Athletics:** A type of aerobic exercise to build the body, develop reflexes and grace, and learn a few very basic self-defense moves.

Sense of Balance (30% +5% per level of experience)

+2D4 S.D.C.

+1 to disarm

+1 to pull punch

+2 to kick damage

**Athletics (General):** Training in, and enjoyment of, vigorous exertion for competitive sports, exercises, and contests of strength, endurance, and agility. Provides the following bonuses:

+1 to parry and dodge

+1 to roll with punch or fall

+1 to P.S.

+1D6 to Spd.

+1D8 to S.D.C.

**Body Building & Weight Lifting:** The building of muscle tone and body strength through weight lifting and exercise. Provides the following:

+2 to P.S.

+10 to S.D.C.

**Boxing:** Classic art of fighting with fists. Training helps build the body and reflexes. Skilled boxers will automatically knockout an opponent on a roll of a natural twenty. The victim of a knockout will remain unconscious for 1D6 melees. Unlike normal knockout/stun, the player does not have to announce that he is trying to knockout his opponent before making a roll to strike. The following bonuses are provided:

+1 additional attack per melee

+2 to parry and dodge

+1 to roll with punch or fall

+2 to pull punch

+2 P.S.

+3D6 to S.D.C.

**Climbing:** Knowledge of the tools and techniques for climbing up sheer surfaces. Players should roll once for every 20 feet (6 m) of a vertical climb. If the roll fails, it means he is losing his grip; however, every "skilled" climber gets a chance to regain his grip, roll again. Two consecutive failed rolls means the character falls. **Base Skill:** 40% +5% per level of experience.

Rappelling is a specialized rope climbing skill used in descending from helicopters, scaling walls and cliff facings. For game purposes, rappelling will include ascending and descending climbs. **Base Skill in Rappelling:** 30% +5% per level of experience.

**Deadball:** This sports skill concentrates on dodging techniques, reaction speed, and general athletic abilities. A character with this skill automatically knows the Deadball game rules and W.P. Deadball (see Weapon Proficiencies, later in this section).

+1 on initiative

+1 to dodge

+1 to roll with fall or impact

+1D6 to Speed attribute

+2D4 to S.D.C.

**Gymnastics:** Learning to do falls, rolls, tumbles, cartwheels, somersaults and to work the parallel bars and rings. This sport builds great upper body strength, grace, and balance. Provides all of the following:

Automatic kick attack at first level: 2D4 damage.

Sense of Balance (50%+5% per level of experience)

Work Parallel Bars & Rings (60%+3% per level of experience)

Climb Rope (70%+2% per level of experience)

Back Flip (70%+5% per level of experience)

25% base Climb ability or adds +7% to Climb skill.

30% base Prowl ability or adds +5% to Prowl skill.

+2 bonus to roll with punch or fall

+2 P.S.

+2 to P.E.

+1 to P.P.

+2D6 to S.D.C.

**Juicer Football:** This sports skill teaches the character the rules of the game, basic tactics and combat elements. A character with Juicer Football can use this skill for most of the game's maneuvers, including throws and passes. **Base Skill:** 32% +4% per level of experience. This skill is not recommended for *ordinary humans*. It imparts the following abilities and bonuses:

**Body Block/Tackle:** Knocks one's opponent to the ground (90% chance if target is smaller than attacker, 60% if the same weight, 50% if target is up to 50% larger, 20% if 100% larger, no chance if target is over 100% larger). The tackled person loses initiative and one melee attack/action and suffers 1D4 S.D.C. +P.S. bonus damage (if any) per each person who tackles him. See *Juicer Uprising* for details about Juicers and their sports.

+1 to roll with punch/fall

+1 to P.S.

+1 to P.E.

+1D4 to Spd

+3D6 to S.D.C.

**Juicer Murderthon:** Another sports skill usually reserved for Juicers. It teaches the character all the basic rules and combat maneuvers of the game. This skill is not recommended for *ordinary humans*. See *Juicer Uprising* for details about Juicers and their sports. It offers the following bonuses:

+1 to strike

+1 to dodge

+1 to roll with punch or fall

+2D6 to Speed

+2D4 to S.D.C.

**Prowl:** This skill helps the character to move with stealth; quietly, slowly, and carefully. Techniques include balance (50%+5% per level of experience) and footing, short steps and pacing, rifle positioning, prone positions for low visibility, and crawling. A failed Prowl roll means that the character has been seen or heard. If the Prowl roll is successful, then the character is not seen or heard and may make a sneak attack. **Base Skill:** 25% +5% per level of experience.

**Running:** A routine of running and exercise to build speed and endurance. Provides the following:

+1 to P.E.

+4D4 to Spd

+1D6 to S.D.C.

**Swimming:** The rudimentary skill of keeping afloat, dives, swimming and lifesaving techniques. The percentile number indicates the overall quality of form as well as skill of execution. A character can swim a distance equal to 3x his P.S. in yards/meters per melee round. This pace can be maintained for a total of minutes equal to his P.E./endurance. **Base Skill:** 50%+5% per level of experience.

**Swimming & Fatigue Note:** For humans and similar surface dwelling D-Bees, the act of swimming on the surface of the water has the same fatigue rate as running and medium to heavy exertion, especially at great speed or for very long periods of time. Swimming underwater with S.C.U.B.A. equipment or other underwater equipment is considered to be light activity, unless extremely active, involved in combat or fast swimming (in which case it is considered strenuous or heavy activity).

For most aquatic life forms, including D-Bees and mutants, underwater activities such as fast swimming, diving, playing and underwater

acrobatics are considered light activities and can be conducted for hours without fatigue. Pulling a heavy load and engaging in combat is considered medium to heavy activity.

The buoyancy of water reduces the weight of most items by 30% when carried underwater. This means the fatigue rate for carrying a heavy load is reduced by 30%, meaning 30% more can be carried at the normal fatigue rate. Characters can also lift 30% heavier weights.

**S.C.U.B.A.:** The letters S.C.U.B.A. stand for Self-Contained Underwater Breathing Apparatus. Individuals learn the methods and equipment needed for skin diving and underwater swimming. A character can swim a distance equal to 2x his P.S. in yards/meters per melee. This pace can be maintained for a total of minutes equal to his P.E./endurance. **Base Skill:** 50% +5% per level of experience. **Note:** The maximum safe depth one can go without getting the bends is about 120 feet (36.5 m). Deeper depths are possible with depressurization, special suits and submarines. Swimming is required to select S.C.U.B.A.

**Wrestling:** As taught in old high schools and colleges, wrestling is more of a sport than a combat skill, but it does provide some useful combat moves. Provides the following:

#### Wrestling Special Moves:

1. Body block/tackle does 1D4 damage (double if the wrestler is 8 to 12 feet/2.4 to 3.6 m tall, and 3D6 damage if larger). The opponent must dodge or parry (push away/deflect attacker) to avoid being knocked down. If knocked down, the opponent loses one melee attack/action and initiative for the rest of that round.

2. Pin/incapacitate on a natural roll of 18, 19, or 20. This means that the wrestler can hold his opponent in such a way that his opponent cannot physically attack or move. However, the character who is using the "pin" hold cannot attack or move without releasing his opponent.

3. Crush/squeeze does 1D4 S.D.C. damage per squeeze attack (double damage if 8 to 12 feet/2.4 to 3.6 m tall, and 3D6 damage if larger). Each "squeeze" counts as one melee action/attack.

#### Wrestling Bonuses:

- +1 to roll with punch, fall or impact.
- +2 to P.S.
- +1 to P.E.
- +4D6 to S.D.C.

## Physical Space Skills

**Depressurization Training:** This skill represents extensive training in coping with and surviving depressurization in space and the use of spacesuits. It certainly does not allow one to live through extended exposure to the vacuum of space, but it does extend the time that the character can go without oxygen and teaches techniques to minimize damage from depressurization. Even a character with this skill will die unprotected in space, but they can last longer than most others while waiting to be saved or trying to save themselves. This skill only helps those races vulnerable to such pressure changes and is of no benefit to mineral aliens.

**Bonuses:** +1 to P.E. and +10 to S.D.C. Can survive twice as long as normal (takes half damage) when exposed to the void.

**Oxygen Conservation:** Oxygen conservation is a physical skill, and allows a character to reduce the amount of oxygen that they need to survive. By concentrating on nothing else, a character with this skill can lower their heartbeat, metabolic rate and breathing to half their normal rate, and therefore, will consume half as much oxygen (lasts twice as long). It is often taught as a survival precaution. It also adds +1 to P.E. attribute. **Base Skill:** 30% +5% per level of experience. Must know Basic Math.

**Zero Gravity Combat: Basic:** Rudimentary experience in a weightless environment that allows for controlled movements and adequate compensations.

**Bonuses:** Number of attacks per melee round are unchanged. +1 on initiative, +1 to strike, parry, disarm, and pull punch, +3 to dodge, and +5 to normal speed.

**Zero Gravity Combat: Elite:** Advanced skills in a weightless environment, including specific combat training in such. This skill allows for fully controlled movements and skilled compensations for drift and physical reactions.

**Bonuses:** +1 attack per melee round, +1 on initiative, +2 to strike, parry, dodge, disarm, and pull punch, and +10 to normal speed. **Note:** The bonuses from either zero gravity combat skill apply ONLY when the character is in a *weightless state*.

**Space Movement: Zero Gravity:** This skill is given automatically to any character born in zero gravity or a gravity field of less than 0.1 g (10% of Earth); all others must select it as normal. It simply allows a character to move with complete freedom in conditions of zero gravity. G.M.s may, at their discretion, make players roll against this skill rather than making a P.P. check for difficult moves. Characters who do not have this skill will have difficulty performing normal tasks in zero gravity. They move and fight with the following penalties: -15% on skill performance, -1 attack/action per melee, -2 on initiative, combat bonuses are reduced by half and speed is reduced by half. **Base Skill:** P.P. multiplied by 5%, +4% per level of experience.

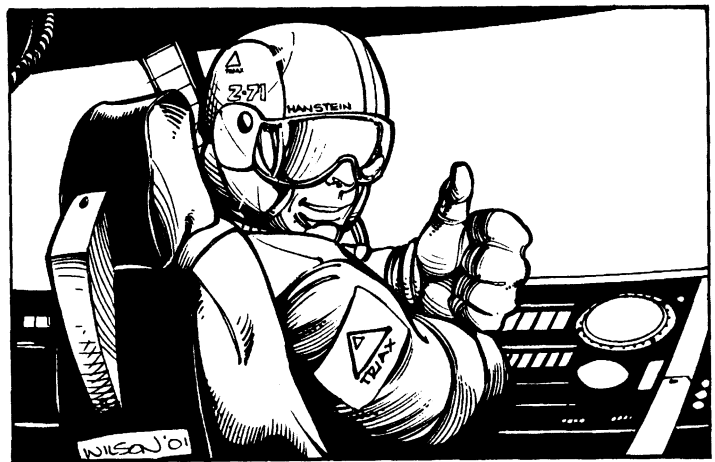

## Pilot Skills (Ground, Air, Water)

**Advanced Deep Sea Diving:** Skill in the methods, techniques and equipment used in deep sea diving and exploration. Includes the use of most types of diving suits, diving pods (attached to tethers/lifelines) and light to medium power armor! It does not include combat models. **Base Skill:** 40% +5% per level of experience.

**Airplane:** Includes old propeller, single and twin engine types. **Base Skill:** 50% +4% per level of experience.

**Automobile:** Manual and automatic transmission; includes dune buggies, jeeps, and small trucks. **Base Skill:** 60% +2% per level of experience.

**Bicycling:** Means the character can ride over rough terrain, reach two times normal running speed and travel cross-country at normal running speed, and perform tricks and jumps (roll below skill level; failed roll means a crash). Maximum speed can be maintained for a time equal to the P.E.x5 in minutes. Skill also includes basic maintenance/repairs. **Base Skill:** 44% +4% per level.

**Boats: Sail Types:** Small sailing and medium-sized sailing yachts, and fishing boats. **Base Skill:** 60% +5% per level of experience.

**Boats: Motor & Hydrofoil Types:** These include all types of small motor driven boats and yachts. **Base Skill:** 55% +5% per level of experience.

**Boats: Ships:** This includes all large sailing and motor driven seafaring vessels. **Base Skill:** Sailing Ships: 45% +5% per level of experience. Motor Driven Ships: 44% +4% per level of experience.

**Boat: Warships & Patrol Boats:** Special training in the use of military warships, combat hydrofoils, patrol boats and amphibious beach craft/transports. Includes a basic idea of how to use sonar and targeting equipment, depth charges, torpedoes, and other common weapon systems, as well as evasive maneuvers and piloting. **Base Skill:** 40% +4% per level. **Note:** Characters with the motor boat or ship skill can also pilot these vessels but at a -12% penalty.

**Combat Driving:** This skill supplements other driving skills by helping to make the character a master of the roads when driving ground vehicles (cars, motorcycles and ground hugging hover vehicles are included, but aircraft, bots and power armor are not).

It helps to turn the character into an aggressive road-hog and cool-headed “chicken” player. In fact, tricks, dangerous maneuvers and car chases are challenging and fun for this daredevil, although his passengers are likely to fear for their lives.

In game mechanics, skill penalties for tricks, vehicular attacks (ram, sideswipe, etc.), and evasive maneuvers are reduced by half, plus the character is +2 to dodge when driving, +2 to survive a crash, fall or impact, can fire a weapon from a moving vehicle at only a -2 penalty, and can even make an aimed or “called shot” (at -2 to strike) while on a *moving* vehicle. This is a supplemental piloting skill applicable only to ground vehicles and does not have a base skill or level of progression other than reduce penalties an additional one point per level of the driver’s experience. **Note:** This skill originally appeared in *Rifts® Australia One* where it was called *Outback Combat Driving*. It is a NOT likely to be a conventional skill known to most O.C.C.s outside of Australia, especially those born and raised in the city. Consequently, the G.M. can prohibit players from taking Combat Driving if he feels it is inappropriate. The *Wilderness Scout*, *Crazy*, *Operator*, *Psi-Stalker*, *Fly-Boy Ace (CS)*, *Highwayman (bandit)*, *Cossack (Russian)*, *Wingrider (Russian)* and *Headhunters (any)* are among the most likely candidates for this skill. No psychic or magic O.C.C.s should have it, with the possible exception of the *Controller Battle Magus*.

**Combat Pod (Naruni vehicle):** Training includes maneuvering and controlling remote-control drones, evasion and combat pod attack strategies. **Base Skill:** 40% +4% per level of experience. The skill gives the user +2 to strike, parry and dodge while inside a combat pod of any kind. **Note:** This vehicle is super-rare on Rifts Earth.

**Contragravity Pack (Naruni):** Similar to piloting a jet pack, only for systems that use antigravity or other super-high-tech modes of propulsion. Contragravity packs are well beyond the manufacturing capabilities of any human power currently present on Rifts Earth. **Base Skill:** 42% +4% per level of experience. **Note:** Rare on Rifts Earth.

**EVA:** Short for Extra-Vehicular Activity, this skill involves working outside a spacecraft while wearing a vacuum suit. The skill covers suit operation and repair, damage control, maneuvering and knowing what to do when things go wrong. A character should have Zero Gravity Movement to take this skill. **Base Skill:** 40% +5% per level of experience.

**Flight System Combat (Juicer):** Exclusive to Juicers, Crazies and similarly augmented people/O.C.C.s. This skill allows the character to use specialized flight packs like the *Icarus Flight System* at full efficiency and take advantage of all possible bonuses. The sophisticated control systems of the Icarus are as quick to react as the systems of a suit of power armor. Those without training do not get the following bonuses and the base skill level is reduced by half. **Base Skill:** 40% +5% per level of experience; applicable for trick maneuvers. **Bonuses:** +1 attack/action per melee while flying at levels 1, 3, 5, 8 and 11, and +2 to dodge when flying. If the pilot has auto-dodge, he can use it while flying!

**Helicopter:** The specialized skill required to fly all types of helicopters, including combat ‘copters (but must have the Weapon Systems skill to operate weapons on a combat helicopter). **Base Skill:** 35% +5% per level of experience.

**Hover Craft (Ground):** The knowledge needed in piloting hovercycles and other hover vehicles used for ground transport. These vehicles can be tricky, because they utilize several air jets and directional thrusters that push the craft along, above the ground, on a cushion of air. The vehicles can usually attain great speeds, are capable of driving over incredibly rugged terrains, and make sensational jumps over small craters and ravines. **Base Skill:** 50% +5% per level of experience.

**Hovercycle:** Characters who select the pilot Hover Craft skill can drive hovercycles, hover cars, etc., however, those who specifically select the pilot Hovercycle skill can pilot any type of hovercycle, rocket sleds, or jet propelled, one- or two-man hover vehicles with skill and finesse. They can also perform jumps, stop on a dime, perform dive-drops (i.e. soar off the edge of a cliff, keep control of the hovercycle and keep on going without crashing when they reach the bottom), and tricks without penalty (-20% to piloting rolls if the only skill is the general pilot Hover Craft). **Base Skill:** 70% +3% per level of experience.

**Jet Aircraft:** Includes large and small commercial transport jets. **Base Skill:** 40% +4% per level of experience.

**Jet Fighters:** Training includes flying, maneuvering, aerial combat strategies, and typical fighter jet weapon systems. **Base Skill:** 40%+4% per level of experience.

**Jet Packs:** This is the piloting skill for backpack-like units that strap to the back of an individual to carry him airborne. The typical jet pack is a one person unit capable of hovering above the ground and flying at an average altitude of 300 feet (91.5 m). **Base Skill:** 42% +4% per level of experience.

**Jump Bike Combat (Juicer):** Exclusive to Juicers, Crazies and similarly augmented people/O.C.C.s for the use of the specialized *Tarantula Jump Bike*. **Base Skill:** 45% +5% per level of experience.

**Bonuses:** +1 attack per melee round with bike’s weapon systems, +1 to Automatic Dodge.

**Bike Jump Attack:** This attack uses the rockets to have the bike jump in the air and then land on a target. The sensitive rocket controls require a special skill roll. **Base Skill:** 25% plus 5% per level of experience. If the skill roll is successful, the pilot can make a normal attack roll (at +1 to strike in addition to normal bonuses) to hit the target. Damage to his opponent is 3D6 M.D. **Note:** This attack can only be done if there is room to maneuver (open terrain only).

**Kayaking & Canoes:** Allows the use of most paddled boats and canoes, row boats and knee boards, as well as the Kayak. Speed in still water is usually equal to the character’s P.S. attribute (treated for all purposes as Spd) and can be maintained for P.E. x5 in minutes without pause. The skill also includes basic principles behind using currents, maintenance, and even “tricks” like sculling and right-siding a flipped canoe, etc. **Base Skill:** 50% +5% per level.

**Motorcycle:** This skill includes the piloting of all two- and three-wheeled vehicles such as motorcycles of all types, dirt bikes, and mopeds, as well as snowmobiles, jet sleds, Landfliers, miniature ATVs and other scaled-down vehicles. **Base Skill:** 60% +4% per level of experience.

**Road Train (Australia):** To get a picture of a road train, imagine a semi-trailer, only with four or even five trailers pulled behind the cab. These beasts guzzle gas, but are more economical than four or five trucks. They are also very unique to handle. Someone with the Pilot: Truck skill may attempt to pilot one, but with a -30% skill penalty and at half maximum speed. Some of the road trains that cross the Australian wastes are simply HUGE. In most cases, road trains are used to haul large amounts of goods and materials across such vast expanses. **Note:** This skill originates from *Rifts Australia* and can be excluded for the rest of the world, although it seems appropriate for the Africa, Chinese and Russian tundra, plains and deserts too. **Basic Skill:** 40% +4% per level of experience.

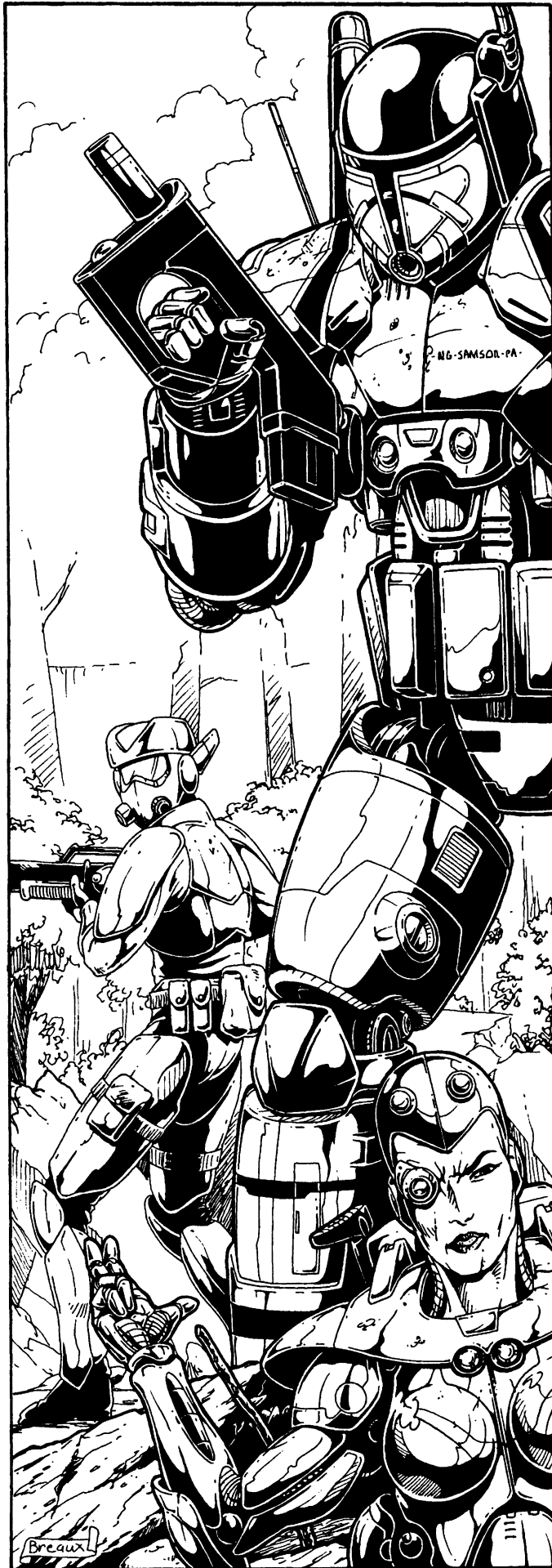

**Robots and Power Armor:** Piloting only, basic operations without any combat training or bonuses. Characters with this skill are taught the *fundamentals* of maneuvering *light and medium* giant robots (like the Titan Reconnaissance Scout or NG-M56 Multi-Bot) and power armor suits (such as the Triax Terrain Hopper, Flying Titan and Samson). These are robot exoskeletons and vehicle type robots that require a pilot and/or crew to be inside to pilot them. The training focuses on piloting, not combat; thus, *robot combat* is a separate and distinct skill (see Robot Combat skills as follows). This skill enables the character to pilot ANY type of robot vehicle or power armor (including combat models), but focuses only on “piloting” and basic function, not on how to fight or operate weapon systems.

Consequently, the character does not get ANY special bonuses or extra attacks when piloting the ‘bot or power armor – he has only his *own* physical number of attacks per melee round and bonuses to rely upon. He can use a weapon system if it is built-in, but with no special aptitude with it. In fact, the use of weapons and special combat features (targeting, radar, etc.) are so unfamiliar that they confuse the ordinary non-combat pilot, causing the following penalties whenever he tries to use weapons or fight with the robot: -1 attack per melee round (yes, that is *minus* one; loses an action trying to figure out what’s what and exactly how to use weapons and combat equipment), -2 to strike (with punches, blades, guns or missiles), and -1 to parry and dodge. Penalties do not apply if the character has the Weapon Systems skill. **Base Skill:** 56%+3% per level of experience.

*Power Armor* is typically man-sized and often worn like body armor, although sometimes the pilot sits inside. In all cases, the power armor responds to the pilot’s physical movements.

*Robot Vehicle* is typically a giant construct with vaguely human or animal features such as legs, claws, etc., but may also be vehicular in appearance or combine the two.

Many types of robots and power armor, including airborne types like the SAMAS, are suitable for use underwater, although flight/propulsion speed is reduced by 80%. Power armor without jet propulsion can travel underwater (swim or walk along the bottom), but at -80% their normal land speed. Each specific description will indicate aquatic capabilities, if any.

**Robot (and Power Armor) Combat: Basic:** Basic combat training in robot vehicles and power armor gives the pilot a fair working knowledge of most robot vehicles and their most basic combat capabilities. The pilot will be able to operate the ‘bot and use the various weapon systems and fighting capabilities, but not at maximum skill and efficiency. Bonuses and abilities imparted by “Basic” Robot Combat Training are detailed in the *Combat* section of this sourcebook. **Note:** *Hand to Hand Bonuses from Power Armor Basic Training* applies to ALL types of power armor, ground, aquatic and flyers. Use “basic” tables only.

**Robot (and Power Armor) Combat Elite:** Each robot or power armor *type* has a different weapon system, hand to hand aptitude, and quirks that make each specific *type* unique. Because each handles differently, the “elite” pilot studies *individual* types of robot war machines to familiarize himself with every element of that specific type of robot. This means the pilot must select the Robot Combat: Elite skill for *each* specific *robot or power armor type* in which he desires to be an expert operator to enjoy its maximum combat effectiveness. Elite training automatically gives the pilot a *basic* understanding and ability to pilot ALL standard types of robot vehicles and power armor at the “basic” level.

**Example of Types:** All SAMAS, CS power armor with the numerical designation PA-double digits “A” (i.e. PA-07A) are one type. CS power armor with three digits (i.e. PA-100, PA-200, etc; including the Mauler, Terror Trooper, and Glitter Boy Killer) are one type. All *UAR* robots constitute one type, and all *IAR* ‘bots another. Likewise, all *Titan* TR-three digit I.D. robots are of the same type, just at the *Triax* “X” double digit series (i.e. X-10A Predator), “X” triple digit series (i.e.

X-500 Forager), and “X” four digit series (i.e. X-1000 Ulti-Max) are each a distinct and separate “group” of robot types.

**Robot Combat: Elite** is usually reserved for specialists in the military or mercenaries such as the infamous Glitter Boys; however, just about anybody can learn to pilot and fight with a robot or power armor. There is no Base Skill percentile because the pilot gets specific bonuses as he progresses in level of experience. Bonuses and abilities imparted by Robot Combat training are detailed in the *Combat section* of this sourcebook.

**Spacecraft, Small:** This skill covers small spacecraft, ranging from maneuverable escape pods to shuttles and scouting ships to single-pilot craft. The general rule of thumb is that a small spacecraft is anything under 100 tons and/or can be piloted by a single person. These are mostly shuttle craft, one-and two man vessels and small transports (3-12 man and/or cargo bay the size of a van to a semi-trailer). Some have interstellar capabilities, but most are comparatively slow transports intended for relatively short-range travel; typical speed is about half the speed of light. **Base Skill:** 60% +3% per level of experience.

**Spacecraft, General:** The character can pilot most types of commercial spacecraft, large and small, but is most comfortable piloting medium-sized vessels such as cargo and shuttle crafts designed for interplanetary jaunts from planet to planet or solar system to solar system rather than deep space travel. **Base Skill:** 50% +4% per level of experience.

**Spacecraft, Advanced:** This skill allows a player to pilot almost any spaceship, small to large, passenger and cargo types, in almost any situation, including interplanetary journeys, deep space travel, combat and chases. They can also pull fancy stunts, make landings on the Moon in gravity wells and if necessary, can cut the amount of fuel used on a journey by up to 50%. **Base Skill:** 40%+4% per level of experience.

**Space Fighter:** Small military combat vehicles. Typically crewed by one lone pilot or pilot and crew of 1-4 men (co-pilot, gunner, etc.), designed for defense and combat: fighter to fighter combat, fighter to power armor combat, fighter to ship, and fighter to robot combat. These vessels engage in reconnaissance, escort operations, rescue, search and destroy, military support, close combat, dog-fights, and surgical strikes. Some resemble atmospheric jet fighters or shuttle craft (and may have trans-atmospheric capabilities) while others may look like rockets, geometric shapes or resemble animals (like fish) or insects. **Base Skill:** 50% +3% per level of experience.

**Space Yacht:** This skill allows a character to pilot a solar yacht and giant ore ships in orbit and on interplanetary journeys. Anyone trying this without the skill is liable to destroy the yacht’s delicate sail, making it useless. **Base Skill:** 44% +4% per level of experience.

**Starships:** These are the BIG intergalactic vessels, massive cargo ships, ore haulers, transports, battleships and other immense ships, usually with a crew and/or passengers that number into the hundreds or even thousands. **Base Skill:** 36% +4% per level of experience.

**Submersibles:** The knowledge and skill of piloting all types of submersibles, including underwater sleds, mini-sub and most types of submarines, including military submersibles. **Base Skill:** 40% +4% per level of experience. **Note:** -20% when using alien or unusual submarines. Does not include power armor or deep sea diving suits.

**Tanks and APCs:** Military vehicles often have unconventional controls and handle differently than conventional vehicles, especially the many ton, armored combat vehicles such as tanks and armored personnel carriers (APCs). Thus, special training is required to pilot them. **Base Skill:** 36% +4% per level of experience. **Note:** Those with this skill can also pilot other types of “tracked vehicles,” but at the Tank & APC skill level.

**Tracked Vehicles:** Includes landcrawlers, half-tracks, light tanks, tractors and heavy construction vehicles (bulldozers, steam shovels, etc.). **Base Skill:** 40% +4% per level of experience. Can pilot tanks and APCs but at -20% penalty and -1 attack per melee round.

**Truck:** Specifically applies to driving large cargo and transport vehicles like eight to sixteen-wheeled commercial trucks and multi-ton transports. **Base Skill:** 40% +4% per level of experience.

**Water Scooters:** The knowledge and skill of piloting all types of one- and two-man water sleds (underwater) and jet skis (surface sleds). **Base Skill:** 50% +5% per level of experience.

**Water Skiing & Surfing:** All water skiing techniques, methods and use of most types of recreational forms of “riding the waves,” including skis, ski jet boots, water boards, surf boards and sail boards. **Base Skill:** 40% +4% per level of experience.

**Wingrider Flying Wing (Russia):** The very specialized and difficult skill of piloting the Wingrider Flying Wing, gliders and similar “Wing” shaped vehicles. This skill is unlikely to be practiced by anybody outside of Russia where Wingriding was invented. **Base Skill:** 15% +5% per level of experience.

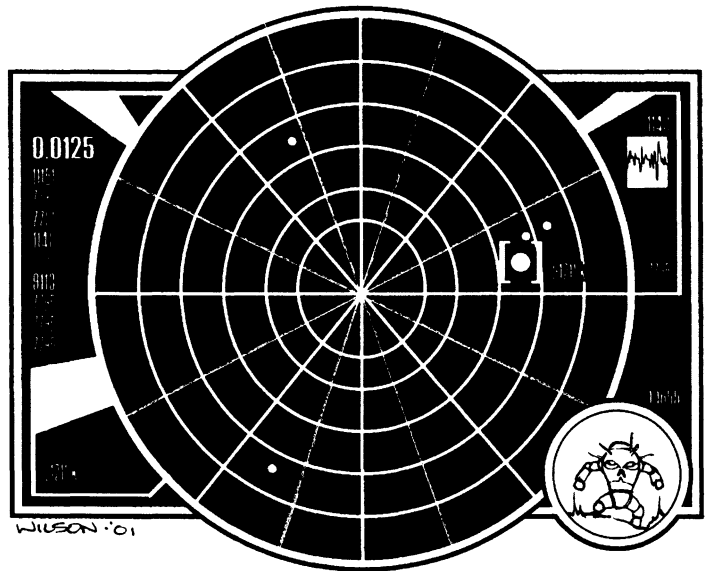

## Pilot Related Skills

**Navigation:** Training in map reading, star charts, course computation, following landmarks, and use of navigational equipment. Includes land, air, and water navigation, as well as piloting by instruments alone. A failed roll means the pilot is off course. Roll 2D6x100 for most aircraft, 4D6x100 for jets, and 2D6x10 for ground vehicles to determine how many miles/kilometers they are off course. Roll for every hour that one is off course. This skill enables characters to pilot ships and other water vessels that ride on the surface of the water by charting the stars and landmarks and using instruments. Likewise, the character can navigate submersibles using instruments and other data. Navigating marine vessels is also an aspect of the standard navigation skill. **Base Skill:** 40% +5% per level of experience. **Requires:** Basic Mathematics, Read Sensory Equipment, and at least minimal literacy.

**Space Navigation: Interplanetary:** See Navigation: Space. This was a redundant skill that has been merged with this skill.

**Navigation: Orbital:** Characters with Orbital Navigation will be able to plot courses for traveling in the orbital planes of the Earth and its moon, and will know the positions of any major objects within this area, such as space stations, rogue asteroids and “no-go” zones. **Base Skill:** 50% +5% per level of experience. **Requires:** Basic Mathematics.

**Navigation Space:** This allows a character to plot and lay in a course for the large distances between the planets, stars and solar systems. A failed skill roll means that the spacecraft is off course. To find out how far it is from its destination, subtract the character’s skill from the failed roll and multiply the result by one million (or 4D6 light years off course if traveling between galaxies). **Base Skill:** 40% +5% per

level of experience. Gets an extra +5% for interplanetary navigation in the same solar system. **Requires:** Basic and Advanced Math and Computer Operation.

**Radar/Sonar Operations:** See Read (and Operate) Sensory Equipment.

**Read (& Operate) Sensory Equipment:** Individuals with this training can operate, maintain, understand, and “read” or interpret sensory data from all types of conventional, military and scientific sensors and devices. These devices include *radar*, sonar, motion detectors, surveillance equipment, optical enhancements, instrument panels, medical monitors, and so on. Note that characters without this skill can not understand or operate advanced aircraft or detection/surveillance equipment.

**Radar & Sonar Note:** The character can expertly use radar (radio echo bounces) and sonar (underwater sound echo bounces) equipment and correctly read the information to precisely locate and track aircraft, ships and submarines, as the case may be. In submarines (and radar for spaceships), there are two methods or types of operations, *passive* and *active*. To use active sonar, the sub must give a pulse of sound to bounce off any nearby ships or objects. This is very dangerous since it immediately gives away the position of the submersible itself. Most vessels will not use active sonar unless absolutely necessary. Most will rely on passive sonar systems. This is much more difficult since the sonar operator must sift through the background noise to find any enemy ships. Sometimes they will not be able to distinguish the location of a ship from the background static. Despite this fact, passive sonar is used because it does not give away the location of the vessel. -15% skill penalty when using passive sonar or radar. **Base Skill:** 30% +5% per level of experience. **Note:** At some point a redundant skill called *Radar/Sonar Operations* appeared as a separate skill. It should be ignored as this skill covers its abilities.

**Weapon Systems:** This is the complete understanding of weapon units and systems incorporated into military vehicles, power armor, and robot vehicles. It includes lasers, particle beams, rail guns, missile and grenade launchers, cannons, and vehicle/robot weapon systems. Adds a special bonus of +1 to strike when using these types of weapons; this does not include hand-held weapons (see Weapon Proficiencies). **Base Skill:** 40% +5% per level of experience.



## Rogue Skills

**Cardsharp:** A skill that involves the manual dexterity of hand and finger manipulation to perform tricks, palming, and other gimmicks of sleight of hand with playing cards. This includes dealing from the bottom or middle of the deck, stacking a deck (to the cardsharp’s favor), hiding cards up the sleeve (and elsewhere), fancy and impressive methods of shuffling and dealing the cards, as well as “marking” cards, card counting and understanding the odds.

Marking cards often includes a complex series of Braille-like indentations, punctures or trimmed edges so that they are slightly concave or convex, all things that the delicate touch of the professional cardsharp can feel as he deals the cards. Other types of “marks” include incredibly subtle, almost indiscernible variations of the pattern on the back of cards, typically in the right, upper corner.

*A failed roll means* the character has fumbled the trick, missed (or misread) one of his secret markings, or was too obvious and is caught cheating! **Base Skill:** 24% +4% per level of experience. Add +4% if the character also has the Palming skill.

**Computer Hacking:** This is a computer skill similar to computer programming; however, the emphasis of the skill is breaking computer access codes to gain illegal access to other computer systems and steal or sabotage its data. The character is an expert in tracing computer data, bypassing defense systems, and breaking (“hacking”) codes; add a one time bonus of +5% to the Cryptography, Surveillance Systems, and Locksmith (electronic and computer controlled locks only) skills if the character is a hacker. **Base Skill:** 15% +5% per level of experience. **Requires:** The ability to read and write, Computer Operation, Computer Programming, and at least Basic Mathematics.

**Concealment:** The practiced ability to hide small items on one’s body or in hand, usually by continually moving it around from hand to hand or place to place unnoticed. Objects must be no larger than 14 inches (36 cm) in height and depth, and six inches (15 cm) in width. The weight must also be 10 pound (4.5 kg) or less. The smaller and lighter the object, such as a knife, gem, key, credit card, etc., the easier it is to conceal (add a bonus of +5%). Larger items, such as a book, scroll, club, statue, or similarly large or heavy object, are more difficult to conceal on one’s person for obvious reasons. **Base Skill:** 20% +4% per level of experience.

**Find Contraband, Weapons & Cybernetics:** The character with this skill knows where to find arms dealers, smugglers, body chop-shops, M.O.M. and Juicer conversions, criminal Cyber-Docs and illegal medical treatment, as well as how to spot them. He is also familiar with their hang-outs, gang or criminal ties, general practices, codes of conduct, pricing structures and modes of operation. Likewise, the character has a good idea of what black market weapons and cybernetics should cost and what these people pay for contraband items (typically about 20% of what they sell it for). The character also knows the penalty for being caught with an illegal weapon, implant or bionics. For most societies, any M.D. weapons, concealed weapons and sidearms are forbidden inside large population centers. This skill is especially appropriate in the modern cities of Rifts Japan, as well as in large cities of the Coalition States, the NGR, Atlantis, and other large, modern cities. **Base Skill:** 26% +4% per level of experience. **Note:** This skill should be considered a separate skill apart from streetwise.

**Gambling (Standard):** This skill enables the character to skillfully play several different games of chance. The character knows the rules of 1D4 games, plus one additional game for every 2 points of the character’s I.Q. (rounded up). In addition to rules, the character understands the theories of mathematical “odds” (+5% bonus to math skill), some basic strategies and tactics for winning consistently, when to hold them, fold them, etc. **Base Skill:** 30% +5% per level of experience.

**Gambling (Dirty Tricks):** This is the other side of gambling in which the character is skilled at cheating in games of chance. This includes knowledge of dirty tricks such as counting cards, how to use marked cards, using trick/loaded dice, stacking the deck (in one’s favor), sleight of hand tricks to hide cards up sleeves or in the palm of the hand, dealing from the bottom of the deck, and other cheats (must have the Palming skill for the latter two). **Base Skill:** 20% +4% per level of experience.

**Palming:** Simply the ability to pick up and seemingly make a small object, such as a coin, key, or credit card, disappear by concealing it in one’s hand. Adds a bonus of +5% to the Pick Pockets skill. **Base Skill:** 20% +5% per level of experience.



**Pick Locks:** The character knows the methods and tools for picking/opening key and basic tumbler type locks. This does not include sophisticated computer or electronic locks.

It takes 1D6 melee rounds for each attempt to pick a lock. A failed roll means the lock holds; try again. **Base Skill:** 30% +5% per level of experience.

**Pick Pockets:** An ability to remove items from a person without their being aware of it. If a pick pocket attempt fails, the item has NOT been removed and there is a 67% likelihood of the intended victim recognizing the intent of the action. **Base Skill:** 25% +5% per level of experience.

**Prowl:** This skill helps the character to move with stealth; quietly, slowly, and carefully. Techniques include balance and footing, short steps and pacing, rifle positioning, prone positions for low visibility, and crawling. A failed prowl roll means that the character has been seen or heard. If the prowl roll is successful, then the character is not seen or heard and may make a sneak attack. **Base Skill:** 25% +5% per level of experience.

**Safe-Cracking:** This is a specialized skill in which the character studies the strengths, weaknesses, and construction of safes and how to open them without damaging the contents inside. The fingers of the safecracker are so sensitive that they can "feel" the subtle calibration of combination locks and other locking mechanisms. When using explosives, they can use their abilities to such precision that they can "blow" the lock off a safe, security door, safe deposit box and similar without creating a big, area affect explosion or inflicting damage to the contents (a failed Safe-Cracking skill or demolitions roll means the explosion was too much and the contents are damaged). **Base Skill:** 20% +4% per level of experience. **Bonuses:** Adds +5% bonus to the Lock Picking and Demolitions skills. **Penalties:** Requires focus, concentration and keen hearing, characters with a M.E. under 15 are -10% on this skill.

**Seduction:** This is the ability to make the opposite sex melt with desire. This skill is somewhat similar to the interrogation skill, in that the seducer knows how to ask the right questions to get information without being obvious. The seducer usually seems attentive, sympathetic, and alluring/sexy. Men and women who are seduced tend to have loose lips, meaning they tend to talk freely, say more than they should, and tell secrets. They also lose track of time, spend big money to impress and please their seducer, and lavish her or him with their affection, time and attention, while oblivious to everything else around them. Most of all, somebody who is seduced is vulnerable. The person who is successfully seduced is distracted, skill performance is half and takes twice as long to perform, the character has no initiative, does not notice people or events around him/her, and is easily caught off guard; no initiative and all bonuses are at half when attacked by a character other than the seducer.

Worse, the victim(s) of seduction is completely vulnerable to the seducer! The seducer always gets the first strike/attack/action (any roll above a 4 hits or is successful). The victim has no chance of self-defense against that first attack, plus loses one attack/action from surprise or horror. In addition, the seducer is +5% to Pick the Pockets of, Palm, or plant things on, his/her victim of seduction, as well as +5% to the skills Cardsharp, Sing and Dance. Research has shown that the more alcohol the intended victim drinks, the easier he/she is to seduce (+5%). **Base Skill:** 20% +3% per additional level of experience. **Skill Bonuses:** +1% for every one M.A. attribute point above 20, and every two P.B. points above 17. So a character with a P.B. 23 (+3) and M.A. 24 (+4) would be +7% to successfully seduce a victim. The seducer can influence more than one person at a time; one additional per every three levels of experience.

**Streetwise:** This skill instills an understanding of the darker side of city life and the scoundrels who roam the streets. The streetwise character will be able to recognize gang members by their actions and philosophies, gang colors (emblems and clothing that denote membership to a particular organization), gang symbols and mannerisms, and dan-

gerous locations and gangland haunts. The individual will also recognize a potential brawl situation, assess a gang member's rank/power in the organization, and know some of the hangouts, modes of operation, rituals, ethics, and perhaps even notorious gang leaders of the more infamous street gangs. This skill also includes the ability to recognize and locate black market dealers/organizations, illegal Cyber-Doc clinics, drugs and arms dealers, and similar criminal outfits. **Base Skill:** 20% +4% per level of experience.

**Streetwise: Drugs:** The following additional street knowledge can be included as part of the regular streetwise skill or used as an additional rogue skill; G.M.'s choice. If used as a separate skill, then **Base Skill:** 25% +5% per level of experience.

This skill gives the character the ability to recognize characters addicted to drugs, street corner pushers, big time dealers, drug smugglers, Juicers, Japes, and undercover agents looking to bust dealers. Similarly, the character has a good idea what drugs cost, how to use them and where to buy them (even if he doesn't use them himself). The character also knows most of the "street names" of common drugs, recognizes the drug when he sees it and knows the general effects and dangers it represents. He can also recognize the symptoms in others and can guess what drug a user may be high on with reasonable accuracy (roll under skill ability).

**Ventriloquism:** The practiced ability to throw one's voice. This can be used to create the illusion of not speaking while making a voice or verbal noise appear to be coming from someone or something else, such as a puppet, a tree, box, chair, etc. Maximum range is 10 feet (3 m) away. A failed roll means the voice is not well thrown or the ventriloquist's mouth is seen moving, so the trick does not work. **Base Skill:** 16% +4% per level of experience.



## Science Skills

**Note:** In the world of Rifts, the majority of people can not read nor write. Most of the science skills *require* Literacy as a prerequisite skill. Anthropology and Mathematics are the only exceptions because they can be committed to memory.

**Anthropology:** This is the behavioral study of man and other intelligent life-forms and their environments. Studies include societies, customs and beliefs, religions, political structure, as well as rudimentary history and archaeological background. It is important to note that anthropology is more concerned with the study of modern races and societies than it is with ancient ones. This is especially important when dealing with other races and cultures in the present time in order to avoid accidentally breaking taboos or codes of behavior. It will also tell the anthropologist whether he may be dealing with a dangerous people (hate humans, fear technology or magic, are cannibals, worship demons, etc.).

The skill can also be used in the examination of items/artifacts and ruins to identify the probable people/race, purpose, and technological level. The character can identify the period in which the item was used (contemporary or ancient), but is not skilled enough to tell whether an item is an authentic artifact or a forgery. In the world of Rifts, few humans and fewer non-humans know much about humankind or the world before the Rifts. The anthropological student is one of the few who is well versed in the legends and few facts about the "Time of Man." As a result, he can often identify pre-Rifts technology and man-made creations. He is also knowledgeable in their black market value and the many laws that prohibit the possession, sale, and scavenging of ancient artifacts. **Base Skill:** 20% +5% per level of experience.

**Archaeology:** This is the scientific study of relics of ancient civilizations by excavation and other means. Studies include proper excavation (digs) techniques, analysis, preservation, restoration, and dating methods (including carbon dating), as well as a rudimentary history and anthropology background.

Like the anthropological student, the archaeologist is one of the few who is well versed in the legends and few facts about the "Time of Man." He is an expert in the identification of pre-Rifts technology and man-made creations, from books and clothing to vehicles and buildings. The character can ascertain whether the item is an ancient artifact or of recent construction, and therefore, if an item is an authentic artifact or a forgery. He is also well versed in their black market value and the many laws that prohibit the possession, sale, and scavenging of ancient artifacts. For example: The possession of books (even comic and children's books), video discs, or other pre-Rifts educational or technological data is illegal by the decree of the Coalition. Failure to turn such items over to the government is a serious crime punishable by imprisonment or death. **Base Skill:** 20% +5% per level of experience.

**Artificial Intelligence:** This an area of science that is usually available only to those who specialize in robotics and computers (which may include the Operator and Rogue Scientist O.C.C.s). True artificial intelligences (A.I.s) – robots that can think and learn for themselves – are incredibly rare in North America and most of Rifts Earth. Thus, this skill is more common "off-planet" on advanced worlds like Phase World and other space settings (including that of *Mutants in Orbit* around the Earth). A.I.s range from simple thinking computers and devices with problem solving capabilities and the ability to learn and think independent of an operator, to devices modeled on the neural network of the human mind and can think, learn, solve problems, create and even imagine (i.e. Archie-3).

A character with this science skill understands the many principles and theories behind how advanced artificial intelligences work, how they "think" and "understand" the world around them, how to communicate with them and how to reprogram them, either directly or by argument. **Requires:** Computer Operation. **Bonuses:** +5% to all other computer skills including Programing and Hacking. **Base Skill:** 30% +3% per level of experience.

**Astrology:** Astrology is still a questionable science, written off as pure hokum by its critics. Those who put their faith in this discipline maintain it helps them make informed guesses about the near future from the positions of the stars and planets. It is still far from an exact science, depending more on hypothesis, emotions/sensations and the study of human nature, than on factual learning, but anyone can understand the basic principles behind it.

Astrologers do not pretend to know the exact future. They may be able to detect general trends from the patterns and arrangements of the heavens, and if asked a specific questions can sometimes make more accurate predictions. They are more likely to sense or see "danger," or "turmoil," or "a big decision," this week than specific knowledge. The future that they predict is not what will happen, but what might happen, depending on circumstances. And that's their pitch, be more prepared so one can make the best decisions and act accordingly.

Making an astrological prediction takes about an hour of game time, during which the character is assumed to be plotting a star chart. A quick glimpse into the person's psyche or the general future takes 1D6 minutes and is very vague. A player may ask a specific question, in which case their skill roll is increased by 10%. The G.M. should roll the dice in secret, since the character should not know if the roll has been a success or a failure.

If the skill roll is a success then the astrologer gains a rough, undetailed insight into what may happen in the future (based on the G.M.'s knowledge of that character, the party as a whole and the adventure they are playing). The accuracy and detail of the prediction is left to the G.M., as this is a very inaccurate science, but the G.M. should never give an exact view of the future. At best, it should reveal a few hints and possible directions for the future; at worst a successful roll should be clouded with mystery and only make itself clear once the events have actually begun to unfold.

If the roll is a failure, then the astrologer has misread the stars and the G.M. must make up a false future to tell them. The worse the failure of the roll, the more misleading, or just plain wrong, the prediction should be. Since it is rare for an Astrologer to get a high percentage in this skill, astrology is clearly not to be relied on. **Base Skill:** 8% +M.E. attribute number, and +3% per level of experience.

**Astronomy:** The study of the stars and other celestial bodies, their movements, positions, cycles, alignments, and interrelations with the earth and each other. This knowledge can also be used to determine direction, approximate distances, identify seasons, and tell the time of day. **Base Skill:** 25%+5% per level of experience.

**Astrophysics:** Knowledge of stellar astronomy and how it relates to nuclear physics, quantum mechanics, relativity and other explanations for the creation of deep space phenomena, like quasars and black holes. Gravitonic drive systems require this skill to understand the principles under which they work. **Requires:** Basic and Advanced Mathematics. **Base Skill:** 30% +5% per level of experience.

**Biology:** Basic understanding of cells, anatomy, physiology, evolution, and genetics. The character will know how to use a microscope, cultivate bacteria, and how to classify new organisms. **Base Skill:** 30% +5% per level of experience.

**Botany:** Plants, their categories and functions, are studied extensively. Characters will know the basics of cross-fertilization and germinating, as well as growing experimental plants. **Base Skill:** 25% +5% per level of experience.

**Chemistry:** The basic understanding of chemical principles and formulae. Characters know enough chemical laboratory procedures for analyzing and synthesizing chemical compounds to act as competent assistants. **Base Skill:** 30% +5% per level of experience.

**Chemistry (Analytical):** Training in chemical engineering theories useful in the analysis of compounds and their practical applications. Characters will be highly skilled in the use of laboratory equipment and can analyze and synthesize chemicals. **Base Skill:** 25% +5% per level of experience. **Requires:** Chemistry, Advanced Mathematics, and Literacy. Computer Operation is strongly suggested but not required.

**Marine Biology:** This skill is a general knowledge of the ecology of oceans and seas, with an emphasis on undersea habitats, environments, and the types of fish and sea animals attracted to such places. This skill also gives the character the knowledge of where to look for particular types of sea creatures (i.e. in coral reefs, under rocks, inside caves, warm water, cold water), the types of food sea animals eat/prey upon, migration patterns of fish and sea mammals, and a knowledge of tides, water composition, and ocean plant life.

The Marine Biology skill also gives the character specific medical and scientific knowledge about the behavior, habits, evolution, physiology, cells, anatomy, and genetics of fish, marine mammals and other types of sea life. This knowledge enables the character to perform surgery, remove glands and sacs of poison or chemicals, prepare antidotes to poisons (from sea creatures only) and the care, keeping, and medical

treatment of marine animals, including dolphins and whales. **Basic Skill:** 35%/25% +5% per level of experience. The first number is the character's general knowledge. The second number is specific medical and scientific applications, including making antidotes to poison, capturing animals without killing them (+ 10% to hunt/kill), surgery (sea animals only; -60% on humanoids), and the care, keeping and medical treatment of marine animals. **Note:** -30% when dealing with alien and mutant life forms. Requirements: Biology, Advanced Mathematics and Chemistry.

**Mathematics (Basic):** Knowledge of basic math, including the ability to count, addition, subtraction, multiplication, division, and fractions. **Base Skill:** 45% +5% per level of experience.

**Mathematics (Advanced):** Knowledge of all basic and advanced mathematics, including algebra, geometry, trigonometry, calculus, and techniques for using advanced mathematical formulae. **Base Skill:** 45% +5% per level of experience.

**Oceanographic Surveying:** The methods and ability to identify natural geographic formations (mountains, trenches, coral reefs, etc.), identify wreckage and underwater cities, identify Earth minerals, damage caused by earthquakes, earthquake zones, determining depth, accurate map making, accurate map reading and geographic photograph identification and evaluation, as well as a basic knowledge of geology and oceanography. **Base Skill:** 15% +5% per level of experience (+15% to read maps).

**Oxygen Systems:** This skill allows a character to understand all the different ways of obtaining and recycling oxygen, and to build and repair the machinery and equipment necessary for both. This is applicable to underwater and space environments with some kind of oxygen recycling system. Space and underwater stations and large ships may have a hydroponics plant, which they depend on for both food and recycled oxygen, while smaller vessels and habitats may have a basic recycling unit. Both will have some kind of equipment for converting water into oxygen and hydrogen. This is not a very exciting skill, but a necessary one for outer space and deep sea travel and habitation. **Base Skill:** 58% +4% per level of experience.

**Undersea Farming:** The knowledge of cultivating undersea plants, algae, and/or breeding aquatic animals/fish for harvesting and production. Undersea farming includes, but is not limited to, growing crops (either through hydroponics or on the ocean floor), lobster farms, oyster beds, and fish hatcheries. **Base Skill:** 35% +5% per level of experience.

**Xenology:** The biological and physiological study of alien species (rather than their culture or society). This skill provides general medical and physiological information about the most commonly encountered species in a particular region to solar system (the type of air they breathe, how their body works, any natural weapon, poisons or toxins, strengths and weaknesses, presence of psionics or other natural abilities, etc.). *On Rifts Earth*, this skill might cover the many aliens and D-Bees of a single continent. Whereas in the *Phase World*® setting (where dissemination of information is much better and aliens are everywhere) this skill covers aliens from all over the "Three Galaxies." Without Xenology, any attempts to use a medical skill on a creature from another species are at -20% to skill rolls. **Base Skill:** 30% +5% per level of experience.

## Technical Skills

**Advanced Fishing:** The normal fishing skill has to do with the recreational hobby and sport of fishing with a hook, line and pole. Advanced fishing is the knowledge of *commercial fishing techniques*, including the use of nets, cages (for lobsters and crabs), trolling, explosives, harpoon guns and other methods and techniques used in commercial fishing of mass catches from the ocean. It also includes a knowledge of baiting, as well as cleaning, preparing, storing and preserving catches for transport to market. **Base Skill:** 30% +5% per level of experience. **Note:** -15% when dealing with alien creatures and mutants.

**Art:** The ability to draw, paint and/or sculpt or do craft-work. Selection as an O.C.C. related skill indicates a professional quality, while selection as a Secondary Skill indicates a talented amateur. **Base Skill:** 35% +5% per level of experience.

**Breed Dogs:** The first percentile number indicates the art of raising, mating/breeding, taming and training domestic and wild canines, as well as a knowledge about canines in general.

The second percentile number is used to attempt to tame a wild canine, teach a dog tricks, or to train the animal for a specific task like tracking, retrieving, pointing, herding animals, attacking on command, and so on. A failed roll means that the animal refuses to learn that particular trick or specialty. **Note:** These are trained work animals or pets, not familiars. **Base Skill:** 40%/20% +5% per level of experience.

**Calligraphy:** The ability to produce beautiful Japanese letters using a brush, ink and paper with great skill and legibility. The character can also copy Chinese characters/symbols and, if he or she is literate in the Chinese language, can *write* Chinese. Traditionally, any person of culture and education in the Orient, especially a noble, is expected to be able to produce gorgeous ideograms. Calligraphy is a skill almost as necessary as literacy for traditionalists in Asia. **Note:** It is unlikely to be practiced by anybody outside of the Orient. **Base Skill:** 35% +5% per level of experience.

**Computer Operation:** A knowledge of how computers work, along with the skills to operate peripherals like keyboards, printers, and modems. Characters can follow computer directions, enter and retrieve information, use the web/internet and similar basic computer operations. However, this does *not* include programming or hacking. **Base Skill:** 40% +5% per level of experience. **Requires:** Literacy.

**Computer Programming:** Advanced computer knowledge that includes designing, programming, debugging, and testing computer programs and software. Hacking is possible, but at a penalty of -40% unless the character also has the Computer Hacking skill (see Rogue Skills). **Base Skill:** 30% +5% per level of experience. **Requires:** Computer Operation and Literacy.



**Cyberjacking:** Some computers allow their users to go beyond the normal "interface" of a keyboard, joystick or mouse, and to communicate directly with the computer via a socket ("dataplug" or "headjack") implanted in the back of their necks. This means that the computer operator's *mind* effectively enters the computer, seeing its memory and processors as a kind of virtual reality. Once accessed, the Cyberjack can alter data, add data, change files, and redesign the computer's programs, all with his mind. If the computer is linked to others in a network, such as the Link that connects all the computers in and around the Freedom station, the user can communicate with other Cyberjacks within the network. If Cyberjacking is used in conjunction with a ship's weapons using a targeting computer, it will add +2 to strike.

Cyberjacking is much more direct and up to ten times faster than normal computer programming, but not without its perils: software bombs, viruses and Trojan horses may lurk within the computer's

memory; other Cyberjacks can ambush you or design programs to trap your mind within the computer; and if the computer itself is artificially intelligent then anything might happen.

Characters must have the Computer Operation skill to take Cyberjacking. Any player character starting with this skill automatically has a dataplug implant. Others must pay for the dataplug and its implantation later. **Base Skill:** 50% +3% per level of experience.

**Falconry:** The art of training and handling falcons, and other birds of prey. The use of these animals is much more limited than many fantasy gamers would believe. Falcons were used specifically for the entertainment of the rich and hunting game fowl. A standard hunt would entail a game bird, such as a quail, pheasant, duck, etc., being flushed out into the air by dogs, and the falcon released to strike it down.

Players take note! For game purposes, let us presume that these avian predators can be trained to pursue and attack any, visible, flying foe or target, strike down other birds, and return them to its master. Let us further suppose that they can be trained to strike at any "moving" target that they are directed at. This means a falcon could be sent to fly in the face of an opponent and slash at him with its claws for up to two attacks before returning to its master or flying into the sky. These trained birds respond to hand signals and whistles. They are trained to strike and return, little more. Under no circumstances can these birds fly alongside their masters or follow even simple instructions; this is a dumb bird, not a dog with wings. **Note:** Falcons or any uncaged birds cannot be taken into underground dwellings or inside buildings without panicking. This is one reason they are always blinded with a leather hood. Another reason is that they instinctively attack any small, moving prey and are easily startled. Furthermore, it is impossible to engage in combat with a falcon on one's wrist or shoulder without injuring the falcon or oneself.

Trainers must roll two out of three successful rolls to succeed in training their bird. Failure means that the animal cannot be broken of bad habits and training is a general failure. **Base Skill:** 30% +5% per level of experience.

**Gemology:** Skill in identifying and appraising the value of precious metals (silver, gold, etc.) and stones (jade, emerald, ruby, sapphire, diamond, etc.). This ability also enables the person to identify fakes, but at a penalty of -10%. A failed roll means the character cannot tell whether or not the item is fake or real, or its value is grossly under or overestimated. **Base Skill:** 25% +5% per level of experience.

**General Repair & Maintenance:** Not everyone can be an Operator, blacksmith or carpenter, but many are good with their hands and capable of doing satisfactory repairs on simple mechanisms, gears, pulleys, wheels, rope, and so on. The general repair/maintenance skill includes: sharpening blades, minor repairs on weapons, pack their own S.D.C. bullets, sew tears in clothes (it may not look pretty, but does the job), replace a wagon wheel, change a tire, shoe a horse, repair furniture, paint, varnish, nail and assist in basic woodworking, and even do minor patchwork on armor (restores 1D6 M.D.C.). Roll once to see whether the character can figure out what is broken, what must be done to fix it, and whether it is beyond his meager abilities to repair. Roll again to determine success or failure in making the actual repair. If failure, the player may try again, but only twice. **Base Skill:** 35% +5% per level of experience. Reduce skill proficiency by half if the item is extremely damaged, complex, high-tech or alien.

**History:** This is a basic historical knowledge of the myths, legends and (distorted) history of a particular region in the world (i.e. North America, Mexico, Europe, etc.), from both before and after the Rifts. This includes a basic history of the region, its legends, lore, religions, traditions, famous people, and so on. This skill may be taken repeatedly to cover multiple regions of the world. Thus, a character who takes this skill three times might apply it to Russia, Western Europe, and North America. The base skill percentage indicates the approximate degree of information the character has learned or can remember accurately. **Base Skill:** 30% +5% per level of experience.

**Jury-Rig:** Jury-rigging is an essential part of life in the wilderness and outer space, be it in a burnt out wreck on the plains of the New West or the high-tech interstellar reaches of Phase World. When something breaks down it must be repaired quickly and with anything that comes to hand. A character with this skill can repair almost anything, or even build something out of scrap components. There is no guarantee that the jury-rig will hold for very long (4D6 hours or 2D4 days, whichever is most appropriate), or will even work in the way intended (roll again, a failed roll means the system is only 50% functional), but it may well save a character's life until they can get to a base and buy something more permanent. **Requirements:** At least Basic Mechanics and Basic Electronics. **Base Skill:** 25% +5% per level of experience (add an extra +10% bonus if the character is an Electrical or Mechanical Engineer).

**Language:** Characters with a language skill can understand and speak in a language other than their own native tongue. Language is one of the few skills that can be selected repeatedly in order to select several different languages. Each selection gives the character knowledge of a different language and costs one skill selection each time. **Base Skill:** 50% +5% per level of experience.

There are nine major languages in the world of Rifts, they include:

*American* (English, the universal language of the American continents).

*Techno-Can* (Basic but modified American/English; a universal computer/techno language used in high-tech computer communications and systems. Not used as an everyday spoken language but as a specialized tech-language developed for technical journals and as a universal computer language).

*Spanish* (the second major tongue of the Americas).

*Japanese* (language of the Japanese Islands and the New Japanese Republic).

*Chinese* (a language spoken widely across Asia, even well beyond the Celestial Kingdom's traditional borders).

*Euro* (a blend of Russian, German, and Polish spoken by virtually all humans between England and China).

*Dragonese/Elven* (perhaps the most ancient and widely spoken of the "magical tongues," and a universal language for all magic users).

*Gobblely* (spoken by all sorts of loathsome and barbaric creatures such as Goblins, Hob-Goblins, Orcs, and Ogres, among others).

*Faerie Speak* (the universal tongue of all Faeries, though one can communicate with Faeries using Dragonese/Elven or Gobblely at -10%).

Across the world, there are dozens of additional language groups to learn, but these tend to be regional and much less common than the Big Nine. These additional languages include, but are hardly limited to the following: *Demongogian*, a common language among supernatural beings, Gargoyles, Brodkil, Deevils and demons of all kind, and the minions of *Wormwood*. In Australia, *Aboriginal/Kwarta* and *Australian English* are noteworthy tongues to learn, as is the language of the alien *Molokoi*. In Russia and Eastern Europe, *Russian* is seeing a huge upsurge and is displacing the use of Euro in many places. Likewise in parts of Asia, *Mongolian* is spoken along with several dialects of traditional Chinese.

In any given area where a language is spoken, there might be a number of dialects in use. The G.M. may apply a -10% to a -20% modifier to one's Language ability depending on what kind of dialect they are up against. In the Deep South of North America, the Outback of Australia, and throughout China, for example, regional dialects are practically their own language.

**Law (General):** The study of Law allows the character to know many legal precedents, procedures and punishments common throughout a particular place or region, such as the New West of North America or the Outback of Rifts Australia. This includes the laws and customs of most major towns, settlements, gangs, tribes, etc., as well as

the rudimentaries of the nearest major nation or power bloc. This can be an invaluable skill when trying to bargain for one's life in a courtroom. **Base Skill:** 25% +5% per level. **Note:** This skill has also appeared in sourcebooks as *Lore: Law*.

**Law (Space; the CCW):** This skill covers the laws of the *Consortium of Civilized Worlds* and the *Civilization Compact*, both major parts of the **Phase World**® Dimensional Books. This skill is unlikely to be practiced by anybody outside of the Phase World setting. **Base Skill:** 30% +5% per level of experience.

**Literacy:** The written word is more valuable than ever in the world of Rifts, yet, sadly, the majority of the world's population can not read or write. Illiteracy is encouraged by the Coalition as it is a means of securing the empire's power base and hold over the people. Those who are literate will be viewed with suspicion unless they are a member of the Coalition's elite aristocracy or military.

Like the spoken *Language skill*, the character may be able to read and write several different languages, but each language counts as a separate skill selection. American/English is the official written language of the Coalition States and North America in general. **Base Skill:** 30% +5% per level of experience.

**Lore: Aborigines (Exclusive to Australia):** Characters with this skill can recognize the different tribes, warriors, shamans, totems, fetishes and warnings of the Aboriginal people. They can identify the people by their housing, clothing, wall paintings, skin painting/decorations, and weapons. This skill also gives the character a fundamental understanding about the Aborigine society, beliefs, customs and laws; at least the most notable ones. Also see *Lore: Dreamtime Culture* for a more in-depth understanding about Aboriginal gods, Dreamtime, spirits, and magic. This skill is unlikely to be practiced by anybody outside of Australia. **Base Skill:** 25% +5% per level.

**Lore: Cattle & Animals:** This is a general knowledge about cattle, horses, livestock, and other such animals. This knowledge includes what they eat, where they live in the wild, means of defense, the value of their meat, fur, hides and horns, and their natural predators, as well as the most notable tales about supernatural animals, spirits, gods and magic attributed to or involving animals. This skill is practiced most widely in the New West of North America, but it is also known throughout parts of South America, Europe, Africa, Asia, and Australia. **Base Skill:** 30% +5% per level of experience.

**Lore: The Cities:** To most outsiders, what goes on inside the fortress cities of the world is an enigma. Hence, characters with the City Lore skill have gathered useful snippets of basic information regarding common laws, operating procedures, customs, politics, and even fashions/dress/appearance of city dwellers, particularly their military and police. As a result, the character knows what constitutes illegal trade and activities, is able to recognize City soldiers, police officers, and aircraft, estimate the location and probable number of sentries, predict guard movements and responses, understand standard procedure, and so on. This skill is known most commonly in Australia but it can also be applied to parts of Rifts Earth where a fortress city, such as Chi-Town, might dominate an otherwise vast and inhospitable wilderness. **Base Skill:** 20% +5% per level of experience. Aboriginal characters from Australia can never take this skill.

**Lore: D-Bee:** Most D-Bees (the slang for Dimensional Beings) are just alien humanoids from another dimension or planet. To be classified as a D-Bee, the creature must be remotely humanoid in appearance, usually a biped, have a human-like intelligence and not possess supernatural powers. Creatures who are not humanoid in appearance and have extremely monstrous or demonic appearances and/or strange powers, are usually considered to be monsters rather than D-Bees.

D-Bee lore is the general study of alien humanoids, their culture, common types, common behavioral patterns, the distinction between instinctive predators and social oriented beings, myths and legends. The skill is often limited to those living in a specific geographic region where the skill is being taught; i.e. beings commonly known to live in North America will be known by the CS. The region may be limited to

smaller geographic locations, such as D-Bees of Western America, Midwest, East, Coalition States and so on. D-Bee lore is not a science. Consequently, it is not always accurate, complete or in-depth. See the Anthropology skill for an in-depth approach to behavioral science. **Base Skill:** 25% +5% per level of experience.

**Lore: Demons & Monsters:** This is the study of demonic creatures and supernatural monster lore throughout the ages and around the world. It includes the beliefs of ancient and primitive cultures, as well as documentation in the modern Rifts world regarding demons, vampires, possession, places of magic, reputed places of demonic habitation or attraction, and the study of legendary and known supernatural beings, including their known habits, appearance, weaknesses, strengths, powers, and abilities. The master of demon lore may be able to identify a particular type of monster by hearing its description or a description of its actions, seeing a drawing or photograph or footprint, or by how it acted, killed, or exhibited certain abilities. **Base Skill:** 25% +5% per level of experience.

**Lore: Dreamtime Culture (Exclusive to Australia):** There is a very powerful mythology surrounding Aboriginal culture. Many tribes consider the Coming of the Rifts to be a second Dreamtime (the Dreamtime being their creation myth, when the world was formed). Now that the spirits have returned and the "Songlines" have risen to new heights of power, Dreamtime Culture is pervasive among the native people. This is a very intricate skill to those not born and bred in the Aboriginal culture. The philosophy/religion/world view of the Australian Aborigines is a strange blend of animism with the more bizarre aspects of modern physics. In other words, Dreamtime is another version of reality. Here are some of the features of Dreamtime:

- All time, from the remote past to the far future, is together, as if it were all one piece. This helps to give the Aborigines infinite patience, knowing that if a thing is meant to be, it will happen.
- Animals, insects, and plants all have voices in Dreamtime. They do not speak as individuals, but as a collective. In other words, one could be talking to an Emu, but not just any Emu, but the primal Emu, sort of a super-Emu who represents all Emus.
- One must dream of lives to come (unborn children) or they will not come. And one must dream of lives that have left.
- All the land, the plants, insects and animals, must be dreamed of too, or they will cease to exist or not come into existence.

To non-Aboriginals, the skill translates into a "lore" skill that gives the character a very loose understanding of Dreamtime myth, spirits, rituals and beliefs, as well as knowing a hundred stories about the Dreamtime. Such characters are also able to identify and know something about the gods, spirits and monsters associated with the Dreamtime, and the danger they may represent.

To Aboriginal people, the skill is about ancestry, identification of omens and spirits, performing dances and rituals, Aboriginal history, being at peace with the world, and general theory on how the spirits and magic interact to form the universe in the current time. It also provides the Aborigines with a basic instinct that translates into the ability to Sense Supernatural Evil, roughly equal to that of a Dog Boy or Psi-Stalker. This skill is unlikely to be practiced by anybody outside of Australia. **Base Skill:** 20% +5% per level of experience (all Aborigines get a skill bonus of +20%; shamans and select others may be higher).

**Lore: Faerie:** This skill is effectively the same as the previous Demon and Monster lore skill, except that the emphasis of the lore is on Faerie Folk. Since the Coming of the Rifts and magic, the Faeries of ancient myths have proven to be quite real and often encountered in the wild, especially near ley lines and nexus points. Faerie Folk include Faeries, Sprites, Pixies, Brownies, Bogies, Toad Stools, Pucks, Kelpies, Gnomes, Goblins, and a host of other creatures of magic. **Base Skill:** 25% +5% per level of experience.

**Lore: Galactic/Alien (Space):** This skill helps characters identify known alien races, and provides information on their culture, habits,

etc. Given the number of alien species in the Three Galaxies, it is very difficult to know every single recorded alien species without a computer database handy. It also includes most of the well known legends and speculations about the Cosmic Forge, Cosmo-Knights, Kreeghor and Prometheans. **Note:** Not usually applicable to those born on Rifts Earth, but may be known to Temporal Raiders, True Atlanteans and others who traverse the Megaverse. **Base Skill:** 25% +5% per level of experience. When dealing with lesser known alien species, G.M.s can assign a penalty from -5% to -30% at their discretion.

**Lore: Juicer:** This skill covers all there is to know about Juicers, different Juicer variants, what powers they possess, Juicer lore and myths, drug side effects, etc. A character with this skill will recognize Juicers by their armor and abilities, as well as know the names of the most famous Juicers in history, current famous Juicer leaders, infamous gangs, and similar facts. **Base Skill:** 30% +5% per level of experience.

**Lore: Indians:** Characters with this skill can recognize the different tribes and nations, warriors and shamans, totems, fetishes and warnings, identify the people by their housing, clothing and weapons, and has a fundamental understanding about the Native Americans' society, beliefs, customs and laws; at least the most notable. They also know about Indian gods, spirits, and magic. This skill is unlikely to be practiced by anybody outside of the New West. **Base Skill:** 25% +5% per level.



**Lore: Magic:** This area of study does not give the character any magic powers, the ability to use Techno-Wizard devices, or the ability to read magic symbols. What it provides is general information about magic, magic creatures, the Federation of Magic, Lazlo, Tolkeen, and myths about magic. For example, a character with this skill knows about the general powers and abilities of infamous magic creatures such as the various types of dragons, sphinxes, unicorn, and so on. He'd know what are the main types of magic (on Earth or at least his geographic area), such as spell casting/Line Walkers, Sum-

moning/Shifters, Rifting/Shifters, Techno-Wizardry, Conjuring, Stone Magic, Bio-Wizardry, Necromancy, and so on. Likewise, the character is likely to know legends about powerful magic items, places, curses and notorious practitioners of magic. Although the character cannot read runes or mystic symbols, he is likely to be able to recognize whether the symbol is a real magic ward, rune or warning.

The following abilities come with this layman's skill: **Base Skill (general knowledge):** 25% +5% per level of experience. **Recognize Wards, Runes and Circles:** 15% +5% per level of experience. **Recognized Enchantment:** i.e. magic items, people under the influence of magic charms, possession, curses, mind control and similar: 10% +5% per level of experience.

**Lore: Psychics & Psionics:** Knowledge about psionic powers, how they are believed to work, how they affect people, their limitations, and who possesses them. This skill also provides a rudimentary knowledge about people and beings who possess psionic powers such as minor and major psychics, healers, Psi-Stalkers, Simvan, Bursters, Mind Melters, Mind Bleeders, and the most infamous supernatural creatures (vampires, possessing entities, Goquas, Mindolars, Raksashas, etc.). The character may also have a passing knowledge about some of the psionic weapons and symbiotes of Atlantis, famous psychics in the region, mind control (via drugs, psychology, hypnosis, magic and psionics) and myths and legends about such places as the Astral Plane, Dreamstream, The Enclave and Psyscape. The character does not have to be a psychic himself, but he should believe that psychic powers really exist. **Base Skill:** 25% +5% per level of experience.

**Lore: Religion:** The study of religions, gods and beliefs. This skill provides a comprehensive knowledge of the religions of a particular region, such as North America, South America, Russia, Europe, Japan, etc. This knowledge includes mastery of regional beliefs, rituals, holy places, pantheons of deities and supernatural creatures (demons, spirits, angels) and their stories of creation, myths and legends. The skill will help a character recognize specific rituals, their purpose, the deity(s), whether a blood sacrifice is necessary as well as religious fetishes, charms, icons, and similar. The percentile number indicates the degree of knowledge one has about a particular religion and his ability to remember it. **Base Skill:** 30% +5% per level of experience.

**Masonry:** A rudimentary understanding of the principles of brick-laying and stone construction. The percentile number indicates the success ratio of recognizing deterioration, improper construction, the intended purpose of construction, styles of masonry, approximate age or period of construction, identify alien and human construction, and general data about mason guilds. The character can also mend masonry and assist in construction and demolitions. **Base Skill:** 30% +5% per level of experience.

**Mining:** Mining is an important part of post-Rifts life because it is the main source for new metals and rock so desperately needed to rebuild the world. In space, mining supplies the oxygen, water, ores and rare metals that the space stations need to survive. The skill covers prospecting, identifying minerals and frozen gases (when mining in space), as well as operating mining equipment, explosives and refining gear. A character with the skill can also tell the quality of a refined product, and will know about many of the current mining operations on the planet or in the solar system. **Base Skill:** 35% +5% per level of experience (includes both demolition skills).

**Mythology:** Includes extensive knowledge of a particular region's myths relating to ghosts, spirits, demons, goblins, faerie folk, monsters, dragons, immortals, undead, elemental forces, supernatural animals and gods. Some parts of the world are mythologically richer than others (Japan, China, India, Scandinavia, Africa, and the Greek Isles are all very rich in this regard). **Base Skill:** 30% +5% per level of experience.

**Photography:** Training in the art of still photography, the use of lighting, cameras, lenses, filters, and other camera equipment, as well as storage, development, enlargement, and duplication of film/photos. **Base Skill:** 35% +5% per level of experience.

**Prospecting:** The character can recognize and evaluate precious and semi-precious metals (gold, fool's gold, silver, bronze, copper) in their natural ore appearance and as refined and polished jewelry. In addition, the character has a good idea of where to look for such mineral deposits, and the fundamentals of "panning" for gold and the general knowledge of mining and how to use various types of simple mining equipment.

Furthermore, the character can identify and appraise the value of precious metals (silver, gold, etc.) and stones (diamonds, rubies, etc.), and to identify fakes, but at a penalty of -10%. A failed roll means the character cannot tell whether or not the item is fake or real, or he grossly under or overestimates its value. **Base Skill:** 20% +5% per level of experience.

**Research:** Training in the use of methods, techniques, and locations for finding information, including public records, libraries, federal information services, data bureaus, interviews, surveys, demographics, trade journals, clipping services, computer services, and legal searches. This skill is helpful in locating information about people, places and things. The *Game Master* will ultimately regulate the availability of accessible, known information regarding a particular subject. In some cases, there may be a ton of history and information, while in others, very little or nothing at all (which may reveal something by its sheer lack of info). The research skill simply gives characters access to available data. **Base Skill:** 40% +5% per level of experience. **G.M. Note:** A good rule of thumb is to let characters investigate/research something as much as they want, but keep the game moving along. If no information is available, find out where they are conducting research and say something like, "Despite the help of a clerk, and three hours of research, you still find nothing (or nothing unusual)." If the character(s) wishes to keep looking, let him, but quickly click off the hours; "Another hour and still nothing." If another player conducting research elsewhere says, "What do I find in the City County Building?" Make the answer "Nothing," or "Something quite surprising," and tell him/her something in private. Do not drag out the research aspect, but do consider a reasonable length of imaginary game time. Likewise, if the information is common knowledge or easy to locate, fast forward through what might be a couple of hours of research and tell the character what he has found.

ANY CHARACTERS CAN DO RESEARCH AND ASK QUESTIONS! However, the Research skill will reduce the amount of time it takes to find and gather available info by about half. Additionally, the "skilled" character is trained to notice relevant data that an untrained character is likely to overlook. Thus, for the truly mysterious, secret or difficult information, have the character with the Research skill try to uncover it. Only roll to determine success in finding data and on these difficult, rare, lost or secret bits of information, including addresses, unlisted telephone numbers, car license plate numbers, CS Identification Codes/data on registered CS psychics, CS military info, and obscure and suppressed data. Top secret information is usually protected and has a -20% skill penalty. **Note:** The Rogue Scholar and Rogue Scientist O.C.C.s automatically get this skill at +10%.

**Rope Works:** This is a skill that takes into account the various needs and uses of rope. The character knows a variety of ways to tie knots, the advantages to various types of ropes and cords, their tensile strength and how to weave/make rope. A failed roll to tie a knot means that it is loose and sloppy and easy to untie, slip out of, or likely to unravel or snap when strained. **Base Skill:** 30% +5% per level of experience. Characters bound/tied by this character are -10% to escape/slip knots.

**Salvage:** This skill allows characters to find, identify, pick up, strip down, evaluate and possibly sell, any debris, wrecks and junk that they can locate. They can also strip a piece of wrecked machinery for spare parts and may even be able to make something work again, given time and enough parts. Many characters make a living out of salvage work. **Base Skill:** 35% +5% per level of experience.

**Space Contacts:** Exclusive to the space community in orbit around Earth (see *Mutants in Orbit*). Because the number of people living in orbit and the rest of the solar system is so small, there is a good chance that a character will know or have heard of a particular person. This skill measures how good that knowledge of the people around him is. It can also be used to make connections between objects and people who are particularly associated with them.

The base percentage of this skill is a character's chance of having heard of a character before. If the person in question is from the same home base or in the same occupation as the character making the roll, this base percentage is doubled. One-tenth of the base percentage is the character's chance of personally knowing the person mentioned.

To give an example, Parks, a pilot from the Yuro base, notices a distinctively designed transport vessel moving near his ship. His contacts skill is 12%, but because particular ships are associated with their pilots and he is a pilot, he doubles it to 24% before he rolls the dice. He gets an 02, less than one-tenth of his 24%, and recognizes the ship as belonging to an old business associate, Tobermory. They dock and Tobermory introduces his new engineer Clint, originally from the Freedom base. Parks rolls against his base 12% because he is not an engineer nor from Freedom Station, and the result of 45% shows that he has never heard of Clint before (too bad, because Clint is a dangerous psychotic). **Base Skill:** 6% +2% per level of experience.

**Undersea Salvage:** The character knows how to locate and identify objects (ships, armor, gold, etc.), recognize salvageable components and materials (valuable parts, electronic equipment, E-Clips, weapons, coins, magic items, precious metals and gems, etc.), retrieve (with minimal damage and effort), evaluate (estimate approximate resale value based on the item's condition), clean/restore (restoration gets top salvage price), and sell salvaged underwater artifacts, equipment, parts, and scrap metal. The salvage skill also offers methods of exploiting and capitalizing on some of the simple resources under the seas, including rudimentary mining, excavation, and gathering coral, rocks, seaweed, sponges, clams, oysters, and starfish. The character is also familiar with underwater cutting tools, cranes, pulleys, and tow lines, and can strip/cut apart and retrieve wreckage and machinery for use as scrap metal. Those with mechanical engineering can salvage working parts, make repairs on slightly damaged items, and even raise small sunken ships, subs, and robots! **Base Skill:** 30% +5% per level of experience; add a salvage bonus of +5% if a Mechanical Engineer.

**Whittling & Sculpting:** The art of carving wood, bone and horn into three-dimensional figures/statues/toys, designs, and simple objects like wooden stakes, arrows, fishing hooks, walking sticks, staves, bowls, a simple flute or whistle, and similar. Many characters with this skill simply use it to pass time and don't necessarily make anything from their whittling. The percentile number indicates the quality of technique and the quality of the work/appearance. Taking the skill twice indicates a professional quality and gets a bonus of +10%. Selecting it once indicates a talented amateur. **Base Skill:** 30% +5% per level of experience.

**Writing:** The ability to write prose (stories), poems, or journalistically (articles, reports, news). Scholastic training indicates a professional quality, while the secondary skill indicates a talented amateur. A failed roll means an awkward and poorly written work that is boring and difficult to understand. Try again. Note that the written word can be a powerful tool in the ignorant and oppressed society of the Coalition. **Base Skill:** 25% +5% per level of experience. **Requires:** Literacy.

## Weapon Proficiencies

**Note:** Each W.P. provides combat training with a particular type of weapon. Each W.P. counts as one skill. The character may select several W.P.s or a few. Characters without a W.P. can use *any* weapon, but without benefit of the W.P. bonuses.

There are two categories of Weapon Proficiencies, *Ancient* and *Modern*. These are somewhat misleading, since what they really refer to is unpowered melee type weapons (swords, spears, etc.) and modern, powered weapons (guns of every stripe). A Juicer's Deadball W.P. will be found under Ancient weapons, even though the device itself was not invented until well after the modern age began.



## Ancient Weapon Proficiencies

Each Ancient W.P. provides combat training with a particular type of weapon. The result is hand to hand combat bonuses to strike and parry whenever that particular "ancient" style weapon is used. All bonuses are accumulative. Each W.P. counts as one skill.

**W.P. Archery and Targeting:** This is an expertise with thrown and bow weapons. It includes throwing spears, forks, slings, short bows, long bows, crossbows, and modern bows. **Bonuses:** Add 20 feet (6.1 m) to the normal effective range per level of the character, +1 to parry with that weapon (effective at level one), and +1 to strike at levels 2, 4, 6, 8, 11, and 14.

**Rate of Fire:** Two at level one, +2 at level three, +1 at levels 5, 7, 9, and 12.

**Combat Note:** Typically, a character loses all bonuses and rate of fire is half when riding on horseback or a moving vehicle.

### Thrown and Bow Type Weapons and Typical Ranges:

- Boomerangs (1D6 damage): 60 feet (18 m)
- Throwing Sticks & Irons (1D6 damage): 30 feet (9 m)
- Sling (1D6 damage): 80 feet (24 m)
- Spear (1D6 damage): 100 feet (30.5 m)
- Short Bow (1D6 damage): 340 feet (104 m)
- Long Bow (2D6 damage): 640 feet (195 m)
- Modern Compound Bow (2D6 damage): 700 feet (213 m)
- Traditional Crossbow (2D4 or 1D8 damage): 600 feet (182 m)
- Modern Crossbow (2D6 damage): 700 feet (213 m)

**W.P. Battle Axe:** Training in all types of battle axes and picks. **Bonuses:** +1 to strike at levels 1, 4, 8 and 12. +1 to parry at levels 2, 5, 8 and 13. +1 to strike when thrown at levels 3, 8 and 12.

**W.P. Blunt:** Training with all types of blunt weapons including maces, hammers, cudgels, pikes, staves, and clubs. **Bonuses:** +1 to strike and parry at levels 1, 4, 8 and 13.

**W.P. Bola:** The Bola is an old weapon of the South American Indians who taught its construction and use to the gauchos. The classic weapon was three rawhide thongs joined at one end and at the other, three cords tipped with metal or leather covered stones; the length of the cords varied from 3-10 feet (0.9 to 3 m). When thrown accurately, the bola could entangle the legs to bring down a running animal. One or two weighted balls were used for hunting small prey like rabbits and birds. **Damage:** 2D4 S.D.C. As one might expect, various weapon manufacturers have created bolas with 1-3 grenades instead of weights, and Northern Gun has created one that works like a Neural Mace, with the stunning charge delivered by remote control once a victim has been ensnared. **Bonuses:** +1 to strike, disarm and entangle at levels 2, 5, 10 and 15.

**W.P. Boomerang (Australia):** An aerodynamic curved throwing "stick" that is the Aboriginal technological equivalent of the bow and arrow. Some can be no larger than a foot (0.3 m) long, others can be almost man-sized and require two hands to launch, but most range between 1-3 feet (0.3 to 0.9 m) long. There are many variations, some designed to return to the thrower if the shot misses, others designed purely as throwing sticks intended to inflict damage and which fall flat if they miss.

**Bonuses to Strike:** +1 at levels 1, 3, 5, 7, 10 and 15.

**Bonuses to Damage:** +1 to damage at levels 2, 5, 9, 11 and 15.

**Combat Notes:** The boomerang is a hunting weapon. Nonetheless, this is an RPG, and boomerangs make pretty cool weapons (see the equipment section for more), and players are likely to try all sorts of tricks.

1. In all cases, opponents are at -2 to parry and dodge boomerang attacks, as they are highly unpredictable missile weapons difficult to avoid and defend against. Add this penalty to other penalties that may apply from special attacks. The boomerang can be employed in several different ways:

2. Thrown with a slight curve so that it returns if it misses. In such a case, the range is 150 feet (45.7 m). To make a boomerang return, a character must have this W.P. Such trained individuals can throw those designed to return to come back to them when they miss. The process of returning uses up one melee action worth of time, during which the character can perform something else (aside from moving).

3. Straight Shot. Thrown with full force, the range is an incredible 600 feet (182 m). The boomerang will not return. +2 to damage from the velocity of a fast moving, full force boomerang. If the victim is within 100 feet (30.5 m), he is -4 to parry or dodge the attack.

4. The Back Shot is a particularly tricky method of attack. The boomerang is thrown with full force, but curves to return toward its thrower and strike a target on its return, from the opposite side. The maximum range is 250 feet (76.2 m), and the target is -8 to parry and dodge due to the element of surprise. This can even catch someone hiding behind cover if the thrower is aware of the hiding target and can accurately estimate where to strike. The difficulty of this attack means the throw is made without benefit of any bonuses and is -3 to hit the hidden target.

5. Bounce Shot. Thrown at a down angle, the boomerang appears to fall short then rises before hitting the ground and strikes the victim from below. The attack has the element of surprise and can be disorientating, so the intended target is -4 to parry and dodge. If the roll to strike is 16 or higher, an opponent will be knocked off his feet by the attack (as well as suffering damage) and loses two melee actions. A successful "roll" vs punch, fall or impact will prevent the knockdown, but uses up one melee action.



6. Ricochet Shot. The W.P. also enables the character to use any type of boomerang to ricochet off one object or person and hit a second! This ricochet or bounce-off attack is done without benefit of any bonuses other than those from this W.P. Damage is inflicted to both targets struck. The second target struck is -4 to parry or dodge.

7. Trying to Catch a Boomerang thrown by somebody else. Wily opponents may attempt to catch a boomerang thrown at them with a successful parry roll that scores 18 or higher, but the character must make the "call" that he intends to try to catch it, must drop or holster anything in his hand, and the "catch" uses up two melee attacks/actions. Do not discourage this tactic, but catching a full velocity boomerang is *not* recommended. A successful catch uses up two melee actions and a failed catch means the character is struck and takes normal damage. This hurts.

**W.P. Bow & Arrow:** Includes short bow, long bow, Samurai bow, Mongol bow, and Ninja short bow, as well as modern compound bows. **Bonuses:** Start with +1 to strike and two shots per melee round. Add +1 to strike at levels 2, 4, 7, 10, 13 and 15. An extra shot per melee round is added at levels 2, 4, 5, 8, 10, 12 and 14.

**W.P. Chain:** Training with all types of chain weapons including ordinary lengths of chain, nunchaku, flail, and ball or mace and chain. **Bonuses:** +1 to strike at levels 1, 4, and 12. +1 to parry at levels 4, 8, and 13.

**W.P. Crossbow:** Includes both heavy and light crossbows. **Bonuses:** 1 shot per melee at first level. +1 to strike at levels 2, 4, 6, 8, 10, 12 and 14. An extra shot per melee round at levels 2, 5, 7, 9, 11, 13 and 15.

**W.P. Deadball:** This skill allows the character to throw the spiked, ricocheting ball in the Deadball game with great accuracy. A character with this skill can hit a target by ricocheting the ball off walls, ceilings and floors. This is a called shot, at -1 for every ricochet needed to strike the target. It is very hard to parry or dodge the ricocheting Deadball; the victim is at -2 to dodge, and at an additional -1 for every additional ricochet beyond the first.

**W.P. Forked:** Includes sai, tiger forks and other weapons with tines except for tridents, which have their own separate W.P. **Bonuses:** +2 to Entangle at level one and +1 at levels 2, 5, 8, 10, 12 and 14. +1 to strike at levels 1, 3, 5, 7, 9, 12 and 15. +1 to parry at levels 5, 9, and 13.

**W.P. Grappling Hook:** Trained use of a grappling hook for climbing, scaling walls (adds +5% to that skill), boarding vessels, tripping an opponent (by hooking the foot, ankle or leg. Does no damage, but knocks victim to the ground and he loses initiative and one melee attack) and impaling (does 1D6 damage). **Bonuses:** +1 to strike or entangle at levels 3, 6, 9 and 12. This weapon can NOT be used to parry!

**W.P. Knife:** Training with all types of knives. **Bonuses:** +1 to strike at levels 2, 4, 7, 10, and 13. +1 to parry at levels 1, 3, 6, 9, and 12. +1 to strike when thrown at levels 1, 3, 6, 8, 10 and 13.

**W.P. Mouth Weapons:** Includes blowpipes, mouth darts, and other weapons that depend on a person's lungs and aim out of the mouth. Weapons such as these are the hallmark of assassins worldwide, but especially of Japanese ninja. **Bonuses:** Start with +1 to strike at levels 1, 4, 8 and 12. An extra shot per melee round is added at levels 3, 7 and 11.

**W.P. Net:** Primarily a gladiator or slaver's skill, the net is used to trip an opponent (same as grappling hook), parry or snare/entangle. **Bonuses:** +1 to strike or entangle at levels 2, 5, 8, 11 and 15. +1 to parry at levels 2, 4, 6, 9 and 12. In addition to the regular entangle attack, there are two other types of attacks possible with a net:

Snaring an opponent's weapon. The weapon becomes entangled and is pulled out of the opponent's hand. A natural, unmodified (no bonus) roll of 18, 19 or 20 will disarm an opponent in this way, unless he can roll an equally unmodified high parry (no bonuses).

Snare one's opponent by throwing the net over him: The intended victim must dodge or be netted; only characters with a spear, pole-arm or staff can parry a thrown net attack. If caught in the net, the victim is

-8 to strike, -10 to parry and dodge, and running is impossible. It will require 1D4+1 melee rounds to cut free of the net.

If the character dodges or the net thrower misses, it is the net wielder who will suddenly find himself weaponless. Even if the net has a drawstring attached to it, the thrower will need one melee action/attack to pull it back to him or to grab a different weapon; the throwing of a net to capture an opponent requires the use of two hands. However, if the net is being used to parry, entangle or whip an opponent, it can be used with one hand, while the other wields a sword or other weapon; parry the same as usual. Using the net as a whipping weapon does 1D4 damage.

**W.P. Paired Weapons:** Weapons are limited to the one-handed types and can be used in any combination; for example, two short swords, or short sword and broadsword, sword and knife, mace and shield, etc. Two-handed weapons cannot be used as paired weapons. Those with W.P. Paired Weapons can do the following:

1. Strike and parry simultaneously. In other words, warriors skilled in paired weapons can often perform two actions for every one melee action/attack.

2. Twinned simultaneous strikes against the same target. Both weapons hit, but is considered ONE melee attack/action, (roll only once to strike). The defender can only try to parry one of the weapons with his defensive parry! The other *will strike*, unless the defender is using two weapons, or a weapon and a shield, and has the W.P. Paired Weapons skill to try to block both simultaneous attacks.

3. Strike two different targets or strike one and parry the other, simultaneously; both must be within reach.

4. Parry two different attackers; one with each hand-held weapon.

**W.P. Pole Arm:** Training in the large spear-like weapons known as the pole arm. Also includes tridents. **Bonuses:** +1 to strike at levels 1, 5, 9, and 14. +1 to parry at levels 1, 3, 6, 9 and 12. +1 to strike when thrown at levels 2, 5, 9 and 14.

**W.P. Shield:** Combat skills with large and small shields used primarily for parrying and self-defense in close combat. **Bonuses:** +1 to parry at levels 1, 3, 6, 9, 12 and 15. A shield can be used in one hand and a weapon in the other. +1 to strike with a shield (1D4 damage) at levels 4, 8 and 12. No bonus to strike when thrown. Note: A shield cannot be used to block bullets, rail gun bursts or energy blasts, at least not easily. Any such attempt is done without any bonuses (straight die roll) and at -8 to parry.

**W.P. Siege Weapons:** An understanding of the tactics, use and mechanics of siege weapons, including balista, catapult, onager and trebuchet. **Bonuses:** +1 to strike at levels 2, 5, 9 and 12.

**W.P. Slingshot:** Includes both ancient slings and modern slingshots. **Bonuses:** +1 to strike and 2 shots per melee at first level. +1 to strike and one extra shot per melee at levels 2, 4, 6, 8, 10, 12 and 15.

**W.P. Small Thrown Weapons:** Includes shuriken, throwing spikes, etc. **Bonuses:** Start with being able to throw three per melee round. +1 to throw at levels 4, 7, 10 and 13. Extra shot per melee at levels 2, 3, 5, 6, 8, 9, 11, 12, 14 and 15.

**W.P. Spear:** Combat skill with large and small spears. The use of a rifle equipped with a bayonet also falls into this category. **Bonuses:** +1 to strike and parry at levels 1, 4, 7, 10, and 13. +1 strike when *thrown* at levels 2, 4, 8, 12, and 15. **Maximum throwing range** is 150 feet (45.7 m), unless a woomera, atlatl, or other form of primitive spear-throwing device is employed. These simple but effective tools may be used only by those who already have W.P. Spear. They are hand-held wooden sticks or rods with a channel cut into their length and often with a hook at the end. The user slides the spear into place in the groove and then holds it there with a single hand. With a throwing motion, he whips the stick up and out, giving the spear a great deal of additional thrust, effectively doubling its throwing range. They are difficult to use (-1 to strike for all users) and take a lot of training.

**W.P. Staff:** Combat skill with large and small staves. **Bonuses:** +1 to strike at levels 1, 3, 7, 10 and 13. +1 to parry at 2, 5, 8, 11 and 14. +1 to strike when thrown at levels 4, 8, and 14.

**W.P. Sword:** Combat skills with large and small swords, including fencing type training. Includes rapiers, sabers, two-handed, and short swords. **Bonuses:** +1 to strike and parry at levels 1, 3, 7, 11, and 14.

**W.P. Trident:** The practiced use of the trident as a weapon. **Bonuses:** +1 to strike and parry at levels one, three, seven, eleven and fifteen. "Catch" or "Pin" an opponent's arm, hand, foot or weapon between the prongs: +1 at levels two, five, ten and fifteen. If a limb is caught or pinned, the trident user can twist and swing the trident with a quick movement that will force the "pinned" opponent to follow the movement and be "flipped" off his feet or upside down underwater. The victim of a body flip is thrown to the ground/down/over and loses initiative and one melee action/attack. W.P. Trident provides the body flip move only when using the trident. Typical damage is 3D6 S.D.C. or 3D6 M.D.C.; can be thrown 50 feet (15.2 m) in the air or 30 feet (9 m) underwater.

**W.P. Whip:** Skill at "whipping" or snapping with long, flexible, light weapons. **Bonuses:** +1 to strike at levels 1, 3, 5, 7, 9, 11 and 13. +1 to damage at 4, 8, and 12. +1 to entangle at levels 2, 6, 8, 10, and 14.

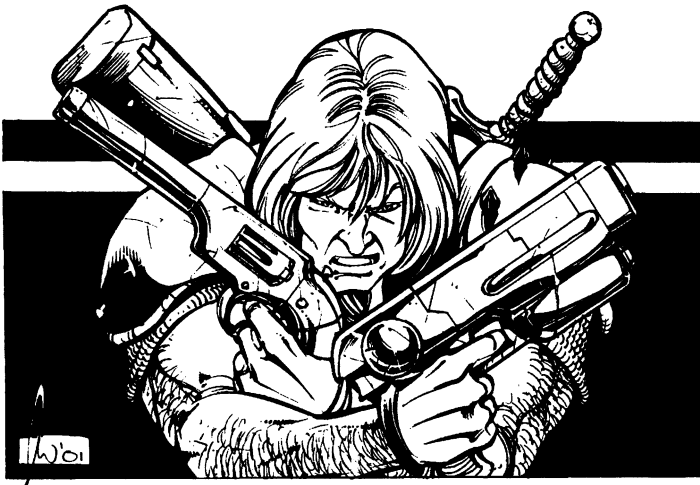

## Modern Weapon Proficiencies

These are areas of training and practiced skill with a particular type of modern weapon. Each W.P. counts as one skill selection. Modern W.P. bonuses are found in the Combat section under Modern Weapon Proficiency Explanation. Characters with no knowledge of modern weapons can fire loaded weapons, but will take twice as long to reload and always shoot "wild" meaning they get NO bonuses to strike; straight dice roll, P.P. bonuses are NOT included.

**W.P. Revolver:** All cylinder style handguns; not automatic (trigger must be pulled each time the gun is fired).

**W.P. Automatic Pistol:** All modern military automatic pistols (automatic means the weapon keeps firing while the trigger is depressed and until the trigger is released or the rounds are all expended).

**W.P. Bolt-Action Rifle:** Includes most hunting and sniping rifles; not an automatic firing weapon.

**W.P. Automatic and Semi-Automatic Rifles:** Includes all assault rifles like the M-16 and AK-47.

**W.P. Submachine-gun:** Includes all small arms automatic weapons like the Uzi.

**W.P. Flamethrower:** A modern weapon proficiency (obviously), employed sparingly by the military, mercenaries and people who use them. This weapon is loved in the Outback of Australia but due to fuel shortages and the dry countryside (thus, the risk of bush fires) it is not a

Weapon used very often. **Bonuses:** +1 to strike at levels 2, 6 and 14; generally, everything is set on fire.

**W.P. Grenade Launcher:** Any device, including certain rifle models, that fire grenades. This skill includes the use of the Triax pump-weapons (i.e. TX-16) and the launcher of the Coalition's C-14 "Fire Breather." **Bonuses:** +1 to strike at levels 3, 7 and 11.

**W.P. Harpoon & Spear Gun:** Proficiency with the harpoon gun. The weapon can be used either with a plain pointed end (2D6 S.D.C. damage) or with an explosive head (4D6 M.D.). **Bonuses:** +1 to strike at levels 2, 4, 7, 10, and 15.

**W.P. Heavy Weapons:** Includes machine-guns, bazookas, rocket launchers, and mortars. Anything heavier is likely to fall under the Weapon Systems skill in the Pilot Related Skills category.

**W.P. Torpedo:** Maintenance and a keen understanding of a torpedo's speed, range, trajectory, and most effective use. **Bonuses:** +1 to strike at levels two, six and twelve. +1 to strike with a depth charge at level four.

**W.P. Energy Pistol:** Includes lasers and all types of energy firing small arms.

**W.P. Energy Rifle:** Includes all long-range energy firing rifles.

**W.P. Heavy Energy Weapons:** Includes plasma ejectors, rail guns, and similar high-tech, Mega-Damage weapons.

**W.P. Sharpshooting:** Sharpshooting is a combination of special expertise and trick shooting with a particular type of weapon, typically revolvers, pistols and energy pistols, but sometimes includes rifles. It was first developed by Gunfighters and quickly adopted by the Gunslingers and Lawmen of the New West. This skill can be developed by any of the Men at Arms O.C.C.s but is fairly *uncommon* among most, except for the *Gunfighter*, *Sheriff* and *Gunslinger*.

W.P. Sharpshooting must be selected for each weapon type or category of weapon (revolver, pistol, energy pistol, rifle, etc.) in which the Sharpshooting expertise is desired. This means if the character wants to be a specialist with revolvers, that's one Sharpshooting selection at the cost of two O.C.C. Related skill selections, plus the W.P. selection (sharpshooting can be applied to O.C.C. weapon skills, but not secondary skills). If Sharpshooting is also desired for W.P. Energy Pistol, the skill must be selected again (at the cost of two O.C.C. Related skills). This process is repeated for each W.P. for which the added benefits of Sharpshooting is desired. Since each Sharpshooting selection costs the equivalent of two O.C.C. Related skill selections, even most Gunslingers and Gunfighters seldom have more than one or two Sharpshooting specialties — most Men at Arms don't have any.

**Restrictions & Conditions:** All bonuses and tricks are only possible with W.P.s to which the Sharpshooting skill has been added. Thus, a character with Sharpshooting: Revolver does not get the Sharpshooting bonuses when firing an energy pistol.

The Sharpshooting skill can be added to all modern guns, from revolvers (six-shooters) to energy rifles, but does not include W.P. Heavy and W.P. Heavy Energy Weapons; i.e. it cannot be applied to rail guns, rocket launchers, mini-missile launchers, bazookas, artillery weapons, vehicle or robot weapons, hand grenades, or explosives. Likewise, Sharpshooting cannot be applied to weapons that don't shoot, such as clubs, maces, knives, swords, axes, whips, or even spears, knives, bolas and other weapons that can be thrown.

The Sharpshooting skill can be combined with the W.P. Archery & Targeting skill, but is applicable only to the sling, crossbow, and bow and arrow.

Only the Gunfighter, Sheriff and Gunslinger O.C.C.s automatically get a few Sharpshooting skills among their O.C.C. skills, but any additional selections cost them two O.C.C. Related skills like anybody else.

This skill is never available to robots, master psionics, practitioners of magic, dragons, demons or any creatures of magic or supernatural beings. Juicers, Crazies, and 'Borgs are limited to only one Sharpshooting skill. Characters cannot trade in Secondary Skills for the Sharpshooting skill.

**W.P. Sharpshooting Bonuses:** All bonuses are in addition to the conventional W.P. bonuses.

**The Sharpshooter's "Aimed" Shot** (applicable to both the single shot and the aimed burst shot): +1 to strike with a P.P. 20 and for every additional five P.P. points above 20, but the bonuses are only applicable when the appropriate type of weapon is used. Aimed shots only. No bonuses for shooting wild.

**The Sharpshooter's "Called" Shot:** The Sharpshooter's "aimed" shot bonuses are NOT applicable when using this special "Called Shot." Instead the sharpshooter uses the following superior bonuses: +1 to strike with a P.P. 18 and for every additional three (3) P.P. points above 18, but the bonuses are only applicable when the appropriate type of weapon is used and this special called shot counts as two melee attacks/actions. Aimed shots only.

**Quick Draw:** +1 to initiative at a P.P. 18 and for every additional four (4) P.P., in addition to other initiative bonuses.

**The Bonus Attack:** +1 melee attack when using that specific weapon for the entire melee round.

**Trick Shooting:** Most Men at Arms can pick *one* of the following tricks (or roll 1D6 for random determination), but the *Gunfighter*, *Sheriff* and *Gunslinger O.C.C.s* get ALL six!

1. Can fire a traditional two-handed weapon, like a rifle, one-handed without penalty (normally the shooter loses all strike bonuses).

2. Can shoot over his shoulder by holding up a mirror and using the reflection to aim. Reduce the bonus to strike by half, unless a Gunslinger or Gunfighter who keeps full bonuses to strike.

3. Accurately shoot while riding a horse or a moving vehicle (normally a wild shot), but strike bonuses are half and a "called" shot is impossible (-8 to strike and strike bonuses do not apply).

4. Shoot accurately while standing on head or hanging upside down; all bonuses applicable at full.

5. Dodge, roll or somersault and come up shooting (normally a wild shot); no bonuses or penalties to strike; straight roll of the dice.

6. Ricochet shot! The shooter can bounce bullets, arrows, slings, and other fired projectiles (depending on the specific W.P.) off of one surface and angle the shot in such a way that the projectile ricochets/bounces off and hits a different/second target! Inflicts only one point of damage to the first surface and full damage to the second. Reduce bonuses to strike by half.

This can also be done with laser weapons but the ricocheting surface must be mirrored or highly polished. Glitter Boys are excellent reflective surfaces for performing a ricochet laser shot. Particle beams, ion blasters, rail guns, mini-missiles and other types of weapons cannot be used.

## Wilderness Skills

**Blend (Australian):** This skill is a variation on the skill Prowl, except a little different in application. It is the natural ability to simply fade into the underbrush and remain unseen in the bush lands. With a successful roll, a *motionless* character can remain hidden and undetected, even when somebody is standing mere inches away. The Blending character is so still, and so in tune with his surroundings, that he is practically invisible to the naked eye. Of course, electronic sensors and optics will defeat this ability, as will magical or psionic perception. Furthermore, the character must have appropriate clothing or natural concealment; i.e. he must be partially camouflaged.

It is possible to vanish from view the moment a pursuer or antagonist looks away. This means the opponent must be distracted for a few seconds. This ability can NOT be used during combat, but it can be used (especially) for an ambush. A favorite tactic of Aboriginal warriors is to run from an opponent and fool him into chasing. He will then wait for an opportune moment (such as running around a rock) to Blend, so that he may burst out behind the foolish aggressor and slice

him to bits (never battle such an opponent on his home ground; many Bushmen will tell of the healthy respect they have for their fighting capacity). **Basic Skill:** 14% +4% per level of experience; +4% if the character also has the ability to prowl, and +4% if at night. Note that all Aboriginal characters automatically get a +10% bonus which is in addition to any probable O.C.C. bonus. Native American Indians can also get this skill if the G.M. approves it. **Note:** If the hidden character is being *actively* sought after, he suffers a skill penalty of -10% to remain concealed.

**Boat Building:** This skill enables the character to build a variety of rafts, small rowboats, large flatbed boats, and canoes. A small raft (two man) can be made within 1D6+1 hours if the lumber or other suitable materials and tools are readily available. A large raft will take about 4D6 hours, a canoe, 2D6 days, rowboat, 4D4 days, large flatbed, 1D4x10 days. Time is doubled or tripled if trees must be cut down and wood prepared. Of course, the time can be reduced if several knowledgeable people are working on the construction. A failed skill roll means the boat has leaks. Trying to patch it will require 4D4 hours. **Base Skill:** 25% +5% per level of experience.

**Carpentry:** A fundamental knowledge of working with wood. The character knows how to prepare, treat, and preserve wood, recognize quality craftsmanship, repair damaged wood and wood items, and build (chests, chairs, tables, cabinets, houses, etc.). Adds +5% bonus to the Boat Building skill if taken. **Base Skill:** 25% +5% per level of experience.

**Dowsing:** This is the ability to locate fresh water whether it be with a divining rod or by more scientific and logical means. For some (like Gypsies) it is a mystical ability, while for others (like the Huntsman-Trapper), it is done through deductive analysis and knowledge of nature. The percentage number indicates the success ratio of locating fresh water. A person can roll once every melee to sense water, but must roll two consecutive successful rolls to locate the water. **Base Skill:** 20% +5% per level of experience.



**Hunting:** The skill of killing and preparing an animal for food. **Special Bonuses:** Add the following bonuses to the appropriate skills:

- +5% to Cook (but only applies to freshly caught and killed game)
- +2% to Prowl
- +5% to Track Animals
- +5% to Skin Animals
- +5% to Wilderness Survival

**Identify Plants & Fruits:** Training in the recognition of the many different types of plants and vegetation and where they grow. The emphasis is placed on edible, herbal, and poisonous plants. **Base Skill:** 25% +5% per level of experience.

**Land Navigation:** This skill enables the person to stay on course while traveling over land by means of observation. It includes mentally marking/recognizing geographic landmarks, estimating distance and movement, recognizing sounds, night travel, and other navigational

tricks. The player should roll once for approximately every three miles (4.8 km) traveled. A failed roll means the character is drifting off course; 2D10x100 yards/meters. Consecutive failed rolls means the individual does not realize that he's off course and continues in the wrong direction. **Travel Note:** A group of average men can cover about five miles (8 km) an hour at a brisk, but relaxed, pace through grassland, along dirt roads or pavement. Travel through dense forest or jungle at a cautious pace, with eyes open for danger, is about one mile (1.6 km) an hour, sometimes slower! Heavy rain or snow, fog, swamps, etc., will also reduce speed. **Base Skill:** 36% +4% per level of experience.

**Outback Survival (Exclusive to Australia):** Just like the skill Wilderness Survival, except adjusted to suit the varied terrains of the Australian wilderness. This is a particularly useful skill for those that intend to travel the Outback without the benefit of radio navigation, computers, radar, sensors and electronics (few people in the Outback have equipment like this). This is the way the Aborigines have been "reading the Outback" for centuries without technological aid.

A successful skill roll means the character can tell which direction is North (day and night) and estimate his current or desired direction, determine the approximate time of day, as well as when the sun will rise and set, keep an accurate calendar (month and day of the year), accurately estimate distances and not be confused by the similarity of terrain, as well as understand the advantages and pitfalls of the seasons, and feels at home in the bush and deserts. Most importantly, it includes living off the land, finding food and water, and similar. The plants, animals, and availability of water in the Outback are unique in the world, and therefore, finding "tucker" (as food is sometimes referred to) is quite a different process. With this skill, the character can locate edible berries, honey, bark, leaves and nutritious bulbs, find water holes and so forth. The character will also be skilled in gathering water through various means such as stretching a plastic sheet between two branches and collecting the condensation or rainfall, and even finding edible bugs and small animals (though the thought may be disgusting, there are some ants and grubs that are delicacies to both the Aborigines and white survivalists). At higher levels, the character will be perfectly happy to live on bush "tucker," but at lower levels, meats and prepared foods will still be a welcome sight. This skill is exclusive to Australian characters. **Base Skill:** 58%+2% per level of experience. Note: Some bush foods can be highly dangerous. The humble eucalyptus, for instance, is poisonous. Characters from other parts of the world who have the Wilderness Survival skill are -15% to survive in the Australian Outback.

**Preserve Food:** Knowledge in the preparation of foods for storage and later consumption. Includes canning fresh fruit and vegetables, making jams and honey, drying fruit, vegetables, and herbs, drying meat and fish, plus various smoking, salting, and pickling methods. **Base Skill:** 25% +5% per level of experience.

**Roadwise (Australia):** This skill originated in the *Rifts® Australia World Book* but can apply anywhere in the world. The Outback is still crossed with roads. Some are ancient, pre-Rifts concrete creations that have not been maintained since before the Apocalypse, others are patched and rebuilt roads, while others are new stone or concrete creations, trails and dirt paths. To the untrained traveler, they are no more than tracks in the dirt, barely suitable for travel; half disintegrated highways that are little more than ruts cutting through the hostile landscape. But to those trained to see them as something more (in Australia that includes Outbackers, gangs, warriors and adventurers that roam them), they still have the capacity to speed travel and smooth out rides that would be difficult and slow without four-wheel drive vehicles. The roads also serve as signs and paths to the struggling wilderness communities scattered across the land. Follow a road, and sooner or later (usually later), one is likely to come across a nearby town, shabby settlement, farm or outpost.

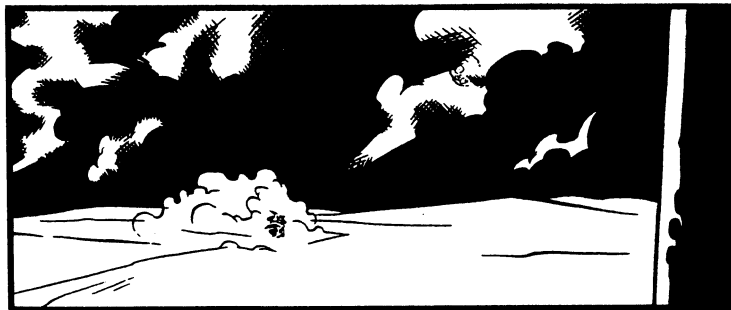

Characters with this skill can identify roads by name, use roads to help pinpoint their location, map out routes across the country, determine the safety of a road or region, find a shortcut and even predict who or what is likely to be found along particularly notorious roadways and regions. The skill is not just limited to the old roads either, it also applies to the new routes that have been forged by continuous travel or built by regional communities. Note that the skill is most effective on the character's home turf — the 200 mile (321 km) radius where he grew up (+20% for roads in that region). This skill is unlikely to be practiced by anybody outside of Australia. **Base Skill:** 26% +4% per level of experience. **Note:** City dwellers, even Military Troops, other than specialized "Military Scouts," are -14% on this skill, if they bother to take the skill at all.

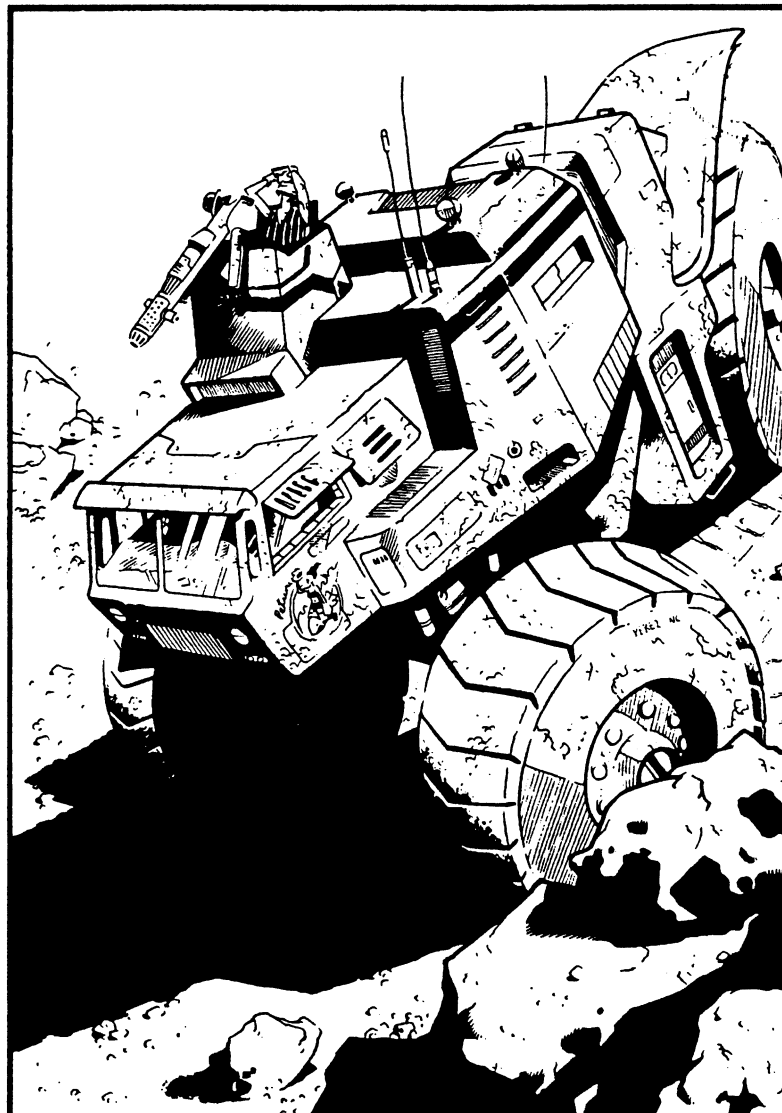

**Skin & Prepare Animal Hides:** Training in the methods and techniques in skinning, tanning, stretching, and preserving animal hides as

fur or leather. Adds a +5% bonus to the Sewing skill. **Base Skill:** 30% +5% per level of experience.

**Spelunking:** The art of exploring and climbing underground cave systems. This skill enables the character to navigate a cave or underground cave network, retain a sense of direction (including up and down), have a sense of the cave's depth, know how to make subtle markings and note formations to find his way out and to better navigate the cave(s) at a later date, as well as rock climbing. The spelunker can answer questions about a cave system, such as what it is called (if it is a named landmark), where it may lead, how deep it continues, what type of rock it leads through and so on. This skill also lends familiarity with the correct equipment needed to go spelunking, and how to apply it. Characters without this skill have about as much chance surviving underground as they would climbing a mountain without information or equipment. **Base Skill:** 35% +5% per level experience. Add +5% if the character also has the Climbing skill.

**Track Animals:** This skill enables the character to identify an animal by its tracks, scent, spoor, and habits. The individual can also follow the animal's tracks and other signs. This means he can also estimate how fresh the tracks are, what direction they are heading, whether the animal is hurt or sick, and guess its age. The habits and habitats of animals and animal behavior are also learned. Tracking humans with this skill is also possible, but is done with a penalty of -20%. **Base Skill:** 20% +5% per level of experience.

**Track & Hunt Sea Animals:** General knowledge of the oceans and seas, with an emphasis on undersea habitats and environments, and the types of fish and animals attracted to such places. The character knows where to look for particular types of fish and sea creatures (i.e. in coral reefs, under rocks, inside caves, in warm water, cold water, etc.), the types of food the sea animals eat/prey upon, migration patterns of fish and sea mammals, and notable types of seaweed and their uses (edible, poisonous, etc.). **Basic Skill:** 35%/25% +5% per level of experience. The first number is the general knowledge, and the second is the character's ability to locate and capture small and large undersea creatures (crustaceans, fish, eels, sea mammals, etc.). **Note:** -20% when dealing with mutants and alien creatures.

**Undersea & Sea Survival:** Methods and information for surviving in an underwater environment or lost at sea (on the water's surface). Includes a basic knowledge of what sea animals and fish are edible and easiest to find and catch, how to make simple fishing hooks and lines, dangerous predators and D-bees to avoid, how to protect oneself from the sun, water and food rationing, and fundamental survival techniques. **Base Skill:** 25% +5% per level of experience. **Note:** At the G.M.'s option, this can be included as part of a character's basic *Wilderness Survival* as found at the end of this section. This is especially likely of Navy men, Sailors, Pirates, Sea Druids, Ocean Wizards, and aquatic D-Bees.

**Underwater Navigation:** This skill is the deep sea version of Land Navigation. The character can identify his whereabouts, direction and traveling speed, and stay on course by means of observation. This method includes mentally marking and recognizing underwater landmarks (mountain ranges, reefs, sunken wreckage, cities, animal habitats, etc.), as well as noting the direction of currents, tides, determining the time of day, recognizing sounds, surface landmarks, the positions of the stars and sun, and other navigational tricks. The character should roll once for every ten miles (16 km) traveled in order to stay on track. A failed roll means he is drifting off course by 1D6x100 yards/meters. Consecutive failed rolls means the individual does not realize that he's off course and continues in the wrong direction. His course can only be corrected when he makes a successful roll. **Base Skill:** 30% +4% per level of experience.

**Use Songlines (Exclusive to Australia):** Ley Lines are called "Songlines" by the Aboriginal people, and are said to lead to what have been recently called the "Demon Gates," but what used to be thought of as sacred points in the land (Nexus Points). However, the Aboriginals

have a very deep understanding of the Songlines, to the point where they can use and "read" them in a similar way to a Ley Line Walker. The Aboriginal will literally sing over the landscape, using a very complicated code of notes and words combined with a ritual dance called the Corroboree. The Ley Lines pick up the songs and store them as resonant vibrations, so that anyone with the Songlines skill can tune into the magical energy and use them for the following effects:

1. **Land Navigation.** The character can see, in his mind, the terrain on and surrounding the line, up to one mile (1.6 km) on either side of the line per level of experience. This knowledge includes any towns or settlements, and the presence of caves, forests, water, notable landmarks and similar things necessary for land navigation.

2. **Stories.** Information about past events that occurred on or near the line can be picked up by the songline reader. These stories are typically limited to major or significant events (in the scope of Dreamtime) such as whether there was once a great battle or evil done on or near (within one mile/1.6 km) the line, past geology or weather (a pond or water hole once existed, a great storm once swept away a village, an underground stream is located in the general area of ... and so on), as well as events involving "the people" (Aboriginals) and whether supernatural demons or monsters have passed through the area recently, or linger along the line, or whether there is a Demon Gate (ley line nexus) along its length, and where it is. These stories will also warn of impending Ley Line Storms, natural storms or an opening of a Demon Gate, provided such an event will occur within the next 24 hours (cannot see beyond 24 hours into the future). Events and stories involving the Aboriginals, the land, wildlife and Dreamtime spirits are considered major events.

3. **Find Caches.** The user of a Songline can hide caches of food, supplies or weapons within one mile (1.6 km) anywhere along the Songline/ley line. He can find these locations at a later date without fail and without needing to search for them or leaving any sort of tell tale marker. Furthermore, the moment he reaches a Songline, he can sense whether or not the cache has been disturbed and looted by others. Note that listening to Songline stories may reveal the general location of large caches left by others (small caches and those with food are considered insignificant), however, finding somebody else's cache will require performing the Corroboree for 1D4 hours while listening to stories and then another 1D4 hours of searching to find the exact location of the cache.

4. **Find Hidden Sources of Water.** Like divining, if water exists along the line, the Songline will describe it, and provide the general direction and general location.

5. **Determine Distances.** The precise length of the line and the exact distance of settlements and major landmarks on or near the line can be determined, provided the character knows about them.

6. **Telling & Transmitting Stories.** This skill can be used to tell a story to an individual or group audience (from a handful to thousands), anywhere on the Songline, even if they are many miles away. This is a one-way transmission from the Corroboree dancer and singer to that particular group.

**Base Skill:** There are two levels to the Songline skill. First is the correct execution of the Corroboree at a base skill of 30% +4% per level of experience, and the second is for the translation and interpreting of the impressions/stories/information transmitted by the Songline at 20% +2% per level of experience. **Note:** All Aboriginals are +20% to the understanding of the songs and stories they receive. City folk can not learn this skill. Finally, this skill is exclusive to Australian characters; those from outside the continent can not take it unless they naturalize themselves there.

**Wilderness Survival:** Techniques for living off the land, getting water, food, shelter, and help when stranded in wild forests, deserts, or mountains. Characters without this skill will not be able to stay healthy for more than a few days in the wilderness once their supplies run out. **Base Skill:** 30% +5% per level of experience.

# Psionics

## Psionic Powers Checklist

**Note:** The number in parenthesis indicates the amount of I.S.P. needed to use that power.

### Healing

Bio-Regenerate (self) (6)  
Deaden Pain (4)  
Detect Psionics (6)  
Exorcism (10)  
Healing Touch (6)  
Increased Healing (10)  
Induce Sleep (4)  
Psychic Diagnosis (4)  
Psychic Purification (8)  
Psychic Surgery (14)  
Resist Fatigue (4)  
Restore P.P.E. (4)  
Suppress Fear (8)

### Physical

Alter Aura (2)  
Deaden Senses (4)  
Death Trance (1)  
Ectoplasm (6 or 12)  
Ectoplasmic Disguise (12)  
Impervious to Cold (2)  
Impervious to Fire (4)  
Impervious to Poison (4)  
Levitation (varies)  
Mind Block (4)  
Nightvision (4)  
Resist Fatigue (4)  
Resist Hunger (2)  
Resist Thirst (6)  
Summon Inner Strength (4)  
Telekinesis (varies)  
Telekinetic Leap (8)  
Telekinetic Lift (6)  
Telekinetic Punch (6)  
Telekinetic Push (4)

### Mind Bleeder Powers

Bleed Aura (6)  
Bleed P.E. Energy (10)  
Bleed Memory (6)  
Bleed Skills (15)  
Bleed Truth (8)  
Brain Bleed (10)  
Brain Scan (10)  
Day Dream (8)  
Healing Leech (6)  
Impervious to  
Bio-Manipulation (10)  
Mental Block (10 or 30)  
Mental Block Removal (12)  
Mind Trip (6)  
Neuro-Touch (varies)  
Neural Strike (25)

### Sensitive

Astral Projection (8)  
Clairvoyance (4)  
Commune with Spirits (6)  
Empathy (4)  
Intuitive Combat (10)  
Machine Ghost (12)  
Mask I.S.P. & Psionics (7)  
Mask P.P.E. (4)  
Mind Block (4)  
Object Read (6)  
Presence Sense (4)  
Read Dimensional Portal (6)  
Remote Viewing (10)  
See Aura (6)  
See the Invisible (4)  
Sense Dimensional Anomaly (4)  
Sense Evil (2)  
Sense Magic (3)  
Sense Time (2)  
Sixth Sense (2)  
Speed Reading (2)  
Telepathy (4)  
Total Recall (2)

### Super-Psionics

Astral Golem (50+)  
Bio-Manipulation (10)  
Bio-Regeneration (Super) (20)  
Electrokinesis (varies)  
Empathic Transmission (6)  
Group Mind Block (22)  
Group Trance (15)  
Hydrokinesis (varies)  
Hypnotic Suggestion (6)  
Mentally Possess Others (30)  
Mind Block Auto-Defense (special)  
Mind Bolt (varies)  
Mind Bond (10)  
Mind Wipe (special)  
P.P.E. Shield (10)  
Psi-Shield (30)  
Psi-Sword (30)  
Psionic Invisibility (10)  
Psychic Body Field (30)  
Psychic Omni-Sight (15)  
Psychosomatic Disease (30)  
Pyrokinesis (varies)  
Radiate Horror Factor (8)  
Telekinesis (Super) (10+)  
Telekinetic Acceleration Attack (10-20)  
Telekinetic Force Field (30)  
Telemechanic Mental Operation (12)  
Telemechanic Paralysis (20)  
Telemechanic Possession (50)  
Telemechanics (10)



Beyond technology, beyond magic, beyond the Rifts, there is the realm of the psychic. Often tapped, rarely understood, the powers of the mind have become a major factor in the world of **Rifts**®, and those who master their mental gifts find themselves catapulted into realms of power far beyond those of ordinary men and women.

This section consists of six main parts: a *Psionic Powers Checklist*, *Healing Psionics*, *Physical Psionics*, *Sensitive Psionics*, *Super Psionics*, and *Mind Bleeder Powers*.

The Psionic Powers Checklist is a handy reference listing all of the powers commonly available to psychic characters. It is meant mostly as an aid during character creation, when those making psychic characters might need a comprehensive list of psionic abilities to choose from.

The **Healing Psionics**, **Physical Psionics**, **Sensitive Psionics**, and **Super Psionics** sections consist of psionic powers compiled from the *Rifts*® RPG and *Psyscape*™ World Book. The **Mind Bleeder Powers** were compiled from the *Rifts*™ Africa and *Psyscape*™ sourcebooks. While both of those sourcebooks are fine, plenty of tech-heavy G.M.s who run psychically rich campaigns are missing out on one of the game setting's more bizarre manifestations of psionics. Mind Bleeders make great villains, and their powers alone are inspiration for all sorts of mental nastiness. G.M.s, have fun with them!

### A few Notes on Psionics

**1. Mind Control** powers are abilities to control another character's *mind* and force or induce that individual to do something against his will and to the specifications of the psychic controlling him. Psionic mind control powers include *Hypnotic Suggestion*, *Mentally Possess Others*, *Psionic Invisibility*, *Mind Wipe*, *Psychosomatic Disease* and the Mind Bleeder powers of *Day Dream*, *Mental Block* and *Mind Trip*.

Telepathy, Empathy and other types of scans, probes and most bleedings are NOT mind control. They do not make the victim do any-

thing. The psychic only sees or feels the thoughts and emotions of the character being scanned or probed. The psychic may gather information he can use on or against his opponents, but the psychic scans do not control or make the victim do anything he or she doesn't want to do. Unwanted telepathic communication may play inside a character's head like a radio in the background, and while it may be annoying, and the voice inside one's head may make suggestions, egg on or cajole, but it does NOT control or force the victim into taking any action against his will. **Note:** Unless a character is already seriously considering suicide, Mind Control can NOT be used to force a character to kill himself. Nor can Mind Control be used to make the character do anything that he or she normally finds abhorrent (i.e. rape, torture, murder, self-mutilation, etc.) or self-destructive. On the other hand, the mind controlled character will obey simple innocuous commands like open the safe, call Tina and tell her to come over, give me your wallet or car keys, tell me where so and so is at, and so on, without hesitation. Likewise, the character will follow, help and protect the psychic (or mage) who has control of him if told to do so (unless that act is truly abhorrent).

*Possession* is a different story entirely, because the character being victimized is no longer in control of his or her own body. The possessing psychic, monster or sorcerer is in control now, and uses the other person's body as he would a suit of power armor.

*Empathic Transmission*, *Horror Factor* and similar psionic powers are NOT mind "control." They do not directly affect the logical thinking, control part of the brain. Rather they influence *emotions* such as hate, fear, despair, etc. While these emotions will trigger a response from the victim (run away, attack, curl up and cry, etc.), it is a knee-jerk, emotional reaction. The victim is not actually controlled by the psychic, rather he is *affected* by his own emotions brought out by the psychic.

**2. Can psionics affect people in body armor?** In most cases, yes. Opponents in ordinary S.D.C. armor, M.D.C. environmental body armor and power armor are ALL vulnerable to psionic attack, influence and mind control. This means, Telepathy, Empathy, Mind Bleeding, probes and sensings (See *Aura*, *Sense Evil*, *Clairvoyance*, etc.), are all viable against characters clad in armor. Moreover, *Bio-Manipulation* will affect the body inside the armor.

Physical psionic manifestations like all types of *Telekinesis*, *Hydrokinesis*, *Electrokinesis*, *Pyrokinesis*, *Mind Bolt*, *Psi-Sword*, *Force Field*, *Ectoplasm*, *energy blasts* and any physical attack created by a psionic power are stopped by the armor, but the armor takes the damage.

**3. What about those inside vehicles and giant robots?** Physical psionic manifestations will strike the machine itself.

The use of Telepathy, Empathy and other psychic powers on those "inside" are generally *blocked* by the nature of the vehicle and the fact that a *barrier* and space exists between the psionic and the individuals riding inside. (The same is true of characters locked behind a closed door.) Although the psychic can use some "sense" powers like Presence Sense, Empathy, Sense Evil, Sense Magic, and others, their effectiveness may be limited. Powers like *Sense Aura*, *Psychic Diagnosis*, *Hypnotic Suggestion*, *Bio-Manipulation*, *Empathic Transmission*, *Telekinesis*, and *most others* can NOT be directed at those *INSIDE* a vehicle or giant robot. Why?

Mainly because the psychic usually needs to *see* his potential victim for more than a split second as the vehicle speeds past him or engages the psychic in active combat. Also because most vehicles are moving fast and psionic powers have a short range; some even require touch or eye contact and/or verbal commands or cues.

*Telepathy* and *Empathy* can be used on a specific individual inside the vehicle "if" the psychic knows him even in passing (does not need to know the character's name), and if the vehicle remains within range long enough.

*Empathy* can be used to sense the general emotions emanating from inside, but only the most powerful one or two emotions or most numerous emotions will be picked up. Thus, if six people inside a vehicle are filled with hate and revenge that will be felt.

*Presence Sense* can be used to tell if anybody (alive) is inside a sealed or wrecked vehicle.

And of course, *psionically manifested physical attacks* (energy attacks, Psi-Sword, Telekinesis, etc.) can be directed against the *vehicle* itself.

**HOWEVER, those inside can be affected under certain conditions.** All of the following must be in place to use a psionic attack like *Empathic Transmission* on a character inside a vehicle.

a) The psychic must be able to *see* his intended victim through a window.

b) Can only target one specific victim inside (i.e. the pilot, the gunner, somebody he knows by name, etc.).

c) Those inside can see and hear the psychic if the power requires it. **Note:** In most cases the psychic must be able to see his target and the potential victim must see and hear the psychic or be within close proximity and not "sealed" away inside a moving vehicle and its occupants preoccupied with other things.

d) The target must be in range for more than four seconds.

**Note:** Psi-Powers requiring *physical contact/touch* can not be used on any character sealed inside a vehicle, nor environmental armor for that matter, unless it is the mechanical armor that is being attacked or targeted.

*Psionic powers requiring sound* (i.e. the victim must hear the psychic's words, like Hypnotic Suggestion) do not work unless the psychic can be heard and is within range. Many giant robots and other vehicles can "turn off" their external audio system and/or radio. If the psychic can not be heard, he can not use that power against anybody. Of course, there are only a few psionic abilities that require verbal suggestions and cues.

*Radiate Horror Factor* affects anybody who sees and comes within 90 feet (27.4 m) of the psychic.

**4. Psionic Attacks per Melee:** Unlike magic which requires time to cast a spoken incantation and involves hand gestures, most psionic abilities are activated or done at the speed of thought. Thus, each use of a psionic power or attack counts as one melee action/attack. Some psionic abilities require time and concentration, using up several melee actions to perform. This will be indicated in the description of the power, such as *Bio-Regeneration*.

**5. Can not Syphon I.S.P. from other sources:** Psychics can NOT draw I.S.P. from ley lines, magic items or other people (except in a Group Trance). However, they can regenerate *six I.S.P. points* every hour through meditation. All Mystics and Minor, Major and Master Psychics should automatically get *Meditation* as a one of their learned or intuitive skills.

**6. Psychics & Techno-Wizard Devices:** All psychics can use TW weapons but must spend twice the number of I.S.P. compared to the P.P.E. necessary to operate the magical device.

**7. Psionic Summary:** P.C.C. stands for Psychic Character Class.

**No Psionics – Ordinary People & Animals:** Needs a 15 or higher to save vs psionic attack. Actually, certain animals can sense supernatural evil and the presence of demons and magic.

**Minor Psychic:** Gets two powers from any ONE power category: Healer, Physical or Sensitive. Base I.S.P.: M.E. attribute number +2D6. Additional I.S.P.: 1D6 per level of experience. Needs a 12 or higher to save vs psionic attack.

**Major Psychic:** Gets eight psionic powers if ALL eight are selected from the same power category, otherwise six powers if selected from two or more psionic power categories: Healer, Physical or Sensitive. Base I.S.P.: M.E. attribute number +4D6. Additional I.S.P.: 1D6+1 per level of experience. Needs a 12 or higher to save vs psionic attack.

**Master Psychic:** Typically a specific P.C.C. or R.C.C. such as the *Mind Melter*, *Mind Bleeder*, *Mystic*, *Burster*, *Zapper*, *Nega-Psychic*, *Psi-Druid*, *Psi-Ghost*, *Psi-Nullifier*, *Psi-Slayer*, *Psi-Tech*, and *Psi-Warrior*. With rare exceptions, only the “Master” Psychic can select Super-Psionic powers and gets a huge selection from the three other categories. Needs a 10 or higher to save vs psionic attack. **I.S.P.:** Varies with the particular R.C.C./P.C.C.

**Mind Bleeder:** A human-looking D-Bee with mysterious psychic powers that leaches knowledge and power from other intelligent beings.

See *Rifts® World Book 12: Pyscape™* for details on most types of psychic characters.

## Healing Psionics

### Bio-Regeneration

**Range:** Self.

**Duration:** Permanent.

**I.S.P.:** 6

**Saving Throw:** None.

This is the ability to mentally heal *oneself* of disease, poison, or physical damage. Unfortunately, this ability can *not* be used to help others. The process requires one full minute of concentration, meaning the character can not use any other psionic power during that time. Bio-Regeneration does not restore missing limbs, but it does restore 2D6 Hit Points or 3D6 physical S.D.C. points per melee round. In addition, when cuts and scrapes are healed through bio-regeneration there is *no* scarring. This power can be used as often as once every *other* minute (every eight melee rounds).

### Deaden Pain

**Range:** Immediate proximity, touch or within 3 feet (0.9 m).

**Duration:** One hour per level of experience.

**Length of Trance:** Two minutes (8 melee rounds).

**I.S.P.:** 4

The ability to deaden pain; can be used as a pain killer which temporarily negates existing pain or as an anesthetic to be used for surgery.

### Detect Psionics

**Range:** Self, sensing range is 30 feet (9 m) per level of experience.

**Duration:** One minute per level of experience.

**I.S.P.:** 6

This is a mental probe that will indicate the presence of psionic energy within the immediate area. The probe can not be used to pinpoint the exact location of psychic energy nor the level of power other than a vague sense of weak, medium, or powerful, but will indicate whether an individual is psychic by directing the probe at a specific person (does not reveal the type or strength of the person’s powers other than low, medium, high). It will also indicate whether a Group Mind Block is in effect and also indicate if a person is *psionically possessed*.

### Exorcism

**Range:** Immediate area, touch or within 8 feet (2.4 m).

**Duration:** Instant, if successful.

**Length of Trance:** 30 minutes of preparation and 6D6 minutes with the possessed person or animal. **Note:** Can only exorcize the living.

**I.S.P.:** 10

The healer can perform a Rite of Exorcism that uses psychic energy to expel the loathsome being from its mortal, host body. A completely successful exorcism will free the victim of the supernatural force that controls him and send it back to its own non-earthly realm. A partially successful exorcism will drive the evil force out of the possessed person or animal, but does not send the damnable thing back to its own dimension. Thus, it can *try* to possess the psychic healer or flee to wander the Earth in search of a new victim. An exorcism can only be used on

living people and animals whose bodies are inhabited by a supernatural entity or other type of invasive spirit, not symbiotes or psychic possessors.

Roll to determine success for an exorcism at the end of the time period. First, roll to see if the being has been expelled from its victim’s body. **Success Ratio:** 28% + 7% per each additional level of experience.

Second, roll to see if the thing is forced back into its own dimension. **Success Ratio:** 21%+7% per each additional level of the psychic’s experience. A failed roll means the creature can remain in our dimension, but it must leave the area and can not possess the same individual for at least six months. **Note:** The chance of a successful exorcism on a Nega-Psychic is reduced by half, as is the success ratio for sending the being back to its own dimension. The same is true of some of the more powerful supernatural beings capable of possession.

During the exorcism the possessing force can use whatever powers it may have, as well as physical attacks or any special psychic abilities of its *host body*. Fortunately, the Rite of Exorcism weakens the creature, reducing its number of attacks per melee by half. It is wise to always have one or more assistants to help defend against the being’s attacks and actions. Sedating the physical host body will immobilize it, but will not prevent psychic attacks or the creature’s use of its own natural powers (if any). Too many assistants or spectators can be a liability, for the creature may attempt to flee by possessing one of them. An exorcism can be attempted on the same individual as often as the healer desires.

### Healing Touch

**Range:** Touch.

**Duration:** Instant, with lasting effects.

**Length of Trance:** Two minutes (8 melee rounds).

**I.S.P.:** 6

The Healing Touch is a remarkable healing ability that can instantly heal cuts, burns, bruises and similar physical wounds. The touch restores 1D8 (or 2D4 whichever dice are preferred) Hit Points or 2D6 S.D.C. The healing touch can only be used on *other* living creatures, never on the psychic himself.

### Increased Healing

**Range:** Touch or within 3 feet (0.9 m).

**Duration:** 2D4 days.

**Length of Trance:** 1D6 hours.

**I.S.P.:** 10

The healer is able to stimulate another person’s healing energies, dramatically increasing one’s recuperative powers. Hit Points and S.D.C. recovery are double the normal professional treatment rate. That’s recovery of 4 Hit Points a day for the first two days and 8 H.P. for each subsequent day until restored to full strength or the psionic energy fade, whichever comes first. S.D.C. is healed at a whopping 12 points per day from the very beginning.

### Induce Sleep

**Range:** Touch or within 6 feet (1.8 m).

**Duration:** One hour per level of experience (or until awakened).

**Length of Trance:** Two minute preparatory meditation.

**I.S.P.:** 4

**Saving Throw:** Standard; unwilling victims are +5 to save vs psychic attack.

This is not an offensive ability, but is intended to be a recuperative power to induce sleep on those who are ill, exhausted, or an insomniac. The person will fall into a normal, restful sleep from which he can be easily roused. Unwilling victims of the induce sleep psi-power get a +5 bonus to save. A character must want rest (can *not* be involved in combat or some other activity and be forced to fall asleep).



## Psychic Diagnosis

**Range:** Touch or within 3 feet (0.9 m).

**Duration:** Immediate knowledge.

**Length of Trance:** 2D4 melees of meditation.

**I.S.P.:** 4

**Saving Throw:** None; except for the Nega-Psychic, standard.

The psychic healer can sense physical pain and damage, external and internal injury, disease and possession with absolute clarity. This pinpoint accuracy enables the character to suggest treatment or to conduct psychic surgery.

## Psychic Purification

**Range:** Touch.

**Duration:** Immediate.

**Length of Trance:** 6D6 minutes of meditation.

**I.S.P.:** 8

**Saving Throw:** None; except for the Nega-Psychic, standard.

The healer can use his abilities to slow a person's metabolism and destroy chemicals, drugs, poisons, and toxins in the body. The effects of the drugs/impurities are immediately halted at the beginning of the meditation, and completely destroyed/negated by its end. Damage sustained prior to the psychic's intervention still remains.

## Psychic Surgery

**Range:** Touch.

**Duration:** Varies with injury.

**Length of Trance:** 2D6 minutes of preparatory meditation, plus the duration of the surgery (which is half the time of conventional modern medicine).

**I.S.P.:** 14

Psychic Surgery is used to repair broken bones, internal injuries, and remove foreign objects (bullets, arrows, etc.) using only one's bare hands; no tools or instruments. Can also be used to heal a character who has suffered so much damage that he or she has lapsed into a coma (zero Hit Points or less). Psychic Surgery is the equivalent of "professional hospital" treatment. The recovery from a coma (near death) is equal to treatment from a hospital, 1-66%. Note that there is minimal bleeding and pain, and absolutely no scarring from Psychic Surgery (*no pain* if the Deaden Pain ability is used). **Note:** A psychic diagnosis must be made before surgery is possible.

## Resist Fatigue

**Range:** Self.

**Duration:** One hour plus 20 minutes per level of experience.

**Length of Trance:** 1D6 melees of preparatory meditation.

**I.S.P.:** 4

A mind over matter discipline which enables the character to engage in physical activity without suffering from exhaustion. However, fatigue is only temporarily suspended, so the psychic feels extremely tired and may even collapse when the duration of this power elapses.

## Restore P.P.E.

**Range:** Touch.

**Duration:** Permanent.

**I.S.P.:** 4 plus the amount of P.P.E. transferred.

This power allows the psychic to convert some of his I.S.P. into P.P.E. energy and transfer that energy to another person. Two I.S.P. counts as one P.P.E. point. In addition, the conversion and transfer costs four I.S.P. to initiate. For example, 10 I.S.P. converts into five P.P.E. and costs an additional four points to make the transferal and conversion. Total cost is 14 I.S.P. A Mind Block will prevent this energy transfer. **Note:** P.P.E. can *not* be turned into I.S.P.

## Suppress Fear

**Range:** Self or others by touch.

**Duration:** One minute per level of experience.

**I.S.P.:** 8

This power temporarily suppresses the chemical and psychological components of fear in the recipient. As a result, the character is unable to feel fear or is barely frightened even if intellectually he realizes he is in grave danger, or is facing a terrifying monster or situation. This enables the character to think rationally and take calm, calculated action, rather than respond with the typical "fight or flight" reactions of those who are scared. While this power is activated, the character automatically succeeds on any roll to resist *Horror Factor*, even if magically induced. This power can be used on the psychic himself or on one or two others.

## Physical Psionics

### Alter Aura

**Range:** Self.

**Duration:** One hour per each level of experience.

**I.S.P.:** 2

**Saving Throw:** None.

A truly unique power that many skeptics claim does not exist. Only a handful of physical psychics can manipulate their physical energy in such a way that it changes their aura. The altered aura will send the wrong message to those who can see auras. Alterations include:

- General level of experience can be made to seem much lower (level 1 or 2) or much higher (2D4 levels higher) than it really is.
- Conceal the presence of psychic abilities and high levels of I.S.P. (seems low).
- Conceal level of base P.P.E. (made to seem much lower).
- Conceal the presence of magic.

### Deaden Senses

**Range:** 160 feet (48.8 m); line of sight.

**Duration:** 2D6 minutes; roll for random determination of duration.

**I.S.P.:** 4

**Saving Throw:** -1 to save.

A form of bio-manipulation that is so subtle that its victims seldom realize they have fallen under the influence of this psionic attack. The psychic is able to induce a physical influence on a single character to make him or her momentarily less alert and attentive to the things around him. Small sounds, odors, movements, and details go unnoticed (+10% to the psychic on the following skills when used against this *be-fuddled* character: Camouflage, Prowl, Concealment, Palming, Pick Pockets, Cardsharp, Forgery, Seduction, Disguise and Impersonation). And the deadened character is also slow to react; reduce Spd by 10%, -1 on initiative, and -5% on skill performance. This power is typically used on guards, sentries, and investigators to make them miss something in a search, not notice the psychic, etc.

### Death Trance

**Range:** Self.

**Duration:** As long as the psychic senses he must feign death, up to a maximum of four days.

**I.S.P.:** 1, because Physical Psychics find it easy to control their bodies.

A state of mind over matter that slows the metabolism to such a degree that it creates a temporary state of suspended animation, simulating death. Without hospital facilities, even a medical doctor is likely to believe the character is dead (1-89% likelihood). The effects of drugs, toxins and chemicals are slowed to a crawl, causing minimal damage or effect, but will take full effect the instant the death trance is stopped (unless treatment is administered first). While in the death-like state, the psychic can not be roused or respond to any type of stimulation, in-

cluding psychic probes. This means he is incapable of attacking or defending himself in any way until the trance is broken.

## Ectoplasm

**Range:** 40 feet + 5 feet (12.2 + 1.5 m) per level of experience.

**Duration:** 4 minutes (16 melees) per level of experience.

**I.S.P. (Vapor):** 6

**I.S.P. (Solid):** 12 I.S.P.

This mystifying ability enables the psychic to create a slightly luminous, vapor-like substance that is exuded from the pores. Ectoplasm has two forms: an invisible vapor and a luminous, solid state.

The vapor is a sort of floating, probing finger that can snuff out candles, open doors, knock over or pick up small objects (weighing under 9 ounces/255 grams), tap somebody on the shoulder, rustle leaves and knock on a door. The Ectoplasmic vapor can be seen only by its creator, psychics and supernatural beings who can *see the invisible*, or with infrared optic systems (including infrared camera lenses, infrared gun sights, binoculars, etc.). Ectoplasm, although an invisible vapor, has physical properties, which means it can *not* go through walls or solid objects. Thus, a person walking into an ectoplasm stream may feel a slight sensation, like walking into a spider's web or brushing against a cotton ball. Often a person will unwittingly walk into and snag the stream of floating ectoplasm, pulling or stretching it along without being aware of it. In such cases, the psychic must maneuver the snagged portion to loop around the human obstruction. The creator of the vapor can control the full length of the vaporous stream like a floating tentacle. Although the vapor can not go through solid objects it can slip through keyholes, cracks under doors or loose seals around a window. If a breeze can blow through, so can ectoplasm. The only drawback is that the psychic must be able to see the ectoplasm to maneuver it.

*The solid state of ectoplasm* can be a startling sight. In this form the ectoplasm can be shaped into an extra limb, such as an arm and hand, or just a hand or tentacle, or even a foot attached to a long stream spooling out of the psychic. The Ectoplasmic limb appears as a white, slightly luminous appendage connected to a trail of ectoplasm stretching back to its creator like a life-line of silly putty. The appendage and its connecting line can hover, float, levitate and fly (at a speed of 18). The solid Ectoplasmic limb has much greater strength and is able to carry, lift or hold up to 40 lbs (18 kg), but can not squeeze through the tiny openings that the vapor can. An opening must be at least the size of a quarter for solid ectoplasm to fit, and then the limb must be turned into a thin tentacle and reformed on the other side of the opening. Ectoplasm can also be used to create a face or even a full figure, although detailed features are impossible. Ectoplasmically created images may explain apparitions reported during some seances.

**Ecto-Combat:** The ectoplasm vapor and solid form both have an automatic dodge against all attacks directed at any of its length. That means an attempt to hack the middle of the Ectoplasmic stream will see that portion of the ectoplasm suddenly swerve, loop or bend with a life of its own to avoid the attack. The dodge by the mid-section (or anywhere else) does not count as a melee action by the ecto-appendage. Moreover, the ectoplasm's creator can direct the appendage to hit back or pick up and use a weapon. The solid ectoplasm appendage is not a great tool for combat, however. It limits its creator's attacks/actions per melee and has minimal strength; equal to about a P.S. attribute of 4. A punch or kick does a mere one point of Hit Point/S.D.C. damage. Damage can be increased by the appendage using any type of hand-held weapon weighing under 40 lbs (18 kg) and less than five feet (1.5 m) long. Small modern weapons, such as an energy pistol or revolver, can be used, but are -10 to strike. Meanwhile, the vapor can not use any weapons weighing more than 9 ounces and can inflict no damage of its own.

A vapor or solid appendage must be controlled by its creator at all times (except the automatic dodge); thus, it has a number of attacks/actions equal to its creator. So, if the psychic has four attacks per melee,

the ectoplasm appendage also has four attacks. However, each attack/action by the ectoplasm counts as one of its creator's actions for that melee round.

## Ecto-Combat Statistics:

- Vapor and solid get an automatic dodge against all attacks, including multiple or simultaneous attacks.
- +5 to dodge; applies to vapor and solid.
- +1 to parry; applies to vapor and solid.
- +1 to strike; applies to vapor and solid.
- Vapor inflicts no physical damage, but can touch, tap or pick up and carry objects weighing 9 ounces or less.
- Solid ectoplasm inflicts one point of damage in combat or by weapon.
- Attacks or actions per melee are equal to its creator's. A pair of Ectoplasmic limbs will divide the attacks between the two equally.
- Astral S.D.C. is 40 plus one Hit Point. Applies to vapor and solid. If the ectoplasm is destroyed the creator takes one Hit Point and 10 S.D.C. points of physical damage.
- Sunlight or bright artificial light (250 watts) reduces the range to half.
- Maximum range possible for vapor and solid is 40 feet plus 5 feet per level of experience (12.2+1.5 m per level).
- One full melee (15 seconds) is required to create an ectoplasm vapor or solid appendage. Half a melee (7 seconds) is needed to withdraw/return ectoplasm into its creator.

## Ectoplasmic Disguise

**Range:** Self.

**Duration:** 10 minutes per level of experience.

**I.S.P.:** 12

This is an enhanced control over ectoplasm that gives the psychic the ability to cover and disguise his physical features. Ectoplasm is created as normal, with the mysterious pseudo substance rising from the pores of the skin. Instead of forming wispy tentacles, the ectoplasm covers the face. As it solidifies, it becomes a sort of putty-like material that can be mentally shaped and molded by the psychic. Once the desired shapes and features are achieved, the psychic can make the ectoplasm look like real flesh. The best way to create an Ectoplasmic disguise is for the psychic to look at a photograph or a frozen video image and concentrate on that image while the ectoplasm automatically molds into that shape/image, including skin color. Not only can the psychic create a mask to hide his facial features, but he can also change the shape and bulk of his body with ectoplasm, adding a pot belly, muscles, a tail or extra eye, etc.

**Level of Proficiency:** 50% +3% per level of experience (add +16% if the character has the Disguise skill). This percentage applies primarily when trying to accurately imitate a specific person's identity. In most other cases, the disguise is successful in that it obscures the psychic's true identity.

**Problems & Limitations:** An Ectoplasmic disguise is especially effective from a distance, but does not hold up under close scrutiny. The ectoplasm always has a bit of a "dull" and "pasty" appearance, regardless of skin color. If punched, cut, scraped, etc., the Ectoplasmic covering will tear away and, in a matter of seconds, noticeably reform to cover the tear/damage.

The psychic must also concentrate on maintaining his disguise, which means his attention is divided and concentration hampered. While the disguise is maintained, the psychic suffers the following penalties: -4 on initiative and reduce all combat bonuses, attacks per melee, running speed and skill performance by half. To perform better, the character must relinquish some of his control over the disguise, with notable results, like features obviously shifting, drooping or even melting. If the character is seriously injured, knocked unconscious or slain,

the ectoplasm melts away, turns into floating globs and disappears into him in a matter of seconds.

## Impervious to Cold

**Range:** Self.

**Duration:** 20 minutes per level of experience.

**Length of Trance:** 1D4 melees for preparatory meditation.

**I.S.P.:** 2

A mind over matter discipline which enables the character to suffer absolutely no ill effects or discomfort from exposure to even extreme sub-zero freezing conditions.

## Impervious to Fire

**Range:** Self.

**Duration:** 3 minutes per level of experience.

**Length of Trance:** 2D4 melees for preparatory meditation.

**I.S.P.:** 4

Another mind over matter discipline enabling the psychic to endure intense heat, fire, boiling water, hot coals, and so on, without suffering pain, damage, injury or scarring. Magic fires inflict half damage.

## Impervious to Poison/Toxin

**Range:** Self.

**Duration:** 2 minutes (8 melees).

**I.S.P.:** 4

The character can negate the full effects of poisons and toxic chemicals which he has ingested (eaten or drank) or introduced into the bloodstream, as long as he has advance knowledge of its deadly properties. A poison, toxin, or drug which has been unknowingly inflicted (and starting to take effect) can be negated too, but will do half damage or effect before it can be completely negated. **Bonuses:** Identify poisons: 30% +4% per level of experience; +2 to save vs poisons and drugs whenever this power is in place.

## Levitation

**Range:** Up to 60 feet (18.3 m) away.

**Duration:** 2 minutes per level of experience.

**I.S.P.:** Small: 2, medium: 6, large: 6 plus 1 per every 10 lbs (4.5 kg) over 20 lbs (9 kg).

**Saving Throw:** None.

Levitation is a limited form of Telekinesis that can raise an object or a person straight up into the air and suspend it there, hovering in the air. Sideways movement is NOT possible.

Small objects weighing two pounds (0.9 kg) or less are the easiest to levitate. Maximum height is 8 feet (2.4 m) plus one foot (0.3 m) per each level of experience. Medium-size objects weighing 3 to 20 pounds (1.4 to 9 kg) are more difficult, requiring greater concentration. Maximum height is 6 feet (1.8 m) plus one foot (0.3 m) per level of experience. Large objects or people weighing over 20 lbs (9 kg) cost 6 I.S.P. plus one I.S.P. for every 10 lbs (4.5 kg) beyond 20 (9 kg). Thus, a 125 pound (56.2 kg) weight would require 17 I.S.P. to raise it into the air. Maximum height is 4 feet (1.2 m) plus one foot (0.3 m) per level of experience. Or the psychic can levitate himself 10 feet (3 m) +2 feet (0.6 m) per level of his experience.

## Mind Block

**Range:** Self.

**Duration:** 10 minutes per level of experience.

**I.S.P.:** 4 (per each duration period).

This is the ability to completely close or block oneself from all psychic/mental emanations. When intentionally closed to supernatural or psychic forces the character can not sense anything, can not use psychic abilities, nor be influenced by others. A Mind Block will prevent penetration of Telepathy, Empathy, Hypnotic Suggestion, and Empathic Transmission. It can be an invaluable protective mask when dealing with malevolent psychic forces. Adds a bonus of +1 to save vs all psychic and mental attacks.

## Nightvision

**Range:** Self, visual range about 600 feet (183 m).

**Duration:** 10 minutes per level of experience.

**I.S.P.:** 4

The psionic can adjust his visual capabilities through a form of Bio-Manipulation. The eyes are made to become much more light sensitive and basically work on the same principles of mechanical light amplification. The eyes simply amplify existing light, such as candle-light or star and moonlight, to see clearly. There must be some source of light to see (can not see in total darkness).

**Note:** If suddenly exposed to light brighter than a single candle, the psychic will be temporarily blinded for 3D4 melee rounds. The nightvision power can also be used to change one's vision to *polarized sight*, reducing glare as would a pair of polarized sunglasses.

## Resist Fatigue

**Range:** Self.

**Duration:** 1 hour +20 minutes per level of experience.

**I.S.P.:** 4

A mind over matter discipline which enables the character to engage in physical activity without suffering from exhaustion. Although fatigue is temporarily suspended, the psychic will feel extremely tired and may even collapse when the psi-power wears off.

## Resist Hunger

**Range:** Self.

**Duration:** 6 hours.

**I.S.P.:** 2

Another mind over matter discipline that subdues any feeling of hunger, allowing the character to function at full effectiveness without nourishment. It is important to point out that while the psi-power maintains full operations, the body is still suffering from malnutrition and starvation. Loses 3 lbs (1.35 kg) of weight per day. **Note:** A psychic can survive up to 60 days, functioning as normal, without any food by continually using Resist Hunger. On day 61 the character will lapse into a coma. Under this extreme condition, 60 days of food deprivation while still fully active physically, the character is -20% to save vs coma/death.

## Resist Thirst

**Range:** Self.

**Duration:** 6 hours.

**I.S.P.:** 6

This ability is identical to the Resist Hunger psi-power except it applies to the consumption of water. It does not negate the long-range damage from dehydration.

## Summon Inner Strength

**Range:** Self.

**Duration:** 10 minutes per level of experience.

**I.S.P.:** 4

This psi-power enables the character to draw on his inner reserves of strength to ward off pain and fatigue. Every time the psychic calls upon his Inner Strength the following bonuses apply:

- Add +10 S.D.C.
- Add +2 to save vs poison or toxins.
- Add +5% to save vs coma/death.
- Fatigue is temporarily forgotten and the character can function as if he was fully rested for the full duration of the summon inner strength power.

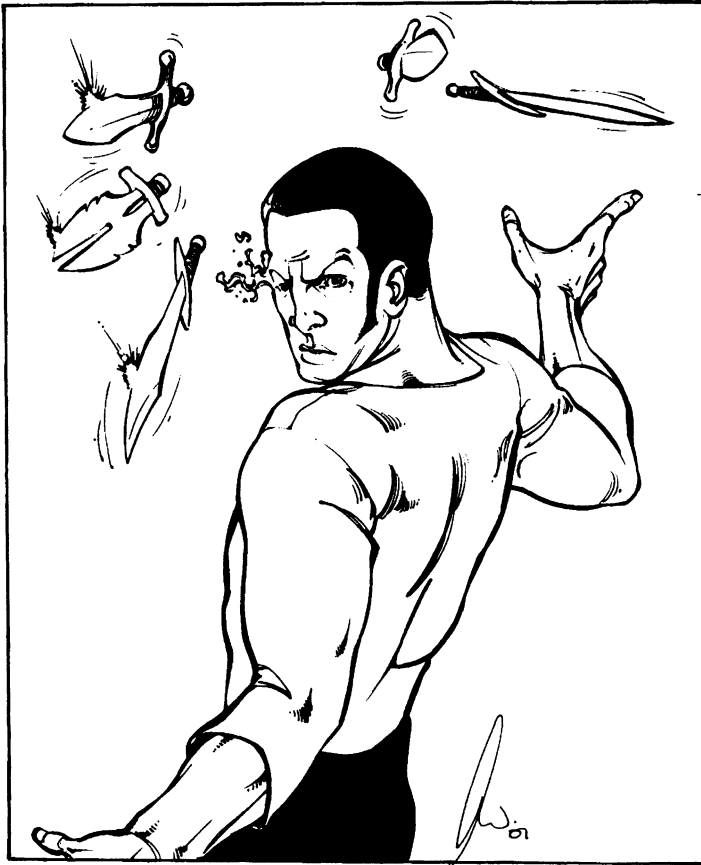

## Telekinesis

**Range:** Up to 60 feet (18.3 m) away.

**Duration:** 2 minutes per level of experience.

**I.S.P.:** Small: 3, medium: 8, large (over 20 lbs/9 kg): 8+1 per every 10 lbs (4.5 kg) of weight.

Telekinesis is the ability to move objects without any other means than directed psychic energy. The character can make an object hop, fall, roll, rise into the air, suspend it there (hover) or make it fly across the room.

In order to move an object by telekinesis, the item must be clearly visible, within the psychic's range (60 feet/18.3 m) and the point of focus. As usual, the psychic must concentrate on what he is doing; thus, each telekinetic feat counts as one of the character's physical attacks. The total number of telekinetic attacks is equal to the character's number of physical attacks per melee; usually 3 or 4. One can attack with telekinesis by hurling an object as if thrown or causing it to buzz about a room, swinging and hitting like a club controlled by an invisible hand. Several objects can be telekinetically thrown around within the same melee round, but not simultaneously. The psychic can only concentrate on one item at a time. For example: A physical psychic with four, normal, hand to hand attacks per melee can perform four attacks with telekinesis. First, he makes a flower vase fly from the table, aiming it at his opponent's head. Second, he makes the lamp hurl at the guard at the door. Third, the table is suddenly flipped up on end and, fourth, the doorknob is turned and the door flung open. Four attacks or actions using telekinesis.

As we can see in the example, telekinesis can be used to do more than making objects fly around. The telekinetic power can be used to open doors, flick switches, press buttons, turn knobs and dials, open windows, make a rocking chair rock and so on. The range of possibilities is extensive when you stop and think about it. Remember, each action counts as one of the character's physical actions/attacks per melee.

It is easiest to move or hurl small objects weighing *two pounds* (0.9 kg or less). Maximum height or distance is 60 feet (18.3 m). Medium-size objects weighing 3 to 20 pounds (1.35 to 9 kg) are more dif-

icult to manipulate. Maximum height or distance is reduced by half; 30 feet (9.1 m). Large or heavy objects weighing over 20 lbs (9 kg) are the most difficult to maneuver, reducing maximum height and distance to 15 feet (4.6 m). I.S.P. cost for large, heavy objects is 8 I.S.P. for the first 20 lbs (9.1 kg) plus one I.S.P. for each additional 10 lbs (4.5 kg) of weight. This means it would cost 19 I.S.P. to move a 125 lb (56.2 kg) weight (8 I.S.P. For the first 20 lbs (9 kg) +11 I.S.P. for the remaining 105 lbs). Remember, the height and distance of effect is limited to 15 feet (4.6 m) for such a heavy object.

### Telekinesis Combat Bonuses:

- +3 to strike with telekinesis; physical/skill bonuses to strike do not apply when telekinesis is used.
- +4 to parry with telekinesis, by using a controlled object to parry or sheer telekinetic force to block an attack. Counts as a medium heavy object; costs 8 I.S.P.
- *S.D.C. Damage from Hurled Objects:* Very Small: 6 ounces to 1 pound (0.17 to 0.45 kg): 1D4. Small: 1.5 to 2 lbs (0.6 to 0.9 kg): 1D6. Medium Small: 2-4 lbs (0.9 to 1.8 kg): 2D4. Medium: 5 to 10 lbs (2.25 to 4.5 kg): 3D4. Medium Large: 11 to 25 lbs (4.95 to 11.2 kg): 3D6. Large: 26 to 40 lbs (11.7 to 18 kg): 4D6. Add 1D6 damage for each additional 20 lbs (9 kg).

**Note:** Telekinesis is not a force field, thus, while it can be used to parry/block a punch, kick, club, knife or even sword, it can not stop bullets, arrows, gas, flying tackles, and similar attacks. Furthermore, a failed roll to Telekinetically parry means the psychic did not parry and is struck by his opponent.

## Telekinetic Leap

**Range:** Self.

**Duration:** One melee attack/action; in this case, a leap.

**I.S.P.:** 8

This telekinetic application boosts the person's leaping ability, propelling the psychic an additional two feet (0.6 m) when leaping upwards, and three feet (0.9 m) when leaping across or lengthwise, per level of experience. This power can be used in conjunction with a leap kick attack (damage: 6D6+6 plus P.S. bonuses), but the character will take 2D6 S.D.C. points of damage himself from the hard impact. A die roll to roll with punch, fall or impact, may be needed to land safely after one of these leaps.

## Telekinetic Lift

**Range:** Self or Touch.

**Duration:** 2 melees per level of experience.

**I.S.P.:** 6

Rather than moving objects solely with the power of the mind, this use of telekinesis is used to increase the character's ability to lift and carry heavy weights. The psychic creates a telekinetic field around the object and lifts both physically and mentally (via telekinesis). This enables the psychic to lift and carry weights 20% heavier than his P.S. normally allows. This use of telekinetics is limited exclusively to lifting and carrying heavy weights and cannot be used to hurl boulders and heavy objects as weapons nor can it be used to augment the damage inflicted by a punch, kick or other physical attack.

## Telekinetic Punch

**Range:** By touch or one foot (0.3 m) per level of experience.

**Duration:** Instant.

**I.S.P.:** 6

**Saving Throw:** Dodge or parry as usual.

This telekinetic power enables the psychic to deliver a powerful punch or kick-like force through telekinetic energy. The character must actually make a physical punch or kick, but a successful strike delivers a telekinetically enhanced blow. A telekinetic punch will inflict 3D6 S.D.C./Hit Point damage plus P.S. bonus (if any), and a kick will do 4D6 S.D.C. plus P.S. bonus. The I.S.P. is spent whether or not the

punch or kick actually hits the target (roll to strike as normal). The power is used in conjunction with a normal, physical attack that can be parried or dodged by the enemy. Every time the power is used, the psychic must make a save of 14 or higher or he will take 1D6 points of damage himself as a result of wrenched muscles or a dislocated joint from the extra strain on his body.



## Telekinetic Push

**Range:** By touch or one foot (0.3 m) per level of experience.

**Duration:** Instant.

**I.S.P.:** 4

**Saving Throw:** None.

The psychic can effectively create a telekinetic force that pushes away an attacker or anything within range (a door, chair, cart, statue, etc.). The pushing force has the rough equivalent of a P.S. 16 +1 per level of the psychic. The telekinetic push is roughly equal to a body block and does 1D4 S.D.C./Hit Point damage, will knock most ordinary humans back two yards/meters and has a 01-60% chance of knocking the person off his feet (if so, that character loses initiative and one melee action). Characters weighing more than 200 pounds (90 kg) or who possess robotic P.S. or supernatural P.S. are only shoved a foot or two and there is only a 01-12% chance of being knocked off their feet. Inanimate objects weighing under 50 pounds (22.6 kg) are "pushed" or slid across the ground twice as far, roughly four yards/meters (12 feet/3.6 m).

## Sensitive Psionics

### Astral Projection

**Range:** Self.

**Duration:** 5 minutes per level of experience.

**I.S.P.:** 8

Through intense concentration/meditation (4D4 minutes of preparation), the psychic can free his mind, or inner self, from his physical body. This psychic inner self is the Astral body, a whitish, transparent,

ghostly image of the character's physical form. A long silver thread or cord connects the Astral body with its physical self. If the cord is severed the character is likely to die of sudden shock as body and soul are torn asunder. There is only a 30% chance the Astral self can locate its physical body without the silver umbilical cord (roll best 2 out of 3).

The physical body lapses into a coma-like trance when the Astral self has left it. In this state the body is completely helpless. It can not walk, move or think; completely catatonic.

The hazards are threefold. First, if the physical body is killed, the Astral body is forever lost and will die, fade away, within six hours. Second, if the Astral body gets lost or captured while in the Astral plane, the body will begin to waste away and die. (Note: One minute of our time is equal to one week in the Astral plane). Third, the Astral body is vulnerable to psychic attacks and attacks from ghosts, entities and creatures of the Astral plane.

There are two levels of Astral projection, coexistence (physical body and spirit form) in the material world and/or in the Astral plane (another dimension). Astral projection from the physical body into the material world creates a ghostly specter of the Astral self which can be seen only by other psychics, young children under 13 years old, animals and most supernatural creatures. While in Astral form the character automatically gains the ability to float, fly (mach one/670 mph maximum), see the invisible, pass through solid objects, impervious to physical harm (including cold, heat and energy), and see and hear as usual. The Astral body can not communicate with the physical world except through telepathy or empathy, nor speak to, smell or touch anything on the material plane. The Astral self is little more than a mute, ghostly observer. Of course, this is a great way to locate invisible supernatural entities, as well as spy on other humans on the material plane (although limited by short sprints. See duration).

Traveling in Astral form has its own very special dangers. While the character can see the invisible and other Astral travelers, they can also see him. This makes him susceptible to their psychic and Astral form attacks, for two Astral travelers can lock into hand to hand combat as well. The most vulnerable target is the silver cord which is the Astral traveler's lifeline to the physical world. Fortunately, the cord has an Astral S.D.C. which is two times that of the person's physical Hit Points and S.D.C. combined. The thread-like silver cord is a difficult target to hit; attackers are -6 to strike. The Astral body also has S.D.C. two times the Hit Points and S.D.C. of the physical body combined. This means if the character has 18 Hit Points and 28 S.D.C., both the Astral body and its silver cord have 92 Astral S.D.C. each (18+28=46x2=92 each). Remember, magic and psychic influence have full effect on the Astral body. This includes exorcism, which will force the Astral traveler to leave the immediate area (400 foot/122 m radius) and not return for 24 hours. The Astral traveler has the same number of attacks per melee, bonuses, hand to hand, skills, knowledge and psychic powers that he or she has in the material plane.

Entering the Astral plane is like entering the twilight zone. After a minute of concentration the Astral gateway appears as a bright patch of shimmering, white light. Once the Astral traveler passes through it, he will find himself in an endless expanse of white light, and rolling, white clouds. There is no up or down, no bottom or top; no north or south, no land or air or sea, just endless, slowly swirling white. Time too, is a different or altered state, for what would seem to be a week in the Astral plane is barely one minute in the physical world. Time and space twisted and distorted, the Astral traveler can travel from one end of our planet to the other in the blink of an eye, by hopping through the Astral plane. While this may sound wonderful, the Astral plane has its dangers as well. First, the distortion of space and time makes it extremely difficult to find the material world and one's dormant, physical body. Even trying to follow the silver cord can lead to nowhere.

To return from the Astral plane to the physical body, roll on the following table: Each roll will determine the Astral traveler's state of mind and sense of direction. The percentile dice can be rolled up to three times per melee (15 seconds). The player must roll "definitely

certain” to successfully return. The player may keep trying until he succeeds or time elapses.

## Location of the Physical Body

**Roll Percentile Dice to Return from the Astral Plane:**

**01-30%:** Hopelessly Lost (roll again).

**31-50%:** Uncertain, Confused (roll again).

**51-76%:** Fairly certain of location; on the right track (roll again).

**77-00%:** Definitely certain of location. (Whew! Made it Back).

Astral travel with a partner is a much safer way to travel, because if one can find his body, he can lead the other one out with him.

**Note:** Traveling on the material plane in Astral form is infinitely easier than the Astral plane. To find the physical body the character need only return to where he left it. If it has been moved or hidden the Astral self can sense its location with a 60% efficiency (roll once per melee).

The other danger lies in being attacked by other beings in the Astral plane. Entities and elemental creatures of magic live in the Astral plane or travel through it. These beings are usually hostile, evil forces. While the Astral body can not touch or communicate with the material world, the Astral body is quite solid to other inhabitants of the Astral plane. The Astral body is also vulnerable to magic and psychic powers, as well as physical assault by Astral entities.

The energy which composes the Astral plane is responsive to thoughts and desires. The strongest Astral beings can mentally or magically control what a small area might look like. This means that the Astral plane is made up of hundreds or perhaps thousands or even millions of tiny Astral “kingdoms” adrift within the vast whiteness. Exactly what these kingdoms look like is up to the entities that create them. Some may look like a modern city, others like castles or forests, while still others, a frightening landscape. Perhaps this is where legends of visitations to Heaven and Hell originate? It is always wise to avoid an Astral kingdom, because only the most powerful entities and Astral beings can create and maintain them.

## Clairvoyance

**Range:** Self (although the image could pertain to people or places thousands of miles away).

**Duration:** 6D6 melees.

**I.S.P.:** 4

**Base Skill:** 58% +2% per level of experience.

This allows the psychic to see or feel glimpses of the possible future. This is achieved through meditation or intense concentration in which the clairvoyant thinks about a particular person, event or place. Add +5% to the base skill if the person involved is a friend or loved one.

Clairvoyance is unpredictable and can not be turned on and off like a light bulb. Sometimes it works (if the roll is under the base skill) and sometimes it does not (when the roll is above the base skill). A failed roll means the psychic received no insight to the future.

A clairvoyant trance can be attempted as often as twice every day. The message can be a sudden feeling that somebody is in need (“...something’s wrong. It’s...it’s...Janet! I’ve got to see her!”) or, more often, a sudden flash of insight, a sudden image that races through the mind. The image is like a brief snippet of film from a movie or a dream. Often all the details are not clear, but the potential danger is. For example, the psychic character is in a trance or meditation, thinking about his/her friend Janet. Suddenly, the mind is flooded with an image of Janet rushing down a crowded street. It’s dusky, like morning, twilight or evening. She seems very upset. The traffic light changes to amber. Janet races into the street, ignoring the light. It turns red. There’s a car, squeal of tires, Janet screams. The image ends. Is Janet hurt? Killed? Unknown, but the danger is clear. There are also other hints of information: the time of day, Janet seeming upset, rushing, etc. The glimpse into the future could be twenty minutes, eight hours, 24 hours, or a week. The psychic has no way of knowing. Of course, he has the

advantage of recognizing the potential danger as it begins to unfold and may be able to avoid it, stop it or change the outcome. The image may last a few minutes or be a sudden flash lasting but a few seconds. The flash could be a peculiar noise, a face, or a specific image, like a particular door or object.

It is important to note that sometimes a clairvoyant image will occur unintentionally, without the psychic trying to do so. These most often manifest themselves as dreams or nightmares during sleep. The clairvoyant dream is exactly like the image from a meditative trance described previously. The precognitive flash of the future may also occur unbeckoned while awake, but this is extremely rare. These brief glimpses of the possible future happen because the clairvoyant is acutely attuned to his world. Anything that might hurt or change that world (including people and places) will often be foretold in a flash of insight.

**Game Masters:** Be careful of revealing too much. Use the examples provided as a guide. Remember, these are brief glimpses of the possible future, not a motion picture. The psychic can NOT engage in any actions, combat or otherwise, during a moment of clairvoyance or the image will instantly stop. It usually requires 2D4 melees of concentration or meditation before the image occurs. Remember, a failed base skill roll means absolutely nothing happens, but still burns up the 4 I.S.P. and time.



## Commune with Spirits

**Range:** Self.

**Duration:** Two minutes per level of experience.

**I.S.P.:** 6

**Saving Throw:** Standard.

Using this power, a psychic can “feel” (not see) the presence of spirits. The term “spirit” includes entities (including ghosts and possessing ones), invisible Astral Travelers/Astral beings, the splintered life essence of a god or Alien Intelligence, the mysterious Indian Spirits, a

spirit or demon (or god) possessing a familiar or witch, and imprisoned souls and life essences in rune weapons and similar magical prisons.

The psychic can ask the spirit questions by speaking aloud, although the creature often understands the question on an empathic or intuitive level. Only the psychic hears the answer (unless he's using a group trance) and the answer can be in words or powerful emotions (he suddenly feels its hate, fear, anger, sorrow, etc., instead of a verbal response). It is important to note that the spirit is under no obligation to answer truthfully or to answer at all. Angry and uncooperative spirits may lie, pretend to be somebody else, lash out at the psychic with its own psi-abilities or cause mischief. Likewise, the psychic cannot "feel" or sense the creature's alignment, or magic energy, nor can he use any of his other psionic powers while he is in communion with the spirit. Furthermore, the spirit may break off communication at any time, although the psychic can still "feel" if it is within the immediate area (30 foot/9 m radius). The psychic can also break contact at any time, but when he does so, he can no longer tell if the spirit is still hanging about.

## Empathy

**Range:** 100 foot (30.5 m) area.

**Duration:** Two minutes (8 melees) per level of experience.

**I.S.P.:** 4

**Saving Throw:** Standard; a save vs Empathy means the psychic can not get a clear sense of the emotions of that particular person. To save vs Empathy, the person must roll to save once each melee that the psychic is using empathy. Mind block will prevent any empathic emanations from the blocked person.

Empathy is a psi-ability that makes the psychic aware of, or feel, the emotions of other people, animals and supernatural creatures. The strongest emotions are easiest to sense: hate, anger, terror, love. Feeling for emotions can often be used to establish that somebody or something is nearby, but can NOT be used to pinpoint an invisible or hiding person/creature. Empathy can be especially helpful in recognizing and communicating with ghosts and other supernatural creatures.

Questioning a person/being while using empathy can be very handy in establishing how they are reacting to you. In a limited sense, empathy can be used like a lie detector to see if the emotions match the verbal response. For Example: "Did you know the deceased?" The verbal answer is no, but there is a sudden flare of nervousness and fear (or hate). This doesn't mean the guy is the killer, but it might mean he is lying about knowing the dead man. Further questions might pull out a strong emotion such as anger or hate (or happiness), which may confirm the psychic's suspicions that this man might be involved in the murder. However, remember that this is, at best, *circumstantial evidence* and definitely inadmissible in court. Physical proof must be found, but the empathic readings may put characters on the right track. Also, remember that the empathic psychic is feeling the person's real emotions, but interpreting their significance. A very nervous person may always radiate fear or anxiety, while a cold-blooded, pathological killer may feel nothing at all and stay calm and cool as he lies through his teeth. The feeling of hate may mean that the person did know the murder victim, or knew of him, and hated him for any number of reasons. That does not mean he killed him. As you can see, interpreting emotions can be a tricky thing.

Haunting Ghosts and entities rarely mask their emotions. Thus, the psychic can easily tell if one or more is nearby (within 100 feet/30.5 m) and what it is feeling. "I sense great sorrow." or "Do as it says! It is angry, almost crazed. I think it will carry out its threat if you try to stop it."

## Intuitive Combat

**Range:** Self.

**Duration:** Two melee rounds per level of experience.

**I.S.P.:** 10

This is a form of telepathy geared to give the psychic an advantage in melee combat. To put this ability in place, the psychic must concen-

trate for one melee round (15 seconds), putting himself in a Zen-like state of awareness. For the next two melee rounds, the Intuitive Combat sense makes the character one with his body and weapon, reacting quickly and efficiently with amazing reflex action, balance and grace. **Note:** The psychic is unable to use any other psionic power, including Mind Block, while this power is in use. He can cancel it with a thought.

**Bonuses:** +3 on initiative, +1 to strike, +1 to parry, +4 dodge, +4 to pull punch, +2 to roll with punch, fall or impact, and +2 to disarm.

- Cannot be caught by surprise, even by attacks from behind or from long-range, which means he can *try* to parry or dodge all attacks leveled at him.
- +10% to abilities (balance, etc.) provided by the Acrobatics and/or Gymnastic skills, as well as +10% to Climb and Swim skills.

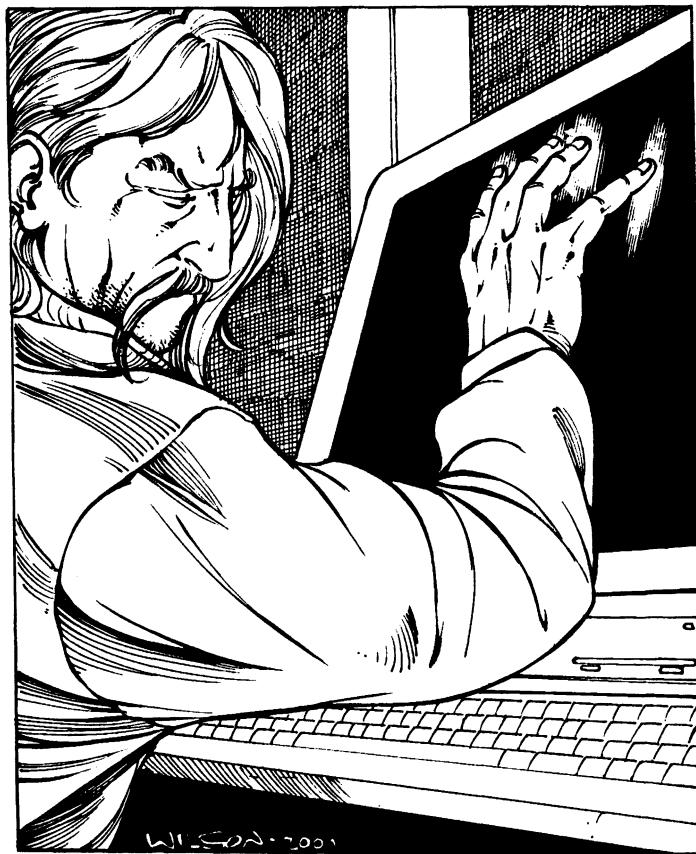

## Machine Ghost

**Range:** Self; computer by touch.

**Duration:** Three minutes per level of experience.

**I.S.P.:** 12

**Saving Throw:** Not applicable.

The psychic goes into a trance as he focuses his concentration on entering a computer or most any type of artificial intelligence (not applicable to sentient, self-aware machines like Archie-3). This power is limited to the acquisition or reading of information only. The psychic cannot input, program, or delete data on the machine. He can also access information *stored* by most electronic means, including computer disks, video and audio disks, film or audio tape, and hard drives. Reading electronically encoded disks and tapes is similar to Object Read, except in this case, he hears and sees the data as if he were playing it on a computer or disk player, only he perceives the information 10 times faster. Thus, the character can read (never input) information from disks or broken computers without a physical "jack" connection or an actual display device, i.e. computer and monitor, CD player, etc.

As an actual *Machine Ghost*, the psychic mentally enters and travels the neural network of an active computer. He is actually inside the device. In many ways, this experience is similar to Astral Projection ex-

cept the psychic is “projecting” into the machine rather than into the Astral Plane. It also has the same pitfalls as Astral Projection, as in the character enters a strange, seemingly very real world that he must learn to navigate. Like Astral Projection, the electronic world of computers takes on a virtual world landscape. This means in the computer virtual world, its programs, viruses and defense mechanisms will take on virtual manifestations that can interact, confront, impede, or attack the Machine Ghost.

A password or special access code may appear as a metal door or iron gate, or locked filing cabinet that needs to be (seemingly) broken open to gain access to what is held inside. The more difficult the code, the bigger, stronger and more difficult the door and lock(s). Data is likely to appear as books, paper files, diagrams, film, holograms, and other common means of communication and documentation. The more sophisticated defense measures are likely to appear as one or more *guards* who must be defeated before the information is accessible. They can appear as sorcerers, Coalition troops, known enemies or exotic aliens. Viruses and defenses designed to attack an intruder typically appear as demons or monsters.

Combat in the virtual world seems real and is conducted the same as it would happen in the real world. Combat and damage is measured by the character’s perception of his real body, armor, weapons and natural powers. When the psychic has lost more than 70% of his armor, or S.D.C./M.D.C., he will feel the urge to flee the virtual world. If he flees, a computer defender will not follow, however a virus will pursue and continue to fight. Although all such damage is only in the mind of the psychic (no physical damage occurs in the real world), if he dies in the virtual world, he can *die* in the real world as well! The shock to his psyche and body will momentarily stop his heart, and he slumps over dead! The character must roll to save vs coma and death. In this case, physical treatment is not necessary and the recovery process, if successful, takes less than a minute. The psychic must roll three times, and the best two out of three rolls determines life or death. Rolling between 01-75%, two out of three times, means the heart starts and the character is shaken but fine; feels woozy for 2D4 minutes (reduce Spd 25% and all combat bonuses by half). Failure to recover from the heart attack means immediate CPR medical treatment is required — paramedic skill will suffice, provided any protective body armor can be removed so that treatment can be issued; rescuers have 10 minutes. Roll to save vs coma and death again; must roll twice under 80%.

The downside in the usage of this power is the psychic loses all sense of time and reality outside the data he is accessing. This means he is oblivious to what is happening around him, and unless protected by a companion, vulnerable to attack without any means of defense. Pain or being struck or shaken will alert the psychic to trouble, but he has the choice of breaking contact and responding, or ignoring it and continuing to retrieve data. Only telepathy can reach the character while in this state (can’t hear spoken words or sounds outside the computer), and is a means of two-way communication.

A character accessing a file on a disk can break contact at any time with a thought, although he will be disoriented for one melee round; reduce his number of attacks and combat bonuses by half. Breaking free of a computer virtual world is not so easy.

Unfortunately, leaving the virtual world of a computer is fundamentally the same as the Astral Plane. The psychic can vaguely sense the way he came and must follow it back to the virtual access point. To do so, the player must roll on the following table and must roll “definitely certain” to have his character successfully escape. The player must keep trying until he succeeds or time elapses. If the character cannot escape virtual space before the duration of this ability elapses, he is flung out with the same effect as “virtual death”; roll to save vs coma and death as described above. Note: The psychic will instinctively know when he’s down to the last three minutes of the duration and when trying to exit, can fly toward the way out (typically appears as a door or 2 dimensional Rift).

01-30%: Hopelessly lost (roll again).

31-45%: Uncertain (roll again).

46-65%: Fairly certain, on the right track (roll again).

66-00%: Definitely certain! Whew! Made it back.

## Mask I.S.P. & Psionics

**Range:** Self.

**Duration:** 10 minutes per level of experience.

**I.S.P.:** 7

This is a psionic power that enables the character to completely mask all spiritual aspects of his psionic energy and powers. Even the aura is temporarily altered. As a result, other psychics, Dog Boys, Psi-Stalkers, and creatures who can Detect Psionics or See Aura will not sense psionics in a character who is masked. However, the masked psychic must “block” himself from the world, which means he cannot use any of his psionic senses or abilities, nor receive Empathic or Telepathic impressions until he lets the mask go.

## Mask P.P.E.

**Range:** Self.

**Duration:** Ten minutes per level of experience.

**I.S.P.:** 4

A psionic power that enables the character to completely mask all but 1D4 P.P.E. of his personal P.P.E. base. Characters who can sense magic energy or see aura will regard this character as having an insignificant amount of P.P.E. This power is especially good as protection against Psi-Stalkers and other P.P.E. vampires. Mystics can easily hide their magical powers through this psionic concealment.

## Mind Block

**Range:** Self.

**Duration:** 10 minutes per level of experience.

**I.S.P.:** 4 (per each duration period).

This is the ability to completely close or block oneself from all psychic/mental emanations. When intentionally closed to supernatural or psychic forces, the character can not sense anything, can not use psychic abilities, nor be influenced by others. A Mind Block will prevent penetration of Telepathy, Empathy, Hypnotic Suggestion, Day Dream and Empathic Transmission. It can be an invaluable protective mask when dealing with malevolent psychic forces. Adds a bonus of +1 to save vs all psychic and mental attacks.

## Object Read

**Range:** Touch.

**Duration:** Varies; usually about 2D6 minutes.

**I.S.P.:** 6

**Saving Throw:** None.

**Base Skill:** Impressions: 56% +2% per level of experience. Images: 48% +2% per level. Present: 38% +2% per level of experience.

Also known as *Psychometry*, this uncanny ability enables the psychic sensitive to receive impressions and images from an object regarding its use, history and last owner. This is done by holding the object and concentrating on a specific line of thought or opening up to general impression, (the latter is always more vague and random). Just as a psychic must open himself to sense evil or magic, he must open himself to the object. If successful, he will receive impressions and/or images revealing bits of information.

**Impressions include:** General alignment of its last owner (good, selfish, evil), general emotional state of mind (angry, happy, sad, hate filled, confused, etc.), the object’s general purpose (what it is used for), whether or not the last owner is living or dead, and whether the item has been used with/by magic or supernatural forces. Object read will also conclusively indicate whether the item is currently enchanted or contains a supernatural force/entity (as well as its alignment and emotions). If the item is possessed, an object read makes the reader totally vulnerable to psychic attack (no bonuses to save).



**Images:** The psychic can also see images of isolated events which have happened in the past. This will provide brief snippets of images and events that will offer glances of the previous owner and others close to him. Traumatic and emotion filled events/images are the easiest to see. Impressions will accompany the images, adding to the story as it unfolds. Information includes: approximate age, height, weight, build, race, sex, sometimes occupation, hair color and length; special facial or body features such as a scar or tattoo or beard (very often the exact facial features are out of focus, blurred or obscured); the object's use/purpose; and some special event, usually very traumatic, important or happy. Often the event image will be fragmented as if it was a piece of movie film edited by a crazy man. The event will always be one in which the object was involved in some way.

**The success or failure of an object read:** Roll percentile dice once for impressions and once for images. The roll must fall under the character's base skill ability to succeed. A roll higher than the base skill means a failure and the psychic feels and/or sees nothing. Impressions and images are two different things, so roll for each. The psychic may get no impressions, but see images or vice versa. The present can not be seen unless the psychic was successful on at least one of the previous read impressions or images rolls. Once an object has been read it can not be read again by the same psychic, even if he did not see or feel a thing. Of course, the psychic can attempt to object read other items, but each attempt will cost 6 I.S.P.

**The present** can also be glimpsed, but costs an additional 4 I.S.P., with no guarantee of success. Sometimes the psychic can focus in to see and feel the last owner as he or she is at that very moment. This will provide an idea of what is his current state of mind/emotion, appearance, dress, general location (that is to say, a bedroom, office, street, outdoors, etc.; no address or sense of close or far is provided), general features (shaved his beard, dyed hair, etc.) and so on. The psychic may be able to identify a place or person by feature, if he has seen it before or runs into him in the near future.

## Presence Sense

**Range:** 120 foot (36.6 m) area.

**Duration:** 2 minutes (8 melees) per level of experience.

**I.S.P.:** 4

**Saving Throw:** None.

Presence sense is a sixth sense that alerts the character to the presence of supernatural and magic creatures in the area. The ability can not pinpoint the location of the presence, but will give the psychic the impression of whether it is near (within 50 feet/15.2 m) or far (beyond 90 feet/27.4 m). It will also give the character a vague idea of how many presences there are; one (1 or 2), a few (3 to 6), several (7 to 14), or many (15 or more). The psychic can also sense human presences, but with much less accuracy. It is more of a feeling of "We are not alone." The person's distance is undeterminable and the number of people is limited to a sense of one or two or many, and that is only right half of the time.

## Read Dimensional Portal

**Range:** Touch or one foot (0.3 m) per level of experience.

**Duration:** One melee round per level of experience.

**I.S.P.:** 6

**Saving Throw:** Not applicable.

**Limitations:** Applicable only to active (open) dimensional portals and devices that can create a dimensional portal.

This power allows the psychic to get impressions from the portal or dimension spanning device, which instills the character with the following information:

- Destination is relatively dangerous/hostile or safe to the psychic. This includes whether or not the environment can support human life.
- Whether there is a strong (or numerous) presence of the supernatu-

ral (i.e. alien intelligence, gods, demons, etc.) and whether that presence is evil.

- A psychic flash – a brief vision of who was the last person or persons to use the portal, if any (may be none if it is a random Rift that hasn't been used by any living force).
- Intuitively sense whether the portal or machine leads to any of the following dimensions: The Astral Plane, Xiticix home world, the Dreamstream, or to another location on Rifts Earth.
- If a mechanical gateway or device capable of dimensional travel/opening a dimensional portal, whether it is a creation of magic or science, the psychic will get a basic idea of how to operate it in order to open or close a dimensional portal (similar to object read).

## Remote Viewing

**Range:** Self.

**Duration:** 2D6+6 second flash of insight or vision of current events.

**I.S.P.:** 10

**Saving Throw:** Special. Other psychics can feel or sense when somebody is trying to observe them and can try to resist it by concentrating (uses up one I.S.P.); standard save vs psionic attack (in this case, psionic intrusion). Failure means the psychic is seen via Remote Viewing. Success means the psychic trying to view is blocked, and he knows that the target has deliberately done so. The target of this power gets no impression from being viewed remotely and has no idea why he is being watched or by whom.

To use this power, the psychic needs a photo or video image to focus on, even if he knows the person or place intimately. When focused on a particular person, the psychic can see in his mind what the person is doing at that moment for 2D6+6 seconds. The image appears as if the character were looking down through a skylight. He sees only a glimpse of things and may not remember all details. Likewise, he may not see other people outside his line of vision, because the focus is a particular person, not the entire room. If the target is moving, walking, or driving, the remote viewer will know this and follow along for a few seconds, although he may not have a clear idea of his surroundings, but enough of an impression to recognize it if he sees it personally.

The character may also Remote View a specific place such as a small to medium room, a corner in a playground or field, a specific entrance to a building, a particular section of an alley, etc., but not an entire house, office building, stadium, street, etc. As before, he must have a photograph, video or frame of film to focus upon. For 2D6+6 seconds, the psychic will see whatever occurs in that small area of that particular place.

In the alternative, the psychic can use Remote Viewing to catch glimpses/images that tell something about the subject of the viewing. In this instance, he must have 2-4 specific questions, such as, "is so and so alive ...?" Then the image of the character smiling as he walks through the area appears, or flashes of a brutal attack, blood, and a falling body (indicating death), and so on, appear for an instant in answer to his query. In either case, the psychic cannot look at the same person or place via Remote Viewing again for another 24 hours.

## See Aura

**Range:** 60 feet (18.3 m) and must be visible.

**Duration:** 2 melees (30 seconds).

**I.S.P.:** 6

**Saving Throw:** None, but a Mind Block will hide the presence of psychic abilities, the level of P.P.E., and possession by a supernatural force.

All things, organic and inorganic, have an aura. The aura has many distinctions and indicates things to the psychic normally invisible to the ordinary eye.

Seeing an aura will indicate the following:

- Estimate the general level of experience. Low (1-3), medium (4-7), high (8th and up).
- The presence of magic (no indication of what type or the power level).
- The presence of psychic abilities (again though, not the type or power level).
- High or low base P.P.E.
- The presence of a possessing entity.
- The presence of an unusual human aberration and/or indicates a serious illness, insanity, or that the individual is not human, could be a mutant or supernatural, but does not specify which.

**Note:** A psychic can not tell one's alignment by using this power.

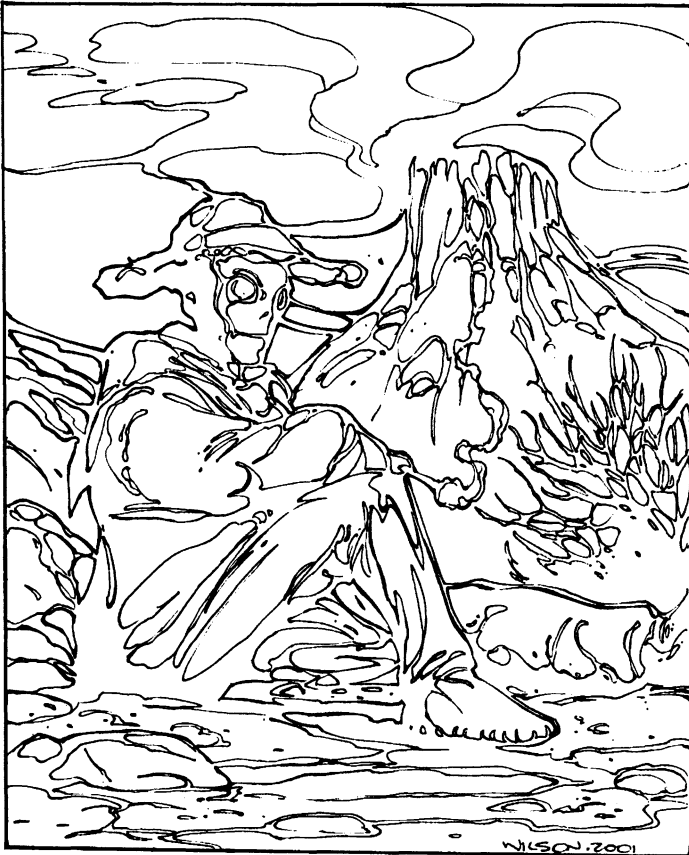

## See The Invisible

**Range:** 120 feet (36.6 m) distances.

**Duration:** 1 minute per each level of experience.

**I.S.P.:** 4

**Saving Throw:** None.

The character can see entities, beings, forces, objects and creatures which can turn invisible or are naturally invisible. Even if the creature has no form per se, the psychic will be able to discern the vaporous image or energy sphere which is the being. This includes ghosts, entities, Elementals and Astral beings.

## Sense Dimensional Anomaly

**Range:** 100 foot (30.5 m) radius per level of experience.

**Duration:** 2 minutes per level of experience.

**I.S.P.:** 4

**Saving Throw:** None.

This power detects the presence of a dimensional anomaly like an open/active dimensional portal or Rift, the random opening and closing of a Rift, ley line storms, and dimensional triangles (The Devil's Sea/Bermuda Triangle), as well as any disturbances caused by teleportation, the use of Temporal or Ley Line Magic or other powers that

disrupt the fabric of reality. The psychic knows when it happens, when it ends/closes, the general direction, and whether it is far or near, but no exact knowledge of its location or what is happening because of it.

## Sense Evil

**Range:** 140 foot (42.7 m) area.

**Duration:** 2 minutes (8 melees) per level of experience.

**I.S.P.:** 2

**Saving Throw:** None.

This psi-power is a much more refined ability to feel the presence of evil. All supernatural creatures radiate their alignment, good or evil. A psychic sensitive will automatically feel supernatural evil without spending a single I.S.P. point. However, to get a clearer picture of the evil force(s) the character must open himself and use the Sense Evil ability.

Sense Evil will indicate the general number of supernatural evil beings: one, a few (2-6), several (7-14), or many (15 or more). It can also register the intensity of the evil and pinpoint the general location of the source(s) to a particular room(s), possessed object, character, and distance; i.e. very near (within 15 feet/4.5 m), near (within 50 feet/15.2 m), or far (60 to 140 feet/18.2 to 42.7 m). The character can track the source of supernatural evil, like a bloodhound, by sensing how close it is to him.

Evil emanations from human beings are much less distinct and can not be felt unless the source-person has an immediate evil intention and has psychic powers or is psychotic. The former can mask his evil intentions with a Mind Block.

## Sense Magic

**Range:** 120 foot (36.6 m) area.

**Duration:** 2 minutes per level of experience.

**I.S.P.:** 3

**Saving Throw:** None.

The ability to sense magic enables the psychic to feel magic energy, tell whether it is near (within 20 feet/6.1 m) or far (up to 120 feet/36.6 m away), and follow the emanations to pinpoint their source as a particular place, room, person or object. **Note:** Invisible, magical or supernatural creatures or objects can only be traced to a general area, like a specific room or area. The psychic will also be able to sense whether or not an object has magic powers, if a person or item is enchanted/under a magic spell (this does not include psionic influences), when magic is being used within the area (120 feet/36.6 m) and when a person is casting a spell (human users of magic do not radiate magic energies until they call upon them).

## Sense Time

**Range:** Self.

**Duration:** 15 minutes per level of experience.

**I.S.P.:** 2

The psychic is able to accurately measure the passage of time, down to within 1D4 seconds. This can be useful when in an environment where the passage of time can be lost, and especially when the character must meet with or do something at a precise moment in time, like gauging exactly when a bomb will detonate, when a switch must be turned on or off, and so on.

## Sixth Sense

**Range:** 90 feet (27.4 m).

**Duration:** Until the danger passes or happens. Bonuses apply only to the first melee round of the attack from the source of the sensed danger.

**I.S.P.:** 2

**Saving Throw:** None.

The Sixth Sense is a power that gives the psychic a precognitive flash of imminent danger to himself or somebody near him (within 90 feet/27.4 m). The character will not know what the danger is or where it

will come from, nor who it will be directed at when in a group. All he knows is that something life threatening will happen within the next 60 seconds (4 melees)! The sixth sense is triggered automatically, without the consent of the psychic, whenever his life is in great peril or the life of somebody he greatly cares about (friend, partner, loved one, etc.). The sixth sense is only triggered by an unexpected, life threatening event (a trap or ambush is within 90 feet/27.4 m or a flash flood is rushing his way) which is already set into motion and will happen any second. The power can not be called upon at will to sense for traps or ambush. Instead, it works like an automatic reflex. If the character has used all his I.S.P. the Sixth Sense is temporarily rendered inoperative.

**Bonuses:** The sudden flash of insight provides the following bonuses. All bonuses apply only to the first, *initial* melee (15 seconds) when the attack/danger occurs. Bonuses are lost in subsequent melee rounds after the danger is revealed. +6 on initiative roll, +2 to parry, +3 to dodge and the character can not be surprised by a sneak attack from behind.

## Speed Reading

**Range:** Self.

**Duration:** 3 minutes per level of experience.

**I.S.P.:** 2

This is the ability to read and comprehend the written word extremely quickly. Speed of reading is 30 pages per minute (4 melee rounds). The psychic will retain the information as he would normally. Highly technical texts will reduce the speed reading by half (15 pages per minute) and may require two readings to remember in detail.

## Telepathy

**Range:** Read surface thoughts up to 60 feet (18.3 m) away or two-way telepathic communication up to 140 feet (42.6 m).

**Duration:** 2 minutes per level of experience.

**I.S.P.:** 4

**Saving Throw:** Conditional. When a character suspects he is being telepathically probed he can resist, getting the standard saving throw. Mind Blocks will completely prevent telepathic probes or communications as long as the block is up.

The power of Telepathy allows the psychic to eavesdrop on what another person is thinking at a particular moment. This is done by focusing on that one individual and picking up on his or her surface thoughts. Surface thoughts are those thoughts and musings uppermost in a target's mind. A deep probe into memory is not possible. Although the psychic can read the thoughts of several people, he can only do so by focusing on one person at a time. Simultaneous, multiple mind reading is impossible for the character.

Limited Telepathic communication is also possible. The Telepath can send a directed thought message to one person at a time. The message must be as brief and clear as possible. Like, "John, I need you immediately. Hurry!" or "Stop! Don't do that." "Come here," "Look out" or "Press the green button." However, two-way telepathic communication is not possible except between two characters both with Telepathic abilities.

## Total Recall

**Range:** Self.

**Duration:** Permanent.

**I.S.P.:** 2

The character remembers every word he reads. Specific blocks of information can be recalled in perfect detail at will. Each block of information costs 2 I.S.P. to recall in absolute detail. If all I.S.P. have been expended the memory is a little fuzzy, so that exact quotes and details may be impossible to recall. Roll percentile to see how much is retained:

01-50%: Remembered in full detail, word for word.

51-80%: Details are forgotten, but the full essence of the ideas are clear.

81-00%: Can only recall the most basic concepts; no details nor strong comprehension.

# Super-Psionics

## Astral Golem

**Range:** One mile (1.6 km) per level of experience.

**Duration:** Special.

**I.S.P.:** 50 to create the Golem, 10 to mentally animate/control it.

This is an unusual psionic ability that is known only to psychics trained in *Psyscape*, and is possible only in the Astral Plane. Using the "loose" ectoplasm that makes up much of the Astral Plane, the psychic is able to build a vaguely humanoid construct. By intermingling some of the psychic's own ectoplasm he can animate and control it. The construct, often called an Astral Golem, resembles a Rodin sculpture made of a protoplasmic material. Through concentration, the psychic can animate it like a giant puppet. It is not actually alive and cannot see, hear, feel pain or emotions, nor think or act independent of the psychic. This construct is typically used to carry heavy objects, and for defense and combat. As an Astral Creation, it can float and fly as a natural ability (as can most Astral Travelers). Made of the stuff of the Astral Plane, the Astral Golem can inflict damage to all Astral beings.

### Stats for the Astral Golem:

- The Golem is a large, human to double human-sized construct of whitish or light grey, semi-translucent material that glows faintly. It can be formed into whatever general shape its creator desires, but is typically humanoid.
- Horror Factor: 8 for human-sized, 10 for giant-sized.
- P.S. 18 (supernatural), Spd 16+1D6.
- Attacks per Melee: Equal to those of his creator. In combat, every action by the Astral Golem counts as one of the psychic's. The Astral Golem must remain in sight of the psychic and is rarely sent more than several hundred feet (30.5 m) away. Does 1D6 M.D./damage to other Astral Beings from punches and kicks.
- -2 on initiative, -1 to parry and dodge, for it is slow and clumsy, but powerful.
- Impervious to most psionic attacks, mind control, fear, and possession (it is not alive). Also impervious to cold, heat, disease, poison, and gases. Energy and projectile attacks do half damage. Vulnerable to physical attacks from other Astral Beings.
- 3000 S.D.C./30 M.D.C.; can be repaired/regenerated by its creator expending an additional one I.S.P. per 2 M.D.C./200 S.D.C.

## Bio-Manipulation

**Range:** 160 feet (48.8 m).

**Duration:** 4-16 minutes (roll 4D4).

**I.S.P.:** 10

**Saving Throw:** Standard; if a character successfully saves against the attack he is not affected at all. This applies to all seven bio-manipulative attacks.

The psychic is able to induce physical trauma to the nervous system of others by sheer force of will and conveyance of psychic energy. This psi-power is also known as the *Evil Eye*, especially in rural areas where magic and folklore rule the day.

There are seven types of Bio-Manipulation effects. Each affects only one person per attack and can be used in any combination. Intended victims must be within line of vision or their exact location known to the psychic. Each costs 10 I.S.P. to inflict.

This psychic power enables the psychic to temporarily manipulate specific biological functions or conditions in human and animal life forms. The duration can be extended 4-16 (4D4) minutes per additional 6 I.S.P.

**Blind:** Temporarily knocks out the victim's optic nerves, rendering that person quite helpless. Victims are -10 to strike, parry and dodge.

**Deafness:** Can be caused by manipulating the eardrum. Victims can not hear anything, and are -6 to parry or dodge attacks from behind. In addition, the shock of suddenly becoming deaf makes them -3 to strike, parry or dodge any other attacks, and they automatically lose the initiative on all attacks while deaf.

**Mute:** Impairs the victim's vocal cords, making speech impossible. Victims are likely to be shocked and panic, making them -2 to strike, parry and dodge for the first melee ONLY.

**Pain:** By manipulating the nerve centers the psionic can induce terrible pain, shooting throughout the body. Victims are -6 to strike, parry, and dodge, and take one point of damage off their Hit Points (not S.D.C.) per each minute affected.

**Paralysis:** Immobilizes the motor part of the brain, causing legs and arms to stop functioning. Victims are completely incapacitated for the duration.

**Stun:** This attack disorients and confuses its victims. Victims forfeit one attack per melee, speed is cut by half, and the character is -4 to strike, parry and dodge.

**Tissue Manipulation:** Affects the tissue's connecting nerve fibers which can cause a variety of effects. By irritating the nerve fibers, a victim will suddenly feel itchy, as if breaking out in a severe rash. Through endothermic manipulation the victim can also be made to suddenly feel cold or hot while everyone around him feels fine. This is done by manipulating the body chemical which absorbs heat. ALL three conditions are more annoying or frightening than physically impairing. In each case the victims are -1 to strike, parry and dodge.

## Bio-Regeneration (Super)

**Range:** Self.

**Duration:** Permanent.

**I.S.P.:** 20

Another bio-manipulation power that enables the psionic to direct his psychic energies to immediate self-healing. The character must concentrate for one full minute while his body instantly heals itself. 4D6 Hit Points and 4D6 S.D.C. points are simultaneously restored at the end of 60 seconds! As usual, there is no scarring.

## Electrokinesis

**Range:** Varies.

**Duration:** Varies.

**I.S.P.:** Varies.

Electrokinesis is a psychic power that allows the psychic to exert amazing physical control over electricity.

**1. Electrical Resistance.** The psychic can manipulate his body so to become resistant to electricity. Up to 60,000 volts will inflict no damage or ill effect. Currents greater than 60,000 volts, including lightning and magic electricity, do half damage. **Range:** Self. **Duration:** 3 minutes per level of experience. **I.S.P.:** 4.

**2. Electrical Discharge.** The character can cause static electricity within a six foot (1.8 m) area, as well as emit an electrical discharge by touch. The discharge can be a little jolt or inflict up to 1D6 damage as often as once per melee. **Range:** Touch or 2 feet (0.6 m) away. **Duration:** Instant. **I.S.P.:** 2 per each discharge.

**3. Manipulate Electrical Devices.** Through focused thought the psychic can enforce a limited control over electrical devices, such as turning off and on light switches, computers, televisions, radios, blenders, microwave ovens, flashlights, toys (battery and plug types), windshield wipers, and all types of electrically operated appliances, toys and devices. He can also manipulate the controls of the device, such as volume, channel selection, tuners, speakers, change speed, dim lights, and so on. A dozen different electrical functions can be manipulated each melee. This can mean flicking the light off and on six times (12 functions/6 off, 6 on) or turn on the T.V., turn its volume up to the max. and

turn on 10 other appliances (12 functions in all). **Range:** 45 feet (13.7 m) +5 feet (1.5 m) per level of experience. **Duration:** 2 minutes per level of experience. **I.S.P.:** 4. **Note:** The character does not need to see the devices to manipulate them. He can feel their presence.

**4. Sense Electricity.** The psychic can sense or feel electricity and pinpoint its exact location with fair expertise. **Range:** 45 feet (13.7 m) +5 feet (1.5 m) per level of experience. **Duration:** 2 minutes of extreme sensitivity when he can pinpoint every source of electricity in the area. **I.S.P.:** 2 per every two minutes. **Base Skill:** 55% +5% per each additional level of experience. A failed roll means only 1D6x10% of all the electrical devices/sources of electricity could be sensed.

## Empathic Transmission

**Range:** 60 feet (18.3 m).

**Duration:** 2D6 minutes.

**I.S.P.:** 6

**Attacks Per Melee:** Equal to the individual's psychic abilities.

**Saving Throw:** Standard.

This incredible ability enables the psychic to instill a powerful emotion into another living creature; person, animal or supernatural being. Each psychic attack/transmission can only affect one creature at a time. Several supernatural creatures have this ability or some aspect of it.

**Despair or Sorrow:** Invokes great emotional upheaval, deep sorrow and a sense of loss. There is a 50% chance of the victim surrendering or leaving without a battle; furthermore, victims are -2 to parry and dodge.

**Confusion:** Disorients the person so badly that he has no sense of direction, time, or of what is exactly going on. Victims are -3 to strike, parry and dodge, and lose initiative in any combat.

**Fear:** Invokes unreasoning terror in all those affected. Victims are -3 to strike, parry and dodge, plus there is a 66% chance that those affected will turn and run.

**Hate or Anger:** Will prompt those affected to act rashly, charge, attack, argue violently, etc. Victims are likely (60% chance) to attack, kill, harm, or betray those they dislike; +1 (yes, that's plus) to strike, -1 to parry and dodge.

**Love or Peacefulness:** Will induce a deep feeling of serenity, dispelling anger, hatred, sorrow, and so on. Hostile opponents are likely (60% chance) to reconsider their actions, deciding not to attack, show mercy, leave without being overtly cruel or destructive, halt a rampage, and so on. It does NOT make its victims docile sheep, but curbs hostility.

**Trust:** Will make its victims believe everything the psionic tells them, but only while under the empathic influence. Life threatening suggestions that go against deep-seated fears, morals or ideals provide an additional saving throw against the suggested action; with a bonus of +3 to save.

## Group Mind Block

**Range:** 120 feet (36.6 m).

**Duration:** 10 minutes per level of experience.

**I.S.P.:** 22

The Master Psionic can instantly erect a mental barrier or Mind Block to protect himself and those around him, within a 120 foot (36.6 m) area. The Group Mind Block works just like the individual Mind Block power. It can be a means of protecting those around the psychic from psionic probes and mind attacks, but it can also be used to prevent outside forces (good or evil) from communicating via telepathy or empathy. Thus, a villainous psychic can use the Group Mind Block for his own evil purposes. Everyone within the 120 foot (36.6 m) area of affect will be automatically blocked, but the effect is not detectable so they are not likely to know that they are being Mind Blocked (a Detect Psionics will indicate a Group Mind Block)!

## Group Trance

**Range:** All willing subjects within 20 feet (6 m) of the psychic, +10 feet (3 m) per level of experience.

**Duration:** Two minutes per level of experience or until the trance is broken, whichever comes first.

**I.S.P.:** 15

**Saving Throw:** None for willing participants. Those unwilling to participate cannot be entranced.

There are a couple of different applications for this power. The non-combat use is a sort of shared communication. Everybody entranced can share in the psionic experiences of the group leader, the character who is using the Group Trance power. First, the entire group of willing participants enters into a trance state. While entranced, the group is subtly linked to the character using the power. That psychic can then perform one or two other psychic communication abilities per melee round. These abilities are limited to a few forms of psionic communication (not Healing, Physical or Super-Psionic powers), including Clairvoyance, Empathy, Telepathy, Object Read, Presence Sense, Commune with Spirits, Remote Viewing, and Sixth Sense. The thoughts, visions/images, and communications received by the lead psychic are simultaneously transmitted via the trance-link to all participants. They see, know or feel everything he does.

The other use of this ability is to willingly pool the I.S.P. of the trance group to make it available to the lead psychic (the one who is using the Group Trance ability). Once every melee round, the psychic to whom they are linked can draw upon three I.S.P. points from each psychic in the trance group. I.S.P. cannot be drawn from characters who don't have any. These I.S.P. can be used by the lead psychic in any way he desires. The others linked to him see, feel and experience whatever he does, including his rationale, motives and emotions.

In both instances, only the psychic group leader has any melee actions, and he is limited to two psionic actions/attacks while entranced. All those in the group are simply passive observers and secondary participants. All participants react calmly toward the events, emotions, and visions they experience while entranced. The moment the trance ends, they are back to normal and can respond as is appropriate. Only the lead psychic or the genuine fear of death can break the trance. All snap out of it even if only one person breaks the trance.

## Hydrokinesis

**Range:** Varies.

**Duration:** Varies.

**I.S.P.:** Varies.

This ability enables the character to use psychic energy to sense and influence water.

**1. Sense Chemical Impurities.** The psychic can sense whether or not water is polluted or contains other substances. The exact nature of the additive or pollutant may be unknown, but he will know that it is not completely natural. When sensing water, first roll to determine: 1) Pure or drinkable (nonhazardous/tap water), 70%+5% per each additional level of experience. 2) Roll for general nature of the pollutant; this identifies whether it is a chemical/drug (not deadly, but will cause a reaction if drunk) or poison/toxin (deadly or harmful if swallowed). Success ratio in identifying the general nature of the pollutant is 35%+5% per each additional level of experience. **Range:** Self/six inches (0.15 m). **Duration:** One minute (4 melees). **I.S.P.:** 2 per minute.

**2. Boil Water.** The psychic can increase the temperature of water, raising it to boiling level within one minute (four melees). Up to one gallon (3.8 liters) can be affected. Once set a boiling, it will take the usual amount of time to cool. This power can not be made to boil the water or blood in a living creature. **Range:** 8 feet (2.4 m) +2 feet (0.6 m) per level of experience. **Duration:** One minute (4 melees). **I.S.P.:** 3 per gallon of water.

**3. Water Spout.** An ability that enables the psychic to control and hurl water. The effect can be used to make water bubble (but not



heated), shoot straight up like a geyser or a water blast hurling across a room like a short, powerful spray from a garden hose. Up to one gallon of water per level of experience can be manipulated and hurled up to a distance of 20 feet (6 m). **Note:** The fluid must be 75% water to be controlled, such as punch, hot coffee, chicken soup, tea, Kool-Aid, etc. Forget about hurling ice (frozen does not count), paint, gasoline, or cake batter.

Making water leap with a life of its own can be startling to others and can make a great distraction if handled right. Hurling normal water or a cool drink into somebody's face/eyes will momentarily blind and surprise the individual, causing him/her to lose initiative and one attack that melee. Hurling hot or boiling water on the body (especially the crotch) will have the same results. Hurling boiling water in the face is horribly painful, causing 2D4 damage, loss of initiative, loss of all attacks for 1D6 melees and temporary blindness for 3D6 melees (-10 to strike, parry and dodge). Characters of a good alignment will not hurl boiling water in the face unless under an absolutely life and death circumstance.

**Hurling range:** 20 feet (.6 m). **Duration:** Instant. **I.S.P.:** 5. **Bonus:** +1 to strike. Making water bubble or rise up like a fountain can be maintained for up to 30 seconds (2 melees). **Note:** The psychic can influence up to one gallon (3.8 liters) of water per level of experience up to 20 feet (6 m) away, whether he can see it or only feel its presence.

**4. Sense Water.** The character can sense the presence of any water exposed to the open air automatically at no cost of I.S.P. **Range:** 20 feet (6 m). **Duration:** Permanent. **I.S.P.:** None. **Note:** Underground rivers, airtight containers, etc., can not be sensed.

## Hypnotic Suggestion

**Range:** 12 feet (3.6 m), with eye contact.

**Duration:** Varies with each circumstance and subject; rarely more than a few hours maximum.

**I.S.P.:** 6 per idea or attempt to implant an idea.

**Saving Throw:** Standard.

The power of suggestion is a psychically boosted form of simple hypnosis. The power is limited to relaxing/calming somebody down,

putting a person or animal in a light sleep, helping a person to relax and focus on a particular thought (good for helping someone to remember things) and implanting subtle ideas. The implanting or “suggestion” of an idea must be subtly worked into a verbal comment. The suggestion must be kept simple and clear, such as “You know you can trust me.” or “You feel like you have a fever.” or “You don’t want to go there.” The power of suggestion can also be used to make the victim imagine sounds and images. “Did you hear that? Listen! Footsteps. You hear the footsteps...yes, you do!” Or, “At midnight the specter appears. Everybody who is ever present sees the specter at midnight.” The poor individual who fails his saving throw will indeed imagine he sees something at midnight and hears footsteps.

## Mentally Possess Others

**Range:** Touch.

**Duration:** 5 minutes per level of experience.

**I.S.P.:** 30

The psychic can completely take over and control another person. The psychic essence of the controlling mind is transferred into the body of another individual. While in the victim’s body/mind, the psionic retains all his own knowledge and identity. He can not read the mind of the person he now possesses, nor access any knowledge from the victim’s memory. Only the physical body can be controlled, like a living robot.

During the period that the victim is possessed, the individual goes into a trance state and remembers nothing about the things that happen while he is possessed. Meanwhile, the psychic’s natural body falls into a coma-like state and is vulnerable to attack unless protected by others.

The possessing character can return to his own body at any time regardless of distance. When his essence leaves the body of the possessed, the victim suddenly becomes conscious again, as if suddenly being woken up.

## Mind Block Auto-Defense

**Range:** Self.

**Duration:** Special.

**I.S.P.:** Special.

The moment the psychic is mind probed, a personal Mind Block automatically snaps into place. It also alerts the character to the fact that he or she is being probed or attacked by Empathy or Telepathy. The character must consciously and willingly lower the mind shield and open himself to the psi-probes in order to receive them. Otherwise, the automatic defense Mind Block will stay in effect until the probe/attack is over. Engages automatically.

The I.S.P. cost is different in that the character must permanently give up 14 I.S.P. when this power is selected. However, the Mind Block will automatically take place whenever under Telepathic and Empathic probes or mind control attacks at no additional I.S.P. cost.

## Mind Bolt

**Range:** 100 feet (30.5 m) per level of experience.

**Duration:** Instant.

**I.S.P.:** Varies.

The psionic can focus his psionic energy into a powerful bolt of mental force and hurl it at a visible target with amazing accuracy. The amount of damage the bolt inflicts depends on the amount of energy expended.

6 I.S.P.: 1D6 S.D.C. damage.

12 I.S.P.: 3D6 S.D.C. damage.

20 I.S.P.: 6D6 S.D.C. damage.

40 I.S.P.: 2D4 Mega-Damage!

**Note:** All mind bolts are +4 to strike, but adding an additional 10 I.S.P. increases the strike bonus to + 8 to strike. Remember, ley lines and nexus points increase the range and damage.

## Mind Bond

**Range:** Touch.

**Duration:** Special.

**I.S.P.:** 10

**Saving Throw:** Standard.

This creates an instant mind link between the psionic and the victim. When this happens, *each* will learn EVERYTHING there is to know about the other. This includes all skills, secret identities, phobias, etc. In both cases, the memory is complete for only 3-12 hours (roll 3D4). After that, the characters must roll under 15% to recall any particular item. A month later, all memories completely disappear. Players should bear in mind that only the psionic knows the memories are not permanent, thus the other person would have no reason to make notes or act quickly before the memories fade.

**Note:** Skills and skill bonuses are also temporarily absorbed, meaning that the psychic possesses all of his victim’s skills and skill bonuses (and vice versa). Physical attributes, such as S.D.C. and attribute bonuses gained through physical training are NOT acquired.

Alien or extremely mentally and/or emotionally disturbed minds can permanently impair the psionic’s own mind as a result of the bond. If bonded with an alien or extremely disturbed person, roll on the following tables for a permanent insanity:

01-40%: No Insanity

41-80%: Phobia

81-90%: Affective Disorder

91-00%: Neurosis

## Mind Wipe

**Range:** Touch.

**Duration:** Special.

**I.S.P.:** Special.

**Saving Throw:** Standard; a successful save means the person is unaffected and still retains his memory.

To Mind Wipe an intelligent creature, the psionic must make physical contact, touching his victim’s temples to erase whatever he desires. This is done by verbal suggestion and can erase any past event, knowledge, skill, and so on. The process takes about three minutes to complete.

The loss of memory is temporary, lasting 1D4 days for every 10 I.S.P. expended. The memory can be permanently erased if the psychic exerts 50 I.S.P. at once. A psychic can also permanently wipe a mind completely blank by expending 50 I.S.P. and four Mental Endurance (M.E.) points. This is an extremely grueling process for the psychic, and the loss of the four M.E. points is permanent, even if the opponent successfully saves against the wipe and is not affected.

## P.P.E. Shield

**Range:** Self.

**Duration:** 6 minutes per level of experience.

**I.S.P.:** 10

A psionic defense that can be used to prevent P.P.E. vampires, Psi-Stalkers, and mages from siphoning off one’s psychic energy. The shield works similarly to a Mind Block, only it prevents others from draining one’s P.P.E.

## Psi-Shield

**Range:** Self.

**Duration:** 5 minutes per level of experience.

**I.S.P.:** 30

A companion power to the Psi-Sword, in which the psionic can create a Mega-Damage shield out of thin air. The shield can be used to parry all hand to hand combat attacks including attacks from robots, power armor, and magic. The shield can not be used to parry energy blasts and projectiles. Shield M.D.C. is 80.

## Psi-Sword

**Range:** Self.

**Duration:** 5 minutes per level of experience.

**I.S.P.:** 30

A Psi-Sword is a Mega-Damage energy weapon that the psychic can mentally will into existence! The weapon appears out of thin air as a shimmering blade of energy that resembles a glowing sword. The sword's actual appearance will generally reflect its creator. A character who is impressed by strength and power will create a huge Claymore-like weapon. A character who prides himself on speed and agility is likely to create a rapier or saber type blade, while a hero who enjoys cunning and subterfuge may create a short sword. Each is equally powerful regardless of its form and size.

The creation of the Psi-Sword is a very personal thing and requires years of mastery and great psionic power. Like the Cyber-Knight, the Mind Melter can change the shape and even the color of the sword to fit his current mood, but unlike the Knight, can do so from day one.

The Mind Melter can create the Psi-Sword after only a few moments of concentration (about 15 seconds/one melee) and maintain it for five minutes per level of experience. This means a third level Mind Melter can create and maintain a Psi-Sword for 15 minutes at the cost of 30 I.S.P., while a first level character must expend the same 30 I.S.P. but can maintain the weapon for a mere five minutes. If the psychic is knocked unconscious, the weapon disappears. Likewise, the character can willingly dispel the weapon with a thought.

Psi-Sword damage: 4D6 M.D. at level three (one can not select this power until level three). Add 2D6 at levels four, seven, nine, twelve, and fifteen.

The Psi-Sword of the Mind Melter is incredibly powerful, but can be adjusted to inflict a minimum of 2D6 Mega-Damage (M.D.) or increased by increments of 1D6 up to the character's current maximum. For Example: A fourth level Mind Melter can inflict a maximum of 6D6 M.D., but the character decides, for whatever reason, to decrease the power to the minimum of 2D6 M.D.; he can, at will, increase the damage capability of the sword by increments of 1D6 M.D. up to the maximum of 6D6 M.D. (3D6, 4D6, 5D6, and 6D6).

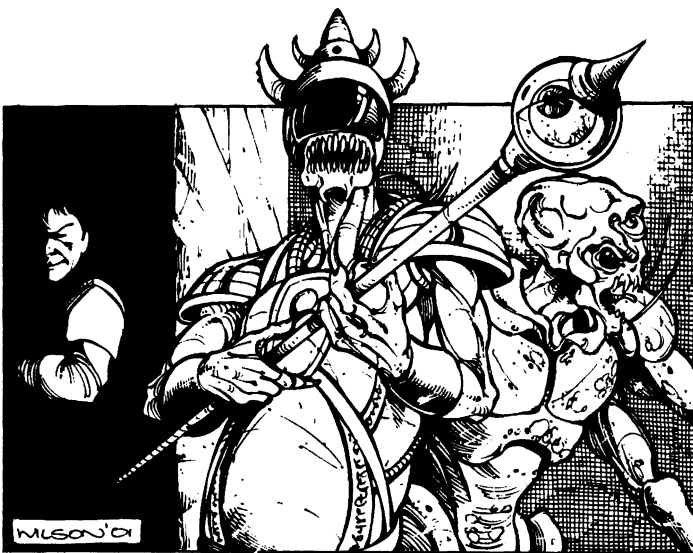

## Psionic Invisibility

**Range:** Line of sight or 100 foot (30.5 m) radius.

**Duration:** One minute per level of experience.

**I.S.P.:** 10

**Saving Throw:** Potential victims are -2 to save; area affect.

Psionic invisibility is the ability to remain undetected when in plain sight. This is accomplished via a Telepathic impulse that convinces by-

standers that the psychic is not a threat and insignificant – beneath their notice. Those affected by the impulse are unable to see the character, and subconsciously avoid colliding with him; they don't see him on a conscious level. **Note:** This invisibility works only if the character is "passing through" or hiding, and honestly has no intention of attacking or hurting anybody in the area. The slightest ill intent or act toward perpetrating violence instantly cancels the psionic influence.

Individuals watching through video monitors and other sensory equipment can be similarly tricked into ignoring the psychic, but only if within his radius of influence. Those out of range will react appropriately, and once the psychic has been seen, the person is immune to his ability to seem invisible. Likewise, while a watch guard may not see or react to the psychic, he will be captured and recorded on film and by sensors. Video cameras, computers and similar devices are never fooled by this power; they are able to notice and record the character as normal (some may sound an alarm too).

## Psychic Body Field

**Range:** Self.

**Duration:** Two minutes per level of experience.

**I.S.P.:** 30

With a thought, the psychic instantly surrounds himself with a Telekinetic force field that conforms to the shape of his body and enables him to physically move and fight. It is a Mega-Damage structure with 10 M.D.C. per level of experience. The field takes the shape of a dim, white, transparent aura that completely surrounds and encloses the body of the psychic. Items held in his hands, hung from his back, or worn on top of his head are not protected.

On the downside, the field does not protect against disease, radiation, or toxic fumes, nor magic or psionic attacks other than physical ones (energy blasts, fire, etc.). Worse, the TK-force field means the psychic loses his sense of touch, because the field is between him and all objects/materials outside the force field. This lack of touch sensation means the character cannot feel much of anything he picks up or touches after the field has been erected. This makes the use of skills that require a sense of touch and manual dexterity -30%, and delicate items may be accidentally dropped or crushed.

## Psychic Omni-Sight

**Range:** 500 foot (152 m) radius.

**Duration:** 5 minutes per level of experience.

**I.S.P.:** 15

An advanced form of extrasensory perception that allows the psychic to have a sort of controlled out-of-body experience. The psychic must spend one minute (four melee rounds) in meditation and enter into a trance state. While entranced, his spirit or essence seems to rise 10-20 feet (3-6 m) above his physical body (this is not visible to anybody but other psychic sensitives and those who can see the invisible, auras or spirits).

From this vantage point, combined with heightened awareness, the psychic sees through his mind's eye, without having to use his normal vision or senses. Psychic Omni-Sight is incredible, enabling the psychic to see in all directions at once, to see radiation, thermal patterns, the invisible, and to literally see any movement, even of the wind! This power enables the psychic to guard or survey a campsite for signs of wayward group members or approaching dangers (maximum range 500 feet/152 m; this psionic vision is stopped/contained by walls and other obstacles). It can also be used to survey an area for things that might otherwise escape normal sight or take much longer to locate and identify.

## Special Bonuses & Abilities:

- Pinpoints the locations of electrical outlets, electronic "bugs" (spy and surveillance devices), electronic devices and other energy and heat sources, as well as bionic body parts and cybernetic implants close to the surface of the skin (not bio-systems or artificial internal



organs). Such concealed or obscured items can be identified by their shape and heat pattern. Success Ratio: 40% +5% per level of experience.

- This ability can also help the psychic to locate secret compartments and trap doors. Success Ratio: 25% +5% per level of experience.
- See the infrared and ultraviolet spectrums of light.
- See heat signatures: can tell if an engine has been recently used or a weapon recently fired (within the last 15 minutes), follow recent footprints or vapor trails (within the last five minutes), see heat signature in darkness and so on.
- Hyper-sensitive to movement. The psychic can not be surprised by movement or attacks within the 500 foot (152 m) radius or confines of the area under psionic scrutiny (may be substantially smaller indoors; closed off by walls and doors).

**Limitations:** Although keenly aware and alert while using Psychic Omni-Sight, the psychic cannot take physical action, not even to speak, nor use most psionic powers unless he cancels/ends the ability. He can awaken the instant the psi-ability ends and leap into action.

While entranced by Omni-Sight, the character can only use the following psionic powers: Empathy, Telepathy, See Aura, Empathic Transmission and Telekinesis. The number of psionic attacks/actions per melee round are half those normally available when not entranced.

## Psychosomatic Disease

**Range:** 10 feet (3 m) and verbal suggestion.

**Duration:** 1D4 days per level of the psychic.

**I.S.P.:** 30

**Saving Throw:** Standard.

This power employs the principle of mind-over-matter and mind control by inducing the victim to believe he suffers from a particular disease, although no actual physical cause can be found. It is all in the victim's mind.

This is done in a similar way to Hypnotic Suggestion, requiring the psychic to "suggest" that the character looks ill or that a particular disease is in the area, as well as mention the name of a specific disease

along with the most notable (and debilitating or frightening) symptoms. Within 2D6 minutes, the intended victim will begin to come down with those symptoms. He will suffer from the affliction with all its pain and penalties, until one of the following occurs: The psychic who caused the affliction removes it, the character is healed by a psychic healer, a successful magical or priestly Remove Curse spell or ritual is performed, or the psychosomatic disease runs its course (see duration above).

In the meantime, the character will suffer from physical trauma and symptoms (fever, vomiting, coughing, convulsions, skin rashes, hives, etc.) associated with that disease, as well as emotional anguish. In most cases, the disease is debilitating for days, but sometimes it can be deadly, causing the victim to die from dehydration, starvation, injury, etc., brought on by the symptoms and/or fear of the psionic illness.

## Pyrokinesis

**Range:** Varies.

**Duration:** Varies.

**I.S.P.:** Varies.

Pyrokinesis is a psychic ability that gives a character the power to manipulate fire.

**1. Fire Resistant:** The psychic can endure great heat and fire with minimal ill effect. Damage is reduced by half. Magic fires do full damage. **Range:** Self. **Duration:** 5 minutes per level of experience. **I.S.P.:** 2.

**2. Spontaneous Combustion:** The ability to create a spark that will ignite combustible material, such as paper, old rags, dry grass, gasoline, etc. **Note:** Human hair should not be considered a combustible material. This is a slow fire, starting with a tiny spark and grows. Initially, it is not a roaring blaze. **Range:** Can be ignited up to 30 feet away (9 m). **Duration:** Instant; fire will last and spread until it is put out or there is nothing to burn. **I.S.P.:** 2.

**3. Fuel Flame:** The character can feed the fire with psychic energy, doubling it in size. Affects a 10 foot (3 m) area. **Range:** Up to 30 feet (9 m) +5 feet (1.5 m) for each additional level of experience. **Duration:** Instant. **I.S.P.:** 4.

**4. Extinguish Flames:** The power to instantly put out an area of fire. Affects a 15 foot (4.6 m) radius of fire. **Range:** Up to 30 feet (9 m) away +5 feet (1.5 m) per each additional level of experience. **Duration:** Permanent until set on fire again. **I.S.P.:** 4.

**5. Create Flame:** The incredible ability to create fire out of thin air. Can be an 8 foot (2.4 m) pillar of fire affecting a 4 foot (1.2 m) diameter or a 6 foot (1.8 m) high wall of fire stretching six feet (1.8 m) long +1 foot (0.3 m) per each additional level of experience. **Damage:** 4D6 M.D. from the pillar, 6D6 M.D. from the wall, plus both have a 72% likelihood of setting any combustibles they touch ablaze (including cloth, rugs, curtains, furniture, etc.). **Range:** Cast up to 30 feet (9 m) +2 feet (0.6 m) per additional level of experience. **Duration:** 2 minutes per level of experience; longer if it sets other things on fire. **I.S.P.:** 20.

**6. Fire Ball:** Another fire creation ability is the hurling of a fire ball. **Damage:** 1D6x10 S.D.C. or 6D6 M.D., **Range:** 30 feet (9 m) +2 feet (0.6 m) per each additional level of experience. **Duration:** Instant. **Bonus:** +2 to strike. **I.S.P.:** 25.

**7. Sense Fire:** The psychic can sense or feel the presence of fire and pinpoint its exact location. **Range:** 100 feet (30.5 m) +5 feet (1.5 m) per level of experience. **Duration:** 2 minutes of extreme sensitivity when he/she can pinpoint the exact location of every fire in the area. **Base Skill:** 90% success ratio. A failed roll means only 2D4x10% of the fires can be located by sensing. **I.S.P.:** 2 per every two minutes.

## Radiate Horror Factor

**Range:** Self; affects all who come within 100 feet (30.5 m) of the psychic.

**Duration:** 5 minutes per level of experience.

**I.S.P.:** 8

**Saving Throw:** -1 to save vs Horror Factor.



The psychic can channel his psionic powers, alignment and emotions to radiate as an aura of power that is frightening. This aura is equal to a Horror Factor and perceived on a subconscious level by all who see the psychic or come within range. The usual H.F. reaction and penalties apply; see page 367 of *Rifts® Ultimate Ed.* for details.

The level of horror varies as follows:

- Horror Factor 10 if the character is of a *good* or *Unprincipled alignment*.
- Horror Factor 10 +1 per every three levels of experience if the character is *Anarchist*.
- Horror Factor 12 +1 per every three levels of experience if the character is of an *evil alignment*.
- Add one Horror Factor point to any of the above if the character is *also insane or enraged beyond reason*.

## Telekinesis (Super)

**Range:** 100 feet (30.5 m) per level of experience.

**Duration:** 2 minutes per level of experience.

**I.S.P.:** 10 to lift/move/hurl an object that weighs 100 lbs (45 kg), +10 I.S.P. per each additional 100 lbs (45 kg).

**Damage:** See below.

The power is basically the same as the ability described in the Physical Category of psionic powers, but greatly enhanced. Differences are increased range, dramatically increased weight and damage. The character can use Super Telekinesis to manipulate as many as one object per level of his experience, as long as the combined weight does not exceed his total weight capacity.

- +3 to strike with Telekinesis; physical/skill bonuses to strike do *not* apply when Telekinesis is used.
- +4 to parry with Telekinesis, by using a controlled object to parry or sheer telekinetic force to block an attack. Counts as a medium heavy object; costs 8 I.S.P.
- *S.D.C. Damage from Hurled Objects:* **Very Small:** 6 ounces to 1 pound (0.13 to 0.45 kg): 1D4. **Small:** 1.5 to 2 lbs (0.6 to 0.9 kg): 1D6 S.D.C. **Medium Small:** 2-4 lbs (0.9 to 1.8 kg): 2D4 S.D.C. **Medium:** 5 to 10 lbs (2.25 to 4.5 kg): 3D4 S.D.C. **Medium Large:** 11 to 25 lbs (4.95 to 11.2 kg): 3D6 S.D.C. **Large:** 26 to 40 lbs (11.7 to 18 kg): 4D6 S.D.C. and add 1D6 damage for each additional 20 lbs (9 kg) up to 200 lbs (90 kg).
- *Mega-Damage from Huge Hurled Objects:* M.D. is only possible with Super Telekinesis and only when the hurled object is 100 lbs (45 kg) or heavier and is a hard material like wood, stone or metal (not people). Does 1D4 M.D. per 100 pounds (45 kg).

## Telekinetic Acceleration Attack

**Range:** 50 feet (15 m) +10 (3 m) per level of experience; line of sight.

**Duration:** Instant.

**I.S.P.:** 10 for S.D.C. damage, 20 for Mega-Damage.

This power works on the same principle as the rail gun but uses Telekinetic power rather than electromagnetic force. Rather than use Telekinesis to lift and move one or more objects, this Super-Psionic power causes a half dozen to a dozen small objects (coins, pencils, small stones, arrows, unloaded bullets, etc.) to hurl at an incredibly high velocity in a powerful (if not long-range) burst of telekinetic energy. All items strike one target at tornado wind velocity. **Damage:** If 10 I.S.P. are expended the damage inflicted is 2D4x10 S.D.C. If 20 I.S.P. are expended, the damage is 3D6+4 *Mega-Damage!* The psychic must roll to strike at +1 to do so (no other bonuses apply except any R.C.C. psi-power bonus) and the target must be clearly visible. The psionic attack counts as one of the character's melee attacks.



## Telekinetic Force Field

**Range:** Self or 40 feet (12.2 m) per level of experience within line of vision.

**Duration:** 10 minutes per level of experience.

**I.S.P.:** 30

The psychic can instantly erect a force field around himself or others in the blink of an eye. If the creation of the force field is to parry an attack, the psionic must roll a successful parry to see if he was able to create the field before the attack strikes. A successful parry means the force field beat the attacker's strike and it absorbs the damage.

The TK Force Field can be made so that it only encircles its creator or as large as a 10 foot (3 m) area per level of experience and can be created yards/meters away, but always within the *line of vision*. The smallest force field possible covers about a three foot area (0.9 m)

The field is a Mega-Damage structure with 25 M.D.C. per level of experience.

Once one field is created, the psionic can create as many others as his I.S.P. will allow. All must be in the character's line of vision. The TK Force Field(s) will remain in place until all its M.D.C. is destroyed or its creator dispels it. If the psychic is rendered unconscious or killed the force fields instantly vanish. However, the psychic can willingly leave the area, leaving the force fields up. They will remain in place until the duration time limit expires. People may be able to move around inside a force field, but the force field itself can not be moved. The TK Force Field is actually a force bubble and is airtight, with enough air inside for the duration of the field.

## Telemechanic Mental Operation

**Prerequisite:** Psychic must also have the Telemechanics power.

**Range:** 20 feet (6.1 m) +5 feet (1.5 m) per level of experience.

**Duration:** 2 melee rounds per level of the psychic.

**I.S.P.:** 12

**Saving Throw:** Special. Regular, non-intelligent machines cannot save vs Telemechanic operation. Cybernetics and bionics attached to living flesh, sentient machines and magic items and devices are imperious.

This power is a step beyond the mere understanding of machines granted by Telemechanics, it allows the psychic to telepathically operate machines with his mind! As long as the machine functions, he knows how to use it, and it is turned "on," the psychic can manipulate it with his mind as if his fingers were on the controls! This means he can operate computers, key-pads, set/program an alarm clock, change the radio station, operate a VCR or television, drive a hover car (even if there is already a driver, but at -30% when usurping the pilot), cook something in a microwave, turn off (or on) a surveillance video camera, and so on.

The Telemechanic Mental Operation power will only work on machines that have an electronic or other power source. This power does not work on artificially intelligent machines (i.e. intelligent computers, robots, etc.), nor on cybernetics, bionics, Techno-Wizard devices, rune weapons or magic items. **Note:** Also see *Machine Ghost* and *Telemechanic Possession*.

The psychic can use other psionic powers and engage in other activities, but must maintain some level of mental concentration and contact to keep control of the machine. During this period he is -1 melee attack/action and -5% on skill performance. He must also stay within range. If he steps out of range or loses concentration, the machine returns to normal in 1D4 seconds.

## Telemechanic Paralysis

**Prerequisite:** Psychic must also have the Telemechanics power.

**Range:** Touch or 40 feet (12.2 m)

**Duration:** One minute per level of experience.

**I.S.P.:** 20

**Saving Throw:** Special. Regular, non-intelligent machines cannot save vs Telemechanic paralysis. Cybernetics and bionics attached to living flesh, sentient machines and magic items and devices are imperious.

This is a form of techno-manipulation whereby the psychic is able to psychically bond with the machine and momentarily prevent it from functioning. The psychic blocks the transmission of signals along the machine's "nervous system," effectively incapacitating it. This means the power is only effective against machines that require an energy source. Simple devices like wind-up toys, scissors, old revolvers and pistols, swords, knives, crossbows, and similar items cannot be affected. The paralyzed machine freezes in place and does not respond to any of its controls until the psionic influence comes to an end.

The psychic can use other psionic powers and engage in other activities, but must maintain some level of mental concentration and contact to keep the machine inactive. During this period, he is -1 melee attack/action and -5% on skill performance. He must also stay within range (40 feet/12.2 m). If he steps out of range or loses concentration, the machine returns to normal in 1D4 seconds.

## Telemechanic Possession

**Prerequisite:** Psychic must be a master psionic and also have the powers of Object Read and Telemechanics.

**Range:** Touch or 10 feet (3 m) per level of experience.

**Duration:** Two minutes (8 melees) per level of experience.

**I.S.P.:** 50

**Saving Throw:** Special. Regular, non-intelligent machines cannot save vs Telemechanic possession. Artificial intelligences (robots like

Skelebots) need a 15 or higher to save and sentient machines (like Archie-3) require a 12 or better to save. Artificial intelligences and sentient machines also get to save when being forced to do something that is contrary to their programming. Cybernetic and bionic devices attached to living tissue can NOT be possessed. Neither can magic items, including Rune Weapons and Techno-Wizard devices.

This ability is identical to the psionic power, Mentally Possess Others, in every way, except that the psychic possesses a machine rather than another person. The character overrides the programming/controls of the machine, even in the case of sentient machines, and controls it like a living robot. Essentially, the possessing psychic is an immaterial pilot who controls the machine as he desires; computers, factory equipment, vehicles, robots, empty power armor, a toaster, etc.

While the psychic possesses the machine, it responds to the character's thoughts and does whatever he desires. Of course, physical, mechanical limitations still apply. The machine needs a power source and cannot do anything it is not normally capable of doing. For example, the psychic may be able to take possession of an energy rifle and make it shoot (or not) seemingly of its own volition, but he cannot make the rifle aim, move or hop around. Likewise, if the device is unplugged, or runs out of fuel, the machine is deactivated with no ill effect to the psychic, except his possession comes to a premature end. Likewise, if it needs wheels to move, destroying the wheels will cripple it, etc.

If the machine he possesses is destroyed while the psychic's essence is still inside it, the character loses one third of his Hit Points (or one third of his M.D.C. if a Mega-Damage creature) from the shock and pain from the destruction of his surrogate machine body. Furthermore, he is stunned for 1D4 minutes (reduce attacks per melee, speed, combat bonuses, and skill performance by half while stunned).

During the period that the machine is possessed, the psychic's natural body falls into a coma-like state and is vulnerable to attack unless protected by others.

While in mental possession of a simple machine, the psychic has only a vague awareness of his surroundings and can see, hear and feel things around him but as if in a cloud or haze. However, if the machine has optics and/or sensors, he is able to use them like his own natural eyes and senses. The machine, regardless of its capabilities and programming, has attacks and actions equal to those of the character possessing it.

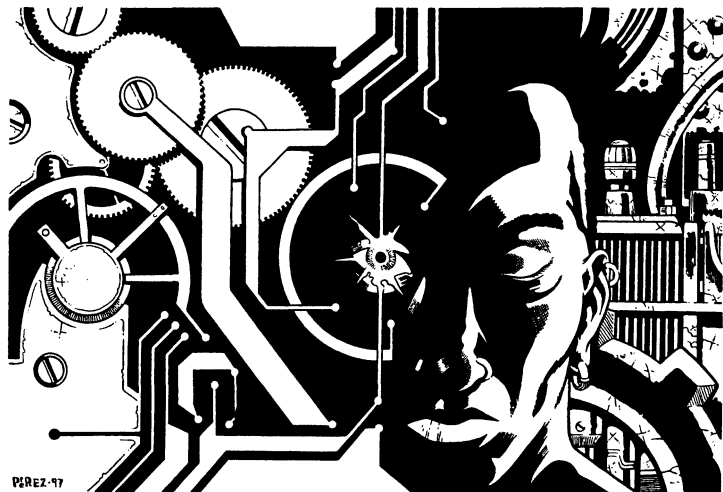

## Telemechanics

**Range:** By touch or up to 5 feet away (1.5 m).

**Duration:** 10 minutes plus 2 minutes per level of psionic.

**I.S.P.:** 10

**Saving Throw:** None.

This ability allows the psionic to mentally communicate with and understand machines. This psi-power is a bizarre combination of object read and telepathy, except that it applies to mechanical devices only.

By touching any non-artificially intelligent machine, whether it be a bicycle, gun, car or airplane, the psionic will instantly have a complete (although temporary) knowledge of exactly how the machine operates. I must stress that the psychic knows *everything* about the machine; the complete schematic diagram and operation knowledge are clearly seen in his mind's eye. The level of skill expertise is equal to 80%.

When touching an artificially intelligent machine, i.e., computers, the psionic not only understands everything about its operation, repair, access codes, etc., but can actually communicate with it telepathically. This means he can tap into a computer's memory bank without using a terminal because the information would be sent directly into the psychic's mind. Remember, the telepathic link and memory are temporary abilities (although a total recall would be able to call up small bits of info). The psychic's skill knowledge is equal to an 88% skill proficiency and applies to all aspects of the machine, its operation, repair, special codes, programming, etc.



## Mind Bleeder Powers

These powers are generally exclusive to the Mind Bleeder R.C.C.

### Bleed Aura

**Range:** Four feet (1.2 m) per level of experience.

**Duration:** Instant.

**I.S.P.:** 6

**Saving Throw:** -2 to save.

The Mind Bleeder can copy the aura of another living being, including humans, D-Bees and large animals, to completely disguise his own aura signature. The bleeding of an aura has the interesting side effect of distorting the aura of the person whose aura has been stolen. Anybody trying to read the aura of the victim will find it extremely difficult to see and will be very off on the level, health and similar things one can usually tell by looking at an aura.

### Bleed P.E. Energy

**Range:** Four feet (1.2 m) per level of experience

**Duration:** Instant.

**I.S.P.:** 10

**Limitations:** Can only be used when physically fatigued or in need of sleep.

**Saving Throw:** Standard.

The psychic can syphon the physical energy of another character in the way of physical stamina. The Bleeder can replenish his energy to avoid fatigue by drawing off energy from another living being, including humans, D-Bees and animals. The bleeding of physical energy has minimal effect on the victim, simply causing him or her to become fatigued themselves twice as quickly and they temporarily lose 1D4 S.D.C. points. Meanwhile, the Mind Bleeder becomes instantly re-

freshed (no longer tired/fatigued) and gains 1D4 S.D.C. points toward the healing of wounds. If the character has gone for an unusual amount of time without sleep, the bleeding of energy will enable the bleeder to stay awake and alert for another 1D4 hours without the ill effects of sleep deprivation.

### Bleed Memory

**Range:** Four feet (1.2 m) per level of experience.

**Duration:** Instant.

**I.S.P.:** 6 per each thought.

**Limitations:** Non-combat skills only.

**Saving Throw:** -2 to save.

This is a limited, but powerful form of mental Telepathy. The Mind Bleeder can focus on a very specific thought, such as a secret code word or number, combination sequence to a lock, a name, an address and similar, up to four words or a 24 number sequence and pluck it from a person's mind. Similarly, the character can concentrate on what the person is about to say and know or say the last one to four words of the statement a second before the speaker does. This can be an excellent means of pretending to know about things that the Mind Bleeder doesn't really know anything about.

The only absolute defense against memory bleed is a Mind Block, otherwise the intended victim rolls to save vs psionic attack as usual.

### Bleed Skills

**Range:** Self and must be within four feet (1.2 m) of the victim.

**Duration:** Five minutes per level of experience.

**I.S.P.:** 15 per each skill.

**Limitations:** Non-combat skills only.

**Saving Throw:** Standard.

The character can temporarily absorb/syphon another character's skills and level of skill proficiency. As many as one skill per level of experience can be stolen, but each costs 15 I.S.P. This means a first level Mind Bleeder can steal only one skill, but at second level he can take two, at third level three, and so on.

The most frightening and annoying thing is that the person he has bled the skill from, temporarily suffers a memory loss regarding the stolen skill and has great difficulty remembering and executing the stolen skill; -50% in the performance of that skill and takes twice as long. For example: A third level Mind Bleeder can temporarily steal the skills of Computer Operation and Computer Hacking (and one other if so desired) from an eighth level City Rat. The psychic has all the skill knowledge and expertise (8th level) of the City Rat. Meanwhile, the City Rat's skills are impaired. He is slower than usual, has difficulty remembering procedures and makes mistakes (-50% skill penalty), including simple typographical errors.

When the duration time expires, the Mind Bleeder completely forgets the skills and the victim from whom the skills were temporarily borrowed is completely restored.

The only absolute defense against skill bleed is a Mind Block, otherwise the intended victim rolls to save vs psionic attack as usual. Sleeping or unconscious characters have no mental save against the bleeding of their skills, the psychic automatically steals their skill knowledge.

### Bleed Truth

**Range:** Four feet (1.2 m) per level of experience.

**Duration:** Instant.

**I.S.P.:** 8 per each thought, key word or phrase.

**Limitations:** Non-combat situations only.

**Saving Throw:** Standard.

This is another form of limited, but powerful mental telepathy. The Mind Bleeder can focus on a very specific word or phrase and get an impression about whether or not the person is telling the truth by seeing what he is really thinking.

The process is similar to word association. The character being scanned says, "I'm here in peace. I mean you no harm." The key words are peace and no harm. The Mind Bleeder gets an instant word association, such as "war," or "hate," or "kill," indicating that the character is lying. "No harm" might elicit the same words, "no harm," or "yes," meaning the person is telling the truth. Or the word association might come back as "kill," "revenge," "get you," and so on, meaning he's lying and out to get the person or group he is addressing.

Another example is a stranger or a suspected enemy saying, "I'm alone." To which the Mind Bleeder might get a response like, "yes, alone," or "others," or "many," or "outside" (suggesting others wait outside). This can be an extremely useful ability in ferreting out traps and truths. Unfortunately, the word association is limited and not always clear. Also, other psionics can prevent being mind read.

No word association means the character either made a successful save vs psionic attack or is protected by a Mind Block. The latter should trigger suspicion. The only absolute defense against truth bleed is a Mind Block, otherwise the intended victim rolls to save vs psionic attack as usual.

## Brain Bleed

**Range:** 10 feet (3 m).

**Duration:** Four minutes per level of experience.

**I.S.P.:** 10

**Limitations:** Non-combat skills only.

This power affects the mind and mental perception. The victim's head suddenly begins to throb, he can hear his heart beating in his ears and the sound of blood rushing through blood vessels in the head. The overall sensation is that the head is going to explode, accompanied by a sense of panic. This causes great distraction and concern. **Penalties:** All skills of the victim are at -40%, all combat bonuses are reduced by half, and -4 to save vs Horror Factor, Empathic Transmission, Mind Control psionics and drugs, and magic illusions. Speed is reduced by 25%, unless fleeing, then speed is normal.

## Brain Scan

**Range:** Touch.

**Duration:** Varies.

**I.S.P.:** 10

The psychic can scan the brain to locate and identify both physical and mental aberrations, damage and impairment, including bruises, tumors, aneurysm, diseases, mental blocks, hypnotic suggestions, phobias, obsessions, traumas, magic insanities, magic curses, and similar mental blocks and aberrations. A Brain Scan does not reveal anything about the character's personality, memories, skills or thoughts. A Brain Scan is necessary to *detect* Mental Blocks, magic insanity and other forms of insanity. It also *detects* possession and Mind Control.

## Day Dream

**Range:** Four feet (1.2 m) per level of experience.

**Duration:** Two minutes per level of experience.

**Limitations:** Non-combat/action situations. The intended victim cannot be involved in combat or similarly intense activity. He must be sedentary or relaxed or bored, like a guard, somebody reading a book, laying down, sitting and resting, eating, etc.

**I.S.P.:** 8

**Saving Throw:** Standard.

The Mind Bleeder can pull up a random, pleasant memory in the minds of others. The memory can be anything: thoughts about a sweet-heart, family, party, winning a competition, a movie, an upcoming event that the person is anxiously anticipating and similar experiences. The *victim* focuses on the memory, daydreaming about it with the following penalties: -10 on initiative, slow to take action (speed and number of attacks for the first round of melee action are reduced by half), and will not notice intruders who have a Prowl skill of 60% or higher, nor will the character notice his pockets being picked by characters

with a skill of 60% or higher. Likewise, it will take the daydreaming victim a while to snap out of the dream (about 4D4 seconds) to notice somebody knocking, screaming or buzzing at the door, a telephone ringing, alarms sounding and so on. Once activity has broken the spell of the day dream, all penalties are gone and the character functions completely unimpaired.

## Healing Leech

**Range:** Touch.

**Duration:** Instant.

**I.S.P.:** 6

**Saving Throw:** Standard.

An injured Mind Bleeder can heal himself by drawing on the S.D.C. and Hit Points of other creatures. To do so, he must spend six I.S.P. while touching the creature. If the creature fails to save vs psionic attack, the poor victim will suddenly feel weak, losing six Hit Points and six S.D.C. points, which are given to the Mind Bleeder. The Mind Bleeder can drain his victim down to about half his normal Hit Points before he can drain no more from that particular being and must seek a new source of healing. As the psychic drains his victim, he is visibly healed; wounds close, scars and bruises disappear, etc. Fortunately, the victims of the healing leech recover twice as fast than is normal.



## Impervious to Bio-Manipulation

**Range:** Self.

**Duration:** Four minutes per level of experience.

**I.S.P.:** 10

The Mind Bleeder can use this power before or after being affected by a psionic Bio-Manipulation attack. If put in place before getting hit by the psionic attack, the character automatically saves against it. If hit and affected by the psionic attack, the Mind Bleeder can use this power to negate its effects, at least temporarily (the duration of the Bio-Manipulation attack may last longer than the countermeasure).

## Mental Block

**Range:** Touch.

**Duration:** Varies.

**I.S.P.:** 10 points for simple, 30 for severe.

**Saving Throw:** Standard.

This is a form of hypnotism and mind control in which the psionic can place mental blocks in the victim's mind, preventing him from remembering specific things.

**Simple brain blocks** are tiny pockets of memory loss, such as being unable to remember a person's name (excluding his own), a person's face, a specific object, an address, a code number or password, a combination to a lock and similar.

**A severe Mental Block** is a mental barrier that prevents the victim from remembering much larger amounts of information, including the events that transpired during a particular hour's time, that he ever saw or met the Mind Bleeder or other characters, or one specific skill or memory about somebody or something. Victims with any measure of psionic power or high M.E. attribute will feel a nagging sensation of having something being wrong, as if he or she should know something or has forgotten something whenever confronted by the subject that is artificially blocked/hidden in their own mind.

As usual, the only defense against this mind control is the Mind Block power, otherwise roll to save vs psionic attack. The only way to remove the Mental Block is to allow a Mind Bleeder to do a Brain Scan or have another powerful psychic to Mind Bond and mentally remove the barrier in place.

## Mental Block Removal

**Range:** Touch.

**Duration:** Varies.

**I.S.P.:** Varies.

Only the Mind Bleeder can find and remove Mental Blocks without having to endure the discomfort of a full Mind Bond. The character must first perform a Brain Scan. The Brain Scan will locate and identify all the Mental Blocks and traumas. The Mind Bleeder can then remove them one by one. The removal of each Mental Block requires the expenditure of I.S.P.

**I.S.P. Cost:** 12 points for the removal of simple Mind Blocks, 35 for severe Mind Blocks, 40 points to break mental, magic or supernatural possession, 40 points to break magic or chemical forms of mind control and 80 I.S.P. to remove magic insanities and curses. It costs a whopping 100 to cure a single phobia or obsession and 200 points to cure trauma and other more serious forms of insanity. However, it is likely that the cure of these genuine insanities (phobias, obsessions, disorders, traumas, etc.) is only temporary. Exposure to a similar traumatic situation is likely (01-75%) to cause the insanity to return. Only mental traumas, disorders, phobias, multiple personalities, etc., induced by M.O.M. conversion can NOT be eliminated.

## Mind Trip

**Range:** 10 feet (3 m) per level of experience and the intended victim must be visible.

**Duration:** Four minutes per level of experience.

**I.S.P.:** 6

**Saving Throw:** Victims are -1 to save.

The use of this power causes the *victim* to make a mental mistake or trip/stumble. For example: The use of a Mind Trip while reading numbers, calculating numbers or figuring the price of things will cause the person to make a mistake (off by ID4x10%), always in the Mind Bleeder's favor. Likewise, the power can be used to make the victim misread the time of day, add too much or too little ingredients in food or a potion, misread or misquote a line of text, get tongue tied and say the wrong word or mispronounce a word or name, make typographical or keyboard errors, fumble a skill (-10% on skill proficiency), or cause an attacker to hesitate or stumble during combat (reduce the attacker's strike, parry, dodge or initiative bonuses by half but only for that particular melee action, not the entire melee).

## Neuro-Touch

**Range:** Touch or 10 feet (3 m).

**Duration:** Varies.

**I.S.P.:** Varies. Double the I.S.P. cost if the attack is cast as a purely mental attack up to 10 feet (3 m) away.

**Saving Throw:** Standard.

The Neuro-Touch causes a neurological disruption to the brain with several possible results.

**Stumble:** 4 I.S.P. The victim loses control over his legs for just an instant, stumbles and loses one melee attack/action.

**Jolt:** 6 I.S.P. The victim receives a sudden jolt as if struck by a light electrical charge and suffers 1D4 S.D.C./Hit Point damage (one M.D. if a Mega-Damage creature). The jolt is usually used as a warning or to catch somebody's attention.

**Momentary Stun:** 10 I.S.P. The victim is momentarily stunned and can barely move for seven or eight seconds. Penalties: Loses the initiative and half his melee attacks, -4 to defend (parry and dodge) for those seven or eight seconds.

**Disorientation:** 12 I.S.P.: A sudden shock to the system causes the victim's vision to blur and he feels disoriented: -3 on initiative, strike, parry, dodge, and roll with impact. Speed is reduced by 50% and the character loses one melee attack/action. Lasts one melee round (15 seconds) per level of the Mind Bleeder.

**Paralysis of Arms:** 14 I.S.P. A sudden shock to the system causes the arms and hands to go limp. Nothing can be picked up, held or carried. No "hand" to hand attacks or operation of machines is possible using one's hands and arms. The victim can only take evasive action or attack using psionics, magic or voice commands. Duration is one melee round (15 seconds) per level of the Mind Bleeder.

## Neural Strike

**Range:** Touch or five feet (1.5 m) per level of experience.

**Duration:** Varies.

**I.S.P.:** 25

**Saving Throw:** Standard.

This attack on the brain can inflict damage directly to Hit Points or cause complete paralysis.

**The Hit Point attack:** The victim of a neural strike is ravaged by a neurological backlash that inflicts 2D6 points of damage directly to Hit Points (2D6 M.D. if a Mega-Damage creature)! This attack also temporarily impairs the victim's reaction time, causing the loss of one melee action, loss of initiative, and speed is reduced by 25% for one melee per level of experience of the attacker. The victim also suffers from a pounding headache (-10% on the execution of skills) that lasts for 30 minutes (accumulative length of time for the headache from multiple attacks).

**Paralysis of motor responses:** The legs of the victim become paralyzed and cannot move. The arms and hands become numb and lose the sensation of touch, jerk and tremble, rendering them virtually useless. Penalties: Speed/movement is impossible, the number of melee attacks is reduced to one, all combat actions are -10. Duration is one melee round (15 seconds) per level of the Mind Bleeder.

# Personal Weaponry

Guns, guns, guns!

If one thing is certain about **Rifts**®, it is that there are *plenty* of ways to arm one's character.

What follows is a comprehensive listing of every *small arm* commonly found on Rifts Earth to date, each with a complete description. Alien weapons from *Phase World* and other planets are *not* included. We regret we could not include an illustration for every weapon. That would have added another 40 pages to this already 65+ page reference section. Still, it is the ultimate reference for the weapons of Rifts Earth. Cool, huh.

## The Availability of Weapons

The world of Rifts (and related worlds in other dimensions offer) a vast range of interesting weapons and equipment of varying degrees of power (and fun). The question is, where can one find these items? Are they everywhere? Can anybody get one on the open market?

Ultimately, that decision is up to the Game Master. If he or she has some reason to make the item available, or wants to present it as a "reward" for a hard fought adventure, the G.M. can certainly make it available. However, many types of weapons and equipment (vehicles and magic included) are **NOT** available everywhere to everyone. Many are limited to a specific (and often small) geographic region.

Many of these arms manufacturers, like the *Silver River Republics*, distribute to a "select region" of Rifts Earth or the Megaverse at large. Even large manufacturers such as *Northern Gun* and *Wilk's* are found largely in one, albeit large, geographic area, namely North America (Canada, USA, and Mexico). Why? Because North America is their place of origin, base of operation and range of greatest influence.

Remember, on Rifts Earth, the "global" economy is a thing of the distant past. Communities large and small are typically isolated by geographic barriers and circumstances that prevent trade, communication or interaction with other lands, let alone other continents. Many have little or no contact with the outside world beyond their town, city, kingdom, nation or geographical region. For example, on a large scale, *Wilk's*, *Northern Gun*, and the *Manistique Imperium* dominate the North American arms trade, but they have virtually no presence in Europe. There, *Triax Industries* is the dominant weapons-maker. Weapons and equipment found in Europe built by North American manufacturers are brought to Europe by adventurers and the occasional merchant trader and pirates. Thus, these big time, North American "brand" names *may* have limited availability in Europe, here and there, but overall they are a rare and unknown commodity that brings in lower than normal list prices. Most available on the European market will be used, second-hand items sold or traded by world-trotting adventurers down on their luck. And in the case of Europe where Triax is so technologically superior, most North American weapons are considered a cut (or two) below the level of quality and power of Triax equipment and sell for 10-30% less.

On the other hand, most North American weapons and equipment are considered top notch, state of the art in Central and South America, or Africa or Australia, as well as other places where high-technology is a rare and precious commodity. At these low tech places, such weapons are likely to command top dollar to 10-30% more than is the typical selling price. The problem is, the North American manufacturers can **NOT** get their weapons, armor and vehicles to these places. Hostile nations and people, dangerous wilderness, monster filled seas, dimensional anomalies, pirates and raiders, language, poverty, cost of transport, routes, time and other obstacles may make *exporting* the weapons too hazardous and costly to attempt. And vice versa. In many

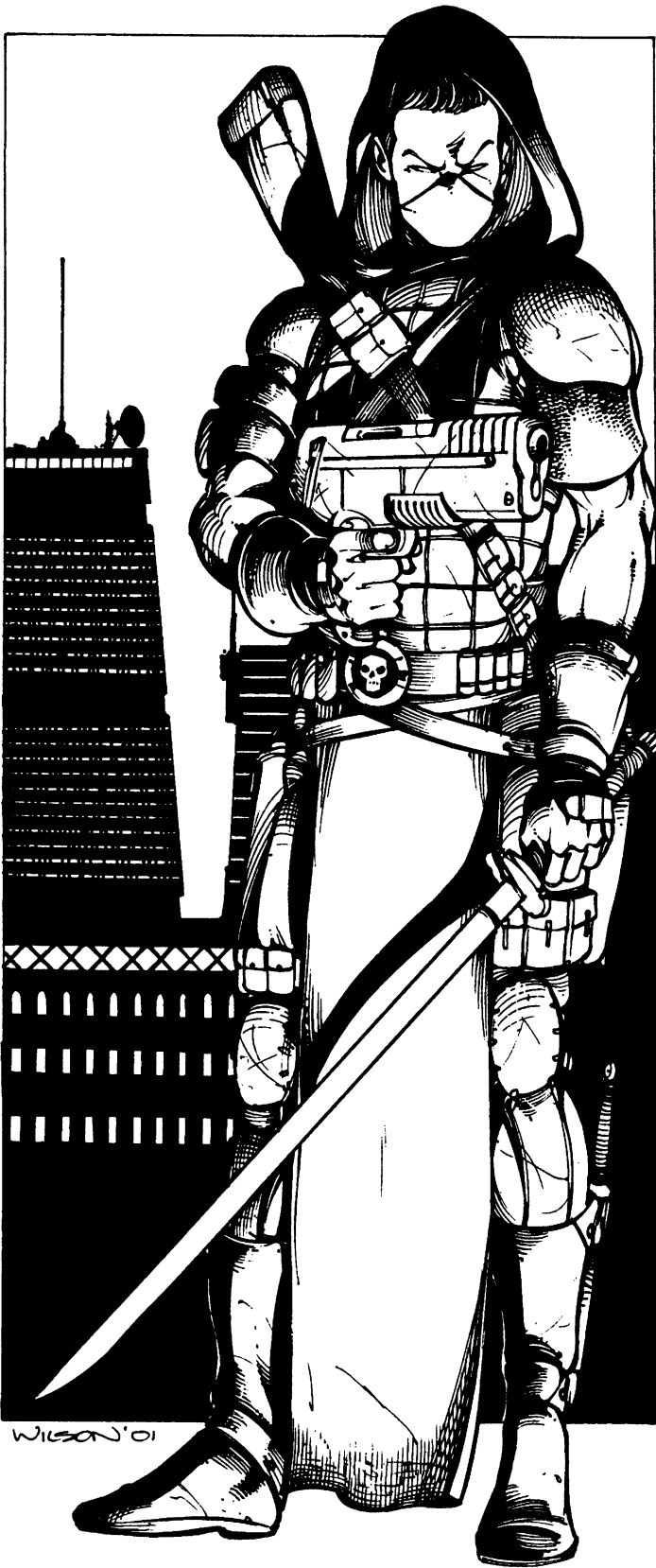

cases, low- and no-tech people have nothing of value to “trade,” killing any market for weapon dealers even if the natives want them. It is not worth the time, trouble and expense to do it, so they concentrate on their main markets and expand a little here and there on their home turf.

Thus, weapons and equipment from strange or isolated cultures like the *Arkhons* or distant lands like *Japan*, *China*, *Russia*, *Africa*, *Australia* and even *South America* are all going to be super-rare and *may NEVER* be available to North America, and Europe. NEVER!

Likewise, items from the *Splugorth's Atlantis*, *Wormwood*, *Phase World*, *Skrapers* and other *alien worlds* are also going to be super-rare. In some cases, the item may even be considered a one-of-a-kind artifact not found *anywhere* else on Rifts Earth. Only a few Megaversal trading companies, like the Naruni, actively sell their wares wherever they can find buyers for them. And because they are so rare or powerful and coveted, they demand an exorbitant price when they do, occasionally, become available.

**Sorry, local only.** Even items produced by a “local” company in the same geographic region *may* not be available as close as a few hundred miles away. For example, the Techno-Wizard creations of the *Colorado Baronies* or even the larger and more aggressive marketing and sales force of *Bandito Arms* are NOT likely to be found outside of the New West. Even in the geographic region designated the New West, the availability of these products are scarce to nonexistent the farther one gets from their base of operations. And nothing is available in the wilderness. It is not like the player group turns the bend to find an exotic weapons dealer sitting under a tree with his wares for sale. That just does not happen. Remember, there are often hundreds, sometimes thousands of miles of hostile wilderness between one community and the next.

**No cash, trade only?** In many places on Rifts Earth, especially in remote places, “trade” may be the only way to buy things. Even Universal Credits, gold and gems have no value in some remote regions. Moreover, “trade” might require the acquisition of a particularly rare and difficult *commodity* to find, or trade might require a *service* or *favor* like, “Kill the dragon (or demon, or powerful sorcerer, etc.) and the item is yours.”

**The G.M. ultimately has the final say** on what weapons, equipment, armor, and vehicles are likely to be found anywhere, as well as how much they might cost.

## Limiting weapons availability for other reasons

Again, the availability and cost of *any* piece of equipment is left entirely to the desires and discretion of the Game Master. If it does not make sense for the item to be available, then make it unavailable. If you, as the Game Master, do not like the item, feel uncomfortable with it (for whatever reason), don't want it in the group, or fear it will unbalance the ongoing campaign, then do NOT make that darn thing available to the player characters. It is as simple as that. Some G.M.s feel it is unfair to limit equipment, but if its inclusion is going to cause you a problem as G.M. or frustrate and/or anger the other players, then by all means, exclude it. That's your right as Game Master, and duty to making every night of adventure fun.

There are all kinds of reasons in the context of the world setting as to why a specific item or brand of weapons may not be available. Here are just a few.

1. As noted earlier, the biggest and most likely reason, is geography. Sorry, that item from South America, Japan or Mars is NOT available in Wisconsin or even Chi-Town, Tolkeen or Lazlo. Get over it, and buy something from a local vendor!

2. A competitor has made certain he will eliminate the competition, in more ways than one. Anybody selling that rival brand(s) is run out of town. If the winning competitor has political clout, any rivals run into

trouble with the law, can not get permits, are (falsely) accused of unfair trade practices and breaking the law and are either locked up and their stock impounded, or told to get out now while the going is good; or worse. Some may go as far as burning their competition out, vandalizing stock, stealing and destroying it, and even beating up or killing the competition. The bottom line is that certain brands of product (namely the ones the player is looking for) are NOT available.

3. A warlord, mercenary brigade, raiders, bandits, government or criminal organization bought, stole or commandeered every last one! Who knows when any will be available again.

4. The manufacturing plant(s) making, or the merchant selling, said item has been damaged or destroyed in a fire, flood, war, raid, monster attack, etc. It will be months, maybe years, before the manufacturer will be back in production. Or the disaster may have put the place out of business completely – no money to rebuild, owner killed, etc. (Most of the businesses destroyed in the Tolkeen-Coalition War, for example, are gone forever. They are NOT coming back someplace else.)

5. Sold out. Demand far outstrips the supply. (Anybody who has ever collected comic books, trading cards or toys knows exactly how this works.) Even if the character can find the desired item, he'll have to pay 3-20 times its original list price (more than the character can afford?). And after acquiring it, the hotly sought after item may be targeted for theft by unscrupulous sorts down the road.

6. Out of stock. Next shipment in 1D6 months and the desired item might not even be with it!

7. If the manufacturer is small, like Colorado Baronies, they only sell in a small, specific region, so outside of Colorado, it is impossible or very difficult (and expensive) to buy their products. Moreover, demand may far outstrip the supply, making the items unavailable. During the Siege on Tolkeen, the Colorado Baronies were selling them their TW weapons as fast as they could make them, leaving only a small percentage available to other buyers and sellers.

8. Key parts/components may not be available, limiting supply or stopping production. This could last for months and even lead to the discontinuation of the item.

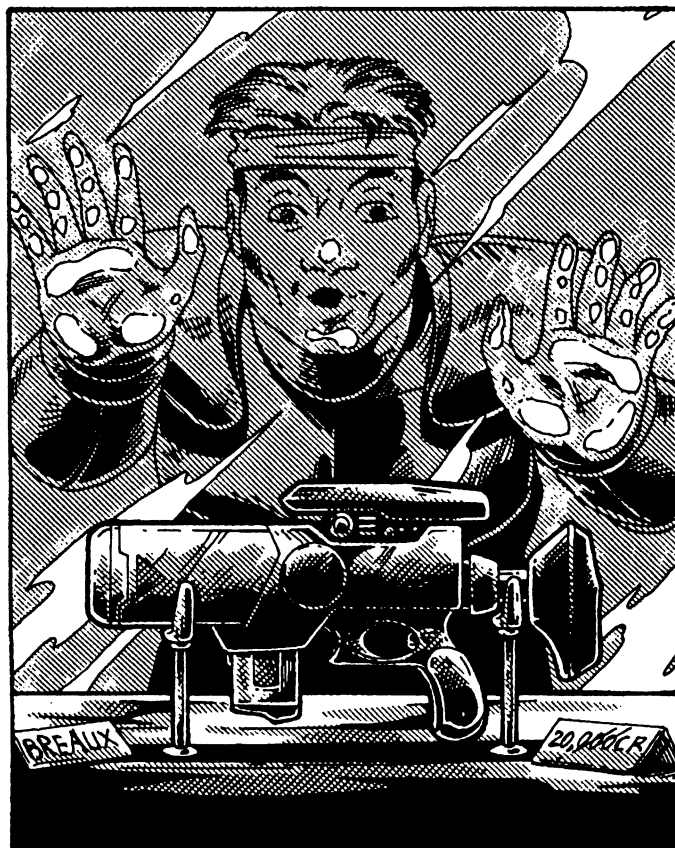

9. If it is imported from a different country or distant place, shipments might be getting intercepted and stolen or destroyed by pirates, raiders, competitors, monsters or god only knows what (the shipments just disappear).

10. It is banned! Illegal in this part of the country, for whatever reason. In fact, the situation may be so bad that the local authorities or military seizes and destroys or impounds the weapon (forever) whenever someone appears in their jurisdiction with one. (This can be a good way to get rid of unwanted items in the group that the G.M. wishes he or she never allowed in the first place. Can segue into a fight or full-fledged adventure too, if the G.M. wants it to).

11. The item *is* available, only it is stolen and the rightful owner or the authorities are looking to get it back.

## A Few Weapon Notes

**1. All laser weapons**, from pistols to cannons, have no “kick,” unlike projectile weapons which always have some amount of recoil and sound. Range is double in outer space.

**2. Heavy energy weapons**, ion blasters, particle beams and plasma ejectors have some amount of recoil and/or reverberate with energy, to make some kind of sound and offer some kind of kick.

**3. Lasers are completely silent!** The beams do not make any noise except for the click of the trigger, the soft hum of the energy clip and the sizzling “ssswhack” sound it makes when it hits (and sears through or into) its target. This is one reason lasers are preferred by assassins and snipers.

The sounds we, as players, *imagine* are the result of a lifetime of hearing movie and cartoon sound effects. From Star Wars and Star Trek to Lost in Space and Robotech, energy and laser-type weapons have always made cool sounds. Of course, explosions in space also have sound, but in real life, there would be no sound in space. The reason sound is added to these fictional portrayals is because the audience expects to hear something! And let’s admit it, we all love these sound effects. That having been said, I must admit that when I (KS) play Rifts, The Mechanoids or any game where energy weapons are used, I make sounds for them (I also do voices for characters, but that’s me). But this expectation holds true for the people of Rifts Earth too. Consequently, the manufacturers of laser weapons realize this, and for those who want them, actually build in cool *sound generators* for enhanced (psychological) effect and bigger sales. Marketing research by Wilk’s and Northern Gun have shown that energy weapons that make sounds sell better by 20-33% (a substantial difference). In most cases, weapons with sound generators, particularly all sniper laser rifles, have an “on and off” switch for the sound.

**4. Most laser weapons fire a short light beam or blast**, rather than one long, continuous beam; mainly to conserve energy and to prevent the weapon from overheating.

**5. Rapid-fire “pulse” lasers** are the latest in laser technology and typically fire two or three super fast, high-powered laser beams in a matter of a half a second or less with each pull of the trigger. This quick, multi-blast often appears as one, and does greater damage than the more conventional single blast.

**6. Range:** Lasers (amplified light) have the longest range of all energy weapons, which is another reason warriors are attracted to them.

Particle beams and ion blasts generally do more damage, but have significantly shorter ranges and often burn up more energy than the efficient and silent laser.

**7. Rail guns** kick like a mule, sound like a machine-gun (along with a high-pitched whine the moment they are turned on), and weigh 5-10 times more than the average rifle. Some, like the Glitter Boy’s big, cannon-like gun, make a booming or exploding sound each time they are fired.

**8. Particle beam weapons, ion blasters** and other types of energy weapons have a slight recoil and make sounds when they are fired, typically a high-pitched whistle or whine of energy through the air, or a low thrum, or a short crack of energy as it erupts from the weapon.

## 9. Black Market Prices for E-Clips & Rechargings:

Cost of standard Mini-E-Clip: Typically used for tools and derringers (especially by Wilk’s). 2000 credits for a new, fully charged mini-clip. Takes about 1D4+4 minutes to recharge.

Cost of standard E-Clip (20 shots): 5,000-7,000 credits for a new, fully charged clip; 1500 credits to recharge. Takes about 1D6+10 minutes to recharge

Cost of a Long E-Clip (30 shots): 9,000-12,000 credits for a new, fully charged clip; 2000 credits to recharge. Takes about 2D4+15 minutes to recharge.

Cost of a CS Weapon Canister (or E-Canister): 10-30 shots depending on weapon type. Typically suitable only for old style CS weapons and knock-offs: 10,000 to 15,000 credits; 2000 credits to recharge. Takes about 3D6+30 minutes to recharge,

Cost of a CS Mini-Power Pack: A CS hip or backpack canister (new CS weapons): Approximately 60 shots, but is likely to require modification of the weapon in order to use it, at a cost of 5,000 cr. The canister costs 20,000-30,000 credits and 4,000 to recharge. Takes about 3D6+60 minutes to recharge. Also see #10 below.

**10. Northern Gun (NG) Self-Charging Power Packs.** These items are relatively small battery packs that can be worn on the hip or back depending on the size. A cable runs from the pack to what looks like a standard E-Clip. The E-Clip *end* snaps into the weapon like a normal clip, but provides additional power from the pack. Designed to power heavy ion, plasma and particle beam weapons that require a lot of energy. Payload: Typically provides six or seven times the capacity of a *standard E-Clip* before being drained. ALL NG power packs regenerate four energy blasts per hour until fully recharged. Each can regenerate a full payload six times before needing a factory recharge and overhaul (won’t work without it). The recharging and overhauling of the unit takes one day and costs one-third the original price and can be overhauled four times before a replacement is needed.

Cost by Class: *Class One Power Pack* (Pistols and Light Rifles): 3 lbs (1.35 kg) and costs 60,000 credits. *Class Two* (Rifles & Medium Weapons): 12 lbs (5.4 kg) and costs 70,000, and *Class Three* (Heavy Weapons/Plasma & Particle Beam guns): 20 lbs (9 kg) and costs 80,000 credits. Note: These are the list prices, but is currently being sold for 50-100% more. Poor availability due to high demand and CS pressure to keep production low. This item is the rage in the Midwest.

Russian E-Packs. These are about half the size of a backpack and can be worn on the hip or on the back (2-3 can fit on the back of a human-sized character). A unit that looks like an E-Clip attached to a cable is connected to the energy pack/battery to fit into a weapon, generator or other machine. E-packs can run everything from computers and light machines to generators and tractors. Payload: A typical Russian E-Pack is roughly equal to *four standard E-Clips* when used in a weapon, and can run 4-6 light machines like a computer, monitor, radio, light, fan, etc., for 72 hours before requiring recharging. It can run a jet pack, vehicle or generator for about 24 hours. Cost: 35,000 for the E-Pack and 7000 credits to recharge it in Russia; rare elsewhere.

Note: The evil *Mystic Knight O.C.C.* can magically recharge an ordinary E-Clip, canister, power packs or other type of battery in a few seconds (1D4+2 seconds; counts as two melee actions). All that is required is sufficient P.P.E. to do so (see page 93 of *Rifts® World Book 16: Federation of Magic™*). Similarly, a practitioner of magic or psychic can recharge a Techno-Wizard E-Clip, battery or weapon by placing P.P.E. or I.S.P. into it.

**11. A “knock-off”** is an exact or close to exact copy by another manufacturer. However, most knock-offs are cheaper versions that use inferior (cheaper) materials or labor, so while they may cost the same or a bit less (typically 10-20% less), the quality of the product is also less – it does not look as nice, is likely to have 1D6x10% less M.D.C., is likely to be 1D4x10% heavier, may jam more frequently, etc.

**12. The M.D.C. of typical weapons:** Unless stated otherwise, the average energy pistol or Vibro-Blade has 15-25 M.D., an energy rifle





30 to 50 M.D.C., a rail gun 75-100 M.D.C., while giant-sized weapons for cyborgs, robots and power armor usually have 100 M.D.C.

**13. Costs for Conventional S.D.C. Rounds.** Available S.D.C. rounds/bullets include all the common types, from .22 caliber to 10 mm. Armor piercing rounds (add 1D6 S.D.C. to the bullet's damage) or high explosive cartridges (add 1D6x10 S.D.C.) are also available. A box of 48 rounds (normal bullets) typically costs about 20 to 50 credits (the higher calibers cost the most). 150 credits for armor piercing, dum-dums, and other special rounds like silver rounds. See the *Compendium of Contemporary Weapons* for a huge range of modern S.D.C. weapons, body armor, grenades and ammunition.

**14. Special Ammunition:** Made and sold by most weapon manufacturers. Only Wellington makes *Ramjet* rounds.

**Shotgun Shell:** 4D6 S.D.C. or 8D6 S.D.C. for a double blast at the same target (counts as one melee attack). **Solid Slugs:** 5D6 S.D.C. or 1D6x10 S.D.C. for a double blast at the same target (counts as one melee attack). 1-2 credits each; 50% less when bought in bulk. **Explosive Shell (Fragmentary):** 2D6 M.D. to a 10 foot (3 m) diameter, or 3D6 M.D. to a 20 foot (6.1 m) diameter for a double blast (counts as one melee attack). Cost: 130 credits each.

**Explosive Shell (Plasma):** 3D6 M.D. to a 6 foot (1.8 m) diameter area, or 5D6 M.D. to a 12 foot (3.6 m) diameter area for a double blast (counts as one melee attack). Cost: 170 credits each.

**Rifle Grenade (Standard):** 2D6 M.D. and costs 550 credits. Commonly available.

**Rifle Micro-Fusion Grenades (CS):** 6D6 M.D. and cost 2000-3000 credits. Available only on the Black Market; rare.

**APRJ "Ramjet" Rounds (Wellington):** The ramjet rounds are fired from the gun like a normal bullet, but once they are in the air a secondary rocket booster kicks in, propelling the heavy M.D.C. slug at rail gun-like speeds. **Typical Damage:** Standard WI-10 round does One

M.D. point to Mega-Damage targets or 3D6x10 S.D.C. to "soft" targets. WI-2E Explosive ramjet does 1D6 M.D. to M.D. targets or 2D4x10 S.D.C. to "soft targets." WI-20 does 1D4 M.D. Cost: 5-10 credits per round. Fair to poor availability; mainly in the Midwest.

**Note:** See Coalition States, Japan, Northern Gun, Triax and Wellington for various types of ammunition, explosives and weapons.

**15. Balancing South America.** When C.J. Carella wrote the South America books (and a few others), I foolishly gave the author too much leeway and latitude in his writing. I was trying to give the new guy freedom and let him run with his own ideas.

Well, C.J. is a heck of a writer and has come up with some excellent ideas, characters, places and gizmos. HOWEVER, the power level of his early books (the two South America titles included) is unbalanced and overpowering compared to the rest of Rifts Earth. While these items are pretty limited to isolated geographic locations (namely South America), they can still be a problem, especially if the G.M. brings South American weapons, armor, vehicles and magic into North America or other parts of the world.

To resolve that, I suggest the following modifications: **Reduce Mega-Damage** by 25% (i.e. a die or two less), **Range** by 20%, **Bonuses** by half, and **Payload** by 20%. That evens them out nicely.

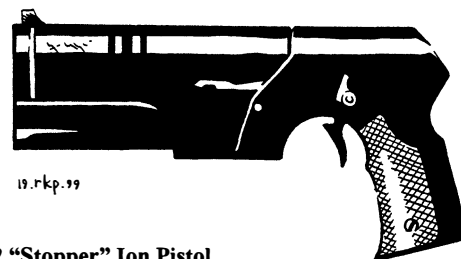

19.rkp.99

Q1-02 "Stopper" Ion Pistol

# Known Arms Manufacturers on Rifts Earth

**Note:** Includes data from Rifts® World Books 1-24, Rifts® Mercenaries, Sourcebooks 1-4, Coalition Wars™ 1-6, Rifts® Mercenaries and Dimension Books 1-4.

Arrows (see Miscellaneous)  
Atlantis (see Kittani & Splynn)  
Arkxon Weapons (South America; Alien)  
Australian Weapons  
Bandito Arms (New West)  
Black Market (see Bandito Arms & Misc.)  
Coalition States Weapons  
Colombian Weapons (South America)  
Colorado Baronies (TW)  
Conventional Weapons (Worldwide)  
Empire of the Sun Weapons (South America)  
Explosives (see CS, Japan or Triax)  
Free Quebec Weapons  
Gargoyle Weapons (Europe)  
Horune Weapons (Sea Pirates)  
Japanese Weapons  
Juicer Weapons  
Kittani Weapons (Atlantis)  
Megaversal Legion Weapons (S. America; Alien)  
Mindwerks Weapons (Europe)  
Miscellaneous Weapons  
Naruni Enterprises (Alien)  
Native American Weapons  
Naut'Yll Weapons (Sea weapons)  
New Navy Weapons (Sea weapons)  
NGR Weapons (see Triax; Europe)  
Northern Gun Weapons  
Phase World Weapons (Alien; *not* included)  
Russian Weapons (Eur-Asia)  
Silver River Weapons (South America)  
Splynn/Splugorth Weapons (Atlantis)  
Tolkeen (*not* included)  
Triax (NGR; Europe)  
Tritonian Weapons (Sea weapons)  
Wellington Industries  
Wilk's Laser Technologies  
Xiticix Weapons (Alien, but North America)

## Arkxon Weapons

### Rifts® World Book Nine: South America Two

The Arkxon are alien invaders with bad luck. Their first invasion fleet was destroyed by the magic of the Nazca civilization two thousand years before the Coming of the Rifts. The second invasion fleet shattered and was cast to the four corners of the Earth when ravaged by the magic and dimensional energies surrounding Rift Earth. One of the few surviving Arkxon forces lays in a shambles in the Andes Mountains with a smaller force in the Amazon Jungle.

Arkxon technology is *alien* to Earth and most of the known Megaverse. Thus, it is super-rare even in South America and is seldom found anywhere else in the world, except for parts of China and Asia where some other survivors from the Arkxon invasion fleet managed to land.

While not incredibly advanced compared to the Splugorth or the Three Galaxies, the Arkxons have developed a number of specialized technologies that few others have matched.

These aliens developed and discarded lasers centuries ago; they decided the light beams were too easy to deflect, block out and defend against. Instead, they focused on *particle beam* and *plasma weapons*. Their greatest breakthrough was the creation of a *combined beam* that

shared characteristics of lasers, ion beams, plasma and other charged particles. The result is called a *Tri-Beam*. **Tri-Beams** form a composite energy discharge, traveling along an ionized path created by an invisible ionizing laser nanoseconds before the visible, mixed energy blasts. The visual effect is impressive, as three beams of energy appear to jump out of the multi-barreled gun and then intertwine around each other! Even more impressive is the effect they have on targets. The charged particles break down molecular bonds, and plasma burns down the weakened matter. As a result, Tri-Beams do double damage to most materials, although they do normal damage to technological, psionic and magical *force fields*. Only the special ceramic/plastic composite armor they've developed, called *Cerasteel*, defends adequately against the triple threat.

(**Cerasteel** was designed specifically for use against the devastating Tri-Beams. The materials of the armor plates are designed to dissipate direct energy attacks. The resulting composite armor halves the power of most energy weapons and neutralizes the Tri-Beam's double damage. The main drawback is that the composite material is relatively fragile against physical impacts, such as bullets, missiles, rail guns, robot punches and kicks, etc. Such impacts can eventually shatter the armor. This means Arkxon armor takes only half damage from most energy beams, except Tri-Beams, which do normal damage, and exotic weapons like phase beams, which are not affected by material barriers, but takes double damage from physical attacks. Explosions have concussive waves that are evenly spread by the ceramic/plastic composite, so most explosive attacks do normal damage to Arkxon armors unless struck directly by a missile. Rockets that impact right on the armor do double damage. As with anything of Arkxon technology, Cerasteel is an unknown, and so far, not even the Naruni have been able to duplicate it. Super-rare.

**Arkxon E-Clips:** The Arkxons have their own equivalent of Earth's E-Clips. The alien version is slightly smaller and lighter, and it has roughly the same energy capacity as Earth types. Earth E-Clips will *not* function in Arkxon weapons and vice versa, unless a competent armorer makes a successful Weapons Engineer roll at -20% to jury-rig connections. Even then, a normal Earth E-Clip will only provide two-thirds the normal energy an Arkxon clip does, due to the energy that is lost through the improvised connections.

In the last couple of years, the Arkxons in South America have captured enough territory, tools, weapons and factory equipment to make them want to use Earth E-Clips in their weapons. Warlord Enno realizes his people are stuck on the planet for centuries, and that the ships' mini-factories cannot cope with the demands of a centuries-long campaign of warfare and conquest. Thus, a small factory using stolen Earth equipment is producing normal E-Clips and about 20% of all Arkxon weapons have an adapter to use Earth E-Clips built into them. This adapter can accommodate normal Earth E-Clips without any loss of energy and performance. If the player characters capture any Arkxon weapons, the Game Master should roll percentiles: 1-20 means the weapon has an adapter; 21-00 means it doesn't and must use Arkxon E-Clips or be customized as noted above.

### "Rare" Arkxon Weaponry

**TB-3 Tri-Beam Energy Pistol.** The Tri-Beam or "TB" pistol is a relatively stubby, short-barreled weapon, easily confused for a flashlight with a pistol grip. It has the characteristic three barrels of all tri-beam weapons, but they only extend about two inches (5 cm) from the firing mechanism. The pistol grip is slightly curved and made to fit the hands of the Arkxons. Humans using them will find the grip new and unfamiliar, but can easily get used to them (-1 to strike until the user practices for 1D4 hours). Standard issue to support personnel (clerks, mechanics, medics) and others in non-combat positions. The Arkxons even use the weapon as a trade item among the few D-Bee

communities that do business with the aliens. Traded guns will have an E-Clip adapter, but have a self-destruct system that will detonate if someone tries to tamper with its outer casing (whether to repair or disassemble the weapons). This is done to prevent outsiders from learning the secrets of Tri-Beam technology. Most Arkhon soldiers prefer the more powerful TB-9 pistol, which is never used as a trade item. Weight: 2 lbs (0.9 kg), Mega-Damage: 2D4 M.D.; double damage to most materials, except force/energy fields and Arkhon Cerasteel armor. Rate of Fire: Can only fire single shots (each counts as one melee attack); no burst capability. Range: 500 feet (152 m). Payload: 15 shots. Cost: 12,000 credits; unheard of outside of areas under Arkhon influence.

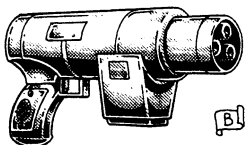

**TB-9 Auto-Pistol.** This heavy weapon is big enough to be used two-handed (although most Arkhons believe a “true male” should fire the gun one-handed). TB-9’s are issued to officers, pilots and vehicle crews, as well as military police and intelligence units. The weapon does not have the range or the penetration power of a true combat rifle, but is a close second. Weight: 5 lbs (2.25 kg). Mega-Damage: 4D6 M.D.; double damage to most materials, except force/energy fields and Arkhon Cerasteel armor. Rate of Fire: Standard. Range: 1200 feet (365 m). Payload: 30 shots. Cost: Not normally sold. Captured weapons can cost anywhere between 30,000 and 90,000 credits; add 50% to the price if the weapon has an adapter for use with Earth E-Clips.

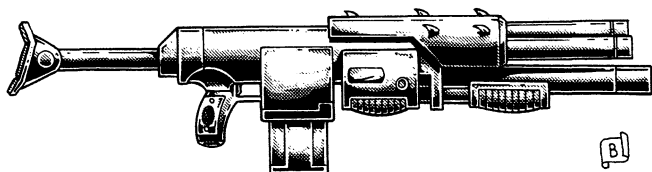

**TB-Prime Tri-Beam Energy Rifle.** The Prime TB Rifle is the pride of the Arkhon military. A solid, dependable battle rifle, this weapon sports a Tri-Beam system over a semi-automatic grenade launcher with a three round clip. Every infantryman in the Arkhon army has the capability to shell enemies with indirect grenade fire, and the Tri-Beam blasts chew through most materials if given enough time. Also known as “demon rifles” by people of the Andes. Weight: 10 lbs (4.5 kg). Mega-Damage: 5D6 M.D.; double damage to most materials, except force/energy fields and Arkhon Cerasteel armor. Grenade: 4D6 M.D. to a 12 foot (3.65 m) area. Rate of Fire: Standard. Range: 2000 feet (610 m). Payload: 30 Tri-Beam blasts, and 3 grenades. Cost: Not for sale. The few captured rifles can be purchased (if available) for 100,000 to 160,000 credits. Add 30% if the weapon has an adapter for Earth E-Clips.

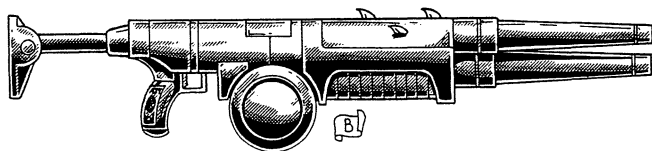

**M-100 Tri-Beam Crew Served Gun.** This support weapon uses an extended energy clip; roughly equivalent to the Coalition’s Canister E-Clip or Triax’s FSE-Clip, but even more powerful. The weapon is the equivalent of a medium machine-gun and is typically carried by a team of two (one carries the weapon, the other has extra ammo in addition to a TB-9 auto-pistol); fired from a bipod rest. Cyborgs and soldiers in power armor use this weapon instead of a standard rifle. The M-100 can chew through the armor of a main battle tank with a few long bursts, and its long range makes it a favored support weapon. **Note**: This weapon does not have an adapter, and will not accept either

Arkhon or Earth standard clips. A specially jury-rigged clip will only provide the weapon with 15 shots if using an Arkhon E-Clip or a mere 10 with an Earth E-Clip. Weight: 21 lbs (9.4 kg). Mega-Damage: A single shot inflicts 5D6 M.D.; a three round burst does 1D4x10+10 M.D., double damage to most materials, except force/energy fields and Arkhon Cerasteel armor. Rate of Fire: Standard burst firing. Range: 3,000 feet (914 m). Payload: 60 shots in an extended magazine. Cost: Rarely available for sale even in South America; price starts out at 130,000+ credits.

**BM-2 Backpack Mortar System.** The BM-2 is worn just like a backpack. The system has a launch tube and a mortar magazine, and it is linked electronically to a HUD (Heads-Up Display) on the Arkhon’s helmet visor. Basically, when the gunner wishes to activate it, he can verbally give the system a range and coordinates, and the launch tube will orient itself and fire in that direction. The mortar is useless against targets closer than 300 feet (91 m), but it has a range of nearly two miles (3.2 km)! The mortar carrier can use information given by forward observers or other soldiers. The bomblets have 1 M.D.C. each. The only problem is that they are very small and hard to spot when airborne. Unlike missiles, they have no contrails to indicate their position; a called shot to hit one is at -4 to strike. Arkhon mortars are far more advanced than Earth equivalents. Although they can fire conventional “dumb” mortar rounds, most units are equipped with smart bombs that have an electronic guidance system and fins that control their trajectory. These smart bomblets will zero in on humanoid or vehicular targets with frightening accuracy (+3 to strike!). Fortunately for everyone, the Arkhons are having trouble manufacturing enough smart bomblets to keep up with the expenditures, so only about 30% of the mortar’s ammo will be of this sort. Weight: 30 lbs (13.5 kg). Mega-Damage: Dual-purpose mortar round. The shooter can electronically “prime” the rounds before firing them, selecting either fragmentary or anti-armor. In the first mode, the bomblet detonates in the air, 8 feet (2.4 m) before hitting the ground, and showers the area with lethal fragments. In the second mode, the bomb explodes on impact, with a minimal blast radius but maximum damage to the target. Fragmentary Bombs: 3D6 M.D. to a 20 foot (6.1 m) radius. Anti-Armor: 6D6 M.D. to a 2 foot (0.6 m) radius. Rate of Fire: Single shot, burst of three, or long burst of six. Each counts as one melee attack. Range: Up to 2 miles (3.2 km). Minimum Range: 300 feet (91.4 m). Payload: 18 bomblets in the magazine. Reloading the magazine takes 5 minutes. Changing magazines (spares are loaded on trucks or similar cargo vehicles) takes one melee round for two people or four melees for one. Cost: 160,000 to 200,000 credits. Smart bombs cost 3,000-5,000 credits each; rarely available outside the Arkhon Army.

**BRL-3 Backpack Rocket Launcher.** The last of the “terrible trio” of Arkhon infantry support weapons, the BRL-3 is designed for use against armored vehicles and as a direct and indirect fire weapon. The missiles are equally effective blowing up buildings and bunkers as they are stopping giant robots and tanks. The weapon consists of a rocket tube on the right side of the backpack, and a missile rack contained in the “backpack.” It can be used in two modes: guided and direct. *On guided mode*, the rocketeer simply designates a target through an aiming point projected into the face plate of his helmet. When he lines up the electronic cross-hairs on the target, the missile launches itself from the backpack and arcs towards the target (+3 to strike). *On direct fire mode*, the soldier lifts the tube and fires it over the shoulder like a bazooka (use the soldier’s W.P. bonuses for aimed fire). *Direct fire* is limited to line of sight, but tends to be more accurate at short-range. The big advantage of guided mode is that any member of a squad can act as a target designator. Thus, the missileman could be hundreds of feet behind the lines, and a soldier far ahead could target an enemy vehicle or fortification for the rocket launcher. To reload, the soldier has to “re-chamber” the tube into the backpack (takes one melee attack/action to reload in either mode). The missiles are slightly more powerful than conventional mini-missiles, and have the advantage of being guided. The Arkhons have found themselves unable to mass produce

guided missiles, and have to rely on easier to make “dumb” missiles (can only be used in the direct fire mode). Weight: 30 lbs (13.5 kg). Mega-Damage: 2D4x10 M.D. for a direct hit, plus inflicts 4D6 M.D. to an additional 10 foot (.3 m) radius around the strike point. Rate of Fire: Each missile shot counts as one hand to hand attack. Cannot fire volleys. Range: Guided: 5 miles (8 km). Direct Fire: Line of sight to 2000 feet (610 m). Payload: 12 rockets; each is about twice the size of a hand grenade. Cost: 150,000+ credits; super-rare even in South America. Note: Captured rocket launchers are being used and copied by the human nations of *Cordoba* and *Santiago*, South America. These knock-offs substitute the Arkhon rockets with *conventional mini-missile launchers* and can only be used in direct fire mode, with a range of one mile (1.6 km). Knock-offs carry only 6 mini-missiles and cost 100,000 credits.

**Tri-Blade Energy Sword.** When deactivated, this weapon looks like a sword handle with three long, thin wires protruding from the hilt instead of a blade. The flick of a button creates a Tri-Beam charge that runs up the connecting wires, and turns into an energy blade that can slice through most alloys and construction materials with ridiculous ease. The Tri-Blade sword is assigned to officers, but many soldiers purchase a personal blade. Weight: 3 lbs (1.35 kg). Mega-Damage: 3D6 M.D.; double damage to most materials, except force/energy fields and Arkhon Cerasteel armor. Rate of Fire: Hand to hand combat only. Range: Close combat melee weapon. Payload: Arkhon E-Clip powers the weapon for 8 hours of continuous use; every time the sword is activated, it consumes a minimum of one minute’s worth of energy even if the sword is turned off in less than a minute. Cost: 50,000-100,000 credits; rare even in South America.

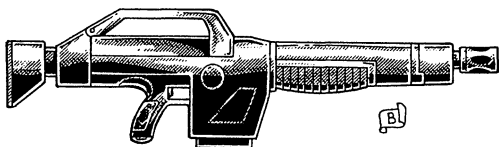

**FR-5 Flechette Rifle.** Despite the effectiveness of their Tri-Beam technology, the Arkhons don’t like to rely on only one type of weapon. Thus, about 30% of Arkhon troops are armed with flechette rifles. These weapons use anti-gravity beams to accelerate aerodynamic flechettes (miniature arrows) at astronomical speeds. The FR-5 fires cartridges loaded with 10 of these flechettes, much like a shotgun shell. Each flechette has enough penetration to bore through M.D.C. armor and ten of them will tear through armor and the flesh beneath with horrifying ease. Furthermore, these weapons exploit the weaknesses of Arkhon body armor, and do double damage to those armor suits (a necessity when facing one’s own kind in battle). Weight: 15 lbs (6.8 kg). Mega-Damage: 6D6 M.D. per shot. Rate of Fire: Single shot only. Wild “bursts” spread the flechettes over an area, doing 2D4 M.D. to each target hit. Range: 1200 feet (365 m). Payload: 20 shot box magazine. Cost: 50,000+ credits; super-rare even in South America.

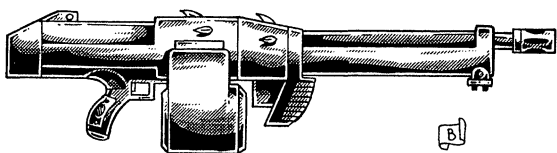

**FRA-1 Flechette Auto-Cannon.** The flechette machine-gun/auto-cannon is a support weapon that fires heavier ammo than the FR-5 rifle from either a drum magazine or a disintegrating belt. The FRA-1 is used as a squad weapon or carried by powered armor and cyborg soldiers as a “rifle.” They are also mounted on light vehicles, especially captured Earth vehicles that need extra armament. The FRA-1 cannot be fired from the shoulder or hip unless the wearer has a natural P.S. of 24, a supernatural P.S. of 18, or is a cyborg or wearing a power armor with a P.S. of 20 or higher. Weight: 30 lbs (13.5 kg). Mega-Damage: 1D4x10 M.D. per shot. A burst is 10 rounds

and does 2D6x10+10 M.D. The burst can be used to spray an area, doing one shot damage to affected targets. Rate of Fire: Standard. Range: 4000 feet (1219 m). Payload: 30 round drum magazine or 200-round belt. Cost: 80,000 credits or more; super-rare even in South America.

## Australian Weapons

### Rifts® World Book 19: Australia One

#### Primitive & Conventional S.D.C. Weapons

**Boomerangs.** Boomerangs come in a variety of shapes and sizes. The range and rules for using them are found under the W.P. Boomerang description. The G.M. may wish to treat the Boomerang as a bullet for the sake of the pain it causes (for any saves or effects he employs). They have a rotating force that strikes with bone jarring impact, making them very effective. It is deceptive just how dangerous they can be. Here are some sample boomerangs, all are extremely uncommon anywhere in the world but Australia.

**Average Boomerang.** Damage: 2D4+2 or 1D10 S.D.C. May or may not be thrown to return, depending on manufactured style. Weight: 1 pound (0.45 kg). Length: 1.5 feet (0.46 m). Cost: \$28, or \$35 if the boomerang is the returning type. Usually made by hand or traded.

**Hunting Boomerang.** Damage: 2D6+2 S.D.C. Does not return when thrown. Weight: 2 lbs (0.91 kg). Length: About two feet (0.61 m). Cost: \$48; is usually made by hand or traded.

**War Boomerang.** Damage: 3D6 S.D.C. Will not return no matter how hard you try. Weight: 4-5 pounds (1.8 to 2.3 kg). Length: 4-5 feet (1.2 to 1.5 m)! These suckers are about the size of a hefty long bow. Cost: \$65 or based on trade.

**Metal Boomerang.** Damage: 3D6 S.D.C. May be thrown to return. Weight: 2 lbs (0.91 kg). These are a modern innovation, and are deadly despite the fact that they are no larger than your average boomerang. Length: About two feet (0.61 m). Cost: \$250. Aboriginals will not use these items.

**Sporting Boomerang.** Damage: 1D4 S.D.C. Designed mainly to return for fun. These are plastic or ceramic sporting reproductions that are fairly ineffective as weapons, but make good fun for throwing and catching. Weight: 2 lbs (0.91 kg). Length: About two feet (0.61 m). Cost: \$10 to \$15.

**Spears.** Spears are the backbone weapon of any Aboriginal community. The typical spear does 1D6 +P.S. damage bonus (if any) with a jab/thrust or blunt (clubbing) attack, or 2D6 S.D.C. when thrown (no P.S. damage bonus). Add 1D6 damage for a trident or other large spears. Throwing range, bonuses, and details are found under the W.P. Spear skill description. All spears are available, even a type of trident is an Aboriginal weapon (usually made with splayed wooden forks and employed when fishing). A spear will cost \$50-\$100, 30% more if the spearhead is silver plated; a woomera costs \$12.

**Air-Powered Crossbow.** The air-powered crossbow uses a pneumatic pack to expel its bolt ammunition with incredible force. The weapon looks more like a rifle than a crossbow, with a tube to fit the bolts into and an air canister in the shoulder brace. They may be vehicle mounted or hand carried, and come in a variety of forms. Air-powered crossbows are very popular with outback road gangs due to the cheap ammo they require; bolts are far easier to make than bullets. Quite often a bolt will have greater armor piercing capacity than a bullet, as well. Note: Aboriginals will not use these weapons. Single-Barrel: The single-barreled variety has a range of 350 feet (107 m) and inflicts 3D6 points of S.D.C. Weighs 5 lbs (2.3 kg), and costs \$300. Double-Barreled: Each barrel does 2D6+1 S.D.C., or both can be fired at once to inflict 4D6+1 to a single target. The range is 300 feet (91 m). Weighs 8 lbs (3.6 kg), and costs \$480. Quad-Barrel: This monster is at -2 to strike if man-portable. As such, they are usually only found in vehicle turrets. Each tube inflicts 2D6+1 S.D.C., and they can be fired ei-

ther one at a time or all at once. The simultaneous blast from all four does 1D6x10 S.D.C. Effective range is 300 feet (91 m). Weights 12 lbs (5.4 kg) and costs \$1000. **Note:** Reloading the tubes takes one action per barrel. For an extra \$100 per barrel, the crossbow can have a magazine holding four bolts for each tube, reducing the frequency of reloading. The air canister required to power the weapon holds enough gas for 50 total shots before it needs to be refilled with an air compressor, and costs \$120 to replace.

**Flame Thrower.** Flame throwers come in many varieties. The following statistics will do for any number of stock model or homespun flame throwers, and are divided into three categories: small, medium and heavy. **Damage:** 4D6 S.D.C. for small, 6D6 S.D.C. for medium, and 2D6 M.D. for heavy. **Range:** A cone of flame 60 feet (18.3 m) long and 5 feet (1.5 m) wide spreads from the nozzle of the flame thrower for the medium and heavy models. In small flame throwers, the cone is only 30 feet long (9 m). This may be sprayed, as per the Modern Combat Rules. **Payload:** Small: 20 shots in a weapon mounted canister. Medium: 30 shots in a weapon mounted canister. Heavy: 24 shots in a backpack canister of thermite plasma. If the fuel source is struck and damaged by a firearm, there is a percentage chance equal to the damage done that it will explode and do standard damage for one shot to the user, and everything in a radius of 2 feet (0.6 m) per shot remaining in the payload. Most canisters are quite sturdy, and can take 5 M.D.C. before this rule applies. **Typical Weight:** 15-25 lbs (6.7 to 11 kg). **Cost:** \$400 for small, \$900 for medium, and \$7000 for heavy. New ammo canisters cost \$40, \$90 and \$500 respectively.

**S.D.C. Firearms.** Any S.D.C. firearm mentioned in the Conventional Weapons section can be found in Australia. In fact, many Outback adventurers use these more than Mega-Damage weaponry, which on this continent is relatively scarce and expensive.

**Ammunition for S.D.C. Firearms.** On average, a single bullet will cost 20-50 cents, with special rounds costing 2-5 times more. An E-Clip will cost at least 6,000 dollars/credits and usually two or three times that.

## Australian High-Tech Weaponry from the Tech-Cities

Most M.D. weapons, explosives (of all kinds), and M.D.C. armor are banned within city limits and their use limited to Police, Military and Level 5 Administrators. S.D.C. weapons are also restricted, but available to Sportsmen and Level 4-5 personnel, as well as Police and Military. Both Tech-Cities have fundamentally the same pre-Rifts technology and weapons, and in most cases, even use the same pre-Rifts names and styling.

**NeraTech 9 mm P-18, Conventional Sidearm.** This weapon is the standard gun one finds at the side of bodyguards and police personnel in low risk positions. It is mainly a deterrent and not a serious combat weapon. Civilian gun owners are likely to have this weapon. **Weight:** 1.8 lbs (0.81 kg). **Damage:** 2D6+2 S.D.C. **Rate of Fire:** Standard. **Range:** 200 feet (61 m). **Payload:** 18 bullets to a clip. **Bonuses:** +1 to strike when aimed. **Cost:** \$1600; \$15 for a new clip, only \$2.00 for 18 bullets.

**NeraTech 9 mm SMG-30; Conventional Submachine-gun.** Another sidearm issued to all military and police personnel as one of their standard weapons. It is easy to maintain, and therefore reliable, holds a good clip and has enough stopping power to shatter brick. **Weight:** 3.5 lbs (1.6 kg). **Damage:** 4D6+2 S.D.C. **Rate of Fire:** Standard. **Range:** 250 feet (76 m). **Payload:** 30 bullets to a clip. **Bonuses:** None. **Cost:** \$3200; \$30 for a new clip, only \$5.00 for 30 bullets.

**NeraTech WA-30, Conventional Assault Rifle.** When in higher risk situations or raiding Outback communities, this is the operational weapon of choice. It has a high rate of fire, is well cooled and in all ways is a superior class of weapon, as conventional "hard ammo" weapons go. **Weight:** 9 lbs (4 kg). **Damage:** 6D6 S.D.C. **Rate of Fire:** Standard. **Range:** 1,450 feet (442 m). **Payload:** 30 bullets to a clip. **Bonuses:** +1 to strike when aimed, and in burst mode. **Cost:** \$6,800; \$65 for a new clip, only \$10.00 for 30 bullets.

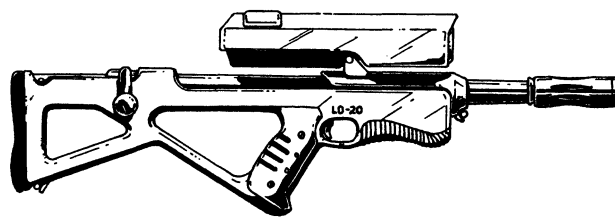

**NeraTech LO-20, Conventional Hunting Rifle.** A bolt-action sportsman's weapon with a high stopping power. These are also owned by a lot of boat owners for killing sharks and large catches before bringing them aboard. The TRG may use them for lightweight sniping situations, especially in the City against S.D.C. enemies. **Weight:** 8 lbs (3.6 kg). **Damage:** 1D4x10 S.D.C. **Rate of Fire:** Single shot only; each shot counts as one melee attack. **Range:** 1800 feet (549 m). **Payload:** 8 bullets to a clip. **Bonuses:** +1 to strike when aimed. **Cost:** \$8400; \$40 for a new clip, only \$30.00 for 32 bullets.

## Australian Mega-Damage Weapons: EIPP Technology

One of the developments made by Advanced Technologies Australia is something they call EIPP, nicknamed "Eep!" The nickname has stuck because of the reaction many had to the field testing of this relatively new firearm innovation. Because energy weapons tend to be very destructive, their use was severely limited and even banned for non-military personnel. So the rules were bent to produce a weapon that could fire with the power of an energy weapon, but use a hard slug.

EIPP stands for "Electro-Induced Plasma Propellant." Simply put, a liquid within the handle of the weapon is heated by an E-Clip to the point of becoming explosive plasma. This resultant plasma bolt is then used to propel a slug with awesome velocity. A trend you will see is ATA weapons using this system over and over again. The Administration is trying hard to ban the weaponry, or at least limit it to military sales, but its popularity with the people has made passing such a law very difficult. **Note:** EIPP are made and sold only in Australia!

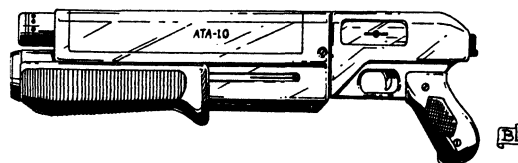

**ATA "Super 10" Shotgun.** Also known as the "Doorbuster," a potent firearm, and a favorite of bodyguards and Police. It fires a tight shot cluster that maximizes damage while minimizing the spread of the shell. It stops an unarmored opponent dead, and is likely to knock an armored person flat. It also has a high intimidation factor. Can use S.D.C. load or M.D. **Weight:** 8 lbs (3.6 kg). **Damage:** 6D6 S.D.C. or 5D6 M.D.; 01%-50% chance of knocking an opponent weighing up to 300 lbs (135 kg) off his feet (lose initiative and one melee attack) with either round. **Rate of Fire:** Each blast counts as one melee action. **Range:** 60 feet (18.3 m) at its most effective, but good for up to 100 feet (30.5 m). **Payload:** 8 shells in an internal magazine, but must use one type of ammo or the other. An S.D.C. and M.D. mix is not possible. **Bonuses:** +1 to strike when within 60 feet (18.3 m) or less. **Cost:** \$19,950; \$1.00 each for S.D.C. shells, \$200.00 for eight shot M.D. EIPP cartridge. Available only in Australia.

**ATA "Mega-20" Shotgun.** Again, ATA has broken all the rules and produced the master of all shotguns. This is an impressive weapon indeed, but has a recoil that requires a P.S. of 15 to brace against (otherwise 1D4 S.D.C. damage to the user, due to recoil). Again, they have employed their patented EIPP system to produce a weapon of frightening destructive power. Thankfully, it can be set to fire like a standard

shotgun by disengaging the battery, doing S.D.C. damage instead. This is a rare weapon, and is unlikely to be found easily. The military has them, but sees little use in them, and the civilian population can't touch them. Weight: 11 lbs (5 kg). Damage: 1D4x10 M.D. or 1D6x10 S.D.C. depending on firing mode. Rate of Fire: Two shots per melee round maximum. Range: 80 feet (24.4 m). Payload: 10 slugs in an internal magazine, and 50 shots out of the battery. Cost: \$43,000; \$25 for a slug, and \$3000 for a new battery.

**ATA P-2/10 "Popper" High-Powered Derringer.** It is pretty ineffective against armor, but it chews through soft (S.D.C.) targets. Again, ATA have used their EIPP plasma propellant, so a small battery is required. The weapon is only the size of a pen flashlight and can fit in the palm of the hand or up a sleeve. Weight: 0.5 lbs (0.23 kg). Mega-Damage: 1D4 M.D. Rate of Fire: Once before reloading. Range: Accurate to 20 feet (6.1 m), but the bullet may travel up to 100 feet (30.5 m), and is -3 to strike when a target is beyond 20 feet (6 m) and only does one M.D. or 100 S.D.C. Payload: One bullet; 20 shots per battery. Bonuses: +1 to strike when within 20 feet (6.1 m), -3 when outside that range. Cost: \$6,600; \$600 for a new battery, and \$10 for a new slug. Available only in Australia.

**ATA 003 "Boom-Boom" Hard Ammo Sidearm.** It uses an E-Clip with the EIPP plasma system. It's a loud, loud gun, and needs to be reloaded by a breach action of the barrel. And yes, it is a handgun and can be used with one hand. However, a P.S. of 15 is required without using the other arm to brace. Weight: 4.5 lbs (2 kg). Mega-Damage: 4D6 M.D. Rate of Fire: One shot per action, and one action to reload each slug. Range: 300 feet (91 m). Payload: 5 slugs when fully loaded; 30 charges in the E-Clip. Cost: \$32,000; \$4500 for a new E-Clip, and \$25 for each EIPP slug (\$125 for five). Australia only. Civilian legal.

**ATA "Pinpoint" Needler Handgun.** An elegant weapon, this uses an EIPP system to expel a very fine needle with varying results. The weapon has two settings: high and low power. At high power, against soft targets, the needle is so fine it will pass through with minimal trauma. But at low power it will stick, causing damage, plus the needle can be drugged. A high velocity needle will, however, penetrate M.D. armor with little difficulty and deliver its cargo once lodged in the target beneath. Cunning, also, is the design of the needle, which has an internal case that dissolves and releases the drugs. Clips of dry needles are available, mainly for practice. Weight: 2 lbs (.9 kg). Damage: Low Power: Needle will stick into S.D.C. targets and do 1D4 damage. At this setting it can be used to deliver drugs. Drugged needles do 4D6 S.D.C. damage if a save vs harmful drugs fails, or 1D6 if the save succeeds. Or it can deliver a sleeping agent with a similar effect as the "sleep agent" of the Splatter Gun. Neither drug will affect M.D.C. creatures. Damage: High Power: The Needle does 1D4 M.D. against M.D.C. targets, and can deliver a drug or toxin to M.D. creatures (usually with minimal effect due to their superhuman and alien metabolisms). Rate of Fire: Standard. Range: 250 feet (76.2 m). Payload: 30 needles to a clip, and 100 shots to a battery. Bonuses: +1 to strike when aimed. Cost: \$19,500; \$400 for a new clip, \$1200 if drugged. A new battery costs \$900. Available only in Australia.

**ATA "20K" 20,000 Volt-Taser.** Personal security at its best. This taser uses two trailing wires to send a high voltage current into the victim, rendering him unconscious. The amperage can be adjusted, so the taser can even be lethal if used correctly. The civilian versions cannot be adjusted, and are moderately mild compared to what the police and military are allowed. Weight: 1 pound (.45 kg). Damage: 1D4 S.D.C. damage and the victim must save vs pain (14 or higher) or be stunned for 2D4 minutes. A successful save means the victim loses 1D4 melee actions (that melee round and may spill into the next) and combat bonuses are halved, but he remains conscious and angry. The higher grade Police and Military version does 2D6 damage to Hit Points/S.D.C. regardless of save, in addition to the usual effects, and requires a 16 or higher to save. Rate of Fire: Single-shot only. The wires take one melee action to reel back in if they miss. Range: 10 feet (3 m). Direct contact versions are available, and are considered melee weapons. Payload: 30

charges to an E-Clip. Cost: \$7000; \$5500 for a new E-Clip/battery. Note: Not effective against opponents in environmental body armor (but is good against homespun armor) or M.D. creatures. Available only in Australia.

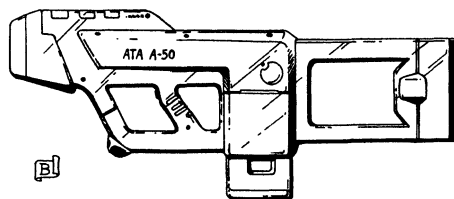

**ATA A-50, "Icer" Energy-Arc Thrower.** Advanced Technologies Australia (ATA) has come across the first true variation of the laser rifle since ion weaponry. The A-50 uses a low-powered laser, but this is not the method of attack. The laser simply ionizes the air in a straight line which then allows a high voltage charge to be conducted along this pathway to the target. The result is a high energy drain on the E-Clip, but a very destructive "lightning bolt" effect. The weapon is very obvious when fired, quite loud and not very accurate, but is well loved for its high intimidation factor and "spray" capacity. Weight: 11 lbs (5 kg). Mega-Damage: 3D6 M.D. Rate of Fire: Standard. Range: 600 feet (183 m). Payload: 10 shots from a single E-Clip, and 20 with a long clip. Bonuses: +2 to strike when within 100 feet (30.5 m), -2 when outside that range. Cost: \$32,500; \$5500 for an E-Clip, and \$12,000 for a long E-Clip. Available only in Australia.

**ATA P-20/50 Variable Frequency Sniper Rifle.** The highest-grade rifle available, it is limited to use by the military. It can be collapsed down — doing so takes about one melee round by a skilled character (1D4+2 if not) — and fitted into a case. It also has a fold-down bipod, excellent scopes and recoil compensation, as well as a form-fitting "squeeze" trigger and the variable laser settings common to the Juicer Rifles of North America. That is, after one full melee round, it can be adjusted to do full damage against laser resistant armors by finding the right frequency to fire at. What makes this weapon unique is that a passive targeting laser can be used to "paint" the target and determine the frequency first, without firing the gun! If a sniper spends a round doing so, his next shot against an armored opponent will do full damage. Weight: 9 lbs (4.05 kg). Damage: Three settings: 4D6 M.D., 3D6 M.D., or 1D6x10 S.D.C. Rate of Fire: Each shot counts as one melee attack; ideal for sniping. Range: 3,000 feet (914.4 m). Payload: 12 shots per standard E-Clip, 24 shots with a long E-Clip. Bonuses: +1 to strike when aimed. Cost: \$57,000; \$5,500 for a standard E-Clip; \$10,000 for a long one. Available only in Australia.

**ATA P-20/20, Plasma Sidearm.** The heaviest of all the handguns by ATA, this is a weapon restricted to Police and Military use *outside* city limits. Like most plasma weapons, it's heavy and not terribly accurate, but packs quite a punch. Weight: 4.8 lb (2.2 kg). Mega-Damage: 4D6 M.D. Rate of Fire: Standard. Range: 1,000 feet (305 m). Payload: 12 shots to a clip. Cost: \$27,000; \$5500 for a new E-Clip, or \$2600 to recharge. Available in Australia only.

**NeraTech Light Energy Pistol.** This is the first in a line of M.D. Laser weapons. It is very well balanced and is standard military issue. Civilians will have a hard time getting a permit to own such a weapon. Weight: 1 lb (0.45 kg). Mega-Damage: 1D6 or 1D6+2 M.D.; two settings. Rate of Fire: Standard. Range: 1,000 feet (305 m). Payload: 18 shots per E-Clip. Bonuses: +2 to strike when aimed. Cost: \$21,500; \$5,500 for a new E-Clip; \$2600 to recharge. Australia only.

**NeraTech M-01 Military and Police Sidearm.** A slightly higher-powered version of the Light Laser Pistol above, this is issued to heavy-duty TRG teams and to higher military personnel for use in dangerous situations. Weight: 2.5 lbs (1.1 kg). Mega-Damage: 1D6+2 M.D. or 2D6+3 M.D.; two settings. Rate of Fire: Standard. Range: 1,000 feet (305 m). Payload: Fifteen 2D6+3 shots to a clip. Bonuses: +1 to strike when aimed. Cost: \$25,000; \$5500 for a new E-Clip; \$2,600 to recharge. Available only in Australia.

**NeraTech I-20, "Mankiller" Ion Pistol.** When S.D.C. firepower is futile against hard armored opponents such as those wearing homespun or environmental M.D. body armor, or hiding in an M.D. automobile, and innocent, unprotected (Hit Point/S.D.C.) people might get caught in the line of fire, or the use of M.D. weapons would destroy property, the City Police and Military pull out this little sucker. The "Mankiller" is a very low-powered energy pistol that, in theory, virtually ignores hard armor, passing right through most hard objects, but sears flesh. It is used by the City Police, Military and special Outback City Agents to bypass a criminal or raider's body armor and inflict damage *direct* to the S.D.C. and Hit Points of the person underneath! In the alternative, it can be used on any S.D.C., flesh and blood opponent without damage to clothing or the exterior of windows or non-military vehicles. It can ignore up to an inch of M.D. armor plating (i.e. most body armor, but not Power Armor) and plays havoc with electrical systems, to the point of shutting them down or frying computer processors. The disadvantage to the weapon is that it has a very low rate of fire. There are very stringent laws against this gun, as destruction of technology is a capital offense, and a stray shot could be very harmful to the city. Restricted to Police and Military use, with special exceptions made for bodyguards of important officials and select Level 5 citizens. Note: This weapon has become the most coveted of all by Outback raiders, criminals and thieves who can use it to kill an opponent without seriously damaging M.D. body armor, vehicles, clothing, etc. Many will pay (or more likely trade) up to \$130,000 for one! Weight: 3.5 lbs (1.6 kg). Damage: 4D6 H.P./S.D.C. to living targets. The beam will ignore up to 90 M.D.C. of armor before the special effect is blocked. If the M.D.C. of heavy body armor is battered and worn down by damage from other weapons, then this weapon may penetrate to damage the wearer and/or fry electronics housed within or behind that armor. To score such a hit, the shooter simply aims and shoots as normal. To target electronics, the player must announce a called shot and roll a 15 or higher on the strike roll. Failing the called shot, but successfully striking the target, results in no electrical damage, but S.D.C./H.P. damage to the character inside. If the called shot succeeds, electrical systems begin to malfunction as they are disrupted. This results in -1 to combat rolls and -10% to any skill checks involving electronic devices (radar, communications, special helmet optics, MUDS, etc.), until it is replaced or repaired. Multiple blasts to electronics have an accumulative effect. Note: Cannot punch through or interfere with environmental Power Armor, robots or cyborg armor even when that armor is beat to hell — it is thicker and more resistant to outside attacks and disruption. Rate of Fire: Each blast counts as one melee attack. Range: 500 feet (152 m). Rate of Fire: Single shot; each blast counts as one melee attack. Payload: 30 shots to an E-Clip. Cost: \$52,500; \$5500 for a new E-Clip, \$2600 to recharge. Available only in Australia, and it is uncommon there.

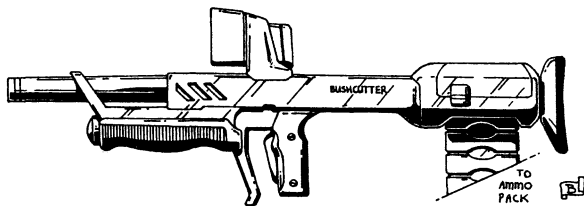

**NeraTech "Bushcutter" Rail Gun.** This is your typical Rail Gun, used by door gunners and other hardier military personnel that delve into the bush lands. A P.S. of 22 is required, or it can be used with a bipod mount. Weight: 24 lbs (10.8 kg) plus ammo (15-40 lbs/6.8 to 18 kg). Mega-Damage: 4D6 M.D. per burst of 12 rounds. Rate of Fire: Only fires bursts of 12 rounds. Each burst counts as one melee attack. Range: 3,000 feet (914 m). Payload: 120 round mini-clip (10 bursts), 360 round belt (30 bursts) or full 1440 drum (120 bursts). Cost: \$110,000, \$2,000 for a mini-clip, \$8000 for a new belt, \$24,000 for a drum. Available only in Australia.

**NeraTech "Fletcher 12" Light Rail Gun.** Quite possibly the smallest rail gun ever developed, it fits against the torso, and the user

has to tense his hip against it to withstand the recoil. It fires single slugs, and makes half the noise of your typical rail gun. Highly destructive but easy to control and damage is localized. It can also be ground-mounted and used as an ambush sniping weapon (despite the noise) or mounted on a vehicle. A P.S. of 15 is needed to fire the weapon, otherwise the character takes 1D4 S.D.C. himself every time the gun is fired, regardless of armor. Weight: 12 lbs (5.4 kg). Damage: 3D6 M.D. per single round. Rate of Fire: Standard. Range: 2,000 feet (610 m). Payload: 20 shots per ammo-clip or 100 per drum (weighs 10 lbs/4.5 kg). Cost: \$54,000; \$6500 for a new ammo drum, \$1500 for a clip. Available only in Australia.

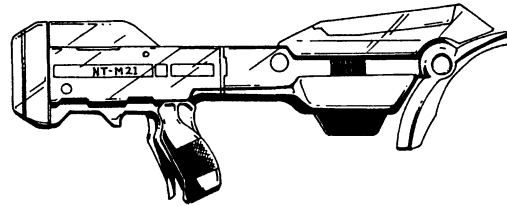

**NeraTech M-21 Heavy Particle Beam Cannon.** This heavy weapon is a hefty, shoulder mounted gun that requires a backpack to supply its power, but it can slice armor like it was tissue paper. Requires a P.S. of 18 to use, otherwise -2 to strike even when aimed. Weight: 35 lbs (15.7 kg). Mega-Damage: When rolling to hit, if the strike roll is 17 or less but still hits, the damage is 1D6x10 M.D. If the strike roll hits and is 18 or more, the damage is a blistering 2D4x10 M.D.! Rate of Fire: Twice per melee round; each shot counting as one melee attack. Range: 2,000 feet (610 m). Payload: 30 shots to a backpack unit; cannot use E-Clips. Cost: \$295,000; \$48,000 for a new E-pack, \$12,500 to recharge it. Available only in Australia.

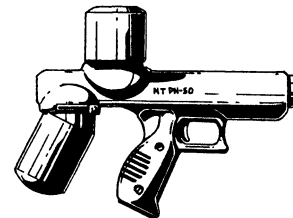

**NeraTech P.N.-50, "Splatter Gun."** A paint-ball gun that uses pneumatic pressure to pump out its payload. Not very accurate or far reaching, but very effective. It can release modules containing nerve gas, bio-toxins, sleep agents, molecular acid or even paint to mark. And the best part? It inflicts very little environmental damage. Weight: 1.8 lbs (.8 kg). Damage: Varies as follows. Acid: 4D6 S.D.C. or 2D6 M.D., depending on what type of target it hits, in a one yard/meter splatter radius. Sleep Agent: Opponents not wearing environmental body armor must roll to save vs non-lethal poison (16 or higher) or fall asleep within 1D4 melee rounds. The area affected has a radius of one yard/meter per pellet fired. Victims sleep for 1D4+2 minutes per pellet of exposure. Toxin or Nerve Gas: Victims not wearing environmental body armor must save vs lethal poisons (12 or higher). If the save fails, the target is racked by convulsions (incapable of fighting or running), suffers 1D6x10 damage direct to Hit Points (1D4x10 M.D. if a Mega-Damage creature), and will lapse into unconsciousness for 2D4+4 minutes. Even if the save is successful, the target takes 1D6+1 direct to Hit Points (or M.D.C.). The gas cloud has a one yard/meter radius per pellet fired. Demons, characters in body armor or under some other suitable shielding are immune to this nasty effect. Injecting oneself with an anti-nerve agent will reduce damage of the gas or toxin by half and the victim will not lose consciousness or suffer from convulsions, and can continue to fight. Rate of Fire: Standard, including bursts! Range: 60 feet (18.3 m). Payload: 18 pellets to a clip. Cost: \$2500; \$40 for a new clip of paint, \$1200 for sleep agent, \$20,500 for toxin or nerve gas, \$2700 for acid. Also, \$50 for a new compressed air module, or the old one can be refilled for \$10. Anti-nerve agent serum costs \$1200+ per single injection. Available only in Australia.

# Bandito Arms™

## Rifts® World Book 14: New West™

Bandito Arms is a division of the Black Market, not that most of its clientele know that or care. In fact, Bandito Arms represents 30% of all weapons, armor, vehicles and equipment sold in the North American Western Wilderness and 42% of all sales in the State of Lone Star, particularly in the *Pecos Empire*. Northern Gun represents a third of the market in both the New West and the State of Lone Star. The remaining sales in the arms market are divided between Wilk's, Manistique Imperium, Iron Heart, Golden Age Armaments and a dozen other manufacturers, smugglers and traders.

The Coalition Military actively interferes with the operations of Bandito Arms and other Black Market operations, smugglers and independent weapons dealers in the West, especially targeting those based in or near CS territories. And raid the outposts, camps and manufacturing plants of arms dealers, bandits, smugglers and agents of the Black Market whenever they are found. One reason is the Black Market's relentless efforts in the manufacture and sale of "knock-offs" (cheap copies) based on CS weapons and technology. Another is the fencing and resale of stolen goods from the CS Army. Such knock-offs and stolen weapons are routinely confiscated from adventurers and fighters traveling in the Coalition States and Territories, especially in the 'Burbs. The possession of knock-offs and stolen CS equipment is a crime, even if the character "bought" the goods (didn't steal them himself). Those caught with contraband are fined, their weapons seized (sometimes including legitimate items not of CS origin), and the owners interrogated to reveal the name and location of the seller(s). Those who cooperate are usually released — frightened, perhaps beaten or tortured, but alive and free. Those suspected of terrorism, crimes against the CS, the sale and/or distribution of illegal arms, or who fail to cooperate, are executed!

Bandito Arms' primary base of operations in the New West is located at a town called El Diablo S-4, near the Devil's Lake, once known as *Groom Lake* or the infamous *Area 51* (the pre-Rifts US Military Base where secret United States weapons and vehicles were tested). Bandito Arms also has branches and outposts in Lone Star, including *El Paso*, *Laredo*, *Los Alamos*, *Crossroads*, and the *Kingdom of Worth*. *San Antonio*, under the control of Black Market Kingpin, Warlord Don Marcos, is the main center of operations in that State. Ciudad Juarez in Northern Mexico, New Mexico, Colorado, Oklahoma, and Kansas (an unofficial CS Territory) also have Bandito Arms dealers.

In addition to the weapons and equipment described in this section, Bandito Arms also sells most standard items and services offered by the *Black Market*, including the fencing of goods, false I.D.'s and documents, illegal bionics and cybernetics, the purchase and sale of pre-Rifts artifacts, CS weapon knock-offs and a fairly good range of weapons, armor, power armor, equipment and vehicles manufactured by (and bought in bulk from) Northern Gun, Manistique Imperium, and Golden Age Weaponsmiths. The Black Market dealers also offer select items from Wellington Industries, Triax (the latter at premium prices; 200%-300% the normal price), and even the occasional Techno-Wizard items, Glitter Boys, stolen CS equipment (weapons, body armor, power armor, or vehicles) and Naruni Enterprises items (300%-600% higher than the standard price, now that the CS has declared Naruni items highly illegal). Black Market "knock-offs" (cheap copies) of Coalition weapons include all old style weapons, a few of the new style ones, and variations of (or repainted, slightly modified and reconditioned, scavenged or stolen) Dead Boy armor. **Note:** Some of the Black Market's weapons and equipment are based on pre-Rifts designs uncovered through archeological digs, purchases of technology, and stolen technology. Bandito weapons are mostly available in the *New West* and *Northern Mexico*.

**Bandit IP-10 Ion Pistol.** Also known as the "Eye-Pie Ten," a heavy damage ion pistol. As an added selling point, the IP-10 is designed to

look like a revolver of the Old West, with an E-Clip designed to fit into the handle of the weapon. Weight: 3 lbs (1.4 kg). Mega-Damage: 3D6 M.D. Rate of Fire: Standard. Range: 400 feet (122 m). Payload: 10 shots from a standard short E-Clip, 20 shots with a long E-Clip. Bonuses: Well balanced and +1 to strike. Cost: 12,000 credits.

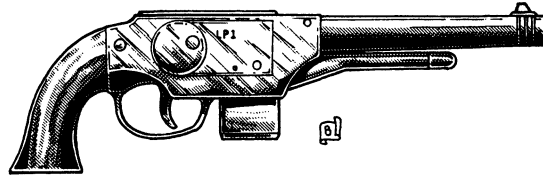

**Bandit LPI Laser Pistol.** Also known as the "No Lip" Pistol, the Bandit LPI is a lightweight, highly accurate laser pistol with good range. Damage yield could be higher, but the accuracy of the weapon and its large payload more than offset this disadvantage. Weight: 2 lbs (0.9 kg). Mega-Damage: 2D4 (or 1D8 if one prefers) M.D. Rate of Fire: Standard. Range: 1000 feet (305 m). Payload: 20 shots from a standard short E-Clip, 40 shots with a long E-Clip! Bonuses: Due to this weapon's superior laser focusing optics, light weight and handling, it has a bonus of +1 to strike. Cost: 20,000 credits for the gun, 2,000 credits per magazine.

**Bandit BigBore Revolver.** The BigBore series is a new line of old style S.D.C. guns that fire heavy explosive rounds. They have been met with wild enthusiasm among gunfighters and bandits in the New West. One of the earliest BigBore weapons was the Bandit BigBore Revolver, also known as the "BB-6" (for six-shooter). The BigBore is a large revolver that fires high-explosive shells. The "bullets" could be considered small grenades. The advantages to the BigBore handgun are its knockdown power, damage yield, and intimidation factor. It is just plain scary to look down the business end of the BigBore, and it has a Horror Factor of 10 when pointed in someone's face. Note: A strength of 14 or better is required to shoot the BB-6 (those with a weaker P.S. are -2 to strike even with an aimed shot, and -6 when shooting wild); a P.S. 17 is needed to fire it one-handed. Weight: 4 lbs (1.8 kg). Mega-Damage: 1D6 M.D. per round/bullet, plus human and human-sized D-Bees who are shot must roll a 20-sided die to maintain their footing. This balance roll must equal or surpass the attacker's roll to strike. A successful roll means the character feels like he's been kicked by a mule, but remains standing and suffers no penalties, except he loses initiative if he had it. A failed roll means the victim is knocked off his feet, falls back onto the ground (fall back 1D4 feet), loses initiative (if he had it) and loses one melee attack/action! Even characters in M.D.C. body armor will be knocked down, however, those in power armor, full conversion cyborgs, robots, giants, supernatural beings and creatures of magic (demons, metamorphed dragons, etc.) are not. Rate of Fire: Single shot, each shot counts as a melee action, unless shooting wild. Range: 200 feet (61 m). Payload: Six; revolver style cylinder weapon. Cost: 6,500 credits for the gun, 80 credits per round/bullet or 10,000 credits for a gross (box of 144 rounds).

**Bandit BigBore Sawed-Off.** Also known as the "BB Sawed-Off" and the "Mule." The BigBore Sawed-Off looks like a sawed-off shotgun and fires a large, high explosive shell and has even greater knockdown power. This is another intimidating weapon that has a Horror Factor of 12 when pointed at most mortal opponents. Note: A strength of 18 or better is required to shoot the BB Sawed-Off (those with less P.S. will be knocked on their butt, and lose one melee attack/action); P.S. 22 is required to fire it one-handed. It is also known as "the Mule" because it has a kick like one. A single barrel and double-barreled variety are available. The double-barreled is most popular. Weight: 6 lbs (2.7 kg). Mega-Damage: 2D4 M.D. per single round/bullet or 4D4 per double-barrel blast. Human and human-sized D-Bees must roll a 20-sided die, -6 to stay standing. The roll must equal or surpass the attacker's roll to strike. A successful roll means the character is staggered, knocked to his knees and loses initiative (if he had it). A failed roll means the victim is knocked off his feet and flung 8-10 feet (2.4 to



3 m) before hitting the ground! The victim loses initiative (if he had it), is momentarily dazed (reduce all combat bonuses by half for one melee round per each blast he endures), and loses one melee attack/action! Even characters in M.D.C. body armor will be knocked down and suffer the penalties above. Those in power armor, and full conversion cyborgs, robots, giants, supernatural beings and creatures of magic (demons, metamorphed dragons, etc.) are not likely to be knocked down (+6 to save vs knockdown), but will lose initiative and are staggered with each shot. **Rate of Fire:** Each shot, single or double barrel, counts as one melee action/attack. **Range:** 150 feet (46 m). **Payload:** Two, or 12 with an ammo drum. **Cost:** 15,000 credits for the gun, 120 credits per round/bullet or 16,000 credits for a gross (box of 144 rounds).

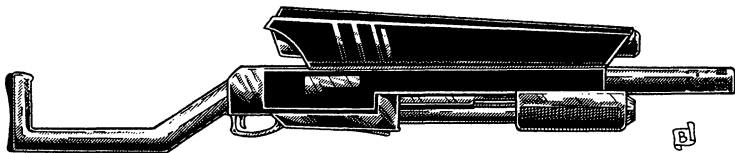

**Bandit BigBore Shotgun.** The BB Long-Barrel looks like a heavy shotgun and fires the same high explosive shell as the BB Sawed-Off; Horror Factor 12. A strength of 18 or better is required to shoot it (those with less P.S. will be knocked off their feet, and lose one melee attack/action); P.S. 22 to fire it one-handed. The advantage of this rifle is its greater range. A single barrel and double-barreled variety are available. **Weight:** 8 lbs (3.6 kg). **Mega-Damage:** 2D4 M.D. per single round/bullet or 4D4 per double-barrel blast. Same knockdown as the sawed-off. **Rate of Fire:** Each shot, single or double barrel, counts as one melee action/attack. **Range:** 300 feet (91.4 m). **Payload:** Four, or 12 with an ammo clip. **Cost:** 18,000 credits for the gun, 120 credits per round/bullet or 16,000 credits for a gross (box of 144 rounds).

**5000 Series Light Rail Guns** are effectively high-tech, lightweight machine-guns (some argue that they are heavy assault rifles) that fire either explosive rounds (same as the BigBore) or flechette rounds (much like a mini-version of the Glitter Boy's boom gun). The Bandit 5000 series of rail guns are comparatively light, manageable weapons that deliver the same punch as the average rail gun, but are easily used by a two-man team of normal humans, or by a single individual with a P.S. of 20 or greater, making them ideal for Juicers, Crazies, and cyborgs, as well as many mutants and D-Bees. This also works to the weapons' disadvantage, because they have a tiny payload compared to conventional rail guns, and a reduced range. The basic (pre-Rifts) design and technology for these weapons was uncovered by Bandito arms at Area 51! They also produce "knock-offs" of Coalition, Northern Gun and other types of rail guns.

**Bandit 5000 BigBore Rail Gun.** Also known as the "Big Bear," it can fire single, aimed shots (each pull of the trigger is one melee attack/action) or in short bursts. A P.S. of 20 or higher is necessary to use the weapon without penalty, otherwise -3 to strike. **Weight:** Gun: 25 lbs (11.3 kg), including the weight of an E-Clip and standard ammunition drum (60 rounds). **Mega-Damage:** 1D6 M.D. per single round/bullet or 2D6 M.D. per short burst of six rounds. Same knock down as the sawed-off BB-Mule. **Rate of Fire:** One at a time or in bursts; each counts as one melee action/attack, but the burst is less controlled and less accurate (all rounds fired do not hit the intended target). **Range:** 2,000 feet (610 m); the E-Clip provides the extra "zip." **Payload:** Standard Drum: 60 rounds or 10 bursts. It takes one melee round (15 seconds) to reload (30 if the user doesn't have the W.P. Heavy Weapons skill). A large, backpack ammo drum can be substituted. It holds 240 rounds (40 bursts), but weighs an additional 22 pounds (10 kg). The E-Clip can fire 960 rounds (160 bursts) before needing to be replaced. **Bonus:** Laser targeting standard; +1 to strike on aimed shots. **Cost:** 50,000-55,000 credits for the gun, 80 credits per round/bullet or 10,000 credits for a gross (box of 144 rounds).

**Bandit 5500 Flechette Rail Gun.** Also known as the "Cactus Juicer." A slightly heavier version of the Big Bear 5000, but instead of

explosive rounds it fires flechette rounds. This weapon is extremely popular among cyborgs and power armor pilots, who typically use it with the backpack ammo drum capable of 30 bursts. It got its nickname, Cactus Juicer, because when used to shoot cactus for target practice, all it leaves behind is juice where the cactus once stood. A P.S. of 20 or higher is necessary to use the weapon without penalty, otherwise -3 to strike. **Weight:** Gun: 30 lbs (13.6 kg), including the weight of the E-Clip power supply and standard ammunition drum (42 rounds). **Mega-Damage:** 1D4 M.D. per single round/bullet or 3D6 M.D. per short burst of six rounds. No knockdown feature. **Rate of Fire:** One at a time or in bursts; either one counts as one melee action/attack, but the burst is less controlled and less accurate (all rounds fired do not hit the intended target). **Range:** 2000 feet (610 m); the energy clip provides the extra "zip." **Payload:** Standard Drum: 42 rounds or 7 bursts. It takes one melee round (15 seconds) to reload (30 if the user doesn't have the W.P. Heavy Weapons skill). A large, backpack ammo drum can be substituted. It holds 180 rounds (30 bursts), but weighs an additional 30 pounds (13.6 kg). The E-Clip can fire 960 rounds (160 bursts) before needing to be replaced. **Bonus:** Laser targeting standard; +1 to strike on aimed shots. **Cost:** 52,000-58,000 credits for the gun, 80 credits per flechette round or 10,000 credits for a gross (box of 144 rounds).

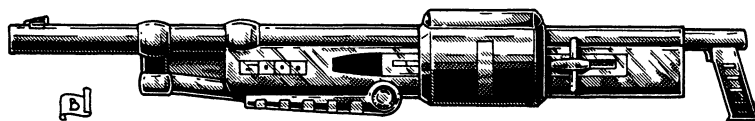

**Bandit 6000 Grenade Launcher.** Also known as the "Big Bang" Assault Rifle. The Bandit 6000 is a rapid-fire grenade launcher! Its size and shape is somewhat reminiscent of Bandito Arms' rail guns, but the payload unleashed by this heavy weapon is literally explosive. The drum canister holds the main payload of grenades (50), but an additional 12 grenades can be held in the gun itself. A folding bipod stand is located in the front of the weapon for use in a prone position and for extra support. It is designed for use by power armor pilots, Juicers, Crazies and cyborgs; a P.S. of 24 or higher is necessary to use the weapon without penalty (otherwise -4 to strike). Like the rail guns, the Big Bang is based on technology uncovered at Area 51, so it is nothing more than a knock-off of a forgotten (experimental?) weapon designed for the US Army or Air Force. Probably a weapon originally intended for the SAMAS. **Weight:** Gun: 40 lbs (18 kg), plus the grenade drum, 20 lbs (9 kg) — can be used with or without the drum (grenades must be hand loaded). **Mega-Damage:** 2D6 M.D. per single round/grenade or 4D6 M.D. per rapid-fire burst of two grenades fired one microsecond apart. The damage is inflicted to everything in a 12 foot (3.6 m) radius. **Rate of Fire:** One at a time or two simultaneous at the same target (counts as one melee action/attack). **Range:** 2000 feet (610 m)! **Payload:** 12; an additional 50 grenades are packed into the ammo drum. It takes one melee round (15 seconds) to reload the weapon by hand with 12 grenades (or one melee action to load two). **Bonus:** Laser targeting and telescopic scope optional (6000 cr.). **Cost:** 80,000-100,000 credits for the gun, 500 credits per grenade. Fair to poor availability. This weapon is outlawed in the Coalition States.

## Coalition States™ Weapons

The Coalition States (CS) have a standardized army with standard weapons and equipment. Generally, the *new* model CS weapons and equipment are standard issue to the soldiers in the *CS Military*. However, distant outposts will remain equipped with the old weapons and armor for several (1D4+2) years. Old weapons and equipment may also be issued for special assignments or in case of supply shortages of the new equipment. The old weapons are good and reliable, they just aren't quite as powerful or versatile as many of the new models. Only Coali-

tion Juicers, Scouts, Special Forces operatives and commissioned officers are allowed to use the old style CS weapons and equipment not of CS manufacture (Northern Gun, Triax, etc.) without special permission. But permission is liberally granted to veterans who prefer the old guns. *Coalition Police* (the ISS, NTSET and PRP) continue to use a mix of old and new weapons.

**Note about Uranium Rounds:** The Coalition government and military have both agreed to *ban* the use of Uranium Rounds for environmental reasons. Northern Gun, the Manistique Imperium and most other arms and munitions manufacturers also avoided the creation of U-Rounds for the same reason. As part of its agreement with the CS, Triax does not export U-Rounds to the Americas.

**C-5 Pump Pistol.** The C-5 pump pistol is an authorized knock-off of the Triax TX-5 that fires high explosive cartridges/rounds which are much smaller than the conventional grenade, but pack a wallop. The blast is very concentrated, about one foot (0.3 m), unlike the larger grenades which affect an area 5-20 times larger. It is used primarily by CS commandos, Special Forces, and the occasional field officer. It is widely used by the ISS urban forces and even the occasional ISS Psi-Hound. Weight: 5 lbs (2.25 kg). Mega-Damage: 4D6 M.D. Rate of Fire: Standard. Range: 800 feet (244 m). Payload: 5 rounds, loaded manually one round at a time. A speed loader will load all five rounds in four seconds (one melee action) and costs 1200 credits. Black Market Cost: 10,000 credits for the gun and 400 credits per round. Poor to fair availability.

**C-18 Laser Pistol.** This was the standard issue sidearm of the Coalition Army, but it is being replaced by the C-20 and CP-30 laser pistols. Weight: 4 lbs (1.8 kg). Mega-Damage: 2D4 M.D. Rate of Fire: Standard. Range: 800 feet (244 m). Payload: 10 shots (less efficient energy delivery system). Black Market Cost: 12,000 credits.

**C-20 Laser Pistol.** This is the new, standard issue sidearm of the Coalition Army. It is primarily issued to officers, military police, guards and special operatives as well as ISS law enforcement officers. Its advantage is a heavier damage capacity without sacrificing its light weight, excellent balance, or range. Weight: 3.5 lbs (1.57 kg). Mega-Damage: 2D6 M.D. Rate of Fire: Standard. Range: 800 feet (244 m). Payload: 21 shots standard short clip or 30 with a long E-Clip. Black Market Cost: 16,000 credits.

**CP-30 Laser Pulse Pistol.** This is the standard issue "officer's" sidearm of the Coalition Army. It is also used by Special Forces as well as NTSET law enforcement officers (monster hunters). It comes standard with laser targeting (+1 to strike). The multi-pulse firing capability provides heavy firepower in close combat. Weight: 4 lbs (1.8 kg). Mega-Damage: 2D4 M.D. per single blast or 4D6 M.D. per multiple pulse burst (three simultaneous shots). Rate of Fire: Equal to the number of hand to hand attacks of its user (usually 3-6). Range: 600 feet (183 m). Payload: 21 single shots (7 pulse blasts) per standard short E-Clip, or 30 single shots (10 pulse blasts) with a long E-Clip. Special Payload: The standard E-Clip of the CP-30 can be replaced with a clip connected to an energy cable that connects to a portable hip or backpack carried energy canister (both are the same small size). The energy canister provides 72 single blasts or 24 triple blasts. The weight of the energy canister, pack included, is four pounds (1.8 kg). A dual backpack is also available, but is typically reserved for use with energy rifles. It has two energy canisters; when one is used up, the connector cable is removed and reattached to the second, full canister (takes one full melee round/15 seconds). Laser Targeting: Add +1 to strike on an aimed shot. Black Market Cost: 26,000 credits for the weapon; 90,000 for the portable generator.

**C-10 Light Assault Laser Rifle.** The C-10 light laser rifle is an old, earlier version of the C-12. It remains a favorite sniper rifle and is known for its accuracy and durability in the field. Weight: 5 lbs (2.3 kg). Mega-Damage: 2D6 M.D., no variable settings. Rate of Fire: Standard. Range: 2,000 feet (610 m). Payload: 20 blasts from a standard E-Clip or 30 from a long E-Clip. Laser Targeting: Add +3 to strike on an aimed shot, but only when the laser targeting system is functioning.

No bonus when on the blink. Black Market Cost: 16,000 credits for the rifle. Standard clip and recharge costs. An E-Clip canister can *not* be used with this weapon.

**C-12 Heavy Assault Laser Rifle.** This was the standard weapon of the infantry, a sturdy and reliable rifle that can survive a great amount of combat abuse and activity without mechanical failure. The rifle has three settings, one S.D.C. and two M.D.C. The rifle can also be set to fire a single shot or a burst of five. Comes standard with a passive nightvision scope and laser targeting. It remains a favorite infantry workhorse and will remain in service for at least another decade. Weight: 7 lbs (3.2 kg). Mega-Damage: Setting one: 4D6 M.D. or Setting two: 2D6 M.D. S.D.C. Damage: Setting Three: 6D6 S.D.C. Rate of Fire: Equal to the number of combined hand to hand attacks of its user (usually 3-6). Range: 2,000 feet (610 m). Payload: 20 M.D. blasts from standard E-Clip or 30 from a long E-Clip, plus another 30 can be added with one E-Clip cannister. Note that six S.D.C. shots equals one Mega-Damage blast. Laser Targeting: Add +1 to strike on an aimed shot. Black Market Cost: 20,000 credits for the rifle.

**C-14 "Fire Breather" Laser Assault Rifle and Grenade Launcher:** The weapon has an over-and-under firing capability and is durable and reliable. The top barrel is a laser, the bottom is the grenade launch tube, fired like a pump action shotgun. The weapon comes standard with a passive nightvision scope. Weight: 10 lbs (4.5 kg). Mega-Damage: 3D6 M.D. per laser blast or 2D6 M.D. per single to a blast area of 12 feet (3.6 m). Rate of Fire: Each laser blast or fired grenade counts as one melee attack. Range: Laser is 2000 feet (610 m); grenade is 1200 feet (365 m). Payload: Laser has 20 shots per standard E-Clip. Grenade launcher holds 12 grenades. Black Market Cost: 30,000 credits for the rifle. Fair availability.

**C-27 "Light" Plasma Cannon.** The C-27 plasma cannon has been reclassified from a heavy support infantry weapon to "light." It is dependable and inflicts good levels of damage. It is ideal against light to heavy body armor troops and light vehicles. Standard issue includes a telescopic and laser distancing scope. Weight: 12 lbs (5.4 kg). Mega-Damage: 6D6 M.D. per blast. Rate of Fire: Equal to the number of attacks of the user; each blast counts as one melee action/attack. Range: 1600 feet (488 km). Payload: 10 blasts per energy canister; hooked into the underside of the weapon. Targeting Scope: Add a bonus of +1 to strike on an aimed shot. Black Market Cost: 32,000 for the rifle; can only be used with an E-Clip Canister which costs 10,000 credits new and fully loaded. A recharge is 2000 credits.

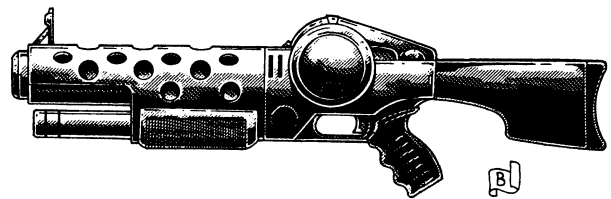

**C-29 "Hellfire" Heavy Plasma Cannon.** The C-29 "Hellfire" plasma cannon is an anti-armor and heavy infantry support weapon. It is a dependable, durable weapon and inflicts incredible damage. If it has a shortcoming, it is limited firing range. Standard issue includes a telescopic and laser distancing scope. Weight: 12 lbs (5.4 kg). Mega-Damage: 1D6x10 M.D. Rate of Fire: Equal to the number of attacks of the user; each blast counts as one melee action/attack. Range: 1,400 feet (427 km). Payload: 8 blasts per energy canister; mounted on the top-side of the weapon. In addition, the C-29 can be connected with an energy cable to a portable hip or backpack carried energy canister the same as the CP-40. This gives the weapon a total initial payload of 16 blasts. The dual backpack is commonly issued with this weapon, with two to four additional energy canisters carried in a satchel; each canister weighs approximately four pounds (1.8 kg). Targeting Scope: Add a bonus of +1 to strike on an aimed shot. Black Market Cost: 32,000 for the rifle; can only be used with an E-Clip Canister which costs 10,000 credits new and fully loaded. A recharge is 2,000 credits.

**CP-40 Pulse Laser Rifle:** This is one of the Coalition Army's new weapons in its arsenal. A rapid-fire pulse laser rifle with four damage settings, two S.D.C. and two M.D. The rifle can also be set to fire single shots or triple pulse blasts. Comes standard with a passive nightvision scope and laser targeting. Weight: 9 lbs (4.1 kg). Mega-Damage: Setting one: 2D6 M.D. or Setting Two: 6D6 M.D. S.D.C. Damage: Setting Three: 3D6 S.D.C. or Setting Four: 1D6x10 S.D.C. Rate of Fire: Each blast, whether S.D.C. or M.D.C., single shot or triple pulse counts as one melee action. Range: 2,000 feet (610 m). Payload: 21 M.D. single shots or 7 triple pulse shots from standard E-Clip or 30 single shots (10 triple pulses) from a long E-Clip, or can be cabled to a energy hip or backpack providing 60 single shots or 20 pulse blasts. Note that six S.D.C. shots equals one Mega-Damage blast. Laser Targeting: Add +1 to strike on an aimed shot. Black Market Cost: 40,000 credits for the rifle. Poor availability, highly desirable.

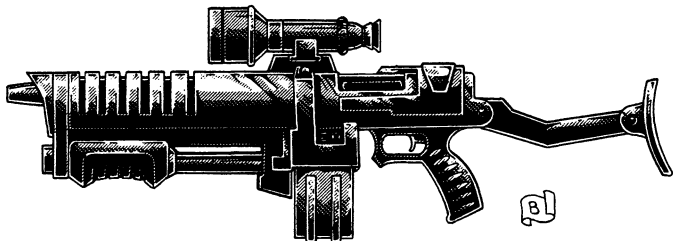

**CP-50 "Dragonfire" Pulse Laser Rifle & Grenade Launcher:** Second generation over-and-under heavy infantry weapon. The top barrel is a laser, the bottom is the pump action grenade launcher. The weapon comes standard with a passive nightvision scope and built-in laser targeting. Weight: 10 lbs (4.5 kg). Mega-Damage: 2D6 M.D. per single laser blast or 6D6 M.D. per rapid-fire triple pulse. Standard Grenade does 2D6 M.D. to a blast area of 12 feet (3.6 m). Mirco-Fusion Grenade does 6D6 M.D. to a 12 foot (3.6 m) area. Rate of Fire: Each single or triple laser blast or fired grenade counts as one melee attack. Range: Laser is 2000 feet (610 m); grenade is 1200 feet (365 m). Payload: 21 M.D. single shots or 7 triple pulse shots from standard E-Clip or 30 single shots (10 triple pulses) from a long E-Clip, or can be cabled to a energy hip or backpack providing 60 single shots or 20 pulse blasts. Grenade launcher holds 12 grenades. Laser Targeting: Add +1 to strike on an aimed shot. Black Market Cost: 40,000 credits for the rifle. Poor availability, high demand.

**CV-212 Variable Light Frequency Laser Rifle.** The CV-212 Variable Light Frequency Laser Rifle has become an official weapon of the Coalition Army. A microchip in the weapon's computer automatically analyzes an opponent's armor (if not already preprogrammed into its memory) and after one melee round (15 seconds), adjusts to the light frequency that will inflict full damage (the attacks for that first melee round do only half damage). It is a sturdy, reliable rifle that can survive a fair amount of combat abuse and activity without firing failure. However, M.D.C. damage (80%) is likely to disengage the computer analyzer (01-80%), making only manual frequency adjustments possible — it takes at least 1D4 melee rounds to find the optimum frequency and each adjustment attempt counts as one melee action/attack. The rifle can be set to fire a single shot or a burst of three. It comes standard with a passive nightvision scope and laser targeting. The CV-212 remains popular among Special Forces and is only issued to the infantry when they are expected to engage Glitter Boys or other enemy forces with laser resistant armor. The CV-213 is fundamentally the same weapon, but designed specifically for use by Skelebots, particularly the original FASSAR-20 models, to overcome laser resistant armor. Weight: 8 lbs (3.6 kg). Mega-Damage: 2D6 M.D. per single shot or 6D6 M.D. per triple burst. S.D.C. Damage: Special damage setting: 6D6 S.D.C. per single blast. Rate of Fire: Equal to the combined number of hand to hand attacks of the user. Effective Range: 2000 feet (610 m). Payload: 21 blasts (7 pulse) per standard E-Clip, 30 blasts (10 pulse) per long E-Clip. In the alternative, the CV-212 and CV-213 can be connected with an energy cable to a portable hip or backpack carried

energy canister (both are the same small size). The energy canister provides 60 single blasts or 20 triple blasts. The weight of the standard energy canister, pack included, is four pounds (1.8 kg). A dual backpack is also available, with two energy canisters; when one is used up, the connector cable is removed and reattached to the second, full canister (takes one full melee round/15 seconds). Skelebots are typically given the dual backpack. Note that six S.D.C. shots equals one, light, Mega-Damage blast. Laser Targeting: Add +1 to strike on an aimed shot. Black Market Cost: 50,000 credits for the rifle, 5000 credits for a new, fully charged, standard E-Clip, 1500 for a recharge. An E-Clip canister costs 10,000 new and fully charged. A canister recharge costs 2000 credits. Good availability in North America.

**C-40R Coalition SAMAS Rail Gun.** The SAMAS rail gun is not only a widely used Coalition arm, but it has been extensively duplicated by knock-off arms manufacturers across North America. The CS is *not* pleased about this, and they try to curb illegal C-40R production when they can, but it is definitely a losing battle for the Coalition. The C-40R is light enough to be used as a vehicle mounted or tripod mounted machine-gun, as well as a standard arm for power armor. Weight: 92 lbs (41.4 kg), Power Pack: 60 lbs (27 kg), One Ammo-Belt: 30 lbs (13.5 kg), Case of six belts: 190 lbs (85.5 kg). Mega-Damage: A burst is 40 rounds and inflicts 1D4x10 M.D., one round does 1D4 M.D. Rate of Fire: Standard. Range: 4,000 feet (1,219 m). Payload: As a machine-gun: 400 round belt. Black Market Cost: 110,000 credits. Rare.

**CTT-P40 Particle Beam Cannon.** This giant-sized rifle is a particle beam weapon with exceptional range (for a P-beam weapon). Mounted on the top of the rifle is a box laser targeting system and passive nightvision scope with telescopic capabilities (20x magnification; 3000 foot/914 m range). This weapon is standard issue for the Special Forces' Striker SAMAS and is frequently used by the Terror Trooper, full conversion 'Borgs, and the occasional CS Juicer. Weight: 89 lbs (40 kg). Mega-Damage: Particle beam: 1D6x10 M.D. per single blast. Range: 2,000 feet (610 m). Rate of Fire: Equal to the number of hand to hand attacks per melee round. Payload: 40 particle beam blasts — virtually the entire back half of the giant rifle/cannon is a rechargeable energy cell. Notes: Using the weapon one-handed requires a P.S. of 24 or greater and even then one-handed shooting has a penalty of -2 to strike, unless a Terror Trooper or Super SAMAS. Black Market Cost: Currently unavailable on the Black Market.

**CTT-M20 Missile Rifle.** The CTT-M20 Missile Rifle is an over-sized heavy weapon that's about twice the size of the typical energy rifle. It was specifically designed for the Terror Trooper Power Armor, but has been adopted by SAMAS pilots, full conversion 'Borgs and the occasional CS Juicer (Crazies would love 'em too; need two hands and a P.S. of 24 or better to use the weapon effectively). The CTT-M20 is standard issue for the Terror Trooper, although the CTT-P40 or a rail gun can be substituted. This weapon houses a row of mini-missiles down each of its long, twin barrels. Each pull of the trigger fires one mini-missile. Remember, mini-missiles are self-guided, so once launched they will find their target. Mounted on the top of the rifle is a box that is both a laser targeting system and medium-range laser. Weight: 110 pounds (49.5 kg) fully loaded; roughly 30 pounds (13.6 kg) less unloaded. Missile Type: Any mini-missile types can be used, but standard issue is armor piercing (1D4x10 M.D.) or plasma (1D6x10 M.D.). Mega-Damage: Varies with missile type. The laser does 2D6 M.D. per shot. Range: Mini-missiles: Usually about a mile (1.6 km). Laser: 2000 feet (610 m). Rate of Fire: One at a time, or in volleys of two or four. Payload: 20 total; 10 per launch tube. The laser mounted on the top of the CTT-M20 takes a standard E-Clip (20 shots) or long E-Clip (30 shots). Notes: The lower port on the box laser is a targeting sight that provide a bonus of +1 to strike. Using the weapon one-handed requires a P.S. of 24 or greater and even then one-handed shooting has a penalty of -2 to strike unless the shooter is in Terror Trooper or Super SAMAS power armor or has a P.S. of 36 or higher. Note: Not currently available on the Black Market.

**Enhanced Missiles.** The Coalition Army has been able to significantly increase the damage of its missiles without having to increase missile size. Both the old, light damage types and the new, heavy damage missiles are available. The light damage missiles are generally be-

ing sent to military outposts, bases, and city defenders in low risk, low hostility posts, cities and territories. The new, heavy damage missiles are most commonly made available to front-line troops, infantry troops and military posts in hostile regions.

### Short Range Missiles

<u>Warhead</u>	<u>Mega-Damage</u>	<u>Speed</u>	<u>Maximum Range</u>	<u>Blast Radius</u>	<u>M.D.C.</u>
High Explosive (light)	2D4×10	500mph (804kmph)	5 miles (8km)	10ft (3m)	5
High Explosive (medium)	2D6×10	500mph (804kmph)	5 miles (8km)	15ft (4.6m)	5
Fragmentation (light)	2D4×10	450mph (724kmph)	3 miles (4.8km)	20ft (6.1m)	5
Armor Piercing (medium)	2D6×10	650mph (1045kmph)	5 miles (8km)	5ft (1.5m)	5
Plasma/Napalm (medium)	2D6×10	500mph (804kmph)	3 miles (4.8km)	15ft (4.6m)	5
Tear Gas	None	200mph (321kmph)	1/2 mile (.8km)	10ft (3m)	5
Knock-Out Gas	None	200mph (321kmph)	1/2 mile (.8km)	10ft (3m)	5
Smoke (colors available)	None	300mph (482.7kmph)	1 mile (1.6km)	20ft (6.1m)	5
Fire Retardent	None	200mph (321kmph)	1/2 mile (.8km)	20ft (6.1m)	5

### Medium Range Missiles

<u>Warhead</u>	<u>Mega-Damage</u>	<u>Speed</u>	<u>Maximum Range</u>	<u>Blast Radius</u>	<u>M.D.C.</u>
High Explosive (light)	2D4×10	1200mph (1929kmph)	50 miles (80.4km)	20ft (6.1m)	10
High Explosive (medium)	2D6×10	1200mph (1929kmph)	40 miles (64.3km)	20ft (6.1m)	10
High Explosive (heavy)	3D6×10	1200mph (1929kmph)	40 miles (64.3m)	30ft (9.1m)	10
Fragmentation (light)	2D6×10	1000mph (1608kmph)	40 miles (64.3km)	40ft (12.2m)	10
Armor Piercing (medium)	3D6×10	1600mph (2571kmph)	60 miles (96.5km)	20ft (6.1m)	10
Plasma/Napalm (medium)	4D6×10	1400mph (2251kmph)	40 miles (64.3km)	40ft (12.2m)	10
Multi-Warhead*	5D6×10	1200mph (1929kmph)	80 miles (128.7km)	20ft (6.1m)	10
Smoke (colors available)	None	1000mph (1608kmph)	40 miles (64.3km)	40ft (12.2m)	10

### Long Range Missiles

<u>Warhead</u>	<u>Mega-Damage</u>	<u>Speed</u>	<u>Maximum Range</u>	<u>Blast Radius</u>	<u>M.D.C.</u>
High Explosive (medium)	3D6×10	2010mph (Mach 3)	500 miles (804km)	30ft (9.1m)	20
High Explosive (heavy)	4D6×10	2010mph (Mach 3)	500 miles (804m)	40ft (12.2m)	20
Fragmentation (light)	2D6×10	1400mph (2251kmph)	400 miles (643km)	80ft (24.4m)	20
Armor Piercing (medium)	3D6×10	2010mph (Mach 3)	800 miles (1286km)	30ft (9.1m)	20
Plasma/Heat (medium)	4D6×10	1400mph (2251kmph)	500 miles (804km)	40ft (12.2m)	20
Plasma/Heat (medium)*	5D6×10	1400mph (2251kmph)	500 miles (804km)	50ft (15.2m)	20
Proton Torpedo (heavy)*	6D6×10	2010mph (Mach 3)	1200 miles (1928km)	50ft (15.2m)	25
Nuclear (medium)*	1D4×100	2010mph (Mach3)	1000 miles (1608km)	40ft (12.2m)	20
Nuclear (heavy)*	1D6×100	2010mph (Mach 3)	1000 miles (1608km)	50ft (15.2m)	20
Nuclear Multi-warhead*	2D4×100	2010mph (Mach3)	1800 miles (2893km)	50ft (15.2m)	25

### Mini Missiles and Special Armaments

<u>Warhead</u>	<u>Mega-Damage</u>	<u>Speed</u>	<u>Maximum Range</u>	<u>Blast Radius</u>	<u>M.D.C.</u>
High Explosive	5D6	500mph (804kmph)	1 mile (1.6km)	5ft (1.5m)	1
Fragmentation	5D6	500mph (804kmph)	1/2 mile (0.8km)	20ft (6.1m)	1
Armor Piercing	1D4×10	1400mph (2251kmph)	1 mile (1.6km)	3ft (0.9m)	2
Plasma/Napalm (medium)	1D6×10	1200mph (1929kmph)	1 mile (1.6km)	15ft (1.5m)	1
Smoke (colors available)	None	500mph (804kmph)	1/2 mile (0.8km)	20ft (6.1m)	1

\*Available as smart bombs, +5 to strike.

**Fusion Blocks.** A fusion block is a little square case about the size of a handheld computer. On top of the block is a small key-pad for programming the time of detonation. An automatic 30 second delay is built into each fusion bomb as a safety feature to avoid instant detonation. Weight: 8, 12 and 16 lbs (3.6, 5.4 and 7.2 kg) respectively. Mega-Damage: Three types: Light: 1D4x10 M.D.; cost: 1,000 credits. Medium: 2D6x10 M.D.; cost: 3,000 credits. Heavy: 4D6x10 M.D.C.; cost: 8,000 credits. Blast Radius: Each has a contained blast radius of 10 feet (3 m). Range: The blocks are made for placement, not throwing or shooting, however, one can try throwing the explosive, typical range is 1D6x10 feet (3 to 18 m); fusion blocks are not aerodynamic. Black Market Cost: Listed with damage, above. Rare/poor availability.

**CS Hand Grenades.** Smaller explosive canisters designed for throwing and exploding. Weight: 0.5 lbs (.23 kg), to almost 1 lb (.45 kg) for Heavy HE and Plasma. Fragmentation: 2D6 M.D. to a 20 foot (6 m) area. Light High Explosive: 3D6 M.D. to a 6 foot (1.8 m) area. Heavy High Explosive: 4D6 M.D. to a 6 foot (1.8 m) area. Plasma: 6D6 M.D. to a 12 foot area (3.6 m) area. Effective Range Throwing a Grenade: About 40 yards/120 feet/36 m. Black Market Cost: 250 credits for fragmentation, 200 credits for light high explosive, 275 credits for heavy high explosive, and 350 credits for plasma. Good availability.

**CS Rifle Grenades:** Standard: 2D6 M.D. to a 12 foot (3.6 m) diameter blast area. Range: 1200 feet (365 m). Cost: 500-550 credits; good availability.

**Micro-fusion grenades:** 6D6 M.D. to a 12 foot (3.6 m) diameter blast area; available only as rifle launched rounds. Range: Typically 1200 feet (365 m). Black Market Cost: 1500-3000 credits. Extremely rare on the Black Market; those available are stolen from the CS.

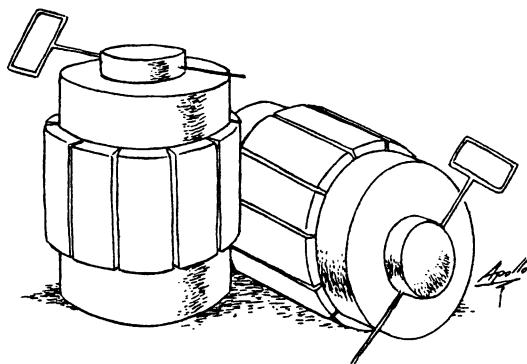

**Stun/Flash Grenade.** This riot/anti-terrorist weapon is designed to disorient and confuse criminals who are holding hostages in confined places. The grenade makes a loud exploding boom and emits a bright flash followed by a shower of white-hot sparklets and some white smoke. The flash, burning sparks, and smoke should blind and startle any character without environmental armor or protective goggles. The victims of a stun/flash grenade are -10 to strike, parry and dodge, -1 on initiative and lose one melee attack/action for the next 1D4 melee rounds (15 to 60 seconds). Even those in armor should be momentarily distracted for 1D4 seconds and lose initiative. Weight: 0.5 lbs (.23 kg). Cost: 100 credits. Poor availability.

**Tear Gas Grenades.** The gas will instantly affect all characters without protective masks or environmental body armor. The eyes burn, sting and water profusely, causing great discomfort and makes seeing clearly impossible. The gas also makes breathing difficult and irritates exposed skin. The effects last for 3D4 minutes. The 25 foot (7.6 m) cloud dissipates in about five minutes unless blown away by wind (dissipating more quickly in 1D4 minutes). The victims of tear gas are -10 to strike, parry and dodge, -3 on initiative and lose one melee attack/action for each of the next 1D6+1 melee rounds. Those in environmental armor are completely safe and not affected. Weight: 0.5 lbs (.23 kg). Cost: 200 credits. Poor to fair availability.

**Smoke Grenades.** This type of grenade releases a thick cloud of smoke that covers a 20 to 40 foot (6 to 12 m) radius. The smoke obscures vision in and through the cloud from those on the outside of it.

Infrared cannot penetrate a smoke cloud or be used inside one. Those inside the cloud will be blinded and have trouble breathing. Those who are not protected by environmental suits or a gas mask and goggles will be -5 to strike, parry and dodge and -1 on initiative. Attackers firing into/through the cloud will be shooting wild. Note that passive nightvision scopes will work in a smoke cloud. Weight: 0.5 lbs (.23 kg). Cost: 50 credits. Good availability.

**Hand-Held Flare.** This is the type of item truck drivers and road patrols use to signal for help or to warn others of an accident or danger. The flare burns for 20 minutes. Weight: 0.5 lbs (.23 kg). Cost: One credit each. Good availability.

**Parachute Flares.** This pyrotechnic device usually comes in a hand-held, throw-away launch tube. Three seconds after launching, it ignites into a bright, sparkling light that slowly drifts back down to earth. While in the air, the flare burns for 60 seconds and illuminates an area of roughly 150 feet (45.7 m) in diameter. Note: This is NOT a weapon but if shot into a person, the flare does 6D6 S.D.C. each melee round for one minute (four rounds). There is also a 50% chance of causing combustibles to catch fire. Weight: 1 lbs (.45 kg) with launch tube. Cost: 10 credits each. Excellent availability.

## CS Vibro-Blades™ & Other Hand Weapons

All Vibro-Blades are blade weapons surrounded by an invisible, high-frequency energy field that gives them Mega-Damage capabilities. Vibro-Blades were originally designed by the CS, but have been “knocked off” by virtually every weapon manufacturer in the Americas. Vibro-knives, claws and sabers are widely available throughout North America and Germany (Triax via a trade deal with the CS). In the CS they are also issued to ISS and NTSET officers, Psi-Hounds, military officers and Special Forces. The blades are ideal for the Dog Pack squads assigned to urban duty (where a full 60% of all Dog Boys are assigned) because the weapons provide close combat Mega-Damage capabilities avoiding the potential danger of long-range weapons which are hazardous to both human life and property. All Dog Pack city patrols are issued either two Vibro-Blades of choice, or have a blade and a neural mace. **Note:** The ancient weapon proficiency skills and bonuses apply to the Vibro-Blades. Claws fall into the W.P. Knife category.

**Vibro-Knife.** Mega-Damage: 1D6 M.D. Weight: 1 lb (.45 kg). Cost: 7000 credits.

**Vibro-Bayonet.** Mega-Damage: 1D6+1 M.D., designed for attachment to a variety of rifles, but rarely used by the CS. Cost: 7,500 credits.

**Vibro-Saber (short sword).** Mega-Damage: 2D4 M.D. Weight: 3 lbs (1.35 kg). Cost: 9000 credits.

**Vibro-Sword (large, one-handed sword).** Mega-Damage: 2D6 M.D. Weight: 4 lbs (1.8 kg). Cost: 11,000 credits.

**Giant-Sized Sword.** Mega-Damage: 3D6 M.D.; usually used by oversized power armor suits or by giant robot vehicles. Rarely used by the CS. Weight: 8 lbs (5.4 kg). Cost: 18,000 credits.

**Vibro-Spear.** Mega-Damage: 1D6 M.D. (2D6 M.D. if giant-sized). Rarely used by the CS. Cost: 11,000 credits.

**Vibro-Axe.** Rarely used by the CS. Mega-Damage: 2D6 M.D. (3D6 M.D. or 4D6 M.D. if giant-sized). Cost: 12,000 credits.

**Vibro-Pole Arm.** Rarely used by the CS. Mega-Damage: 3D6 M.D. for large blade pole arms (which is most), 4D6 M.D. if truly giant-sized. Cost: 15,000 or 20,000 credits depending on size.

**Vibro-Forearm Claws.** Mega-Damage: 2D6 M.D.; usually three hooked blades attached to a forearm gauntlet or protective plate. Great for parrying (+1 bonus) and slashing. Weight: 3 lbs (1.35 kg). Cost: 11,000 credits.

**CS Vibro-Blade Vambraces.** Dog Boys have forearm vambraces available to them with a variety of Vibro-Blades, large and small. These vambraces can be part of the DPM Riot Control Armor (half

suits) or the full environmental suit. Having armor or a vambrace with both forearm and hand-guard blades does not increase the overall damage, because only one set of blades can be used at a time; hand or forearm.

**Short Blade Hand-Guard.** Two short Vibro-Blades with serrated edges. Ideal for slashing and stabbing as well as sawing/cutting or chipping through light M.D.C. wire, plastic, and ceramics, or S.D.C. metal and concrete. Mega-Damage: 2D4 M.D. Cost: 9,000 credits.

**Triple-Bladed "Cat's Claw" Hand-Guard.** Three curved, claw-like Vibro-Blades, sharp on one or both sides, serrated or not. Damage: 3D4 M.D. Cost: 11,000 credits.

**Dual Long-Blade Hand-Guard (2).** A pair of long, sharp Vibro-Blades that are partially retractable (half length), maximum length is 10 inches (0.29 m). Ideal for slashing, stabbing and parrying. Mega-Damage: 2D6 M.D. Cost: 11,000 credits.

**Hooked Forearm Vibro-Blades (2).** The vambrace or forearm plate has a pair of hooked Vibro-Blades that are partially retractable (half length), maximum length is 20-24 inches (0.58 to 0.6 m). Excellent for slashing, parrying and hooking weapons and disarming opponents. They are also suitable for climbing (+5% to climb skill). Mega-Damage: 2D6 M.D. and is +1 to parry and +2 to disarm. Cost: 14,500 credits.

**Sabre Forearm Vibro-Blades.** The vambrace or forearm plate has a pair of straight blades that are partially retractable (half length), maximum length is 24 inches (0.6 m). Mega-Damage: 2D6+2 M.D. and is +1 to parry. Black Market Cost: 16,000 credits.

**Dog Pack Spikes.** One of the Dog Pack's patented images is spikes. This is largely a stylistic gimmick to evoke a feeling of fear and power. Spiked collars, arm and wrist bands, knee pads, gloves and vambraces are all available in a large variety of different styles. Damage for all spikes is S.D.C./Hit Point damage. The spiked gloves are weighted "sap gloves" and add 1D6+1 S.D.C. damage to punches. The knee pads have the weight and power of the leg behind it and add 1D6 S.D.C. to knee kicks. All others inflict 1D4 S.D.C. damage. The hand and arm spikes can also be used to parry normal S.D.C. attacks; +1 bonus to parry with spiked arm bands or glove only. Ideal in urban, civilian situations where Mega-Damage weapons are not appropriate. Cost: Varies; 50 to 200 credits.

**Neural Mace.** This hand-held weapon is used most commonly by the CS Dog Packs and Police. It is a stun weapon that releases an energy charge that temporarily short-circuits the nervous system. Damage: Non-lethal; the victim who is stunned is -8 to strike, parry, and dodge plus reduce the character's speed and number of attacks per melee round by half. The accumulative effect on the nervous system of the body being repeatedly struck and stunned may knock the victim unconscious, even if he has previously saved. After being struck more than four times, the unprotected character may be stunned into unconsciousness for 2D4 melee rounds. When he recovers, he will suffer the stun penalties for 1D4 minutes. Roll to save, a failed roll means there is a 01%-42% chance of being rendered unconscious. Note that in this case, even if the individual remains conscious, the charge will impair his movement as per the penalties previously described. Physical damage from the mace is 2D6 S.D.C. plus P.S. attribute bonus. when used as a club; 1D6 plus strength bonuses when used as a jabbing weapon. The mace is an M.D.C. structure and can be used to parry M.D. attacks from Vibro-Blades, 'Borgs, 'bots and power armor. Duration of Stun Effects: 2D4 melee rounds. The duration of the impairment is increased 2D4 melee rounds for every hit by the mace in which the character does not save. Save vs Neural Mace: 16 or higher; the same as saving against non-lethal poison. The character must save each time he or she is struck. A successful save means the character loses initiative and one melee attack/action that round but is otherwise okay. Note: The mace is ineffective against environmental, M.D.C. body and power armor, but is effective against Dog Pack armor and half suits, or body armor without a helmet (not fully environmental without the helmet attached). Black Market Cost: 8,000 credits. Payload: 8 zaps per E-Clip.

## CS Underwater Weapons (Navy)

**CSN-20 Speargun.** The gun can hold and fire three spears whether they are conventional, explosive tipped or special tracer or flare spears. It also has a light, short-range blue-green laser built into the lower housing of the weapon. Weight: 6 lbs (2.7 kg). Mega-Damage: Light Laser: 2D6 M.D. Fragmentation: 2D6 M.D. to a 10 foot (3 m) radius (inflicts 1D6 M.D. less damage on the surface); cost: 300 credits. High Explosive: 4D6 M.D. (inflicts 1D6 M.D. less damage on the surface); cost: 600 credits. Plasma: 4D6 M.D.; cost: 1000 credits. Flare: Emits a bright, sparking light; burns for 120 seconds. Cost: 15 credits. Tracer Bug: Transmits a radio signal that can be followed up to 8 miles (12.8 km) away. Battery powered with a life of 72 hours of constant transmission. The spear must stick into the target or fall on top of the object (without falling off). There is always a chance that the tracer bug will become dislodged and fall off (roll once for every half hour; 01%-32% chance). Cost: 200 credits each. Inflicts normal S.D.C. spear damage. Conventional spears inflict 2D6 S.D.C. and can be fired underwater or in the air with equal effectiveness. Rate of Fire: Spears: One at a time, or two or three simultaneously. Laser Blasts: Equal to the number of attacks of the user. Range: Spears: 200 feet (61 m) underwater or 300 feet (91 m) in the air. Laser: 1200 feet (365.7 m). Payload: 3 spears maximum. A pouch with 12 additional spears (conventional and/or explosive) is often carried by the diver, but each spear must be reloaded by hand and each action counts as one melee attack/action. Laser: 20 shots per standard E-Clip. Black Market Cost: Northern Gun and the Black Market offer knock-offs at the price of 21,000 credits.

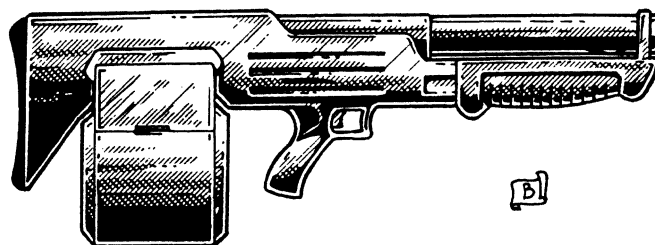

**CSN-T30 Torpedo-Grenade Launcher.** The CSN-T30 is a unique rifle of Coalition design created for underwater engagements. It is modeled after old-style non-energy auto-shotguns and fires special self-propelled explosive cartridges. These cartridges, called torpedo-grenades, are roughly the same size as standard CS rifle grenades and function in the same manner, but underwater. Exclusive to the CS Navy and is standard issue for Marine Commandos, and available to *Sea Dogs* and others upon special assignment. Weight: 10 lbs (4.5 kg). Mega-Damage: 4D6 M.D. to a blast area of 15 feet (4.6 m) per regular torpedo-grenade, or 1D4x10 M.D. to a blast area of 60 feet (18.3 m) with a new micro-fusion grenade. The micro-fusion torpedo grenades are experimental, in short supply, and seldom available even to CS Marines. Note: Explosives in general do 10-15% more damage underwater than on the surface as a result of the concussive effects of water; this damage factor is included in the torpedoes. Rate of Fire: One at a time, or up to six torpedo-grenades fired in rapid succession (burst if all at the same target, wild if sprayed into an area). Range: 400 feet (122 m) underwater. Torpedo-grenades can be fired on the surface but have a minuscule range of 30 feet (9 m), have a blast radius of 10 feet (3 m) and do less damage (3D6 M.D.; micro-fusion 6D6 M.D. to a 40 foot/12.2 m blast area). Payload: 10 shots per detachable circular drum magazine. Note: Standard CS rifle grenades can be fired from the CSN-T30 for surface combat. Black Market Cost: Neither the gun nor the micro-fusion grenades are available on the Black Market (if it were, it would sell for at least 30,000 credits).

**Limpet Mines.** Limpet mines are a type of explosive charge specially designed for underwater demolition. Horseshoe magnets are housed with the explosive charge in a plastic or metal container to allow secure attachment of the mine to a metal ship hull (or to any metal object for that matter). Once it is attached, the limpet mine is unobtrusive.

sive and, if discovered, very hard to dislodge due to the powerful magnets. A combined P.S. of 30 or higher (12 if supernatural P.S.) is required to remove a limpet mine. To make matters even more difficult, the Coalition has produced a limited number of limpet mines with electro-adhesive pads, much stronger than magnets, which can only be removed by a robot or with a supernatural strength of 30 or more! As with standard CS explosive munitions, the limpet mine is activated by an affixed key-pad/detonator. The detonator has a time delay feature that can be set for any length of time from 30 seconds to 5 hours. Instant detonation of a limpet mine is impossible; the time delay automatically sets to 30 seconds if no other value is entered. The Coalition manufactures both *fusion block* and *plastique* limpet mines in several models that inflict varying degrees of damage. There are three models of underwater fusion-type mines, each with a contained blast radius of 10 feet (3 m). Note: High explosives inflict more damage underwater because water is a better conductor of concussion waves than air.

**Fusion-Type Mines:** Use the damage values listed in brackets if the mine is detonated out of water. Mega-Damage: 1D6x10 M.D. (1D4x10 M.D. out of water/on the surface), 3D6x10 M.D. (2D6x10 M.D. surface) and 5D6x10 M.D. (4D6x10 M.D. surface). Weight: 10, 14 & 18 lbs (4.5, 6.3, & 8.1 kg).

**Plastique Mines:** Blast radius that can be contained to a few feet or made to cover an area as big as 50 feet (15.2 m). Damage: 1D4x100 S.D.C./1D4 M.D. (2D4x10 S.D.C. or one M.D. on the surface), 1D6x10 M.D. (1D4x10 M.D. on the surface), 2D4x10 M.D. (1D6x10 M.D. on the surface), 1D4x100 M.D. (4D6x10 M.D. on the surface). Weight: 10-25 lbs (4.5-11.3 kg). Note: Conventional explosives and hand grenades detonated in the water will do roughly 10-15% more damage.

Cost: Fusion Type: 1,600, 3,600, and 10,000 credits respectively. Plastique: 600, 1,400, 2,200 and 12,000 credits respectively. Rare; very poor availability outside of the CS & Quebec Military.

## Colombian Weapons

### Rifts® World Book Six: South America (One)

Besides the weapons listed in this section, Colombia's dealings with the *Silver River Republics* enable them to acquire many energy weapons and powered armor suits identical to or similar to the ones found in North America. For example: There is an Argentinean series of laser weapons sold in Colombia that closely resemble Wilk's and Northern Gun products, and rail guns and grenades identical to Northern Gun, Iron Heart and Manistique models. In addition, there is an ample supply of archaic S.D.C. firearms; mostly pistols, rifles and machine-guns, as well as bow weapons, blow guns, swords, machetes, knives, and hatchets.

Over the last few years, some indirect trade via pirates has begun between the residents of the *Splugorth's Atlantis* and the Republic of Colombia. The pirates gladly exchange slaves and other goods for Atlantis made weapons and armor; mostly Kittani exports. As a result, elite units, mercenaries and private individuals may have access to Kittani plasma swords, energy weapons, rail guns, Kittani Explorer armor and Manling power armor, as well as a few vehicles, and the occasional lesser rune weapons, or Bio-Wizard item. As usual, however, the Kittani reserve their best equipment for their own use, so they are not usually for sale (if they are, they are extremely expensive). See *Rifts® Atlantis* for information about this technology.

"C" series weapons are only manufactured at *Camargo*, where an Argentinean-sponsored weapons factory survived the Coming of the Rifts.

**RC-10 Laser Pistol.** A low-powered laser gun that represents the best that can be produced with local technology. Popular with street gangs and local police. Soldiers disdain its use due to its low power and damage. Weight: 2 lbs (0.9 kg). Mega-Damage: 1D6 M.D. Rate of Fire:

Standard. Range: 1000 feet (305 m). Payload: 20 shots. Market Cost: 9,000 credits.

**RC-15 Laser Rifle.** Standard issue weapon of the Colombian Army. It too is very primitive compared to North American or European models, but it can take a beating, holds up well in the hot and humid jungle and has excellent stopping power. Many think of it as an energy shotgun. Weight: 21 lbs (9.5 kg). Mega-Damage: 3D6+6 M.D. Rate of Fire: Standard. Range: 1000 feet (305 m). Payload: 20 shots. Market Cost: 14,500 credits.

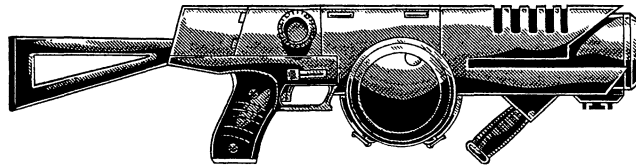

**Dragon-1 Plasma Projector.** A heavy plasma cannon similar to the Coalition's C-27, minus the targeting scope and with a lighter charge. Usually distributed to Anti-Monsters or heavy weapon squads. Weight: 21 lbs (9.5 kg). Mega-Damage: 5D6 M.D. Rate of Fire: Standard. Range: 1200 feet (366 m). Payload: 12 shots. Market Cost: 20,000 credits.

**RP-C20 Rocket Pistol.** The weapon fires self-propelled ammunition. The gun has a gas propellant tank that ejects the rocket at bullet speed, then once it is airborne, air vents on the nose of the bullet ignite the jet fuel inside it, turning it into a fast rocket with an explosive tip. Weight: 4 lbs (1.8 kg). Mega-Damage: 3D6 M.D. standard explosive round. Wooden warheads (for anti-vampire purposes) inflict 1 M.D. point to normal targets, but do 4D6 damage to vampires. Rate of Fire: Standard. Range: 1200 feet (366 m). Payload: 9 shots. Market Cost: 14,000 credits for the pistol; 80 credits per standard explosive round or 50 credits per wooden warhead (anti-vampire) round.

**RR-C40 Rocket Rifle.** The rifle version, firing the exact same cartridge. The rocket rifle has semi-automatic and automatic firing capabilities; the flip of a selector switch makes the proper adjustment. The rifle also has a larger magazine capacity. Weight: 21 lbs (9.5 kg). Mega-Damage: A single round inflicts 3D6. A burst is 10 shots and does 1D4x10 M.D. Wooden warheads (for anti-vampire purposes) inflict 1 M.D. point to normal targets (1D4 M.D. on a burst), but do 4D6 damage to vampires or 1D6x10 on a burst. Rate of Fire: Standard. Range: 1,200 feet (366 m). Payload: 60 or 100 shot ammo clip. Market Cost: 35,000 credits for the rifle; 80 credits per standard round or 50 credits per wooden warhead round.

**RAR-C15 Rocket Auto-Cannon Rifle.** A slightly smaller and lighter, rifle version of the heavy tripod weapon limited for the use of robots, cyborgs, power armor troops and characters with a P.S. of 24 or greater. Characters with a lower P.S. cannot use the RAR-C15 because it is too heavy (-10 to strike and can barely be lifted and aimed), unless it is mounted on a vehicle or tripod and manned by two operators with a combined P.S. of 24 or greater. When fighting vampires, the gun is loaded with solid wood warheads. Weight: 50 lbs (23 kg). Mega-Damage: A single round inflicts 3D6+5. An eight round short burst does 1D4x10 M.D.; a long burst is 20 rounds and inflicts 2D4x10 M.D. Wooden warheads (for anti-vampire purposes) inflict one M.D. point to normal targets (1D4 M.D. on a burst), but do 4D6 damage to vampires or 1D6x10 on a short burst and 2D6x10 on a long burst. Rate of Fire: Standard. Range: 2000 feet (610 m). Payload: 200 round belt (allowing for ten long bursts or 25 short bursts). A 48 round magazine can be substituted if so desired (that's six short bursts, or two long bursts and one short). Market Cost: 65,000 credits.

**RA-C15 Rocket Auto-Cannon.** A larger, crew-served, heavy weapon used either in vehicles or as the tripod-mounted support gun of a squad. A rifle model (RAR-C15) is often carried by the Anti-Monster and other cyborgs and exoskeleton troopers. The RA-C15 (and RAR-C15) uses a larger rocket than the standard rifle model and can use either a long magazine or a belt fed ammo drum. A typical crew is

a two- or three-man team with a combined strength of 30. This weapon has superior firepower and range. Weight: 70 lbs (32 kg). Mega-Damage: A round does 4D6 M.D. An eight round short burst inflicts 1D6x10 M.D. A long burst is 20 rounds and inflicts 2D6x10 M.D.; wooden warheads (for anti-vampire purposes) inflict 2 M.D. points to normal targets (2D6 M.D. on a long burst), but do 6D6 damage to vampires or 2D6x10 on a short burst or 3D6x10 on a long burst. Rate of Fire: Standard. Range: 2600 feet (792 m). Payload: 400 round belt (allowing for 20 long bursts or 50 short bursts). A 48 round magazine can be substituted if so desired (that's six short bursts, or two long bursts and one short). Market Cost: 85,000 credits.

## Colorado Baronies™

The Colorado Baronies is a small kingdom that manufactures, uses and sells conventional S.D.C./Hit Point weapons, particularly Old West styled revolvers and rifles, as well as some other conventional weapons and basic adventuring gear. However, they are most famous for producing a variety of Techno-Wizard (TW) weapons. Magic weapons are not presented in this book, but can be found in the **Rifts® Book of Magic**, another massive sourcebook dedicated to everything magical.

## Conventional S.D.C. Weapons

These are mostly knock-offs of pre-Rifts leftovers using chemical propellant to fire a small metal slug. They inflict S.D.C./Hit Point damage only, and are most commonly used by ordinary folk for *hunting* or *home defense*. Needless to say, they are virtually useless against foes packing Mega-Damage firepower, but that does not stop old weapons from being used by the hundreds of thousands across North America and elsewhere in the world.

### Modifying Conventional Weapons

The following gun modifications and options were originally presented in **Rifts® Australia**, but they can be just as easily exported to any of the world's other hard luck locales, from the ruins of a major American city, to a vast and harsh Rift-ridden wilderness. For convenience, we have converted the prices from Aussie dollars to Universal Credits.

**Customized Grip (available for all guns)**: 200 credits. Adds +1 to strike, but only for one individual, -1 to strike for others who use the gun. If the character buys a weapon that has had its grip modified for someone else in the past, then he can usually subtract 80 credits from its price.

**Extended Barrel (pistols and SMGs only)**: 100 credits. Adds 50 feet (15.2 m) to the effective range.

**Extended Magazines (guns with magazines only; no revolvers, shotguns or weapons with cylinders or internal magazines)**: 100 credits. Increase the ammo payload by 50%. So a gun that originally held 12 would hold 18 bullets, for example.

**Flash Suppressor (any rifle)**: 90-120 credits. A muzzle that reduces the flash and flare caused by a round being fired. Really only visible at night, muzzle flash can easily give away a sniper's position. The key word here is flash "suppressor." It is still there, simply the angles from which the flare can be seen are reduced.

**Full-Auto Capacity (automatic pistols only)**: 50-100 credits. By cutting firing pins and reconfiguring venting, a pistol can be modified to fire in full-auto mode (i.e. fires half its payload with every press of the trigger). This is not a common modification, as ammo is too precious.

**Full-Auto Trimming (any weapon capable of bursts and sprays)**: 60-100 credits. Most wise wilderness folk will usually have this done to their weapons. The modification changes the weapon into single shot or volley capacity only, therefore reducing the chance of wasting bullets.

**Hair Trigger (revolvers, pistols and submachine-guns only)**: 200 credits. The trigger has been filed and modified to fire with a light touch. +1 to initiative.

**Improved Balance (any automatic firearm)**: 150 credits. Through better venting, better balance and so forth, a gun is made to be more accurate. +1 to strike, even when fired Wild.

**Sawed Off (shotguns only)**: 20 credits (nothing to do it oneself). Reduce the range in half. If using buckshot, subtract 1D6 from damage, but add +2 to strike. The G.M. may also allow the user to strike multiple targets with one shot with buckshot, if they are close together (within 3-5 feet/0.9 to 1.5 m of each other).

**Silencer (submachine-guns and automatic pistols only)**: 120-150 credits. These reduce the noise a round makes when fired. Not very popular; people who own guns in the wilderness want to announce the fact. Reduce range by 15% when a silencer is used.

**Speed Loader (revolvers only)**: 25-50 credits. Not a modification, but an accessory. Bullets are held in a dummy barrel that speeds reload time to one melee action, as opposed to the time that revolvers would otherwise take to reload (one full melee round or four actions, whichever comes first).

### Weapon Deterioration Rules

Some thoughts about weapon reliability. Used guns, old relics and weapons found in the wilderness or among ruins get knocked out of joint, suffer from rust and dirt buildup in the barrel or trigger, and so on. Without proper cleaning and care, guns become less reliable. Harsh wilderness environments and the extensive use of a gun places severe wear and stress on the mechanism. Any weapon (conventional or energy based) that is "found" is likely to need cleaning and repair. The following table presents likely random problems from weapons left to the elements. The G.M. can easily adopt these rules to include M.D. energy weapons as well. A successful roll on the *Recognize Weapon Quality* skill will reveal any of these faults without having to find out the hard way (i.e. trying to use it).

### Weapon Condition Table (roll percentile dice)

- 01-02%**: Excellent! Like new, +1 to strike and gets top dollar in trade.
- 03-10%**: Excellent condition, although it shows signs of use, the weapon has been well maintained, and gets good value in trade.
- 11-50%**: Used and worn, but a fine weapon. No penalties. Good to fair trade value.
- 51-60%**: Mild Corrosion. Looks poor and the trigger is stiff (-1 to strike); gets mid- to low-range value in trade. When shooting it, if a 1-6 is rolled to strike, the weapon jams and must be stripped and parts shaken to unjam. The problem will never go away until thoroughly cleaned. Gets a mere 20% of its value in trade.
- 61-70%**: Heavy with corrosion. Looks terrible and the trigger is stiff (-3 to strike, -2 on initiative/quick draw); gets bottom dollar in trade (12 +1D6%), maybe less! When shooting it, a roll of 1-10 to strike means the weapon jams and must be stripped and parts shaken to unjam. The problem will never go away until thoroughly cleaned and the trigger filed and adjusted.
- 71-80%**: Heavy with corrosion and/or damaged. Looks terrible and the trigger is incredibly stiff and tends to stick (-4 to strike and -3 on initiative/quick draw); gets bottom dollar in trade (10+1D4%), maybe less! When shooting it, a roll of 1-5 means the trigger sticks and keeps shooting whether the gunman wants it to or not! It will fire until its payload is completely expended. To get it to stop, the weapon must be struck violently against the ground, a rock, etc. (striking the gun counts as one melee action). A roll to strike that is a 6-12 means the weapon jams and must be stripped and parts shaken to unjam. The jamming problem can be fixed with a thorough cleaning, but the sticking requires a complete trigger replacement and adjustment.
- 81-90%**: Severely corroded and damaged. The weapon just won't work and gets minimal payment (5%). It requires some new parts, and



machining equipment to clear and repair it for firing again. Once fixed, cleaned and polished, it is as good as new.

**91-95%:** Severely corroded and damaged, but can fire. However, using the weapon is dangerous. Looks like crap, is -4 to strike and -3 on initiative/quick draw, and gets the lowest payment one might get for a weapon (1 or 2%). When shooting it, a roll of 1-5 means the gun jams and explodes! The shooter takes half damage from the round that he would have fired. The gun can be repaired, but at -30% to the repair skill roll and costs 20% the value of a good, working gun.

**96-00%:** A complete loss, even if the weapon looks fairly good at a quick glance, most of it is a mangled piece of scrap or corroded into one solid piece and beyond repair. If fact, just handling it may cause pieces to break and fall off. No value. Junk.

## Common Conventional S.D.C. Weapons

**Price Note:** The price listed is for a basic, no frills weapon. Double or triple the price for extra fancy features like nickel plating, pearl handle, special grip.

**Bow & Arrow:** S.D.C. Damage: 1D6 for a Short Bow, 2D6 for a Long Bow or Cross Bow. Base Range: Short Bow: 340 feet (104 m), Long Bow: 640 feet (195 m); may be extended via W.P. or special and magical bows. Rate of Fire: One arrow at a time; each shot counts as one melee action unless one takes W.P. Archery & Targeting skill. Payload: Typical quiver can carry 24 arrows. Cost: Typical short bow: 200 credits. Typical long bow: 400 to 600 credits. Typical modern composite bow: 500 to 1200 credits. Typical traditional crossbow: 400 to 600 credits. Typical crossbow pistol: 200 credits. Typical modern crossbow: 600 to 1200 credits. Note: The modern bow weapons are product of high technology and are generally made of man-made materials, lightweight (2-5 lbs/0.9 to 2.25 kg), and are very durable and accurate. See *Miscellaneous Weapons* for high-tech arrows.

**.38 or .40 Caliber Derringer.** Easy to palm and conceal and fits in a pocket, belt or boot. Weight: 1 lb (.45 kg). S.D.C. Damage: 3D6 per shot. Payload: Two rounds. Range: 40 feet (12.2 m). Single shot.

**.22 or .25 Revolver.** Made by a variety of manufacturers, this is the kind of "Saturday Night Special" most commonly sold in the pre-Rifts U.S. Commonly used for protection or for committing crimes. Generally, they are lightweight and have a limited effective range. Weight: 1 lb (.45 kg). S.D.C. Damage: 1D6 per round. Rate of Fire: Standard. Range: 50 to 150 feet (15.2 to 45.7 m). Payload: Typically 6 or 8 shots. Cost: 150 to 500 credits. Excellent availability.

**.38 Revolver.** A standard police officer's sidearm. Roughly the equivalent of all .38 specials. Weight: Just under 2 lbs (.9 kg). S.D.C. Damage: 2D6 per shot; there is also a .38+ power round that does 3D6 S.D.C. per round. Rate of Fire: Standard. Range: 150 feet (45.7 m). Payload: 6 shots. Cost: 250 credits.

**.45 Automatic Pistol.** Formerly the standard sidearm for many militaries before it was replaced by the 9mm automatic. Still, this pistol remained in wide use, where its knockdown power made it a wartime favorite. Weight: Just over 2 lbs (.9 kg). S.D.C. Damage: 4D6 per round. Rate of Fire: Standard. Range: 135 feet (41.1 m). Payload: 7 shots. Cost: 400 credits.

**.357 Magnum Revolver.** Weight: Just over 2 lbs (.9 kg). S.D.C. Damage: 4D6 per shot. Rate of Fire: Standard. Range: 150 feet (45.7 m). Payload: 6 shots. Cost: 400 credits.

**7.65 mm Automatic Pistol.** This is typical of the kind of small automatic pistol used for protection and criminal activities. Weight: 1.5 lbs (.68 kg). Damage: 2D6 per round. Rate of Fire: Standard. Range: 120 feet (36.5 m). Payload: 8-15 shots depending on the magazine/clip. Cost: 500 credits.

**9mm Automatic Pistol.** Used as a sidearm by many pre-Rifts military personnel, terrorists, and well-equipped criminals. Weight: Just under 2 lbs (.9 kg). Damage: 3D6 per round. Rate of Fire: Standard. Range: 120 feet (36.5 m). Payload: Typically 13 to 17 shots depending on the clip. Cost: 600 credits.

**10mm Automatic Pistol.** Used as a sidearm by many pre-Rifts military personnel, terrorists, and well-equipped criminals. Weight: 2 lbs (.9 kg). S.D.C. Damage: 4D6. Rate of Fire: Standard. Range: 120 feet (36.5 m). Payload: Typically 13 to 17 shots depending on the clip. Cost: 800 credits.

**7.65 Submachine-gun.** This was the kind of fast-firing, easy-to-hide weapon favored by terrorists. It saw a lot of use in the Eastern Bloc and throughout the Third World. Weight: 3.5 lb (1.58 kg). S.D.C. Damage: 1D8 per round. Rate of Fire: Standard. Range: 150 feet (45.7 m). Payload: 10 to 30 round magazines. Cost: 900 credits.

**.45 Submachine-gun.** Weight: 6.25 lbs (2.81 kg). S.D.C. Damage: 4D6 per round. Rate of Fire: Standard. Range: 600 feet (183 m). Payload: 30 shot magazine. Cost: 700 credits.

**9mm Submachine-gun.** An extremely common weapon throughout the world among military and security personnel, terrorists, mercenaries, police forces, and criminals. Weight: 7.5 lbs (3.38 kg). S.D.C. Damage: 3D6 per round. Rate of Fire: Standard. Range: 600 feet (183 m). Payload: 20, 25 or 30 round magazines. Cost: 900 credits.

**9mm Submachine Pistol.** Similar to the 9mm submachine-gun in most respects except for range and accuracy. Weight: 5.5 lbs (2.48 kg). S.D.C. Damage: 3D6 per round. Rate of Fire: Standard. Range: 500 feet (152.4 m). Payload: 15 to 30 round magazines. Modifiers: -2 to strike when burst firing, and another -2 to strike when shooting at anything beyond 150 feet (45.7 m). Cost: 800 credits.

**12 Gauge Shotgun.** Far and away, the most common type of shotgun in use throughout the world. There were shotguns of larger and smaller gauge, but these never were so commonly used as the 12 gauge. Weight: Under 7 lbs (3.15 kg). S.D.C. Damage: 4D6 (buckshot), 5D6 (solid slug), 6D6 (rocket propelled slug or flechette). Rate of Fire: Standard. Many shotguns were Aimed fire only, however. Range: 300 feet (91 m). Payload: Break-open shotguns typically carried one or two rounds. Tubular mag shotguns carried 3 to 8 rounds. Magazine or rotary drum shotguns carried 6 to 20 rounds. A few even accommodated ammo drums of up to 50 rounds. Cost: 300 to 900 credits.

**.30 Rifle.** There were hundreds of variants of this weapon, both for hunting and military purposes. In almost all cases, it was a hard-hitting, accurate and reliable weapon used worldwide by private citizens and military personnel alike. Weight: 7-20 lbs (3-9 kg). S.D.C. Damage: 5D6 per round. Rate of Fire: Standard, though there are variants that are Aimed fire only, just as some gunsmiths have modified weapons to be Burst fire only. Range: 1,200 feet (365.8 m). Payload: Single-shot up to a 15 round magazine. Cost: 400 to 1,000 credits, depending on their features and quality of weapon (some are valuable collectors' items).

**5.56 Assault Rifle.** Common throughout the world as a standard military battle weapon. Only the 7.62 mm assault rifle was more common. In the world of Rifts, villagers frequently use such weapons for hunting and defense. They are also commonly used by mercenaries, bandits and militiamen. Weight: 6.5 lbs (2.93 kg). S.D.C. Damage: 4D6 per round. Rate of Fire: Standard. Range: 1,200 feet (365.8 m) Payload: 20 or 30 round magazines, typically. Some experimental drums holding up to 50 or 100 rounds were manufactured but not commonly used. Cost: 700-1,200 credits.

**7.62 mm Assault Rifle.** The most common battle weapon in use before the Rifts, and still widely used after the world went to hell in a handbasket. What they lacked in range they made up for in rugged construction and utter reliability. Weight: 9.5 lbs (4.28 kg). S.D.C. Damage: 4D6 per round. Rate of Fire: Standard. Range: 900 feet (274.3 m). Payload: 30 round magazine. Cost: 900-1,500 credits.

**.30, 5.62, and 7.62 mm Light Machine-gun.** These were the most common light machine-guns used all over the world. They generally saw action as man-portable squad support weapons. Weight: 15.25 lbs (6.75-11.25 kg). S.D.C. Damage: 5D6 per round. Rate of Fire: Standard, though many were Burst firing only. Range: 3,000 feet (914.4 m). Payload: 30 round magazines and ammo belts or drums of 100, 200 and

250 rounds. Cost: 2,000 credits and up. Illegal and banned in most civilized settlements.

**.50, 12.7 mm and 14.5 mm Heavy Machine-gun.** These are commonly found mounted on military vehicles. Weight: 30-100 lbs (13.5-45 kg). S.D.C. Damage: 7D6 per round. Rate of Fire: Burst firing only. Range: 3,000 feet (914.4 m). Payload: Ammo belts or drums of 100 to 1,000 rounds. Cost: 5,000 credits and up. Banned and highly illegal for private use in most settlements. Military issue.

**66mm Light Antitank Weapon (LAW).** By the time of the Rifts, these weapons had largely been phased out on the modern battlefield, instead finding a niche among terrorists, revolutionaries and the occasional criminal. Weight: 5.2 lb (2.34 kg). S.D.C. Ordnance: 1D4x10 or 1D6x10 S.D.C. to a 10 foot (3 m) area. Mega-Damage: 1D6 M.D. Rate of Fire: Aimed fire only. Range: 1,000 feet (305 m). Payload: Use once and discard. Cost: 2,000-2,500 credits for S.D.C. LAWs, 15,000 credits for M.D. version. Fair to poor availability. Illegal in most communities.

**Rocket Launcher.** Sometimes called the "super bazooka," this was commonly used against armored fighting vehicles and fortified bunkers. In the anarchy and civil wars worldwide shortly before the Coming of the Rifts, devices such as these wrought utter havoc in the cities of the world. Weight: 12 lbs (5.4 kg). S.D.C. Ordnance: 2D4x10 or 2D6x10 S.D.C. to a 30 foot (9 m) area. Mega-Damage: 2D6 or 3D6 M.D. depending on the rocket to a 40 foot (12 m) area. Rate of Fire: Aimed fire only. Range: Up to one mile (1.6 km). Payload: From one to six shots. Single-shot rocket launchers are most common for infantry; multiple-shot launchers were usually vehicle-mounted. Bonuses: Those with a special guidance systems (laser targeting) are +3 to strike. Some of these had attached 9mm spotting guns that fired single tracer rounds to help aim the weapon (tracer rounds identical to a 9mm automatic pistol, only with triple the range). When using a spotter gun, if the spotter round hits, and the gunner fires the rocket at the exact spot, +2 bonus to strike with this system. Cost: 2,000-5,000 credits for S.D.C. rocket launchers, 30,000-40,000 for M.D. launchers without guidance system, 8,000+ for guidance system. Fair availability. Banned and illegal in most civilized communities.

**90mm Recoilless Rifle.** This is an older version of the rocket launcher. Like the LAW, it no longer had a place on the modern battlefield by the Coming of the Rifts, except for certain third world hot spots where these venerable weapons kept busy. Weight: 35 lbs (16 kg) unloaded. S.D.C. Ordnance: 1D4x10 S.D.C. to a 20 foot (6 m) area. Mega-Damage: 2D6 to a 40 foot (12 m) area. Rate of Fire: Aimed fire only, but can only be fired once per minute (four melee rounds). If fired continuously for 10 minutes in a row, a 15 minute cooling off period must be observed, or the next shot will explode the weapon. Range: 1,200 feet (365.8 m). Payload: Single shot, basically the rocket launcher version of the bolt-action or muzzle-loading rifle. Cost: 2,000-6,000 credits for S.D.C. types; 25,000 to 35,000 for M.D. Rifles. All are banned and illegal in most civilized communities.

**40 mm Grenade Launcher.** An incredibly common weapon used by infantry in the late modern age. Assault rifles commonly had single-shot grenade launchers fitted under the barrel, while multi-shot grenade launchers were carried as a squad support weapon or mounted on vehicles (especially jeeps and helicopters). Weight: 11 lbs (.5 kg). S.D.C. Ordnance: 6D6 points of damage to a 10 foot (3 m) area. Mega-Damage: 1D6 or 2D6 M.D. depending on the type of grenade, to a 12 foot (3.6 m) area. Rate of Fire: Varies. Single-shot and certain magazine-fed grenade launchers are Aimed fire only. Heavy grenade launchers have a Standard rate of fire, or are Burst firing only. Range: 1,200 feet (365.7 m). Payload: Many carried a single shot and had to be reloaded after each use. Multi-shot grenade launchers used magazines, belts or drums ranging from 6 shots to 100 shots. Cost: 1200 credits for a single-shot S.D.C. grenade launcher, 4,000-6,000 credits for multi-shot rifles, and 18,000-24,000 for M.D. launchers and rifles. 1D6 M.D. grenades cost 275 credits, 2D6 M.D. grenades cost 550 credits. All are banned and illegal in most civilized communities.

**Tranquilizer Rifle.** This is a bolt-action rifle designed to fire a tranquilizer dart. Its effective range is about half that of a normal rifle. Weight: 4 lbs (1.8 kg). Range: 800 feet (244 m). Rate of Fire: Aimed fire only. Damage: Tranquilizer will render its victim unconscious within 1D4 melees unless he saves vs non-lethal poison. Even if the save is successful, victim will become woozy in 1D4 melees, making him -2 to strike, parry, and dodge and -10% to skill rolls for 4D4 minutes. Duration: Effects last 4D4 minutes. Cost: 800-1500 credits. Uncommon.

**Dart Gun.** This is basically a pistol version of the rifle above. Weight: 2 lbs (.9 kg). Range: 110 feet (33.5 m). Rate of Fire: Aimed fire only. Damage: Tranquilizer will render its victim unconscious within 1D4 melees unless he saves vs non-lethal poison; same as Tranquilizer Rifle above. Duration: Effects last 4D4 minutes. Cost: 500 credits. Uncommon.

**Gas Gun.** The gas gun is a long, wide, tubular barreled handgun that fires a gas canister. Weight: 3 lbs (1.35 kg). Types of gases: Tear Gas, Tranquilizer (knockout), Nerve Gas, and Smoke Gas/Screen. Range: 160 feet (48.8 m). Rate of Fire: One shot per melee. Damage: Varies with the type of gas used. Uncommon. Cost: 600 credits for the gun. Tear Gas and Tranquilizer Gas Canisters cost 50 credits each. Cost of Nerve Gas: 75 credits each. Cost of Smoke: 25 credits each. Note: See Gas Grenades under *Japanese Explosives* for the effects of the various gases.

**Stun Gun.** This hand-held item is made of plastic, with a pair of contact posts on the business end. When the trigger is depressed, it discharges a couple thousand volts of electricity into the victim, stunning him. Weight: 2 lbs (.9 kg). Damage: Victims are dazed, -8 to strike, parry and dodge, for 2D4 melees. A successful saving throw vs non-lethal poison means that the person has successfully fought off the effect and is unimpaired. Roll to save against each successful strike. Range: Touch. Rate of Fire: Equal to the number of melee attacks. Energy Capacity: 10 charges per standard E-Clip. Cost: 200 credits, plus cost of E-Clip (around 3,000 credits).

**Stun Blaster.** This pistol fires an energy charge that short-circuits the nervous system. Weight: 3 lbs (1.35 kg). Damage: Victims are dazed, -10 to strike, parry and dodge, for 2D4 melees. A successful saving throw vs non-lethal poisons means that the person has successfully fought off the effect and is unimpaired. Roll to save against each blast that strikes. Range: 100 feet (30.5 m). Rate of Fire: Aimed fire only. Energy Capacity: 10 charges per standard E-Clip. Cost: 4,000 credits plus cost of E-Clip (3,000 credits). Uncommon.

## Empire of the Sun Weapons™

### Rifts® World Book Nine: South America Two

Most of the technology of the pre-Rifts nations of *Peru* and *Bolivia* was lost during the Great Cataclysm. A few energy weapons from that period have been hoarded and jury-rigged over the centuries, but the bulk of the Inca's technological weapons come from the city-state of *Arequipa*, or from trade with the D-Bee/Human nation of *New Babylon* of the Silver River Republics. A few other goods and products also come from other SRRs, including the nation of Santiago. The Empire is a big market for Glitter Boy power armor. Glitter Boys are liked because they look like homages to the sun god, plus they are extremely efficient weapons. Some Inca soldiers also use captured Arkhon weapons. *Arequipa* has one of the few factories where Arkhon weapons can be converted and retooled to accept Earth energy clips. The factory only works on *captured* weapons; they can not build their own from scratch. Note: These weapons are available only in the Peru region. Cost also reflects that region and would easily cost 2-3 times more in other parts of the world.

**Inti-10 Variable Laser Pistol.** The frequency of the laser beams can be changed which allows it to defeat laser-resistant armor like the Glitter Boy and similar alloys. Unfortunately, this weapon was developed as a countermeasure against Arkhon Cerasteel armor, and in that regard, it is a failure. The pistol has been adopted as the Imperial armies' sidearm. Note: The variable frequency laser system will defeat laser-resistant armor 1D4 attacks after the first hit. Weight: 2 lbs (0.9 kg). Mega-Damage: 2D4+2 M.D. Rate of Fire: Standard. Range: 1,000 feet (305 m). Payload: 10 shots. Cost: 10,000 credits.

**Inti-20 Variable Laser Rifle.** A rifle version of the laser pistol, the Inti-20 is the standard issue long-arm of the Inca Army, equipping about 60% of the infantry (the other 40% use rocket rifles). Note: The variable frequency laser system will defeat laser-resistant armor 1D4 attacks after the first hit. Weight: 4 lbs (1.8 kg). Mega-Damage: 2D6+6 M.D. per single shot or 1D4x10+10 M.D. for a triple pulse. Rate of Fire: Standard. Range: 2,000 feet (610 m). Payload: 24 shots. Cost: 18,000 credits.

**Illapa-1 Rocket Pistol.** Fires 15mm explosive bullets. These fat pistol bullets (about twice as thick as a .45 round) are fed from a drum magazine located in front of the trigger guard, making it a front-heavy and rather clumsy gun. The 15mm explosive rounds are comparable to lasers in terms of damage and penetration, and work very well against Arkhon Cerasteel armor. Weight: 5lbs (2.25 kg). Mega-Damage: 2D6+4 M.D. per shot. Rate of Fire: Standard. Range: 600 feet (183 m). Payload: 80 shots in drum magazine or 20 in a small clip. Cost: 14,000 credits; each bullet costs 20 credits.

**Illapa-5 Rocket Rifle.** The Illapa-5 rifle fires 15mm "long" cartridges. These rifle warheads are longer and pack more punch than the pistol ammo, and have much better range. Like all Illapa weapons, the ammunition is carried in a drum magazine, somewhat similar to the magazine in the Thompson submachine-gun (but the gun design is far different). Weight: 9 lbs (4 kg). Mega-Damage: 4D6 M.D. per shot. A three round burst does 1D4x10 M.D., and a 10 round burst inflicts 2D4x10 M.D. Rate of Fire: Selective fire; single aimed shots, 3-round bursts, and 10-round bursts. The weapon has a disengage mechanism that prevents full-automatic fire (the gun stops cycling after 10 rounds have been shot and until the soldier releases the trigger and presses it again). Range: 2400 feet (731.5 m). Payload: 60 shot drum magazine. Cost: 26,000 credits.

## Free Quebec™ Weapons

### Rifts® World Book 22: Free Quebec™

Many of Free Quebec's weapons have a bit of an old German Mauser styling. They are also a bit reminiscent of the sleek, black Wilk's laser weapons. Their distinct styling has become preferable over the old CS look, although many of the CS weapons also remain hugely popular. All the following weapons are exclusive to the Quebec Army (the police use the old CS weapons and Northern Gun imports).

**Mini-HUD System.** Applying some of the cybernetic technology and coupling it with advanced optical enhancement systems through the trade agreement with the NGR and Triax, Free Quebec has co-developed (with Triax) this advanced optic system for use with assault rifles. The mini-Heads Up Display weighs around one pound (0.45 kg), fits onto most rifles like a scope and can either be used for "visual" targeting as a multi-optics scope, or through a direct link to the user's helmet. The link provides a Heads Up Display (HUD) to help the shooter more accurately "acquire" his target. It provides telescopic, passive nightvision, infrared and thermo-imaging optical enhancements as well as the exact distance, angle and targeting hairs all displayed on the shooter's faceplate/visor. The mini-HUD is an experimental system which is, for now, only available on assignment to Special Forces, Commandos, Rangers, snipers and other personnel who warrant the system on special assignment. The Free Quebec Army is endeavoring to supply them to Side Kicks and Cyborg Shock Troopers (most Juicers

prefer to rely on their natural abilities). Weight: One pound (0.45 kg). Bonuses: +1 on initiative and +2 to strike with long-range weapons, in addition to any applicable W.P. bonuses and the obvious benefits of the optic enhancements (i.e. can see in darkness, read heat images, etc.). Cost: 15,000 credits. The mini-HUD is only available to the Free Quebec military and its existence is presently unknown to outsiders. It has never been available to the Black Market, but if it is knocked off it will sell for at least 35,000 credits.

**Q1-01 Laser Pistol.** The "Que-One-Oh-One" is the new, standard issue sidearm for the Free Quebec Military. It is primarily issued to officers, guards, and special operatives. Weight: 3.5 lbs (1.57 kg). Mega-Damage: 3D4 M.D. per single shot or 4D6 per short burst (counts as one attack but fires four blasts). Rate of Fire: Standard: Aimed, short burst or wild (3D4 M.D.). Range: 800 feet (244 m). Payload: 20 shots per standard E-Clip or 30 shots per long E-Clip. Cost: 10,000 credits. The Black Market has only been able to obtain a few of these weapons and sells them for around 16,000 credits.

**Q1-02 "Stopper" Ion Pistol.** This is a heavy energy pistol with tremendous damage capabilities and represents a breakthrough in Quebec weapon technology. Well, at least a partial breakthrough. The "Stopper" has two major drawbacks: terrible range and it is heavy. Still, Commandos, Special Forces, Juicers and Cyborg troopers love it for close combat.

Weight: 4.5 lbs (2 kg). Mega-Damage: 4D6+4 M.D. per single blast. Can not fire bursts. Rate of Fire: Semi-automatic. Equal to the hand to hand attacks of the shooter. Each shot counts as one melee action/attack. Range: 200 feet (61 m). Payload: 12 shots per standard E-Clip or 24 shots per long E-Clip. Cost: 12,000 credits. Not available on the Black Market. When it is, it will probably sell for 18,000-20,000 credits.

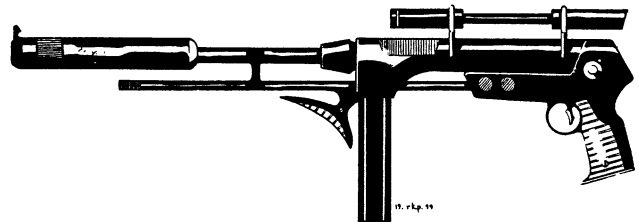

**Q2-10 Laser Pulse Rifle.** A durable laser with three settings and the capability of firing a single shot for precision shooting and sniping, or as an automatic weapon firing short bursts of five. Comes standard with a telescopic scope but can use the Mini-HUD System. Weight: 6 lbs (2.7 kg). Mega-Damage: 1D6 M.D., 2D6 M.D. or 3D6 M.D. per individual shot, or 6D6+6 per short burst (counts as one attack but fires five blasts). Rate of Fire: Standard: Aimed, short burst or wild. Range: 2000 feet (610 m). Payload: 20 shots per standard E-Clip or 30 shots per long E-Clip. Cost: 16,000 credits. Not available on the Black Market. When it is, it should sell for 22,000-24,000 credits.

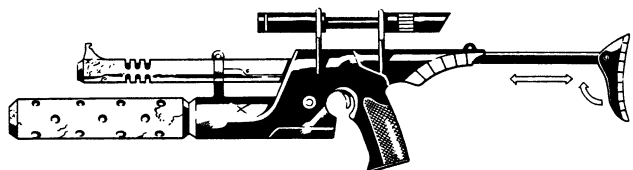

**Q2-20 LLG "Infantry Standard" Light Laser & Grenade Launcher.** The LLG was inspired by the CS "Fire Breather" assault rifle and is proving to be just as versatile. A bayonet (typically a Vibro-Blade) can be mounted to the lower barrel via a special attachment housing (with magnetic lock), and the mini-HUD system can also be used. (The Vibro-Bayonet can also be detached and used separately.) The LLG is the standard issue weapon for all Free Quebec Infantry troops and available to all branches of the Quebec Military. The same weapon with a slightly different styling is used by the Quebec Navy. Weight: 7 lbs (3.2 kg); 8 lbs (3.6 kg) with mini-HUD, 9 lbs (4

kg) if the bayonet is added. **Mega-Damage:** *Laser:* 3D6 M.D. per single shot or 6D6 per short burst (counts as one melee attack but uses up five blasts). *Grenade Launcher:* Typically uses high explosive (4D6 M.D. to a 6 foot area/1.8 meters in diameter) or a concussion charge. The latter does 2D6 M.D. to what it hits and knocks everybody/thing within a 15 foot (4.6 m) radius off their feet (victims lose initiative and one melee attack/action). Smoke grenades (no damage) to provide cover or to mark an area can also be used. *Vibro-Bayonet:* 2D4 M.D. per strike. **Rate of Fire:** *Laser:* Standard (3D6 M.D. when shooting wild, only a single shot hits the desired target). *Grenade Launcher:* One at a time, or in volleys of two. *Vibro-Bayonet:* Equal to the number of hand to hand attacks per melee. **Range:** *Laser:* 2,000 feet (610 m). *Grenade Launcher:* 1,100 feet (335 m). *Vibro-Bayonet:* Hand to hand. **Payload:** *Laser:* 20 shots per short E-Clip (standard), or 30 shots per long E-Clip. *Grenade Launcher:* The grenade launcher part of the weapon holds four rifle grenades at a time. Reloading one explosive round counts as one melee action, reloading all four counts as four melee actions (quickly aiming and shooting counts as another). Most troops carry 32 rounds with them plus four in the gun. Additional rounds may be carried in a hip-pouch (24 rounds, weighs 15 lbs/7 kg), backpack or shoulder satchel (32-64 extra rounds depending on the size of the container; 22 lbs/10 kg or 44 lbs/20 kg respectively). *Mini-Grenade Launcher:* A separate standard unit that attaches below the laser barrel. **To reload,** flip open the bottom plate; holds four grenades. **Cost:** 26,000 credits with *Vibro-Bayonet*, one E-Clip and 36 grenades. Not yet available on the Black Market. When it is, it should sell for around 40,000 credits. Black Market Grenades cost 550 apiece or 4,500 a dozen.

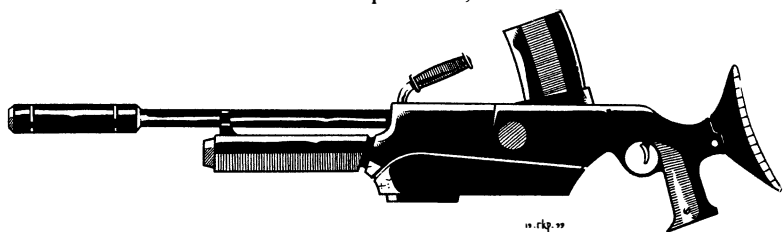

**Q2-30 Rapid-Fire Heavy Laser.** The Q2-30 is a heavy, long-range laser that resembles a rail gun in its size and weight. It has surprising firepower, a large payload and is used like a light machine-gun. It comes with a long E-Clip inserted in the top housing, a standard E-Clip in the handle, and another long E-Clip concealed inside (crack open the lower half of the gun to gain access; takes three melee actions to open, remove and reload this clip; the others take only one or two). This is something of an experimental design created with Cyborg Shock Troopers, Juicers and power armor units in mind. Ordinary soldiers must have a P.S. of 22 or higher to effectively use this big, awkward weapon (-2 to strike and takes twice as long to reload if P.S. is lower than 22). It is also mounted on hover jeeps and trucks, and used like a machine-gun on a tripod. Note: An energy power pack can be attached to the weapon for additional firepower but requires either a second man or vehicle to haul it (weight 50 lbs/22.5 kg) or the mechanical strength and stamina of a full conversion cyborg or power armor. **Weight:** Weapon fully loaded, 24 lbs (10.8 kg); 26 lbs (11.7 kg) with tripod and mini-HUD unit. **Mega-Damage:** 3D6 M.D. per single shot. +3 to strike if the shooter has the W.P. Heavy Weapons skill (no bonus without a W.P.). 6D6 M.D. per short burst. Counts as one melee attack but uses up five blasts. +2 to strike with the W.P. Heavy Weapons skill. 1D6x10 M.D. per medium burst. Uses up 20 shots and counts as two of the shooter's melee attacks/actions. +1 to strike with W.P. 2D6x10 M.D. per long burst. Uses 40 shots and counts as two of the shooter's melee attacks/actions. +1 to strike with W.P. 4D6x10 M.D. when the entire payload (80 shots) is emptied into a target or expended in spray shooting (3D6 M.D. done to 4D4 targets when a spray attack is used)! No bonuses to strike. **Rate of Fire:** Standard. **Range:** 3,000 feet (914 m). **Payload:** Standard 80 shots total; 20 from the standard E-Clip and 30 each from the two long E-Clips. An additional 120 shots can be added from a small, portable power pack attached to the heavy rifle with a power cable. The power pack weighs 50 lbs (22.5 kg) and can be car-

ried as a backpack or with a back-mounted harness by cyborgs or power armor. Note: This weapon and the QR-12A were designed with the help of Triax engineers a year before Free Quebec seceded from the CS. A fact that Triax and the NGR has tried to keep secret. Quebec does not broadcast this fact in an effort to help Triax and the German government avoid trouble with the CS. **Cost:** 35,000 credits. Fair to poor availability. Typically reserved for elite, heavy combat troops like Juicers and cyborgs, as well as Rangers, Commandos and Special Forces. Not yet available on the Black Market. When it is, it should sell for 65,000-75,000 credits.

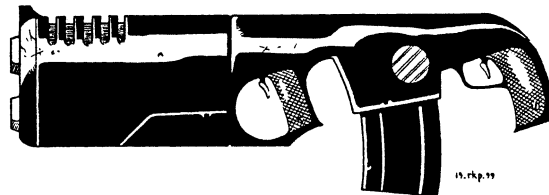

**Q4-40 "Mule" Assault Rifle.** This projectile weapon fires the same explosive rounds as the QST-104 Glitter Girl Assault Cannon. The main differences are this weapon is designed for use by ordinary humans, has a comparatively very short range and a kick like a mule, which is why it has two handles. Only cyborgs, power armor, and characters with a P.S. of 26 or higher can fire this weapon one-handed without penalty. *Ordinary humans* with a P.S. 25 or less are -2 to strike for a single shot and -4 to strike when firing a burst. This weapon has the nice feature of being able to fire from either the front or the back handle grip. To use the traditional back handle trigger, a switch is flipped and the forward trigger depressed (without actually firing rounds). To shoot, pull the traditional back-handle trigger as usual. To use the front handle, flip a switch and fire away (the other trigger is momentarily immobilized). This can sometimes confuse those not familiar with the weapon. **Weight:** 15 lbs (6.75 kg), plus 5 lbs with ammo drum (20 lbs/9 kg). **Mega-Damage:** One explosive round 2D6 M.D., a rapid-fire burst (3 rounds) fired at the same target does 6D6 M.D. and counts as one melee attack/action. **Rate of Fire:** Equal to the number of combined hand to hand attacks of the shooter; each shot or burst (3 rounds) counts as one melee attack. **Range:** 800 feet (244 m). **Payload:** 12 total; six held in the weapon, six in the standard clip. The clip can be replaced with a 24 round drum (for a total payload of 30 rounds — six in the gun plus ammo drum). **Cost:** 15,000 credits. Fair to good availability, but typically reserved for heavy combat troops like Juicers and cyborgs, and power armor troops, as well as Rangers, Commandos and Special Forces. Not available on the Black Market. When it is, it should sell for 45,000-50,000 credits with explosive rounds costing 700-800 credits each.

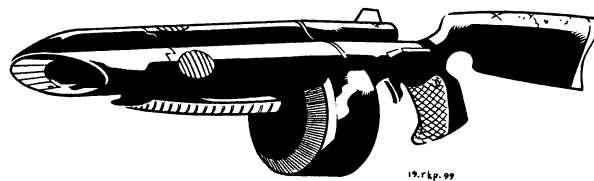

**Q4-44 "Drummer" Double-Barreled Shotgun.** Cheap, efficient, and practical, this high-tech variant is a shotgun that can fire conventional S.D.C. shotgun rounds or light M.D. rounds. Super-durable: Not only can it take a beating and keep firing without jamming, but can fire underwater even after being submerged for over an hour. **Weight:** 16 lbs (7.2 kg) with ammo drum. **Mega-Damage:** One explosive round does 1D6 M.D., or 2D6 M.D. from a simultaneous double-barrel blast (counts as one melee attack/action) fired at the same target. S.D.C. rounds typically inflict 4D6 S.D.C./H.P. damage from buckshot and 5D6 S.D.C. from solid slugs; double damage from a double-barrel blast. **Rate of Fire:** Equal to the number of combined hand to hand attacks of the shooter; each shot or double-barrel blast (2 rounds) counts as one melee attack. **Range:** 600 feet (183 m); 200 feet (61 m) underwater. **Payload:** 42; two hand loaded rounds in each barrel plus a 40

round drum. Only two rounds if a drum is not available. Cost: 4,500 credits. Good availability, and a favorite of Reload Teams, Headhunters, Rangers/Scouts, Juicers, Commandos and Naval troops. Not available on the Black Market. When it is, it should sell for 45,000-50,000 credits with explosive shotgun rounds costing 200-300 credits each.

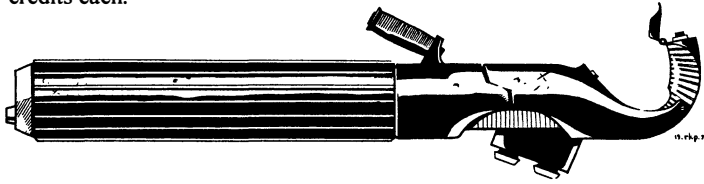

**Q5-50 Light Rail Gun.** This is a light, anti-personnel weapon used by human troops wearing power armor, cyborgs, and characters with a strength of 24 or greater. The Q5-50 rail gun can use what is called a short clip with 200 rounds (10 bursts), light drum with 600 rounds (30 bursts), or a heavy belt feed drum containing 2000 rounds (100 bursts). The latter is typically reserved for cyborgs and is carried as a backpack or by a partner in a two-man team. Weight: Gun: 45 lbs (20.25 kg), short clip: 10 pounds (4.5 kg), light ammo-drum: 30 lbs (13 kg), or a heavy ammo-drum: 100 lbs (45 kg). Ammo-drums are hooked to the back of body armor or housing on the back of a 'Borg or power armor. Mega-Damage: A full damage burst fires 20 rounds and inflicts 4D6 M.D.; a single round does 1D4 M.D. Rate of Fire: Equal to the character's hand to hand attacks per melee round. Range: 4,000 feet (1,219 m). Payload: The short clip holds 200 rounds and is capable of firing ten full damage bursts (20 rounds). The light drum holds 600 rounds and can fire 30 bursts. The 2,000 round drum is capable of firing 100 full damage bursts (20 rounds each). Reloading a drum will take about two minutes for those not trained, but only 20-30 seconds by a capable field mechanic or Reload Team. A strength of 24 or higher is required to handle the drum. Cost: 32,000 credits. Good availability. Not yet available on the Black Market. When it is, it should sell for 60,000-70,000 credits.



**QN-06 Laser Harpoon Gun.** This a Naval weapon used by Navy divers, Navy power armor troops and Army Special Forces (usually available to Army personnel on special assignment). The top notch in the barrel fires a blue-green laser, the two side and one bottom slots hold any variety of spears. Weight: 6.5 lbs (3 kg). Mega-Damage: Laser 3D6 M.D. per blast. Damage from Spears: Varies with type. Standard is 2D6+3 S.D.C./Hit Points. Cost: 6 credits. Radio/Transmitter: 2D4 S.D.C./Hit Points as a weapon, plus the radio/transmitter can send a tracking signal (lasts 72 hours) and/or transmit sounds from wherever or whatever it is impaled into or hooked onto. Great spy device. A magnetic clip allows the harpoon to cling to M.D.C. metal structures. Transmits a radio signal that can be followed up to 8 miles (12.8 km) away. Battery powered with a limited life of 72 hours of constant transmission. The spear must stick into the target or fall on top of the object (without falling off). There is always a chance that the tracer bug will become dislodged and fall off (roll once for every half hour; 1-32% chance). Cost: 200 credits each. Flare: Emits a bright, sparking light; burns for 120 seconds. Cost: 15 credits. High Explosive: 4D6 M.D.; cost: 600 credits. Rate of Fire: Each shot counts as one melee attack. Only one harpoon can be fired at a time. Range: Laser: 1200 feet (365.7 m). Harpoons: 350 feet (106.7 m) above water, or 200 feet (61 m) underwater. Payload: Laser: 20 shots per standard E-Clip or 30 shots per long E-Clip. Harpoons: Three (types may vary). A pouch with 12 additional harpoons (conventional and/or explosive) is often carried by a diver, but each spear must be reloaded by hand and the reloading of each counts as one melee attack/action. Cost: 15,000 credits. Northern Gun and the Black Market offer knock-offs at the price of 21,000 credits.

# Gargoyle Weapons of Europe

Rifts® World Book Five: Triax™ & The NGR™

**Note:** These items are used only by European Gargoyles and Gurgoyles, especially those of the Gargoyle Empire. All are rare elsewhere in the world.

**Spikes & Blades.** Gargoyles frequently wear combat apparel that adds to the potential damage of hand to hand attacks as described below. Gargoyles and the wingless Gurgoyles are especially fond of *blade weapons* and spikes and adorn their armor and weapons with them. Spiked brass knuckles, footwear, knee pads, shoulder pads, and gauntlets may all be lined with sharp spikes or blades. These add 1D4 M.D. plus the damage inflicted by the monster's supernatural strength to any attack that utilizes them.

**Blaster Knuckle Spikes.** This is an energy weapon variation on brass knuckles. First, the knuckles add damage to punches and the spikes can be used to stab. However, every time the knuckle portion or spikes strikes they emit a low intensity energy burst which inflicts additional damage and jolts one's opponent. Weight: 5 lbs (2.3 kg). Mega-Damage: Normal blunt damage (blaster turned off): 1D4 M.D. plus the damage inflicted by the Gargoyle's supernatural P.S. or 1D6 M.D. from a spike. Damage with the blaster turned on: 2D4 M.D. plus the damage inflicted by the Gargoyle's supernatural P.S. or 2D6 M.D. from a spike. Additional Penalties: The startled victim of the blast also loses initiative (if he had it in the first place) and is -2 to roll with a punch or impact from any attack with the knuckles. Rate of Fire: Equal to the user's number of melee attacks per round. Range: Arm's length. Payload: 32 blasts/jolts; recharges after two hours. A blast is expended every time the knuckle weapon strikes something. The blaster can be turned on and off as desired. Black Market Cost: 15,000 credits. Fair availability. Remember, this is a giant-size weapon.

**Wing & Tail Blades.** The giant monsters wear blades on their wings and tail. Wing blades are used to rake across the body of an enemy as the Gargoyle flies past him. Tail blades are used like a whip to stab and slash an opponent. Ordinary types add 1D6 M.D. to the damage inflicted by the creature's supernatural strength. However, some have started using Vibro-Blades which adds 2D6 M.D. plus the damage from their supernatural strength. **Note:** Gargoyle Lords may use magic blades instead; rune weapons, Techno-Wizard creations and others.

**Blaster Neural Whip.** A close combat weapon used by Gargoyles and other giants. Like the neural mace, this weapon releases an energy charge that temporarily short-circuits the nervous system whenever it strikes an opponent with the ball at the end of the whip. There is a chance of rendering an unarmored person unconscious, but even if the individual remains conscious the charge will impair his movement. Unlike the neural mace which is designed to stun an opponent for the purpose of capture, the whip is intended to kill! Weight: 10 lbs (4.5 kg). Mega-Damage: 2D4 M.D. plus damage from the supernatural strength of its user. Note that the whip is an M.D.C. structure and can be used to parry M.D. attacks from robots and power armor. Stun penalties for the Victim protected by half armor, magic armor or the Armor of Ithan spell: The body armor absorbs the Mega-Damage, but the character inside is still shocked and suffers the following penalties: -8 to strike, parry, and dodge for 2D4 melees. The duration of the impairment is increased 2D4 melees for every hit by the whip (also roll each time to see if knocked unconscious). Remember, stun is only effective against characters who are not protected by environmental armor. Using this weapon against Mega-Damage beings such as demons and dragons will inflict the same amounts of M.D., but has different stun penalties. The jolt will cause the creature to only lose initiative and one melee action/attack per strike of the whip. Save vs The Blaster Neural Whip is the same as saving against non-lethal poison, 16 or higher. The charac-

ter must save each time he or she is struck. A successful save means the character is not stunned and only loses initiative.

**Note:** The whip is ineffective against environmental M.D.C. body armor, power armor, and robots. It is effective against cyborgs not completely enclosed in full environmental armor, half suits or armor like those worn by the Gurgoyles, or body armor without a helmet (it's not fully environmental without the helmet attached), other Gargoyles, demons and Mega-Damage creatures.

**Gargoyle Firebrand Spear.** The firebrand spear is a Techno-Wizard device. The spear's shaft is made of metal with fine strands of copper and silver imbedded in it. The spearhead is a blood red crystal. The magic is activated by thought and 7 P.P.E. or 15 I.S.P. When activated, the spearhead glows red like a hot ember and is enveloped with heat vapors. When it strikes an opponent there is a blast as if he was struck by a fireball or plasma blast! Weight: 15 lbs (6.8 kg). Mega-Damage: The spear can be used as an M.D. weapon to stab and parry whether it is magically charged or not. The giant, *uncharged* weapon inflicts 2D6 M.D. plus the damage inflicted by the Gargoyle's supernatural P.S. (1D6 M.D. when the spear is human-size). Firebrand Damage: When magically charged, the weapon inflicts 5D6 M.D. plus the damage inflicted by the Gargoyle's supernatural P.S. There is a 01-50% chance that combustibles will catch fire. Rate of Fire: Equal to the warrior's hand to hand attacks per melee. Range: Hand to hand, or 500 feet (153 m) when thrown by a Gargoyle or Gurgoyles (about 200 feet/61 m for human-sized spears thrown by a human). However, a thrown spear must be physically retrieved or it is lost. Payload: Depends on the P.P.E. and/or I.S.P. of the warrior. Each plasma/fire strike costs 15 I.S.P. or 7 P.P.E. points. Market Cost: 75,000 to 100,000 credits whether the spear is human or giant-size.

**Triax Electro-Mace & Neural Mace.** The Gargoyles love the Electro-Mace used by the *X-2500 Black Knight*. Its capture or purchase is a prize. See the Triax weapon section for the description. Gurgoyles and Gargoylites (imps) sometimes use the Neural Mace (see CS weapons for the description of it).

**WR-12 Giant Ion Pistol.** This is an energy pistol designed for giant humanoids. The appearance is that of a Pre-Rifts submachine-gun with a short shoulder stock. Weight: 10 lbs (4.5 kg). Mega-Damage: 2D6 M.D. Rate of Fire: Standard. Range: 600 feet (183 m). Payload: 30 shots per E-Clip. Market Cost: 10,000 credits. Fair availability.

**Gargoyle Grenade Mace.** At first glance, this giant-sized weapon looks like a spiked battle axe, but upon closer scrutiny one can see that it also has an opening at the top, a round magazine, handle and trigger. The weapon can be used as a mace/morning star, axe or projectile weapon! Weight: 25 lbs (11 kg). Mega-Damage: Blunt/Mace: 1D6 plus supernatural P.S.; Chopping/Axe: 1D6 plus supernatural P.S.; Grenade: 5D6 M.D. each to everything in a 20 foot radius. Rate of Fire: Grenade: One per melee action; point, squeeze the trigger and boom. Range: 400 feet (122 m). Payload: Grenades: Six. They can be reloaded in one melee round (15 seconds). Black Market Cost: 20,000 credits for the weapon and 200 credits for each grenade. Fair availability. Remember, this is a giant-size weapon (although the grenades are like large bullets to the Gargoyles).

**Gargoyle Laser Mace.** Looks identical to the grenade mace except that it has an energy clip sticking out of it rather than a round magazine. As the name suggests, it fires a laser beam. Weight: 20 lbs (9 kg). Mega-Damage: Blunt/Mace: 1D6 plus supernatural P.S. Mega-Damage. Chopping/Axe: 1D6 plus supernatural P.S. Mega-Damage. Laser: 3D6 M.D. per shot. Rate of Fire: Standard. Range: 800 feet (244 m). Payload: 20 shots from an FSE-Clip or 10 from a short clip. Black Market Cost: 25,000 credits for the weapon. Fair availability. Remember, this is a giant-size weapon.

**Super-Eight Pistol Mace.** This is another giant mace-like item that is also a projectile weapon. It can be used in hand to hand combat or fire explosive cartridges similar to the Triax pump guns (which are what inspired this design). Weight: 25 lbs (11 kg). Mega-Damage:

Blunt/Mace: 1D6 plus supernatural P.S. Mega-Damage. Explosive Bullets (large): 1D4 M.D. per single shot, 4D4 M.D. from a short burst (4 rounds) or 5D6 M.D. from a full burst (8 rounds). Rate of Fire: Standard. Range: 800 feet (244 m). Payload: 48 shots or six full bursts. Black Market Cost: 15,000 credits for the weapon and 100 credits per box of 48 rounds. Fair availability in and around the New German Republic. Remember, this is a giant-size weapon.

**WR-100 Giant Laser Rifle.** A heavy laser rifle designed for giant humanoids. Comes standard with an infrared, telescopic sight. Weight: 20 lbs (9 kg). Mega-Damage: 3D6 M.D. per blast. Rate of Fire: Standard. Range: 1,600 feet (488 m). Payload: 20 shots per E-Clip. Bonuses: +1 to strike (so an aimed shot is +5). Black Market Cost: 25,000 credits. Fair availability.

**WR-200 Giant Rail Gun.** The WR-200 is an old-fashion heavy rail gun designed for cyborgs, robots and giant D-Bees. The rail gun can use what is called a short clip with 300 rounds (10 bursts) or a belt feed drum containing 3000 rounds (100 bursts). Weight: 250 lbs (112.5 kg). Mega-Damage: A full damage burst fires 30 rounds and inflicts 1D4x10 M.D. A short burst of 15 rounds does 3D6 M.D.; single shots are not possible. Rate of Fire: Equal to number of combined hand to hand attacks (usually 4-8). Range: 6000 feet (1828 m). Payload: The short clip holds 300 rounds and is capable of firing 10 full damage bursts (30 rounds) or 20 half damage short bursts (15 rounds). The 3000 round drum is capable of firing 100 full damage bursts or 200 half damage bursts (15 rounds). Reloading a drum will take the average Gargoyle 1D4 minutes, but a field mechanic could do it in under a minute. A strength of 28 or higher is required to handle the gun and the drum. Black Market Cost: 65,000 credits. Good availability in Germany.

## Horune™ Weapons

### Rifts® World Book Seven: Rifts® Underseas™

These items tend to be exclusive to the monstrous Horune Pirates. Many of these items are manufactured or traded and sold at *Atlantis*. This means only those who encounter Horune, take up Horune practices or visit Atlantis (and live to tell the tale) will have access to these items.

**Horune Harpoon Gun.** A man-sized underwater rifle that fires harpoons/metal spears. As many as three spears can be housed and fired at a time. An additional quiver of spears can be carried on the back or strapped to a waist belt. Weight: 5 lbs (2.3 kg). Damage: Standard spear/harpoon: 3D6 S.D.C. Explosive tipped: 2D4 M.D. per each spear. Magic/Techno-Wizard Spears: 1) Electrical charge: 6D6 M.D. 2) Heat/plasma type 4D6 M.D. 3) Releases a Magic Net upon impact (same as the spell; 4th level in strength). Rate of Fire: Single shot, or can fire a volley of two or three spears simultaneously. Range: 500 feet (152 m) underwater or in the air. Payload: Three harpoons. It takes one melee action to reload per each harpoon. A quiver holds 12 harpoons. Cost: 2,000 credits. Manufactured in Atlantis. Uncommon.

**Horune Sonic Rifle.** This is a short rifle that functions similarly to the Naut'Yll weapon. It is a creation of the *Ship Dreamers* and as such, registers as pure magic. It can only be recharged by a Ship Dreamer or by leaving the weapon on a Dream Ship for six hours, or when in the possession of a Dolphin Combat Drone (the ships are a magic extension of the Ship Dreamers and continue to be influenced by their magic). Once charged, anybody can use the weapon. It is the standard issue of the Dolphin Combat Drones and may also be assigned to ships' officers and captains. Only one in 50 Horune pirates will carry this weapon. Weight: 6 lbs (2.7 kg). Mega-Damage: Same as the Sonic Blast spell; 6D6 M.D. per blast. Rate of Fire: Single shot; each blast counts as one melee action. Range: 2000 feet (610 m). Payload: 40 sonic blasts. Cost: 10,000 credits, since most other beings have no way of recharging it. Note: The magic rifle has 100 M.D.C. points and is very durable. Rare.



**Horune Energy Trident.** Many of these are stolen from the Naut'Yll, others are Splugorth knock-offs (two prongs). The trident can be energized, firing particle waves or delivering energy strikes in close combat. Weight: 12 lbs (5.4 kg). Mega-Damage: Both the ranged particle wave attack and the energized strike inflict 5D6 M.D. Rate of Fire: Each blast counts as one melee attack. Range: Energy blast: 1000 feet (305 m) or hand to hand combat. Payload: 30 energy blasts or close combat blows (every successful strike drains one charge). Changing E-Clips counts as one melee attack/action. Cost: 70,000 credits. Rare except in Atlantis.

**Other Weapons.** As stated previously, the pirates capture, seize, steal, trade and buy all types of weapons from around the world. In and around the Americas, their favorite trade partner is Atlantis; 85% of all Horune booty ends up there. Favorites include items made by Triax, the Kittani, The New Navy, Tritonia, Naut'Yll, Lemuria and Japan. Horune also love magic, and they covet magic weapons and equipment of all kinds, as well as Kittani plasma swords, tridents, lances, and blasters. However, Kittani weapons are usually kept for themselves.

## Japanese Weapons

### Rifts® World Book 8: Rifts® Japan

**ArmaTech Industries.** ArmaTech is the old international name used by Akizuki International, a weapons manufacturer that grew to prominence in the 21st Century. It became a world leader in the development of laser technology, particle acceleration, bionics and nano-technology for the application of weapon systems, power armor, and medicine. ArmaTech had research, development and manufacturing facilities around the world, including Germany, Mexico, America and Canada. In fact, it was one of the very few foreign manufacturers who actually won a US Government contract to perfect and develop variations for the Glitter Boy and the experimental (at the time) SAMAS power armor (Strategic Armored Military Assault System)!

A wide variety of weapons are produced by this company in the Post-Rifts world, including bionic weapons and components,

Vibro-Blades, rail guns, lasers and other energy weapons. They are produced and sold to the military, police, and corporations under strict Japanese government supervision and control. Sales to corporations include security forces, security companies, bodyguards, and executives, especially those of samurai descent. ArmaTech does not manufacture or distribute weapons to any of the non-allied kingdoms outside the Republic of Japan and never sells to mercenaries or outsiders. Of course, ninjas, ronin, mercenaries, adventurers, pirates, criminals, and the occasional merchant sometimes "acquire" their creations for personal use, or to sell or trade on the open market, but ArmaTech equipment is uncommon even in the Orient and super-rare everywhere else.

**H-Brand.** The only other high-tech weapons manufacturer of note on the entire island chain is a small company nestled among the independent kingdom of Otomo. Its products are known simply as H-Brand weapons. Some are original designs but most are "knock-offs" of ArmaTech and foreign weapons acquired from occasional visitors and seafarers. In addition to Mega-Damage weapons and armor, H-Brand also produces a large number of semi-automatic and automatic S.D.C. weapons and specialty items like high-tech (M.D. and S.D.C.) bows, arrows, Vibro-Blades and explosives. Its products are of a lower quality than ArmaTech, but are generally good and reliable.

### Odds & Ends

All ArmaTech brand weapons have the prefix "AT" and are of superior quality.

Most, but not all, H-Brand weapons have the prefix "H," are of fair to good quality, and are mainly cheap "knock-offs" of ArmaTech weapons.

The occasional other weapon smith can be found here and there outside of the Republic of Japan, but they are extremely uncommon and vary in quality. These operators repair and recharge energy weapons and make S.D.C. ammunition and weapons. Remember, technology is viewed with disdain in the kingdoms of the New Empire.

The M.D.C. of Typical Japanese Weapons: Unless stated otherwise, the average energy pistol or Vibro-Blade has 15 M.D., an energy rifle 30 to 40 M.D.C., a rail gun 50 to 75 M.D.C., while giant-sized weapons for cyborgs, 'bots and power armor usually have 100 M.D.C.

**Weapon Prices & Availability:** ArmaTech weapons are most common in the Republic of Japan, and although officially restricted to law enforcement and military authorities, they can be purchased from smugglers, pirates and illegal weapon dealers found in the cities. City prices vary according to the current market and from one seller to the next. The most common items are Vibro-weapons and pistols. Costs can be anywhere from plus or minus 10% to 20% of those listed in the weapon descriptions.

ArmaTech weapons can also be purchased on the Japanese islands outside the Republic of Japan, and even parts of China, but typically cost 50% to 200% more than the list price. They are uncommon in these regions with very poor availability, and in Japan's wilderness areas, it will be difficult to find someone willing to part with a weapon even at double or triple the normal market price. H-Brand weapons and magic items are more common among independent kingdoms as well as in wilderness and monster dominated regions of Japan. **Note:** The occasional weapon, armor or vehicle of the New Navy and Tritonia (*Rifts® Underseas*), and Triax or Splugorth/Kittani manufacture may also find their way to Japan thanks to pirates. The prices for these weapons are usually comparable to ArmaTech items but are sometimes considered "special and rare" and can cost as much as 300% more.

## Traditional Japanese S.D.C. Weapons

A variety of conventional, S.D.C. weapons are manufactured by H-Brand, the New Empire, many of the independent kingdoms, and warrior families like the samurai and ninja. The following are some of the most common or interesting weapons and items. The damage listed is from the weapon alone; also include any P.S. damage bonus.

**Aikuchi/Tanto.** Curved Japanese daggers which can be thrown. The Tanto has a hilt, the Aikuchi does not. Cost: 100 to 500 credits; varies according to the weapon's quality and beauty. S.D.C. Damage: 1D6 points. W.P. Category: Knife.

**Bisento.** A large spear with a broad, curved blade, considered to be a kind of pole arm. Cost: 500 credits. S.D.C. Damage: 3D6+4 points. W.P. Category: Polearm.

**Bow Gun.** Essentially a small pipe through which darts are fired by air pressure. A favorite weapon of the ninja despite its short range of 50 feet (15.2 m). Cost: 30 credits. Damage: None; the dart stings, but causes no damage unless coated with poison or drugs (which they usually are). W.P. Category: Archery & Targeting.

**Bokken.** A wooden version of the samurai's katana, often used in practice or competition. It is still a deadly weapon in the right hands, which will be more than capable of taking down an armed opponent. The Bokken is a popular weapon in The Zone for use against vampires and their ilk. Cost: 80 credits. S.D.C. Damage: 2D4. W.P. Category: Sword.

**Daisho.** The word Daisho literally means, "the long and the short," and refers specifically to the pair of swords known as the Katana and Wakizashi. The Katana is the long killing sword, up to 3 feet (0.9 m) in length. The Wakizashi is a short sword (Westerners might consider it a long knife), and is frequently used with the larger blade, one in each hand, as paired weapons.

The Daisho is the symbol of the samurai caste; only samurai can carry them. "True" Daisho or *Samurai swords* are treated with reverence for, according to ancient beliefs, each "True" Samurai sword possesses a soul and is a living thing. See the *True Samurai O.C.C.* in *Rifts® Japan* for full details about these special, minor rune weapons.

Cost: Manufactured versions sell for 900 to 1,200 credits for the Katana and 400 to 600 credits for the Wakizashi. S.D.C. Damage: Katana: 3D6; Wakizashi: 2D6 S.D.C. W.P. Category: Sword. **Note:** Authentic samurai swords are considered priceless, inflict Mega-Damage, and are usually passed on from generation to generation of samurai. They are occasionally available for sale when a True Samurai is slain and his weapons are taken by his slayer. The cost of these lesser rune swords is typically 1D4 million credits!

**Jitte or Sai.** These weapons look like oversized, three-pronged forks and are generally designed to be used as a pair, one in each hand. Both weapons are modified farming tools originally designed by the ninja to counter the samurai sword (parry and pin swords). Even in the Japan of Rifts Earth, they are easier to acquire than a sword or spear, especially in the feudal society of the New Empire where peasants are forbidden to have weapons. A skilled user can entangle an opponent with one hand and attack with the Sai in the other (requires paired combat skill). Cost: 100 credits per pair. S.D.C. Damage: 1D6. Bonus: +2 to disarm. W.P. Category: Knife.

**Katana.** A mass market version of the samurai sword, predominantly sold by H-Brand. Cost: 450 credits. Damage: 3D6 S.D.C. W.P. Category: Sword.

**Kusari-Fundo.** A larger, more deadly version of the Manriki-Gasser. The chain is heavier and from 2 ½ feet to 4 feet (0.76 to 1.2 m) long. Cost: 120 credits. S.D.C. Damage: 2D6. W.P. Category: Chain. Bonus: +2 to disarm. **Note:** This weapon can be used only by those trained in hand to hand martial arts, assassin, Ninjitsu or W.P. Chain. All others are -2 to strike and parry and each attack counts as two melee actions.

**Kusari-Gama/Kyoketsu-Shogi.** Another ninja favorite is the combination of a chain with a weight on one end and a sickle weapon on the other. The Kyoketsu-Shogi is a similar weapon but is made with rope attached to an iron ring on one end and a double blade on the other. Both weapons can be used to entangle with one end while the other can still be used for striking. All the components of the weapons are easily acquired by non-samurai, making it easy to make or purchase in the New Empire. Cost: The Kyoketsu-Shogi costs 200 credits, the Kusari-Gama costs 500 credits. S.D.C. Damage: Kyoketsu-Shogi: 1D8 or 2D4; Kusari-Gama: 1D10 or 2D4+2 S.D.C. Bonus: +1 to disarm. W.P. Category: Chain. **Note:** These weapons can be used only by those trained in hand to hand martial arts, assassin or Ninjitsu. All others are -2 to strike and parry and each attack counts as two melee actions.

**Manriki-Gusari.** A chain weapon with solid, blunt weights on each end. It is used in the same style as a Kusari-Gama, entangling with one end, striking with the other. The weapon is also easy to disassemble and conceal. The materials to make a Manriki-Gusari are readily available and as a result, this weapon can be easily found in the New Empire. Cost: 30 credits. S.D.C. Damage: 1D8 or 2D4. Bonuses: +1 to entangle, +1 to disarm. W.P. Category: Chain. **Note:** This weapon can be used only by those trained in hand to hand martial arts, assassin, Ninjitsu or W.P. Chain. All others are -2 to strike and parry and each attack counts as two melee actions.

**Naginata/Yari.** Long spears; difficult to conceal. The difference between the two is that the Naginata blade is curved while the Yari is straight. Cost: 300 credits. S.D.C. Damage: 2D6. W.P. Category: Spear.

**Ninja-to/Ninja Short Sword.** A short sword similar to the Wakizashi but with a straighter blade, used by the Ninja. Because of its small size the weapon is easier to conceal. Cost: 500 credits. S.D.C. Damage: 2D4. W.P. Category: Sword.

**No-Dachi.** A huge, curved, two-handed sword, 5 to 6 feet (1.5 to 1.8 m) long. Typically the weapon is pulled from a scabbard slung over the back or shoulder. Cost: 600 credits. S.D.C. Damage: 3D6+4. W.P. Category: Sword.

**Nunchaku.** These weapons consist of two lengths of wood or iron connected by a short chain. Originally an agricultural flail, the Nunchaku have been adopted for martial arts use as paired weapons for striking. One of the main advantages of Nunchaku is for entangling. This can only be done if one weapon is used with two hands. Cost: 50 credits. S.D.C. Damage: 1D8 or 2D4. Bonus: +1 to disarm. W.P. Category: Chain. **Note:** This weapon can be used only by those trained in hand to hand martial arts, assassin, Ninjitsu or W.P. Chain. All others are -2 to strike and parry and each attack counts as two melee actions.

**Shinobi-Zue.** A hollow wooden staff which contains a weighted length of chain. Cost: 250 credits. S.D.C. Damage: 1D10 or 2D4+2 S.D.C. W.P. Category: Staff.



**Shikomi-Zue.** This is a staff with a concealed blade which is spring loaded and released by a trigger stud that is pressed or turned. The weapon is a favorite of Ninja who often disguise themselves as blind men. The Shikomi-Zue can be used as a somewhat fragile (S.D.C. 50) Bo Staff or Spear. Cost: 200 credits. S.D.C. Damage: 1D8. W.P. Category: Staff or Spear.

**Shuriken.** The famous “throwing stars” of the ninja designed for concealment and to distract the enemy (when thrown) rather than for deadly effect. To discourage pursuit, the ninja often threw these weapons, covering their retreat. Shurikens are often covered with poison or drugs. Any of the chemicals/toxins/poisons described in the various Rifts titles may be applicable if approved by the G.M. Cost: 10 credits each. S.D.C. Damage: 1D4. W.P. Category: Archery & Targeting.

**Tonfa.** A short wood weapon ideal for parrying and close combat. It is similar in appearance to the nightstick. Cost: 50 credits. S.D.C. Damage: 1D6. W.P. Category: Blunt.

**Wakizashi.** A mass market version of the Samurai short sword, predominately sold by H-Brand. Cost: 300 credits. S.D.C. Damage: 2D6. W.P. Category: Sword.

## Japanese Vibro-Blades

All Vibro-Blades are blade weapons surrounded by an invisible, high-frequency energy field that gives them Mega-Damage capabilities. Both ArmaTech and H-Brand manufacture these weapons. See the descriptions under the *Coalition States Weapons* for a complete description of standard Vibro-Blades found worldwide. Listed here are those unique to Japan.

**Vibro-Bayonet.** Mega-Damage: 1D6+1 M.D., designed for attachment to a variety of rifles including the AT-18. Cost: 7,500 credits.

**Vibro-Knife, Tanto, Jitte or Sai.** Mega-Damage: 1D6 M.D. Cost: 7,000 credits.

**Vibro-Saber/Short Sword or Ninja Short Sword.** Mega-Damage: 2D4 M.D. Cost: 9,000 credits.

**Vibro-Sword/Large One-Handed Sword (straight sword).** Mega-Damage: 2D6 M.D. Cost: 11,000 credits.

**Vibro-Wakizashi (curved, samurai short sword).** Mega-Damage: 2D6 M.D. Cost: 11,000 credits.

**Vibro-Katana (curved, Samurai long sword).** Mega-Damage: 3D6 M.D. Cost: 15,000 credits.

**Vibro-Robot Sword (giant-size for robots and large power armor).** Mega-Damage: 4D6 M.D. Cost: 25,000 credits. Note: For military use only.

## H-Brand Special Vibro-Blades

All the following items are made exclusively by H-Brand and are illegal in the Republic of Japan.

**Vibro-No-Dachi and most Large Two-Handed Swords.** Mega-Damage: 3D6 M.D. Cost: 15,000 credits.

**Vibro-Kusari-Gama (sickle weapon).** Mega-Damage: 2D6 M.D. Cost: 10,000 credits. The chain and weighted end are S.D.C. weapons (1D6 damage) and are sometimes silver coated (useful against some monsters).

**Vibro-Yagi Spear.** Mega-Damage: 2D6 M.D. Cost: 10,000 credits.

**Naginata (curved spear) or Bisento (broad blade spear).** Mega-Damage: 3D6 M.D. Cost: 15,000 credits.

**Vibro-Arm Claws.** Mega-Damage: 2D6 M.D., usually three hooked blades attached to a forearm gauntlet or protective plate. Great for parrying and slashing. Cost: 11,000 credits; add 2000 credits if retractable.

**Vibro-Tiger Claws and Ninja Climbing Claws.** Mega-Damage: 1D4 M.D. Cost: 5,000 credits. Note: These are hand-held claws with three curved spikes used for climbing Mega-Damage structures or as a slashing weapon.



## Japanese Energy Weapons

**SNARLS Sensor System.** SNARLS (Super-Natural Assault Rifle Sensor) was devised as an advanced sensor suite to give soldiers an edge in fighting the supernatural. The mechanism resembles a telescopic sight that can be attached to any rifle or rail gun in place of a scope. The sensor scans for distances, motion, heat, radiation, pheromones (scent via molecular analyzer), and detectable bio-patterns (including high levels of P.P.E.; 80 or more points) as well as using radar and other sensors to help locate and identify non-humans and invisible beings. The sensors sweep an area in front of the soldier in a 120 degree arc to a distance of 200 feet (61 m). All information gathered by the sensor is fed to a mini-computer clipped to the trooper's belt. The computer processes the data and sends a digital message display inside the soldier's helmet, or a pair of special HUD goggles or visor (direct to the artificial eyes of a cyborg) in less than three seconds. Special, advanced SNARLS systems include the transmission of audio data and warnings, usually sent to an ear implant or receiver in a helmet. In addition to the basic data, a silhouette of invisible or otherwise cloaked creatures will appear on the Heads Up Display (HUD) and simulate its estimated location, distance and movement. If the soldier's helmet or augmentation has a targeting sight the computer will automatically lock onto the nearest (or desired) silhouette. The computer also displays a percentile number indicating the accuracy level of the readings.

A general rule of thumb is that any reading under 68% should be considered a dangerous “suspect” but not a confirmed supernatural or inhuman being. A reading of 80% to 100% is considered to be a “confirmed” inhuman/monster by most soldiers and a signal to engage the enemy. The SNARLS system can identify 2000 known creatures, including humans, augmented humans (Juicers, Crazies, cyborgs, mutants), so-called demons, dragons, and scores of inhuman beings common to the area. However, SNARLS only has a 01%-25% success ratio in identifying shape changers, like changelings and vampires in human or animal form. The same is true for beings magically transformed into a different shape. Elves, Dwarves, Ogres, Simvan, Dog

Boys, and most S.D.C. beings will register as “human” or *not* supernatural. High level (8+) practitioners of magic, as well as dragons and other creatures of magic may register as supernatural because of the high amount of P.P.E. energy contained and/or channeled through their bodies.

Production of SNARLS is exclusively limited to Japanese Military Special Forces, with tight security. It is *NOT* available on the Black Market or from H-Brand. Weight: 1.2 lbs (0.54 kg) for the sensor, the mini-computer weighs one pound (0.45 kg). Range: 200 feet (61 m) in a 120 degree arc. 50% margin for error beyond 200 feet, up to about 500 feet (152 m). Mega-Damage Capacity: Sensor: 6 M.D.C., computer: 12 M.D.C. Note: Both the sensor and computer are extremely small targets and require a called shot to hit, and even then the attacker is -4 to strike. Penalty: Accuracy levels vary depending on the environment, sensory data, number of targets being scanned and other circumstances. Invisible Beings: On the first melee action/attack, the invisible creature automatically gains initiative as the computer is processing the data. Once the silhouette has appeared on the visor initiative is determined normally until the creature is slain/subdued or leaves the sensor range. SNARLS cannot identify a vampire or demon in mist or animal form. Cost: 125,000 credits. Rare even in Japan, super-rare outside this country.

**Armed Forces Personnel Backpack** The standard issue backpack of the Republic’s armed forces is filled with all the items necessary for a soldier to continue to survive and fight in the field. Each pack shares the same basic design and features, but three types exist, the PR-1 standard backpack, the PR-2 radio operator pack, and the PR-3 rail gunner’s pack. Cost: PR-1: 5000 credits, PR-2: 6500 credits, and 4500 credits for a fully loaded PR-3. M.D.C.: 20. Contains a built-in homing beacon so that lost or separated soldiers can be tracked and rescued by the signal.

An electromagnetic adhesive pad is built into the back of the rucksack which can be sealed to an identical pad built into the back of standard issue body armor. When the two are sealed together they cannot be separated unless one or the other is destroyed or a combined P.S. of 50 is used to pull off the pack. Basic Survival Equipment: Includes a survival knife, water purification tablets, a one quart canteen, medical kit and 5 days rations. The standard pack also includes one quart canteen, 3 weeks freeze-dried rations, portable stove, camouflage uniform of local terrain, infrared flashlight, fishing kit with basic hooks, sinkers, lures and line, a waterproof thermal poncho which doubles as a tent, and water purification system that fits onto a canteen and can safely clean 200 gallons (758 liters). Features include a large interior compartment and three smaller exterior compartments. The PR-2 has a built-in radio carrier wave amplifier which is linked to the wearer’s helmet radio. With the amplifier, the range of the helmet radio is extended to 50 miles (80 km). The backpack contains the radio in addition to a basic tool kit, weapon cleaning kit, spare rifle parts and 10 standard E-Clips. In addition, the backpack comes with one Satchel Charge, and two fragmentation hand grenades. The PR-3 main compartment is designed to fit an ammunition drum for the AT-600 rail gun. Other than the ammunition, the pack contains only basic survival equipment in the outer pockets.

**Standard Japanese Pistol E-Clips.** All ArmaTech pistol weapons use the same standard hand-loaded energy magazine. H-Brand weapons use the same standard for their pistol clips which are cheap knock-offs of ArmaTech E-Clips. The magazines of both brands are interchangeable, although ArmaTech is of higher quality. They can also be used to power most bionic and cybernetic weapons. It is interesting to note that ArmaTech energy clips and basic weapon designs are fundamentally the same as those used by the Coalition States in distant North America; evidence that the Coalition’s technology is based heavily on *pre-Rifts* technology unearthed from ancient ruins and held secret by the respective governments. Consequently, the weapons and E-Clips of both ArmaTech and H-Brand can be used in many of the weapons produced by the CS, Northern Gun, Bandito Arms and most North Ameri-

can manufacturers.), as well as the *New Navy*. With the proper modifications, they can be used in Triax and Naruni weapons too. Typical Payload for the pistol E-Clip: 10 to 20 shots for pistols/handguns. Cost: 6,500 credits for an undamaged, fully charged pistol E-Clip. Recharging an empty clip to full power in Japan usually costs around 1,200 to 2,000 credits. Note: In the wilderness, a character may find himself at the mercy of unscrupulous businessmen who charge double to quadruple for E-Clips and recharging.

**Japanese Rifle & Heavy Weapon E-Clips.** Standard Rifle Clips manufactured by ArmaTech and by H-Brand are identical, interchangeable E-Clips. They are larger than those of pistols and cannot be used to power the smaller weapons. Typical Payload for the Japanese Rifle E-Clip: 20 to 30 shots. Cost: A typical rifle E-Clip costs 10,000 credits when purchased new. A recharge to full power usually costs around 3000 credits.

**Japanese Energy Canisters.** Designed for attachment to most rifles, these canister magazines have a much higher payload. They are bulkier and weigh down the weapon slightly (-1 to strike penalty). Energy Canisters are produced mainly for the military and are extremely difficult to acquire on the Black Market. They are very similar to the CS canisters used in Coalition Weapons. Typical Payload for the Energy Canister: 30 to 50 shots. Cost: An energy canister costs 21,000 credits. Rates for recharging are high, averaging about 5,500 credits.

**Costs for Conventional S.D.C. Rounds.** Available S.D.C. rounds/bullets include all the common types, from .22 caliber to 10 mm. Armor piercing rounds (add 1D6 S.D.C. to the bullet’s damage) or high explosive cartridges (add 1D6x10 S.D.C.) are also available. A box of 48 rounds (normal bullets) typically costs about 20 to 50 credits (the higher calibers cost the most). 150 credits for armor piercing, dum-dums, and other special rounds like silver rounds.

**AT-N20 Neural Stick.** ArmaTech has created a blunt, club or mace-like weapon used by the police for close combat and riot control. This stun weapon resembles the classic “nightstick” of pre-Rifts days and is used to subdue criminals and troublemakers without having to use deadly force. The Neural Stick delivers an electric charge that temporarily short-circuits the nervous system when it strikes. There is a chance of rendering an unarmored person unconscious, but most victims remain conscious, with impaired movement. Physical Damage: 1D6 S.D.C. plus P.S. attribute bonus (if any) when used as a clubbing weapon. The stick is a Mega-Damage structure (17 M.D.C.), making it suitable for parrying S.D.C. and M.D. weapons like Vibro-Blades. Stun Damage: Victims struck by the neural stick must roll to save vs non-lethal poison/attack and need a 16 or higher to save. A successful save means the victim loses one melee action from the jolt but is otherwise unimpaired. A failed roll to save means the character is stunned: -7 on initiative, -5 to strike, parry, and dodge, and reduce melee actions/attacks, speed and skill performance by half. The character must save each time he or she is struck. Stun Duration: 2D4 melee rounds. The duration and penalties are increased by 2D4 melee rounds for every hit by the stick. There is also a cumulative chance of 15% per each subsequent hit that the character will be rendered unconscious for 1D4 minutes. This means the second hit has a 15% chance of knocking the victim out, the third hit 30%, fourth hit 45%, and so on. Limitations: The stick is ineffective against environmental M.D.C. body armor, power armor, and full conversion cyborgs, but is effective against Dog Pack armor and half suits, or body armor without a helmet (not fully environmental without the helmet attached). Partially reconstructed cyborgs, Juicers and Crazies are all +2 to save and the stun effect lasts half as long. No effect against robots, androids, or most supernatural beings and creatures of magic. Black Market Cost: 8,000. Generally unavailable.

**AT-AAD Anti-Armor Dissolver Missile or Grenade.** Upon impact, the grenade or missile releases a cloud of tiny particles. These particles are actually thousands of tiny nano-robots that attack Mega-Damage armor on a molecular level, usually starting from the point of impact. It is most effective against M.D.C. body armor, power

armor and thin plates of metal. The AADs are programmed to only attack the primary target, e.g. the first armor they find/strike. They do not “leap” from one armored Mega-Damage structure to another like fleas on a dog, or move from one target to the next like a swarm of ants. Furthermore, they are programmed to seek out and attack only military-type metal alloys like those used for power armor, body armor, cyborgs, robots, guns and armored vehicles. They will NOT attack M.D. ceramics, plastics, concrete, or superhuman flesh (or magic items/materials). Nor will they attack Mega-Damage materials coated, encased or attached to real or artificial flesh; protecting most cybernetic and bionic implants, optics, organs, and limbs. However, cyborg armor and external weapons, guns and plating are vulnerable and subject to dissolving. As an additional fail-safe, the nano-robots only have a life of 50 minutes, after which time they become inert and harmless. Weight: The average grenade weighs one pound (0.45 kg); the average mini-missile: 8 lbs (3.6 kg). Mega-Damage: Special. The nano-robots attack and reduce the physical integrity of body armor and thin plating, reducing the overall M.D.C. of most body armor and light power armor by half! Heavy power armor and light vehicles will see their M.D.C. reduced by 30%, while heavy, thick armor like those used in giant robots and tanks are reduced by 10%. This overall reduction of M.D.C. occurs within one minute (four melee rounds) of exposure to the armor dissolving nano-robots. Its effects are noticeable as a fading of the color of the material or dull blotches. Many of the more sophisticated environmental computer monitoring systems of such suits and vehicles will indicate structural weakness or damage. Additional effects and damage on the armor takes longer (1D4x10 minutes) but can be devastating as the nano-assailants focus on one specific area of their victim and completely dissolve it. Roll percentile or pick one:

**01-20%:** Main weapon. This will always be the most powerful and/or important weapon of the armor, ‘bot, cyborg or vehicle and can include hand-held weapons.

**21-40%:** External Sensor array. On robots, cyborgs, and body or power armor, this is likely to include the destruction of radar/sonar, targeting and communications.

**41-60%:** A specific appendage. On human-shaped robots and armor, this will be one of the legs, arms or thrusters. Plating on that part of the armor will completely dissolve and disappear. This also breaches the environmental protection of the armor, exposing the pilot to external atmosphere and conditions, as well as leaving the appendage/limb completely exposed to attack. Of course, any special features, weapons, or abilities built into that limb are also destroyed. On an M.D.C. vehicle, this will mean one of its legs, wheels, treads, or thrusters are destroyed. In the alternative, a weapon turret, cannon or sensor or communications array can be destroyed. On an armored bunker/building, this will mean either a weapon turret, cannon, communications tower or sensor array.

**61-80%:** Head or Hatch. On human-shaped armor, the helmet is attacked and dissolved, leaving the head exposed to potential attack and damage (-3 for attackers to strike and requires a “called shot”), as well as exposing the pilot to external atmosphere and conditions (toxic gas, pollution, heat, radiation, etc.). If a vehicle, building or giant robot, the AAD attack can dissolve one entire hatch/door, offering attackers a way inside.

**81-00%:** Two secondary weapon systems. On power armor or robots, this might include Vibro-Blades, forearm lasers, chest guns, etc. On a vehicle or bunker it may include small or secondary turrets, light energy weapons, short-range or mini-missile launchers, and manned weapon turrets.

Rate of Fire: Varies with weapon type; usually fired one at a time or in small volleys of three mini-missiles. Not available in large missiles. Range: Hand grenades can be thrown about 100 feet (30.5 m), rifle launched grenades/rockets about 300 feet (91.5 m) and mini-missiles one mile (1.6 km), although the latter is usually launched at the comparatively close range of 3,000 feet (914 m) to insure a strike. Payload: One AAD package per missile or grenade. Elite Republic soldiers, like

the Japanese SAMAS troops, may have a maximum of six or as few as one grenade or missile. Delivery System: Nano-robots are typically contained in a hand grenade, rifle grenade/rocket, or mini-missile. Note: AAD nano-technology is ONLY available in the Republic of Japan and even then only to authorized military defense units. G.M. Note: The AAD is a carefully guarded military secret and should rarely be available to player characters. For that matter, only elite military troops and special government agents will have access to it, so they are not available even to most non-player characters and villains. The AAD is NOT available on the Black Market or in any other part of the world. Nano-technology, like the SAMAS and many other pre-Rifts technologies and secrets, exists only in the Republic of Japan and the city of Nagasaki in particular. The Black Market, Coalition States and most nations do NOT have the technology, resources or understanding to “knock-off” any sort of nano-technology. Only Triax or Naruni Enterprises could learn and develop nano-tech, but it will take even them 10 to 15 years of study and development to reach a stage equal to that currently held by the Republic of Japan. Also remember that the people of Japan are isolated from the rest of the world and like it that way — most other nations have no idea that they even exist.

**AT-23 Plasma Thrower.** The average flame-thrower unit had become an obsolete weapon with the advancement of modern arms. With the appearance of supernatural menaces vulnerable to fire, the flame-thrower has again become a useful tool. ArmaTech has produced a modernized version of the weapon that shoots short plasma streams instead of flaming napalm. Weight: 15 lbs (7 kg). Mega-Damage: 1D4x10 M.D. per spray. Rate of Fire: Aimed shots only. Range: 200 feet (61.0 m). Payload: 8 sprays per plasma canister. Cost: 20,000 credits. Note: No availability in the Republic of Japan (limited to the military), but H-Brand makes a knock-off version with poor availability in other parts of Japan.

**AT-6 “Mini” Laser Pistol.** The ArmaTech AT-6 is a new development for military service. Nicknamed the “Escape Artist,” it is a small pistol that fits easily in the closed palm of a hand. Designed for concealment (+10% to palming and concealment skill rolls), it is made in two shapes, one looks like a cigarette lighter, the other a pen flashlight. It is intended to allow a captured soldier to remain armed and effect an escape, as well as for use in espionage and as a tool. Even with the high security of ArmaTech Industries, a handful of these weapons have found their way to the street. An AT-6 is an extremely valuable commodity on the Black Market and fetches a high price. Weight: 1 pound (0.45 kg). Mega-Damage: 1D6 M.D. Rate of Fire: Standard. Range: 300 feet (91.4 m). Payload: 6 blasts, requires a special E-Clip. Cost: 30,000 credits; 50,000 credits on the Black Market, 5,000 credits per mini-E-Clip. Note: Available only to the military. Rarely available on the Black Market and H-Brand does not even know it exists yet, so there are no knock-offs available.

**AT-8 Laser Pistol.** One of the few mass market Mega-Damage weapons allowed to be sold to the civilian population. However, all AT-8’s must be registered and their sale limited. Of course, some AT-8’s and H-Brand knock-offs have made their way into the criminal underworld and are available illegally to crooks and citizens alike. The AT-8 laser pistol is light, reliable and offers a good damage capacity, although its low payload and limited stopping power has made it unacceptable for police and military use. Weight: 3 lbs (1.4 kg). Mega-Damage: 1D6 M.D. Rate of Fire: Standard. Range: 500 feet (152 m). Payload: 8 shots. Cost: 10,000 credits; 8500 credits on the Black Market. Note: Good availability in Japan and China. H-Brand makes a knock-off called the “H-8” and a “Super H-8.” The former is identical to the AT-8 and sells for 8000 credits. The “Super” is fundamentally the same but has a 12 shot E-Clip, an 800 foot (244 m) range and sells for 11,000 credits.

**AT-20 “Sharpshot” Police Special Laser Pistol.** A heavy laser pistol with greater stopping power, a larger payload, telescopic sight mounts and laser targeting. It is also extremely accurate at long-range. Weight: 2 lbs (0.9 kg). Mega-Damage: 2D6 M.D. Rate of Fire: Aimed

shots and short bursts (4 blasts) only. Range: 1,000 feet (305 m). Payload: 20 shots. Bonus: +1 to strike on an aimed shot. Cost: 15,000 credits; 22,000 on the Black Market. Note: Available only to the military, police agencies and authorized corporate security forces. H-Brand has a knock-off called the *H-20 Sniper Pistol* that costs 17,000 credits; poor availability inside the Republic, fair to good outside of Japan in Asia.

**AT-30 Combat Laser Pistol.** The AT-30 is the official military sidearm of the Republic Armed Forces. The weapon is sleeker in overall design and has a longer barrel which has greatly improved accuracy. It comes standard issue with a pair of extra E-Clips, telescopic sight mounts and a laser targeting mechanism. Weight: 2.5 lbs (1.1 kg). Mega-Damage: 2D6+2 M.D. Rate of Fire: Standard. Range: 1000 feet (305 m). Payload: 30 shot clip. Bonus to Strike: +1 bonus to aimed shot due to the laser targeting and superior balance of the pistol. Cost: 22,000 credits; 30,000 credits on the Black Market but is rarely available. The H-30 knock-off costs 35,000 credits. Note: Available only to the military and elite members of police agencies. H-Brand has a knock-off called the H-30 Siege Pistol; poor availability inside the Republic, fair outside.

**AT-130 Particle Beam Pistol.** Particle beam technology has always been one of ArmaTech's areas of specialty. The P-beam pistol is a pre-Rifts design and is the only particle beam pistol of human design on Earth. The AT-130 is exclusive to high ranking officers and espionage agents in the military. It comes standard issue with a pair of extra E-Clips, telescopic sight mounts and laser targeting mechanism. Weight: 4 lbs. (1.8 kg). Mega-Damage: 5D6+6 M.D. per single blast! Rate of Fire: Standard; single shot only. Range: 600 feet (183 m). Payload: 10 shots per E-Clip. Bonus: +1 to strike on an aimed shot. Cost: 30,000 credits; limited military availability. Note: Available only to the Republic of Japan's military. Rarely available on the Black Market and when it is, it costs a staggering 90,000+ credits. H-Brand does not even know it exists, but even if it did, they cannot duplicate P-beam technology; no knock-offs.

**H-10 Combat Laser Pistol.** The H-10 is a super-cheap, but large, archaic laser pistol sold by the H-Brand Company. The pistol has only 23 M.D.C. and uses a standard E-Clip, but is heavy and has light stopping power. These weapons are common among adventurers, bandits and thugs. Weight: 4.5 lbs (2 kg). Mega-Damage: 2D4 M.D. Rate of Fire: Standard. Range: 600 feet (183 m). Payload: 30 blasts! Cost: 12,000 credits, good availability throughout Japan.

**H-13 Ion Pulse Pistol.** Another heavy H-Brand pistol made with mercenaries and Special Forces in mind. It was turned down for military use by most kingdoms, but has since become a popular weapon among adventurers. The H-13 resembles a pre-Rifts submachine-gun. Weight: 5 lbs (2.25 kg). Mega-Damage: 2D6 M.D. single shot, or 6D6 M.D. per multiple pulse burst (three nearly simultaneous shots). Rate of Fire: Standard. Range: 800 feet (244 m). Payload: 20 shots Cost: 22,000 credits; poor availability in the Republic, good availability elsewhere in Japan.

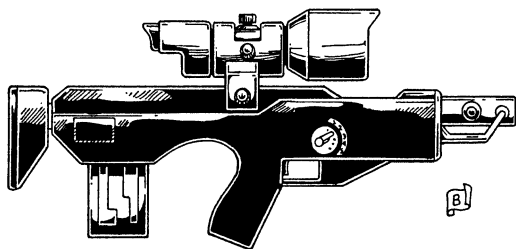

**AT-23 Police Stun Rifle.** The AT-23 stun rifle is standard issue for the police in the Republic of Japan. In fact, it was specifically designed for the police force in dealing with human criminals, riot control, and augmented humans. The stun rifle, like the neural stick, offers the police a non-lethal alternative to subduing lawbreakers. The rifle fires an electrical charge that temporarily short-circuits the nervous system when it strikes. There is a chance of rendering an unarmored person unconscious, but most victims remain conscious, with impaired move-

ment. The stun rifle does inflict some measure of physical damage, but far less than conventional weapons. It also has five settings so that it can be appropriately adjusted for the best response to the needs of the situation. For example, the lowest stun setting can be used on children, the second on the elderly and young teenagers, the third on adults, while the highest are reserved for Juicers, Crazies, mutants and supernatural creatures. The weapon comes standard with a telescopic, passive nightvision scope and laser targeting. Weight: 8 lbs (3.6 kg). Physical Damage: Setting One: 1D6 S.D.C.; can be used against children, pregnant women, and the very weak/injured/elderly. Setting Two: 2D6 S.D.C.; can be used against the elderly, young teenagers, adults in poor to average physical condition, and small to medium-sized animals like dogs and monkeys. Setting Three: 3D6 S.D.C.; suggested for use against adults in good to excellent physical condition. Setting Four: 6D6 S.D.C.; suggested for use against adults in superior physical condition, those high on the effects of drugs, Juicer, Crazies, partially reconstructed cyborgs, mutants, and non-humans, as well as large animals like horses, cattle, wolves, tigers, etc. Setting Five (Maximum Level): 1D6 M.D.; used only against Juicers, Crazies, partially reconstructed cyborgs, full conversion cyborg monsters, and non-humans. Stun Damage: At the correct setting, most victims shot by the stun rifle will suffer the same type of damage and effects. In all cases, the character must roll to save vs non-lethal poison/attack and needs a 16 or higher to save (children and small animals need an 18 or higher to save). A successful save means the victim loses one melee action from the jolt and takes damage, but is otherwise unimpaired. A failed roll to save means the character is stunned: -9 on initiative, -7 to strike, parry, and dodge, and reduce speed, melee actions/attacks, and skill performance by half. The character must save, each time he or she is struck. Stun Duration: 2D4 melee rounds. The duration and penalties are increased by 2D4 melee rounds for every blast that hits. There is also cumulative chance of 15% that each subsequent stun blast will render the character unconscious for 1D4 minutes. This means the second hit has a 15% chance of knocking the victim out, the third hit 30%, fourth hit 45%, and so on. Limitations: If the setting is too low, the stun blast will have no or little effect. Characters are +4 to save for each level the blast is too low. For example, an adult in excellent physical condition shot at setting one is +8 to save while a Juicer shot at setting one would be +16 to save! If the setting is too high, the character suffers greater, potentially lethal damage and is +15% more likely to lose consciousness. Obviously an M.D. blast will atomize an S.D.C. character. The police use this weapon very judiciously and with extreme caution. The weapon is ineffective against environmental M.D.C. body armor, power armor, and full conversion cyborgs, but is effective against Dog Pack armor and half suits, or body armor without a helmet (not fully environmental without the helmet attached). Partially reconstructed cyborgs, Juicers and Crazies are only vulnerable to settings 4 and 5, but even then are +1 to save. Full conversion cyborgs can be affected at the maximum setting of five, but are +4 to save, and the penalties and duration are half. No effect against robots, androids, vampires, demons and the most powerful supernatural beings and creatures of magic. However, lesser demons and young supernatural beings can be affected by setting number five, but are +3 to save. Rate of Fire: Single shot; semi-automatic, best for aimed shots. Range: 800 feet (224 m). Payload: 20 shots per standard E-Clip. Cost: 25,000 credits; 35,000 on the Black Market (fairly rare). Note: Available only to the police and military (used by Military Police and Special Forces). There is no H-Brand copy. Available only in Japan.

**AT-84 "Sharpshot" Laser Rifle.** The AT-84 is a sleek, accurate and lightweight rifle used by the police, military and security/guard agencies. This weapon has also become a favorite of assassins and snipers. Weight: 6 lbs (2.7 kg). Mega-Damage: Two settings: light, inflicting 2D6 M.D. or heavy, inflicting 4D6 M.D. Rate of Fire: Standard. Range: 3000 feet (914 m) Payload: 30 light shots; each heavy blast counts as two light. Bonus: +1 to strike on an aimed shot. Cost: 20,000 credits; 34,000 on the Black Market. Note: Available only to the

Japanese military, police agencies and authorized corporate security forces. H-Brand has a knock-off called the *H-84 Sniper Rifle* that costs 29,000 credits, but range is limited to 2,000 feet (610 m) and one setting at 3D6 M.D.; poor availability inside the Republic, fair to good elsewhere in Japan.

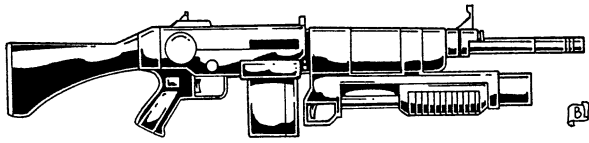

**AT-88 Combat Laser Rifle.** The AT-88 is the standard issue rifle of the Republic Armed Forces. The rifle is very accurate, has good range, good stopping power and the addition of an underbarrel, pump-action grenade launcher. Weight: 9 lbs (4.1 kg). Mega-Damage: Laser: 3D6 M.D. Grenade: 4D6 M.D. fragmentation, 5D6 HE/AP, smoke, or AAD-Dissolver. Rate of Fire: Standard. Range: 3,000 feet (914 m). Payload: Laser: 30 shots per E-Clip or 100 shots per E-canister. Rate of Fire: Standard. Range: 3,000 feet (914 m). Payload: Laser: 30 shots per E-Clip or 100 shots per E-canister. Grenade: Three, but can be reloaded by hand at the cost of one melee action per grenade loaded. Cost: 30,000 credits; 54,000 on the Black Market (rare). Note: Available only to the Japanese military and elite police teams. There is no H-Brand copy.



**AT-230 Particle Beam Rifle.** The AT-230 P-beam rifle has incredible stopping power in a durable, compact frame. The weapon is issued to Japan's elite power armor troops, SAMAS, cyborgs, Special Forces and other special operatives. It is one of the most powerful rifles on Earth. Weight: 11 lbs (5 kg). Mega-Damage: 1D4x10+10 M.D. per single blast. Rate of Fire: Standard. Range: 1,300 feet (396 m). Payload: 10 shots per standard E-Clip, 50 shots from an energy canister. Cost: 45,000 credits; limited military availability. Note: Available only to the military of the Republic of Japan. Rare even in Japan outside the Republic; super-rare elsewhere. On the Black Market and when one is available, it costs a staggering 150,000+ credits. H-Brand does not have the technology to duplicate particle beam weapons.

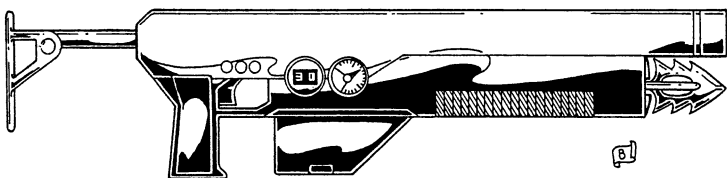

**ATU-80 Underwater Assault Rifle.** The standard weapon of the Republic's tiny navy, the ATU-80 is suitable for use both on dry land and underwater. ArmaTech has produced a combination weapon that combines a laser rifle with a Vibro-spear/harpoon launcher. In addition to the blue laser, the rifle has a single spear launcher that can fire a conventional S.D.C. spear or a Vibro-spear. Weight: 8 lbs (3.6 kg). Mega-Damage: Three settings for the laser, 6D6 S.D.C., 2D6 M.D. or 4D6 M.D. per shot. The latter drains the payload as if two blasts were fired. The Vibro-spear does 1D6 M.D., while the conventional spear inflicts 2D6 S.D.C. Rate of Fire: Standard. Range: The laser has a maximum range of 2000 feet (610 m) underwater or in the air; 400 feet (122 m) for spears. Payload: 30 shots per standard E-Clip or 100 shots per energy canister (heavy 4D6 M.D. blasts count as two blasts). Spear launcher: One shot; takes one melee attack/action to reload. Cost: 25,000 credits; 30,000 on the Black Market. Note: Available only to the Japanese military, police agencies and authorized corporate security forces. There is no H-Brand version because market demand is minimal.

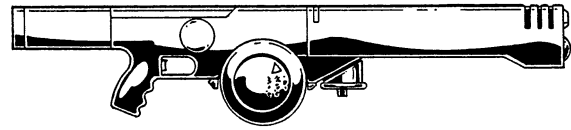

**AT-600 Rail Gun.** ArmaTech has spent years and huge sums of money in research of rail gun technology. Their goal has been to develop a weapon light enough to be used by regular infantry soldiers as well as SAMAS and cyborg troops. The AT-600 is their latest breakthrough, a rail gun that retains its knock-down power and damage capabilities, but is lighter and more compact. Even the rounds for the weapon are made of lighter materials to reduce overall weight. The result is a squad support weapon which can be used by anyone with a P.S. of 20 (or higher). The main weight limitation remains with the multi-round ammunition container, so it is still often used as a two-man weapon; one carries and uses the gun, the other carries additional ammunition and assists in setting up the weapon. Thus, like all rail guns, it is most effective as a vehicle or bunker mounted weapon or placed in the hands of a cyborg or power armor. Weight: Gun: 48 pounds (21.7 kg), rucksack 84 pounds (38 kg), short clips 7 lbs (3 kg), light ammo drums 20 lbs (9 kg), and heavy ammo drums 78 lbs (35 kg). Mega-Damage: A burst of 30 rounds does 6D6 M.D. Rate of Fire: Bursts and wild only. Range: 3,000 feet (914 m). Payload: A short clip holds 300 rounds or 10 full bursts. A light ammo drum holds 600 rounds or 20 bursts. A heavy drum, like those built into the PR-3 rucksack, holds 2400 rounds of ammo, enough for 80 bursts! Reloading a drum takes three minutes for the untrained, or one minute (4 melees) by those trained in the use of rail guns. A strength of 20 is required to handle the drum. Cost: 65,000 credits; limited military availability. Note: Available only to the military of the Republic of Japan. Rarely available on the Black Market and when it is, it can cost as much as 100,000+ credits. H-Brand has no equivalent.

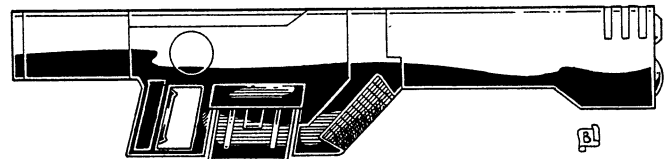

**AT-1200 "Super Rail Gun."** The AT-1200 is basically a larger version of the AT-600 designed for use by power armor, robots or heavy infantry cyborgs. All concern for weight was eliminated in this design. The AT-1200 was developed for superior damage, consequently it is a large gun that fires heavy rounds with greater force. In order to carry and fire this weapon, an individual must have a P.S. of 28 (or higher). Weight: Gun 228 lbs (103 kg), Clip 20 lbs (9 kg), One AT-1200 ammo drum, which fits on the back of the cyborg or 'bot, weighs 200 lbs (90 kg). Mega-Damage: A burst is 40 rounds and inflicts 1D6x10 M.D. One round does 1D6 M.D. Rate of Fire: Standard; bursts, spray or wild. Range: 4000 feet (1219 m). Payload: A clip holds 400 rounds and is capable of firing 10 bursts. The AT-1200 ammo drum holds 4000 rounds and is capable of firing 100 bursts! Reloading a drum takes three minutes for the untrained, but a mere one minute by somebody trained in the use of power armor. A strength of 28 or higher is required to handle the drum. Cost: 80,000 credits; limited military availability. Note: Available only to the military of the Republic of Japan. Rarely available on the Black Market and when it is, it can cost as much as 150,000+ credits. H-Brand has no equivalent.

**ARC-2 "Nighthawk" Defense System.** The ARC-2 is an automated sentry device designed to detect, recognize and engage the enemy in combat. It is a gatling-style rail gun mounted on a tripod with a special sensor array. The radar or thermo-imaging sensor (range 2000 feet/610 m), combined with an internal computer, pick up and identify intruders by heat signature from the thousands of patterns stored in its memory. Once an enemy is detected, the rail gun will begin to fire devastating bursts to destroy the enemy target and alert friendly troops.

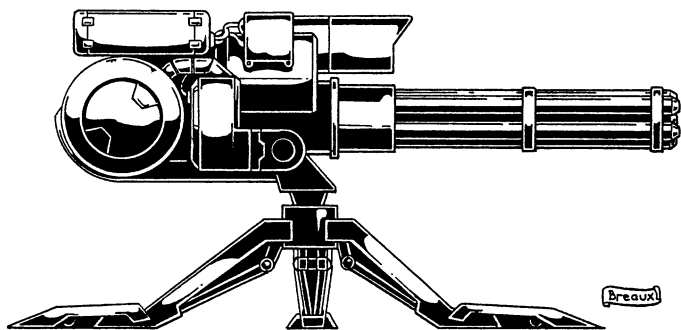

The "Nighthawk" is used in ambushes, to set traps, and defend perimeters either as a stand-alone robot sentry or in conjunction with troops or other defenses.

The ARC-2 can rotate in a 180 degree semicircle with a forward up and down arc of 30 degrees. Together with its huge payload, the weapon is definitely not man-portable and has to be transported by a vehicle or cyborg. A coded radio signal can be used to deactivate the sentry or a shut off time can be programmed into the system before it is activated. There is also a fail-safe manual off and on button. Weight: Gun, includes stand and sensors, 187 lbs (84 kg), power/ammo pack 320 lbs (144 kg). Mega-Damage: 1D6x10 M.D. per 60 round burst. Range: 2,000 feet (610 m); the rail gun can fire up to 4000 feet (1219 m), but is limited by the range of the sensors. Rate of Fire: Bursts only, up to four times per melee round. Payload: The power/ammo pack connected to the cannon holds 6000 rounds of ammunition, that's 100 bursts! The pack can only be reloaded by technicians with special equipment, requiring 10 minutes to complete. Targeting System: Once firing has begun, the ARC-2 relies on its motion sensor to locate its targets and its memory to accurately identify the enemy (human, inhuman and vehicular). The computer system chooses the target(s) closest to it for destruction. The ARC-2 is extremely effective against many supernatural opponents who are magically invisible, detecting them by heat signature and motion. Cost: 180,000 credits; limited military availability. Note: Available only to the military of the Republic of Japan. Not available on the Black Market and H-Brand has no equivalent.

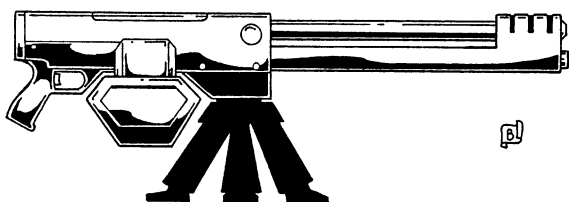

**H-600 Rail Gun.** H-Brand has a standard rail gun that comes with a tripod. It requires a combined P.S. of 25, so the weapon is best suited for augmented humans, power armor, cyborgs and robots. Weight: Gun: 100 pounds (45 kg), light ammo drum: 40 lbs (18 kg), and heavy ammo drums 80 lbs (36 kg). Mega-Damage: A burst of 40 rounds does 1D4x10 M.D. Rate of Fire: Standard; bursts, spray or wild. Range: 4,000 feet (1219 m). Payload: A light ammo drum holds 800 rounds or 20 bursts. A heavy drum holds 2400 rounds of ammo, enough for 60 bursts. Reloading a drum takes three minutes for the untrained, or one minute (4 melees) by those trained in the use of rail guns. A strength of 20 is required to handle the drum. Cost: 65,000 credits; poor to fair availability. Note: Illegal in the Republic of Japan and is rare even among criminal organizations. Poor availability.

**H-12 "Defender" Ion Pulse Rifle.** The H-12 ion pulse rifle can fire a single blast or three simultaneous shots in a damaging pulse. The weapon is popular with adventurers, bandits and mercenaries. Weight: 9 lbs (4.1 kg). Mega-Damage: 2D6 M.D. single shot, 6D6 M.D. per multiple pulse burst (three simultaneous shots). Rate of Fire: Standard. Range: 1,600 feet (488 m) Payload: 30 shots per standard E-Clip. Cost:

26,000 credits, good availability. Note: Illegal in the Republic of Japan, but can be found on the streets, especially among criminals.

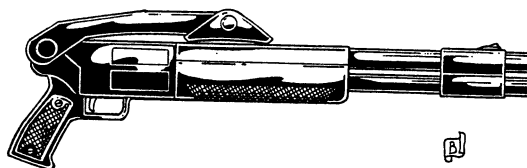

**H-15 "Scattergun" Shotgun.** The H-15 is a modern version of an old, pre-Rifts weapon designed to fire the 25 mm M.D. shot shell. These shells contain a number of explosive pellets that pack a wallop but have a short range. H-Brand has produced a double-barreled weapon and a sawed-off version of the H-15 has become an extremely popular armament among urban criminals. Weight: 9 lbs (4 kg). Mega-Damage: 4D6 M.D. Rate of Fire: Standard. Range: 500 feet (152 m) standard, or 200 feet (61 m) sawed-off. Payload: 2 shots. Note: It takes two melee attacks/actions (about 16 seconds) to completely reload the weapon. Cost: 20,000 credits, good availability throughout Japan and Asia. Note: Illegal in the Republic of Japan.

### Japanese Missiles:

All of the common missile types and explosives found in the Rifts RPG and Triax are available in Rifts Japan. Advanced technology has seen the production of advanced guidance packages and a few unique items not found anywhere else.

**Heat-Seeking Missiles.** With this guidance package a missile locks onto the specific heat signature of a target. Once a lock is obtained, the missile will continue to follow the target until it hits or runs out of fuel. Heat-seekers gain a +5 bonus to strike.

**Knock-Out Missiles.** These concussion missiles are fundamentally the same as Triax Industries' "Slammers." They are designed to blow opponents off their feet and stun them for several moments. Anyone in the blast radius of the missile is likely (01-88%) to be knocked off their feet and stunned (01-65%). The victim of a direct strike will always be knocked down. A character, robot or monster knocked down will lose one melee attack/action and initiative. If stunned, the victim will be dazed, -10 to strike, parry, dodge, roll with impact or pull punch, is the last to attack (no initiative) and loses half his attacks/actions per melee round for 1D4 melee rounds! Speed is also reduced by half during this period.

**Mini-Concussion Missiles.** Damage: 5D6 M.D. Blast Radius: 30 feet (9.1 m). Range: 2,000 feet (610 m). Cost: 4000 credits, poor availability.

**Short Concussion Missiles.** Damage: 1D6x10 M.D. Blast Radius: 60 feet (18.3 m). Range: 6,000 feet (1,829 m). Cost: 8500 credits, poor availability.

**Medium Concussion Missiles.** Damage: 2D4x10 M.D. Blast Radius: 90 feet (27.4 m). Range: 6,000 feet (1,829 m). Cost: 11,000 credits, poor availability.

**Heavy Concussion Missiles.** Damage: 3D4x10 M.D. Blast Radius: 120 feet (36.5 m). Range: 2 miles (3.2 km). Cost: 20,000 credits, poor availability.

**Heavy-Hitter Missiles.** These missiles have become extremely popular for their damaging capacity. The Heavy-Hitter (HH) is a high explosive (HE) missile which uses a large warhead. The warhead used in an HH missile is usually that of the next highest size. For example, a short-range explosive charge is mounted on a mini-missile. The resulting HH missile has much higher damaging capabilities but has a severely reduced range.

**Mini-HH Missile.** Damage: 1D6x10 M.D. Range: ½ mile (0.8 km). Cost: 5000 credits.

**Short HH Missile.** Damage: 2D4x10 M.D. Range: 1 mile (1.6 km). Cost: 9,500 credits.

**Medium HH Missile.** Damage: 3D4x10 M.D. Range: 20 miles (32 km). Cost: 14,000 credits.

**Long HH Missile.** Damage: 3D6x10 M.D. Range: 30 miles (48 km). Cost: 22,500 credits.

---

## Japanese Explosives:

---

**AT-D10 Satchel Charge.** The standard issue explosive charge for the military is a 4 pound (1.8 kg) block of plastique with attached detonator packed in a canvas satchel. The flip of a switch activates a 3 minute delay for the charge. Mega-Damage: 3D4x10 M.D. (blast radius of 30 feet/9.1 m). Range: The satchel charge is not very aerodynamic, but can be thrown a distance of 2D4x10 feet (6.1 to 24.4 m). Cost: 4600 credits. Note: Available only to the military of the Republic of Japan. Occasionally available on the Black Market or H-Brand at around the same cost.

**Hand Grenades.** A hand grenade is a small, softball-sized explosive canister designed for throwing and exploding. Average effective throwing range is about 100 feet (30.5 m). Note: Grenades are illegal and hard to acquire in the Republic of Japan. Their use is limited exclusively to the police and military. These explosives may be available to mercenaries and adventurers serving other kingdoms or from select H-Brand dealers.

**Fragmentation Grenade (anti-personnel) AT-D25 (Light Frag.):** Mega-Damage: 2D6 M.D. to everything in a blast radius of 20 feet (6.1 m). Cost: 200 credits each.

**AT-D26 (Heavy Frag.).** Mega-Damage: 3D6 M.D. to everything in the blast radius of 30 feet (9.1 m). Cost: 250 credits each.

**AT-D28 High Explosive Grenade (anti-armor).** Mega-Damage: 4D6 M.D. to a 6 foot (1.8 m) blast area. Cost: 150 credits.

**AT-D29 Plasma Grenade.** Mega-Damage: 5D6 M.D. to a 12 foot (3.65 m) area. Cost: 350 credits.

**AT-D30 Stun/Flash Grenade.** This riot/anti-terrorist weapon is designed to disorient and confuse criminals who are holding hostages in confined places. The grenade makes a loud exploding boom and emits a bright flash, followed by a shower of white-hot sparks and some white smoke. The flash, burning sparks, and smoke should blind and startle any character without environmental armor or protective goggles. The victims of a stun/flash grenade are -8 to strike, parry and dodge, -1 on initiative and lose one melee attack/action for the next 1D4 melee rounds (15 to 60 seconds). Even those in armor should be momentarily distracted for 1D4 seconds and lose initiative. Cost: 100 credits.

**AT-D31 Tear Gas Grenades.** The gas will instantly affect all characters without protective masks or environmental body armor. The eyes burn, sting and water profusely, causing great discomfort and seeing clearly is impossible. The gas also makes breathing difficult and irritates exposed skin. The effects last for 3D4 minutes. The 25 foot (7.6 m) cloud dissipates in about five minutes unless blown away by the wind (dissipating quickly in 1D4 minutes). The victims of tear gas are -10 to strike, parry and dodge, -3 on initiative and lose one melee attack/action for each of the next 1D6+1 melee rounds. Those in environmental armor are completely safe and not affected. Cost: 200 credits.

**AT-D32 Concussion Grenade.** This explosive canister is not designed for mass destruction but to knock down and stun victims. The materials of the canister are instantly melted in the blast instead of becoming deadly projectiles. When detonated, the AT-D32 erupts in a 30 foot (9.1 m) blast radius causing 1D4 M.D. to everyone within. Individuals caught in the blast are likely (01-88%) to be knocked off their feet and stunned (01-65%). If only knocked down, the victim of this attack will have ringing ears and a headache, but only loses one melee action/attack and initiative. If stunned, the victim is dazed, -10 to strike, parry, dodge, roll with impact or pull punch, is the last to attack (no initiative) and loses half his attacks/actions per melee round for 1D4 melee rounds! Speed is also reduced by half during this period. Cost: 100 credits.

**AT-D40 Smoke Grenade.** Upon detonation, this will release a thick cloud of smoke that covers a 20 to 40 foot (6.1 to 12.2 m) radius. The smoke obscures vision in and through the cloud from those on the outside of it. Infrared cannot penetrate a smoke cloud or be used inside a smoke cloud. Those inside the cloud will be blinded and have trouble breathing while inside it. Those who are not protected by environmental suits or gas masks and goggles will be -5 to strike, parry and dodge and are -1 on initiative. Attackers firing into/through the cloud are shooting wild. Note that passive night scopes will work in a smoke cloud. Cost: 50 credits.

**Hand-Held Flare.** This is the type of item truck drivers and road patrols use to signal for help or to warn others of an accident or danger. The flare burns for 20 minutes. Cost: One credit each.

**Parachute Flares.** This pyrotechnic device usually comes in a hand-held, throw-away launch tube. Three seconds after launching the flare, it ignites into a bright, sparkling light that slowly drifts back down to earth. While in the air, the flare burns for 60 seconds and illuminates an area roughly 150 feet (45.7 m) in diameter. Cost: 10 credits each. Note: This is NOT a weapon, but if shot into a person, the flare does 6D6 S.D.C. each melee round for one minute (four melees). There is also a 50% chance of causing combustibles to catch fire.

**AT-25 Pump Grenade Launcher.** A pump-action grenade launcher with a light laser. The weapon is somewhat reminiscent of the Coalition States' C-14 "Firebreather" and the TX-16 pump rifle. It can fire a variety of grenades and is in wide service both in the military and by police units. The launcher can take a lot of punishment but still delivers rounds right on target. The range, damage and area of effect vary with each cartridge. Weight: 10 lbs (4.5 kg). Mega-Damage: Grenade: Varies with type of round. Laser: 2D6 M.D. Rate of Fire: Laser: Standard. Grenade Launcher: one aimed, or four fired in rapid succession (burst or spray). Range: Grenade Launcher: 1200 feet (365 m). Laser: 2000 feet (610 m). Payload: Laser: 30 shots per standard E-Clip, 12 rounds for grenades. Grenade Type: Any as described above. Cost: 28,000 credits; 34,000 on the Black Market. Note: Available only to the military, police agencies and authorized corporate security forces. H-Brand has a knock-off called the H-25 Super Rifle that costs 31,000 credits, but range is 20% less than the AT-25 for both weapons and it weighs 14 lbs (6.3 kg); poor availability inside the Republic, fair to good outside of it.

**CC-26 Bomb Detector.** This hand-held unit is a combination of metal detector and chemical sensor which in concert can detect the presence of land mines and explosives. Despite its limited range, a mere 75 feet (22.8 m), the CC-26 is an excellent tool for both the military and police forces. The unit detects explosives with a 65% level of accuracy. Weight: 3 lbs (1.4 kg). Range: 75 feet (22.8 m). Cost: 950 credits, poor availability.

---

## Japanese Land Mines:

The Republic of Japan uses a variety of land mines in protection of its borders. These weapons are closely guarded by military personnel and are rarely found on the Black Market or available from H-Brand. Rare elsewhere in the world.

Detecting Mines: Traveling on foot and looking for mines, either the Detect Ambush or Detect Concealment skills at -10% can be used to spot land mines and booby-traps. If the individual placing the mine or booby-trap makes a successful Camouflage skill roll then there is an additional -20% penalty.

Vehicles can be outfitted with a basic mine detector for 50,000 credits. This unit has a 40% chance of locating mines before they are struck and detonated, but will also indicate harmless metal fragments as well (fragments must be the size of a soccer ball or bigger). The basic system can be "fine-tuned" and enhanced +10% for an additional 20,000 credits up to a maximum of 90% efficiency, but those are rare (most are at 70%). A pilot can try the Detect Ambush or Detect Concealment skill rolls, but is -25% if traveling is at a crawl and -50% if traveling at

over 30 mph (46 km). Note: Land mines are illegal and hard to acquire in the Republic of Japan. Their use is limited exclusively to the police and military. These explosives may be available to mercenaries and adventurers serving other kingdoms or from select H-Brand dealers.

**AT-D50 Anti-Personnel Mine.** The AT-D50 is the simplest form of land mine, a small platter charge detonated by 200 pounds (90 kg) of pressure. With several minor modifications, the AT-D50 can be used with a trip wire that will cause the mine to explode if 30 pounds (13.6 kg) of pressure is exerted on the line. Weight: 12 lbs (5.4 kg). Mega-Damage: 6D6 M.D. Blast Area: 12 feet (3.65 m). Black Market Cost: 4500 credits, fair availability. Notes: The mine casing has 15 M.D.C. which, if depleted, will detonate the contained explosives. There is a -5% penalty to Camouflage skill to conceal the mine due to its size and bulk.

**AT-D52 "Bullet" Anti-Personnel Mine.** The AT-D52 is an extremely small mine with relatively small damage capabilities. But due to the small size it is extremely hard to detect; -30% penalty to detect concealment or ambush. The AT-D52 is a plastic cylinder, three inches in length (75 mm) and a little over an inch (30 mm) in diameter. Contained within the tube is a grenade projectile from the AT-25 launcher, resting atop a steel pin. The tube is embedded in the ground so that only the top protrudes slightly. Pressure from a footfall causes the cartridge to fire. Weight: 1 lb (0.45 kg). Mega-Damage: 4D6 M.D. Blast Area: 1 foot (0.3 m). Black Market Cost: 500 credits, poor to fair availability. Notes: The plastic tube which holds the round has 20 S.D.C. Damage of one point of M.D. will cause the grenade round to detonate. Arrows on both sides of the mine indicate which end is the top. Due to its small size, this device gets a bonus of +15% to Camouflage skill rolls.

**AT-D54 Anti-Armor Mine.** A large platter-style mine akin to those used before the Rifts. Pressure of 500 pounds (225 kg) will detonate the mine's explosive charge. Weight: 45 lbs (20.25 kg). Mega-Damage: 2D6x10 M.D. Blast Area: 15 feet (4.5 m). Black Market Cost: 18,000 credits, fair availability. Notes: The metal casing has an M.D.C. value of 5 to protect the explosive. If the case is depleted, the mine will detonate prematurely. A -25% penalty applies to the Camouflage skill when attempting to hide this mine.

## Juicer™ Weapons

The following weapons and equipment are either produced by such a wide variety of manufacturers that no one can claim ownership over any of these devices, or they are pre-Rifts artifacts locally reproduced (like the Juicer specialty rifles). All in all, this is the gear most favored by Juicer warriors, and it has become something of a trademark for them. So much so, in fact, that non-Juicers are rarely seen using any of these devices for fear of being labeled a Juicer imposter or wannabe.

**Advanced Thermal Sights.** Advanced thermal sights existed in pre-Rifts days and had many military applications, from night fighting to allowing the user to "see" inside buildings and other structures. These advanced sights can sense heat signatures even through walls and other obstructions! Assassins often use them to locate a target and then shoot through often flimsy S.D.C. walls to hit him. Only thick (4 inches or thicker), reinforced M.D.C. walls will block thermal readings enough to foil the sights. Cost: 15,000 credits for goggles, 30,000 to build them into armor or helmet. Poor to fair availability.

**Combat Gauntlets.** These gauntlets have the same mechanical "muscles" used by cyborgs and powered armor. While wearing them, the user can crush objects as if he had a robotic strength of 26. Juicers, Crazyes, cyborgs and other augmented humans can inflict Mega-Damage with their punches when wearing these gauntlets. The gauntlets are also useful as tools, allowing the wearer to grip objects with mechanical strength. Weight: 4 lbs (1.8 kg). Mega-Damage: Crush/Squeeze does 1D6 M.D. A Juicer, Crazy, cyborg or other aug-

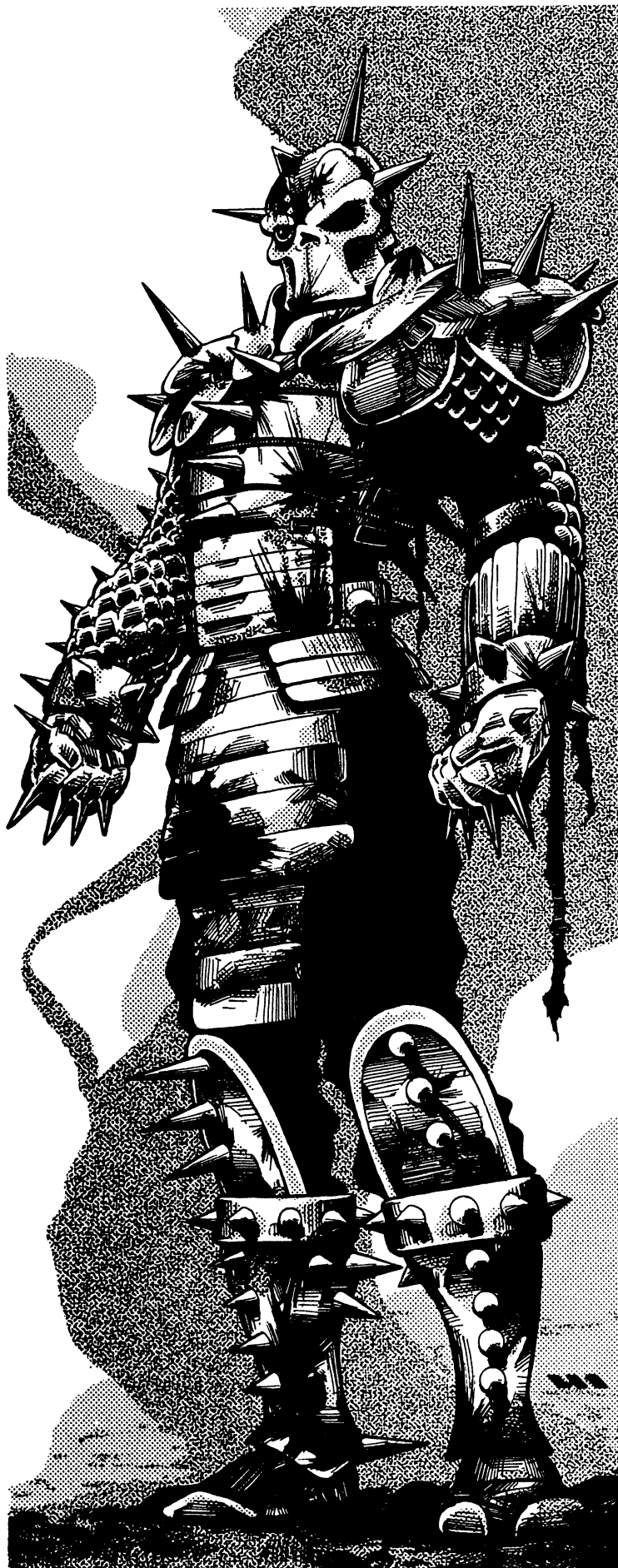



mented human can inflict one M.D. point on a normal punch or 1D6 M.D. on a power punch (counts as two attacks). Characters with Supernatural P.S. add +4 M.D. to their normal punch damage. Normal human punches inflict 2D6 S.D.C. plus P.S. bonuses or 3D6 with a crush/squeeze. **Penalties:** While wearing the gauntlet, any fine manipulation skills requiring the use of the hand are -20%, use of a weapon is -4 to strike and parry. Most guns cannot be fired by a hand fitted with the large gauntlet. **Payload:** Powered by a rechargeable battery with 20 hours of life. **Black Market Cost:** 5,000 credits per gauntlet. Poor availability.

**Combat Vambrace.** This is a piece of power armor that entirely covers the arm and is either strapped to the body or built into a suit of environmental armor. The Vambrace uses the same mechanical systems of power armor, and has a robotic P.S. of 24. A Juicer or Crazy (normal humans cannot use this weapon without risking broken bones) can attack and inflict hand to hand damage as if he had that strength. Furthermore, the power armor piece can be fitted with bionic or power armor weapon systems (they must be purchased separately). Only one Vambrace can be built into a suit of body armor. **Weight:** 15 lbs (6.75 kg; this adds to the weight of the armor). **Mega-Damage:** 6D6 S.D.C. plus P.S. bonus on a restrained punch, 2D4 M.D. on a full strength punch, and 4D4 M.D. on a power punch (counts as two melee attacks). **Payload:** Powered by a rechargeable battery with an energy life of 8 hours. **Black Market Cost:** 40,000 credits. Poor availability.

**Deadball Grenade.** Designed for players and fans of the Juicer sport *Deadball*, this grenade consists of an explosive charge surrounded by a highly elastic plastic sheathing, shaped like a ball (roughly the size of a baseball). Unlike true Deadballs, this sphere does not have spikes; instead, it can ricochet off almost any surface. The grenade's detonator can be set to explode after one, two, or more impacts (ricochets), to a maximum of five impacts/bounces. A trained Juicer Deadball player can bounce the ball around corners, into small holes, into a tank's crew compartment, etc. Characters without the Deadball W.P. can attempt to do the same, but must make "called shots" at -4 to strike for each ricochet. **Weight:** 1 pound (0.45 kg). **Mega-Damage:** 3D6 M.D. to a 20 foot (6.1 m) area. **Rate of Fire:** A throw counts as one hand to hand attack. **Range:** With the Deadball W.P., up to 200 feet (61 m); otherwise, 120 feet (36.5 m). **Black Market Cost:** 1,000 credits per grenade. Poor availability.

**FIWS (Forearm Integral Weapon System).** This weapon was developed for the use of the Chi-Town Special Forces Battalion of Coalition Juicers. Colonel Lyboc, the officer in charge of the project, is always trying to make a buck, so the blueprints for the weapon were "stolen" by the Black Market and pirated FIWS are now on sale throughout North America. The FIWS looks like a simple piece of armor at first, a thick, heavy forearm plate. Over and under the wrist are two thick-barreled particle beam projectors and a thinner targeting laser (+1 to strike). Additionally, three Vibro-Blades can spring into action at the flick of the wrist, providing the wearer with a lethal close assault weapon. A long E-Clip powers the particle beam projectors. This fearsome weapon is meant for close assault; the particle beam weapons are very powerful, but relatively short-ranged. Combat trials have shown that a team of FIWS equipped Juicers who manage to get within 500 feet (152 m) of a tank will be able to destroy the vehicle before it can destroy them! **Weight:** Adds 5 lbs (2.25 kg) to the weight of the armor. **Mega-Damage:** *Vibro-Blades* (3 per arm): 3D6 M.D. *Particle Beam Weapons:* 5D6 M.D. per single blast, or 1D6x10 M.D. per double blast (counts as one attack but uses up two shots). **Rate of Fire:** Single shots only. **Range:** Particle Beam: 500 feet (152 m). Blades: hand to hand combat. **Payload:** Particle Beam: 30 single shots or 15 double shots (long E-Clip). **Black Market Cost:** 24,000 credits. Poor availability.

**Forearm Grenade Bracers.** This is an armor accessory, a built-in grenade bracer that holds 3 grenades on the forearm of the wearer (6 total if one is built into the armor of *both* arms). The grenades are stuck to magnetic clip holders; to grab a grenade, all the wearer has to do is hold it and twist it in a clockwise fashion to automatically disable the

magnetic clip. **Damage:** As per grenade. **Range:** Thrown. **Black Market Cost:** 800 credits per Bracer. Can be built into normal body armor, or combat vambrace, as well as into bionic limbs or power armor. Grenade cost not included.

**Forearm Grenade Launchers.** An electromagnetic launch system usually built into a vambrace or body armor along with a laser targeting system. To shoot at a target, the wearer aims the laser beam and presses a firing stud; can be built into a glove, wrist, or computerized as a voice command grenade launcher! **Weight:** Adds 3 lbs (1.35 kg) to the armor weight. **Mega-Damage:** Varies with grenade type. **Rate of Fire:** One at a time or in "volley" of two or three. **Range:** 600 feet (183 m). **Payload:** Three grenades per forearm launcher. **Black Market Cost:** 2,000 per forearm; 8,000 if a voice activated launch system is built into the armor.

**Forearm Vibro-Blades (UTI).** These weapons are mounted on the forearms of body armor. When activated, they extend two or three Vibro-Blades, which can be used in close combat. Juicers, Crazies and Quick-Flex Aliens are particularly fond of the weapon, since it allows them to engage in hand to hand combat where their physical abilities give them a huge edge over normal humans. **Mega-Damage:** Double Blade: 2D6 M.D. Tri-Blade: 3D6 M.D. **Black Market Cost:** 4,000-6,000 for the double blade; 8,000 for the tri-blade. Widely available.

**Holdout Speed Holsters Weapon Accessory.** This is a holster equipped with a spring that, at the flick of a wrist, flings the gun into the character's hand. These holsters are typically worn on the forearm, allowing the wearer to be the first to draw a weapon. At the beginning of a fight where no guns have been drawn, the character is at +3 to initiative to be the first to draw his weapon and fire. If the character is the one to initiate the attack, it counts as an ambush/sneak attack (automatically wins initiative). **Cost:** 1500 credits.

**JA-9 Juicer Assassin Variable Laser Rifle.** Another German Pre-Rifts design for the Juicer. A variable light frequency laser to overcome the laser resistant armors, like that of the Glitter Boy power armor. The Juicer can adjust the frequency of the laser to blast through a Glitter Boy's defenses (or anybody else). Greatly resembles the JA-11, complete with laser targeting and scope. **Weight:** 6 lbs (2.7 kg). **Mega-Damage:** 2D6 M.D. **Rate of Fire:** Standard. **Range:** 4,000 feet (1,219 m). **Payload:** 10 shots with a short E-Clip or 30 with a long E-Clip. **Laser Targeting Bonus:** +1 to strike on an aimed shot. **Black Market Cost:** 20,000 credits.

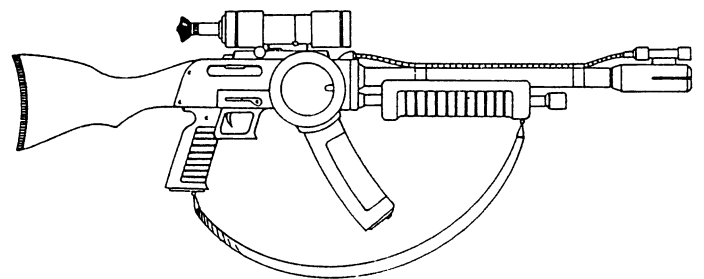

**JA-11 Juicer Assassin's Energy Rifle.** The Juicer Assassin's rifle is a Pre-Rifts design of remarkable ingenuity. The weapon can fire a single, hand loaded 7.62 mm round for S.D.C. damage, fire a high intensity laser beam, or switch to an ion beam. The weapon also has a built-in laser targeting system and comes standard with a telescopic (2 mile/3.2 km) and infrared scope. The standard Juicer optics helmet offers passive nightvision and other optical enhancements. The JA-11 also has a canister energy cell similar to the new CS canister E-Clips, and this is presumably where the Coalition got the idea to develop the device. The difference between the two is that the canister on the JA-11 can not be physically removed from the rifle, but can be recharged. Other than this, the energy cells work identically, adding more power to the E-Clip's capacity. In the case of the JA-11, the E-Clip is used up first. Apparently, the canister was considered to be an energy *reserve* system. **Weight:** 6.5 lbs (2.9 kg). **Mega-Damage:** *Laser* has two set-

tings: 2D6 M.D. and 4D6 M.D., both work on different light frequencies too. *The ion beam* does 3D6 M.D. S.D.C. **Damage:** Single, hand loaded 7.62mm shell. Available types include a standard 7.62mm round that inflicts 5D6 S.D.C., or armor piercing 6D6 S.D.C., or exploding 1D6x10 S.D.C. damage. **Rate of Fire:** *Laser:* This is meant to be a precision sniper/assassin weapon and as such, can only be fired as an aimed shot; i.e. each blast whether 2D6 or 4D6 counts as one melee attack. It can not fire bursts. *Ion beam:* Each shot counts as one melee action. *The 7.62mm round:* Loading and firing counts as two melee attacks/actions, one to load and one to aim and fire. **Range:** *Laser:* 4,000 feet (1,219 m), *Ion Beam:* 1,600 feet (488 m), S.D.C. 7.62mm round: 2,000 feet (610 m). **Payload:** Standard E-Clip has 10 shots, Long clip 30 shots. **Canister E-Cell:** Adds 30 shots. 7.65 mm round: One loaded in weapon, others to be added. **Laser Targeting Bonus:** +1 on an aimed shot. **Black Market Cost:** 40,000 credits.

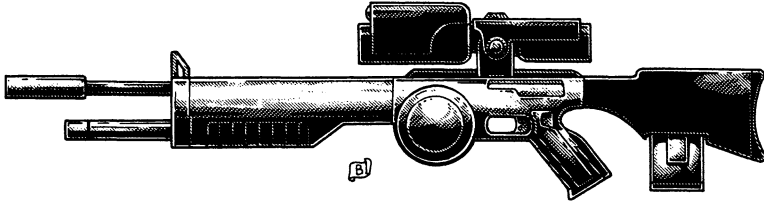

**JA-12 Laser Rifle.** Released in recent years, the JA-12 is a recreation of a pre-Rifts German design meant primarily for Juicers. The JA-12, like the JA-11, has an energy canister in addition to a normal E-Clip. More importantly, however, the weapon was optimized for both sniping and assault purposes. Not only can the laser fire accurate single shots, it can also fire multiple-pulse bursts (losing its targeting capabilities), and it also has a grenade launcher. Since it went into production, the JA-12 has been known as “the one-man-army rifle.” The main shortcoming of the JA-12 is that it does not have a variable frequency setting (the multiple pulse system cannot be reset), making it less effective against Glitter Boys and similar laser resistant vehicles or robots. **Weight:** 13 lbs (5.85 kg). **Mega-Damage:** A single shot inflicts 4D6 M.D. A triple-pulse shot does 1D6x10+10 M.D. (counts as one melee attack, but does not get the special targeting bonuses). Each grenade inflicts 3D6 M.D. to a 10 foot (3 m) radius. **Rate of Fire:** Standard. **Range:** *Laser:* 4000 feet (1219 m); *Grenade:* 2,000 feet (610 m). **Bonuses:** +1 to strike on aimed/called shots, cumulative with other bonuses. No bonus for auto-pulse or grenades. **Payload:** Standard E-Clip has 10 shots; long E-Clip 30 shots. Energy canister (cannot be removed but is rechargeable) holds an additional 30 energy shots. The grenade launcher has a four-shot pump magazine and can be reloaded by hand. **Black Market Cost:** 50,000 credits.

**Rocket Boots.** These bizarre accessories are the rage among Juicers and Crazies. As their name indicates, this footwear has focused explosive charges built into their soles; charges powerful enough to propel the wearer up to 60 feet (18.3 m) into the air! An Acrobatics or Gymnastics roll (equivalent to a back flip roll) will allow the wearer to do midair rolls, somersaults, back flips and cartwheels in two seconds and land on his feet. This maneuver enables the rocketing character to turn around, dodge (+1), land behind a person, or move 10-20 feet (3-6 m) in any lateral direction, or to land on a rooftop, tree branch, etc. Each rocket jump counts as one melee action.

*Any non-augmented humans or D-Bees* who try to use rocket boots risk injury; each time the boot is used, the non-Juiced character must roll a 16 or higher to successfully execute the jump or maneuver to land safely on his feet. A bad roll means failure to execute any special maneuver (back flip, etc.) and a bad landing causes 2D6 S.D.C. damage and loss of initiative (if he had it). Body armor does not protect against this injury. Broken legs, sprained ankles, and pulled ligaments from the stress of the rocket boots or nasty impacts and landings are very common. Even so, many Juicer Wannabes keep trying to use the boots. **Note:** Characters with cybernetic or bionic legs or who are Mega-Damage beings can use the boots without penalties. **Payload:**

The boots are powered by an E-Clip and can make 20 jumps per standard clip. **Black Market Cost:** 30,000 credits. Can be built into a suit of M.D.C. environmental armor for an additional 2,000 credits. Fair availability.

**Sensor Jammers.** These “spoofers” can be built into a suit of light or medium M.D.C. armor (50 M.D.C. or less). They consist of several fiber optic arrays and special insulating materials that jam and block thermal and radar signatures, and also diffuse laser targeting systems. When the Jammers are activated (they are powered by an E-Clip built into the armor), the character only has a 01-15% chance of being detected by *standard thermal optics and sensors*, and *motion and radar detectors*. Furthermore, guided missiles are at -2 to strike, and even a volley of four or more missiles is -2 (roll once for entire volley). Laser aiming systems lose their targeting bonus when shooting at the wearer. **Note:** The Sensor Jammers are destroyed when over half the M.D.C. of the body armor has been depleted. The E-Clip operates the system for up to eight continuous hours; *each activation* of the jamming field depletes the equivalent of 10 minutes of charge, whether or not the jammers are active for that long. The system has been tried on power armor and vehicles, but found to be ineffective due to the larger size, large energy supply, and much stronger heat signatures. The system is also useless for any creature who is over 10 feet (3.0 m) tall. Juicers, spies and special operations agents love this accessory. **Black Market Cost:** 20,000 to install into a suit of armor. Fair availability.

**Vibro-Deadball.** Like the Deadball grenade, this weapon looks like the play ball of the popular Juicer game. Unlike a real Deadball, the spikes of this one always come out after a throw and they are surrounded by a Vibro-field, inflicting Mega-Damage. A trained Deadball player can align the strike so it will hit a target, slash it, and ricochet back, at distances of up to 200 feet (61.0 m)! The spikes automatically extend after the first impact. **Weight:** One pound (0.45 kg). **Mega-Damage:** 2D4 M.D. **Rate of Fire:** A throw counts as one hand to hand attack. **Range:** 200 feet (61.0 m). **Black Market Cost:** 4,000 credits.

## Kittani™ Weapons

### Rifts® World Book Two: Atlantis (One)

**Note:** All are common to Atlantis and available to those people and nations the Splogorth trade with, including the Phoenix Empire in Africa, Gargoyle Empire in Europe, Horune Pirates (who in turn trade with Japan and other coastal communities) and some extremely limited trade with others. Most are considered very rare in North America, England, Europe, and Australia. The *Columbian Republic* and *Silver River Republics* (i.e. Southern Federations) of South America trade extensively with the Splogorth of Atlantis, but most of these weapons are uncommon outside the military even among these nations and rare throughout the rest of the country.

**Double Blade Plasma Axe.** An energy weapon used in close combat, originally designed for use with Kittani power armor. This is a man-size version of the giant original weapon and can be used as a bludgeon or energized to slice through Mega-Damage material like a hot knife through butter. It can also fire a short-range burst of plasma. Unlike the power armor version, this weapon draws its power from an E-Clip. **Weight:** 10 lbs (4.5 kg). **Mega-Damage:** 3D6 M.D. per axe strike or 6D6 M.D. per plasma blast. Each blast drains 10 minutes from the power supply. 3D6 S.D.C. damage when not energized. **Rate of Fire:** 60 minutes or less per clip, depending on the number of plasma blasts fired. A maximum of six plasma blasts. **Range:** Close combat or plasma blast of 100 feet (30.5 m). **Payload:** 60 minutes or less per clip, depending on the number of plasma blasts fired. Six blasts maximum per clip. **Cost:** 32,000 credits, good availability in Atlantis.

**Forearm Plasma Blaster.** A forearm blaster similar to the one used by the *Splogorth Slaver*. It shoots bolts of fiery plasma. **Mega-Damage:** 5D6 M.D. per blast (double the damage and range when on a ley line or

at a nexus). Range: 2,000 feet (610 m). Rate of Fire: Each blast counts as one melee action. Payload: 20 blasts. Magically recharged by Splugorth High Lords, Techno-Wizards, or at stone pyramids; requires 70 P.P.E to recharge. Cost: 110,000 credits; rare except in Atlantis.

**Head or Helmet Laser.** A cylindrical rod that combines light spells and laser optics; attaches to a helmet or special headband. Mega-Damage: 2D6 M.D. per blast (double the damage and range when on a ley line or at a nexus). Range: 2,000 feet (610 m). Rate of Fire: Up to four blasts per melee. Payload: 20 blasts. Magically recharged by High Lords, Techno-Wizards, or at stone pyramids; requires 60 P.P.E to recharge. Cost: 125,000 credits; limited availability.

**K-4 Laser Pulse Rifle.** A knock-off of the latest design from Wilk's Laser Industries, Inc. The K-4 is a rapid-fire pulse rifle that has the trademark features of all of Wilk's high quality weapons; sleek, lightweight, black plastic and ceramic construction, long distance firing range, and reliability in the field. Weight: 4 lbs (1.8 kg). Mega-Damage: 3D6+6 M.D. per single shot, or 1D6x10+6 per multiple pulse burst (three simultaneous shots). Rate of Fire: Standard. Range: 3,000 feet (914 m). Payload: 30 shots long E-Clip. Bonus to Strike: +1 to strike on an aimed shot. Cost: 75,000 credits. Fair availability even outside of Atlantis.

**K-30 Ion Pulse Rifle.** A devastating close-range weapon with the benefit of rapid-fire bursts and greater damage. Weight: 7 lbs (3 kg). Mega-Damage: 4D6 M.D. per single shot, or 1D6x10+6 per multiple pulse burst (three simultaneous shots, but -2 to strike). Rate of Fire: Standard. Range: 1000 feet (305 m). Payload: 15 shots short E-Clip or 30 shots long E-Clip. Cost: 45,000 credits.

**K-1 Sniper Laser Rifle and Launcher.** A light laser rifle designed for single shots and maximum accuracy. Comes standard with an infrared telescopic sight and a mini-missile style grenade launcher (self-propelled heat-seeker, +1 to strike). Weight: 6 lbs (2.7 kg). Mega-Damage: 4D6 M.D. from the laser or 6D6 M.D. from grenade. Rate of Fire: Equal to the number of hand to hand attacks of its operator; aimed and wild shots only. Can not fire bursts. Grenade launcher can be fired in place of the laser with the press of a button. Range: 2000 feet (610 m) – half range for grenade launcher. Payload: Laser: 20 shots standard clip or 30 shots long E-Clip. Grenade launcher holds two grenades and takes one full melee round, 15 seconds, to reload. Cost: 60,000 credits; each additional SPG grenade costs 10,000 credits. Special Bonus: +1 to strike (so an aimed shot is +4) for both the laser blast and the heat-seeking, self-propelled grenade (SPG). Rare outside of Atlantis.

**K-500 Rail Gun.** A light rail gun similar to the Triax cyborg gun. As usual, it is a comparatively lightweight, portable weapon designed for use by cyborgs and other creatures with a strength of 24 (or higher) and a high physical endurance (or made of steel and hydraulics). It can also be used as a machine-gun mounted on a tripod. The K-500 comes equipped with a telescopic, nightvision scope and laser targeting system (+1 to strike). Weight: Gun: 80 lbs (36 kg), Power Pack: 30 lbs (13.6 kg), One Ammo-Belt: 25 lbs (11 kg), Case of Six Belts: 150 lbs (67.5 kg). Mega-Damage: A burst is 30 rounds and inflicts 6D6 M.D., one round does 1D4 M.D. Rate of Fire: Standard. Range: 4,000 feet (1,219 m). Payload: As a machine-gun: 390 round belt (13 full 6D6 bursts). Or can be fitted with the mini-clip which contains 90 rounds (3 full bursts). Each mini-clip weighs 3.3 lbs (1.5 kg). Cost: 155,000 credits. Fair availability.

**K-1000 Spider Defense System.** The Kittani geniuses have developed a portable, multi-purpose laser cannon that can be used as a mounted weapon, with power armor, by cyborgs and robots, or as a self-contained, programmable, automatic defense system. When used as a rifle or personnel operated mounted weapon, the K-1000 offers light and heavy laser capabilities, plus telescopic scope, nightvision scope, thermo-imager and laser targeting system (+1 to strike). As an automatic defense system, the weapon is programmed to recognize either specific targets (memory can hold 1000 targets) or to defend an area from all intruders (kills indiscriminately). In addition, the "smart"

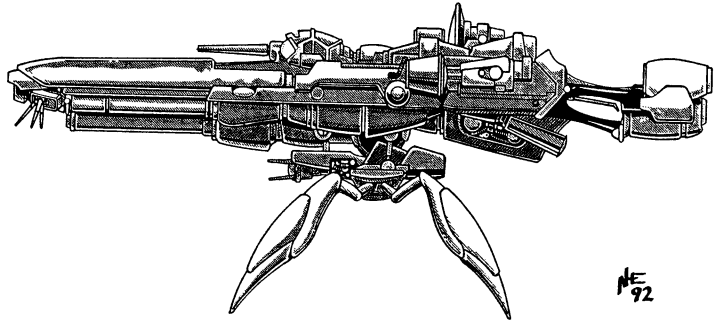

weapon has four crab or spider-like robot legs and can take evasive action, reposition itself, climb inclines up to 90 degrees, and/or be suspended from ceilings or heavy branches of trees (in the latter case, the K-1000 must be physically attached — the legs hold on). Weight: Gun: 80 lbs (36 kg); nuclear powered. Mega-Damage: Light laser: 4D6 M.D. or heavy: 1D4x10 M.D. per blast. It can also fire a short-range (20 feet/6.1 m) electric current from the base of its quadrupled legs to chase away curious animals and pests; 3D6 S.D.C. damage. Furthermore, it can fire as many as four smoke grenades to create cover, a distraction, or to signal allies (range 100 feet/30.5 m; no damage). Also see robot defense system. Rate of Fire: Standard. Range: Light laser: 4,000 feet (1,219 m). Heavy laser: 3,000 feet (914 m). Payload: 100 light blasts and 40 heavy blast before requiring a two hour period to energize back to full capacity. An E-Clip can be used in case of emergencies (10 light blasts or 5 heavy). Robot Defense System: Combat data file enables it to relocate to a better position, hide and take evasive action (+2 to dodge), and to recognize 1000 different targets. Bonus of +2 to strike, six attacks per melee (fire light or heavy or mix), Spd 22, and M.D.C. of weapon: 50. Cost: One million credits. Fair availability.

**KEP-Special Energy Pump Pistol.** The KEP-Special is a short-range ion blaster that works like a sawed off shotgun, with pump action. The range is short but the damage is impressive. Weight: 4 lbs (1.8 kg). Mega-Damage: 5D6 M.D. Rate of Fire: Equal to the user's number of hand to hand attacks (each pump action counts as a melee attack). Range: 200 feet (61 m). Payload: 10 blasts from a short E-Clip or 20 from a long E-Clip. Cost: 26,000 credits.

**K-E4 Plasma Ejector.** A heavy energy weapon inspired by designs from the people at Northern Gun. Like most Kittani weapons, the K-E4 is a bit heavy and has below average range capability. Comes equipped with telescopic sight; can be fitted with any optic system. Weight: 12 lbs (5.4 kg). Mega-Damage: 6D6 M.D. Rate of Fire: Standard. Range: 2,000 feet (610 m). Payload: 20 shots standard clip or 30 shots long E-Clip. Cost: 60,000 credits.

**Kittani Energy Lance.** A hand-held, long-range, precision laser weapon. Designed for use by cyborgs, 'bots and power armor. Only fires single shots and is + 2 to strike on called shots. Weight: 20 lbs (9 kg). Mega-Damage: 3D6 M.D. per single shot at long range. The weapon can be adjusted to half the range and twice the damage (6D6 M.D.). Or 2D4 M.D. as a stabbing lance or blunt weapon. Rate of Fire: Equal to number of combined hand to hand attacks of the operator (usually 4-6). Range: 6,000 feet (1,828 m) or 3,000 (915 m) Payload: 40 shots; recharges after four hours.

**Kittani Jolt Gun (TW).** This device is used primarily for herding slaves. Damage: Three settings: 2D6 S.D.C. or 4D6 S.D.C. or 1D4 M.D. per blast (double the damage and range when on a ley line). Range: 1,000 feet (305 m). Rate of Fire: Equal the user's number of melee attacks. Payload: 20 blasts. Magically recharged by High Lords, Techno-Wizards, or at stone pyramids; requires 30 P.P.E to recharge. Cost: 45,000 credits; rare.

**Laser Wrist Blasters (TW).** A pair of wrist bands just like the ones used by the Altara warrior women. Mini-lasers with a magic power pack worn on the back. Mega-Damage: 2D6 M.D. per blast. Range: 1,200 feet (366 m). Rate of Fire: Up to five blasts per melee. Payload: 60 blasts; backpack recharges completely in four hours. Cost: 22,000 credits.

**Mental Incapacitator (TW).** This device fires Wisps of Confusion, identical to the spell of the same name. Affects 1D8 (or 2D4) people in a closed area. Range: 180 feet (55 m). Rate of Fire: Two per melee. Payload: 10 blasts. Duration: 50 minutes; no effect if saving throw vs magic is successful. Note: Splugorth design. Cost: 200,000 credits; 8,000 credits to recharge.

**Plasma Rifle.** A rifle version of the forearm blaster. Mega-Damage: 6D6 M.D. per blast when on a ley line or at a nexus. Range: 3,000 feet (914 m). Rate of Fire: Equal to the user's number of hand to hand attacks. Payload: 20 blasts. Magically recharged by High Lords, Techno-Wizards, or at stone pyramids; requires 80 P.P.E. to recharge. Cost: 150,000 credits; limited availability.

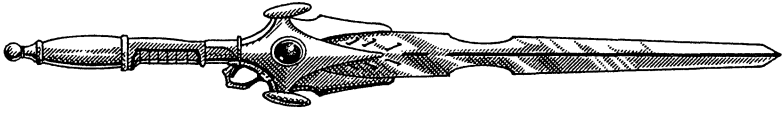

**Plasma Sword.** A sword that radiates plasma energy for both close combat and ranged attacks. Weight: 3 lbs (1.35 kg). Mega-Damage: 2D6 M.D. per sword strike or 4D6 M.D. per plasma blast. Each blast drains 10 minutes from the power supply. Or 2D6+2 S.D.C. damage when not energized. Rate of Fire: 60 minutes or less per clip, depending on the number of plasma blasts fired. A maximum of six plasma blasts. Range: Close combat or plasma blast of 100 feet (30.5 m). Payload: 60 minutes or less per clip, depending on the number of plasma blasts fired. Cost: 28,000 credits, good availability in Atlantis.

**Slaver's Net Gun (TW).** Just as the name suggests, this weapon of Splugorthian Techno-Wizardry launches a magic net to ensnare its opponent; same stats as the magic spell. The gun is the large, bulky weapon depicted on the *Rifts*® cover; the figure on the right. Range: 180 feet (55 m). Rate of Fire: Two per melee. Payload: 20 nets; must be magically recharged at about 8,000 credits. Duration: Up to 20 minutes. Note: Splugorth design. Cost: 250,000 credits.

## Kittani Underwater Weapons

The many different Kittani plasma weapons already noted, can be used underwater with the following modifications and penalties: Mega-Damage is reduced by 1D6 points. Rate of Fire is equal to the number of hand to hand attacks of the wielder. Range: Reduce laser beams by 25%, plasma bolts by 67% (reduced to 33%, so a 100 foot/30.5 m range would be reduced to 33 feet/10.05 m), and throwing range is reduced by 90%! All other stats are unchanged.

**Kittani Energy Trident.** It can be used both in hand to hand combat and as a ranged weapon, when the Trident is energized to fire blue-green laser beams or charged with energy to inflict Mega-Damage strikes in close combat. Weight: 12 lbs (5.4 kg). Mega-Damage: Triple pulse laser blast 6D6 M.D., energized strike inflicts 4D6 M.D. and de-energized strike 2D4 M.D. Rate of Fire: Equal to the number of hand to hand attacks of the wielder. Range: Laser blast: 2000 feet (610 m), thrown: 100 feet (30.5 m), or hand to hand combat. Payload: 30 energy blasts or close combat blows (every successful strike drains one charge). Changing E-Clips counts as one melee attack/action. Cost: 55,000 credits.

**Kittani Energy Net.** This a man-sized net composed of Mega-Damage fibers stronger than steel. It has 30 M.D.C. and small weights along the edges to provide weight and control. The net is used to ensnare fish, animals and humanoid prey. Like the Naut'Yil net, once prey is ensnared, the net can be activated by remote control to release an electrical burst to hurt, stun or kill its captive(s). Other than being made of a different material and having more M.D.C., it is fundamentally the same as the Naut'Yil energy net described in that section.

**Kittani Rocket Grenades.** These are small grenade-like explosives that are hooked to an ammo-belt or carried in pouches, backpacks or satchels. They can be dropped from above like depth charges (-2 to

strike and automatically detonate at the depth of one mile/1.6 km), or a very short-range propeller can be activated with the pull of a pin, to send the grenade rocketing through the water toward its target. Weight: One pound (0.45 kg). Damage: High Explosive (HE): 5D6 M.D. with a four foot (1.2 m) blast diameter. Fragmentation: 3D6 M.D. to a 40 foot (12.2 m) diameter area. Concussion Grenade: 4D6 M.D. to a 20 foot (6.1 m) diameter plus 2D6 M.D. to an additional area 40 feet (12.2 m) in diameter. Furthermore, the concussion grenade has a 01%-35% chance of stunning humans, Naut'Yil, Amphibs, Lemurians, Dolphins, and most marine creatures caught in the center of the blast for 1D4 melee rounds; not effective against giant-sized creatures, most whales, creatures of magic, supernatural beings, and characters inside power armor, robots or submersible vehicles. Gill Clog: This grenade releases a chemical cloud that fills a 20x20x20 feet (6.1x6.1x6.1 m) area. The cloud clogs the gills and chokes creatures who need gills to breathe. The following penalties apply to those affected (a saving throw of 16 or higher means the victim caught in the cloud suffers only half the normal penalties): -6 on initiative, -6 to strike, parry and dodge, reduce speed and melee attacks/actions per round by half, and skill performance is -50%. The penalties of the gill clog cloud will diminish by half as soon as the creature flees the cloud, but the reduced effects linger for 2D4 minutes. Those who stay in the cloud for more than a minute are likely to choke and die; 01-79% chance! The cloud is diluted and dissipates after 1D4 minutes. Note: All explosive rocket grenades do half damage and have half the damage radius on dry land and must be thrown, not jet propelled (they cannot fly). The gill clog grenade has NO effect on dry land and simply covers a 10 foot (3.0 m) area with a chemical dust. Rate of Fire: Each use of one, or two grenades launched simultaneously, counts as one melee attack. Range: Jet propelled: 300 feet (91.5 m). Dropped to float down like a tiny depth charge: One mile (1.6 km). Detonates the instant it hits anything or reaches a depth of one mile. Payload: Whatever can be reasonably carried; typically two to six if strapped to a belt, as many as 12 if carried in a backpack or large satchel. Cost: 150 credits for fragmentation, 200 for HE and Gill Clog, and 350 for concussion. Available at Atlantis, Horune Pirates and from the occasional other pirate, ocean merchant, and some Black Market outposts along the coast.

**Kittani Underwater Rail Gun.** A rail gun that is designed to operate at maximum efficiency underwater. The rounds are either tiny metal balls or needle-like spikes. Weight: Gun 125 lbs (56 kg), plus ammo-drum 45 lbs (20.25 kg). Mega-Damage: A burst is 40 rounds and does 1D4x10 M.D.; a single round does 1D4 M.D.; same damage on ground or underwater. Rate of Fire: Standard. Range: 1,000 feet (305 m) underwater, 2,500 feet (762 m) in an air environment. Payload: 1,120 rounds, 28 short bursts per ammo drum. Cost: 70,000 credits.

**Naut'Yil & Other Underwater Weapons.** The Splugorth also sell knock-offs of Naut'Yil particle wave guns, energy nets, energy tridents, and body armor, as well as items from human and D-Bee nations from around the world and beyond. The Splugorth import and sell exotic, tech and magical wares from around the Megaverse; although most are rare and expensive on Rifts Earth; G.M.s, use your discretion.

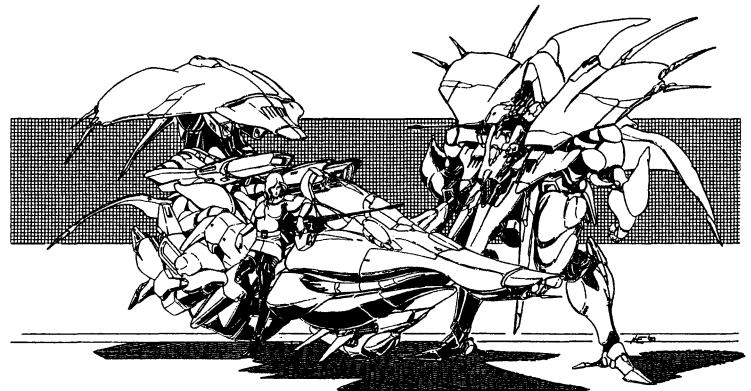

# Megaversal® Legion Weapons

## Rifts® World Book Nine: South America Two

Most of the weapons used by the Megaversal Legion are manufactured in *Fort Desperado*, and use Dakir (alien) technology. In their arrogance, the Dakir aliens kept the factories in the same area they keep their soldiers, and the Men-Rall (alien) scientists have been able to keep those factories going.

The Dakir have mastered a unique form of force technology they call *Inertia Beam* or *I-Beam* technology, which uses a curious energy field that reverses natural physical forces! Instead of slowing down, objects surrounded by I-Beam technology actually gain velocity and momentum as they travel. A bullet that has the normal speed of a 20th Century pistol as it leaves the muzzle will speed up to rail gun velocity after it travels 10 feet (3.0 m), and will continue accelerating for as long as it travels along the path of the I-Beam. Theoretically, such a bullet could travel indefinitely, accelerating until it approached (or maybe even reached) the speed of light! As soon as an object is no longer affected by the I-Beam (surpasses the range limit or the beam is shut off) however, it instantly loses all its momentum and velocity, seemingly stops in midair and drops to the ground. The range of I-Beam weapons is limited to the range of the inertia beam projector.

The same technology responsible for I-Beams also creates two kinds of energy fields: *recoil-dampening fields* (also called RD-Fields) and *inertial shields* (I-shields). RD-Fields are used to allow humanoids to fire heavy weapons without suffering the effect of recoil. A human firing a cannon, for example, would normally be smashed into the ground, no matter how strong he was. With the RD-field on, however, the momentum of the gun firing is actually rerouted and refocused forward, increasing the speed of the projectile!

Inertial shield generators are built into the body armor and cyborg frames of all Legionnaires. The energy field is powered by an E-Clip in the case of body armor or hooked into the power supply of cyborgs and powered armor. The energy field "senses" incoming projectiles (slugs, bullets and missiles) and activates an inertial shield to intercept the object. This works like a parry; the system has a +3 to parry the attack; on a success, the missile loses all forward momentum and falls, inert, to the ground. Even grenades and impact-activated explosives will not go off. If the parry misses, bullets, rail gun slugs and similar attacks will strike, but only inflict half damage as their momentum is reduced but not neutralized by the shield. Explosive force does normal damage and the I-shield cannot stop the force of punches, kicks, or hand-held weapons (swords, etc.), which inflict normal damage. Nor has it any effect against energy attacks (lasers, ion, particle beams, plasma, etc.). The shield can only stop a certain number of attacks every round (typically 1-3). See individual armor descriptions for more information.

**Note:** Weapons and equipment that use Dakir technology are NEVER sold or traded to the outside world. Nor abandoned! The Legionnaires will confiscate or chase down any Dakir weapon or technology that falls into an adventurer's, or worse yet, an enemy's hands (and that includes the Naruni and Splugorth). The ammo and I-Beam technology can only be found in the automated factories of *Fort Desperado* (and the worlds controlled by the Dakir in other parts of the Megaverse). The Coalitions States, Triax, Northern Gun, Naruni, the Splugorth and others would pay a fortune to acquire this technology if they realized it existed.

**IAR-2 Auto-Pistol.** This hand weapon is used by officers and pilots, as well as a back-up for line soldiers. It uses the same I-Beam technology to propel rounds at great speeds as the JAR-20 rifle. The pistol has a cylindrical magazine on top of the receiver. Weight: 3 lbs (1.35 kg). Mega-Damage: 3D6 M.D. Rate of Fire: Standard. Range: 1000 feet (305 m). Payload: 20 rounds. Cost: Not available.

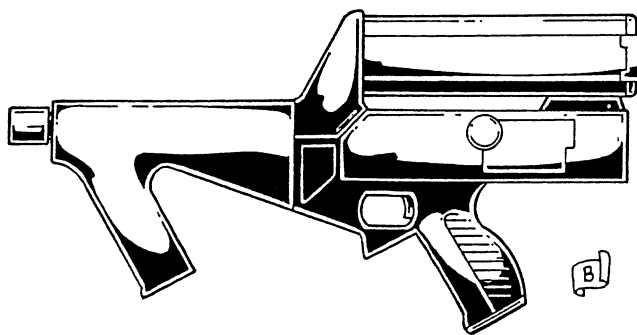

**JAR-20 Inertia Rifle.** This unusual weapon uses the unique Dakir Inertia Beam technology to eliminate recoil and fire an accelerated 76mm rifle round at incredible speed. This is the most common rifle among the humanoid members of the Legion; about 60% of all human-sized line infantrymen use this weapon; 30% rely on the ARP-1, described below, and the remainder use specialized rifles. The IAR-20 is light and compact, with a folding stock, a short barrel, more appropriate for a carbine than a rifle, and a round magazine located on top of the gun, somewhat similar to the 20th Century Calico submachine-gun. The gun's small size and light weight allows it to be used by tank crews, pilots and support personnel in addition to line soldiers. About 20% of these rifles (the IAR-20G) have an attached grenade launcher with a shotgun-like, tubular magazine that holds seven grenades. Weight: 6 lbs (2.7 kg). Mega-Damage: 2D6 M.D. per single shot, burst of 15 rounds does 1D4x10 M.D., a long burst is 30 rounds and does 2D4x10+10 M.D. The IAR-20G grenades do 3D6 M.D. to a 20 foot (6.1 m) blast radius. Rate of Fire: Single shots, or bursts of 15 or 30 rounds. Single shot only with the grenade launcher. Range: 3000 feet (914 m) for both the bullets and the grenades. Payload: 90 shot magazine; the grenade launcher can hold up to seven grenades. Cost: Not available to the outside world.

**ARP-1 Plasma Assault Rifle.** The ARP-1 is a light but powerful rifle that fires thin plasma discharges. The weapon is designed for human-sized users, and is very easy to use and carry. The high rate of fire provided by this rifle allows for *aimed bursts*. Concentrated fire from several ARP-1 rifles can melt down most M.D.C. vehicles. The gun is slightly heavier and larger than the IAR-20, and its use is limited to line infantrymen. In operations against the Arkhons, the rifle has proved to be less efficient. Weight: 8 lbs (3.6 kg). Mega-Damage: 3D6+4 M.D. per shot; three round burst does 1D6x10+10 M.D. Rate of Fire: Single shot or three round burst only. No recoil, so it can fire aimed bursts at +3 to strike. Range: 2000 feet (610 m). Payload: 30 shots. Cost: Not available.

**HIAR-22 Heavy I-Beam Rifle.** This is the Ojahee version of the IAR-20 Rifle. Like the HRP-1, this rifle also has an axe attachment. Damage and range are the same, but the HIAR-22 has an oversized magazine for extra ammunition. Weight: 24 lbs (10.8 kg). Mega-Damage: 2D6 M.D. per shot, burst of 15 rounds does 1D4x10 M.D., long burst is 30 rounds and does 2D4x10+10 M.D. Vibro-Axe: 3D6 M.D. plus supernatural P.S. damage. Rate of Fire: Single shots, or bursts of 15 or 30 rounds. Range: 3000 feet (914 m). Payload: 150 shot oversized magazine. Cost: Not available.

**HRP-1 Plasma Heavy Rifle.** Designed for the Ojahee warriors, the HRP-1 is a long, heavy rifle that fires an extra-heavy plasma discharge. The gun is built along the same lines as a musket to ease the Ojahee into using this advanced weapon. The rifle even has a Vibro-Axe attachment, just like the traditional Ojahee musketoons. Weight: 30 lbs (13.5 kg). Mega-Damage: Plasma: 1D6x10+10 M.D. per blast. Vibro-Axe: 3D6 M.D. plus supernatural P.S. damage. Rate of Fire: Single shot only. Range: 3,000 feet (914 m). Payload: 20 shots per E-Clip. Cost: Not available to outsiders.

**H-11A Howitzer.** The H-11A is a hand cannon, a 75mm howitzer configured as a giant rifle. Ordinarily, such a weapon has such tremendous recoil that no biped, even a cyborg, could fire it from a standing position (and very few beings could shoot it from a crouch, either).

However, the science of the Dakir has found a way around this problem through the use of recoil-dampening fields, or RD-fields. These energy fields somehow channel and deflect the incredible recoil this weapon produces. The RD-field is invisible, so their only effect is the fact that a normal human can fire a cannon-like weapon without any more difficulty than shooting a heavy rifle. The howitzer fires a number of projectiles. Unlike 20th Century cannon shells, the H-11A's ammunition is light and compact while packing even more explosive power. Each shell is roughly 3 inches (75 mm) thick and 5 inches (13 cm) long. The fin-stabilized rounds can be used for direct fire (like a rifle) or indirect bombardment (like a mortar). Even with the RD-System, this hand cannon is so heavy that only humans with a P.S. of 24 or higher can use it effectively. Humans with a P.S. of 19-23 fire at -2 to strike, those with a P.S. of 16-18 fire at -4, and weaker humans simply cannot use it unless they are wearing power armor. The cannon looks like an oversized rifle with a huge revolver cylinder that holds 10 shells. The cylinder can be reloaded by hand or replaced by a new one. The gun is attached to the wearer by a harness that makes it easier to handle (without the harness, the penalties are doubled). Weight: 120 lbs (54 kg). Mega-Damage: High Explosive: 1D6x10 M.D. to a 40 foot (12.2 m) radius. Anti-Armor: 2D4x10 to a 3 foot (0.9 m) radius. Fragmentary: 4D6 M.D. to a 100 foot (30.5 m) radius. Rate of Fire: Each shot counts as one melee attack. Fragmentary and High-Explosive rounds can be fired in a high arc; the rounds are "smart" and will home in on any enemies within a 500 foot (152 m) radius of its arc of descent. The bomb is at +2 to strike as it falls. Range: 2000 feet (610 m) direct fire, or 2 miles (3.2 km) indirect fire. Payload: 10-round drum. Cost: Not for sale.

## Mindwerks™ Weapons

### Rifts® Sourcebook Three: Mindwerks™

#### (Giant-Sized Weapons)

**Note:** These weapons are most common in and around *Poland* and *Germany*, and become uncommon and rare the farther one goes from them. Most are designed with giants, Gargoyles and Brodkil in mind. The Mindwerks E-Clip is different than the Triax or CS style clips which means clips produced by manufacturers other than Mindwerks must be specially modified to fit these weapons. Such modifications cost about 3,500 credits.

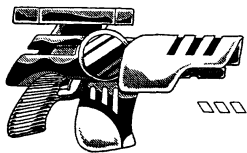

**M-12 Plasma Pistol.** A powerful, short-range energy pistol that fires plasma bolts. Like most of Mindwerks' weapons, the pistol is designed for use by *large humanoid*s, 8 to 15 feet (2.4 to 4.6 m) tall. This means humans find the weapon awkward to hold and fire (-2 to strike). It comes standard with a telescopic sight and laser targeting (+1 to strike). Weight: 15 lbs (6.8 kg). Mega-Damage: 4D6 M.D. per blast. Rate of Fire: Each blast counts as one melee attack. Range: 500 feet (152 m). Payload: 12 shot E-Clip. The weapon also has a self-charging energy supply that can fire one plasma bolt per hour without an E-Clip.

**M-18 Ion Pulse Pistol.** Another powerful, short-range energy pistol designed for giants 8 to 15 feet (2.4 to 4.6 m) tall. This means humans find the weapon awkward to hold and fire (-2 to strike). Weight: 10 lbs (4.5 kg). Mega-Damage: 2D6 M.D. per single blast or 6D6 per multiple pulse (three simultaneous shots). Rate of Fire: Equal to number of combined hand to hand attacks (usually 3-7). Range: 500 feet (152 m). Payload: 18 shot E-Clip. The weapon also has a self-charging energy supply that can fire one ion pulse per hour without an E-Clip.

**M-25 "Firebrand" Laser & Grenade Launcher Giant Rifle.** This rifle is a giant-sized knock-off of the Coalition State's C-14 Fire Breather assault laser and grenade launcher. The weapon has an over-and-under firing capability and is durable and reliable. The top barrel is a laser, the bottom is the grenade launch tube, fired like a pump-action shotgun. The weapon comes standard with a passive nightvision scope. Weight: 45 lbs (20 kg). Mega-Damage: 4D6 M.D. per laser blast. Grenades inflict 4D6 M.D. to a blast area of 14 feet (4.3 m). Rate of Fire: Each blast or fired grenade counts as one melee attack. Range: Laser is 2000 feet (610 m); grenade is 1000 feet (305 m). Payload: Laser: 20 shot E-Clip.

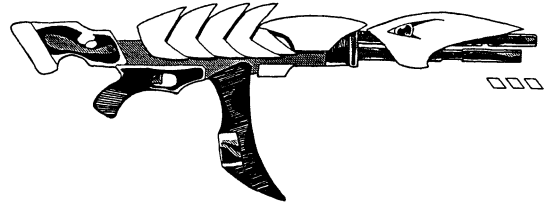

**M-30 Dual Energy Rifle.** The M-30 dual energy rifle is a versatile and powerful weapon designed for use by large creatures with *superhuman strength*. The rifle comes in two sizes: medium and large. The medium size is heavy and big, making it awkward to use by most humans (-2 to strike), but is ideal for use by cyborgs, Ogres, Brodkil and other beings that stand about seven to 10 feet tall (2.1 to 3 m) and who have a P.S. of 20 or higher. It is roughly equivalent to a large cyborg rail gun. The large-sized weapon is designed for giants roughly 14 to 20 feet (4.2 to 6 m) tall, although slightly smaller or larger beings can use it, provided they have a P.S. of 24 or greater. The upper barrel of the gun fires a particle beam. The lower barrel, a long-range laser. A laser targeting beam can be fired from the upper shield to provide a bonus of +1 to strike. Weight: Medium: 40 lbs (18 kg); Large: 90 lbs (40.5 kg). Mega-Damage (regardless of size): The particle beam inflicts 1D4x10+6 M.D.; the laser beam does 4D6 M.D. per blast. Rate of Fire: Each blast counts as one melee attack. Range: Medium-sized rifle: 1,600 feet (488 m) for the particle beam, or 2000 feet (610 m) for the laser. Large rifle: 2,000 feet (610 m) for the particle beam or 3000 feet (914 m) for the laser. Payload: Medium-sized rifle: 40 shot E-Clip. Large rifle: 60 shot E-Clip. The weapon also has a self-charging energy supply that can fire four laser beams or one particle beam per hour without an E-Clip.

**M-40 Ion Rifle Tube.** This energy rifle is commonly used by the Mindwerks robot defenders. It can also be used by large humanoids 8 to 15 feet (2.4 to 4.6 m) tall, but humans find the weapon awkward to hold and fire (-2 to strike). Weight: 30 lbs (13.6 kg). Mega-Damage: 5D6 M.D. per single blast or 1D6x10 per simultaneous double blast (like a shotgun; counts as one melee action). Rate of Fire: Each blast counts as one melee attack. Range: 1600 feet (488 m). Payload: 20 shot E-Clip. The weapon also has a self-charging energy supply that can fire two ion blasts per hour without an E-Clip. **Note:** The weapon can be connected to the 'bot via a hose-like conduit, tapping into the 'bot's power supply, giving it an effectively unlimited payload. An E-Clip may also be used as an energy reserve in case the hose is severed.

**M-120 Plasma Rifle.** A powerful, short-range rifle that fires plasma bolts. Like most of Mindwerks' weapons, the rifle is designed for use by large humanoids and robots 8 to 15 feet (2.4 to 4.6 m) tall. This means humans find the weapon awkward to hold and fire (-2 to strike). It comes standard with a telescopic sight and laser targeting (+1 to strike). Weight: 35 lbs (15.7 kg). Mega-Damage: 5D6 M.D. per blast. Rate of Fire: Equal to number of combined hand to hand attacks (usually 3-7). Range: 1200 feet (365 m). Payload: 12 shot E-Clip. The weapon also has a self-charging energy supply that can fire one plasma bolt per hour without an E-Clip.

# Miscellaneous Weapons & Equipment

Collected from the various Rifts® titles

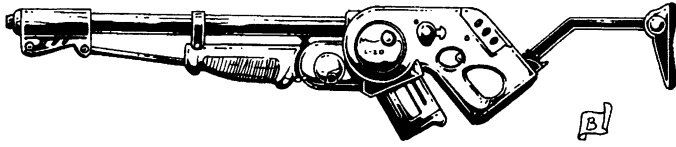

**L-20 Pulse Rifle.** A common frontier weapon is the L-20 pulse laser rifle manufactured by the *Black Market* and several kingdoms across the land. It is a dependable, lightweight weapon with the added feature of multiple laser bursts. Weight: 7 lbs (3 kg). Mega-Damage: 2D6 M.D. single shot, or 6D6 multiple pulse burst (three simultaneous shots). Rate of Fire: Standard. Range: 1600 feet (488 m). Payload: 40 shots per standard E-Clip or 50 shots long E-Clip. Black Market Cost: 25,000 credits.

**Green Laser Rifle:** It is made of black plastic and ceramic and is popular among pirates and coastal people: Weight: 6 lbs (2.5 kg). Mega-Damage: 3D6 M.D. single shot. Rate of Fire: Standard. Range: 2000 feet (610 m). Payload: 20 shots per standard E-Clip or 30 shots long E-Clip. Black Market Cost: 30,000 credits.

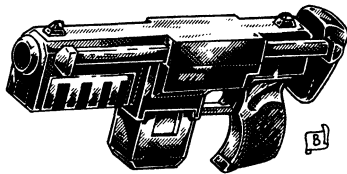

**Zapper Gun.** The Zapper is the latest release from *Ultra-Tech Incorporated*. This bulky weapon has a short, stubby barrel and a retractable stock; it can be fired one-handed like a machine pistol or two-handed like a submachine-gun. The weapon fires an ionizing beam that, when it touches an M.D.C. alloy, discharges a powerful electrical blast. The result is an arc of electricity that can melt M.D.C. materials, and furthermore, produces a stunning or even lethal shock to most living creatures. Potential targets are -2 to dodge, because the ionizing beam is invisible until it touches the target, and then the electrical charge hits instantaneously. Weight: 8 lbs (3.6 kg). Mega-Damage: 2D4 M.D. Additionally, humans and most humanoids have to make a save of 14 or higher or suffer 1D6 S.D.C. (or 1D6 M.D.C. in the case of M.D.C. creatures), lose initiative and are at -1 to all combat actions for 1D4 melee rounds. Beings immune to electricity take no damage; some powerful entities may have bonuses of +2 to +6 (in addition to P.E. bonuses) to save, at the G.M.'s discretion. This attack will affect people in body armor, and most types of light power armor. Vehicles and robots with a reinforced pilot's compartment, and heavy power armor will protect the pilot and crew completely. Rate of Fire: Single shots only. Range: 1,000 feet (305 m). Payload: 15 shots with a standard E-Clip. Black Market Cost: 30,000 credits. Incredibly rare.

**High-Tech Arrowheads.** Bows and arrows of all types are popular among many of the denizens of Rifts Earth. Even compared to high-tech energy weapons, the bow and arrow still have their advantages. One, the firing mechanism requires no artificial energy supply. Second, the weapon is entirely silent. Third, it is extremely accurate in trained hands. Lastly, the weapon can be made by hand (carpentry skill is needed) without machinery.

Light Explosive: S.D.C. Damage: 1D6x10 S.D.C. Cost: 100 credits each.

Medium Explosive: Mega-Damage: 1D6 M.D. Cost: 300 credits each.

Heavy Explosive: Mega-Damage: 2D6 M.D. Cost: 550 credits each.

High Explosive: Mega-Damage: 3D6 M.D. Cost: 900 credits each.

Gas: Arrowhead shatters on impact, releasing a toxic gas that fills a ten (10) foot area (3 m). Tear gas costs 100 credits, tranquilizer gas (sleep/knockout for 1D6 minutes) costs 250 credits, paralysis gas (a nerve toxin, causing temporary paralysis for 1D6 minutes) costs 400 credits each. Everybody in the gaseous area must roll to save versus harmful drugs (15 or higher).

Smoke: No damage; creates a smoke screen covering a 20 foot (6 m) area. Cost: 80 credits each; come in four colors, yellow, red, grey and black.

Flare: Emits a bright, sparkling light; burns for 60 seconds. Cost: 10 credits each.

Neural Disrupter: Works like a Neural Mace (see Coalition Weapons). Cost: 400 credits each; rechargeable and reusable 1D6 times before breaking. Inflicts no other damage.

Tracer Bug: Transmits a radio signal that can be followed up to 8 miles (12.8 km) away. Battery powered, with a limited life of 72 hours of constant transmission. Arrow must stick into the target or fall on top of the object (without falling off). There is always a chance that the tracer bug arrow will become dislodged and fall off (roll once for every half hour; 1-32% chance). Cost: 200 credits each. Inflicts normal S.D.C. arrow damage.

Magic Arrows: Cost: A typical magic arrow costs 1D6x1,000 credits each. Any of the following magic spells can be placed on arrows (one spell per arrow). Globe of Daylight, Blinding Flash, Cloud of Smoke, Energy Bolt, Lightning, Fire Bolt and Paralysis: Lesser. Those that inflict energy damage typically do 4D6 M.D., 5D6 M.D. 6D6 M.D. or 1D4x10 M.D.

Mega-Damage Bow & Arrow: Also see the *NA-SW4 M.D.C. Bow & Arrow* described under Native American Indian Weapons, ahead.

## Naruni Enterprises

### Rifts® Mercenaries & Phase World®

The Naruni are alien arms dealers from another dimension. Like the Splugorth, they sell and trade throughout the Megaverse. Presently, they are about half as well known, powerful, and hated as the Splugorth, but are working hard to catch up. Naruni Enterprises and the Splugorth are ruthless competitors so the Naruni try to avoid dealing with them or Splugorth controlled worlds.

No one race runs the trans-dimensional corporation that is Naruni Enterprises. Rather, its employees are chosen from all over the Megaverse, with a preference toward those from high-tech worlds. However, most of Naruni Enterprises' top management and owners are members of the Naruni race. Naruni factories are located in other dimensions, where hundreds of thousands of vehicles, weapons and munitions are produced every day for sale on hundreds of worlds.

To make a sale, the salespeople at N.E. allow governments and large businesses to buy on credit. The weapon merchants are friendly, cheerful and helpful in consummating the sale, but when it is time to collect the debt, the corporation is ruthless! If the purchaser cannot pay in cash, the corporation will consider trading goods or services, but is more inclined to acquire (seize) mining and land rights as payment. On several worlds, this credit and collection policy has enabled Naruni Enterprises to seize entire planets! Naruni Enterprises will get its money any way it can. In some instances they have taken the entire population of a indebted kingdom or planet to sell into slavery. In other cases, it has forced the population to build and operate high-tech factories and into a life of hard labor. Beautiful lands, sometimes entire planets, are transformed into giant, smoke-belching factory worlds. Few dare to fight Naruni Enterprises because they have resources across the Megaverse and access to troops, allies and weapons that dwarf any one

planet or even most collectives of planets. The corporation can be heartless and in this regard, they aren't much better than the Splugorth (although they do not make a practice of slave trading nor do they engage in the horrible science of Bio-Wizardry).

Since the Coalition's crackdown on the "evil alien weapon dealers," Naruni arms dealers are gone and their goods in North America are more rare and difficult to come by than ever before. Anybody found with a Naruni weapon or Naruni gear of any kind will see the CS try to seize it (and destroy it) and are likely (01-50% chance) to be searched, interrogated and beaten – 20% are killed as Naruni agents or smugglers of illegal contraband. Tolkeen was one of the last places where one could locate and acquire Naruni weapons. Now it is gone too. This has tripled and quadrupled the cost of Naruni weapons still in circulation. Greatly coveted.

**NE-H10 Plasma Derringer.** This pistol is small enough to be hidden in a pocket or even up a sleeve (a sleeve holster, complete with a spring system that "shoots" the gun into the owner's hand, costs an additional 1000 credits). It has two miniature plasma cartridges that do less damage than a normal Naruni revolver, but still packs more energy than a conventional laser. The only problem with this weapon is that its short barrel is uncomfortably close to the wearer's hand. Each time the gun is shot, there is a 10% chance that the shooter's hand will take 5D6 S.D.C. of heat damage from residual heat (no damage if wearing M.D.C. armor or insulated gloves). Weight: Less than one pound (0.45 kg). Mega-Damage: 5D6 M.D. Rate of Fire: Up to two shots. Range: 200 feet (61 m). Payload: 2 plasma cartridges. Reloading the weapon takes one melee action per cartridge, or one melee action if a speed loader (200 credits) is used. Cost: 10,000 credits. Each cartridge costs 15 credits.

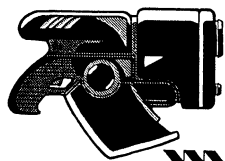

**NE-4 Plasma Cartridge Pistol.** The pistol version of the NE-10; it fires the same cartridges and inflicts the same damage, but has reduced range. It is very heavy and cumbersome for a pistol, but firepower fans love it. Characters with a P.S. of 17 or less are -2 to strike even on an aimed shot. Weight: 6 lbs (2.7 kg). Mega-Damage: 1D4x10 M.D. Rate of Fire: Standard. Range: 500 feet (152 m). Payload: 10 shot magazine. Cost: 25,000 credits for the gun. Each round costs 40 credits, so a full magazine costs 400 credits.

**NE-6 "Magnum" Plasma Cartridge Revolver.** The NE-6 uses a revolver cylinder instead of a magazine for this popular plasma cartridge weapon. The revolver action is easier to maintain and fix, so the "magnum" is popular among colonists, spacers, runners, outlaws and pirates. These guns also appeal to some romantic humans who still remember the legends of the "Old West" from a time when humans still dwelt on the mythical planet Earth. Weight: 6 lbs (2.7 kg). Mega-Damage: 1D4x10 M.D. per each plasma round. Rate of Fire: Standard; each shot counts as one melee attack. Range: 500 feet (152 m). Payload: 6 shot cylinder. Reloading the weapon takes one melee action per cartridge, or one melee action to load all six if a speed loader (200 credits) is used. Cost: 15,000 credits. Each round costs 20 credits.

**NE-2L Plasma Cartridge Auto-Pistol.** A "light" version of the NE-4 pistol that fires the same small cartridges used by the NE-H10. The NE-2L has more penetration and stopping power than most handguns on the market, and its magazine is built into the handle of the pistol rather than in front, making it less cumbersome than its heavier "cousin." Several police and military units of the Three Galaxies have adopted the NE-2L as their standard sidearm. In some circles the weapon is dismissed as a "sissy gun," although it is only slightly less powerful than the NE-4. Weight: 4 lbs (1.8 kg). Mega-Damage: 5D6 M.D. per shot. Rate of Fire: Standard for automatic pistols. Range: 500

feet (152 m). Payload: 9 shot magazine. Cost: 10,000 credits. Each cartridge costs 15 credits.

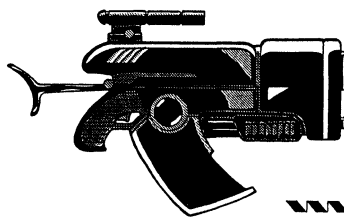

**NE-10 Plasma Cartridge Rifle.** This weapon is an energy rifle that does not require an E-Clip. Instead, it uses thick cartridges that have a small impact primer. When the primer is hit by the mechanical weapon, the cartridge is converted into energy, causing a plasma discharge. The blast inflicts a lot of damage, but the weapon has a very limited range. Furthermore, it has the drawback that the ammunition cannot be duplicated with Earth technology and MUST be purchased from Naruni Enterprises. The gun's bore is almost two inches wide — having it pointed your way is very intimidating. Weight: 20 lbs (9 kg). Mega-Damage: 1D4x10 per single shot. Rate of Fire: Standard. Range: 1200 feet (365 m). Payload: 20 shot magazine. Cost: 40,000 credits for the gun. Each round costs 40 credits, so a full magazine costs 800 credits.

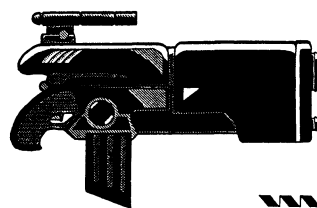

**NE-50 Particle Beam Rifle.** A heavy energy rifle that has been "modified" to operate on Earth type "E-Clips." Weight: 13 lbs (5.9 kg). Mega-Damage: 1D4x10 M.D. per blast. Rate of Fire: Standard. Range: 1,200 feet (365 m). Payload: 8 shots from a standard "short" E-Clip or 16 from a long E-Clip. Cost: 45,000 credits. Note: The NE-50 (unmodified) particle beam rifle sold in other dimensions has a range of 1600 feet (488 m) and an NE energy clip can fire 24 shots; same damage. This weapon has not been offered to the Earth market yet, but may be used by some of the sales reps.

**NE-75H "Shoulder Cannon."** The NE-75H is a sniper and anti-armor rifle somewhat similar to 20th Century Earth's .50 caliber Barretta rifle. The NE-75H is a huge weapon, about 6 feet (1.8 m) long from the butt to tip, and much heavier than a standard rifle. Like all Naruni cartridge weapons, its bore is two inches wide. It fires an oversized version of the Naruni plasma cartridge with a much more powerful charge. Its range is an amazing 6,000 feet (1,829 m). Its sophisticated optic system makes it one of the most accurate weapons on the market. To make it more versatile, the Naruni weapon smiths also sell a conversion kit that allows the gun to use "standard" plasma cartridges (reduce damage to 1D4x10+10 M.D., and range to 4,000 feet (1,219 m), but increase payload to 20 rounds). Refitting the gun with the kit takes 1D4 minutes. These rifles are assigned to elite sniper units in the military and are also popular among assassins and big game hunters. Weight: 30 lbs. (13.6 kg). Mega-Damage: 2D4x10+20 M.D. per shot from heavy bore cartridges. 1D4x10+10 M.D. for light NE-H10 and NE-2L cartridges. Rate of Fire: Each shot counts as one melee attack. Range: 6,000 feet (1,829 m) or 4,000 feet (1219 m) when using the light NE-H10 cartridges. Payload: 8 cartridges in magazine (20 with light cartridges). Cost: 80,000 credits, plus 5,000 credits for the conversion kit. Each oversized cartridge costs 50 credits.

**NE-95 "Double Threat" Assault Rifle.** This weapon is an over-and-under, two-barreled rifle. The lower barrel is a semi-automatic grenade launcher with a drum magazine. The upper barrel fires standard Naruni plasma cartridges. The drum magazine is



located in the front, while the cartridge magazine is in the back in a “bull-pup” configuration. Both weapon systems use the same trigger mechanism; switching from one to the other is a matter of pressing a button on the handle of the rifle. The resulting weapon is heavy and cumbersome for humanoid soldiers, but is a very useful weapon for cyborgs, robots, those with superhuman strength and troopers wearing exoskeletons and power armor. Characters who are strong enough to disregard the extra weight, love this devastating assault weapon and its particle beam equivalent, the NE-195 (see below). Weight: 25 lbs (11.3 kg). Mega-Damage: Plasma Cartridge: 1D4x10 M.D. Grenade Launcher: Varies with grenade. Typically fires NE-90G fragmentation (4D6 M.D.) or high explosive (6D6 M.D.) grenades. Rate of Fire: Standard. The shooter can only operate one weapon system at a time. Range: Plasma Cartridge: 1200 feet (365 m). Grenade Launcher: 1000 feet (305 m). Payload: Plasma Cartridge: 20 round magazine. Grenade Launcher: 12 round drum magazine. Cost: 42,000+ credits.

**NE-195 Assault Rifle.** This weapon is almost identical to the NE-95, but it replaces the plasma cartridge action with a conventional plasma ejector system. Mega-Damage: Plasma Ejector: 6D6 M.D. Grenade Launcher: Varies with grenade. Typically fires NE-10G fragmentation (4D6 M.D.) or high explosive (6D6 M.D.) grenades. Rate of Fire: Standard. The shooter can only operate one weapon system at a time. Range: Plasma Ejector: 2,000 feet (610 m); Grenade Launcher: 1,000 feet (305 m). Payload: Plasma Ejector: 16 shots; Grenade Launcher: 12 shots. Cost: 50,000 credits.

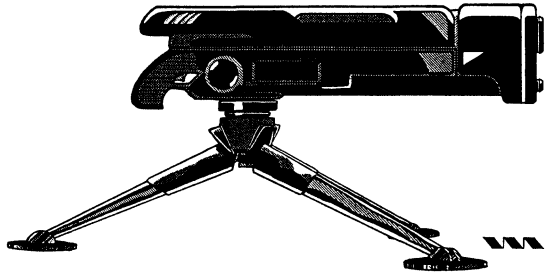

**NE-200 Plasma Cartridge Machine-gun.** This is a belt-fed, heavier version of the NE-10 rifle, used as a tripod or vehicle mounted weapon. There is also an oversized rifle version suitable for use by power armor troops, cyborgs and robots (that model has a 40-shot magazine). The user must have a P.S. 24 or greater. Weight: 70 lbs (31.5 kg) with magazine. The belt weighs another 15 lbs (6.8 kg). Mega-Damage: 1D4x10 M.D. per single shot, or 2D6x10 M.D. for a burst of 10 shots. Rate of Fire: Standard. Range: 2,000 feet (610 m). Payload: 200 shot belt or 40 shot magazine. Cost: 95,000 credits. Each round costs 40 credits, so a full magazine costs 1600 credits and a belt, 8000 credits.

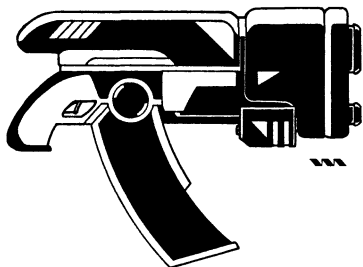

**NE-300 “Stutterer.”** The “Stutterer” is a plasma cartridge submachine-gun, somewhat similar to a Thompson SMG from Earth, but much heavier. It uses a lighter cartridge than the standard Naruni weapons (the same cartridge as the NE-H10 and the NE-2L, previously described) to allow for a larger magazine capacity and automatic firing capability. The weapon’s short range makes it unsuitable for many military operations, but is ideal for house to house, urban combat, for boarding starships and any “close quarters” combat. Pirates and police forces prefer this weapon to assault rifles. Weight: 20 lbs (9 kg) with drum magazine, or 15 lbs (6.8 kg.) with short clip. Mega-Damage: A

single shot does 5D6 M.D.; a 10 shot burst does 1D6x10+10 M.D. Rate of Fire: A single shot or a burst counts as one melee attack. Range: 600 feet (183 m). Payload: 50 shot drum magazine or 30 shot “banana” magazine. Cost: 20,000 credits. Each cartridge costs 15 credits.

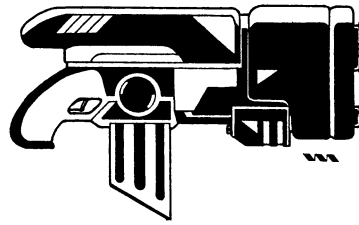

**NE-600 Pulse Laser.** Designed to be compatible with standard E-Clips, the NE-600 is built on the NE-300 frame (see above); the main outward difference between the two guns is the absence of a drum magazine in the NE-600. Like the plasma cartridge “Stutterer,” the NE-600 is a fast-firing weapon designed to shoot bursts. The laser does more damage because the beam is “wider” than normal, affecting a larger area. For the same reason, it has a surprisingly short range for a laser, because the beam loses cohesion more quickly. Weight: 14 lbs (6.3 kg). Mega-Damage: 4D6 per single shot or 1D6x10+10 per multiple pulse burst (three simultaneous shots). Rate of Fire: Standard. Range: 600 feet (183 m). Payload: 20 shots. Cost: 30,000 credits.

**NE-1000 “Modified” Plasma Ejector Rifle.** A heavy energy rifle that looks a lot like the cartridge rifle but works on energy clips. The “modified” version has been adjusted to operate on Earth type “E-Clips.” Weight: 22 lbs (10 kg). Mega-Damage: 6D6 M.D. per blast. Rate of Fire: Standard. Range: 2,000 feet (610 m). Payload: 8 shots from a standard E-Clip or 16 from a long E-Clip. Cost: 36,000 credits. Note: The NE-1000 (unmodified) plasma rifle sold in other dimensions has a range of 3,000 feet (914 m) and an NE energy clip can fire 30 shots and does 1D4x10 M.D. per blast. This weapon has not been offered to the Earth market yet, but may be used by some of the sales reps.

**NE-74GL Grenade Launcher.** The NE-74GL uses Naruni Enterprises’ new micro-grenades (see below). The small size of the grenades gives this weapon a greater payload and range than conventional grenades, allowing the wielder to spray a large area with explosives. So far, a number of mercenary armies have adopted this weapon. The weapon has a short “banana” magazine with 24 rounds or a drum magazine with 48 shots. Weight: 21 lbs (9.45 kg) with short magazine, or 30 lbs (13.5 kg) with drum magazine. Mega-Damage: Varies with grenade type. Usually carries fragmentation (3D6 M.D. to a radius of 20 feet/6.1 m). A short burst is 8 rounds and will do the same damage to an area of 50 feet (15.2 m). A long burst (16 rounds) will do an extra 1D6 damage to an 80 foot (24.4 m) area. Rate of Fire: Standard. Range: 4,000 feet (1,219 m). Payload: 24 or 48 shots. Cost: 75,000 credits. The grenades cost 350 credits each.

**K-HEX Explosives.** Naruni Enterprises has released a new explosive substance called K-HEX (Killaryte High Explosive). Killaryte is a strange crystalline substance found only on a few planets in the *Three Galaxies*. Researchers have determined that Killaryte is created through the same natural process as coal and petroleum — decomposed organic matter subjected to enormous pressures deep underground. Whereas petroleum and coal are flammable, however, Killaryte is extremely explosive; about ten times more so than conventional explosives. The crystals are also ten times less stable than nitroglycerin, so even minor vibrations could detonate it! Somehow, Naruni Enterprises has been able to stabilize Killaryte and manufacture a chemical explosive more powerful than plasma explosives!

K-HEX products include plastique cubes, explosive ammunition, grenades, and an entire line of missiles, among them a new type of micro-missile. A number of military organizations in the Three Galaxies have conducted tests with the new explosives, which have exceeded expectations on every front. Naruni Enterprises is just beginning to intro-

duce these weapons to other markets in the Megaverse, including Rifts Earth. The corporation is confident it can corner the explosives market in a matter of years. The only obstacle to this plan is the price of K-HEX; the substance is a lot more expensive than conventional explosives.

In its natural form, the crystals are extremely dangerous. Even a loud noise has a 20% chance of setting off Killaryte crystals. Any sort of impact (such as dropping a case of the crystals on the floor) has a 60% chance of causing an explosion. The only safe way to transport Killaryte is to surround it in soft cushioning materials and keep it in a contra-gravity chamber, using gravity fields to keep the cases firmly anchored. Natural Killaryte is actually more explosive than K-HEX: each pound of the crystals does 2D4x10 M.D. to a 50 foot (15.2 m) radius when it explodes! 2,000 lbs (900 kg) of the crystal could vaporize a starship!!

**K-HEX Plastique Cubes.** K-HEX cubes are sold in units of one pound (0.45 kg). These cubes are as easy to mold as Silly Putty, and can only be exploded with a detonator or by triggering an explosion on top of them. They are ideal for breaking through ship bulkheads, hatches, safes, and security doors. The substance is also used to make booby-traps and improvised mines. A demolitions skill roll is necessary to get the most out of the explosion. A failed roll means the explosive does 1/5 of its normal damage. Damage: A one pound (0.45 kg) cube of K-HEX does 1D6x10 M.D. to a 20 foot (6.1 m) area. By molding it around an object, the damage can be focused and doubled. Used as a thrown weapon, the cubes are not very effective; damage is reduced to 5D6 M.D. to a 10 foot (3.0 m) area. Cost: 1,000 credits per cube.

**NE-10G Grenades.** A new line of Naruni Enterprise grenades use K-HEX. They are the NE-10G grenades and come in fragmentation and high explosive variants. These grenades can be used on any standard grenade launcher weapon system, including Naruni's new "Double Threat" assault rifle. NE-10G grenades can be thrown or fired from a launcher and their hand-set timers can delay detonation for up to one minute, or can be set to go off as quickly as two seconds. Fragmentation: 4D6 M.D. to a 30 foot (9.1 m) area. High Explosive: 6D6 M.D. to a 12 foot (3.6 m) area. Cost: 400 credits for fragmentation and 500 credits for high explosive.

**NE-20G Micro-Grenades.** The enhanced power of K-HEX grenades has allowed Naruni Enterprises to produce a line of small grenades about half the size of a shotgun shell and which are roughly as powerful as conventional hand grenades! The small size of the NE-20Gs makes them ideal for grenade launchers (see the NE-74GL, above). They are also useful for spies and assassins, because the little explosives can be easily disguised as harmless items like lipstick, marker pens, flashlights, etc. Fragmentation: 3D6 M.D. to a 20 foot (6.1 m) area. High Explosive: 4D6 M.D. to a 6 foot (1.8 m) area. Cost: 300 credits for fragmentation or 350 credits for high explosive.

**Naruni Guided Missiles.** Naruni Enterprises has developed guidance systems for mini-missiles, as well as short- and medium-range missiles. These guided missiles work like smart missiles: +5 to strike, +4 to dodge, and have two attacks per melee. Their radar systems have a range equal to the missile's attack range: about one mile (1.6 km) for mini-missiles, 3 to 5 miles (4.8 to 8 km) for short-range missiles, and approximately 50 miles (80 km) for medium-range. Cost: The guidance system costs 15,000 credits in addition to the cost of the missile.

**Naruni Micro-Missiles.** Micro-Missiles are a triumph of Naruni technology and are rapidly becoming the rage in the Three Galaxies. These weapons combine sophisticated miniaturized guidance and contra-gravity systems with a K-HEX warhead. The resulting rocket explosive is roughly the size of a magic marker, but it has almost the same explosive power as a mini-missile! Plus it can be purchased in a "smart" version that can track down its target! Smart missiles can shoot around corners and track down a target through a crowd, making them ideal for snipers.

Non-smart versions are cheaper but can only be used as direct-fire weapons. The NE-28R wrist launcher is already a best-seller in the

mercenary and outlaw community. Smart micro-missiles are +4 to strike. If they miss, they will double back and attack again (two attacks per melee round!). Their size makes them very difficult targets to hit (require a called shot to strike and can dodge +4!). They fly at relatively low speeds (Speed 88, or 60 mph/96 km) to weave around obstacles. If the target is fast-moving or there is a relatively clear path towards it, the missile can attain a flight speed of up to Mach 2. Standard missiles use the shooter's bonuses to strike, and fly in a straight line at about Mach 2. Damage: Armor-piercing only: 6D6 M.D. to a 3 foot (0.9 m) area. Range: One mile (1.6 km) for "dumb" missiles; 2 miles (3.2 km) for smart micro-missiles. Cost: 1,600 credits for a standard missile; 8000 for a smart micro-missile. See launch systems, below.

**NE-28R Micro-Missile Wrist Launcher.** The NE-28R is mounted on the wrist and forearm, and fires two micro-missiles. The weapon should only be used while wearing body armor, because the heat of the missiles' exhaust will inflict 5D6 S.D.C. to unprotected skin and leaves ugly scars. The launcher makes a handy back-up weapon and is easy to conceal, thus it has become a favorite among spies, mercenaries, pirates, assassins and outlaws. The weapon can also be built into body armor, power armor or bionic arms (add 7,000 credits for installation costs and increase the payload to four; giant-sized robots can have as many as ten micro-missiles in a forearm, shoulder or chest launcher). The wrist launcher is typically loaded with "dumb" (non-guided) missiles, but it can use either kind. Weight: 3 lbs (1.35 kg). Mega-Damage: 6D6 M.D. to a 3 foot (0.9 m) area. Rate of Fire: One at a time or volley of two. Range: Typically one mile (1.6 km). Payload: Two micro-missiles. Reloading the launcher takes one melee action per missile. A missile pouch holding 10 micro-missiles weighs 10 lbs (4.5 kg) and can be carried in a hip pack, shoulder pack, or backpack. Cost: 50,000 credits for the wrist launcher; micro-missiles sold separately.

**NE-800R Missile Assault System.** Touted by the Naruni publicists as "the ultimate small arm," the NE-800R can be used as an anti-personnel, anti-armor and anti-aircraft weapon system, all in a relatively compact package. The launcher-rifle resembles a shortened four-barreled shotgun with a large box magazine. The magazine can be loaded with "dumb" micro-missiles and used as a devastating assault rifle, or use smart micro-missiles to fire at long distance targets, aircraft, flying power armor, etc. The main drawbacks of the weapon are its bulk and high cost, especially for its ammunition. Weight: 22 lbs (10 kg). Mega-Damage: 6D6 M.D. per missile to a 3 foot (0.9 m) area. Rate of Fire: One at a time or volleys of two, three or four missiles. Each volley counts as one melee attack. Range: One mile (1.6 km). Payload: 16 missiles in a box magazine. Changing magazines takes up two melee actions. Cost: 80,000 credits for the rifle; micro-missiles sold separately (1,600 for dumb missiles, 8,000 for smart).

**K-HEX Missiles.** Besides micro-missiles, a whole line of K-HEX explosive missiles have been released on the market. These missiles do more damage but are considerably more expensive (double normal cost), which has limited their popularity to wealthy mercenaries, armies and governments. Adventurers, space explorers, pirates and mercenaries with the necessary funds are snapping them up in small quantities.

Mini-Missiles: Fragmentation: 1D4x10 M.D.; Armor Piercing: 1D6x10 M.D.; High Explosive: 1D4x10 M.D.; range and blast radius remains unchanged; same as normal mini-missiles. Short-Range Missiles: High Explosive (medium only): 2D4x10 M.D.; Fragmentation: 1D6x10 M.D.; Armor Piercing: 2D6x10 M.D.; range and blast radius remains unchanged; same as conventional missiles. Medium-Range Missiles: High Explosive (medium): 2D6x10 M.D.; High Explosive (heavy): 3D4x10 M.D.; Fragmentation: 2D6x10 M.D.; range and blast radius remains unchanged; same as conventional missiles. Long-Range Missiles: High Explosive (Medium): 3D4x10 M.D.; High Explosive (Heavy): 4D6x10 M.D.; Fragmentation: 3D6x10 M.D.; Armor Piercing (heavy): 4D6x10 M.D.; range and blast radius remains unchanged; same as conventional missiles. Cost: All K-HEX missiles are double the cost of conventional missiles.

# Native American Weapons

## Rifts® World Book 15: Spirit West

These items are generally manufactured and/or available at high-tech communities of Modern Indians as well as from *Bandito Arms*, *the Black Market* and *Northern Gun* as specialty items for the Western market.

**NA-LB1 Laser Bow.** This bow looks very much like a modern compound bow, complete with pulleys and multiple strings, but the area where an arrow is normally fired has a short barrel and metallic laser discharge mechanism. A cable attaches the mechanism to the bowstring (which is really a cable, not a string). When the string is drawn, the cable pulls on a plunger type generator in the mechanism and generates enough energy for a single laser blast. The weapon is aimed and can be fired like a normal bow, but does not fire normal arrows, but a laser bolt. There are two fire settings for the Laser Bow. It can be drawn back and released, just like a normal bow, or it can be drawn and the charge stored in a small battery. In the latter case, firing the shot is done by the touch of a button. The small battery can only hold one shot in this manner, but a port is located on the weapon for an E-Clip (20 shot) in the event of a broken string or jammed plunger. A strength of 12 or higher is needed to draw this bow because of the power needed to cycle up a charge in the generator. Weight: 4 pounds (1.8 kg). Mega-Damage: 2D6 M.D. Rate of Fire: Single shot. Range: 1,000 feet (305 m). Payload: Effectively unlimited, but the draw cord and plunger wear out after about 500 shots. Cost: 8,000 credits.

**NA-SW4 M.D.C. Bow & Arrow.** This bow looks exactly like a modern compound bow, but instead of fiberglass or lightweight composites, it is constructed of M.D.C. materials and designed to fire M.D.C. arrows! These weapons are constructed for use by *Spirit Warriors* and other humans who possess *supernatural strength*. The bows are large and very unwieldy for normal humans, and the string pull is nearly 1,000 pounds (450 kg)! The actual pull weight is only a few hundred, thanks to the pulley array, but humans with less than a 21 P.S. cannot even draw the string an inch, let alone fire it. To shoot, one needs a non-supernatural P.S. of 35 or a Supernatural P.S. of 18 or higher. Special M.D.C. alloy arrows are standard ammunition, but high-tech and conventional arrows can be substituted. Weight: 24 lbs (10.9 kg) for the bow; arrows are 3.5 lbs (1.6 kg) each. Mega-Damage: Ordinary arrows do an *extra 3D6 S.D.C.* and may shatter on impact. Arrows made of M.D.C. material (about three times thicker than normal arrows) inflict 2D6 M.D. Rate of Fire: Varies with experience; see W.P. Archery and Targeting skill. Range: 1,500 feet (457 m). Payload: Up to six arrows can clip onto the bow itself. Quivers typically hold 12, 20, or 24 arrows. Cost: 18,000 credits for the bow. M.D.C. arrows cost 80 credits each. Most common in the New West and Canadian wilderness.

**Vibro-Axe or Tomahawk.** Mega-Damage: 1D6+3. Black Market Cost: 1,600 credits.

**Vibro-Spear.** Mega-Damage: 2D6+2 M.D. Black Market Cost: 2 500 credits.

**Conventional Tomahawk:** 2D4 S.D.C.; can be thrown.

**Conventional War Club (wood or wood and stone):** 2D4+1

**Magic Weapons:** See *Spirit West* for magic weapons, masks and fetishes.

## Naut'Yll Weapons

### Rifts® World Book Seven: Rifts® Underseas™

The Naut'Yll have advanced technology, magic, and Techno-Wizardry, especially in the areas of combat. In addition to the weapons described here, they also have access to any TW weapons or equipment described in *Rifts*, *Vampire Kingdoms* and other

sourcebooks. Captured weapons and equipment from other civilizations are occasionally given to officers, special forces and champions as spoils of war or as a reward for acts of heroism.

**Dual-Purpose Self-Propelled Explosives (DPSE).** The Naut'Yll use special rockets/torpedoes that can operate both underwater and in the air. Mega-Damage: They are roughly the equivalent of plasma/heat mini-missiles and torpedoes in terms of damage. Rate of Fire: Available in LAW style, one- and two-shot rifle launchers and small, portal backpacks with a payload of four and which can be fired one at a time or in volleys of two, three or four. These launchers and missiles can also be attached to underwater sleds and vehicles. Range: When underwater, use the range and speed of the equivalent mini-torpedo class. On the surface, use the range and speed of equivalent plasma missiles. Cost: Same as equivalent mini-torpedoes or mini-missiles; roughly 2000 credits.

**Energy Net.** This a metal or Korallyte net with 20 M.D.C. and small weights along the edge to provide weight and control. The net is used to ensnare fish, animals and humanoid prey. The most unique aspect is that once the prey is ensnared, the net can be activated by remote control to release an electrical pulse. Weight: 8 lbs (3.6 kg). Damage: 2D4 S.D.C. damage as a striking, whipping weapon, which can also be used to ensnare and entangle. The electrical burst can be set to inflict 1D6x10 S.D.C. or 2D6 M.D.; the charge affects everybody inside the net and those within a 10 foot (3 m) radius around the net. Those beyond 10 feet (3 m), but within 30 feet (9 m) suffer a slight shock that does 1D4 points of damage (S.D.C. or M.D. depending on the setting). There is also a 1-35% chance that characters receiving the shock will be stunned for 1D4 melee rounds (15 to 60 seconds); roll for each shock burst. Note that on dry land, damage is half and there is no radius damage, only those inside the net are affected. Rate of Fire: Equal to the number of hand to hand attacks of the wielder. Range: The net can be thrown underwater about 30 feet (9 m) or dropped from above up to 1,000 feet (305 m); any farther and the net is -4 to strike and the intended victim can dodge with ease. On dry land the net can be thrown about 40 feet (12 m). The electric burst can be activated up to 1,200 feet (365 m) away. Payload: 8 electric bursts/shock attacks; regenerates within 30 minutes. Cost: 6,000 credits from Naut'Yll settlements, the Black Market, Atlantis, pirates and merchant sailors.

**Energy Trident.** Carried as a Badge of Office by Naut'Yll military leaders and heroes, this powerful weapon can be used both in hand to hand combat and as a ranged weapon. The Trident can be energized, firing particle waves or delivering energy strikes in close combat. Weight: 12 lbs (5.4 kg). Mega-Damage: Both the ranged particle wave attack and the energized strike inflict 5D6 M.D. Rate of Fire: Equal to the number of hand to hand attacks of the wielder. Range: Energy blast: 1000 feet (305 m). Strike: hand to hand combat. Payload: 30 energy blasts or close combat blows (every successful strike drains one charge). Changing E-Clips counts as one melee attack/action. Cost: 70,000 credits outside Naut'Yll settlements.

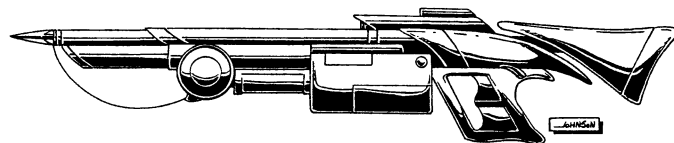

**Harpoon Rifle.** A rifle that fires hypervelocity barbed darts. It works much like a rail gun, but is light enough to be carried by Naut'Yll infantrymen. The barbs can be attached to the gun's barrel with a thin cable, enabling the shooter to "hook" or "spear" a target and pull it in. A special reel attachment is available to use it as a fishing pole. Of course, large or powerful prey may yank a cabled harpoon rifle from the character's hands or drag him for miles until the wounded beast tires, dies or turns to attack. The harpoon rifle (and reel) is also used to snag rides from passing sea vessels and to board ships. Weight: 15 lbs (6.8 kg). Mega-Damage: 1D6 M.D. per standard dart. The fish-hook's "barbed" end requires the dart to be surgically removed/cut

out (one additional point of damage). Pulling it out will tear a hunk of flesh or material with it and inflict an additional 1D6 M.D. Each explosive tipped round inflicts 4D6+6 M.D. underwater or 4D6 M.D. on land. Poison tipped rounds are sometimes used against whales, sea monsters, mutants, D-Bees and M.D.C. creatures. Lethal poison inflicts 5D6 additional M.D. when first struck and another 5D6 M.D. for 1D6 melee rounds afterwards. Neural poison does 3D6 M.D. when struck and affects the target's motor response with the following penalties: reduce speed, skill performance, attacks per melee and combat bonuses by half. **Note:** Most supernatural beings are impervious to both types of poisons: the standard saves vs poison are applicable: 16 or higher for nonlethal, 14 or higher vs lethal. Smoke and flare rounds (suitable for use underwater or above) are also available. They last for about 2D4 minutes and inflict 1D6 M.D. when used as a weapon. **Rate of Fire:** Single shot only, so each shot counts as one melee action/attack of the shooter. **Range:** 2,000 feet (610 m) without a cable attached. Maximum range with an attached cable is limited to 500 feet (152 m). **Payload:** 40 darts in a drum magazine or 20 darts in a smaller box magazine. A "dart" is a small spear or projectile about eight inches long. **Cost:** 50,000 credits outside Naut'Yll settlements. Not sold to outsiders, but captured weapons may be available from the Black Market, Atlantis, pirates and sailors.

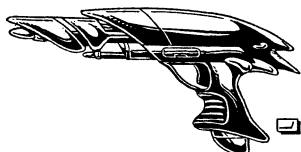

**Particle Wave Pistol.** These weapons fire a spiraling wave of charged particles, inflicting a great deal of burn and energy damage to any solid target they hit. Their range and damage are unchanged in or out of water. **Weight:** 4 lbs (1.8 kg). **Mega-Damage:** 4D6 M.D. per shot. **Rate of Fire:** Standard. **Range:** 1000 feet (305 m). **Payload:** 20 shots per E-Clip equivalent (cannot use standard surface E-Clips unless an armorer modifies their power couplings for use underwater). **Cost:** 20,000 credits outside Naut'Yll outposts. Not for sale to outsiders, but captured weapons may be found on sale in the Black Market, at Atlantis, or from the occasional pirate or sailor.

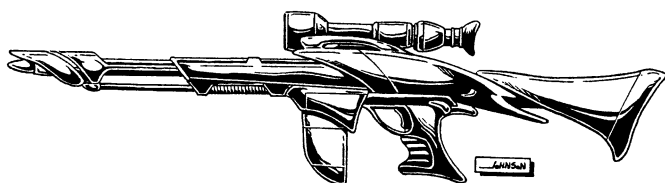

**Particle Wave Rifle.** Basically the same as the pistol above, but with greater damage and range. This is the standard issue of the Naut'Yll infantry. **Weight:** 7 lbs (3.2 kg). **Mega-Damage:** 6D6 M.D. per shot. **Rate of Fire:** Standard. **Range:** 2,000 feet (610 m). **Payload:** 30 shots with an E-Clip equivalent (cannot use standard E-Clips unless an armorer modifies their power couplings). **Cost:** 40,000 credits outside Naut'Yll outposts. Not for sale to outsiders, but captured weapons may be available from the Black Market, Atlantis, pirates and sailors.

**Sonic Wand (TW).** This is a Techno-Wizard weapon that looks like a nightstick used by police officers, with two small nodules near the tip and a coil of wire near the handle. The user of the weapon must be psionic or a sorcerer with P.P.E. **Mega-Damage & Payload:** By channeling 10 P.P.E. or 20 I.S.P., the user can fire three individual sonic blasts each inflicting 2D6 M.D. (and each counting as a melee action), or as one powerful blast doing 6D6 M.D. to the same target (counts as one melee action). By channeling 15 P.P.E. or 30 I.S.P. into the weapon, the character can fire two sonic stun blasts. **Stun Damage:** First victims get to save vs magic; 14 or higher. Only those who fail to save suffer the following. 3D6 S.D.C. damage, of which 2D4 actually passes through body and power armor to affect the character inside! Those stunned are -6 to strike, parry and dodge. Speed and attacks per

melee are also reduced by half. Penalties last for 1D4 melee rounds. The weapon does 2D6 S.D.C. as a blunt weapon and has 100 M.D.C. **Range:** 600 feet (183 m). **Cost:** 45,000, but never sold or traded by Naut'Yll; rare.

**Sonic Rifle (TW).** This is a rifle version of the Techno-Wizard Sonic Wand with greater range and number of shots. In this case, the weapon can be charged and ready to be used by anybody. Like a regular rifle, the shooter simply aims and fires. However, only a Techno-Wizard, other practitioner of magic or psychic can recharge the weapon. **Weight:** 6 lbs (2.7 kg). **Mega-Damage:** 5D6 M.D. per blast or stun. **Stun Damage:** Same as Sonic Wand, previous. **Range:** 2,000 feet (610 m). **Payload:** 30 sonic blasts and 20 sonic stuns. 60 P.P.E. or 120 I.S.P. are required to recharge the weapon; 200 P.P.E. to make it. **Cost:** 80,000 credits, but never sold or traded by Naut'Yll; rare.

**Techno-Wizard Grenades.** These are ordinary looking canisters that release magic spells when activated. All have a six second delay and are dropped or placed in an area. **Black Water Grenade:** Same as the spell. **Sonic Blast:** 4D6 M.D. to a 20 foot (6.1 m) blast diameter. **Note:** See *Coalition Wars, Book One* for a large range of TW grenades and weapons.

## New Navy

### Rifts® World Book Seven: Rifts® Underseas™

The secretive New Navy has access to pre-Rifts technologies that survived in their giant sub and the two secret bases in the Pacific Ocean. This equipment is as sophisticated as anything produced in the CS or Triax Industries. The automated mini-factories at The Refuge and Salvation Bases can produce replacements for the great submarine and other Navy vessels originally assigned to operate in that part of the world. However, quantities and the speed of production and repairs are very limited. Still, a small surplus had been stockpiled by the Navy and some items are beginning to be sold or traded to other people, most notably the people of Tritonia and trustworthy seafaring merchants and adventurers who visit the two ocean cities. In the future, trade may possibly be expanded to include Lemuria, the Coalition States, the NGR/Triax, and the human forces based in and around Japan. Limited trade has allowed the members of the New Navy to acquire weapons, equipment and technology from other nations. Although the New Navy and its civilian counterparts limit trade, making most of their own military weapons, armor and vehicles unavailable to outsiders, some of this equipment may appear in the hands of mercenaries, adventurers and pirates around the world. In most cases, these items have been *stolen*, *captured*, or *salvaged*. In some cases, these weapons are similar to weapons in other parts of the world that are also based on pre-Rifts designs. For the most part, the weapons that follow are exclusive to the New Navy and are rare to the outside world.

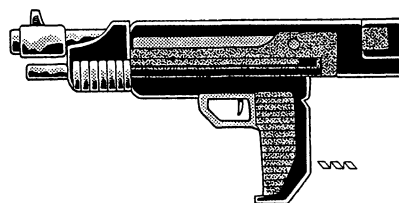

**M-2011 Energy Pistol.** A heavy ion blaster with slightly less range than a laser pistol but more stopping power and penetration. This is the standard sidearm of officers, pilots and vehicle crews. In terms of size and weight, it more closely resembles a machine-pistol or small submachine-gun. **Mega-Damage:** Two settings: 1D4x10 S.D.C. and 3D6 M.D. per single shot. **Rate of Fire:** Standard. **Range:** 800 feet (244 m). **Payload:** 20 shots with short E-Clip, 30 shots with long E-Clip. **Cost:** 19,000 credits. Rare.

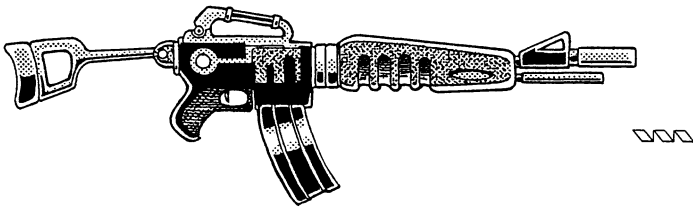

**M-160 Assault Rifle.** The M-160 is an ion pulse rifle that was the standard issue of the US Marines prior to the Great Cataclysm. The rifle fires energy “packets” that explode on contact with a solid object. The M-160 can be fired underwater without losing range or performance, and can inflict a great deal of damage with a short burst. Both the standard and long E-Clips can be used with this weapon. Mega-Damage: 3D6 M.D. per single shot, or 1D6x10 M.D. multiple ion burst (three simultaneous shots). Range: 2000 feet (610 m). Payload: 30 shots short E-Clip, or 55 shots long E-Clip. Cost: 38,000 credits. Rare.

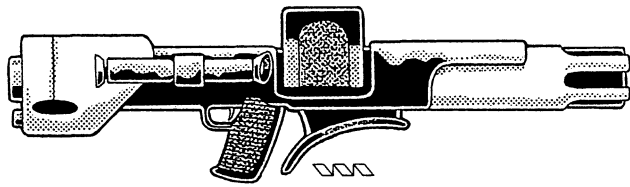

**Rapid-Fire LAWS-3 Rocket Launcher.** This Light Anti-tank Weapon System (LAWS) fires rocket-propelled grenades from a six round, disposable clip. The LAWS rounds can be laser-guided (it has a laser designator built into the sight system) or fired without guidance/line of sight. The launcher has a rapid fire system that allows for automatic fire, enabling the rocketeer to fire *three round* bursts. The disposable plastic clip ejects automatically when empty and can be reloaded in under three seconds by trained personnel (approx. six to 10 seconds for the uninitiated). Additional clips are usually carried in a bandoleer slung over the shoulder (a bandoleer holds five clips) in a medium-sized ammo satchel (holds 8 clips) or attached to a belt, slung over the shoulder or hooked to a backpack. Two of these weapons are assigned to each ten man squad. The rockets can be either armor piercing warheads or fragmentation. Mega-Damage: 1D4x10 M.D. from armor-piercing (AP), 1D6x10 from high explosive (HE) or 4D6 M.D. to a 20 foot (6 m) blast area for fragmentation. A three round burst does 3D4x10 M.D. for AP rounds, 3D6x10 for HE rounds, and doubles the damage and blast area (40 feet/12 m) for fragmentation. Rate of Fire: One at a time or bursts of three rounds; burst or single shell fire counts as one melee attack. Laser Targeting Bonus: +2 to strike; no bonus when shooting line of sight without targeting enhancement. Range: 2,000 feet (610 m) for the laser guidance system. Rockets can be fired “dumb” beyond that to about 4,000 feet (1220 m), but any attacks beyond 2000 feet (610 m) are at -2 to strike. Payload: Six round clip. Replacing a clip counts as one melee attack/action and typically takes about three seconds. Cost: 45,000 credits for a launcher. Loaded clips cost 3,000 credits for armor-piercing or 2,100 credits for fragmentation. Rare.

**M-20 Assault Rifle.** This pre-Rifts weapon was one of the last non-energy weapons still in service when the Great Cataclysm struck the Earth. It resembles the M-16AI with a semi-automatic grenade launcher. It is primarily an S.D.C. weapon although bursts of advanced armor-piercing rounds can inflict minor Mega-Damage and the grenades can inflict Mega-Damage. Damage: Single normal round does 4D6 S.D.C., a single armor-piercing (AP) round does 1D4x10 S.D.C.; a short burst of 8 normal rounds does *one M.D.* point of damage; AP rounds do three M.D. There are three types of *grenades*, all are smaller and inflict less damage than the LAWS. Fragmentation: 3D4 M.D. to a 10 foot (3 m) blast area, plasma/napalm: 4D6 M.D. to a six foot (1.8 m) blast area and sets flammable material on fire, AP: 3D6 M.D., or smoke (no damage; creates a cloud of smoke that encompasses a 20 ft/6 m ra-

dius, lasts 2D4 minutes). Rate of Fire: Bullets: one round at a time or short bursts of eight rounds automatically regulated by the weapon system for controlled bursts. A single shot or a controlled burst counts as one melee attack. Grenades can only be fired one at a time; each grenade fired counts as one melee attack/action. Laser Targeting Bonus: +2 to strike at targets within 1200 feet (366 m); no bonus for shooting without targeting enhancement or beyond 1200 feet. Range: 2000 feet (610 m) for rifle rounds; 1200 feet (366 m) for the laser guidance system and grenade launcher. Payload: Four round grenade capacity (loaded by hand, takes about five seconds). 64 round cartridge magazine/clip. Replacing a clip counts as one melee attack/action and typically takes about three seconds. Cost: 35,000 credits. Bullets cost about 90 credits a clip (64 rounds) for standard cartridges and 150 for armor-piercing rounds. Grenades cost 220 credits each for fragmentation or 350 credits each for AP or plasma; 50 for smoke. This is one of the items *commonly traded* or sold to outsiders.

## NGR Weapons

The letters N-G-R stand for *New German Republic*, the Rifts Earth nation of Germany, a high-tech mecca besieged by Gargoyles, Brodkiel and other monsters. Triax Industries is the primary weapons and military designer and manufacturer. The NGR’s weapons are described under Triax Industries, later in this section.

## Northern Gun Weapons

### Collected from various Rifts® titles

The Northern Gun Company is located in the northern peninsula of Michigan. It is one of the largest manufacturers of non-Coalition arms and armor on the continent. Most of its products are widely available throughout North America, with limited trade to parts of South America and Europe. Also bought, sold and traded by the Black Market, pirates and private arms dealers.

**Energy Clips.** The weapon designers at Northern Gun’s Ishpeming headquarters continue to develop new weapons and features, including providing a greater availability of the “standard” E-Clip (5,500 credits), “long” E-Clip (10,000 credits) and power packs (60,000-80,000 credits).



**NG-H5 Holdout Ion Pistol.** This weapon is manufactured by Northern Gun exclusively for its spy and security organizations. Its very existence was secret until the Black Market somehow got its hands on a shipment of several thousand. NG-H5 knock-offs can now be found for sale in many parts of North America. Use and possession of this weapon is illegal in most civilized parts of the continent, including the Coalition States. Finding such a weapon in the hands of anybody is usually grounds for imprisonment on the suspicion of being an assassin.

The NG-H5 is a Derringer-sized weapon that uses a specially manufactured mini-energy clip (2000 credits). The gun can fit in the palm of the hand and can be easily hidden in boots, hidden sleeve holsters, and even under light clothing (+6% to concealment rolls). It is also built to foil most commonly-used weapons detectors, including most CS detectors. Common systems used at medium or low level security areas have no chance of detecting these weapons! More advanced systems (used at high-level security areas) have a 01-40% chance, depending on their complexity, at the G.M.’s discretion. Juicers and assassins love this highly concealable weapon. Weight: Under one pound (0.45 kg). Mega-Damage: 1D4+1 M.D. per shot. Rate of Fire: Single shots only. Range: 200 feet (61.0 m). Payload: 6 shots. Cost: 50,000 credits.

**NG-33 Northern Gun Laser Pistol.** Looks like a sleeker blaster with a pointed nose. Weight: 4 lbs (1.8 kg). Mega-Damage: 1D6 M.D. Rate of Fire: Standard. Range: 800 feet (244 m). Payload: 20 shots per standard E-Clip, 40 shots with a Long. Cost: 6,500 credits.

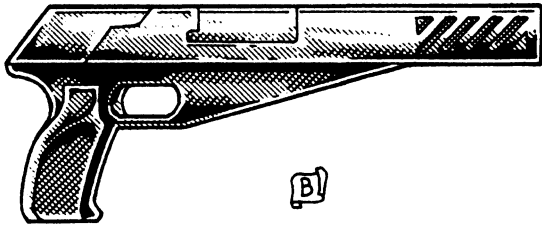

**NG-45LP "Long Pistol."** The NG-45 is a long-barreled pistol that has nearly the range of a rifle and fires a powerful particle beam. Juicers and Bounty Hunters love this weapon for the intimidation factor. It is also popular among pilots (small enough to fit into a weapons compartment, and yet almost as good as a rifle), outlaws and travelers. Weight: 5 lbs (2.25 kg). Mega-Damage: 5D6 M.D. per shot. Rate of Fire: Single shots only. Range: 1,200 feet (365 m). Payload: 8 shots per standard E-Clip, 13 with a Long E-Clip, 42 with power pack. Cost: 15,000 credits.

**NG-56 Northern Gun Light Ion Pistol.** A slightly smaller, lighter version of the NG-57. Weight: 3 lbs (1.4 kg). Mega-Damage: 2D6 M.D. Rate of Fire: Standard. Range: 400 feet (122 m). Payload: 6 shots standard E-Clip, 12 shots long E-Clip, or 42 shots with Power Pack. Cost: 5,000 credits.

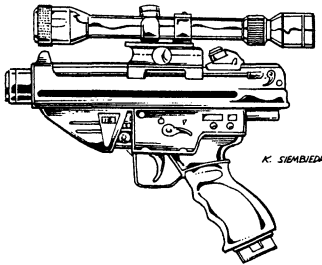

**NG-57 Northern Gun Heavy-Duty Ion Blaster.** The NG-57 is a sturdy pistol that packs a wallop, but is comparatively heavy. A variety of scopes can be attached. Weight: 5 lbs (2.25 kg). Mega-Damage: Two settings, 2D4 or 3D6 M.D. Rate of Fire: Standard. Range: 500 feet (152 m). Payload: 10 shots per standard E-Clip, 18 with a Long Clip, 60 with power pack. Cost: 8,000 credits.

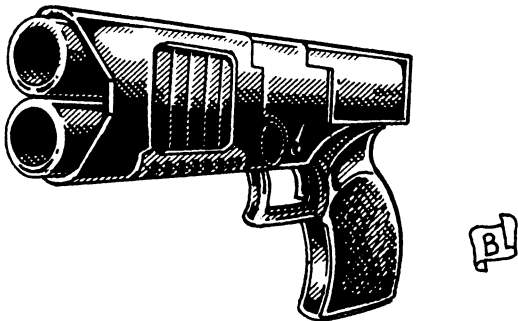

**NG-11S "Sawed-Off."** This weapon resembles a double-barreled sawed-off shotgun with a pistol grip. This .60 caliber smoothbore weapon can fire regular 12-gauge shotgun shells, but it can also fire special explosive rounds (equivalent to small grenades), as well as special ramjet rounds designed to crack open M.D.C. body armor. The ramjet rounds are fired from the gun like a normal bullet, but once they are in the air a secondary rocket booster kicks in, propelling the heavy M.D.C. slug at rail gun like speeds. The main drawback of the NG-11S is that it can only fire two rounds at a time (reloading the gun takes one melee action). Juicers, bandits and adventurers like the gun nonetheless, and often carry 20 to 50 rounds in ammo belts/bandoleers. Some

Juicers have adopted a "Bandito" look, and walk around with criss-crossing ammo belts across their chests. Weight: 3 lbs (1.35 kg). Mega-Damage: Varies with ammo type. Shotgun Shell: 4D6 S.D.C. or 8D6 S.D.C. for a double blast at the same target (counts as one melee attack). Solid Slugs: 5D6 S.D.C. or 1D6x10 S.D.C. for a double blast at the same target (counts as one melee attack). Explosive Shell (Fragmentary): 2D6 M.D. to a 10 foot (3 m) diameter, or 3D6 M.D. to a 20 foot (6.1 m) diameter for a double blast (counts as one melee attack). Explosive Shell (Plasma): 3D6 M.D. to a 6 foot (1.8 m) diameter area, or 5D6 M.D. to a 12 foot (3.6 m) diameter area for a double blast (counts as one melee attack). APRJ (Armor-Piercing Ramjet) Rounds: 2D6 M.D. per shot, or 4D6 M.D. for a double blast at the same target (counts as one melee attack). Rate of Fire: Single or double shot only. Range: Shotgun shells or slugs: 300 feet (91.4 m). Explosive Shells and APRJ: 500 feet (152 m). Payload: Two shots. Reloading the gun takes one melee round. Cost: 4,000 credits. Explosive Shells cost 150 credits a piece; APRJ rounds cost 20 credits each.

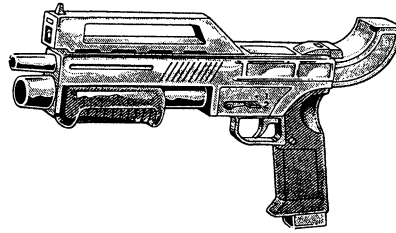

**NG-Super Laser Pistol and Grenade Launcher.** The NG-Super is a dynamic short-range weapon with the dual functions of laser gun and grenade launcher. The weapon resembles a submachine-gun or a sawed-off shotgun more than a pistol. The kick from the grenade launcher is tremendous and the weapon's weight is a problem for the average adventurer. Characters with a strength of 19 or less are -3 to strike firing one-handed, and -1 to strike when bracing it with both hands or on something, whether firing it as a laser or a launcher. This is why the gun is not popular among most humans, but extremely popular among cyborgs, Headhunters, Juicers, Crazies, and those who are unusually strong. Weight: 13 lbs (5.8 kg). Mega-Damage: Laser 2D4 M.D. Grenade Launcher 2D6 M.D. to a blast area of six feet (1.8 m). Rate of Fire: Laser: Standard. Grenades: one aimed, four fired in rapid succession (burst if all at same target, wild if sprayed into an area). Range: Laser is 800 feet (244 m). Grenade Launcher is 500 feet (152 m). Payload: Laser is 20 blasts, Grenade Launcher is a standard six hand loaded into the gun plus an additional eight in a top feeding grenade clip. Reloading the Launcher: Requires one full melee, 15 seconds, to manually reload the grenade launcher. As always, reloading an E-Clip takes about five seconds or equal to one melee action/attack. Cost: 21,000 credits. Grenades cost 400 credits apiece or 3,800 a dozen. Note: The introduction of the NG-LG6 rifle and increasing competition from Triax and Naruni Enterprises (among others) has caused a dramatic decrease in the price of the NG-Super laser pistol and grenade launcher; from 21,000 credits to 12,000 at most weapon shops.

**NG-L5 Northern Gun Laser Rifle.** A durable, heavy-duty laser rifle that suffers from the usual problem of weight, but can endure a massive amount of abuse and keep on working. Weight: 14 lbs (6.3 kg). Mega-Damage: 3D6 M.D. Rate of Fire: Standard. Range: 1,600 feet (488 m). Payload: 10 shots standard clip or 20 shots long E-Clip. Cost: 16,000 credits.

**NG-LG6 Northern Gun Laser Rifle & Grenade Launcher.** A grenade launching laser rifle that is slowly gaining popularity with Headhunters, Juicers, and other soldiers of fortune. Weight: 19 lbs (8.6 kg). Mega-Damage: 3D6 M.D. per laser blast or 4D6 M.D. per grenade. Rate of Fire: Standard. Range: Laser: 1600 feet (488 m). Grenade Launcher 1100 feet (335 m) and a blast radius of about 12 feet (3.6 m). Payload: Laser: 10 shots standard E-Clip, or 20 shots long E-Clip, or 70 shots with power pack (pack weighs 12 lbs/5.4 kg and regenerates 4

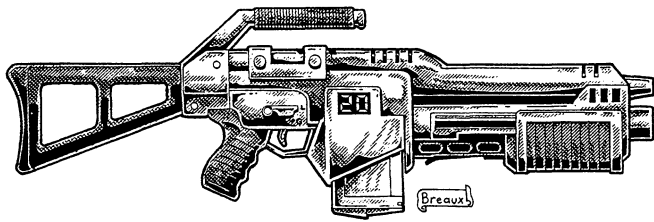

blasts per hour; costs 70,000 credits). Grenade Launcher: Four grenades (pump action). Can be reloaded in five seconds. Cost: 20,000 credits; grenades cost 400 credits each.

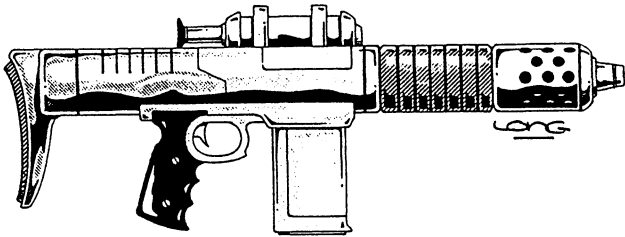

**NG-E4 Plasma Ejector.** Another heavy energy weapon from the people at Northern Gun. Like most of their weapons, the NG-E4 is a bit heavy and has minimum range capability. Comes equipped with telescopic sight; can be fitted with any optic system. Weight: 20 lbs (9 kg). Mega-Damage: 6D6 M.D. Rate of Fire: Standard. Range: 1,600 feet (488 m). Payload: 6 shots standard clip, 12 shots long E-Clip, or 42 shots with Power Pack (pack weighs 20 lbs/9 kg and regenerates 4 blasts per hour). Cost: 30,000 credits for the gun.

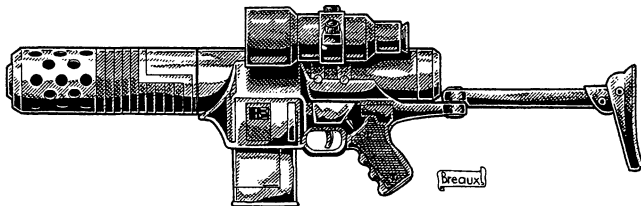

**NG-E12 Heavy Plasma Ejector.** This is a heavier version of the NG-E4 rifle designed as a tripod mounted or light vehicle weapon. A secondary version, the NG-E4A, has a rifle configuration to be used by cyborgs and troops in powered armor. The weapon is too big and heavy to be used as a shoulder weapon by normal humans. Weight: 30 lbs (13.5 kg) using an E-Clip, 50 lbs (22.5 kg) with a Power Pack. Mega-Damage: 1D6x10 M.D. Rate of Fire: Standard. Range: 2000 feet (610 m). Payload: 4 shots standard clip, 8 shots long E-Clip, or 30 shots with Power Pack (20 lbs/9 kg and regenerates 4 blasts per hour). Cost: 80,000 credits.

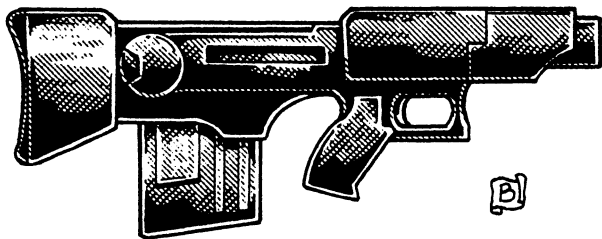

**NG-IP7 Ion Pulse Rifle.** A combat rifle that uses a shortened "bull-pup" design to make it compact and easy to carry and conceal. Liked by Juicers, security forces, and urban combat units. Weight: 7 lbs (3.15 kg). Mega-Damage: Single shot 3D6 M.D. or multiple pulse burst 1D4x10 M.D. (counts as one attack but consumes three shots). Rate of Fire: Standard. Effective Range: 1,600 feet (488 m). Payload: 18 with a standard E-Clip, 30 shots with a Long clip. Cost: 20,000 credits.

**NG-P7 Northern Gun Particle Beam Rifle.** Another heavy-duty weapon that is a bit heavy and awkward, but sturdy and dependable in combat. Weight: 21 lbs (9.45 kg). Mega-Damage: 2D4x10 M.D. Rate of Fire: Standard. Range: 1,200 feet (365 m). Payload: 6 shots with a

standard E-Clip, 10 with a Long E-Clip and 40 with power pack. Cost: 22,000 credits for gun.

**NG-101 Rail Gun.** While a perfectly serviceable light rail gun, the NG-101's sales have suffered badly in recent years, thanks to cutthroat competition from Triax. Weight: Gun: 128 lbs (57.6 kg), Power Pack: 80 lbs (36 kg), One Ammo-Belt: 25 lbs (11 kg), Case of six belts: 160 lbs (72 kg). Mega-Damage: A Burst is 30 rounds and inflicts 6D6 M.D., one round does 1D4 M.D. Rate of Fire: Standard. Range: 4,000 feet (1,219 m). Payload: As a machine-gun: 300 round belt. Black Market Cost: 70,000 credits. Not often available.

**NG-202 Rail Gun.** The size and weight of this arm makes it one best used by those with supernatural strength or those in power armor. Its sales have suffered terribly in recent years with the advent of the Triax rail guns, which hit hard, look great, and have been ruthlessly marketed throughout North America. Weight: Gun: 198 lbs (89 kg), Power Pack: 100 lbs (45 kg), One Ammo-Belt: 35 lbs (16 kg), Case of six belts: 210 lbs (94.5 kg). Mega-Damage: A Burst is 40 rounds and inflicts 1D4x10 M.D. One round does 1D4 M.D. Rate of Fire: Standard. Range: 4000 feet (1219 m). Payload: As a machine-gun: 300 round belt. Black Market Cost: 70,000 credits. Not always available. Note: Also see robots and power armor for other rail guns.

## NG Explosives

**Blasting Cap:** Cost: Five credits (S.D.C. explosives) or 40 credits (M.D.C. explosives).

**S.D.C. Dynamite.** Damage: 5D6 S.D.C. per stick. Cost: 10 credits each.

**M.D. Dynamite.** Mega-Damage: 2D4 M.D. per stick; blast radius of 10 feet (3 m). Cost: 130 credits each stick. Fair availability. A stick of dynamite is usually placed and detonated. It is not made for throwing. Maximum effective range throwing: 1D4x10 feet (1D4x3 m) (varies). Cost: 150 credits a stick.

**NG Hand Grenades.** Northern Gun produces its own line of grenades. They are cheaper, but slightly less powerful than the Coalition equivalents. Fragmentation: 2D4 M.D. to a 20 foot (6 m) area. High Explosive: 3D4 M.D. to a 6 foot (1.8 m) area. Plasma: 4D6 M.D. to a 12 foot (3.6 m) area. Smoke: No damage, but creates a smoke screen that covers a 40 foot (12 m) area. Effective Range: When Throwing a Grenade: About 40 yards/meters. Cost: 160 credits for fragmentation, 120 credits for high explosive, 275 credits for plasma, and 50 credits for smoke.

**Plastique** is a wax or clay-like explosive that can be shaped like putty into a patty, block, rope or blob. It will not detonate if it is dropped, shaken, shot, blasted, or set on fire. It is detonated by an electric charge usually contained in a blasting cap. However, it can be detonated by lightning or Electrokinetics. The explosion is usually contained mainly to the area where the plastique was placed, causing little shrapnel and putting the full force of the explosion on one concentrated area. Plastiques are used for safe-cracking, sabotage and other precision explosions to blow out locks, open safes, cut girders, set off other explosives, etc. It comes in S.D.C. and M.D. types.

**Commercial Plastique.** Damage: 1D4 S.D.C. per ounce (28 grams) or 1D6x10 S.D.C. per pound (0.45 kg). Cost: 5 credits an ounce. Fair availability.

**C4 (military HE) Plastique.** Damage: 1D6 S.D.C. per ounce or 2D4x10+20 S.D.C. per pound (0.45 kg). Cost: 8 credits an ounce. Fair availability.

**NG 2 M.D. Plastique.** Mega-Damage: One M.D. point per ounce or 16 M.D. per pound (0.45 kg). Cost: 20 credits an ounce or 320 credits a pound. Fair availability.

**NG 4 M.D. Plastique.** Mega-Damage: 1D4 M.D. points per ounce or 1D4x10 M.D. per pound (0.45 kg). Cost: 40 credits an ounce or 640 credits a pound. Poor to fair availability.

**NG 6 M.D. Plastique.** Mega-Damage: 1D6 M.D. points per ounce or 2D4x10+20 M.D. per pound (0.45 kg). Cost: 60 credits an ounce or 960 credits a pound. Poor availability.

**NG Mines:** Northern Gun has started manufacturing some simple land mines for anti-vehicle and anti-personnel purposes. Poor availability.

Mine Detector: Traveling on foot and looking for mines, the Detect Ambush or detect concealment skills at -10% can be used to spot land mines and booby-traps. Vehicles can be outfitted with a basic mine detector for 50,000 credits. This unit has a 40% chance of locating mines before they are struck and detonated, but will also indicate harmless metal fragments as well (fragments must be the size of a soccer ball or bigger). The basic system can be "fine-tuned" and enhanced +10% for an additional 20,000 credits up to a maximum of 90% efficiency, but those are rare (most are at 70%). A pilot can try Detect Ambush or Detect Concealment skill rolls, but is -25% if traveling is at a crawl and -50% if traveling at over 30 mph (50 km).

**NG Anti-Personnel Mines.** These mines typically use fragmentary or incendiary charges designed to inflict damage to a large area, crippling troops with shrapnel or fire. Most are triggered by snapping a trip wire or responding to pressure/weight (100 lbs/45 kg or more). Sensor Special: High-tech mines that come with special sensors that will detect a human-sized creature 6 feet (1.8 m) away, or a 'bot, cyborg, giant, or light vehicle up to 12 feet (3.6 m) away and detonate. The sensor types cost twice as much. Mega-Damage: 4D6 M.D. to a 40 foot (12 m) area. Cost: 600 credits for the standard mine, 1,200 with sensor. Poor availability.

**NG Anti-Vehicle Mines.** Most have a rudimentary electronic sensor suite that can be programmed to detonate the explosives when a target of a pre-determined size comes close enough to be detected. The larger the size, the greater the detectable range. The weapons can also be triggered by a radio signal sent at a distance (ambushers can wait until the target is close enough, then detonate the explosive). Poor availability.

Type One: NG Light Anti-Vehicle Mines: Detects a vehicle of under 5 tons at 3 feet (one meter) away, a vehicle weighing 5-10 tons from 10 feet (3 m) away, and vehicles over 10 tons at 20 feet (6 m). People on foot only trigger it if they actually step over the mine, or if a remote controller detonates it by radio. Treat heavy creatures and humanoids weighing over 400 lbs (180 kg) as light vehicles. Mega-Damage: Uses either a high explosive (HE), doing 5D6 M.D. to a 20 foot (6 m) area, or plasma, doing 1D4x10 to a 30 foot (9.1 m) area. Cost: 1,000 credits for HE, 2,000 for plasma. Poor availability.

Type Two: Medium Anti-Vehicle Mine: As above, but does more damage. Mega-Damage: HE explosion does 1D6x10 M.D. and the plasma inflicts 2D4x10 M.D. (area and detection range remain unchanged). Cost: 3,000 credits for HE, 4,000 for Plasma. Poor availability.

Type Three: Heavy Anti-Vehicle Mine: As above, but even greater damage. Mega-Damage: HE explosion inflicts 2D6x10 M.D. and the plasma does 3D6x10 M.D.; both with a blast area of 70 feet (21 m). Cost: 6,000 credits for HE, 8,000 for Plasma. Rare.

## Phase World & Space Technology

Phase World and most space technology is NOT really suitable for the environment that *is* Rifts Earth. What weapons and equipment that *might* make their way to Rifts Earth from Phase World, the Three Galaxies, the Skraypers environment and other outer space settings are extremely rare at best (i.e. there might be a total of a dozen items in North America). In order to squeeze in everything necessary for adventuring on *Rifts Earth*, we have to omit them. See the following **Rifts® Di-**

**mension Books™** for details: **Phase World®, Phase World® Sourcebook, Skraypers™** and **Mutants in Orbit™** (a sourcebook for *After the Bomb®* and *Rifts®*).

## Russian Weapons

### World Book 17: Warlords of Russia

Russian weapons, vehicles and equipment are almost never found elsewhere in the world as the country is very isolated. Generally, Russian weapons are found, well, in Russia/the old USSR, Eastern Europe, Mongolia and northern China. A few make their way to Alaska and Japan. Most are big and bulky. Many are attached to shoulder and/or back and chest harnesses with the gun itself "slung" under the arm or over the shoulder when not in use. Weapons, E & G-Clips, E-Packs, missiles, grenades, explosives, and Vibro-Weapons are all excellent trade goods, as well as the targets of raids by bandits, mercenaries, pirates, Warlord Reavers and invaders from China. As trade goods, one can usually get up to 80% market value, however, if selling for silver, gold, gems, Rubles, or credits, one will be lucky to get 33% (15-30% is typical).

Warlord weapons tend to be of the vicious and destructive nature, very much designed to kill and destroy. A Warlord desires to spread fear, to break his enemy's resolve and scatter him. Thus, wicked designs have emerged to maximize terror on the battlefield.

The most common *foreign* weapons, magic and equipment will come from the *New German Republic (Triax)* and *Poland (Mindwerks)*. Weapons, magic items and Symbiotes from the Splugorth's Atlantis occasionally make their way to Eastern Europe, Russia and Asia (more common in Africa, the Middle East and India, though). Russia has all of the usual vampire fighting weapons but Techno-Wizard items are incredibly rare in Russia.

**Price Note:** The prices listed apply to those in Russia, where people are poor and prices are lower than elsewhere in the world. Russian Weapons, E-Clips, E-Packs and other equipment would cost 40% to 80% more in the West.

**E-Clip Adaptor.** Western style E-Clips (including NGR/Triax and CS types) are too narrow to fit into Russian weapons so they are useless without an adaptor. The E-Clip snaps snugly into the wide housing of the adaptor, which in turn snaps into the weapon. Cost: 1,000 credits for a Russian weapon adaptor.

**E-Packs.** These are about half the size of a backpack and can be worn on the hip or on the back (2-3 can fit on the back of a human-sized character). A unit that looks like an E-Clip attached to a cable is connected to the energy pack/battery to fit into a weapon, generator or other machine. E-packs can run everything from computers and light machines to generators and tractors. Payload: A typical E-Pack is roughly equal to *four standard E-Clips* when used in a weapon, and can run 4-6 light machines like a computer, monitor, radio, light, fan, etc., for 72 hours before requiring recharging. It can run a jet pack, vehicle or generator for about 24 hours. Cost: 35,000 for the E-Pack and 7000 credits to recharge it.

**G-Clips.** The G-Clip is the Russian style Long Energy-Clip with double the standard E-Clip capacity and is common for most weapons manufactured in *Russia, Ukraine, Yugoslavia, Mongolia* and parts of *China*. These Energy-Clips are a bit wider than the NGR and American CS types. The "G" stand for "gdye." An example of Russian pragmatism and humor in action, because Gdye means "where" in Russian. Most Russian energy weapons may take a standard type of E-Clip with an adaptor, as well as the G-Clip, but *where* the clip is loaded into the weapon can be dramatically different from weapon to weapon. Approximately 55% of all Russian energy rifles and handguns load on one side or the other, but some load from the top, others the bottom, others in the handle or in the back, or are connected to an E-pack or other power source. Cost: G-Clips sell for 4,500 credits for short clips (up to 20 shots), and 9,500 credits for long clips (50 shots). Excellent availability



in Russia, rare elsewhere. **Note:** Most people in the Americas and most other parts of the world have no idea such G-Clips or E-Packs exist. Consequently, there is NO adaptor that converts the Russian clips for use in the weapons of other countries, including the Americas, Western Europe, the UK, Africa, Australia, etc. Russia is quite isolated from the rest of the world.

**Heavy Cyber-Shield.** A large, heavy Mega-Damage shield designed for gritty battlefield conditions. The smallest is four feet (1.2 m) tall, the largest is six feet (1.8 m). They can be used by any character with a *P.S.* of 25 or higher and are designed to clamp on to the forearm of body armor or power armor, or a bionic limb. The shield is actually a machine in itself with sliding panels that move back and forth hydraulically to better distribute damage done to it. This is accomplished through sensor arrays lining the shield's edges (not visible save as circuitry). The Cyber-shield is used by heavy cyborgs in all the Warlord Camps, but is not overwhelmingly popular. Like any shield, it offers protection when charging and the ability to parry Mega-Damage melee weapons. A shield cannot be used to block bullets, rail gun bursts, energy blasts, or magic energy bolts, at least not easily. Any such attempt is done without any bonuses (straight die roll), with a penalty of -8 to parry! Blocking thrown rocks, knives, spears and other weapons is basically the same but is only -3 to parry on an unmodified die roll. A large shield has 90 M.D.C. and a small, human-sized shield has 40 M.D.C. It only takes damage when used to block energy blasts, missiles or explosions, or is specifically targeted by an opponent with the intention of destroying or chopping through the shield. **Cost:** Small: 20,000; Large: 26,000 credits. **Weight:** 70 pounds (31.5 kg).

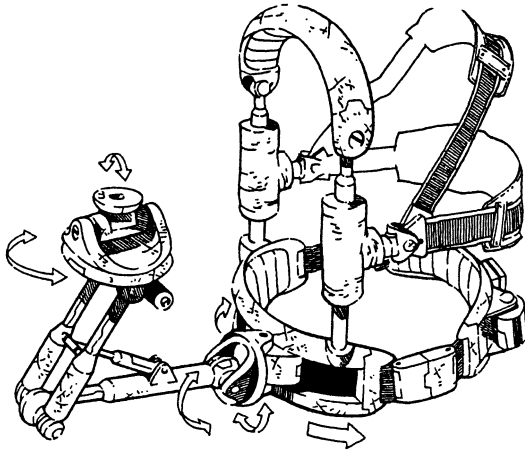

**Servo-Harness Rig.** Many heavy weapons are supported with a shoulder and/or back and chest harness, with the gun itself "slung" under the arm or over the shoulder when not in use. This harness is called a "Servo-Harness Rig," or simply a "Servo-Rig" or even just "The Rig." The Rig enables ground troops to carry and use weapons larger and heavier than they could normally handle. This includes rail guns, heavy energy weapons/cannons, and missile launchers. It is worn like a parachute harness over body armor. There are two popular styles of the Weapon Rig, but both are made of padded, M.D.C. metal bars and M.D.C. ceramic plated straps linked to a gyro-stabilizer and a light hydraulic system. The weapon connector unit is modular to accommodate most heavy weapons of Russian manufacture. It lets an individual use the weight of his entire body to maneuver and hold a weapon steady, giving him the capability of fielding big guns normally reserved for cyborgs. A weapon mated to the Servo-Harness rig must be worn under one arm or over the shoulder. What it all boils down to in game terms is that an individual with a *P.S.* as low as 9 can carry and use weapons equaling his body weight x2. **For Example:** Ivan weighs 160 pounds (72 kg) and has a *P.S.* Attribute of 11. Using a Servo-Harness Rig, he can now field a rifle weighing 320 pounds (144 kg). **Cost:** 8,000 credits (2,200 for the Warlords to make it).

**AR-36 "Clenched Fist" Light Rail Gun.** The Ammodyne series of rail guns are pre-Cataclysm relics of the Soviet Military Machine un-

earthed and reverse engineered. They are manufactured and sold by the Sovietski, Poland and the Black Market, as well as offered by numerous arms dealers in and around Russia. The AR-36 is one of the smaller weapons of the line, a light but rugged rail gun popular among Reavers. It is designed in the "bull-pup" configuration (ammo clip or belt feed inserts behind the grip), and uses a G-Clip or power feed directly from a cyborg to power it. The weapon is light and small enough to be used one in each hand by full conversion cyborgs, two-handed by most ordinary humans and partial 'Borgs (-3 to strike if used one-handed by them). **Weight:** Gun: 30 pounds (13.5 kg) plus one short ammo-clip (8 lbs/3.6 kg), or one ammo-belt (300 rounds; 12 lbs/5.4 kg), or a 1200 round ammo-drum (50 lbs/22.5 kg) hooked to a Servo-Harness Rig. The weapon has 40 M.D.C. **Mega-Damage:** A burst is 10 rounds and inflicts 3D6 M.D.C. per burst. **Rate of Fire:** Only fires bursts of 10 rounds. Each burst counts as one melee attack. **Range:** 3,000 feet (914 m). **Payload:** 100 round mini-clip (10 bursts), 300 round belt (30 bursts) or full 1200 round drum (120 bursts). **Cost:** 30,000 credits, plus most humans will need a Rig to handle it, unless they have a *P.S.* of 24 or greater. Without a Rig the character is -10% to climb and prowl, acrobatics, gymnastics and swimming are impossible, and speed is reduced by 40%. With the Rig the first penalties are negated, and speed is normal, but acrobatics, gymnastics and swimming are still impossible.

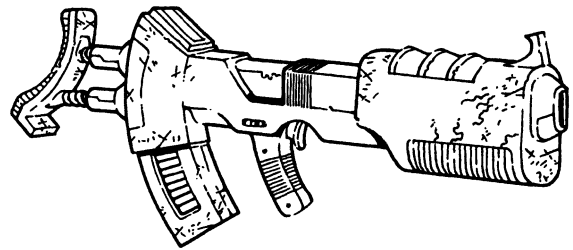

**AR-41 "Howler" Rail Gun.** The Howler is the intermediary, medium weight rail gun, designed in a "bull-pup" configuration. It has a large top-loading banana clip for an extra ammo reserve and a built-in shock absorption system. **Weight:** Gun: 100 pounds (45 kg); plus E-Pack, and dual ammo-clips (15 lbs/6.7 kg), or one ammo-belt (400 rounds; 20 lbs/9 kg), or a 2000 round ammo-drum (100 lbs/45 kg) hooked to a Servo-Harness Rig. The weapon has 80 M.D.C. **Mega-Damage:** A burst is 15 rounds and inflicts 4D6 M.D.C. **Rate of Fire:** Only fires 15 round bursts, and each counts as one melee attack. **Range:** 4,000 feet (1219 m). **Payload:** 120 round mini-clip (8 bursts), 300 round belt (20 bursts) or full 2000 round drum (133 bursts). **Cost:** 60,000 credits, plus humans will need a Rig to handle it.

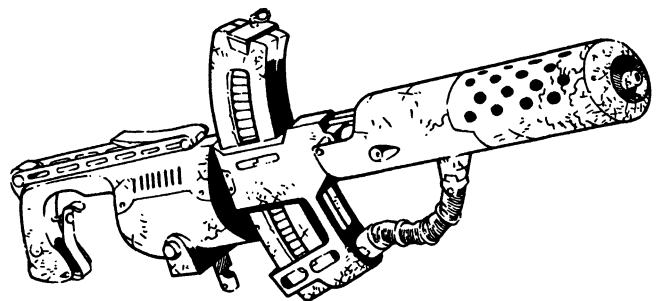

**AR-44 "Sledgehammer" Rail Gun.** The AR-44 is unique for its very high rate of fire. It uses an experimental chambering system that forces shells into the weapon chamber at a higher pressure, coupled with a timing system set about as high as its designers could make it. It is also a heavy weapon, designed as an anti-vehicle, anti-'Borg and anti-monster weapon. **Weight:** Gun: 150 pounds (67.5 kg); plus E-Pack, and ammo-clip (200 rounds; 20 lbs/9 kg), ammo-belt (500 rounds; 35 lbs/15.7 kg), or a 3000 round ammo-drum (140 lbs/63 kg) hooked to a Servo-Harness Rig. The weapon has 100 M.D.C. **Mega-Damage:** A burst is 20 rounds and inflicts 1D4x10 M.D.C. **Rate of Fire:** Only fires 20 round bursts, and each counts as one melee attack. **Range:** 4,000 feet (1,219 m). **Payload:** 200 round clip (10 bursts), 500 round belt (25

bursts), or full 3000 round drum (150 bursts). Cost: 80,000 credits, plus humans will need a Rig to handle it.

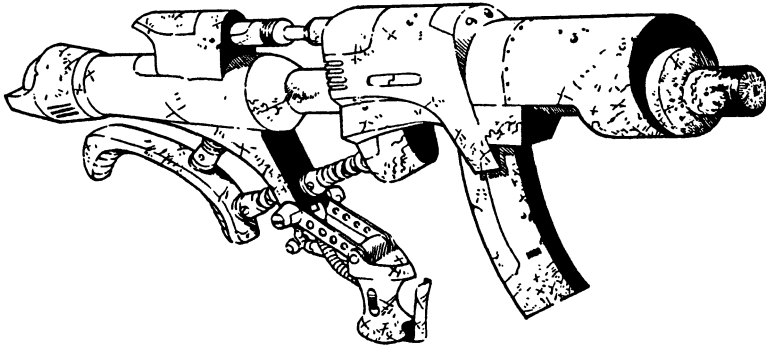

**AR-60 "Nikita" Super-Rail Gun.** This very large rail gun has a padded shoulder rest worn over the shoulder (something like the Glitter Boy Boom Gun). It can be used by Heavy Machines and Cyborg Shock Troopers, but most humans and Light Machines can't handle it, even with a Rig, due to the weight and bulk. Weight: Gun: 250 pounds (112 kg); plus E-Pack, and one ammo-clip (100 rounds; 20 lbs/6.1 kg), ammo-belt (500 rounds; 45 lbs/20 kg), or a 3000 round ammo-drum (180 lbs/81 kg); may be hooked to a Servo-Harness Rig or not. The weapon has 120 M.D.C. Mega-Damage: A burst is 20 rounds and inflicts 1D6x10 M.D.C. per burst. Rate of Fire: Only fires 20 round bursts, and each counts as one melee attack. Range: 5,000 feet (1,524 m). Payload: 100 round clip (5 bursts), 500 round belt (25 bursts) or full 3000 round drum (150 bursts). Cost: 110,000 credits, plus humans will need a Rig to handle it.

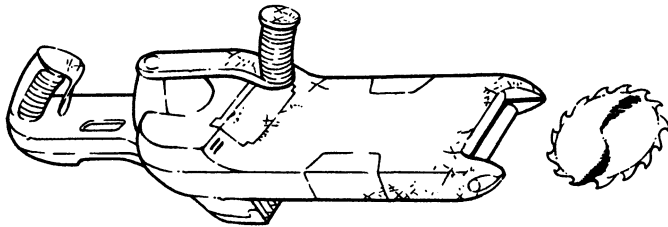

**AR-110 Razor Disk Cannon.** The AR-110 is an interesting weapon development, employing a Lateral-Magnetic (L-Mag) rail system. The whole thing is just wider and flatter than a normal rail gun. It fires M.D.C. discs, about twice the size of a 20th century compact disc, at Mach speed velocity. However the distance is dramatically less than most true rail guns. A Servo-Rig is required by humans and it is sometimes used by cyborgs. Weight: Gun: 150 pounds (67.5 kg); plus E-Pack, and one ammo-belt (200 rounds; 35 lbs/15.7 kg), or a 2000 round ammo-drum (180 lbs/81 kg); may be hooked to a Servo-Harness Rig or not. The weapon has 80 M.D.C. Mega-Damage: A single blade does 1D6 M.D. and a burst fires 10 discs to inflict 1D6x10 M.D.C., but counts as two melee attacks. Rate of Fire: One at a time or a 10 round burst; bursts count as two melee attacks. Range: 2,000 feet (610 m). Payload: 200 round belt (20 bursts) or full 2000 round drum (200 bursts). Cost: 80,000 credits, plus humans will need a Rig, at 8,000 credits, to handle it.

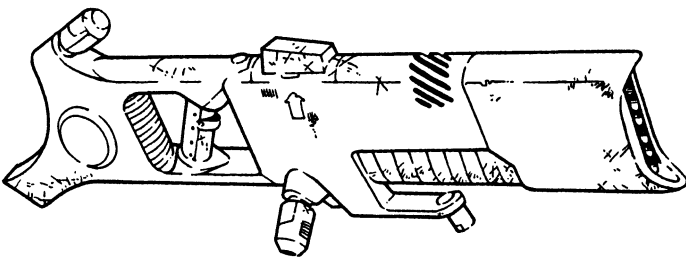

**AR-210 Grapeshot Cannon.** This weapon fires a nasty payload of M.D.C. rockets which explode on impact or at 3500 feet (1067 m), whichever comes first. The explosion releases a volley of tiny metal balls that inflicts damage, shotgun style, to a larger area. Weight: Gun:

200 pounds (90 kg); plus E-Pack, and ammo-belt (100 rounds; 35 lbs/15.7 kg), or a 1000 round ammo-drum (180 lbs/81 kg); may be hooked to a Servo-Harness Rig or not. The weapon has 100 M.D.C. Mega-Damage: A single round does 1D6 M.D. and a burst fires 10 rounds to inflict 1D6x10 M.D.C. to a target under 3,500 feet (1,066.8 m). The shotgun effect occurs at 3,500 feet (1067 m) and the grapeshot hurls another 500 feet (152 m) for a total range of 4,000 feet (1219 m). It does 3D6 M.D. (1 point of M.D.C. for a single shot) to everybody or everything in a 12 foot (3.6 m) wide area of fire (if one large, tank- or building-sized target, the grapeshot peppers it for 1D6x10 M.D./1D6 from a single shot). Note: The shotgun effect can also be set to occur at 1,000 feet (305 m) and hurl the tiny balls another 500 feet (152 m) for a total range of 1500 feet (457 m), for use against infantry troops. Rate of Fire: One at a time or 10 round bursts; bursts count as two melee attacks. Range: 4,000 feet (1219 m). Payload: 100 round belt (10 bursts) or full 1000 round drum (100 bursts). Cost: 100,000 credits, plus humans will need a Rig, at 8,000 credits, to handle it.

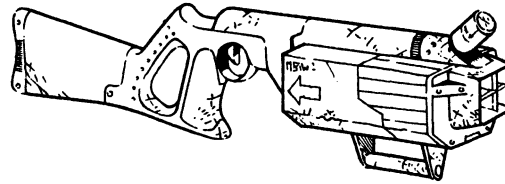

**AR-M36 Rifle Mini-Missile Launcher.** A rifle style mini-missile launcher that can be used by humans and partial cyborgs using a Servo-Rig, or by full conversion cyborgs or heavy power armor one-handed. Point and shoot — tends to be front-heavy. Weight: Gun 50 pounds (22.6 kg) plus 20 pounds (9 kg) fully loaded with eight mini-missiles. The weapon has 40 M.D.C. Mega-Damage: Varies by missile type (typically 1D4x10 M.D.). Range: One mile (1.6 km). Rate of Fire: One, or in volleys of 2, 3 or 4. Payload: Eight mini-missiles; hand loaded. An extra pack of eight mini-missiles can be carried in a 20 M.D.C. case; weighs 30 lbs (13.6 kg). Takes two melee rounds (30 seconds) to reload. Cost: 19,000 credits for the launch-rifle, 2,000 credits each for light missiles, and 3,500 for heavy ones.

**AR-M40 Dual Launcher.** The Dual launcher is comparatively, a small, light launcher that hooks to a Servo-Rig, although full conversion cyborgs can use it as a hand-held gun. A handle and trigger is located underneath the launcher, with a second handle for control in the back — it is a two-handed weapon for humans, even with a Rig. The top section launches four mini-missiles, while the lower, front launchers fire wooden stakes. Obviously, this weapon was designed for slaying vampires and similar creatures harmed by shafts of wood. Weight: Launcher: 50 pounds (22.6 kg) plus 20 pounds (9 kg) fully loaded. The weapon has 40 M.D.C. Mega-Damage: Varies by missile type (typically 1D4x10 M.D.). Wooden Stakes do 2D6 S.D.C. per single shaft (fired with great velocity) or 4D6 S.D.C. per twin shafts, or in a burst of four doing 6D6 S.D.C./H.P. damage. Range: Mini-Missiles: One mile (1.6 km). Wooden Stakes: 1000 feet (305 m). Rate of Fire: Mini-Missiles: 1 or 2. Wooden Stakes: 1-4. Payload: Four mini-missiles; hand loaded, and 40 stakes. Cost: 15,000 credits for the launcher, 2,000 credits each for light missiles, and 3,500 for heavy ones. Wooden stakes cost around 5 credits each.

**AR-M45 Cyborg Missile Launcher.** A mini-missile launcher that can be used as a shoulder mounted weapon on full conversion cyborgs or as a Servo-Rig mounted weapon. In the latter case, there is a handle and trigger in the back of the launcher. It is a favorite among Heavy Machines. Weight: Launcher: 80 pounds (36 kg) plus 30 lbs (13.6 kg) fully loaded. The weapon has 50 M.D.C. Mega-Damage: Varies by missile type (typically 1D4x10 M.D.). Range: One mile (1.6 km). Rate of Fire: 1, or in volleys of 2, 3 or 4. Payload: 12 mini-missiles; hand-loaded. An extra pack of eight mini-missiles can be carried in a 20 M.D.C. case; weighs 30 lbs (13.6 kg). Takes three melee rounds (45 seconds) to reload. Cost: 25,000 credits for the launcher, 2,000 credits each for light missiles, and 3,500 for heavy ones.

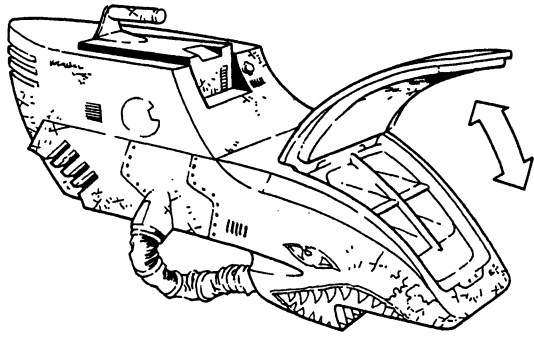

**AR-M50 Heavy Missile Launcher.** A massive mini-missile launcher that can be used as a shoulder mounted weapon on full conversion cyborgs, or as a Servo-Rig mounted weapon. In the latter case, there is a handle and trigger in the back of the launcher as well as a handle in the top. Its shape, size and weight make it difficult to handle by humans, even with a Servo-Rig. Fortunately, one does not need to point the missiles with tremendous accuracy. It is a favorite among Heavy Machines as a hip blasting Servo-Rig unit. Weight: Launcher: 140 pounds (63 kg) plus 44 pounds (20 kg) fully loaded. The weapon has 90 M.D.C. Mega-Damage: Varies by missile type (typically 1D4x10 M.D.). Range: One mile (1.6 km). Rate of Fire: One, or in volleys of 2, 3 or 4. Payload: 18 mini-missiles; hand-loaded. An extra pack of eight mini-missiles can be carried in a 20 M.D.C. case; weighs 30 lbs (13.6 kg). Takes four melee rounds (one minute) to reload. Cost: 45,000 credits for the launcher, 2,000 credits each for light missiles, and 3,500 for heavy ones.

**Belofsky Double-Dealer Laser Cannon.** A massive, four-barreled, heavy energy weapon that can be used as a two-handed weapon by Light Machines and humans with a P.S. of 22, or one-handed by full conversion cyborgs. The top barrel is a heavy laser, the one below it, a short-range ion blaster (the one on the side is a scope). Weight: Gun: 60 pounds (27 kg). Backpack Weight: 55 pounds (24.75 kg; holds two E-Packs). The weapon has 90 M.D.C. Mega-Damage: Laser: 3D6 M.D.; Ion Blaster 5D6 M.D. Rate of Fire: Each blast counts as one melee attack. Both can not be fired simultaneously, so the shooter must pick one or the other. Range: Laser: 3000 feet (914 m). Ion: 2,000 feet (610 m). Payload: Varies with power source; about 10 shots from a standard E-Clip and 100 from an E-Pack, but uses a dual pack system. Cost: 65,000 credits.

**G-410C Goldbeam Laser Cannon.** A bulky and ominous looking shoulder-mounted weapon used by full conversion cyborgs, but can be used by partial or super-strong characters in conjunction with a Servo-Rig, as well as mounted on vehicles by cavalry troops as a heavy support weapon, and heavy assault piece. Support cavalry troops carry the G-410C, as well as heavy infantry and certain S & D squad members. It has four separate lasers that can be fired individually, one at a time, two at a time or all at once. The advantage of this cannon over the Belofsky is its lighter weight and versatility. Weight: 135 pounds (61 kg); Backpack Weight: 55 pounds (24.75 kg; holds two E-Packs). The weapon has 70 M.D.C. Mega-Damage: 3D6 M.D. per single blast, 6D6 per double blast or a rapid-fire burst from all four lasers, doing 1D6x10+10 M.D. (counts as one melee attack). Rate of Fire: Each blast counts as one melee attack. Range: 2,800 feet (853 m). Payload: 20 single shots, 10 dual shots or 5 quadruple shots from a standard E-Clip, or 50 from an E-Pack, but typically uses a dual E-Pack system. Cost: 124,000 credits.

**Belofsky Heavy Laser Cannon.** A massive, four-barreled, heavy laser with increased range and payload. It is worn with a Servo-Rig. All barrels fire simultaneously. Weight: Gun: 200 pounds (90 kg). Backpack Weight: 55 pounds (24.75 kg). The weapon has 110 M.D.C. Mega-Damage: 1D6x10+10 M.D.; all barrels fire simultaneously. Rate of Fire: Each blast counts as one melee attack. Range: 3,000 feet (914 m). Payload: Three shots from a standard E-Clip, or 50 from an E-Pack, but typically uses a dual E-Pack system. Cost: 90,000 credits.

**Belofsky Plasma Cannon.** Another massive, heavy energy weapon that requires the use of a Servo-Rig when used by humans. Full conversion cyborgs can use it as a two-handed weapon. Weight: Gun: 170 pounds (76.5 kg). Backpack Weight: 55 pounds (24.75 kg). The weapon has 100 M.D.C. Mega-Damage: 1D4x10+10 M.D. Rate of Fire: Each blast counts as one melee attack. Range: 1,800 feet (548.6 m). Payload: Varies with power source; four shots from a standard E-Clip and 70 from an E-Pack, but typically uses a dual E-Pack system. Cost: 145,000 credits.

**Big Bear Plasma Rifle.** A heavy assault weapon that has been outlawed by the Warlords — only members of the War Camps may legally possess this weapon. That has not slowed down brisk trade through the Black Market and other criminal arms dealers and mercenaries. Weight: 14 lbs (6.3 kg); has 50 M.D.C. Mega-Damage: 5D6 M.D. per single shot. Rate of Fire: Each blast counts as one melee attack. Range: 1,600 feet (488 m). Payload: 10 shots from a standard E-Clip. Cost: 29,000 credits.

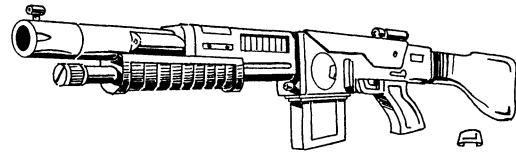

**"Homesteader" Ion Beam Rifle.** A heavy ion rifle for inflicting excellent damage. Soldiers love it. Weight: 9 lbs (4 kg); has 40 M.D.C. Mega-Damage: 4D6 M.D. Rate of Fire: Each blast counts as one melee attack. Range: 1,700 feet (518 m). Payload: 12 shots from a standard E-Clip. Cost: 21,000 credits.

**Lynx Laser Rifle.** A dual-barrel Laser rifle that has proven to be sturdy and reliable. It is popular among Huntsmen, thieves, assassins and adventurers as a backup or assault weapon. Its really interesting feature is that it can take both Western E-Clips or Russian G-Clips. Weight: 6 lbs (2.7 kg). Mega-Damage: 2D6 from a single blast or 4D6 M.D. from a dual, simultaneous blast (counts as one melee attack). Rate of Fire: Each blast counts as one melee attack. Range: 1,800 feet (548.6 m). Payload: 20 shots from a standard E-Clip. Cost: 19,000 credits.

**G-295R "Steamer" Pulse Laser Rifle.** The "Steamer" is a long-range, heavy laser rifle that can be used as a single-shot sniper rifle. Comes standard with laser targeting and telescopic sight. It is popular among War-Knights, Heavy Machines and adventurers, particularly the Huntsman-Trapper. Weight: 15 pounds (6.8 kg); has 45 M.D.C. Mega-Damage: 4D6 M.D. per single shot. Rate of Fire: Each blast counts as one melee attack. Range: 2,200 feet (670 m). Payload: 14 shots from a standard E-Clip. Cost: 32,000 credits.

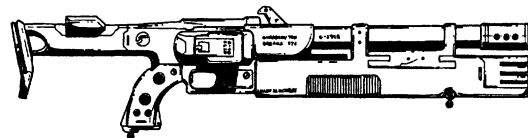

**G-294R "Toughman" Laser Rifle.** A superior quality, standard laser rifle that is effective, rugged and reliable in the field. It functions at up to 150 degrees Fahrenheit (-101 C) below freezing (most others jam up at 100 degrees below/-73 C). This weapon has been in use for over 60 years. Weight: 13 pounds (6 kg); has 50 M.D.C. Mega-Damage: 3D6 M.D. per single shot. Rate of Fire: Each blast counts as one melee attack. Range: 1,600 feet (488 m). Payload: 20 shots from a standard E-Clip. Cost: 32,000 credits.

**G-293M "Fat Boy" Laser.** A short-barrel laser similar to a sawed-off shotgun or submachine-gun, with an over and under, pump, grenade launcher. The weapon fires a laser from the top barrel and explosive cartridges/bullets/rounds from the lower barrel (a knock-off of the Triax Pump pistol). These explosive rounds have good range, and contain a powerful explosive charge. Weight: 6 pounds (2.7 kg); has 30 M.D.C. Mega-Damage: 3D6 M.D. per single shot. Rate of Fire: Each blast counts as one melee attack. Range: Laser: 1,000 feet (305

m). Grenades: 800 feet (244 m). Payload: Laser: 20 shots from a standard E-Clip. Grenades: Six rounds, and can be hand loaded in one melee round (15 seconds). Cost: 32,000 credits.

**S-500 "Cyclone" Pulse Laser Rifle.** A large, rapid-fire laser based on pre-Rifts Soviet technology. It is a large weapon designed specifically for use by Light and Heavy Machines. Ordinary humans need a Servo-Rig to use it, or must possess a P.S. of 25 or greater. The weapon fires four nearly simultaneous pulses and draws upon an E-Pack contained in the circular housing in the center undercarriage of the weapon. It is a favorite among the cyborg soldiers of the Sovietski. Weight: 45 lbs (20 kg). The weapon has 90 M.D.C. Mega-Damage: 1D6x10 M.D. per pulse blast. A switch can make the weapon fire one precision shot doing 2D6 M.D. Rate of Fire: Each blast counts as one melee attack. Range: 3,000 feet (914 m). Payload: Four shots from a standard E-Clip (inserted in the side), or 60 from an E-Pack which is standard issue. Black Market Cost: 100,000 credits and up. Extremely rare even in Russia, because its designs are exclusive to the Sovietski and no knock-offs have come onto the market (namely because only Triax and the CS have the technology to do so).

**S-1000 "Thunderhead" Assault Rifle.** A dual system weapon that combines a heavy laser with a rapid-fire grenade launcher. This weapon is also based on pre-Rifts Soviet technology. It is a very large weapon designed specifically for use by cyborgs. Ordinary humans need a Servo-Rig to use it, or must possess supernatural P.S. The weapon draws upon an E-Pack contained in the lower housing. The upper housing contains the payload of self-loading grenades. It is a favorite among the cyborg soldiers of the Sovietski. Weight: 90 lbs (40.5 kg) fully loaded (62 lbs/28 kg without the grenades and firing canister). The weapon has 100 M.D.C. Mega-Damage: Heavy Laser: 4D6 M.D. Grenades: 5D6 M.D. per single grenade, but can be fired in bursts of 2-4 grenades at the same target (counts as two melee attacks). Blast radius is four feet (1.2 m) regardless of the number of grenades fired. A switch on the weapon changes the firing from laser to grenade. Both cannot be fired simultaneously. Rate of Fire: Laser: Each blast counts as one melee attack. A single grenade or burst of 2-4 grenades counts as one melee action. Range: Laser: 2,000 feet (610 m). Grenade Launcher: 1200 feet (366 m). Payload: Laser: 100 shots per E-Pack or 14 per standard E-Clip. Grenade Launcher: 32; takes four minutes to reload grenades by hand, one at a time, or one melee round (15 seconds) to slap in a pre-loaded canister (weighs 28 lbs/12.6 kg). Black Market Cost: 140,000 credits and up. Extremely rare, because its design is exclusive to the Sovietski and no knock-offs have come onto the market (only Triax and the CS have the technology to do so).

**G-21P Laser Pistol.** A universally popular, heavy laser sidearm found throughout Russia. Weight: 4 pounds (1.8 kg); has 30 M.D.C. Mega-Damage: 2D6 M.D. per single shot. Rate of Fire: Each blast counts as one melee attack. Range: Laser: 900 feet (274 m). Payload: 20 shots from a standard E-Clip. Cost: 12,000 credits.

**G-27P Ion Pistol.** A universally popular sidearm found throughout Russia. It does more damage than the laser but has inferior range, as usual, but is another one of those super-reliable weapons that works underwater and in freezing temperatures. Weight: 4 pounds (1.8 kg); has 30 M.D.C. Mega-Damage: 4D6 M.D. per single shot. Rate of Fire: Each blast counts as one melee attack. Range: 500 feet (152 m). Payload: 20 shots from a standard E-Clip. Cost: 12,000 credits.

**S-20-20 "Popper" Assault Pistol.** A dual system weapon that combines a double-barreled laser on the bottom and a rapid-fire grenade launcher on the top. This weapon is also based on pre-Rifts Soviet technology and is intended for use by cyborgs. Ordinary humans need a P.S. of 21 or higher to use it one-handed without penalty. Those with a P.S. of 16-20 are -3 to strike, while those who are weaker are -6 to strike (if they can aim it at all) unless they use two hands (even then, still -1 to strike). Weight: 11 lbs (5 kg) fully loaded (10 lbs/4.5 kg without the grenades). The weapon has 50 M.D.C. Mega-Damage: Laser: 2D6 M.D. from a single beam or 4D6 M.D. from a simultaneous double beam blast (counts as one melee attack). Grenades: 5D6 M.D. per

single grenade. Cannot fire in bursts. Blast radius is four feet (1.2 m). A switch on the weapon changes the firing from laser to grenade. Both cannot be fired simultaneously. Rate of Fire: Laser: Each single or double blast counts as one melee attack. A single grenade counts as one melee action. Range: Laser: 800 feet (244 m). Grenade Launcher: 600 feet (183 m). Payload: Laser: 20 shots per each E-Clip. The weapon draws upon a side mounted G- or E-Clip and can take an additional E-Clip in the handle for a greater payload (40 total). Grenade Launcher: Six hand-loaded grenades. The cap on the rear housing flips open to load. It takes one melee round (15 seconds) to reload. Cost: 50,000 credits and up. Extremely rare, because its design is exclusive to the Sovietski and no knock-offs have come onto the market.

**War-Knight Combat Shield.** A relatively small to medium-sized shield made of reasonably light Mega-Damage materials. It is most commonly used by War-Knights, Bogatyr, and Cavalry troops for additional protection when charging and to parry Mega-Damage melee weapons like Vibro-Blades, Neuro-Maces, and magic weapons. A shield cannot be used to block bullets, rail gun bursts, energy blasts, or magic energy bolts, at least not easily. Any such attempt is done without any bonuses (straight die roll), with a penalty of -8 to parry! Blocking thrown rocks, knives, spears and other weapons is basically the same but is only -3 to parry on an unmodified die roll. The shield has 30 M.D.C. and only really takes damage when used to block energy blasts or explosions, or is specifically targeted by an opponent with the intention of destroying or chopping through the shield. Cost: 12,000 credits. Weight: 15 pounds (6.8 kg).

**Russian Vibro-Blades:** All Vibro-Blades are blade weapons surrounded by an invisible high-frequency energy field that gives them Mega-Damage capabilities. They were originally developed by the Coalition States and "knocked-off" (imitated) by Triax and, ultimately, other weapon manufacturers. See the *Coalition States* or *Japan* for different types and stats.

## Silver River Republics

### Rifts® World Book Nine: South America Two

**Note:** All weapons are limited to the local region and rarely found outside South America.

**Amaki Blast-Sword (New Babylon).** The Amaki blast-sword looks like a blunt fencing weapon. Its handle is at an angle with the "blade," a bit like a pistol grip but not too different from some types of fencing foils. This weapon can fire plasma discharges, and it can also run a continuous plasma stream, held in place by a magnetic field along the blade. The plasma blade is a devastating M.D. weapon, and yet is so light it can be wielded quickly and easily by a fencing enthusiast. This weapon is a favorite among the people of New Babylon, who admire and practice swordsmanship. Most models are richly decorated, with golden and gold-plated hand guards, pommels, and scabbards, some are even studded with jewels. Weight: 4 lbs (1.8 kg). Mega-Damage: Plasma Discharge: 3D6 M.D. Plasma Blade: 2D6+6 M.D. Rate of Fire: Equal to the number of hand to hand attacks per melee. Range: Plasma Discharge: 500 feet (152 m). Plasma Blade: Hand to hand combat. Payload: 20 shots; if every shot is fired, the plasma blade becomes inert until a new E-Clip is inserted. Each "shot" can keep the plasma blade active for 10 minutes. Cost: 25,000 credits; higher for the better decorated models. Most well-to-do Babylonians spend a small fortune on these blades.

**Amaki Blast Rifle (New Babylon).** This is the standard issue rifle of the New Babylon Army. A few thousand rifles have also been sold to the Empire of the Sun and the Achilles Republic. The weapon fires a "packet" of charged particles, exploding on impact. The gun is richly decorated, and the barrel is often shaped like a fish, a snake or dragon, with an opened mouth for the muzzle of the gun. Weight: 10 lbs (4.5 kg). Mega-Damage: 6D6 M.D. per blast. Rate of Fire: Single shot only. Range: 2000 feet (610 m). Payload: 15 shots. Cost: 20,000 credits.

**Amaki TW Psi-Blade (New Babylon).** A product of Amaki Techno-Wizardry, the Psi-Blade enhances the psychic energies that create the feared Psi-Sword. The weapon can only be used by Master Psychics who have that power, but its effects are devastating. The few Cyber-Knights who have gotten their hands on the Psi-Blade have become fearsome fighters. Most of these weapons are used by the Amaki Duelists. These feared sword fighters and assassins can also extend Psi-Swords, and are extensively trained with the TW Psi-Blade. In most places of South America, ownership of one of these weapons is enough to brand the user a New Babylonian and/or a Duelist — either of which is enough to get the character in a lot of trouble. Weight: 3 lbs (1.35 kg). Mega-Damage: Varies; the Psi-Blade adds 2D6 M.D. to the damage caused by the normal Psi-Sword! For example, a 5th level Mind Melter (normal Psi-Sword damage 6D6 M.D.) would inflict 8D6 M.D. while using a TW Psi-Blade. Rate of Fire: Not applicable. Range: Hand to hand combat. Payload: I.S.P. cost is the same for the super-psionic power; Cyber-Knights and Duelists must spend 2 I.S.P. per minute to activate the weapon. Cost: 30,000+ credits. Rare even in South America.

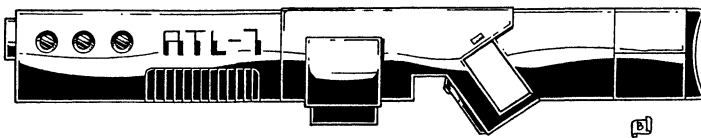

**ATL-7 Anti-Tank Laser Rifle (New Babylon).** This is a one-shot weapon that releases all the energies contained in a normal E-Clip in one single shot! The shortcomings of this powerful weapon are that it must be reloaded by hand (takes two melee actions to reload after firing), and that it's so heavy (the barrel is thick with insulation to protect against the heat) that it takes two normal humans to carry it (cyborgs and power armor troopers can use it as a rifle without trouble). Also, they use up E-Clips so fast that only large organizations or wealthy characters can afford to equip themselves with it. Mega-Damage: 3D6x10+20 M.D. per shot! Rate of Fire: Single shot only. Each shot empties an entire E-Clip! Range: 3,000 feet (914 m) Payload: 1 shot per E-Clip. Cost: 100,000 credits; poor availability even in South America.

**Equalizer Combat Shotgun (Achilles Republic).** A smooth-bore, semi-automatic shotgun that fires 16mm explosive cartridges. The gun can also fire regular 12-gauge shotgun shells, flares, and smoke or tear gas grenades, making it a very useful multi-purpose weapon. The weapon is incredibly rugged and durable, designed to function even after being submerged in a swamp or in mud for 24 hours; it is highly resistant to water damage and other environmental hazards. The Equalizer is manufactured in the Achilles Republic, and is one of the few weapons that is exported abroad; the Amaki traders from New Babylon have started selling the weapon across several dimensions. Cordoban weapon makers have manufactured a cheap knock-off (reduce damage of the 16 mm explosive cartridges to 4D6 M.D. and range to 500 feet/152 m) for the use of the National Guard and private individuals. Damage: Varies with cartridge type. The most common include: Standard 12-gauge buckshot: 4D6 S.D.C. Cost: 1 credit per round. Standard 12-gauge slugs: 5D6 S.D.C. Cost: 2 credits per round. 16mm Armor-Piercing Explosive (APE): 5D6 M.D. (no blast radius). Cost: 100 credits per round. 16mm Fragmentary Grenade (FG): 2D4 M.D. to a 10 foot/3.0 m blast radius. Cost: 500 credits per round. 16mm Smoke: Blocks vision in a 20 foot/6.1 m radius. Cost: 100 credits per round. 16mm Tear Gas: Save vs non-lethal poison or blinded (-6 to strike, parry or dodge in either case). 20 foot/6.1 m radius. Cost: 200 credits per round. Rate of Fire: Each shot counts as one melee attack. Cannot fire bursts. Range: 1,000 feet (305 m) for 16mm rounds, 300 feet (91.4 m) for regular shotgun rounds. Payload: Box magazine: 10 rounds. Drum magazine: 20 rounds. Can use either type. Cost: 12,000 credits. Ammunition costs are listed above. Rare outside South America.

**IP-7 Ion Pistol (Cordoba/Santiago).** Italo Industries, a large weapons manufacturer, sells its wares to anybody with the cash. IP-7s are carried by officers, security officers, and is also issued as a back-up gun to line soldiers. Mega-Damage: 2D6 M.D. Rate of Fire: Standard. Range: 600 feet (183 m). Payload: 12 shots. Cost: 15,000 credits. Rare outside South America.

**I-9 Heavy Ion Rifle (Cordoba/Santiago).** Another product of Italo Industries. Mega-Damage: 4D6 M.D. Rate of Fire: Standard. Range: 2000 feet (610 m). Payload: 20 shots. Cost: 20,000 credits. Rare outside South America.

**I-11 Long Gun (Cordoba/Santiago).** This weapon is meant to be used as a sniper rifle or heavy hunting rifle. Its main drawbacks are its length (almost six feet/1.8 m long) and weight, which makes it difficult to carry. The plains cyborgs, who rely on their cybernetic horses, have no such problem with it and love these long rifles. Mega-Damage: 1D6x10 M.D. per blast! Rate of Fire: Single shots only (each counts as one melee attack). Range: 4000 feet (1219 m). Payload: 10 shots. Bonuses: The enhanced sights of these rifles give a +1 to strike on aimed shots. Cost: 50,000 credits. Rare outside South America.

**Lightbringer Laser Rifle (Achilles Republic).** This is a compact, bull-pup configuration laser rifle with a long carrying handle, somewhat similar to the M-16's, but running the length of the short rifle (to allow mutants with larger than human hands to carry them with comfort). Some 50% of the Achilles soldiers use this weapon (the other half use Equalizer shotguns or personalized energy weapons). Mega-Damage: 4D4 M.D. per single blast or 1D4x10+10 MD. per multiple pulse burst (3 simultaneous shots). Rate of Fire: Standard. Range: 2000 feet (610 m). Payload: 30 shots. Cost: 15,000 credits. Rare outside South America.

**NP-10 Plasma Net Launcher (Cordoba).** This weapon was developed as a way to deal with supernatural beings, monsters and other dangerous enemies. The weapon looks like a single-shot grenade launcher with a 50mm bore. The missile it fires opens up in midair, becoming a net made up of Mega-Damage metal strands. The metal is a special alloy that can burn explosively if exposed to the right temperatures. Small plasma charges are placed all throughout the net. As soon as a person or object is entangled, the plasma charges ignite and the net starts burning at ultra-hot temperatures, consuming itself (and the target) within a minute. Mega-Damage: Special: The net entangles the victim (it takes four melee actions/attacks to untangle oneself, half that for beings with supernatural P.S. 40 or greater), and then bursts into flames, inflicting 2D6 M.D. for 1D4 melee rounds, at which time the net is completely consumed. Meanwhile, the victim cannot strike or parry, is at -2 to dodge, and moves at a speed of 4! Rate of Fire: Each shot counts as one melee attack/action. Range: 500 feet (152 m). Payload: One shot only; a bandoleer holds 20 net-grenades. Cost: 20,000 credits. Each net-grenade costs 500 credits. Rare outside South America.

## Weapons of the Splynn Dimensional Market

### Rifts® World Books 2 & 21: Atlantis One & Two

Far and away, the Kittani have a lock on weapons production and distribution on Atlantis, but various vendors in the Splynn Dimensional Market have made inroads peddling their own peculiar methods of destruction. Below is just a sampling of the alien wares to be found in the Marketplace.

### Alien Weapons

**Kizh Merchandise:** The Kizh are a warlike race of semi-aquatic humanoids who are known for their particularly practical and visually frightening weapons. Only a very limited selection of their numerous offerings is presented here, but the Game Master is welcome to use his

imagination in presenting others. The Kizh are also known as raiders and imitators, and often make knock-offs and use any technological secrets they may have “acquired” to make money for themselves. The Techno-Wizard Sensor Gauntlet is one example of the many alien items they have copied and now sell for their own profit.

**Kizh Plasma Pistol.** The versatile Kizh plasma pistol is a bulky, but well balanced weapon that is rounded on its top, but sports a jagged front end just under its four barrels. The spike and bladed business end of the energy weapon is designed to let the shooter also use the gun as a punching or slashing melee weapon. The spines and blades are even covered by a sonic field, making them an M.D. Vibro-Blade. Weight: 6 lbs (2.7 kg). Mega-Damage: 3D6+4 per quad-blast for the plasma pistol and 1D6 M.D. for the Vibro-Blade. Rate of Fire: Equal to the number of attacks of the wielder for both weapon systems. Range: Plasma blast: 450 feet (137 m). Payload: 15 blasts per E-Clip. Cost: 24,000 credits.

**Kizh Ion Rifle.** The ion rifle is very similar in its basic design to the plasma pistol, and it too is a bulky, but well balanced weapon. It is rounded on its top, but the jagged front end of the rifle is large and curved, about the size of an axe. As with the pistol, the spike and bladed axe is a Vibro-Blade, but it is designed as a slashing and chopping melee weapon. Weight: 13 lbs (6 kg). Mega-Damage: 4D6 per blast for the ion beam and 2D6+2 M.D. for the Vibro-Axe. Rate of Fire: Standard for the ion beam and equal to the number of attacks of the wielder for the axe. Range: 1,800 feet (548.6 m). Payload: 25 blasts per E-Clip. Cost: 44,000 credits.

**Kizh TW Sensor Gauntlet.** Captured in one of their raids, the design for the TW Sensor Gauntlet is now put to use as a marketable commodity. The Kizh (with the help of some enslaved Techno-Wizards from the race that created the gauntlet) market the item as a “mystical tracking system,” but it is actually a practical item for general sensory use, though it is far from inconspicuous. Despite its appearance, it is not designed as a weapon and can only do 2D6 S.D.C. when used as such. The long spines are sensor probes and retract against the gauntlet when not in use. P.P.E. Cost to Activate: 30. Duration Once Active: One hour. Effects: Duplicates the sensor features of a bionic sensor hand (heat, motion, radiation, radar detector), and bionic molecular analyzer, plus the abilities bestowed by the following spells at 8th level proficiency (where applicable): Sense Evil, Sense Magic, Eyes of the Wolf, and Locate. Cost: 64,000 credits

**Octurill Weaponry:** The Octurill are an other-dimensional race of intelligent Octopoids. They have an advanced culture and some highly advanced Mega-Damage weaponry. The weapons and an occasional piece of equipment regularly show up in the Splynn Dimensional Market, and are a perfect example of the diversity of The Market. They are high quality and top of the scale, but the designs are intended to be used by a person with tentacles, not someone with bony skeletal structures in their appendages. Thus, they are awkward for humans, but their good features tend to eclipse their problems for humanoids. Humans and others can certainly use the fine weapons, but they will have penalties due to the strange grips and awkward balance. Any creature without a prehensile tentacle or tail that uses an Octurill weapon will suffer a -3 penalty to their strike and parry rolls. The weapons can be converted to accommodate a fingered extremity, but doing such will triple the price and take at least a month via special order.

**Octurill Vibro-Axe.** Weight: 5 lbs (2.3 kg). Mega-Damage: 3D6+4. Cost: 32,000 credits.

**Octurill Charged Particle Ejector.** Weight: 14 lbs (6.4 kg). Mega-Damage: 1D4x10 per blast. Rate of Fire: Single blasts only. Effective Range: 3,000 feet (914 m). Payload: 20 blasts per E-Clip. Cost: 26,000 credits.

## Miscellaneous Splynn Merchandise

**Mega-Blades (TW).** Mega-Blades are quite common in The Splynn Dimensional Market. The devices are Techno-Wizard items built so simply, yet so involved, that the spell in them lasts for years (decades or even centuries if one can pay for it). The sole purpose of the

Mega-Blade attachment is to change the damage of a normal S.D.C. melee weapon to Mega-Damage. All normal rules for using M.D. melee weapons apply, and any ancient style of weapon, other than bow or sling, can be so modified. So an S.D.C. sword that normally inflicts 2D6+2 S.D.C. would inflict 2D6+2 M.D. with a Mega-Blade attachment! These attachments can not be removed or transferred to other weapons except by an 8th level Techno-Wizard or a Mystic Kuznya of any level (see *Rifts® Mystic Russia* for the Kuznya). About half the weapon dealers in The Market can get or have Mega-Blade weapons for sale, but no one quite does them as impressively as the bird-like Qua-Teek. These inter-dimensional artisans form weapons that are works of art, using the malleability of S.D.C. steel to create sweeping forms and shapes. One of their specialties is sculpting an exact likeness of the weapon’s owner onto the weapon and enchanting it with minor illusion magicks to move and talk at the wielder’s command. Custom orders are, of course, more expensive (50%-200% higher). Weight: By weapon type. M.D.C.: The weapon itself has 130 M.D.C., but can only be damaged if attacks are directed at the weapon itself and with the intention of damaging it. Mega-Damage: By weapon type; S.D.C. becomes M.D.C. Cost: 100 times the weapon’s normal cost for a standard Mega-Blade (active life of 3+1D4 years), so a sword worth 300 credits would cost 30,000 credits as a Mega-Blade. Extending the operating lifetime to 10 years adds 100,000 credits to the cost, 20 years 180,000, 30 years 320,000, 50 years 700,000, and 100 years 1.2 million. Add another million for each additional century up to 300 years. This item is found at Splynn and other Splugorth markets, but is rare elsewhere, even in the TW communities of North America. Special Magic Feature/Power: For another 350,000-500,000 credits the weapon can be made to contain one spell (limited to wizard magic levels 1-5) that can be cast as often as three times a day at 5th level strength. However, to cast it, the user must pump in the necessary amount of P.P.E. (same as to cast the spell; or I.S.P. at double the number of points necessary if they were P.P.E.).

**Power Jaw Helmet.** Designed and manufactured by an unknown source, but often attributed to the same maker as the Titan series of power armors, this power armor accessory is built with a powerful, hinged jaw, allowing humans and others who lack natural M.D.C. bite attacks to use them in melee combat. The helmet comes in many styles, from the simple to the demonic, and has a universal coupling at the neck to allow it to mate with nearly any human-sized power armor. Despite cosmetic appearances, the damage for all of these helmets is constant and based on the mechanical capabilities of the hydraulics and the Vibro-field of the teeth themselves. The jaw can not be retrofitted to an existing helmet, but special orders that cosmetically match the existing helmet or rest of the body armor can be made, but with a 25% price increase. Weight: 5 lbs (2.3 kg). M.D.C.: 60. Mega-Damage: 2D4 M.D. per bite. Cost: 35,000 credits.

Also see **Kittani Weapons** earlier in this weapon section.

---

# Tolkeen Weapons

## Coalition Wars™ Series

The Kingdom of Tolkeen used conventional, M.D. energy weaponry, rail guns and missiles produced by other North American manufacturers as well as ordnance *stolen* from the CS. Tolkeen *manufactured* a number of Techno-Wizard weapons, armor, and vehicles, but since Techno-Wizard weapons are magical only a smattering have been included in this book. See the *Rifts® Book of Magic™* and/or the *Coalition Wars: Siege on Tolkeen™* series, *Federation of Magic™* and *New West™* for a nice range of TW weapons and all kinds of magic.

# Triax Weapons

## Rifts® World Book Five: Triax & the NGR™

The following descriptions are of weapons commonly used in and around the New German Republic. The majority are designed and manufactured by Triax. All Triax weapons are identified with the "TX" prefix or the word Triax. Lasers are among the most common human energy weapons because they offer the greatest range; ion and particle beams rarely exceed 1,600 feet (488 m) unless they are giant-sized.

**Prices listed:** In the cities and most NGR villages, mainstream items can vary by 10% to 20%, up or down, depending on the seller and market demands. In the European wilderness and other parts of the world, items can cost two to four times more; seldom less, unless stolen. Items listed with a "Black Market" cost are not normally available to the average character, are frequently illegal contraband, and can only be purchased from the Black Market, bandits, mercenaries or gypsies. NGR soldiers are likely to confiscate any Black Market items brought into the territory controlled by the Republic. However, they will often ignore characters with contraband weapons in the wilderness, particularly in the Monster Zones, unless they are suspected as enemies of the NGR. In North America, the CS has negotiated limited and controlled trade to much of North America, making Triax weaponry uncommon and costing 50% to 200% more than list price.

### Triax Energy-Clips

**1. Triax Forward Sliding Clip (FSE-Clip):** Most Triax weapons use a forward facing, sliding E-Clip rather than the handle style clip used in automatic weapons and by the Coalition States. The energy clip fits snugly into the front housing and can be used as a handhold or grip for two-handed firing by the shooter. This design also means the E-Clip can be larger and hold a dramatically larger payload. Note: The front loading E-Clip makes the weapon a bit unbalanced when shooting one-handed, pulling the front down (-2 to strike), but has good balance and accuracy when braced with two hands and is therefore, more accurate (+1 to strike). Also note that virtually ALL rifles of any kind are designed as two-handed weapons for maximum accuracy, and are -1 to strike when fired with one hand.

Typical payload for the FSE-Clip: 40 or 50 shots for pistols/handguns or 20 to 40 shots for rifles. Cost: A typical FSE-Clip costs 17,000 credits. Recharge cost is 5,000 credits — an energy clip can be recharged to full payload for about one-third of its original cost.

**2. Triax Short Clip:** Some energy pistols and older style weapons can only use the more traditional handle-loaded energy clip, usually referred to as a "short" clip. Many cybernetic/bionic weapon systems also need the smaller magazine. Many of the new Triax weapons have housings for both, giving the weapon greater versatility. Typical payload for the short E-Clip: 10 to 20 shots for pistols/handguns, or 8 to 10 shots for rifles. Cost: A typical short E-Clip costs 9,000 credits. A recharge to full power costs about 2000 credits. Note: In the wilderness, a character may find himself at the mercy of unscrupulous businessmen who charge double to quadruple for E-Clips and recharging. Energy weapons and common equipment rarely cost more than double.

**3. Costs for Conventional S.D.C. Rounds:** Available S.D.C. rounds/bullets include all the common types, from .22 caliber to 10 mm. Armor-piercing rounds (add 1D6 S.D.C. to the bullet's damage) or high explosive cartridges (add 1D4x10 S.D.C.) are also available. A box of 48 rounds (normal bullets) typically costs about 10 credits. Triple for armor-piercing, dumdums, and other special rounds. One hundred credits for a box of 48 exploding rounds.

**4. Costs for Pump Rounds:** High explosive mini-grenades cost 300 credits each; a box of 48 is 14,400 credits.

**5. Costs for Hand Grenades:** 100 to 400 credits each, depending on the type and availability.

### Other types of ammo

**Depleted Uranium Rounds.** Also known as "DU Rounds," Depleted Uranium rounds are special rail gun cartridges made from old nuclear material with only trace levels of radiation. The material is much heavier than normal slugs, giving it much greater armor-piercing and damage capability. DU-Rounds do not have enough radiation to inflict additional damage or prevent healing in supernatural beings, unlike the U-Rounds. Mega-Damage: Depleted Uranium slugs inflict 1D6x10 M.D. from a standard burst of 30 rounds fired from a rail gun or 1D4x10 M.D. for a 20 round burst. They typically do 25% more damage than a comparable standard metal cartridge. Cost: Not commonly available. The Black Market or bandits occasionally sell a few single rounds for around two to five credits per each.

**Uranium Rounds.** One of the great threats from supernatural monsters such as alien intelligences, gods, demons, the Four Horsemen of the Apocalypse, Elementals, vampires, dragons, and supernatural beings in general, is that they have incredible powers of bio-regeneration. Most are impervious to fire, cold, poison and radiation. In many instances, they can restore hundreds of points of Mega-Damage in a matter of minutes. Many can completely regrow amputated limbs and damaged internal organs. Even some of the lesser so-called demons, including werewolves, Brodkil and Gargoyles, have healing and regenerative powers far greater than humans.

Mega-Damage from plasma, lasers, and other energy attacks is healed in an instant, without any trace of burns or scarring. Conventional Mega-Damage projectiles are dissolved in the body and disappear, or are painlessly pushed out/ejected by the super healing powers of these incredible beings. Some may have vulnerabilities to common items like silver or a wooden stake, but still they are dangerous creatures who recover from damage quickly.

Frequently, combatants of the supernatural find they must completely destroy the monster in the initial battle, using methods of overkill to accomplish the task. To let the fiend crawl off into the shadows means it will recover (sometimes in a matter of minutes) and seek revenge. These demonic beings have a very different sense of mortality than humans. They don't understand lingering pain, or fear accumulative damage. Consequently, they enter combat without fear, confident of their triumph. If they suffer too much damage, they simply flee to a temporarily safe haven, heal and return to fight the next day (or even later that night). However, the NGR has made a recent discovery that will strike fear into the hearts of fearless monsters and teach supernatural denizens the meaning of pain and mortality!

Triax has learned that the phenomenal healing powers of most (92%) supernatural menaces and creatures of magic are seriously impaired by radioactive material. Not radiation itself, but radioactive material that penetrates the skin. This has led to the development of a special type of rail gun projectile/bullet. A low radiation round called Uranium Rounds or more commonly known as U-Rounds.

U-Rounds inflict 25% additional damage to supernatural beings (the same as DU rounds), but more importantly, they prevent the creature from instantly regenerating. The damage inflicted by U-Rounds cannot be healed until the object is physically removed, thereby dramatically reducing the threat from that being.

Even after the U-Rounds are removed, the wounds/damage do not heal quickly. Thus, another frightening, new experience for supernatural beings! The creature can heal completely with time, but only after the radioactive projectiles have been removed and a much longer time to heal is required than these monsters are accustomed to. Mega-Damage that can usually be healed in a matter of melee rounds (seconds) takes the equivalent time in hours. Damage that normally heals in minutes takes the equivalent time in days! Damage healed in hours takes the equivalent time in weeks!! Note: Magic potions, herbs and healing spells are also affected by the U-Rounds' damage to supernatural beings and creatures of magic, restoring only half their normal healing amount. If the U-Rounds are removed first, then the magic has

full effect. Psychic healers/surgeons are especially helpful in removing these slugs and treating these characters.

**The Problems with U-Rounds.** Uranium Rounds have a low level of radiation so they must be used with caution. The radiation level from a single round is so low that a human could carry it around for weeks with no ill effects from radiation. However, after a couple of months the character might suffer from radiation poisoning. More likely, such exposure would contribute to the person developing cancer or blood disease 2D4 years later.

An entire weapon magazine or ammo-drum of U-Rounds is too "hot" to handle safely for more than a few hours. Again, radiation sickness or cancer are of grave concern. Even environmental body armor is not guaranteed protection, especially when exposed for weeks at a time in the field of combat. For this reason, the use of Uranium Rounds is typically restricted to rail guns used by cyborgs and robots. Robot vehicles are self-contained, radiation proof environments. Smaller robots and cyborgs have better radiation shielding than body armor and no (or few) human components to damage. The belt that feeds the rounds into the gun is sealed and radiation proof. The ammo-drums containing hundreds to thousands of rounds are heavily shielded containers. This is considered the only "safe" usage of the radioactive material.

There is also the issue of damage to the environment. A couple hundred stray rounds will not noticeably damage the environment, but in a big fire fight, tens of thousands to millions of rounds could be expended. Where the largest concentration of Uranium Rounds are located, the greater the damage to the environment and the greater the risk to human life! An area peppered by U-Rounds will register dangerous levels of radiation. Vegetation will be stunted — smaller, shriveled and discolored. There aren't likely to be strange mutations, just an absence of healthy life. D-Bees or humans living in the area will show a dramatically higher incidence of cancer, blood disease and birth defects. The ground and ground water could also become contaminated and hazardous to humans.

For all of these reasons, the use of U-Rounds is restricted and carefully monitored. In many instances after a successful battle, a "clean-up" team will examine the area, collecting as many of the U-Rounds as possible; typically a 50% to 80% clean-up rate. The use of Uranium Rounds is frequently denied within the borders of the New German Republic, but often authorized for campaigns outside the nation, especially deep in enemy territory and against monster strongholds. Special squads may be authorized to use the ammunition for engagements with powerful supernatural beings even within the NGR. The logic being that the risks from the U-Rounds are less than letting a dangerous monster prowl city streets.

**Note:** Uranium Rounds are top secret! Triax and the leaders of the NGR have kept their discovery from allies and even the lower ranks of the military. Only elite commandos, trusted intelligence officers and robot fighter pilots may know about U-Rounds, and even many of them don't understand the principles, dangers or elements behind the new round. In many circumstances, the soldiers may not even be told about the bullets. All they know is that the "new" or "special" ammunition they've been given seems to be extremely more effective against the enemy and that's good enough for them. This information will not be shared with the Coalition States until the alliance is signed (even then the NGR may hold back its secret).

The following supernatural or magic creatures (among others) are effected by U-Rounds: Gargoyles, Brodkil, dragons, sphinxes, unicorns, Zavors, Splugorth, vampires, werebeasts, ghouls, most gods, alien intelligences, demons, Deevils, Earth Elementals, Ice Elementals and most supernatural beings or so-called "demons." They are not effective against fire, air or water Elementals, Entities, Temporal Raiders, Spectres, and other energy beings.

**Black Market Cost:** 10 credits a round but can range from half that cost to twice as much.

## Triax Weapons

**TX-5 Triax Pump Pistol.** The TX-5 is a pistol version of the pump rifle. The weapon fires high explosive cartridges/bullets/rounds which are much smaller than the conventional grenade, but pack a wallop. These explosive rounds are fired at a high velocity, have good range, and contain a powerful explosive charge. The blast is very concentrated, about a one foot (0.3 m) area, unlike the larger grenades which affect an area five to twenty times larger. Weight: 5 lbs (2.25 kg). Mega-Damage: 4D6 M.D. Rate of Fire: Standard. Range: 800 feet (244 m). Payload: 5 rounds, loaded manually, one round per melee action. A speed loader will load all five rounds in four seconds (one melee action) and costs 1,200 credits. Note: A "pump" weapon can also fire DU-Rounds or U-Rounds (only 1D6 M.D. per round but both are excellent armor-piercing cartridges and the U-Rounds prevent supernatural beings from instant healing). Cost: 10,000 credits for the gun and 400 credits per round. Fair availability in Europe.

**TX-20 "Short" Laser Pistol.** The TX-20 Short is the standard issue sidearm for officers and police in the NGR's armed forces. It is an older style weapon that use a "short" E-Clip but has good firepower and is lightweight and reliable. Weight: 2 lbs (0.9 kg). Mega-Damage: 2D6 M.D. Rate of Fire: Standard. Range: 800 feet (244 m). Payload: 20 shots. Cost: 12,000 credits. Good availability in Europe.

**TX-22 Precision Laser Pistol.** The TX-22 comes standard with a forward sliding energy clip, but can also use a short clip fitted into its handle. This is a long-range weapon with fine calibrations, ideal for target shooting. Weight: 3 lbs (1.4 kg). Mega-Damage: 2D4 M.D. Rate of Fire: Standard. Range: 1000 feet (305 m). Payload: 50 shots from an FSE-Clip or 20 from a short clip. Bonus: +1 to strike on an aimed shot. Cost: 15,000 credits. Good availability in Europe.

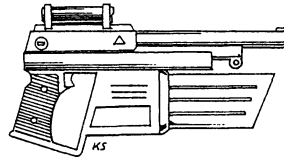

**TX-24 Ion Pulse Pistol.** The TX-24 comes standard with a forward sliding energy clip, but can also use a short clip fitted into its handle. Weight: 4 lbs (1.8 kg). Mega-Damage: 2D4 M.D. per single shot or 4D6 per multiple pulse burst (three simultaneous shots). Rate of Fire: Standard. Range: 500 feet (152 m). Payload: 30 shots from an FSE-Clip or 10 from a short clip. Cost: 20,000 credits. Good availability in Europe.

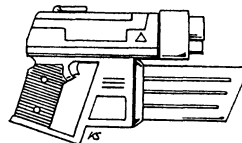

**TX-26 Particle Beam Pistol.** The TX-26 comes standard with a forward sliding energy clip, but can also use a short clip fitted into its handle. The amount of energy used by each particle beam charge limits the payload more than for any other weapon. Weight: 5 lbs (2.25 kg). Mega-Damage: 5D6 M.D. per shot. Rate of Fire: Standard. Range: 400 feet (122 m). Payload: 15 shots from an FSE-Clip or 6 from a short clip. Cost: 35,000 credits. Fair availability in Europe.

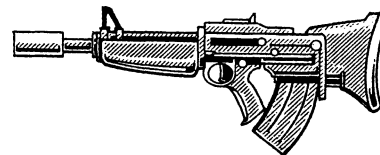

**WR-10 Wilderness Ion Pistol.** The WR-10 is an old style weapon that uses a "short" E-Clip but has good firepower and is lightweight and reliable. The design is that of a Pre-Rifts submachine-gun with a short shoulder stock. Weight: 2 lbs (0.9 kg). Mega-Damage: 2D4 M.D. Rate of Fire: Standard. Range: 600 feet (183 m). Payload: 20 shots. Cost: 10,000 credits. Excellent availability in Europe.



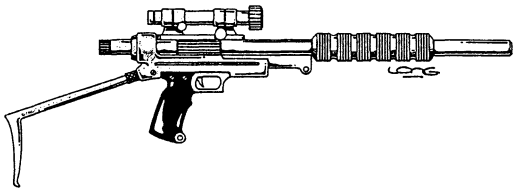

**TX-11 Triax Sniper Laser Rifle.** A light laser rifle designed for single shots and maximum accuracy. Comes standard with an infrared telescopic sight. Weight: 3 lbs (1.35 kg). Mega-Damage: 3D6 M.D. Rate of Fire: Equal to the number of hand to hand attacks of its operator; aimed shots only. Can not fire bursts. Range: 1600 feet (488 m). Payload: 10 shots "short" clip or 20 shots FSE Clip. Special Bonus: +1 to strike (so an aimed shot is + 5). Black Market Cost: 20,000 credits. Fair availability in Europe.

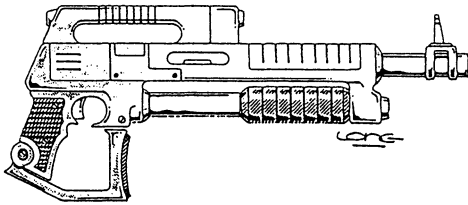

**TX-16 Pump Rifle.** Triax was the first to introduce a new concept in Mega-Damage assault rifles, one that uses M.D. projectiles rather than energy blasts. Some have called the TX- 16 Pump Rifle a glorified grenade launcher or shotgun, but regardless of its detractors, the weapon has become increasingly popular and widely imitated. It fires high explosive cartridges/bullets/rounds which are much smaller than the conventional grenade, but pack a wallop. These rounds are fired at a high velocity, have good range, and contain a powerful explosive charge. The blast is very concentrated, about a one foot (0.3 m) area, unlike the larger grenades which affect an area five to twenty times larger. The TX-16 Pump is a bit heavy, but well balanced and dependable in combat. Weight: 21 lbs (9.45 kg). Mega-Damage: 4D6 M.D. Rate of Fire: Standard. Range: 1,600 feet (488 m). Payload: 16 rounds, loaded manually, one round at a time (i.e., one round per melee action). A speed loader will load eight (8) rounds in four seconds (one melee action) and costs 2000 credits. Note: A "pump" weapon can also fire DU-Rounds or U-Rounds but these cartridges do only 1D6 M.D. per round. However, they have excellent armor penetration and U-Rounds prevent supernatural beings from instant bio-regeneration. Cost: 30,000 credits for the gun and 200 credits per explosive round. Fair availability.

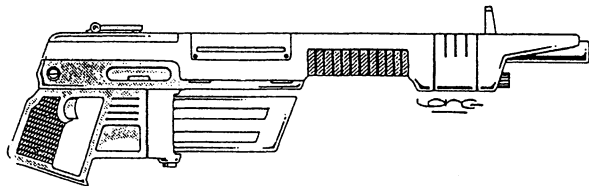

**TX-30 Triax Ion Pulse Rifle.** A popular frontier weapon with a front loading E-Clip. It is a dependable, lightweight weapon with the benefit of multiple ion bursts and excellent range. Weight: 7 lbs (3 kg). Mega-Damage: 2D6 M.D. single shot, or 6D6 multiple pulse burst (three simultaneous shots). Rate of Fire: Standard. Range: 1,600 feet (488 m). Payload: 40 shots, short E-Clip or 50 shots, long E-Clip. Black Market Cost: 22,000 credits. Good availability.

**TX-41 Laser Pulse Rifle (Giant Size).** This is a giant version of the TX-42 pulse rifle used by giant-sized robots and power armor (robots that stand 10 to 20 feet/3 to 6 m tall). The weapon is also a variable frequency laser with 12 different light frequencies. The operator can change frequencies with a touch or voice command. An internal computer makes the desired change. Number 7 counters the USA-10 Glitter Boy. The other settings are able to overcome other laser resistant armors. Weight: 20 lbs (9.1 kg). Mega-Damage: 3D6 M.D. per single shot or 1D6x10 M.D. per rapid-fire pulse (three nearly

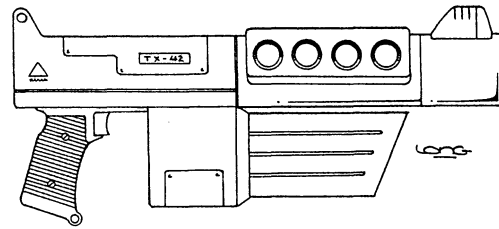

simultaneous shots). Rate of Fire: Equal to the total number of hand to hand attacks. Range: 4,000 feet (1,219 m). Payload: 100 shots from the giant, energy clip located in the front of the gun. A special cable can connect the weapon to a robot's energy supply, giving it an effectively unlimited payload. The danger is that the weapon is rendered useless if the cable is cut. Black Market Cost: 90,000 to 120,000 credits. This weapon is not sold to the mass market so it is available only on the black market. The military and law enforcement agencies of the NGR consider it an illegal weapon when in the possession of non-military personnel and will confiscate it. Very poor availability even in Europe.

**TX-42 Laser Pulse Rifle.** This is the standard energy assault weapon used by the human troops of the NGR's armed forces. The weapon is a variable light frequency laser with 12 different settings. The operator can change frequencies with a touch or voice command. An internal computer makes the desired change. Number 7 counters the USA-10 Glitter Boy. The other settings are able to overcome other laser resistant armors. Weight: 9 lbs (4 kg). Mega-Damage: 2D6 M.D. per single shot or 1D4x10 M.D. per rapid-fire pulse (three nearly simultaneous blasts fired one micro-second after the other). Rate of Fire: Equal to the total number of hand to hand attacks. Range: 2000 feet (610 m). Payload: 40 shots with an FSE-Clip. Black Market Cost: 50,000 to 75,000 credits. Poor availability even in Europe.

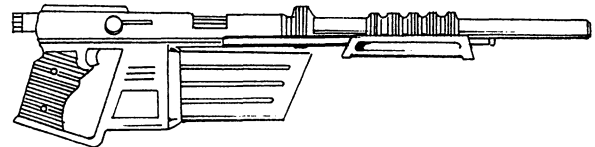

**TX-43 Light Assault Laser Rifle.** The TX-43 is a long-range, all-purpose laser weapon with three damage settings. It is a sturdy and reliable weapon popular among adventurers and mercenaries. The forward sliding energy clip is standard, but a short clip can fit into its handle. Weight: 7 lbs (3 kg). Damage: Three settings: 6D6 S.D.C., 2D6 M.D. or 4D6 M.D. per shot. Rate of Fire: Standard. Range: 2,000 feet (610 m). Payload: 20 blasts from a short E-Clip or 30 from a FSE-Clip. Cost: 26,000 credits for the rifle. Good availability.

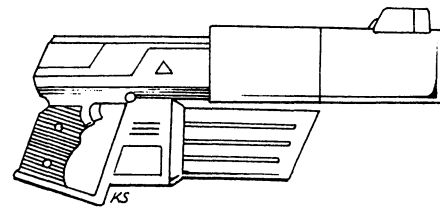

**TX-45 Particle Beam Rifle.** The TX-45 comes with the standard forward sliding energy clip, but can also use a short clip fitted into its handle. The amount of energy used by each particle beam charge limits the payload more than for any other weapon. Weight: 9 lbs (4 kg). Mega-Damage: 5D6+6 M.D. per shot. Rate of Fire: Standard. Range: 1,200 feet (365 m). Payload: 20 shots from an FSE-Clip or 8 from a short clip. Cost: 35,000 credits. Poor to fair availability even in Europe.

**TX-50 Rail Gun.** This is a light, all-purpose weapon used by human troops wearing T-11 Enhanced body armor or power armor, as well as cyborgs, human-sized robots, and characters with a strength of 24 or greater. The TX-50 rail gun can use what is called a short clip with 200 rounds (10 bursts), light drum with 600 rounds (30 bursts), or a heavy belt feed drum containing 2000 rounds (100 bursts). The latter is typically reserved for robots and cyborgs. Weight: Gun: 60 lbs (27

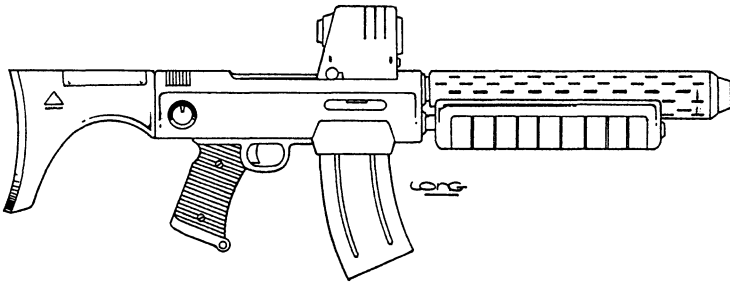

kg), short clip: 10 pounds (4.5 kg), light ammo-drum: 30 pounds (13 kg) or a heavy ammo-drum: 100 lbs (45 kg). Ammo-drums are hooked to the back of body armor or a housing on the back of 'bots. **Mega-Damage:** A full damage burst fires 20 rounds and inflicts 4D6 M.D.; a single round does 1D4 M.D. **Rate of Fire:** Equal to the character's hand to hand attacks per melee round (usually 3 to 6). **Range:** 4,000 feet (1,219 m). **Payload:** The short clip holds 200 rounds and is capable of firing ten full damage bursts (20 rounds). The light drum holds 600 rounds and can fire 30 bursts. The 2000 round drum is capable of firing 100 full damage bursts (20 rounds each). Reloading a drum will take about three minutes for those not trained, but a mere 30 seconds by a capable field mechanic. A strength of 24 or higher is required to handle the drum. **Special TX-50 Feature:** The TX-50 rail gun for human troops has its own laser targeting/distancing and telescopic sight and nightvision scope. Telescopic and laser targeting range is 6,000 feet (1,828 m). **Bonus:** +1 to strike. **Black Market Cost:** 50,000 credits. Poor to fair availability.

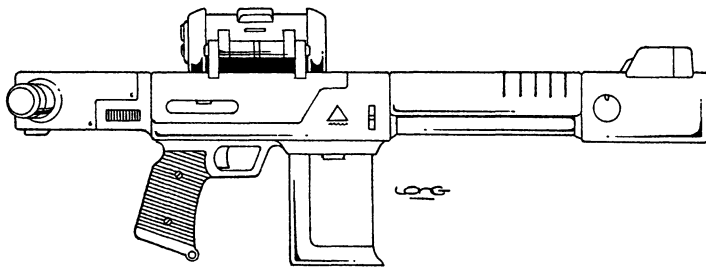

**TX-250 Rail Gun.** This is the standard weapon for the X-535 Hunter/Jager but can also be used by other power armor units, 'bots and cyborgs with a strength of 28 or greater. The weapon is light enough that the 12 foot (3.6 m) Jager can use one in each hand, if so desired. The TX-250 rail gun can use what is called a short clip with 300 rounds (10 bursts) or a belt feed drum containing 3,000 rounds (100 bursts). One of the unique features of the TX-250 is that it has three damage settings. It can fire one bullet, a 15 round short burst, or a maximum damage burst of 30 rounds. Few rail guns are as versatile. **Weight:** Gun: 250 lbs (112.5 kg), One TX-250 Ammo-Drum is another 250 lbs (112.5 kg). The ammo-drum hooks to the back of the 'bot. **Mega-Damage:** A full damage burst fires 30 rounds and inflicts 6D6 M.D. A short burst of 15 rounds does 3D6 M.D. and a single round does 1D4 M.D. **Rate of Fire:** Equal to number of combined hand to hand attacks (usually 4-8). **Range:** 6,000 feet (1,828 m). **Payload:** The short clip holds 300 rounds and is capable of firing 10 full damage bursts (30 rounds) or 20 half damage short bursts (15 rounds). The 3,000 round drum is capable of firing 100 full damage bursts or 200 half damage bursts (15 rounds). Reloading a drum will take about three minutes for those not trained, but a mere one minute by somebody trained in the use of power armor. A strength of 28 or higher is required to handle the drum. **Special TX-250 Feature:** The rail gun is has its own laser targeting and radar tracking system built into the weapon itself (the large, round cylinder). This can be especially useful if the 'bot's sensor head is destroyed. **Range:** 6000 feet (1828 m). **Bonuses:** +1 to strike, +1 to parry and dodge. **Black Market Cost:** 75,000 credits. Poor availability even in Europe.

**TX-500 Triax 'Borg Rail Gun.** This rail gun is a comparatively light, portable weapon designed for use by cyborgs and other creatures with a strength of 24 (or higher) and a high physical endurance (or

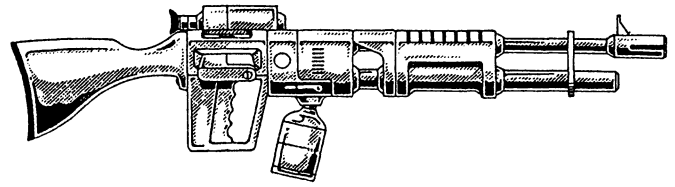

made of steel and hydraulics). It can also be used as a machine-gun, mounted on a tripod or vehicle. The TX-500 comes equipped with a telescopic, nightvision scope and laser targeting system (+1 to strike). **Weight:** Gun: 80 lbs (36 kg), Power Pack: 50 lbs (22.7 kg), One Ammo-Belt: 25 lbs (11 kg), Case of Six Belts: 150 lbs (67.5 kg). **Heavy Ammo Drum:** 80 lbs (36 kg). **Mega-Damage:** A burst is 30 rounds and inflicts 6D6 M.D., one round does 1D4 M.D. A half burst (15 rounds) inflicts 3D6 M.D. DU-rounds add 2D6 to a full burst or 1D6 to a half burst. **Rate of Fire:** Standard. **Range:** 4,000 feet (1,219 m). **Payload:** Heavy Ammo Drum: 1,170 rounds (39 full bursts); 390 round belt (13 full 6D6 bursts). Or can be fitted with the mini-clip which contains 90 rounds (3 full bursts). Each mini-clip weighs 10 lbs (4.5 kg). **Black Market Cost:** 85,000 credits. Fair availability.

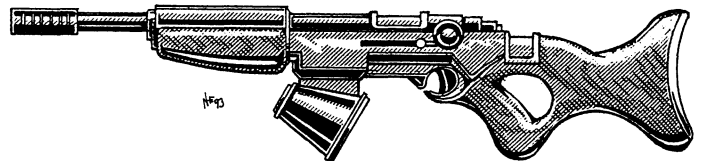

**WR-15 Wilderness Laser Rifle.** A popular frontier weapon with a unique, drum style E-Clip. It is a dependable weapon. The front loaded drum E-Clip makes the rifle unbalanced when fired with one hand (-2 to strike, but is +1 to strike when braced by two hands). **Weight:** 9 lbs (4 kg). **Mega-Damage:** 3D6 M.D. per single shot. **Rate of Fire:** Standard. **Range:** 1,600 feet (488 m). **Payload:** 40 shots per energy drum. **Cost:** 18,000 credits. Excellent availability.

**WR-17 Wilderness "Double" Rifle.** Another popular frontier weapon. This weapon has two barrels with two different firing capabilities, a heavy ion gun and a light laser (short range for a rifle). **Weight:** 12 lbs (5.4 kg). **Mega-Damage:** Ion: Two settings: 3D6 M.D. or 4D6 M.D. per single shot. **Mega-Damage:** Laser: One setting: 2D6 M.D. **Note:** If the target is within range (1200 feet/365 m maximum), both the laser and ion beams can be fired simultaneously, inflicting 5D6 M.D. **Rate of Fire:** Standard. **Range:** Ion: 1,600 feet (488 m). **Range:** Light Laser: 1,200 feet (365 m). **Payload:** 20 shot "short" E-Clip. **Cost:** 24,000 credits. Excellent availability.

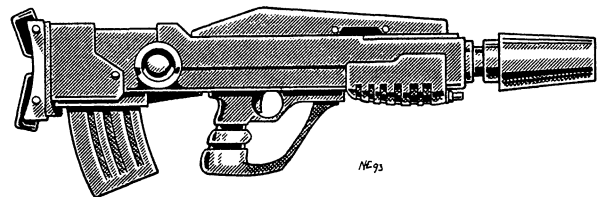

**WR-19 (human size) and WR-20 (giant size) Plasma Ejector.** An old-style energy weapon that continues to be reasonably popular outside the NGR. The giant version has the same stats, only bigger, and is a favorite among the Gurgoyles, Brodkil and other giant, humanoid monsters. **Weight:** 14 lbs (6.4 kg) human size, or 25 lbs (11 kg) giant size. **Mega-Damage:** 5D6 M.D. per single shot. **Rate of Fire:** Standard. **Range:** 1,600 feet (488 m). **Payload:** 10 shot "short" E-Clip. **Cost:** 28,000 credits. Fair to good availability.

**TX-10 Mini-Missile Launcher.** A portable, reusable mini-missile launcher that resembles the 20th Century bazooka. The launcher comes equipped with a multi-optic scope. The capabilities of the scope include telescopic (x10 magnification, 2 mile/3.2 km range), infrared (2000 foot/610 m range), passive night vision (2000 ft), and laser targeting. **Weight:** The launcher weighs 14 lbs (6.3 kg), each missile weighs about two pounds (0.9 kg). **Mega-Damage:** Any mini-missile can be

used, but armor piercing or plasma (1D4x10 M.D.C. or 1D6x10 M.D.C.) are the most commonly used. Rate of Fire: The weapon can only fire one mini-missile, but a two-man team can load and fire three missiles per melee (15 seconds). A single operator can only fire one per melee round. Range: One mile (1.6 km). Payload: One per launcher. A carrying case can hold six mini-missiles (weighs about 12 pounds/5.4 kg), a backpack can hold 12 missiles and a portable carrying case (10 M.D.C.) can hold 24 mini-missiles (weighs about 48 lbs/21.6 kg). Black Market Cost: 18,000 for the launcher and 2,000 credits for each light damage missile (5D6 M.D.) and 3500 for each plasma or armor piercing.

**TX-M4 Mini-Missile Launch Pack.** A portable mini-missile launcher contained in a backpack. The unit usually has a pocket-size control pad as well as a launch pad in the launch unit itself. The launcher holds four mini-missiles, but can be easily reloaded within approximately 1D4 melee rounds (15 to 60 seconds). With practice, a character can reload all four missiles within 15 to 30 seconds every time. Missile Type: Any mini-missile can be used, but standard issue is armor piercing (1D4x10 M.D.) or plasma (1D6x10). Fragmentation, stun and/or tear gas may be used for anti-personnel operations. Missile Weight: A typical mini-missile weighs about two pounds (0.9 kg). Launcher Weight: 30 pounds (13.6 kg) empty, 38 pounds (17 kg) loaded. Mega-Damage: Varies with missile type. Range: Usually about a mile. Rate of Fire: One at a time, or in a volley of two, or four. Payload: 4 total. Cost: 2000 credits for light missiles, 3,500 for plasma or armor piercing.

**Robot & Cyborg Mini-Missile Systems.** There are a variety of mini-missile launch systems available to robots, power armors and cyborgs. Usually, a specific type of launch system is designed for a particular 'bot or 'Borg and is not subject to change (especially in the military). Those without a missile system can not usually acquire one other than the portable launchers previously described.

**Triax Fusion Blocks.** A fusion block is a little square case about the size of a hand-held computer. On top of the block is a small key-pad for programming the time of detonation. An automatic 30 second delay is built into each fusion bomb as a safety feature to avoid instant detonation. Weight: 8, 12 or 16 lbs (3.6, 5.4 or 7.2 kg). Mega-Damage: There are three types of fusion block bombs.

1) 1D4x10 M.D., 2) 2D6x10 M.D., 3) 4D6x10 M.D. (blast radius is a contained 10 foot/3 m area). Range: The blocks are made for placement, not throwing or shooting, however one can try throwing the explosive, typical range is 1D6x10 feet (3 to 18 m); fusion blocks are not aerodynamic. Black Market Cost: 1000, 3000, and 8000 credits respectively.

**Triax Hand Grenades.** A hand grenade is a small, softball-sized explosive canister designed for throwing and exploding. Average effective throwing range is about 100 feet (30.5 m). Note: Grenades are more common, less expensive and easier to acquire than in the Coalition States. Weight: 0.5 lbs (.23 kg), to almost 1 lb (.45 kg) for HE and Plasma. **Fragmentation Grenade (anti-personnel)**: Light: 2D6 M.D. to everything in the blast radius of 20 feet (6 m). Cost: 200 credits each. Heavy: 3D6 M.D. to everything in the blast radius of 30 feet (9 m). Cost: 250 credits each. **High Explosive Grenade (anti-armor)**: 4D6 M.D. to a 6 foot (1.8 m) area. Cost: 150 credits. **Plasma Grenade**: 5D6 M.D. to a 12 foot (3.6 m) area. Cost: 350 credits.

**Stun/Flash Grenade:** This anti-terrorist weapon is designed to disorient and confuse criminals who are holding hostages in confined places. The grenade makes a loud exploding boom and emits a bright flash, followed by a shower of white-hot sparks and some white smoke. The flash, burning sparks, and smoke should blind and startle any character without environmental armor or protective goggles. The victims of a stun/flash grenade are -8 to strike, parry and dodge, -1 on initiative and lose one melee attack/action for the next 1D4 melee rounds (15 to 60 seconds). Even those in armor should be momentarily distracted for 1D4 seconds and lose initiative. Weight: 0.5 lbs (.23 kg). Cost: 100 credits.

**Tear Gas Grenades.** The gas will instantly affect all characters without protective masks or environmental body armor. The eyes burn, sting and water profusely, causing great discomfort and making seeing clearly impossible. The gas also makes breathing difficult and irritates exposed skin. The effects last for 3D4 minutes. The 25 foot (7.6 m) cloud dissipates in about five minutes unless blown away by wind (dissipating more quickly in 1D4 minutes). The victims of tear gas are -10 to strike, parry and dodge, -3 on initiative and lose one melee attack/action for each of the next 2D6+1 melee rounds. Those in environmental armor are completely safe and not affected. Weight: 0.5 lbs (.23 kg). Cost: 200 credits.

**Smoke Grenades** release a thick cloud of smoke that covers a 20 to 40 foot (6 to 12 m) radius. The smoke obscures vision in and through the cloud from those on the outside of it. Infrared cannot penetrate a smoke cloud or be used inside a smoke cloud. Those inside the cloud will be blinded and have trouble breathing while inside it. Those who are not protected by environmental suits or gas mask and goggles will be -5 to strike, parry and dodge and -1 on initiative. Attackers firing into/through the cloud are shooting wild. Note that passive nightscopes will work in a smoke cloud. Weight: 0.5 lbs (.23 kg). Cost: 50 credits.

**Hand-held Flare.** This is the type of item truck drivers and road patrols use to signal for help or to warn others of an accident or danger. The flare burns for 20 minutes. Weight: 0.5 lbs (.23 kg). Cost: One credit each.

**Parachute Flares.** This pyrotechnic device usually comes in a hand-held, throw-away launch tube. Three seconds after launching the flare, it ignites into a bright, sparking light that slowly drifts back down to earth. While in the air, the flare burns for 60 seconds and illuminates an area roughly 150 feet (45.7 m) in diameter. Weight: 1 lb (.45 kg) with launch tube. Cost: 10 credits each. Note: This is NOT a weapon but if shot into a person, the flare does 6D6 S.D.C. each melee round for one minute (four rounds). There is also a 50% chance of causing combustibles to catch fire.

**Vibro-Blades and Other Weapons:** All Vibro-Blades are blade weapons surrounded by an invisible, high-frequency energy field that gives them Mega-Damage capabilities. They were originally developed by the *Coalition States* and "knocked-off" (imitated) by Triax and other weapon manufacturers. They are popular among soldiers, mercenaries, city rats, adventurers and bandits (the Brodkil love 'em too). See the earlier section under *Coalition States Weapons* for complete Vibro-Blade descriptions.

**Neural Mace.** Fundamentally the same as the *Coalition States'* weapon of the same name, knocked off by Triax. See the description under *Coalition Weapons*.

**Electro-Mace (giant).** The electro-mace is a giant, hand-held weapon that can be used as a pounding blunt weapon, or to fire a bolt of energy, by giant robots (typically 20 ft/6 m tall or bigger). The weapon has a sheathing to protect the hand and forearm of the 'bot and has its own power supply. This weapon is especially useful against monsters that are vulnerable to electricity. It was specifically designed for the X-2500 Black Knight. Mega-Damage: 1) As a blunt, pounding weapon in the hands of the Black Knight, it inflicts 4D6 M.D. per strike. 2) The mace can also be electrically charged so that one's opponent is shocked every time the mace strikes. Add 10 M.D. to blunt, pounding attacks. 3) Alternatively, the mace can fire up to three powerful electrical blasts inflicting 1D4x10 M.D. each. Range: The electrical blast has a maximum range of 1000 feet (305 m). Rate of Fire: Equal to number of combined hand to hand attacks (usually 4-8). The electrical blast can only be fired three times per melee. Payload: Effectively unlimited. Black Market Cost: Not available on the Black Market.

## Triax Underwater Weapons

**TXT-10 Ultra-Mini Torpedoes.** These are similar to the Kittani rocket grenades, in that they are light explosives about the size of a grenade and have a range limited to about 1,000 feet (305 m). Ideal against

small submersibles, boats, lightly armored personnel, monsters and missile volleys. Mega-Damage: Typically uses high explosive (4D6 M.D. to a 6 foot/1.8 m diameter) or concussion charge (3D6 M.D. to a 30 foot/9.1 m radius underwater; half that radius on dry land). Rate of Fire: One at a time, or in volleys of two or four. Range: About 1,000 feet (305 m); the range is half in the air.

**TXD-01 Deep-Sea Sonic Beam Rifle.** This is a short-range underwater weapon that is especially effective against aquatic animals and D-Bees. Mega-Damage: 5D6 M.D. per sonic blast; 2D6 M.D. on land. Same basic effects as the Sonic Blast ocean spell. Rate of Fire: Equal to the combined hand to hand attacks of the gunner. Range: 300 feet (91 m) underwater or 80 feet (24.4 m) on land. Payload: 40 shots with an FSE-Clip. Black Market Cost: Not available. Top Secret! But should command a price of 60,000 to 75,000 credits.

**TXD-02 Deep-Sea Laser/Harpoon Rifle.** This is a short-range laser weapon equipped with a heavy harpoon like spear. Mega-Damage: 3D6 M.D. per laser blast. 1D6 M.D. from a conventional M.D.C. harpoon or 5D6 M.D. from an exploding harpoon. Rate of Fire: Equal to the combined hand to hand attacks of the gunner. Range: Laser: 1200 feet (366 m) underwater or 2,000 feet (610 m) on land. Harpoon: 300 feet (91.5 m) underwater or on land. Payload: Laser: 40 shots with an FSE clip. Harpoon: One, but can be reloaded (takes one melee action); a standard quiver holds eight additional spears. Black Market Cost: Not available. Top Secret! But should command a price of 60,000 to 75,000 credits.

**TXD-03 Deep-Sea Laser Assault Rifle.** This is a versatile, multi-system weapon designed for use in all sea environments, as well as being reasonably suitable for land assault (the gun is a bit heavy). The rifle has 120 M.D.C. and can survive deep-sea pressure up to four miles deep (6.4 km). Standard issue to the Triax Frogman. The main weapon is a high-powered, blue-green, pulse laser. It also comes equipped with a small, high-powered infrared light and a Vibro-Blade bayonet that can be fired like a harpoon! Mega-Damage: 2D6 M.D. per single shot or 1D4x10 M.D. per rapid-fire pulse (three nearly simultaneous blasts fired one micro-second apart). Rate of Fire: Equal to the combined hand to hand attacks of the user. Range: 2,000 feet (610 m) underwater, 3,000 feet (914 m) on land. Payload: 60 shots with an FSE-Clip. Cost: Not available. Top Secret! But should command a price of 50,000 to 75,000 credits.

**Vibro-Blade Bayonet.** The blade can be used as a bayonet attached to TDX-03 Deep Sea Laser Assault Rifle, removed and used as a hand weapon, or fired like a projectile. Mega-Damage: 2D6 M.D. per strike. 3D6 M.D. when fired like a harpoon or missile. Rate of Fire: One, intended for hand to hand combat. Range: 200 feet (61 m) underwater or on land. Payload: One.

## Tritonian Weapons

### Rifts® World Book Seven: Rifts® Underseas™

In addition to the weapons and equipment described below, Tritonians have access to most weapons manufactured in *South America* or by *Nemo-2's New Navy*, plus they may be able to obtain items from around the world and other dimensions through trade or salvage.

**BG-15 Blue-Green Laser Pistol.** This laser uses a light frequency that allows it to fire unimpeded through water. The weapon has the same range and damage above or under water. This pre-Rifts design bears some similarity to the Wilk's pistol, and amateurs often confuse them. Weight: 2 lbs (.9 kg). Mega-Damage: 2D4 M.D. Rate of Fire: Standard. Range: 1,000 feet (305 m) above or under water. Payload: 15 shots. Cost: 13,000 credits.

**BG-20 Blue-Green Laser Rifle.** A larger, heavier version of the BG laser pistol, this rifle is the standard issue of Tritonian security forces, including the elite Sea Wolves. It is also a favorite of pirates, undersea explorers and fishermen. It is made of black plastic and ceramic, making it easy to confuse with the Wilk's 447 rifle. Weight: 6

lbs (2.5 kg). Mega-Damage: 3D6 M.D. Rate of Fire: Standard. Range: 2,000 feet (610 m). Payload: 20 shots. Cost: 20,000 credits.

**M-80 "Stormbringer" Multi-Weapon Assault System (MWAS).** This heavy weapon is a man-sized version of the giant-sized M-90 used by the Merbot. It consists of a powerful ion-pulse rifle over a LAWS rocket launcher, tipped by a long Vibro-bayonet. Because of its heavy weight, the MWAS requires a P.S. of 20 or greater. Those with less strength are -2 to strike and will fatigue twice as quickly lugging this heavy weapon around. Weight: 21 lbs (9.45 kg). Mega-Damage: Ion Pulse Gun: Each energy burst inflicts 4D6 M.D. The LAWS launcher can fire airborne mini-missiles or torpedoes; both types inflict 1D6x10 M.D. The Vibro-bayonet inflicts 1D6 M.D. in hand to hand combat. Rate of Fire: Each attack counts as one melee action. Range: Ion pulse gun: 2,000 feet (610 m). LAWS: 4,000 feet (1,220 m). Bayonet: Close combat only. Payload: Pulse Gun: 12 shots from a standard E-Clip or 25 shots from a long E-Clip. The LAWS uses a drum magazine with five rounds.

## Wellington Industries

### Rifts® Mercenaries

Wellington Industries (W.I.) operates from the city of Wellington, a semi-independent manufacturing city-state in the *Manistique Imperium* located in the Upper Peninsula of Michigan. The company was founded when a group of archaeologists discovered a pre-Rifts weapon manufacturing complex, complete with blueprints for several experimental weapon systems. Over the last two years, the city has enjoyed an economic boom, especially since its alliance with the CS. W.I.s is one Northern Gun's main rivals and the competition between the two weapons dealers is beginning to turn ugly.

Besides the weapons described below, W.I. manufactures normal vehicles, farm equipment and bulldozers. The company has also been dealing with Golden Age Weaponsmiths for several years now. W.I. does not have the resources to get into the robotics market and is likely to limit its manufacturing to weapons and weapon systems for vehicles. This has helped to placate Northern Gun.

Other weapons produced by the corporation include the WI-15 and WI-20, a laser pistol and rifle nearly identical to the *Northern Gun* NG-33 and NG-L5, respectively (use the same stats and price).

**WI-10 Ramjet Rounds.** Ramjets are specially-designed cartridges with a hollow, ultra-hard casing filled with jet fuel. When it is fired, the air rushing into the speeding bullet burns with the jet fuel, propelling the round at supersonic speeds comparable to those of a rail gun round! The bullet is made of super-hard alloys, giving it enough penetration to damage M.D.C. armor. The rounds are outlawed in the Coalition States, banned as "cop-killing" bullets. Some mercenary outfits use them, because the bullets transform cheap S.D.C. weapons into Mega-Damage capable firearms. Damage: Against Mega-Damage targets, ramjets inflict 1 M.D. point. "Soft" S.D.C. targets take 3D6x10 S.D.C. A burst from an automatic weapon (like an Ingram or an assault rifle) is 20 rounds and inflicts 2D4 M.D. Limitations: Available only for .45, 9 mm, 10 mm, and 7.62 mm calibers. Cost: 5 to 10 credits per round, depending on supply, demand and the seller. So a box of 100 will cost 500 to 1000 credits. Ramjets are very scarce and expensive; only a half dozen places produce them.

**WI-20 Heavy Ramjet Rounds.** Limitations: These cartridges are built for the 14.5 mm and .50 caliber machine-guns. Damage: 1D4 M.D. per single round. A burst is 40 rounds and inflicts 5D6 M.D. Cost: 10 to 15 credits per round (to fill a belt of 200 rounds will cost 2,000 to 3000 credits).

**WI-2E Explosive Rounds.** Explosive rounds are an attempt to increase the damage capabilities of normal slug-throwers. In a time when many animals and creatures are M.D.C. creatures, many designers are trying to come up with ways to "beef up" the destructive potential of

normal S.D.C. guns. Explosive and ramjet bullets are two ways to achieve this. They use new explosives and materials to create more effective cartridges. Damage: An explosive bullet inflicts triple normal damage, so a 9 mm explosive bullet does 6D6 S.D.C. and a 5.56 mm rifle bullet will inflict 2D4x10 S.D.C. This increased damage means automatic weapons can inflict Mega-Damage with bursts. A submachine-gun will inflict 1D4 M.D., an assault rifle 1D6 M.D., and a heavy machine-gun: 2D6 M.D. per burst of 20 rounds! Cost: 2-4 credits per explosive pistol bullet, 4-6 credits for each rifle cartridge, and 6-10 for each heavy machine-gun round. Fair availability.

**MP-10 Caseless Pistol.** The "MP" line fires 10 mm caseless rounds. These bullets have no metal casing to hold the chemical propellants that fire them. Instead, the propellant is made up of a solid chemical that is completely consumed by combustion. This eliminates the need for an ejection port (which helps keep the gun clean) and allows for a greater number of bullets to be stored in a magazine. These bullets also do a little more damage than old-style rounds. The gun can be fired on semi-automatic or full auto settings. Weight: 2 lbs (0.9 kg). Cartridge: 10 mm caseless. S.D.C. Damage: Standard rounds: 3D6 S.D.C. for a single shot, 1D6x10 S.D.C. for a burst of 10 rounds. Depleted Uranium Armor-Piercing Bullets: 4D6 S.D.C. for a single shot, 2D4x10 S.D.C. for a 10 round burst. Range: 1,200 feet (365 m). Payload: 20 or 30 round magazine. Cost: 2,500 for the pistol, 30 credits for a box of 50 standard cartridges (excellent availability) or 100 credits for a box of depleted uranium rounds.

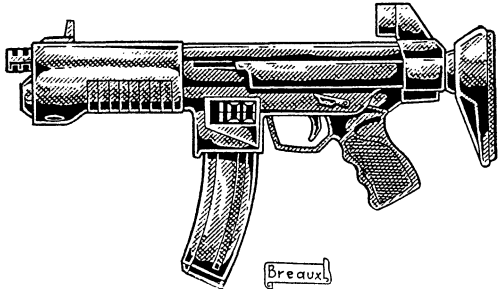

**MP-23A Caseless SMG.** This is a submachine-gun version of the MP-10 that fires the same caliber bullet but has a greater payload and rate of fire. The longer barrel gives the gun more damage and range. With depleted uranium armor-piercing rounds, it can inflict Mega-Damage! Weight: 3 lbs (1.4 kg) Cartridge: 10 mm caseless. Damage: Standard rounds: 4D6 S.D.C. for a single shot, 2D6x10 S.D.C. for a burst of 20 rounds. Depleted Uranium Armor-Piercing Bullets: 5D6+5 S.D.C. for a single shot, or 3D6x10 S.D.C./1 M.D. point for a 20 round burst. Range: 1,800 feet (548.6 m). Payload: 100 round magazine Cost: 4,500 for the submachine-gun, 30 credits for a box of 50 standard cartridges (excellent availability) or 100 credits for a box of depleted uranium rounds.

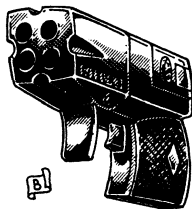

**WI-LP3 Pepperbox Laser.** A common holdout pistol, the Pepperbox is a small handgun whose four barrels are built into a solid block. The gun is small enough to conceal in a pocket or boot (+4% on Concealment rolls). Instead of using an E-Clip, the gun has four mini-batteries that prime and fire, one for each barrel. This gives the shooter four shots or any combination of multiple shots up to a single, powerful quadruple shot. The gun has a breakaway action that ejects the spent batteries when it is opened (changing batteries counts as one melee attack/action with a speed loader similar to the one used in revolvers, or four melee actions if doing it one by one). The laser is relatively weak and short-ranged, but is quite capable of killing at up to

100 feet (30.5 m). This gun is popular with City Rats, gang-bangers, gamblers, assassins and other undesirables. Although weapon detectors will pick up the presence of the gun, the Pepperbox can be hidden from cursory inspections or searches. Juicers like it as a backup weapon or to give enemies a nasty surprise. Assassins often use them in places where conspicuous weaponry would get them stopped and questioned. Weight: Less than one pound (0.45 kg). Mega-Damage: 1D4 M.D. per shot. A double shot does 2D4 M.D., a triple shot does 3D4 M.D., and a quadruple shot inflicts 4D4 M.D. and empties the battery payload. Rate of Fire: Can fire single, double, triple or quadruple shots (all count as one melee attack). Range: 100 feet (30.5 m). Payload: Four shots; one shot per battery (each battery is roughly the size of a shotgun cell). Reloading the batteries takes four melee actions, or one if a speed loader is used. Cost: 12,000 for the gun; each battery costs 100 credits. A special speed loader (loads all four batteries at once) cost 75 credits.

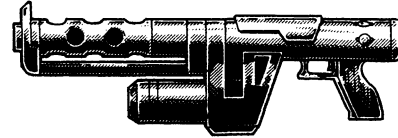

**WI-FT1 Plasma Flamethrower.** This fearsome weapon is the brainchild of a collaboration between Golden Age Weaponsmiths and Wellington Industries. Golden Age researchers recognized the flamethrower as an ideal shock weapon, and Wellington researchers adapted normal plasma weapon systems to produce a short-ranged, but continuous stream of Mega-Damage flames. A separate team working on the same project developed a form of plasma-based napalm that is used with another model of flamethrower (see the WI-NFT-1, below). Primarily a terror weapon, the flamethrower is also ideal for attacking certain monsters, lightly armored ground troops, vehicles, bunkers and other hardened positions. Weight: 30 lbs (13.5 kg) or 45 lbs (20 kg) with plasma tank. Mega-Damage: A short plasma burst does 3D6 M.D. A concentrated plasma burst (counts as two attacks; 7 seconds) does 1D4x10+10 M.D. Or the attacker can cover an area with plasma: up to 10 feet (3.0 m) can be covered with each hand to hand melee attack/action, so a character with four hand to hand attacks could cover an area or length of 40 feet/12.2 m; everybody in the area affected takes 2D6 M.D. Rate of Fire: Single shot or concentrated burst. Range: 500 feet (152 m). Payload: Standard E-Clip holds 8 bursts, a long E-Clip holds 16 plasma bursts. A plasma tank holds 100 "shots." Cost: 30,000 credits. A plasma tank costs 1,200 credits and is disposable.

**WI-NFT-1 Napalm-P Flame Thrower.** The NFT-1 is a research breakthrough for Wellington Industries. Using pre-Rifts technologies, the company's developers have created a weapon that projects "long-lived" plasma. This concentrated Mega-Damage fire does not dissipate within 10-20 seconds, but lasts for a period of 1D4 minutes. During this time, a target enveloped in the burning substance will continue to take damage. A well-placed shot of "Napalm-P," as this substance is called, will consume a man in light body armor in a matter of minutes. Only by wiping the sticky substance off can the target hope to survive. The NFT-1 uses specially designed fuel tanks that hold Napalm-P. If the tank is destroyed (called shot, and the tank has 15 M.D.C.), it will explode, inflicting 2D6x10 M.D. to a 30 foot (9.1 m) radius. Weight: 45 lbs (20.5 kg). Mega-Damage: A plasma burst does 3D6 M.D. A concentrated plasma burst (counts as two attacks) does 1D4x10+10 M.D. Or the attacker can cover an area with plasma: up to 10 feet (3.0 m) can be covered with each hand to hand attack, so a character with four hand to hand attacks could affect an area of 40 feet (12.2 m); everybody in the area affected takes 2D6 M.D. Additionally, any target that is hit by the plasma will continue to take damage: 2D6 M.D. every melee round for 1D4 minutes! The only way to save oneself from the damage is to roll in dirt or sand (water will not extinguish the plasma) for one entire melee round (15 seconds), until the plasma is rubbed off. Rate of Fire: Single shot or concentrated burst only. Range: 500 feet (152 m). Payload: A Napalm-P tank holds 100 "shots." Cost: 40,000 credits. A plasma tank costs 2,000 credits and is disposable.

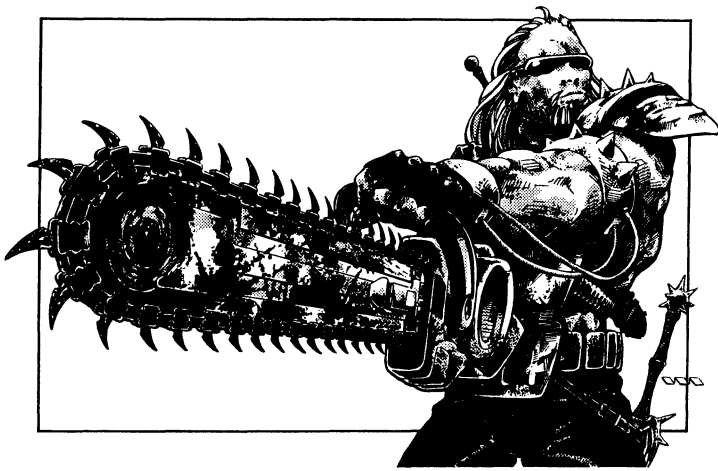

**WI-C8 Close Combat Weapon System.** Also known as the “Juicer Chainsaw,” this Wellington Industries (W.I.) product is nothing more than a chainsaw with M.D.C. teeth, sharpened to a near mono-molecular edge. The saw bits use relatively cheap discarded or recycled M.D.C. alloys (often from damaged or destroyed power armor suits), but the sharpening process is very expensive. The chainsaw motor is powered by an E-Clip, and is powerful enough to cut through almost any material if given enough time. The WI-C8 is very heavy and cumbersome, however. Normal humans who try to use it will be slow and clumsy with it. Juicers, however, have the strength and reflexes to use even this weapon without penalties. Although somewhat archaic and useless in an era of ranged weapons, the chainsaw has a tremendous intimidation value and is a favorite in gladiatorial combat. Weight: 20 lbs (9 kg). Mega-Damage: When activated, the chainsaw inflicts 5D6 M.D. Rate of Fire: Equal to hand to hand attacks. Range: Hand to hand combat only. Payload: The E-Clip powers the chainsaw for one hour of continuous use. Every time the chainsaw is activated, it drains a minimum of one minute’s worth of energy, even if used for less than a minute. Penalties: Can only be used without penalties by characters with a P.S. 22 or higher or supernatural P.S. (any). Weaker characters will be at -4 to strike and -6 to parry. Cost: 30,000 credits.

**WI-CL8 Multi-Purpose Weapon System.** This variant on the Juicer Chainsaw mounts a laser rifle over the saw motor. This adds to the weapon’s weight but gives its user a long-range attack. The heavy weapon requires a minimum P.S. of 24 to fire accurately, otherwise the user is at -3 to strike. Weight: 28 lbs (12.6 kg). Mega-Damage: Chainsaw: 5D6 M.D. Laser: 3D6 M.D. Rate of Fire: Laser: Standard. Chainsaw: Hand to hand. Range: Laser: 2000 feet (610 m). Chainsaw: Hand to hand combat only. Payload: Requires two E-Clips. The laser has 20 shots. The second E-Clip powers the chainsaw for one hour of continuous use. Every time the chainsaw is activated, it drains a minimum of one minute’s worth of energy, even if used for less than a minute. Penalties: -1 to strike with laser or chainsaw even by characters with a P.S. 24 or higher or supernatural P.S. (any). Weaker characters will be at -5 to strike and -7 to parry with the saw and -3 to strike with the laser (the weapon is heavy and unbalanced). Cost: 45,000 credits.

**WI-23 Missile Launcher.** This weapon is a clear improvement over the CR-1 Rocket Launcher and other similar anti-vehicle weapons. The WI-23 is an auto-loading launcher with a six-shot box magazine mounted on the right side of the tube. This allows the user to fire repeatedly without having to rely on a loader. The multi-optics scope is a copy of the CR-1 system, thinly disguised to avoid accusations of patent violations (which are fairly unimportant anyway, since there are few commercial treaties between the CS and other nations). Weight: A fully loaded launcher weighs 26 lbs (11.7 kg), including its payload of 6 missiles. Each box magazine weighs 12 lbs (5.4 kg) fully loaded. Mega-Damage: Any type of mini-missile can be used, but the most common are armor piercing and plasma (1D4x10 or 1D6x10 M.D.). Rate of Fire: Equal to the user’s number of attacks per melee (maximum 6); reloading the magazine takes three melee actions if using a

box magazine, or one full melee round if reloading loose missiles. Range: 1 mile (1.6 km). Payload: Six missiles per magazine. Cost: 30,000 for one launcher and one magazine, 4,000 for each additional magazine, not counting missile costs.

**WI-GL4 Revolving Grenade Launcher.** This weapon has a rotating drum that holds 24 grenades, similar to the 20th-century MM-1 Grenade Launcher! The GL4 uses a slightly heavier grenade than the one made for the *NG-Super Laser Pistol*, inflicting more damage over a wider area. This is a heavy and bulky weapon (-1 to strike if P.S. is below 20), but it is also very intimidating, with a thick, wide barrel poking over the rotating drum of grenade tubes. Weight: 20 lbs (9 kg). Mega-Damage: Fragmentary: 4D6 M.D. to a blast area of 12 feet (3.6 m). Armor-Piercing: 1D4x10 M.D. to a blast area of 3 feet (0.9 m). Can also fire smoke, illumination and chemical rounds. Rate of Fire: As many as hand to hand attacks per melee. Reloading the tubes takes two full melee rounds. Range: 1,000 feet (305 m). Payload: 24 rounds! Black Market Cost: 50,000 credits; fair availability.

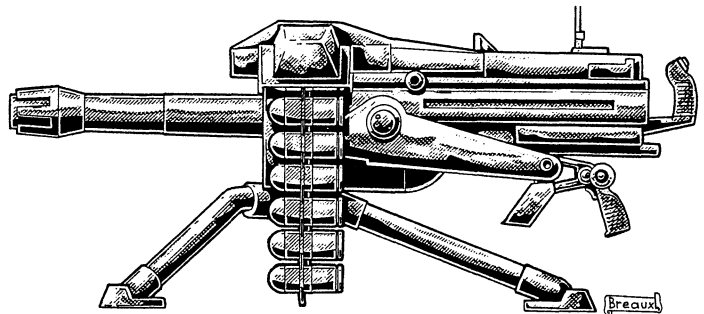

**WI-GL20 Automatic Grenade Launcher.** This weapon resembles a bulky machine-gun that fires grenades from either a magazine or a disintegrating belt. It is designed as a tripod, crew-serviced infantry weapon, or as a vehicle or turret-mounted weapon. Note: A “rifle” model, the WI-GL21, is made for use with power armor and cyborg soldiers and is fundamentally the same as the GL20, except that the user must have a P.S. 22 or higher, is-1 to strike and the rifle model cannot use the ammo-belt feed system. Weight: 130 lbs (58 kg); 150 lbs (68 kg) with ammo belt. Mega-Damage: Fragmentary: 4D6 M.D. to a blast area of 12 feet (3.6 m). Armor-Piercing: 1D4x10 M.D. to a blast area of 3 feet (0.9 m). A burst is 10 rounds! A burst of fragmentary grenades inflicts 2D6x10 M.D. with a blast area of 40 feet (12 m)! A burst of Armor Piercing grenades does 3D6x10 M.D. with an 8 foot (2.4 m) blast radius. Rate of Fire: Standard. Range: 3000 feet (914 m). Payload: 40 round magazine or 200 round belt! Cost: 150,000 credits; poor availability.

**WI-40M Fire & Forget Super-Heavy Missile Launcher.** The WI-40M provides the firepower of a tank (for one melee round) and is advertised as “the heaviest man-portable missile launcher in the world.” That’s partially true. It is man-portable for anyone who can lug its 120 lbs (54 kg) of missile and crude, disposable launch trigger. This means the operator must be a creature with a P. S. of 24 or greater, otherwise it will require two or three men to transport it. The WI-40M is basically a medium-range missile with a plastic launching platform that has a handle and big trigger (big enough for the hand of most powered armor suits and giants). Once the missile is fired, the launching platform is ruined and discarded (the plastic has a recycle value of 2D4x10 credits). The exhaust of the rocket also inflicts 1D6x10 S.D.C. to anything within 15 feet (4.5 m) of the shooter; it won’t affect characters in M.D.C. armor, but will ignite brush fires or explode any fuels and other volatile flammables nearby. Despite those shortcomings, it is a new favorite of power armor pilots and cyborgs. Weight: The missile system weighs 120 lbs (54 kg) and is six feet (1.8 m) long. Mega-Damage: Any medium-range missile can be used. It is usually Armor-Piercing (2D4x10 M.D.), Fragmentation (2D4x10 M.D.) or Plasma/Heat (2D6x10 M.D.). Rate of Fire: One-shot weapon. Range: 10 miles (16 km). The missile has less fuel than a vehicle-mounted medium-range missile. Payload: One. A missile box containing four missiles and

weighing 520 lbs (234 kg) is available. Taking a missile out of its box and aiming it usually counts as two melee actions/attacks. Cost: The firing unit costs 25,000 credits. Missiles cost: 5,000 credits for a High Explosive (light), 8,000 for a High Explosive (medium), and 10,000 for a High Explosive (heavy). Fragmentation, Armor Piercing, and Plasma/Heat missiles cost 12,000 credits. Poor to fair availability.

## Wellington Land Mines.

Wellington Industries has developed its own series of land mines, also known as *Sensor-Controlled Anti-Vehicle Weapon Systems (SAWS)*. Their standard line is identical to Northern Gun's (described previously), but they've also released a more sophisticated, pre-Rifts, anti-vehicle mine. This so-called mine is a sensor suite (radar, laser, seismic, thermographic, all patched into a targeting computer) mated with a missile launcher. The sensors detect and identify vehicles from as far away as a mile (1.6 km), or if an enemy fires at it, and responds with the missile launcher "popping up" from its concealed position. Alternately, the mines can be operated by a human and controlled via remote control radio. The gunner doesn't have to be near the weapon, so he can remain hidden and relatively safe as he designates targets for the missiles. The targeting computer can be programmed to recognize friendly vehicles and fire only upon enemy targets. The recognition program of this "smart bomb" can be limited even further to fire only upon specific enemy targets. The spectrum of targets can be incredibly broad (any moving object larger than a motorcycle) or narrow (a CS UAR-1 only). The sensors can also be programmed to sweep a specific area and not pay attention to the rest of the sector. The SAWS has an 87% accuracy rating, but if damaged, the unit's reliability drops to 43%. If multiple targets appear and there is only one SAWS, the device will pick one (usually the most dangerous, choosing from a priority list) and attack. Multiple SAWS can be radio linked so their computers can work in concert, each firing at a different target or one can fire while the others wait. There are three types of this weapon: *Light SAWS*, *Medium SAWS* and *Heavy SAWS* (each are described below). All are reusable; after it fires it can be moved to a new location (or leave it where it is), reload, reset, and leave. Poor availability; mines are not much used in North America.

**Light SAWS (mini-missiles):** This system consists of 3 mini-missiles in a two-tube launcher inside a square box, which also contains the sensors. The box is buried by the side of a road, in a clearing or other inconspicuous location. Laser and radar sensors can detect a vehicle as far away as one mile (1.6 km), but the effective range is often less than that due to terrain (the sensors cannot read through a hill, buildings, or dense forest, for example). Note: The light SAWS has 20 M.D.C. and can be reused. Combat Bonuses: The missiles are +3 to strike. Even when remotely controlled, do not add the operator's combat bonuses. Mega-Damage: Varies with missile type. Usually armor piercing (1D4x10 M.D.) or plasma (1D6x10 M.D.). Range: 4,000 feet (1,219 m; due to sensor limitations). Rate of Fire: One at a time, or in volleys of two or four missiles. Payload: Six total mini-missiles; three in each launcher. Black Market Cost: 30,000 plus missile cost (about 3000 each).

**Medium SAWS:** Works like the light model, but it uses two medium-range missiles and has a longer range (6,000 feet/1828 m). These SAWS are often placed on top of hills or mountains, where they have a good field of fire. Note: The Medium SAWS has 35 M.D.C.

Combat Bonuses: The missiles are +5 to strike. Even when remotely controlled, do not add the operator's combat bonuses. Mega-Damage: Any kind of medium-range missiles. Usually armor piercing (2D4x10 M.D.) or plasma (2D6x10 M.D.). Range: 6,000 feet (1,828 m) when set on automatic due to sensor limitations, or average 40 to 50 miles (64 to 80 km) when controlled by a human operator equipped with long-range radar. Rate of Fire: Volley of two missiles. Payload: Two medium-range missiles. Black Market Cost: 50,000 plus missile cost (about 15,000 each).

**Heavy SAWS:** This system has the same sensor suite as the Medium SAWS, but it is large enough to accommodate two long-range missiles. The Heavy SAWS is well-armored (55 M.D.C.). The SAWS are often used to defend national borders by some wealthy kingdoms. The sensors will only attack large vehicles or animals (5 tons or greater, unless the sensors are reprogrammed). Note: The Heavy SAWS has 55 M.D.C. Combat Bonuses: The typical missile is +5 to strike, even when remotely controlled; do not add the operator's combat bonuses. Smart bombs are +7 to strike! Mega-Damage: Any kind of long-range missile. Usually plasma/heat (3D6x10 M.D.) or proton torpedo (4D6x10 M.D.). Range: 6,000 feet (1,828 m) when set on automatic due to sensor limitations, or 500 miles (800 km) when controlled by a human operator equipped with long-range radar. Rate of Fire: Volley of two missiles. Payload: Two long-range missiles. Black Market Cost: 65,000 plus missile cost (about 25,000 each).

# Wilk's Laser Technologies

## Various World and Sourcebooks

Wilk's Laser Technologies was born early during the Golden Age of Science, before the Great Cataclysm. With advances in laser technology making leaps and bounds, the time was right for a young entrepreneur by the name of *John Harrington Wilk* to start a fledgling company specializing in laser technologies. His company grew slowly at first, catering to the needs of the various civilian users of the laser, primarily in the medical community. Wilk's laser scalpel was revolutionary and sent company stock soaring. Gradually, Wilk's expanded into the areas of precise laser distancing mechanisms for geographic surveying and construction, security systems, and even acquired a small contract with the ancient American Empire's Armed Forces to build a small number of advanced laser guidance systems. Wilk's Laser Technologies would quickly become a leader in civilian laser manufacturing and number two in the military application of lasers. Within 10 years the company was worth trillions and John Harrington Wilk was heralded as a genius.

When the ley lines erupted and the Cataclysm came, the Wilk's South Dakota factory complex, near Ellsworth Air Force Base, was spared total destruction. As fate would have it, Wallace John Wilk, a rogue scientist and an actual descendant of John Harrington Wilk, discovered the old factory while he and a team of other scientists and scholars were scavenging for ancient relics from Earth's past at old military bases. It took 15 years and a financing deal with the fledgling kingdom of Tolkeen, but by 36 P.A., Wallace Wilk and his associates had the factory up and running. By 59 P.A., Wilk's Laser Industries (its exact location successfully kept secret until 84 P.A.) had become a major manufacturer and arms dealer in North America. It was able to keep a low profile and its location secret for years because Wilk's wholesaled its products to arms dealers including the Black Market/Bandito Arms and Northern Gun.

Around 79 P.A., Wilk's began to actively sell weapons directly to the consumer and opened several gun shops in the West and some of the Eastern 'Burbs. Northern Gun immediately reduced its purchases of Wilk's weapons by 80% and other laser items by 20% (it has also turned to creating cheap copies of Wilk's Remi laser weapons, but hasn't dared to knock-off the distinctive styling of modern Wilk's laser pistols and rifles). Wilk's move into the direct market has not affected its relationship with the Black Market/Bandito Arms in the least. Furthermore, Northern Gun and the Manistique Imperium's recent alliance with the Coalition States has increased sales for Wilk's and Bandito Arms products in Minnesota and with numerous other independent kingdoms and cities who don't wish to support the Coalition States or its allies in any way. This has caused NG and MI to see sales to such clients drop 37%, although the increased business with the CS will guarantee record profits for both.

Initially, Wallace wisely focused on what the Wilk's company had always done best, lasers, and not just guns, but laser distancers, scalpels

and medical equipment, optics, communications and other areas where Wilk's had always made tremendous profits. However, for the last 18 years, Wilk's Laser Technologies has focused on weapon systems and particularly on the burgeoning market in the New West. A move that has made Wilk's number one in the sales of energy handguns and laser rifles. The precision and superior range of Wilk's rifles make them ideal in the wilderness and Wilk's brilliant move to produce laser pistols styled after Old West Remingtons and Colts have made them the most popular weapons in the west, especially among lawmen, cowboys, gunfighters and 'Slingers. Note: Northern Gun has since followed their lead with several cheap knock-offs, although the range of NG energy six-shooters is typically 15% to 20% shorter, the guns 10% heavier, the damage often 1D6 less, and only 10% cheaper.

**Wilk's 210 "Pocket Pistol."** A truly unique and revolutionary design for any of the weapon manufacturers, the 210 Pocket Pistol is inspired by the Derringer. Its small size (it can fit in the palm of the hand) meant that the weapon could not use the traditional E-Clip, so the Wilk's engineers designed a tiny gun with a permanent built-in energy cell. A special "plug-in" hookup allows for the use of an ordinary E-Clip recharger to power up the empty weapon. The 210 has become popular among City Rats, saloon bums, barmaids, gamblers, spies, and thieves because it is easily palmed and concealed (in a garter belt, boot, hat, hand, etc.). Weight: 8 ounces (0.26 kg). Mega-Damage: 1D6 M.D. Rate of Fire: Single shot, each shot counts as a melee action. Range: 400 feet (122 m). Payload: 3 shots. Cost: 8,000 credits.

**Wilk's 227 Pulse Pistol.** The 227 is a small, double-barreled pistol designed for maximum distance and firepower in a small laser handgun. This new weapon has become an instant favorite of mercenaries, soldiers, gunfighters, lawmen, 'Slingers and Juicers. Weight: 2.5 lbs (1.1 kg). Mega-Damage: 2D6 M.D. per single blast, or 4D6 per double blast. Rate of Fire: Standard. Range: 900 feet (274.3 m). Payload: 12 double pulse shots with a standard short E-Clip, 24 shots with a long E-Clip. Bonus to Strike: +2 bonus to strike on an aimed shot because of the light weight and superior balance. Cost: 18,000 credits.

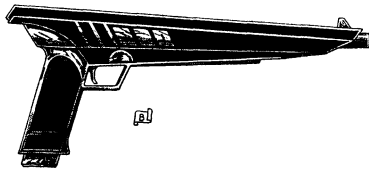

**Wilk's 320 Laser Pistol.** The 320 is the "classic" Wilk's laser pistol known for its durability, range, accuracy and light weight. It is a sleek black, plastic and ceramic weapon popular among most mercenaries and adventurers. Headhunters and city rats are especially fond of the Wilk's series of laser weapons. Weight: 2 lbs (0.9 kg). Mega-Damage: 1D6 M.D. Rate of Fire: Standard, aimed, burst, wild. Range: 1000 feet (305 m). Payload: 20 shots with a standard short E-Clip, 40 shots with a long E-Clip. Bonus to Strike: +2 bonus to strike on an aimed shot because of the light weight and superior balance. Cost: 11,000 credits.

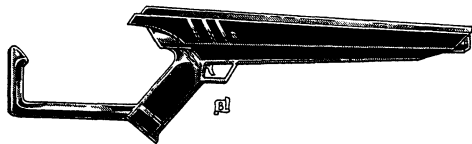

**Wilk's 330 Sniper Laser Pistol.** A heavier version of the 320 with a retractable folding stock for precision shooting. A favorite among bounty hunters, gunslingers, gunfighters, assassins, Juicers and some lawmen. Weight: 2.5 lbs (1.1 kg). Mega-Damage: 2D6 M.D. Rate of Fire: Standard. Range: 1,000 feet (305 m). Payload: 12 shots with a standard short E-Clip, 24 shots with a long E-Clip. Bonus to Strike: +3 bonus to strike on an aimed shot because of the light weight, superior balance and support from the shoulder stock. Cost: 15,000 credits.

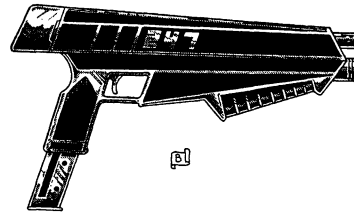

**Wilk's 247 "Hero" Dual Pistol.** The Hero is a dual, over and under laser pistol designed on the principles of the old, automatic submachine-guns. It is designed to pack as much firepower and versatility as possible into a relatively small package. The top barrel is a medium, long-range laser with its own standard E-Clip loaded in the back of the weapon. The lower barrel is a heavy short-range laser with a separate long E-Clip. Weight: 5 lbs (2.3 kg). Mega-Damage: Medium Laser: 2D6 M.D.; Heavy Laser 3D6 M.D. Rate of Fire: Standard. Range: Medium Laser: 1000 feet (305 m). Heavy Laser: 500 feet (152 m). Payload: Medium Laser: 20 shots. Heavy Laser: 32 shots with a long E-Clip-standard (16 with a short clip). Bonus to Strike: +2 bonus to strike on an aimed shot when used with two hands; no bonus if fired with one hand or wild. Cost: 25,000 credits.

**Wilk's 237 "Backup."** The 237 is Wilk's first heavy laser pistol sacrificing range for firepower. It has become an instant hit with bounty hunters, lawmen, gamblers, 'Slingers, Juicers and bandits. Weight: 3 lbs (1.4 kg). Mega-Damage: 3D6 M.D. per single blast or 6D6 per double blast. Rate of Fire: Standard. Range: 500 feet (152 m). Payload: 8 double pulse shots with a standard short E-Clip, 16 shots with a long E-Clip. Bonus to Strike: +2 bonus to strike on an aimed shot because of the light weight and superior balance. Cost: 24,000 credits.

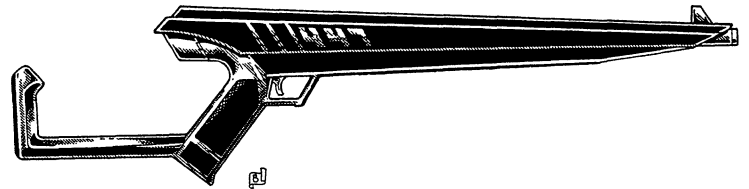

**Wilk's 447 Traditional Laser Rifle.** The sleek, lightweight "classic" Wilk's laser rifle made from Wilk's famous black plastic and ceramic with all the usual features of a Wilk's product. Weight: 5 lbs (2.25 kg). Mega-Damage: 3D6 M.D. Rate of Fire: Standard. Range: 2,000 feet (610 m). Payload: 20 shots standard clip, can not use a long E-Clip. Bonus to Strike: +1 to strike on an aimed shot. Cost: 18,000 credits.

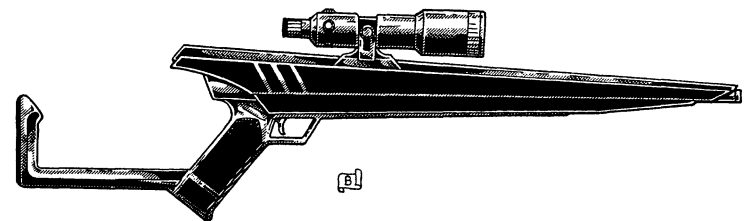

**Wilk's 457 Laser Pulse Rifle.** One of the newer designs from the wizards at Wilk's Laser Industries Inc. is a rapid-fire pulse rifle that has the trademark features of all of Wilk's high quality weapons; sleek, lightweight, black plastic and ceramic construction, long distance firing range, and reliability in the field. Weight: 6 lbs (2.7 kg). Mega-Damage: 3D6+2 M.D. per single shot, or 1D6x10 per multiple pulse burst (three simultaneous shots). Rate of Fire: Standard. Range: 2000 feet (610 m). Payload: 30 single shots per standard long E-Clip or 10 pulse. Bonus to Strike: +1 to strike on an aimed shot. Cost: 40,000 credits.

**Wilk's 547 "Double Dealer."** The 547 has become a very popular weapon throughout the west simply because it takes an already fine weapon and makes it better. Wilk's has taken the popular 447 laser rifle



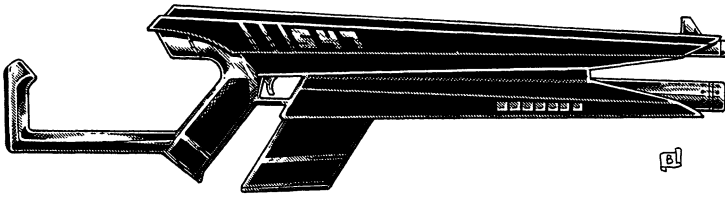

and added a light automatic grenade launcher. The laser provides range and accuracy, the grenade launcher provides area effect firepower. The laser E-Clip fits in the handle (takes standard or long clips), but also has the added feature of a second E-Clip housing in the top, butt end of the weapon which can also take a short or long clip. The grenade magazine fits into the lower housing in front of the trigger. A folding stock provides additional stability. **Weight:** 6.5 lbs (2.9 kg). **Mega-Damage:** Laser: 3D6 M.D. per single shot. Grenade: 3D6 M.D. to a 12 foot (3.6 m) radius. **Rate of Fire:** Laser: Standard (single shot, burst or wild). Grenade Launcher: Each shot counts as a melee action. **Range:** Laser: 2000 feet (610 m). Grenade Launcher: 500 feet (152 m). **Payload:** Laser: 40 shots with a long E-Clip which comes standard with the weapon; 80 with two long clips. Grenade Launcher: Eight; two in the chamber and a six grenade magazine. **Bonus to Strike:** +1 to strike on an aimed shot. **Cost:** 32 000 credits.

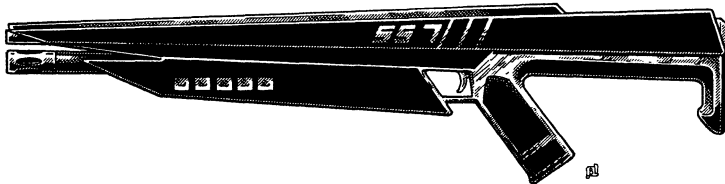

**Wilk's 557 VFALR "Chameleon."** The 557 is Wilk's first production model, variable frequency laser rifle. Designed to combat such laser resistant foes as the Glitter Boy. The VFALR designation stands for Variable Frequency Advanced Laser Rifle. This weapon is a marvel of weapons technology. The variable frequency laser has 24 different light frequencies in its memory and will automatically reset itself after one attack if the target proves to be impervious to that frequency. **Weight:** 6 lbs (2.7 kg). **Mega-Damage:** 2D6 M.D. per single shot or 6D6 per triple pulse burst. **Rate of Fire:** Standard. **Range:** 2,000 feet (610 m). **Payload:** 51 single shots per standard long E-Clip or 17 pulse shots. **Bonus to Strike:** +1 to strike on an aimed shot. **Cost:** 36,000 credits.

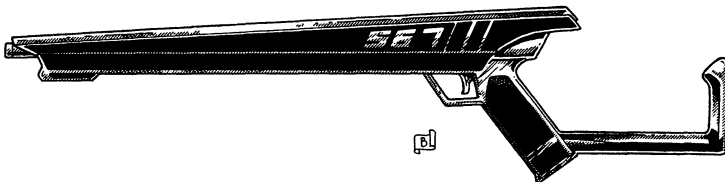

**Wilk's 567 "Long Gun."** The 567 is a versatile rifle with slightly enhanced range and five different damage settings. This gives the shooter a large damage capacity. A laser targeting system is built in (it's the small barrel at the top). A long E-Clip is housed in the upper butt end of the weapon and a short E-Clip in the handle for extra firepower. **Weight:** 6.5 lbs (2.9 kg). **Mega-Damage:** A single blast does 1D6 M.D., a double pulse does 2D6 M.D., a triple pulse does 3D6 M.D., a quadruple pulse 4D6 M.D., or maximum, doing 5D6 M.D. **Rate of Fire:** Standard. **Range:** 2,200 feet (670.5 m). **Payload:** 50 shots for 1-3 dice damage blasts (two E-Clips), or 25 4-5 dice pulse shots (two E-Clips), reduce payload 25% with out the short clip. **Bonus to Strike:** +1 to strike on an aimed shot. **Cost:** 38,000 credits.

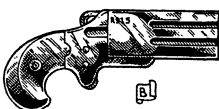

**Wilk's-Remi 104 Derringer.** In a brilliant marketing move, Wilk's has produced a series of weapons that "look" like the revolvers and rifles of the Old West but are really laser pistols. In most cases they are

the rough equivalent to the sleek black ceramic pistol except made out of ceramics and steel, weigh more (which is what gunmen and gunslingers want), have a shorter range, but heavy damage. These are the Wilk's *Remi* models, and the 104 Derringer is the smallest of the lot, a classic looking Derringer similar in design concept to the "pocket pistol." The palm gun is a small, easily concealed weapon designed to fire simultaneous shots for greater damage. This weapon is usually used as either a backup weapon or a purse gun. Like all Wilk's-Remi products, it is very well made. Available with a walnut, ivory or pearl handle. A special "plug-in" hookup allows for the use of an ordinary E-Clip recharger to power up the empty weapon. **Weight:** 10 ounces (0.27 kg). **Mega-Damage:** 2D4 M.D. **Rate of Fire:** Two simultaneous shots. **Range:** 300 feet (91 m). **Payload:** 4 shots. **Cost:** 9,000 credits.

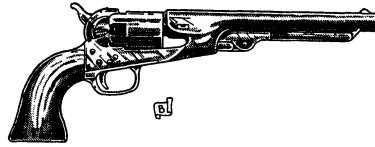

**Wilk's-Remi 130 "Six Shooter."** This is a beautiful revolver that has the look of a Pre-Rifts artifact from the late 1800s, a Remington New Model Army 1863, .45 caliber revolver. This weapon is extremely well balanced and a common sight across the New West. **Weight:** 2.5 lbs (1.1 kg). **Mega-Damage:** 2D6 M.D. **Rate of Fire:** Standard. **Range:** 1,000 feet (305 m). **Payload:** 20 shots with a standard short E-Clip, 40 shots with a long E-Clip. **Bonus to Strike:** +1 bonus to strike on an aimed shot because of the light weight and superior balance. **Cost:** 12,000 credits.

**Wilk's-Remi 136 "Big Man."** This heavy laser pulse pistol is designed to look like the massive Walker Colt .44 caliber revolver, manufactured around 1847. It has become an instant hit with gunslingers, bounty hunters, lawmen, gamblers, 'Slingers, Juicers and bandits. **Weight:** 3 lbs (1.4 kg). **Mega-Damage:** 3D6 M.D. **Rate of Fire:** Standard. **Range:** 600 feet (183 m). **Payload:** 15 shots with a standard short E-Clip, 30 shots with a long E-Clip. **Cost:** 15,000 credits.

**Wilk's-Remi 137 "Kingdom Come."** A heavy, pulse laser pistol designed to look like an 1874 Smith & Wesson .45 caliber revolver; comes standard with a telescopic scope. It has become an instant hit with bounty hunters, lawmen, gamblers, 'Slingers, Juicers and bandits. **Weight:** 3.2 lbs (1.5 kg); the scope adds 6 ounces. **Mega-Damage:** 3D6 M.D. per single blast or 6D6 per double blast. **Rate of Fire:** Standard. **Range:** 500 feet (152 m). **Payload:** 8 double pulse shots with a standard short E-Clip, 16 shots with a long E-Clip. **Cost:** 27,000 credits.

**Wilk's-Remi 147 "Sharp Shooter."** An Old West version of the "classic" Wilk's 447 laser rifle made to look like a Sharp Winchester .50 caliber rifle. **Weight:** 5 lbs (2.25 kg). **Mega-Damage:** 3D6 M.D. **Rate of Fire:** Standard. **Range:** 2000 feet (610 m). **Payload:** 20 shots standard clip, can not use a long E-Clip. **Bonus to Strike:** +1 to strike on an aimed shot. **Cost:** 18,000 credits.

**Wilk's-Remi 150 "Volcanic."** This laser rifle is reminiscent of the old Volcanic manufactured around 1850. The old rifles had the hoop cocking mechanism behind the trigger. In the Wilk's-Remi laser version, it is used to release the spent E-Clip which is concealed in the rifle stock. The weapon has two long barrels that can be fired individually (one shot) or simultaneously (two shots; counts as one melee attack). The 150 is popular because of its firepower and toughness. **Weight:** 6 lbs (2.7 kg). **Mega-Damage:** 3D6 M.D. per single shot or 6D6 simultaneous double blast. **Rate of Fire:** Standard, see Modern Weapon Proficiency Section. **Range:** 2,000 feet (610 m). **Payload:** 34 single shots per standard long E-Clip or 17 double blasts. **Cost:** 34,000 credits.

**Wilk's-Remi 157 "Judgement Day."** This big weapon has been called the pride of the New West, but is only a variation of the Wilk's 457 Laser Pulse Rifle made to look like a classic Winchester 40-82. **Weight:** 6 lbs (2.7 kg). **Mega-Damage:** 3D6+2 M.D. per single shot, or 1D6x10 per multiple pulse burst (three simultaneous shots). **Rate of**

**Fire:** Standard. **Range:** 1,800 feet (548.6 m). **Payload:** 30 single shots per standard long E-Clip or 10 pulse shots. **Cost:** 38,000 credits.

**Wilk's Beehive Laser Grenade.** The Beehive is an "electronic" grenade designed to use laser technology instead of standard chemical explosive technology. The Beehive is designed as an offensive grenade that fires 40 single laser beams out to a 30 foot (9 m) radius from the detonation point. The Beehive is intended for riot control, anti-terrorism and as a means to incapacitate or distract an opponent. **Weight:** 12 ounces (0.35 kg). **S.D.C. of the Grenade:** 20 points; A.R. 10. **Mega-Damage:** Every individual caught in the blast takes 3D6 M.D. Giant-sized individuals take 5D6 M.D. and vehicles the size of a car or bigger take 1D6x10 M.D. **Rate of Fire:** One can be thrown at a time; each tossing of a grenade counts as one melee action. **Throwing Range:** 120 feet (122 m); double with supernatural P.S. **Radius of Effect:** 30 feet (9 m). The entire blast lasts about 1.5 seconds. **Cost:** 1200 credits each (sometimes a 10% bulk discount is available if one orders 72 or more).

**Wilk's Blinder Laser Grenade.** The Blinder Grenade is an "electronic" grenade designed to use laser technology instead of standard chemical explosive technology. It is designed not to injure, but to blind both men and electronics. The high intensity light beams blind anybody without protective eye covering and it happens so fast that it circumvents light adjusting goggles and visions. Victims are blinded for 1D4 melee rounds, -8 to strike, parry and dodge, no initiative and lose two melee attacks, after which the vision is obscured with a dot of light for an additional 2D4 melee rounds; -1 on initiative, -4 to strike, parry and dodge, and lose one melee attack/action. Even those in power armor or vehicles with special light shielding should be momentarily distracted for 1D6 seconds, lose initiative and one melee action. All cameras and optics are also blinded by the sudden intense light (temporarily don't work) but come back on line in 1D4 melee rounds (15-60 Seconds). **Weight:** 12 ounces (0.35 kg). **S.D.C. of the Grenade:** 20 points; A.R. 10. **Note:** Lyn-Srial and Fire and Air Elementals are not affected by blinding light. **Rate of Fire:** One can be thrown at a time; each tossing of a grenade counts as one melee action. **Throwing Range:** 120 feet (36.5 m); double with supernatural P.S. **Radius of Effect:** 30 feet (9 m). The entire blast lasts about 1.5 seconds. **Payload:** One charge/effect per grenade, although if it can be recovered, Beehive grenades can be re-charged at a cost of 800 credits and the Blinder for 200 credits. **Cost:** 400 credits.

**Wilk's Laser Knife.** The laser knife grew out of the technology used for the laser scalpel. Adventurers wanted a hand to hand weapon that was more powerful than the average Vibro-Blade. The laser knife was the first attempt at this. The laser knife projects a stable laser field eight inches (0.21 m) from the generator hilt. The laser is projected in the visible light spectrum and resembles a magic energy blade or Psi-Sword. It is still considered experimental and sold with no warranty and a warning about safety. **Weight:** One pound (0.45 kg). **Mega-Damage:** 3D6 M.D. per strike of the weapon. **Rate of Fire:** As per hand to hand attacks. **Range:** Hand-held like any knife; cannot be thrown (automatic shut off feature). **Note:** The laser knife cannot be used to parry any type of attack: it cuts everything it touches. **Payload:** 30+1D4x10 minutes per standard E-Clip; unpredictable duration. **Cost:** 18,000 credits.

**Wilk's Laser Cane.** Effectively a laser rod disguised as walking sticks/canes in a variety of styles, from simple to the ornate, to the garish and outrageous with silver or gold plating, inset gems, sculpted features and so on. **Weight:** 1-2 lbs (0.45 to .9 kg). **Mega-Damage:** 2D4 M.D. or 2D6 M.D. per blast (add 20% to the cost for 2D6 M.D.). **M.D.C. of the Cane:** 25. **Rate of Fire:** As per hand to hand attacks. **Range:** 800 feet (244 m). **Note:** The cane can be used to parry physical attacks from fists to swords. **Payload:** 20 shots per standard E-Clip; cannot take a long clip. **Cost:** 10,000 credits. Artistic additions can add as little as 500 credits to 30,000 depending on exactly what is done and the materials used, especially when it comes to gems.

**Wilk's Portable Laser Torch (tool).** A wonderful tool for cutting and welding. The laser welding gun has the familiar Wilk's black, lightweight plastic and ceramic construction. A power cord connects the gun to its portable power pack that can be hooked to a belt or fit in a backpack, tool case, or duffel bag. The power pack is charged by two standard weapon E-Clips. The torch has a variety of Mega-Damage and S.D.C. settings. It is designed to be a tool, not a weapon. Welding is normally done only a few feet from the object of the work, but the torch beam can be increased up to ten feet (3 m). The torch can cut through an S.D.C. structure like butter. Remember, one M.D. point is about one hundred S.D.C., thus the torch can slice all around a 600 S.D.C. point metal door in 15 seconds on setting number 1D6 M.D. (1D4 M.D. setting to weld); a higher setting might shoot past the door and hit/hurt someone/thing of value. **Weight:** One pound (0.45 kg). **Mega-Damage:** 1D4, 1D6, 2D4, 3D6, and 4D6 M.D. **S.D.C. Damage:** 1D6, 3D6, 6D6, 1D6x10 S.D.C. **Rate of Fire:** Standard. **Range:** 10 feet (3 m). **Payload:** 100 shots or about two hours of continuous use per pair of E-Clips. **Cost:** 7,000 credits.

**Wilk's Laser Wand (tool).** A small pen or pocket flashlight size item about 6 inches (15 cm) long. It is designed for detail laser work on electronics. The handy little device has one Mega-Damage setting and four S.D.C. settings. It is designed for close work, one to three feet (.3-9 m), and not meant to be a weapon. **Weight:** Two ounces. **Mega-Damage:** One M.D. point. **S.D.C. Damage:** 1D4, 1D6, 2D6, or 3D6 S.D.C. **Rate of Fire:** Standard. **Range:** 10 feet (3 m). **Payload:** 50 shots. **Cost:** 2,000 credits. Mini-Energy clip costs 200 credits.

**Wilk's Laser Scalpel.** This is a laser tool designed for delicate surgery. The scalpel has several settings for under one S.D.C. point of damage and can inflict as much as 1D6 S.D.C. points. It is not meant to be used as a weapon. Range is six inches (15 cm). **Cost:** 2,500 credits.

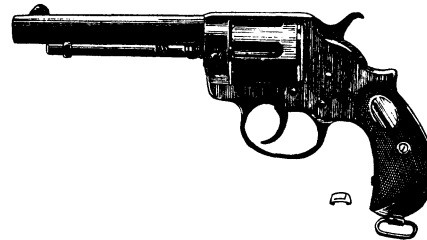

## CFT Experimental "Cartridge" Weapons

Wilk's has also developed a revolutionary "cartridge" energy weapon system specifically with the frontier of the New West in mind. Fearing this new, experimental (and very different) product might be poorly received by the public, Wilk's Laser Technologies decided to release it under the brand name of CFT. This way, if the CFT energy cartridge system (known as the CFT Energy Six System) failed, it would not have a negative impact on the sterling reputation of Wilk's. CFT handguns hold 6 to 12 small energy rounds that have the same general appearance and size of a standard .44 to .45 caliber or 9-10 mm bullet. The energy contained in each round/bullet is totally expended in a single coherent blast the moment the weapon is fired. The spent energy cartridge/bullet is worth only about 25 cents per shell casing and is usually discarded. To Wilk's delight, the CFT Energy-6 weapons have been a huge hit in the West, particularly among gunslingers, gunfighters, bandits, gamblers and average citizens looking for protection or a bit of excitement and power. The big advantages to CFT weapons are that the gun is comparatively inexpensive, one can buy as many or as few E-6 cartridges as he wants (or can afford), the cartridges should last for 8-10 years without losing power, anybody used to handling a gun (i.e. has a W.P. Revolver or W.P. Pistol skill) can use a CFT "energy" gun, and the energy blasts do good amounts of damage. CFT weapons have four notable disadvantages, most of which don't seem to bother the users of these popular weapons: 1. Limited payload (6-10 rounds) depending on the type of weapon. 2. Limited range: about half to a third the range of a conventional energy pistol. 3. CFT Revolvers re-

quire manual removal of the spent shells and reloading; pistols will have a clip. 4. The discharge of energy has a recoil, or “kick,” like a conventional revolver or pistol; something that many Westerners like (it keeps with tradition and has the look and feel of a real S.D.C. six-shooter but with Mega-Damage power). **Note:** Although these weapons have been designed to look like old-style Colt revolvers (6 shots) and automatic pistols (10 shots), the CFT Energy Six System weapons require a special gun made from M.D. materials to fire the E-6 cartridge. If desperate enough, a character may try to fire a CFT E-6 cartridge from a conventional revolver or pistol. However, there is a 01%-65% likelihood that the round will explode in the gun and inflict double damage to the shooter (roll for each shot/attempt); this is a good way to lose fingers or a hand. If the energy round is successfully discharged, the range is half and firing more than two E-6 rounds a minute will melt the gun, fusing parts together and making it useless junk (irreparable damage). The cost of each E-6 round is 320 credits or 29,700 cr. for a box of 96 (roughly a 1000 credit savings). The CFT weapons are not illustrated because they look like the classic Colt revolvers of the old west and similar to those already shown.

**CFT “Peacebringer.”** The “Peacebringer” is modeled after the long-barreled, single-action Army or “Peacemaker” Colt .45 caliber revolver, circa 1872-1900; used by the likes of Wyatt Earp, Bat Masterson, Neal Brown and other legendary figures from the Old West. Like its ancient predecessor, the Peacebringer is one of the finest handguns available. It is reliable and sturdy enough to sustain rough use in the field of combat as both a reliable shooting iron and as a club, used to hit an opponent over the head or alongside the ear with the barrel or handle. This weapon is handcrafted and is commonly found with such added features as pearl, bone, or wooden grips. It has good accuracy and balance, but nothing impressive enough to provide bonuses to shoot. **Weight:** 3 lbs (1.4 kg). **Mega-Damage:** 2D6+3 M.D. **Rate of Fire:** Each single shot counts as one melee action/attack. **Range:** 500 feet (152 m). **Payload:** Six-shot revolver; it takes one melee round (15 seconds) to reload, unless a Gunslinger, Lawman, Gunfighter, or Bounty Hunter O.C.C., in which case it takes half a melee round and uses up half the character’s attacks that (or the next) melee round. **Cost:** 4,400 credits for the gun; each E-6 round costs 320 credits.

**CFT “1886er” or “86er.”** The “86er” is a short-barreled, single-action Army .45 caliber Colt revolver, also known as the “Frontier Six-Shooter” or “Hog Leg,” circa 1870-1886. It is a big gun that commands respect and is well known for its durability. It does a bit more damage but has shorter range. **Weight:** 3 lbs (1.4 kg). **Mega-Damage:** 3D6 M.D. **Rate of Fire:** Each single shot counts as one melee action/attack. **Range:** 300 feet (91 m). **Payload:** Six-shot revolver; it takes one melee round (15 seconds) to reload, unless a Gunslinger, Lawman, Gunfighter, or Bounty Hunter O.C.C., in which case it takes half a melee round and uses up half the character’s attacks that (or the next) melee round. **Cost:** 4,800 credits for the gun; each E-6 round costs 320 credits.

**CFT “Auto-Shooter.”** A .45 caliber automatic pistol with a 10 shot clip, designed to look like the old Colt Government Model M1911A1. **Weight:** 2.7 lbs (1.2 kg). **Mega-Damage:** 3D6 M.D. **Rate of Fire:** Single shot (each shot counts as a melee action) or automatic (can fire bursts; standard: aimed, burst, wild). **Range:** 300 feet (91 m). **Payload:** 10 shot pistol; when the ammo-clip is empty, pop out the old one and slap in a new one. It takes one melee round (15 seconds) to reload a spent clip. **Cost:** 6,500 credits for the gun; each E-6 round costs 320 credits.

**CFT “Cavalryman.”** The Cavalryman is one of only two CFT rifles available, namely because the individual E-6 cartridges do not offer enough range to match modern energy rifles, or even most energy pistols. The tiny cartridges just do not hold enough power to propel the blast any great distance. It looks much like the old Spencer rifles from the Old West, circa 1865-1880. **Weight:** 4 lbs (1.8 kg). **Mega-Damage:** 2D6+3 M.D. **Rate of Fire:** Each single shot counts as one melee action/attack. **Range:** 600 feet (183 m). **Payload:** Six-shot rifle; it takes one melee round (15 seconds) to reload, unless a Gunslinger, Lawman,

Gunfighter, or Bounty Hunter O.C.C., in which case it takes half a melee round and uses up half the character’s attacks that (or the next) melee round. **Cost:** 8,800 credits for the gun; each E-6 round costs 320 credits.

**CFT “Rangemaster.”** The “Rangemaster” is a favorite in the New West for its range, versatility and accuracy. The “Rangemaster” is designed to use both a conventional E-Clip (for long range and rapid-fire) and E-6 cartridges (for short range and power). The weapon can switch from one to the other with the flick of a switch. The Rangemaster is designed to resemble a Winchester Model 1876 carbine. **Weight:** 5 lbs (2.25 kg). **Mega-Damage:** Conventional laser: 2D6 M.D.; E-6 charge: 3D6 M.D. **Rate of Fire:** Standard or single shot. **Range:** Conventional Laser: 2000 feet (610 m). E-6 Cartridge: 600 feet (183 m). **Payload:** Conventional Laser: 20 shots standard clip or 40 from a long E-Clip. E-6 Charge: Six; reloaded by hand. **Bonus:** +1 to strike on an aimed shot. **Cost:** 20,000 credits for the rifle with a standard (20 shot) E-Clip, plus the cost of E-6 rounds, 320 credits each.

## Xiticix Weapons

### World Book 23: Xiticix Invasion™

The ranged, Mega-Damage TK guns of the Xiticix are the same as they’ve always been, but now that these alien predators are properly classed as *aliens* with supernatural strength, their melee weapons are to be considered M.D.C. weapons. They are made from the same Mega-Damage resin that goes toward building the hive. Only this is “pure” resin, making them strong and difficult to break, even for the supernaturally strong Xiticix. In most cases, the weapon M.D. is added to the character’s supernatural punching damage, described under each R.C.C. entry. If used by an ordinary human, D-Bee, Headhunter or basic cyborg, then only use the weapon’s M.D. (because the character normally inflicts only S.D.C. damage). The four-armed Xiticix fighters are likely to be armed with 2-4 different weapons and may use a different weapon for each melee attack.

### Xiticix Weapon Notes

- Captured Xiticix weapons are sometimes adopted by Juicers, Cra-zies, Headhunters, ‘Borgs, dragons, demons and other super-strong beings as well as reasonably strong (P.S. 21 or higher) Wilderness Scouts, Woodsmen, Native Americans, Psi-Stalkers, Noli-Bushmen, Simvan, Groot Hunters, Mastadonoids, and other D-Bees. The Coalition Military *never* uses Xiticix weapons and usually destroys any they acquire.
- Resin weapons are rare outside of Xiticix Territory, i.e. Manitoba, Minnesota, North Dakota and Northern Wisconsin. Most are commonly found in the hands of Psi-Stalkers, Groot Hunters and Noli-ushmen living in southern Canada (namely southern Manitoba and western Ontario) or the middle northern United States, mainly the Dakotas, Minnesota, and Wisconsin.
- Xiticix weapons tend to be large and heavy by human standards (typically 2-5 times heavier than a comparable human weapon), making them awkward to use by humans and D-Bees. This is because they are made of heavy concrete-like resin sometimes reinforced with shards and scraps of M.D.C. materials underneath as part of the weapon’s framework. Of course, the weight means nothing to these supernaturally strong insectoids.
- Ultimately, anybody strong enough to wield the weapon (typically P.S. 21 or greater) can use them. However, weaker characters strike and parry *without* benefit of attribute or skill bonuses. Characters with *Supernatural Strength* use them the same as Xiticix, without penalty.
- Most resin weapons appear to be crude and look as if they were carved from stone or molded from concrete. This concrete appearance is accentuated by their light gray or grayish tan color and rough surface texture.

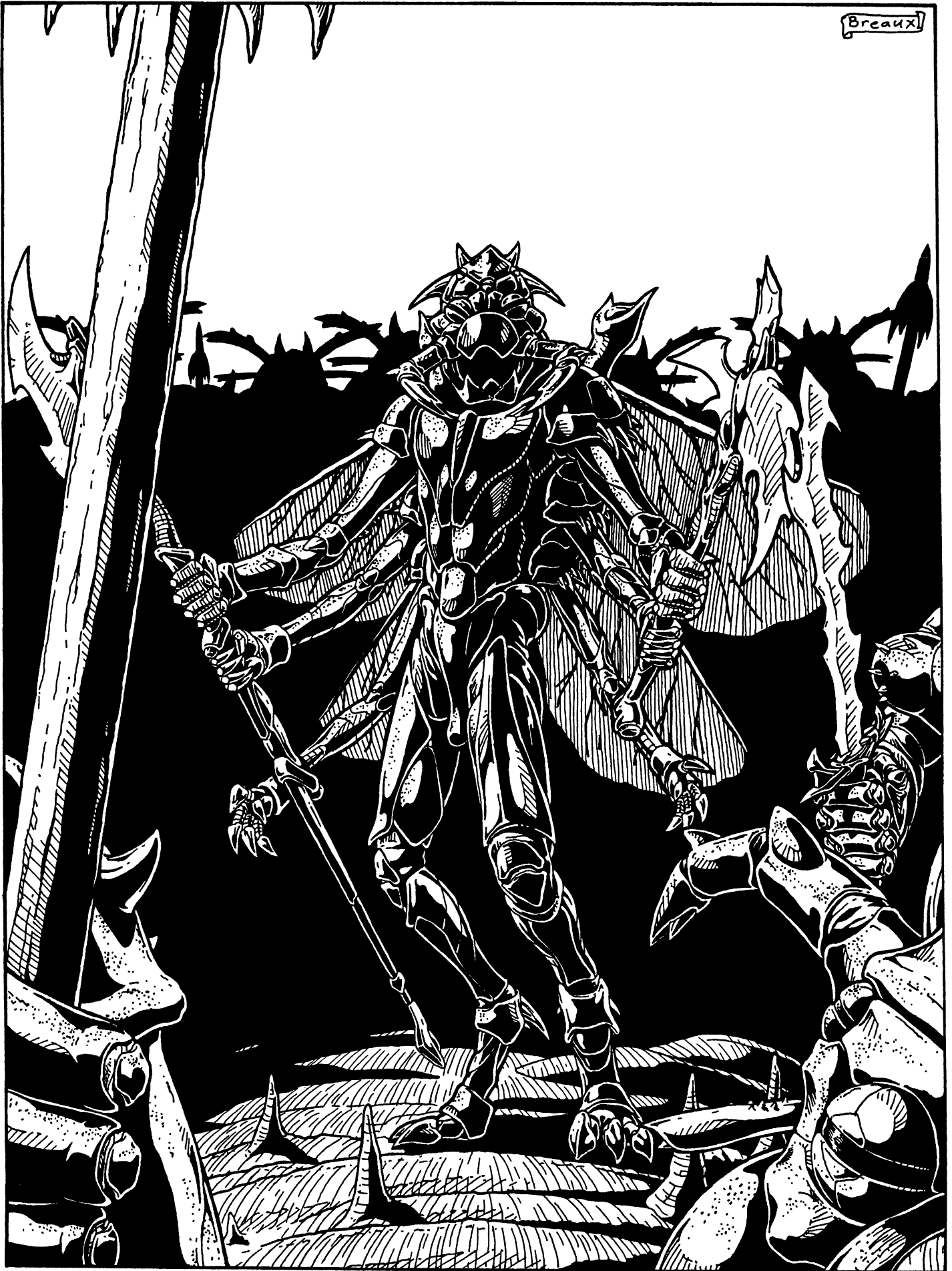

- The Xiticix rarely use weapons not of Xiticix manufacture, meaning they will never use human or D-Bee energy weapons but, in a pinch, may use a melee weapon such as a Vibro-Blade, club or magic weapon. However, once the crisis that forced them the use a non-Xiticix weapon is over, they will discard it.

## Known Xiticix Weapons

**Xiticix Bayonet & Hand-Held Knives.** This weapon is a simple, narrow, resin blade, sharp on both edges and designed for stabbing and slashing. The bayonet is a standard feature on the Xiticix TK Rifle and is sometimes adhered to the body of Warriors and other fighting class Xiticix as extra spikes to be used in combat or to look more menacing. Weight: 3-4 lbs (1.3 to 1.8 kg). Mega-Damage: 1D4 M.D. from the weapon +Supernatural P.S. punching damage. Cost: 3,000-5,000 credits; rarely on the market for humanoids.

**Xiticix Double-Dagger.** A rather long and unusual weapon with a handle in the middle and a long, curved knife or short-sword blade at both ends. It is used by all fighting classes of Xiticix, but is a favorite of the *Super-Warrior* and *Leaper*. Both of these murderous combatants are skilled with twirling and using the twin-bladed weapon in one hand. The blade is designed so that one end is facing out to be used as a knife, while the other rests flush against the arm. This latter position enables the user to parry incoming attacks with the flick of his wrist and quickly counterstrike or parry and hit an enemy coming up from the side or behind. Weight: 6-7 lbs (2.7 to 3.1 kg). Mega-Damage: 2D4+2 M.D. from the weapon +Supernatural P.S. punching damage. Leapers (not Super-Warriors) frequently coat the weapon with their lethal M.D. poison to inflict considerably more damage. Poison Damage: 1D4x100 S.D.C./Hit Points to humans and most D-Bees, plus the victim (if he survives) sees all combat bonuses reduced by half and attacks per melee are -1. Mega-Damage creature such as dragons and demons will suffer 4D6 M.D., plus 1D6 M.D. additional damage at the beginning of each new melee round for 1D6 melees!

Save vs Poison: A roll of 14 or better to save vs lethal poison (include bonuses to save if applicable) means the character suffers only 10% of the poison damage, but still suffers from the penalties for 1D6 melee rounds.

Note: The poison does its full damage because the blades of the Double-Dagger are designed to hold the poison (they positively drip with venom) and because the poison is freshly secreted by the Leaper so it is at full strength. Covering the blades counts as one melee action/attack. The poison is only effective against opponents who have exposed skin, because the weapon must cut flesh to inflict damage. On arrows and spears, the dose of poison is only good for one hit, but on the Double-Dagger, swords, axes and other large blade weapons, the poison can inflict damage from two cutting attacks before it is sufficiently wiped clean from the blade. (See the description for #4. *Poisonous Bite* described under the Natural Abilities of the Xiticix Leaper, page 58, in *Rifts® World Book 23*, for complete details on the poison.)

Range: Hand-held melee weapon, but can be thrown (without bonuses) up to 50 feet (15.2 m). -1 to strike for each additional 10 feet (3 m). Bonuses: +1 to strike and +2 to parry when used in hand to hand combat; bonuses do not apply when thrown. Cost: 10,000-15,000 credits; very rare on the humanoid market, and the poison is rarer still.

**Xiticix Hooked Short Sword.** The Xiticix are fond of hooked and curved blades with serrated edges. The Hooked Short Sword is a weapon used for combat, parrying and disarming opponents (catching one's adversary's weapon with the hook and twisting in such a way as to disarm him). The heavier tip makes the weapon good for chopping and the serrated part enables the Xiticix to use the sword as a saw to cut through M.D.C. cables, chains, pillars and supports. Weight: 8-10 lbs (3.6 to 4.5 kg). Mega-Damage: 1D6 M.D. +Supernatural P.S. punching damage. Bonuses: +1 to strike, +2 to parry, +3 to disarm. Cost: 8,000-12,000 credits; uncommon.

**Xiticix Mace or Morning Star.** This is a large club that ends with a spiked ball. It is used as a hammering weapon that can be used one-

two-handed by the Xiticix. Weight: 14-18 lbs (6.3 to 8 kg). Mega-Damage: 1D6+4 M.D. +Supernatural P.S. punching damage. Bonuses: +1 to parry and +1 to disarm. Cost: 11,000 to 15,000 credits; rare on the humanoid market.

**Xiticix Long Sword.** This is a large weapon that can be used two-handed or one-handed by the supernaturally strong Xiticix. Weight: 12-15 lbs (5.4 to 6.75 kg). Mega-Damage: 2D6 M.D. +Supernatural P.S. punching damage. Bonuses: +1 to parry and +1 to disarm. Cost: 12,000-15,000 credits; uncommon on the humanoid market except among wilderness folk.

**Xiticix Spear.** The spear is among the Xiticix Warriors' favorite weapons and can be used as a stabbing, parrying, blunt (when using the end without the blade) and throwing weapon. Its versatility also means it can be used one-handed or two. Weight: 10-12 lbs (4.5 to 5.4 kg). Mega-Damage: 1D6+3 M.D. as a stabbing, slashing or thrown weapon + Supernatural P.S. punching damage, but only 1D4 M.D. +P.S. punch damage as a blunt weapon. Range: A hand-held melee weapon that can be thrown effectively (by Xiticix) up to 300 feet (91 m) away. 120 feet (36 m) by most strong characters (bionic or robot P.S. of 21 or higher) and only about 60 feet (18.3 m) for most humans and D-Bees. Bonuses: +1 to disarm and +2 to parry. +3 to strike when thrown. Cost: 7,000 to 10,000 credits; uncommon on humanoid market except among wilderness folk.

**Xiticix Spike Whip.** This resin-molded weapon is a wicked looking spiked ball attached to a length of cord/fiber and used like a classic ball and chain weapon. The handle end has a small spike or blade built into it, allowing the Xiticix Warrior to use it as a dagger and to parry attacks. Weight: 12-15 lbs (5.4 to 6.75 kg). Mega-Damage: 1D6+4 M.D. +Supernatural P.S. punching damage. Range: Hand-held melee weapon with an extended 5-6 foot (1.5 to 1.8 m) range/length from the hand to the whipping ball of the weapon. Bonuses: +1 to strike, +3 to disarm, +2 to entangle. Can not be thrown well. Bonuses do not apply if the character does not also have W.P. Ball & Chain or W.P. Whip. Cost: 10,000 to 14,000 credits; rare.

**Xiticix Beheading Axe.** This is big two-handed weapon ends with a large axe blade. It is a favorite of Xiticix Warriors and especially Super-Warriors. The muscle put behind this two-handed blade makes it a truly lethal weapon. Weight: 15-20 lbs (6.75 to 9 kg). Mega-Damage: 1D6+3 M.D. + Supernatural P.S. punching damage when used one-handed, and bonuses listed below do not apply. Or 2D6+6 M.D. +Supernatural P.S. damage when used two-handed! The bonuses listed for the axe apply only when used two-handed. Range: Hand-held melee weapon. Bonuses: +3 to strike and +1 to parry. Can not be thrown well, and is -6 to strike (no bonuses), with an effective range of 20 feet (6.1 m); -2 per each additional 10 feet (3 m). Cost: 15,000-18,000 credits; rare.

**Xiticix Sickle Axe.** The Sickle Axe is used by Warriors and fighters as a weapon and by Workers as a tool to dig through the earth and chop through rock. The wider, flatter blade is the axe part, while the narrow curved blade is more like a pick. Weight: 10-12 lbs (4.5 to 5.4 kg). Mega-Damage: 1D6+4 M.D. +Supernatural P.S. punching damage. Range: Hand-held melee weapon, but can be thrown (without bonuses) up to 50 feet (15.2 m). -1 to strike for each additional 10 feet (3 m). Bonuses: +2 to strike and +1 to parry. +1 to strike when thrown. Market Cost: 12,000 to 15,000 credits; uncommon.

**Resin Claws.** A three blade claw that is attached to the hand of Xiticix Warriors. Only fighting class Xiticix may get this enhancement. Similar spikes and blades may be attached to the forearm, elbows, shoulders, and knees. Weight: 8-10 lbs (3.6 to 4.5 kg). Mega-Damage: 1D6 M.D. + Supernatural P.S. punching damage. Bonuses: +1 to parry and +1 to disarm. Cost: Available only to Xiticix. Note: Can be created and applied by the Digger or Queen.

**Resin Shoulder Spikes.** Additional armor and protection for the shoulder of the fighting class Xiticix, most commonly used by Warriors and Leapers. Weight: 10-12 lbs (4.5 to 5.4 kg). M.D.C. Bonus: +15 to M.D.C. of the arm and it must be destroyed before the upper arm can

be severed. **Mega-Damage:** +1D6 M.D. to shoulder blocks and ram attacks. **Cost:** Available only to Xiticix. **Note:** Can be created and applied by the Digger or Queen.

**Resin Spike Gun.** A submachine-gun type of automatic weapon or small assault rifle that fires resin spikes. Used only by the Warriors. **Weight:** 20 lbs (9 kg). **Mega-Damage:** 1D6 M.D. per three spike burst; otherwise 2 M.D. per single shot. Comes standard with a Bayonet (1D4 M.D.). **Range:** 400 feet (122 m). Defenders can attempt to dodge but do so with a penalty of -6. **Rate of Fire:** Each three spike burst counts as one melee attack/action. Roll once to strike, either all the spikes in the burst hit or all miss. **Payload:** 60 rounds for 20 bursts. It costs 24 P.P.E. or 48 I.S.P. to magically recreate the shooting spikes. Reloading can be done by the shooter or a Xiticix Queen. **Cost:** 90,000-120,000 credits; considered a Techno-Wizard weapon and is very rare. **Note:** Can only be created by the Queen; rare.

**Shooting Shoulder Spikes.** This is effectively a Techno-Wizard weapon somehow created by the Queen (nobody has ever seen it done). Presumably this is some sort of instinctive ability, because the types of Techno-Wizard-like weapons are extremely limited, and magic is not normally known or practiced by the Xiticix. **Weight:** 10-12 lbs (4.5 to 5.4 kg). **M.D.C. Bonus:** +15 to M.D.C. of the arm and it must be destroyed before the upper arm can be severed. **Mega-Damage:** +1D6 M.D. to shoulder blocks and ram attacks. A flying resin projectile does one M.D. point of damage. **Range:** 60 feet (18.3 m); no bonuses to strike apply. Defenders can attempt to dodge but do so with a penalty of -3. **Rate of Fire:** One at a time or in volleys of 2, 4 or 6. Whether one or a volley is fired it counts as one melee action/attack. Roll once to strike, either all the spikes in the volley hit or all miss. **Payload:** 12; costs 12 P.P.E. or 24 I.S.P. to magically recreate the shooting spikes. Reloading can be done by the user or a Xiticix Queen. **Cost:** Available only to Xiticix. **Note:** Can only be created by a Queen.

**Resin Spitter.** Also known as the "Resin Gun" or "Glop Rifle," this weapon fires globs of quick-drying resin similar to the concrete-like material produced by the Digger and Queen used for building. As noted, each glob represents about three feet (0.9 m) of resin which is enough to cover roughly half of a human-sized target. A creature must be covered halfway to suffer the penalties listed below. And to be restrained completely, the character must be "globbed" twice, once at the feet and legs, and once above the waist. Meanwhile, a twelve foot (3.6 m) creature would have to be hit twice just to cover the feet and legs, and four times to have his entire body covered from shoulders to toes. **Weight:** 40 lbs (18 kg); most humanoids must use two hands to aim and shoot, otherwise they are -4 to strike. Beings with supernatural strength, or a bionic or robot P.S. of 30 or higher, can fire the rifle with one hand. **Damage:** None per se, but the heavy goop clings to the clothes, body armor and the body and impairs movement. It is very sticky, difficult to remove and quickly hardens in 1D4+1 melee rounds (30-75 seconds)! Comes standard with a Bayonet (1D4 M.D.). **Rate of Fire:** Twice every round (15 seconds), with each glob attack counting as one of the shooter's melee actions/attacks. **Range:** 240 feet (73 m). **Payload:** 8 blasts. Requires 30 P.P.E. or 60 I.S.P. to recharge/reload with 8 more resin glob attacks. **Cost:** 130,000-160,000 credits; considered a Techno-Wizard weapon and is very rare. **Note:** Only the Queen can create a working resin gun. Nobody knows exactly how she does it. Super-rare.

**TK-Rifle.** The TK-Rifle works very similar to the principles of Techno-Wizardry and the TK-Machine-gun. **Weight:** 20 lbs (9 kg). **Mega-Damage:** 4D6 M.D. per blast. Comes standard with a bayonet (1D4 M.D.). Warriors may secrete their poison on the blade. **Range:** 4000 feet (1219 m). Defenders can attempt to dodge but do so with a penalty of -6. **Rate of Fire:** Each three spike burst counts as one melee attack/action. Roll once to strike, either all the spikes in the burst hit or all miss. **Payload:** 40 blasts. It costs 20 P.P.E. or 40 I.S.P. to magically recharge. Reloading can be done by the shooter or a Xiticix Queen. **Cost:** 110,000-150,000 credits; considered a Techno-Wizard weapon and is rare. **Note:** Can only be created by the Queen. Uncommon.

# Equipment

**Note:** The prices listed are for average, good to very good, quality items. Generally, double or triple the price for truly fancy/dress articles and multiply the price by 5-10 times for expensive, luxurious custom-made articles. This section covers everyday items and clothes to electronics and medical equipment. You asked for it, so now you've got it.

## Adventuring & Camping Equipment:

- Air Filter (12, disposable): 5 credits (cr.)
- Animal Trap, small: 30-50 cr.
- Animal Trap, large/bear/wolf: 120 cr.
- Backpack, large, high quality: 100-200 cr.
- Backpack, small, high quality: 40-100 cr.
- Bandages, Self-Adhesive (box of 72; various sizes): 5 cr.
- Bandages (6 foot/1.8 m roll): 5 cr.
- Bandoleer (with pouches and/or belt loops): 12-25 cr.
- Belt, Ammo (with six pouches; military style): 10-15 cr.
- Belt, Utility (military style): 3-5 cr.
- Bicycle (basic): 60-100 cr.
- Bicycle (heavy duty, mountain bike): 300-600 cr.
- Bedroll: 30 cr.
- Blanket, Heavy: 20 cr.
- Blanket, Light: 10 cr.
- Canteen: Aluminum: 30 cr.
- Canteen: Plastic: 20 cr.
- Canteen: 2 M.D.C.: 2200 cr.
- Chain, Light, per foot (0.3 m): 3 cr.
- Chain, Heavy, per foot (0.3 m): 6 cr.
- Chain, 1 M.D.C., per yard/meter: 700 cr.
- Cigarettes (16 in a pack): 2-6 cr.
- Cigarette Lighter (refillable): 10-25 cr.
- Cigarette Lighter Fluid: 6 credits per 16 ounce can.
- Compass: 50-150 cr.
- Cross/Crucifix (wood; 8-12 inches): 2-10 cr.
- Cross/Crucifix (silver; 4-6 inches): 80-150 cr. (double for gold)
- Cross/Crucifix (silver, 8-12 inches): 200-400 cr. (double for gold)
- Disposable Lighter or Box of 200 matches: One cr.
- Duffle Bag: 25-80 cr.
- Fishing Line: Per 50 feet/15 m: 5 cr.
- Fishing Net: 20 cr.
- Fishing Rod and Reel: 50 cr.
- Flashlight, large: 12-20 cr.
- Flashlight, pen/pocket size: 6 cr.
- Frying Pan (small): 8-10 cr.
- Frying Pan (medium): 10-15 cr.
- Frying Pan (large): 15-25 cr.
- Gas Mask (human-size): 50-80 cr. (half that used)
- Gas Mask (larger than human): 80-120 cr.
- Grappling Hook and Line (100 feet/30 m): 80 cr.
- Hammer (average, metal): 10-20 cr.
- Hammock: 50 cr.
- Hand Axe/Hatchet (does 1D6 S.D.C. damage): 15-30 cr.
- Insect Repellent: 4 cr.
- Knapsack: 50-100 cr.
- Knife, Large (does 1D6 S.D.C. damage): 20-100 cr.
- Knife, Skinning (does 1D6 S.D.C. damage): 80-200 cr.
- Knife, Small (does 1D4 S.D.C. damage): 15-75 cr.
- Knife, Survival (does 1D6 S.D.C. damage): 120-300 cr.
- Knife, Survival Commando (does 2D4 S.D.C. & can saw wood): 180-500 cr.
- Knife, Throwing (does 1D6 S.D.C.): 200-600 cr.

Knife, Silver Plated: +100 credits to normal cost of the weapon.  
 Machete with canvas sheath (does 2D4 S.D.C. damage): 40-100 cr.  
 Magnifying Glass (small): 5 cr.; double for large.  
 Mallet (small): 2-4 cr.  
 Mallet (medium): 4-8 cr.  
 Mallet (large): 10-15 cr.  
 Marker Pen (1): 1 cr.  
 Marker Pens (dozen): 6-8 cr.  
 Mechanical Pencil (1): 2-5 cr.  
 Mechanical Pencil lead (24 in a pack): 10 cr.  
 Microscope (basic): 50-100 cr.  
 Mosquito Netting, per square yard/meter: 12 cr.  
 Note Book/Pad (small, 100 pages): 1 cr.  
 Pillow: 10-25 cr.  
 Pocket or Signal Mirror: 2-5 cr.  
 Rappelling Equipment: 1200 cr.  
 Rope Ladder, per 10 feet (3 m): 40 cr.  
 Rope, Per 20 feet/6 m: 15 cr.  
 Saddle (simple): 200-400 cr.  
 Saddle (fancy): 700-1,500 cr.  
 Sketch Book (100 sheets, soft-cover): 4 cr.  
 Sketch Book (100 sheets, hardcover): 8-12 cr.  
 Sleeping Bag: 110-160 cr.  
 Snare Cord, per yard/meter: 5 cr.  
 Soldering Iron: 20-50 cr.  
 Spikes (6, iron): 6 cr.  
 Spikes/Wooden Stakes (6, wood): 4 cr.  
 Tackle Box: 20-40 cr.  
 Tape, Clear (all tapes have about 12 ft/3.6 m): 1 cr.  
 Tape, Electrical: 3 cr.  
 Tape, Duct: 3 cr.  
 Tape, Masking: 2 cr.  
 Tent Canvas, per square yard/meter: 20 cr.  
 Tent, Four-Man: 300-500 cr.  
 Tent, Two-Man: 150-200 cr.  
 Tent, One-Man: 100-150 cr.  
 Tent, Military Command Post (25 pounds/11 kg, 8x8 foot floor, 5 foot ceiling/2.4x2.4x1.5 m; camo-green or khaki): 500 cr.  
 Utensil Kit (knife, fork, spoon set with sheath): 25 cr.  
 Web Vest (military style shoulder belt): 10-15 cr.  
 Welding Torch & Tank: 100-300 cr.

## Containers:

Backpack, large, high quality: 100-200 cr.  
 Belt Purse (attaches to belt): 10 cr.  
 Canteen, half gallon (1.9 liters; 20 S.D.C.): 10-20 cr.  
 Canteen, half gallon (1.9 liters; 4 M.D.C.): 2000 cr.  
 Cask, Wooden, 4 gallons (15 liters): 30 cr.  
 Cask, Wooden, 10 gallons (38 liters): 40 cr.  
 Cask, Wooden, 25 gallons (95 liters): 60 cr.  
 Cask, Wooden, 50 gallons (189 liters): 100 cr.  
 Cask, Wooden, 100 gallons (378 liters): 170 cr.  
 Cloth Handle Bag: 10-20 cr.  
 Crate, Large Wooden: 50 cr.  
 Crate, Medium Wooden: 35 cr.  
 Crate, Small Wooden: 20 cr.  
 Jar, one gallon/3.8 liters: 10 cr.  
 Jar, 2 pints (0.9 liters): 2 cr.  
 Jar, 4 pints (1.9 liters): 4 cr.  
 Jar, Glass, one pint (475 ml): 1 cr.  
 Jug, plastic, half gallon (1.9 liters): 2 cr.  
 Jug, plastic, one gallon (3.8 liters): 4 cr.  
 Jug, ceramic/pottery, half gallon (1.9 liters): 10 cr.  
 Jug, ceramic/pottery, one gallon (3.8 liters): 25-50 cr.  
 Jug, ceramic, five gallons (19 liters): 125-250 cr.  
 Metal Security Box, Large, 15 lbs (6.8 kg, 90 S.D.C.): 100 cr.

Metal Security Box, Small, 5 lbs (2.3 kg, 30 S.D.C.): 40 cr.  
 Metal Trunk, Large, 80 lbs (36 kg; 200 S.D.C.): 500 cr.  
 Metal Trunk, Small, 35 lbs (16 kg; 100 S.D.C.): 250 cr.  
 Metal Trunk, Large, 80 lbs (36 kg, 40 M.D.C.): 25,000 cr.  
 Metal Trunk, Small, 35 lbs (16 kg, 20 M.D.C.): 12,000 cr.  
 Pocket Purse, Small: 5 cr.  
 Sack, Large: 15-30 cr.  
 Sack, Medium: 10-20 cr.  
 Sack, Small: 6-10 cr.  
 Saddlebags (horse): 100-200 cr.  
 Shoulder Purse, Large: 35-100 cr.  
 Shoulder Purse, Small: 20-50 cr.  
 Tobacco Pouch: 10-20 cr.  
 Vial, Glass: 2 ounces (60 ml): 4 cr.  
 Water Skin, half gallon (1.9 liters): 15-30 cr.  
 Water Skin, one gallon (3.8 liters): 30-50 cr.

## Clothing of Note

**Aviator's Jacket:** A leather waist or hip length jacket popular among Techno-Wizards and City Rats. Two lower pockets, two large breast pockets, two inside pockets, and may have a belt loop or two. Cost: 150-300 credits. Roughly the same for motorcycle and similar size and types of jackets; 30% less in the New West.

**Military Field Jacket:** Includes adjustable collar and cuffs, epaulettes, 4 large outer pockets with heavy brass zippers, hidden hood, waist cord and snap closures. Cost: 80-150 credits.

**Reversible Flight Jacket:** Comes in navy blue, grey, green and brown. Cost: 100-200 credits.

**Extreme Cold Weather Flight Jacket:** Heavily insulated; comes in navy blue, grey, green, brown and white. Cost: 250-400 cr.

**Battle Dress Utility:** Shirt and pants in choice of arctic, desert, jungle or autumn forest camouflage. Shirt has two breast pockets, one pen pocket, and one (left-side) interior pocket. Pants equipped with hip, rear and thigh pockets. Lightweight (desert and jungle): 85 credits. Medium Weight (forest and mountain): 130 credits. Arctic Weight (down lined): 300-500 credits.

**Battle Jacket:** Comes equipped with breast, hip and interior pockets on both sides. A hidden pocket on the inside of the back is also useful. Available in camouflage, khaki, green or black. Cost: 225-400 credits.

**Arctic Parka:** High quality down lining provides protection in sub-zero conditions (-50 degrees below zero Fahrenheit). Same pocket arrangement as Battle Jacket. Available in orange, green, grey, and white only. Cost: 450-600 credits.

**Wool Sweaters:** Finest quality knit with leather reinforcements at shoulders, elbows and neck. Cost: 100-160 cr.

**Ponchos:** Waterproof nylon. Useful for rain protection, ground cover, emergency tent, etc. 5 feet by 5 feet square (1.5x1.5 m). Available in camouflage. Cost: 50-100 credits.

## Clothes: General Purpose

Arctic Trooper Hat with Fur Earflaps: 25-40 cr.  
 Baseball Cap: 12-25 cr.  
 Bathrobe: 35-80 cr.  
 Boots, High Quality Hunter/Woodsman, & Insulated: 140+ cr.  
 Boots, Leather Dress: 80-200 cr.  
 Cape or Cloak, Long: 150-250 cr. +200-400 cr. if fur.  
 Cape or Cloak, Long & Hooded: 300-400 cr. +300-400 cr. if fur.  
 Cape or Cloak, Short: 100-200 cr. +150-200 cr. if fur.  
 Coveralls, Insulated Vest, 6 pockets: 50 cr.  
 Coveralls, Work: 35-60 cr.  
 Denim Jeans: 25-60 cr.  
 Dress Shirt: 40-100 cr.  
 Flannel Shirt: 30-50 cr.  
 Hard Hat: 40 cr.



- Hat, Cowboy; Large Brim: 60-150 cr.
- Hat, Fur with ear coverings: 40-80 cr.
- Hat, Leather, Large Brim: 80-120.00 cr.
- Hat, Pull Over (toque): 6-15 cr.
- Hat, Short Brim: 40-100 cr.
- Insulated Long Coat, knee length, 4 pockets: 50-120 cr.
- Lab Coat: 50-100 cr.
- Machinist's Apron, 6 pocket: 25-50 cr.
- Pants/Slacks: 30-80 cr. (also see denims)
- Raincoat: 30-75 cr.
- Rain Poncho: 30-60 cr.
- Rain Suit; Hooded Coat & Pants: 100-150 cr.
- Reversible Hunting Parka: 120 cr.
- Robe, Heavy: 100-200 cr.
- Robe, Hooded: 150-300 cr.
- Shoes or Boots, Leather Dress: 50-200 cr.
- Shoes, Running/Walking: 30-120 cr.
- Shoes, Steel-Toed Boots: 60-200 cr.
- Shoes, Work: 40-200 cr.
- Survival Coat, Insulated, 4 big pockets & hood: 150-200 cr.
- T-Shirt: 6-20 cr. depending on type and color.
- Thermal Parka, Hooded Sweat Shirt: 85-120 cr.
- Waterproof Hunter's Boots: 80-150 cr.
- Waterproof Rubber Boots: Knee High: 50-80 cr.
- Waterproof Rubber Boots: Hip High: 100-125 cr.
- Windbreaker Jacket: 30-80 cr.
- Winter Gloves: 30-50 cr.
- Winter Jacket, down to knees: 200-300 cr.
- Winter Jacket, waist length: 125-200 cr.
- Winter Mittens: 30-50 cr.
- Winter Ski Mask: 10-25 cr.
- Work Apron, Denim, 4 pockets: 30-50 cr.
- Work Boots: 50-100 cr.
- Work Gloves: 6-20 cr.
- Work Pants: 35-60 cr.

## Communications Equipment

**Communicator Old Style Radio:** Basically an enhanced "walkie-talkie," it is a basic instrument issued to all military personnel and field operatives. Was also used by the public in recreation. **Weight:** 6-10 ounces (170 to 284 grams). **S.D.C.:** 30. **Range:** 3 miles (4.8 km). **Cost:** 150 credits per single unit. **S.D.C.:** 15 each. Excellent availability.

**Communicators:** Small, the size of a pack of cigarettes or cell phone fitted with a handy clip and holster case with clip to hook onto armor, pockets, collars and vests, as well as fit in pockets and belt pouches. **Weight:** 5 ounces (142 grams). **S.D.C.:** 10. **Range:** Five miles (8 km). **Cost:** 1,500 credits (3,500 credits for a communicator with one M.D.C. point). Excellent availability.

**Medium:** The size of a 20th Century walkie-talkie. **Weight:** 12-16 ounces (340-454 grams). **S.D.C.:** 30. **Range:** 10 miles (16 km). **Cost:** 3,000 credits (6,000 credits for a version that has 4 M.D.C.). Excellent availability.

**Communications Helmet:** A common protective helmet used by people in all walks of life, from messengers and laborers to adventurers and warriors. Its visor has automatic polarizing optics that adjust to the sun, and it has a radio receiver and transmitter built into it. (Most environmental body armor automatically comes with this means of communication.) Miniature headphones pipe the message to both ears and a slide-out microphone allows for two-way communication. **Range:** 5-10 miles (8 to 16 km). **M.D.C.:** 30 or 50, for the helmet only. **Cost:** 5,500 or 10,000 credits respectively.

**Field Radio:** An inexpensive backpack style radio transmitter and receiver with wide-band, long-range capabilities, frequency equalizer, field strength detector and scrambler. **Range:** 60 miles (96 km) in a city or area with radio clutter and disturbance, but 150 miles (240 km) in the wilderness. **Weight:** 16 lbs (7.2 kg). **Cost:** 600 credits; standard, low end. Good availability.





**Language Translator (Portable):** A unique device that is programmed with the nine known languages of the Americas and can hold three additional languages. 12 others can be added with a supplemental language disc. The amazing device can recognize and monitor up to three different voices and two different languages or dialects. Level of accuracy is 98.7%, with a three second delay when directed at one individual, but drops to 78% with a six second delay when translating three speakers simultaneously. The operator must hold the microphone portion of the translator out toward the individual(s) whose words he wishes to translate. The tiny computer inside the hand-held unit identifies and translates the words, transmitting them to the accompanying head/earphones or can be set to broadcast the words over the speaker in the base of the handle. The earphones can be substituted with a cybernetic headjack. The translator can also be set to translate the operator's words into the language of those he is speaking to with the same level of accuracy and speed. Conversations can be recorded on a one inch audio disk (3 hour capacity, costs about 20 credits each). The unit is about the size of a wireless microphone or a remote control and weighs about a half a pound (0.23 kg). Cost: 9600 credits.

**Laser Holographic Portable Computer (Triax LHP-1000):** This is actually a knock-off of the *Wilk's PC-2020 Field Identifier and Holographic Computer*. The devices are virtually identical. It is a multi-purpose computer about the size of a briefcase. The case is fire-proof, shockproof and padded with a Mega-Damage protective housing. The most unique features are its holographic projector beam (has a hard plasma screen as back-up) and its "Identifier program." The identifier program can recognize and identify 6000 vehicles and robots, 21,000 animal species (indigenous and known D-Bee life forms), 40,000 insects, and 50,000 plants and fruits. The data display highlights dangerous and friendly life forms, poisonous and edible plant life, and military vehicles. The identification system is activated by typing in data/features of note (01%-72% success ratio and accuracy) or by inputting a visual image like video footage, still photographs, or drawings (94% accuracy/success ratio). The computer then creates a rotating, three-dimensional image of the subject along with the corresponding data available. Many species of alien life are unknown so data is limited to the varieties known in Europe and the Americas (the latter was pirated from the Wilk's computer). Knowledge about Atlantis, Africa, and Asia is minimal (about 12%). If the computer cannot identify the subject it will report either, "Insufficient data: Alien or mutation?," or "Unknown indigenous life," meaning it cannot identify the subject but available data seems to indicate the subject is native to Earth. A complete lack of information on the part of the operator will result in, "Insufficient data. Please elaborate," meaning that the computer simply does not have enough information to make an assessment. Cost: 20,000 credits. Good availability.

**Long-Range "Military" Field Radio:** A backpack style radio transmitter and receiver with wide-band, long-range capabilities, frequency equalizer, field strength detector and scrambler. Range: 300 miles (480 km) in a city or area with radio clutter and disturbance, but 500 miles (800 km) in the wilderness. Weight: 25 lbs (11.25 kg). M.D.C.: 5 or 15 (the latter costs an extra 10,000 credits). Cost: 6,000 credits. Good availability.

**PDD Pocket Digital Disc Audio Player and Recorder:** Basically a future CD player with recording capabilities that is the size of a transistor radio or walkman. Plays or records on one and three inch discs. Typical blank disc will cost 10 to 20 credits with a two or three hour recording time. Pre-recorded discs will cost 20 to 80 credits depending on the quality, length of the recording, and availability. Cost of the PDD: Varies, usually 1200 to 2400 credits.

**PDD-V Pocket Digital Disc Audio and Video Player:** A slightly larger and more complex system that plays and records audio discs, but also plays video discs. A four inch, color monitor/TV screen displays the image. The unit can also be used with video equipment as a hand-held video monitor or attached to a larger screen to display its recording. Cost: Varies, usually 6000 to 12,000 credits.

**Video Communicator:** The video communicator is part radio and part television. It is a wide wristband or paperback book sized, hand-held device with a small video screen. Communications can be sent and received on either cellular telephone or radio waves. The unit scans for the clearest frequency and broadcasts on it. Optional headline accessories are available at little cost (basically phone lines to jack into a wall and the unit). Its multi-band capabilities give it a considerable range: 10 miles (16 km), double in open areas without radio clutter. Cost: 10,000 credits.



## Medical Equipment

**Bio-Comp Monitor:** A portable computer and sensor system in which a sensor is clipped to the patient's ears or two fingers to measure and record vital signs: blood pressure, temperature, heartbeat, respiration, level of hydration (or dehydration), and a number of specific chemical responses detectable through the skin. The vital signs are displayed on a small hand-held computer the size of a paperback novel and can be stored in memory, on disk, or transmitted to another computer system. The Bio-Comp will highlight and warn of dangerous or irregular vital signs. Cost: 2,500 credits. Good availability.

**Blood Pressure Kit:** Computerized, hand-held unit, small and portable; fits in a small pouch or case. Cost: 50-100 credits. Good availability.

**Compu-Drug Dispenser:** A medical tool that is a combination computer, hypodermic gun, and chemical storage and dispensing unit. Can hold 48 different measured shots of drugs. The operator indicates which drug and the amount, presses the gun portion to the patient's arm and injects the appropriate medicine into the individual. Costs: 3000 credits plus each drug dose (average drug dose costs 1D4x100 credits). Good availability.

**First-Aid Kit (Standard):** Contains gauze bandages, 48 band-aids of various sizes, dozen tongue depressors, pen flashlight, a roll of medical tape, a dozen disposable medicated wipes, six butterfly clamps, disinfectant, pair of plastic gloves, scissors, forceps, six razor blades,

lighter, tweezers, a thermometer, 100 aspirin tablets, and 24 decongestant tablets (allergy/cold). Cost: 100 credits. Excellent availability.

**Hypodermic Gun:** A quick, painless method of giving shots. Most hypodermic guns come with a self-cleaning mechanism that instantly cleans and sterilizes the needle after every use. Cost: 200 credits (drugs not included). Excellent availability.

**Hypodermic Syringe:** Cost: 10 cr. for the reusable type syringe, and 10 cr. for 24 disposable ones. Good availability.

**IRMSS Internal Robot Medical Surgeon System:** An amazing medical device that injects a dozen microscopic robot units, about the size of a pinpoint, into the bloodstream to repair internal injury. The containment unit is placed over or near the suspected area of damage and the depression of a button releases the micro-surgeons into the body. The tiny robots search for the damage and repair it. Types of internal injury which they can repair include the removal of blood clots, repairing torn/ruptured veins, internal bleeding, and minor damage to internal organs. Equal to a medical doctor's surgical skill of 75%. When the units are done, they simply turn off and are naturally flushed from the body (average life is one hour). They are not reusable. Each IRMSS holds 48 surgical robots for four uses. Cost: 42,000 credits. Good availability.

**IROU Internal Robot Oxygen Unit or "Breather":** This is the largest of the internal robots although still quite small. The bot resembles a caterpillar, because it is long and narrow and has many tiny legs. It can enter the body through the mouth or a tracheotomy in the esophagus tube. It crawls through the narrow passage with a pair of thin, narrow plastic tubes trailing behind it. As the bot makes its way towards the lungs it can transmit video images and data about damage to the throat. Once in the lungs, it transmits data and video images of damage and does analysis. A tiny molecular analyzer is used to identify toxins, drugs and foreign agents. Respiration is also monitored. The video pictures enable the doctors to accurately assess problems and determine the most appropriate treatment without surgery. One of the tubes is hooked up to an external device to extract fluids in the lungs and the other supplies oxygen. The Breather can also release a half dozen IRMSS bots to repair small holes and perform minor surgery. Cost: 50,000 credits. Good availability.

**IRVT Internal Robot Visual Transmitters or "Seekers":** This is another nano-bot about the size of a pinhead. It is injected into the vein of a patient and goes traveling through the vein. It is tracked and monitored via a homing device. The bot transmits a more powerful signal and video image of obstructions and damage to the veins and arteries as they are encountered. The bot is used primarily to locate blocked, pinched and damaged arteries, veins, and other internal passageways. Cost: 80,000 credits per unit; disposable (less than 33% can be safely retrieved, thus they harmlessly disintegrate inside the body after about 72 hours). Good availability.

**RAU Robot Antiseptic Units or "Cleaners":** A cleaner is a tiny robot roughly three inches (76 mm) long and one inch (25 mm) in diameter. They are reminiscent of a mechanical beetle that gently crawls along a wound or infected area destroying infection, removing puss and dead flesh, while cleaning the wound and spraying it with antiseptic protein for faster healing. The cleaners are usually sold and dispatched in pairs. Cost: 50,000 credits per pair. Good availability.

**RMK Robot Medical Kit or "Knitter":** A unique medical kit, developed with the mastery of nano-technology, in which a half dozen tiny robots, about the size of a shirt button, are released and automatically seek out cuts in the skin. One sprays the wound with disinfectant, another sprays antibiotics, a third cuts away dead or infected flesh, while the other three surgically suture the cut closed. When the cut is repaired, the tiny bots return to their carrying unit, refill their supplies and wait till activated again. Equal to a paramedic suturing skill of 90%. Not effective against internal injury, broken bone, or severe wounds. But great for cuts, bruises, bullet and stab wounds. Cost: 24,000 credits. Excellent availability. Hot among adventurers.

**RSU Robot Sedative Units or "Sleepers":** Four tiny robots, each the size of a pinhead, enter the brain and stimulate certain areas to make the patient relax and feel drowsy. The calming effect of these nano-bots causes the patient to breathe slow, even breaths, keeps the pulse rate steady and calm, and helps maintain normal blood pressure. When they are done the bots return to a tiny housing device. Cost: 100,000 credits per set of four. Good availability.

**Suture Gun:** Effectively a staple-like gun that fires staples made of dissolvable sutures. The staples cause little pain or discomfort, leave little scarring and can be used to close a wound at lightning speed. Cost: 100 credits per gun and 10 credits per 5 feet (1.5 m) of suture.

**Suture Tape:** A special, antiseptic tape used to hold cuts closed instead of sutures. Cost: 20 credits per 30 foot (9 m) roll. Excellent availability.

**Micro Scale:** A digital pocket scale, about the size of a person's hand or an old transistor radio. It can be hooked to a belt, slipped into a large pocket, sack, purse or a backpack. The scale can weigh up to 200 lbs (90 kg); digital display. Cost: 120 credits. Widely available.

**Protein Healing Salve:** This is a special high protein chemical solution that comes in a tube like toothpaste. The salve can be applied to burns, cuts, and rashes to increase the rate of healing (doubles normal healing). Costs: 100 credits per eight ounce tube. Widely available.

**Palm Bio-Unit:** A palm-size biological analyzer. The digital display can indicate body temperature, blood pressure, respiration, and dehydration level simply by inserting the patient's finger into the finger scanner housing. Cost: 150 credits. Widely available.

**Portable Bio-Scan & Bio-Lab:** The bio-scan is an impressive biological monitoring device with a multitude of functions. Sensors are attached to the skin and body which send information to the computer display screen and/or to be recorded.

1. Basic bio-mode indicates and records such basic body functions as body temperature, heartbeat rate, blood pressure, breathing, and glandular changes in the skin, including sweating.

2. Stress evaluator that operates much like a polygraph machine, recording stress and anxiety (without attaching sensors) by monitoring the voice quality of its subject. A character with the proper training and experience can use the device as a "lie detector," but the information is often difficult to read and open to interpretation. Even a positive reading can not be declared absolute evidence of a falsehood. Chance of proper reading as a lie detector is 25% plus 5% per level of experience.

3. A Toxin analyzer that can analyze any liquid (water, blood, etc.) and be able to identify 380 toxins dangerous to humans. Solid items, such as fruits and vegetables, must be pulped or squeezed in order to be analyzed.

4. A Dosimeter used to measure radiation. Good availability.

Cost: 5000 credits; poor availability, since it's generally reserved exclusively for field expeditions of a scientific or military nature. Weight of this unit is 20 lbs (9 kg).

**Portable Laboratory:** This is another impressive portable unit that can perform several functions.

1. Microscope in a specially padded housing.

2. One dozen specimen slides and another dozen specimen trays for storage and transportation of item(s) for further analysis. A variety of vials, jars and test tubes.

3. An incubation chamber that is about the size of a VCR.

4. Four burners.

5. Instrument tray with a variety of common tools such as scalpels, tweezers, pins, tape, needles, calculator, etc.

6. A refrigeration chamber which is about half the size of the incubation chamber.

7. An insolation chamber. A special, airtight, sealable compartment about the size of the incubation chamber.

8. A chemical cabinet which holds several dozen chemicals commonly needed in the analysis of chemical structures.
9. Centrifuge Device.
10. Dosimeter.
11. Micro-computer.
12. Digital camera, still photograph and video.
13. Toxin analyzer, identical to the one used in the "portable bio-scan".

Cost: 12,000 credits; poor availability. Weight of the whole unit is 58 lbs (26 kg).

**Portable Scan Dihilator:** The portable scan dihilator is a uniquely comprehensive sensory device with FULL scanning capabilities.

1. Radar/Sonar: Range: limited to a 5 mile (8 km) area. A trained operator (Read Sensory Equipment skill) can positively identify readings as specific objects or vehicles, pinpoint location, and estimate rate of travel and direction at 65% proficiency.

2. Sensors include dosimeter, radar detector, heat, infrared, ultraviolet, microwave, and energy sensitive instruments; all of which identify, locate source, and record.

3. Long-range wide-band radio with scrambler. Range: 40 mile radius.

4. Detachable short-range (hand-held) communicator. Range: 3 miles.

Cost: 4,200 to 5,000 credits. Fair availability. Weight: 40 lbs (18 kg).

**Stethoscope:** Cost: 80-150 credits.

**Surgical Gloves (disposable):** Cost: 12-20 credits for a box of 100.

**Thermometer:** Cost: 3 credits for traditional oral type. 10-15 credits for battery operated digital type that gets temp by placing sensor tip in the ear (the size of a small cell phone).

## Miscellaneous Equipment

**Bullet Resistant Attache Case:** 6 M.D.C., Cost: 5,000 cr. Courier Briefcase: 15 M.D.C., Cost: 11,000 credits.

**Camouflage Paint Kit:** 4 spray cans plus 6 stencils allow for easy camouflaging of vehicles, bunkers, and any field equipment. One kit will cover approximately 100 square feet (about 9 square meters) of surface. Available in jungle, forest or arctic. Cost: 35 credits.

**Camouflage Tape:** The ever popular duct tape. Comes in rolls 26 feet (7.9 m) long and two inches (5 cm) wide. Available in jungle, forest or desert camouflage, or in olive drab. Cost: 6 credits per roll.

**Camouflage Compact:** A one-man kit for camouflage or night operations. Includes enough face and hand paint for 6 applications. Mirror, brush and disposable cleaning pads are also included in a neat, black case, 4 inches in diameter and ½ inch high (10x1.3 cm). Cost: 20 credits each.

**Candle Stick,** per box of 12: 10 credits.

**Climbing Kit:** A complete set of equipment for rappelling, rock scaling or climbing. Includes three 600 foot (183 m) reels of 4500 pound (20,000 Newton) test rope (each reel weighs 40 pounds/18 kg). An adjustable harness with clamps, 6 pairs of canvas climbing gloves, 48 clamps, 48 fasteners, 48 pitons, 3 hammers, 2 grappling hooks, and one pulley, straps, harness, boots, and backpack. Weight with shipping crate is 190 pounds (86 kg). Cost: 1200 credits.

**Computer, Portable:** This is a fully functioning computer that is about the size of an opened paperback book or the size of an average human's hands placed together. When closed, the handle can be folded up and the entire unit can easily fit in most jacket pockets. The computer can be powered by a small, rechargeable battery (about 24 hours of life) or plugged into an electrical outlet. A hard copy of text can be printed out on the thermo-paper printer, but a magnifying glass is needed to read the tiny print. The computer can also be plugged into

most video and cybernetic systems for use as a video monitor. Removable memory storage can take a variety of forms, including CD-ROMs, micro-ROMs, memory tabs, memstiks, or any of the other amazing information storage options developed during the time before the Rifts. The display for such small computers might be as simple as a tiny LCD screen, or it might be a miniature holographic projector, or it might simply link into a set of VR goggles or one's cybernetic eyes. Input might be through a keyboard (how low-tech!), running a stylus of finger across the screen, voice commands, mental interface (a popular option for cyborgs), etc. Weight: From a few ounces to one pound (0.45 kg). Cost: From 100 credits (palm organizer) to tens of thousands of credits (mega-computer; military application), depending on the performance of the machine and its condition. Note: We have shied away from giving specific stats on Rifts computers because by the time this book sees print, those figures will be wrong, and in a couple of years, they will be laughable. A good rule of thumb for gauging what computers can do in your campaign is to consider what computers can do at the moment you are running a game, and magnify that potential by about a hundred.

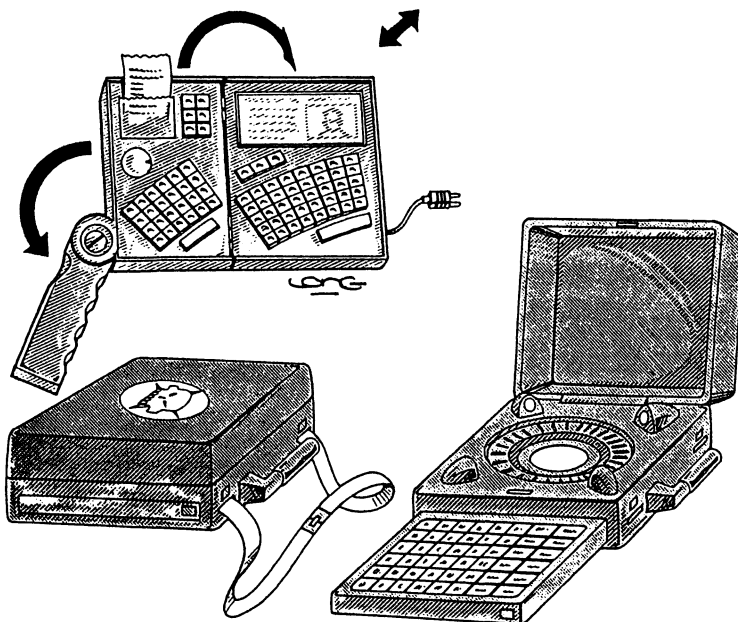

**Computer: Portable Field Unit:** Somewhat similar to others used across the Megaverse, the hand computer has a pistol grip for easier handling, and has a built-in scanner and laser distancer so it can be used to accurately determine range and measurements by pointing it at or along something. The standard unit comes with a clock and calendar, as well as a mathematics calculating capability, word processing and other basic programs. One can plot vectors, figure out ratios and algebraic functions, send or receive signals to/from any device it is plugged into (it comes with two universal cyberjack plugs and two 10-foot/3 m cords), and sort lists of numbers and names by various parameters. The screen is a concave oval, and easily seen in even harsh daylight conditions. Cost: 2,500 credits.

**Computer Reference Libraries:** Reference libraries are portable stores of information used mainly by City Rats, Rogue Scientists, Scholars and Techno-Wizards for research and reference purposes in their work. Basically, it is a large set of encyclopedias on portable mini-disks with information on a number of things, depending on what the purchaser chooses when buying them. The software is built around a highly efficient search and filter program that allows for easy location of data in its stores in a very short period of time. A reference library for any skill is available, but it is only written information on the subject. A chemistry library might help a character interpret the readings on a chemical analyzer, but it won't do a whole lot to help him actually make compounds or drugs. Likewise, a library on climbing will describe how to do it and what gear is required, but the reader will still

need the skill to correctly scale a wall. Experience and practice are what make proper skill use possible.

So, while the libraries are helpful in certain circumstances, they are in no way a substitute for the actual skills they document. Trying to perform a skill using only a reference library can be done: the user will know how, but have no practice. However, the chance of success is only half the *base skill rating* and takes three times as long. On the flip side, a character using a library for a skill he already has adds a 5% *bonus* to his skill proficiency when he is cross-referencing with the computer library, but it will take him 50% longer to perform because he is checking with and reading the data in the library. **Subjects on Disk:** Basic Electronics, Basic Mechanics, First Aid, Swimming, Climbing, General Athletics, and the equivalent of all Domestic, Science and Technical skills (some, like Lore and Law, may be broken down by different countries or continents). **Cost:** 200-400 credits per skill subject (i.e. Lore: Demons and Monsters is one library disk, Cooking is another, Mathematics another, and so on).

**Ear Protector Headphones:** The answer to the demo expert's and grenadier's dreams. The same model is used by airport workers to preserve hearing in noisy environments. **Cost:** 40-80 credits.

**Electro-Adhesive Pad:** This is a hand-held device that will adhere strongly to any metal surface by means of passing a small current through two metal electrodes. These pads are commonly used by astronauts and can be used in astronaut's shoes, but the hand-held pads are much more flexible and generally preferred. **Cost of the Electro-Adhesive Pads (2) and generator (hip or back pack):** 30,000 credits. **In shoe form:** 40,000 credits. Can hold up to 1000 lbs (450 kg); works only on metal.

**Flashlight (standard):** **Cost:** 6-12 credits, small to medium, or 15-20 large. **S.D.C.:** 15.

**Flashlight, Rechargeable & Unbreakable:** Is ten times brighter than most conventional types; quartz-halogen bulb, 12 inches (30 cm), 1.8 pounds (0.8 kg), 30,000 candle power. **S.D.C.:** 100. **Cost:** 160-200 credits.

**Gas Mask** to filter out smoke, fumes, particles, and a variety of military gases. Not recommended as protection against nerve gas or radiation. **Cost:** 50-80 credits.

**Handcuffs (novelty item):** 10 credits; 40 S.D.C.

**Handcuffs (police):** **Cost:** 20 credits; 80 S.D.C.

**Handcuffs, (light M.D.C.):** **Cost:** 1,200 credits; 2 M.D.C.

**Handcuffs (M.D.C., military):** **Cost:** 5,000 credits; 8 M.D.C.; double the cost and M.D.C. for heavy M.D.C. cuffs. Available in human and larger than human sizes.

**Laser Distancer/Measuring:** To 6,000 feet (1828 m). **Cost:** 26,000 credits. Fair to poor availability.

**Lock Pick:** The pick can be almost any style or size, but is always a small, thin, steel tool which ends in a slight, upward curve or special tip configuration. It is used to raise the pins of the lock so that it will open. A good range of pick thicknesses is .025-.035. These are available through locksmiths, and locksmith suppliers, and some establishments that specialize in rare, hot and illegal items. **Cost** is usually high, 20 credits per pick, with at least a dozen needed for a proper range. **Note:** Smiths and suppliers will not sell these tools to anyone off the street and may investigate or report the inquiry.

**Lock Pick Release Gun (Automatic):** This item is only sold to law enforcement agencies at a cost of about 40 credits. Throws all pins into position at one time and never damages or harms the lock mechanism. Opens all types of locks (tumbler, spool, regular or mushroom). **Cost on the street (only 19% chance it is even attainable):** 600 credits minimum; may cost as much as 200% more depending on the seller and circumstance.

**NG-S2 Basic Survival Pack:** A very popular item among adventurers and other travelers, the NG-S2 survival pack contains all the basic things someone traveling through the wilderness could need.

**Cost:** 3000 credits.

- **Two-Person Tent:** Folded, it's the size of a paperback book. Unfolded, it can sleep two people comfortably. Offers protection against the cold and rain; insulates and keeps people inside relatively warm at temperatures up to -40 degrees Fahrenheit (-40 Centigrade). The tent has a water collection system to help the user(s) survive in desert climates as well. The tent collects all moisture that evaporates from the occupants, basically increasing any water supplies the user carries by 20%; with the tent, eight days of water will last ten days.
- A sleeping bag.
- Flashlight with a concealed pocket knife and 6 batteries (each battery has a life of 48 hours of continuous use).
- Compass/inertial mapper; lets you know how far you've traveled and in which direction(s); + 10% to Land Navigation rolls. The compass has a mirror finish on one side and can use the sun to signal others or send Morse-code messages.
- Short-Range Radio: 5 mile (8 km) range.
- Mini-First-Aid Kit (1): A roll of gauze, 48 adhesive bandages (different sizes), roll of medical tape, pair of small scissors, pocket knife, and a tube of protein healing salve.
- Hunting and Fishing Kit: Wires, fishing line and several hooks and pulleys, useful for both fishing and setting snares for small game.
- Saw-Wires (3): A serrated, ultra-hard wire with two ring handles, able to cut through wood, stone and even S.D.C. metals. Does most of the chores of an axe, but with less time and effort.
- Fire Starter (1): A pocket cigarette lighter and a flint striker with 6 extra flints (good for starting hundreds of fires).
- Survival Knife, a small hatchet, and a wooden cross. Four signal flares.
- 30 feet of lightweight climbing cord, a pair of climbing gloves, four ceramic spikes and a small mallet.
- Bar of soap and a washcloth.
- Canteen and a food rations bag.
- **Nightstick (Fiberglass):** **Cost:** 10 credits; 1D4 damage.
- **Nightstick (Steel Encased):** **Cost:** 20 credits; 1D6 damage.
- **Oil Lantern, 6 hours (1 pint/0.7 liters):** 20-50 credits.
- **Oil Lantern, 12 hours (2 pints/1.4 liters):** 30-60 credits.
- **Oil Lamp, 6 hours (1 pint/0.7 liters):** 30 credits.
- **Pocket Laser Distancer:** A handy item, about the size of a cigarette lighter, that is used for measuring distances. The unit also has a digital display and built-in calendar (day, month, year), clock, and alarm clock capability. **Laser range is 4000 feet (1219 m).** **Cost:** 1000 credits.
- **Padlock, Light:** 25 S.D.C., 4-8 credits.
- **Padlock, Medium:** 40 S.D.C., 8-15 credits.
- **Padlock, Heavy:** 60 S.D.C., 15-30 credits.
- **Padlock, Burglar proof:** -40% to be picked, 80 S.D.C., 400-500 cr.
- **Padlock, Burglar proof:** -40% to be picked, 5 M.D.C., 3000 cr.
- **Portable Computer:** See Computer, Portable, earlier under this heading.
- **Portable Short-Range Radar System:** This is a backpack style radar scanner that can track as many as 20 different targets, estimate speed, trajectory, and direction (65% proficiency). **Weight:** 15 lbs (6.8 kg). **Range:** 5 miles (8 km), **Cost:** 4000 credits.
- **Portable Tool Kit:** A general purpose tool kit with an electric screwdriver and socket wrench, as well as 36 lightweight, high impact conventional tools. Approximate weight is 12 pounds (5.4 kg) and comes in a convenient carrying case. **Cost:** 400 credits.
- **Protective Work Goggles:** **Cost:** 10 credits.
- **Portable Robotics Tool Kit:** This is a large, heavy briefcase (22 lbs/10 kg) filled with small mechanical tools (wrenches and screwdrivers), electronic tools, a small diagnostic computer, and welding/solder-

ing tools. It can be used to locate and identify problems and realign, recalibrate, and repair armor and basic body parts, make simple modifications, and perform routine maintenance, as well as perform similar functions on environmental body armor and power armor. This kit carries enough supplies and spare parts to repair up to 35 M.D.C. worth of damage and one complete system (i.e. arm or leg). Any further repairs will require additional materials and/or spare parts. Cost: 20,000 credits. As well as environmental body armor, Cost: 50,000 credits.

**Sap Glove:** Six ounces of powdered lead is built into each glove just above the knuckles, padding the wearer and adding weight and strength to the force of one blow. +2 to damage. Available from most security guard suppliers. Cost: 30 credits.

**Skis: Downhill/Cross-Country:** Modern downhill skis are made of super-ceramics and possess superior turning, "shushing" ability. Cross-country skis are also of superior manufacture and designed for extended treks across rough terrain. Both types can be broken down into two pieces per ski for easier storage. Cost: Downhill: 500-750 credits, Cross-Country: 300-500 credits. Excellent availability.

**SPU-5, Sonic Pulsar Unit; Electronic Flea & Insect Repellent:** This handy device is suitable for use by animals, intelligent mutant animals, D-bees and even humans. City dwellers don't often have a problem with fleas, ticks, lice, mosquitos and other pesky insects, but wilderness travelers do. Fleas, lice and biting insects are common to many natural habitats and can be a real problem for explorers, but not with the SPU-Sonic Pulsar unit. The small device is typically about the size of a cigarette lighter and weighs a mere 4 ounces. It generates sound waves inaudible to dogs, cats, and humans, but intolerable to fleas, ticks, lice and many other bothersome insects. The sound waves prevent parasites and bugs from ever jumping on board and chases away those already present. The micro-battery has a life of one year (costs 10 credits and is easy to replace) or the unit can easily tap into most energy backpacks, a vehicle's lighter or battery, E-Clips, and other power sources. Cost: 100 credits for the belt, collar, or necklace variety. 2000 credits as a cybernetic implant. Wide availability in all styles.

**Sunglasses or Goggles (cheap):** 15-50 credits.

**Sunglasses (fancy or light adjusting):** 100-300 credits.

**Shooting Glasses:** Cost: 100-200 credits. Change color and density in response to changes in light and weather. Also reduces glare and improves visibility.

**Thermal Suit:** This is a waterproof, environmental suit, customized for cold-weather operation. It has additional padding, an insulation weave and is equipped with battery-powered warming coils. Gloves are extra-thick, but molded so they can still manipulate larger items like weapons and machinery. Wearing a thermal suit is less restrictive than body armor, so they are used extensively in winter construction projects and by certain adventurers. One is completely protected from temperatures as low as -100 Centigrade (-148 Fahrenheit). Good mobility, so there is only a -5% penalty to the skills Prowl, Climb, Swim, Acrobatics, and Gymnastics. Battery Life: One winter of constant use. Cost: 150 credits for the battery, 750-850 credits for the suit.

**Thermal Jacket:** Fundamentally the same as the waterproof, heated, thermal suit system, but limited to a hooded jacket that comes down to just below the waist and includes heated gloves. Cost: 150 for the battery, 450 credits for the jacket.

**Thermal Arctic Boots:** Reinforced with ceramic overlapping plates, insulated, and warmed by an internal electric battery. Developed at the end of the 21st century, the boots are in widespread use even during the warm months, when the heating units disengage. M.D.C.: 5. Battery Life: One winter of constant use; replacement battery costs 40 credits. Cost: 180 credits for a pair of boots.

**Treated Torch:** Cost: 10 credits (can be made for 2 credits by those with carpentry skill). Lasts for 2D6+60 minutes.

**Wire-Cutters:** 8 inch (20 cm) wire-cutter has nonconducting handles to avoid the nasty "shock" of electrified fences. Complete with belt sheath. Cost: 65 credits.

**Winter Survival Kit:** A winter survival kit is a light metal box (25 S.D.C., 20 lbs/9 kg) that contains 3 hand-held flares, one smoke grenade, signal mirror, box of 36 waterproof matches, a cigarette lighter, 6 sterno canisters, folded thermo-blanket, 4 heat packs (the size of a paperback novel; each lasts 4 hours), freeze-dried food and vitamins for seven days, 16 concentrated fat pills, an extra pair of thick mittens, pair of thick socks, a ski mask, scarf, tinted goggles, pocket knife, and a hand axe (1D6 S.D.C.). Cost: 100 credits. Excellent availability.



## Optics, Goggles & Binoculars

**Conventional Binoculars:** Range: 1 mile (1.6 km). Magnification through a series of lenses. Cost: 400-700 credits. Fair availability; rather outmoded.

**Infrared Distancing Binoculars:** A high-powered optical enhancement device with infrared adjustments, cross-hair indicator lines, and digital readout of estimated distance and rate of travel. Range: 2 miles (3.2 km). The I.D. binoculars enjoy extreme popularity among the populace, being used for field work, exploration and recreation, and are standard issue for the military. Cost: 1200 credits. Wide availability and in high demand.

**Infrared Optic System:** Range: 1200 feet (366 m). This type of optical enhancement device relies on a source of infrared light, usually a pencil thin beam of light projected from the goggles or binoculars to illuminate its targets. The narrowness of the beam severely limits the scope of one's view to a small area of about two square yards/meters. This can make surveying a large area a problem. Another drawback is that the infrared light beam is clearly visible to another infrared optic system, giving away the operator's position. These drawbacks are inherent to ALL infrared systems. Cost: about 1000 credits. Fair to good availability; rather outdated..

**Multi-Optics Helmet (M.O.H.):** The multi-optics helmet is a special optical enhancement system built into a protective helmet. It includes the following features:

1. Targeting Sight: Range: 1,600 feet (488 m).
2. Infrared Optics System: Range: 1,600 feet (488 m).
3. Telescopic Monocular Lens: Range: 2 miles (3.2 km).
4. Thermo-Imager: Range: 1600 feet (488 m). Special Bonus: +1 to strike when the optics and targeting sight are engaged. Note that the thermo-imager is a special, optical, heat sensory unit that allows the infrared radiation of warm objects to be converted into a visible image. Enables the operator to see in darkness, shadows and through smoke.

Cost: 2,800-3,400 credits. Good availability.

**Night Sight (Passive):** Range: 1600 feet (488 m). A nightvision optics system that is an image intensifier, meaning that it is a passive system that does not emit any light of its own, but electronically *amplifies* existing ambient light to provide a visible picture. Cost: 1400 credits for a gun scope, 1800 credits for goggles. Good to excellent availability, especially at tech centers.

**Optics Band:** The optics band is a headband type optical system most often used in research, micro-repairs and scientific study. Its range is limited as it is designed for close work, not long-distance or combat surveillance. Features include:

1. Infrared and Ultraviolet Optic System: Range: 200 feet (61 m) maximum.
2. Magnification Lens (to the 400th power): Range: 7 feet (2.1 m).
3. Night Sight: Range: 200 feet (61 m).
4. Adjustable Color Filters.

Cost: 800-1200 credits. Fair to good availability.

**Pocket Night Viewer:** Range: 800 feet (244 m). This is a mini-night sight, usually a monocular style, easily concealed and portable. Cost: 800-1000 credits. Fair availability.

**Polarized Goggles:** Light sensitive to automatically lighten and darken depending on the ambient light to protect the eyes from glare and bright light. Cost: High impact goggles (has 1 M.D.C.): 1200 credits. Ordinary Polarized Goggles (15 S.D.C.): 75-100 credits.

**Sunglasses or Tinted Visor:** Similar to Polarized Goggles (8 S.D.C.): 15 to 300 credits depending on the style and quality.

**Thermo-Imager:** Range: 1600 feet (488 m). Basically an optical heat sensor, it converts the infrared radiation of warm objects into a visible image. These devices allow the operator to see in darkness, shadows and through smoke. Battery powered and electrically cooled. A typical running life is 16 hours. Cost: about 2000 credits; poor availability.

**Ultraviolet System:** Range: 400 feet (122 m). Enables its wearer to see into the ultraviolet range of light radiation. It's usually integrated into a larger optics package rather than used alone. Cost: 500 credits.

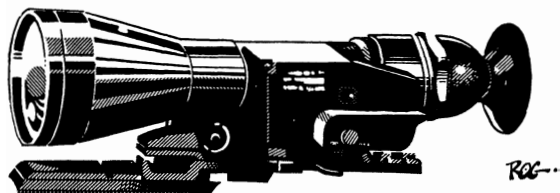

## Optics for Gun Scopes

All of these optic systems are available as gun scopes for pistols and rifles as well as goggles and binoculars. As many as four different optics can be combined in a single scope (add the cost of each plus 20% to determine the total cost of the complete multi-optic system).

**Telescopic Scope:** 10 x magnification; works like a pair of binoculars or camera lens. Typical range is 2000-6000 feet (610 to 1828 m). Cost: 1000 credits.

**Cross Hair Sight:** Targeting cross-hairs for better aim. When the cross-hairs are centered over the desired subject the aim is on target. **Bonus:** Add +1 to strike but only on aimed shots. This bonus is not applicable when laser targeting is engaged. Cost: 500 credits for an excellent sight.

**Infrared Vision:** Infrared scopes are ancient technology and inferior to other passive optical enhancements. However, it is inexpensive and therefore popular among City Rats, bandits and adventurers down on their luck. The scope emits a narrow beam of infrared light that is invisible to human eyes. However, the light beam is visible to other characters using infrared vision, including most bots, power armor and a number of D-bees! Those who can see the light can avoid it and/or follow it to its source, giving up its user's location. Furthermore, the narrowness of the light beam limits the available viewing area to about seven feet (2.1 m). Cost: 1000 credits. Maximum Range: 2000 feet (610 m).

**Laser Targeting:** Add + 3 to strike on an aimed shot, but only when the laser targeting system is functioning. No bonus if the system is broken or turned off. Cost: 2000 credits. Note: Laser targeting can be used in conjunction with a telescopic sight and/or thermo-imager. Range: 4000 feet (1219 m).

**Light Filters:** Simple transparent lens covers designed to filter sunlight and reduce glare. Cost: 25 credits each.

**Passive Nightvision:** This system amplifies existing ambient light to provide vision in darkness. It is also known as a "starlight" scope because it can amplify the light from stars and the moon to see when outdoors. If in absolute darkness such as an underground tunnel, it is rendered useless; it must have some source of ambient light. Range: 2000 feet (610 m). Cost: 6,000 credits.

**Thermo-Imager:** A thermo-imaging system as goggles has a range equal to normal human sight and does not automatically come with a telescopic feature. However, it can be combined with a telescopic scope. A thermo-imager converts infrared radiation of warm objects into a visible image. The operator can see heat as represented by bands of color and enables him to see in darkness, shadows and through smoke with 20/20 vision. Cost: 12,000 credits. Note: Can be added to a telescopic gun or camera scope (add the cost of the telescopic feature to the total cost). Range: 2000 feet (610 m).

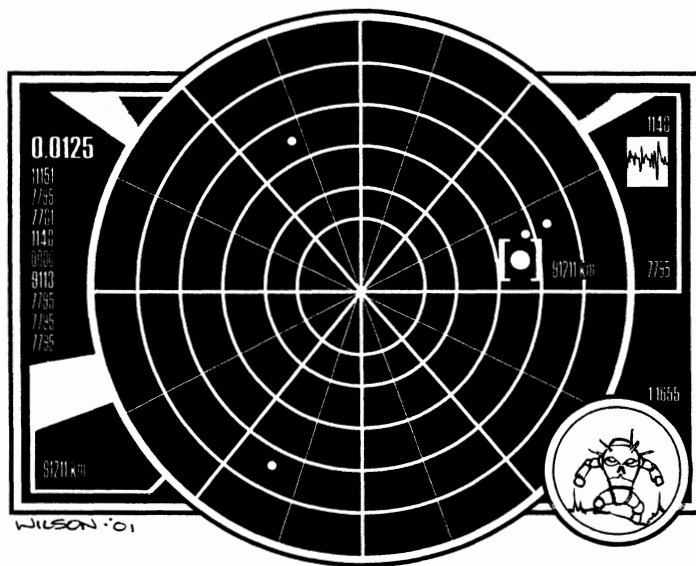

## Sensor Equipment

**Dosimeter:** Picks up and measures radiation levels. Range: 20 feet (6.1 m). Hand-held; Weight: One pound (0.45 kg). Cost: 200 credits. Wide availability.

**Ecto-Sensor:** A portable device about the size of a backpack field radio that can detect motion, changes in temperature, electromagnetic energy and changes in the electromagnetic field; a so-called "Ghost De-

pector.” The device detects barely discernable shifts in molecular structure which match patterns stored in its computer. This is done via neutrino bombardment of the surrounding area, with data feeding back in real time through sensors. Its imaging system is capable of portraying a rough image on a HUD or built-in monitor/screen. It can detect entities and similar energy beings, and solid but invisible beings (including those made invisible by magic) with an 89% level of accuracy (roll once every minute to maintain contact). It can also pinpoint and track the movement of such beings (89% level of accuracy). Ethereal beings such as supernatural spirits, Astral beings and fragmented life essences usually escape detection; only a 01-12% chance of detection, +12% if they are using magical energy, casting a spell, moving physical objects and similar. Detection range is extremely limited, only a 300 foot radius (91.5 m). Cost: 350,000 credits. Poor availability.

**Ground Sensor System:** Uses seismic and laser sensors to detect vehicles, troops, their direction and their numbers. A good technician can make such projections with 75% accuracy. The control unit with digital display, computer mount and monitor, is located at the center of a sensor web or fence. Up to 22, transmitter/receiver, sensor units can be linked to the control unit. Range between transmitters is 800 feet (244 m) and can register activity up to 10 miles (16 km) away. Cost: 18,500 credits. Poor availability; generally limited to the military and scientific research.

**Heat:** Special sensors pick up and measure heat emanations. Can monitor temperature, or made directional to pinpoint a specific heat point/target. Range: 250 feet (76.2 m); field of detection is 25 feet (7.6 m). Portable/hand-held. Weight: 8 lbs (3.6 kg). Cost: 1200 credits.

**Microwave Fence:** Transmitter and receiver sensor posts emit an invisible, microwave curtain or fence that will light up and send a signal to the control unit when an intruder breaches its curtain. Range between transmitter posts is 500 feet (152 m). Posts are 7 feet (2.1 m) high. Can effectively cover a 14 mile (22.4 km) area. Cost: 20,000 credits. Poor availability; primarily used for military purposes.

**Motion:** Detects movement by measuring minute changes in the air and pinpoints location of the source of the changes in the air. Requires sensor placement and monitor screen. Range: 60 feet (18.3 m). Portable; Total Weight: 15 lbs (6.8 kg). Cost: 400 credits. Fair availability.

**Radar Detector (portable):** Indicates the use/presence of radar in the area. Range of Detection: One mile (1.6 km). Cost: 200 credits. Fair availability.

**Radar, Mini:** A portable mini-radar unit and monitor. Trained operators (Read Sensory Equipment skill) can positively identify readings/objects, pinpoint location and estimate rate of travel and direction. Can track up to 72 images simultaneously and identify over 500 targets. Can NOT track targets on ground level or flying under 200 (61 m) above the ground. Range: 5 miles (8 km). Total Weight: 18 lbs (8.1 kg). Cost: 2500 credits. Fair availability.

**Radar, Military Unit (large):** Semi-portable in that it can be pulled along a trailer hitch or carried by small truck or van. About the size of a desk. Trained operators (Read Sensory Equipment skill) can positively identify readings/objects, pinpoint location and estimate rate of travel and direction. Can track up to 300 targets simultaneously and identify over 1000 targets. Can NOT track targets on ground level or flying under 100 (30.5 m) above the ground. Weight: 300 lbs (135 kg). Range: 100 miles (160 km); double in wide open flatlands. Cost: 16,000 credits.

## Surveillance Equipment

**Acoustic Noise Generator:** Muffles conversations, distorts bugging systems by 35%. Cost: 900 credits.

**Keyhole or Tube Microphones:** A microphone with a long, hollow tube which can be flexible or stiff, allowing it to be placed in cracks, mounted in walls or placed in similar, small, “keyhole” type crevices. Picks up sounds up to 34 feet (10.3 m) away and transmits up to 1000 feet (305 m). Cost: 150 credits; fair availability.

**Video Wall Mount:** This small, remote video camera is only about the size of a man’s palm (5 inches/13 cm in diameter), thus it is easily concealed. The camera is backed with a powerful suction device that will adhere to any smooth surface, whether it be a wall, table, appliance, vehicle and so on. The video wall mount can broadcast continually for 72 hours, or by remote or preprogrammed, regulated intervals. The lens has limited mobility, able to rotate in about a 90 degree radius. Its audio capacity has twice the duration of its video transmission and able to pick up sounds up to twenty feet (6.1 m) away with crystal clarity. The monitor can be the mini-hand-held screen or any variety of larger or multi-unit monitors. Cost: 200 credits; fair availability through the conventional market, but a hot commodity at 300 credits on the black market. Hand-held monitor costs 150 credits.

**Contact Microphone:** Translates vibrations into sound, but requires a sounding board such as a wall, window, large object, etc. Can be as small as a tie tack. Picks up sounds up to 10 yards/meters away, and transmits up to 1000 feet (305 m). Cost: 170 credits; fair availability.

**Wireless Microphone:** This compact microphone is about the size and thickness of a box of matches. It can pick up sounds up to 14 feet (4.3 m) away and broadcast up to 300 feet (91 m) away. Cost: 250 credits; poor availability.

**Tracer Bug:** This is a tiny device about the size of a checker which has a sticky or magnetic side that can be attached to a vehicle or slipped into a person’s pocket, backpack, briefcase, etc. It can transmit a signal that can be followed up to 8 miles (12.8 km) away. Battery powered, it has a limited life of 72 hours of constant transmission. Cost: 140 credits; fair availability.

**Pocket Scrambler:** The scrambler will distort or “scramble” outgoing radio signals, preventing interception and interpretation by the enemy. Cost: 300 credits; good availability.

**Ultraviolet Signaler:** The signaler is a small strip of ultraviolet sensors and another transmitter strip that can be adhered to a doorway, walls and so on, to create a beam of invisible light blocking that area. When the beam is broken by an intruder or vehicle, etc., it will send a silent signal to a monitoring device and/or trigger a video unit. Range: 100 feet (30.5 m) apart. Cost: 900 credits; fair availability.

**Video Camera, Digital (mini):** An advanced, studio quality camera about the size of a paperback novel or cell phone. Has both wide and narrow angle lenses. Records sound and image, low light capabilities (two candle light), records on one or three inch discs with digital meter; lens filters, telescopic lens (488 m), carrying case and tripod included. Capable of radio telemetry when boosted by long-range radio. Cost is about 4200 credits. Half that for a traditional video camera. Good availability for both.



# Body Armor

In a world of Mega-Damage weaponry, having a decent suit of M.D.C. body armor is often the only thing standing between a quick death and living to fight another day. Any adventurer worth his salt who does not have some kind of natural or magical M.D.C. protection can be found wearing *some* form of body armor. The list below details the most common types of body armor in the world (covered in *World Books 1-23* at any rate). Designer, Kevin Siembieda, has added more complete M.D.C. stats for each suit.

Body armor, by its very nature, holds only one person and often is *not* powered. Most are, however, full environmental systems. Few types have more than 100 to 150 M.D.C.; most are 60-120 M.D.C. **Note:** Armor presented here are *condensed* to the simplest and most important stats. **EBA** is short for "Environmental *Body* Armor" or "Environmental *Battle* Armor."

## Body Armor by Manufacturer

### Australian Body Armor

Armored Trench Coat  
Light Anti-Assassin Vest  
Police Armored Jump Suit  
Police & TRG Riot Armor  
Special Ops Heavy Combat Armor  
"Trencher" Body Armor

### Black Market/Bandito Arms & Generic Armor

**Note:** Mainly North American Armor.

Bandito, The  
Branaghan Armor  
Bushman  
Crusader  
Cyber-Knight Armor  
Fury Beetle Armor  
G-10 Soldier  
Gladiator  
Homemade M.D.C. Armor  
Huntsman  
Juicer Armor: Most local styles, some imports.  
Kittani Centaur Armor  
Kittani: Explorer Armor  
LEWS-9 Light Environmental Wet Suit  
MEWS-10  
Plastic-Man  
Urban Warrior

### Coalition States (North America)

CA-1 Light Old Style "Dead Boy" Armor  
CA-2 Heavy Old Style "Dead Boy" Armor  
CA-3 Light "Dead Boy" Armor  
CA-4 "Standard" Dead Boy Armor  
CA-4 Mk2 "Shark" Naval Infantry Armor  
CA-5 "Juicer" Armor  
CA-6C Cyborg armor  
CA-6EX Heavy Infantry Armor & Exoskeleton  
CA-7 Special Forces Heavy "Dead Boy" Armor  
CA-7 Mk2 "Skull" Naval Commando Armor  
CNA-2 "Barracuda" Naval Commando Armor  
CSNA-1 "Lightning Strike" SCUBA Armor  
DPM D0 Dog Boy Armor  
DPM D1 Dog Boy Armor  
DPM D2 Dog Boy Armor

### Free Quebec (North America)

JEBA-12 Juicer Armor  
JEBA-TX-150 Heavy Juicer Armor  
QEBA-10 Environmental Body Armor

### Generic Body Armor

See Black Market

### Japanese Armor (H-Brand & Ichto)

AT-A11 Kuru Street Armor  
AT-A14 "Trooper" Body Armor  
AT-A15 Marine Heavy Combat Body Armor  
HA-4 & HA-5 Hiker  
HA-6 & HA-7 Frontiersman  
IA-100 Infiltrator  
IA-130 Sumo

### Juicer Armor (from around the World)

CA-5 "Juicer" Armor  
H-20 Juicer Environmental Armor  
JEBA-12 Juicer Armor  
JEBA-TX-150 Heavy Juicer Armor  
Juicer "Classic" Assassin Armor  
Man-Killer EBA (UTI)  
Mega-Juicer Combat Armor (UTI)  
Spiked Armor (UTI)  
Super-Hide Armor (UTI)  
Titan Plate Armor (UTI)  
Vibro-Spike Armor (UTI)

### Naruni Enterprises (Alien)

N-F12A Light Force Field  
N-20A & N-20B Medium Force Field  
N-F40A Heavy Force Field  
N-F50A Superheavy Force Field  
NE-CW20 Camouflage Armor

### New Navy (Sea; old USA)

Navy Body Armor  
U.S. Marine Combat Armor

### Northern Gun (North America)

Cavalry Barding (for Horses)  
MI "Vaquero" Armor  
NG "Buffalo" Riding Armor  
NG "Maverick" Riding Armor  
NG "Range Rider" Riding armor

### Poland – Kingdom of Tarnow (Europe)

Tarnow Environmental Body Armor  
Tarnow Non-Environmental Chain Mail  
Tarnow Non-Environmental Plate Mail

### Russian Body Armor (Europe & Asia)

Battleforge Body armor  
Bear Body Armor  
Cyborg Battle Armor (Light)  
Cyborg Battle Armor (Medium)  
Cyborg Battle Armor (Heavy)  
Lynx Body Armor  
Sovietski "Red Star" Medium Body Armor  
Trapper Body Armor

### South America

#### (Empire of the Sun & Silver River Republics)

Amaki Combat Armor  
Armored Fatigues  
Battle Infantry Armor  
Blood Rider "Claw" Armor  
Customizable Armor  
Duelist Articulated Armor  
Gaucho Body Armor  
Gilded Body Armor (Empire of the sun)  
Sichi Body Armor (Empire of the Sun)

### Triax (Germany & Europe)

T-10 Cyclops  
T-11 Enhanced Body Armor  
T-12 Field Medic  
T-13 Field Mechanic  
T-40 "Plain Clothes"  
T-41 Riot Suit  
T-42 Commando Scout  
T-43 Explorer

### Tritonia (Sea)

Amphib Body Armor  
SCUBA Body Armor

### Tundra Rangers (North America)

Legion Tundra Body Armor  
Thermal-Armor Body Suit

### UTI (Juicer Armor; North America)

See Juicer Armor.



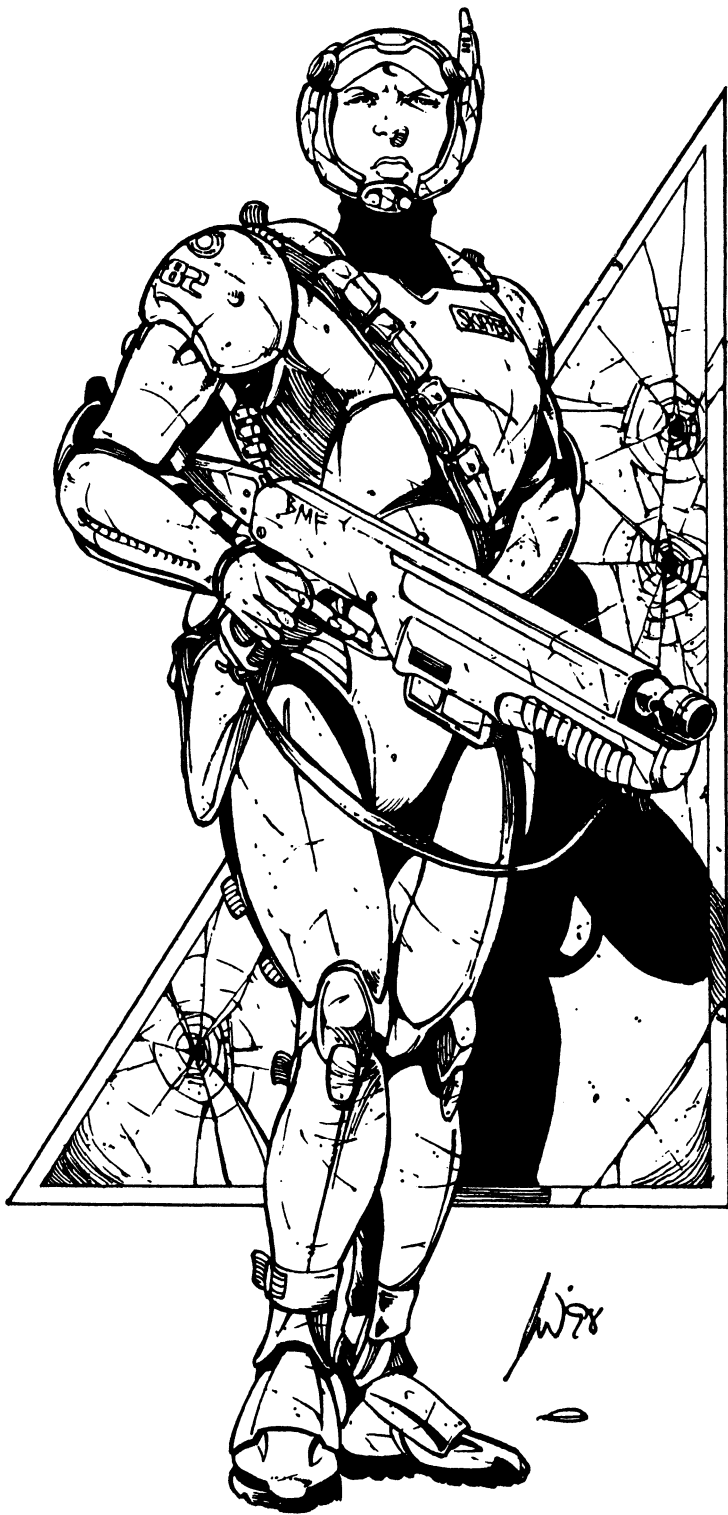

## Australian Body Armor

### Armored Trench Coat

**Manufacturer:** Various (Australia, p. 208).

**M.D.C.:** Main Body: 25; helmet, if any, is separate (30-50 M.D.C.).

**Mobility:** No penalties.

**Black Market Cost:** 5,000 Aussie dollars or credits.

### Light Anti-Assassin Vest

**Manufacturer:** Various (Australia, p. 208).

**M.D.C.:** Main Body: 15; helmet, if any, is separate (30-50 M.D.C.).

**Mobility:** No penalties.

**Black Market Cost:** 6,000 Aussie dollars or credits.

## Police Armored Jump Suit

**Manufacturer:** Various (Australia, p. 208).

**M.D.C.:** Helmet: 28 or 50. Main Body: 35. Arms: 22 each. Legs: 28 each.

**Mobility:** -5% to climb, prowl, gymnastics, acrobatics, and other such physical skills.

**Black Market Cost:** 25,000 Aussie dollars or credits.

## Police & TRG Riot Armor

**Manufacturer:** Various (Australia, p. 208).

**M.D.C.:** Helmet: 50. Main Body: 55. Arms: 22 each. Legs: 32 each.

**Mobility:** -5% to climb, -10% to prowl, gymnastics, acrobatics, and other such physical skills.

**Special Equipment:** Riot shield (40 M.D.C., strikes for 1D6 S.D.C.).

**Black Market Cost:** 28,000 plus 10,000 for the shield in Aussie dollars or credits.

## Special Ops Heavy Combat Armor

**Manufacturer:** Various (Australia, p. 209).

**M.D.C.:** Helmet: 30 or 70. Main Body: 115. Arms: 60 each. Legs: 75 each.

**Mobility:** -10% to climb, -25% to prowl, gymnastics, acrobatics, and other such physical skills.

**Black Market Cost:** 125,000 to 180,000 credits or Aussie dollars; generally unavailable to the public.

## “Trencher” Body Armor

**Manufacturer:** Various (Australia, p. 209).

**M.D.C.:** Helmet: 30 or 60. Main Body: 70. Arms: 40 each. Legs: 60 each.

**Mobility:** -5% to climb, -10% to prowl, gymnastics, acrobatics, and other such physical skills.

**Black Market Cost:** 75,000 to 130,000 credits or Aussie dollars; generally unavailable to the public.

## Black Market, Bandito Arms & Generic Armor

### The Bandito

**Manufacturer:** Bandito Arms (New West, p. 177).

**M.D.C.:** Helmet: 30, if any. Main Body: 38. Arms: 18 each. Legs: 24 each.

**Mobility:** No penalties.

**Note:** This does not have an environmental system.

**Black Market Cost:** 10,000 credits.

### Branaghan EBA Armor

**Manufacturer:** Bandito Arms and others (New West, p. 178).

**M.D.C.:** Helmet: 40. Main Body: 75 (+28 with overcoat). Arms: 28 each (+8 with overcoat). Legs: 38 each (+12 with overcoat).

**Mobility:** -10% to climb; -20% to prowl, gymnastics, acrobatics, and other such physical skills. Add on an additional -5% when the overcoat is worn too.

**Black Market Cost:** 38,000 credits for the main armor, 12,000 credits for the coat.

### Bushman EBA

**Manufacturer:** Generic (Rifts Ultimate Edition, p. 268).

**M.D.C.:** Helmet: 50. Main Body: 60. Arms: 28 each. Legs: 35 each.

**Mobility:** -10% to climb, prowl, gymnastics, acrobatics, and other such physical skills.

**Black Market Cost:** 32,000 credits.

### Crusader EBA

**Manufacturer:** Generic (Rifts Ultimate Edition, p. 267).

**M.D.C.:** Helmet: 35. Main Body: 55. Arms: 20 each. Legs: 30 each.

**Mobility:** No penalty, full mobility.

**Black Market Cost:** 40,000 credits.

## Cyber-Knight Body Armor

Several styles are found on pages 108-112 of *Siege on Tolkeen™*  
**Four: Cyber-Knights™.**

## Fury Beetle Armor (not EBA)

**Manufacturer:** Generic. Made from the chitin of the Fury Beetle.

**M.D.C.:** Helmet: 30. Main Body: 40-50 for partial armor; 75-80 for full plate armor.

**Mobility:** -10% to climb, prowl, gymnastics, acrobatics, and other such physical skills for partial armor. -30% for full armor.

**Black Market Cost:** 10,000-14,000 cr. for partial armor. 16,000-20,000 credits for full armor.

## G-10 Soldier EBA

**Manufacturer:** Generic (*Triax and the NGR*, p. 39).

**M.D.C.:** Helmet: 40. Main Body: 60. Arms: 25 each. Legs: 40 each.

**Mobility:** -10% to prowl, gymnastics, acrobatics, and other such physical skills.

**Black Market Cost:** 25,000 credits.

## Gladiator EBA

**Manufacturer:** Generic (*Rifts Ultimate Edition*, p. 267).

**M.D.C.:** Helmet: 50. Main Body: 70. Arms: 28 each. Legs: 35 each.

**Mobility:** -5% to prowl, gymnastics, acrobatics, and other such physical skills.

**Black Market Cost:** 50,000 credits.

## Homemade M.D.C. Armor

**Manufacturer:** Generic.

**M.D.C.:** Helmet: 20. Main Body: 30-40 for light armor, 50-65 for medium, heavy is not possible.

**Mobility:** -10% to climb, prowl, gymnastics, acrobatics, and other such physical skills.

**Black Market Cost:** 8,000 to 12,000 credits; +25,000 to make it EBA; most are not.

## Huntsman (not EBA)

**Manufacturer:** Generic (*Rifts Ultimate Edition*, p. 268).

**M.D.C.:** Main Body: 40; helmet, if any, is separate (30-50 M.D.C.).

**Mobility:** -15% to prowl, gymnastics, acrobatics, and other such physical skills.

**Black Market Cost:** 20,000 credits.

## Juicer (Light Assassin) Plate Armor (not EBA)

See Juicer Armor.

## Kittani Centaur Armor

**Manufacturer:** The Kittani/Splugorth (*Atlantis One*, p. 138).

**M.D.C.:** Helmet: 50. Main Body: 130. Arms: 35 each. Legs (4): 50 each.

**Mobility:** -15% prowl penalty.

**Black Market Cost:** 75,000 credits, rare outside Atlantis.

## Kittani Explorer Armor

**Manufacturer:** The Kittani/Splugorth (*Atlantis One*, p. 138).

**M.D.C.:** Helmet: 50. Main Body: 85. Arms: 28 each. Legs: 40 each.

**Mobility:** -15% prowl penalty.

**Black Market Cost:** 75,000 credits, rare outside Atlantis.

## LEWS-9 Light Environmental Wet Suit

**Manufacturer:** Generic (*Underseas*, p. 137).

**M.D.C.:** Helmet/Head Gear: 20. Main Body: 25.

**Mobility:** No penalty. Full mobility.

**Special Equipment:** 3 hour air supply; underwater jet boots (3 mph/4.8 km).

**Black Market Cost:** 15,000 credits.

## MEWS-10 EBA

**Manufacturer:** Generic (*Underseas*, p. 139).

**M.D.C.:** Helmet: 20. Main Body: 55. Arms: 25 each. Legs: 30 each.

**Mobility:** -5% to prowl, gymnastics, acrobatics, and other such physical skills.

**Special Equipment:** 8 hour air supply; underwater jet boots (6 mph/9.6 km).

**Black Market Cost:** 50,000 credits.

## Plastic-Man EBA

**Manufacturer:** Generic (*Rifts Ultimate Edition*, p. 268).

**M.D.C.:** Helmet: 35. Main Body: 35. Arms: 15 each. Legs: 20 each.

**Mobility:** -10% to prowl, gymnastics, acrobatics, and other such physical skills.

**Black Market Cost:** 18,000 credits.

## Urban Warrior EBA

**Manufacturer:** Generic (*Rifts Ultimate Edition*, p. 268).

**M.D.C.:** Helmet: 50. Main Body: 50. Arms: 20 each. Legs: 30 each.

**Mobility:** -10% to prowl, gymnastics, acrobatics, and other such physical skills.

**Black Market Cost:** 35,000 credits.

---

## Coalition States Military Armor

---

### CA-1 Light “Old Style” EBA Armor

#### – Now used by the Police/ISS

**Manufacturer:** Coalition States (*Coalition War Campaign*, p. 104 or *Rifts®* p. 193).

**M.D.C.:** Helmet: 50. Main Body: 50. Arms: 35 each. Legs: 50 each.

**Mobility:** -5% to climb; -10% to prowl, gymnastics, acrobatics, and other such physical skills.

**Black Market Cost:** Knock-offs and stolen or salvaged armor sell for 40,000 credits.

### CA-2 Heavy “Old Style” EBA Armor

#### – Now used by the Police/ISS

**Manufacturer:** Coalition States (*Coalition War Campaign*, p. 104 or *Rifts®* p. 193).

**M.D.C.:** Helmet: 50. Main Body: 80. Arms: 35 each. Legs: 50 each.

**Mobility:** -5% to climb; -10% to prowl, gymnastics, acrobatics, and other such physical skills.

**Black Market Cost:** Knock-offs and stolen or salvaged armor sell for 50,000 credits.

### CA-3 Light “Dead Boy” EBA Armor; New Style

**Manufacturer:** Coalition States (*Coalition War Campaign*, p. 100).

**M.D.C.:** Helmet: 70. Main Body: 80. Arms: 55 each. Legs: 70 each.

**Mobility:** -5% to climb; -10% to prowl, gymnastics, acrobatics, and other such physical skills.

**Black Market Cost:** 40,000-45,000 credits; available thanks to the war at Tolkeen.

### CA-4 “Standard” Dead Boy

#### EBA Armor; New Style

**Manufacturer:** Coalition States (*Coalition War Campaign*, p. 100).

**M.D.C.:** Helmet: 70. Main Body: 100. Arms: 60 each. Legs: 80 each.

**Mobility:** -5% to climb; -20% to prowl, gymnastics, acrobatics, and other such physical skills.

**Black Market Cost:** 50,000-55,000 credits; available thanks to the war at Tolkeen.

### CA-4 Mk2 “Shark” Naval Infantry EBA Armor

**Manufacturer:** Coalition States (*Coalition Navy*, p. 41).

**M.D.C.:** Helmet: 70. Main Body: 100. Arms: 60 each. Legs: 80 each.

**Mobility:** -5% to climb, prowl, gymnastics, acrobatics, and other such physical skills.



**Special Equipment:** Vibro-Blade fins (1D6 M.D. or 2D6 M.D.), depth gauge and gyro-system, modular backpack system.

**Black Market Cost:** Unavailable; exclusive to the Coalition.

### CA-5 Juicer “Dead Boy” EBA Armor

**Manufacturer:** Coalition States (Coalition War Campaign, p. 101).

**M.D.C.:** Helmet: 80. Main Body: 125. Arms: 70 each. Legs: 85 each.

**Mobility:** -5% to climb; -20% to prowl, gymnastics, acrobatics, and other such physical skills. Increase the penalty to climb to -15% and other physical skills to -30% if worn by anybody besides a Juicer (or Crazy). See other types of Juicer armor under UTI.

**Special Equipment:** CAJ-5 Weapon Arm.

**Plasma Blaster:** Mega-Damage: 4D6 M.D. Rate of Fire: Equal to number of attacks per melee round. Range: 800 feet (243.8 m). Payload: 10 shots on an E-Clip, 50 shots when connected to an energy hip pack or backpack.

**Light Laser Tool:** Mega-Damage: Three settings: 4D6 S.D.C., 1D4 M.D., and 1D6 M.D. Rate of Fire: Equal to number of attacks per

melee round. Range: 800 feet (243.8 m). Payload: 20 shots on an E-Clip.

**Vibro-Blades Tri-Claw:** Mega-Damage: 3D6 M.D. Rate of Fire: Equal to number of attacks per melee round. Range: Melee. Payload: Unlimited.

**Black Market Cost:** Unavailable; exclusive to the Coalition States.

### CA-6C Cyborg Armor

**Manufacturer:** Coalition States (Coalition War Campaign, p. 102).

**M.D.C.:** Helmet: 100. Main Body: 200. Arms: 100 each. Legs: 120 each.

**Mobility:** -15% to climb; -30% to prowl, gymnastics, acrobatics, and other such physical skills.

**Special Equipment:** HUD Multi-Screen, Computer & Video Link, Optical Enhancements, Laser Distancer, Laser Targeting (+1 to strike).

**Black Market Cost:** Unavailable; exclusive to the Coalition States.

## CA-6EX Heavy Infantry EBA Armor & Exoskeleton

**Manufacturer:** Coalition States (*Coalition War Campaign*, p. 102).  
**M.D.C.:** Helmet: 100. Main Body: 200. Arms: 100 each. Legs: 120 each.

**Mobility:** -30% to prowl; -30% to climb, gymnastics, acrobatics, and other such physical skills.

**Exoskeleton:** +8 to P.S., +14 to Spd, +10 feet (3 m) to the length and height of leaps, and reduce rate of fatigue by 50%.

**Special Equipment:** HUD Multi-Screen, Computer & Video Link, Optical Enhancements, Laser Distancer, Laser Targeting (+1 to strike).

**Black Market Cost:** Unavailable; exclusive to the Coalition States.

## CA-7 Special Forces Heavy "Dead Boy" EBA Armor

**Manufacturer:** Coalition States (*Coalition War Campaign*, p. 103).

**M.D.C.:** Helmet: 75. Main Body: 100. Arms: 60 each. Legs: 80 each.

**Mobility:** -5% to climb; -20% to prowl, gymnastics, acrobatics, and other such physical skills.

**Special Equipment:** Vibro-Blades (2; 1D6 M.D. each), Garrote Cord (left arm), and jet pack.

**Black Market Cost:** Unavailable to the Black Market; exclusive to the Coalition States.

## CA-7 Mk2 "Skull" Naval Commando EBA Armor

**Manufacturer:** Coalition States (*Coalition Navy*, p. 42).

**M.D.C.:** Helmet: 70. Main Body: 100. Arms: 50 each. Legs: 70 each.

**Mobility:** -5% to climb, -20% to prowl, gymnastics, acrobatics, and other such physical skills.

**Special Equipment:** Vibro-Blades in forearms (1D6 M.D.), garrote cords in left wrist, depth gauge and gyro-system, maneuvering jets, modular backpack system, Special Ops breathing tank.

**Black Market Cost:** Unavailable; exclusive to the Coalition.

## CNA-2 "Barracuda"

### Naval Commando EBA Armor

**Manufacturer:** Coalition States (*Coalition Navy*, p. 44).

**M.D.C.:** Helmet: 55. Main Body: 55. Arms: 22 each. Legs: 40 each.

**Mobility:** No penalties.

**Special Equipment:** Depth gauge and gyroscope, modular backpack system, combo-tank system, stealth equipment (experimental), electromagnetic dampers (experimental), multi-optic band.

**Black Market Cost:** Unavailable; exclusive to the Coalition.

## CSNA-1 "Lightning Strike" SCUBA EBA Armor

**Manufacturer:** Coalition States (*Coalition Navy*, p. 42).

**M.D.C.:** Helmet: 60. Main Body: 60. Arms: 26 each. Legs: 40 each.

**Mobility:** -5% to climb, prowl, gymnastics, acrobatics, and other such physical skills.

**Special Equipment:** Depth gauge, gyroscope, modular backpack, combo-tank system.

**Black Market Cost:** Unavailable; exclusive to the Coalition.

## DPM D0 "Traditional" Dog Boy Riot & Police Armor

**Manufacturer:** Coalition States (*Coalition War Campaign*, p.104; *Lone Star*, p. 52).

**M.D.C.:** Helmet: 20. Main Body: 50. Arms: 12 each. Legs: 20 each.

**Mobility:** No penalty, full mobility, but suit is NOT a full environmental EBA.

**Special Equipment:** Both forearms sport retractable Vibro-Sabers (2D6 M.D.).

**Black Market Cost:** 18,000 credits.

## DPM D1 "Heavy" (full EBA) Dog Boy Armor

**Manufacturer:** Coalition States (*Lone Star*, p. 52).

**M.D.C.:** Helmet: 50. Main Body: 80. Arms: 35 each. Legs: 50 each.

**Mobility:** -10% to climb; -20% to prowl, gymnastics, acrobatics, and other such physical skills.

**Special Equipment:** Both forearms sport retractable Vibro-Sabers (2D6 M.D.).

**Black Market Cost:** 35,000-40,000 credits.

## DPM D2 "Light" (full EBA) Dog Boy Armor

**Manufacturer:** Coalition States (*Lone Star*, p. 52).

**M.D.C.:** Helmet: 50. Main Body: 50. Arms: 35 each. Legs: 50 each.

**Mobility:** -5% to climb; -10% to prowl, gymnastics, acrobatics, and other such physical skills.

**Special Equipment:** Both forearms sport retractable Vibro-Sabers (2D6 M.D.).

**Black Market Cost:** 25,000-30,000 credits.

## Free Quebec



## JEBA-12 Juicer Armor

See Juicer Armor.

## JEBA-TX-150 Heavy Juicer Armor

See Juicer Armor.

## QEBA-10 Standard Military EBA

**Manufacturer:** Free Quebec (*Free Quebec*, p. 49).

**M.D.C.:** Helmet: 50. Main Body: 80. Arms: 35 each. Legs: 50 each.

**Mobility:** -10% to climb, -20% to prowl, gymnastics, acrobatics, and other such physical skills.

**Special Equipment:** Full environmental protection, built-in language translator, video camera and long-range transmitter, forearm flashlight.

**Black Market Cost:** Unavailable as yet. Exclusive to Free Quebec.

## Generic Body Armor

See Black Market Armor at the beginning of this section.

## Japanese Armor

(ArmaTech Industries, H-Brand & Ichto)

### AT-A11 Kuru Street EBA

**Manufacturer:** ArmaTech. Knocked off by H-Brand and Ichto Robotics (Japan, p. 182).

**M.D.C.:** Helmet: 50. Main Body: 65 (50 to 75 for knock-offs, depending on styling). Arms: 12 each. Legs: 20 each.

**Mobility:** -5% to prowl, gymnastics, acrobatics, and other such physical skills.

**Black Market Cost:** 30,000 credits (35,000 to 40,000 credits for knock-offs).

### AT-A14 "Trooper" Body EBA Armor

**Manufacturer:** ArmaTech Industries (Japan, p.183).

**M.D.C.:** Helmet: 50. Main Body: 95. Arms: 25 each. Legs: 35 each.

**Mobility:** -10% to prowl, gymnastics, acrobatics, and other such physical skills.

**Special Equipment:** Magnetic seal, sound filtration and muffler system, thermo-imaging, and laser targeting (+1 to strike).

**Black Market Cost:** 38,000 to 48,000 credits.

### AT-A15 Marine Heavy Combat EBA Armor

**Manufacturer:** ArmaTech Industries (Japan, p.183).

**M.D.C.:** Helmet: 60. Main Body: 120. Arms: 35 each. Legs: 70 each.

**Mobility:** -35% to prowl, gymnastics, acrobatics, and other such physical skills.

**Exoskeleton:** +8 to P.S., +8 to Spd, +10 feet (3 m) leap, reduce rate of fatigue by 50%.

**Special Equipment:** Magnetic seal, sound filtration and muffler system, thermo-imaging, laser targeting (+1 to strike).

**Black Market Cost:** 85,000+ credits.

### HA-4 & HA-5 Hiker

**Manufacturer:** H-Brand (Japan, p. 185).

**M.D.C.:** Helmet: 35. Main Body: 45. Arms: 18 each. Legs: 25 each.

**Mobility:** -10% to prowl, gymnastics, acrobatics, and other such physical skills.

**Special Equipment:** None. The HA-5 is the same as the HA-4 except it is styled to look like traditional bamboo or splint laminate armor.

**Black Market Cost:** 18,000 credits.

### HA-6 & HA-7 Frontiersman

**Manufacturer:** H-Brand (Japan, p. 186).

**M.D.C.:** Helmet: 50. Main Body: 70. Arms: 25 each. Legs: 35 each.

**Mobility:** -10% to prowl, gymnastics, acrobatics, and other such physical skills.

**Special Equipment:** None. The HA-7 is the same as the HA-6 except it has been styled to resemble traditional samurai armor.

**Black Market Cost:** 27,000 credits (HA-6) or 30,000 credits (HA-7).

### H-20 Juicer Environmental Armor

See Juicer Armor.

### IA-100 Infiltrator EBA

**Manufacturer:** Ichto Robotics (Japan, p. 184).

**M.D.C.:** Helmet: 18. Main Body: 60. Arms: 15 each. Legs: 24 each.

**Mobility:** -8% to prowl, gymnastics, acrobatics, and other such physical skills.

**Special Equipment:** Electro-adhesive hand pads (+5% to climb), concealed wrist computer (+5% to computer hacking, cracking electronic locks).

**Black Market Cost:** 45,000 credits.

### IA-130 Sumo EBA

**Manufacturer:** Ichto Robotics (Japan, p. 185).

**M.D.C.:** Helmet: 60. Main Body: 145. Arms: 50 each. Legs: 80 each.

**Mobility:** -60% to prowl, gymnastics, acrobatics, and other such physical skills. -20% to Spd.

**Exoskeleton:** +6 to P.S., +1 to roll with impact.

**Black Market Cost:** 40,000 credits.

## Juicer Armor (various)

### CA-5 Juicer "Dead Boy" Armor (CS EBA)

**Manufacturer:** Coalition States (Coalition War Campaign, p. 101).

**M.D.C.:** Helmet: 80. Main Body: 125. Arms: 70 each. Legs: 85 each.

**Mobility:** -5% to climb; -20% to prowl, gymnastics, acrobatics, and other such physical skills. Increase the penalty to climb to -15% and other physical skills to -30% if worn by anybody besides a Juicer (or Crazy). See other types of Juicer armor under UTI.

**Special Equipment:** CAJ-5 Weapon Arm.

**Plasma Blaster:** Mega-Damage: 4D6 M.D. Rate of Fire: Equal to number of attacks per melee round. Range: 800 feet (243.8 m). Payload: 10 shots on an E-Clip, 50 shots when connected to an energy hip pack or backpack.

**Light Laser Tool:** Mega-Damage: Three settings: 4D6 S.D.C., 1D4 M.D., and 1D6 M.D. Rate of Fire: Equal to number of attacks per melee round. Range: 800 feet (243.8 m) Payload: 20 shots on an E-Clip.

**Vibro-Blades Tri-Claw:** Mega-Damage: 3D6 M.D. Rate of Fire: Equal to number of attacks per melee round. Range: Melee. Payload: Unlimited.

**Black Market Cost:** Unavailable; exclusive to the Coalition States.

### H-20 Juicer Environmental Battle Armor

**Manufacturer:** H-Brand (Japan, p. 186).

**M.D.C.:** Helmet: 50. Main Body: 75. Arms: 35 each. Legs: 40 each.

**Mobility:** -10% to prowl, gymnastics, acrobatics, and other such physical skills.

**Special Equipment:** Sound filtration and muffler, thermo-imaging, laser targeting (+1 to strike).

**Black Market Cost:** 38,000 credits.

### JEBA-12 Juicer EBA (Free Quebec)

**Manufacturer:** Free Quebec (Free Quebec, p. 50).

**M.D.C.:** Helmet: 50. Main Body: 55. Arms: 25 each. Legs: 38 each.

**Mobility:** -5% to climb, prowl, gymnastics, acrobatics, and other such physical skills.

**Black Market Cost:** Unavailable as yet. Exclusive to Free Quebec Army.

### JEBA-TX-150 Heavy Juicer EBA (Free Quebec)

**Manufacturer:** Free Quebec (Free Quebec, p. 50).

**M.D.C.:** Helmet: 70. Main Body: 90. Arms: 40 each. Legs: 55 each.

**Mobility:** -5% to climb, prowl, gymnastics, acrobatics, and other such physical skills.

**Black Market Cost:** Unavailable as yet. Exclusive to Free Quebec Army.

### Juicer "Classic" Light Assassin

#### Plate Armor (not EBA)

**Manufacturer:** Generic (Rifts Ultimate Edition, p. 267).

**M.D.C.:** Helmet: 20. Main Body: 45. Arms: 15 each. Legs: 15-20 each.

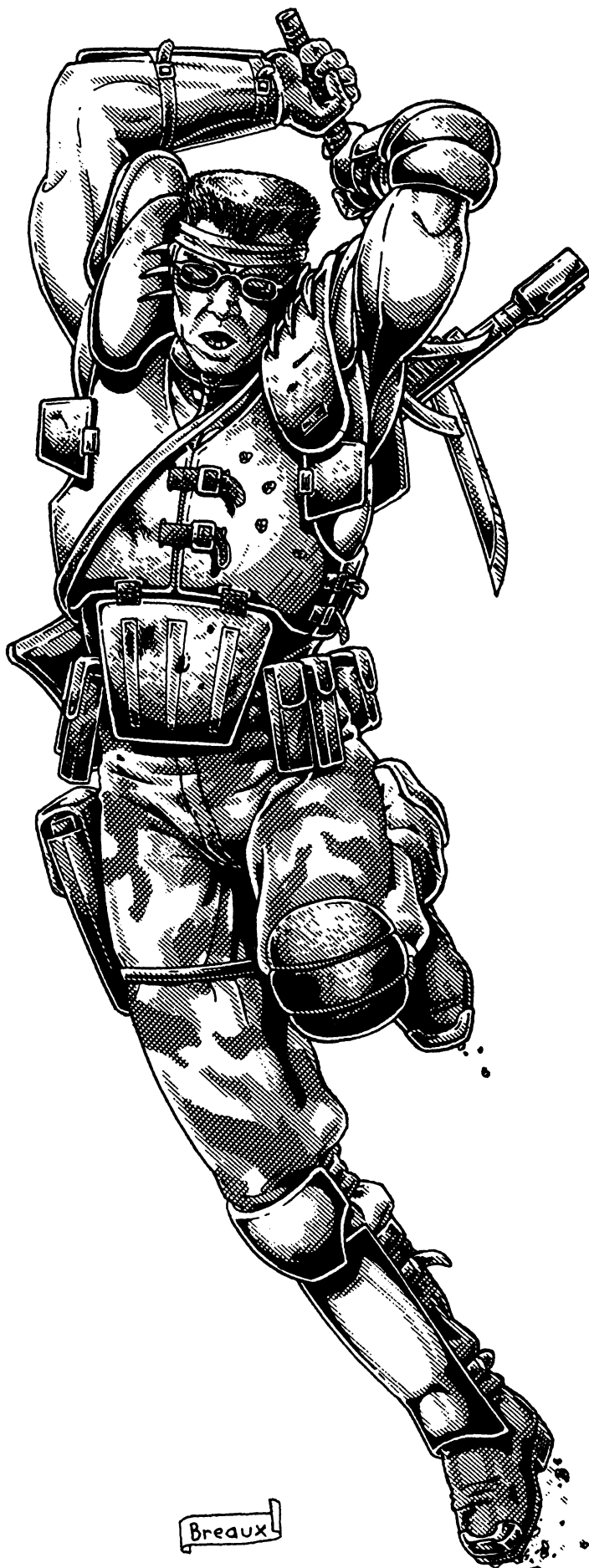

**Mobility:** -5% to prowl, gymnastics, acrobatics, and other such physical skills.

**Black Market Cost:** 24,000-28,000 credits. Not an environmental suit.

### Man-Killer Juicer EBA

**Manufacturer:** UTI and Northern Gun.

**M.D.C.:** Helmet: 50. Main Body: 110. Arms: 25 each. Legs: 40 each.

**Mobility:** -20% to prowl; -5% to gymnastics, acrobatics, and other such physical skills.

**Special Equipment:** The Man-Killer has spikes which can be used to harm M.D.C. materials and supernatural beings. A body slam with spike armor inflicts 2D6+P.S. S.D.C. damage on unarmored targets. If a user with a P.S. 25+ body slams an opponent with M.D.C. skin or armor, the attack inflicts one point of Mega-Damage. A power slam (counts as two attacks) does 4D6+P.S. damage bonus to S.D.C. targets and 1D6 M.D. to Mega-Damage structures and creatures. If used by a character with supernatural strength, the spikes will add 1D6 M.D. to hand to hand damage.

**Black Market Cost:** 60,000 credits.

### Mega-Juicer Combat Armor & EBA

**Manufacturer:** UTI and Northern Gun (**Juicer Uprising**, p. 69).

**M.D.C.:** Helmet: 50. Main Body: 130. Arms: 40 each. Legs: 55 each.

**Mobility:** For wearers with a normal P.S. of 30+ or a supernatural P.S. of 20+, the character is -10% to prowl and -5% to climb, swim, or to the performance of acrobatics or gymnastics skills. Also, reduce speed by 10%. Weaker characters (but no less than P.S. 24 normal or P.S. 16 supernatural) are -25% to prowl, and -15% to climb, swim, or perform acrobatics or gymnastics skills. Also, reduce speed by 30%. Characters weaker than P.S. 24 normal or P.S. 16 supernatural can not move while wearing this armor.

**Black Market Cost:** 55,000 credits. 65,000 credits for full environmental (EBA) version.

### Spiked Juicer EBA

**Manufacturer:** UTI and Northern Gun (**Juicer Uprising**, p. 69).

**M.D.C.:** Helmet: 45. Main Body: 45. Arms: 30 each. Legs: 35 each.

**Mobility:** -5% to prowl, gymnastics, acrobatics, and other such physical skills.

**Special Equipment:** A body slam or tackle with spiked armor will inflict 2D6 +P.S. damage on unarmored targets. If a Juicer with a P.S. of 25+ body slams an opponent with M.D.C. armor or skin, the attack will inflict one point of Mega-Damage. A power slam (counts as two attacks) does 5D6+P.S. damage bonus to S.D.C. targets and 1D6 M.D. to Mega-Damage structures and creatures. If used by a character with Supernatural P.S., the spikes add 1D6 M.D. to hand to hand damage; treat a body slam as a punch, and a power slam as a power punch and add 1D6 M.D.

**Black Market Cost:** 30,000-40,000 credits.

### Super-Hide Juicer Armor (not EBA)

**Manufacturer:** UTI and Northern Gun (**Juicer Uprising**, p. 71).

**M.D.C.:** Helmet: 30-50, if any. Main Body: Varies, from 70 to 140 M.D.C.. Arms: 25-35 each. Legs: 20-70 each depending on how much is covered.

**Mobility:** A base prowl penalty of -15% with -1% per 5 M.D.C. over 100. In addition, the wearer is -10% to climb, swim, or performing gymnastics or acrobatics.

**Black Market Cost:** 80,000 credits plus 1D6x10,000 credits. Not EBA.

### Titan Juicer Plate Armor EBA

**Manufacturer:** UTI (**Juicer Uprising**, p. 68).

**M.D.C.:** Helmet: 70. Main Body: 195. Arms: 80 each. Legs: 100 each.

**Mobility:** For wearers with a normal P.S. of 40+ or a supernatural P.S. of 25+, the character is -15% to prowl and -5% to climb, swim, or to the performance of acrobatics or gymnastics skills. Also, reduce speed by 10%. Weaker characters (but no less than P.S. 25 normal or P.S. 20 supernatural) are -30% to prowl, and -15% to climb,

swim, or perform acrobatics or gymnastics skills. Also, reduce speed by 40%. Characters weaker than P.S. 25 normal or P.S. 20 supernatural can not move while wearing this armor.

**Black Market Cost:** 85,000 credits. 110,000 credits for full environmental version.

### Vibro-Spike Armor Juicer EBA

**Manufacturer:** UTI and Northern Gun (**Juicer Uprising**, p. 69).

**M.D.C.:** Helmet: 45. Main Body: 50. Arms: 30 each. Legs: 35 each.

**Mobility:** -8% to prowl, gymnastics, acrobatics, and other such physical skills.

**Special Equipment:** Vibro-Spikes inflict 2D6 M.D. per hit and a power slam (counts as two attacks) does 4D6 M.D. Characters with supernatural strength add these damages to their basic hand to hand damage.

**Black Market Cost:** 55,000 -70,000 credits.

---

## Naruni Enterprises

**Note:** Force Field runs out in 2-12 hours on one E-Clip or when all M.D.C. had been depleted. Protects entire body equally; but once total Main Body M.D.C. is gone, so is the field, even if all the damage was directed at one particular part of the body. All offer excellent mobility.

### N-F12A Light Force Field

**Manufacturer:** Naruni Enterprises (**Phase World**, p. 121 and N-F10A equivalent in **Rifts® Mercenaries**, p.125).

**M.D.C.:** Main Body: 45; protects entire body equally.

**Black Market Cost:** 25,000 credits. Rare and costs double on Earth.

### N-20A & N-20B Medium Force Field

**Manufacturer:** Naruni Enterprises (**Phase World**, p. 121 or **Rifts® Mercenaries**, p. 125).

**M.D.C.:** Main Body: 75; protects entire body equally.

**Black Market Cost:** 50,000 credits (N-20) or 60,000 credits for N-20B installed into power armor or other equipment. Rare and costs double on Rifts Earth.

### N-F40A Heavy Force Field

**Manufacturer:** Naruni Enterprises (**Phase World**, p. 122 or **Rifts® Mercenaries**, p. 126).

**M.D.C.:** Main Body: 110; protects entire body equally.

**Black Market Cost:** 90,000 credits. Rare and costs double on Rifts Earth.

### N-F50A Super-Heavy Force Field

**Manufacturer:** Naruni Enterprises (**Phase World**, p. 122 or **Rifts® Mercenaries**, p. 126).

**M.D.C.:** Main Body: 160; protects entire body equally.

**Black Market Cost:** 170,000 credits. Rare and costs double on Rifts Earth.

### NE-CW20 Camouflage Variable Armor

**Manufacturer:** Naruni Enterprises (**Rifts® Mercenaries**, p. 124).

**M.D.C.:** Helmet: 40. Main Body: 80. Arms: 20 each. Legs: 30 each.

**Mobility:** -5% gymnastics, acrobatics, and other such physical skills. No prowl penalty.

**Special Abilities:** Masks heat sensors, invisible to thermal optics and changes color.

**Black Market Cost:** 75,000-100,000 credits. Rare since outlawed by CS; costs double.

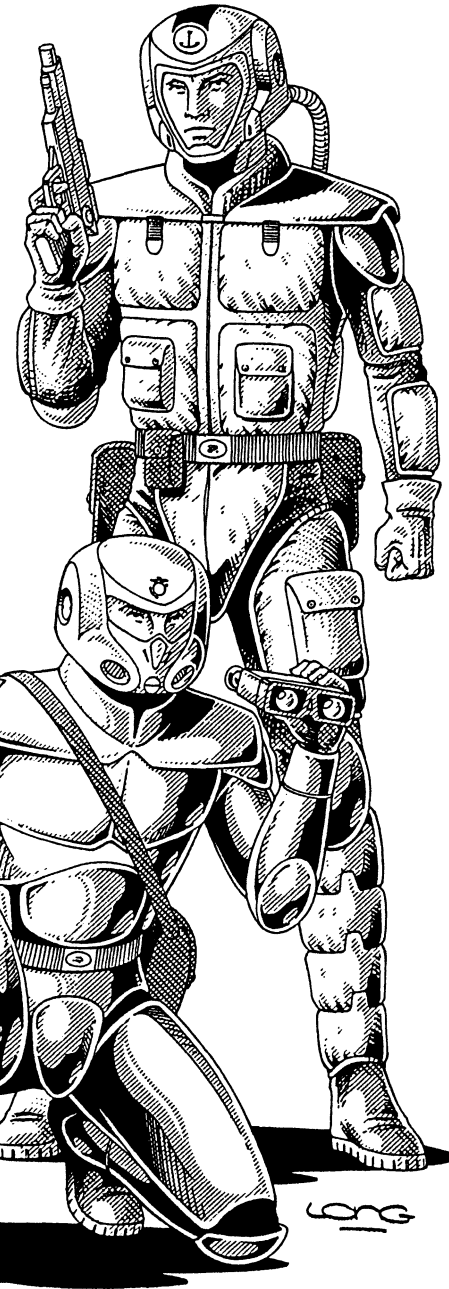

## New Navy

### Navy Body Armor

**Manufacturer:** New Navy (**Underseas**, p. 118).

**M.D.C.:** Helmet: 30. Main Body: 45. Arms: 15 each. Legs: 20 each.

**Mobility:** -5% to prowl, gymnastics, acrobatics, and other such physical skills.

**Special Equipment:** SCUBA gear; 1000 foot (305 m) maximum depth.

**Black Market Cost:** 40,000 credits.

### U.S. Marine Combat Armor

**Manufacturer:** New Navy (**Underseas**, p. 118).

**M.D.C.:** Helmet: 50. Main Body: 85. Arms: 25 each. Legs: 35 each.

**Special Equipment:** SCUBA gear; 2000 foot (610 m) maximum depth.

**Mobility:** -10% to prowl, gymnastics, acrobatics, and other such physical skills.

**Black Market Cost:** 50,000 credits.

## Northern Gun

### Cavalry Barding (Armor for Horses)

**Manufacturer:** Northern Gun (New West, p. 182).

**M.D.C.:** Head & Neck: 50. Main Body: 90. Front Legs: 18 each. Hind Legs: 25 each.

**Mobility:** Reduce the animal's speed by 5%.

**Black Market Cost:** 20,000-25,000 credits.

### MI "Vaqueros" Armor

**Manufacturer:** Northern Gun/Manistique Imperium (New West, p. 179).

**M.D.C.:** Helmet: 45. Main Body: 90. Arms: 32 each. Legs: 45 each.

**Mobility:** -20% to climb, prowl, gymnastics, acrobatics, and other such physical skills.

**Black Market Cost:** 40,000 credits.

### NG "Buffalo" Riding Armor

**Manufacturer:** Northern Gun (New West, p. 180).

**M.D.C.:** Helmet: 40. Main Body: 65. Arms: 30 each. Legs: 28 each.

**Mobility:** -5% to climb and -10% to prowl, gymnastics, acrobatics, and other such physical skills.

**Black Market Cost:** 32,000 credits.

### NG "Maverick" Riding Armor

**Manufacturer:** Northern Gun (New West, p. 179).

**M.D.C.:** Helmet: 10 (hat) or 35 (helmet). Main Body: 36. Arms: 12 each. Legs: 16 each.

**Mobility:** No penalties.

**Black Market Cost:** 14,000 credits.

### NG "Range Rider" Riding Armor

**Manufacturer:** Northern Gun (New West, p. 179).

**M.D.C.:** Helmet: 10 (hat) or 35 (helmet). Main Body: 30. Arms: 12 each. Legs: 15 each.

**Mobility:** No penalties.

**Black Market Cost:** 15,000 credits.

### Other NG Armor Types

Northern Gun also makes and sells ALL generic/Black Market body armor, such as the Bushman, Crusader, Gladiator, Plastic Man, Urban Warrior, etc. and a Triax, *Explorer* knock-off. Doesn't make any Bandito styles.

## Poland – Kingdom of Tarnow

### Tarnow Environmental Body Armor

**Manufacturer:** Kingdom of Tarnow (Mindwerks, p. 95).

**M.D.C.:** Mega-Damage Iron, Nickel & Aluminum Composite: Main Body: 80, Helmet: 50, Arms: 15 each, and Legs: 30 each.

Royal Mega-Damage EVA Body Armor: Main Body: 90, Helmet: 50, Arms: 30 each, and Legs: 50 each.

**Mobility:** -15% to climb, prowl, gymnastics, acrobatics, and other such physical skills. Reduce Spd by 10%. This applies to both armor types.

**Black Market Cost:** 35,000 to 50,000 credits (both types).

### Tarnow Non-Environmental Chain Mail

**Manufacturer:** Kingdom of Tarnow (Mindwerks, p. 94).

**M.D.C.:** Aluminum & Zinc: Main Body: 25; Arms: 5, and Legs: 10.

Copper and/or Nickel: Main Body: 40; Arms: 10, and Legs: 18.

Iron: Main Body: Main Body: 55; Arms: 15, and Legs: 20.

Iron, Nickel & Aluminum Composite: Main Body: 50; Arms: 12, and Legs: 18

**Mobility:** Aluminum & Zinc: No penalties. Copper and/or Nickel: -5% to climb, prowl, gymnastics, acrobatics, and other such physical skills. Iron: -15% to climb, prowl, gymnastics, acrobatics, and other

such physical skills. Iron, Nickel & Aluminum Composite: -10% to climb, prowl, gymnastics, acrobatics, and other such physical skills.

**Black Market Cost:** Aluminum & Zinc: 8,000 to 10,000 credits. Copper and/or Nickel: 12,000 to 16,000 credits. Iron: 18,000 to 25,000 credits. Iron, Nickel & Aluminum Composite: 20,000 to 30,000 credits.

### Tarnow Non-Environmental Plate Mail

**Manufacturer:** Kingdom of Tarnow (Mindwerks, p. 94).

**M.D.C.:** Aluminum & Zinc: Main Body: 35, Helmet: 30, Arms: 10 each, and Legs: 20 each.

Copper and/or Nickel: Main Body: 65, Helmet: 30, Arms: 15 each, and Legs: 35 each.

Iron: Main Body: 110, Helmet: 50, Arms: 28 each, and Legs: 40 each.

Iron, Nickel & Aluminum Composite: Main Body: 80, Helmet: 50, Arms: 24 each, and Legs: 35 each.

Iron and Nickel Plate and Chain: Main Body: 70, Helmet: 50, Arms: 20 each, and Legs: 30 each.

**Mobility:** Aluminum & Zinc: -10% to climb, prowl, gymnastics, acrobatics, and other such physical skills. Copper and/or Nickel or any Iron Composite Suit: -15% to climb, prowl, gymnastics, acrobatics, and other such physical skills. Iron (entirely): -25% to climb, prowl, gymnastics, acrobatics, and other such physical skills.

**Black Market Cost:** Aluminum & Zinc: 9,000 to 12,000 credits. Copper and/or Nickel: 18,000 to 25,000 credits. Iron: 18,000 to 25,000 credits. Iron, Nickel & Aluminum Composite: 25,000 to 35,000 credits. Iron and Nickel Plate and Chain: 25,000 to 35,000 credits.

## Russian Body Armor

### Battleforge Body Armor

**Manufacturer:** Warlords of Russia (Warlords of Russia, p. 174).

**M.D.C.:** Helmet: 60. Main Body: 90. Arms: 40 each. Legs: 50 each.

**Mobility:** -20% to climb, prowl, gymnastics, acrobatics, and other such physical skills.

**Black Market Cost:** 27,000 to 30,000 credits.

### Bear Body Armor

**Manufacturer:** Warlords of Russia (Warlords of Russia, p. 174).

**M.D.C.:** Helmet: 70. Main Body: 150. Arms: 110 each. Legs: 110 each.

**Mobility:** -30% to climb, prowl, gymnastics, acrobatics, and other such physical skills.

**Exoskeleton:** Robot P.S. of 26; 1D4 M.D. (restrained punch); 1D6 M.D. (full punch); 2D6 M.D. power punch; counts as two attacks).

**Black Market Cost:** 75,000 credits.

### Cyborg Battle Armor (Light)

**Manufacturer:** Warlords of Russia (Warlords of Russia, p. 175).

**M.D.C.:** Helmet: 50. Main Body: 140. Arms: 60 each. Legs: 70 each.

**Mobility:** -10% to climb, prowl, gymnastics, acrobatics, and other such physical skills.

**Black Market Cost:** 45,000 credits.

### Cyborg Battle Armor (Medium)

**Manufacturer:** Warlords of Russia (Warlords of Russia, p. 175).

**M.D.C.:** Helmet: 65. Main Body: 180. Arms: 70 each. Legs: 90 each.

**Mobility:** -10% to climb, prowl, gymnastics, acrobatics, and other such physical skills.

**Black Market Cost:** 70,000 credits.

### Cyborg Battle Armor (Heavy)

**Manufacturer:** Warlords of Russia (Warlords of Russia, p. 175).

**M.D.C.:** Helmet: 80. Main Body: 280. Arms: 80 each. Legs: 105 each.

**Mobility:** -20% to climb, prowl, gymnastics, acrobatics, and other such physical skills.

**Black Market Cost:** 120,000 credits.



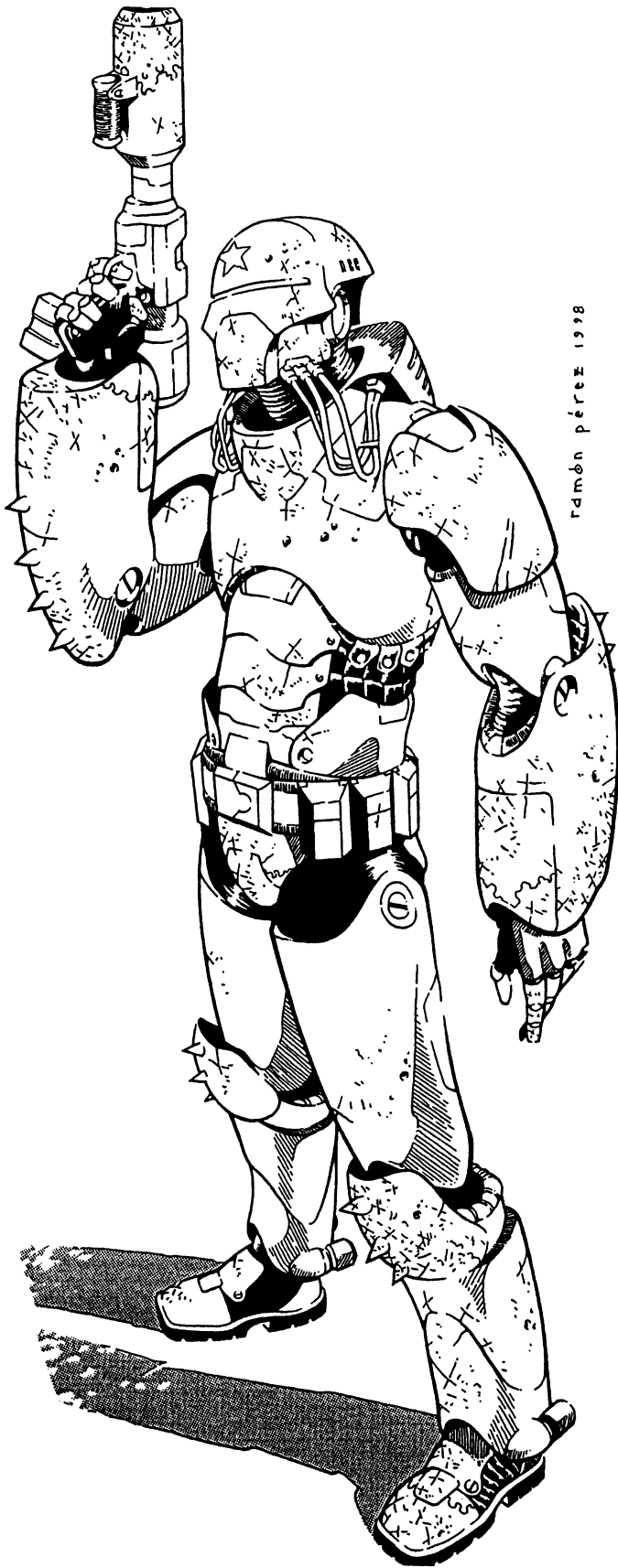

### Lynx Body Armor

**Manufacturer:** Warlords of Russia (*Warlords of Russia*, p. 175).  
**M.D.C.:** Helmet: 40. Main Body: 60. Arms: 40 each. Legs: 55 each.  
**Mobility:** -5% to climb, prowl, gymnastics, acrobatics, and other such physical skills.  
**Vibro-Blades:** 2D6 M.D. (single blade); 4D6 M.D. (double blade); +1 to parry.  
**Black Market Cost:** 26,000 credits.

### Trapper Body Armor in Russia

**Manufacturer:** Various; Russian (*Warlords of Russia*, p. 173).  
**M.D.C.:** Main Body: 45; helmet, if any, is separate (20-40 M.D.C.).  
Arms: 10 each. Legs: 20 each.  
**Mobility:** No penalties.  
**Special Equipment:** Retractable Vibro-Blades: 2D4 M.D.  
**Black Market Cost:** 12,000-15,000 credits (15,000-20,000 for American equivalent).

### South American Armor

#### Amaki Combat Armor

**Manufacturer:** Silver River Republics (*South America Two*, p. 168).  
**M.D.C.:** Helmet: 40. Main Body: 90. Arms: 35 each. Legs: 60 each.  
**Mobility:** -8% to prowl, gymnastics, acrobatics, and other such physical skills.  
**Black Market Cost:** 50,000 credits.

#### Armored Fatigues

**Manufacturer:** Silver River Republics (*South America Two*, p. 167).  
**M.D.C.:** Helmet: 40. Main Body: 65. Arms: 25 each. Legs: 32 each.  
**Mobility:** -15% to prowl, gymnastics, acrobatics, and other such physical skills.  
**Black Market Cost:** 35,000 credits.

#### Battle Infantry Armor

**Manufacturer:** Silver River Republics (*South America Two*, p. 167).  
**M.D.C.:** Helmet: 25. Main Body: 60. Arms: 15. Legs: 28.  
**Mobility:** -15% to prowl, gymnastics, acrobatics, and other such physical skills.  
**Black Market Cost:** 30,000 credits.

#### Blood Rider "Claw" Armor

**Manufacturer:** Blood Riders (*South America Two*, p. 168).  
**M.D.C.:** Helmet: 20-40; if any. Main Body: 65. Arms: 20 each. Legs: 30 each.  
**Mobility:** -8% to prowl, gymnastics, acrobatics, and other such physical skills.  
**Black Market Cost:** 35,000 credits.

#### Customizable Armor

**Manufacturer:** Silver River Republics (*South America Two*, p. 168).  
**M.D.C.:** Helmet: 20-40; if any. Main Body: 75. Arms: 20-30 each. Legs: 30-40 each.  
**Mobility:** -15% to prowl, gymnastics, acrobatics, and other such physical skills.  
**Black Market Cost:** 45,000 credits.

#### Duelist Articulated Armor

**Manufacturer:** Silver River Republics (*South America Two*, p. 167).  
**M.D.C.:** Helmet: 40. Main Body: 75. Arms: 12 each. Legs: 15 each.  
**Mobility:** No penalty.  
**Black Market Cost:** 120,000 credits. Refitting a suit that belonged to somebody else costs 20,000 credits.

#### Gaucha Body Armor

**Manufacturer:** Silver River Republics (*South America Two*, p. 166).  
**M.D.C.:** Helmet: 40. Main Body: 45. Arms: 20 each. Legs: 35 each.  
**Mobility:** -5% to prowl, gymnastics, acrobatics, and other such physical skills.  
**Black Market Cost:** 40,000 credits.

### Sovietski "Red Star" Medium Body Armor

**Manufacturer:** Sovietski; knocked off by indie manufacturers (*Warlords of Russia*, p. 173).  
**M.D.C.:** Helmet: 50. Main Body: 75. Arms: 40 each. Legs: 60 each.  
**Mobility:** -10% to climb, prowl, gymnastics, acrobatics, and other such physical skills.  
**Black Market Cost:** 28,000 to 32,000 credits.

### Gilded Body Armor EBA; Empire of the Sun

**Manufacturer:** Empire of the Sun (South America Two, p. 58).

**M.D.C.:** Helmet: 50. Main Body: 70. Arms: 25 each. Legs: 42 each.

**Mobility:** -10% to prowl, gymnastics, acrobatics, and other such physical skills.

**Black Market Cost:** 50,000 credits.

### Sichi Body Armor; Empire of the Sun

**Manufacturer:** Empire of the Sun (South America Two, p. 58).

**M.D.C.:** Helmet: 35. Main Body: 45. Arms: 8 each. Legs: 30 each.

**Mobility:** -5% to prowl, gymnastics, acrobatics, and other such physical skills.

**Black Market Cost:** 25,000 credits.

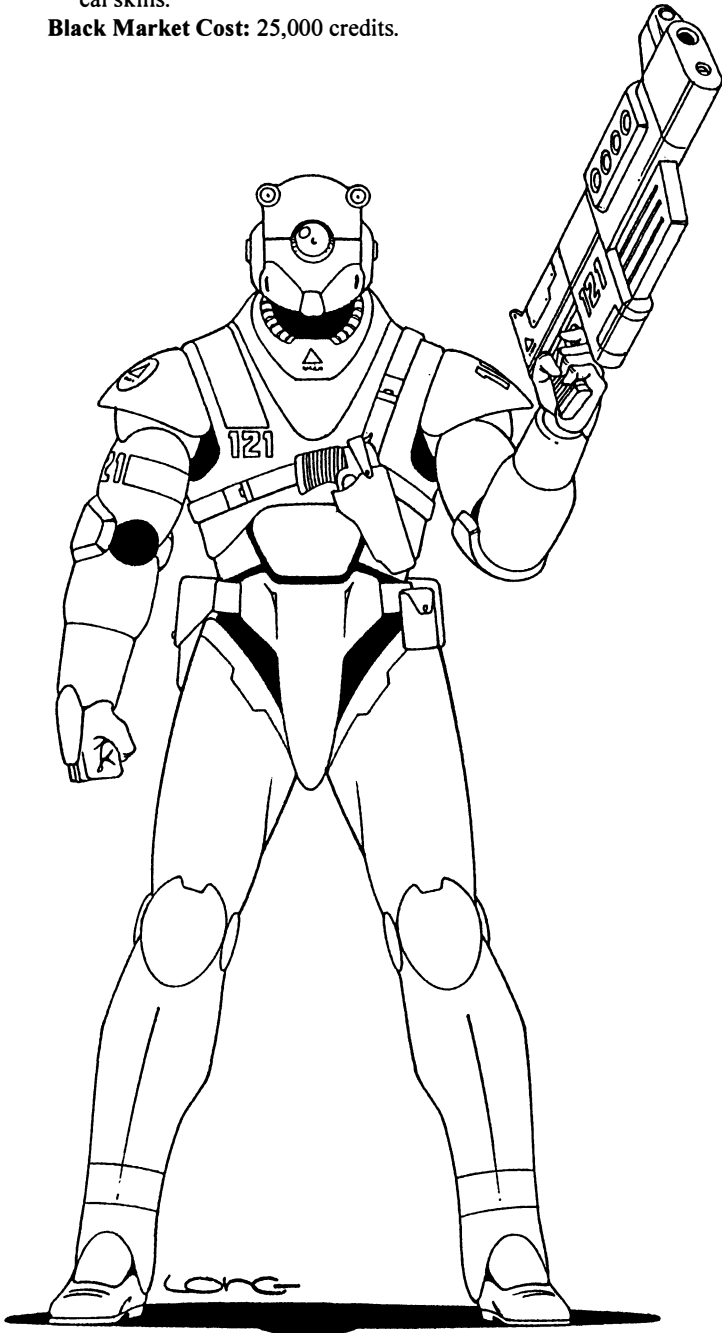

## Triax

**Note:** Widely available in Germany and Europe. Some imported to North & South America, and Africa as well as elsewhere.

### T-10 Cyclops EBA

**Manufacturer:** Triax (Triax and the NGR, p. 35).

**M.D.C.:** Helmet: 60. Main Body: 100. Arms: 55 each. Legs: 70 each

**Mobility:** -15% to prowl, gymnastics, acrobatics, and other such physical skills.

**Black Market Cost:** 60,000 credits.

### T-11 Enhanced EBA

**Manufacturer:** Triax (Triax and the NGR, p. 35).

**M.D.C.:** Helmet: 60. Main Body: 100. Arms: 65 each. Legs: 80 each.

**Mobility:** -5% to prowl, gymnastics, acrobatics, and other such physical skills.

**Exoskeleton:** +6 P.S., +10 Spd, +10 feet (3 m) to leaping, +10% to climb skill, reduce rate of fatigue by 50%.

**Black Market Cost:** 100,000 credits.

### T-12 Field Medic EBA

**Manufacturer:** Triax (Triax and the NGR, p. 35).

**M.D.C.:** Helmet: 60. Main Body: 70. Arms: 40 each. Legs: 60 each.

**Mobility:** -5% to prowl, gymnastics, acrobatics, and other such physical skills.

**Special Equipment:** Medical Cyclops helmet, medical harness.

**Black Market Cost:** 65,000 credits.

### T-13 Field Mechanic

**Manufacturer:** Triax (Triax and the NGR, p.36).

**M.D.C.:** Helmet: 60. Main Body: 80. Arms: 50 each. Legs: 60 each.

**Mobility:** -6% to prowl, gymnastics, acrobatics, and other such physical skills.

**Special Equipment:** Laser torch, extendable robot arm.

**Black Market Cost:** 75,000 credits.

### T-40 "Plain Clothes"

**Manufacturer:** Triax (Triax and the NGR, p. 37).

**M.D.C.:** Varies according to type; 10-20 M.D.C.

**Mobility:** Varies according to type. Most have no to -5% penalty.

**Black Market Cost:** Varies according to type. Most are 25,000-50,000 credits.

### T-41 Riot Suit

**Manufacturer:** Triax (Triax and the NGR, p. 37).

**M.D.C.:** Helmet: 30. Main Body: 50. Arms: 20 each. Legs: 40 each. Shield: 23.

**Mobility:** No penalty.

**Special Equipment:** Riot Shield (23 M.D.C.); clear on top.

**Black Market Cost:** 25,000 credits; costs 25% more in North America.

### T-42 Commando Scout

**Manufacturer:** Triax (Triax and the NGR, p. 38).

**M.D.C.:** Helmet: 60. Main Body: 70. Arms: 40 each. Legs: 50 each.

**Mobility:** No penalty.

**Special Equipment:** Enhanced optics package, miniature multi-purpose computer, laser distancer, laser targeting (+1 to strike).

**Black Market Cost:** 50,000 credits; costs 10-20% more in North America.

### T-43 Explorer (For Adventurers)

**Manufacturer:** Triax (Triax and the NGR, p. 38 and Sourcebook One, p. 59).

**M.D.C.:** Helmet: 50. Main Body: 70. Arms: 40 each. Legs: 50 each.

**Mobility:** -20% to prowl, gymnastics, acrobatics, and other such physical skills.

**Special Equipment:** Falcon 3000 Jet Pack.

**Black Market Cost:** Armor: 45,000 credits. Jet Pack: 30,000 credits (gas); 46,000 credits (electric); 400,000 credits (nuclear). Widely sold throughout the Americas and Europe.

### Other Triax Armor Types

Triax also makes and sells ALL generic/Black Market body armor, such as the Bushman, Crusader, Gladiator, Plastic Man, Urban Warrior, various Juicer Armor, Russian EBA, etc. Does not make any CS, Bandito Arms or Polish styles of armor.

## Tritonia

### Amphib Body Armor

**Manufacturer:** Tritonia (*Underseas*, p. 101).

**M.D.C.:** Helmet: 70. Main Body: 100. Arms: 50 each. Legs: 60 each.

**Mobility:** -5% prowl penalty (Amphibs); -25% prowl penalty (humans).

**Black Market Cost:** 75,000 credits.

### SCUBA Body Armor

**Manufacturer:** Tritonia (*Underseas*, p. 100).

**M.D.C.:** Helmet: 40. Main Body: 70. Arms: 30 each. Legs: 40 each.

**Mobility:** -5% to prowl, gymnastics, acrobatics, and other such physical skills.

**Black Market Cost:** 65,000 credits.

## Tundra Rangers

### Legion Tundra Body Armor

**Manufacturer:** Tundra Rangers (*Canada*, p. 187).

**M.D.C.:** Helmet: 50. Main Body: 60. Arms: 40 each. Legs: 60 each.

**Mobility:** -5% to climb, prowl, gymnastics, acrobatics, and other such physical skills.

**Special Equipment:** Thermal insulation.

**Black Market Cost:** Unavailable for sale. Exclusive to the Tundra Rangers.

### Thermal-Armor Body Suit

**Manufacturer:** Tundra Rangers (*Canada*, p. 187).

**M.D.C.:** Helmet: 50. Main Body: 50. Arms: 25. Legs: 40.

**Mobility:** No penalties.

**Black Market Cost:** Unavailable for sale. Exclusive to the Tundra Rangers.

## UTI

See Juicer Armor.

## Used & Reconditioned Armor

**Patchwork creations** provide effective Mega-Damage protection, and can appear very striking, but are not usually full environmental suits, so gases, fumes, radiation and disease will seep in and affect the wearer. Furthermore, most patchwork suits have 15-20% less M.D.C. than a professional, quality, full environmental suit. On the other hand, patchwork armor typically costs 40% less than a comparable full environmental suit, so many will take their chances with the armor and a gas mask or air filter. Those with environmental protection only sell for 20% less than normal, while creations that are artistic, frightening or striking in some way (may have 10-20 additional M.D.C. too) will sell for 20-50% more!

**Used Armor:** The cost of used armor can vary dramatically. Armor that's "like new" will have all standard features, have full environmental protection, full M.D.C., and sells for full price (sometimes sold as new). Typically used armor will have 4D6% less M.D.C. than new, with a proportional discount off the usual price; sometimes an additional 5% discount if paid for in universal credits.

Used armor that has been patched and repaired will have 20-30% less M.D.C. than new, but full environmental protection and sells for 30% less than the price of new.

Used armor that is battered or has been patched, has 30% less M.D.C. and *no* environmental system, but will sell for 50% less than the price for new, perfect armor.

**Note:** Customization and patchwork armor are two reasons there are so many variations of armor seen throughout the country.

**Customized & Modified Armor:** Most Black Market outlets and many arms dealers provide low cost customizing of body armor. This

means the helmet can be changed or modified (200 credits), the armor can be custom painted (600 cr.; one or two colors), insignias or special designs can be painted or etched into the armor (1000-2000 cr.), and body styling can be done (change the vambrace/forearms, shoulder plates, knee and leg plates, chest plates, face plate, add spikes, horns or blades, etc.; prices vary — small changes can cost 200-600 cr. while a complete overhaul could cost 3000 to 6000 plus the paint job).

Additional M.D.C. armor padding or plating can be added to most medium to heavy suits for the cost of 1000 credits per two points of M.D.C. (up to 20 points maximum)! Add another -5% penalty to movement.

**Note:** Northern Gun, Manistique Imperium, Golden Age Weaponsmiths and other arms dealers offer similar customizing services for body armor, power armor, vehicles and even cyborg armor and external cyborg components. Adventurers who don't have the money, but who have some artistic ability (or a friend with some) also engage in cosmetic alterations and personalization of armor, mostly painted insignias, designs and slogans to bolting on extra belts, spikes and such, or combining pieces of one or more types of armor to make *patchwork* suits of armor.

### Standard features of fully sealed, environmental body armor

The following are usually *standard* to all EBA whether it is from the CS, Northern Gun, Triax, the Black Market or a little homespun shop in the back alley of the 'Burbs. *Used and reconditioned EBA* may not have all these features. Customer beware.

- Complete environmental battle armor suitable for use in all hostile environments including space.
- Computer controlled life support system that monitors and displays bio-data of the wearer as well as the capacity and failure of life support systems and damage to the armor. The wearer will know *approximately* how much M.D.C. is remaining and whether or not the armor has been breached.
- Computer controlled, independent oxygen supply and purge system that automatically engages in low oxygen or contaminated air environments. Five hour oxygen supply.
- Internal cooling and temperature control.
- Artificial air circulation systems, gas filtration, humidifier.
- Insulated, high-temperature resistant shielding for up to 300 degrees centigrade. Normal fires do no damage. Nuclear, plasma, magic fires and Mega-Damage fire and heat do full damage.
- Radiation shielded.
- Polarized and light-sensitive visor with a tint that automatically adjusts to the level of available light.
- Built-in loudspeaker; 80 decibels.
- The helmet can be completely removed, and some allow for the removal of the protective face plate without having to take off the entire helmet.

### Typical Options:

- Directional, short-range radio built into the helmet. Range is five miles (8 km). Cost: 1000 credits.
- Loudspeaker: 300 credits.
- Built-in Language Translator: 12,000 credits.
- Passive night-sight goggles/visor: 1500 credits.
- Multi-Optic Helmet in place of conventional one: 5000 credits.
- Additional M.D.C. armor padding or plating can be added to most medium to heavy suits for the cost of 1000 credits per two points of M.D.C. (up to 20 points maximum), but add another -5% penalty to movement from the bulk of the extra armor.

# Power Armor

Below is a synopsis of most major Power Armor suits currently encountered in Rifts Earth. The stats below are just the barest bones for each unit, intended to give the G.M. what he needs to put these suits of armor into play. For each unit, this section provides its name, who makes it, what kind of armor it is, how many people it fits (in most cases, just one), main body M.D.C., physical strength, movement, primary weapon, secondary weapon, other notable weapons, bonuses, and Black Market cost. For the full description of any of these suits of power armor, please consult the appropriate **Rifts®** sourcebook. **Note:** In general, power armor utilizing Techno-Wizardry was exempted from this list.

## General Power Armor Notes

Power armor might be thought of as a sort of super-suit of environmental body armor. High-tech body armor is a protective plating or padding much like the knights of old wore, only much lighter and flexible. Power Armor is a suit of armor that protects its wearer completely from the environment, but also *augments* the wearer/user, giving the pilot superhuman strength, extra attacks per melee and a battery of advanced weaponry at his beck and call. Most power armor responds to the operator's every movement like an outer skin. Most types of power armor are robot *exoskeletons* designed for combat; a robot suit. It is a form of mechanical augmentation that does not require the user to submit to any permanent physical alterations. The human pilot steps into it and activates the armor. The moment the armor is activated, the suit becomes a self-contained environmental system and offers superhuman strength, speed and other abilities to its pilot (the capability to fly being one of the most common).

Power armor is *always* a one person unit that is usually human-size, although most power armor adds one to three feet (0.3 to 0.9 m) to one's height. Some older styles of power armor are larger and may tower as high as twelve feet (3.6 m). Anything larger is considered to be a *full robot vehicle*.

All Power Armor have the following features:

- 1. Nuclear Powered:** Which means they have an effectively unlimited fuel capacity and power source. **Average life:** 15 to 20 years.
- 2. Radar:** Can identify and track up to 24 targets simultaneously at a range of 10 miles (16 km).
- 3. Combat Computer:** Calculates, stores, and transmits data onto the heads-up display (H.U.D.) of the pilot's helmet. It is tied to the targeting computer.
- 4. Targeting Computer:** Assists in tracking and identification of enemy targets. Ten mile range (16 km).
- 5. Laser Targeting System:** Assists in the selection and focusing of specific targets and adds a bonus of +1 to strike when using long-range weapons. Does not apply to hand to hand combat or SAMAS.
- 6. Radio Communication:** Long-range, directional communication system with an effective range of about 500 miles (800 km), as well as a directional, short-range radio. Range is 5 miles (8 km). Plus a built-in loudspeaker; 80 decibels.
- 7. Complete Environmental Battle Armor:** Suitable for use in all hostile environments, including under water (150 foot/46 m max. depth) and space. The following features are included.
  - Computer controlled life support system.
  - Internal cooling and temperature control.
  - Artificial air circulation systems, gas filtration, humidifier.
  - Computer controlled, independent oxygen supply and purge system that automatically engages in low oxygen or contaminated air environments. Eight hour oxygen supply.
  - Insulated, high temperature resistant shielding for up to 400 degrees centigrade. Normal fires do no damage. Nuclear, plasma, and magic fires do full damage.
  - Radiation shielding.

## Power Armor by Manufacturer

### Coalition States

Death Wing Air Assault Armor  
PA-06-A SAMAS  
PA-07A Smiling Jack Light Assault SAMAS  
PA-08A Special Forces "Striker" SAMAS  
PA-09A Super SAMAS  
PA-10A Sea SAMAS  
PA-20B Trident  
PA-100 Mauler  
PA-200 Terror Trooper  
PA-300 Glitter Boy Killer

### Free Quebec

QGB-100 "Classic" Glitter Boy  
QGB-2-20 Glitter Girl  
QGB-3-30 Tarantula Glitter Boy  
QGB-8-88 Silver Wolf Glitter Boy  
QGC-7-70 Taurus Glitter Boy  
QPA-98 Glitter Boy Side Kick  
QPA-101 Pale Death SAMAS  
QPA-102 Violator SAMAS  
QPA-201 Power Trooper

### Japan

ArmaTech: ATPA-85 Power-Spy  
ArmaTech: PA-10A "Samurai Class" SAMAS  
ArmaTech: USA-G10A1 "Point" Glitter Boy  
ArmaTech: USA-G10A2 "Hawkeye" Glitter Boy  
H-Brand Ninjabot  
IPA-40 Dai-Katana Bugei  
IPA-45 Ikusa (Warrior)  
IPA-50 Grenadier  
IPA-60 Tazu-Tengu  
IPA-62 Super-Tengu  
IPA-70 Mizu Mi (Water Serpent)

### Kittani

K-Universal Light Power Armor  
Kittani Allosaurus "Firedrake"  
Kittani Centipede  
Kittani Equestrian  
Kittani Flying Fox  
Kittani Manling  
Kittani Raptor  
Kittani Serpent  
Kittani War Fish

### Miscellaneous Power Armor worldwide

**Note:** Includes Black Market, Bandito Arms, Chipwell Armaments, Northern Gun & others

Africa: Phoenix Power Armor  
Angrar Robotics: Angrar Mark II  
Australia: "Rusty"/APAA Modular Power Armor  
Australia: X50 Bushbasher  
Bandito: Sidewinder SAMAS  
Bandito: Wild Weasel SAMAS  
Chipwell: CAI-50 Challenger  
Chipwell: CAI-100 Warmonger  
Chipwell Assault Suit  
Native American: Iron Bear Power Armor  
Native American: U.S.A. SAMAS  
Native American: War Chief Power Armor  
Naut'YII: APAL-10 Naut'YII Torpedo Power Armor  
New Navy: APA-15 "Semper FI" Amphibious Assault PA  
Northern Gun: The Defender (J.A.P.E. II)

Northern Gun: NG-JK1A and NG-JK1B Juicer Killer  
Northern Gun: NG-X9 Samson

### Naruni Enterprises

Mecha-Knight Medium Powered Armor  
PA E-1000 Enforcer

### South America

Arkhn: APA-III Ghost Wasp  
Arkhn: APA-9 Death Cyclops  
Arkhn: APA-100 Counterstrike  
Arkhn: LE-457S Stormwind Assault Exoskeleton  
Cibola: Dragon Death Power Armor  
Columbia: D-20 Light Combat Exoskeleton  
Columbia: D-30 "Conquistador"  
Empire of the Sun: AC-1 Atahualpa Combat Suit  
Empire of the Sun: NPA Mark I Nazca Power Armor  
Empire of the Sun: SC-Mark III Solar Combat Armor  
Manoa: Hoplite Power Armor  
Silver River: AA-GB7 Glitter Boy Number 7  
Silver River: PA-10ML Mecha Lizard  
Silver River: TPA-7 Toro "Minotaur"

### Titan Robotics

FT-005 Flying Titan

### Triax

Aqua-Tech LEA-50 Deep Sea Power Armor  
Aqua-Tech Orca-50 Deep Sea Power Armor  
Aqua-Tech Orca-100 Deep Sea Power Armor  
T-21 Terrain Hopper  
T-C20 Terrain Hopper  
T-31 Super Trooper Robot Destroyer  
T-550 Glitter Boy  
TXD-100 Ultra Deep Sea Power Armor

### Tritonia

Man-O-War Dolphin & Orca Combat Armor  
Merbot Power Armor  
Sea-Snake Class Fast Scout Power Armor  
Sea Tiger Killer Whale Combat Armor  
Unicorn Scout Class "Killer Whale" Power Armor

## Coalition States

### Death Wing Air Assault Armor

**Manufacturer:** Coalition States (**Lone Star**, p.62).

**Main Body M.D.C.:** 290.

**Physical Strength:** Not augmented.

**Speed:** Running: Not possible. Flying: 600 mph (960 km); max altitude of 16,000 feet (4.8 km). Flying Endurance: 18 hours before overheating.

**Bonuses (In Flight):** +2 on initiative, +1 to strike, +2 to dodge, +1 attack per melee.

**High-Powered Wing Laser Guns:** Mega-Damage: 4D6 M.D. (single blast), 1D4x10+8 M.D. (double blast), 2D4x10+12 M.D. (quadruple blast). Rate of Fire: Equal to the number of attacks per melee round. Range: 4,000 feet (1,220 m). Payload: Unlimited.

**Short-Range Robot arm Lasers:** Mega-Damage: 2D6 M.D. (single blast), 4D6 M.D. (double blast). Rate of Fire: Equal to the number of attacks per melee round, plus one. Range: 2,000 feet (610 m). Payload: Unlimited.

**Other Weapons:** Top Mounted Weapon System (Rail Gun or Mini-Missile Launcher)

**Cost:** 4.3 million credits; unavailable on the Black Market.

### PA-06-A SAMAS

**Manufacturer:** Coalition States (**Rifts RPG**, p.193; **Coalition War Campaign**, p. 113).

**Main Body M.D.C.:** 250

**Physical Strength:** P.S. 30.

**Speed:** Running: 60 mph (96 km). Leaping: 15 feet (4.6 m) high; jet assist to 100 feet (30.5 m) high and 200 feet (61 m) across. Flying: Hover up to 200 feet (61 m) or fly at up to 300 mph (480 km). Cruising speed is 150 mph (240 km) and max altitude is 500 feet (152 m). Flying Range: Ten hours of constant flight time before cool off period is required.

**C-40R SAMAS Rail Gun:** Mega-Damage: 1D4 M.D. (single shot) or 1D4x10 M.D. (burst). Rate of Fire: Equal to number of hand to hand attacks. Range: 4,000 feet (1,220 m). Payload: 2,000 round drum (50 bursts).

**CM-2 Rocket Launcher:** Mega-Damage: 1D4x10 M.D. (armor piercing) or 1D6x10 M.D. (plasma). Rate of Fire: One or two. Range: One mile (1.6 km). Payload: Two.

**Bonuses:** +2 to strike and +1 to dodge in ranged combat only.

**Black Market Cost:** 1.6 million credits.

### PA-07A Smiling Jack Light Assault SAMAS

**Manufacturer:** Coalition States (**Coalition War Campaign**, p.114).

**Main Body M.D.C.:** 250

**Physical Strength:** P.S. 30.

**Speed:** Running: 60 mph (96 km). Leaping: 15 feet (4.6 m); jet assist to 100 feet (30.5 m) up and 200 feet (61 m) across. Flying: Hover up to 1,000 feet (305 m) or flight to 300 mph (480 km). Max altitude is 6,000 feet (1,828 m). Flying Endurance: Ten hours before overheating.

**Bonuses:** +1 to strike, +1 to dodge.

**C-40R SAMAS Rail Gun:** Mega-Damage: 1D4 M.D. (single shot); 1D4x10 M.D. (burst). Rate of Fire: Equal to the number of attacks per melee round. Range: 4,000 feet (1,220 m). Payload: 3,000 rounds (75 bursts).

**SJ-6 Mini-Missile Launchers:** Mega-Damage: 1D4x10 M.D. (armor piercing) or 1D6x10 M.D. (plasma). Rate of Fire: Single shot or volleys of two, four or six. Range: One mile (1.6 km). Payload: Six total, three per wing.

**Market Cost:** 1.8 million credits.

### PA-08A Special Forces "Striker" SAMAS

**Manufacturer:** Coalition States (**Coalition War Campaign**, p. 119).

**Main Body M.D.C.:** 325

**Physical Strength:** P.S. 36.

**Speed:** Running: 70 mph (112 km). Leaping: 20 feet (6.1 m); jet assist to 100 feet (30.5 m) high and 200 feet (61 m) across. Flying: 330 mph (528 km); max altitude is 6,000 feet (1,828 m). Flying Endurance: 10 hours of max speed or 24 hours of half speed before overheating.

**Bonuses:** +1 on initiative, +1 to strike, +1 to dodge.

**C-40R SAMAS Rail Gun:** Mega-Damage: 1D4 M.D. (single shot); 1D4x10 M.D. (burst). Rate of Fire: Equal to the number of attacks per melee round. Range: 4,000 feet (1,220 m). Payload: 3,000 rounds (75 bursts).

**Striker-6 Mini-Missile Wing Launchers:** Mega-Damage: 1D4x10 (armor piercing) or 1D6x10 (plasma). Rate of Fire: Single shot or volleys of two, four or six. Range: One mile (1.6 km). Payload: Six total.

**Other Weapons:** Striker-6 Mini-Missile Chest Launcher, Striker-8 Forearm Mini-Missile System.

**Market Cost:** 2.6 million credits.

### PA-09A Super SAMAS

**Manufacturer:** Coalition States (**Coalition War Campaign**, p. 117).

**Main Body M.D.C.:** 425

**Physical Strength:** P.S. 38.



**Speed:** Running: 40 mph (64 km). Leaping: Jet assist to 200 feet (61 m) high and 300 feet (91 m) across. Flying: 500 mph (800 km); max altitude is 16,000 feet (4,876.8 m). Flying Endurance: Eight hours before overheating.

**Bonuses:** +3 to pull punch, +2 on initiative.

**SS-09 Dual Plasma & Laser Weapon System:** Mega-Damage (plasma): 1D6x10 M.D. (single blast) or 2D6x10 M.D. (synchronized blast). Mega-Damage (laser): 3D6 M.D. (single blast) or 6D6 M.D. (dual blast). Rate of Fire: Equal to the number of attacks per melee round. Range: 1,600 feet (488 m) for plasma, 2,000 feet (610 m) for laser. Payload: Unlimited.

**Forearm Grenade Launchers (2):** Mega-Damage: 6D6 M.D. to a 12 foot (3.6 m) area. Rate of Fire: Single shot or volleys of two, four, six or eight. Range: 1,000 feet (305 m). Payload: 80 total; four per arm.

**Other Weapons:** Forearm Vibro-Blades.

**Market Cost:** 5.8 million credits.

### PA-10A Sea SAMAS

**Manufacturer:** Coalition States (Coalition Navy, p. 49).

**Main Body M.D.C.:** 295

**Physical Strength:** P.S. 36.

**Speed:** Running: 60 mph (96 km). Leaping: 15 feet (3.6 m); jet assist to 100 feet (30.5 m) high and 200 feet (61 m) across. Flying: 150 mph (240 km); max altitude is 200 feet (61 m). Flying Endurance: Two hours before overheating. Underwater: 55 mph (88 km; 47.3 knots); max depth: one mile (1.6 km).

**Bonuses:** +1 on initiative, +1 to parry, +2 to dodge underwater.

**CSN-60 Variable Beam Laser Cannon:** Mega-Damage: 5D6 M.D. Rate of Fire: Equal to the number of attacks per melee round. Range: 2,000 feet (610 m) underwater, 4,000 feet (1,220 m) on land. Payload: Unlimited.

**Rail/Ion Gun:** Mega-Damage: 6D6 M.D. (ion gun); 4D6 M.D. (rail

gun). Rate of Fire: Equal to the number of attacks per melee round. Range (ion gun): 1,000 feet (305 m). Range (rail gun): 2,000 feet (610 m) underwater and 3,000 feet (914 m) on land. Payload: Unlimited for ion blaster, 1,000 rounds (50 bursts) for rail gun.

**Other Weapons:** CM-4 Shoulder Mini-Missile Launchers, Leg-Mounted Mini-Torpedo Launchers, Forearm Vibro-Blades.

**Black Market Cost:** 2.3 million credits.

### PA-20B Trident

**Manufacturer:** Coalition States (Coalition Navy, p. 51).

**Main Body M.D.C.:** 190

**Physical Strength:** P.S. 30.

**Speed:** Running: 30 mph (48 km). Swimming: 20 mph (32 km). Leaping: 15 feet (4.6 m); jet assist up to 40 feet (12.2 m) or 50 feet (15.2 m) across. Underwater: 40 mph (64 km; 34.4 knots). Max depth: 3,500 feet (1,066.8 m).

**Bonuses:** None.

**Modular, Interchangeable Forearm Units:** Various weapons, including Vibro-Blade, Mini-Missile Launcher, Triple-Barrel Spear Gun, Single- and Double-Barreled Utility Laser, Plasma Torch, and Robot Hand.

**Black Market Cost:** 1.6 million credits.

### PA-100 Mauler

**Manufacturer:** Coalition States (Coalition War Campaign, p.106).

**Main Body M.D.C.:** 280

**Physical Strength:** P.S. 36.

**Speed:** Running: 40 mph (64 km). Leaping: 15 feet (4.6 m) with running start.

**Bonuses:** None.

**Shoulder Plasma Ejectors:** Mega-Damage: 4D6 M.D. (single shot); 8D6 M.D. (double shot). Rate of Fire: Each gun can be fired up to twice per melee. Range: 1,200 feet (366 m). Payload: Unlimited.

**Concealed, Back-Mounted Mini-Missile Launcher:** Mega-Damage: 1D4x10 M.D. (armor piercing ) or 1D6x10 M.D. (plasma). Rate of Fire: Single shot or volleys of two or three. Range: One mile (1.6 km). Payload: Eight.

**Other Weapons:** Forearm Lasers, Retractable Forearm Vibro-Sabers.  
**Market Cost:** 3.4 million credits.

## PA-200 Terror Trooper

**Manufacturer:** Coalition States (Coalition War Campaign, p. 108).

**Main Body M.D.C.:** 400

**Physical Strength:** P.S. 40.

**Speed:** Running: 60 mph (96 km). Leaping: 15 feet (4.6 m) with running start.

**Bonuses:** None

**Forearm Laser Blasters (2):** Mega-Damage: 3D6 M.D. (single shot); 6D6 M.D. (double shot). Rate of Fire: Equal to the number of attacks per melee round. Range: 2,000 feet (610 m). Payload: Unlimited.

**Mini-Missile Tubes (2):** Mega-Damage: 1D4x10 M.D. (armor piercing) or 1D6x10 M.D. (plasma). Rate of Fire: Single shot or volleys of two or four. Range: One mile (1.6 km). Payload: 20 total; 10 per launch tube.

**Other Weapons:** CTT-M20 Missile Rifle or CTT-P40 Particle Beam Cannon.

**Market Cost:** 4.1 million credits.

## PA-300 Glitter Boy Killer

**Manufacturer:** Coalition States (Coalition War Campaign, p. 110).

**Main Body M.D.C.:** 440

**Physical Strength:** P.S. 40.

**Speed:** Running: 100 mph (160 km). Leaping: 20 (6.1 m).

**Bonuses:** None.

**Forearm Plasma Gun:** Mega-Damage: 6D6 M.D. (single blast); 1D6x10 M.D. (double blast combined with Ion Gun). Rate of Fire: Equal to the number of attacks per melee round. Range: 1,600 feet (488 m). Payload: Unlimited.

**Forearm Ion Gun:** Mega-Damage: 3D6 M.D. (single blast); 1D6x10 M.D. (double blast combined with Plasma Gun). Rate of Fire: Equal to the number of attacks per melee round. Range: 1,200 feet (366 m). Payload: Unlimited.

**Other Weapons:** Forearm Grenade Launcher, Forearm Vibro-Blades (4), Extra Weapon Arms (2), Triple Barrel Laser Turret.

**Market Cost:** 12.6 million credits.

# Free Quebec

## QGB-100 "Classic" Glitter Boy

**Manufacturer:** Free Quebec (Free Quebec, p.82).

**Main Body M.D.C.:** 770

**Physical Strength:** P.S. 40.

**Speed:** Running: 60 mph (96 km). Leaping: 12 feet (3.6 m), add 10 feet (3 m) if running.

**Bonuses:** +2 to strike with Boom Gun.

**RG-15 Rail Gun:** Mega-Damage: 3D6x10 M.D. Rate of Fire: Equal to the number of attacks per melee round. Range: 11,000 feet (about 2 miles/3.2 km). Payload: 100 rounds.

**Rimouski Weapon Package:** This add-on contains the RM-100 Laser Blaster, a concealed Laser Finger, and the RM-100 Vibro-Sword.

**Market Cost:** 20 million credits; exclusive to the Free Quebec and NGR Military. 15 million for a unit without the Boom Gun or Rimouski Weapon Package.

## QGB-2-20 Glitter Girl

**Manufacturer:** Free Quebec (Free Quebec, p. 87).

**Main Body M.D.C.:** 650

**Physical Strength:** P.S. 36.

**Speed:** Running: 90 mph (144 km). Leaping: 15 feet (4.6 m), add 12 feet (3.6 m) if running. Jet assist up to 18 feet (5.5 m), for up to 2D4x10 seconds.

**Bonuses:** +2 on initiative, +3 to strike with Double-Up Cannon, +1 to dodge, +2 to pull punch.

**QST-104 "Double-up" Assault Cannon:** Mega-Damage: 6D6+12 M.D. (plasma bolt); 2D6 M.D. (explosive round). Rate of Fire: Equal to the number of attacks per melee round. Range: 6,000 feet (1,828 m) for explosive rounds, 2,400 feet (731.5 m) for plasma bolts. Payload: 100 explosive rounds, 120 plasma blasts (two shots recharge per minute).

**Shoulder Mounted Mini-Missile Canister Launchers (2):** Mega-Damage: 5D6 M.D. (frag), 1D4x10 M.D. (armor piercing) or 1D6x10 M.D. (plasma). Rate of Fire: Single shot or volleys of two. Range: One mile (1.6 km). Payload: Two total; one per launcher.

**Other Weapons:** Optional Missile Backpack Unit, optional RG-14 Rail Gun.

**Market Cost:** 24 million credits, exclusive to the Free Quebec Military. 18 million for a unit without any weapons.

## QGB-3-30 Tarantula Glitter Boy

**Manufacturer:** Free Quebec (Free Quebec, p.95).

**Main Body M.D.C.:** 850

**Physical Strength:** P.S. 40.

**Speed:** Running: 50 mph (80 km). Leaping: 10 feet (3 m), doubled if running. Jet assist to 60 feet (18.3 m) across and can hold unit aloft up to 10 feet (3 m) for 1D6x10 seconds.

**Bonuses:**

**QST-333 "Shaker" Cannon:** Mega-Damage: Laser: 4D6 M.D.; Plasma Bolt: 1D6x10+6 M.D.; Rail Gun: 1D6 M.D. (single round) or 1D6x10 (burst). Rate of Fire: Equal to the number of attacks per melee round. Range: Laser: 2,000 feet (610 m); Plasma Bolts: 2,400 feet (731.5 m); Rail Gun: 6,000 feet (1,828 m). Payload: Laser: Unlimited; Plasma: Unlimited; Rail Gun: 3,000 rounds (100 bursts).

**Forearm Ion Blaster:** Mega-Damage: 4D6 M.D. Rate of Fire: Equal to the number of attacks per melee round. Range: 1,000 feet (305 m). Payload: Unlimited.

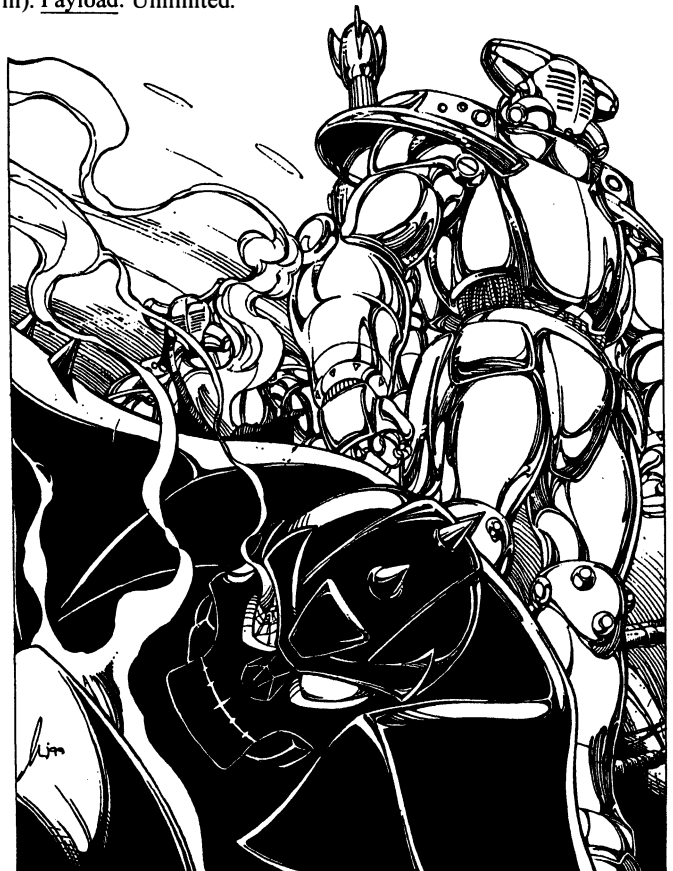

**Other Weapons:** Vibro-Sword, Optional Type Two Head with Dual Lasers, Optional Forearm Mini-Missile Launcher, Optional RG-15 Rail Gun.

**Black Market Cost:** 23 million credits. Exclusive to Quebec military. Not yet available on Black Market, but when it is, it will go for 30 to 50 million credits.

### QGB-8-88 Silver Wolf Glitter Boy

**Manufacturer:** Free Quebec (Free Quebec, p.101).

**Main Body M.D.C.:** 450

**Physical Strength:** P.S. 32.

**Speed:** Running: 90 mph (144 km). Leaping: 15 feet (4.6 m), add 12 feet (3.6 m) if running. Jet assist to 120 feet (36.6 m). Jets can hold unit aloft up to 18 feet (5.5 m) high for as long as 2D4x10 seconds.

**Bonuses:** +2 on initiative (+3 in hand to hand combat), +1 to strike (+2 with energy weapons), +2 to parry, +2 to dodge, W.P. Paired Weapons.

**QST-1888 Particle Beam Assault Cannon:** Mega-Damage: 1D6x10+6 M.D. Rate of Fire: Equal to the number of attacks per melee round. Range: 2,000 feet (610 m). Payload: Unlimited.

**Forearm Shield-Mounted Mini-Missile Launchers:** Mega-Damage: 5D6 M.D. (frag), 1D4x10 M.D. (armor piercing), or 1D6x10 M.D. (plasma). Rate of Fire: Single shot or volleys of two.. Range: One mile (1.6 km). Payload: Eight total; four per shield.

**Other Weapons:** Anti-Personnel Laser, Vibro-Swords.

**Cost:** 20 million credits; exclusive to the Quebec Military; 15.4 million for a unit without any weapon systems.

### QGC-7-70 Taurus Glitter Boy

**Manufacturer:** Free Quebec (Free Quebec, p.98).

**Main Body M.D.C.:** 800

**Physical Strength:** P.S. 40.

**Speed:** Running: 50 mph (80 km). Leaping: 8 feet (2.4 m). Add 10 feet (3 m) for a running start. Jet assist up to 60 feet (18.3 m).

**Bonuses:** None.

**High-Powered Mortars (2):** Mega-Damage: 1D6x10 M.D. (single strike); 2D6x10 M.D. (double strike). Rate of Fire: Single shot to a volley of two. Range: 2.2 miles (3.5 km). Payload: 12 total; six per gun.

**High-Powered Laser Cannons:** Mega-Damage: 1D4x10 (single blast); 2D4x10 (double blast). Rate of Fire: Equal to the number of attacks per melee round. Range: 4,000 feet (1,220 m). Payload: Unlimited.

**Black Market Cost:** 18 million credits without weapons. Exclusive to Free Quebec and NGR Military. A fully loaded Taurus GB on the Black Market would fetch 30-45 million credits.

### QPA-98 Glitter Boy Side Kick

**Manufacturer:** Free Quebec (Free Quebec, p. 92).

**Main Body M.D.C.:** 280

**Physical Strength:** P.S. 26.

**Speed:** Running: 40 mph (64 km). Leaping: 12 feet (3.6 m); jet assist to 60 feet (18.3 m) high and 300 feet (91 m) across. Flying: 120 mph (192 km); max altitude is 600 feet (183 m). Flying Endurance: One hour before overheating.

**Bonuses:** +1 to strike with ranged weapons, +1 on initiative, +1 to parry, +2 to dodge, +6 to dodge while traveling by means of power jumps.

**QST-98 "Kicker" Grenade Launcher:** Mega-Damage: 5D6 M.D. per round to a six foot (1.8 m) radius. Can also fire bursts of three shots, doing 2D4x10 M.D. This burst attack counts as only one action, but the strike roll gets *no* bonuses whatsoever. Rate of Fire: Equal to the number of attacks per melee round. Range: 1,800 feet (548.6 m). Payload: 120.

**Other Weapons:** Hand weaponry often carried as a sidearm.

**Black Market Cost:** 8.5 million, largely due to the Glitter Boy, laser resistant, chrome plating used to make this power armor. Exclusive to the Quebec Military. Not available on the Black Market ... yet.

### QPA-101 Pale Death SAMAS

**Manufacturer:** Free Quebec (Free Quebec, p.107).

**Main Body M.D.C.:** 250

**Physical Strength:** P.S. 30.

**Speed:** Running: 60 mph (96 km). Leaping: 15 feet (4.6 m); jet assist to 100 feet (30.5 m) high and 200 feet (61 m) across. Flying: Hover up to 200 feet (61 m) or flight up to 300 mph (480 km). Max altitude is 6,000 feet (1,828 m). Flying Endurance: Ten hours before overheating.

**Bonuses:** +1 to strike, +1 to dodge.

**C-40R SAMAS Rail Gun:** Mega-Damage: 1D4 M.D. (single round); 1D4x10 (burst). Rate of Fire: Equal to the number of attacks per melee round. Range: 4,000 feet (1,220 m). Payload: 2,000 rounds (50 bursts).

**CM-2 Rocket Launcher:** Mega-Damage: 5D6 M.D. (frag), 1D4x10 M.D. (armor piercing), 1D6x10 M.D. (plasma). Rate of Fire: Single shot or volleys of two. Range: One mile (1.6 km). Payload: Two.

**Market Cost:** 1.6 million credits. The Black Market sells captured and undamaged units for 2.4 to 3 million credits, or for 1.5 to 2 million credits without weapons. Rarely available.



### QPA-102 Violator SAMAS

**Manufacturer:** Free Quebec (Free Quebec, p.109).

**Main Body M.D.C.:** 312

**Physical Strength:** P.S. 32.

**Speed:** Running: 70 mph (112 km). Leaping: 20 feet (6.1 m); jet assist to 100 feet (30.5 m) high and 200 feet (61 m) across. Flying: 360 mph (576 km); max altitude is 10,000 feet (3,048 km). Flying Endurance: 10 hours at max speed (24 hours at half speed) before overheating.

**Bonuses:** +2 on initiative, +1 to strike, +1 to dodge.

**QR-12A SAMAS Laser Rifle:** Mega-Damage: 3D6 M.D. (single shot); 1D4x10 (triple burst). Rate of Fire: Equal to the number of attacks per melee round. Range: 2,800 feet (853.4 m). Payload: Unlimited.

**CM-2B Wing Mini-Missile Launchers (2):** Mega-Damage: 1D4x10 M.D. (armor piercing) or 1D6x10 M.D. (plasma). Rate of Fire: Single shot or volleys of 2, 4, 8 or 16. Range: One mile (1.6 km). Payload: 16; eight per launcher.

**Other Weapons:** Wing Blades, Vibro-Blade Short Sword.

**Market Cost:** 2.1 million credits. Exclusive to the Quebec Military. Not available on the Black Market or to the CS.

### QPA-201 Power Trooper

**Manufacturer:** Free Quebec (Free Quebec, p. 105).

**Main Body M.D.C.:** 295

**Physical Strength:** P.S. 40.



**Speed:** Running: 40 mph (64 km). Leaping: 12 feet (3.6 m); jet assist to 60 feet (18.3 m) high and 200 feet (61 m) across. Flying: 80 mph (128 km); max altitude of 200 feet (61 m). Flying Endurance: One hour before engine problems.

**Bonuses:** None.

**QRL-201 High-Powered Laser Rifle:** Mega-Damage: 3D6 M.D. (single shot); 1D4x10 M.D. (burst). Rate of Fire: Equal to the number of attacks per melee round. Range: 2,000 feet (610 m). Payload: 60 shots (E-Clip) or Unlimited (plugged into armor).

**Shoulder Laser Cannon:** Mega-Damage: 6D6 (single blast). Rate of Fire: Equal to the number of attacks per melee round. Range: 4,000 feet (1,220 m). Payload: Unlimited.

**Other Weapons:** Left Forearm Weapons Package, Shoulder Mini-Missile System (2), Folding Mini-Missile Launcher.

**Market Cost:** 6 million credits. Exclusive to Quebec military. Not available on the Black Market or to the CS.

## Japan Power Armor

**ArmaTech: ATPA-85 Power-Spy**

**Manufacturer:** ArmaTech Industries (Japan, p.143).

**Main Body M.D.C.:** 110

**Physical Strength:** P.S. 22.

**Speed:** Running: +20 to Speed attribute. Leaping: 20 feet (6.1 m). Flying: Jet Pack only.

**Bonuses:** +1 to dodge and roll with impact at level five. +2 to pull punch.

**AT-85 Ion Gun:** Mega-Damage: 4D6 M.D. Rate of Fire: Equal to the number of attacks per melee round. Range: 800 feet (244 m). Payload: Unlimited.

**Vibro-Blades (2):** Mega-Damage: 2D6 M.D. Bonus: +1 to strike and +2 to parry.

**Black Market Cost:** 450,000 credits.

**Armatech: PA-10A "Samurai Class" SAMAS**

**Manufacturer:** ArmaTech Industries (Japan, p.134).

**Main Body M.D.C.:** 290

**Physical Strength:** P.S. 30.

**Speed:** Running: 60 mph (96 km). Leaping: 15 feet (4.6 m); jet assist to 100 feet (30.5 m) high and 200 feet (61 m) across. Flying: 320 mph (512 km); max altitude is 6,000 feet (1,828 m). Flying Endurance: Ten hours at max speed before overheating.

**Bonuses (Ranged Combat):** +2 to strike and +1 to dodge.

**AT-P1000 SAMAS Particle Beam Rifle:** Mega-Damage: 1D6x10 M.D. (particle beam); 3D6 M.D. (laser). Rate of Fire: Equal to the number of attacks per melee round. Range: 2,000 feet (610 m) for particle beam, 1,600 feet (488 m) for laser. Payload: Unlimited.

**AT-M2 Rocket Launchers (2):** Mega-Damage: 1D4x10 (armor piercing) or 1D6x10 (plasma). Rate of Fire: Single shot or volleys of two. Range: One mile (1.6 km). Payload: Four; two per forearm.

**Other Weapons:** AT-N20 Neural Stick.

**Cost:** 1.6 million credits. Rarely available on the Black Market, where they sell for 3-4 million credits.

**ArmaTech: USA-G10A1 "Point" Glitter Boy**

**Manufacturer:** ArmaTech Industries (Japan, p. 137).

**Main Body M.D.C.:** 480

**Physical Strength:** P.S. 30.

**Speed:** Running: 90 mph (144 km). Leaping: 15 feet (4.6 m); jet assist to 100 feet (30.5 m).

**Bonuses:** None.

**Multi-Barrel Laser Rifle (M-BiLAR) AT-5000:** Mega-Damage: 4D6 M.D. (double blast), 1D4x10+8 M.D. (quadruple blast), 1D6x10 M.D. (full strength blast). Rate of Fire: Equal to the number of attacks per melee round. Range: 6,000 feet (1,828 m). Payload: Unlimited.

**AT-200 III Rail Gun:** Mega-Damage: 3D6 M.D. (short burst); 6D6 M.D. (full burst). Rate of Fire: Equal to the number of attacks per melee round. Range: 3,000 feet (914 m). Payload: 3,300 rounds (110 full bursts).

**Other Weapons:** Smoke Dispensers, Optional AT-1800 Rail Gun, Optional Underwater M-BiLAR AT-5500, Optional GMS-APM Launcher.

**Black Market Cost:** Generally unavailable for purchase. Built expressly for the military of the Republic of Japan. Very rarely does it find its way into the hands of criminals, rival kingdoms, etc.

**ArmaTech: USA-G10A2 "Hawkeye" Glitter Boy**

**Manufacturer:** ArmaTech Industries (Japan, p.140).

**Main Body M.D.C.:** 770

**Physical Strength:** P.S. 30.

**Speed:** Running: 60 mph (96 km).

**Bonuses:** +3 on initiative, +1 to roll with impact.

**M-BiLAR AT-5000:** Mega-Damage: 4D6 M.D. (double blast), 1D4x10+8 (quad blast), 1D6x10 M.D. (full strength blast). Rate of Fire: Equal to the number of attacks per melee round. Range: 6,000 feet (1,828 m). Payload: Unlimited.

**GMS-24 Medium-range Missile Launcher:** Mega-Damage: 2D6x10 M.D. (high explosive), 3D6x10 M.D. (plasma), 4D6x10 M.D. (fusion). Rate of Fire: Single shot or volleys of two or four. Range: 21 miles (33.7 kg). Payload: 24 total.

**Other Weapons:** GMS-SAM Launcher, GMS-FAM Launcher, Optional AT-1800 Rail Gun, Optional Underwater M-BiLAR AT-5500, Optional GMS-APM Launcher.

**Black Market Cost:** Generally unavailable for purchase. built expressly for the military of the Republic of Japan. Very rarely does it find its way into the hands of criminals, rival kingdoms, etc.

**H-Brand Ninjabot**

**Manufacturer:** H-Brand (Japan, p. 144).

**Main Body M.D.C.:** 190

**Physical Strength:** P.S. 25.

**Speed:** Running: 50 mph (80 km). Leaping: 10 feet (3 m). Flying: Jet Pack only.

**Bonuses:** +1 to parry, +1 to pull punch.

**H-85 Ion Gun:** Mega-Damage: 4D6 M.D. Rate of Fire: Equal to the number of attacks per melee round. Range: 800 feet (244 m). Payload: Unlimited.

**Mini-Missile Tube Launchers (6):** Mega-Damage: 1D4x10 M.D. (armor piercing) or 1D6x10 M.D. (plasma). Rate of Fire: Equal to the number of attacks per melee round. Range: One mile (1.6 km). Payload: Six total.

**Other Weapons:** Vibro-Blade.

**Black Market Cost:** One million credits.

**Ichto Robotics: IPA-40 Dai-Katana Bugei**

**Manufacturer:** Ichto Robotics (Japan, p.146).

**Main Body M.D.C.:** 250

**Physical Strength:** P.S. 30.

**Speed:** Running: 100 mph (160 km). Leaping: 15 feet (4.6 m); jet assist to 80 feet (24.4 m) high and 100 feet (30.5 m) across. Flying: hover up to 200 feet (61 m) or flight to 200 mph (320 km). Flying Endurance: Five hours at max speed before overheating.

**Bonuses:** +1 on initiative, +2 to pull punch, +1 to parry and dodge, +1 attack per melee at level three, no prowling penalties.

**IR-60 Rail Gun:** Mega-Damage: 2D6 M.D. (short burst); 1D4x10 M.D. (full burst). Rate of Fire: Equal to the number of attacks per melee round. Range: 4,000 feet (1,220 m). Payload: 2,400 rounds (60 full bursts).

**Shoulder Mini-Missile Launchers (2):** Mega-Damage: 5D6 M.D. (frag), 1D4x10 (armor piercing), 1D6x10 (plasma). Rate of Fire: Single shot, or volleys of two or three. Range: One mile (1.6 km). Payload: Six; three per launcher.

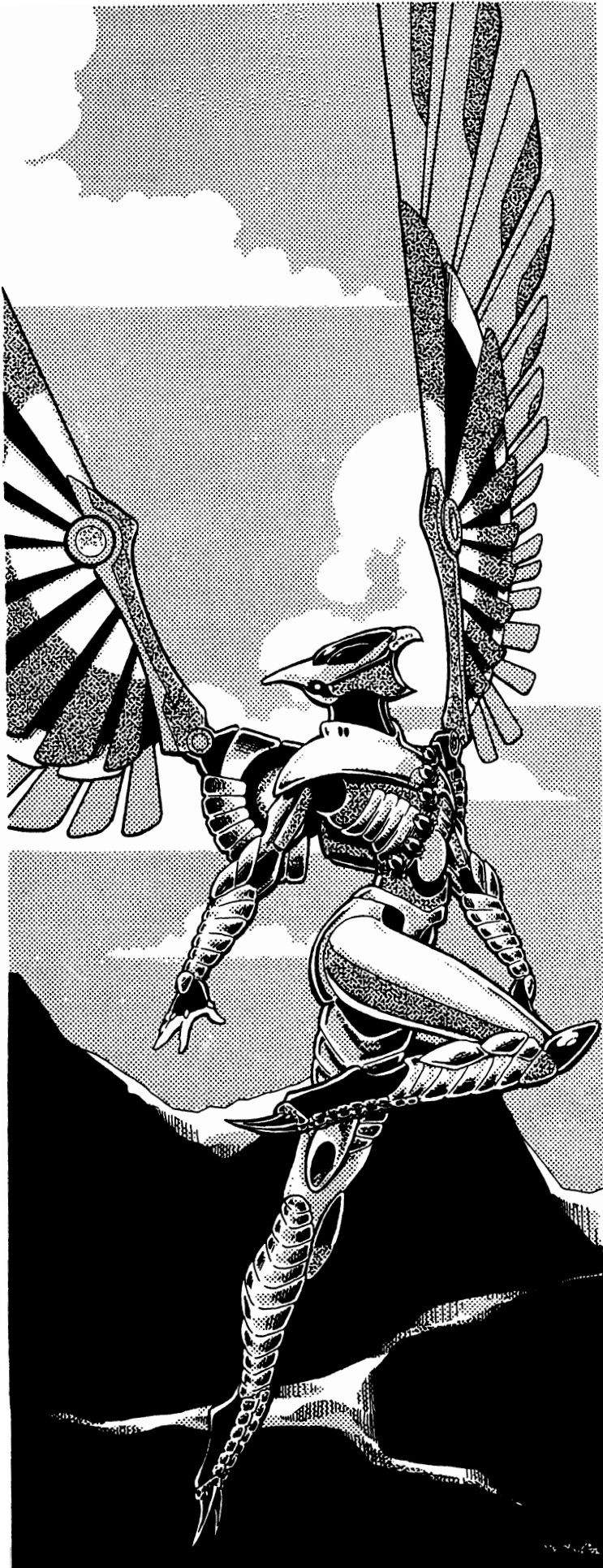

**Other Weapons:** VL-40 Head Laser, Retractable Vibro-Katanas (2), Forearm Blades (2).

**Black Market Cost:** 2 million credits.

### Ichto Robotics: IPA-45 Ikusa (Warrior)

**Manufacturer:** Ichto Industries (Japan, p.148).

**Main Body M.D.C.:** 290

**Physical Strength:** P.S. 34.

**Speed:** Running: 50 mph (80 km). Leaping: 15 feet (4.6 m).

**Bonuses:** None.

**IR-70 Rail Gun:** Mega-Damage: 3D6 M.D. (short burst), 1D6x10 M.D. (long burst). Rate of Fire: Equal to the number of attacks per melee round. Range: 4,000 feet (1,220 m). Payload: 3,200 rounds (80 bursts).

**Mini-Missile Launchers (8):** Mega-Damage: 5D6 M.D. (frag), 1D4x10 M.D. (armor piercing), 1D6x10 (heavy hitter). Rate of Fire: Single shot or volleys of two or three. Range: One mile (1.6 km). Payload: Eight.

**Other Weapons:** Shoulder Laser, Vibro-Swords (2).

**Market Cost:** 6.2 million credits.

### Ichto Robotics: IPA-50 Grenadier

**Manufacturer:** Ichto Industries (Japan, p.150).

**Main Body M.D.C.:** 580

**Physical Strength:** P.S. 35.

**Speed:** Running: 50 mph (80 km). Leaping: 10 feet (3 m).

**Bonuses:** +1D6 M.D. to punches and kicks, triple damage from power strikes (counts as two attacks), +1 to roll with impact.

**IR-50 Super-Launcher:** Mega-Damage: Varies by type, up to 5D6 M.D. to a 12 foot (3.6 m) area. Rate of Fire: Single shot or volleys of two, four or eight. Range: 160 feet (488 m). Payload: 200 rounds.

**Shoulder Mini-Missile Launchers (2):** Mega-Damage: 1D4x10 M.D. (armor piercing) or 1D6x10 M.D. (plasma). Rate of Fire: Single shot or volleys of two, three, four or six. Range: One mile (1.6 km). Payload: 12 total; six per shoulder.

**Other Weapons:** Forearm Mini-Missile Launcher, Leg Mini-Missile Launchers (4), Hand Lasers (2).

**Market Cost:** 16 million credits.

### Ichto Robotics: IPA-60 Tazu-Tengu

**Manufacturer:** Ichto Industries (Japan, p.153).

**Main Body M.D.C.:** 200

**Physical Strength:** P.S. 24.

**Speed:** Running: 40 mph (64 km). Leaping: 12 feet (3.6 m); 30 feet (9.1 m) with wings extended; jet assist to 100 feet (30.5 m) high and 150 feet (45 m) across. Flying: 350 mph (560 km); max altitude is 10,000 feet (3,048 m). Flying Endurance: Ten hours max speed, 24 hours at half speed, before overheating.

**Bonuses:** None.

**Market Cost:** 825,000 credits.

### Ichto Robotics: IPA-62 Super-Tengu

**Manufacturer:** Ichto Industries (Japan, p.155).

**Main Body M.D.C.:** 260

**Physical Strength:** P.S. 28.

**Speed:** Running: 40 mph (64 km). Leaping: 8 feet (2.4 m); jet assist to 100 feet (30.5 m) high and 150 feet (45 m) across. Flying: 260 mph (416 km); max altitude is 6,000 feet (1,828 m). Flying Endurance: Ten hours at max speed (24 hours at half speed) before overheating.

**Bonuses:** None.

**Mini-Missile Launcher:** Mega-Damage: 1D4x10 M.D. (armor piercing) or 1D6x10 M.D. (plasma). Rate of Fire: Single shot, or volleys of two, three or four. Range: One mile (1.6 km). Payload: 12 total.

**Market Cost:** 1.2 million credits.

## Ichto Robotics: IPA-70 Mizu Mi (Water Serpent)

**Manufacturer:** Ichto Industries (Japan, p.156).

**Main Body M.D.C.:** 330

**Physical Strength:** P.S. 38.

**Speed:** Running: 40 mph (64 km). Leaping: 10 feet (3 m) high and 15 feet (4.6 m) across. Swimming: 25 mph (40 km). Underwater: 50 mph (80 km).

**Bonuses:** None.

**AT-70 Blue-Green Laser:** Mega-Damage: 2D6 M.D. Rate of Fire: Equal to the number of attacks per melee round. Range: 500 feet (152 m) underwater or 1,000 feet (305 m) on the surface. Payload: Unlimited.

**Shoulder Mounted Mini-Torpedo Launcher:** Mega-Damage: 1D6x10 M.D. Rate of Fire: Single shot or volleys of two, three or four. Range: One mile (1.6 km). Payload: 10 total.

**Other Weapons:** AT-90F Plasma Cutter, RVB-70 Vibro-Cutter.

**Market Cost:** 3.1 million credits.

## Kittani

### K-Universal Light Power Armor

**Manufacturer:** Kittani (Atlantis, p.138).

**Main Body M.D.C.:** 220

**Physical Strength:** P.S. 30.

**Speed:** Running: 40 mph (64 km) or leap running at 170 mph (272 km). Leaping: 50 feet (15.3 m) high or 300 feet long (91 m).

**Bonuses:** +1 to long-range combat. +1 to parry and dodge, automatically +2 to dodge while moving.

**Black Market Cost:** 1.6 million credits.

### Kittani Allosaurus "Firedrake"

**Manufacturer:** Kittani (South America, p. 82).

**Main Body M.D.C.:** 475

**Physical Strength:** P.S. 48.

**Speed:** Running: 100 mph (160 km). Leaping: 15 feet (4.6 m). Jet boost to 50 feet (15.2 m) high and 100 feet (30.5 m) long.

**Bonuses (Hand to Hand):** +1 attack per melee at levels one, five and ten. +2 on initiative, +2 to strike and parry, +1 to dodge, +1 to roll with impact.

**Medium-Range Missile Launcher:** Mega-Damage: 2D6x10 M.D. Rate of Fire: Single shot or volleys of two or four. Range: 40 miles (64 km). Payload: Four; two in each chest housing.

**Tri-Barrel Super Rail Gun Arms (2):** Mega-Damage: 1D4x10 M.D. (single burst), 2D4x10 M.D. (double burst; counts as one attack). Rate of Fire: Up to six bursts per melee; each burst counts as one attack. Range: 6,000 feet (1,828 m). Payload: 4,000 round drum (100 bursts).

**Other Weapons:** Concealed Mini-Missile Launchers, Mouth-Mounted Plasma Projector.

**Black Market Cost:** 50 million credits. Sold only to allies like the New Dragcona government, never on the open market.

### Kittani Centipede

**Manufacturer:** Kittani (Splynn Dimensional Market, p. 164).

**Main Body M.D.C.:** 260 (head), 150 (each of the suit's ten body segments).

**Physical Strength:** P.S. 46.

**Speed:** Running: 30 mph (48 km).

**Bonuses:** +1 on initiative, +2 to strike and parry.

**Energy Lance:** Mega-Damage: 3D6 M.D. (normal range); 6D6 M.D. (half range). Rate of Fire: Equal to the number of attacks per melee round. Range: 6,000 feet (1,828 m) or 3,000 feet (915 m). Payload: 40 shots and recharges one blast every six minutes; 10 per hour.

**Short-Range Missile Tubes (18):** Mega-Damage: 1D6x10 M.D. Rate of Fire: Single shot or volleys of two, three, four, eight, or twelve. Range: Varies with missile type; typically three to five miles (4.8 to 8 km). Payload: 54 total; three per missile tube.

**Other Weapons:** Shoulder Mini-Missile Launchers, Eye Lasers, Class Two Rocket Shield.

**Black Market Cost:** Not available. If the Kittani ever decided to sell the armor, it would cost between 25 and 50 million credits.

## Kittani Equestrian

**Manufacturer:** Kittani (Atlantis, p.141).

**Main Body M.D.C.:** 375 (pilot), 400 (horse).

**Physical Strength:** P.S. 60.

**Speed:** Running: 144 mph (230 km). Leaping: 40 feet (12.2 m) up or across standing; 60 feet (18.3 m) up and 120 feet (36.6 m) across running.

**Bonuses:** +2 to strike with all long-range weapons.

**Tri-Barrel Super Rail Gun (right arm):** Mega-Damage: 1D6x10 M.D. (burst). Rate of Fire: Up to six bursts per melee; each burst is one attack. Range: 6,000 feet (1,828 m). Payload: 4,000 round drum (100 bursts). **Bonuses:** +2 to strike.

**KL Twin-Barrel Pulse Cannon (left arm):** Mega-Damage: 1D6x10 M.D. per dual blast (two simultaneous energy pulses) or 5D6 M.D. per single pulse. Rate of Fire: Equal to number of hand to hand attacks per melee. Range: 4,000 feet (1,220 m). Payload: Unlimited. **Bonuses:** +2 to strike.

**Other Weapons:** Dual Shoulder Mini-Missile Launchers, Class Two Rocket Shield, Energy Lance.

**Black Market Cost:** Never sold. The Coalition or Triax would pay 60 to 100 million credits for an unharmed, complete suit. Were the Kittani to sell this suit, it would go for at least 30 or 50 million.

## Kittani Flying Fox

**Manufacturer:** Kittani (Splynn Dimensional Market, p. 167).

**Main Body M.D.C.:** 350

**Physical Strength:** P.S. 40.

**Speed:** Running: 50 mph (80 km). Leaping: 15 feet (4.6 m); jet assist to 200 feet (61 m) high or 300 feet (91 m) across. Flying: Hover up to 300 feet (91 m) or flight up to 600 mph (960 km). Max altitude is 20,000 feet (6,096 m). Flying Endurance: 12 hours at top speed or 36 hours at half speed before overheating.

**Bonuses:** +3 on initiative, +1 to strike and parry, +2 to dodge in flight.

**Double-Bladed Plasma Axe:** Mega-Damage: 1D4x10 M.D. (energized strike or short-range energy blast). Rate of Fire: Equal to the number of attacks per melee round. Range: Close combat or 200 feet (61 m). Payload: Unlimited.

**Class One Combat Shield and Mini-Missile Launcher:** Mega-Damage: 3D4 M.D. (shield strike) or 1D4x10 M.D. (mini-missile). Rate of Fire: Equal to the number of attacks per melee round for shield strikes. Mini-missiles fire single shot or in volleys of two, three, or four. Range: Close combat (shield) or one mile (1.6 km) (mini-missiles). Payload: Four mini-missiles. Parrying: Can intercept incoming ranged attacks at only -4.

**Other Weapons:** Wing Mini-Missile Launchers (4), Wing Lasers (2), Wing Vibro-Blades (2).

**Black Market Cost:** Not available. If the Kittani ever decided to sell the armor, it would cost between 30 and 60 million credits.

## Kittani Manling

**Manufacturer:** Kittani (Atlantis, p.143).

**Main Body M.D.C.:** 375

**Physical Strength:** P.S. 46.

**Speed:** Running: 40 mph (64 km). Leaping: 20 feet (6.1 m) up or across. Flying: Only with jet pack.

**Bonuses:** +1 on initiative, +1 to parry and dodge, and +1 to roll with impact, all during hand to hand combat.

**Black Market Cost:** Never been sold. The Coalition or Triax would pay 40 million credits for a complete, undamaged suit. Were the Kittani to begin selling these, they would go for 10 to 50 million credits each.

## Kittani Raptor

**Manufacturer:** Kittani/Lagarto (South America, p.79).

**Main Body M.D.C.:** 350

**Physical Strength:** P.S. 35.

**Speed:** Running: 150 mph (240 km). Leaping: 40 feet (12.2 m); 60 feet (18.3 m) high and 120 feet (36.6 m) with a running start.

**Bonuses (Hand to Hand):** +1 attack per melee at levels one, four and nine, +3 on initiative, +3 to strike and parry, +4 to strike with a leap kick, +3 to automatic dodge, +2 to roll with impact.

**Laser Mounts (2):** Mega-Damage: 6D6 M.D. for a single pulse, 1D6x10 for a combined laser burst (counts as two attacks). Rate of Fire: Equal to attacks per melee round. Range: 4,000 feet (1,220 m). Payload: Unlimited.

**Shoulder Missile Launchers (2):** Mega-Damage: 1D6x10 M.D. Rate of Fire: Single shot or volleys of two, four, six, eight or twelve. Range: One mile (1.6 km). Payload: 12; six per launcher.

**Other Weapons:** Head Laser Beams.

**Black Market Cost:** 30 million credits; sold only to Splugorth allies like New Dragcona, never on the open market.

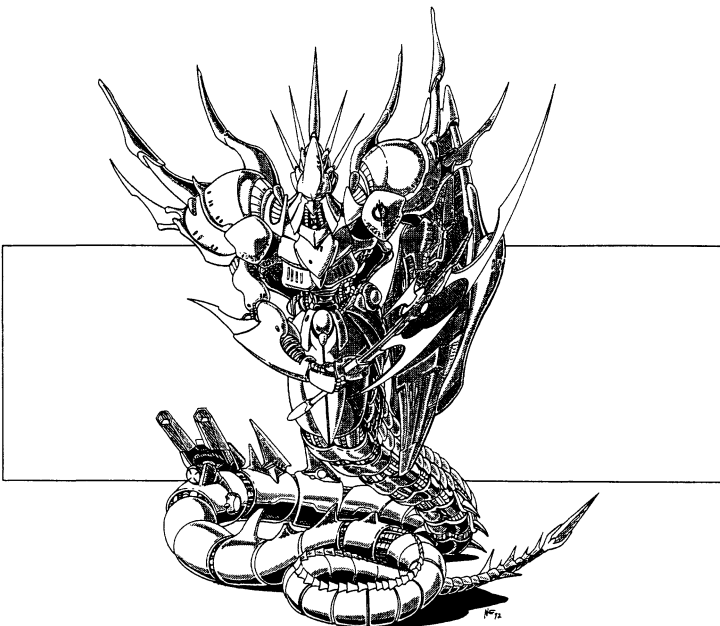

## Kittani Serpent

**Manufacturer:** Kittani (Atlantis, p.139).

**Main Body M.D.C.:** 375

**Physical Strength:** P.S. 46.

**Speed:** Running: 40 mph (64 km). Lunging: 40 feet (12.2 m) long or 30 feet (9.1 m) high.

**Bonuses:** +2 to strike in ranged combat.

**Double-Bladed Plasma Axe:** Mega-Damage: 1D4x10 M.D. per energized strike, 1D4x10 M.D. from energy blast, 1D4 M.D. as blunt weapon. Rate of Fire: Equal to number of hand to hand attacks. Range: 200 feet (61 m) for energy blast; hand to hand otherwise. Payload: Unlimited when tapped into power suit; one hour by E-Clip.

**Class One Shield and Mini-Missile Launcher:** Mega-Damage: 1D4x10 (armor piercing) or 1D6x10 (plasma). Rate of Fire: Single shot or volley of two, three or four. Range: One mile (1.6 km). Payload: Four. Parrying: Can parry physical and energy blasts at only -4.

**Black Market Cost:** Never sold. Coalition or Triax would pay 50 to 100 million credits for an unharmed, complete suit. Were the Kittani to sell this suit, it would go for at least 20 or 30 million.

## Kittani War Fish

**Manufacturer:** Kittani (Underseas, p.179).

**Main Body M.D.C.:** 375

**Physical Strength:** P.S. 30.

**Speed:** Running: 40 mph (64 km). Swimming: 100 mph (160 mph; 86 knots) underwater or 140 mph (224 km; 120.4 knots) on the surface.

**Bonuses:** +1 on initiative, +2 to strike (all systems), +4 to normal dodge, +3 to automatic dodge, +2 to roll with impact.

**Main Gun:** Mega-Damage: 1D6x10 M.D. per blast. Rate of Fire: Equal to number of attacks per melee round. Range: 1,000 feet (305 m) underwater, 3,000 feet (914 m) above the surface. Payload: Unlimited.

**Mini-Torpedo Launchers:** Mega-Damage: 1D6x10 M.D. Rate of Fire: Single shot or volleys of two, four or six. Range: One mile (1.6 km). Payload: 12 total; six per launcher.

**Other Weapons:** Forward Lasers, Fin Blades.

**Black Market Cost:** Has never been sold in any marketplace. The Coalition or Triax would pay 50 to 100 million credits for a complete, unharmed suit. Should the Kittani sell the War Fish, it would go for 30 or 40 million credits per suit.

# Miscellaneous Power Armor

## Africa: Phoenix Power Armor

**Manufacturer:** The Phoenix Empire (Africa, p. 136).

**Main Body M.D.C.:** 200

**Physical Strength:** P.S. 30.

**Speed:** Running: 40 mph (64 km) or leap running at 170 mph (272 km). Leaping: Jet pack boost to 50 feet (15.3 m) up or across. Running start can leap to 300 feet (91 m). Flying: Can hover at up to 300 feet (91 m) or fly at up to 100 mph (160 km). Flying Range: 30 minutes before overheating.

**Bonuses:** +1 to strike in ranged combat. +1 to parry and dodge, +2 to dodge when using mode of propulsion.

**Black Market Cost:** 1.4 million credits.

## Angrar Mark II

**Manufacturer:** Angrar Robotics (Mercenaries, p.141).

**Main Body M.D.C.:** 700

**Physical Strength:** P.S. 40 (supernatural).

**Speed:** Running: 44 mph (70 km). Leaping: 15 feet (4.6 m), add 10 feet (3 m) with a running start.

**Bonuses:** +2 to strike with rail gun.

**Angrar Rail Gun:** Mega-Damage: 1D6x10 M.D. Rate of Fire: Equal to the number of attacks per melee round. Range: 4,000 feet (1,220 m). Payload: 4,000 rounds (100 bursts).

**AR-90 Plasma Gun:** Mega-Damage: 1D4x10 M.D. Rate of Fire: Equal to the number of attacks per melee round. Range: 4,000 feet (1,220 m). Payload: Unlimited.

**Black Market Cost:** 8 million credits (intentionally priced down by their maker).

## Australia: "Rusty"/APAA Modular Power Armor

**Manufacturer:** Australian Outback and Tech-Cities (Australia, p.210).

**Main Body M.D.C.:** 200

**Physical Strength:** P.S. 28.

**Speed:** Running: 55 mph (88 km). Leaping: 15 feet (4.6 m) high and 20 feet (6.1 m) across. Flying (jet pack): 120 mph (192 km) to an altitude of 2,000 feet (610 m).

**Bonuses:** +1 to dodge, +1 on initiative.

**Weapons Systems:** This unit can accommodate a wide variety of weapon systems, including forearm weapons, concealed Vibro-Blades, and shoulder-mounted weapons. Each of these are installed by the user, and at additional cost.

**Black Market Cost:** 1.7 to 2 million credits; weapons systems cost extra.

## Australia: X50 Bushbasher

**Manufacturer:** Australian Tech-Cities (Australia, p.212).

**Main Body M.D.C.:** 240

**Physical Strength:** P.S. 30.

**Speed:** Running: 35 mph (56 km). Leaping: 5 feet (1.5 m) high or 10 feet (3 m) across.

**Bonuses:** +1 to strike, +1 to dodge, +1 on initiative, +1 to roll with impact.

**Shoulder-Mounted Mini-Missile Launcher:** Mega-Damage: 1D4x10 M.D. Rate of Fire: Single shot or volleys of two. Range: One mile (1.6 km). Payload: Five.

**Concealed Forearm Lasers (2):** Mega-Damage: 3D6 M.D. (single blast); 6D6 M.D. (double blast). Rate of Fire: Equal to the number of attacks per melee round. Range: 2,000 feet (610 m). Payload: Unlimited.

**Other Weapons:** Shoulder Mounted Gun (variable types), Belly Flame Thrower, Concealed Vibro-Blades.

**Black Market Cost:** 2.8 million in the Tech-Cities; up to ten times that in the Outback.

## Bandito Arms: Sidewinder SAMAS

**Manufacturer:** Bandito Arms (New West, p.181).

**Main Body M.D.C.:** 230

**Physical Strength:** P.S. 30.

**Speed:** Running: 100 mph (160 km). Leaping: 15 feet (4.6 m); jet assist to 110 feet (33.5 m) high and 200 feet (61 m) across. Flying: Can hover up to 300 feet (91 m) or flight up to 250 mph (400 km). Max altitude is 6,000 feet (1,828 m). Flying Endurance: Ten hours before overheating.

**Bonuses:** +1 on initiative, +1 to parry, +2 to dodge.

**MML 12 Mini-Missile Launchers (2):** Mega-Damage: 1D4x10 M.D. or 1D6x10 M.D. Rate of Fire: Single shot or volleys of 2 or four. Range: One mile (1.6 km). Payload: 24 total; 12 per launcher.

**Arm-Mounted Short-Range Lasers (2):** Mega-Damage: 2D6 M.D. (single blast), 4D6 M.D. (double blast). Rate of Fire: Equal to the number of attacks per melee round. Range: 1,200 feet (366 m). Payload: Unlimited.

**Black Market Cost:** 3.6 million credits.

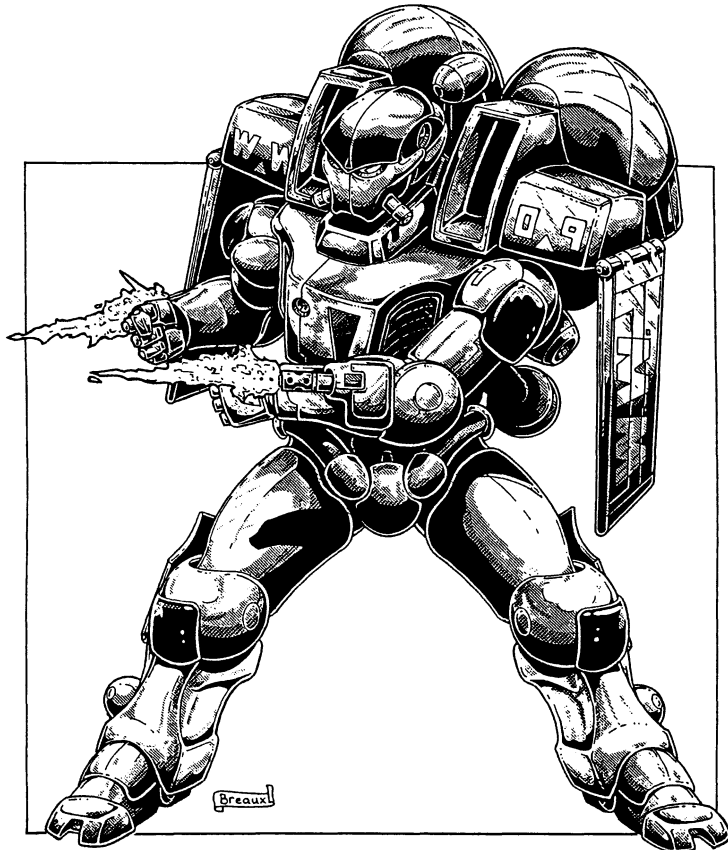

## Bandito Arms: Wild Weasel SAMAS

**Manufacturer:** Bandito Arms (New West, p.184).

**Main Body M.D.C.:** 320

**Physical Strength:** P.S. 30.

**Speed:** Running: 60 mph (96 km). Leaping: 15 feet (4.6 m); jet assist to 110 feet (33.5 m) high and 200 feet (61 m) across. Flying: Hover up to 1,000 feet (305 m) or flight to 220 mph (352 km) with a max altitude of 6,000 feet (1,828 m). Flying Endurance: Ten hours before overheating.

**Bonuses:** +3 on initiative, +1 to strike and parry, +2 to dodge, +1 to roll with impact, +1 to pull punch.

**WWECM 6 Black Boxes:** Advanced sensor jamming capabilities.

**Arm-Mounted Short-Range Plasma Ejectors (2):** Mega-Damage: 4D6 M.D. (single blast); 8D6 M.D. (double blast). Rate of Fire: Equal to the number of attacks per melee round. Range: 1,000 feet (305 m). Payload: Unlimited.

**Other Weapons:** Chaff-Flare Decoy.

**Market Cost:** 4.8 million credits.

## Chipwell: CAI-50 Challenger

**Manufacturer:** Chipwell Armaments (Mercenaries, p.144).

**Main Body M.D.C.:** 120

**Physical Strength:** P.S. 20.

**Speed:** Running: 40 mph (64 km). Leaping: 15 feet (4.6 m). Suit Endurance: 24 hours; less than 500 miles (800 km).

**Bonuses:** None.

**Weapon Systems:** None.

**Black Market Cost:** 90,000 credits.

## Chipwell: CAI-100 Warmonger

**Manufacturer:** Chipwell Armaments (Mercenaries, p.145).

**Main Body M.D.C.:** 40 (4,000 S.D.C.).

**Physical Strength:** P.S. 20.

**Speed:** Running: 40 mph (64 km). Leaping: 15 feet (4.6 m).

**Bonuses:** None.

**WI-23 Missile Launcher:** Mega-Damage: 1D4x10 M.D. Rate of Fire: Equal to the number of attacks per melee round. Range: One mile (1.6 km). Payload: Six.

**Black Market Cost:** 80,000 credits (100,000 with missile launcher).

## Chipwell Assault Suit

**Manufacturer:** Chipwell Armaments (Mercenaries, p.145).

**Main Body M.D.C.:** 150

**Physical Strength:** P.S. 24.

**Speed:** Running: 40 mph (64 km). Leaping: 15 feet (4.6 m).

**Bonuses:** None.

**Machine-gun:** Mega-Damage: 1D4 M.D. (single round); 5D6 M.D. (burst). Rate of Fire: Equal to the number of attacks per melee round. Range: 2,000 feet (610 m). Payload: 800 rounds (20 bursts).

**Integral Laser:** Mega-Damage: 3D6+2 M.D. (single shot); 1D6x10 M.D. (multiple burst). Rate of Fire: Equal to the number of attacks per melee round. Range: 2,000 feet (610 m). Payload: Unlimited.

**Black Market Cost:** 250,000 credits.

## Native American: Iron Bear Power Armor

**Manufacturer:** Native American (Spirit West, p.201).

**Main Body M.D.C.:** 400

**Physical Strength:** P.S. 50.

**Speed:** Running: 55 mph (88 km). Leaping: 10 feet (3 m); jet assist to 50 feet (15.2 m).

**Bonuses:** None.

**Ion Cannons (2):** Mega-Damage: 5D6 M.D. (single blast), 1D6x10 M.D. (double blast). Rate of Fire: Equal to the number of attacks per melee round. Range: 1,200 feet (365.7 m). Payload: Unlimited.

**Mini-Missile Launchers (2):** Mega-Damage: 1D4x10 M.D. Rate of Fire: Single shot or in volleys of two, four, six or eight. Range: One mile (1.6 km). Payload: 36 total; 18 per launcher.

**Other Weapons:** Gas/Smoke Dispensers, Vibro-Claws.

**Black Market Cost:** Not sold on any market. If one were to make it out of the Native Americans' control and onto a market, it would sell for 4+ million credits.

### **Native American: U.S.A. SAMAS**

**Manufacturer:** Native American (Spirit West, p.196).

**Main Body M.D.C.:** 250

**Physical Strength:** P.S. 30.

**Speed:** Running: 60 mph (96 km). Leaping: 15 feet (4.6 m); jet assist to 100 feet (30.5 m) high and 200 feet (61 m) across. Flying: Hover to 200 feet (61 m) or flight to 320 mph (512 km). Max altitude is 650 feet (198 m). Flying Endurance: 10 hours before overheating.

**Bonuses:** None.

**USA-M31 Rail Gun:** Mega-Damage: 1D4+1 M.D. (single round), 1D6x10 M.D. (burst). Rate of Fire: Equal to the number of attacks per melee round. Range: 4,000 feet (1,220 m). Payload: 2,000 rounds (50 bursts).

**USA-M17 Mini-Missile Launcher:** Mega-Damage: 1D4x10 M.D. or 1D6 M.D. Rate of Fire: Single shot or in volleys of two, four or six. Range: One mile (1.6 km). Payload: Up to six.

**Other Weapons:** Rotary Mini-Missile Launcher.

**Black Market Cost:** 4+ million, not sold outside of Indian reserves.

### **Native American: War Chief Power Armor**

**Manufacturer:** Native American (Spirit West, p.199).

**Main Body M.D.C.:** 250

**Physical Strength:** P.S. 28.

**Speed:** Running: 75 mph (120 km). Leaping: 18 feet (5.4 m); jet boost to 120 feet (36.6 m) high and 240 feet (73 m) across. Flying: Hover to 200 feet (61 m) and flight to 380 mph (608 km). Max altitude is 1,000 feet (305 m). Flying Endurance: Ten hours before overheating.

**Bonuses:** None.

**NAE-1D Ion Gun System:** Mega-Damage: 6D6 M.D. Rate of Fire: Equal to the number of attacks per melee round. Range: 3,500 feet (1,067 m). Payload: Unlimited. The gun can fire 100 blasts per hour before the gun needs to cool for 30 minutes. As many as 200 blasts can be fired per hour, but each blast beyond 100 has a 1% cumulative chance of destroying the weapon.

**Shoulder Mini-Missiles:** Mega-Damage: 1D4x10 M.D. or 1D6x10 M.D. Rate of Fire: Single shot or volleys of two. Range: One mile (1.6 km). Payload: Four; two per shoulder.

**Black Market Cost:** Not sold on any market. If one were to make it out of the Native Americans' control and onto a market, it would sell for 3+ million credits.

### **Naut'Yll: APAL-10 Naut'Yll**

#### **Torpedo Power Armor**

**Manufacturer:** Naut'Yll (Underseas, p.156).

**Main Body M.D.C.:** 180 (standard) or 300 (Korallyte).

**Physical Strength:** P.S. 30.

**Speed:** Running: 44 mph (70 km). Leaping: Jet boost to 100 feet (30.5 m) high and 120 (36.6 m) across. Underwater: 69 mph (111 km; 60 knots).

**Bonuses:** +1 to strike with ranged weapons, +1 to parry and dodge underwater, +1 attack per melee underwater.

**Weapons:** None.

**Black Market Cost:** Never sold to outsiders but would go for one to three million credits on the Black Market or at Atlantis.

### **New Navy: APA-15 "Semper Fi"**

#### **Amphibious Assault Power Armor**

**Manufacturer:** New Navy (Underseas p.118).

**Main Body M.D.C.:** 300

**Physical Strength:** P.S. 30.

**Speed:** Running: 60 mph (96 km). Leaping: 12 feet (3.6 m). Swimming: 40 mph (64 km; 34 knots).

**Bonuses:** None.

**Wrist Ion Gun:** Mega-Damage: 4D6 M.D. per blast. Rate of Fire: Equal to number of attacks per melee round. Range: 2,000 feet (610 m). Payload: Unlimited.

**Mini-Missile Launchers:** Mega-Damage: 1D6x10 M.D. Rate of Fire: Single shot or volleys of two, four or six. Range: One mile (1.6 km). Payload: Six total; three per launcher.

**Other Weapons:** M-90 Multi-Weapon Assault System (MWAS).

**Black Market Cost:** 2.5 million credits. Never sold or traded to outsiders (Tritonia is not considered an outsider).



### **Northern Gun: NG-X9 Samson**

**Manufacturer:** Northern Gun (Rifts Ultimate Edition, p. 271).

**Main Body M.D.C.:** 240

**Physical Strength:** P.S. 30.

**Speed:** Running: 150 mph (240 km). Leaping: 25 feet (7.6 m) high or across; jet assist to 100 feet (30.5 m) high or 200 feet (61 m) across.

**NG-202 Super Rail Gun:** Mega-Damage: 1D6 M.D. (single round) or 1D6x10 M.D. (burst). Rate of Fire: Equal to number of hand to hand attacks. Range: 4,000 feet (1,220 m). Payload: 6,000 round drum (100 bursts).

**Forearm Rocket Launcher:** Mega-Damage: 1D4x10 M.D. (armor piercing) or 1D6x10 (plasma). Rate of Fire: One or Two. Range: One mile (1.6 km). Payload: Four, two per arm.

**Black Market Cost:** 850,000 credits.

## Northern Gun: The Defender (J.A.P.E. II)

**Manufacturer:** Northern Gun (**Juicer Uprising**, p.79).

**Main Body M.D.C.:** 210.

**Physical Strength:** P.S. 30.

**Speed:** Running: 120 mph (192 km). Leaping: 30 feet (9.1 m); jet assist to 120 feet (36.5 m) high and 200 feet (61 m) across. Flying: Can hover in place for up to 2D4x10 seconds before overheating.

**Bonuses:** +1 to dodge and roll with punch at levels 2, 6 and 12.

**Neural Disruptor:** Mega-Damage: SPECIAL! Rate of Fire: Up to four attacks per melee. Range: 1,200 feet (365 m). Payload: Unlimited.

**Shoulder Mounted Grenade Launchers (2):** Mega-Damage: Varies with grenade type. Rate of Fire: Single shot or volleys of two, four or six. Range: 1,200 feet (365). Payload: 24 total; 12 per launcher.

**Other Weapons:** Forearm Mounted Variable Frequency Laser, Capture Assault System.

**Black Market Cost:** 1.1 million credits.

## NG-JK1A and NG-JK1B Juicer Killer

**Manufacturer:** Northern Gun (**Juicer Uprising**, p.77).

**Main Body M.D.C.:** 170 (NG-JK1A); 210 (NG-JK1B).

**Physical Strength:** P.S. 30.

**Speed:** Running: 90 mph (144 km). Leaping: 25 feet (7.6 m) high and 30 feet (9.1 m) across. Jet assist to 100 feet (30.5 m) in any direction. Flying: 100 mph (160 km); max altitude is 300 feet (91 m) Flying Endurance: Five minutes at a time.

**Bonuses:** +1 on initiative, +2 to strike, +1 to parry at levels 1, 3, 6, 10 and 13. No dodge or body flip/throw possible due to the armor's bulk. +2 to roll with impact. +2 to pull punch. +1 attack per melee at levels 1, 5 and 10.

**Laser Guns (2):** Mega-Damage: 3D6 M.D. (single blast); 6D6 M.D. (double blast). Rate of Fire: Equal to the number of attacks per melee round. A double blast counts as two attacks. Range: 4,000 feet (1,220 m). Payload: Unlimited.

**Particle Beam Guns (2):** Mega-Damage: 5D6 M.D. (single blast); 1D6x10 M.D. (double blast). Rate of Fire: Equal to the number of attacks per melee round. A double blast counts as two melee attacks. Range: 1,600 feet (488 m). Payload: Unlimited.

**Other Weapons:** Grenade Launchers (4), Forearm Mini-Rail Guns (2), Response Computer System (Suit's guns automatically fire at incoming targets up to eight times per melee!).

**Market Cost:** 3.6 million credits.

# Naruni Enterprises

## Mecha-Knight Medium Powered Armor

**Manufacturer:** Naruni Enterprises (**Mercenaries**, p.134).

**Main Body M.D.C.:** 400

**Physical Strength:** P.S. 40.

**Speed:** Running: 44 mph (70 km). Leaping: 15 feet (4.6 m); jet assist to 100 feet (30.5 m) high and 200 feet (61 m) across. Flying: Hover up to 500 feet (152 m) or flight to 300 mph (480 km).

**Bonuses:** None.

**Particle Beam Rifle:** Mega-Damage: 2D4x10 M.D. Rate of Fire: Standard. Range: 4,000 feet (1,220 m). Payload: Unlimited.

**Energy Sword:** Mega-Damage: 1D6x10 M.D. Rate of Fire: Equal to

the number of attacks per melee round. Range: Close combat. Payload: Unlimited.

**Other Weapons:** Laser (Right Shoulder).

**Black Market Cost:** 25 million credits.

## PA E-1000 Enforcer

**Manufacturer:** Naruni Enterprises (**Phase World Sourcebook**, p. 67).

**Main Body M.D.C.:** 300

**Physical Strength:** P.S. 30.

**Speed:** Running: 50 mph (80 km). Leaping: 15 feet (4.6 m); add 10 feet (3 m) from a running start.

**Bonuses:** None.

**Foam Dispensers (2):** Mega-Damage: M.D.C. Immobilization! Targets struck require a P.S. of 40 or higher to break free. Rate of Fire: Two blasts per melee round. Range: 200 feet (61 m). Payload: 80 spray blasts, 40 per gun.

**Secondary Weapon:** Mega-Damage: Weapon Limbs: 1D6x10 M.D. Rate of Fire: Equal to the number of attacks per melee round. Range: 2000 feet (610 m). Payload: Unlimited.

**Other Weapons:** Grenade Launchers (2), Mini-Missile Launchers (2), Sensor System.

**Market Cost:** 5 million credits (4 million without special optics package). Price tends to range 1D4x10% higher on the Black Market.

# South America

## Arkhn: APA-III Ghost Wasp

**Manufacturer:** Arkhn (**South America 2**, p. 86).

**Main Body M.D.C.:** 350

**Physical Strength:** P.S. 35.

**Speed:** Running: 50 mph (80 km). Flying: 600 mph (960 km). No altitude limit. Flying Endurance: 10 hours before overheating.

**Bonuses:** +1 attack per melee at levels one, six and twelve. +1 to dodge at levels three, seven and eleven. +1 to roll with punch, fall or impact.

**Flechette Gun:** Mega-Damage: 1D6x10 M.D. (single shot); 2D6x10+10 (burst). Rate of Fire: Equal to the number of attacks per melee round. Range: 4,000 feet (1,220 m). Payload: 400 rounds (40 bursts).

**Tri-Beam Stinger:** Mega-Damage: 6D6 M.D. (single shot); 2D4x10 M.D. (three-round burst. Double damage to most materials except force/energy fields and Arkhn composite armor. Rate of Fire: Equal to the number of attacks per melee round. Range: 3,000 feet (914 m). Payload: Unlimited.

**Other Weapons:** Side-Mounted Launchers, Long-Range Missiles, Stealth System.

**Black Market Cost:** Not for sale. Available only at the Arkhn Freehold. Captured suits can be sold secondhand for 7-10 million credits.

## Arkhn: APA-9 Death Cyclops

**Manufacturer:** Arkhn (**South America 2**, p.88).

**Main Body M.D.C.:** 450

**Physical Strength:** P.S. 45.

**Speed:** Running: 80 mph (128 km).

**Bonuses:** +1 attack per melee at levels one, six and twelve. +1 to dodge at levels one, four, eight and twelve. +2 to roll with impact. +1 to pull punch.

**Assault Rifle:** Mega-Damage (flechette): 1D4x10 M.D. (single shot); 1D6x10 M.D. (burst). Mega-Damage (tri-beam): 5D6 M.D. (single shot); 1D4x10+10 M.D. (burst). Both flechette and tri-beam inflict double damage to everything except against energy/force fields and Arkhn composite armor. Rate of Fire: Equal to the number of attacks per melee round. Range: 4,000 feet (1,220 m) for flechette, 3,000 feet (914 m) for tri-beam. Payload: 100 rounds (10 bursts) for flechette, Unlimited for tri-beam.

**Torso Tri-Beams (4):** Mega-Damage: 2D4+2 M.D. (single beam); 4D4+4 M.D. (double beam); 1D4x10 M.D. (quad beam). Rate of Fire: Equal to the number of attacks per melee round. Range: 500 feet (152 m). Payload: Unlimited.

**Other Weapons:** Mini-Missile Module, Optional Anti-Aircraft Module, Optional Anti-Aircraft Module 2, Optional Mortar Module.

**Black Market Cost:** Not for sale. Stolen or captured suits will sell for 11 million, if unharmed. Only 5 million if damaged.

### Megaversal Legion: APA-100 Counterstrike

**Manufacturer:** Megaversal Legion (South America 2, p.116).

**Main Body M.D.C.:** 550

**Physical Strength:** P.S. 40.

**Speed:** Running: 100 mph (160 km). Flying: 600 mph (960 km). Max altitude is 40,000 feet (12,192 m). Flying Endurance: Unlimited.

**Bonuses:** +1 attack per melee at levels one, six and twelve. +1 to dodge at levels one, four and eight. +2 to roll with impact. +2 to pull punch.

**I-Beam Gatling Gun:** Mega-Damage: 2D6x10 M.D. Rate of Fire: Equal to the number of attacks per melee round. Range: 3,000 feet (914 m). Payload: 2,000 rounds (100 bursts).

**Plasma Blaster:** Mega-Damage: 1D6x10 M.D. Rate of Fire: Equal to the number of attacks per melee round. Range: 2,000 feet (610 m). Payload: Unlimited.

**Other Weapons:** Mini-Missile Launchers (2), Torso Lasers (2), Grenade Launchers (2), Double Wrist Blades.

**Black Market Cost:** Not for sale. Period.



### Arkxon: LE-457S Stormwind Assault Exoskeleton

**Manufacturer:** Arkxon (South America 2, p. 84).

**Main Body M.D.C.:** 150

**Physical Strength:** P.S. 22.

**Speed:** Running: 50 mph (80 km). Flying: 200 mph (320 km). No altitude limit. Flying Endurance: Unlimited.

**Bonuses:** None.

**Tri-Beam Wrist Pistol:** Mega-Damage: 4D6 M.D.; double damage to most materials except force/energy fields and Arkhon composite armor. Rate of Fire: Equal to the number of attacks per melee round. Range: 1,200 feet (365 m). Payload: Unlimited.

**Black Market Cost:** Not for sale. Captured suits typically sell for 1-2 million credits, depending on the state of the unit. If they knew of the suit's antigravity system, the CS, Triax, Splugorth and Naruni would pay 5 million for a suit.

### Cibola: Dragon Death Power Armor

**Manufacturer:** Cibola, the Gilded City (South America, p.141).

**Main Body M.D.C.:** 350

**Force Field M.C.C.:** 100

**Physical Strength:** Not applicable.

**Speed:** Running: 100 mph (160 km). Leaping: 20 feet (6.1 m) high and 30 feet (9 m) long. Flying: Can hover up to 200 feet (61 m) or fly at up to 300 mph (480 km). Flying Endurance: Ten hours before overheating.

**Bonuses:** None.

**Mini-Missile Launchers (2):** Mega-Damage: 1D4x10 (armor piercing) or 1D6x10 (plasma). Rate of Fire: Single shot or volleys of two, four, or six. Range: One mile (1.6 km) Payload: 12 total; six per launcher.

**Plasma Cannon:** Mega-Damage: 1D6x10 M.D. per blast or 3D4x10 per long burst (counts as two attacks). Rate of Fire: Equal to melee attacks per round. Range: 4,000 feet (1,220 m). Payload: Unlimited.

**Other Weapons:** None.

**Black Market Cost:** Six to twelve million credits. Sold in trans-dimensional markets everywhere. A favorite among giant races.

### Columbia: D-20 Light Combat Exoskeleton

**Manufacturer:** Republic of Colombia (South America, p.25).

**Main Body M.D.C.:** 150

**Physical Strength:** P.S. 24.

**Speed:** Running: 50 mph (80 km). Leaping: 10 feet (3 m) high and long; double with a running start. Suit Endurance: 600 miles (960) if running straight before the battery wears out (12 hours).

**Bonuses:** None.

**RAR-C15 Rocket Auto-Cannon Rifle.** Mega-Damage: 3D6+5 M.D. (single round); 1D4x10 M.D. (eight round burst); 2D4x10 M.D. (20 round burst). Rate of Fire: Standard. Range: 2,000 feet (610 m). Payload: 200 round belt (ten long bursts or 25 short bursts). A 48 round magazine can be substituted if so desired (that's six short bursts, or two long bursts and one short).

**Black Market Cost:** 150,000 credits.

### Columbia: D-30 "Conquistador"

**Manufacturer:** Republic of Colombia (South America, p.27).

**Main Body M.D.C.:** 230

**Physical Strength:** P.S. 30.

**Speed:** Running: 60 mph (96 km). Leaping: 12 feet (3.6 m) high and long; double from a running start. Suit Endurance: 10 hour charge; 600 miles (960 km) maximum walking distance before the batteries die.

**Bonuses:** None.

**Auto-Loading Bazooka:** Mega-Damage: 1D6x10+20 M.D. (anti-armor) to a 3 foot (0.9 m) radius; 6D6 M.D. (fragmentary) to a 20 foot (6.1 m) radius. Rate of Fire: Twice per melee. Range: 1,200 feet (366 m). Payload: 12 shots.

**Arm-Mounted Mini-Missile Launchers (2):** Mega-Damage: 1D4x10 M.D. (armor piercing) or 1D6x10 M.D. (plasma). Rate of Fire: One or two. Range: One mile (1.6 km). Payload: four total; two per arm.

**Other Weapons:** Shoulder-Mounted Rocket Gun.

**Black Market Cost:** 240,000 credits.



## Empire of the Sun: AC-1 Atahualpa Combat Suit

**Manufacturer:** Empire of the Sun (South America 2, p. 63).

**Main Body M.D.C.:** 200

**Physical Strength:** P.S. 30.

**Speed:** Running: 50 mph (80 km).

**Bonuses:** None.

**Illapa Giant Rifle:** Mega-Damage: 4D6 M.D. (single shot); 1D4x10 M.D. (3-round burst); 2D4x10 M.D. (10-round burst). Rate of Fire: Each shot or burst counts as one attack. Range: 2,400 feet (731.4 m). Payload: 600 rounds (60 full bursts; 200 short bursts).

**Mini-Missile Launchers (2):** Mega-Damage: 1D4x10 M.D. (armor piercing) or 1D6x10 M.D. (plasma) Rate of Fire: Single shot or volleys of three or six. Range: One mile (1.6 km). Payload: 18; 9 per launcher.

**Other Weapons:** Chest Guns.

**Market Cost:** 1.5 million credits.

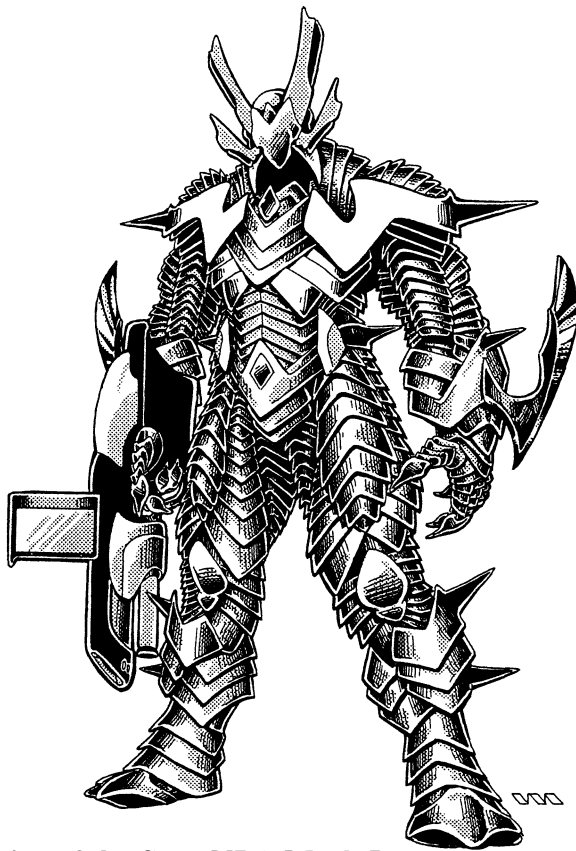

## Empire of the Sun: NPA Mark I

### Nazca Power Armor

**Manufacturer:** Empire of the Sun (South America 2, p.59).

**Main Body M.D.C.:** 600 (200 when not energized).

**Physical Strength:** P.S. 35 (supernatural).

**Speed:** Running: 60 mph (96 km). Leaping: 30 feet (9.1 m).

**Bonuses:** None.

**Rocket Rifle/15mm Machine-gun:** Mega-Damage: 1D6x10 M.D. (rocket); 2D4x10 M.D. (MG burst). Rate of Fire: Equal to the number of attacks per melee round. Range: 2,000 feet (610 m) for both weapons. Payload: Six rockets, 300 MG rounds (30 bursts).

**Short-Range Missile Launcher:** Mega-Damage: 1D6x10 M.D. or 2D4x10 M.D. Rate of Fire: Single shot or volleys of two or four. Range: One to three miles (1.6 to 4.8 km). Payload: Eight missiles.

**Other Weapons:** Energy Blasters.

**Black Market Cost:** Not for sale! Only troops loyal to the Empire of the Sun will be issued these rare and valuable suits. Stolen or captured units will sell for 10 million credits; their mystic energy will last for only 1D4 years.

## Empire of the Sun: SC-Mark III

### Solar Combat Armor

**Manufacturer:** Empire of the Sun (South America 2, p. 64).

**Main Body M.D.C.:** 320

**Physical Strength:** P.S. 35.

**Speed:** Running: 60 mph (96 km). Flying: 400 mph (640 km). Max altitude is 20,000 feet (6,096 m). Flying Endurance: 24 hours before overheating.

**Bonuses:** None.

**Plasma Projectors (6):** Mega-Damage: 1D4x10+10 M.D. (single blast); 2D4x10+20 M.D. (double blast). Rate of Fire: Equal to the number of attacks per melee round. Range: 2,000 feet (610 m). Payload: Unlimited.

**Arm Mounted Rail Gun:** Mega-Damage: 1D6x10 M.D. per burst. Rate of Fire: Equal to the number of attacks per melee round. Range: 4,000 feet (1,220 m). Payload: 2000 rounds (25 bursts/double blasts). Takes five minutes to reload.

**Other Weapons:** Eye Lasers, Plasma/Flame Field System.

**Market Cost:** 20 million credits.

## Manoa: Hoplite Power Armor

**Manufacturer:** Manoa (South America, p.92).

**Main Body M.D.C.:** 300

**Force Field M.D.C.:** 100

**Physical Strength:** P.S. 26 (supernatural).

**Speed:** Running: 60 mph (96 km). Leaping: 20 feet (6.1 m) across and 12 feet (3.6 m) high.

**Bonuses:** None.

**Energy Spear:** Mega-Damage: 5D6 M.D. (long-range energy blast), 6D6 M.D. (energized spear strike), 3D6 M.D. (non-energized spear strike). Rate of Fire: Equal to number of attacks per melee. Range: 1,000 feet (305 m) for energy blast, 300 feet (91 m) thrown. Payload: Unlimited when armor is activated.

**Shield:** Mega-Damage: 2D6+6 M.D. (bash), 2D6 M.D. (shockwave) Rate of Fire: Equal to number of melee attacks per round. Range: 300 feet (91 m) for shockwave. Payload: Unlimited while armor is charged.

**Other Weapons:** Various Optional Abilities.

**Black Market Cost:** 60 million credits.

## Silver River: AA-GB7 Glitter Boy Number 7

**Manufacturer:** Silver River Republics (South America 2, p. 173).

**Main Body M.D.C.:** 700

**Physical Strength:** P.S. 30.

**Speed:** Running: 70 mph (112 km). Leaping: 10 feet (3 m) high or 15 feet (4.6 m) across.

**Bonuses:** +1 on initiative, +1 to strike, parry and dodge, +1 to roll impact.

**Variable Frequency Laser Cannon:** Mega-Damage: 2D4x10 M.D. Rate of Fire: Equal to the number of attacks per melee round. Range: 8,000 feet (2,438 m). Payload: Unlimited.

**Gatling Rail Gun:** Mega-Damage: 3D6x10 M.D. Rate of Fire: Equal to the number of attacks per melee round. Range: 4,000 feet (1,220 m). Payload: 8,000 rounds (40 bursts).

**Other Weapons:** Hip Lasers (2).

**Market Cost:** 30 million credits for a new, undamaged unit. Price drops by 10 million if unit is damaged or a weapon is missing.

## Silver River: PA-10ML Mecha Lizard

**Manufacturer:** Silver River Republics (South America 2, p. 170).

**Main Body M.D.C.:** 320

**Physical Strength:** P.S. 30.

**Speed:** Running: 80 mph (128 km). Leaping: 20 feet (6.1 m); double if running.

**Bonuses:** +1 attack per melee at levels one, seven and fourteen. +1 to dodge at levels one, four, eight and twelve. +2 to roll with impact. +3 to pull punch.

**Multi-Weapon:** Mega-Damage: 1D6x10 M.D. (laser); 4D6 M.D. to 20 foot (6.1 m) area (grenade launcher); 6D6 M.D. to a six foot (1.8 m) area (armor piercing). Rate of Fire: Equal to the number of attacks per melee round. Range: Laser is 2,000 feet (610 m); grenade launcher is 3,000 feet (914 m). Payload: 30 GL rounds; unlimited for laser.

**Sonic Pulse Cannon:** Mega-Damage: 4D6 M.D. to a 30 foot (9.1 m) area; 1D4x10 M.D. (single target). Rate of Fire: Equal to the number of attacks per melee round. Range: 500 feet (152 m). Payload: Unlimited.

**Other Weapons:** Mini-Missile Launchers (2), Wrist Ion Blasters (2).  
**Market Cost:** 10 million credits.

### Silver River: TPA-7 Toro "Minotaur"

**Manufacturer:** Silver River Republics (South America 2, p. 171).

**Main Body M.D.C.:** 450

**Physical Strength:** P.S. 45.

**Speed:** Running: 70 mph (112 km). Leaping: 15 feet (4.6 m); doubled if running.

**Bonuses:** +1 attack per melee at levels one and seven. +1 to parry. +1 to dodge at levels one, six and twelve. +1 to roll with impact. +3 to pull punch.

**Ion Blasters (2):** Mega-Damage: 1D4x10 M.D. (single blast); 2D4x10 M.D. (double blast). Rate of Fire: Equal to the number of attacks per melee round. Range: 1,000 feet (305 m). Payload: Unlimited.

**Energy Axe:** Mega-Damage: 1D4x10 M.D. (energized); 1D4 M.D. (blunt). Rate of Fire: Equal to the number of attacks per melee round. Range: Close combat. Payload: Unlimited.

**Other Weapons:** Mini-Missile Launchers (2), Medium-Range Missiles (2), Laser Horns.

**Market Cost:** 8 million credits.

## Titan Robotics

### FT-005 Flying Titan

**Manufacturer:** Titan Robotics (Rifts Ultimate Edition, p. 272).

**Main Body M.D.C.:** 180

**Physical Strength:** P.S. 24.

**Speed:** Running: 50 mph (80 km). Leaping: 15 feet (4.6 m) up or across; jet boost to 100 feet (30.5 m) high or 200 feet (61 m) across. Flying: Hover up to 200 feet (61 m) or fly at up to 400 mph (640 km). Cruising speed is 200 mph (320 km). Max altitude is 4,000 feet (1,220 m). Flying Range: Ten hours of continuous flight before requiring cooling off.

**Wing Lasers (2):** Mega-Damage: 2D6 M.D. per blast. Rate of Fire: Equal to number of hand to hand attacks. Range: 4,000 feet (1,220 m). Payload: Unlimited.

**Wing Rockets:** Mega-Damage: Depends on missile type (mini-missile or short-range missile). Rate of Fire: Single shot or a volley of two, three or four. Range: One mile (1.6 km). Payload: 12 mini-missiles or 6 short-range missiles.

**Black Market Cost:** One million credits.

## Triax

### Aqua-Tech LEA-50 Deep Sea Power Armor

**Manufacturer:** Triax. Also produced by Iron Heart Armaments, Northern Gun, Atlantis and the Black Market. (Underseas, p.139).

**Main Body M.D.C.:** 200

**Physical Strength:** P.S. 28.

**Speed:** Running: 40 mph (64 km). Leaping: 12 feet (3.6 m). Flying: With jet pack, 100 mph (160 km). Swimming (without jet pack): 5 mph (8 km; 4.3 knots). Swimming (jet pack): 40 mph (64 km; 34 knots) on the surface and 50 mph (80 kn; 43 knots) underwater.

**Bonuses:** None.

**Quad-Wrist Laser:** Mega-Damage: 1D6 M.D. (single blast), up to 4D6

M.D. (four simultaneous blasts). May be substituted for a Vibro-Blade (2D6 M.D.). Rate of Fire: Equal to number of attacks per melee round. Range: 1,200 feet (366 m). Payload: Unlimited.

**Mini-Missiles:** Mega-Damage: 1D6x10. Rate of Fire: Single shot or volleys of two, four or six. Range: One mile (1.6 km). Payload: Six.

**Black Market Cost:** 2.5 million credits.

### Aqua-Tech Orca-50 Deep Sea Power Armor

**Manufacturer:** Triax. Also produced by Atlantis, and the Black Market (Underseas, p.140).

**Main Body M.D.C.:** 280

**Physical Strength:** P.S. 35.

**Speed:** Running: 40 mph (64 km). Leaping: 15 feet (4.6 m). Flying: With jet pack, 80 mph (128.7 km). Swimming (minus jet pack): 8 mph (12.8 km; 6.8 knots). Swimming (with jet pack): 30 mph (48 km; 25.8 knots) on surface and 40 mph (64 km; 34.4 knots) underwater.

**Bonuses:** None.

**Laser Finger:** Mega-Damage: 1D6 M.D. per blast. Rate of Fire: Equal to number of attacks per melee round. Range: 300 feet (91 m). Payload: Unlimited.

**Shoulder Weapon System:** Mega-Damage (Ion Blaster): 3D6 M.D. (single blast) or 6D6 M.D. (double blast). Mega-Damage (Vibro-Swords): Each does 2D6 M.D.; add 1D6 M.D. for every 20 mph (32 km) of speed if raking/cutting while swimming or flying. Rate of Fire: Equal to number of attacks per melee round. Range: 1,200 feet (366) for ion blasters. Payload: Unlimited.

**Black Market Cost:** 4 million credits.

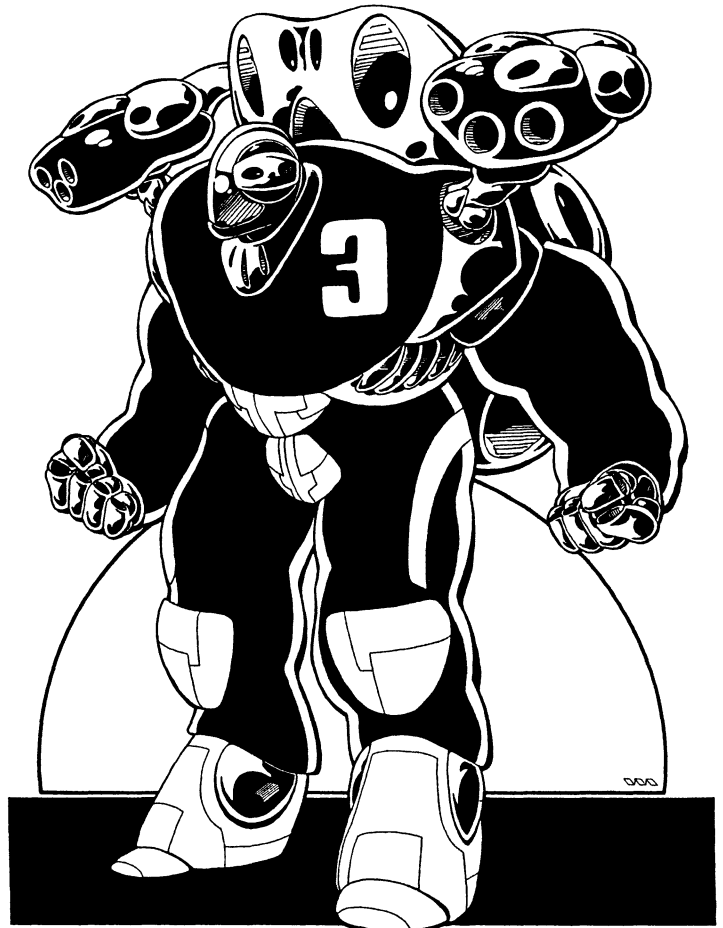

### Aqua-Tech Orca-100 Deep Sea Power Armor

**Manufacturer:** Triax. Also produced by Atlantis, and the Black Market (Underseas, p.141).

**Main Body M.D.C.:** 480

**Physical Strength:** P.S. 45.

**Speed:** Running: 40 mph (64 km). Leaping: 10 feet (3 m). Swimming (minus jet pack): 8 mph (12.8 km; 6.8 knots). Swimming (with jet pack): 30 mph (48 km; 25.8 knots) on surface and 40 mph (64 km; 34.4 knots) underwater.

**Bonuses:** None.

**Right Shoulder Weapon Cluster:** Mega-Damage (particle beam): 1D6x10 M.D. (single blast), 2D6x10 (double blast), 3D6x10 M.D. (triple blast). Mega-Damage (laser): 3D6 M.D. per blast. Rate of Fire: Equal to number of attacks per melee round. Range: Particle beams: 600 feet (183 m) underwater, 1,200 (366 m) above surface. Laser: 3,000 feet (914 m). Payload: Unlimited.

**Left Shoulder Weapon Cluster:** Mega-Damage (mini-missiles): 1D6x10 M.D. Mega-Damage (twin lasers): 3D6 M.D. (single blast), 6D6 M.D. (double blast). Rate of Fire (mini-missiles): Single shot or volleys of two or three. Rate of Fire (twin lasers): Equal to number of attacks per melee. Range (mini-missiles): One mile (1.6 km). Range (twin lasers): 3,000 feet (914 m). Payload: Six mini-missiles. Unlimited laser payload.

**Other Weapons:** Blue-Green Head Laser.

**Black Market Cost:** 12 million credits.

## T-21 Terrain Hopper

**Manufacturer:** Triax (Triax & NGR, p. 39).

**Main Body M.D.C.:** 170

**Physical Strength:** P.S. 20.

**Speed:** Running: 40 mph (64 km). Leaping: 15 feet (4.6 m) up or across. Jet assisted leap (stationary) up to 200 feet (61 m) up or across. Jet assisted leap (moving) up to 300 feet (91.5 m) long and up to 50 feet (15.3 m) high. Limited Flight: Hover up to 200 feet (61 m), or fly up to 100 mph (160 km). Cruising speed is 60 mph (96 km). Flying Endurance: Two hours.

**Bonuses:** +1 to strike (long-range), +1 to parry and dodge (HTH), automatically +2 to dodge if power jumping.

**Black Market Cost:** 500,000 credits.

## T-C20 Terrain Hopper

**Manufacturer:** Triax (Triax & NGR, p.41).

**Main Body M.D.C.:** 200

**Physical Strength:** P.S. 23.

**Speed:** Running: 40 mph (64 km). Leaping: 15 feet (4.6 m) up or across. Jet assisted leap (stationary) up to 200 feet (61 m) up or across. Jet assisted leap (moving) up to 300 feet (91.5 m) long and up to 50 feet (15.3 m) high. Limited Flight: Hover up to 200 feet (61 m), or fly up to 100 mph (160 km). Cruising speed is 60 mph (96 km). Flying Endurance: Two hours.

**Bonuses:** +1 to strike (long-range), +1 to parry and dodge (HTH), automatically +2 to dodge if power jumping.

**Forearm Lasers (2):** Mega-Damage: 1D6 M.D. or 3D6 M.D. per single blast. Rate of Fire: Equal to number of melee attacks. Range: 2,000 feet (610 m). Payload: Unlimited.

**Back-Mounted Mini-Missile Launcher:** Mega-Damage: 1D4x10 M.D. (armor piercing) or 1D6x10 M.D. (plasma). Rate of Fire: Single shot or volleys of two. Range: One mile (1.6 km). Payload: Six.

**Black Market Cost:** 750,000 credits.

## T-31 Super Trooper Robot Destroyer

**Manufacturer:** Triax (Triax & NGR, p.42).

**Main Body M.D.C.:** 250

**Physical Strength:** P.S. 30.

**Speed:** Running: 40 mph (64 km). Leaping: 12 feet (3.6 m) up or across; jet assist up to 60 feet (18.3 m) high or 100 feet (30.5 m) across.

**Bonuses:** +2 to strike on all weapon systems except MAE-3.

**F4-Dual Fusion Shoulder Launchers (2):** Mega-Damage: 2D6x10 M.D.; blast area is 10 feet (3 m). Rate of Fire: One or two. Range: 300 feet (91.5 m). Payload: Four; two per launcher.

**MAE-3 Hand Charges (Maysies):** Mega-Damage (small disks):

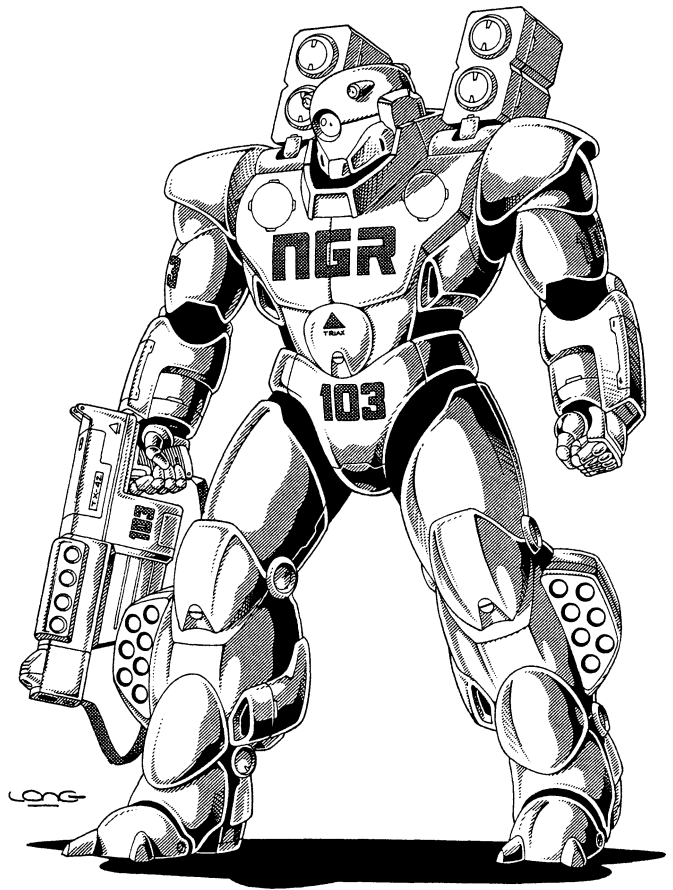

1D6x10 M.D. with a blast area of 5 feet (1.5 m). Mega-Damage (large disk): 2D4x10 M.D. with a blast area of 10 feet (3 m). Rate of Fire: One per melee action. Range: Can throw up to 1D4x10+30 yards/meters. Payload: Three; two small and one large.

**Other Weapons:** Leg Mini-Missile Launchers, RVB-31 Vibro-Blade, LGL-31 Grapnel & Launcher, PL-31 Palm Laser Torch (2).

**Black Market Cost:** 1.8 million credits.

## T-550 Glitter Boy

**Manufacturer:** Triax (Triax & NGR, p.45).

**Main Body M.D.C.:** 650

**Physical Strength:** P.S. 30.

**Speed:** Running: 60 mph (96 km). Leaping: 10 feet (3 m) standing; 15 feet (4.6 m) running.

**Bonuses:** +2 to strike with Boom Gun, +1 on initiative, +2 to roll with impact, -1 to dodge (-3 when pylons are engaged).

**TX-550 Boom Gun:** Mega-Damage: 3D6x10 M.D. Rate of Fire: Equal to number of melee attacks per round. Range: 11,000 feet (3.2 km). Payload: 100 rounds.

**TX-550 Anti-Personnel Laser:** Mega-Damage: 3D6 M.D. per blast. Rate of Fire: Equal to number of attacks per melee. Range: 1,000 feet (305 m). Payload: Unlimited.

**Other Weapons:** TX-550 Mini-Missile Launchers (4), Vibro-Sword (right arm).

**Black Market Cost:** 60+ million credits; none have yet surfaced on the Black Market, however. No availability.

## TXD-100 Ultra Deep Sea Power Armor

**Manufacturer:** Triax (Underseas, p.195).

**Main Body M.D.C.:** 400

**Physical Strength:** P.S. 34.

**Speed:** Running: 20 mph (32 km). Leaping: With thrusters, 60 feet (18.3 m). Flying: 40 mph (64 km); max altitude 1,000 feet (305 m). Underwater: 60 mph (96 km; 51.6 knots).

**Bonuses:** None.

**Mini-Torpedoes:** Mega-Damage: 1D6x10 M.D. Rate of Fire: Single

shot or volleys of two or five. Range: One mile (1.6 km). Payload: Ten total; five per wing.

**TXT-10 Ultra Mini-Torpedo Drum Launcher:** Mega-Damage: 3D6 M.D. to a 30 foot radius (9.1 m) underwater and half that radius on land. Rate of Fire: Single shot or volleys of two, four or eight. Range: 1,000 feet (305 m). Payload: 56 (!).

**Other Weapons:** Forearm Lasers, Head Lasers, TXD-01 Sonic Beam Gun.

**Black Market Cost:** Unavailable, but would cost 4 million credits were it otherwise.

## Tritonia

### Man-O-War Dolphin & Orca Combat Armor

**Manufacturer:** Tritonia (Underseas, p.82).

**Main Body M.D.C.:** 225 (Dolphin size); 330 (Orca size).

**Physical Strength:** Not applicable.

**Speed:** Water Surface: 40 mph (64 km; 34.4 knots). Underwater: 45 mph (72 km; 38.7 knots).

**Bonuses:** +1 to dodge, +3 to strike with ranged weapons.

**Forward Blue-Green Laser Turret:** Mega-Damage: 1D6 M.D. (single shot); 2D6 M.D. to 7D6 M.D. (simultaneous volley). Rate of Fire: Each shot or volley counts as one attack. Range: 1,200 feet (366 m). Payload: Unlimited.

**Rail Guns (2):** Mega-Damage: 1D4 M.D. (single round); 1D4x10 (burst). Rate of Fire: Each shot/burst counts as one attack. Range: 1,200 feet (366 m) underwater, 3,000 feet (914) above water. Payload: 4,800 rounds, 120 bursts (60 per gun).

**Other Weapons:** Blade Fins.

**Black Market Cost:** 1.5 million credits (nuclear), one million credits (solar), add one million credits for Orca size.

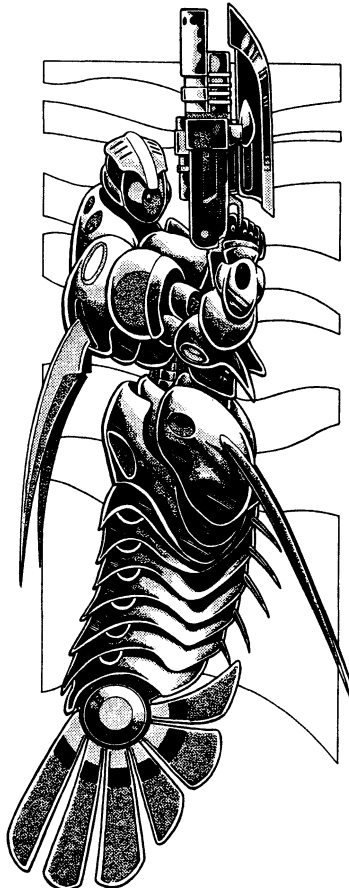

### Merbot Power Armor

**Manufacturer:** Tritonia (Underseas, p.101).

**Main Body M.D.C.:** 300

**Physical Strength:** P.S. 40.

**Speed:** Running: 40 mph (64 km). Swimming: 50 mph (80 km).

**Bonuses:** None.

**Wrist Laser:** Mega-Damage: 4D6 M.D. per blast. Rate of Fire: Equal to number of attacks per melee. Range: 2,000 feet (610 m). Payload: Unlimited.

**Torpedo Launcher:** Mega-Damage: 1D6x10 M.D. Rate of Fire: Single shot or volleys of two or four. Range: One mile (1.6 km). Payload: Four total; two per launcher.

**Other Weapons:** M-90 "Beach Stormer" Multi-Weapon Assault System.

**Black Market Cost:** 3 million credits.

### Sea-Snake Class Fast Scout Power Armor

**Manufacturer:** Tritonia (Underseas, p.81).

**Main Body M.D.C.:** 145

**Speed:** Water Surface: 60 mph (96 km; 51.6 knots) Underwater: 70 mph (112 km, 60.2 knots).

**Bonuses:** +2 to dodge.

**Forward Blue-Green Laser Turret:** Mega-Damage: 2D6 M.D. per blast. Rate of Fire: Equal to number of attacks per melee. Range: 2,000 feet (610 m). Payload: Unlimited.

**Mini-Torpedoes:** Mega-Damage: 1D6x10 M.D. Rate of Fire: Single shot or in volleys of two, three and four. Range: One mile (1.6 km). Payload: 12.

**Black Market Cost:** 900,000 credits (nuclear) or 560,000 credits (solar).

### Sea Tiger Killer Whale Combat Armor

**Manufacturer:** Tritonia (Underseas, p. 83).

**Main Body M.D.C.:** 430

**Physical Strength:** Not applicable.

**Speed:** Water Surface: 35 mph (56 km; 30 knots). Underwater: 40 mph (64 km; 34.4 knots).

**Bonuses:** +1 to dodge, +3 to strike with ranged weapons.

**Forward Blue-Green Pulse Laser:** Mega-Damage: 2D6 M.D. (single shot), 4D6 M.D. (double blast), 6D6 M.D. (triple blast). Rate of Fire: Each shot or multiple burst counts as one attack. Range: 2,500 feet (762 m). Payload: Unlimited.

**Rail Guns (2):** Mega-Damage: 1D4 M.D. (single shot), 1D4x10 M.D. (burst). Rate of Fire: Each shot or burst counts as one attack. Range: 1,200 feet (366 m) underwater; 3,000 feet (914 m) above water. Payload: 9,600 rounds (240 short bursts; 120 per gun).

**Other Weapons:** Ram Fin, Mini-Torpedo Tubes.

**Black Market Cost:** 2.6 million credits (nuclear); 1.7 million credits (solar).

### Unicorn Scout Class "Killer Whale"

#### Power Armor

**Manufacturer:** Tritonia (Underseas, p. 84).

**Main Body M.D.C.:** 450

**Physical Strength:** Not applicable.

**Speed:** Water Surface: 32 mph (51 km, 27.5 knots). Underwater: 38 mph (60.8 km; 32.6 knots).

**Bonuses:** +1 to dodge, +2 to strike with ranged weapons.

**Forward Blue-Green Pulse Laser:** Mega-Damage: 2D6 M.D. (single shot), 4D6 M.D. (double pulse). The laser can also be fired simultaneously with the ion gun, inflicting 7D6 M.D. (double pulse is not possible when both guns are fired). Rate of Fire: Each shot or multiple burst counts as one attack. Range: 2,500 feet (762 m). Payload: Unlimited.

**Forward Ion Blaster:** Mega-Damage: 5D6 M.D. per blast or 7D6 M.D. when fired simultaneously with the Pulse Laser. Rate of Fire: Each shot or multiple shot counts as a single attack. Range: 1,200 feet (366 m) underwater or 2,000 feet (610 m) above water. Payload: Unlimited.

**Other Weapons:** Unicorn Lance.

**Black Market Cost:** 2.4 million credits (nuclear), 1.5 million credits (solar).

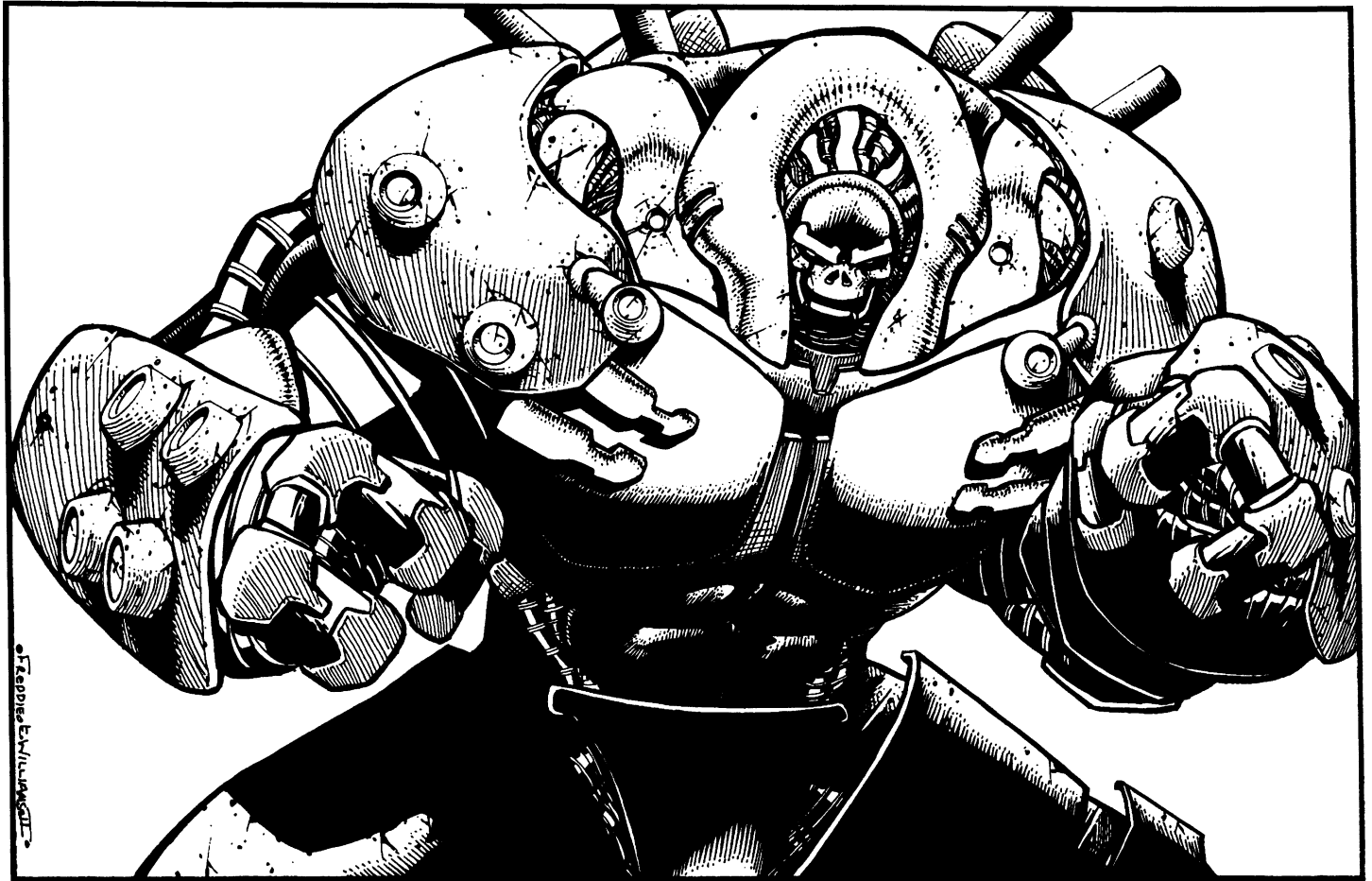

## Robot Vehicles

Only notable robot *vehicles* are presented in this section. Again, due to space restraints, only a summary of the basic and most essential stats are presented. Skelebots and other “true” robots are not presented, nor are A.R.C.H.I.E. 3 creations. Also, robot vehicles that employ *magic* in any way, such as the Manoan Lictor Assault Robot, are not included. Sorry.

### Robot Vehicle Basics

All robot vehicles, regardless of make or manufacturer, have the following features:

- 1. Nuclear Powered:** Which means they have an effectively unlimited fuel capacity and power source. Average life: 15 to 20 years.
- 2. Radar:** Can identify and track up to 48 targets simultaneously at a range of 30 miles (48 km).
- 3. Combat Computer:** Calculates, stores, and transmits data onto the heads-up display (H.U.D.) of the pilot’s helmet. It is tied to the targeting computer.
- 4. Targeting Computer:** Assists in tracking and identification of enemy targets. 30 mile range (48 km).
- 5. Laser Targeting System:** Assists in the selection and focusing of specific targets and adds a bonus of +1 to strike when using long-range weapons. Does not apply to hand to hand combat or SAMAS.
- 6. Radio Communication:** Long-range, directional communication system with an effective range of about 500 miles (800 km), as well as

a directional, short-range radio. Range is 5 miles (8 km). Plus a built-in loudspeaker; 80 decibels.

**7. External Audio Pickup:** A sound amplification listening system that can pick up a whisper 300 feet (91.5 m) away.

**8. Spotlights:** Most will have at least one or two spotlights. Typical range is 600 feet (182 m).

**9. Ejector Seat:** In case of an emergency, the pilot and crew can be instantly ejected (about 1000 feet/305 m) and parachute to safety.

**10. Self-Destruct:** A last resort measure to prevent one’s robot from being captured by the enemy. The explosive damage is fairly self contained, destroying most of the internal systems with 2D6x10 M.D. However, it is very likely (01-89% chance) that the nuclear power system will spew forth deadly levels of radiation after the blast!

**11. Voice Actuated Locking System:** The robot’s access hatch is sealed by an automatic locking system. A six digit spoken code programmed to a specific voice(s) pattern (six voice memory) is standard operating procedure. A manual key-pad is provided in case of system failure/override.

**12. Complete Environmental Pilot and Crew Compartment:** The compartment can usually seat 2 to 6 people and is reinforced to protect the people from Mega-Damage. It is air tight, pressurized and suitable for use in all hostile environments, including underwater (500 foot/152 m max. depth) and space. The following features are included.

- Computer controlled life support system.
- Internal cooling and temperature control.
- Air purification and circulation systems, gas filtration, humidifier/dehumidifier automatically engages when needed. Can

recirculate breathable air for up to four weeks before getting too stale to breathe.

- Computer controlled, independent oxygen supply and purge system that automatically engages in low oxygen or contaminated air environments. Twelve hour oxygen supply.
- Insulated, high temperature resistant shielding for up to 400 degrees centigrade. Normal fires do no damage. Nuclear, plasma, and magic fires do full damage.
- Radiation shielding.
- Polarized and light sensitive/adjusting tinted visor.

## Robots from around the world

### Coalition States

CR-003 Spider-Skull Walker  
CR-004 Scout Spider-Skull Walker  
CR-005 Scorpion-Skull Walker  
CSN-006 Sea-Spider Walker  
IAR-2 Abolisher  
IAR-3 Skull Smasher  
IAR-4 Hellraiser  
IAR-5 Hellfire  
UAR-1 Enforcer

### Japan

AT-1053 Ka-Kuma "Big Bear"  
AT-1063 Hi-Tora "Fire Tiger"  
IR-2015 Kani "Crab Walker"  
IR-2020 Wrecker  
IR-2040 Destroyer  
IR-2050 Apocalypse  
IR-2060 Banshee  
IR-2070 Gemini  
IR-4000 Tatsu "Dragon"

### Miscellaneous (World Wide)

Free Quebec: QR-1 Enforcer Prime  
Free Quebec: QR-2 Abolisher Prime  
Free Quebec: QR-3 Guardian  
Gargoyle Empire: G-40 Gurgoyles Super Bot  
Kittani ATV-RV War Crab  
Kittani Tyrannosaurus  
Mindwerks: M-1600 Bear  
Native American: THAR-06 Thunderbird  
Native American: UWS-HAR-02 Uktena  
Native American: WH-GAR-06 Wolf  
Naut'Yll: DD-2 Deathbringer  
Northern Gun: NG-V7 Hunter Mobile Gun  
Northern Gun: NG-M56 Multi-Bot  
Northern Gun: NG-V10 Super Robot Vehicle  
Poland: TC-R3 Missleer  
Poland: TC-R5 Gargoyle Stopper

### Naruni Enterprises

DK-AR500 Death-Knight  
N-SR20 Nomad  
O-AR600 Ovoid

### South America

Arkhan: AB-17 Great Cyclops  
Columbia: G9A Jaguar  
Columbia: G-18B Aguirre  
GATV-5 Galapagos  
SHAB-10 Mastodon

### Titan Robotics (North America)

EX-5 Behemoth Explorer Robot  
TR-001 Titan Combat Robot  
TR-002 Titan Exploration and Light Combat Robot  
TR-003 Titan Reconnaissance Robot

### Triax

X-10A Predator  
X-60 Flanker Urban Defender  
X-500 Forager  
X-535 Hunter  
X-545 Super Hunter  
X-622 Bug  
X-821 Landcrab  
X-1000 Ulti-Max  
X-2000 Dyna-Max  
X-2500 Black Knight  
X-2700 Dragonwing  
X-5000 Devastator

## Coalition States

### CR-003 Spider-Skull Walker

**Manufacturer:** Coalition States (Rifts Ultimate Edition, p. 250).

**Crew:** Two: pilot and co-pilot; can seat six additional passengers.

**Main Body M.D.C.:** 500

**Physical Strength:** P.S. 50.

**Speed:** Running: 80 mph (128 km).

**Bonuses:** +1 on ranged weapons.

**C-100R Spider Rail Guns (2):** Mega-Damage: 2D4 M.D. (single shot); 2D4x10 M.D. (burst); 4D4x10 M.D. (dual burst). Rate of Fire: Equal to the number of attacks per melee round. Range: 6,000 feet (1,828 m). Payload: 20,000 rounds (250 bursts) per gun.

**CR-4T Laser Turrets (2):** Mega-Damage: 6D6 M.D. Rate of Fire: Equal to the number of attacks per melee round. Range: 4,000 feet (1,220 m). Payload: Unlimited.

**Other Weapons:** Smoke Dispenser.

**Black Market Cost:** 36 million credits. Only three have been known to make it onto the Black Market in the last 25 years. The distinctiveness of the craft makes it easy for Coalition troops to spot – and destroy – it.

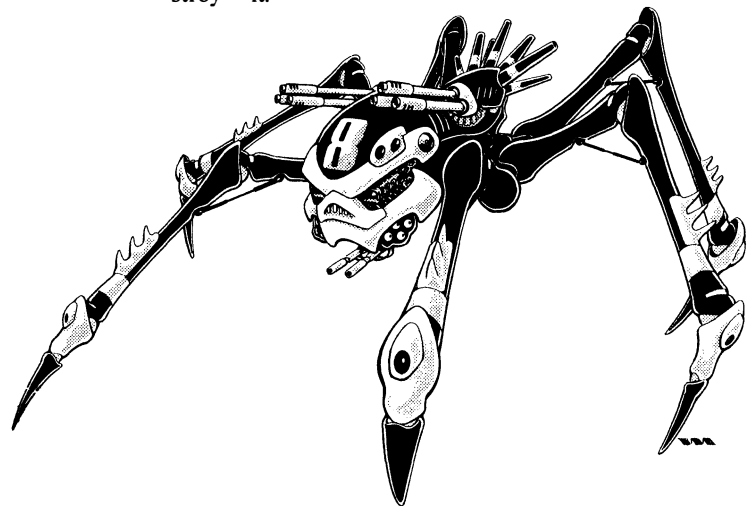

### CR-004 Scout Spider-Skull Walker

**Manufacturer:** Coalition States (Coalition War Campaign, p. 146).

**Crew:** Two: pilot and gunner; can hold two additional passengers.

**Main Body M.D.C.:** 280

**Physical Strength:** P.S. 40.

**Speed:** Running: 100 mph (160 km). Leaping: 10 feet (3 m) high or 20 feet (6.1 m) across.

**Bonuses:** +1 on initiative, +1 on dodge, prowl/hide at 44%+2% per level of the pilot.

**C-104 Tri-Barrel Rail Guns (2):** Mega-Damage: 1D4x10 (single burst); 2D4x10 (double burst). Rate of Fire: Equal to the number of attacks per melee round. Range: 6,000 feet (1,828 m). Payload: 10,000 rounds (166 bursts) per gun.

**CR-2T Laser Turret:** Mega-Damage: 5D6 M.D. Rate of Fire: Equal to the number of attacks per melee round. Range: 2,000 feet (610 m). Payload: Unlimited.

**Other Weapons:** Mini-Missile Launchers (2), Smoke Dispenser.

**Black Market Cost:** 22 million credits; currently unavailable on the Black Market, despite *intense* illegal efforts to make them so.

### CR-005 Scorpion-Skull Walker

**Manufacturer:** Coalition States (Coalition War Campaign, p. 148).

**Crew:** Two: pilot and gunner.

**Main Body M.D.C.:** 200

**Physical Strength:** P.S. 45.

**Speed:** Running: 50 mph (80 km).

**Bonuses:** +1 on initiative; prowl/hide at 48%+2% per level of the pilot.

**Tail Rail Guns (3):** Mega-Damage: 1D4x10 M.D. (single burst); 2D4x10 M.D. (double burst); 3D4x10 M.D. (triple burst). Rate of Fire: Equal to the number of attacks per melee round. Range: 4,000 feet (1,220 m). Payload: 8,000 rounds (200 bursts) per gun.

**Tail Lasers (2):** Mega-Damage: 3D6 M.D. (single blast); 6D6 M.D. (double blast). Rate of Fire: Equal to the number of attacks per melee round. Range: 2,000 feet (610 m). Payload: Unlimited.

**Other Weapons:** Tail Multiple Missile Launcher, Tail Mini-Missile Launcher, Skull Double-Barreled Lasers, Smoke Dispenser.

**Black Market Cost:** No cost; currently unavailable to the Black Market. Exclusive to the Coalition States.

### CSN-006 Sea-Spider Walker

**Manufacturer:** Coalition States (Coalition Navy, p. 53).

**Crew:** Three: pilot, co-pilot and gunner.

**Main Body M.D.C.:** 670

**Physical Strength:** P.S. 50.

**Speed:** Running: 80 mph (128 km) on dry land. 30 mph (48 km; 25.8 knots) underwater. Underwater Propulsion System: 25 mph (40 km; 21.5 knots).

**Bonuses:** None.

**C-120R Rail Guns (2):** Mega-Damage: 1D4x10 M.D. (burst; one gun); 2D4x10 M.D. (burst; both guns). Rate of Fire: Equal to the number of attacks per melee round. Range: 6,000 feet (1,828 m). Payload: 8,000 rounds (200 bursts) per weapon.

**CT-36 Mini-Torpedo Launchers (12):** Mega-Damage: 1D6x10 M.D. underwater; 1D4x10 M.D. on the surface. Rate of Fire: Single shot or volleys of two, four, six, eight, ten or twelve. Range: One mile (1.6 km). Payload: 48; 4 per launcher.

**Other Weapons:** CR-4T DP Laser Turrets (2), Mine Laying Unit.

**Black Market Cost:** 38 million credits, but these have not yet been seen on the Black Market so far. That, Black Marketeers insist, is only a matter of time.

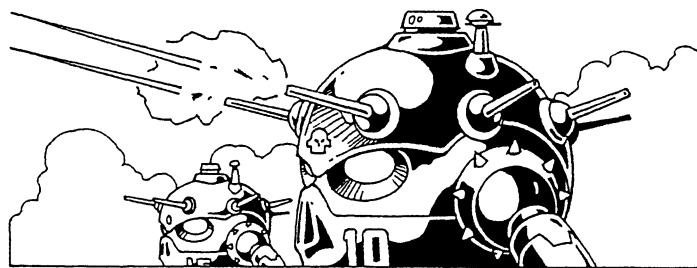

### IAR-2 Abolisher

**Manufacturer:** Coalition States (Coalition War Campaign, p. 136).

**Crew:** Six: pilot, co-pilot, communications officer, gunners (3).

**Main Body M.D.C.:** 590

**Physical Strength:** P.S. 60.

**Speed:** Running: 70 mph (112 km). Leaping: 20 feet (6.1 m) high or across; 01-70% chance of falling over upon landing because this thing's so damn top heavy.

**Bonuses:** +4 to parry, +1 to strike (ranged).

**C-144 Auto-Cannons (6):** Mega-Damage: 2D4x10 M.D. (single blast); 4D4x10 M.D. (double blast). Rate of Fire: 2, 4, 6, or 12 times per melee. Range: 6,000 feet (1,828 m). Payload: 240 rounds.

**CR-3T Dual Laser Turret:** Mega-Damage: 4D6 M.D. Rate of Fire: 2 per melee. Range: 2,000 feet (610 m). Payload: Unlimited.

**Other Weapons:** Top Gunner's Hatch can accommodate a light weapons mount, like a man-portable rail-gun.

**Black Market Cost:** 80 million credits. Rarely available.

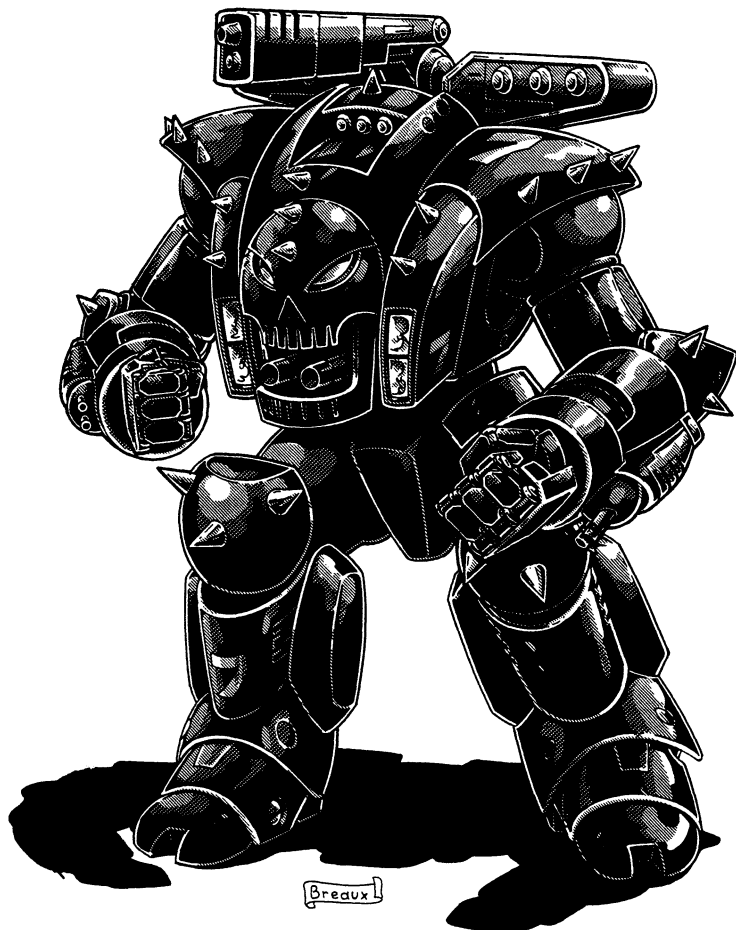

### IAR-3 Skull Smasher

**Manufacturer:** Coalition States (Coalition War Campaign, p. 137).

**Crew:** Five: pilot, co-pilot, communications officer, gunners (2). Can accommodate two additional passengers.

**Main Body M.D.C.:** 990

**Physical Strength:** P.S. 60.

**Speed:** Running: 90 mph (144 km). Leaping: 30 feet (9.1 m) high or across with a short running start.

**Bonuses:** +2 to roll with impact, +2 on initiative, +2 to strike in Hand to Hand combat, +4 to parry, +2 to dodge, +3 to pull punch.

**Heavy Laser Cannon:** Mega-Damage: 1D6x10 M.D. Rate of Fire: Equal to the number of attacks per melee round. Range: 6,000 feet (1,828 m). Payload: Unlimited.

**Double-Barreled Particle Beam Cannon:** Mega-Damage: 1D4x10 M.D. (single blast); 2D4x10 M.D. (double blast). Rate of Fire: Equal to the number of attacks per melee round. Range: 1,400 feet (426.7 m). Payload: Unlimited.

**Other Weapons:** Medium-Range Missile Launchers (2), Mini-Missile Launchers (3), Double-Barreled, Forearm Ball-Laser Turrets.

**Black Market Cost:** 74 million credits, however, these 'bots are exclusive to the Coalition and have not yet appeared on the Black Market.



### IAR-4 Hellraiser

**Manufacturer:** Coalition States (*Coalition War Campaign*, p. 140).

**Crew:** Two: pilot and gunner.

**Main Body M.D.C.:** 200

**Physical Strength:** P.S. 50.

**Speed:** Running: 90 mph (144 km). Leaping: 20 feet (6.1 m) high or across.

**Bonuses:** +3 to roll with impact, +2 on initiative, +2 to strike in Hand to Hand combat, +2 to parry, +2 to dodge, +4 to pull punch.

**H-4 Quatro Gun:** Mega-Damage: 2D6 M.D. (Short-Range Laser); 4D6 M.D. (Long-Range Laser); 1D4x10 M.D. (Particle Beam); 1D6 M.D./2D6 M.D. (Torch/Flame Thrower). Rate of Fire: Equal to the number of attacks per melee round. Range: 1,000 feet/305 m (Short-Range Laser); 3,000 feet/914 m (Long-Range Laser); 1,400 feet/426.7 m (Particle Beam); 100 feet/30.5 m (Torch). Payload: Unlimited.

**H-40 Plasma Ejector:** Mega-Damage: 1D4x10 M.D. Rate of Fire: Equal to the number of attacks per melee round. Range: 2,000 feet (610 m). Payload: Unlimited.

**Other Weapons:** H-L24 Double-Barreled Laser Turret, HV-60 Vibro-Claw.

**Black Market Cost:** 47 million credits; currently unavailable on the Black Market; exclusive to the Coalition.

### IAR-5 Hellfire

**Manufacturer:** Coalition States (*Coalition War Campaign*, p. 143).

**Crew:** Two: pilot and gunner.

**Main Body M.D.C.:** 480

**Physical Strength:** P.S. 45.

**Speed:** Running: 120 mph (192 km). Leaping: 30 feet (9.1 m) high or across; jet assist to 60 feet (18.3 m) high or across.

**Bonuses:** +3 to roll with impact, +3 on initiative, +2 to strike in Hand to Hand combat, +2 to dodge (+4 when running or leaping).

**HF-36 Hellfire Rail Guns (2):** Mega-Damage: 1D4x10 M.D. (single burst); 2D4x10 M.D. (double burst). Rate of Fire: Equal to the number of attacks per melee round. Range: 4,000 feet (1,220 m). Payload: 10,000 rounds (250 bursts) per gun.

**HF-36 Double-Barreled Plasma Ejector:** Mega-Damage: 5D6 M.D. (single blast); 1D6x10 M.D. (double blast). Rate of Fire: Equal to the number of attacks per melee round. Range: 1,600 feet (488 m). Payload: Unlimited.

**Other Weapons:** Mini-Missile Launchers (2), HF-12 Laser Turrets (2).

**Black Market Cost:** 25 million credits; currently unavailable on the Black Market; 'bot is exclusive to the Coalition.

### UAR-1 Enforcer

**Manufacturer:** Coalition States (*Rifts Ultimate Edition*, p. 249).

**Crew:** One or two.

**Main Body M.D.C.:** 350

**Physical Strength:** P.S. 40.

**Speed:** Running: 60 mph (96 km). Leaping: 15 feet (4.6 m) high or across. Add 10 feet (3 m) for a running start.

**Bonuses:** +1 to strike on ranged weapons.

**C-50R Enforcer Rail Gun:** Mega-Damage: 1D6 M.D. (single round); 1D6x10 M.D. (burst). Rate of Fire: Equal to the number of attacks per melee round. Range: 4,000 feet (1,220 m). Payload: 20,000 rounds (250 bursts).

**CR-6 Medium-Range Rocket Launcher:** Mega-Damage: 2D6x10 M.D. Rate of Fire: Single shot or volleys of two, three or four. Range: 80 miles (128 km). Payload: 6.

**Other Weapons:** CR-10 Short-Range Rocket Launchers (2), CR-20 Mini-Missile Turret, CR-2T Laser Turrets (2), Smoke Dispenser.

**Black Market Cost:** 28 million credits.

### Skelebots

**Manufacturer:** Coalition States (*Coalition War Campaign*, p. 122).

**Note:** These are not robot *vehicles* but are famous enough to mention where the full range of Skelebots and their descriptions can be found.

## Japan Robots

### ArmaTech: AT-1053 Ka-Kuma "Big Bear"

**Manufacturer:** ArmaTech Industries (*Japan*, p. 159).

**Crew:** Four: pilot, co-pilot/communications officer, gunners (2).

**Main Body M.D.C.:** 590

**Physical Strength:** P.S. 50.

**Speed:** Running: 40 mph (64 km).

**Bonuses:** None.

**AT-1053 Rail Cannons (2):** Mega-Damage: 2D6x10 M.D. with a blast radius of 80 feet/24.4 m (Frag); 3D4x10 M.D. to a blast radius of 30 feet/9.1 m (High Explosive); 4D6x10 M.D. to a blast radius of 100 feet/30.5 m (Nuke). Rate of Fire: Four total per melee round; two shots per gun per melee round. Range: 7 miles (11.2 km). Payload: 100 rounds (50 per gun) in any combination.

**AT-2400 Rail Gun:** Mega-Damage: 2D4x10 M.D. (burst). Rate of Fire: Equal to the number of attacks per melee round. Range: 6,000 feet (1,828 m). Payload: 9,000 rounds (150 bursts).

**Other Weapons:** Shoulder Mini-Missile Launchers (2), Forearm Short-Range Missile Launcher (1), Belly Laser Turret, Flame-throwers (2), Light Particle Beam Head Lasers (2).

**Black Market Cost:** 38 million credits.

### ArmaTech: AT-1063 Hi-Tora "Fire Tiger"

**Manufacturer:** ArmaTech Industries (*Japan*, p. 161).

**Crew:** Three: pilot, co-pilot/communications officer, gunner. Room for one additional passenger.

**Main Body M.D.C.:** 500

**Physical Strength:** P.S. 40.

**Speed:** Running: 60 mph (96 km). Leaping: 30 feet (9.1 m) high or across.

**Bonuses:** +4 to parry, +3 to dodge, +2 to strike in Hand to Hand combat.

**Light Particle Beam Head Blasters:** Mega-Damage: 1D4x10 M.D. (single blast); 2D4x10 M.D. (double blast). Rate of Fire: Equal to the number of attacks per melee round. Range: 1,200 feet (365 m). Payload: Unlimited.

**Mouth Flamethrower:** Mega-Damage: 3D6 M.D. plus 01-90% chance of igniting combustibles. Rate of Fire: Equal to the number of attacks per melee round. Range: 200 feet (61 m). Payload: 50 blasts.

**Other Weapons:** Flamethrowers (4), Laser Fingers (2), Chest Spray.

**Black Market Cost:** 32 million credits.



## Ichto: IR-2015 Kani “Crab Walker”

**Manufacturer:** Ichto Robotics (Japan, p. 164).

**Crew:** One; can hold an additional four passengers.

**Main Body M.D.C.:** 200

**Physical Strength:** P.S. 28.

**Speed:** Running: 40 mph (64 km). Underwater (thrusters): 35 mph (56 km; 30 knots).

**Bonuses:** +2 to dodge (+4 underwater), +2 to roll with impact, +1 attack per melee at levels six and twelve.

**Short-Range Torpedo/Missile Launcher:** Mega-Damage: 2D4x10 M.D. (HE) or 1D6x10 M.D. (Plasma). Rate of Fire: Single shot or volleys of two, three or four. Range: 5 miles (8 km). Payload: 8.

**Belly Laser Turret:** Mega-Damage: 2D6 M.D. (single blast); 4D6 M.D. (double blast). Rate of Fire: Equal to the number of attacks per melee round. Range: 1,800 feet (549 m). Payload: Unlimited.

**Other Weapons:** Forward Mini-Torpedo/Missile Launch Tubes (2), Forearm Laser Torch, Plasma Torch/Cutter.

**Black Market Cost:** 4 million credits; H-Brand sells a knock-off for only 3.2 million credits, but it only comes with a tape deck, not a CD player.

## Ichto: IR-2020 Wrecker

**Manufacturer:** Ichto Robotics (Japan, p. 165).

**Crew:** Two: pilot and co-pilot. Can hold one additional passenger.

**Main Body M.D.C.:** 480

**Physical Strength:** P.S. 48 (24 for small arms).

**Speed:** Running: 40 mph (64 km). Leaping: 10 feet (3 m) high and 20 feet (6.1 m) across.

**Bonuses:** +1 attack per melee at levels four, eight and twelve.

**Forearm Buzz-Saws (2):** Mega-Damage: 5D6 M.D. Rate of Fire: Equal to the number of attacks per melee round. Range: Melee. Payload: Unlimited.

**Plasma Cutter:** Mega-Damage: Four settings: 1D6x10 S.D.C., 3D6x10 S.D.C., 3D6 M.D., and 1D4x10 M.D. Rate of Fire: Equal to the number of attacks per melee round. Range: 20 feet (6.1 m). Payload: Unlimited.

**Other Weapons:** Laser Torch, Fusion Block Compartment, Optional Laser Turrets (1 or 2), Optional Shoulder Mini-Missile Launchers (2), Optional Back Missile Launcher.

**Black Market Cost:** 11 million; H-Brand knock-off sells for 10 million, or an upgraded version with better weapons and armor for 14 million.

## Ichto: IR-2040 Destroyer

**Manufacturer:** Ichto Robotics (Japan, p. 168).

**Crew:** One pilot.

**Main Body M.D.C.:** 420

**Physical Strength:** P.S. 38 (19 for small arms).

**Speed:** Running: 60 mph (96 km). Leaping: 10 feet (3 m) high or across; 25 feet (7.6 m) high or across with a short running start.

**Bonuses:** +1 additional attack per melee at levels five, ten and fifteen. +1 on initiative, +1 to strike, +2 to parry, +3 to dodge, +3 to roll with impact.

**Shoulder Mini-Missile Launchers (2):** Mega-Damage: Varies with missile type. Rate of Fire: One at a time, or in volleys of 2, 3, or 4. Range: Usually about a mile. Payload: 16 total; 8 in each launcher.

**IR-60 Rail Gun:** Mega-Damage: 1D4x10 full burst; 2D6 short burst. Rate of Fire: Equal to the number of hand to hand attacks per melee round. Range: 4,000 feet (1,220 m). Payload: 2400 rounds per standard drum (60 full bursts or 240 short bursts). Small drum: 1200 rounds (30 full or 120 short bursts). Clip with 200 rounds (5 full bursts).

**Other Weapons:** Forearm Lasers (2), Laser Torch, Grenade Storage Compartment.

**Black Market Cost:** 12 million credits.

## Ichto: IR-2050 Apocalypse

**Manufacturer:** Ichto Robotics (Japan, p. 170).

**Crew:** Four: pilot, co-pilot/communications officer, gunners (2).

**Main Body M.D.C.:** 625

**Physical Strength:** P.S. 50.

**Speed:** Running: 40 mph (64 km).

**Bonuses:** None.

**High-Powered Laser Cannons (2):** Mega-Damage: 1D4x10 M.D. (single blast); 2D4x10 M.D. (double blast). Rate of Fire: Equal to the number of attacks per melee round. Range: 6,000 feet (1,828 m). Payload: Unlimited.

**Belly Rail Gun:** Mega-Damage: 2D4x10 M.D. (burst). Rate of Fire: Equal to the number of attacks per melee round. Range: 6,000 feet (1,828 m). Payload: 12,000 rounds (200 bursts).

**Other Weapons:** Medium-Range Missile Launchers (2), Chest Mini-Missile Launchers (4), Forearm Lasers (2), Plasma Belly Gun, Leg Mini-Missile Launchers (4), Main Weapon Arms, Unmanned Drone Aircraft.

**Black Market Cost:** 68 million credits; replacement drone aircraft cost one million credits. Neither are very available on the open market.



## Ichto: IR-2060 Banshee

**Manufacturer:** Ichto Robotics (Japan, p. 173).

**Crew:** Two: pilot and co-pilot/gunner.

**Main Body M.D.C.:** 400

**Physical Strength:** P.S. 40.

**Speed:** Running: 60 mph (96 km). Leaping: 15 feet (4.6 m) high or across; 100 feet (30.5 m) high or across. Flight: 260 mph (416 km); max altitude is 6,000 feet (1,828 m). Can fly 10 hours at max speed before overheating.

**Bonuses:** +2 on initiative, +1 to strike, +1 to parry, +2 to dodge (+4 when flying), +3 to pull punch, +2 to roll with fall or impact, +1 attack per melee at levels five and ten.

**Sonic Cannon:** Mega-Damage: 1D6x10 M.D. plus 3D6 M.D. to a 10

foot (3 m) diameter around the blast area. Double effect underwater. Rate of Fire: Equal to the number of attacks per melee round. Range: 2,000 feet (610 m); double underwater. Payload: Unlimited.

**Wing Mini-Missile Launchers (2):** Mega-Damage: 5D6 M.D. (Frag) or 1D6x10 M.D. (plasma). Rate of Fire: Single shot or in volleys of two, four or five. Range: One mile (1.6 km). Payload: 20; 10 missiles per launcher, usually 5 of each type.

**Other Weapons:** Light Wrist Lasers (2), Forearm Vibro-Swords (2).

**Black Market Cost:** 28 million credits. Fair to good availability.

### Ichto: IR-2070 Gemini

**Manufacturer:** Ichto Robotics (Japan, p. 176).

**Crew:** Two: pilot and co-pilot/gunner; room for one additional passenger.

**Main Body M.D.C.:** 500

**Physical Strength:** P.S. 45.

**Speed:** Running: 50 mph (80 km). Leaping: 10 feet (3 m) high or 15 feet (4.6 m) across.

**Bonuses:** +2 on initiative (when invisible), +1 to strike, +1 to parry, +1 to dodge (+4 when invisible), +2 to roll with impact, +2 attacks per melee, +1 additional attack per melee at levels five and ten.

**Shoulder Mini-Missile Launchers (2):** Mega-Damage: 1D4x10 M.D. (armor piercing) or 1D6x10 M.D. (plasma). Rate of Fire: Single shot or volleys of two, three or four. Range: 3,000 feet (914 m). Payload: 24; 12 per launcher.

**Other Weapons:** Forearm Vibro-Sword, Optional IR-120 Rail Gun.

**Black Market Cost:** Not available on the market. Should a Gemini prototype make its way out of Ichto hands, it could go for 50 million credits or more.



### Ichto: IR-4000 Tatsu "Dragon"

**Manufacturer:** Ichto Robotics (Japan, p. 178).

**Crew:** Four: pilot, co-pilot/communications/radar operator, gunners (2).

**Main Body M.D.C.:** 1,000

**Physical Strength:** P.S. 50.

**Speed:** Running: 40 mph (64 km).

**Bonuses:** +1 to strike with tiny hands, +2 to strike with head/bite, +2 to strike with tail/weapons, +2 to parry with horns, +4 to parry with tail, +3 to dodge for the head, +1 to dodge for entire body, +2 to roll with impact.

**Mouth Plasma Cannon:** Mega-Damage: 1D4x10 M.D. Rate of Fire: Equal to the number of attacks per melee round. Range: 1,600 feet (487 m). Payload: Unlimited.

**Mouth Plasma Thrower:** Mega-Damage: 3D6 M.D. plus 01-90% chance of igniting combustibles. Rate of Fire: Equal to the number of attacks per melee round. Range: 200 feet (61 m). Payload: 50 shots.

**Other Weapons:** Snout Mini-Missile Launchers (2), Biting Head and Horns, Palm Lasers (2), Shoulder Missile Launcher, Tail Laser, Prehensile Tail.

**Black Market Cost:** Not available on the open market. Production cost is 750 million credits per unit.

## Miscellaneous Robots (Worldwide)

### Free Quebec: QR-1 Enforcer Prime

**Manufacturer:** Free Quebec (Free Quebec, p. 63).

**Crew:** One or two.

**Main Body M.D.C.:** 350

**Physical Strength:** P.S. 40.

**Speed:** Running: 60 mph (96 km). Leaping: 15 feet (4.6 m) high or across. Add 10 feet (3 m) for a running start.

**Bonuses:** +1 to strike on ranged weapons.

**C-50R Enforcer Rail Gun:** Mega-Damage: 1D6 M.D. (single round); 1D6x10 M.D. (burst). Rate of Fire: Equal to the number of attacks per melee round. Range: 4,000 feet (1,220 m). Payload: 20,000 rounds (250 bursts).

**CR-6 Medium-Range Rocket Launcher:** Mega-Damage: 2D6x10 M.D. Rate of Fire: Single shot or volleys of two, three or four. Range: 80 miles (128 km). Payload: 6.

**Other Weapons:** CR-10 Short-Range Rocket Launchers (2), CR-20 Mini-Missile Turret, CR-2T Laser Turrets (2), Smoke Dispenser.

**Black Market Cost:** 28 million credits.

### Free Quebec: QR-2 Abolisher Prime

**Manufacturer:** Free Quebec (Free Quebec, p. 65).

**Crew:** Six: pilot, co-pilot, communications officer, gunners (3).

**Main Body M.D.C.:** 590

**Physical Strength:** P.S. 60.

**Speed:** Running: 70 mph (112 km). Leaping: 20 feet (6.1 m) high or across; 01-70% chance of falling over upon landing because this thing's so damn top heavy.

**Bonuses:** +4 to parry, +1 to strike (ranged).

**C-144 Auto-Cannons (6):** Mega-Damage: 2D4x10 M.D. (single blast); 4D4x10 M.D. (double blast). Rate of Fire: 2, 4, 6, or 12 times per melee. Range: 6,000 feet (1,828 m). Payload: 240 rounds.

**CR-3T Dual Laser Turret:** Mega-Damage: 4D6 M.D. Rate of Fire: 2 per melee. Range: 2,000 feet (610 m). Payload: Unlimited.

**Other Weapons:** Top Gunner's Hatch can accommodate a light weapons mount, like a man-portable rail-gun.

**Black Market Cost:** 80 million credits. Rarely available.

### Free Quebec: QR-3 Guardian

**Manufacturer:** Free Quebec (Free Quebec, p. 66).

**Crew:** Two: pilot and gunner.

**Main Body M.D.C.:** 560

**Physical Strength:** P.S. 50.

**Speed:** Running: 100 mph (160 km). Leaping: 20 feet (6.1 m) high or across.

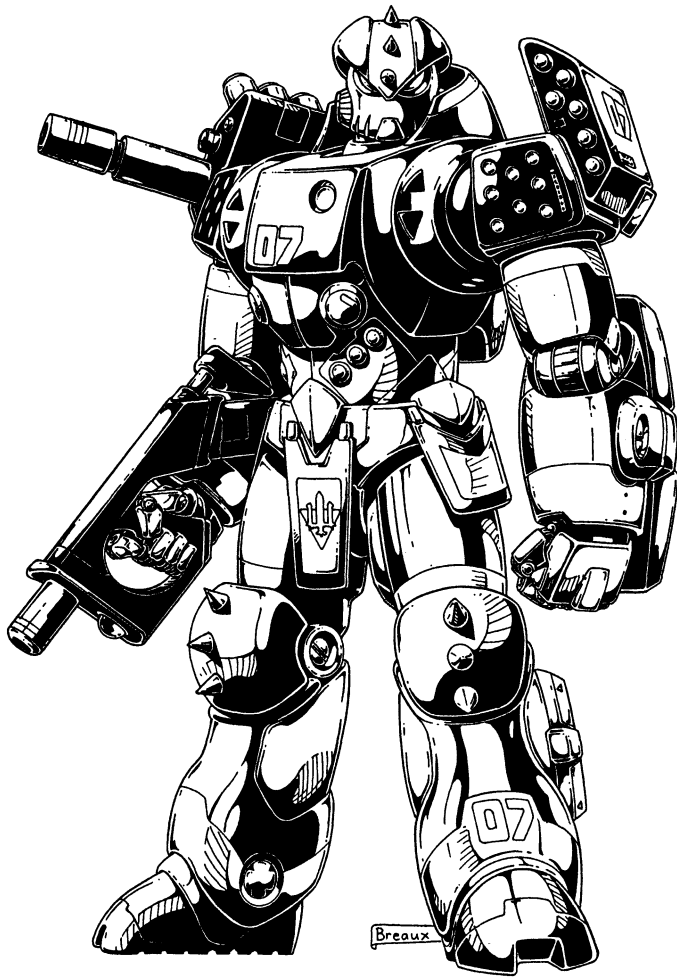

**Bonuses:** Elite Robot Combat: Guardian provides the following bonuses: +3 to roll with impact, +1 on initiative, +1 to strike in Hand to Hand combat, +2 to parry, +2 to dodge, +4 to pull punch.

**GP-03 Particle Beam Cannon:** Mega-Damage: 1D6x10+10 M.D. Rate of Fire: Equal to the number of attacks per melee round. Range: 2,000 feet (610 m). Payload: 60 shots. Weapon recharges at a rate of one shot every three minutes.

**Forearm Laser Turret:** Mega-Damage: 4D6 M.D. Rate of Fire: Equal to the number of attacks per melee round. Range: 2,000 feet (610 m). Payload: Unlimited.

**Other Weapons:** Retractable Vibro-Blade, Folding Missile Launchers (2), Mini-Missile Shoulder Launchers, Leg Mini-Missile Launchers (2).

**Black Market Cost:** Not sold on the open market. Production cost is 31 million credits.

## Gargoyle Empire: G-40 Gurgoy Super Bot

**Manufacturer:** Undetermined (Mindwerks, p. 79).

**Crew:** Three: pilot, gunner and supervisor.

**Main Body M.D.C.:** 2,550

**Physical Strength:** P.S. 60.

**Speed:** Running: 35 mph (56 km).

**Bonuses:** A total of 10 attacks per melee round. +3 to strike from punches, +4 to parry, +2 to roll with impact, +2 to pull punch.

**Ion Finger Blasters (8):** Mega-Damage: 2D6 M.D. (single finger); 4D6 M.D. (two fingers); 6D6 M.D. (three fingers); 1D4x10+8 M.D. (four fingers) or 2D4x10+8 (from full blast from both hands at once). Rate of Fire: Equal to the number of attacks per melee round. Range: 2,000 feet (610 m). Payload: Unlimited.

**Microwave Beam Weapons:** Mega-Damage: SPECIAL! Basically, these things cook people alive. Rate of Fire: Equal to the number of attacks per melee round. Range: 200 feet (61 m). Payload: Unlimited.

**Other Weapons:** Concealed Mini-Missile Launchers (2), Retractable Ball and Chain (2).

**Black Market Cost:** Unavailable. Exclusive to the Gargoyle Empire.

## Kittani ATV-RV War Crab

**Manufacturer:** Kittani (Underseas, p. 181).

**Crew:** Two: pilot and gunner.

**Main Body M.D.C.:** 600

**Physical Strength:** P.S. 50.

**Speed:** Running: 20 mph (32 km). Underwater: 20 mph (32 km) using jet thrusters or walking.

**Bonuses:** None.

**Quad-Plasma Cannon Turret:** Mega-Damage: 1D6x10 M.D. (single blast); 2D6x10 M.D. (double blast); 3D6x10 M.D. (triple blast); 4D6x10 M.D. (quadruple blast). Rate of Fire: Equal to the number of attacks per melee round. Range: 1,000 feet (305 m) underwater, 3,000 feet (914 m) in air. Payload: Unlimited.

**Forward Rail Guns (2):** Mega-Damage: 1D4x10 M.D. (burst). Rate of Fire: Equal to the number of attacks per melee round. Range: 2,000 feet (610 m) underwater, 4,000 feet (1,220 m) in air. Payload: 1,000 short bursts per gun.

**Other Weapons:** Right Weapon Turret, Rear Laser Mini-Turrets (2), Leg Spikes, Crab-Man Heat Beam, Crab-Man Shoulder Spikes, Crab-Man Claws.

**Black Market Cost:** Has never been sold in any marketplace. The Coalition or Triax would pay 50 to 100 million credits for a complete, undamaged suit. If the Kittani should sell the armor, they could easily get 30 to 40 million credits per unit.

## Kittani Tyrannosaurus

**Manufacturer:** Kittani (South America, p. 83).

**Crew:** Two: pilot and gunner. Can hold another two passengers.

**Main Body M.D.C.:** 600

**Physical Strength:** P.S. 60.

**Speed:** Running: 80 mph (128 km).

**Bonuses:** +1 attack at levels one and seven. +2 to strike and parry, +1 to dodge.

**Twin-Barrel Pulse Canons (2):** Mega-Damage: 5D6 M.D. (single blast); 1D6x10 M.D. (dual blast), 2D6x10 M.D. (quad blast). Rate of Fire: Equal to the number of attacks per melee round; maximum six shots per round. Range: 6,000 feet (1,828 m). Payload: Unlimited.

**Belly Rail Gun:** Mega-Damage: 1D6x10 M.D. (burst). Rate of Fire: Equal to the number of attacks per melee round, up to six bursts per round. Range: 4,000 feet (1,220 m). Payload: 4,000 rounds (100 bursts).

**Other Weapons:** Shoulder Medium-Range Missile Launchers (2), Concealed Mini-Missile Launchers (2), Head Laser Cannon (2).

**Black Market Cost:** 100 million credits. Sold only to Splugorth allies; never on the open market.

## Mindwerks: M-1600 Bear

**Manufacturer:** Mindwerks (Mindwerks, p. 31).

**Crew:** One; can hold one more passenger.

**Main Body M.D.C.:** 580

**Physical Strength:** P.S. 50.

**Speed:** Running: 60 mph (96 km). Leaping: 25 feet (7.6 m) high and 50 feet (15 m) across from a running start.

**Bonuses:** +1 attack per melee at levels one, three, six and ten. +1 on initiative, +3 to strike, +3 to parry, +2 to dodge, +2 to roll with impact, +2 to pull punch.

**Multi-Weapon Arm:** Mega-Damage: 3D6 M.D. (laser); 1D4x10 M.D. (ion beam); 1D6x10 M.D. (particle beam), 2D4x10+20 M.D. (ion and particle beam dual blast). Rate of Fire: Equal to the number of attacks per melee round. Range: 3,000 feet (914 m). Payload: Unlimited.

**Laser Knuckle Blasters:** Mega-Damage: 3D6 M.D. (single blast); 6D6 M.D. (dual blast); 1D6x10 M.D. (triple blast). Rate of Fire: Equal to the number of attacks per melee round. Range: 3,000 feet (914 m). Payload: Unlimited.

**Other Weapons:** Canister Grenade Launch Tubes (2), Top-Mounted Mini-Missile Launchers (2), Tri-Barrel Head Blaster (2), Forearm Vibro-Sword.

**Black Market Cost:** Not sold. Exclusive to Mindwerks.

### Native American: THAR-06 Thunderbird

**Manufacturer:** Native American (Spirit West, p. 192).

**Crew:** Two: pilot and gunner.

**Main Body M.D.C.:** 350

**Physical Strength:** P.S. 48.

**Speed:** Running: 60 mph (96 km). Leaping: 20 feet (6.1 m) high and 30 feet (9 m) across; jet assist to 50 feet (15.2 m) high and 100 feet (30.5 m) across. Flight: 600 mph (960 km). Max altitude is 30,000 feet (9,144 m).

**Bonuses:** +2 attacks per melee at level one; +1 additional attack at levels six and twelve. +1 on initiative, +2 to strike, +2 to parry, +2 to dodge (+4 in flight), +3 to roll with impact, +3 to pull punch.

**Multi-Barrel Rail Gun:** Mega-Damage: 2D4 M.D. (single shot); 1D4x10 M.D. (burst). Rate of Fire: Equal to the number of attacks per melee round. Range: 2,000 feet (610 m). Payload: 4,000 rounds (100 bursts).

**Particle Beam Cannon:** Mega-Damage: 1D6x10 M.D. Rate of Fire: Equal to the number of attacks per melee round. Range: 2,000 feet (610 m). Payload: Unlimited.

**Other Weapons:** Mini-Missile Launchers (12), Medium-Range Missile Launchers (2).

**Black Market Cost:** Not sold in any market outside the preserves. If one were to make it to the black market, it would sell for up to 20 million credits and another 20 million credits for its experimental targeting system.

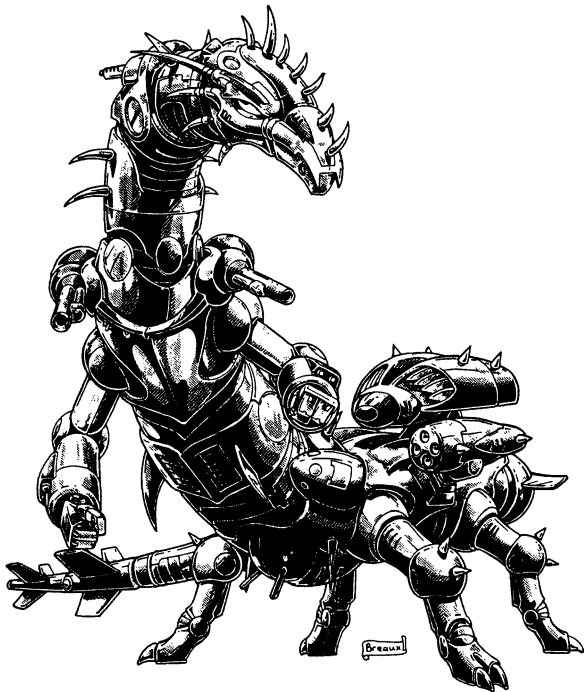

### Native American: UWS-HAR-02 Uktena

**Manufacturer:** Native American (Spirit West, p. 189).

**Crew:** Three: pilot, co-pilot and gunner.

**Main Body M.D.C.:** 635

**Physical Strength:** P.S. 50.

**Speed:** Running: 75 mph (120 km). Underwater: 30 mph (48 km; 25.8 knots) Water Surface: 40 mph (64 km; 34.4 knots). Rearing: Can not leap, but it can rear back on its hind legs and reach out to 45 feet (13.8 m).

**Bonuses:** +1 attack per melee round at levels five and ten. +2 to strike, +3 to parry, +2 to roll with impact, +2 to dodge underwater.

**Laser Particle Beam Cannons (2):** Mega-Damage: 1D6x10 M.D. (single blast); 2D6x10 M.D. (double blast). Rate of Fire: Equal to the number of attacks per melee round. Range: 3,000 feet (914 m). Payload: 40 shots per gun.

**Plasma Cannon:** Mega-Damage: 2D6x10 M.D. Rate of Fire: Equal to the number of attacks per melee round. Range: 1,200 feet (365 m). Payload: Unlimited.

**Other Weapons:** Laser Turret, Mini-Missile Launchers (2), Long-Range Missile Launchers (2), Rapid-Fire Pulse Laser.

**Black Market Cost:** Not sold in any market outside the preserves. If one were to make it to the black market, it would sell for up to 100 million credits.

### Native American: WH-GAR-06 Wolf

**Manufacturer:** Native American (Spirit West, p. 194).

**Crew:** Three: pilot, gunner and communications officer.

**Main Body M.D.C.:** 480

**Physical Strength:** P.S. 50.

**Speed:** Running: 160 mph (256 km). Leaping: 40 feet (12.2 m) high and 60 feet (18.3 m) across but can reach 60 feet (18.3 m) high and 120 feet (36.6 m) across with a running start of 100 feet (30.5 m) or more.

**Bonuses:** +2 attacks per melee round at level one, and +1 attack at levels four, eleven and fifteen.

**Dual Particle Beam (2):** Mega-Damage: 1D6x10 M.D. (single blast); 2D6x10 M.D. (dual blast). Rate of Fire: Equal to the number of attacks per melee round. Range: 2,000 feet (610 m). Payload: Unlimited.

**Dual Laser Cannons (2):** Mega-Damage: 2D6+2 M.D. (single blast); 1D4x10 (triple pulse blast); 2D4x10 M.D. (triple pulse blast from both guns). Rate of Fire: Equal to the number of attacks per melee round. Range: 4,000 feet (1,220 m). Payload: Each gun can fire 100 times per hour before requiring recharging.

**Other Weapons:** Shoulder Mini-Missile Launchers.

**Black Market Cost:** Not sold in any market outside the preserves. If one were to make it to the black market, it would sell for up to 25 million credits.

### Naut'Yll: DD-2 Deathbringer

**Manufacturer:** Naut'Yll (Underseas, p. 158).

**Crew:** Two: pilot and gunner; can hold another two passengers.

**Main Body M.D.C.:** 500

**Physical Strength:** P.S. 55.

**Speed:** Running: 50 mph (80 km) on dry land, 24 mph (38 km) underwater. Underwater: Thrusters give speed of 35 mph (56 km; 30 knots).

**Bonuses:** None.

**Particle Wave Canon Turret:** Mega-Damage: 1D6x10+6 M.D. (single blast); 2D6x10+12 M.D. (double blast); 3D6x10+20 M.D. (triple blast). Rate of Fire: Equal to the number of attacks per melee round. Range: 5,000 feet (1,524 m). Payload: Unlimited.

**Concealed Laser Gun:** Mega-Damage: 6D6 M.D. Rate of Fire: Equal to the number of attacks per melee round. Range: 6,000 feet (1,828 m). Payload: Unlimited.

**Other Weapons:** Heavy Torpedo/Missile Launchers (2), Medium Torpedo/Missile Launchers (2), Mini-Torpedo/Missile Launcher.

**Black Market Cost:** Not sold to outsiders. Would fetch 25 to 40 million credits from the Black Market, Atlantis or pirates.

### Northern Gun: NG-V7 Hunter Mobile Gun

**Manufacturer:** Northern Gun (Sourcebook One Revised, p. 52).

**Crew:** Three: pilot, co-pilot and gunner; can accommodate another four passengers.

**Main Body M.D.C.:** 410

**Physical Strength:** P.S. 40.

**Speed:** Running: 70 mph (112 km). Leaping: 20 feet (6.1 m) high and

20 feet (6.1 m) lengthwise. 01-62% chance of toppling upon landing, due to poor balance.

**Bonuses:** None.

**NG-H155 Howitzer Rail Gun:** Mega-Damage: 1D6x10 M.D. (single blast) or 2D6x10 (double blast). Rate of Fire: Equal to the number of attacks per melee round. Range: 6,000 feet (1,828 m). Payload: 80,000 rounds (2,000 single bursts) per drum.

**Forearm Rocket Launchers (2):** Mega-Damage: 1D6x10 M.D. (plasma). Rate of Fire: Equal to the number of attacks per melee round. Range: 2,000 feet (610 m). Payload: Unlimited.

**Other Weapons:** NG-330 Heavy Laser.

**Black Market Cost:** 40 million credits.

### Northern Gun: NG-M56 Multi-Bot

**Manufacturer:** Northern Gun (Sourcebook One Revised, p. 53).

**Crew:** Two: pilot and co-pilot/gunner. Can hold an additional six passengers.

**Main Body M.D.C.:** 290

**Physical Strength:** P.S. 40.

**Speed:** Running: 60 mph (96 km). Leaping: 10 feet (3 m) high or across; 20 feet high or 30 across (9m) with a running start. Flight: The robot has a detachable hover craft perched on it that can reach speeds of up to 240 mph (384 km) and has a max altitude of 10,000 feet (3,050 m).

**Bonuses:** None.

**Scissor Medium Missile Launchers:** Mega-Damage: 2D4x10 M.D. Rate of Fire: Single shot or volleys of two or three. Range: 40 miles (64 km). Payload: 10; five per shoulder.

**Heavy Ion Cannon:** Mega-Damage: 5D6 M.D. Rate of Fire: Equal to the number of attacks per melee round. Range: 4,000 feet (1,220 m). Payload: Unlimited.

**Other Weapons:** Concealed Shoulder Mini-Missile Launchers (2), NG-101 Light Rail Gun.

**Black Market Cost:** 22 million credits.

### Northern Gun: NG-V10 Super Robot Vehicle

**Manufacturer:** Northern Gun (Sourcebook One Revised, p. 61).

**Crew:** One; can hold one additional passenger.

**Main Body M.D.C.:** 350

**Physical Strength:** P.S. 40.

**Speed:** Running: 60 mph (96 km). Leaping: 10 feet (3 m) high or across; 20 feet (6.1 m) high or 30 feet (9.1 m) across with a running start.

**Bonuses:** None.

**Laser-Claw Hand:** Mega-Damage: Four settings: 1D6 M.D., 2D6 M.D., 4D6 M.D., 6D6 M.D. Rate of Fire: Equal to the number of attacks per melee round. Range: 2,000 feet (610 m). Payload: Unlimited.

**Other Weapons:** Optional NG-202 or TX-500 Rail Gun.

**Black Market Cost:** 15 million credits.

### Poland (Kingdom of Tarnow): TC-R3 Missileer

**Manufacturer:** Kingdom of Tarnow (Mindwerks, p. 98).

**Crew:** Two: pilot and gunner. Can hold one extra passenger.

**Main Body M.D.C.:** 330

**Physical Strength:** P.S. 47.

**Speed:** Running: 45 mph (72 km). Leaping: 10 feet (3 m) high or across from a running start.

**Bonuses:** +2 on initiative, +2 to strike, +2 to parry, +2 to dodge, +3 to roll with impact, +4 to pull punch.

**Forearm Grenade Launchers:** Mega-Damage: Varies with grenade type. Rate of Fire: Single shot or volleys of two or four. Range: 35 feet (10.7 m) to 250 feet (76 m) maximum. Payload: 80 total; 40 in each arm.

**Chest Laser:** Mega-Damage: 3D6 M.D. Rate of Fire: Equal to the number of attacks per melee round. Range: 2,000 feet (610 m). Payload: Unlimited.

**Other Weapons:** Mini-Missile Launchers (2), Smoke Dispensers (2).

**Black Market Cost:** 12 million credits. An unarmed version is available for 6 to 8 million credits.

### Poland: TC-R5 Gargoyle Stopper

**Manufacturer:** Kingdom of Tarnow (Mindwerks, p. 99).

**Crew:** One: can hold one extra passenger.

**Main Body M.D.C.:** 280

**Physical Strength:** P.S. 40.

**Speed:** Running: 60 mph (96 km). Leaping: 15 feet (4.6 m) high or 20 feet (6.1 m) across from a running start.

**Bonuses:** +1 attack per melee at levels one, two, six, 10 and 14. +4 on initiative, +4 to strike, +3 to parry, +2 to dodge, +2 to roll with impact, +2 to pull punch.

**Giant-Sized Energy Rifle:** Mega-Damage: 3D6 M.D. (single blast); 6D6 M.D. (double blast). Rate of Fire: Equal to the number of attacks per melee round. Range: 8,000 feet (2,438 m). Payload: 40 shots.

**Forearm Rail Gun:** Mega-Damage: 1D4 M.D. (single shot); 6D6 M.D. (burst). Rate of Fire: Equal to the number of attacks per melee round. Range: 4,000 feet (1,220 m). Payload: 3,000 rounds (100 bursts).

**Other Weapons:** Medium-Range Missile Launcher, Mini-Missile Launcher, Hand Weapons, Concealed Shoulder Grenade Launchers (2).

**Black Market Cost:** 20 million credits.

## Naruni Enterprises

### DK-AR500 Death-Knight

**Manufacturer:** Naruni Enterprises (Mercenaries, p. 136).

**Crew:** Three: pilot, co-pilot, gunner.

**Main Body M.D.C.:** 600

**Physical Strength:** P.S. 60.

**Speed:** Running: 70 mph (112 km). Leaping: 20 feet (6.1 m) high or across.

**Bonuses:** None.

**Particle Beam Cannon:** Mega-Damage: 1D6x10+10 M.D. Rate of Fire: Equal to the number of attacks per melee round. Range: 6,000 feet (1,828 m). Payload: Unlimited.

**Energy Axe:** Mega-Damage: 2D6x10 M.D. (energized strike); 2D6 M.D. (blunt weapon). Rate of Fire: Equal to the number of attacks per melee round. Range: Melee. Payload: Unlimited.

**Other Weapons:** Missile Launchers (4), Laser Gun, Belly Rail Gun.

**Black Market Cost:** 90 million credits.

### N-SR20 Nomad

**Manufacturer:** Naruni Enterprises (Mercenaries, p. 139).

**Crew:** One. Can hold two additional passengers.

**Main Body M.D.C.:** 470

**Physical Strength:** P.S. 40.

**Speed:** Running: 150 mph (240 km). Leaping: 15 feet (4.6 m) high or across.

**Bonuses:** None.

**Rail Gun Turret:** Mega-Damage: 1D6x10 M.D. (burst). Rate of Fire: Equal to the number of attacks per melee round. Range: 4,000 feet (1,220 m). Payload: 1,200 rounds (30 bursts).

**Mini-Missile Launcher:** Mega-Damage: 1D6x10 M.D. Rate of Fire: Single shot or volleys of two, three or four missiles. Range: One mile (1.6 km). Payload: 16.

**Other Weapons:** Laser Gun, Camouflage System.

**Black Market Cost:** 20 million credits.

### O-AR600 Ovoid

**Manufacturer:** Naruni Enterprises (Phase World Sourcebook, p. 73).

**Crew:** Two: pilot/gunner and gunner. Can hold another two passengers.

**Main Body M.D.C.:** 650

**Force Field M.D.C.:** 320  
**Physical Strength:** P.S. 50.  
**Speed:** Running: 70 mph (112 km). Flight: Mach One.  
**Bonuses:** None.  
**Plasma Cartridge Machineguns (2):** Mega-Damage: 2D6x10 M.D. (burst). Rate of Fire: Equal to the number of attacks per melee round. Range: 2,000 feet (610 m) in an atmosphere; one mile (1.6 km) in space. Payload: 2,000 rounds (200 bursts) per gun.  
**Rail Guns (2):** Mega-Damage: 2D6x10 M.D. (burst). Rate of Fire: Equal to the number of attacks per melee round. Range: 6,000 feet (1,828 m). Payload: 8,000 rounds (100 bursts) per gun.  
**Other Weapons:** Short-Range Missile Launcher, Long-Range Missile Launcher, Laser Guns (2).  
**Black Market Cost:** 95 million credits.

## South America

**Arkhor: AB-17 Great Cyclops**  
**Manufacturer:** Arkhor (South America 2, p. 91).  
**Crew:** One; can hold another three passengers.  
**Main Body M.D.C.:** 750; energy weapons do half damage but kinetic weapons do double damage.  
**Physical Strength:** P.S. 55.  
**Speed:** Running: 100 mph (160 km). Flight: 400 mph (640 km). Can fly six hours at max speed before overheating.  
**Bonuses:** +1 attack per melee at levels one, five and ten. +1 to dodge at levels one and eight. +2 to roll with punch, fall or impact.  
**Hand Tri-Beam Cannons (2):** Mega-Damage: 2D4x10 M.D. (single blast); 4D4x10 M.D. (double blast); double damage to anything except force fields or Arkhor composite armor. Rate of Fire: Equal to the number of attacks per melee round. Range: 4,000 feet (1,220 m). Payload: Unlimited.  
**Tri-Beam Guns (2):** Mega-Damage: 3D6 M.D. (single blast); 6D6 M.D. (double blast); double damage to anything except force fields or Arkhor composite armor. Rate of Fire: Equal to the number of attacks per melee round. Range: 2,000 feet (610 m). Payload: Unlimited.  
**Other Weapons:** Torso Missile Launchers (5), Flechette Machine-gun, Mini-Missile Launchers (2), Smoke Dispensers (2).  
**Black Market Cost:** Not for sale. No reconditioned or stolen units have ever made it to market.

### Colombia: G9A Jaguar

**Manufacturer:** Republic of Colombia (South America, p. 29).  
**Crew:** One; can hold another three passengers.  
**Main Body M.D.C.:** 320  
**Physical Strength:** P.S. 40.  
**Speed:** Running: 90 mph (144 km). Leaping: 20 feet (6.1 m) high or across; add 10 feet (3 m) if running.  
**Bonuses:** +1 additional attack per melee at levels one, three, seven and twelve. +1 on initiative, +1 to strike, +2 to parry, dodge, pull punch, and roll with impact.  
**20mm Autocannon:** Mega-Damage: 2D4x10 M.D. (burst). Rate of Fire: Equal to the number of attacks per melee round. Range: 4,000 feet (1,220 m). Payload: 4,000 rounds (100 bursts) in the gun; another 12,000 rounds (300 bursts) stored in the robot's body.  
**Laser Eye Beams (2):** Mega-Damage: 6D6 M.D. (dual blast). Rate of Fire: Equal to the number of attacks per melee round. Range: 4,000 feet (1,220 m). Payload: Unlimited.  
**Other Weapons:** Mini-Missile Launchers (2).  
**Black Market Cost:** 25 million credits.

### Colombia: G-18B Aguirre

**Manufacturer:** Republic of Colombia (South America, p. 31).  
**Crew:** One; can hold four passengers.  
**Main Body M.D.C.:** 380  
**Physical Strength:** P.S. 44.

**Speed:** Running: 60 mph (96 km). Leaping: 15 feet (4.6 m) high or across. Add 10 feet (3 m) when running.  
**Bonuses:** +1 additional attack per melee at levels one, four, eight and twelve. +1 to strike (+3 with sword), +3 to parry (+5 with sword; +1 to parry energy blasts), +2 to dodge, +2 to pull punch, +3 to roll with impact.  
**Giant Vibro-Sword:** Mega-Damage: 1D6x10 M.D. (energized); 3D4 M.D. (unenergized). Rate of Fire: Equal to the number of attacks per melee round. Range: Melee. Payload: Unlimited.  
**Rocket Autocannon:** Mega-Damage: 1D6x10 M.D. (burst). Rate of Fire: Equal to the number of attacks per melee round. Range: 4,000 feet (1,220 m). Payload: 4,000 rounds (400 bursts).  
**Other Weapons:** Medium-Range Missile Launchers (2), Laser Cannons (2).  
**Black Market Cost:** 30 million credits.

### GATV-5 Galapagos

**Manufacturer:** Silver River Republics (Cordoba & Santiago) (South America 2, p. 177).  
**Crew:** 14: commander, pilot, navigator/co-pilot, communications/sensor officer, engineers (2), gunners (8).  
**Main Body M.D.C.:** 1,800  
**Physical Strength:** P.S. 60.  
**Speed:** Running: 50 mph (80 km). Flying: 200 mph (320 km) or 300 mph (480 km) with head and legs retracted.  
**Bonuses:** +1 attack per melee at levels one, three, six, and eleven. +2 to strike. NO DODGE.  
**Laser Cannons (2):** Mega-Damage: 2D4x10 M.D. (single blast); 4D4x10 M.D. (dual blast). Rate of Fire: Equal to the number of attacks per melee round. Range: 6,000 feet (1,828 m). Payload: Unlimited.  
**Quad Rail Gun:** Mega-Damage: 2D4x10 M.D. (burst). Rate of Fire: Equal to the number of attacks per melee round. Range: 3,000 feet (914 m). Payload: 24,000 rounds (200 bursts).  
**Other Weapons:** Medium-Range Missile Launchers (2), Ion Gun Turrets (3), Missile/Laser Batteries (4).  
**Black Market Cost:** Not for sale. Production cost, per unit, is 550 million credits (subject to credit approval, no money down, 1.9% APR).

### SHAB-10 Mastodon

**Manufacturer:** Silver River Republics (Cordoba) (South America 2, p. 176).  
**Crew:** Five: pilot, co-pilot/gunner, gunners (3).  
**Main Body M.D.C.:** 950  
**Physical Strength:** P.S. 55.  
**Speed:** Running: 70 mph (112 km).  
**Bonuses:** +1 attack per melee at levels one, two, six, and eleven. +2 to parry, +2 to pull punch, +2 to strike and parry with trunk, -2 to dodge (it's slow!).  
**Boom Gun Turret:** Mega-Damage: 3D6x10 M.D. Rate of Fire: Equal to the number of attacks per melee round. Range: Two miles (3.2 km). Payload: 15,000 rounds (75 blasts).  
**Morningstar Trunk:** Mega-Damage: 1D6x10 M.D. (energized); 4D6+6 M.D. (unenergized). Rate of Fire: Equal to the number of attacks per melee round. Range: Melee. Payload: Unlimited.  
**Other Weapons:** Long-Range Missile Launchers (2), Death Mirrors (2), Particle Beam Belly Gun, MLRS Multiple Mini-Missile Launchers (2).  
**Black Market Cost:** 200 million credits.

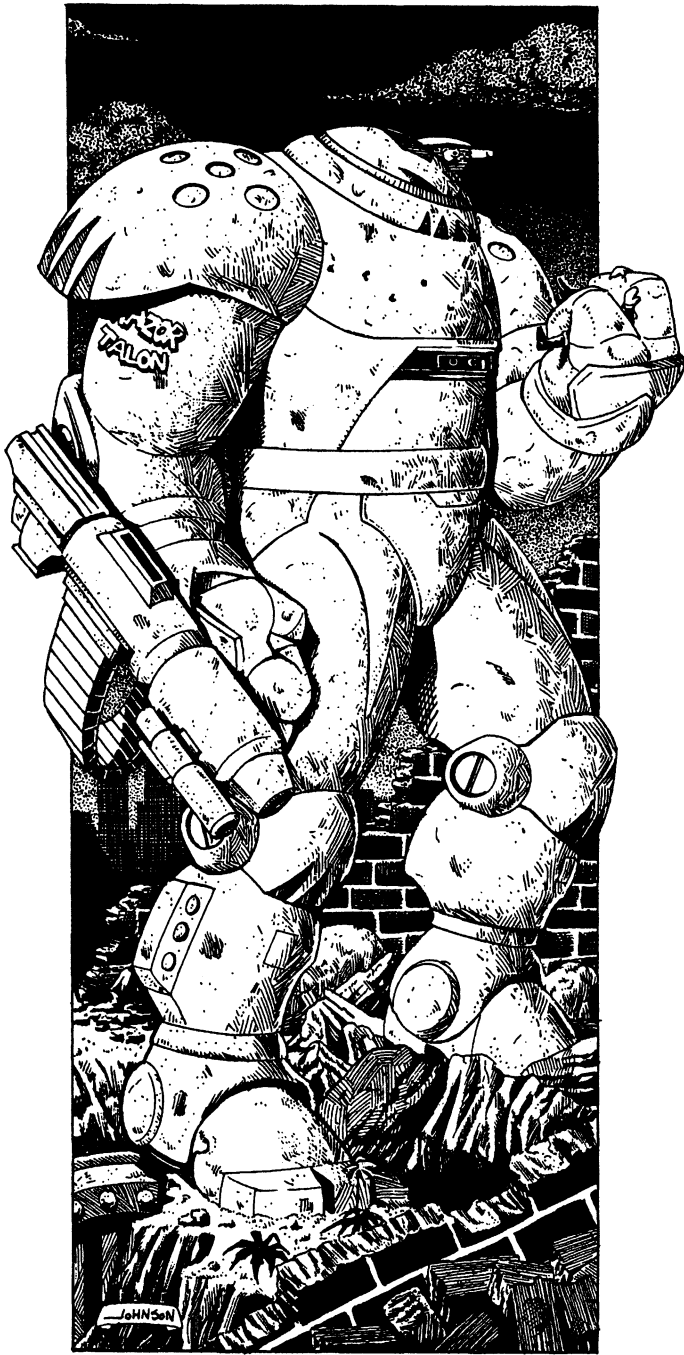

## Titan Robotics

### EX-5 Behemoth Explorer Robot

**Manufacturer:** A pre-Rifts design, but recent evidence shows that the mysterious firm *Titan Robotics* has resumed production of these vehicles and is working on a line of variants, including those more suitable for combat (Rifts® Sourcebook One Revised, p. 55).

**Crew:** Three: pilot, co-pilot and communications officer. Can accommodate an additional 30 to 80 passengers, depending on the equipment load of the vehicle.

**Main Body M.D.C.:** 500

**Physical Strength:** P.S. 40.

**Speed:** Running: 40 mph (64 km).

**Bonuses:** None.

**Mini-Missile Forearm Launchers (2):** Mega-Damage: 5D6 M.D. (frag) or 1D6x10 M.D. (plasma). Rate of Fire: Single shot or volleys of two, three or four. Range: One mile (1.6 km). Payload: 48; 24 per arm.

**Other Weapons:** None, but the enormous size of this vehicle makes it possible to mount up to six other weapons systems on the hull. This vehicle also comes with an advanced sensor package, including a thermo-imager, infrared and ultraviolet optics, infrared searchlights, and enhanced radar.

**Black Market Cost:** 100 million credits for a new robot; 30 million for a rebuilt one.

### TR-001 Titan Combat Robot

**Manufacturer:** Titan Robotics (Rifts® Ultimate Edition, p. 273).

**Crew:** One; can hold an additional two passengers.

**Main Body M.D.C.:** 370

**Physical Strength:** P.S. 36.

**Speed:** Running: 60 mph (96 km). Leaping: 15 feet (4.6 m) high or across; add 10 feet (3 m) with a running start.

**Bonuses:** None.

**T-001 Rapid-Fire Rail Gun:** Mega-Damage: 1D4 M.D. (single round) or 1D4x10 M.D. (burst). Rate of Fire: Equal to the number of attacks per melee round. Range: 4,000 feet (1,220 m). Payload: 20,000 rounds (250 bursts).

**T-001 Medium-Range Rocket Launcher:** Mega-Damage: Varies with missile type. Rate of Fire: Single shot or volleys of two, three or four. Range: 80 miles (128 km). Payload: 10; 5 per arm.

**Other Weapons:** T-001 Mini-Missile Leg Launchers (2), T-001 Laser Turrets.

**Black Market Cost:** 24 million credits.

### TR-002 Titan Exploration and Light Combat Robot

**Manufacturer:** Titan Robotics (Sourcebook One Revised, p. 109).

**Crew:** One; can accommodate four additional passengers.

**Main Body M.D.C.:** 300

**Physical Strength:** P.S. 32.

**Speed:** Running: 90 mph (144 km). Leaping: 15 feet (4.6 m) high or across. Add 10 feet (3 m) with a running start.

**T-002 Short-Range Rocket Launcher:** Mega-Damage: 1D4x10 (armor piercing) or 1D6x10 M.D. (plasma). Rate of Fire: Single shot or volleys of two, three or four. Range: One mile (1.6 km). Payload: 10; 5 per launcher.

**T-002 Laser Ball Turret:** Mega-Damage: 3D6 M.D. (single blast) or 6D6 M.D. (dual blast). Rate of Fire: Equal to the number of attacks per melee round. Range: 2,000 feet (610 m). Payload: Unlimited.

**Other Weapons:** Retractable Vibro-Claws.

**Black Market Cost:** 14 million credits.

### TR-003 Titan Reconnaissance Robot

**Manufacturer:** Titan Robotics (Sourcebook One Revised, p. 111).

**Crew:** One; can accommodate one additional passenger.

**Main Body M.D.C.:** 270

**Physical Strength:** P.S. 28.

**Speed:** Running: 150 mph (240 km). Leaping: 15 feet (4.6 m) high or across. Add 10 feet (3 m) with a running start.

**Bonuses:** None.

**T-003 Mini-Laser:** Mega-Damage: 3D6 M.D. Rate of Fire: Equal to the number of attacks per melee round. Range: 2,000 feet (610 m). Payload: Unlimited.

**Other Weapons:** None.

**Black Market Cost:** 10 million credits.

# Triax

## DV-12 Dyna Bot

**Manufacturer:** Triax (Sourcebook One Revised, p. 46 & Triax & the NGR, p. 82).

**Note:** This is not a robot *vehicle*, but a man-sized robot.

## X-10A Predator

**Manufacturer:** Triax (Triax and the NGR, p. 49).

**Crew:** One.

**Main Body M.D.C.:** 380

**Physical Strength:** P.S. 40.

**Speed:** Running: 50 mph (80 km). Leaping: 15 feet (4.6 m) high or across; jet assist to 100 feet (30.5 m) high or across. Flight: 290 mph (464 km); max altitude is 500 feet (152 m). Can fly for 24 hours at max speed before overheating.

**Bonuses:** None.

**X-10-453A Pulse Cannon:** Mega-Damage: 2D4 M.D. (single shot); 1D4x10 M.D. (four-shot volley). Rate of Fire: Equal to the number of attacks per melee round. Range: 4,000 feet (1,220 m). Payload: Unlimited.

**Dual Shoulder Mini-Missile Launcher:** Mega-Damage: 1D4x10 M.D. (armor piercing) or 1D6x10 M.D. (plasma). Rate of Fire: One or two. Range: One mile (1.6 km). Payload: Two.

**Other Weapons:** Hand Weapons.

**Black Market Cost:** It used to be that the slightly weaker and slower X-10 Predator sold in the Americas for 1.9 million credits. Since the X-10As have begun appearing on the Black Market in substantial numbers, many X-10s have been retrofitted to X-10A specs and sold at a higher price tag. The going rate now for any X-10 or X-10A on the Black Market is 2.4 million credits per unit.

## X-60 Flanker Urban Defender

**Manufacturer:** Triax (Triax and the NGR, p. 51).

**Crew:** One.

**Main Body M.D.C.:** 380

**Physical Strength:** P.S. 30.

**Speed:** Running: 50 mph (80 km). Leaping: 10 feet (3 m) high or 15 feet (4.6 m) across.

**Bonuses:** +1 to strike, +1 to dodge, +2 to parry. Climb skill at 70%/60%.

**Weapons:** Extendable Hydraulic Hands/Arms, Riot Baton Launchers (2), Flip-Top Shoulder Canister Launchers (2), Dual Leg Mini-Missile Launchers (2), Energy Rifle or Rail Gun.

**Black Market Cost:** 500,000 credits, very poor availability.

## X-500 Forager

**Manufacturer:** Triax (Rifts® Sourcebook One Revised, p. 49).

**Crew:** Two: pilot and co-pilot.

**Main Body M.D.C.:** 450

**Physical Strength:** P.S. 40.

**Maximum Speed:** Ground: 60 mph (96 km). Flight: 10 feet (3 m) high or across, 20 feet (6.1 m) high or 30 feet (9.1 m) across with a running start.

**Bonuses:** None.

**Dual Shoulder Medium Missile Launchers:** Mega-Damage: 2D4x10 M.D. (multi-warhead) or 2D6x10 M.D. (plasma). Rate of Fire: Single shot or volleys of two or four. Range: 40+ miles (64+ km). Payload: 16 missiles; 8 per launcher.

**Ion Belly Gun Turret:** Mega-Damage: 4D6 M.D. (single blast) or 1D4x10 M.D. (double blast). Rate of Fire: Equal to the number of attacks per melee round. Range: 4,000 feet (1,220 m). Payload: Unlimited.

**Other Weapons:** None.

**Black Market Cost:** 22 million credits. 13 million for unarmed labor and exploration models.

## X-535 Hunter

**Manufacturer:** Triax (Triax and the NGR, p. 55).

**Crew:** One.

**Main Body M.D.C.:** 300

**Physical Strength:** P.S. 40.

**Speed:** Running: 140 mph (224 km). Leaping: 30 feet (9.1 m) high or across; 40 feet (12 m) or 60 feet (18.3 m) across from a running start.

**Bonuses:** +2 to strike, +4 to parry, +3 to dodge, +4 to roll with impact, +4 to pull punch, +10% to climb, +1 attack per melee round at levels one, two, four, seven, ten and fourteen.

**TX-250 Maxi-Rail Gun (1 or 2):** Mega-Damage: 1D4 M.D. (single round); 3D6 M.D. (short burst); 6D6 M.D. (full burst). Rate of Fire: Equal to the number of attacks per melee round. Range: 6,000 feet (1,828 m). Payload: Each clip holds 300 rounds (10 full bursts).

**Head Guns (2):** Mega-Damage: 3D6 M.D. (short burst) or 6D6 M.D. (long burst). Rate of Fire: Equal to the number of attacks per melee round. Range: 2,000 feet (610 m). Payload: 2,000 rounds (66 full bursts or 133 short bursts).

**Other Weapons:** Forearm Mini-Missile Launchers (2), TX-843 Interchangeable Particle Beam Cannon, TX-862FC Interchangeable Recoilless Anti-Aircraft Flak Gun, TX-884I Interchangeable Ion Cannon & Missile Launcher, TX-871MM Interchangeable Rotary Missile Drum Launchers (2).

**Black Market Cost:** 12 million credits; add 8 million credits for each of the heavy, long-range weapon systems.

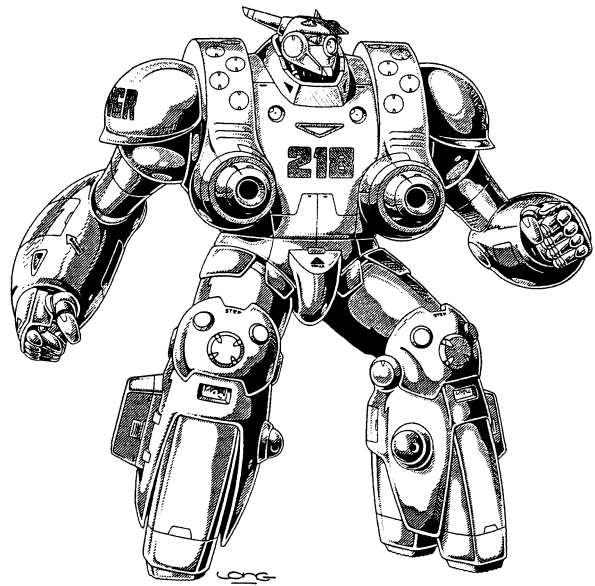

## X-545 Super Hunter

**Manufacturer:** Triax (Triax and the NGR, p. 60).

**Crew:** One.

**Main Body M.D.C.:** 500

**Physical Strength:** P.S. 50.

**Speed:** Running: 70 mph (112 km). Leaping: 20 feet (6.1 m) high or across; 30 feet (9.1 m) to 40 feet (12.2 m) across with a running start.

**Bonuses:** +2 to strike, +3 to parry, +2 to dodge, +2 to roll with impact, +2 to pull punch, +1 attack per melee round at levels one, three, six, and ten.

**TX-250 Maxi-Rail Gun (1 or 2):** Mega-Damage: 1D4 M.D. (single round); 3D6 M.D. (short burst); 6D6 M.D. (full burst). Rate of Fire: Equal to the number of attacks per melee round. Range: 6,000 feet (1,828 m). Payload: Each clip holds 300 rounds (10 full bursts).

**Head Guns (2):** Mega-Damage: 3D6 M.D. (short burst) or 6D6 M.D. (long burst). Rate of Fire: Equal to the number of attacks per melee round. Range: 2,000 feet (610 m). Payload: 2,000 rounds (66 full bursts or 133 short bursts).



**Other Weapons:** Ion Cannons (2), Shoulder Mini-Missile Launchers (2), Forearm Mini-Missile Launchers (2), Forearm Vibro-Sword, Lower Leg Mini-Missile Launchers (2), Flamethrowers (2).

**Black Market Cost:** 16 million credits.

### X-622 Bug

**Manufacturer:** Triax (Triax and the NGR, p. 63).

**Crew:** Two: pilot and co-pilot.

**Main Body M.D.C.:** 400

**Physical Strength:** P.S. 40.

**Speed:** Running: 60 mph (96 km). Underwater: 30 mph (48 km).

**Bonuses:** +1 to strike, +2 to parry, +2 to dodge, +2 to roll with impact, +2 to pull punch, +1 attack per melee round at levels one, three, seven and eleven.

**TX-150 "Man Killer" Rail Gun:** Mega-Damage: 1D6x10 M.D. (Uranium rounds). Rate of Fire: Equal to the number of attacks per melee round. Range: 4,000 feet (1,220 m). Payload: 3,000 rounds (100 bursts).

**Rear Laser Turret:** Mega-Damage: 2D6 M.D. (single blast) or 6D6 M.D. (triple blast), Rate of Fire: Equal to the number of attacks per melee round. Range: 4,000 feet (1,220 m). Payload: Unlimited.

**Other Weapons:** Flip-Top Mini-Missile Launcher.

**Black Market Cost:** 9 million credits.

### X-821 Landcrab

**Manufacturer:** Triax (Triax and the NGR, p. 66).

**Crew:** Two: pilot and co-pilot/gunner. Can hold an additional 12 passengers.

**Main Body M.D.C.:** 650

**Physical Strength:** P.S. 60.

**Speed:** Running: 60 mph (96 km). Underwater: 30 mph (48 km).

**Bonuses:** +1 to strike, +3 to parry, +2 to dodge, +1 to roll with impact, +1 to pull punch, +1 attack per melee round at levels one, three, seven and eleven.

**Particle Beam Cannons (2):** Mega-Damage: 2D4x10 M.D. Rate of Fire: Equal to the number of attacks per melee round. Range: 2,000 feet (610 m). Payload: Unlimited.

**Rail Guns (2):** Mega-Damage: 1D4x10 M.D. (burst). Rate of Fire: Equal to the number of attacks per melee round. Range: 4,000 feet (1,220 m). Payload: 2,000 rounds (100 bursts) per gun.

**Other Weapons:** Rear Laser Turrets (2), Concealed Mini-Missile Launcher.

**Black Market Cost:** 14 million credits.

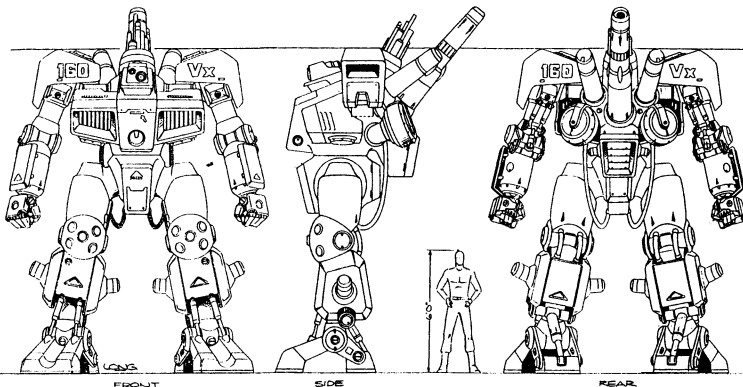

### X-1000 Ulti-Max

**Manufacturer:** Triax (Triax and the NGR, p. 68).

**Crew:** One.

**Main Body M.D.C.:** 400

**Force Field M.D.C.:** 100

**Physical Strength:** P.S. 40.

**Speed:** Running: 44 mph (70 km).

**Bonuses:** +2 to strike (ranged combat), +1 to dodge.

**VX-180 Maxi-Rail Gun:** Mega-Damage: 1D6x10 M.D. (burst). Rate of Fire: Equal to the number of attacks per melee round. Range: 6,000 feet (1,828 m). Payload: 4,000 rounds (100 bursts).

**VX-160 Mini-Missile Launchers (2):** Mega-Damage: 1D4x10 (armor piercing) or 1D6x10 plasma). Rate of Fire: Single shot or volleys of two, four or six. Range: One mile (1.6 km). Payload: 30; 15 per launcher.

**Other Weapons:** VS-180 Laser.

**Black Market Cost:** 22 million credits average, but can sell for twice as much for a new, undamaged suit with all weapons. Poor availability.

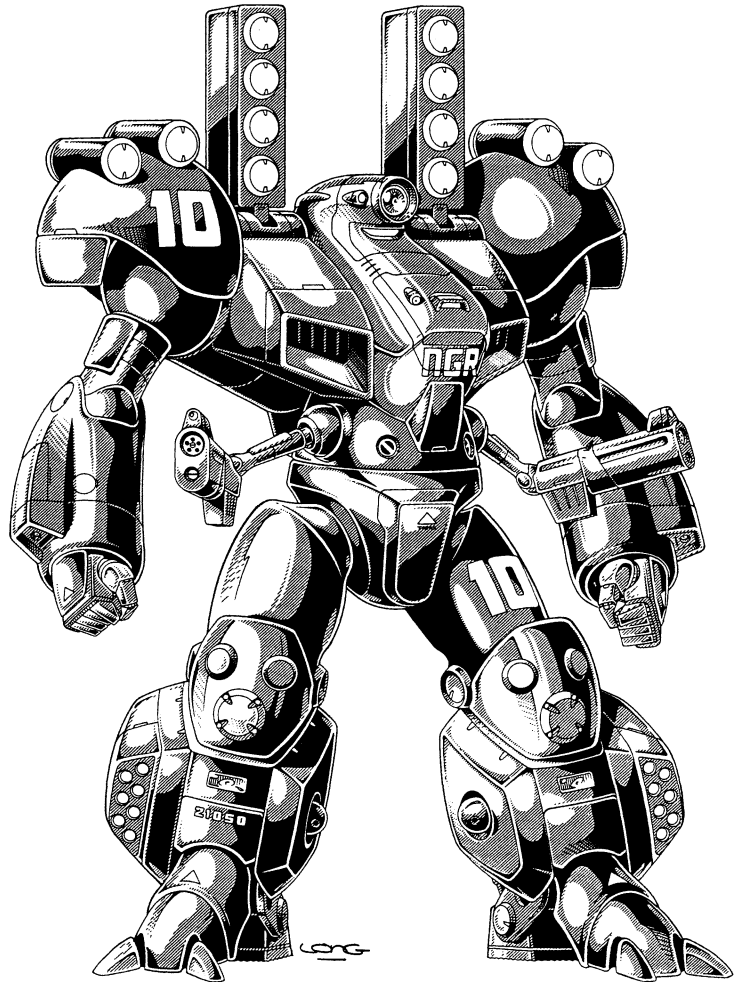

### X-2000 Dyna-Max

**Manufacturer:** Triax (Triax and the NGR, p. 70).

**Crew:** Two: pilot and co-pilot/gunner.

**Main Body M.D.C.:** 550

**Physical Strength:** P.S. 50.

**Speed:** Running: 70 mph (112 km) Leaping: 20 feet (6.1 m) high and across; 30 feet (9 m) high and 15 feet (4.6 m) across from a running start.

**Bonuses:** +2 to strike, +4 to parry, +3 to dodge, +4 to roll with impact, +4 to pull punch, +2 attacks per melee round at level one, +1 attack per melee at levels four, six, nine and twelve.

**Slammer Missile Launchers (2):** Mega-Damage: 2D4x10 M.D. plus stun effect. Rate of Fire: Single shot or in volleys of two. Range: 6,000 feet (1,828 m). Payload: 8; 4 per launcher.

**Forearm Lasers (2):** Mega-Damage: 4D6 M.D. (single blast) or 1D4x10+6 M.D. (per double blast). Rate of Fire: Equal to the number of attacks per melee round. Range: 6,000 feet (1828 m) Payload: Unlimited.

**Other Weapons:** Slammer Shoulder Missile Tubes (4), Forearm Vibro-Swords (2), Rail Gun Appendages (2), Lower Leg Mini-Missile Launchers (2), Flamethrowers (2), optional TX-250 Rail Gun.

**Black Market Cost:** 40 million credits.

## X-2500 Black Knight

**Manufacturer:** Triax (Triax and the NGR, p. 73).

**Crew:** Two: pilot and co-pilot/gunner. Can hold four additional passengers.

**Main Body M.D.C.:** 750

**Physical Strength:** P.S. 50.

**Speed:** Running: 70 mph (112 km). Leaping: 20 feet (6.1 m) high or across; 30 feet (9.1 m) high or 40 feet (12.2 m) across with a running start.

**Bonuses:** +2 to strike, +4 to parry, +3 to dodge, +2 to roll with impact, +2 to pull punch, +2 attacks per melee round, +1 attack per round at levels three, six, ten and fourteen.

**Ion Cannon:** Mega-Damage: 1D6x10 M.D. Rate of Fire: Equal to the number of attacks per melee round. Range: 4,000 feet (1,220 m). Payload: Unlimited.

**Electro-Mace:** Mega-Damage: 4D6 M.D. (blunt); 4D6+10 M.D. (energized), 1D4x10 M.D. (electrical blasts). Rate of Fire: Equal to the number of attacks per melee round; three electro-blasts per round, max. Range: Melee or 1,000 feet (305 m) for electro-blasts. Payload: Unlimited.

**Other Weapons:** Forearm Lasers (2), Forearm Vibro-Swords (2), Lower Leg Mini-Missile Launchers (4), Grenade Tubes (8).

**Black Market Cost:** 45 million credits.

round. Quad blasts count as two attacks. Range: 2,000 feet (610 m). Payload: Unlimited.

**Forward Rapid-Fire Machine-guns (2):** Mega-Damage: 2D4 M.D. (single burst); 4D4 M.D. (double burst). Rate of Fire: Equal to the number of attacks per melee round. Range: 4,000 feet (1,220 m). Payload: 3,000 rounds (150 bursts) per gun.

**Other Weapons:** Concealed Chest Missiles, Tail Swivel Laser Mounts (2), Optional Electro-Mace, Optional Slammer Concussion Bombs.

**Black Market Cost:** 45 million credits.

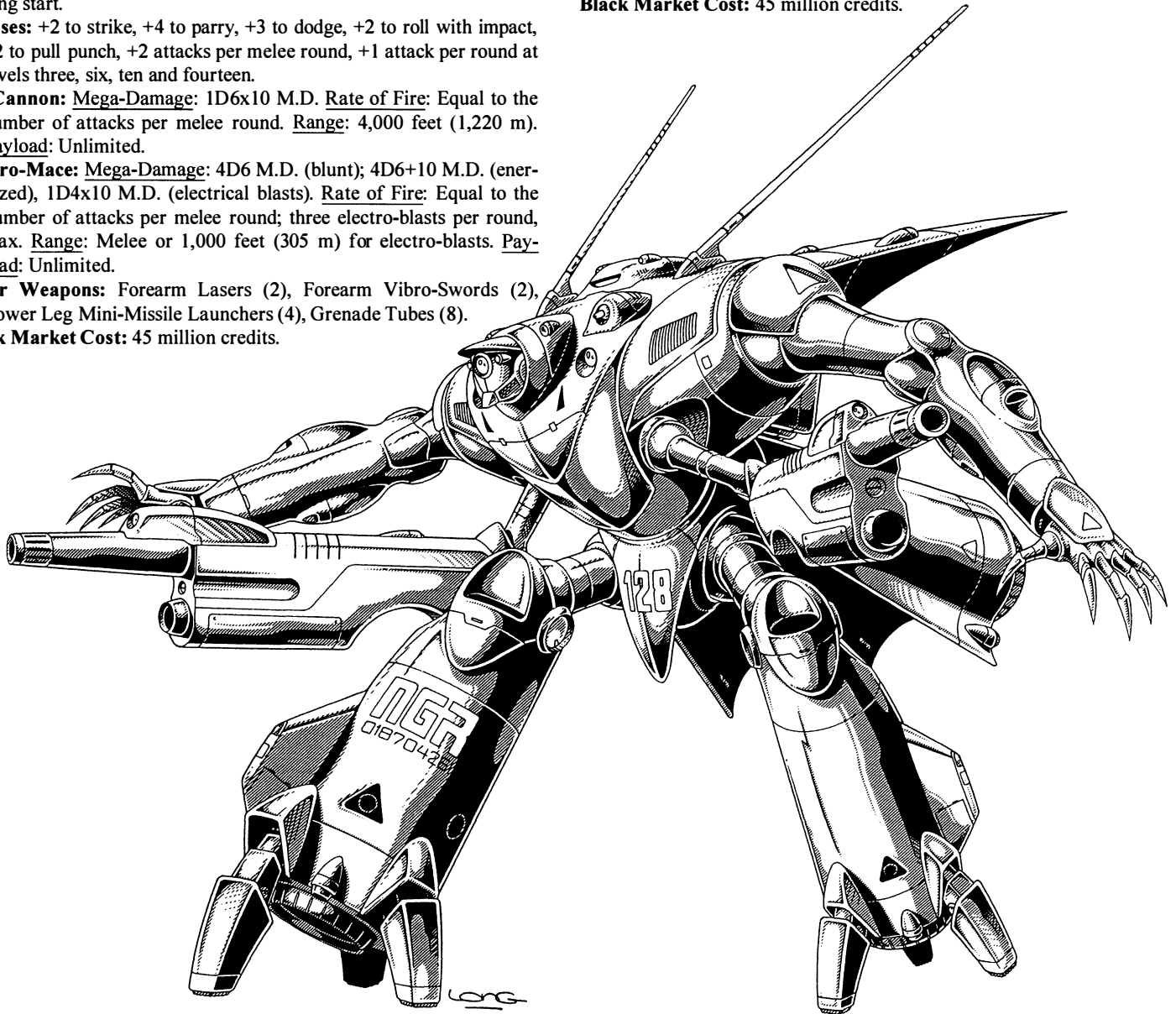

## X-2700 Dragonwing

**Manufacturer:** Triax (Triax and the NGR, p. 75).

**Crew:** Two: pilot and co-pilot/gunner. Can hold an additional two passengers.

**Main Body M.D.C.:** 525

**Physical Strength:** P.S. 50.

**Speed:** Running: 40 mph (64 km). Leaping: 10 feet (3 m). Jet assist to 100 feet (30.5 m) high or across. Flight: 300 mph (480 km); max altitude is 45,000 feet (13,716 m).

**Bonuses:** +2 to strike, +4 to parry, +3 to dodge (+5 in flight), +2 to roll with impact, +2 to pull punch, +2 attacks per melee round at level one, +1 attack per melee at levels three, six, ten and fourteen.

**Weapon Arms (2):** Mega-Damage: 1D4x10 M.D. (single laser blast); 2D4x10 M.D. (double laser blast); 1D4x10 (single ion blast); 2D4x10 M.D. (double ion blast); 4D4x10 M.D. (all weapons — quad blast). Rate of Fire: Equal to the number of attacks per melee

## X-5000 Devastator

**Manufacturer:** Triax (Triax and the NGR, p. 79).

**Crew:** Two: pilot and co-pilot/gunner.

**Main Body M.D.C.:** 1,500

**Physical Strength:** P.S. 60.

**Speed:** Running: 40 mph (64 km).

**Bonuses:** +1 to strike, +1 to parry, NO dodge, NO roll with impact, NO pull punch.

**TX-5000 Super Laser Cannon:** Mega-Damage: 1D6x10 M.D. (power blast); 4D M.D. (low-power blasts). Rate of Fire: Equal to the number of attacks per melee round. Range: 8,000 feet (2,438 m). Payload: 50 blasts.

**TX-5001 Super Ion Cannon:** Mega-Damage: 2D4x10 M.D. Rate of Fire: Equal to the number of attacks per melee round. Range: 4,000 feet (1,220 m). Payload: Unlimited.

**Black Market Cost:** 150 million credits.

# Vehicles



Breaux

The only way we could squeeze in *all* (okay, most of) the vehicles from the first 23 **Rifts® World Books**, **Rifts® Mercenaries** and the first four **Sourcebooks** was for Bill to create a stripped down stat block with only the most essential information and minus a description. Then I arranged them in an order I thought was easiest to use, by type and sometimes by country or organization. This should serve as a solid, easy to use *G.M. reference*, but for complete descriptions, details, weights and weapons (only the main and secondary gun is listed), one will have to go to the original sourcebook where it appeared. This compilation includes the most notable or exemplary types of vehicles. Does not include TW vehicles or spacecraft. Robots and power armor are found in a different section.

## Vehicles by Type or National Powers

### Aircraft

Africa: Robot Spy Wing  
 Arkhon: AF-89 Spikefish  
 Australian: NT-V40 Viper Helicopter  
 Australian: One- and Two-Man Fliers  
 Free Quebec: GBG-96 Sky-Hawk Aircraft  
 Free Quebec: RHV-60 Reloader  
 Iron Heart: AC-29 Air Castle Bomber  
 Iron Heart: GF-1A Grey Falcon Jet Fighter  
 Iron Heart: IE-15AH Iron Eagle Helicopter  
 Juicer: IFS-1 Icarus Flight System  
 Kittani: K-ATV Hover Jet  
 Kittani: K-PF 20 Patrol Flyer  
 Mega-Legion: NAH-50 Neo-Apache Helicopter  
 New Navy: IE-15AH Striker Helicopter  
 New Navy: S-14 Sea Hawk Jet Fighter  
 NG Sky King Aircraft  
 South America: CH-1000 Zancudo Helicopter  
 South America: Cibolan Flying Platform

### Boats & Water Vessels

Australian: Slicer Patrol Boat  
 Iron Heart: IH-MC1A Sea King  
 Iron Heart: IH-PB12 Triton Patrol Boat  
 Iron Heart: IH-TB12 Black Eel Patrol Boat  
 Kittani: KSM-100 Splugorth Slaver Mothership  
 Kittani: KY-HSS Slave Raider  
 New Navy: EPC Mark I Trident Submarine  
 New Navy: MEAS Mark I Manta Ray  
 New Navy: MIFV-99 Iwo Jima-Class Troop Transport  
 New Navy: USS Stingray & USS Seadragon Submarines  
 New Navy: USS Ticonderoga Super-Submarine  
 Poland/Tarnow: TC-B20 Torpedo Boat  
 Poland/Tarnow: TC-B30 Lightning Patrol Boat  
 Poland/Tarnow: TC-B40 Sea Dart Submarine  
 Poland/Tarnow: TC-B100 Walesa Cargo Ship  
 South America: CHB-5 Corsair Hydrobike  
 South America: PTB-20AB Pirahna  
 South America: GB-30C "Black Galleon" Gunboat  
 Tritonia: T-06 Torpedo Sled  
 Tritonia: T-10 Sea Fin Sea Sled  
 Tritonia: T-23CS Bottom Feeder Mini-Submarine  
 UB-20 Basic Underwater Sled  
 UB-300 Mini-Sub

### Coalition States Vehicles

#### CS Aircraft

AFC-023 Sky Cycle (original)  
 AFC-033 Wind Jammer Sky Cycle  
 AFC-050 Death's Head Transport APC  
 AFC-060 Sky Lifter  
 AFC-101 Command Car  
 AFC-103 Scarab Officer's Car

AFC-105 Skull Patrol Car  
 AFC-111 Scout  
 AFC-115 Warbird  
 AFC-151 Death Bringer  
 CH-10 Black Lightning Helicopter  
 CH-10N Sea Storm Helicopter  
 CH-12 Demon Locust Helicopter  
 CH-12N Sea Wasp Helicopter  
 CSN-115 Sea Striker Jet Fighter  
 CSN-117 Shrike Jet Fighter  
 CSN-118 Dagger Bomber Aircraft  
 Eagle Unmanned Aircraft  
 GAW-F14 Super Tomcat Jet Fighter  
 Missile MC1A Sea King  
 NA-15 Nightwing Jet Fighter  
 SF-7 Talon Jet Fighter

### CS Boats

AWC-012 Wave Demon  
 CPB-001 Mark I Barracuda Patrol Boat  
 CPB-004 Mark IV Hurricane Patrol Boat  
 Death's Head Underwater Sea Sled  
 CS Jet Ski  
 CSS James Bay Class Destroyers  
 CSS Orca-Class Submarine  
 CSS Revenge Class Destroyers  
 CSS Shark-Class Submarine  
 CVN-1 Chi-Town Carrier Class  
 CSN Wasp-Class Amphibious Warship  
 CT-008 Supply-Class Merchant Marine Transport  
 Joseph Prosek-Class Aircraft Carrier  
 SSN-10 Stingray Submarine

### Coalition APCs & Tanks

CS Mark V APC  
 CS Mark VII Slayer  
 CS Mark IX EPC  
 CTX-20 Grinning Skull Tank  
 CTX-50 Line Backer  
 CTX-52 Sky Sweeper  
 CTX-54 Fire Storm Mobile Fortress  
 MLRS Mark IX

### Heavy Commercial Ground Vehicles

Australia: MT-6000 Crawler  
 Australia: NT-1200 Devil 4x4  
 Bandito Arms: R-100 Tarantula (a.k.a. NG Spider)  
 Big Boss A.T.V.  
 Kittani: Creax Armored Rover  
 Kittani: Insecton Land Rover  
 Kittani: K-ATV Hover Land & Water Skimmer  
 Kittani: K-GTRV Hover Land Skimmer  
 Kittani: K-GTV Hover Land Skimmer  
 Legion 2/20 Snowmobile  
 Mountaineer A.T.V.

### Robot Horses

Typical Robot Horse (Mustang, no frills)

### Hovercycles & Rocket Bikes

Africa: Phoenix Sand Skimmer (military)  
 A.T.V. Speedster Hovercycle  
 Bronco Scooter  
 Free Quebec: QV-229 Bobcat Hovercycle  
 Kittani: Hover Pods: War Pod (HV-MPC-216)  
 Kittani Hover Speed Pod HV-MPC-113 (one-man version)  
 Legion 50/50 Arctic Hovercycle

Legion SOL Flying Arsenal Hovercycle  
 Manistique: MI-1010 Desert Fox Hovercycle  
 Manistique: MI-3000 Firefly Hovercycle  
 NG-220 Rocket Hovercycle  
 NG-230 Prowler Hovercycle  
 NG-300 Speedster Hovercycle  
 NG-400 Stinger Hovercycle  
 NG-480 Turbo Hovercycle  
 Triax/Germany: WR-2020 Shark Hovercycle  
 Wellington: AHB-2000 Assault Hover (Rocket) Bike

#### Jet Packs

Falcon 300 Jet Pack  
 Legion-90 Sky Pack  
 Triax T-100 Eagle Military Jet Pack  
 Wilk's Jet Pack

#### Military Vehicles

##### Tanks, APCs & Other Armored War Machines

Africa: Phoenix Sand Crawler  
 Arkhon: A-73 "Evil Eye" Military APC  
 Arkhon: T-10 "Porcupine" Tank  
 Free Quebec: QV-119 Cougar Jeep  
 Iron Heart: IH-1B Iron Hammer Tank  
 Iron Heart: IH-12B Iron Fist Tank  
 Iron Heart: IH-15 Iron Bolt Tank  
 Iron Heart: IH APC-10 Iron Maiden APC  
 Kittani: Dragon Dreadnaught  
 Legion Armored Snow Lion APC  
 Megaversal Legion: M6-IFV Neo-Bradley APC  
 Megaversal Legion: MBT-10A1 Neo-Abrams  
 Naruni: J-2 Juggernaut Tank  
 Naruni: N-120B Carnivore Mark I Tank  
 New Navy: AMBT-12X Merovingian Tank  
 NG BAWW-120 Cavalry War Wagon  
 Poland/Tarnow: T-322 Stinger Tank  
 South America: Columbian Tanks  
 LTT-100A, LTT-100B, LTT-100V Lancero  
 South America: HTT-11 Hussar APC  
 South America: PT-34 Puma Tank  
 Wellington: Rolling Thunder Combat Truck

#### Motorcycles

Highway-Man Motorcycle  
 Juicer: Tarantula Combat Jump Bike  
 Kittani: KM-700 Uni-Motorcycle  
 Wastelander Motorcycle  
 Wellington: Road Boss Combat Chopper

#### Russian Vehicles

Landflier Hovercycle  
 Novyet Arctic Hoverbike  
 Novyet Big Bear ATV Truck  
 Novyet Explorer-Sku Truck  
 Novyet Landcrawler-Sku Half-Track  
 Novyet Snow-Jetsled Snowmobile  
 SU-52 Groundthunder Tank  
 SUH-86 Hailstorm Tank  
 SUH-88 Maelstrom Tank  
 Tek-12 YY110 Bushbike  
 Tek-20 YY210 'Borgbike  
 Thundersword Multi-Combat Platform Apc  
 Warrior AH Assault Hoversled  
 War Chariot  
 Warthrone  
 War Wagon/Mechanized Ram  
 Wingrider Flying Wing

ZSU 13/14 Thunderbolt Truck  
 ZSU 17/18 Bulldog APC

#### Triax & The NGR

XM-50 Ambulance Pod  
 XM-60 Field Mechanic Pod  
 XM-70 Covert Operations Pod  
 XM-140 Support Weapon Platform  
 XM-170 Infantry Repair Barge  
 XM-180 Dragonfly Drop Ship  
 XM-250 Medical Hover Station  
 XM-270 Mosquito Air APC  
 XM-275 Lightning Jet Fighter  
 XM-280 Jet Fighter & Bomber  
 XM-288 Supersonic Transport (Aircraft)  
 XM-300 Terror Mini-Tank  
 XM-330 Phantom Tank  
 XM-350 Leopard III APC  
 X-MISB-01 Mobile Infantry Strike Base

#### Triax/NGR Adventuring Vehicles

MZ-10 Wilderness Cruiser  
 WR-1010 Land Rover  
 WR-2020 Shark Hovercycle  
 WR-5050 Super Cargo Hauler  
 WR-5054 Mini-Cargo Hauler

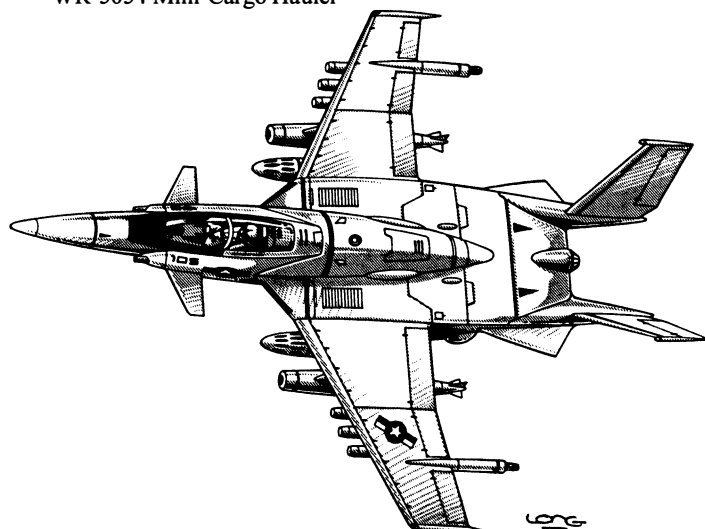

## Aircraft

### Africa: Robot Spy Wing

**Manufacturer:** Phoenix Empire (Africa, p. 140).

**Class:** Robot Hover Unit.

**Crew:** None; drone.

**Main Body M.D.C.:** 40

**Maximum Speed:** Flight: 140 mph (224 km); max altitude is 1,000 feet (305 m).

**Maximum Range:** Unlimited.

**Primary Weapon:** Camera.

**Black Market Cost:** 40,000 credits (conventional engine); 500,000 credits (nuclear engine).

### Arkhon: AF-89 Spikefish

**Manufacturer:** Arkhon (South America Two, p.96).

**Class:** Attack Fighter (air/Space Capable).

**Crew:** One.

**Main Body M.D.C.:** 300

**Maximum Speed:** Flight: Mach 2 in atmosphere, Mach 8 in space.

**Maximum Range:** Unlimited in space, 12 hours before overheating in atmosphere.

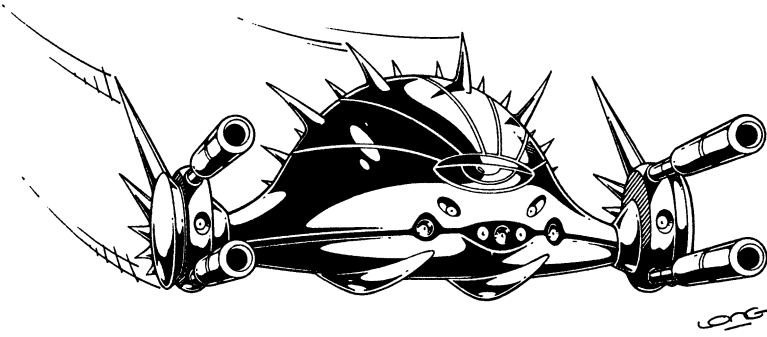

### Free Quebec: GBG-96 Sky Hawk Aircraft

**Manufacturer:** Free Quebec (**Free Quebec**, p. 57).

**Class:** Armored Transport (Glitter Boys).

**Crew:** Four: pilot, co-pilot, communications officer, door gunner. Up to five additional crew.

**Main Body M.D.C.:** 998

**Maximum Speed:** Flight: 440 mph (704 km); max altitude is 6,000 feet (1,829 m).

**Maximum Range:** Unlimited; can fly for 120 hours straight before overheating.

**Bonuses:** None.

**QL-22 Double-Barreled Laser:** Mega-Damage: 3D6 M.D. (single blast); 6D6 M.D. (double blast). Rate of Fire: Equal to the number of attacks per melee round. Range: 2,000 feet (610 m). Payload: Unlimited.

**Concealed Mini-Missile Launchers (2):** Mega-Damage: 1D4x10 M.D. (armor piercing) or 1D6x10 M.D. (plasma). Rate of Fire: Single shot or volleys of two, three, four or five. Range: one mile (1.6 km). Payload: 48; 24 per launcher.

**Other Weapons:** Optional use of 1-6 Glitter Boy Gunners (on running boards — how's *that* for a drive-by?).

**Cargo:** Can carry 10 Glitter Boys, 12 SAMAS, or 20 human-sized troops or any combination thereof.

**Black Market Cost:** 2.9 million credits.

### Free Quebec: RHV-60 Reloader

**Manufacturer:** Free Quebec (**Free Quebec**, p. 60).

**Class:** Military Hover Transport.

**Crew:** Four-Man Glitter Boy Reload Team.

**Main Body M.D.C.:** 328

**Maximum Speed:** Flight: 180 mph (288 km); max altitude is 600 feet (183 m).

**Maximum Range:** Unlimited. Can be used constantly without fear of overheating.

**Bonuses:** None.

**Weapons:** None.

**Black Market Cost:** 2.5 million. The extreme endurance of the engine actually makes these innocuous vehicles favorites among adventurers and deep recon teams, who never need fear their engines conking out.

### Iron Heart: AC-29 Air Castle Bomber

**Manufacturer:** Iron Heart Armaments (**Mercenaries**, p. 114).

**Class:** Heavy Bomber.

**Crew:** Fourteen: Pilot, co-pilot, communications engineers (2), gunners (6), flight engineers (4). Can hold five additional passengers.

**Main Body M.D.C.:** 800

**Maximum Speed:** Flight: 800 mph (1,280 km); max altitude is 50,000 feet (15,240 m).

**Maximum Range:** Unlimited. Can fly at top speed for 10 hours before overheating.

**Bonuses:** None.

**Vulcan Laser Turrets (3):** Mega-Damage: 2D4x10 M.D. Rate of Fire: Each turret can fire up to six times per melee round. Range: 6,000 feet (1,828 m). Payload: Unlimited.

**Auto-Cannon Turrets (3):** Mega-Damage: 2D6x100 M.D. (burst). Rate of Fire: Equal to the number of attacks per melee round. Range: 4,000 feet (1,220 m). Payload: 4,000 rounds (200 bursts) per gun.

**Other Weapons:** Bomb Bay (200 heavy bombs), Long-Range Missile Launchers (12).

**Black Market Cost:** 100 million credits (nuclear); 80 million credits (gasoline; very rare).

### Iron Heart: GF-1A Grey Falcon Jet Fighter

**Manufacturer:** Iron Heart Armaments (**Mercenaries**, p. 113).

**Class:** Supersonic Interceptor.

**Crew:** One.

**Bonuses:** None.

**Double Tri-Beam Cannons (2):** Mega-Damage: 2D4x10 M.D., double damage to everything except force/energy fields and Arkhon composite armor. Rate of Fire: Equal to the number of attacks per melee round. Range: 4,000 feet (1,220 m). Payload: Unlimited.

**Missile Pylons:** Mega-Damage: Varies with missile type. Rate of Fire: Single shot or volleys of 2, 4 or 8. Range: Varies with missile type. Payload: Eight medium-range missile or four long-range missiles.

**Black Market Cost:** Not for sale. None have ever been captured for redistribution.

### Australian: NT-V40 Viper Helicopter

**Manufacturer:** Australian Tech-Cities (**Australia**, p. 218).

**Class:** Helicopter.

**Crew:** Four: pilot, co-pilot/communications, two door gunners. Up to six passengers.

**Main Body M.D.C.:** 210

**Maximum Speed:** Flight: 480 mph (768 km); max altitude is 5,000 feet (1,524 m).

**Maximum Range:** 500 miles (800 km); unlimited if nuclear.

**Bonuses:** +1 to strike with ranged weapons, +1 to dodge, +2 on initiative.

**Nose Gun:** Mega-Damage: 1D4x10 M.D. (burst). Rate of Fire: Equal to the number of attacks per melee round. Range: 4,000 feet (1,220 m). Payload: 4,000 rounds (200 bursts).

**Mini-Missile Launchers (2):** Mega-Damage: 1D4x10 M.D. (armor piercing). Rate of Fire: Single shot or volleys of 2 or 4. Range: One mile (1.6 km). Payload: 48; 24 per launcher.

**Other Weapons:** Medium-Range Missile Launchers (2), Door Gunner Turrets (2).

**Black Market Cost:** 3.9 million (nuclear); 1.8 million (combustion).

### Australian: One- and Two-Man Fliers

**Manufacturer:** Australian Tech-Cities (**Australia**, p. 222).

**Class:** Aerial Fighter.

**Crew:** One or two, typically a pilot and gunner.

**Main Body M.D.C.:** 200 to 300.

**Maximum Speed:** Flight: 480 mph (768 km); max altitude is 5,000 feet (1,524 m).

**Maximum Range:** 500 miles (800 km); unlimited if nuclear.

**Bonuses:** +1 to strike with ranged weapons, +2 to dodge, +1 on initiative.

**Nose Gun:** Mega-Damage: 3D6+2 M.D. (single blast); 1D4x10 M.D. (dual blast). Rate of Fire: Equal to the number of attacks per melee round. Range: 3,000 feet (914 m). Payload: Unlimited.

**Secondary Guns (2):** Mega-Damage: 2D6 M.D. (single blast); 4D6 M.D. (double blast). Rate of Fire: Equal to the number of attacks per melee round, plus one. Range: 3,000 feet (914 m). Payload: Unlimited.

**Other Weapons:** Two Medium-Range Missiles or Four Mini-Missiles per wing, up to two additional light weapons or one additional heavy weapon.

**Black Market Cost:** 2.8 to 6.2 million. These craft vary widely in their performance, armament and styling.

**Main Body M.D.C.:** 170

**Maximum Speed:** Flight: Mach 2; max altitude is 40,000 feet (12,192 m).

**Maximum Range:** Unlimited; 10 hours of straight use before overheating.

**Bonuses:** None.

**Wing-Mounted Long-Range Missile Launchers (2):** Mega-Damage: Varies with missile type. Rate of Fire: Single shot or volleys of two. Range: 500 to 1,000 miles (800 to 1,600 km). Payload: 8; 4 per launcher.

**Side-Mounted Medium-Range Missile Launchers (4):** Mega-Damage: Varies with missile type. Rate of Fire: Single shot or volleys of two or four. Range: 40 to 80 miles (64 to 128 km). Payload: 16; 4 per launcher.

**Other Weapons:** Forward Mounted Rail Gun, Belly Mounted Mini-Missile Launcher.

**Black Market Cost:** 20 million credits.

## Iron Heart: IE-15AH Iron Eagle Helicopter

**Manufacturer:** Iron Heart Armaments (Mercenaries, p. 116).

**Class:** Helicopter.

**Crew:** Four: Pilot, co-pilot/gunner, communications technician and secondary gunner.

**Main Body M.D.C.:** 300

**Maximum Speed:** Flight: 300 mph (480 km); max altitude is 3,000 feet (914 m).

**Maximum Range:** 400 mph (640 km); unlimited if nuclear.

**Bonuses:** None.

**Mini-Missile Launchers (2):** Mega-Damage: 1D4x10 M.D. (armor piercing) or 1D6x10 M.D. (plasma). Rate of Fire: Single shot or volleys of two, three, five, ten or twenty-four. Range: One mile (1.6 km). Payload: 48; 24 per launcher.

**Medium-Range Missile Launchers (2):** Mega-Damage: 2D6x10 M.D. Rate of Fire: Equal to the number of attacks per melee round. Range: 50 miles (80 km). Payload: 8; four per launcher.

**Other Weapons:** 30mm Auto-Cannon.

**Black Market Cost:** 1.5 million credits (gasoline); 24 million credits (nuclear).

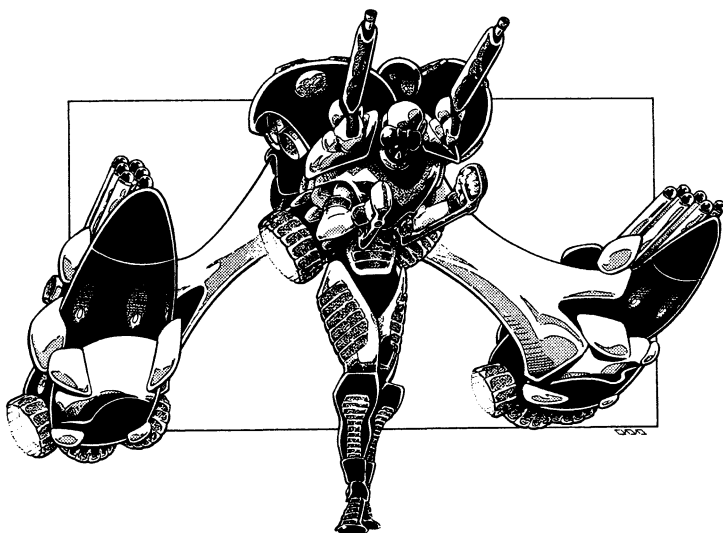

## Juicer: IFS-1 Icarus Flight System

**Manufacturer:** UTI (Juicer Uprising, p. 86).

**Class:** Jet Pack/Wing – requires a special Piloting skill.

**Crew:** One.

**Main Body M.D.C.:** 120

**Maximum Speed:** Flight: Mach 1/670 mph (1,072 km); max altitude is 20,000 feet (6,096 m).

**Maximum Range:** Six hours at max speed; 10 hours at half speed.

**Bonuses:** None.

**High-Powered Laser Guns (2):** Mega-Damage: 5D6 M.D. (single blast); 1D6x10 M.D. (double blast). Rate of Fire: Equal to the number of attacks per melee round. Range: 4,000 feet (1,220 m). Payload: Unlimited.

**Mini-Missile Launchers (2):** Mega-Damage: 1D4x10 M.D. (armor piercing) or 1D6x10 M.D. (plasma). Rate of Fire: Single shot or volleys of 2, 4, 6, or 12. Range: One mile (1.6 km). Payload: 12; six per launcher.

**Black Market Cost:** 3.2 million credits.

## Kittani: K-ATV Hover Jet

**Manufacturer:** Kittani (Atlantis, p.155).

**Class:** Strategic Robot Vehicle Jet.

**Crew:** Pilot, co-pilot, four passengers.

**Main Body M.D.C.:** 225

**Maximum Speed:** Ground: 60 mph (96 km). Flight: 650 mph (1,040 km); ceiling is 25,000 feet (7,620 m).

**Maximum Range:** Unlimited.

**Bonuses:** +1 attack per melee, +1 on initiative, +1 to strike and parry, +3 to dodge.

**Light Lasers (2):** Mega-Damage: 2D6 M.D. (single blast); 4D6 M.D. (double blast). Rate of Fire: Equal to the number of attacks per melee round. Range: 2,000 feet (610 m). Payload: Unlimited.

**Mini-Missiles (8):** Mega-Damage: 1D4x10 (armor piercing); 1D6x10 M.D. (plasma). Rate of Fire: Single shot or in volleys of two, three or four. Range: One mile (1.6 km). Payload: Eight, four per wing.

**Black Market Cost:** 2.4 million credits.

## Kittani: K-PF 20 Patrol Flyer

**Manufacturer:** Kittani (Splynn Dimensional Market, p. 187).

**Class:** Recon and Patrol Aircraft.

**Crew:** One.

**Main Body M.D.C.:** 220

**Maximum Speed:** Flight: Mach 2/1,440 mph (2,340 km); max altitude is 30,000 feet (9,144 m).

**Maximum Range:** Unlimited.

**Bonuses:** +2 to dodge at cruising speed, +4 to dodge when flying above cruising speed, +1 to strike with energy weapons, +3 to strike with missiles.

**Wing Guns (2):** Mega-Damage: 2D6 M.D. (single blast), 4D6 M.D. (twin blast). Rate of Fire: Equal to the number of attacks per melee round. Range: 2,000 feet (610 m). Payload: Unlimited.

**Underbelly Laser Arm:** Mega-Damage: 3D6 M.D. Rate of Fire: Equal to the number of attacks per melee round. Range: 2,000 feet (610 m). Payload: Unlimited.

**Other Weapons:** Modular Missile Launcher.

**Black Market Cost:** 8 million credits.

## Mega-Legion: NAH-50 Neo-Apache Helicopter

**Manufacturer:** Megaversal Legion (South America 2, p. 120).

**Class:** Attack Helicopter.

**Crew:** Four: pilot, co-pilot/gunner, sensor operator, secondary gunner.

**Main Body M.D.C.:** 400

**Maximum Speed:** Flight: Mach 3/2,010 mph (3,216 km).

**Maximum Range:** Unlimited.

**Bonuses:** None.

**Gatling Plasma Gun:** Mega-Damage: 3D4x10 M.D. (burst). Rate of Fire: Equal to the number of attacks per melee round. Range: 4,000 feet (1,220 m). Payload: Unlimited.

**Long-Range Missile Launchers (2):** Mega-Damage: Varies with missile type. Rate of Fire: Single shot or volleys of two or three. Range: Varies with missile type. Payload: Six; three per launcher.

**Other Weapons:** Medium-Range Missile Launcher (2), Mini-Missile Launchers (2), I-Beam Machine-guns (2), Force Field.

**Black Market Cost:** 250+ million credits, were one ever captured and put on sale. So far, none have.

## New Navy: IE-15AH Striker Helicopter

**Manufacturer:** New Navy (Underseas, p. 124).

**Class:** Helicopter Gunship.

**Crew:** Four: pilot, co-pilot/gunner, communications technician and secondary gunner.

**Main Body M.D.C.:** 275

**Maximum Speed:** Flight: 200 mph (320 km); max altitude is 20,000 feet (6,096 m).

**Maximum Range:** Unlimited; can fly at max speed for 10 hours straight before overheating.

**Bonuses:** None.

**Belly Gun:** Mega-Damage: 3D6 M.D. (single blast); 6D6 M.D. (double blast). Rate of Fire: Equal to the number of attacks per melee round. Range: 3,000 feet (914 m). Payload: Unlimited.

**Forward Mounted Lasers (2):** Mega-Damage: 4D6 M.D. (single blast), 1D4x10+8 M.D. (double blast). Rate of Fire: Equal to the number of attacks per melee round. Range: 3,000 feet (914 m). Payload: Unlimited.

**Other Weapons:** Medium-Range Missile Launchers (4), Mini-Missile Launchers (2), Depth Charges.

**Black Market Cost:** 30 million credits.

## New Navy: S-14 Sea Hawk Jet Fighter

**Manufacturer:** New Navy (Underseas, p. 122).

**Class:** VTOL Stealth Fighter.

**Crew:** One with up to two passengers.

**Main Body M.D.C.:** 210

**Maximum Speed:** Flight: Mach 3.2; max altitude is 63,000 feet (19,202 m).

**Maximum Range:** Unlimited; can fly at max speed for 18 hours before overheating.

**Bonuses:** +1 on initiative, +1 to strike with nose guns, +3 to dodge, +5% to pilot skill.

**Forward Mounted (Nose) Lasers:** Mega-Damage: 5D6 M.D. (single blast); 1D6x10 M.D. (double blast). Rate of Fire: Equal to the number of attacks per melee round. Range: 4,000 feet (1,220 m). Payload: Unlimited.

**Concealed Bomb Bay:** Mega-Damage: Bomb: 2D4x10 M.D. to a 100 foot (30.5 m) radius. Depth Charge: 2D4x10 M.D. to a 100 foot (30.5 m) radius and 4D6 M.D. to an additional 30 foot (9.1 m) radius beyond that underwater. Rate of Fire: Single shot or in clusters of two or four. Each cluster dropped counts as one melee attack. Range: One mile (1.6 km) maximum drop. Payload: 48.

**Other Weapons:** Wing-Mounted Long-Range Missiles (6), Mini-Missile Launchers (2), Retractable Belly Gun.

**Black Market Cost:** Unavailable to the Black Market; exclusive to the New Navy.

## NG Sky King Aircraft

**Manufacturer:** Northern Gun (Original Rifts® RPG, p. 228).

**Class:** All-Purpose Air Combat Vehicle.

**Crew:** One pilot.

**Main Body M.D.C.:** 130

**Maximum Speed:** Hover up to 1,000 feet (305 m) or flight up to 570 mph (912 km). Max altitude is: 10,000 feet (3,048 m).

**Maximum Range:** 20 hours constant flight.

**Bonuses:** +2 to dodge in flight, +5 to dodge when flying over 350 mph (560 km).

**Modified NG-101 Rail Guns (2):** Mega-Damage: 6D6 M.D. (single gun); 2D4x10 M.D. (both guns at once). Rate of Fire: Equal to the number of attacks per melee round. Range: One mile (1.6 km). Payload: 600 rounds (20 bursts) each.

**Mini-Missile Launchers (2):** Mega-Damage: 1D4x10 M.D. (armor piercing) or 1D6x10 M.D. (plasma). Rate of Fire: Single shot or volleys of two. Range: One mile (1.6 km). Payload: 12; 6 per launcher.

**Other Weapons:** Forward Mounted Heavy Laser.

**Black Market Cost:** 1.5 million credits.

## South America: CH-1000 Zancudo Helicopter

**Manufacturer:** Republic of Colombia (South America, p.33).

**Class:** Transport and Attack Helicopter.

**Crew:** Pilot and co-pilot/gunner.

**Main Body M.D.C.:** 250

**Maximum Speed:** Flight: 200 mph (320 km); full VTOL capabilities.

**Maximum Range:** 450 miles (720 km).

**20mm Rocket Auto-Cannon:** Mega-Damage: 1D6x10 M.D. (burst).

Rate of Fire: Equal to the number of attacks per melee round.

Range: 4,000 feet (1,220 m). Payload: 4,000 rounds (200 bursts).

**Mini-Missile Launchers (4):** Mega-Damage: 1D4x10 M.D. (armor piercing) or 1D6x10 M.D. (plasma). Rate of Fire: Single shot or volleys of two, four, eight, twelve, sixteen, twenty or twenty-four missiles. Range: One mile (1.6 km). Payload: 48; 12 per launcher.

**Black Market Cost:** 400,000 credits.

## South America: Cibolan Flying Platform

**Manufacturer:** Cibola (South America, p.141).

**Class:** Airborne Weapons Platform.

**Crew:** Pilot and three passengers.

**Main Body M.D.C.:** 250

**Maximum Speed:** Flight: 200 mph (320 km); max altitude is 500 feet (152 m).

**Maximum Range:** Unlimited.

**Bonuses:** None.

**Plasma Cannon:** Mega-Damage: 6D6 M.D. Rate of Fire: Equal to the number of attacks per melee round. Range: 2,000 feet (610 m). Payload: Unlimited.

**Mini-Missile Launcher:** Mega-Damage: 1D6x10 M.D. (plasma). Rate of Fire: Single shot or volleys of two, four or eight. Range: One mile (1.6 km). Payload: Eight.

**Black Market Cost:** 600,000 credits, 400,000 without weaponry.

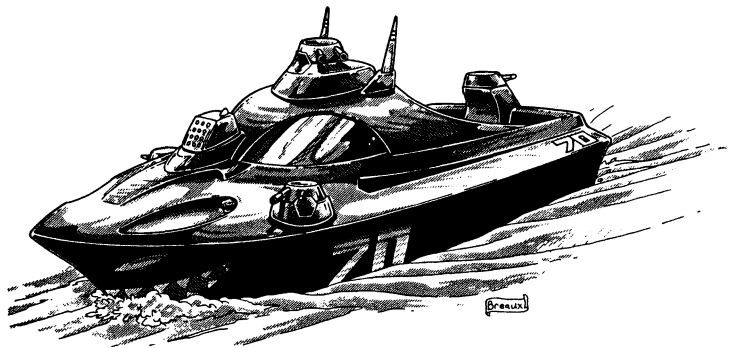

## Boats & Water Vessels

### Australian: Slicer Patrol Boat

**Manufacturer:** Australian Tech-Cities (Australia, p. 217).

**Class:** Patrol Boat.

**Crew:** 9-13: captain/pilot, helmsman/co-pilot, navigator/communications officer, two gunners, 2-4 sailors/Marines, 2-4 Power armor troops.

**Main Body M.D.C.:** 500

**Maximum Speed:** Water Surface: 40 mph (64 km; 34 knots).

**Maximum Range:** 600 miles (960 km); unlimited if nuclear.

**Bonuses:** None.

**Main Weapon Turrets (2):** Mega-Damage: 1D4x10 M.D. (rail gun); 6D6 M.D. (laser). Rate of Fire: Equal to the number of attacks per melee round. Range: 4,000 feet (1,220 m) for rail gun; 3,000 (914 m) for laser. Payload: Unlimited (lasers); 6,000 rounds/400 bursts (rail guns).

**Mini-Torpedo Launcher Rack:** Mega-Damage: 1D6x10 M.D. (high explosive). Rate of Fire: Single shot or volleys of two or four. Range: One mile (1.6 km). Payload: 12.



**Other Weapons:** Pop-Up Missile Launchers (2), Communications Sensor Suite.

**Black Market Cost:** 1.6 million (nuclear), 550,000 if non-nuclear.

### **Iron Heart: IH-MC1A Sea King**

**Manufacturer:** Iron Heart Armaments (*Mercenaries*, p. 120).

**Class:** Missile Cruiser.

**Crew:** 40-50: captain, first officer, chief officers (4), medical officers (2), communications technicians (3), sensor operators (3), navigation technicians (2), engineers/mechanics (4), nurses (4), cooks (5), seamen (15).

**Main Body M.D.C.:** 2,600

**Maximum Speed:** Water: 40 mph (64 km).

**Maximum Range:** Unlimited.

**Bonuses:** None.

**Missile Launchers (4):** Mega-Damage: Varies with missile type. Both medium- and long-range missiles are used. Rate of Fire: Single shot or volleys of two, four or sixteen. Range: Varies; 50 to 500 miles (80 to 800 km). Payload: 160 per launcher; another 560 missiles are held in the ship's hold.

**Torpedo Tubes (6):** Mega-Damage: 4D6x10 M.D. Rate of Fire: Up to six per melee round. Range: 20 miles (32 km). Payload: 600; 100 per tube.

**Other Weapons:** Long Range Rail Gun Turrets (2), Eight-inch Naval Guns (2), Depth Charge Launchers (2), Iron Trident (Iron Eagle) Helicopters (4).

**Black Market Cost:** About 600 million credits.

### **Iron Heart: IH-PB12 Triton Patrol Boat**

**Manufacturer:** Iron Heart Armaments (*Mercenaries*, p. 118).

**Class:** Patrol Boat.

**Crew:** 17: captain, second officer, navigators (2), communications techs (3), gunners (3), engineers (2), doctor, seamen (4). Can also accommodate up to twelve power armor marines or light power suit units.

**Main Body M.D.C.:** 650

**Maximum Speed:** Water: 50 mph (80 km).

**Maximum Range:** Unlimited.

**Bonuses:** None.

**Mini-Missile Launcher:** Mega-Damage: 1D4x10 M.D. (armor piercing) or 1D6x10 M.D. (plasma). Rate of Fire: Single shot or volleys of two, four or sixteen. Range: One mile (1.6 km). Payload: 160; another 320 are stored in the ship's hold.

**Torpedo Tubes (2):** Mega-Damage: 3D4x10 M.D. Rate of Fire: Twice per melee round. Range: 10 miles (16 km). Payload: 100; 50 per tube.

**Other Weapons:** Rail Gun Turrets (2), Depth Charge Launchers (2).

**Black Market Cost:** 200 million credits.

### **Iron Heart: IH-TB12 Black Eel Patrol Boat**

**Manufacturer:** Iron Heart Armaments (*Mercenaries*, p. 117).

**Class:** Torpedo Boat.

**Crew:** Four: pilot, navigator/sensors operator, gunner and mechanic.

**Main Body M.D.C.:** 125

**Maximum Speed:** Water: 70 mph (112 km)

**Maximum Range:** 800 miles (1,280 km).

**Bonuses:** None.

**14mm Machine-gun:** Mega-Damage: 1D4x10 M.D. (burst). Rate of Fire: Equal to the number of attacks per melee round. Range: 2,000 feet (610 m). Payload: 2,000 rounds (50 bursts).

**Heavy Torpedo Tube:** Mega-Damage: Varies with missile type. Rate of Fire: Once per melee round. Range: 20 miles (32 km). Payload: 6.

**Other Weapons:** Depth Charge Launcher.

**Black Market Cost:** 100,000 credits not including torpedoes and depth charge payloads.

### **Kittani: KSM-100 Splugorth Slaver Mothership (sea vessel)**

**Manufacturer:** Kittani (*South America*, p. 154).

**Class:** Dreadnought Combat Ship.

**Crew:** 100 officers, 1,200 crew. Also carries defense force consisting of 960 Kittani warriors, 240 Overlords in Overlord Power Armor, 240 Blind Warrior Women, 60 Splugorth Slavers, 60 Power Lords in Power Armor, a Special Operations squad of 6 Conservators, 4-6 Murex or Volute Metzla, and 2-8 High Lords to lead it all. Those High Lords typically command their own ship, which entails another 700 troops each.

**Main Body M.D.C.:** 28,000

**Maximum Speed:** Water Surface: 40 mph (64 km).

**Maximum Range:** Unlimited.

**Bonuses:** None.

**Main Missile Batteries (6):** Mega-Damage: Can use any type of long-range missile. Rate of Fire: Single shot or in volleys of 4, 8 or 12 missiles. All together, the Batteries can fire a total of 72 LRMs per melee round. Range: 500 to 1,800 miles (800 to 880 km). Payload: 120 missiles per battery (720 missiles total).

**Mini-Missile Launchers (12):** Mega-Damage: 1D4x10 M.D. (armor piercing) or 1D6x10 M.D. (plasma). Rate of Fire: Volleys of 2, 4, 6 or 8. Range: One mile (1.6 km). Payload: 80 per launcher; 960 total.

**Other Weapons:** Laser Turrets (8), Medium Torpedo Launch Tubes (6), Depth Charges (4), Armed Forces.

**Black Market Cost:** You wish! This would cost at least 100 billion credits, even if somebody were crazy enough to sell one.

### **Kittani: KY-HSS Slaver Raider (land & sea)**

**Manufacturer:** Kittani (*South America*, p. 153).

**Class:** Hydrofoil/Hovercraft Assault Ship.

**Crew:** 22; captain, two pilots, navigator, two communications officers, two sensor officers, three petty officers, four weapons officers, seven sailors. Typically carries a complement of 64 armored troops plus 12 Splugorth Slavers on flying barges and 60 Blind Altara Warrior Women.

**Main Body M.D.C.:** 2,500

**Maximum Speed:** Hydrofoil: 100 mph (160 km). Hovercraft System (over water): 400 mph (640 km). Hovercraft (on land): 40 mph (64 km).

**Maximum Range:** Unlimited.

**Bonuses:** None.

**Pulse Cannon Turret:** Mega-Damage: 1D4x10 M.D. (single pulse); 2D4x10 M.D. (double pulse); 3D4x10 M.D. (triple pulse). Rate of Fire: Six blasts per melee, per turret. Range: 6,000 feet (1,829 m). Payload: Unlimited.

**Long-Range Missile Launchers (2):** Mega-Damage: Varies with missile type. Rate of Fire: Single shot or in volleys of two, four, six, eight, twelve or fourteen. Range: 500 to 1,800 miles (800 to 2,880 km). Payload: 128; 64 per launcher.

**Other Weapons:** Depth Charges.

**Black Market Cost:** 500 million credits fully armed and loaded, but almost impossible to find on any marketplace.

### **New Navy: EPC Mark I Trident Submarine**

**Manufacturer:** New Navy (*Underseas*, p. 127).

**Class:** Submersible Carrier.

**Crew:** 24: captain, executive officer, chief petty officers (6), technical officers (8), enlisted sailors (8). Can carry up to 60 additional troops, usually 20 Manta Ray pilots and 40 Marines.

**Main Body M.D.C.:** 1,500

**Maximum Speed:** Water Surface: 69.6 mph (111.3 km; 60 knots). Underwater: 46 mph (73.6 km; 40 knots).

**Maximum Range:** Unlimited; can stay submerged for 24 months before resurfacing.

**Bonuses:** None.

**Ion Pulse Cannons (2):** Mega-Damage: 4D6x10 M.D. The cannons can not fire simultaneously. Rate of Fire: Twice per melee round. Range: Two miles (3.2 km). Payload: Unlimited.

**Laser Cannons (2):** Mega-Damage: 2D4x10 M.D. Rate of Fire: Four shots per melee round. Range: Two miles (3.2 km). Payload: Unlimited.

**Other Weapons:** Torpedo Tubes (6), Long-Range Missile Launchers (4), Cruise Missile Launchers (4), Depth Charge Launchers (2).

**Black Market Cost:** Not for sale. Even if it were, it would cost at least several hundred million credits.

## New Navy: MEAS Mark I Manta Ray

**Manufacturer:** New Navy (Underseas, p. 126).

**Class:** Air-Sub.

**Crew:** One.

**Main Body M.D.C.:** 250.

**Maximum Speed:** Flight: Mach 1.5; max altitude is 30,000 feet (9,144 m). Water Surface: 300 mph (480 km). Underwater: 58 mph (92.5 km; 50 knots).

**Maximum Range:** Unlimited. Can fly at max speed for 10 hours before overheating.

**Bonuses:** +2 to strike with either weapon system, +1 on initiative, +2 to dodge.

**Ion Pulse Guns (2):** Mega-Damage: 1D6x10 M.D. (single burst); 2D6x10 M.D. (double burst). Rate of Fire: Equal to the number of attacks per melee round. Range: 4,000 feet (1,220 m). Payload: Unlimited.

**Missile Pods:** Mega-Damage: Varies with missile type. Rate of Fire: Single shot or in volleys of two or the entire payload. Range: Varies with missile type. Payload: Up to 16 short-range missiles, 8 medium-range missiles, 6 long-range missiles, one cruise missile, or any combination thereof.

**Other Equipment:** Stealth System.

**Black Market Cost:** 90 million credits, were any actually for sale, which they are not. The New Navy guards them closely and scuttles those likely to fall into outsider hands.

## New Navy: MIFV-99

### Iwo Jima-Class Troop Transport

**Manufacturer:** New Navy (Underseas, p. 121).

**Class:** Amphibious Personnel Carrier.

**Crew:** Three: pilot, gunner, commander/gunner.

**Main Body M.D.C.:** 225

**Maximum Speed:** Hovering: 100 mph (160 km); max altitude is 20 feet (6.1 m).

**Maximum Range:** Unlimited.

**Bonuses:** None.

**Ion Pulse Cannon:** Mega-Damage: 3D4x10 M.D. Rate of Fire: Four times per melee round. Range: 6,000 feet (1,828 m). Payload: Unlimited.

**Heavy Missile Launchers (2):** Mega-Damage: Varies with missile type. Rate of Fire: Single shot or volleys of two, four or eight. Range: Varies with missile type. Payload: Eight; four per launcher.

**Other Weapons:** Light Missile Launcher, Light Pulse Gun.

**Black Market Cost:** 40 million credits.

## New Navy: USS Stingray

### & USS Seadragon Submarines

**Manufacturer:** New Navy (Underseas, p. 132).

**Class:** Attack Submarines; vehicular components of the USS Ticonderoga.

**Crew:** 100: crewmen (60); marines (40).

**Main Body M.D.C.:** 3,200

**Maximum Speed:** Water Surface: 29 mph (47 km; 25 knots). Underwater: 52 mph (84 km; 45 knots).

**Maximum Range:** Unlimited.

**Bonuses:** None.

**Ion Pulse Cannon:** Mega-Damage: 2D4x10 M.D. Rate of Fire: Two attacks per melee round. Range: One mile (1.6 km). Payload: Unlimited.

**Heavy Torpedo/Missile Launch Tubes (2):** Mega-Damage: 4D6x10 M.D. Rate of Fire: Single shot or volleys of two or four. Range: 20 miles (32 km) underwater. Payload: 40. Internal magazine routes torpedoes to both tubes.

**Other Weapons:** Mini-Torpedo Launch Tubes (6), MRS-AML Multi-Rocket Surface-to-Air Missile Launcher, Blue-Green Lasers (6), Double-Barreled Deck Laser.

**Black Market Cost:** Not for sale.

**Note:** Both of these craft can actually connect to and become part of the USS Ticonderoga.

## New Navy USS Ticonderoga Super-Submarine

**Manufacturer:** New Navy (Underseas, p. 128).

**Class:** Submersible Carrier.

**Crew:** 3,200. Can accommodate another 2,000 people comfortably, on top of the Troop Complement, below.

**Troop Capacity:** 7,320, consisting of:

One Armored battalion: 360 amphibious tanks, 160 Semper Fi APA-15 power armor units, 40 Manta air-sub and 640 troops, crew and support personnel.

Two Mechanized Infantry Battalions: 160 Merovingian tanks, 200 Iwo Jima troop transports, and 1,920 troops.

Two Marine Infantry Brigades: 3,840 troops, including six companies of Semper Fi APA-15s (960 power armor, 160 per company), one Glitter Boy platoon (40 GBs), 20 Manta Rays, 40 transport vehicles and 50 small patrol boats.

Four Air Wings: 60 Manta Rays, 60 Sea Hawks, 10 S-16S Stealth jets, 30 Strikers, 10 large transport helicopters (hold 40 troops each). 640 troops, pilots and support personnel. The Ticonderoga can also accommodate older fighter jets, like the F-14.

Medical Company: 280 troops; 80 doctors plus medical support personnel.

**Main Body M.D.C.:** 20,000.

**Maximum Speed:** Water Surface: 58 mph (92.5 km; 50 knots). Underwater: 34.5 mph (55 km; 30 knots).

**Maximum Range:** Unlimited.

**Bonuses:** All ship's weapons systems are +1 to strike and +1 on initiative.

**Ion Pulse Cannons (2):** Mega-Damage: 1D4x100 M.D. (single blast); 2D4x100 M.D. (double blast). Rate of Fire: Two shots per cannon, per melee round. Range: 4 miles (6.4 km). Payload: Unlimited.

**Laser CIWS Turrets (6):** Mega-Damage: 1D4x10 M.D. Rate of Fire: Each turret has six attacks per melee round. Range: 4,000 feet (1,220 m). Payload: Unlimited.

**Other Weapons:** Cruise Missile Turrets (8), Counter-Missile Batteries (4), Depth Charge Launchers (4), Stealth System.

**Black Market Cost:** You are kidding, right?

## Poland/Tarnow: TC-B20 Torpedo Boat

**Manufacturer:** Kingdom of Tarnow (Mindwerks, p. 104).

**Class:** Speed Boat.

**Crew:** Two: pilot/navigator and communications/sensor officer.

**Main Body M.D.C.:** 200

**Maximum Speed:** Water Surface: 150 mph (240 km).

**Maximum Range:** 800 miles (1,280 km); unlimited if nuclear.

**Bonuses:** None.

**Laser Gun:** Mega-Damage: 3D6 M.D. Rate of Fire: Equal to the number of attacks per melee round. Range: 4,000 feet (1,220 m). Payload: Unlimited.

**Depth Charge Launchers (8):** Mega-Damage: 2D4x10 M.D. Rate of Fire: Single shot or volleys of two. A volley can be fired up to three times per round. Range: 2,000 foot (610 m) depth. Payload: 8; one per launcher.

**Other Weapons:** None.

**Black Market Cost:** 500,000 credits (electric) or 5 million (nuclear).  
Cost does not cover depth charge launchers.

### **Poland/Tarnow: TC-B30 Lightning Patrol Boat**

**Manufacturer:** Kingdom of Tarnow (Mindwerks, p. 105).

**Class:** Patrol Boat.

**Crew:** 7: Captain, navigator, communications technician, gunners (3), power armor sailor. Can hold up to six additional crew or passengers.

**Main Body M.D.C.:** 370

**Maximum Speed:** Water Surface: 90 mph (144 km).

**Maximum Range:** 700 miles (1,120 km); unlimited if nuclear.

**Bonuses:** None.

**Mini-Missile Launchers (4):** Mega-Damage: 1D4x10 M.D. (armor piercing) or 1D6x10 M.D. (plasma). Rate of Fire: Single shot or volleys of two or four. Launchers must be reloaded from the cargo hold (five minutes). Range: One mile (1.6 km). Payload: 32; 8 per launcher. Ship holds another 32 in storage.

**Torpedo Tubes (2):** Mega-Damage: 3D4x10 M.D. Rate of Fire: Single shot or volleys of two. Each launcher may fire only twice per melee. Range: 10 miles (16 km). Payload: 12; 6 per launcher.

**Other Weapons:** Depth Charge Launchers (2), Heavy Long-Range Laser Turrets (3).

**Black Market Cost:** 10 to 20 million credits.

### **Poland/Tarnow: TC-B40 Sea Dart Submarine**

**Manufacturer:** Kingdom of Tarnow (Mindwerks, p. 103).

**Class:** Mini-Submarine.

**Crew:** Two; pilot/navigator and communications officer. Can hold three passengers.

**Main Body M.D.C.:** 225

**Maximum Speed:** Underwater: 70 mph (112 km). Water Surface: 100 mph (160 km).

**Maximum Range:** 800 miles (1,280 km); unlimited if nuclear.

**Bonuses:** +3 on initiative, +4 to dodge, +10% to pilot skill.

**Exterior Torpedo Launch Tubes (3):** Mega-Damage: 2D4x10 M.D. Rate of Fire: Single shot or volleys of two or three. Range: 5 miles (8 km). Payload: 3; one per launcher.

**Other Weapons:** Mechanical Claw Arms (P.S. 28).

**Black Market Cost:** 1.5 million (electrical); 4 million (nuclear).

### **Poland/Tarnow: TC-B100 Walesa Cargo Ship**

**Manufacturer:** Kingdom of Tarnow (Mindwerks, p. 107).

**Class:** Cargo Ship.

**Crew:** 25-50: captain, first officer, chief officers (2), medical officers (2), communications technicians (3), engineers/mechanics (6), cooks (3), various seamen. Can carry 160 men or power armor troops.

**Main Body M.D.C.:** 2,600

**Maximum Speed:** Water Surface: 40 mph (64 km).

**Maximum Range:** Unlimited.

**Bonuses:** None.

**Medium-Range Missile Launchers (2):** Mega-Damage: Varies with missile type. Rate of Fire: Single shot or volleys of two. Range: 50 miles (80 km). Payload: 20; 10 per launcher.

**Depth Charge Launchers (2):** Mega-Damage: 2D4x10 M.D. Rate of Fire: Single shot or volleys of two. A volley can be fired up to three times per round. Range: 2,000 foot (610 m) depth. Payload: 40; 20 per launcher.

**Other Weapons:** Can accommodate up to six additional weapons turrets. Northern pirates are sometimes known to capture one of these and convert it into a makeshift warship. Their slow speed makes them awkward, but a good staging platform for power armor raids on faster vessels.

**Black Market Cost:** 70 to 80 million credits.

### **South America: CHB-5 Corsair Hydrobike**

**Manufacturer:** Generic/Black Market (South America One, p.156).

**Class:** Personal Amphibious Assault Vehicle.

**Crew:** Pilot and one passenger.

**Main Body M.D.C.:** 126

**Maximum Speed:** Water Surface: 60 mph (96 km).

**Maximum Range:** 800 miles (1,280 km.)

**Bonuses:** None.

**Mini-Missile Launchers (2):** Mega-Damage: 1D4x10 M.D. (armor piercing) or 1D6x10 M.D. (plasma). Rate of Fire: Single shot or volleys of two or four. Range: One mile (1.6 km). Payload: Eight; four per launcher.

**LC-20 Laser Gun:** Mega-Damage: 3D6 M.D. Rate of Fire: Equal to the number of attacks per melee round. Range: 900 feet (274 m). Payload: 20 shots per E-Clip.

**Black Market Cost:** 20,000 to 30,000 credits.

### **South America: PTB-20AB Pirahna**

**Manufacturer:** Generic/Black Market (South America One, p.157).

**Class:** Submersible Attack Boat.

**Crew:** Pilot, co-pilot/gunner, communications/sensor officer, engineer, up to 20 passengers.

**Main Body M.D.C.:** 600

**Maximum Speed:** Underwater: 40 mph (64 km). Water Surface: 80 mph (128 km).

**Maximum Range:** Unlimited.

**Bonuses:** None.

**Rail Gun Turret:** Mega-Damage: 1D6x10 M.D. (burst). Rate of Fire: Equal to the number of attacks per melee round. Range: 4,000 feet (1,220 m). Payload: 8,000 rounds (100 bursts).

**Missile/Torpedo Launchers (2):** Mega-Damage: Any medium-range missile. Rate of Fire: Single shot or volleys of two, four or eight. Range: Varies. Payload: 32; 16 per launcher.

**Black Market Cost:** 300 million credits.

### **South America: GB-30C**

#### **“Black Galleon” Gunboat**

**Manufacturer:** Republic of Colombia (South America, p.158).

**Class:** Patrol Boat.

**Crew:** Six: Pilot, captain, two gunners, communications/sensor officer, and engineer. Up to 20 passengers.

**Main Body M.D.C.:** 900

**Maximum Speed:** Water Surface: 50 mph (80 km).

**Maximum Range:** 500 miles (800 km).

**Bonuses:** None.

**Rocket Auto-Cannons (2):** Mega-Damage: 2D4x10 M.D. (burst). Rate of Fire: Equal to the number of attacks per melee round. Range: 6,000 feet (1,829 m). Payload: 4,000 rounds (200 bursts).

**Missile Turret:** Mega-Damage: Any medium-range missile. Rate of Fire: Single shot or volleys of 2, 4, 8 or 12. Range: Varies. Payload: 36 per launcher; craft carries another 360 (10 reloads) on board.

**Other Weapons:** Light Torpedo Launch Tubes (2), Forward Pulse Laser Cannon, Depth Charge Launchers (2).

**Black Market Cost:** 400,000 credits.

### **Tritonia: T-06 Torpedo Sled**

**Manufacturer:** Tritonia (Underseas, p. 105).

**Class:** Underwater Sled.

**Crew:** One.

**Main Body M.D.C.:** 145

**Maximum Speed:** Water Surface: 34 mph (54 km; 40 knots). Underwater: 50 mph (80 km; 43 knots).

**Maximum Range:** Unlimited.

**Bonuses:** +5% to pilot skill, +5 to dodge underwater.

**Black Market Cost:** 500,000 credits.

## Tritonia: T-10 Sea Fin Sea Sled

**Manufacturer:** Tritonia (Underseas, p. 103).

**Class:** Underwater Sled.

**Crew:** One.

**Main Body M.D.C.:** 180

**Maximum Speed:** Underwater: 65 mph (104 km; 56 knots).

**Maximum Range:** Unlimited.

**Bonuses:** +5% to pilot skill, +3 to dodge.

**Mini-Torpedo Tubes (3):** Mega-Damage: 1D6x10 M.D. Rate of Fire:

Single shot or volleys of two or three. Range: One mile (1.6 km).

Payload: Six; two per launch tube.

**Forward Laser Turret:** Mega-Damage: 3D6 M.D. Rate of Fire: Equal to the number of attacks per melee round. Range: 4,000 feet (1,220 m). Payload: Unlimited.

**Other Weapons:** Lower Forward Harpoon Gun, Rear Laser Turret, Forward Sensor/Camera Turrets.

**Black Market Cost:** One million credits.

## Tritonia: T-23CS Bottom Feeder Mini-Submarine

**Manufacturer:** Tritonia (Underseas, p. 102).

**Class:** Mini-Submarine.

**Crew:** Four, plus can hold six passengers.

**Main Body M.D.C.:** 600

**Maximum Speed:** Water Surface: 58 mph (92.5 km, 50 knots). Underwater: 34 mph (54 km; 29 knots).

**Maximum Range:** Unlimited.

**Bonuses:** None.

**Torpedo Tubes (2):** Mega-Damage: 3D4x10 M.D. (HE) or 2D6x10 M.D. (plasma). Rate of Fire: Single shot or volleys of two. Range: 10 miles (16 km). Payload: 12; one per launcher and 10 in cargo.

**Laser Pods (2):** Mega-Damage: 1D6x10 M.D. (single blast). Pods cannot attack simultaneously. Rate of Fire: Equal to the number of attacks per melee round. Range: 4,000 feet (1,220 m). Payload: Unlimited.

**Other Weapons:** Ion Guns, Mini-Torpedo Tubes (2).

**Black Market Cost:** 5 million credits.

## UB-20 Basic Underwater Sled

**Manufacturer:** Generic (Underseas, p. 144).

**Class:** Underwater Sled.

**Crew:** One.

**Main Body M.D.C.:** 145

**Maximum Speed:** Water Surface: 20 mph (32 km; 17.2 knots). Underwater: 15 mph (24 km; 13 knots)

**Maximum Range:** 800 miles (1,280 km). Unlimited if nuclear.

**Bonuses:** +5% to pilot skill. +2 to dodge.

**Weapons:** None.

**Black Market Cost:** 38,000 credits (gasoline); one million credits (nuclear).

## UB-300 Mini-Sub

**Manufacturer:** Generic (Underseas, p. 143).

**Class:** Mini-Submarine.

**Crew:** One pilot and three passengers.

**Main Body M.D.C.:** 525

**Maximum Speed:** Water Surface: 25 mph (40 km; 21.5 knots). Underwater: 50 mph (80 km; 43 knots).

**Maximum Range:** Unlimited; can stay submerged for weeks.

**Bonuses:** None.

**Laser Turret:** Mega-Damage: 4D6 M.D. Rate of Fire: Equal to the number of attacks per melee round. Range: 4,000 feet (1,220 m). Payload: Unlimited.

**Medium-Range Torpedoes (2):** Mega-Damage: 3D4x10 M.D. (high explosive) or 2D6x10 (plasma). Rate of Fire: Single shot or volleys of two. Range: 10 miles (16 km). Payload: Two.

**Other Weapons:** Mini-Torpedoes (6).

**Black Market Cost:** 6 million credits.

# Coalition States Vehicles

**Note:** The CS, Russia and Triax vehicles are the only vehicle groups that are kept together in one self-contained section. Most of these vehicles are exclusive to the CS Military.

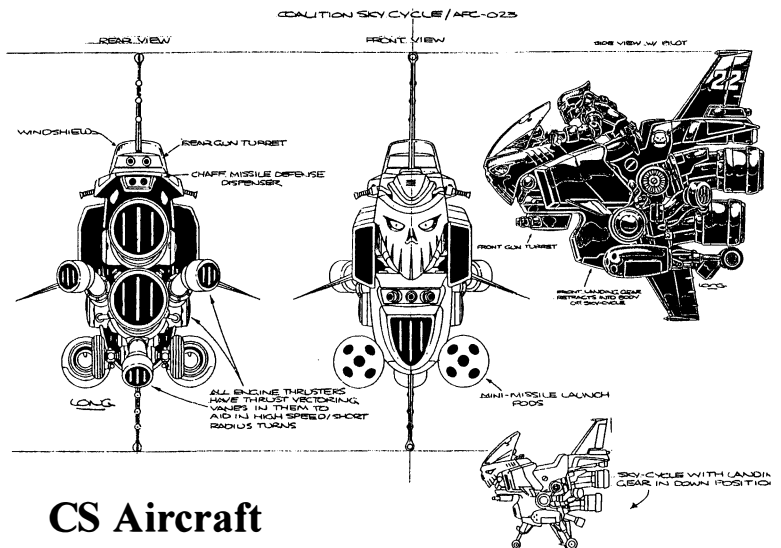

## CS Aircraft

### AFC-023 Sky Cycle (original)

— now used by Police & ISS

**Manufacturer:** Coalition States (Rifts® Ultimate Edition, p. 253).

**Class:** Hovercycle; borderline rocket bike.

**Crew:** One.

**Main Body M.D.C.:** 150

**Maximum Speed:** Ground: 40 mph (64 km). Flight: 520 mph (832 km); max altitude is 5,000 feet (1,524 m).

**Maximum Range:** Unlimited.

**Bonuses:** +3 to dodge in flight (+5 when flying over 250 mph/400 km). Trained CS pilots get +5% to pilot skill.

**CR-21 Mini-Missile Launchers (2):** Mega-Damage: 5D6 M.D. (frag) or 1D6x10 M.D. (plasma). Rate of Fire: Single shot or volleys of two, three, four or five. Range: One mile (1.6 km). Payload: 20; 10 per launcher.

**CR-4T Laser Turret:** Mega-Damage: 6D6 M.D. Rate of Fire: Equal to the number of attacks per melee round. Range: 4,000 feet (1,220 m). Payload: Unlimited.

**Other Weapons:** Smoke Dispenser.

**Black Market Cost:** One million credits.

### AFC-033 Wind Jammer Sky Cycle

**Manufacturer:** Coalition States (Coalition War Campaign, p. 171).

**Class:** Hovercycle; borderline rocket bike.

**Crew:** One.

**Main Body M.D.C.:** 220

**Maximum Speed:** Ground: 200 mph (320 km)! Flight: 620 mph (992 km); max altitude is 6,000 feet (1,828 m).

**Maximum Range:** Unlimited; can fly 24 hours straight before overheating.

**Bonuses:** +1 on initiative, +1 attack per melee round, +2 to dodge when flying at or below 250 mph (400 km); +4 to dodge when flying faster than 250 mph (400 km).

**CR-33 Mini-Missile Launcher:** Mega-Damage: 5D6 M.D. (frag) or 1D6x10 M.D. (plasma). Rate of Fire: Single shot or volleys of two, three, or four. Range: One mile (1.6 km). Payload: 24.

**C-33 Weapon Appendage Rail Guns (2):** Mega-Damage: 1D6x10 M.D. (one gun); 2D6x10 M.D. (two guns). Rate of Fire: Equal to

**CS Wind Jammer  
Sky Cycle**

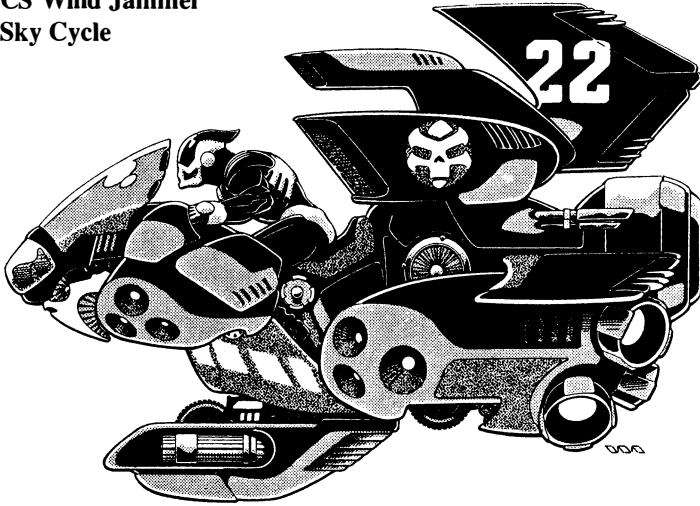

the number of attacks per melee round. Range: 4,000 feet (1,220 m).  
Payload: 4,000 rounds (100 bursts) per gun.

**Other Weapons**: Concealed Laser, Smoke Dispenser.

**Black Market Cost**: 1.8 million credits. No knock-offs have been introduced yet.

**AFC-050 Death's Head Transport APC**

**Manufacturer**: Coalition States (Rifts® Ultimate Edition, p. 252).

**Class**: Armored Personnel Carrier.

**Crew**: Nine: pilot, co-pilot, gunners (2), communications engineers (2), technical officers (3).

**Main Body M.D.C.**: 1,300

**Maximum Speed**: Flight: Mach 1/670 mph (1,072 km); max altitude is 40,000 feet (12,192 m).

**Maximum Range**: Unlimited; 24 hours at max speed before engines must cool off.

**Bonuses**: None.

**C-200DH Rail Gun**: Mega-Damage: 2D4x10 M.D. (burst). Rate of Fire: Equal to the number of attacks per melee round. Range: Two miles (3.2 km). Payload: 40,000 rounds (400 bursts).

**CR-51 Medium-Range Missile Launchers (2)**: Mega-Damage: 2D4x10 M.D. (multi-warhead) or 2D6x10 M.D. (plasma). Rate of Fire: Single shot or volleys of two or four. Range: 80 miles (128 m). Payload: 10; 5 per launcher.

**Other Weapons**: CR-6T Laser Turrets (6), Smoke Dispenser.

**Black Market Cost**: Unavailable on the Black Market.

**AFC-060 Sky Lifter**

**Manufacturer**: Coalition States (Coalition War Campaign, p. 162).

**Class**: Armored Personnel Carrier.

**Crew**: 20: pilot, co-pilot, gunners (2), communication engineers (2), crewmen (14). Six crew use Mauler power armor units for loading.

**Main Body M.D.C.**: 2,300

**Maximum Speed**: Flight: 400 mph (640 km); max altitude is 6,000 feet (1,828 m).

**Maximum Range**: Unlimited.

**Bonuses**: None.

**CPC-200 Double-Barreled Cannon Turret**: Mega-Damage: 1D6x10 M.D. (single shot) or 2D6x10 M.D. (double shot). Rate of Fire: Equal to the number of attacks per melee round, plus one. Range: 8,000 feet (2,438.4 m). Payload: 300 rounds.

**Concealed Mini-Missile Launchers (4)**: Mega-Damage: 5D6 M.D. (frag) or 1D6x10 M.D. (plasma). Rate of Fire: Single shot or volleys of two, four or eight. Range: One mile (1.6 km). Payload: 400! Each launcher has 100 missiles.

**Black Market Cost**: 200 million credits; currently unavailable on the Black Market.

**AFC-101 Command Car**

**Manufacturer**: Coalition States (Coalition War Campaign, p. 164).

**Class**: Hover Car.

**Crew**: Two: pilot and tail gunner. Can hold four passengers comfortably.

**Main Body M.D.C.**: 180

**Maximum Speed**: Flight: 200 mph (320 km); max altitude is 500 feet (152 m).

**Maximum Range**: Unlimited; can be flown at max speed for 96 hours straight without overheating.

**Bonuses**: None.

**C-30R Light Rail Gun**: Mega-Damage: 6D6 M.D. (burst). Rate of Fire: Equal to the number of attacks per melee round. Range: Two miles (3.2 km). Payload: 2,400 rounds (80 bursts).

**Black Market Cost**: 650,000 credits. Reportedly, Northern Gun and some others sell knock-off versions for 850,000 credits.

**AFC-103 Scarab Officer's Car**

**Manufacturer**: Coalition States (Coalition War Campaign, p. 165).

**Class**: Hover Car.

**Crew**: Two: pilot and gunner. Can hold four passengers comfortably.

**Main Body M.D.C.**: 240

**Maximum Speed**: Flight: 220 mph (352 km); max altitude is 1,500 feet (457.2 m).

**Maximum Range**: Unlimited. Can fly for 48 hours straight at a time.

**Bonuses**: None.

**C-40BT Laser Turrets (4)**: Mega-Damage: 4D6 M.D. (single blast); 8D6 M.D. (double blast). Rate of Fire: Equal to the number of attacks per melee round. Range: 2,000 feet (610 m). Payload: Unlimited.

**CR-10 Concealed Mini-Missile Launcher**: Mega-Damage: 5D6 M.D. (frag) or 1D6x10 M.D. (plasma). Rate of Fire: Single shot or volleys of two, three, four or five. Range: One mile (1.6 km). Payload: 20; 10 per launcher.

**Black Market Cost**: 1.6 million. Knock-offs sell for 2.1 million.

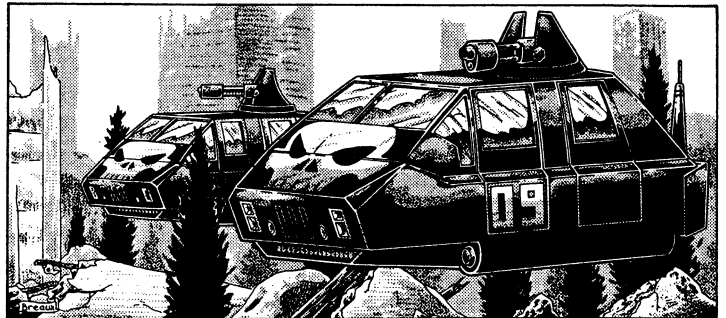

**AFC-105 Skull Patrol Car**

**Manufacturer**: Coalition States (Coalition War Campaign, p. 166).

**Class**: Hover Car.

**Crew**: Two: pilot and gunner. Can hold two passengers.

**Main Body M.D.C.**: 200

**Maximum Speed**: Flight: 150 mph (240 km).

**Maximum Range**: Unlimited. Can fly for 96 hours straight before engine overheats.

**Bonuses**: None.

**C-40PT Plasma Turret**: Mega-Damage: 6D6 M.D. Rate of Fire: Equal to the number of attacks per melee round. Range: 2,000 feet (610 m). Payload: Unlimited.

**CR-02 Concealed Mini-Missile Launchers (2)**: Mega-Damage: 5D6 M.D. (frag) or 1D6x10 M.D. (plasma). Rate of Fire: Single shot or volleys of two. Range: One mile (1.6 km). Payload: 16; 8 per launcher.

**Black Market Cost**: 1.4 million credits. Knock-offs sell for 1.8 million credits.

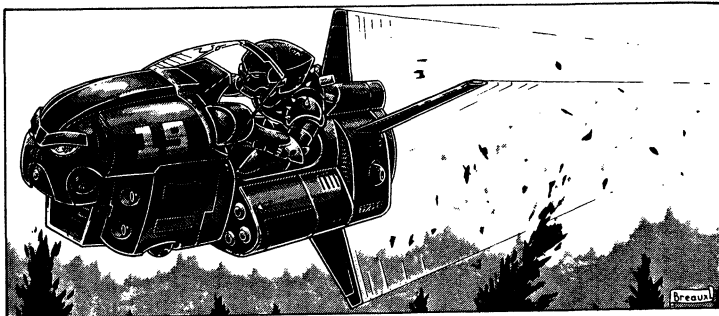

### AFC-111 Scout

**Manufacturer:** Coalition States (Coalition War Campaign, p. 167).

**Class:** Rocket Cycle.

**Crew:** One.

**Main Body M.D.C.:** 150

**Maximum Speed:** Flight: 440 mph (704 km); max altitude is 2,500 feet (762 m).

**Maximum Range:** Unlimited; can fly for 12 hours before overheating.

**Bonuses:** Elite RPA SAMAS pilots and RPA "Fly Boys" get +2 on initiative and +2 attacks per melee when piloting one of these vehicles.

**C-RF4 Rapid-Fire Pulse Lasers (4):** Mega-Damage: 2D6 M.D. (single blast); 4D6 M.D. (double blast); 6D6 M.D. (triple blast); 8D6 M.D. (quad blast). Rate of Fire: Equal to the number of attacks per melee round. Range: 1,800 feet (548.6 m). Payload: Unlimited.

**Modified CR-10 Concealed Mini-Missile Launchers (2):** Mega-Damage: 5D6 M.D. (frag) or 1D6x10 M.D. (plasma). Rate of Fire: Single shot or volleys of two, three, four or five. Range: One mile (1.6 km). Payload: 12; 6 per launcher.

**Black Market Cost:** 850,000 credits; knock-offs sell for 500,000 credits, but they fly at half the speed.

### AFC-115 Warbird

**Manufacturer:** Coalition States (Coalition War Campaign, p. 169).

**Class:** Rocket Cycle.

**Crew:** One.

**Main Body M.D.C.:** 220

**Maximum Speed:** Flight: 400 mph (640 km); max altitude is 6,000 feet (1,828 m).

**Maximum Range:** Unlimited; can fly 24 hours straight before overheating.

**Bonuses:** Elite RPA SAMAS pilots and RPA "Fly Boys" get +1 on initiative and +1 attack per melee when piloting one of these vehicles.

**C-42 Rail Gun Cluster:** Mega-Damage: 1D6x10 M.D. (single gun); 2D6x10 M.D. (double gun); 3D6x10 M.D. (triple gun). Rate of Fire: Equal to the number of attacks per melee round. Range: 4,000 feet (1,220 m). Payload: 4,000 rounds (100 bursts) per gun.

**Forward Lasers (2):** Mega-Damage: 2D6 M.D. (single blast); 4D6 M.D. (double blast). Rate of Fire: Equal to the number of attacks per melee round. Range: 2,000 feet (610 m). Payload: Unlimited.

**Other Weapons:** Forward Particle Beam, Concealed Mini-Missile Launchers (2), Fusion Mini-Bombs (4).

**Black Market Cost:** 1.3 million credits. Knock-offs sell for 900,000 but only have half the speed.

### AFC-151 Death Bringer

**Manufacturer:** Coalition States (Coalition War Campaign, p. 160).

**Class:** Armored Personnel Carrier.

**Crew:** Eight: pilot, co-pilot, communications officer, intelligence officer, gunners (4).

**APC Troop Payload:** 60-80 foot soldiers OR 40 foot soldiers and 20 light power armor units OR 60 light power armor units OR any other such combination.

**Main Body M.D.C.:** 900

**Maximum Speed:** Hovering: 200 mph (320 km). Flight: 400 mph (640 km); max altitude is 6,000 feet (1,828 m).

**Maximum Range:** Unlimited.

**Bonuses:** +1 to dodge when flying at or below 300 mph (480 km); +2 to dodge when flying faster than 300 mph (480 km). Trained CS pilots get an additional +10% to pilot skill.

**CPC-100 Cannon Turret:** Mega-Damage: 1D6x10 M.D. Rate of Fire: Equal to the number of attacks per melee round, plus one. Range: 8,000 feet (2,438.4 m). Payload: 100 rounds.

**Laser Turrets (6):** Mega-Damage: 3D6 M.D. (single blast). Rate of Fire: Equal to the number of attacks per melee round. Range: 4,000 feet (1,220 m). Payload: Unlimited.

**Black Market Cost:** 80-100 million credits; currently unavailable on the Black Market.

### CH-10 Black Lightning Helicopter

**Manufacturer:** Coalition States (Coalition War Campaign, p. 172).

**Class:** Helicopter.

**Crew:** Four: pilot, co-pilot/gunner, communications officer/gunner, secondary gunner.

**Main Body M.D.C.:** 200

**Maximum Speed:** Flight: 300 mph (480 km); max altitude is 20,000 feet (6,096 m). Ground strike can not be fired higher than 3,000 feet (914 m).

**Maximum Range:** 500 miles (800 km).

**Bonuses:** None.

**Weapon Appendage Rail Guns (2):** Mega-Damage: 1D6x10 M.D. (single gun); 2D6x10 M.D. (two guns). Rate of Fire: Equal to the number of attacks per melee round. Range: 4,000 feet (1,220 m). Payload: 2,000 rounds (50 bursts) per gun.

**Tube Mini-Missile Launchers (8):** Mega-Damage: 5D6 M.D. (frag) or 1D6x10 M.D. (plasma). Rate of Fire: Single shot or volleys of two, three, five, ten or twenty-four. Range: One mile (1.6 km). Payload: 48; 6 per launcher.

**Other Weapons:** Nose-Mounted Laser, Nose Rail Gun.

**Black Market Cost:** 750,000 credits. Ishpeming and Golden Age Armaments offer knock offs for one million credits.

### CH-10N Sea Storm Helicopter

**Manufacturer:** Coalition States (Coalition Navy, p. 93).

**Class:** Helicopter.

**Crew:** Four: pilot, co-pilot/gunner, communications officer/gunner, backup gunner.

**Main Body M.D.C.:** 200

**Maximum Speed:** Flight: 300 mph (480 km); max altitude is 20,000 feet (6,096).

**Maximum Range:** 500 miles (800 km).

**Bonuses:** None.

**C-33 Weapon Appendage Rail Guns (2):** Mega-Damage: 1D6x10 M.D. (one gun); 2D6x10 M.D. (two guns). Rate of Fire: Equal to the number of attacks per melee round. Range: 4,000 feet (1,220 m). Payload: 2,000 rounds (50 bursts) per gun.

**Tube Mini-Torpedo Launchers (8):** Mega-Damage: Varies with missile type. Rate of Fire: Single shot or volleys of two, three, five, ten or twenty-four. Range: One mile (1.6 km). Payload: 48; 3 per launcher.

**Other Weapons:** Nose Mounted Laser, Nose Rail Gun, and Depth Charges.

**Black Market Cost:** 750,000 credits.

### CH-12 Demon Locust Helicopter

**Manufacturer:** Coalition States (Coalition War Campaign, p. 174).

**Class:** Helicopter.

**Crew:** Four: pilot, co-pilot/gunner, communications officer/gunner, secondary gunner.

**Main Body M.D.C.:** 250

**Maximum Speed:** Flight: 250 mph (400 km); max altitude is 20,000 feet (6,096 m).

**Maximum Range:** 700 miles (1,120 km).

**Bonuses:** None.

**Wing Rail Guns (2):** Mega-Damage: 1D4x10 M.D. (single gun); 2D4x10 M.D. (double gun). Rate of Fire: Equal to the number of attacks per melee round. Range: 4,000 feet (1,220 m). Payload: 6,000 rounds (150 bursts) per gun.

**Tube Mini-Missile Launchers (6):** Mega-Damage: 5D6 M.D. (frag) or 1D6x10 M.D. (plasma). Rate of Fire: Single shot or volleys of two, three, four or five. Range: One mile (1.6 km). Payload: 60; 10 per launcher.

**Other Weapons:** Forward Mounted Laser Cannon, Nose Rail Gun, Medium-Range Missile Launchers (4).

**Black Market Cost:** 925,000 credits. Knock-offs sell for 1.3 million credits.

## CH-12N Sea Wasp Helicopter

**Manufacturer:** Coalition States (Coalition Navy, p. 95).

**Class:** Helicopter.

**Crew:** Four: pilot, co-pilot/gunner, communications tech, secondary gunner.

**Main Body M.D.C.:** 250

**Maximum Speed:** Flight: 250 mph (400 km); max altitude is 20,000 feet (6,096 m).

**Maximum Range:** 700 miles (1,120 km).

**Bonuses:** None.

**Forward Mounted Laser Cannon:** Mega-Damage: 1D4x10 M.D. Rate of Fire: Equal to the number of attacks per melee round. Range: 4,000 feet (1,220 m). Payload: Unlimited.

**Wing Rail Guns (2):** Mega-Damage: 1D4x10 M.D. Rate of Fire: Equal to the number of attacks per melee round. Range: 4,000 feet (1,220 m). Payload: 6,000 rounds (150 bursts) per gun.

**Other Weapons:** Nose Rail Gun, Canister Torpedo or Mini-Missile Launchers (6), Medium-Range Torpedo Launchers (4).

**Black Market Cost:** 925,000 credits.

## CSN-115 Sea Striker Jet Fighter

**Manufacturer:** Coalition States (Coalition Navy, p. 86).

**Class:** Naval Supersonic Interceptor.

**Crew:** Two: pilot and co-pilot/gunner.

**Main Body M.D.C.:** 465

**Maximum Speed:** Flight: Mach 2.8; max altitude is 60,000 feet (18,288 m).

**Maximum Range:** Unlimited; can fly at max speed for 10 straight hours before overheating.

**Bonuses:** +1 on initiative, +1 to dodge.

**Double-Barreled Laser Turret:** Mega-Damage: 2D4x10 M.D. Rate of Fire: Equal to the number of attacks per melee round. Range: 6,000 feet (1,828 m). Payload: Unlimited.

**Mini-Missile Launchers (2):** Mega-Damage: 1D4x10 M.D. (armor piercing) or 1D6x10 M.D. (plasma). Rate of Fire: Single shot or volleys of two, four or six. Range: One mile (1.6 km). Payload: 72; 36 per launcher.

**Other Weapons:** Mini-Torpedo Launchers (2), Pylon-Mounted Long-Range Missiles (6), Depth Charges (2).

**Black Market Cost:** 50 million credits; currently unavailable on the Black Market.

## CSN-117 Shrike Jet Fighter

**Manufacturer:** Coalition States (Coalition Navy, p. 87).

**Class:** Naval Supersonic Interceptor.

**Crew:** One.

**Main Body M.D.C.:** 390

**Maximum Speed:** Flight: Mach 3.5; max altitude is 60,000 feet (18,288 m).

**Maximum Range:** Unlimited; can fly at max speed for 10 straight hours before overheating.

**Bonuses:** +1 on initiative, +3 to dodge, +10% to pilot skill.

**High Intensity Laser Turret:** Mega-Damage: 2D4x10 M.D. Rate of Fire: Equal to the number of attacks per melee round. Range: 6,000 feet (1,828 m). Payload: Unlimited.

**Pylon-Mounted Long-Range Missiles (6):** 6D6x10.

M.D. Rate of Fire: Single shot or volleys of two, four or six. Range: 1,800 miles (2,880 km). Payload: Six missiles.

**Other Weapons:** AIM-180 ASRAAM Wing-Mounted Missile Launchers (2).

**Black Market Cost:** 50 million credits; currently unavailable on the Black Market.

## CSN-118 Dagger Bomber Aircraft

**Manufacturer:** Coalition States (Coalition Navy, p. 89).

**Class:** Stealth Bomber.

**Crew:** Two: pilot and co-pilot/gunner.

**Main Body M.D.C.:** 360

**Maximum Speed:** Flight: Mach 1.5; max altitude is 60,000 feet (18,288 m).

**Maximum Range:** Unlimited. Can fly at max speed for 12 hours before overheating.

**Bonuses:** +3 to strike.

**High Intensity Laser Cannon:** Mega-Damage: 2D4x10 M.D. Rate of Fire: Equal to the number of attacks per melee round. Range: 6,000 feet (1,828 m). Payload: Unlimited.

**Internal Bomb Module:** Mega-Damage: 2D4x10 M.D. (multi-war-head) or 2D6x10 M.D. (plasma). Rate of Fire: Single shot or volleys of two, four, six or eight. Range: Two miles 93.2 km) above the ground. Payload: 48

**Other Weapons:** Retractable Medium-Range Missile Launchers (2), External Wing hard points (4)

**Black Market Cost:** At least 80 million credits; currently unavailable on the Black Market.

## Eagle Unmanned Aircraft (EUA)

**Manufacturer:** Coalition States (Coalition Navy, p. 91).

**Class:** Unmanned Robot Aircraft.

**Crew:** None.

**Main Body M.D.C.:** 95

**Maximum Speed:** Flight: 500 miles (800 km); max altitude is 15,000 feet (4,572 m).

**Maximum Range:** 600 miles (960 km).

**Bonuses:** None.

**Equipment:** High-resolution cameras.

**Black Market Cost:** One million credits.

## GAW-F14 Tomcat Jet Fighter

**Manufacturer:** GAW/Coalition States (Coalition Navy, p. 92).

**Class:** Naval Supersonic Interceptor.

**Crew:** Two: pilot and weapon systems operator.

**Main Body M.D.C.:** 18

**Maximum Speed:** Flight: Mach 2.3; max altitude is 56,000 feet (17,068 m).

**Maximum Range:** 800 miles (1,280 km).

**Bonuses:** +2 on initiative,

**M61 20mm Gatling Cannon:** Mega-Damage: 1D6x10 M.D. (burst). Rate of Fire: Equal to the number of attacks per melee round. Range: 4,000 feet (1,220 m). Payload: 600 rounds (20 bursts).

**AIM-52 Phoenix Air-to-Air Missiles (6):** Mega-Damage: 3D6x10 M.D. Rate of Fire: Single shot or volleys of up to six. Range: 125 miles (200 km). Payload: Six missiles.

**Other Weapons:** Wing-Mounted Long-Range Missiles (2).

**Black Market Cost:** 4 million credits each or a squadron of 12 for 42 million credits.

## NA-15 Nightwing Jet Fighter

**Manufacturer:** Coalition States (Mercenaries, p. 150).

**Class:** Supersonic Interceptor.

**Crew:** Two: pilot and co-pilot/gunner.

**Main Body M.D.C.:** 450

**Maximum Speed:** Flight: Mach 2.05; max altitude is 30,000 feet (9,144 m).

**Maximum Range:** Unlimited. Can fly for 10 hours straight at max speed before overheating.

**Bonuses:** None.

**High Intensity Laser Turret:** Mega-Damage: 2D4x10 M.D. Rate of Fire: Equal to the number of attacks per melee round. Range: 6,000 feet (1828 m). Payload: Unlimited.

**Wing-Mounted Medium-Range Missile Launchers (4):** Mega-Damage: Varies by missile type. Rate of Fire: Single shot or volleys of two or four. Range: 40 miles (64 km). Payload: 24; 6 per launcher.

**Other Weapons:** Pylon-Mounted Long-Range Missiles (6).

**Black Market Cost:** At least 50 million credits, but this is academic since the Nightwing has never been available on the Black Market and, like so many other Coalition vehicles, is unlikely to be in the foreseeable future.

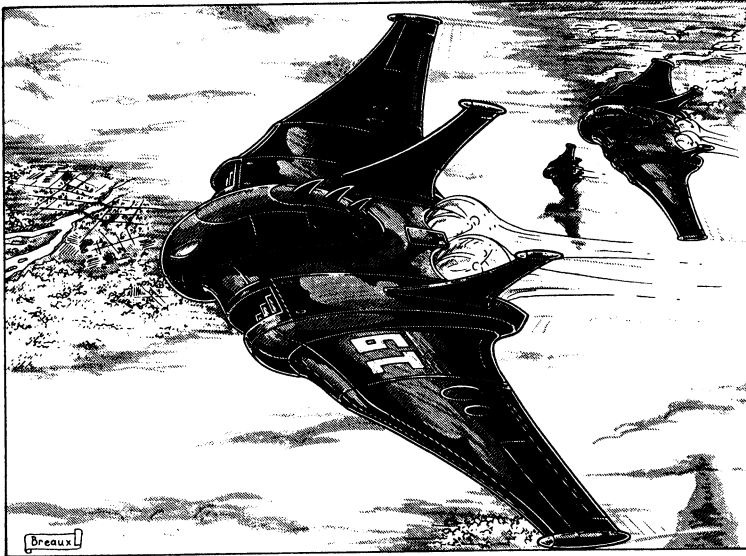

### SF-7 Talon Jet Fighter

**Manufacturer:** Coalition States (Coalition War Campaign, p. 176).

**Class:** VTOL Stealth Fighter.

**Crew:** One; seats for two additional crew members, typically a bombardier and communications officer.

**Main Body M.D.C.:** 350

**Maximum Speed:** Flight: Mach 1.5/1,005 mph (1,608 km), max altitude is 60,000 feet (18,288 m).

**Maximum Range:** Unlimited; 18 hours of constant flight before overheating.

**Bonuses:** +1 when flying at or under Mach One; +4 to dodge when flying above Mach One.

**Belly-Mounted Long-Range Missile Launcher:** Mega-Damage: Varies with missile type. Rate of Fire: Single shot or volleys of two. Range: Varies with missile type. Payload: 6.

**Mini-Missile Launchers (2):** Mega-Damage: 5D6 M.D. (frag) or 1D6x10 M.D. (plasma). Rate of Fire: Volleys of 4, 8, 12, and 24. Range: One mile (1.6 km). Payload: 150; 75 per launcher.

**Other Weapons:** Top Mini-Missile Launchers (4), Concealed Forward Mounted Lasers (2).

**Black Market Cost:** Top secret; rumored to be 70-100 million credits. This an experimental aircraft developed for use against Tolkeen and the Xitix. Only one wing of 30 aircraft currently operate out of Chi-Town.

## CS Boats

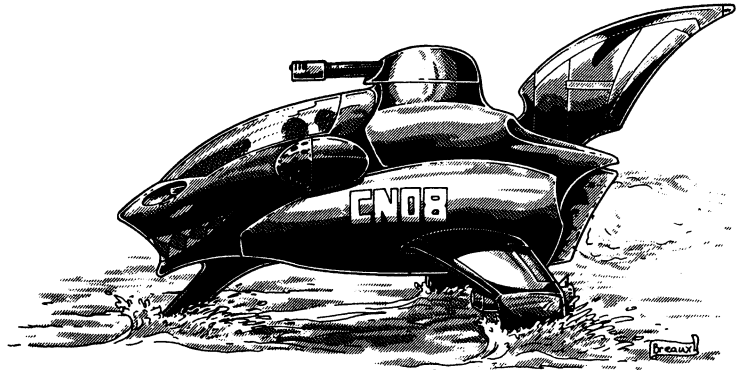

### AWC-012 Wave Demon

**Manufacturer:** Coalition States (Coalition Navy, p. 58).

**Class:** Patrol Hydrofoil.

**Crew:** Two: pilot and gunner.

**Main Body M.D.C.:** 150

**Maximum Speed:** Water Surface: 130 mph (208 km; 112 knots).

**Maximum Range:** Unlimited.

**Bonuses:** +3 to dodge when moving faster than 60 mph (96 km). Trained CS pilots get +5% to pilot skill.

**CR-4T Laser Turret:** Mega-Damage: 6D6 M.D. Rate of Fire: Equal to the number of attacks per melee round. Range: 4,000 feet (1,220 m). Payload: Unlimited.

**CR-25 Mini-Missile Launchers (2):** Mega-Damage: 1D4x10 M.D. (armor piercing); 1D6x10 M.D. (plasma). Rate of Fire: Single shot or volleys of two, four, six or twelve. Range: One mile (1.6 km). Payload: 24; 12 per launcher

**Other Weapons:** Medium Torpedo Launchers (2), C-40R2 Rail Gun Turret.

**Black Market Cost:** 1.8 million credits.

### CPB-001 Mark I Barracuda Patrol Boat

**Manufacturer:** Coalition States (Coalition Navy, p. 60).

**Class:** Modular Patrol Boat.

**Crew:** 12: pilot/commander, co-pilot/sensors operator, gunners (4), enlisted sailors (6). Plus can carry 8-10 soldiers.

**Main Body M.D.C.:** 300

**Maximum Speed:** Water Surface: 55 mph (88 km; 47.3 knots).

**Maximum Range:** Unlimited.

**Bonuses:** None.

**Torpedo Tubes (2):** Mega-Damage: 2D4x10 M.D. Rate of Fire: Single shot or volley of two. Range: 5 miles (8 km). Payload: 40.

**Light Weapons Turret (3):** Being a modular craft, the Barracuda can accommodate various weapons in these mounts, such as the CR-4T Laser, C-40R2 Rail Guns, or the C-50R Enforcer Rail Gun.

**Other Weapons:** Modular Heavy Weapons Turret.

**Black Market Cost:** 40 million credits, but currently unavailable on the Black Market.

### CPB-004 Mark IV Hurricane Patrol Boat

**Manufacturer:** Coalition States (Coalition Navy, p. 62).

**Class:** Submersible Patrol Boat.

**Crew:** Six: captain, co-pilot/first mate, radar/sonar operator, communications technician, gunners (2).

**Main Body M.D.C.:** 290

**Maximum Speed:** Water Surface: 70 mph (112 km). Underwater: 23 mph (36.8 km; 20 knots).

**Maximum Range:** Unlimited.

**Bonuses:** None.

**Short-Range Missile Launchers (2):** Mega-Damage: 1D4x10 M.D. (armor piercing) or 1D6x10 M.D. (plasma). Rate of Fire: Single shot or volleys of two, three or four. Range: 5 miles (8 km). Payload: 20; 10 per launcher.



**Torpedo Tube:** Mega-Damage: 3D4x10 M.D. Rate of Fire: Single shot only. Range: 5 miles (8 km). Payload: 6.

**Other Weapons:** Particle Beam Cannon, C-40R2 Rail Gun.

**Black Market Cost:** 80 million credits; currently unavailable on the Black Market.

## Death's Head Underwater Sea Sled

**Manufacturer:** Coalition States (Coalition Navy, p. 56).

**Class:** Underwater Sled.

**Crew:** One.

**Main Body M.D.C.:** 140

**Maximum Speed:** Water Surface: 20 mph (32 km; 17.2 knots). Underwater: 15 mph (24 km; 13 knots).

**Maximum Range:** 800 miles (1,280 km). Unlimited if nuclear.

**Bonuses:** +5% to pilot skill.

**Mini-Torpedoes (2):** Mega-Damage: 1D4x10 M.D. Rate of Fire: Single shot or volley of two. Range: One mile (1.6 km). Payload: Two.

**Black Market Cost:** 36,000 credits (gasoline); one million credits (nuclear).

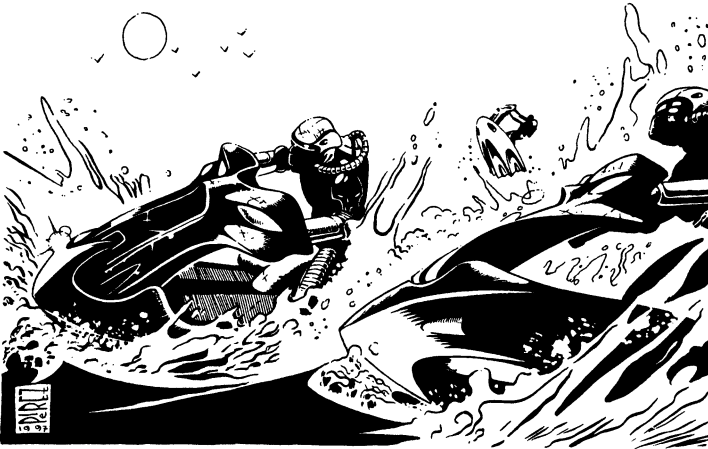

## CS Jet Ski

**Manufacturer:** Coalition States (Coalition Navy, p. 57).

**Class:** Surface Sea Sled.

**Crew:** One.

**Main Body M.D.C.:** 120

**Maximum Speed:** Water Surface: 110 mph (176 km; 94.6 knots).

**Maximum Range:** 500 miles (800 km); unlimited if nuclear.

**Bonuses:** None.

**Mini-Torpedoes (2):** Mega-Damage: 1D4x10 M.D. Rate of Fire: Single shot or volley of two. Range: One mile (1.6 km). Payload: Two.

**Black Market Cost:** 45,000 credits (gasoline); one million credits (nuclear).

## CSS James Bay Class Destroyers

**Manufacturer:** Coalition States, via Iron Heart Armaments (Coalition Navy, p. 65).

**Class:** Guided Missile Destroyer.

**Crew:** 120: officers (8), chief petty officers (13), enlisted crew (99). Can also carry 20 Naval Infantry RPAs in Super SAMAS and 10 Sea SAMAS.

**Main Body M.D.C.:** 1,450

**Maximum Speed:** Water Surface: 42 mph (67 km; 36 knots).

**Maximum Range:** Unlimited.

**Bonuses:** None.

**Heavy Torpedo Tubes (2):** Mega-Damage: 4D6x10 M.D. Rate of Fire: Single shot or volleys of two. Can fire four volleys per melee round. Range: 20 miles (32 km). Payload: 80 torpedoes.

**Medium Missile Launchers (2):** Mega-Damage: 3D4x10 M.D. to an area of 30 feet (9.1 m). Rate of Fire: Up to three shots per melee round. Range: 10 miles (16 km). Payload: 50.

**Other Weapons:** Five-Inch Cannon Turret, Rail Gun Turret, Depth

Charge Launchers (2), Landing Pad (2 CSN helicopters, either Sea Wasps or Sea Storms).

**Black Market Cost:** Unavailable on the Black Market.

## CSS Orca-Class Submarine

**Manufacturer:** Coalition States (Coalition Navy, p. 76).

**Class:** Attack Submarine.

**Crew:** 98: officers (10), enlisted sailors (88). Can carry up to 40 regular troops or 20 light power armor troops.

**Main Body M.D.C.:** 850

**Maximum Speed:** Water Surface: 35 mph (56 km; 30 knots). Underwater: 40.6 mph (65 km; 35 knots).

**Maximum Range:** Unlimited.

**Bonuses:** None.

**Heavy Torpedo Tubes (4):** Mega-Damage: 5D6x10 M.D. Rate of Fire: Single shot or volleys of two, three or four. Range: 20 miles (32 km). Payload: 40.

**VLS Missile Launchers (24):** Mega-Damage: 4D6x10 M.D. Rate of Fire: Single shot or volleys of two, three, four, six, twelve or twenty-four. Range: 1,000 miles (1,600 km). Payload: 72, plus 10 nuclear weapons.

**Other Weapons:** Concealed Ion Cannons (2), On-Board Commando Forces.

**Black Market Cost:** Unavailable on the Black Market.

## CSS Revenge Class Destroyers

**Manufacturer:** Coalition States (Coalition Navy, p. 66).

**Class:** Guided Missile Destroyer.

**Crew:** 342: officers (27), chief petty officers (24), enlisted sailors (291).

**Main Body M.D.C.:** 520

**Maximum Speed:** Water Surface: 35 mph (56 km; 30 knots).

**Maximum Range:** Unlimited.

**Bonuses:** None.

**Medium Torpedo Tubes (6):** Mega-Damage: 3D4x10 M.D. Rate of Fire: Single shot or volleys of two, three, four or six. Can fire one volley per melee round. Range: 10 miles (16 km). Payload: 60; 10 per tube.

**Vertical Launch System (VLS) Missile Launchers (96):** Mega-Damage: Can fire any long-range missile, but often use plasma; 3D6x10 M.D. Rate of Fire: Single shot or volleys of two, four, six or eight. Range: 40 miles (64 km). Payload: 96.

**Other Weapons:** Five-Inch Cannon Turret, CIWS C90R Gatling Rail Guns (2), Helicopters (2 Sea Storms or Sea Wasps).

**Black Market Cost:** Unavailable to the Black Market.

## CSS Shark-Class Submarine

**Manufacturer:** Coalition States (Coalition Navy, p. 74).

**Class:** Attack Submarine.

**Crew:** 132: officers (12), enlisted crew (120). Can accommodate another 12 passengers.

**Main Body M.D.C.:** 320

**Maximum Speed:** Water Surface: 35 mph (56 km; 30 knots). Underwater: 40.6 mph (65 km; 35 knots).

**Maximum Range:** Unlimited.

**Bonuses:** None.

**Torpedo Tubes (4):** Mega-Damage: 4D6x10 M.D. Rate of Fire: Single shot or volleys of two, three or four. Range: 20 miles (32 km). Payload: 32.

**VLS Tomahawk Missile Launchers (12):** Mega-Damage: 4D6x10 M.D. Rate of Fire: Single shot or volleys of two, three, four, or six. Range: 1,000 miles (1,600 km). Payload: 12.

**Black Market Cost:** Unavailable on the Black Market.

## CVN-1 Chi-Town Carrier Class

**Manufacturer:** Coalition States (Coalition Navy, p. 83).

**Class:** Aircraft Carrier.

**Crew:** 2,880: boat officers (160), boat enlisted crew (1,800), air group officers (120), air group enlisted crew (800).

**Troop Capacity:** 1,200 total, divided into one Armor Troop, a Reinforced Mechanized Infantry Company, one Infantry Battalion, one SP Artillery Platoon, two Howitzer Batteries, an Artillery Support Company, one Special Operations Company, and a Headquarters & Intelligence Group.

**Aircraft Capacity:** 62: 12 Shrike Interceptors, 12 Sea Strikers, 8 Daggars, 20 Sky Cycles, 4 Sea Storms, 4 Demon Locusts, 2 Sky Lifter APCs.

**Additional Vehicles:** 20 surface sea sleds, 40 underwater sea sleds, 20 Wave Demons, 20 Barracuda Stealth SCUBA armor, 20 Lightning Strike armor, 40 Trident power armor, 40 Sea SAMAS.

**Main Body M.D.C.:** 13,000

**Maximum Speed:** Water Surface: 40.6 mph (65 km; 35 knots).

**Maximum Range:** Unlimited.

**Bonuses:** None.

**Heavy Torpedo Tubes (8):** Mega-Damage: 4D6x10 M.D. Rate of Fire: Up to eight torpedoes per melee round. Range: 20 miles (32 km). Payload: 100.

**C-406 Tri-Cannon Turret:** Mega-Damage: 1D4x100 M.D. to a 10 foot (3 m) blast radius or 1D6x100 to a 50 foot (15.2 m) blast radius. Rate of Fire: Two rounds per cannon per minute (4 melee rounds). Range: 35 miles (56 km). Payload: 200 shells.

**Other Weapons:** CR-400 Long-Range Missile Turret, Secondary CR-160 MLRS Missile Launchers (2), CIWS C90R Gatling Rail Guns (6), C-50R Enforcer Rail Guns (4).

**Black Market Cost:** The CS construction price per craft is around 2.7 billion credits. Totally unavailable on the Black Market. You'd have a better chance buying out the land beneath Chi-Town.

## CSN Wasp-Class Amphibious Warship

**Manufacturer:** Coalition States (Coalition Navy, p. 68).

**Class:** Amphibious Warship.

**Crew:** 1,080: officers (98), chief petty officers (61), enlisted personnel (921).

**Troop Capacity:** 1,950 embarked troops consisting of a Headquarters Group, a Recon/Special Ops Company, a Combat Engineer or "Sapper" Platoon, a Medical Group, two Armor Troop Companies, one Mechanized Air Infantry Battalion, one SP Artillery Platoon, two Howitzer Batteries, an Artillery Support Company, and one Enlarged Infantry Battalion.

**Main Body M.D.C.:** 8,000

**Maximum Speed:** Water Surface: 27.6 mph (44 km; 24 knots).

**Maximum Range:** Unlimited.

**Bonuses:** None.

**Medium Missile Launchers (2):** Mega-Damage: 3D6x10 M.D. Rate of Fire: Single shot or volleys of two, four or eight. Range: 40 miles (64 km). Payload: 16; 8 per launcher.

**CIWS C90R Gatling Rail Guns (3):** Mega-Damage: 3D4x10 M.D. (burst). Rate of Fire: Up to six attacks per melee round (two per gun). Range: 6,000 feet (1828 m). Payload: 12,000 rounds (200 bursts) per gun.

**Other Weapons:** C-50R Enforcer Rail Guns (8).

**Black Market Cost:** You wish!

## CT-008 Supply-Class Merchant Marine Transport

**Manufacturer:** Coalition States (Coalition Navy, p. 70).

**Class:** Merchant Marine Transport.

**Crew:** 32: commander, mechanic, enlisted sailors (30). Also can carry up to 640 troops.

**Main Body M.D.C.:** 420

**Maximum Speed:** Water Surface: 30 mph (48 km).

**Maximum Range:** Unlimited.

**Bonuses:** None.

**CR-4T Laser Turrets (4):** Mega-Damage: 6D6 M.D. Rate of Fire: Equal to the number of attacks per melee round. Range: 4,000 feet (1,220 m). Payload: Unlimited.

**Other Weapons:** Aircraft (one VTOL fighter or helicopter, plus a half-dozen SAMAS suits), Robot Loaders (2).

**Black Market Cost:** 35 million credits.

## Missile MC1A Sea King

**Manufacturer:** Coalition States, via Iron Heart Armaments (Mercenaries, p. 120)

**Note:** Though manufactured by Iron heart, the CS has purchased a number of these and refitted them to CS specifications.

**Class:** Missile Cruiser

**Crew:** 40-50: captain, first officer, chief officers (4), medical officers (2), communications technicians (3), sensor operators (3), navigation technicians (2), engineers/mechanics (4), nurses (4), cooks (5), seamen (15).

**Main Body M.D.C.:** 2,600

**Maximum Speed:** Water: 40 mph (64 km).

**Maximum Range:** Unlimited.

**Bonuses:** None.

**Missile Launchers (4):** Mega-Damage: Varies with missile type. Both medium and long range missiles are used. Rate of Fire: Single shot or volleys of two, four or sixteen. Range: Varies; 50 to 500 miles (80 to 800 km). Payload: 160 per launcher; another 560 missiles are held in the ship's hold.

**Torpedo Tubes (6):** Mega-Damage: 4D6x10 M.D. Rate of Fire: Up to six per melee round. Range: 20 miles (32 km). Payload: 600; 100 per tube.

**Other Weapons:** Long Range Rail Gun Turrets (2), Eight-inch Naval Guns (2), Depth Charge Launchers (2), Shrike VTOL interceptors or Dagger Bombers (4), Mk-108 Firefly missiles (4), Tomahawk nuclear missiles (6), Eagle Unmanned Aircraft.

**Black Market Cost:** About 600 million credits.

## Joseph Prosek-Class Aircraft Carrier

**Manufacturer:** Coalition States (Coalition Navy, p. 81).

**Class:** Aircraft Carrier.

**Crew:** 4,600: boat officers (200), boat enlisted crew (2,800), air group officers (200), air group enlisted crew (1,400).

**Troop Capacity:** 1,500 total. 400 troops are RPA specialists who operate 180 SAMAS, 140 Sea SAMAS, 20 Special Forces SAMAS, 24 old-style SAMAS, and 10 Hellraisers. There are also 160 Sea Dogs, 10 Nautical Commando troops, and 36 Naval Infantry RLT Commandos.

**Aircraft Capacity:** 94: 12 Super-Tomcats, 12 Skrike Interceptors, 24 Sea Strikers, 12 NB-10 Dagger Bombers, 24 Sky Cycles, 6 Sea Storms, and 4 Death Bringer APCs.

**Other Vehicles:** 60 surface sea sleds, 40 underwater sea sleds, 20 Barracuda Stealth SCUBA Armor, 40 Lightning Strike Armor, 40 Trident Power Armor, 60 Sea SAMAS, two Sea Spiders.

**Main Body M.D.C.:** 12,000

**Maximum Speed:** Water Surface: 34.5 mph (55 km; 30 knots).

**Maximum Range:** Unlimited.

**Bonuses:** None.

**CR-160 MLRS Missile Launchers (3):** Mega-Damage: 3D6x10 M.D. Rate of Fire: Single shot or volleys of two, four or eight. Can fire up to three volleys per melee round. Range: 500 miles (800 km). Payload: 720; 240 missiles each. The ship has an additional 720 LRMs in storage.

**CIWS C90R Gatling Rail Guns (4):** Mega-Damage: 3D4x10 M.D. (burst). Rate of Fire: Six attacks per melee round. Range: 6,000 feet (1,828 m). Payload: 60,000 rounds (500 bursts) per gun.

**Black Market Cost:** The CS purchased this old ship from Golden Age Weaponsmiths for 2 billion credits and spent far more than that retrofitting it.

## SSN-10 Stingray Submarine

**Manufacturer:** Coalition States (Coalition Navy, p. 79).

**Class:** Mini-Submarine.

**Crew:** Three: pilot/captain, co-pilot/gunner, communications officer.

Can also carry a squad of 10 troops or five light power armor troops.

**Main Body M.D.C.:** 400

**Maximum Speed:** Water Surface: 35 mph (56 km; 30 knots). Under-water: 65 mph (54.4 km; 35 knots).

**Maximum Range:** Unlimited.

**Bonuses:** None.

**Torpedo Tubes (2):** Mega-Damage: 3D6x10 M.D. Rate of Fire: Single shot or volleys of two or four. Range: 10 miles (16 km). Payload: 14.

**Mini-Torpedo Launcher:** Mega-Damage: 1D4x10 M.D. Rate of Fire: Single shot or volleys of two or four. Range: One mile (1.6 km). Payload: 40.

**Other Weapons:** Laser Cannons (4), Belly Gun.

**Black Market Cost:** Unavailable on the Black Market.

## Coalition APCs & Tanks

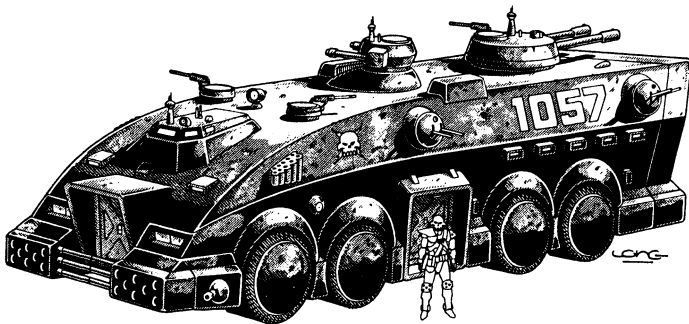

### CS Mark V APC

**Manufacturer:** Coalition States (Rifts® Ultimate Edition, p. 251).

**Class:** Armored Personnel Carrier.

**Crew:** Five: pilot, co-pilot, communications officer, gunners (2). Can also carry up to 20 standard troops, four SAMAS power armor units, and two hovercycles.

**Main Body M.D.C.:** 350

**Maximum Speed:** Ground: 90 mph (144 km).

**Maximum Range:** Unlimited.

**Bonuses:** None.

**C-40R Rail Gun:** Mega-Damage: 1D6 M.D. (single shot); 1D6x10 M.D. (burst). Rate of Fire: Equal to the number of attacks per melee round. Range: 4,000 feet (1,220 m). Payload: 20,000 rounds (250 bursts).

**CR-4T Laser Turrets (2):** Mega-Damage: 6D6 M.D. Rate of Fire: Equal to the number of attacks per melee round. Range: 4,000 feet (1,220 m). Payload: Unlimited.

**Other Weapons:** C-2T Dual Laser Turrets (4), CR-10 Forward Mini-Missile Launchers (2), Forward Auto-Cannons (2), Hatch Laser Guns (3), Smoke Dispensers (2).

**Black Market Cost:** 21 million credits.

### CS Mark VII Slayer

**Manufacturer:** Coalition States (Coalition War Campaign, p. 150).

**Class:** Armored Personnel Carrier.

**Crew:** Eight: pilot, co-pilot, communications officer, intelligence officer, gunners (4). APC troop payload includes various mixes, including: 5-60 foot soldiers OR 20 foot soldiers and 10 power armor units OR 40 SAMAS or other light power armor units OR 20 SAMAS and 10 Super SAMAS OR 20 foot soldiers on Scout Rocket Cycles and 10 light power armor units or 6 heavy power armor units OR 10-15 light robot vehicles.

**Main Body M.D.C.:** 500

**Maximum Speed:** Ground: 80 mph (128 km).

**Maximum Range:** Unlimited.

**Bonuses:** None.

**C-T60 Laser Cannon:** Mega-Damage: 1D6x10 M.D. Rate of Fire: Equal to the number of attacks per melee round. Range: 6,000 feet (1,828 m). Payload: Unlimited.

**C-PT36 Plasma Turret:** Mega-Damage: 6D6 M.D. Rate of Fire: Equal to the number of attacks per melee round. Range: 2,000 feet (610 m). Payload: Unlimited.

**Other Weapons:** C-MV12 Vertical Mini-Missile Launchers (2), C-M6 Dual Mini-Missile Launchers (2), C-4T Dual Laser Turrets (4), Smoke Dispensers (2).

**Black Market Cost:** 28 million credits; unavailable on the Black Market.

### CS Mark IX EPC

**Manufacturer:** Coalition States (Coalition War Campaign, p. 152).

**Class:** Armored ("Exploratory") Personnel Carrier.

**Crew:** Three: pilot, co-pilot, gunner.

**Main Body M.D.C.:** 220

**Maximum Speed:** Ground: 110 mph (176 km).

**Maximum Range:** Unlimited.

**Bonuses:** None.

**CR-2T Laser Turrets (2):** Mega-Damage: 4D6 M.D. Rate of Fire: Equal to the number of attacks per melee round. Range: 4,000 feet (1,220 m). Payload: Unlimited.

**CR-10 Forward Mini-Missile Launcher:** Mega-Damage: 5D6 M.D. (frag) or 1D6x10 M.D. (plasma). Rate of Fire: Single shot or volleys of two, three, five, or ten. Range: One mile (1.6 km). Payload: 20.

**Other Weapons:** None.

**Black Market Cost:** Six million credits.

### CTX-20 Grinning Skull Tank

**Manufacturer:** Coalition States (Mercenaries, p. 146).

**Class:** Main Battle Tank.

**Crew:** Six: pilot, co-pilot, communications officer, gunners (3).

**Main Body M.D.C.:** 500

**Maximum Speed:** Ground: 90 mph (144 km).

**Maximum Range:** Unlimited.

**Bonuses:** None.

**C-144 Cannons:** Mega-Damage: 2D4x10 (single blast); 4D4x10, (double blast). Rate of Fire: Can fire four single blasts or two double blasts per melee round. Range: 6,000 feet (1,828 m). Payload: 60 shells.

**CR-4T Laser Turret:** Mega-Damage: 6D6 M.D. Rate of Fire: Equal to the number of attacks per melee round. Range: 4,000 feet (1,220 m). Payload: Unlimited.

**Other Weapons:** CR-10S Side-Mounted Missile Launchers (2).

**Black Market Cost:** Unavailable on the Black Market.

### CTX-50 Line Backer

**Manufacturer:** Coalition States (Coalition War Campaign, p. 153).

**Class:** Heavy Tank.

**Crew:** Eight: pilot, co-pilot, communications officer, intelligence officer, gunners (4).

**Main Body M.D.C.:** 790

**Maximum Speed:** Ground: 150 mph (240 km).

**Maximum Range:** Unlimited.

**Bonuses:** None.

**C-T60 Laser Cannons (2):** Mega-Damage: 1D6x10 M.D. The cannons can not fire in tandem, although each can fire at the same target for a coordinated attack. This requires two separate rolls to strike. Rate of Fire: Equal to the number of attacks per melee round. Range: 6,000 feet (1,828 m). Payload: Unlimited.

**C-20R Rail Guns (2):** Mega-Damage: 1D6x10 M.D. (burst). These guns can not be fired in tandem, but they may both fire on the same target at the same time, requiring two strike rolls. Rate of Fire:

Equal to the number of attacks per melee round. Range: 4,000 feet (1,220 m). Payload: 6,000 rounds (150 bursts) per gun.

**Other Weapons**: C-20L Laser Turret, CR-8 Medium-Range Missile Launchers (2), Concealed Mini-Missile Launchers (2), Smoke Dispensers (2).

**Black Market Cost**: 32 million credits; unavailable on the Black Market.

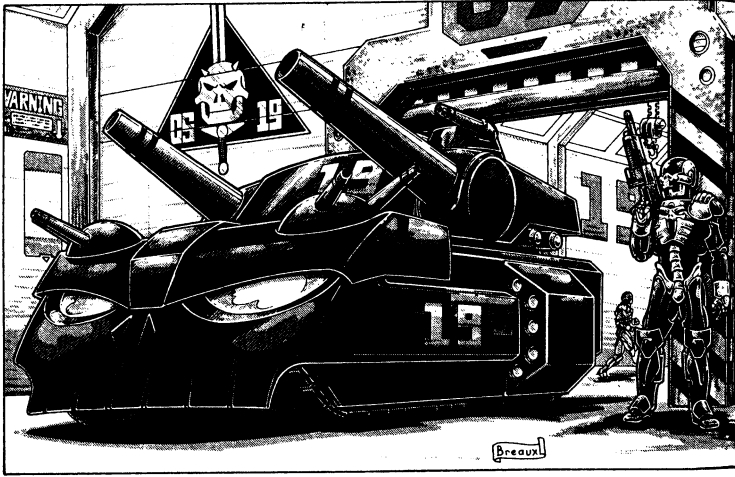

### CTX-52 Sky Sweeper

**Manufacturer**: Coalition States (*Coalition War Campaign*, p. 156).

**Class**: Anti-Aircraft Tank.

**Crew**: Five: pilot, co-pilot/gunner, gunners (2), communications officer.

**Main Body M.D.C.**: 400

**Maximum Speed**: Ground: 90 mph (144 km).

**Maximum Range**: Unlimited.

**Bonuses**: None.

**C-T60 Laser Cannons (2)**: Mega-Damage: 1D6x10 M.D. The cannons can not fire in tandem, although each can fire at the same target for a coordinated attack. This requires two separate rolls to strike. Rate of Fire: Equal to the number of attacks per melee round. Range: 6,000 feet (1,828 m). Payload: Unlimited.

**C-44 Rail Gun Turrets (2)**: Mega-Damage: 2D6x10 M.D. (burst). The guns can not fire in tandem, although each can fire at the same target for a coordinated attack. This requires two separate rolls to strike. Rate of Fire: Equal to the number of attacks per melee round. Range: 4,000 feet (1,220 m). Payload: 12,000 rounds (150 bursts) per gun.

**Other Weapons**: C-20L Double-Barreled Laser Turret, CR-8 Medium-Range Missile Launchers (2), Concealed Mini-Missile Launch Tubes (4), Smoke Dispensers (2).

**Black Market Cost**: 25 million credits; currently unavailable on the Black Market.

### CTX-54 Fire Storm Mobile Fortress

**Manufacturer**: Coalition States (*Coalition War Campaign*, p. 158).

**Class**: Super Tank.

**Crew**: 148. Command Center: 114: division commanders (4), combat officers (30), communications officers (20), crewmen (60). Death's Head Transports (2): 34 total; 17 per transport: pilot, co-pilots (2), communications engineers (2), technical officers (2), crewmen (10).

**Troop Payload**: Common troop mixes include: Six Skull Smashers OR six Spider-Skull Walkers OR ten Glitter Boy Killers OR 40 Scout Spider-Skull Walkers OR 40 Hellraisers OR 40 Hellfires OR CS Cyborg Strike Troopers OR 40 Terror Trooper Commandos or CS Juicers OR 40 troops with Scout Rocket Cycles or Warbird Rocket Cycles OR 80 Special Forces Troops OR 160 SAMAS troops (any kind) OR 160 infantry soldiers.

**Main Body M.D.C.**: 5,000 (main body command center); 2,000 (main body command deck); 1,000 (each transport section).

**Maximum Speed**: Flight: 180 mph (288 km). Max altitude is 1,000 feet (305 m).

**Maximum Range**: Unlimited.

**Bonuses**: None.

**C-2000 Super Rail Cannons (2)**: Mega-Damage: 1D4x100 (single blast) or 2D6x100 (double blast). Double blasts can not be directed at targets less than 60 feet (18.3 m) in size. Rate of Fire: Eight blasts per melee round; four blasts per cannon. Range: Two miles (3.2 km). Payload: 2,000 blasts; 1,000 per cannon.

**C-300DH Rail Gun Turrets (2)**: Mega-Damage: 3D4x100 M.D. Rate of Fire: Equal to the number of attacks per melee round. Range: Two miles (3.2 km). Payload: 100,000 rounds (100 bursts) per gun.

**Other Weapons**: C-60T Deck Laser Turret, Long-Range Missile Battery, Medium-Range Missile Battery, C-2T Dual Laser Turrets (24).

**Black Market Cost**: Estimated to be over one billion credits. The Black Market might as well forget about trying to sell one of these puppies.

### MLRS Mark IX

**Manufacturer**: Coalition States (*Mercenaries*, p. 148).

**Class**: Mobile Missile Platform.

**Crew**: Six: pilot, commander/gunner, sensors operator, communications operator, gunners (2).

**Main Body M.D.C.**: 350

**Maximum Speed**: Ground: 90 mph (144 km).

**Maximum Range**: Unlimited.

**Bonuses**: None.

**MLRS**: Mega-Damage: Varies with missile type. Rate of Fire: Single shot or volleys of two, three, four, six, or eight. Can fire up to three volleys per melee. Range: 500 miles (800 km). Payload: 160 missiles (20 full volleys). Supply trucks that carry 160 missiles can transfer them to the Mark IX in 10 minutes.

**C-2T Dual Laser Turrets (4)**: Mega-Damage: 4D6 M.D. Rate of Fire: Up to six times per melee. Range: 4,000 feet (1,220 m). Payload: Unlimited.

**Other Weapons**: CR-10 Mini-Missile Launchers (2), Forward Auto-Cannons (2).

**Black Market Cost**: Unavailable on the Black Market.

## Heavy Commercial Ground Vehicles

*Note*: See *Hovercycles & Rocket Bikes* in their own section.

### Australia: MT-6000 Crawler

**Manufacturer**: Australian Tech-Cities (*Australia*, p. 215).

**Class**: All-Terrain Vehicle.

**Crew**: Four: driver, communications engineer/navigator, gunner, soldier escort.

**Main Body M.D.C.**: 440

**Maximum Speed**: Ground: 100 mph (160 km); 80 mph (128 km) off-road.

**Maximum Range**: 500 miles (800 km); unlimited if nuclear.

**Bonuses**: None.

**Pop-Up Missile Launcher**: Mega-Damage: 6D6x10 M.D. (plasma). Rate of Fire: Single shots or volleys of 2, 4 or 8. Range: One mile (1.6 km). Payload: 24.

**Main Gun (Particle Beam)**: Mega-Damage: 1D6x10 M.D. Rate of Fire: Equal to the number of attacks per melee round. Range: 2,000 feet (610 m). Payload: Unlimited.

**Other Weapons**: The Crawler can accommodate up to two additional weapons.

**Black Market Cost**: 940,000 Australian dollars or credits.

## Australia: NT-1200 Devil 4x4

**Manufacturer:** Australian Tech-Cities (Australia, p. 214).

**Class:** All-Terrain Vehicle.

**Crew:** Three: driver, gunner, communications officer. Up to seven passengers.

**Main Body M.D.C.:** 225

**Maximum Speed:** Ground: 140 mph (224 km); 110 mph (176 km) off-road.

**Maximum Range:** 300 miles (480 km); unlimited if nuclear.

**Bonuses:** None.

**Pop-Up Grenade Launcher:** Mega-Damage: 5D6 M.D. Rate of Fire: Single shot or volleys of two or four. Range: 500 feet (15.2 m). Payload: 42 grenades.

**Rail Gun:** Mega-Damage: 4D6 M.D. (burst). Rate of Fire: Equal to the number of attacks per melee round. Range: 3,000 feet (914 m). Payload: 1,440 rounds (120 bursts).

**Other Weapons:** The Devil can accommodate up to two additional weapons.

**Black Market Cost:** 180,000 Australian dollars or credits for civilian (unarmed) models; 490,000 for military (armed) versions.

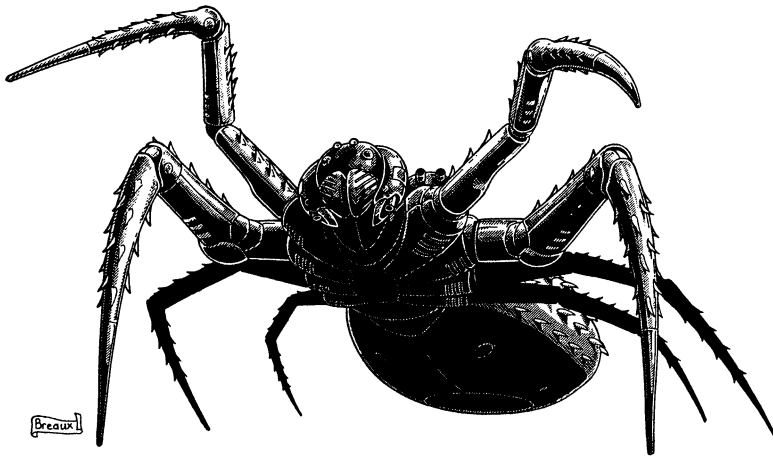

## Bandito Arms: R-100 Tarantula

(a.k.a. NG Spider)

**Manufacturer:** Bandito Arms. Also produced by Northern Gun (New West, p. 194).

**Class:** All-Terrain Vehicle – Walker/crawler type vehicle.

**Crew:** Two: pilot and co-pilot/gunner. Can hold up to three passengers.

**Main Body M.D.C.:** 200 (main body); 300 (abdomen).

**Maximum Speed:** Ground: 100 mph (160 km). Leaping: 30 feet (9 m) across and 10 feet (3 m) high.

**Maximum Range:** Unlimited.

**Bonuses:** None.

**Mandible Rail Guns (2):** Mega-Damage: 1D4x10 M.D. (single burst); 2D4x10 M.D. (double burst). Rate of Fire: Equal to the number of attacks per melee round. Range: 4,000 feet (1,220 m). Payload: 2,400 rounds (60 bursts) per gun.

**Bandito I88 Dual Ion Cannon:** Mega-Damage: 4D6 M.D. (single shot); 8D6 M.D. (double shot). Rate of Fire: Equal to the number of attacks per melee round. Range: 1,000 feet (305 m). Payload: Unlimited.

**Other Weapons:** MML24 Mini-Missile System (2).

**Black Market Cost:** 18 million credits; 14 million without weapons.

## Big Boss A.T.V.

**Manufacturer:** Generic/Black Market (Rifts® Ultimate Ed., p. 266).

**Class:** All-Terrain Dune Buggy.

**Crew:** One pilot, three passengers.

**Main Body M.D.C.:** 65

**Maximum Speed:** 150 mph (240 km).

**Maximum Range:** 300 miles (480 km).

**Weapons:** Virtually any light vehicular weapon can be mounted, from rail guns, to mini-missile launchers, to light energy weapons. Only one weapons hard point.

**Black Market Cost:** 24,000 credits (gasoline engine); 28,000 credits (electric engine).

## Kittani: Creax Armored Rover

**Manufacturer:** Kittani (Atlantis, p. 147).

**Class:** Strategic Robot Vehicle Land Rover.

**Crew:** Three; pilot, communications operator and assistant/field scientist.

**Main Body M.D.C.:** 500

**Maximum Speed:** 40 mph (64 km).

**Maximum Range:** Unlimited.

**Bonuses:** +1 to strike with all ranged weapons.

**Double-Barreled Light Laser:** Mega-Damage: 2D6 M.D. (single blast); 4D6 M.D. (double blast). Rate of Fire: Equal to the number of attacks per melee round. Range: 2,000 feet (610 m). Payload: Unlimited.

**Fixed Forward Auto-Gun Pods:** Mega-Damage: 3D6 M.D. (single burst); 6D6 M.D. (double burst). Rate of Fire: Equal to the number of attacks per melee round. Range: 2,000 feet (610 m). Payload: 100 bursts.

**Other Weapons:** Detachable Robot Claw.

**Black Market Cost:** 20 million credits.

## Kittani: Insecton Land Rover

**Manufacturer:** Kittani (Atlantis, p. 145).

**Class:** Strategic Robot Vehicle Land Rover.

**Crew:** Three; pilot, co-pilot, communications operator/gunner.

**Main Body M.D.C.:** 600 (upper main body/shell); 500 (lower main body/underbody).

**Maximum Speed:** 100 mph (160 km).

**Maximum Range:** Unlimited.

**Bonuses:** +1 to strike with all ranged weapons.

**Particle Beam Turrets (2):** Mega-Damage: 1D4x10 M.D. (single blast); 2D4x10 M.D. (double blast). Rate of Fire: Up to six blasts per melee, per gun. Range: 2,000 feet (610 m). Payload: Unlimited.

**Mini-Missile Pod:** Mega-Damage: 1D4x10 M.D. (armor piercing); 1D6x10 M.D. (plasma). Rate of Fire: Single shot or volleys of two, three or four. Range: One mile (1.6 km). Payload: 32.

**Other Weapons:** Single-Barreled Light Lasers (2), Tri-Barrel Light Lasers (2), Twin-Barrel Pulse Cannon.

**Black Market Cost:** 120 million credits.

## Kittani: K-ATV Hover Land & Water Skimmer

**Manufacturer:** Kittani (Atlantis, p. 157).

**Class:** Hover Vehicle.

**Crew:** Pilot and three passengers.

**Main Body M.D.C.:** 120

**Maximum Speed:** Flight: 260 mph (416 km); max altitude is 400 feet (122 m).

**Maximum Range:** Unlimited.

**Black Market Cost:** 1.4 million credits.

## Kittani: K-GTRV Hover Land Skimmer

**Manufacturer:** Kittani (Atlantis, p. 156).

**Class:** Robot Hover Car.

**Crew:** Pilot and one passenger.

**Main Body M.D.C.:** 200

**Maximum Speed:** Ground: 40 mph (64 km). Flight: 570 mph (912 km).

**Maximum Range:** Unlimited.

**Bonuses:** +1 attack per melee, +2 to dodge.

**Light Lasers:** Mega-Damage: 2D6 M.D. Rate of Fire: Equal to the number of attacks per melee round. Range: 2,000 feet (610 m). Payload: Unlimited.

**Black Market Cost:** 2.1 million credits.

## Kittani: K-GTV Hover Land Skimmer

**Manufacturer:** Kittani (Atlantis, p. 157).

**Class:** Hover Car.

**Crew:** Pilot and three passengers.

**Main Body M.D.C.:** 100

**Maximum Speed:** Flight: 300 mph (480 km); max altitude is 500 feet (152 m).

**Maximum Range:** Unlimited.

**Black Market Cost:** 1.1 million credits.

## Kittani: KY-HSS Slaver Raider (land & sea)

See stats in the Boat Section. Mainly a water craft.

## Legion 2/20 Snowmobile

**Manufacturer:** Tundra Rangers, Northern Gun (Canada, p. 188).

**Class:** Snowmobile.

**Crew:** One, plus one passenger.

**Main Body M.D.C.:** 85

**Maximum Speed:** Ground: 100 mph (160 km). Leaping: 15 feet (4.6 m).

**Maximum Range:** 250 miles (400 km); unlimited if nuclear.

**Bonuses:** None.

**Black Market Cost:** 45,000 to 60,000 credits (combustion; one million credits if nuclear).

## Mountaineer A.T.V.

**Manufacturer:** Generic/Black Market (Rifts® Ultimate Ed., p. 266).

**Class:** Armored All-Terrain Vehicle.

**Crew:** One pilot, three passengers plus cargo area.

**Main Body M.D.C.:** 140

**Maximum Speed:** 120 mph (192 km).

**Maximum Range:** 600 miles (960 km).

**Weapons:** Virtually any light vehicular weapon can be mounted, from rail guns, to mini-missile launchers, to light energy weapons. Only one weapons hard point.

**Black Market Cost:** 64,000 credits (gasoline engine); 70,000 credits (electric engine); 500,000 credits (nuclear engine).

## Robot Horses

See Rifts® World Book 14: New West™, pages 195-199.

## Typical Robot Horse (Mustang, no frills)

**Manufacturer:** Bandito Arms/Black Market (New West™, p. 197).

**Class:** Robot.

**Crew:** One pilot, one passenger plus light cargo.

**Main Body M.D.C.:** 250

**Maximum Speed:** 100 mph (160 km).

**Maximum Range:** Effectively unlimited; 15 year life.

**Weapons:** None, other than kicks and head butts.

**Black Market Cost:** 5.2 million credits (nuclear engine).

# Hovercycles & Rocket Bikes

## Africa: Phoenix Sand Skimmer (military)

**Manufacturer:** Phoenix Empire (Africa, p. 138).

**Class:** Hover Jet Vehicle/Rocket (borderline aircraft).

**Crew:** Pilot and two passengers.

**Main Body M.D.C.:** 250

**Maximum Speed:** Flight: 660 mph (1,056 km); max altitude is 1,000 feet (305 m).

**Maximum Range:** Unlimited.

**Bonuses:** +5% on piloting skill, +1 attack per melee, +3 on initiative, +3 to strike, +6 to dodge.

**Pulse Cannon:** Mega-Damage: 2D6 M.D. (single shot); 1D4x10 M.D. (multiple pulse). Rate of Fire: Equal to the number of attacks per melee round. Range: 4,000 feet (1,220 m). Payload: Unlimited.

**Concealed Mini-Missile Launcher:** Mega-Damage: 1D4x10 M.D. (armor piercing) or 1D6x10 M.D. (plasma). Rate of Fire: Single shot or a volley of two. Range: One mile (1.6 km). Payload: Two.

**Black Market Cost:** 6.5 million credits.

## Bronco Scooter

**Manufacturer:** Bandito Arms (New West, p. 201).

**Class:** Hovercycle that resembles a horse in its appearance.

**Crew:** One.

**Main Body M.D.C.:** 110

**Maximum Speed:** Flight: 190 mph (304 km); max altitude is 60 feet (18.3 m).

**Maximum Range:** 800 miles (1,280 km).

**Bonuses:** +1 to dodge.

**Weapons:** Any standard hovercycle weapon can be added on at extra cost. The Bronco Scooter can handle up to two weapon systems.

**Black Market Cost:** 146,000 credits (combustion engine); 162,000 (electric).

## CS AFC-033 Wind Jammer Sky Cycle

See Coalition States.

## CS AFC-111 Scout Rocket Bike

See Coalition States.

## CS AFC-115 Warbird Rocket Bike

See Coalition States.

## Free Quebec: QV-229 Bobcat Hovercycle

**Manufacturer:** Free Quebec (Free Quebec, p. 55).

**Class:** Hovercycle.

**Crew:** One.

**Main Body M.D.C.:** 180

**Maximum Speed:** Flight: 440 mph (704 km); max altitude is 2,500 feet (762 m).

**Maximum Range:** Unlimited range, but can fly only twelve hours straight before overheating.

**Bonuses:** Elite RPA SAMAS pilots and RPA Fly Boys get a bonus of +2 on initiative and +2 attacks per melee when piloting a Bobcat.

**QL-22 Double-Barreled Laser Turret:** Mega-Damage: 3D6 M.D. (single blast); 6D6 M.D. (double blast). Rate of Fire: Equal to the number of attacks per melee round. Range: 2,000 feet (610 m). Payload: Unlimited.

**Light Rail Gun:** Mega-Damage: 1D4x10 M.D. (burst). Rate of Fire: Equal to the number of attacks per melee round. Range: 4,000 feet (1,220 m). Payload: 4,000 rounds (100 bursts).

**Other Weapons:** QR-10 Concealed Mini-Missile Launchers (2).

**Black Market Cost:** 850,000 credits for a knock-off with lower speed, M.D.C. and weapons; a real Bobcat would go for at least one million credits.

## Kittani: Hover Pods: War Pod (HV-MPC-216)

### And Kittani Hover Speed Pod HV-MPC-113 (one-man version)

**Manufacturer:** Kittani (Splynn Dimensional Market, p. 185)

**Class:** Hover Pod.

**Crew:** One or Two: pilot and gunner.

**Main Body M.D.C.:** 100

**Maximum Speed:** Hovering: Mach 2/1,400 mph (2,240 km); max altitude is 200 feet (61 m). Limited Flight: 300 mph (480 km); max altitude is 6,000 feet (1,828 m).

**Maximum Range:** Unlimited range and flight endurance.

**Bonuses:** +2 to automatic dodge at cruising speed or slower, +5 to dodge when flying above cruising speed.

**Under-Gun Laser:** Mega-Damage: 3D6 M.D. (single blast); 6D6 M.D. (double blast). Rate of Fire: Equal to the number of attacks

per melee round. Range: 2,000 feet (610 m). Payload: 100 twin blasts per hour.

**Top Mounted Particle Beams:** Mega-Damage: 1D4x10+4 M.D. (single blast); 2D4x10+8 M.D. (double blast). Rate of Fire: Equal to the number of attacks per melee round. Range: 2,000 feet (610 m). Payload: 60 twin blasts per hour; regenerates.

**Other Weapons:** Optional Mini-Missile Launcher (one-man variant only).

**Black Market Cost:** 4.2 million credits.

### Legion 50/50 Arctic Hovercycle

**Manufacturer:** Tundra Rangers (Canada, p. 188).

**Class:** Hovercycle (Arctic).

**Crew:** One.

**Main Body M.D.C.:** 120

**Maximum Speed:** Flight: 100 mph (160 km); max altitude is 50 feet (15.2 m).

**Maximum Range:** 300 miles (480 km); unlimited if nuclear.

**Bonuses:** None.

**Forward Laser:** Mega-Damage: 4D6 M.D. Rate of Fire: Equal to the number of attacks per melee round. Range: 1,600 feet (487 m). Payload: Unlimited.

**Black Market Cost:** 90,000 to 120,000 credits (combustion); 1.1 million credits (nuclear).

### Legion SOL Flying Arsenal Hovercycle

**Manufacturer:** Tundra Rangers (Canada, p. 189)

**Class:** Hovercycle Weapons Platform

**Crew:** One plus 2-3 passengers; up to 8-10 passengers can climb on when the platform is fully armed, but they will be in for a rough ride.

**Main Body M.D.C.:** 160

**Maximum Speed:** Flight: 50 mph (80 km); max altitude is 50 feet (15.2 m).

**Maximum Range:** 300 miles (480 m); unlimited if nuclear.

**Massive Medium-Range Missile:** Mega-Damage: 4D6x10 M.D. Rate of Fire: One shot only. Range: 40 miles (64 km). Payload: One.

**Short-Range Missiles (2):** Mega-Damage: 2D4x10 M.D. Rate of Fire: Single shot. Range: 3 to 5 miles (4.8 to 8 km). Payload: Two.

**Other Weapons:** Forward Laser, Nose-Mounted Rail Gun, Mini-Missiles, Main Laser Cannon, Silver Spears (2).

**Black Market Cost:** Undetermined. None have yet made it to the Black Market. They are, in essence, a disposable vehicle. Or a highly mobile weapon, whichever way one chooses to see it.

### Manistique: MI-1010 Desert Fox Hovercycle

**Manufacturer:** Manistique Imperium (Lone Star, p. 56).

**Class:** Hovercycle.

**Crew:** Pilot and one passenger.

**Main Body M.D.C.:** 65

**Maximum Speed:** Flight: 170 mph (272 km); max altitude is 80 feet (24.4 m).

**Maximum Range:** 700 miles (1,120 km).

**Bonuses:** +10% to piloting skill.

**Weapons:** Weapons do not come standard with this bike, but there is room enough to mount a single light weapon (light rail gun, laser cannon, mini-missile launcher, etc.).

**Black Market Cost:** 90,000 credits (combustion engine); 105,000 credits (electric engine).

### Manistique: MI-3000 Firefly Hovercycle

**Manufacturer:** Manistique Imperium (Lone Star, p. 55).

**Class:** Hovercycle.

**Crew:** Pilot and one passenger.

**Main Body M.D.C.:** 72

**Maximum Speed:** Flight: 190 mph (304 km); max altitude is 60 feet (18.3 m).

**Maximum Range:** 800 miles (1,280 km).

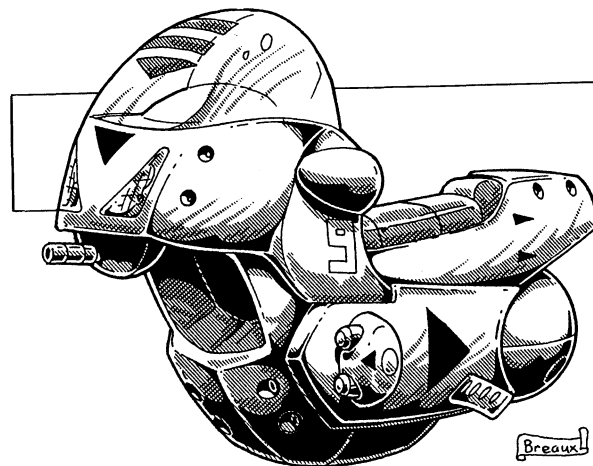

**Bonuses:** None.

**Double-Barreled Heavy Laser:** Mega-Damage: 2D6 M.D. (single shot); 4D6 M.D. (double shot). Rate of Fire: Equal to the number of attacks per melee round. Range: 2,000 feet (610 m). Payload: 40 single shots or 20 double shots.

**Mini-Missile Launchers (2):** Mega-Damage: 1D4x10 M.D. (armor piercing) or 1D6x10 M.D. (plasma). Rate of Fire: Single shot or volleys of two. Range: One mile (1.6 km). Payload: 4; two per launcher.

**Other Weapons:** Laser, Heavy Laser.

**Black Market Cost:** 148,000 credits (combustion engine); 164,000 (electric engine).

### NG-220 Rocket Hovercycle

**Manufacturer:** Northern Gun (Lone Star, p. 57).

**Class:** Hovercycle.

**Crew:** Pilot and one passenger.

**Main Body M.D.C.:** 84

**Maximum Speed:** Flight: 340 mph (544 km); max altitude is 1,000 feet (305 m).

**Maximum Range:** 600 miles (960 km) with combustion or electric engine; unlimited with nuclear engine.

**Bonuses:** -15% to pilot skill and -30% to pilot skill when making special moves. What can we say? This thing handles like a brick.

**Concealed Ion Guns:** Mega-Damage: 3D6 M.D. (single fire); 6D6 M.D. (double fire). Rate of Fire: Equal to the number of attacks per melee round. Range: 500 feet (152 m). Payload: 60 shots each.

**Other Weapons:** Other optional weapons packages include Light Laser, Heavy Laser, Machine-gun, Dual Mini-Missile Launchers, and a Mini-Missile Pod. A total of three laser weapons (or two machine-guns) and four dual mini-missile launchers or two mini-missile pods can be installed. If the lasers or machine-guns are removed, another two dual launchers and two mini-missile pods can be installed.

**Black Market Cost:** 120,000 credits (combustion engine); 135,000 credits (electric engine); 675,000 credits (nuclear engine).

### NG-230 Prowler Hovercycle

**Manufacturer:** Northern Gun (Lone Star, p. 58).

**Class:** Hovercycle.

**Crew:** One.

**Main Body M.D.C.:** 80

**Maximum Speed:** Flight: 190 mph (304 km); max altitude is 700 feet (213 m).

**Maximum Range:** 900 miles (1,440 km).

**Bonuses:** +5% to pilot skill.

**Heavy Laser:** Mega-Damage: 2D6 M.D. Rate of Fire: Equal to the number of attacks per melee round. Range: 2,000 feet (610 m). Payload: 40 single shots.

**Other Weapons:** Additional weapons packages include Light Laser,

Heavy Laser, Dual Mini-Missile Launchers.

**Black Market Cost:** 182,000 credits (combustion engine); 195,000 credits (electric); 875,000 (nuclear).

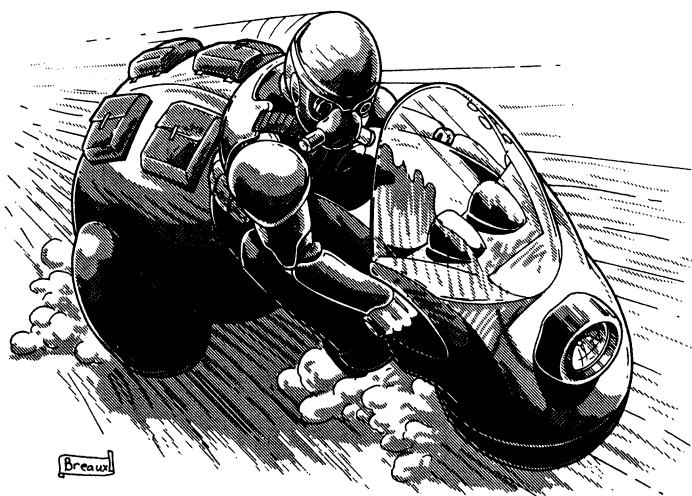

### NG-300 Speedster Hovercycle

**Manufacturer:** Northern Gun (Lone Star, p. 54).

**Class:** Hovercycle.

**Crew:** Pilot and one passenger.

**Main Body M.D.C.:** 75

**Maximum Speed:** Flight: 220 mph (352 km); max altitude is 120 feet (36.5 m).

**Maximum Range:** 800 miles (1,280 km).

**Bonuses:** None.

**Weapons:** Weapons do not come standard with this bike, but there is room enough to mount a single light weapon (light rail gun, laser cannon, mini-missile launcher, etc.)

**Black Market Cost:** 98,000 credits (combustion engine); 110,000 credits (electric engine); 450,000 credits (nuclear engine).

### NG-400 Stinger Hovercycle

**Manufacturer:** Northern Gun (Lone Star, p. 59).

**Class:** Hovercycle.

**Crew:** One.

**Main Body M.D.C.:** 90

**Maximum Speed:** Flight: 250 mph (400 km); max altitude is 200 feet (61 m).

**Maximum Range:** 800 miles (1,280 km); unlimited if nuclear.

**Bonuses:** -5% to pilot skill.

**Weapons:** This cycle supports a variety of weapons packages, including Light Laser, Heavy Laser, Double-Barreled Heavy Laser, Machine-gun, Dual Machine-gun & Heavy Laser, Dual Mini-Missile Launchers, and Mini-Missile Pod.

**Black Market Cost:** 180,000 credits (combustion); 200,000 credits (electric); 795,000 credits (nuclear).

### NG-480 Turbo Hovercycle

**Manufacturer:** Northern Gun.

**Class:** Hovercycle.

**Crew:** Pilot and one passenger.

**Main Body M.D.C.:** 92

**Maximum Speed:** Flight: 220 mph (352 km); max altitude is 400 feet (122 m).

**Maximum Range:** 800 miles (1,280 km); unlimited if nuclear.

**Bonuses:** +1 to dodge, +5% to pilot skill, -10% to pilot skill when pulling special moves like jumps and crazy turns.

**Double-Barreled Heavy Ball Laser:** Mega-Damage: 2D6 M.D. (single shot); 4D6 M.D. double shot. Rate of Fire: Equal to the number

of attacks per melee round. Range: 2,000 feet (610 m). Payload: 120 single shots; 60 double shots.

**Other Weapons:** Other optional weapons packages include Light Laser, Heavy Laser, Double-Barreled Heavy Laser, Machine-gun, Dual Mini-Missile Launchers, Mini-Missile Pod. Up to two additional weapons can be installed.

**Black Market Cost:** 225,000 credits (combustion engine); 240,000 credits (electric); 850,000 credits (nuclear).

### Russian Hovercycles

See **Landflier Hovercycle**, **Novyet Arctic Hoverbike**, and **Warrior AH Assault Hoversled** under the heading of Russian Vehicles.

### Triax/Germany: WR-2020 Shark Hovercycle

**Manufacturer:** Generic NGR (Triax & NGR, p. 139).

**Class:** Hovercycle.

**Crew:** One pilot, one passenger.

**Main Body M.D.C.:** 80

**Maximum Speed:** Hovering: 280 mph (448 km).

**Maximum Range:** 500 miles (800 km); unlimited if nuclear.

**Bonuses:** None.

**Weapons:** The WR-2020 can accommodate up to one light weapons mount (light laser, rail gun, mini-missile launcher, etc.).

**Black Market Cost:** 65,000 credits (gas or electric); 2.065 million (nuclear).

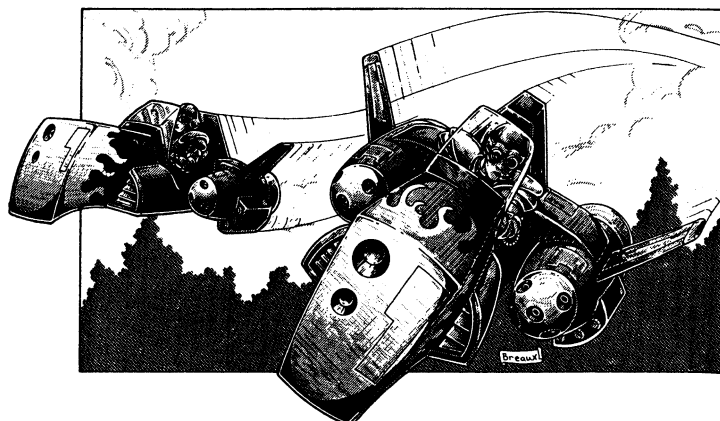

### Wellington: AHB-2000 Assault

#### Hover (Rocket) Bike

**Manufacturer:** Wellington Industries (Juicer Uprising, p. 85).

**Class:** Rocket Bike.

**Crew:** One.

**Main Body M.D.C.:** 190

**Maximum Speed:** Flight: 300 mph (480 km); max altitude is 5,000 feet (1,524 m).

**Maximum Range:** 12 hours at max speed, twice that at half speed.

**Bonuses:** None.

**Particle Beam Guns (2):** Mega-Damage: 5D6 M.D. (single blast); 1D6x10 M.D. (double blast). Rate of Fire: Equal to the number of attacks per melee round. Range: 1,600 feet (488 m). Payload: Unlimited.

**Laser Pods (2):** Mega-Damage: 5D6 M.D. (one pod); 1D6x10 M.D. (both pods). Rate of Fire: Equal to the number of attacks per melee round. Range: 6,000 feet (1,828 m). Payload: Unlimited.

**Other Weapons:** Mini-Missile Launchers (2).

**Black Market Cost:** 900,000 credits.



# Jet Packs

## Legion-90 Sky Pack

**Manufacturer:** Tundra Rangers (Canada, p. 188).

**Class:** Jet Pack.

**Crew:** One.

**Main Body M.D.C.:** 22

**Maximum Speed:** Flight: 90 mph (144 km); max altitude is 1,000 feet (305 m).

**Maximum Range:** 700 miles (1,120 km); unlimited if nuclear but can not fly for more than six hours straight without overheating.

**Bonuses:** None.

**Black Market Cost:** 30,000 credits (combustion); 50,000 (electrical); 400,000 (nuclear).

## Wilk's Jet Pack

**Manufacturer:** Wilk's Laser Industries (Rifts® Ultimate Ed., p. 267).

**Class:** Personal Jet Pack.

**Crew:** One.

**Main Body M.D.C.:** 20

**Maximum Speed:** 120 mph (192 km).

**Maximum Range:** 800 miles (1,280 km).

**Black Market Cost:** 38,000 credits (gasoline engine); 50,000 credits (electric engine); 250,000 credits (nuclear engine).

## Falcon 300 Jet Pack

A popular mainstream jet pack used by mercenaries and adventurers.

**Manufacturer:** Northern Gun, Manistique, Triax, and the Black Market (Rifts® Sourcebook One Revised, p. 51).

**Class:** Personal Jet Pack.

**Crew:** One.

**Main Body M.D.C.:** 18

**Maximum Speed:** 120 mph (192 km).

**Maximum Range:** 700 miles (1,120 km).

**Black Market Cost:** 30,000 credits (gasoline engine); 46,000 credits (electric engine); 400,000 credits (nuclear engine).

## Triax T-100 Eagle Military Jet Pack

**Manufacturer:** Triax (Triax and the NGR, p. 34).

**Class:** Personal Jet Pack.

**Crew:** One.

**Main Body M.D.C.:** 30

**Maximum Speed:** 200 mph (320 km)

**Maximum Range:** 1000 miles (1,600 km).

**Black Market Cost:** 500,000-600,000 credits (nuclear engine only). Northern Gun has recently begun selling a knock-off in North America.

# Military Vehicles

## Tanks, APCs & Other Armored War Machines

### Africa: Phoenix Sand Crawler

**Manufacturer:** Phoenix Empire (Africa, p. 139).

**Class:** Hover Vehicle.

**Crew:** Pilot and two passengers.

**Main Body M.D.C.:** 280

**Maximum Speed:** Flight: 180 mph (288 km); max altitude is 10 feet (3 m).

**Maximum Range:** Unlimited.

**Bonuses:** +1 on initiative, +1 to strike, +3 to dodge, prwl 50%.

**Double-Barreled Pulse Cannon:** Mega-Damage: 1D4x10 M.D. (single barrel); 2D4x10 M.D. (double barrel). Rate of Fire: Equal to the number of attacks per melee round. Range: 4,000 feet (1,220 m). Payload: Unlimited.

**Dual Light Lasers and Ion Blaster:** Mega-Damage: 2D6 M.D. (single laser blast); 4D6 M.D. (double laser blast); 6D6 M.D. (ion blast).

Rate of Fire: Equal to the number of attacks per melee round.

Range: 2,000 feet (610 m) for lasers, 1,000 feet (305 m) for ion.

Payload: Unlimited.

**Black Market Cost:** Two million credits.

## Arkhn: A-73 "Evil Eye" Military APC

**Manufacturer:** Arkhn (South America Two, p. 95).

**Class:** Armored Personnel Carrier.

**Crew:** Three: pilot and two gunners. Can carry up to 12 troops.

**Main Body M.D.C.:** 400.

**Maximum Speed:** Ground: 200 mph (320 km).

**Maximum Range:** Unlimited.

**Bonuses:** None.

**"Evil Eye" Particle Beam Irradiator:** Mega-Damage: 4D6 M.D. to a 30 foot (9.1 m) area, plus another 3D6 M.D. radiation damage. Rate of Fire: Equal to the number of attacks per melee round, but each shot counts as two attacks. Range: 200 feet (61 m). Payload: Unlimited.

**Pintel-Mounted Tri-Beam:** Mega-Damage: 1D4x10+10 M.D., double damage to everything except energy/force fields and Arkhn composite armor. Rate of Fire: Equal to the number of attacks per melee round. Range: 3,000 feet (914 m). Payload: Unlimited.

**Other Weapons:** Mini-Missile Launchers (2).

**Black Market Cost:** Not for sale; unavailable thus far through illicit channels.

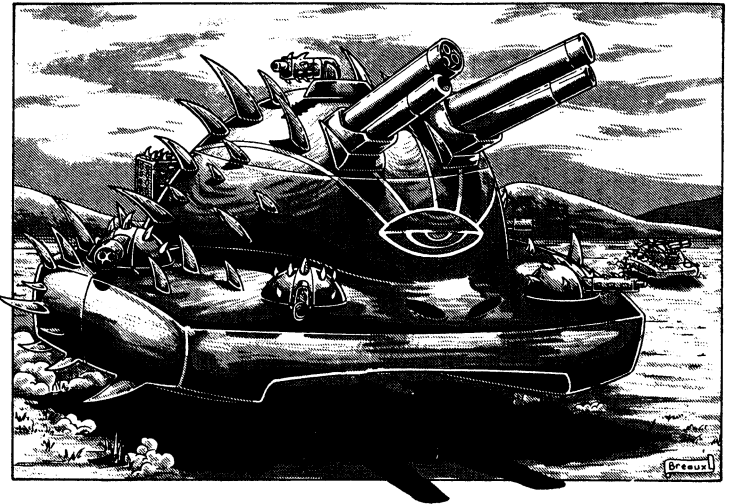

## Arkhn: T-10 "Porcupine" Tank

**Manufacturer:** Arkhn (South America 2, p. 93).

**Class:** Main Battle Tank.

**Crew:** Six: commander, driver, four gunners.

**Main Body M.D.C.:** 600

**Maximum Speed:** Ground: 200 mph (320 km).

**Maximum Range:** Unlimited.

**Bonuses:** None.

**Double Cannons (2):** Mega-Damage: 2D4x10 M.D. (Tri-Beam Cannon); 3D4x10 M.D. (Conventional Cannon). Rate of Fire: Each over-and-under gun can fire twice per melee. Range: 4,000 feet (1,220 m) for Tri-Beam Cannon; 10,000 feet (3,048 m) for Conventional Cannon. Payload: Unlimited for Tri-Beam, 30 shots per Conventional Cannon (60 total).

**Flechette Gun Cupola:** Mega-Damage: 1D4x10+10 M.D. (burst). Rate of Fire: Equal to the number of attacks per melee round. Range: 3,000 feet (914 m). Payload: 600 rounds (200 bursts).

**Other Weapons:** Tri-Beam Mini-Turrets (2), Flechette Gun Mini-Turrets (2), Mini-Missile Turret.

**Black Market Cost:** 10-20 million credits; almost never available, and when it is, it will be seriously stripped or damaged.

## Free Quebec: QV-119 Cougar Jeep

**Manufacturer:** Free Quebec (Free Quebec, p. 53).

**Class:** Hover Jeep.

**Crew:** Two: pilot and co-pilot/gunner.

**Main Body M.D.C.:** 228

**Maximum Speed:** Flight: 220 mph (352 km); max altitude is 800 feet (244 m).

**Maximum Range:** Unlimited.

**Bonuses:** None.

**Nose Laser Turret:** Mega-Damage: 2D6 M.D. (single pulse); 6D6 M.D. (triple pulse). Rate of Fire: Equal to the number of attacks per melee round. Range: 2,000 feet (610 m). Payload: Unlimited.

**Forward Lasers (2):** Mega-Damage: 2D6 M.D. (single blast); 4D6 M.D. (dual blast). Rate of Fire: Equal to the number of attacks per melee round. Range: 2,000 feet (610 m). Payload: Unlimited.

**Other Weapons:** Mini-Missile Launchers (2), Modular Weapon Mount, Various Special Features.

**Black Market Cost:** 1.5 million credits. Knock-off versions are available for as low as 1.1 million credits.

## Iron Heart: IH-1B Iron Hammer Tank

**Manufacturer:** Iron Heart Armaments (Mercenaries, p. 107).

**Class:** Main Battle Tank.

**Crew:** Four: driver, commander, gunners (2).

**Main Body M.D.C.:** 650

**Maximum Speed:** Ground: 60 mph (96 km).

**Maximum Range:** 600 miles (960 km); unlimited if nuclear.

**Bonuses:** None.

**200mm IH-B Auto-Cannon:** Mega-Damage: 3D6x10 M.D. Rate of Fire: Twice per melee round. Range: 6,000 feet (1,828 m). Payload: 80 rounds.

**IH-100 Rail Gun:** Mega-Damage: 1D6x10 M.D. (burst). Rate of Fire: Equal to the number of attacks per melee round. Range: 4,000 feet (1,220 m). Payload: 12,000 rounds (200 bursts).

**Other Weapons:** IH-105 Rail Gun, IH-44L Vulcan Laser, Medium-Range Missile Launchers (2).

**Black Market Cost:** 4 million credits (gasoline); 6 million credits (electric); 35 million credits (nuclear).

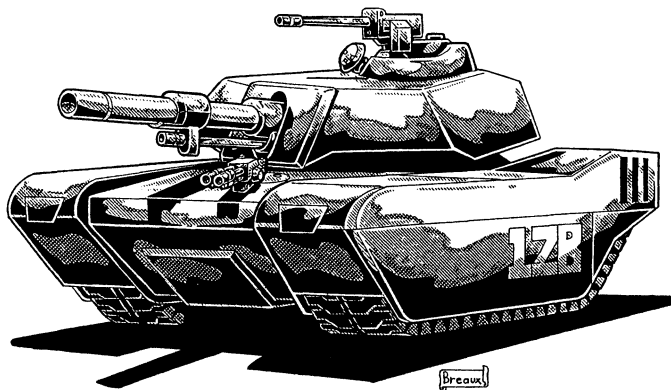

## Iron Heart: IH-12B Iron Fist Tank

**Manufacturer:** Iron Heart Armaments (Mercenaries, p. 109).

**Class:** Medium Tank.

**Crew:** Three: driver, gunner, commander.

**Main Body M.D.C.:** 450

**Maximum Speed:** Ground: 65 mph (104 km).

**Maximum Range:** 600 miles (960 km); unlimited if nuclear.

**Bonuses:** +2 to strike.

**120mm IH-8 Auto-Cannon:** Mega-Damage: 2D6x10 M.D. to an area of 10 feet (3 m). Rate of Fire: Three attacks per melee round. Range: 6,000 feet (1,828 m). Payload: 80 rounds.

**IH-100 Rail Gun:** Mega-Damage: 1D6x10 M.D. (burst). Rate of Fire: Equal to the number of attacks per melee round. Range: 4,000 feet

(1,220 m). Payload: 12,000 rounds (200 bursts).

**Other Weapons:** IH-105 Rail Gun, IH-34L Laser Turret, Smoke/Gas Dispensers (2).

**Black Market Cost:** 2.5 million credits (gasoline); 3 million credits (electric); 23 million credits (nuclear).

## Iron Heart: IH-15 Iron Bolt Tank

**Manufacturer:** Iron Heart Armaments (Mercenaries, p. 110).

**Class:** Missile Tank.

**Crew:** Three: driver, gunner, commander.

**Main Body M.D.C.:** 450

**Maximum Speed:** Ground: 55 mph (88 km).

**Maximum Range:** 400 miles (640 km); unlimited if nuclear.

**Bonuses:** +2 to strike.

**ML-12 Long-Range Missile Systems:** Mega-Damage: Varies with missile type. Rate of Fire: Single shot or volleys of 2, 4, or 6. Range: 500 to 1,000 miles (800 to 1,600 km), depending on missile type. Payload: 12.

**MLRS-120 Multiple Launcher System:** Mega-Damage: 1D4x10 M.D. (armor piercing) or 1D6x10 M.D. (plasma). Rate of Fire: Single shot or volleys of 2, 4, 6 or 10. Range: One mile (1.6 km). Payload: 120 (!).

**Other Weapons:** IH-34L Laser Turret.

**Black Market Cost:** 4 million credits (gasoline); 5 million credits (electric); 23 million (nuclear). Missiles cost extra.

## Iron Heart: IH APC-10 Iron Maiden APC

**Manufacturer:** Iron Heart Armaments (Mercenaries, p. 111).

**Class:** Armored Personnel Carrier.

**Crew:** Two: pilot and gunner. Can carry up to 10 human-sized troops.

**Main Body M.D.C.:** 320

**Maximum Speed:** Ground: 70 mph (112 km).

**Maximum Range:** 400 miles (640 km); unlimited if nuclear.

**Bonuses:** +2 to strike.

**IH-10RJ Ramjet Auto, Cannon:** Mega-Damage: 2D6x10 M.D. Rate of Fire: Equal to the number of attacks per melee round. Range: 3,000 feet (914 m). Payload: 2,000 rounds (100 bursts).

**MLRS-24 Multiple Mini-Missile Launchers (2):** Mega-Damage: 1D4x10 M.D. (armor piercing) or 1D6x10 M.D. (plasma). Rate of Fire: Single shot or volleys of 2, 4, or 6. Range: One mile (1.6 km). Payload: 48; 24 per launcher.

**Other Weapons:** IH-34L Laser Turret, Smoke/Gas Dispensers (2).

**Black Market Cost:** One million credits (gasoline); 1.3 million (electric); 14 million (nuclear).

## Kittani: Dragon Dreadnaught

**Manufacturer:** Kittani (Atlantis, p. 149).

**Class:** Strategic Infantry Assault Robot Fighter.

**Crew:** Seven; pilot, co-pilot, communications officer, four gunners.

**Main Body M.D.C.:** 2,100

**Maximum Speed:** Ground: 50 mph (80 km). Flight: Mach 5/3,700 mph (5,920 km).

**Maximum Range:** Unlimited.

**Bonuses:** +1 attack per melee, +2 to strike on all kicks, +4 to strike with ranged weapons, +1 to parry, +2 to dodge.

**The Four Dragon Heads:** Mega-Damage: 1D4x10 M.D. (bite); 1D4x10 M.D. (single plasma blast); 2D4x10 M.D. (double plasma blast). Rate of Fire: Each head can fire only two plasma blasts per melee. Biting equal to number of attacks per melee round. Range: Close combat (bite); 4,000 feet (1,220 m) (plasma). Payload: Unlimited.

**KLT Twin Barrel Pulse Cannons (4):** Mega-Damage: 5D6 M.D. (single blast); 1D6x10 M.D. (double blast); 4D6x10 (quad blast). Rate of Fire: Six shots per melee round between the four cannons. Range: 6,000 feet (1,828 m). Payload: Unlimited.

**Other Weapons:** Particle Beam Guns (8), Tail Laser, Medium-Range Missiles (8), Long-Range Missiles (16).

**Black Market Cost:** 200 billion credits, fully armed and loaded, but, since this considered a top secret weapon of Atlantis, one of these will *never* make it to an open marketplace.

### Legion Armored Snow Lion APC

**Manufacturer:** Tundra Rangers, Generic (Canada, p. 190).

**Class:** Armored Personnel Carrier.

**Crew:** Two to Four: pilot, co-pilot, gunners. Can hold up to 20 passengers.

**Main Body M.D.C.:** 300

**Maximum Speed:** Ground: 60 mph (96 km).

**Maximum Range:** 700 miles (1,120 km); unlimited if nuclear.

**Bonuses:** None.

**Side Laser Turrets (2):** Mega-Damage: 5D6 M.D. Rate of Fire: Equal to the number of attacks per melee round. Range: 2,000 feet (610 m). Payload: Unlimited.

**Top-Mounted Grenade Launchers (2):** Mega-Damage: 4D6 M.D. Rate of Fire: Equal to the number of attacks per melee round. Range: 1,600 feet (487 m). Payload: 120; 60 per launcher.

**Other Weapons:** Short-Range Missile Launcher.

**Black Market Cost:** 600,000 credits (combustion/electric); one million (nuclear). All weapons cost extra.

### Megaversal Legion: M6-IFV Neo-Bradley APC

**Manufacturer:** Megaversal Legion (South America 2, p. 119).

**Class:** Armored Personnel Carrier.

**Crew:** Two: pilot and gunner. Can carry up to 10 troops.

**Main Body M.D.C.:** 450 (plus 200 M.D. force field).

**Maximum Speed:** Ground: 300 mph (480 km).

**Maximum Range:** Unlimited.

**Bonuses:** None.

**Plasma Cannon:** Mega-Damage: 2D4x10 M.D. Rate of Fire: Equal to the number of attacks per melee round. Range: 4,000 feet (1,220 m). Payload: Unlimited.

**Coaxial Grenade Launcher:** Mega-Damage: 3D6 M.D. to a 30 foot (9.1 m) area (single grenade); 3D6+6 M.D. to 60 foot (18.3 m) area (short burst); 4D6+6 M.D. to 100 foot (30.5 m) area (long burst). Rate of Fire: Equal to the number of attacks per melee round. Range: 4,000 feet (1,220 m). Payload: 120 rounds.

**Other Weapons:** Medium-Range Missile Launchers (2), Force Field.

**Black Market Cost:** 100+ million credits, were one ever captured and put on sale. So far, none have.

### Megaversal Legion: MBT-10A1 Neo-Abrams

**Manufacturer:** Megaversal Legion (South America 2, p. 117).

**Class:** Main Battle Tank.

**Crew:** Four: Commander, driver, two gunners.

**Main Body M.D.C.:** 850 (plus 450 M.D. force field).

**Maximum Speed:** Ground: 300 mph (480 km).

**Maximum Range:** Unlimited.

**Bonuses:** None.

**120mm I-Beam Cannon:** Mega-Damage: 3D6x10 M.D. to 100 foot (30.5 m) area. Rate of Fire: Equal to the number of attacks per melee round, or three times per melee, whichever is less. Range: Two miles (3.2 km). Payload: 60 rounds.

**Coaxial Grenade Launcher:** Mega-Damage: 3D6 M.D. to 30 foot (9.1 m) area (single grenade); 3D6+6 M.D. to 60 foot (18.3 m) area (short burst); 4D6+6 M.D. to 100 foot (30.5 m) area (long burst). Rate of Fire: Equal to the number of attacks per melee round. Range: 4,000 feet (1,220 m). Payload: 120 rounds.

**Other Weapons:** Plasma Machine-gun (Cupola), Plasma Machine-gun (Bow-Mounted), Mini-Missile Launchers (2), Medium-Range Missile Launchers (2), Force Field.

**Black Market Cost:** 200+ million credits, were one ever captured and put on sale. So far, none have.

### Naruni: J-2 Juggernaut Tank

**Manufacturer:** Naruni Enterprises (Mercenaries, p. 132).

**Class:** Heavy Tank.

**Crew:** Four: pilot, gunners (2), commander. Can hold one passenger.

**Main Body M.D.C.:** 900 (plus 600 M.D.C. force field).

**Maximum Speed:** Ground: 200 mph (320 km).

**Maximum Range:** Unlimited.

**Bonuses:** None.

**Naruni Particle Beam Cannon:** Mega-Damage: 5D6x10 M.D. Rate of Fire: Equal to the number of attacks per melee round. Range: 2 miles (3.2 km). Payload: Unlimited.

**Coaxial Rail Gun:** Mega-Damage: 2D4x10 M.D. (burst). Rate of Fire: Equal to the number of attacks per melee round. Range: 6,000 feet (1,828 m). Payload: 20,000 rounds (250 bursts).

**Other Weapons:** Mini-Missile Launchers in Turret (8), Laser Battery on Cupola, Side-Mounted Medium-Range Missile Launchers (8), Bow Mounted Rail Gun.

**Black Market Cost:** 60 million credits; 80 million credits with force field.

### Naruni: N-120B Carnivore Mark I Tank

**Manufacturer:** Naruni Enterprises (Mercenaries, p. 130).

**Class:** Light Tank.

**Crew:** Two: driver and gunner.

**Main Body M.D.C.:** 400

**Maximum Speed:** Ground: 180 mph (288 km).

**Maximum Range:** Unlimited.

**Bonuses:** None.

**Particle Beam Cannon:** Mega-Damage: 1D6x10 M.D. (single shot); 3D6x10 M.D. (triple shot). Rate of Fire: Equal to the number of attacks per melee round. Range: 4,000 feet (1,220 m). Payload: 30 shots.

**Mini-Missile Launcher:** Mega-Damage: 1D4x10 M.D. (armor piercing) or 1D6x10 M.D. (plasma). Rate of Fire: Single shot or volleys of two, four or eight. Range: One mile (1.6 km). Payload: 24.

**Black Market Cost:** 40 million credits.

### New Navy: AMBT-12X Merovingian Tank

**Manufacturer:** New Navy (Underseas, p. 120).

**Class:** Amphibious Tank.

**Crew:** Three: pilot, commander/gunner and secondary gunner.

**Main Body M.D.C.:** 550

**Maximum Speed:** Ground: 70 mph (112 km). Water Surface: 50 mph (80 km).

**Maximum Range:** Unlimited.

**Bonuses:** None.

**Laser Cannon:** Mega-Damage: 2D6x10+10 M.D. Rate of Fire: Twice per melee round. Range: 6,000 feet (1,828 m). Payload: Unlimited.

**200 mm Hypervelocity Cannon:** Mega-Damage: 2D6x10 M.D. with a blast radius of 50 feet (15.2 m) or 3D6x10 M.D. with a blast radius of 12 feet (3.6 m). Rate of Fire: Twice per melee round. Range: 6,000 feet (1,828 m). Payload: 60 rounds.

**Other Weapons:** Heavy Missile Launcher, Mini-Missile Launchers (2), Laser Machine-gun, Bow-Mounted Laser Gun.

**Black Market Cost:** 40 million credits.

### NG BAWW-120 Cavalry War Wagon

**Manufacturer:** Northern Gun. Also produced by the Black Market. (New West, p. 202).

**Class:** Military Transport.

**Crew:** Two: pilot and gunner. Can hold up to four passengers, five un-comfortably.

**Main Body M.D.C.:** 290

**Maximum Speed:** Flight: 200 mph (320 km); altitude 2,000 feet (610 m).

**Maximum Range:** Unlimited; can fly 48 hours straight before over-heating.

**Bonuses:** None.

**C-40BT Laser Turrets (2):** Mega-Damage: 4D6 M.D. (single blast); 8D6 M.D. (double blast). Rate of Fire: Equal to the number of attacks per melee round. Range: 2,000 feet (610 m). Payload: Unlimited.

**CR-10 Concealed Mini-Missile Launchers (2):** Mega-Damage: 1D4x10 M.D. (armor piercing) or 1D6x10 M.D. (plasma). Rate of Fire: Single shot or volleys of two, three, four or five. Range: One mile (1.6 km). Payload: 20; 10 in each launcher.

**Other Weapons:** Light Rail Gun.

**Black Market Cost:** 2.3 million credits.

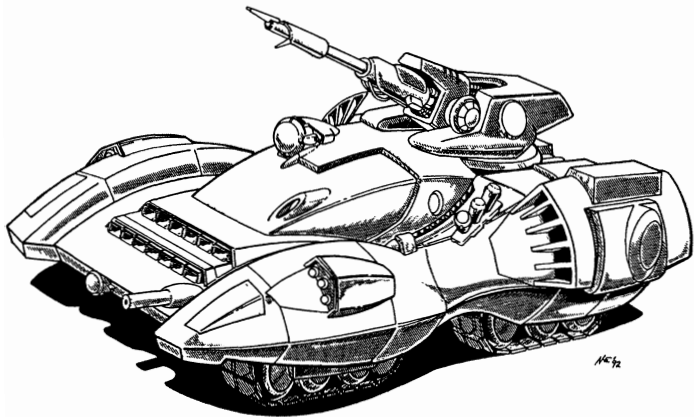

### Poland/Tarnow: T-322 Stinger Tank

**Manufacturer:** Kingdom of Tarnow (*Mindwerks*, p. 102).

**Class:** Light Tank.

**Crew:** Three: commander, driver, gunner.

**Main Body M.D.C.:** 310

**Maximum Speed:** Ground: 110 mph (176 km).

**Maximum Range:** 600 miles (960 km); unlimited if nuclear.

**Bonuses:** +2 to strike.

**Main Laser Turret:** Mega-Damage: 6D6 M.D. Rate of Fire: Equal to the number of attacks per melee round, up to six times per melee. Range: 4,000 feet (1,220 m). Payload: 1,000 blasts; unlimited if nuclear.

**Mini-Missile Launchers (2):** Mega-Damage: 1D4x10 M.D. (armor piercing) or 1D6x10 M.D. (plasma). Rate of Fire: Single shot or volleys of two, three or six. Range: One mile (1.6 km). Payload: 12; 6 per launcher.

**Other Weapons:** Forward Rail Gun, Smoke Grenade Launchers (6).

**Black Market Cost:** 2 million credits (combustion); 2.5 million (electric); 12 million (nuclear).

### South America: Columbian Tanks

#### LTT-100A, LTT-100B and LTT-100V Lancero

**Manufacturer:** Republic of Colombia (*South America*, p. 31).

**Class:** Light Tank/APC.

**Crew:** Pilot, co-pilot, communications engineer, gunner.

**Main Body M.D.C.:** 300

**Maximum Speed:** Ground: 80 mph (128 km).

**Maximum Range:** 600 miles (960 km).

**Main Gun:** Mega-Damage: 2D4x10 M.D. (high explosive) or 2D6x10 M.D. (armor piercing) or anti-vampire weapons. Rate of Fire: Once per melee round. Range: 6,000 feet (1,828 m). Payload: 50 rounds.

**Coaxial Machine-gun:** Mega-Damage: 4D6 M.D. (short burst); 1D4x10 M.D. (long burst). Rate of Fire: Equal to the number of attacks per melee round. Range: 2,000 feet (610 m). Payload: 8,000 rounds (200 long bursts or 400 short bursts).

**Other Weapons:** Rocket Machine-gun, Side Mini-Missile Launchers (2).

**Black Market Cost:** 2.1 million credits.

#### South America: HTT-11 Hussar APC

**Manufacturer:** Silver River Republics (*South America 2*, p. 182).

**Class:** Armored Personnel Carrier.

**Crew:** Two; pilot and gunner. Can carry eight troops in body armor or 6 in power armor.

**Main Body M.D.C.:** 280

**Maximum Speed:** Ground: 100 mph (160 km).

**Maximum Range:** 550 miles (880 km) with combustion or electrical engine. Unlimited if nuclear.

**Bonuses:** None.

**Rail Gun:** Mega-Damage: 1D6x10+10 M.D. (burst). Rate of Fire: Equal to the number of attacks per melee round. Range: 2,000 feet (610 m). Payload: 8,000 rounds (200 bursts).

**Mini-Missile Launchers (2):** Mega-Damage: 1D4x10 M.D. (armor piercing) or 1D6x10 M.D. (plasma). Rate of Fire: Single shot or volleys of two, four, six, eight or sixteen. Range: One mile (1.6 km). Payload: 16; eight per launcher.

**Black Market Cost:** One million (combustion or electrical engine); 10 million credits (nuclear).

### South America: PT-34 Puma Tank

**Manufacturer:** Silver River Republics (*South America 2*, p. 180).

**Class:** Medium Tank.

**Crew:** Four: commander, driver, sensor operator, gunner.

**Main Body M.D.C.:** 550

**Maximum Speed:** Ground: 100 mph (160 km).

**Maximum Range:** 500 miles (800 km) with a combustion or electrical engine. Unlimited if nuclear.

**Bonuses:** None.

**120 mm Main Gun:** Mega-Damage: 2D4x10 M.D. Rate of Fire: Twice per melee round. Range: 4,000 feet (1,220 m). Payload: 90 rounds.

**Medium-Range Missile Launcher:** Mega-Damage: Varies with missile type. Rate of Fire: Single shot or volleys of two or four. Range: 40 to 80 miles (64 to 128 km). Payload: 24; 4 in launcher, five reloads stored in tank.

**Other Weapons:** SLAS, Rail Gun Cupola, Rail Gun Mini-Turrets (2), Mini-Missile Launchers (2).

**Black Market Cost:** 1.5 million credits (combustion or electrical); 10 million credits (nuclear).

### Wellington: Rolling Thunder Combat Truck

**Manufacturer:** Wellington Industries. Also produced by Northern Gun (*Juicer Uprising*, p. 84).

**Class:** All Purpose Vehicle.

**Crew:** One. Up to three passengers.

**Main Body M.D.C.:** 155

**Maximum Speed:** Ground: 166 mph (265 km).

**Maximum Range:** 525 miles (840 km).

**Bonuses:** +10% to piloting skill for augmented humans (Juicers, Cra-zies, etc.).

**NG-202 Rail Gun:** Mega-Damage: 1D4 M.D. (single round); 1D4x10 M.D. (burst). Rate of Fire: Equal to the number of attacks per melee round. Range: 4,000 feet (1,220 m). Payload: 400 rounds (10 bursts).

**Twinned Particle Beams:** Mega-Damage: 5D6 M.D. (single blast); 1D6x10 M.D. (double blast). Rate of Fire: Equal to the number of attacks per melee round. Range: 1,200 feet (365 m). Payload: 50 single shots or 25 double shots.

**Other Weapons:** Mobile Mine Deployment System.

**Black Market Cost:** 275,000 credits.

## Motorcycles

### Highway-Man Motorcycle

**Manufacturer:** Generic/Black Market (*Rifts® Ultimate Ed.*, p. 266).

**Class:** Motorcycle.

**Crew:** One rider.

**Main Body M.D.C.:** 75

**Maximum Speed:** 180 mph (288 km).

**Maximum Range:** 400 miles (640 km).

**Weapons:** Virtually any light vehicular weapon can be mounted, from rail guns, to mini-missile launchers, to light energy weapons. Only one weapons hard point.

**Black Market Cost:** 24,000 credits (gasoline engine); 29,000 credits (electric engine).

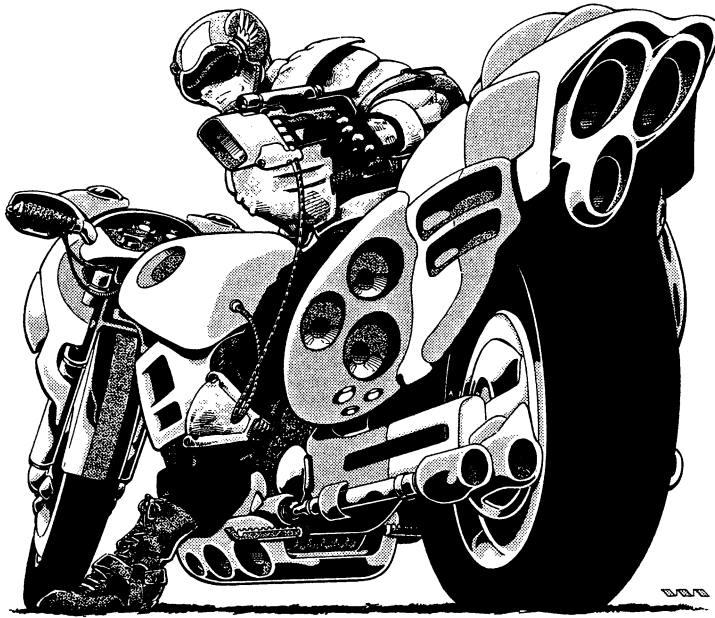

### Juicer: Tarantula Combat Jump Bike

**Manufacturer:** UTI (Juicer Uprising, p. 81).

**Class:** Motorcycle – requires a special Piloting skill.

**Crew:** One.

**Main Body M.D.C.:** 100

**Maximum Speed:** Ground: 200 mph (320 km). Jump Jet: Nine feet (2.7 m) distance for every one mph (1.6 km) being traveled.

**Maximum Range:** 500 miles (800 km); 12 hours constant operation off electrical battery.

**Bonuses:** +15% to piloting skill if pilot is an augmented human (Juicer, Crazy, etc.).

**Pulse Lasers:** Mega-Damage: 1D4x10 M.D. Rate of Fire: Equal to the number of attacks per melee round. Range: 1,600 feet (488 m). Payload: 30 bursts.

**Black Market Cost:** 80,000 credits.

### Kittani: KM-700 Uni-Motorcycle

**Manufacturer:** Kittani (Atlantis, p. 158).

**Class:** Motorcycle.

**Crew:** Pilot and one passenger.

**Main Body M.D.C.:** 100

**Maximum Speed:** Ground: 220 mph (352 km).

**Maximum Range:** Unlimited.

**Laser Cannon:** Mega-Damage: 3D6 M.D. Rate of Fire: Equal to the number of attacks per melee round. Range: 1,600 feet (488 m). Payload: Unlimited.

**Black Market Cost:** One million credits.

### Russian Motorcycles

See Russian Vehicles.

### Wastelander Motorcycle

**Manufacturer:** Generic (Rifts® Ultimate Edition, p. 266).

**Class:** Motorcycle.

**Crew:** One rider.

**Main Body M.D.C.:** 45

**Maximum Speed:** 120 mph (192 km).

**Maximum Range:** 400 miles (640 km).

**Weapons:** Virtually any light vehicular weapon can be mounted, from rail guns, to mini-missile launchers, to light energy weapons. Only one weapons hard point.

**Black Market Cost:** 18,000 credits (gasoline engine); 21,000 credits (electric engine).

### Wellington: Road Boss Combat Chopper

**Manufacturer:** Wellington Industries (Juicer Uprising, p.82).

**Class:** Motorcycle.

**Crew:** One.

**Main Body M.D.C.:** 200

**Maximum Speed:** Ground: 185 mph (296 km).

**Maximum Range:** 725 miles (1,160 km).

**Bonuses:** +10% to piloting skill if pilot is an augmented human (Juicer, Crazy, etc.).

**“Catapult” Assault Cannon:** Mega-Damage: 1D6x10 M.D. to a 3 foot (0.9 m) area. Rate of Fire: Once per melee round. Range: 4,000 feet (1,220 m). Payload: 20 shells.

**Mini-Missile Launchers (2):** Mega-Damage: 1D4x10 M.D. (armor piercing) or 1D6x10 M.D. (plasma). Rate of Fire: Single shot or volleys of two, three or four. Range: One mile (1.6 km). Payload: 16; eight per launcher.

**Other Weapons:** Variable Lasers (3).

**Black Market Cost:** 200,000 credits, 90,000 credits without weapon systems.

## New German Republic

See Triax listing.

## New Navy

See Boats; there is also a tank, a fighter jet and a helicopter.

## Russian Vehicles

### Landflief Hovercycle

**Manufacturer:** Warlords of Russia (Warlords of Russia, p. 153).

**Class:** Hovercycle.

**Crew:** One driver, one passenger.

**Main Body M.D.C.:** 120

**Maximum Speed:** Ground: 120 mph (192 km). Flight: 200 mph (320 km).

**Maximum Range:** 300 miles (480 km); unlimited if nuclear.

**Bonuses:** None.

**Dual Forward Laser:** Mega-Damage: 2D6 M.D. (single blast); 4D6 M.D. (double blast). Rate of Fire: Equal to the number of attacks per melee round. Range: 1,200 feet (366 m). Payload: 100 shots or unlimited if nuclear.

**Black Market Cost:** 85,000 credits (combustion); 1.2 million credits (nuclear).

### Novyet Arctic Hoverbike

**Manufacturer:** Novyet Manufacturers (Warlords of Russia, p.144).

**Class:** Hovercycle.

**Crew:** One.

**Main Body M.D.C.:** 135

**Maximum Speed:** Flight: 100 mph (160 km); max altitude is 150 feet (76.2 m).

**Maximum Range:** 300 miles (480 km); unlimited if nuclear.

**Bonuses:** None.

**Weapons:** None.

**Black Market Cost:** 90,000 to 120,000 credits (combustion); 1.1 million credits (nuclear)

### Novyet Big Bear ATV Truck

**Manufacturer:** Novyet Manufacturers (Warlords of Russia, p. 148).

**Class:** All-Terrain Vehicle.

**Crew:** One driver. Can hold up to 9 additional passengers.  
**Main Body M.D.C.:** 135  
**Maximum Speed:** Ground: 95 mph (152 km).  
**Maximum Range:** 500 miles (800 km); unlimited if nuclear.  
**Bonuses:** None.  
**Weapons:** As many as three light weapons (lasers, rail guns, mini-missile launchers, etc.) can be installed at additional cost.  
**Black Market Cost:** 136,000 credits (combustion); 1.036 million (nuclear).

### Novyet Explorer-Sku Truck

**Manufacturer:** Novyet Manufacturers (*Warlords of Russia*, p. 147).  
**Class:** Tracked Truck.  
**Crew:** 2-4: pilot and up to three loaders. Can hold 6-14 passengers, depending on configuration of cabin.  
**Main Body M.D.C.:** 230  
**Maximum Speed:** Ground: 70 mph (112 km).  
**Maximum Range:** 700 miles (1,120 km); unlimited if nuclear.  
**Bonuses:** None.  
**Weapons:** None.  
**Black Market Cost:** 560,000 credits (combustion); 1.56 million credits (nuclear). +20,000 credits for eight-man living quarters. +100,000 credits for laboratory and research cabin.



### Novyet Landcrawler-Sku Half-Track

**Manufacturer:** Novyet Manufacturers (*Warlords of Russia*, p. 146).  
**Class:** Halftrack.  
**Crew:** Driver and up to three passengers.  
**Main Body M.D.C.:** 130  
**Maximum Speed:** Ground: 72 mph (115 km).  
**Maximum Range:** 250 miles (400 km); unlimited if nuclear.  
**Bonuses:** None.  
**Weapons:** None.  
**Black Market Cost:** 185,000 credits (conventional); one million (nuclear).

### Novyet Snow-Jetsled Snowmobile

**Manufacturer:** Novyet Manufacturers (*Warlords of Russia*, p. 145).  
**Class:** Snowmobile.  
**Crew:** One.  
**Main Body M.D.C.:** 100  
**Maximum Speed:** Ground: 150 mph (240 km).  
**Maximum Range:** 250 mph (400 km); unlimited if nuclear.  
**Bonuses:** None.  
**Weapons:** None.  
**Black Market Cost:** 60,000 credits (combustion); one million credits (nuclear; very rare).

### SU-52 Groundthunder Tank

**Manufacturer:** Sovietski (*Mystic Russia*, p. 164).  
**Class:** Heavy Tank.  
**Crew:** Five: pilot, co-pilot/gunner, gunners (2), communications officer.  
**Main Body M.D.C.:** 375  
**Maximum Speed:** Ground: 90 mph (144 km).  
**Maximum Range:** Unlimited.  
**Bonuses:** None.  
**SGT-50 High-Powered Cannon:** Mega-Damage: 1D4x10 M.D. Rate of Fire: Four blasts per melee round. Range: 6,000 feet (1,828 m). Payload: 60 rounds.  
**Hatch Rail Gun:** Mega-Damage: 1D4x10 M.D. (burst). Rate of Fire: Equal to the number of attacks per melee round. Range: 4,000 feet (1,220 m). Payload: 8,000 rounds (200 bursts).  
**Other Weapons:** Low Profile Laser Turret, Mini-Missile Launcher, Smoke Dispensers (12).  
**Black Market Cost:** 18 million credits. Exclusive to the Sovietski; unavailable on the Black Market.

### SUH-86 Hailstorm Tank

**Manufacturer:** Sovietski (*Mystic Russia*, p. 166).  
**Class:** Heavy Tank.  
**Crew:** Six: pilot, co-pilot/gunner, gunners (2), communications officer, field scientist or intelligence officer.  
**Main Body M.D.C.:** 410  
**Maximum Speed:** Ground: 160 mph (256 km). Flight: 160 mph (256 km); max altitude is 2,000 feet (610 m).  
**Maximum Range:** Unlimited.  
**Bonuses:** None.  
**SRG-500 High-Powered Rail Cannon:** Mega-Damage: 1D6x10 M.D. (short burst); 2D6x10 M.D. (long burst). Rate of Fire: Equal to the number of attacks per melee round. Range: 8,000 feet (2,438 m). Payload: 24,000 rounds (600 short bursts or 300 full bursts).  
**Ball-Laser Turret:** Mega-Damage: 4D6 M.D. Rate of Fire: Equal to the number of attacks per melee round. Range: 2,000 feet (610 m). Payload: Unlimited.  
**Other Weapons:** Medium-Range Missile Launchers (2), Pop-Up Mini-Missile Launchers (2).  
**Black Market Cost:** 26 million credits. Exclusive to the Sovietski; unavailable on the Black Market.

### SUH-88 Maelstrom Tank

**Manufacturer:** Sovietski (*Mystic Russia*, p. 169).  
**Class:** Medium Tank.  
**Crew:** Six: pilot, co-pilot/gunner, gunners (2), communications officer, field scientist or intelligence officer.  
**Main Body M.D.C.:** 540  
**Maximum Speed:** Ground: 120 mph (192 km). Flight: 100 mph (160 km); max altitude is 1,500 feet (457 m).  
**Maximum Range:** Unlimited.  
**Bonuses:** None.  
**SPC-100 High Powered Plasma Cannon:** Mega-Damage: 2D4x10+20 M.D. Rate of Fire: Equal to the number of attacks per melee round. After 50 consecutive shots, the cannon requires one minute (four melees) to cool down. Range: 4,000 feet (1,220 m). Payload: Unlimited.  
**Ball-Ion Turret:** Mega-Damage: 6D6 M.D. Rate of Fire: Equal to the number of attacks per melee round. Range: 1,400 feet (426.7 m). Payload: Unlimited.  
**Other Weapons:** Hatch Rail Gun, Pop-Up Mini-Missile Launcher, Concealed Mini-Missile Launch Tubes (16), Medium-Range Missile Launcher, Smoke Dispensers (2).  
**Black Market Cost:** 32 million credits. Exclusive to the Sovietski; unavailable on the Black Market.

## Tek-12 YY110 Bushbike

**Manufacturer:** Warlords of Russia (**Warlords of Russia**, p. 150).

**Class:** Motorcycle.

**Crew:** One plus one passenger.

**Main Body M.D.C.:** 135

**Maximum Speed:** Ground: 137 mph (219 km).

**Maximum Range:** 560 miles (896 km); unlimited if nuclear.

**Bonuses:** None.

**Front-Mounted Laser:** Mega-Damage: 2D6 M.D. Rate of Fire: Equal to the number of attacks per melee round. Range: 1,600 feet (487 m). Payload: Unlimited.

**Mini-Missile Launchers (2):** Mega-Damage: 1D4x10 M.D. (armor piercing) or 1D6x10 M.D. (plasma). Rate of Fire: Single shot or volleys of two, or four. Range: One mile (1.6 km). Payload: 4; 2 per launcher.

**Other Weapons:** Optional Mini-Missile Blunderbuss Launcher.

**Black Market Cost:** 32,000 credits (combustion; no weapons); 65,000 credits (combustion, with weapons); add 900,000 if nuclear, add 1,500 credits for sidecar.

**Maximum Speed:** Ground: 80 mph (128 km).

**Maximum Range:** Unlimited.

**Bonuses:** None.

**S-5050 Rail Cannon:** Mega-Damage: 1D6x10 M.D. (burst). Rate of Fire: Equal to the number of attacks per melee round. Range: 5,000 feet (1,524 m). Payload: 12,000 rounds (1,200 bursts!)

**LSU-10 Laser Turret:** Mega-Damage: 4D6 M.D. Rate of Fire: Equal to the number of attacks per melee round. Range: 2,000 feet (610 m). Payload: Unlimited.

**Other Weapons:** Pop-Up Mini-Missile Launcher, SU-L60 High Powered Tri-Laser Cannon, Medium-Range Missile Launchers (2).

**Black Market Cost:** 23 million credits. Exclusive to the Sovietski; unavailable on the Black Market.

## Warrior AH Assault Hoversled

**Manufacturer:** Warlords of Russia (**Warlords of Russia**, p. 154).

**Class:** Hovercycle.

**Crew:** Two: pilot/gunner, gunner/navigator.

**Main Body M.D.C.:** 212 (light); 275 (heavy, for 'Borgs).

**Maximum Speed:** Flight: 306 mph (490 km); max altitude is 300 feet (91 m).

**Maximum Range:** 325 miles (520 km) for conventional, 210 miles (336 km) for electric, unlimited if nuclear.

**Bonuses:** None.

**Guraskov G-110 Laser Pulse Cannons (2):** Mega-Damage: 5D6 M.D. (single blast) or 1D6x10 M.D. (double blast). Rate of Fire: Equal to the number of attacks per melee round. Range: 3,000 feet (914 m). Payload: 20 or 50 shots; unlimited if nuclear.

**AR-60 Rail Gun:** Mega-Damage: 1D4x10+10 M.D. (burst). Rate of Fire: Equal to the number of attacks per melee round. Range: 4,000 feet (1,220 m). Payload: 1,200 rounds (120 bursts).

**Other Weapons:** Mini-Missile Launchers (3), Raker Blades (2).

**Black Market Cost:** 900,000 credits (combustion), 1.1 million credits (electric/solar), 2.2 million (nuclear). Add 600,000 credits for the heavy ('Borg) version of any of the three engine types.

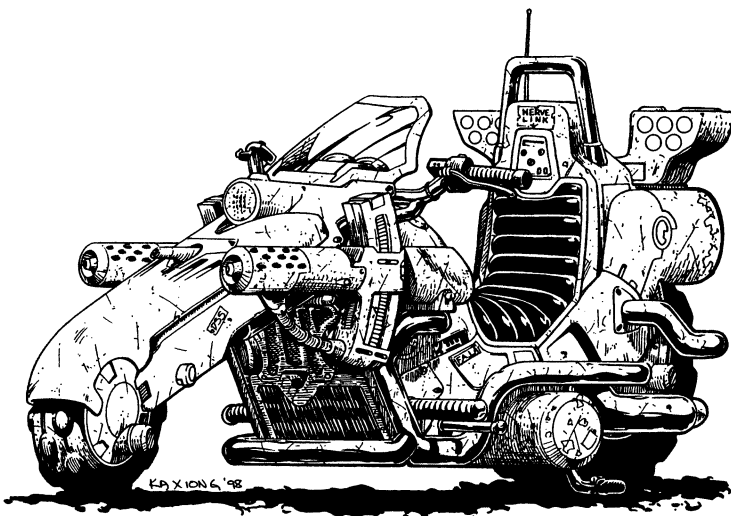

## Tek-20 YY210 'Borgbike

**Manufacturer:** Warlords of Russia (**Warlords of Russia**, p. 151).

**Class:** Motorcycle.

**Crew:** One; holds one passenger.

**Main Body M.D.C.:** 216

**Maximum Speed:** Ground: 204 mph (326 km).

**Maximum Range:** 250 mph (400 km); unlimited if nuclear.

**Bonuses:** None.

**AR-44 Rail Gun:** Mega-Damage: 1D6x10+10 M.D. (bursts). Rate of Fire: Equal to the number of attacks per melee round. Range: 5,000 feet (1,524 m). Payload: 2,400 rounds (60 bursts).

**Short-Range Laser:** Mega-Damage: 3D6 M.D. Rate of Fire: Equal to the number of attacks per melee round. Range: 1,200 feet (365 m). Payload: 120 shots; unlimited if nuclear.

**Other Weapons:** Mini-Missile Blunderbuss Launcher, Vibro-Lance.

**Black Market Cost:** 185,000 credits (combustion); 1.5 million (nuclear).

## Thundersword Multi-Combat Platform APC

**Manufacturer:** Sovietski (**Mystic Russia**, p. 162).

**Class:** Armored Personnel Carrier.

**Crew:** Ten: pilot, co-pilot, communications officers (2), forward gunners (2), medical officer, field commander, rear gunners (2). Can accommodate four more personnel in the forward cabin. The front section of the APC holds 18-24 human-sized troops. The rear section of the APC holds 40 human-sized troops OR 30 heavy cyborgs OR 20 cyborg shock troopers.

**Main Body M.D.C.:** 600 (main body; front section); 600 (main body; rear section); 310 (flexible mid-section).

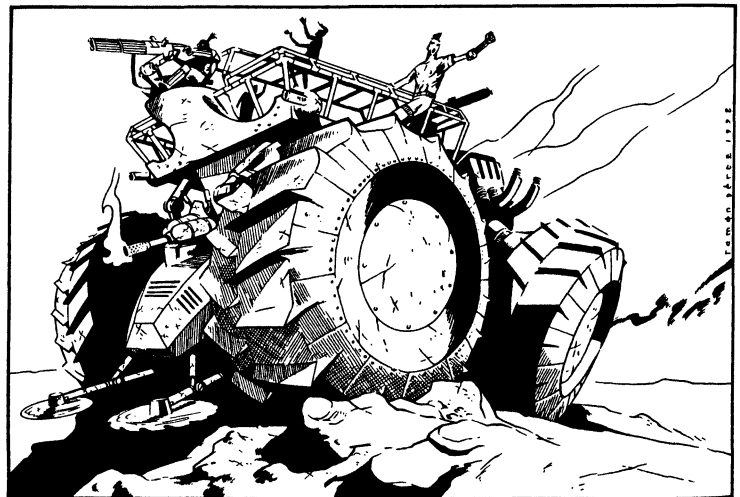

## War Chariot

**Manufacturer:** Warlords of Russia (**Warlords of Russia**, p. 156).

**Class:** Armored Fighting Vehicle.

**Crew:** One pilot plus 4-5 additional warriors.

**Main Body M.D.C.:** 550.

**Maximum Speed:** Ground: 110 mph (176 km).

**Maximum Range:** 200 miles (320 km); unlimited if nuclear.

**Bonuses:** None.

**AR-210 Rail Guns (2):** Mega-Damage: 2D4x10 M.D. (burst). Rate of Fire: Equal to the number of attacks per melee round. Range: 4,000 feet (1,220 m). Payload: 3,000 rounds (100 bursts).

**Giant Wheels:** Mega-Damage: 1D4x10 M.D. for those who get run over.

**Other Weapons:** Flamethrower, Short-Range Lasers (2), Buzz Saws (2).

**Black Market Cost:** 250,000 cost (combustion); 5 million (nuclear).

## Warthron

**Manufacturer:** Warlords of Russia (**Warlords of Russia**, p. 159).

**Class:** Hover Platform.

**Crew:** Three: pilot, gunners (2). Can accommodate up to 13 passengers (a Russian Warlord and his entourage, typically).

**Main Body M.D.C.:** 900

**Maximum Speed:** Flight: 68 mph (109 km); max altitude is 100 feet (30.5 m).

**Maximum Range:** Unlimited.

**Bonuses:** None.

**Concealed Forward Lasers (4):** Mega-Damage: 3D6 M.D. (single blast); 6D6 M.D. (double blast); 1D4x10+10 M.D. (triple blast); 1D6x10+10 M.D. (quad blast). Rate of Fire: Each laser can fire once per melee round. Range: 1,200 feet (366 m). Payload: Unlimited.

**Concealed Underbelly Lasers (10):** Mega-Damage: 2D6 M.D. (single blast); 4D6 M.D. (double blast). Rate of Fire: Equal to the number of attacks per melee round. Range: 500 feet (152 m). Payload: Unlimited.

**Other Weapons:** Multi-Weapon Arms (2), Mini-Missile Launchers (2), Medium-Range Missile Launcher.

**Black Market Cost:** 10 million credits to build. They are not sold on the Black Market because these are the exclusive property of the Warlords of Russia, any of whom would gladly slay anyone who *dares* to ride upon a vehicle reserved just for them!

## War Wagon/Mechanized Ram

**Manufacturer:** Warlords of Russia (**Warlords of Russia**, p. 157).

**Class:** Armored Personnel Carrier.

**Crew:** 6: pilot/commander, co-pilot, navigator, communications officer, weapons officer, heavy cyborg soldier. Can hold up to one full platoon of 40 human troops plus 10 light cyborgs and 10 heavy cyborgs. Or, it can hold 40 human troops and 25 light cyborgs. Or, 50 light cyborgs. Or, 36 heavy cyborgs.

**Main Body M.D.C.:** 400 (forward section); 800 (troop section).

**Maximum Speed:** Ground: 70 mph (112 km).

**Maximum Range:** 200 miles (320 km); unlimited if nuclear.

**Bonuses:** None.

**Ion Turret Banks (20):** Mega-Damage: 3D6 M.D. (single strike); 6D6 M.D. (double strike). Rate of Fire: Equal to the number of attacks per melee round. Range: 1,200 feet (366 m). Payload: 100 per turret; unlimited if nuclear.

**Rail Gun Turrets (2):** Mega-Damage: 1D4x10 M.D. (burst). Rate of Fire: Equal to the number of attacks per melee round. Range: 4,000 feet (1,220 m). Payload: 2,000 rounds (200 bursts).

**Other Weapons:** GU-50 Laser Cannon Turrets (2), Mini-Missile Turrets (2), Medium-Range Missile Launcher, Hydraulic Ram System.

**Black Market Cost:** 500,000 credits (combustion); 5 million credits (nuclear).

## Wingrider Flying Wing

**Manufacturer:** Warlords of Russia (**Warlords of Russia**, p. 162).

**Class:** Hover Vehicle.

**Crew:** One.

**Main Body M.D.C.:** 180

**Maximum Speed:** Flight: 300 mph (480 km); max altitude is 6,000 feet (1,828 m).

**Maximum Range:** 500 miles (800 km); unlimited if nuclear.

**Bonuses:** +1 on initiative, +1 to parry, +2 to dodge.

**Chulki Hooks (2):** SPECIAL! These are used as grapnels for the Wing to hook onto things and make incredibly tight turns. They are not meant as a weapon. Chulki Hook, however, can be used for vari-

ous combat moves (1D6 M.D. or 2D6 M.D. per 50 mph/80 km).

**Strafing Lasers (2):** Mega-Damage: 2D6 M.D. (single shot); 4D6 M.D. (double shot). Rate of Fire: Equal to the number of attacks per melee round. Range: 1,200 feet (366 m). Payload: 100 shots; unlimited if nuclear.

**Other Weapons:** Mini-Missile Launcher. Wingrider pilots often use their power armor weapons, bionic weapons, or personal weapons as well.

**Black Market Cost:** 500,000 to 700,000 credits (nuclear). (50,000 to 70,000 credits if combustion, but this a real rarity.)

## ZSU 13/14 Thunderbolt Truck

**Manufacturer:** Sovietski (**Mystic Russia**, p. 158).

**Class:** Assault Truck.

**Crew:** Two: driver and gunner.

**Main Body M.D.C.:** 175 (forward cab); 180 (truck bed).

**Maximum Speed:** Ground: 70 mph (112 km).

**Maximum Range:** Unlimited.

**Bonuses:** None.

**Artillery Unit:** Mega-Damage: 2D4x10 M.D. (single blast); 4D4x10 M.D. (double blast). Rate of Fire: Equal to the number of attacks per melee round. Range: 8,300 feet (2,530 m). Payload: 20 cannon shells.

**S-500 Cyclone Pulse Laser Rifle:** Mega-Damage: 1D6x10 M.D. Rate of Fire: Equal to the number of attacks per melee round. Range: 3,000 feet (914 m). Payload: 60 from E-Pack or four shots from standard E-Clip.

**Other Weapons:** Mini-Missile Launcher.

**Black Market Cost:** 3.5 million credits for the Warlords of Russia; 5 to 7 million to anybody else. 600,000 credits if stripped of weapons and non-nuclear (rare).

## ZSU 17/18 Bulldog APC

**Manufacturer:** Sovietski (**Mystic Russia**, p. 160).

**Class:** All-Terrain Vehicle.

**Crew:** Four: driver/pilot, co-pilot/communications officer, gunners (2).

**Main Body M.D.C.:** 340

**Maximum Speed:** Ground: 80 mph (128 km).

**Maximum Range:** Unlimited.

**Bonuses:** None.

**Forward Mini-Laser Turrets (2):** Mega-Damage: 4D6 M.D. (single blast); 8D6 M.D. (double blast). Rate of Fire: Equal to the number of attacks per melee round. Range: 2,000 feet (610 m). Payload: Unlimited.

**Rail Gun Turret:** Mega-Damage: 1D4x10 M.D. (burst). Rate of Fire: Equal to the number of attacks per melee round. Range: 4,000 feet (1,200 m). Payload: 9,600 round (600 bursts).

**Other Weapons:** Mini-Missile Launcher, Sensor Cluster System.

**Black Market Cost:** 2.2 million credits.

# Triax & The NGR Vehicles

## XM-50 Ambulance Pod

**Manufacturer:** Triax (**Triax & NGR**, p. 117).

**Class:** Hover Pod.

**Crew:** One.

**Main Body M.D.C.:** 140.

**Maximum Speed:** Flight: 60 mph (96 km); max altitude is 500 feet (152 m).

**Maximum Range:** Unlimited.

**Bonuses:** None.

**Mini-Defense Turret:** Mega-Damage: 2D6 M.D. Rate of Fire: Set to automatic defense, firing five times a round. Range: 1,200 feet (366 m). Payload: Unlimited.



**Other Equipment:** Searchlight Turret, Extendable Stretcher, Rechargeable Force Field, Storage Bays (5), Distress Homing Beacon.  
**Black Market Cost:** 500,000 credits.

### XM-60 Field Mechanic Pod

**Manufacturer:** Triax (Triax & NGR, p. 119).

**Class:** Hover Pod.

**Crew:** One.

**Main Body M.D.C.:** 160

**Maximum Speed:** Flight: 60 mph (96 km).

**Maximum Range:** Unlimited.

**Bonuses:** None.

**Pulse Laser Turret:** Mega-Damage: 2D6 M.D. (single blast); 6D6 M.D. (triple blast). Rate of Fire: Equal to the number of attacks per melee round. Range: 2,000 feet (610 m). Payload: Unlimited.

**Rear Laser Turret:** Mega-Damage: 2D6 M.D. Rate of Fire: Set to automatic defense, firing five times a round. Range: 1,200 feet (366 m). Payload: Unlimited.

**Black Market Cost:** 500,000 credits.

### XM-70 Covert Operations Pod

**Manufacturer:** Triax (Triax & NGR, p. 120).

**Class:** Hover Pod.

**Crew:** One.

**Main Body M.D.C.:** 165

**Maximum Speed:** Flight: 100 mph (160 km).

**Maximum Range:** Unlimited.

**Bonuses:** None.

**Pulse Laser Turret:** Mega-Damage: 2D6 M.D. (single blast); 6D6 M.D. (triple blast). Rate of Fire: Equal to the number of attacks per melee round. Range: 2,000 feet (610 m). Payload: Unlimited.

**Rear Laser Turret:** Mega-Damage: 2D6 M.D. Rate of Fire: Set to automatic defense, firing five times a round. Range: 1,200 feet (366 m). Payload: Unlimited.

**Other Weapons:** Mini-Missile Launcher.

**Black Market Cost:** 800,000 credits.

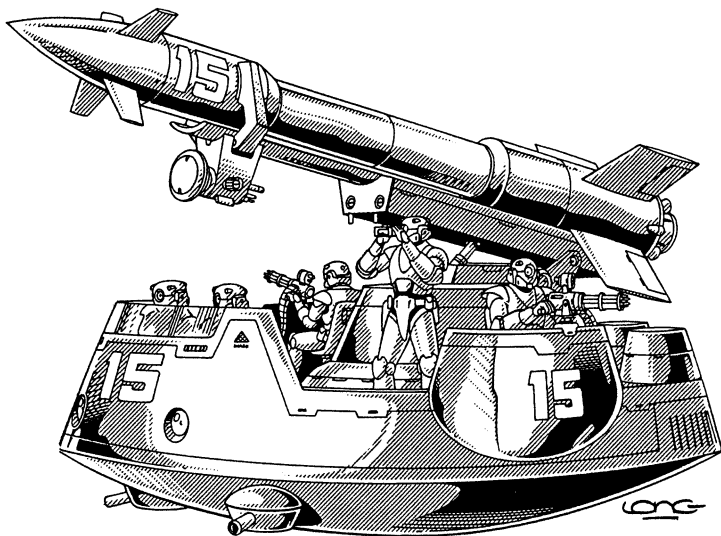

### XM-140 Support Weapon Platform

**Manufacturer:** Triax (Triax & NGR, p. 120).

**Class:** Armored Weapons Platform.

**Crew:** Four: pilot, co-pilot, gunners (2).

**Main Body M.D.C.:** 250

**Maximum Speed:** Flight: 50 mph (80 km); max altitude is 1,000 feet (305 m).

**Maximum Range:** Unlimited.

**Bonuses:** None.

**Long-Range Missile Launcher:** Mega-Damage: Varies with missile type. Rate of Fire: one shot. Range: Varies; typically 500 to 800 miles (800 to 1,280 km). Payload: One.

**Concealed Mini-Missile Launcher:** Mega-Damage: 1D4x10 M.D. (armor piercing) or 1D6x10 M.D. (plasma). Rate of Fire: Single shot or volleys of two or three. Range: One mile (1.6 km). Payload: 12.

**Other Weapons:** Twin Pulse Laser Turrets (2), Light Rail Guns (2), Rechargeable Force Field Generators (4), Storage Bays (4).

**Black Market Cost:** One million credits, plus missile cost.

### XM-170 Infantry Repair Barge

**Manufacturer:** Triax (Triax & NGR, p. 122).

**Class:** Hover Platform.

**Crew:** 25: pilot, co-pilot, communications officers (2), gunner, 10 field mechanics, 10 field mechanic assistants. The repair barge can transport as many as 120 foot soldiers or 32 Jagers or 10 Black Knights on its deck.

**Main Body M.D.C.:** 600 (nose/pilot & crew section); 1,000 (flatbed barge section); 600 (forward repair station).

**Maximum Speed:** Flight: 45 mph (72 km).

**Maximum Range:** Unlimited.

**Bonuses:** None.

**Twin Forward Laser Turrets (2):** Mega-Damage: 5D6 M.D. (single shot); 1D6x10 M.D. (double shot). Rate of Fire: Equal to the number of attacks per melee round. Range: 2,000 feet (610 m). Payload: Unlimited.

**Lower Forward Laser Turret:** Mega-Damage: 5D6 M.D. Rate of Fire: Equal to the number of attacks per melee round. Range: 4,000 feet (1,220 m). Payload: Unlimited.

**Other Weapons & Equipment:** Twin Rear Weapon Turrets (2), Concealed Mini-Missile Launcher, XM-171C Heavy Crane, Concealed Towing Cables (3), X-60 Flanker Power Armor Suits (2), T-11 Enhanced Body Armor Suits (10), XM-60 Mechanic Pods (6).

**Black Market Cost:** Unavailable to the Black Market.

### XM-180 Dragonfly Drop Ship

**Manufacturer:** Triax (Triax & NGR, p. 124).

**Class:** Power Armor and Robot Drop Ship.

**Crew:** Four: pilot, co-pilot, communications officer, gunner.

**Main Body M.D.C.:** 250

**Maximum Speed:** Flight: Mach 1.5; altitude 50,000 feet (15,240 m).

**Maximum Range:** Unlimited.

**Bonuses:** None.

**Medium-Range Missile Launcher (2):** Mega-Damage: Varies with missile type. Rate of Fire: One. Range: Varies with missile style; typically 40 to 80 miles (64 to 128 km). Payload: One.

**Wing Mini-Missiles (16):** Mega-Damage: 1D4x10 M.D. (armor piercing) or 1D6x10 M.D. (plasma). Rate of Fire: Single shot or volleys of two, three or four. Range: One mile (1.6 km). Payload: 16; eight per wing.

**Other Weapons:** Nose Gun, Double-Barreled Laser Turret, Anti-Missile Chaff Dispenser.

**Black Market Cost:** One million credits (plus missile costs).

### XM-250 Medical Hover Station

**Manufacturer:** Triax (Triax & NGR, p. 125).

**Class:** Hover Station.

**Crew:** Five: pilot, co-pilot, communications officer, gunners (2). Also holds 28 medical personnel: surgeons (8), Cyber-Docs (2), nurses (8), orderlies/assistants (4), chemists/lab techs (2), field medics (4). 48 wounded can be accommodated comfortably, but another 24 *could* be squeezed in, in an emergency.

**Main Body M.D.C.:** 700 (nose); 1,000 (rear half).

**Maximum Speed:** Flight: 140 mph (224 km); max altitude is 2,000 feet (610 m).

**Maximum Range:** Unlimited.

**Bonuses:** None.

**Long-Range Pulse Laser Cannons (3):** Mega-Damage: 2D6 M.D. (single blast); 6D6 M.D. (triple blast). Rate of Fire: Equal to the number of attacks per melee round. Range: 4,000 feet (1,220 m). Payload: Unlimited.

**Single Barrel Laser Turrets (2):** Mega-Damage: 3D6 M.D. (single blast); 6D6 M.D. (double blast). Rate of Fire: Equal to the number of attacks per melee round. Range: 2,000 feet (610 m). Payload: Unlimited.

**Black Market Cost:** 15 to 20 million credits.

## XM-270 Mosquito Air APC

**Manufacturer:** Triax (Triax & NGR, p. 127).

**Class:** VTOL Armored Personnel Carrier.

**Crew:** Five: pilot, co-pilot, communications officer, gunners (2). Can carry an additional 24 to 36 human-sized troops.

**Main Body M.D.C.:** 900

**Maximum Speed:** Flight: Mach 2.5; max altitude is 20,000 feet (6,096 m).

**Maximum Range:** Unlimited.

**Bonuses:** None.

**High-Powered Ion Cannons (2):** Mega-Damage: 1D4x10 M.D. (single shot); 2D4x10 M.D. (double shot). Rate of Fire: Equal to the number of attacks per melee round. Range: 3,000 feet (914 m). Payload: Unlimited.

**Rail Gun Turrets (2):** Mega-Damage: 1D4x10 M.D. (single burst); 2D4x10 M.D. (synchronized double burst). Rate of Fire: Equal to the number of attacks per melee round. Range: 4,000 feet (1,220 m). Payload: 9,000 rounds (300 bursts).

**Other Weapons:** Nose Laser, Mini-Missile Side Launchers (10), Anti-Missile Chaff Dispenser.

**Black Market Cost:** 42 million credits.

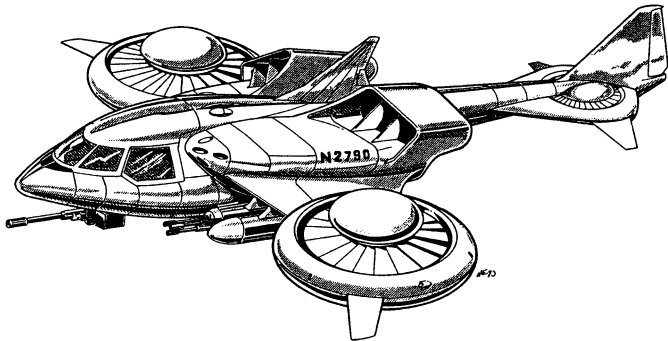

## XM-275 Lightning Jet Fighter

**Manufacturer:** Triax (Triax & NGR, p. 128).

**Class:** VTOL Jet Fighter.

**Crew:** Four: pilot, co-pilot, communications officer, gunner.

**Main Body M.D.C.:** 350

**Maximum Speed:** Flight: Mach 2; max altitude is 50,000 feet (15,240 m).

**Maximum Range:** Unlimited.

**Bonuses:** None.

**Nose Laser:** Mega-Damage: 5D6 M.D. Rate of Fire: Equal to the number of attacks per melee round. Range: 4,000 feet (1,220 m). Payload: Unlimited.

**TX-275 Arc Charge Blaster:** Mega-Damage: 6D6 M.D., plus plays havoc with electrical systems. Rate of Fire: Up to four blasts per melee. Range: 2,000 feet (610 m). Payload: Unlimited.

**Other Weapons:** Anti-Missile Chaff Dispenser.

**Black Market Cost:** 40 million credits.

## XM-280 Jet Fighter & Bomber

**Manufacturer:** Triax (Triax & NGR, p. 130).

**Class:** Fighter/Bomber.

**Crew:** Two: pilot and co-pilot/bombardier.

**Main Body M.D.C.:** 300

**Maximum Speed:** Flight: Mach 3; max altitude is 60,000 feet (18,288 m).

**Maximum Range:** Unlimited.

**Bonuses:** None.

**Nose Lasers (2):** Mega-Damage: 4D6 M.D. (single blast); 1D4x10+6 M.D. (double blast). Rate of Fire: Equal to the number of attacks per melee round. Range: 2,000 feet (610 m). Payload: Unlimited.

**Bomb Payload (16):** Mega-Damage: 3D4x10 M.D. (high explosive); 3D6x10 M.D. (plasma); 4D6x10 M.D. (nuclear). Rate of Fire: Single drop of a volley of four, eight or 16. Range: Can drop from as low as 1,000 feet (305 m) or as high as 20,000 feet (6,096 m). Payload: 16.

**Other Weapons:** Wing Mini-Missiles (8), anti-Missile Chaff Dispenser.

**Black Market Cost:** Unavailable on the Black Market.

## XM-288 Supersonic Transport (Aircraft)

**Manufacturer:** Triax (Triax & NGR, p. 131).

**Class:** Supersonic Transport.

**Crew:** Ten: pilot, co-pilot, communications officer, gunners (3), cargo maintenance laborers (4).

**Main Body M.D.C.:** 200

**Maximum Speed:** Flight: Mach 4.5; max altitude is 100,000 feet (30,480 m; sub-orbital).

**Maximum Range:** Unlimited.

**Bonuses:** None.

**Medium-Range Missile Launchers (2):** Mega-Damage: 2D6x10 M.D. (plasma). Rate of Fire: Single shot or volleys of two. Range: 80 miles (128 km). Payload: 12.

**Pulse Laser Turrets (3):** Mega-Damage: 2D6 M.D. (single blast); 6D6 M.D. (triple blast); 1D6x10+6 M.D. (two bottom turrets firing simultaneously) Rate of Fire: Equal to the number of attacks per melee round. Range: 2,000 feet (610 m). Payload: Unlimited.

**Other Weapons:** Anti-Missile Chaff Dispenser.

**Black Market Cost:** Absolutely unavailable! Even the NGR only has six of these aircraft! Still, it *would* be cool for an adventuring party to be able to jet-set around the planet in one of these babies, wouldn't it?

## Triax Combat Ground Vehicles

### XM-300 Terror Mini-Tank

**Manufacturer:** Triax (Triax & NGR, p. 133).

**Class:** Light Tank.

**Crew:** Two: pilot and gunner.

**Main Body M.D.C.:** 300

**Maximum Speed:** Ground: 95 mph (152 km).

**Maximum Range:** Unlimited.

**Bonuses:** None.

**Ion Cannon:** Mega-Damage: 1D4x10 M.D. Rate of Fire: Equal to the number of attacks per melee round. Range: 3,000 feet (914 m). Payload: Unlimited.

**Laser Gun:** Mega-Damage: 4D6 M.D. Rate of Fire: Equal to the number of attacks per melee round. Range: 2,000 feet (610 m). Payload: Unlimited.

**Other Weapons:** Forward Rail Gun Turrets (2), Dual Mini-Missile Launcher, Flamethrowers (2).

**Black Market Cost:** 40 million credits.

### XM-330 Phantom Tank

**Manufacturer:** Triax (Triax & NGR, p. 134).

**Class:** Heavy Tank.

**Crew:** Three: pilot, gunner, communications officer.

**Main Body M.D.C.:** 700

**Maximum Speed:** Ground: 80 mph (128 km).

**Maximum Range:** Unlimited.

**Bonuses:** None.

**Main Gun (Particle Beam):** Mega-Damage: 2D4x10 M.D. Rate of Fire: Equal to the number of attacks per melee round. Range: 3,000 feet (914 m). Payload: Unlimited.

**Main Gun (Laser Cannon):** Mega-Damage: 1D4x10 M.D. Rate of Fire: Equal to the number of attacks per melee round. Range: 4,000 feet (1,220 m). Payload: Unlimited.

**Other Weapons:** Ion Cannon, Forward Rail Gun Turrets (2), Low Profile Laser Turret, Mini-Missile Launchers (2), Smoke Grenade Launchers (3).

**Black Market Cost:** 40 million credits.

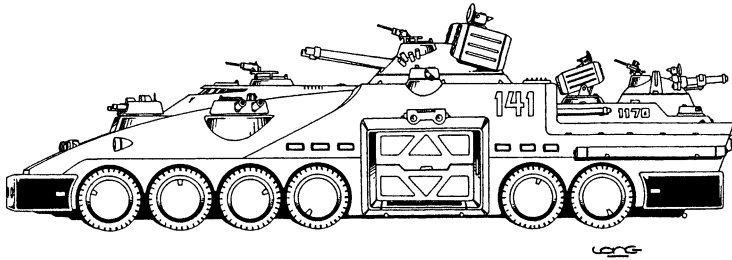

### XM-350 Leopard III APC

**Manufacturer:** Triax (Triax & NGR, p. 136).

**Class:** Armored Personnel Carrier.

**Crew:** Ten: pilot, co-pilot, communications officer, intelligence officer, gunners (6). APC section can hold any mix of troops, but the most commonly used mix is: 20 to 28 foot soldiers; 4 X-10A Predators or X-535 or X-545 Jagers; 4 DV-12 Dyna-Bots, Super Troopers, or Glitter Boys; 2 DV-40 Combat Drones or X-2000 Dyna-Max; 2 Field Mechanics or Commandos, 2 Field Medics, 1 XM-50 Medical Pod, 1 XM-300 Mini-Tank.

**Main Body M.D.C.:** 900

**Maximum Speed:** Ground: 80 mph (128 km).

**Maximum Range:** Unlimited.

**Bonuses:** None.

**Double-Barreled Ion Cannon:** Mega-Damage: 1D4x10 M.D. (single blast); 2D4x10 M.D. (double blast). Rate of Fire: Equal to the number of attacks per melee round. Range: 3,000 feet (914 m). Payload: Unlimited.

**Medium-Range Missile Launchers (2):** Mega-Damage: 2D4x10 M.D. (high explosive) or 2D6x10 M.D. (plasma). Rate of Fire: Single shot or in volleys of two, three or four. Range: 80 miles (128 km). Payload: 16; eight per launcher.

**Other Weapons:** Pulse Laser Turrets (4), Manned Laser Guns (2), Side Rail Gun Turrets (2), Smoke Grenade Launchers (8).

**Black Market Cost:** 80 million credits.

### X-MISB-01 Mobile Infantry Strike Base

**Note:** Has five Components of three different types, A, B, and C.

**Component A : Command Center and Main Cannon(1).**

**Manufacturer:** Triax (Mindwerks, p.81).

**Class:** Main Battle Tank and Armored Personnel Carrier

**Crew:** 100: commander, second in command, pilots (2), co-pilots (2), communications officers (10), field mechanics (10), gunners (12), reserve gunners (6), power armor commandos (12), robot soldiers (6), intelligence officers (6), soldiers (12), medical personnel (20). Can carry up to an additional 40 troops.

**Main Body M.D.C.:** 2,100

**Maximum Speed:** Ground: 12 mph (19 km) on its own, 35 mph (56 km) when joined with other MISB components.

**Maximum Range:** Unlimited.

**Bonuses:** None.

**Main Super PBA Cannon:** Mega-Damage: 3D6x100 M.D. Rate of Fire: Once per melee round. Range: 10,000 feet (3,048 m). Payload: After ten shots, each subsequent shot has a 01-50% chance of system failure, which means it cannot fire again for a full melee round.

**Secondary Super Laser Cannon:** Mega-Damage: 1D6x10 M.D. (single blast); 2D6x10 M.D.; 9 double blast). Rate of Fire: Equal to the number of attacks per melee round. Range: 8,000 feet (2,438 m). Payload: Unlimited.

**Other Weapons:** Secondary Super Ion Cannon, Long-Range Missile Launcher Bay, Forward Double-Barreled Laser Turrets (2), Ion Belly Guns (2), Mini-Double-Barreled Laser Turrets (3), Rear Multi-Turret.

**Black Market Cost:** Not available.

**Note:** This vehicle can synch up with the other X-MISB-01 components to create a monstrous compound fighting vehicle.

**Component B : Forward Troop Carriers (2; identical)**

**Manufacturer:** Triax (Mindwerks, p. 84).

**Class:** Main Battle Tank and Armored Personnel Carrier.

**Crew:** 11: pilot, co-pilot, communications officers (3), gunners (4), reserve gunners (2).

**Main Body M.D.C.:** 1,200

**Maximum Speed:** Ground: 45 mph (72 km) on its own, 35 mph (56 km) when joined with other MISB components.

**Maximum Range:** Unlimited.

**Bonuses:** None.

**Double-Barreled Laser Turret:** Mega-Damage: 1D4x10 M.D. (single strike); 2D4x10 M.D. (double strike). Rate of Fire: Equal to the number of attacks per melee round. Range: 4,000 feet (1,220 m). Payload: Unlimited.

**Ion Turrets (2):** Mega-Damage: 4D6 M.D. (single shot); 1D4x10+8 M.D. (double shot). Rate of Fire: Equal to the number of attacks per melee round. Range: 3,000 feet (914 m). Payload: Unlimited.

**Other Weapons:** Mini-Missile Launchers (3).

**Black Market Cost:** Unavailable.

**Note:** This vehicle can synch up with the other X-MISB-01 components to create a monstrous compound fighting vehicle.

**Component C : Artillery Troop Carriers (2; identical)**

**Manufacturer:** Triax (Mindwerks, p. 86).

**Class:** Main Battle Tank and Armored Personnel Carrier.

**Crew:** 12: pilot, co-pilot, communications officers (3), gunners (4), reserve gunners (3). Can carry two companies of soldiers in body armor or 12 Dyna-Bots or one company (40 troops) in small power armor.

**Main Body M.D.C.:** 1,400

**Maximum Speed:** Ground: 37 mph (59 km) on its own, 35 mph (56 km) when joined with other MISB components.

**Maximum Range:** Unlimited.

**Bonuses:** None.

**Double-Barreled Laser Turret:** Mega-Damage: 1D4x10 M.D. (single blast); 2D4x10 M.D. (double blast). Rate of Fire: Equal to the number of attacks per melee round. Range: 4,000 feet (1,220 m). Payload: Unlimited.

**Mini-Missile Launcher:** Mega-Damage: 1D4x10 M.D. (armor piercing) or 1D6x10 M.D. (plasma). Rate of Fire: Single shot or volleys of two. Range: One mile (1.6 km). Payload: 24; 12 per launch tube.

**Other Weapons:** Ion Turrets (2), Multi-Missile Launcher & Laser System, Mini-Missile Launcher, Heavy Armored Laser Cannon.

**Black Market Cost:** Unavailable.

**Note:** This vehicle can synch up with the other X-MISB-01 components to create a monstrous compound fighting vehicle.

## Triax/NGR Adventuring Vehicles

### MZ-10 Wilderness Cruiser

**Manufacturer:** Triax (Triax & NGR, p. 138).

**Class:** Hover Vehicle/Armored Car.

**Crew:** One pilot, up to six passengers.

**Main Body M.D.C.:** 310

**Maximum Speed:** Hovering: 160 mph (256 km).

**Maximum Range:** 500 miles (800 km); unlimited if nuclear.

**Bonuses:** None.

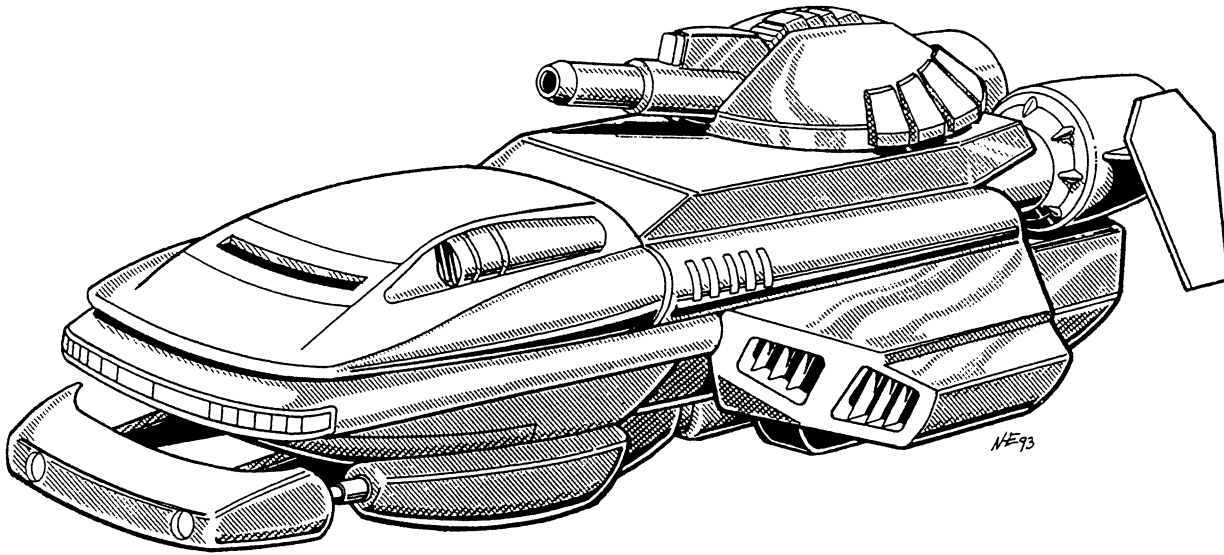

**Ion Cannon:** Mega-Damage: 6D6 M.D. Rate of Fire: Equal to the number of attacks per melee round. Range: 2,000 feet (610 m). Payload: Unlimited.

**Other Weapons:** The front of the vehicle can accommodate one additional weapon system, as can the ion cannon turret.

**Black Market Cost:** 3.5 million credits (gas or electric); 8.5 million credits (nuclear).

### WR-1010 Land Rover

**Manufacturer:** Generic NGR (Triax & NGR, p. 138).

**Class:** Automobile.

**Crew:** One pilot, up to four passengers.

**Main Body M.D.C.:** 100

**Maximum Speed:** Ground: 180 mph (288 km).

**Maximum Range:** 300 miles (480 km); unlimited if nuclear.

**Bonuses:** None.

**Weapons:** The WR-1010 can accommodate up to one light weapons mount (light laser, rail gun, mini-missile launcher, etc.).

**Black Market Cost:** 28,000 credits.

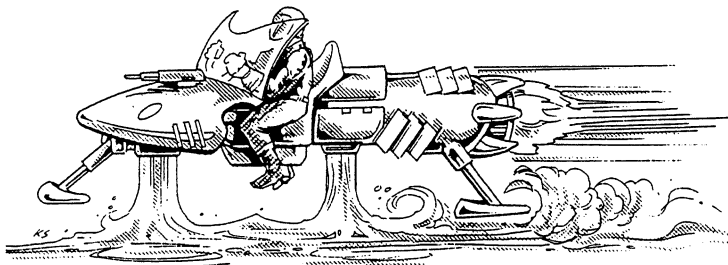

### WR-2020 Shark

**Manufacturer:** Generic NGR (Triax & NGR, p. 139).

**Class:** Hovercycle.

**Crew:** One pilot, one passenger.

**Main Body M.D.C.:** 80

**Maximum Speed:** Hovering: 280 mph (448 km).

**Maximum Range:** 500 miles (800 km); unlimited if nuclear.

**Bonuses:** None.

**Weapons:** The WR-2020 can accommodate up to one light weapons mount (light laser, rail gun, mini-missile launcher, etc.).

**Black Market Cost:** 65,000 credits (gas or electric); 2.065 million (nuclear).

### WR-5054 Mini-Cargo Hauler

**Manufacturer:** Generic NGR (Triax & NGR, p. 140).

**Class:** Armored Personnel Carrier.

**Crew:** Three: pilot, co-pilot, gunner.

**Main Body M.D.C.:** 200

**Maximum Speed:** Ground: 150 mph (240 km).

**Maximum Range:** 200 miles (320 km); unlimited if nuclear.

**Bonuses:** None.

**Forward Laser Turret:** Mega-Damage: 3D6 M.D. Rate of Fire: Equal to the number of attacks per melee round. Range: 2,000 feet (610 m). Payload: Unlimited.

**Other Weapons:** The WR-5054 can accommodate up to two additional weapon systems (lasers and energy weapons, rail guns, mini-missile launchers, etc.).

**Black Market Cost:** 45 million credits (gas or electric); 49 million credits (nuclear).

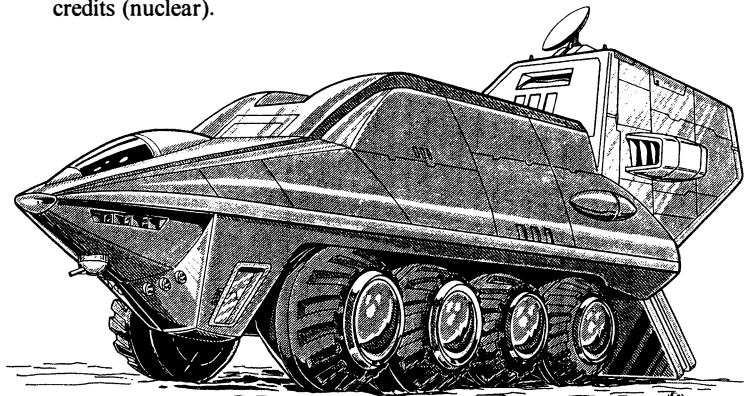

### WR-5050 Super Cargo Hauler

**Manufacturer:** Generic NGR (Triax & NGR, p. 139).

**Class:** Armored Personnel Carrier.

**Crew:** Three: pilot, co-pilot, gunner.

**Main Body M.D.C.:** 400

**Maximum Speed:** Ground: 120 mph (192 km).

**Maximum Range:** 200 miles (320 km); unlimited if nuclear.

**Bonuses:** None.

**Forward Laser Turret:** Mega-Damage: 3D6 M.D. Rate of Fire: Equal to the number of attacks per melee round. Range: 2,000 feet (610 m). Payload: Unlimited.

**Other Weapons:** The WR-5050 can accommodate up to four additional weapon systems (lasers and energy weapons, rail guns, mini-missile launchers, etc.).

**Black Market Cost:** 45 million credits (gas or electric); 57 million credits (nuclear).

# Bionic Notes

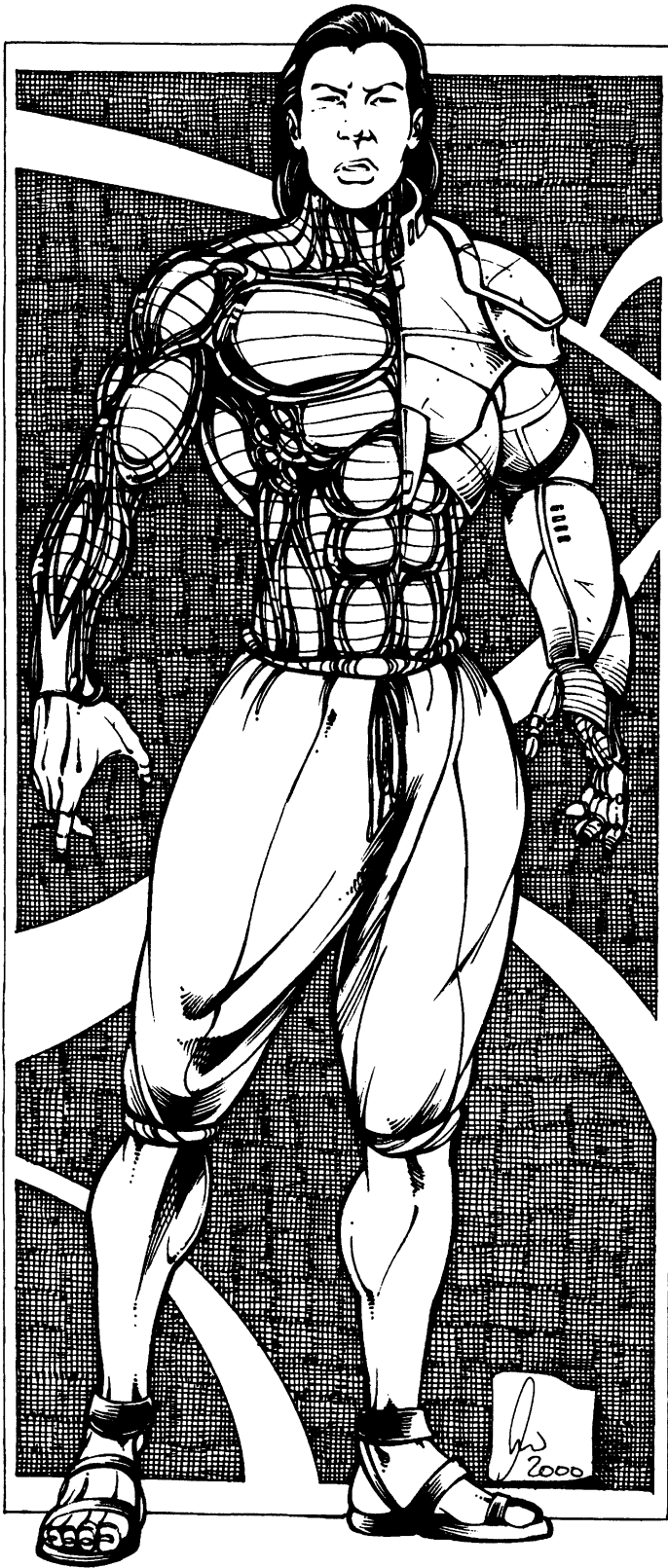

To many people of Rifts Earth, obtaining cybernetic implants, if not military issue bionics, is a routine, everyday occurrence. In high-tech cities like Chi-Town, who have extensive cybernetic and bionic capabilities, most people reserve cybernetics for medical and personal use. If one needs to replace a lost or severely damaged limb, or internal or-

gan, bionics is the likely way to go. In the Coalition States, extensive partial reconstruction (50% or more of the body) and total bionic conversion are exclusive to military purposes, with a few exceptions for those in positions of power. Thus, it is illegal for a CS citizen to get bionics for any reason other than medical or minor augmentation, and none of these are military grade. While the Black Market and other communities outside the CS may offer all manner of cybernetic and bionic augmentation and combat systems, they are illegal in the CS.

Cybernetics used in medicine often look reasonably (sometimes completely) natural and normal, while military grade bionics are often devoid of any cosmetics to make them look “real” or “human.” Instead, most bionics are cold, hard machines, often bigger and bulkier than the human body. As one would expect, the average cyborg is designed for combat and/or heavy labor. As such, they usually have a great deal more physical power, speed, weapons and gadgetry than the average citizen could ever imagine.

Partial and full conversion bionics among the common population are found in surprising numbers in the communities and wilderness outside the Coalition States and throughout much of the world. In Russia, cyborgs are heroes and the military elite. In the Americas there are the infamous “Headhunters,” mercenary warriors who are usually partial cyborgs and those known as “‘Borgs,” full conversion cyborgs who are more machine than flesh and blood.

## The Cyborg Character

The rules for creating a ‘Borg or Headhunter O.C.C. are found in the *Rifts® RPG*. Meanwhile, *Rifts® World Book 5: Triax & the NGR* presents a number of full conversion cyborgs including the famous “Red ‘Borg,” and *World Book 20: Rifts® Canada* presents five *Headhunter O.C.C.s* as well as the *Cyber-Horsemen of Ixion*.

**The psychological impact.** Whenever a character wants bionic augmentation or total conversion, he or she must find a place to get the machine parts and competent surgical installation. This is major surgery and the character will never be the same. Once turned into even a partial cyborg, the character can never return to being completely human. It is a grim fact that has a psychological impact on every Headhunter and ‘Borg ever created. Some handle it well, others do not. Surprisingly, those who love combat, crave raw physical power and look forward to a “life” in the military (whether as a soldier or a mercenary or adventurer) usually do very well. The majority of such individuals *enjoy* their mechanized bodies and have few if any regrets. Headhunters and other partial cyborgs usually maintain enough of their humanity to not be bothered by being an “M&M” (Man and Machine). Additionally, those who save some money can have mechanical appendages converted to more human-looking (and feeling) components if they so desire. Thus, they can fit into human society and can lead normal lives whenever they so chose.

Full conversion ‘Borgs have it harder. Few retain much, if any, of their original flesh and blood bodies other than their brain and their most basic components. Those designed for combat or heavy labor are usually oversized, hulking brutes who look more like a robot than a humanoid. Many deliberately want a frightening visage to intimidate their enemies and want to look mechanical and powerful. Not only does this mean big guns and heavy exterior body armor, but may also include spikes, blades, horns, and the wearing of monstrous face masks.

**Availability and markups** are left up to the Game Master. If the character is smart, he will go to a *reputable* Cyber-Doc and cybernetics facility like those available at Whykin, Ishpeming (Northern Gun), Manistique and Lazlo (among others; Tolkeen used to offer quality Bionic, Juicer and Crazy conversions before it fell to the CS). Most legitimate clinics and out in the open Black Market cyber-facilities are good to excellent, while underground, back-street, criminal operations – *Body Chop-Shops* – vary in quality from good to fair to outright abysmal butcher shops with a horrifying “failure rate” (i.e. death count). Buyer beware!

One simple service that can knock a few percentage points off the cost is for a character with existing bionics to trade in old bionic parts for new components. This can usually get the individual a 10-15% discount for minor cybernetic augmentation and implants, and a 20-50% discount (depending on the items available for trade) for bionics. The Cyber-Doc *may* also offer a discount (normally 2-4%) if the character provides a detailed report to the doctor on how their existing systems work in the field, and any glitches, comments and constructive criticism he may have to offer. In fact, many doctors require such a detailed set of reports or interviews for their data base. Information gained this way is not only valuable to future research, but it can be sold to other researchers for significant money, especially if the cyborg character that provides it is a regular customer with reliable information. Many of the street clinics use this tactic to defer their costs in obtaining bionic

supplies and to ensure they get access to any new systems that become available; however, those lower costs are rarely passed on to the customers.

**In addition to the materials cost,** bionic surgery is expensive. Characters from the Bionics Power Category have their surgery costs waived or absorbed during character creation, but getting additional or upgraded bionics once the campaign is underway will require surgery. Bionic surgery costs 10% of the total cost of the bionic parts being installed. Thus, a bionic arm costing 700,000 credits costs an additional 70,000 for the surgery. Two arms (1.4 million credits) and increased P.S. +10 for both arms (40,000 credits) would cost 144,000 credits in surgical expenses. Again, the additional cost for surgery only applies to upgrades and add-ons that come after the initial creation of the character.



**Surgical Recovery.** Of course, all this hacking off of things and replacing them with foreign objects damages the body. Sure it is controlled damage, but it is damage nonetheless. Once the character has his new implants or bionics, he must heal up from the surgery and adjust to his new mechanical augmentation. Each 25,000 credits (round down) of bionic implants will do one Hit Point (not S.D.C.) of damage to the character which must be healed entirely before the newly implanted systems can come on-line. The Cyber-Doc can gauge on a successful diagnosis roll exactly how many implants or cybernetic reconstructions a patient can endure at one time. Multiple surgeries may be needed to finish the job (i.e. a 5 million credit partial conversion would require 200 Hit Points worth of surgeries. A tough character with 50 Hit Points would have to undergo four or five surgeries before the process was complete). If the doctor fails his surgery roll, both the damage from the surgery and the required time to heal are doubled. If the damage caused by the surgery is greater than the patient's Hit Points, then he will fall into a coma and possibly "die on the table." Roll to save vs coma and death as usual.

Thanks to advanced medical technology, bionics patients typically recover their lost Hit Points at twice the normal rate after a successful cybernetic operation. However, the patient will still require time to debug his new mechanical systems, finalize all cybernetic-organic integration, and undergo monitoring for possible rejection of the new parts. The standard rule of thumb is that for every Hit Point lost during cybernetic implantation, the patient will require an additional hour of full-time medical attention/therapy after his Hit Points are fully recovered. Thus, a 500 Hit Point series of surgeries will require nearly three weeks (20.8 days) of additional medical care and/or therapy after recovery. During this time, it is fair to assume the character performs at a diminished capacity (-1D4x10%; reduce the number of attacks, combat bonuses, and speed accordingly). Certain super powers or the use of magical or psionic healing can reduce this extra recovery time to a fraction (one third the time noted above). **Cost:** Hospital time for recovery is about 500 credits per day.

**"Back-Street doctors" and "underworld Body Chop-Shops"** are those with less than adequate facilities and/or skills. All of them have lower than average scruples which happens to translate into lower than average costs; provided one is willing to risk his life. A clinic hidden in a back alley is not a "back-street clinic" as regards to these rules if it is staffed by good doctors, even though it may be referred to as such. The term is used to refer to *bottom-barrel* doctors and clinics that cater to the poor or desperate, or are the only facilities to be found where bionics are illegal. Such places will also deal with Cyber-Snatchers and purchase "used" bionics and cyber-implants with no questions asked.

Back-Street doctors usually cost half as much as reputable ones when it comes to surgery and recovery costs, but bionic components are the same. A third do not even have recovery facilities and the patient must be taken away immediately after surgery to recover on his own, elsewhere! In addition to their other low rates, those who traffic in "recycled" (cyber-snatched and other types of used) bionics may offer parts for 25% less than standard. The down side to street clinics and Cybernetic Body Chop-Shops, especially underworld clinics, and the reason they are sometimes called "butcher shops," is sloppy work. If a character uses a street clinic or other shady surgeon, the G.M. should require the Cyber-Doc to make a Cybernetics M.D. skill roll. A failed roll (most street Cyber-Docs are not particularly experienced) means the character must roll on the *Back-Street Bionics Side Effects Table* below to see what problems he will have with his poorly implanted bionics. Also, if the doctor uses secondhand parts or releases the patient early (before completely healed from surgery), make an extra roll (or one roll for each shortcut) on the chart and combine the results with the first roll.

## Back-Street Bionics Side Effects Table

**01-10%:** Scarring reduces P.B. or P.P. by 2 points.

**11-20%:** Scarring reduces P.B. and P.P. by 1 point each.

**21-40%:** Double recovery and adjustment time (see below).

**41-50%:** Double adjustment time penalties (see below).

**51-60%:** Bionic components don't work properly. Reduce damage and range of weapons by 1D4x10%, and/or P.S. of limbs by 20%, Spd of bionic legs by 1D4x10%.

**61-70%:** 10% chance bionic implant fails when used.

**71-80%:** 20% chance bionic implant fails when used.

**81-90%:** Doesn't know his own strengths or limits. Is likely to break delicate items when handling them, can't pull a punch (does full damage), overshoots the target when leaping or running, and is off when using bionic weapons (-1 to strike). Needs adjustments.

**91-95%:** Double the damage done by implant surgery (2 H.P. per 25,000 credits).

**96-00%:** Massive damage from implant surgery (1D4 H.P. per 25,000 credits).

As you can see, seeking the best care and the most skilled surgeon is quite desirable for a character when dealing with something as expensive and life threatening as bionic augmentation. Corporate programs that build reliable operations (not their experimental programs to develop new bionic systems) are considered top quality with the best doctors and equipment. Military and government programs will also usually have top quality components and care.



## Adjusting to New Implants

Another consideration is that new bionics replace but do not completely compensate for the sensations of flesh and blood. Bionic O.C.C.s are fully intimate with this phenomenon and prepared for it. Consequently, they adjust almost immediately to new implants (2D6 days), but time others will go through an adjustment period of at least one month (4D6 weeks), during which they will perform at less than

peak levels due to distractions and the need to make constant adjustments or compensations for the bionics and lack of physical sensation. G.M.s should assign penalties based on the new bionics (-5% to skills for one bionic eye, -10% for two, -2% to skills and -1 to strike for implanted weapons in the arm or hand, -15% to skill performance for a new hand, etc.). Multiple systems have cumulative penalties. Full conversion bionic characters spend a year training to adjust to their new bodies, and most spend six months or more undergoing multiple surgeries to gradually acclimate them to their rapidly replaced flesh. This adjustment and training time is half for characters created as a Bionic O.C.C., as they are experts at handling their own cybernetic systems.

In addition, there is a certain mental and emotional strain to consider. Most citizens of Rifts Earth are so accustomed to the very concept of bionics that *most* societies accept cyborgs with little or no social stigma. Thus, cyborgs are generally accepted in most human and D-Bee societies in the Americas and most of Europe. In Russia, 'Borgs are embraced and celebrated as heroes and elite fighting troops. There, only partially reconstructed cyborgs will be treated as lesser (and even cowardly) cyborgs for not becoming full conversion 'Borgs.

Still, most cyborgs feel at least a bit removed from their fellow humanoids, and some come to feel they are freakish. This can lead to a wide range of feelings from isolation and anti-social behavior to feelings of superiority.

Characters who are NOT a Bionic O.C.C. like the 'Borg or Headhunter, and who receive bionic replacements of any kind, whether by choice or happenstance, must roll to save vs insanity after surgery. A failure to save means rolling on the following *Bionic Insanity Table*. Roll once. If the character fails to save, roll again for every three levels of experience as the individual continues to struggle with his inhuman body. This mental damage comes from the patient's inability to cope with the radical changes his body has undergone.

**Note:** This rule does not usually apply to characters created from a Bionic O.C.C. They are usually profiled, prepared with counseling and emotionally stable before and after surgery. HOWEVER, if the player wants to roll on the table, let him, it will only add to the character's personality and quirks.

G.M.s, feel free to use this table when making villains. A great motivation for an evil cyborg's behavior is madness brought on by the very process that gave him his powers.

## Bionic Insanity Table

**01-15%:** Feels he has lost his humanity, has become a monster, and hates the world for it! Number one on his hate list are those he holds responsible for his getting bionics. Number two are anybody who installs bionics. Number three, the world at large. This character is in emotional pain, making him hot-tempered, aggressive, and cruel. The worst may become murderous psychopaths.

**16-30%:** Feels he has lost his humanity and has become a monster! Sees himself as ugly, an outcast and inadequate regardless of how attractive or invisible the bionics may actually be or if others see him in a positive or heroic light. Skill performance is permanently -10% and combat bonuses are reduced by one point. Tends to be a loner and assumes people are saying the worst about him.

**31-45%:** Feels he has lost his humanity and is more machine than human. Feels disconnected with other humanoids and creatures of flesh and blood. Makes him something of a sociopath: lacks a feeling of kinship, compassion and mercy toward flesh and blood people. Tends to be cold, uncaring, and inhumane. *May* also be condescending and cruel.

**46-65%:** Life is precious syndrome. Sees himself as less valuable than ordinary people without bionics, and is fanatical about protecting others, especially women and children. The cyborg will sometimes take dangerous action (to himself) to protect others. If a villain, the outlook is reversed, where he sees anybody who is not a cyborg or robot to be inferior, pawns to be used, abused and enslaved by their superiors (namely him).

**66-70%:** Obsessed with death. Doesn't want to die, but is fascinated by death and the many ways to die, as well as theological aspects of death and the afterlife. Death has no horror for this character and he sometimes takes foolish and reckless chances, assuming he can get mechanically "fixed" later if necessary.

**71-75%:** Paranoia: Dislikes, distrusts and/or fears advanced machines including other cyborgs, robots, androids and computers (not crazy about being on submarines, spaceships or space stations either). Avoids them and is always suspicious of them. Targets opponents who are cyborgs, robots, and those who pilot power armor and robot vehicles. Does not trust Cyber-Doctors or agencies who promote the use of bionics or robotics for any purpose.

**76-80%:** Obsession: Machines. This character either sees machines as *good* (and is obsessed with advanced technology and gizmos, desiring to get more and better bionics whenever possible especially if only a partial cyborg or City Rat), or *hates* them. The latter means the character hates his own machine body (but won't change it) and promotes the values and wonders of being flesh and blood, getting back to nature, physical fitness and not relying on machines to ad nauseam. Dislikes technophiles, City Rats and hardware people.

**81-85%:** Machine-God Syndrome. The cyborg sees himself as a tribute to modern technology and as being superior to "mere mortals." Consequently, he or she has a dramatically inflated sense of self-importance. Most are arrogant and crave the limelight and fame. When they don't get what they consider to be their fair share of accolades, recognition and reward, they will verbally chide and lash out at the "ingrates," as well as get drunk and generally become a grumbling, childish pain in the neck. The slighted cyborg may also start brawls, badmouth those who stole his limelight and/or instigate trouble or issue challenges. These characters also tend to see themselves as "above the law," doing as they please and getting angry if called on the carpet for it ("Do you know who I am? How dare you tell me what to do," and so on).

**86-90%:** Roll once on the Obsession Table in the Rifts® RPG.

**91-95%:** Roll once on the Neurosis Table in the Rifts® RPG.

**96-00%:** Roll once on the Affective Disorder Table in the Rifts® RPG.

# Bionics Index for Rifts®

A compilation of bionics was done, but space limitations prevent us from presenting it here. It can be found in the 112 page **Rifts® Bionics Sourcebook**, along with new bionics and more. In the meanwhile, here is a handy index where one can find various bionics and cybernetics in the Rifts® Megaverse®. It was put together by Julius Rosenstein.

Books with an emphasis on cyborgs include: **Rifts® RPG**, **Coalition War Campaign**, **Triax & the NGR**, **Rifts® Japan** and **Warlords of Russia**. Brain implants for M.O.M. (Crazy) Conversion are found in the **Rifts® RPG** and **Sourcebook 3: Mindwerks**.

**Note:** An asterisk indicates items/systems that are available as both a cybernetic implant or minor surgical augmentation (i.e. replace the hand; the type of things available to City Rats, Headhunters, and other partial reconstructed 'Borgs), as well as being available as a full-blown bionic augmentation (i.e. a feature of a heavy bionic or combat system).

## Bionics & Cybernetics

Bionic Arms & Strength – **Rifts® Ultimate Ed.**, p. 46.

Bionic Arm & Hand Weapons – **Rifts® RPG**, p. 239.

Bionic Legs & Speed – **Rifts® Ultimate Ed.**, p. 46.

Bionic Leg Weapon – **Rifts® RPG**, p. 241.

Black Market Bionics – **Rifts® Ultimate Ed.**, p. 48.

Combat Cyborg O.C.C. – **Rifts® Ultimate Ed.**, p. 45.

Cyber-Horsemen R.C.C. – **Rifts® Canada**, p. 103.

Cyber-Samurai O.C.C. – **Rifts® Japan**, p. 80.





- CyberSlinger O.C.C. – **New West**, p. 189.  
 Cybernetic (common; general) – **Rifts® RPG**, p. 229.  
 Decommissioned Cyborgs: CS – **Coalition War Campaign**, p. 70.  
 Decommissioned Cyborgs: Japan – **Rifts® Japan**, p. 98.  
 Headhunter O.C.C. (original Techno-Warrior) – **Rifts Ultimate**, p. 74.  
 Headhunter O.C.C.s (expanded & defined) – **Rifts® Canada**, p. 107.  
 Japanese Cybernetics of Note – **Rifts® Japan**, p. 109.  
 Japanese Ninja Crazy O.C.C. – **Rifts® Japan**, p. 86.  
 Japanese Ninja Borg O.C.C. – **Rifts® Japan**, p. 88.  
 Japanese Cyborg O.C.C.s of the Republic – **Rifts® Japan**, p. 97.  
 Mining ‘Borg O.C.C. – **New West**, p. 113.  
 Modified Men (M&M) – **Rifts® RPG**, p. 229.  
 Russian Light Machines – **Warlords of Russia**, p. 107.  
 Russian Heavy Machines (full conversion) – **Warlords of Russia**, p. 111.  
 Russian Cyborgs Shocktroopers (many) – **Warlords of Russia**, p. 114.  
 Triax VX Cyborgs – **World Book 5: Triax & NGR**, p. 99.  
 Triax Cybernetics of Note – **World Book 5: Triax & NGR**, p. 153.

### Partial Bionic Reconstruction

- CyberHorsemen of Ixion – **Rifts® Canada**, p. 106.  
 Cyber-Samurai – **Rifts® Japan**, p. 80.  
 Headhunter O.C.C. (original Techno-Warrior) – **Rifts Ultimate**, p. 74.  
 Headhunter O.C.C.s (expanded & defined) – **Rifts® Canada**, p. 107.  
 Japanese: Light Partial Bionics – **Rifts® Japan**, p. 96.  
 Russian Light Machine – **Warlords of Russia**, p. 108.  
 Typical Bionics for ‘Borg Soldier or Mercenary – **Rifts Ultimate**, p. 46.  
 Typical Bionics for Slave-‘Borg – **Rifts® RPG**, p. 237.

### Full Bionic Conversion

- Typical ‘Borg Soldier or Mercenary – **Rifts Ultimate Ed.**, p. 45.  
 Typical Slave-‘Borg – **Rifts Ultimate Edition**, p. 45.  
 Coalition ‘Borg – **Coalition War Campaign**, p. 49.  
 CyberSlinger Mark I: “The Kid” – **New West**, p. 190.  
 CyberSlinger Mark II: “Super Slinger” – **New West**, p. 191.  
 CyberSlinger Mark III: “Gringo” – **New West**, p. 192.

- Japanese: Light Full Bionics – **Rifts® Japan**, p. 96.  
 Japanese: Heavy Full Bionics – **Rifts® Japan**, p. 96.  
 Mining ‘Borg/Prospector – **New West**, p. 113.  
 Ninja ‘Borg – **Rifts® Japan**, p. 88.  
 Russian Heavy Machine – **Warlords of Russia**, p. 111.  
 Russian Light Machine – **Warlords of Russia**, p. 108.  
 Triax VX Series Cyborgs – **Triax**, p. 99.  
 Triax Gurgyle (infiltration) Cyborg – **Triax**, p. 97.

### Prosthetic Weapon Limbs

- Bio-Systems – **Rifts® RPG**, p. 232.  
 Bionic Organs – see *Bio-Systems* in the **Rifts® RPG**; p. 232.  
 Hand – **Rifts® RPG**, p. 239.  
 Hand and Arm – **Rifts® RPG**, p. 239.  
 Foot and Leg – **Rifts® RPG**, p. 239.  
 Partial Reconstruction – **Rifts® Ultimate Ed.**, p. 75.  
 Full Body Conversion – **Rifts® Ultimate Ed.**, p. 45.  
 Robot Strength – **Warlords of Russia**, p. 101 and this book.  
 Treads for Legs – **Warlords of Russia**, p. 104.

### Bionic Hand Weapons & Tools

**Note:** Items with an asterisk are available in both cybernetic and bionic versions.

- Energy-Clip Hand or Arm Port – **Rifts® Ultimate Edition**, p. 53.  
 Extendible Hydraulic Hands/Arm – **Triax**, p. 154.  
 Extra Appendage/Arms – **New West**, p. 189.  
 \* Finger Camera – **Rifts® RPG**, p. 239.  
 \* Fingerjack – **Rifts® RPG**, p. 239.  
 \* Laser Utility Finger – **Rifts® Ultimate Edition**, p. 53.  
 \* Laser Finger Blaster – **Rifts® Ultimate Edition**, p. 53.  
 \* High Explosive Finger Joints – **Rifts® Ultimate Edition**, p. 53.  
 Hydraulic Hammer Hand – **Warlords of Russia**, p. 104.  
 Hydraulic Ram Hand – **Warlords of Russia**, p. 104.  
 Mining Tools – **New West**, p. 187.  
 Modular Housings – **New West**, p. 187.  
 Palm Energy Generators – **Rifts® Japan**, p. 112.  
 1. Laser Blaster – **Rifts® Japan**, p. 112.  
 2. Ion Blaster – **Rifts® Japan**, p. 112.  
 3. Particle Beam – **Rifts® Japan**, p. 112.  
 4. Plasma Ejector – **Rifts® Japan**, p. 112.  
 5. Stun Blaster – **Rifts® Japan**, p. 112.  
 PL-31 Palm Laser Torch – **Triax**, p. 154.  
 W-41 Palm Laser Torch – **Warlords of Russia**, p. 106.  
 Retractable Finger Blades – **Rifts® Ultimate Edition**, p. 53.  
 Retractable Knuckle Blades – **Rifts® Ultimate Edition**, p. 53.  
 Knuckle Spikes – **Rifts® Ultimate Edition**, p. 53.  
 Tool Hand – **Warlords of Russia**, p. 104.

### Bionic “Arm” Weapons & Tools

**Note:** Items with an asterisk are available in both cybernetic and bionic versions.

- Additional Hand And Arm – **Rifts® Ultimate Edition**, p. 51.  
 Additional Non-Human Appendage – **Rifts® RPG**, p. 239.  
 Additional Tail Appendage – **Rifts® RPG**, p. 240.  
 Climb Cord – **Rifts® RPG**, p. 240.  
 Chemical Spray – **Rifts® RPG**, p. 240.  
 1. Blinding chemical agent  
 2. Tear gas  
 3. Burning acid vapors  
 4. Tranquilizer/sleep spray  
 5. CO2 Foam  
 Chemical Spray: Acid – **New West**, p. 187  
 \* Computer & Calculator Built Into the Arm – **Rifts® RPG**, p. 240.  
 Concealed Arm Laser Rod – **Rifts® RPG**, p. 240.  
 Concealed Vibro-Blade – **Triax**, p. 154.  
 Electro-Cannon Forearm Blaster – **Warlords of Russia**, p. 104.  
 Exploding Finger Joints – **Rifts® Ultimate Edition**, p. 53.



Extendible Hydraulic Hands/Arm – **Triax**, p. 154.

Extra Appendage/Arms – **New West**, p. 189.

Forearm Blaster – **Rifts® Ultimate Edition**, p. 51.

1. Laser blaster
2. Ion blaster
3. Plasma Ejector
4. Particle Beam
5. Mini-machine-gun

Forearm Weapon Guards – **Warlords of Russia**, p. 104.

\* Garrote Wrist Wire – **Rifts® Ultimate Edition**, p. 52.

Grapnel & Launcher – **Triax**, p. 154.

Japanese: Weapons, **Rifts® Japan**, p. 112.

1. Ion Blaster
2. Laser Blaster
3. Particle Beam
4. Plasma Ejector
5. Stun Blaster

LGL-31 Grapnel & Launcher – **Triax**, p. 154.

Laser Cannon Arm – **Warlords of Russia**, p. 105.

Mekanikal Barrage Weapon Arm – **Warlords of Russia**, p. 105.

Mekanikal Cutter Weapon/Utility Arm – **Warlords of Russia**, p. 105.

Mekanikal Rail Gun Weapon Arm – **Warlords of Russia**, p. 105.

Mekanikal Vibro-Blade Multi-Weapon Arm – **Warlords of Russia**, p. 105.

Modular Forearm Attachments (various) – **New West**, p. 187-188.

- |   |  |
|---|--|
| <ol style="list-style-type: none"> <li>1. Air Blaster</li> <li>2. Flashlight</li> <li>3. Housings</li> <li>4. Jackhammer</li> <li>5. Laser Hand</li> <li>6. Mining Drill: Heavy</li> <li>7. Mining Drill: Precision</li> <li>8. Multi-Tool</li> <li>9. Plasma Torch</li> <li>10. Shovel Hand</li> </ol> | <ol style="list-style-type: none"> <li>11. Sonic</li> <li>12. Vibro-Monster Claw Hand</li> <li>13. Vibro-Pick</li> </ol> |
|---|--|

Palm Laser Torch – **Triax**, p. 154.

Retractable Blades (large) – **Rifts® Ultimate Edition**, p. 53.

Retractable Vibro-Blades – **Rifts® Ultimate Edition**, p. 53.

Sonic Pulsar Unit (Flea & Insect Repellent) – **Triax**, p. 152

Techno-Wizard Bionics – **Rifts® Canada**, p. 126.

Tool Mechanic's Arm – **Warlords of Russia**, p. 104.

Tool Arms (Mining) – **New West**, p. 187.

Triax Weapons – **Triax**, p. 154.

Vibro-Blades – **Rifts® RPG**, p. 241.

Vibro-Blades: Concealed – **Triax**, p. 154.

\* Wrist Needle & Drug Dispenser – **Rifts® Ultimate Edition**, p. 53.

1. Antibiotics
2. Paralysis
3. Poison
4. Tranquilizer/sleep
5. Truth Serum

### Bionic Leg Weapons & Accessories

Booster Maneuvering Jets – **New West**, p. 188.

Concealed Weapon Rod – **Rifts® Ultimate Edition**, p. 53.

Hydraulic Leg Boosters – **Warlords of Russia**, p. 103.

Quick Draw Holsters – **New West**, p. 189.

Secret Compartments – **Rifts® Ultimate Edition**, p. 49.

Stabilizing Anchors – **New West**, p. 189.

Western Wilderness Survival Kit – **New West**, p. 189.

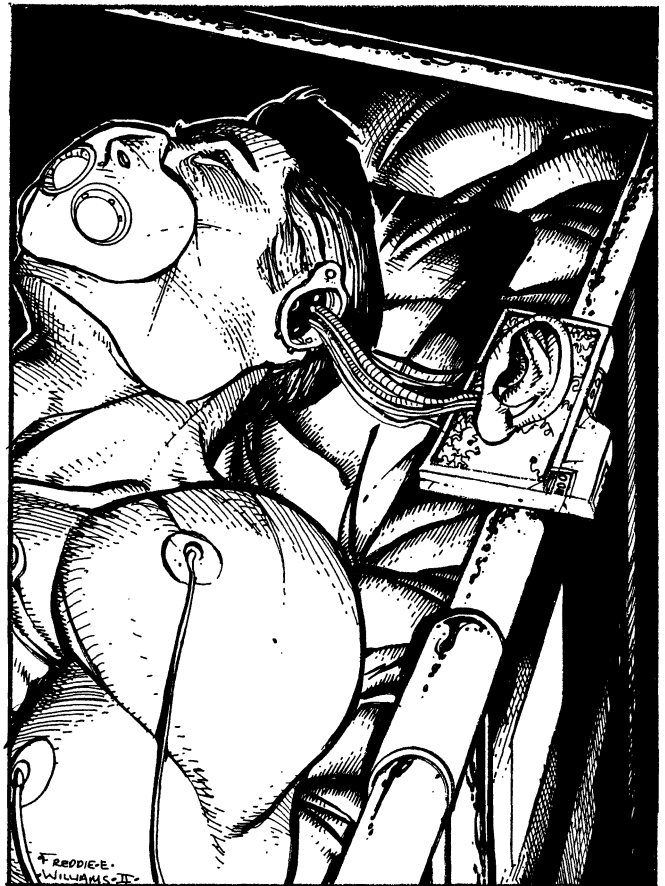

### Bionic Ear & Head Implants

**Note:** Items with an asterisk are available in both cybernetic and bionic versions.

\* Amplified Hearing – **Rifts® Ultimate Edition**, p. 49.

\* Audio Filter & Enhancement – **Warlords of Russia**, p. 102.

\* Computer Hacker Encoder – **Rifts® Japan**, p. 109.

\* Cosmetic Implants – **Rifts® Japan**, p. 109.

\* Cyber-Disguises – **Rifts® RPG**, p. 236.

\* Cyber-Drone – **Rifts® Japan**, p. 110.

- \* Cyberware Networking – **Rifts® Japan**, p. 110.
- \* Data Chip (brain) – **Rifts® Japan**, p. 112.
- \* Internal Comp-Calculator – **Warlords**, p. 103.
- \* Low-Frequency Audio Rig – **Warlords**, p. 102.
- \* Psionic Electro-Magnetic Dampeners – **Triax**, p. 154.
- \* Radio Chip – **Rifts® Japan**, p. 110.
- \* Radio & Scrambler – **Rifts® Japan**, p. 110.
- \* Security Clearance Chip – **Rifts® Japan**, p. 112
- \* Signal Booster – **Rifts® Japan**, p. 110.
- \* Sound Filtration System – **Rifts® Ultimate Edition**, p. 51.
- \* Synthetic Voice Enhancer – **Warlords of Russia**, p. 102.
- \* Ultra-Ear – **Rifts® Ultimate Edition**, p. 51.
- \* Universal Headjack & ear implant – **Rifts® Ultimate Edition**, p. 51.

Also see *Rifts® Sourcebook Three: Mindwerks* for M.O.M. and brain implants.



## Bionic Eyes

**Note:** Items with an asterisk are available in both cybernetic and bionic versions.

- HUD Visor – **Rifts® Japan**, p. 112.
- \* Infrared Eye (old fashion) – **Rifts® Ultimate Edition**, p. 50.
- \* Laser Beam Eye – **Triax**, p. 154.
- \* Laser Beam Eye – **Rifts® Japan**, p. 111.
- \* Laser Beam Eye – **Warlords of Russia**, p. 106.
- \* Light Filters – **Warlords of Russia**, p. 101.
- \* Macro-Eye – **Triax**, p. 153 & **Warlords of Russia**, p. 101.
- \* Macro-Eye Laser – **Triax**, p. 153.
- \* Macro-Eye Laser – **Warlords of Russia**, p. 101.
- \* Mechanical Eye with Polarized Filters – **Rifts® RPG**, p. 231.
- \* Multi-Optic Eye – **Rifts® Ultimate Edition**, p. 50.
- \* Multi-System Eye Socket – **Warlords of Russia**, p. 101.
- \* Optic Nerve video implant – **Rifts® Ultimate Edition**, p. 50.
- \* Panorama Cluster Lens – **Warlords of Russia**, p. 101.
- \* Passive Nightvision Eye – **Warlords of Russia**, p. 102.

- \* Third Eye – **Triax**, p. 153 & **Warlords of Russia**, p. 102.
- \* Spectra-Eye – **Warlords of Russia**, p. 102.
- \* Super-Telescopic Eye – **Warlords of Russia**, p. 102.
- \* Video Camera Eye – **Rifts® RPG**, p. 232.
- \* Wide-Angle Vision – **Warlords of Russia**, p. 102.

## Bionic Head & Throat Features

**Note:** Items with an asterisk are available in both cybernetic and bionic versions.

- Bionic Lung with Gas Filter & Oxygen Storage Cell – **Rifts® Ult. Ed.**, p. 48.
- Built-In Loudspeaker – **Rifts® Ultimate Edition**, p. 48.
- \* Built-In Radio Receiver & Transmitter Headjack – **Rifts® Ult. Ed.**, p. 48.
- \* Built-In Speech Translator – **Rifts® Ultimate Edition**, p. 49.
- Combat Computer – **New West**, p. 189.
- \* Gills – **Rifts® Underseas**, p. 191.
- Molecular Analyzer – **Rifts® Ultimate Edition**, p. 49.
- \* Modulating Voice Synthesizer – **Rifts® Ultimate Edition**, p. 49.
- Rebreather Lung – **Rifts® Japan**, p. 112

## Bionic Sensors

**Note:** Items with an asterisk are available in both cybernetic and bionic versions.

- \* Bio-Comp Self-Monitoring System – **Rifts Japan**, p. 109, **Triax**, p. 153, & **Warlords of Russia**, p. 103.
- \* Clock Calendar – **Rifts® Ultimate Edition**, p. 49.
- Combat Computer (bionic only) – **New West**, p. 189.
- \* Depth Gauge – **Rifts® Japan**, p. 112.
- \* Gromeko Friend or Foe Identification Computer – **Warlords of Russia**, p. 102.
- \* Gyro-Compass – **Rifts® Ultimate Edition**, p. 49.
- \* Internal Comp-Calculator – **Triax**, p. 153 & **Rifts® Japan**, p. 110.
- \* H.U.D. Visor – **Rifts® Japan**, p. 112.
- \* Medical Sensor Hand – **Triax**, p. 153 & **Warlords of Russia**, p. 102.
- \* Metal Detector – **Rifts® Japan**, p. 110.
- \* Sensor Hand – **Rifts® Ultimate Edition**, p. 51.
- \* Schematic Sensor Hand – **Warlords of Russia**, p. 104

## Cyborg Body Armor

- Coalition Army Body Armor – **Coalition War Campaign**, p. 102.
- Customized Face or Armored Plate – **New West**, p. 189.
- Customized Paint Job – **New West**, p. 189.
- Extra Armor Plating – **New West**, p. 189.
- LL-SB Light Labor Slave-Borg Armor – **Rifts® Ult. Ed.**, p. 46.
- LE-B1 Light Espionage Armor – **Rifts® Ultimate Edition**, p. 46.
- LI-B2 Light Infantry Armor – **Rifts® Ultimate Edition**, p. 46.
- HI-B3 Heavy Infantry Armor – **Rifts® Ultimate Edition**, p. 46.
- Japanese: Light Undercover Armor – **Rifts® Japan**, p. 97.
- Japanese: Light Infiltration Armor – **Rifts® Japan**, p. 97.
- Japanese: Light Infantry Armor – **Rifts® Japan**, p. 97.
- Japanese: Heavy Infantry Armor – **Rifts® Japan**, p. 97.
- Snaps, Hook, Tabs, and Buckles – **Rifts® Japan**, p. 111.
- Triax – **Note:** See specific Cyborgs or use **Rifts® RPG** armor.

## Chassis/Body Options

- Aerial Jet Thrusters – **Rifts® Japan**, p. 112.
- Boosters & Maneuvering Jets – **New West**, p. 188.
- \* Cosmetic Implants – **Rifts® Japan**, p. 109.
- Cyborg Jet Pack – **Warlords Russia**, p. 103.
- Cyberjet Nodes – **Warlords of Russia**, p. 103.
- \* Depth Gauge & Alarm – **Rifts® Underseas**, p. 191 & **Rifts® Japan**, p. 110.
- Environmental Upgrade – **Rifts® Japan**, p. 112.
- Head Collar & Hood – **Warlords of Russia**, p. 103.
- Helmet and/or Face Plate – **Warlords of Russia**, p. 103.

Interchangeable Parts – **Warlords of Russia**, p. 101.  
 Internal IV Feed – **Rifts® Japan**, p. 112.  
 Mining Drills & Tools (Various) – **New West**, p. 187.  
 Modular Housing – **New West**, p. 187  
 Rebreather Lung – **Rifts® Japan**, p. 112.  
 Shoulder Weapon Mounts/Clamps – **Warlords of Russia**, p. 104.  
 Underwater Propulsion – **Rifts® Japan**, p. 112.  
*Also see Sensors and Weapons.*

### Cyborg Weapon Systems & Accessories

Black Market – **Rifts® Ultimate Edition**, p. 48.  
 Chest Blaster – **Rifts® Japan**, p. 111.  
 Common Cybernetics & Sensors – **Rifts® RPG**, p. 230.  
 Computer Virus Carrier – **Rifts® Japan**, p. 109.  
 Cyber Shield – **Warlords of Russia**, p. 104.  
 Drills & Mining Tools – **New West**, p. 187.  
 Internal Ammo Drum – **Rifts® Japan**, p. 111.  
 Internal Energy Supply – **Rifts® Japan**, p. 111.  
 Power Booster – **Rifts® Japan**, p. 111.  
 Security Clearance Chip – **Rifts® Japan**, p. 110.  
 Triax Weapons & Accessories – **Triax & the NGR**, p. 98.  
 Weapons: Japan – **Rifts® Japan**, p. 112.  
 Weapons: North America – **Rifts® RPG**, p. 239.  
 Weapons: Black Market – **Rifts® RPG**, p. 235.  
 Weapons: Triax/Germany – **Triax**, p. 154.

### Magic Bionics

Anti-Magic tactics using cybernetics, **Coalition Wars™ One**, p. 31.  
 Anti-Monster/Mystic Cyborg R.C.C. – **South America One**, p. 34.  
 Bio-Borg (Splugorth) – **Splynn Dimensional Market**, p. 154.  
 Techno-Wizard Bionics – **Rifts® Canada**, p. 126.

### Psionic Enhancements

Electro-Magnetic Dampeners – **Triax**, p. 154.  
 Electro-Magnetic Dampeners – **Warlords of Russia**, p. 106.  
 Eruptor Implant – **Psyscape**, p. 153.  
 M.O.M. Conversion: See the Crazy O.C.C. – **Rifts® RPG**, p. 56.  
 M.O.M. Implants – **Mindwerks**, p. 19.  
 M.O.M. Implants: Psynetics – **Mindwerks**, p. 21.  
 Physical Reactor Implant – **Psyscape**, p. 153.  
 Psi-Blocker Implant – **Psyscape**, p. 152.  
 Psionic Actuator Implant – **Psyscape**, p. 152.  
 Psionic Booster Implant – **Psyscape**, p. 152.  
 Psionic Inhibitor Implant – **Psyscape**, p. 152.  
 Sensitive Implant – **Psyscape**, p. 153.

### Torture Implants

Various – **Coalition Wars One**, p. 133.

### Triax/NGR Weapons (exclusive to NGR 'Borgs)

VX-635 Close Contact Spray – **Triax**, p. 112.  
 Laser or Particle Beam Eyes – **Triax**, p. 98.  
 VX-20 Grenade Launcher – **Triax**, p. 114.  
 VX-300 Multiple Grenade Launcher System – **Triax**, p. 100.  
 VX-320 Multiple Grenade Launcher System – **Triax**, p. 102.  
 Head Mounted Mini-Lasers – **Triax**, p. 111.  
 Launchable Shoulder Spikes – **Triax**, p. 111.  
 VX-635 Multi-Weapon Gun-Arm – **Triax**, p. 111.  
 1. Rail Gun  
 2. Vibro-Bayonet  
 3. Mini-Laser Turret  
 VX-340 Mini-Missile Tube Launchers – **Triax**, p. 104.  
 VX-500 Mini-Missile Tube Launchers – **Triax**, p. 108.  
 VX-635 Pneumatic Air Gun – **Triax**, p. 111.  
 1. Dart - Sleep  
 2. Dart - Poison  
 3. Surveillance: Mini-Microphone



4. Surveillance: Homing device  
 Pneumatic Blade Shooter – **Triax**, p. 112.  
 VX-300 Rail Gun-Arm – **Triax**, p. 100.  
 VX-635 Ring Lasers – **Triax**, p. 112

### Underwater Bionics

Deep-Sea Environmental Body Armor – **Rifts® Underseas**, p. 191.  
 Depth Gauge & Alarm – **Rifts® Underseas**, p. 191 & **Rifts® Japan**, p. 110.  
 Gills – **Rifts® Underseas**, p. 191.  
 Sonar – **Rifts® Underseas**, p. 191.  
 Sonic Echo-Location – **Rifts® Underseas**, p. 191.  
 Rebreather Lung – **Rifts® Japan**, p. 112.  
 Underwater Propulsion – **Rifts® Japan**, p. 112.



# Character Compendium

## Alphabetical Character Index

There are literally *hundreds* of different O.C.C.s, R.C.C.s, and P.C.C.s distributed throughout the many **Rifts**® supplements currently available. As Game Masters and writers ourselves, even we at Palladium sometimes find it frustrating when we wanted to look up the stats for a particular O.C.C. or R.C.C. and can not remember which book it appeared in. Inevitably, it takes five, ten, even twenty minutes and flipping through a half dozen to a dozen books before we find our elusive quarry. And we wrote and published the darn thing! There is just so much **Rifts**® material (over 7,000 pages) that even we sometimes lose track of a particular character, weapon, monster, magic or bit of historical fact.

While we could not possibly reprint the description and stats for all the character classes that exist in any one book, *Bill Coffin* has compiled this excellent and comprehensive index for Game Masters everywhere. What follows is a list of all of the O.C.C.s, R.C.C.s and P.C.C.s that appear in every **Rifts**® book to date, including the four Dimension Books. Bill hesitates to say this is 100% comprehensive, since it is possible the odd R.C.C. might have slipped past him here or there. But this section *does* cover the vast majority of character options open to **Rifts**® players, including many that typically require G.M. approval before playing.

After each entry is the boldface "book title" of whatever sourcebook that character class appears in, as well as the page on which the full write-up may be found.

A final note. Many of the O.C.C.s and R.C.C.s presented below are indigenous to a *particular region* of the **Rifts**® Megaverse. Moreover, many of the **Rifts**® **World Books** include sections detailing exactly what other O.C.C.s and R.C.C.s are common to the region besides those described in that book. Which means there are strong reasons for why certain characters from certain parts of the world are not likely to ever meet, much less adventure together. Logic dictates that many character types remain confined to their corner of the game setting, true. But imagination dictates that anything is possible, especially in the no-holds-barred world of **Rifts**®. The enterprising Game Master can *always* find some reason to let characters of disparate types come together if that is what he (and his or her players) really want. Good fun dictates that if a group of players comes together with the flat-out craziest assembly of characters ever seen, so long as everybody is enjoying themselves and the Game Master doesn't mind, then there is no harm done. With that in mind, however, the players should always remember that the G.M.'s word is law. If he or she says that certain character types can *NOT* get together in an adventuring party, then he probably has a good reason for it. Accept it, and pick one of the other hundreds of characters that are available. Whining, arguing, and being a pain in the neck are *not* viable means of getting the G.M. to see things your way. So if he says no, please respect it. Have fun.

There are five basic categories of character classes in **Rifts**®: *Men at Arms, Scholars and Adventurers, Practitioners of Magic, Racial Character Classes* and *Psychic Character Classes*.



**Men at Arms** are all some kind of *warrior*. Some of these are part of large, organized militaries (such as the Coalition and NGR Men at Arms O.C.C.s) while others are merely generic fighters that are not, by nature, part of a formal organization (such as the Juicer and Headhunter O.C.C.s).

**Scholars and Adventurers** are those who are not primarily warriors, do not primarily practice magic, are not, by nature, psychic, and are not restricted to a particular race. As a result, this category is a sort of “loose change” bin for all of the O.C.C.s that do not fit elsewhere.

**Practitioners of Magic**, as their name suggests, are those whose primary vocation is the mastery and casting of some type of magic. Some O.C.C.s seemed more warrior than magic user, and as such, were shifted over to the *Men at Arms* category.

**Racial Character Classes** are basically a secondary kind of character class. The *Rifts*® world is heavily populated by inhuman creatures, many of which are available as Racial Character Classes. Some R.C.C.s allow the character to go on and select an O.C.C. as well, while other R.C.C.s do not. When selecting an R.C.C., be sure to read its description carefully to see if other O.C.C. selections are permitted. In cases where the possibility of additional O.C.C. selection is unclear, the G.M. has the final say.

**Psychic Character Classes** are really another form of Racial Character Class, though one that, by nature, does *not* permit the selection of an O.C.C. as well. Psychic Characters are R.C.C.s or P.C.C.s because generally speaking, psionic powers are determined by race — some races have psionic potential while others do not. The majority of Psychic Character Classes are restricted to humans, with Dog Boys coming in a close second.

## Men at Arms O.C.C.s

### A

- Arkhan Spectral Hunter O.C.C. (*South America 2*, p.73)
- Australian Aerojock O.C.C. (*Australia*, p.121)
- Australian Infantry Grunt O.C.C. (*Australia*, p.122)
- Australian Navy Sailor O.C.C. (*Australia*, p.125)
- Australian Special Operations Soldier O.C.C. (*Australia*, p.124)

### B

- Bandit (Highwayman) O.C.C. (*New West*, p.85)
- Bandit (Peasant Thug) O.C.C. (*New West*, p.83)
- Berserker (*Pantheons of the Megaverse*, p. 168)
- Bishamon Fighting Monk O.C.C. (*Japan*, p.55)
- Blood Rider (*South America 2*, p.133)
- Borg O.C.C. (*Rifts*® Ultimate Edition, p.45)
- Bounty Hunter O.C.C. (*New West*, p.87; *Mercenaries*, p.19)

### C

- CAF Fleet Officer O.C.C. (*Phase World*, p.58)
- CAF Trooper O.C.C. (*Phase World*, p.56)
- City Police (Australia) O.C.C. (*Australia*, p.110)
- Coalition Commando O.C.C. (*Coalition War Campaign*, p.71)
- Coalition Cyborg Strike Trooper O.C.C. (*Coalition War Campaign*, p.69)
- Coalition Elite RPA O.C.C. (*Rifts*® Ultimate Edition, p.233)
- Coalition EOD Specialist O.C.C. (*Coalition War Campaign*, p.73)
- Coalition Grunt O.C.C. (*Rifts*® Ultimate Edition, p.231)
- Coalition ISS Intel Specter O.C.C. (*Coalition War Campaign*, p.184)

## C

Coalition ISS Peacekeeper O.C.C. (**Coalition War Campaign**, p.180)  
Coalition ISS Specter O.C.C. (**Coalition War Campaign**, p.182)  
Coalition Juicer O.C.C. (**Juicer Uprising**, p.42; **Coalition War Campaign**, p.76)  
Coalition Military Specialist O.C.C. (**Rifts® Ultimate Edition**, p.235)  
Coalition Nautical Commando Specialist O.C.C. (**Coalition Navy**, p.37)  
Coalition Nautical Specialist O.C.C. (**Coalition War Campaign**, p.79)  
Coalition Naval Infantryman O.C.C. (**Coalition Navy**, p.34)  
Coalition Navy Sailor O.C.C. (**Coalition Navy**, p.32)  
Coalition NTSET Protector O.C.C. (**Coalition War Campaign**, p.188)  
Coalition NTSET Psi-Hound O.C.C. (**Coalition War Campaign**, p.187)  
Coalition Ranger O.C.C. (**Coalition War Campaign**, p.80)  
Coalition RCGS Scientist O.C.C. (**Coalition War Campaign**, p.82)  
Coalition RPA "Fly Boy" Ace O.C.C. (**Coalition War Campaign**, p.84)  
Coalition Special Forces O.C.C. (**Coalition War Campaign**, p.86)  
Coalition Technical Officer O.C.C. (**Rifts® Ultimate Edition**, p.236)  
Control Agent — Manhunter O.C.C. (**Skrapyers**, p.106)  
Cosmo-Knight O.C.C. (**Phase World®**, p.99)  
Cossack O.C.C. (**Warlords of Russia**, p.73)  
Crazy O.C.C. (**Rifts® Ultimate Edition**, p.53)  
Cyberai O.C.C. (**Phase World® Sourcebook**, p.16)  
Cyber-Knight O.C.C. (**Rifts® Ultimate Ed.**, p.61; **Coalition Wars 4: Cyber-Knights**, p.18)  
Cyber-Samurai O.C.C. (**Japan**, p.80)  
Cyborg Shocktrooper O.C.C. (**Warlords of Russia**, p.114)

## D

Delphi Juicer O.C.C. (**Juicer Uprising**, p.39)  
Destroyer 'Borg O.C.C. (**South America 2**, p.107)  
Dragon Juicer O.C.C. (**Juicer Uprising**, p.47)

## E

Elite Freedom Fighter (Skrapyers) O.C.C. (**Skrapyers**, p.109)  
Euro-Juicer O.C.C. (**Triax & the NGR**, p.175)

## F

Fallam Battlemaster O.C.C. (**South America 2**, p.77)  
Fallen Cosmo-Knight O.C.C. (**Phase World®**, p.102)  
Freedom Fighter (Phase World) O.C.C. (**Phase World®**, p.83)  
Freedom Fighter (Skrapyers) O.C.C. (**Skrapyers**, p.108)  
Freelance Spy O.C.C. (**Mercenaries**, p.22)  
Free Quebec Cyborg Soldier O.C.C. (**Free Quebec**, p.114)  
Free Quebec "Descended" Glitter Boy Pilot O.C.C. (**Free Quebec**, p.36)  
Free Quebec Glitter Girl pilot O.C.C. (**Free Quebec**, p.38)  
Free Quebec Intel Agent O.C.C. (**Free Quebec**, p.32)  
Free Quebec Reload Team O.C.C. (**Free Quebec**, p.40)  
Free Quebec Side Kick RPA O.C.C. (**Free Quebec**, p.39)

## G

Galactic Tracer O.C.C. (**Phase World®**, p.39)  
Glitter Boy O.C.C. (**Rifts® Ultimate Edition**, p.67)  
Gun Brother O.C.C. (**Phase World® Sourcebook**, p.25)  
Gunfighter O.C.C. (**New West**, p.90)  
Gunslinger O.C.C. (**New West**, p.92)  
Gypsy Enforcer O.C.C. (**Mystic Russia**, p.155)

## H

Headhunter O.C.C. (**Rifts® Ultimate Edition**, p.74)  
Headhunter Anti-Robot Specialist O.C.C. (**Canada**, p.116)  
Headhunter Assassin O.C.C. (**Canada**, p.113)  
Headhunter Techno-Hound O.C.C. (**Canada**, p.120)  
Headhunter Techno-Warrior O.C.C. (**Canada**, p.110)  
Heavy Machine O.C.C. (**Warlords of Russia**, p.111 & 215)  
Hyperion Juicer O.C.C. (**Juicer Uprising**, p.30)

## I

Imperial Legionnaire O.C.C. (**Phase World®**, p.82)  
Imperial Security Agent O.C.C. (**Phase World**, p.82)  
Inca Warrior O.C.C. (**South America 2**, p.23)  
Invincible Guardsman O.C.C. (**Phase World Sourcebook**, p.32)



## J

Juicer O.C.C. (**Rifts® Ultimate Edition**, p.78)  
Juicer Assassin O.C.C. (**Juicer Uprising**, p.56)  
Juicer Gladiator O.C.C. (**Juicer Uprising**, p.55)  
Juicer Scout O.C.C. (**Juicer Uprising**, p.57)  
Juicer Techno-Zombie O.C.C. (**Juicer Uprising**, p.150)  
Justice Ranger O.C.C. (**New West**, p.96)

## K

Knight O.C.C. (**England**, p.100)  
Knight of the Hospital O.C.C. (**Wormwood**, p.73)  
Knight of the Temple O.C.C. (**Wormwood**, p.70)

## L

Larhold Human Renegade O.C.C. (**South America 2**, p.186)  
Light Machine O.C.C. (**Warlords of Russia**, p.107 & 214)

## M

Master Assassin O.C.C. (**Mercenaries**, p.23)  
Mega-Juicer O.C.C. (**Juicer Uprising**, p.36)  
Megaversal Trooper (Human) O.C.C. (**South America 2**, p.104)  
Megaversal Trooper (Ojahee) O.C.C. (**South America 2**, p.106)  
Mindwerks Full Conversion Borg O.C.C. (**Mindwerks**, p.35)  
Momano Headhunter O.C.C. (**Canada**, p.122)  
Mystic Ninja O.C.C. (**Japan**, p.51)  
Mystic Warrior O.C.C. (**Spirit West**, p.39)

## N

Naut'Yll Devastator O.C.C. (**Underseas**, p.150)  
Naut'Yll Soldier O.C.C. (**Underseas**, p.149)  
New Navy Marine O.C.C. (**Underseas**, p.112)  
New Navy Seaman O.C.C. (**Underseas**, p.111)  
Nexus Knight O.C.C. (**England**, p. 98)  
NGR Communications Officer O.C.C. (**Triax & the NGR**, p.158)  
NGR Cyborg Soldier O.C.C. (**Triax & the NGR**, p.161)  
NGR Field Mechanic O.C.C. (**Triax & the NGR**, p.162)  
NGR Infantry Soldier O.C.C. (**Triax & the NGR**, p.156)  
NGR Intelligence Commando O.C.C. (**Triax & the NGR**, p.172)  
NGR Intelligence Officer O.C.C. (**Triax & the NGR**, p.171)  
NGR Medic/Medical Officer O.C.C. (**Triax & the NGR**, p.159)  
NGR Police Officer O.C.C. (**Triax & the NGR**, p.173)  
NGR Power Armor Commando O.C.C. (**Triax & the NGR**, p.164)  
NGR Robot Combat Pilot O.C.C. (**Triax & the NGR**, p.165)  
NGR Robot Soldier O.C.C. (**Triax & the NGR**, p.166)  
Ninja Borg O.C.C. (**Japan**, p.88)  
Ninja Crazy O.C.C. (**Japan**, p.86)  
Ninja Juicer O.C.C. (**Japan**, p.84)  
Noro Mystic Warrior O.C.C. (**Phase World®**, p.64)  
Null Psyborg O.C.C. (**Mindwerks**, p.37)

## O

Ojahee Cyborg O.C.C. (**South America 2**, p.109)

## P

Phaeton Juicer O.C.C. (**Juicer Uprising**, p.35)  
Pirate O.C.C. (**South America**, p.47; **Coalition Navy**, p.113)  
Pirate Slaver O.C.C. (**Coalition Navy**, p.115)  
Plains 'Borg O.C.C. (**South America 2**, p.129)  
Privateer O.C.C. (**Coalition Navy**, p.117)  
Promethean Phase Adept O.C.C. (**Phase World®**, p.27)

## Q

Nothing. Nada. Zip. Zero.

## R

Reaver Assassin O.C.C. (**Warlords of Russia**, p.82)  
Reaver Bandit/Raider O.C.C. (**Warlords of Russia**, p.85)  
Reaver Grunt/Warrior O.C.C. (**Warlords of Russia**, p.78)  
Reaver Mechanized Cavalry O.C.C. (**Warlords of Russia**, p.79)  
Reaver Military Scout O.C.C. (**Warlords of Russia**, p.84)  
Republic of Japan Cyborg Soldier O.C.C. (**Japan**, p.97)  
Republic of Japan Glitter Force Trooper O.C.C. (**Japan**, p.93)  
Republic of Japan Infantryman O.C.C. (**Japan**, p.92)  
Republic of Japan Police Officer O.C.C. (**Japan**, p.94)  
Republic of Japan Robot Pilot O.C.C. (**Japan**, p.92)  
Republic of Japan SAMAS Samurai Pilot O.C.C. (**Japan**, p.91)  
River Pirate O.C.C. (**Coalition Navy**, p.116)  
Ronin O.C.C. (**Japan**, p.49)  
Royal Knight O.C.C. (**England**, p.103)  
Rune Warrior O.C.C. (**South America 2**, p.28)

## S

Saddle Tramp O.C.C. (**New West**, p.101)  
Sheriff/Lawman O.C.C. (**New West**, p.102)  
Sheriff's Deputy O.C.C. (**New West**, p.105)  
Smoke Soldier O.C.C. (**Warlords of Russia**, p.89)  
Sohei Warrior Monk O.C.C. (**Japan**, p.58)  
Soldati O.C.C. (**Warlords of Russia**, p.87)  
Soviet Police Officer O.C.C. (**Warlords of Russia**, p.211)  
Soviet Soldier O.C.C. (**Warlords of Russia**, p.212)  
Space Pirate O.C.C. (**Phase World®**, p.40)  
Special Forces O.C.C. (**Mercenaries**, p.26)  
Spirit Warrior O.C.C. (**Spirit West**, p.44)  
Splugorth Bio-Wizard Juicer O.C.C. (**Juicer Uprising**, p.54)  
Sunaj Assassin O.C.C. (**Atlantis**, p.64)  
Super-Spy O.C.C. (**Mercenaries**, p.27)  
Symbiotic Warrior O.C.C. (**Wormwood**, p.64)

## T

Tech-Ninja O.C.C. (**Japan**, p.82)  
Titan Juicer O.C.C. (**Juicer Uprising**, p.32)  
Totem Warrior O.C.C. (**Spirit West**, p.42)  
Traditional Samurai Warrior O.C.C. (**Japan**, p.43)  
TRG Officer O.C.C. (**Australia**, p.112)  
Tribal Warrior O.C.C. (**Spirit West**, p.37)  
Tritonian "Sea Wolf" O.C.C. (**Underseas**, p.96)  
Tundra Ranger O.C.C. (**Canada**, p.84)  
Tundra Ranger Scout O.C.C. (**Canada**, p.85)  
Tundra Ranger Cavalry O.C.C. (**Canada**, p.86)

## U

Ultra-Crazy (a.k.a. TW Crazy) O.C.C. (**South America 2**, p.131)

## V

Nothing to see here. Move along.

## W

War-Knight O.C.C. (**Warlords of Russia**, p.91)  
Warlock Marine O.C.C. (**Phase World® Sourcebook**, p.37)  
Wingrider RPA Pilot O.C.C. (**Warlords of Russia**, p.95)  
Wired Gunslinger O.C.C. (**New West**, p.107)  
Wolfen Quatoria O.C.C. (**Phase World®**, p.66)

## X, Y and Z

This space for rent.





# Scholars & Adventurers

## A

Administrator O.C.C. (**Australia**, p.105)  
Atlantean Nomad O.C.C. (**Atlantis**, p.17)

## B

Body Fixer O.C.C. (**Rifts® Ultimate Edition**, p.86)  
Bogatyr O.C.C. (**Warlords of Russia**, p.58)  
Bushman O.C.C. (**Australia**, p.56)  
Bushranger O.C.C. (**Australia**, p.59)

## C

CAF Scientist O.C.C. (**Phase World**, p.60)  
Catholic Priest O.C.C. (**Warlord of Russia™**, p. 208)  
City Rat O.C.C. (**Rifts® Ultimate Edition**, p.88)  
City Trader O.C.C. (**Australia**, p.67)  
Colonist O.C.C. (**Phase World®**, p.42)  
Cowboy O.C.C. (**New West**, p.110)  
Cyber-Doc O.C.C. (**Rifts® Ultimate Edition**, p.89)  
Cyber-Specter O.C.C. (**Australia**, p.107)  
Cyberoid O.C.C. (**Japan**, p.78)

## D

Demon Queller O.C.C. (**Japan**, p.65)

## E

Ectohunter O.C.C. (**Warlords of Russia**, p.61)  
Ecto-Traveler O.C.C. (**Mindwerks**, p.39)  
Explorer O.C.C. (**Warlords of Russia**, p.64)

## F

Forger O.C.C. (**Mercenaries**, p.21)  
Freelancer O.C.C. (**Wormwood**, p.68)

## G

Gambler O.C.C. (**Juicer Uprising**, p.58)  
Gaucho O.C.C. (**South America 2**, p.128)  
Guide O.C.C. (**Australia**, p.61)  
Gypsy Layer of Laws O.C.C. (**Mystic Russia**, p. 152)  
Gypsy Thief O.C.C. (**Triax & the NGR**, p.180; **Mystic Russia**, p.143)

## H

Huntsman-Trapper O.C.C. (**Warlords of Russia**, p.66)

## I

Can you here an echo in here, or is it just me?

## J

Jackaroo O.C.C. (**Australia**, p.63)

## K and L

Hello? Anybody here?

## M

Merchant Marine O.C.C. (**Coalition Navy**, p.30)  
Merchant Trader O.C.C. (**Australia**, p.65)  
Mining 'Borg/Prospector O.C.C. (**New West**, p.113)

## N

Nothing.

## O

Operator O.C.C. (**Rifts® Ultimate Edition**, p.91)  
Outbacker Runabout O.C.C. (**Australia**, p.70)

## P

Pecos Raider O.C.C. (**Lone Star**, p.153)  
Preacher O.C.C. (**New West**, p.115)  
Professional Gambler O.C.C. (**New West**, p.117)  
Professional Thief O.C.C. (**Mercenaries**, p.28)  
Psynetic Crazy O.C.C. (**Mindwerks**, p.40)

## Q

Q is for Quahog, of which are none here.

## R

Raider O.C.C. (**Australia**, p.72)  
Roadganger O.C.C. (**Australia**, p.74)  
Road Sentinel O.C.C. (**Australia**, p.77)  
Rogue Scholar O.C.C. (**Rifts® Ultimate Edition**, p.93)  
Rogue Scientist O.C.C. (**Rifts® Ultimate Edition**, p.95)  
Runner O.C.C. (**Phase World®**, p.41)

## S

Safecracker O.C.C. (**Mercenaries**, p.24)  
Sailor O.C.C. (**South America**, p.46)  
Saloon Bum O.C.C. (**New West**, p.120)  
Saloon Girl/Barmaid O.C.C. (**New West**, p.123)  
Salvage Expert O.C.C. (**Underseas**, p.133)  
Smuggler O.C.C. (**Mercenaries**, p.25)  
Spacer O.C.C. (**Phase World®**, p.38)  
Sportsman O.C.C. (**Australia**, p.115)

## T

Technologist O.C.C. (**Australia**, p.119)  
Trapper-Woodsman O.C.C. (**Canada**, p.88)  
Traveling Story Teller O.C.C. (**Warlords of Russia**, p.69)  
Tritonian Scientist O.C.C. (**Underseas**, p.97)  
Turbo-Jockey O.C.C. (**Phase World® Sourcebook**, p.41)  
TVIA Inspector O.C.C. (**Phase World®**, p.59)

## U

Better luck yonder "V," perhaps?

## V

Vagabond O.C.C. (**Rifts® Ultimate Edition**, p.97)  
Villager O.C.C. (**Warlords of Russia**, p.71)

## W

Wannabe Juicer O.C.C. (**Juicer Uprising**, p.59)  
Warlord Cyber-Doc O.C.C. (**Warlords of Russia**, p.94)  
Wilderness Scout O.C.C. (**Rifts® Ultimate Edition**, p.98)  
Worldy Sasquatch O.C.C. (**Canada**, p.166)

## X, Y and Z

As often is these case, this noble trinity of end letters has nothing to show for them aside from a bit of flowery prose describing why this noble trinity of end letters has nothing to show for them.



## Practitioners of Magic

### A

African Medicine Man O.C.C. (**Africa**, p. 79)  
African Priest O.C.C. (**Africa**, p. 85)  
African Rain Maker O.C.C. (**Africa**, p. 83)  
African Witch O.C.C. (NPC) (**Africa**, p.72)  
Angakoq (Inuit Shaman) O.C.C. (**Canada**, p.181)  
Animal Shaman O.C.C. (**Spirit West**, p.55)  
Anti-Monster O.C.C. (**South America**, p.34)  
Apok O.C.C. (**Wormwood**, p.55)  
Atlantean Monster Hunter O.C.C. (**South America**, p.99)

### B

Battle Magus O.C.C. (**Federation of Magic**, p.71)  
Biomancer O.C.C. (**South America**, p.61)  
Blood Druid O.C.C. (**England**, p.145)  
Born Mystic O.C.C. (**Mystic Russia**, p.107)

### C

Conjurer O.C.C. (**Federation of Magic**, p.82)  
Controller O.C.C. (**Federation of Magic**, p.74)  
Corrupt O.C.C. (**Federation of Magic**, p.86)

### D

Diabolist O.C.C. (**Rifts® Dark Conversions**, p.185)  
Dryad O.C.C. (**England**, p.40)

### E

Elemental Shaman O.C.C. (**Spirit West**, p.65)

### F

Fetish Shaman O.C.C. (**Spirit West**, p.67)  
Filidh O.C.C. (**England**, p.39)  
Fire Sorcerer O.C.C. (**Mystic Russia**, p.109)

### G

Gifted One (Gypsy) O.C.C. (**Mystic Russia**, p.151)  
Grey Seer O.C.C. (**Federation of Magic**, p.89)  
Gypsy Beguiler O.C.C. (**Mystic Russia**, p.153)  
Gypsy Fortune Teller O.C.C. (**Mystic Russia**, p.148)  
Gypsy Seer O.C.C. (**Triax & the NGR**, p.182; **Mystic Russia**, p.146)  
Gypsy Wizard Thief O.C.C. (**Triax & the NGR**, p.181; **Mystic Russia**, p.145)

### H

Harvester O.C.C. (**Psyscape**, p. 17)  
Healing Shaman O.C.C. (**Spirit West**, p.60)  
Herbalist O.C.C. (**England**, p.22)  
Hidden Witch O.C.C. (**Mystic Russia**, p.79)  
High Magus O.C.C. (**Federation of Magic**, p.79)  
High Priest of Light O.C.C. (**Wormwood**, p.54)

### I

Inca Sun Priest O.C.C. (**South America 2**, p.24)

### J

### L

Larhold Shaman O.C.C. (**South America 2**, p.188)  
Ley Line Walker O.C.C. (**Rifts® Ultimate Edition**, p.113)  
Lord Magus O.C.C. (**Federation of Magic**, p.77)

### M

Mask Shaman O.C.C. (**Spirit West**, p.56)  
Maxi-Man O.C.C. (**Atlantis**, p.95)  
Millennium Druid O.C.C. (**England**, p.44)  
Monk O.C.C. (**Wormwood**, p.59)  
Mystic O.C.C. (**Rifts® Ultimate Edition**, p.118)  
Mystic Knight O.C.C. (**Federation of Magic**, p.91)  
Mystic Kuznya O.C.C. (**Mystic Russia**, p.118)

### N

Naut'Yll Koral Shaper O.C.C. (**Underseas**, p.150)  
Nazca Line Maker O.C.C. (**South America 2**, p.26)



Necromancer O.C.C. (*Africa*, p.99; *Mystic Russia*, p. 84; *Dark Conversions*, p.187)

Night Witch O.C.C. (*Mystic Russia*, p.73)

Ninja Techno-Wizard O.C.C. (*Japan*, p.89)

## O

Ocean Wizard O.C.C. (*Underseas*, p.60)

Old Believer O.C.C. (*Mystic Russia*, p.127)

## P

Paradox Shaman O.C.C. (*Spirit West*, p.62)

Phase Mystic O.C.C. (*Phase World*®, p.29)

Plant Shaman O.C.C. (*Spirit West*, p.50)

Priest of Light O.C.C. (*Wormwood*, p.52)

Promethean Time Master O.C.C. (*Phase World*®, p.28)

## Q

Nothing here folks. Try again next week.

## R

Rifts Priest O.C.C. (*Pantheons of the Megaverse*, p.12)

Russian Ley Line Walker O.C.C. (*Mystic Russia*, p.126)

## S

Scathach O.C.C. (*England*, p.41)

Sea Druid O.C.C. (*Underseas*, p.61)

Sea Inquisitor O.C.C. (*Underseas*, p.49)

Sham-Man/False Sorcerer O.C.C. (*Australia*, p.79)

Shifter O.C.C. (*Rifts*® Ultimate Ed., p.120; *Dark Conversions*, p.177)

Slayer O.C.C. (*Mystic Russia*, p.136)

Star Child O.C.C. (*England*, p.53)

Songjuicer O.C.C. (*Australia*, p.81)

Splugorth Witch O.C.C. (*Atlantis*, p. 68)

Stone Master O.C.C. (*Atlantis*, p.99)

Summoner O.C.C. (*Rifts*® *Dark Conversions*, p.185)

## T

Tattooed Archer O.C.C. (*Splynn Dimensional Market*, p.108)

Tattooed Man O.C.C. (*Atlantis*, p.93)

Techno-Wizard O.C.C. (*Rifts*® Ultimate Edition, p.126)

Temporal Warrior O.C.C. (*England*, p.69)

Temporal Wizard O.C.C. (*England*, p.66)

T-Monster Man O.C.C. (*Atlantis*, p.95)

Totem Warrior O.C.C. (*South America*, p.146)

Tribal Shaman O.C.C. (*South America*, p.145)

## U

Undead Slayer O.C.C. (*Atlantis*, p.97)

## V

Vanguard Mage O.C.C. (*Coalition Wars 3; Sorcerer's Revenge*, p.60)

Voodoo Priest O.C.C. (*South America*, p.51)

## W

Warlock O.C.C. (*Rifts*® *Conversion Book One, Revised*, p.66)

Warlock Marine Magic Specialist O.C.C. (*Phase World*® *Sourcebook*, p.39)

Whale Singer O.C.C. (*Underseas*, p.56)

Witch O.C.C. (*Rifts*® *Dark Conversions*, p.174)

Wormspeaker O.C.C. (*Wormwood*, p.63)

## X

No O.C.C.s available for this letter.



## Y

Yabushi Mountain Priest O.C.C. (*Japan*, p.60)

## Z

In accordance with Megaversal ordinance ZUB-019, the contents of this section have been omitted for security reasons.



# Racial Character Classes

**Note:** Includes D-Bees, Aliens and other strange, intelligent beings.

## A

Aarden Tek R.C.C. (**Canada**, p.130)  
Aberrant Mechanoid R.C.C. (**The Mechanoids®**, p.33)  
Achilles Neo-Human R.C.C. (**South America 2**, p.149)  
Adarok Adventurer R.C.C. (**Atlantis**, p.69)  
Agogwe R.C.C. (**Africa**, p.117)  
Air Fish R.C.C. (**Wormwood**, p.119)  
Algor (Frost Giant) R.C.C. (**Rifts® Conversion Book One**, p.87)  
Altara Warrior Woman R.C.C. (**Atlantis**, p.50)  
Amaki Stone-Man R.C.C. (**South America 2**, p.154)  
Amazon R.C.C. (**South America**, p.97)  
Amorph R.C.C. (**Psyscape**, p.117)  
Amphib R.C.C. (**Underseas**, p.98)  
Ancient (Incan Undead) R.C.C. (**South America 2**, p.48)  
Arkhon R.C.C. (**South America 2**, p.71)  
Armored Slayer R.C.C. (**Canada**, p.140)  
Asama-Tatsu Dragon R.C.C. (**Japan**, p.214)  
Asgardian Berserker R.C.C. (**Pantheons of the Megaverse®**, p.168)  
Asgardian Dwarf R.C.C. (**Pantheons of the Megaverse®**, p.166)  
Asgardian High Elf R.C.C. (**Pantheons of the Megaverse®**, p.167)  
Aunyain R.C.C. (**South America**, p.152)  
Auto-G R.C.C. (**Coalition Wars 3; Sorcerer's Revenge**, p.8)  
Azverkan R.C.C. (**Mindwerks**, p.44)

## B

Bearman of the North R.C.C. (**Rifts® Conversion Book One**, p.74)  
Beast Guard R.C.C. (**Wormwood**, p.120)  
"Beast" Intruder R.C.C. (**Phaseworld Sourcebook**, p.47)  
Bhlaze R.C.C. (**Skrapers**, p.55)  
Bio-Freak R.C.C. (**Skrapers**, p.80)  
Blood Lizard R.C.C. (**South America 2**, p.137)  
Bogie R.C.C. (**Rifts® Conversion Book One**, p.116)  
Brodkil R.C.C. (**Triax**, p.220; **Lone Star**, p.164; **Coalition Wars 1: Sedition**, p.141)  
Brownie R.C.C. (**Rifts® Conversion Book One**, p.117)  
Bruutasaur R.C.C. (**Vampire Kingdoms**, p.147)  
Bug Bear R.C.C. (**Rifts® Conversion Book One**, p.135)

## C

Cactus Person R.C.C. (**New West**, p.127)  
Catyr R.C.C. (**Phase World®**, p.68)  
Centaur R.C.C. (**Rifts® Conversion Book One**, p.136; **Canada**, p.102)  
Cernun Mystic R.C.C. (**England**, p.58)  
Changeling R.C.C. (**Rifts® Conversion Book One**, p.82)  
Chiang-Ku R.C.C. (**England**, p.46)  
Children of Amon R.C.C. (**Africa**, p.65)  
Cihuacoatl/Vernulian R.C.C. (**Vampire Kingdoms**, p.171)  
Coalition Mini-Monkey Spy R.C.C. (**Lone Star**, p.82)  
Coalition Monkey Boy Soldier R.C.C. (**Lone Star**, p.83)  
Coalition Monkey Boy Tech R.C.C. (**Lone Star**, p.85)  
Coalition Mutant Rat R.C.C. (**Lone Star**, p.87)  
Coalition Mutant Bat R.C.C. (**Lone Star**, p.88)  
Condoroid R.C.C. (**South America 2**, p.146)  
Coyle R.C.C. (**Rifts® Conversion Book One**, p.79)  
Crocodillian R.C.C. (**Africa**, p.67)  
C'ro Demon Mage R.C.C. (**Mindwerks**, p.56)  
Cyber-Horseman of Ixion R.C.C. (**Rifts® Conversion Book One**, p.138; **Canada**, p.103)  
Cyclops R.C.C. (**Rifts® Conversion Book One**, p.88)  
Cyden R.C.C. (**Skrapers**, p.37)

## D

Dabugg R.C.C. (**England**, p.55)  
Daitya R.C.C. (**Pantheons of the Megaverse®**, p.142)  
Dakini R.C.C. (**Pantheons of the Megaverse®**, p.142)  
Darkhound R.C.C. (**Psyscape**, p.94)  
Demigod R.C.C. (**Pantheons of the Megaverse®**, p.17)  
Demon-Dragonmage R.C.C. (**Psyscape**, p.120)  
Demon Goblin R.C.C. (**Wormwood**, p.122)  
Demon Hound Rider R.C.C. (**Wormwood**, p.125)  
Devil Shark R.C.C. (**Underseas**, p.45)  
D'norr Devilman R.C.C. (**Coalition Wars 3; Sorcerer's Revenge**, p.12)  
Dolphin R.C.C. (**Underseas**, p.77)  
Dolphin Pneuma-Biform R.C.C. (**Underseas**, p.51)  
Dominator R.C.C. (**Phase World®**, p.96)  
Domovoi R.C.C. (**Mystic Russia**, p.57)  
Draconid R.C.C. (**Phase World®**, p.35)  
Dragon-Ape R.C.C. (**Psyscape**, p.98)  
Dragon Hatchling R.C.C. (**Rifts® Ultimate Edition**, p.156)  
Dragon Ray R.C.C. (**Underseas**, p.21)  
Dragon Wolf R.C.C. (**Rifts® Conversion Book One**, p.145)  
Dreadlor R.C.C. (**Skrapers**, p.23)  
Dreadmaster R.C.C. (**Skrapers**, p.26)  
Duelist R.C.C. (**South America 2**, p.155)  
Dwarf R.C.C. (**Rifts® Conversion Book One**, p.84)  
Dysasha Demon R.C.C. (**Mercenaries**, p.78)

## E

Eandroth R.C.C. (**Rifts® Conversion Book One**, p.146)  
Earth Child R.C.C. (**England**, p.51)  
Elf R.C.C. (**Rifts® Conversion Book One**, p.86)  
Emirin R.C.C. (**Rifts® Conversion Book One**, p.149)  
Entrancer R.C.C. (**Wormwood**, p.126)  
Equinoid (a.k.a. Psi-Taur) R.C.C. (**South America 2**, p.144)  
Erta R.C.C. (**Atlantis**, p.71)  
Ewaipanomas R.C.C. (**South America**, p.102)

## F

Faerie Bot R.C.C. (**Canada**, p.149)  
Faerie: Common R.C.C. (**Rifts® Conversion Book One**, p.118)  
Faerie: Green Wood R.C.C. (**Rifts® Conversion Book One**, p.119)  
Faerie: Night-Elf R.C.C. (**Rifts® Conversion Book One**, p.119)  
Faerie: Silver Bell R.C.C. (**Rifts® Conversion Book One**, p.120)  
Falconoid R.C.C. (**South America 2**, p.148)  
Fallam R.C.C. (**South America 2**, p.76)  
Felinoid R.C.C. (**South America**, p.107)  
Fennodi R.C.C. (**New West**, p.129)  
First Stage Promethean R.C.C. (**Phase World®**, p.24)  
Flame Panther R.C.C. (**South America**, p.111)  
Flooper R.C.C. (**Vampire Kingdoms**, p.132)  
Flying Tiger R.C.C. (**South America**, p.109)  
Fomorian R.C.C. (**England**, p.125)

## G

Gargoyle R.C.C. (**Rifts® Dark Conversions**, p.84; **Triax & the NGR**, p.198)  
Gargoyle Lord R.C.C. (**Rifts® Dark Conversions**, p.86; **Triax & the NGR**, p.199)  
Gargoyle Mage R.C.C. (**Rifts® Dark Conversions**, p.87; **Triax & the NGR**, p.200)

Gargoylite R.C.C. (**Rifts® Dark Conversions**, p.88; **Triax & the NGR**, p.201)  
Gurgoyte R.C.C. (**Rifts® Dark Conversions**, p.84; **Triax & the NGR**, p.198)  
Gatherer R.C.C. (**South America**, p.134)  
Gigante R.C.C. (**Rifts® Conversion Book One**, p.91)  
Gizmoteer R.C.C. (**South America 2**, p.157)  
Glinerach R.C.C. (**Skrappers**, p.30)  
Goblin R.C.C. (**Rifts® Conversion Book One**, p.98)  
Godling R.C.C. (**Pantheons of the Megaverse®**, p.16)  
Grackle Tooth R.C.C. (**Canada**, p.133)  
Groot Hunter R.C.C. (**Canada**, p.135)  
Grimbor Ape-Man R.C.C. (**Rifts® Conversion Book One**, p.151; **South America**, p.138)  
Gromek R.C.C. (**Rifts® Conversion Book One**, p.153)

## H

Hawrk-duhk R.C.C. (**Atlantis**, p.74)  
Hawrk-la R.C.C. (**Atlantis**, p.75)  
Hawrk-ohl R.C.C. (**Atlantis**, p.76)  
Holy Terror R.C.C. (**Wormwood**, p.66)  
Horned Whale R.C.C. (**Coalition Navy**, p.106)  
Horune Pirate R.C.C. (**Underseas**, p.164)  
Human of Seeron R.C.C. (**Skrappers**, p.74)  
Humpback Whale R.C.C. (**Underseas**, p.90)  
Hunter Cat R.C.C. (**South America**, p.113)  
Hytril R.C.C. (**Rifts® Conversion Book One**, p.157)

## I

In'Valian "Robo-Jockey" R.C.C. (**Phase World® Sourcebook**, p.12)

## J

Jotan R.C.C. (**Rifts® Conversion Book One**, p.90)  
Jungle Elf R.C.C. (**South America**, p.57)  
Jungle Person R.C.C. (**Africa**, p.114)

## K

Kankoran R.C.C. (**Rifts® Conversion Book One**, p.80)  
Keeper of the Desert R.C.C. (**New West**, p.130)  
Ki-Lin R.C.C. (**Rifts® Conversion Book One**, p.159)  
Killer Whale R.C.C. (**Underseas**, p.85)  
Killer Whale Pneuma-Biform R.C.C. (**Underseas**, p.53)  
Kinnie Ger R.C.C. (**Original Rifts® Conversion Book**, p.141)  
Kittani Espionage Agent R.C.C. (**Atlantis**, p.53)  
Kittani Field Mechanic/Scientist R.C.C. (**Atlantis**, p.53)  
Kittani Warrior R.C.C. (**Atlantis**, p.52)  
Klied R.C.C. (**Skrappers**, p.50)  
Kreeghor R.C.C. (**Phase World®**, p.73)  
Kree-Lok Nomad R.C.C. (**Underseas**, p.152)  
Kremin Cyborg R.C.C. (**Coalition War Campaign**, p.210)  
Krpt R.C.C. (**Vampire Kingdoms**, p.150)  
Kryygorth Hunter R.C.C. (**Splynn Dimensional Market**, p.73)  
Kryygorth Pegasus R.C.C. (**Splynn Dimensional Market**, p.77)  
Kryygorth's Lesson R.C.C. (**Splynn Dimensional Market**, p.75)  
Kumo-Mi Dragon R.C.C. (**Japan**, p.212)  
Kwarla R.C.C. (**Australia**, p.132)  
Kwarla Mystic R.C.C. (**Australia**, p.135)

## L

Lanotaur Hunter R.C.C. (**Psyscape**, p.123)  
Larhold Barbarian R.C.C. (**South America 2**, p.185)  
Larmac R.C.C. (**Coalition Wars 3; Sorcerer's Revenge**, p.13)

Lashreg R.C.C. (**Skrappers**, p.43)  
Leprechaun R.C.C. (**Rifts® Conversion Book One**, p.122)  
Leshii R.C.C. (**Mystic Russia**, p.59)  
Lizard Mage R.C.C. (**Rifts® Conversion Book One**, p.161)  
Lizard Man R.C.C. (**Rifts® Conversion Book One**, p.160; **South America**, p.79)  
Lost One R.C.C. (**Mercenaries**, p.49)  
Loup Garou R.C.C. (**Canada**, p.156)  
Lycanmorph R.C.C. (**Mindwerks**, p.45)  
Lyn-Srial R.C.C. (**New West**, p.133)  
Lyn-Srial Cloudweaver R.C.C. (**New West**, p.135)  
Lyn-Srial Sky-Knight R.C.C. (**New West**, p.134)  
Lyvorrkian R.C.C. (**Vampire Kingdoms**, p.145)

## M

Machine Person. R.C.C. (**Phase World®**, p.77)  
Mantaz Sectle R.C.C. (**England**, p.57)  
Man-Wolf R.C.C. (**Mystic Russia**, p.69)  
Mastadonoid R.C.C. (**Canada**, p.137)  
Master Blood Rider R.C.C. (**South America 2**, p.135)  
Men-Rall "Tech Master" R.C.C. (**South America 2**, p.111)  
Mii-Tar R.C.C. (**Vampire Kingdoms**, p.112)  
"Mind Creature" Intruder R.C.C. (**Phaseworld Sourcebook**, p.49)  
Minotaur R.C.C. (**Rifts® Conversion Book One**, p.92)  
Molokoi R.C.C. (**Australia**, p.137)  
Monro R.C.C. (**Phase World® Sourcebook**, p.34)  
Monster Brodkil R.C.C. (**Mindwerks**, p.71)  
Morphworm R.C.C. (**Wormwood**, p.129)  
Mountain Giant R.C.C. (**New West**, p.136)  
Murvoma Meztlal R.C.C. (**Atlantis**, p.58)  
Mutant Capybara R.C.C. (**South America 2**, p.142)  
Mutant Cat R.C.C. (**Vampire Kingdoms**, p.61)

## N

Naga R.C.C. (**Pantheons of the Megaverse®**, p.141)  
Naruni Repo-Bot R.C.C. (**Phase World®**, p.46)  
Naut'Yll R.C.C. (**Underseas**, p.148)  
Nazeer R.C.C. (**Skrappers**, p.33)  
Newcomer Android R.C.C. (**Juicer Uprising**, p.152)  
Nikari R.C.C. (**Skrappers**, p.52)  
Nimro R.C.C. (**Rifts® Conversion Book One**, p.93)  
N'mbyr Gorilla Man R.C.C. (**Coalition War Campaign**, p.202)  
Noli Bushman R.C.C. (**Canada**, p.137)  
Noro R.C.C. (**Phase World®**, p.61)  
Norse Giant R.C.C. (**Pantheons of the Megaverse®**, p.163)  
Nuhr Dwarves (**Sourcebook 4**, p.122)  
Nurilian Plant-Person R.C.C. (**Splynn Dimensional Market**, p.82)  
Nymph R.C.C. (**Rifts® Conversion Book One**, p.122)

## O

Octoman R.C.C. (**Splynn Dimensional Market**, p.80)  
Ogeeyln R.C.C. (**England**, p.142)  
Ogeeyin Guardian R.C.C. (**England**, p.143)  
Ogre R.C.C. (**Rifts® Conversion Book One**, p.102)  
Oni R.C.C. (**Phase World® Sourcebook**, p.15)  
Oni Master R.C.C. (**Japan**, p.203)  
Oni Mystic R.C.C. (**Japan**, p.204)  
Oni Ninja R.C.C. (**Phase World® Sourcebook**, p.19)  
Oni of the One Hundred R.C.C. (**Japan**, p.202)  
Oracle Cat R.C.C. (**South America**, p.115)  
Orc R.C.C. (**Rifts® Conversion Book One**, p.101)  
Outback Mutie R.C.C. (**Australia**, p.131)

## P

Phantom R.C.C. (**Phase World**®, p.36)  
Phoenixi R.C.C. (**Africa**, p.60)  
Phoenix Juicer R.C.C. (**Juicer Uprising**, p.151)  
Phreaker Military Grunt R.C.C. (**Australia**, p.131)  
Pincer Warrior R.C.C. (**South America**, p.136)  
Pixie: Common R.C.C. (**Rifts**® **Conversion Book One**, p.123)  
Pixie: Frost R.C.C. (**Rifts**® **Conversion Book One**, p.123)  
Pleasurer R.C.C. (**Phase World**®, p.88)  
Polevoi R.C.C. (**Mystic Russia**, p.61)  
Plumed Serpent (**Spirit West**, p.118)  
Pogtal R.C.C. (**Vampire Kingdoms**, p.150; **South America**, p.135)  
Power Leech R.C.C. (**Psyscape**, p.126)  
Psi-Goblin R.C.C. (**Psyscape**, p.128)  
Psi-Pony R.C.C. (**New West**, p.156)  
Psiren R.C.C. (**Underseas**, p.46)  
Pucara Red Giant R.C.C. (**South America 2**, p.54)  
Puck R.C.C. (**Rifts**® **Conversion Book One**, p.124)  
Pygmy Hunter R.C.C. (**Africa**, p.114)  
Pygmy Shaman R.C.C. (**Africa**, p.115)  
Pythonian R.C.C. (**Splynn Dimensional Market**, p.85)

## Q

Quick-Flex Rogue R.C.C. (**Coalition War Campaign**, p.205)

## R

Rahu-Man R.C.C. (**Rifts**® **Conversion Book One**, p.94)  
Ramen (Knight of Ra) R.C.C. (**Africa**, p.61)  
Ram-Rat R.C.C. (**Wormwood**, p.131)  
Rathos/Rumbler R.C.C. (**Wormwood**, p.132)  
Ratling R.C.C. (**Rifts**® **Conversion Book One**, p.171)  
Rithe R.C.C. (**Skraypers**, p.59)  
Robot R.C.C. (**Rifts**® **Sourcebook Revised**, p.12)  
Royal Kreeghor R.C.C. (**Phase World**®, p.74)  
Rulian Translator R.C.C. (**Splynn Dimensional Market**, p.87)  
Rurlel Eel Person R.C.C. (**Underseas**, p.37)  
Rusalka R.C.C. (**Mystic Russia**, p.63)

## S

Scorpion Person R.C.C. (**Pantheons of the Megaverse**®, p.57)  
Sea Titan R.C.C. (**Underseas**, p.113)  
Secondary Vampire R.C.C. (**Vampire Kingdoms**, p.14)  
Seeker R.C.C. (**Mindwerks**, p.49)  
Seerman R.C.C. (**Skraypers**, p.76)  
Sekhmet R.C.C. (**South America**, p.116)  
Seleniak R.C.C. (**Skraypers**, p.41)  
Seljuk R.C.C. (**Phase World**®, p.69)  
Serpentoid R.C.C. (**South America 2**, p.141)  
Servant of the Deep R.C.C. (**Underseas**, p.47)  
Servant of Kali R.C.C. (**Pantheons of the Megaverse**®, p.142)  
Shade R.C.C. (**Wormwood**, p.133)  
Shadow Person R.C.C. (**Australia**, p.148)  
Shaper R.C.C. (**Vampire Kingdoms**, p.133)  
Shaydor Intel R.C.C. (**Atlantis**, p.79)  
Shaydor Spherian R.C.C. (**Atlantis**, p.77)  
Shertar R.C.C. (**Skraypers**, p.20)  
Shikome Kido-Mi Dragon R.C.C. (**Japan**, p.211)  
Silhouette R.C.C. (**Phase World**®, p.80)  
Shrilt R.C.C. (**Skraypers**, p.46)  
Simvan Monster Rider R.C.C. (**Mindwerks**, p.54; **Lone Star**, p.162)  
Sky Rider R.C.C. (**Wormwood**, p.135)  
Soul Worm R.C.C. (**South America**, p.128)  
Space Wolfen R.C.C. (**Phase World**®, p.65)  
Sperm Whale R.C.C. (**Underseas**, p.88)

Sphinx R.C.C. (**Rifts**® **Conversion Book One**, p.178)  
Spirit Sasquatch R.C.C. (**Canada**, p.160)  
Spirit Wolf R.C.C. (**Mystic Russia**, p.68)  
Spugorth R.C.C. (**Atlantis**, p.41)  
Spugorth Conservator R.C.C. (**Atlantis**, p.45)  
Spugorth High Lord R.C.C. (**Atlantis**, p.43)  
Spugorth Overlord (Kidian) R.C.C. (**Atlantis**, p.47)  
Spugorth Powerlord (Augmented Kidian) R.C.C. (**Atlantis**, p.48)  
Spugorth Slaver R.C.C. (**Atlantis**, p.48)  
Spriggan R.C.C. (**Rifts**® **Conversion Book One**, p.125)  
Sprite: Tree R.C.C. (**Rifts**® **Conversion Book One**, p.125)  
Sprite: Water R.C.C. (**Rifts**® **Conversion Book One**, p.126)  
Sprite: Wind Puff R.C.C. (**Rifts**® **Conversion Book One**, p.126)  
Srrynn Cannibal R.C.C. (**Mindwerks**, p.52)  
Staphra Mystic R.C.C. (**Splynn Dimensional Market**, p.95)  
Staphra Warlord R.C.C. (**Splynn Dimensional Market**, p.93)  
Staphra Warrior R.C.C. (**Splynn Dimensional Market**, p.92)  
Storm Rider R.C.C. (**Underseas**, p.31)  
Sura-Kappa (**Japan**, p.206)  
Swamp-Sludger R.C.C. (**Coalition Navy**, p.109)  
Syvan R.C.C. (**Rifts**® **Conversion Book One**, p.179)

## T

Talus R.C.C. (**Skraypers**, p.78)  
Tandori R.C.C. (**Skraypers**, p.62)  
Tarbull R.C.C. (**Skraypers**, p.17)  
Tarlok Warrior R.C.C. (**Skraypers**, p.12)  
Tauton (Minion of Set) R.C.C. (**Africa**, p.63)  
Teklok Cyborg R.C.C. (**Skraypers**, p.21)  
Temporal Raider R.C.C. (**England**, p.71)  
Tengu R.C.C. (**Japan**, p.66)  
Termite Engineers R.C.C. (**Phase World**, p.93)  
Tirrvol Sword Fist R.C.C. (**Coalition War Campaign**, p.203)  
Titan R.C.C. (**Rifts**® **Conversion Book One**, p.97)  
Ti-Xibalban R.C.C. (**Vampire Kingdoms**, p.162)  
Toad Stool R.C.C. (**Rifts**® **Conversion Book One**, p.126)  
Tokanii R.C.C. (**Lone Star**, p.154)  
Tree People R.C.C. (**Africa**, p.118)  
Trimadore Mechanic R.C.C. (**Coalition War Campaign**, p.208)  
Troll R.C.C. (**Rifts**® **Conversion Book One**, p.107)  
True Atlantean R.C.C. (**Atlantis**, p.15)  
True Bio-Borg R.C.C. (**Splynn Dimensional Market**, p.157)  
True Inca R.C.C. (**South America 2**, p.20)  
True Naruni R.C.C. (**Phase World**®, p.48)  
True Sasquatch R.C.C. (**Canada**, p.162)  
T'Zee R.C.C. (**Phase World**® **Sourcebook**, p.24)

## U

Ugakwa Explorer R.C.C. (**Mindwerks**, p.50)  
Uteni Alien R.C.C. (**Mercenaries**, p.74)

## V

Vacuum Wasps R.C.C. (**Phase World**, p.92)  
Valkyrie R.C.C. (**Pantheons of the Megaverse**®, p.167)  
Vallax R.C.C. (**Juicer Uprising**, p.153)  
Vanguard Brawler Thug R.C.C. (**Coalition War Campaign**, p.207)  
Vodianoi R.C.C. (**Mystic Russia**, p.64)

## W

Warrior of Valhalla R.C.C. (**Pantheons of the Megaverse**®, p.170)  
Wendigo R.C.C. (**Spirit West**, p.127)  
Were-Dragon R.C.C. (**Splynn Dimensional Market**, p.97)  
Werejaguar (Vampire Kingdoms, p.172; **South America**, p.117; **Dark Conversions**, p.101)



Werepanther (South America, p.117; **Dark Conversions**, p.103)  
Wild Vampire R.C.C. (**Vampire Kingdoms**, p.15)  
Whale Pneuma-Biform R.C.C. (**Underseas**, p.55)  
Wolfen R.C.C. (**Rifts® Conversion Book One**, p.76)

## X

Xibalban R.C.C. (**Vampire Kingdoms**, p.161)  
Xiticix Digger R.C.C. (**Xiticix Invasion**, p.45)  
Xiticix Elder Queen R.C.C. (**Xiticix Invasion**, p.64)  
Xiticix Hunter R.C.C. (**Xiticix Invasion**, p.52)  
Xiticix Killer R.C.C. (**Lone Star**, p.91; **Xiticix Invasion**, p.88)  
Xiticix Leaper R.C.C. (**Xiticix Invasion**, p.55)  
Xiticix Nanny R.C.C. (**Xiticix Invasion**, p.59)  
Xiticix Super-Warrior R.C.C. (**Xiticix Invasion**, p.70)  
Xiticix Warrior R.C.C. (**Xiticix Invasion**, p.66)  
Xiticix Worker R.C.C. (**Xiticix Invasion**, p.74)  
Xiticix Young Queen R.C.C. (**Xiticix Invasion**, p.61)

## Y

Yeno R.C.C. (**Canada**, p.139)  
Yhabbayar R.C.C. (**Psyscape**, p.130)

## Z

Zaayr Crystal Dragon R.C.C. (**Psyscape**, p.135)  
Zembahk R.C.C. (**Atlantis**, p.83)  
Zenith Moon Warper R.C.C. (**Psyscape**, p.138)

# Psychic Character Classes

## A

Arkhn ESP Specialist O.C.C. (**South America 2**, p.75)

## B

Burster R.C.C. (**Rifts® Ultimate Edition**, p.139; **Psyscape**, p.48)

## C

Coalition Battle Cat R.C.C. (**Lone Star**, p.76)  
Coalition and “Civilized” Mercenary Psi-Stalker R.C.C. (**Xiticix Invasion**, p.110)  
Coalition Dog Pack (Dog Boy) R.C.C. (**Rifts® Ult. Ed.**, p.142; **Lone Star**, p.32)  
Coalition K-9 “Sniffer” R.C.C. (**Lone Star**, p.41)  
Coalition Kill Cat R.C.C. (**Lone Star**, p.79)  
Coalition Kill Hound R.C.C. (**Lone Star**, p.44)  
Coalition PRP/Psi-Net Agent O.C.C. (**Coalition War Campaign**, p.193)  
Coalition Psycho-Stalker O.C.C. (**Juicer Uprising**, p.45)  
Coalition Sea Dog R.C.C. (**Lone Star**, p.40; **Coalition Navy**, p.39)  
Coalition Ursa-Warrior R.C.C. (**Lone Star**, p.72)

## D & E

Removed for your protection. Trust us on this.

## F

“Feral” Dog Boy R.C.C. (**Lone Star**, p.38)

## G

Gifted Gypsy O.C.C. (**Triax**, p. 184 & **Mystic Russia**, p.151)  
Grey Seers (**Mystic O.C.C.**, **Fed. Of Magic**, p. 88)  
Gypsies, Russian (**Mystic Russia**, p. 139)

## H, I, J, K & L

For there to be this many letters in a row with nothing to show for them is evidence of a dire conspiracy at work. surely another game company is to blame. Ferkelberger Industries, perhaps.

## M

Mind Bleeder R.C.C. ( **Africa**, p. 93; **Psyscape**, p.52)  
Mind Melter R.C.C. (**Rifts® Ultimate Edition**, p.150; **Psyscape**, p.55)

## N

Nega-Psychic R.C.C. (**Psyscape**, p.57)  
Noro Psychic O.C.C. (**Phase World®**, p.63)

## O

Damn those Ferkelbergers!

## P

Psi-Bloodhound R.C.C. (**Mindwerks**, p.42)  
Psi-Druid R.C.C. (**Psyscape**, p.59)  
Psi-Ghost R.C.C. (**Psyscape**, p.63)  
Psi-Nullifer R.C.C. (**Psyscape**, p.66)  
Psi-Slayer R.C.C. (**Psyscape**, p.69)  
Psi-Slinger R.C.C. (**New West**, p.98)  
Psi-Stalker R.C.C. (**Rifts® Ultimate Edition**, p.152; **Lone Star**, p.156;  
**Xiticix Invasion**, p.108)  
Psi-Tech R.C.C. (**Psyscape**, p.74)  
Psi-X Alien R.C.C. (**Lone Star**, p.98)  
Psi-Warrior R.C.C. (**Psyscape**, p.76)  
Pucara Mind Mage O.C.C. (**South America 2**, p.55)

## Q, R, S, T, U & V

Enough is enough. Those Ferkelbergers have gone too far!

## W

Wild Psi-Stalker R.C.C. (**Xiticix Invasion**, p.111)

## X & Y

Oh, I give up.

## Z

Zapper R.C.C. (**Psyscape**, p.81)

# Monster Index

With the Coming of the Rifts, an enormous host of monsters, demons and other hostile creatures have swarmed onto the Earth and made life miserable for what is left of humanity and the D-Bees who have settled in alongside of them. Most monsters stick to a particular region, but just as random Rifts can bring together two places from far across the Megaverse, so can they bring together two places from across the planet. As a result, if the G.M. wishes to export or import monsters from another part of the world to where his player characters are currently adventuring, there really isn't any reason why he can't go ahead and do it. After all, Rifts Earth is a place of wild unpredictability, and seeing unknown monsters (who unbeknownst to the heroes are from halfway around the globe) is all part of daily life.

Should the players themselves protest ("Hey! That thing's from **Mystic Russia**, ain't it?") simply remind them that while *they* might know that, their *characters* most likely do not. It might seem like a cheap out, but it is a valid one. Besides, if all the heroes do is stand around and argue about how they shouldn't be fighting a certain kind of monster when they *ought* to be rolling for initiative, they are gonna find themselves in a world of hurt before you can say, "Fury Beetle." So what are you waiting for? Clear leather and blast that thing!

**Note:** This list does not contain *unique* monstrous creatures (i.e., there being only one of them), animals (there are just too many of them, besides the **Monsters and Animals** sourcebook for Palladium Fantasy does a better job of cataloguing them than this one could), or creatures that can be used as an optional player character/R.C.C.



## A

Adarok (**Atlantis**, p. 70)  
Alu (Demon) (**Rifts® Dark Conversions**, p.12)  
Aqua-Hydra (**Coalition Navy**, p. 98)  
Aquatic (Demon) (**Rifts® Dark Conversions**, p.13)  
Arboreal Wailer (**Phase World®**, p.109)  
Archie Three & Robot Minions (**Rifts® Sourcebook One**, p. 74)  
Archfiend (Deevil) (**Rifts® Dark Conversions**, p.35)  
Ariel (Spirit of Light) (**Rifts® Conversion Book One**, p.204)  
Armored Devil Fish (**England**, p. 60)  
Armored Slayer (**Canada**, p.140)

## B

Baal-roq (Demon) (**Rifts® Dark Conversions**, p.17)  
Banshee (**Rifts® Dark Conversions**, p.68)  
Beast Dragon (**Rifts® Conversion Book One**, p.133)  
Beast Tank (**Coalition Wars 6: Final Siege**, p. 72)  
Belangial (**Skrapers**, p. 48)  
Black Faerie (**Coalition Wars1: Sedition**, p.140; **Rifts® Sourcebook One**, p.113)  
Black-Winged Monster-Man (**Spirit West**, p.106)  
Blood Hawk (**Psyscape**, p. 90)  
Blow Worm (Worm of Taut) (**Rifts® Conversion Book One**, p.185)  
Boogie-Man (**Rifts® Conversion Book One**, p.134)  
Boschala (**Rifts® Dark Conversions**, p.71)  
Brodkil (**Rifts® Sourcebook 1 Revised**, p.141; **Coalition Wars 1**, p.141)  
Bunyip Demon (**Australia** p.173)

## C

Cadborosaurus (**Canada**, p.147)  
Chatterling (**Coalition Wars 6: Final Siege**, p. 73)  
Cheruu (Spirit of Light) (**Original Rifts® Conversion Book**, p.203)  
Chimera (**Rifts® Conversion Book One**, p.141)  
Chyknz Worm (**Skrapers**, p. 36)  
Corrupt, The (**Federation of Magic**, p. 86)  
Craaphery Demon Snake (**Coalition Wars 6: Final Siege**, p. 78)  
Crab Warrior (**Coalition Navy**, p.100)  
Crawlies (Hill Beetles) (**England**, p. 60)

## D

Daemonix: Basal (**Coalition Wars 2: Coalition Overkill**, p. 96)  
Daemonix: Feculence (**Coalition Wars 2: Coalition Overkill**, p. 90)  
Daemonix: Immolator (**Coalition Wars 2: Coalition Overkill**, p. 93)  
Daemonix: Hangdog (**Coalition Wars 2: Coalition Overkill**, p. 95)  
Daemonix: Manslayer (**Coalition Wars 2: Coalition Overkill**, p. 91)  
Dark Behemoth (**Psyscape**, p. 92)  
Darkhound (**Psyscape**, p. 94)  
Dar'ota (Incubus & Succubus) (**Rifts® Dark Conversions**, p.73)  
Deevils

*see Deevil*  
*see Devilkin*  
*see Fenry*  
*see Fiend*  
*see Gorgon*

Deevil (**Rifts® Dark Conversions**, p.29)

Demons  
*see Gargoyle*  
*see Lasae*  
*see Mare*  
*see Nightmare*  
*see Shedim*  
*see Gallu*  
*see Jinn*  
*see Magot*

*see Night Owl*

*see Raksasha*

Desert Sleeper (**New West**, p.138)  
Desert Worm (**Australia** p.162)  
Demon Bear (**Canada**, p.170)  
Demon Locust (Demon) (**Rifts® Dark Conversions**, p.18)  
Demonrunner (**Splynn Dimensional Market**, p. 71)  
Devil Digger (**Rifts® Conversion Book One**, p.142)  
Devil Dingo (**Australia** p.176)  
Devil Sloth (**Coalition War Campaign**, p.211)  
Devil Unicorn (**New West**, p.140)  
Devilkin (Deevil) (**Rifts® Dark Conversions**, p.30)  
Dimensional Ghoul (**Rifts® Dark Conversions**, p.74)  
Dragon-Ape (**Psyscape**, p. 98)  
Dragon Cat (**Psyscape**, p. 99)  
Dragon Ray (**Underseas**, p.20)  
Dragonfish (**Coalition Navy**, p.102)  
Dragonductyl (**Rifts® Conversion Book One**, p.143)  
Dragonsaurus (**Atlantis**, p. 71)  
Drakin (**Rifts® Conversion Book One**, p.142)  
Duckbilled Honker (**New West**, p.141)  
Dybbuk (Demon Ghoul) (**Rifts® Dark Conversions**, p.75)



## E

Elemental: Air (Minor) (**Rifts® Dark Conversions**, p.110)  
Elemental: Air (Major) (**Rifts® Dark Conversions**, p.109)  
Elemental: Earth (Minor) (**Rifts® Dark Conversions**, p.113)  
Elemental: Earth (Major) (**Rifts® Dark Conversions**, p.111)  
Elemental: Fire (Minor) (**Rifts® Dark Conversions**, p.116)  
Elemental: Fire (Major) (**Rifts® Dark Conversions**, p.115)  
Elemental: Water (Minor) (**Rifts® Dark Conversions**, p.118)  
Elemental: Water (Major) (**Rifts® Dark Conversions**, p.117)  
Entity: Poltergeist (**Rifts® Dark Conversions**, p.76)  
Entity: Haunting (**Rifts® Dark Conversions**, p.79)  
Entity: Possessing (**Rifts® Dark Conversions**, p.82)  
Entity: Siphon (**Rifts® Dark Conversions**, p.77)  
Entity: Tectonic (**Rifts® Dark Conversions**, p.80)  
Erta (**Atlantis**, p. 71)  
Eurotorpid (**Mindwerks**, p.58)  
Eye Killer (**Rifts® Conversion Book One**, p.150)

## F

Faerie Folk (**Rifts® Conversion Book One**, p.110)  
Feathered Death (**Rifts® Conversion Book One**, p.151)  
Fenry (Deevil) (**Rifts® Dark Conversions**, p.31)  
Fiend (Deevil) (**Rifts® Dark Conversions**, p.32)  
Fire Worm (Worm of Taut) (**Rifts® Conversion Book One**, p.186)  
Flash Beetle (**England**, p. 63)  
Fury Beetle (**Canada**, p.152)

## G

Gallu (Demon) (**Rifts® Dark Conversions**, p.19)  
Gargoyle (Demon) (**Rifts® Dark Conversions**, p.84; **Triax & the NGR**, p.197; **Final Siege**, p.66)  
Garkain (Vampire) (**Australia**, p.66; **Dark Conversions**, p.83)  
Giant Canyon Worm (**New West**, p.143)  
Giant Clamp-Mouth Dragonfly (**England**, p. 61)  
Giant Cockroach (**Australia** p.163)  
Giant 'Dwombat (**Australia** p.165)  
Giant Kang (**Australia** p.167)  
Giant Leech (**Coalition Navy**, p.103)  
Giant Octopus (**Underseas**, p.23)  
Giant Squid (**Underseas**, p.24; **Canada**, p.154))  
Giant Waterstrider (**Coalition Navy**, p.111)  
Goblin Spider (**Japan**, p.207)  
Goqua (Master of Deception) (**Rifts® Dark Conversions**, p.89)  
Gorgon (Deevil) (**Rifts® Dark Conversions**, p.33)  
Grave Ghoul (**Rifts® Dark Conversions**, p.90)  
Great Dream Snake (**New West**, p.144)  
Great Plains Buffalo (**New West**, p.145)  
Greater Cyclops (**Pantheons of the Megaverse®**, p. 92)  
Gremlin (Techno-Terror) (**Rifts® Dark Conversions**, p.91)  
Grigleaper (**New West**, p.146)  
Gruunor (**Rifts® Conversion Book One**, p.154)  
Gryphon (**Rifts® Conversion Book One**, p.155)  
Gwylack (**New West**, p.147)

## H

Hannya Demon (**Japan**, p.210)  
Harpy ((**Rifts® Conversion Book One**, p.156)  
Hell Horse (**Mystic Russia**, p.22)  
Hell Hound (**Rifts® Dark Conversions**, p.92)  
Horned Demon-Fish (**Coalition Navy**, p.104)  
Horned Whale (**Coalition Navy**, p.105)  
Hundred-Handed (**Pantheons of the Megaverse®**, p. 93)

## I

Il'ya Demon (**Mystic Russia**, p.24)

## J

Japanese Imp (**Japan**, p.209)  
Jinn (Demon) (**Rifts® Dark Conversions**, p.20)

## K

Kaluga Hag (**Mystic Russia**, p.26)  
Kelpie (**Rifts Conversion Book One**, p.158)  
Khitaka Abductor (**Mystic Russia**, p.42)  
Killer Ape (**Phase World**, p.112)  
Killer Beetles (**Phase World**, p. 91)  
Kladovik Guardian (**Mystic Russia**, p.28)  
Koshchei (Deathless One) (**Mystic Russia**, p.46)  
Kreeghor Bloodhound (**Phase World**, p.110)

Kreelong Carapace (**Atlantis**, p. 60)  
Kreewarr Carapace (**Atlantis**, p. 61)  
Kryygorth Shellback **Splynn Dimensional Market**, p. 79)

## L

Land Ray (**Psyscape**, p.101)  
Lasae (Demon) (**Rifts® Dark Conversions**, p.15)  
Leatherwing (**New West**, p.148)  
Lesser Ugly (**Phase World®**, p.111)  
Loogaroo (**Rifts® Conversion Book One**, p.163)  
Lorica Wraith (**Underseas**, p.24)  
Loup Garou (**Canada**, p.155)

## M

Maelstrom-Maker (**Coalition Navy**, p.107)  
Magot (Demon) (**Rifts® Dark Conversions**, p.21)  
Malignous (**Rifts® Dark Conversions**, p.93)  
Mammoth Brontodon (**New West**, p.149)  
Manticore (**Rifts® Conversion Book One**, p.164)  
Man-Eagle (**Spirit West**, p.108)  
Man-Monster: Animal (**Spirit West**, p.111)  
Man-Monster: Plant (**Spirit West**, p.113)  
Man-Monster: Spirit (**Spirit West**, p.115)  
Mare (Demon) (**Rifts® Dark Conversions**, p.15)  
Maxpary (**Rifts® Conversion Book One**, p.164)  
Mechanoids (**Rifts® Sourcebook Two: The Mechanoids®**)  
Mega-Foot Mastica (**Mindwerks**, p.59)  
Melech (**Rifts® Conversion Book One**, p.167)  
Metztla  
*see Murex Metztla*  
*see Volute Metztla*  
*see Murvolva Metztla*  
*see Murvoma Metztla*  
Midnight Demon (**Mystic Russia**, p.30)  
Mindolar (Mind Slug) (**Rifts® Dark Conversions**, p.94)  
Mopaditis (Undead Spirit) (**Australia** p.178)  
Morozko Frost Demon (**Mystic Russia**, p.48)  
Moss-Back Scuttler (**New West**, p.151)  
Murex Metztla (**Atlantis**, p. 54)  
Murvolva Metztla (**Atlantis**, p. 57)  
Murvoma Metztla (**Atlantis**, p. 58)

## N

Nalet (**Mystic Russia**, p.32)  
Necrophim (**Psyscape**, p.104)  
Neuron Beast (**Rifts® Sourcebook One, Revised**, p.143; **Coalition Wars I: Sedition**, p.143)  
Nightfeeder (**Mystic Russia**, p.44)  
Nightmare (Demon) (**Rifts® Dark Conversions**, p.15)  
Night Owl (Demon) (**Rifts® Dark Conversions**, p.22)  
Nipper (Worm of Taut) (**Rifts® Conversion Book One**, p.187)

## O

Oborus-Slitherer (**New West**, p.152)  
Ogopogo (**Canada**, p.157)  
Ostrosaurus (Original **Rifts® Sourcebook**, p.112; **New West**, p.153)  
Owl-Thing (**Rifts® Conversion Book One**, p.169)

## P

Panthera-Tereon (**New West**, p.155)  
Pegasus (**Rifts® Conversion Book One**, p.169)

Peryton (Demon Deer) (**Rifts® Conversion Book One**, p.170)  
Petal Thing (**England**, p. 64)  
Phantasm (**New West**, p.157)  
Picasso Magic Fish (**Underseas**, p.27)  
Plumed Serpent (**Spirit West**, p.118)  
Psymbiote (**Psyscape**, p.105)

## Q

A couple hundred monsters in **Rifts** and not one of them begins with “Q.” Can you believe it?

## R

Raksasha (Demon) (**Rifts® Dark Conversions**, p.23)  
Razorback (**Australia** p.169)  
Rhino-Buffalo (**Rifts® Sourcebook 1, Revised**, p.153; **New West**, p.158)  
Russian Firebird (**Mystic Russia**, p.66)

## S

Sand Fiend (**Australia** p.171)  
Scarecrow (**Rifts® Conversion Book One**, p.173)  
Scorpion Devil (**Rifts® Conversion Book One**, p.175)  
Sea Maw (**Underseas**, p.28)  
Seraph (Spirit of Light) (Original **Rifts® Conversion Book**, p.203)  
Serpent Beast (Worm of Taut) (**Rifts® Conversion Book One**, p.187)  
Serpent Hound (**Mystic Russia**, p.40)  
Shadeling (**Psyscape**, p.108)  
Shadow Dragon (**Coalition Wars 5: Sorcerer’s Revenge**, p.109)  
Shedim (Demon) (**Rifts® Dark Conversions**, p.16)  
Silonar (**Rifts® Conversion Book One**, p.176; **New West**, p. 160)  
Simvan Monster Rider R.C.C. (**Mindwerks**, p.54; **Lone Star**, p.162)  
Soul Snake (**Psyscape**, p.104)  
Soulless Xombie (**Psyscape**, p. 22)  
Sowki (**Rifts® Dark Conversions**, p.96)  
Spectre (**Rifts® Conversion Book One**, p.177)  
Spider Demon (**Rifts® Dark Conversions**, p.97)  
Spiny Ravager (**Coalition War Campaign**, p.212)  
Spirit Wolf (**Mystic Russia**, p.68)  
Spirits of Light  
    *see Ariel*  
    *see Cheruu*  
    *see Seraph*  
    *see Tharsis*

Splugorth (**Atlantis**, p.39)  
Splugorth Minions (**Atlantis**, p.43)  
Stidjron (**Underseas**, p. 35)  
Stone Ball Bug (**England**, p. 65)  
Stone-Claw (**Mindwerks**, p.60)  
Stone Giants (**Spirit West**, p.120)  
Storm Rider (Iey Line Beast) (**Underseas**, p. 31)  
Stone Demon (**Mystic Russia**, p.34)  
Sun Demon, Lipoca (**Psyscape**, p.109)

## T

Teepowka (**Spirit West**, p.122)  
Tharsis (Spirit of Light) (Original **Rifts® Conversion Book**, p.204)  
Thornhead Demon (**Rifts® Sourcebook One, Revised**, p.154; **Coalition Wars 1: Sedition**, p.146)  
Therno Bat-Thing (**Coalition Wars 6: Final Siege**, p. 75)  
Tiger Claw Raptor (**New West**, p.162)  
Tomb Worm (Worm of Taut) (**Rifts® Conversion Book One**, p.189)  
Tree Spider (**New West**, p.163)  
Tri-Fang (Worm of Taut) (**Rifts® Conversion Book One**, p.188)

Tri-Tops (**New West**, p.164)  
Tri-Wolf (**Mindwerks**, p. 69)  
Two-Faced Star-People (**Spirit West**, p.123)  
Tyrannosaurus Rex (**New West**, p. 166)

## U

Ukt Water Serpent (**Spirit West**, p.125)  
Unclean (**Mystic Russia**, p.18)  
Unicorn (**Rifts® Conversion Book One**, p.180)

## V

Vampire Flat Worm (**Coalition War Campaign**, p.212)  
Volute Metztle (**Atlantis**, p. 56)  
Vyarnect (**Psyscape**, p.113)

## W

Wandjinas (**Australia**, p. 183)  
Water Demon (**Mystic Russia**, p.36)  
Water Serpent (**Coalition Navy**, p.110)  
Wendigo (**Spirit West**, p.126)  
Whirlwind Air Demon (**Mystic Russia**, p.50)  
Whisker Coyote (**New West**, p.167)  
White Slayer (**Mindwerks**, p.61)  
Wind-Water Sail Ray (**Coalition Wars 6: Final Siege**, p. 76)  
Windigo Demon (**Canada**, p.177)  
Wing Tip (**Rifts® Conversion Book One**, p.184)  
Witchling (**Rifts® Sourcebook One, Revised**, p.157; **Coalition Wars 1: Sedition**, p.146)  
Wolf-Serpent (**Mystic Russia**, p.53)  
Wood Demon (**Mystic Russia**, p.38)  
Worker Ants (**Phase World**, p. 94)  
Worm Wraith (**New West**, p.168)  
Worms of Taut  
    *see Blow Worm*  
    *see Fire Worm*  
    *see Nipper*  
    *see Serpent Beast*  
    *see Tri-Fang*  
    *see Tomb Worm*

## X

Nope, no monsters starting with “X,” either, unless you count Xitcix; see page 288 of this book.

## Y

Yara Mayha Sho (Vampire) (**Australia** p.182)  
Yazhing Multipede (**Atlantis**, p. 81)  
Yema (**Rifts® Conversion Book One**, p.190)  
Yll Tree Climber (**Atlantis**, p. 80)  
Yowie (**Australia** p.186)

## Z

Za (**Rifts® Conversion Book One**, p.190)  
Zavor (**Rifts® Conversion Book One**, p.191)  
Zomba (Silicon Snake) (**Underseas**, p. 33)

**Note:** See R.C.C. Listings for D-Bees and other monstrous characters, some available to players, provided the G.M. allows it.

# Experience Tables



## Coalition

### Battle Cat CS Soldier

1 0,000 - 1,900  
2 1,901 - 3,600  
3 3,601 - 7,200  
4 7,201 - 14,400  
5 14,401 - 24,500  
6 24,501 - 35,000  
7 35,001 - 45,000  
8 45,001 - 65,000  
9 65,001 - 85,000  
10 85,001 - 115,000  
11 115,001 - 145,000  
12 145,001 - 185,000  
13 185,001 - 250,000  
14 250,001 - 310,000  
15 310,001 - 375,000

### CS "Fly Boy" RPA

1 0,000 - 2,100  
2 2,101 - 4,200  
3 4,201 - 8,400  
4 8,401 - 17,200  
5 17,201 - 25,400  
6 25,401 - 35,800  
7 35,801 - 51,000  
8 51,001 - 71,200  
9 71,201 - 96,400  
10 96,401 - 131,600  
11 131,601 - 181,800  
12 181,801 - 232,000  
13 232,001 - 282,200  
14 282,201 - 342,400  
15 342,401 - 402,600

### CS Ranger/Scout

1 0,000 - 2,100  
2 2,101 - 4,200  
3 4,201 - 8,400  
4 8,401 - 17,200  
5 17,201 - 25,400  
6 25,401 - 35,800  
7 35,801 - 51,000  
8 51,001 - 71,200  
9 71,201 - 96,400  
10 96,401 - 131,600  
11 131,601 - 181,800  
12 181,801 - 232,000  
13 232,001 - 282,200  
14 282,201 - 342,400  
15 342,401 - 402,600

### Coalition Juicer

1 0,000 - 2,200  
2 2,201 - 4,400  
3 4,401 - 8,900  
4 8,901 - 17,000  
5 17,001 - 25,000  
6 25,001 - 35,000  
7 35,001 - 51,000  
8 51,001 - 75,000  
9 75,001 - 100,000  
10 100,001 - 150,000  
11 150,001 - 200,000  
12 200,001 - 250,000  
13 250,001 - 325,000  
14 325,001 - 400,000  
15 400,001 - 500,000

### CS Grunt/Infantrymen

1 0,000 - 1,950  
2 1,951 - 3,900  
3 3,901 - 8,800  
4 8,801 - 17,600  
5 17,601 - 35,600  
6 35,601 - 50,600  
7 50,601 - 70,600  
8 70,601 - 95,600  
9 95,601 - 125,600  
10 125,601 - 175,600  
11 175,601 - 225,600  
12 225,601 - 275,600  
13 275,601 - 325,600  
14 325,601 - 375,600  
15 375,601 - 425,600

### CS EOD Specialist

1 0,000 - 2,000  
2 2,001 - 4,000  
3 4,001 - 8,200  
4 8,201 - 16,400  
5 16,401 - 24,500  
6 24,501 - 34,600  
7 34,601 - 49,700  
8 49,701 - 69,800  
9 69,801 - 94,900  
10 94,901 - 129,000  
11 129,001 - 179,100  
12 179,101 - 229,200  
13 229,201 - 279,300  
14 279,301 - 329,400  
15 329,401 - 389,500

### CS Nautical Specialist

1 0,000 - 2,050  
2 2,051 - 4,100  
3 4,101 - 8,400  
4 8,401 - 16,800  
5 16,801 - 25,560  
6 24,561 - 35,800  
7 35,801 - 50,400  
8 50,401 - 70,800  
9 70,801 - 95,400  
10 95,401 - 130,800  
11 130,801 - 180,400  
12 180,401 - 230,800  
13 230,801 - 280,400  
14 280,401 - 331,800  
15 331,401 - 392,800

### Dog Pack

1 0,000 - 1,950  
2 1,951 - 3,900  
3 3,901 - 8,800  
4 8,801 - 17,600  
5 17,601 - 25,600  
6 25,601 - 35,600  
7 35,601 - 50,600  
8 50,601 - 70,600  
9 70,601 - 95,600  
10 95,601 - 125,600  
11 125,601 - 175,600  
12 175,601 - 225,600  
13 225,601 - 275,600  
14 275,601 - 325,600  
15 325,601 - 375,600

### CS Juicer

#### CS Commando

**CS Strike Cyborg**  
1 0,000 - 2,150  
2 2,151 - 4,300  
3 4,301 - 8,600  
4 8,601 - 17,200  
5 17,201 - 25,500  
6 25,501 - 36,000  
7 36,001 - 52,000  
8 52,001 - 73,000  
9 73,001 - 98,000  
10 98,001 - 134,000  
11 134,001 - 184,000  
12 184,001 - 240,000  
13 240,001 - 295,000  
14 295,001 - 385,000  
15 385,001 - 450,000

### CS Naval Infantryman

1 0,000 - 2,050  
2 2,051 - 4,100  
3 4,101 - 8,250  
4 8,251 - 16,500  
5 18,501 - 24,600  
6 24,601 - 34,700  
7 34,701 - 49,800  
8 49,801 - 69,900  
9 69,901 - 95,000  
10 95,001 - 130,000  
11 130,001 - 180,200  
12 180,201 - 230,000  
13 230,001 - 280,400  
14 280,401 - 340,500  
15 340,501 - 400,600

### CS Navy Sailor

#### CS Sea Dog

1 0,000 - 1,950  
2 1,951 - 3,900  
3 3,901 - 8,800  
4 8,801 - 17,600  
5 17,601 - 25,600  
6 25,601 - 35,600  
7 35,601 - 50,600  
8 50,601 - 70,600  
9 70,601 - 95,600  
10 95,601 - 125,600  
11 125,601 - 175,600  
12 175,601 - 225,600  
13 225,601 - 275,600  
14 275,601 - 325,600  
15 325,601 - 375,000

### CS Navy Commando

1 0,000 - 2,150  
2 2,151 - 4,300  
3 4,301 - 8,600  
4 8,601 - 17,200  
5 17,201 - 25,500  
6 25,501 - 36,000  
7 36,001 - 52,000  
8 52,001 - 73,000  
9 73,001 - 98,000  
10 98,001 - 134,000  
11 134,001 - 184,000  
12 184,001 - 240,000  
13 240,001 - 295,000  
14 295,001 - 385,000  
15 385,001 - 450,000

**CS RCSG Scientist**

1 0,000 - 2,140  
 2 2,141 - 4,280  
 3 4,281 - 8,560  
 4 8,561 - 17,520  
 5 17,521 - 25,520  
 6 25,521 - 35,520  
 7 35,521 - 50,520  
 8 50,521 - 71,000  
 9 71,001 - 96,100  
 10 96,101 - 131,200  
 11 131,201 - 181,300  
 12 181,301 - 231,400  
 13 231,401 - 281,500  
 14 281,501 - 341,600  
 15 341,601 - 400,700

**RPA Elite SAMAS Pilot**

1 0,000 - 1,925  
 2 1,926 - 3,850  
 3 3,851 - 7,450  
 4 7,451 - 14,900  
 5 14,901 - 21,000  
 6 21,001 - 31,000  
 7 31,001 - 41,600  
 8 41,601 - 53,000  
 9 53,001 - 73,000  
 10 73,001 - 103,500  
 11 103,501 - 139,000  
 12 139,001 - 189,000  
 13 189,001 - 239,000  
 14 239,001 - 289,000  
 15 289,001 - 339,000

**CS Military Specialist**

1 0,000 - 2,120  
 2 2,121 - 4,240  
 3 4,241 - 8,480  
 4 8,481 - 16,960  
 5 16,961 - 24,960  
 6 24,961 - 34,960  
 7 34,961 - 49,960  
 8 49,961 - 69,960  
 9 69,961 - 94,960  
 10 94,961 - 129,960  
 11 129,961 - 179,960  
 12 179,961 - 229,960  
 13 229,961 - 279,960  
 14 279,961 - 329,960  
 15 329,961 - 389,960

**CS Technical Officer**

1 0,000 - 2,120  
 2 2,121 - 4,240  
 3 4,241 - 8,480  
 4 8,481 - 16,960  
 5 16,961 - 24,960  
 6 24,961 - 34,960  
 7 34,961 - 49,960  
 8 49,961 - 69,960  
 9 69,961 - 94,960  
 10 94,961 - 129,960  
 11 129,961 - 179,960  
 12 179,961 - 229,960  
 13 229,961 - 279,960  
 14 279,961 - 329,960  
 15 329,961 - 389,961

**Dog Boy: K - 9 Sniffer**

1 0,000 - 2,100  
 2 2,101 - 4,200  
 3 4,201 - 8,400  
 4 8,401 - 16,800  
 5 16,801 - 25,000  
 6 25,001 - 35,000  
 7 35,001 - 50,000  
 8 50,001 - 70,000  
 9 70,001 - 95,000  
 10 95,001 - 130,000  
 11 130,001 - 180,000  
 12 180,001 - 234,000  
 13 234,001 - 285,000  
 14 285,001 - 345,000  
 15 345,001 - 410,000

**Dog Boy: Kill Hound**

1 0,000 - 2,150  
 2 2,151 - 4,300  
 3 4,301 - 9,600  
 4 9,601 - 18,200  
 5 18,201 - 28,400  
 6 28,401 - 38,600  
 7 38,601 - 54,800  
 8 54,801 - 75,200  
 9 75,201 - 100,400  
 10 100,401 - 132,600  
 11 132,601 - 185,800  
 12 185,801 - 240,200  
 13 240,201 - 295,400  
 14 295,401 - 365,600  
 15 365,601 - 425,800

**Dog Boy (CS Soldier)****Sea Dog (CS Navy)**

1 0,000 - 1,950  
 2 1,951 - 3,900  
 3 3,901 - 8,800  
 4 8,801 - 17,600  
 5 17,601 - 25,600  
 6 25,601 - 35,600  
 7 35,601 - 50,600  
 8 50,601 - 70,600  
 9 70,601 - 95,600  
 10 95,601 - 125,600  
 11 125,601 - 175,600  
 12 175,601 - 225,600  
 13 225,601 - 275,600  
 14 275,601 - 325,600  
 15 325,601 - 375,000

**Feline: Kill Cat**

1 0,000 - 2,150  
 2 2,151 - 4,300  
 3 4,301 - 9,600  
 4 9,601 - 18,200  
 5 18,201 - 28,400  
 6 28,401 - 38,600  
 7 38,601 - 54,800  
 8 54,801 - 75,200  
 9 75,201 - 100,400  
 10 100,401 - 132,600  
 11 132,601 - 185,800  
 12 185,801 - 240,200  
 13 240,201 - 295,400  
 14 295,401 - 365,600  
 15 365,601 - 425,800

**ISS Peacekeeper**

1 0,000 - 1,925  
 2 1,926 - 3,850  
 3 3,851 - 7,450  
 4 7,451 - 14,900  
 5 14,901 - 21,000  
 6 21,001 - 31,000  
 7 31,001 - 41,600  
 8 41,601 - 53,000  
 9 53,001 - 73,000  
 10 73,001 - 103,500  
 11 103,501 - 139,000  
 12 139,001 - 189,000  
 13 189,001 - 239,000  
 14 239,001 - 289,000  
 15 289,001 - 339,000

**ISS Specter**

1 0,000 - 2,120  
 2 2,121 - 4,240  
 3 4,241 - 8,480  
 4 8,481 - 16,960  
 5 16,961 - 24,960  
 6 24,961 - 34,960  
 7 34,961 - 49,960  
 8 49,961 - 69,960  
 9 69,961 - 94,960  
 10 94,961 - 129,960  
 11 129,961 - 179,960  
 12 179,961 - 229,960  
 13 229,961 - 279,960  
 14 279,961 - 329,960  
 15 329,961 - 389,960

**Monkey Boy Tech**

1 0,000 - 1,925  
 2 1,926 - 3,850  
 3 3,851 - 7,450  
 4 7,451 - 15,000  
 5 15,001 - 21,500  
 6 21,501 - 31,500  
 7 31,501 - 41,500  
 8 41,501 - 54,000  
 9 54,001 - 75,000  
 10 75,001 - 105,000  
 11 105,001 - 140,000  
 12 140,001 - 190,000  
 13 190,001 - 240,000  
 14 240,001 - 300,000  
 15 300,001 - 350,000

**Monkey Boy Soldier**

1 0,000 - 1,900  
 2 1,901 - 3,600  
 3 3,601 - 7,200  
 4 7,201 - 14,400  
 5 14,401 - 24,500  
 6 24,501 - 35,000  
 7 35,001 - 45,000  
 8 45,001 - 65,000  
 9 65,001 - 85,000  
 10 85,001 - 115,000  
 11 115,001 - 145,000  
 12 145,001 - 185,000  
 13 185,001 - 250,000  
 14 250,001 - 310,000  
 15 310,001 - 375,000

**Monkey Mini Spy****Most Intelligent****Mutant Animals**

1 0,000 - 1,800  
 2 1,801 - 2,600  
 3 2,601 - 5,200  
 4 5,201 - 15,000  
 5 15,001 - 25,000  
 6 25,001 - 35,000  
 7 35,001 - 45,000  
 8 45,001 - 75,000  
 9 75,001 - 95,000  
 10 95,001 - 150,000  
 11 150,001 - 200,000  
 12 200,001 - 250,000  
 13 250,001 - 300,000  
 14 300,001 - 350,000  
 15 350,001 - 450,000

**Mutant Bat**

1 0,000 - 1,900  
 2 1,901 - 3,600  
 3 3,601 - 7,200  
 4 7,201 - 14,400  
 5 14,401 - 24,500  
 6 24,501 - 35,000  
 7 35,001 - 45,000  
 8 45,001 - 65,000  
 9 65,001 - 85,000  
 10 85,001 - 115,000  
 11 115,001 - 145,000  
 12 145,001 - 185,000  
 13 185,001 - 250,000  
 14 250,001 - 310,000  
 15 310,001 - 375,000

**NTSET Protector/Hunter****ISS Intel Specter**

1 0,000 - 2,140  
 2 2,141 - 4,280  
 3 4,281 - 8,560  
 4 8,561 - 17,520  
 5 17,521 - 25,520  
 6 25,521 - 35,520  
 7 35,521 - 50,520  
 8 50,521 - 71,000  
 9 71,001 - 96,100  
 10 96,101 - 131,200  
 11 131,201 - 181,300  
 12 181,301 - 231,400  
 13 231,401 - 281,500  
 14 281,501 - 341,600  
 15 341,601 - 400,700

**NTSET Psi-Hound**

1 0,000 - 2,050  
 2 2,051 - 4,100  
 3 4,101 - 8,400  
 4 8,401 - 16,800  
 5 16,801 - 25,560  
 6 24,561 - 35,800  
 7 35,801 - 50,400  
 8 50,401 - 70,800  
 9 70,801 - 95,400  
 10 95,401 - 130,800  
 11 130,801 - 180,400  
 12 180,401 - 230,800  
 13 230,801 - 280,400  
 14 280,401 - 331,800  
 15 331,401 - 392,800

**Psi - Net Agent****Special Forces**

1 0,000 - 2,200  
 2 2,201 - 4,400  
 3 4,401 - 8,800  
 4 8,801 - 17,600  
 5 17,601 - 27,800  
 6 27,801 - 37,900  
 7 37,901 - 55,100  
 8 55,101 - 75,200  
 9 75,201 - 100,300  
 10 100,301 - 145,500  
 11 145,501 - 190,600  
 12 190,601 - 245,700  
 13 245,701 - 295,800  
 14 295,801 - 345,900  
 15 345,901 - 415,100

**Ursa-Warrior (Bear)**

1 0,000 - 1,900  
 2 1,901 - 3,800  
 3 3,801 - 7,300  
 4 7,301 - 14,300  
 5 14,301 - 30,000  
 6 30,001 - 45,000  
 7 45,001 - 65,000  
 8 65,001 - 90,000  
 9 90,001 - 110,000  
 10 110,001 - 130,000  
 11 130,001 - 180,000  
 12 180,001 - 230,000  
 13 230,001 - 280,000  
 14 280,001 - 340,000  
 15 340,001 - 390,000

**Juicer****"Standard" Juicer****Gladiator Juicer**

1 0,000 - 2,140  
 2 2,141 - 4,280  
 3 4,281 - 8,400  
 4 8,401 - 17,200  
 5 17,201 - 25,400  
 6 25,401 - 35,800  
 7 35,801 - 51,000  
 8 51,001 - 71,200  
 9 71,201 - 96,400  
 10 96,401 - 131,600  
 11 131,601 - 181,800  
 12 181,801 - 232,000  
 13 232,001 - 282,200  
 14 282,201 - 342,400  
 15 342,401 - 402,600

**Dragon Juicer**

1 0,000 - 3,000  
 2 3,001 - 5,000  
 3 5,001 - 10,000  
 4 10,001 - 20,000  
 5 20,001 - 30,000  
 6 30,001 - 50,000  
 7 50,001 - 80,000  
 8 80,001 - 120,000  
 9 120,001 - 170,000  
 10 170,001 - 250,000  
 11 250,001 - 325,000  
 12 325,001 - 400,000  
 13 400,001 - 525,000  
 14 525,001 - 650,000  
 15 650,001 - 900,000

**Euro - Juicer**

1 0,000 - 2,140  
 2 2,141 - 4,280  
 3 4,281 - 8,560  
 4 8,561 - 17,520  
 5 17,521 - 25,520  
 6 25,521 - 35,520  
 7 35,521 - 50,520  
 8 50,521 - 71,000  
 9 71,001 - 96,000  
 10 96,001 - 131,200  
 11 131,201 - 181,300  
 12 181,301 - 231,400  
 13 231,401 - 281,500  
 14 281,501 - 341,600  
 15 341,601 - 401,700

**Juicer**

1 0,000 - 2,140  
 2 2,141 - 4,280  
 3 4,281 - 8,560  
 4 8,561 - 17,520  
 5 17,521 - 25,520  
 6 25,521 - 35,520  
 7 35,521 - 50,520  
 8 50,521 - 71,000  
 9 71,001 - 96,100  
 10 96,101 - 131,200  
 11 131,201 - 181,300  
 12 181,301 - 231,400  
 13 231,401 - 281,500  
 14 281,501 - 341,600  
 15 341,601 - 401,700

**Juicer Assassin**

1 0,000 - 2,200  
 2 2,201 - 4,400  
 3 4,401 - 8,900  
 4 8,901 - 17,000  
 5 17,001 - 25,000  
 6 25,001 - 35,000  
 7 35,001 - 51,000  
 8 51,001 - 75,000  
 9 75,001 - 100,000  
 10 100,001 - 150,000  
 11 150,001 - 200,000  
 12 200,001 - 250,000  
 13 250,001 - 325,000  
 14 325,001 - 400,000  
 15 400,001 - 500,000

**Juicer Scout**

1 0,000 - 2,180  
 2 2,181 - 4,380  
 3 4,381 - 8,500  
 4 8,501 - 18,200  
 5 18,201 - 26,400  
 6 26,401 - 36,800  
 7 36,801 - 52,000  
 8 52,001 - 72,200  
 9 72,201 - 97,400  
 10 97,401 - 132,600  
 11 132,601 - 183,800  
 12 183,801 - 234,000  
 13 234,001 - 284,200  
 14 284,201 - 344,400  
 15 344,401 - 404,600

**Titan Juicer, Hyperion Juicer****Delphi Juicer, Phaeton Juicer**

1 0,000 - 2,250  
 2 2,251 - 4,500  
 3 4,501 - 9,000  
 4 9,001 - 18,000  
 5 18,001 - 26,500  
 6 26,501 - 36,000  
 7 36,001 - 52,000  
 8 52,001 - 75,000  
 9 75,001 - 100,000  
 10 100,001 - 140,000  
 11 140,001 - 200,000  
 12 200,001 - 260,000  
 13 260,001 - 320,000  
 14 320,001 - 400,000  
 15 400,001 - 500,000

**Juicer Wannabe**

1 0,000 - 1,875  
 2 1,876 - 3,750  
 3 3,751 - 7,250  
 4 7,251 - 14,100  
 5 14,101 - 21,200  
 6 21,201 - 31,200  
 7 31,201 - 41,200  
 8 41,201 - 51,200  
 9 51,201 - 71,200  
 10 71,201 - 101,500  
 11 101,501 - 136,500  
 12 136,501 - 186,500  
 13 186,001 - 236,500  
 14 236,501 - 286,500  
 15 286,001 - 326,500

**Mega - Juicer****Maxi - Killer**

1 0,000 - 2,600  
 2 2,601 - 5,000  
 3 5,001 - 10,000  
 4 10,001 - 20,000  
 5 20,001 - 30,000  
 6 30,001 - 49,000  
 7 49,001 - 62,000  
 8 62,001 - 80,000  
 9 80,001 - 110,000  
 10 110,001 - 150,000  
 11 150,001 - 200,000  
 12 200,001 - 250,000  
 13 250,001 - 310,000  
 14 310,001 - 370,000  
 15 370,001 - 520,000

**Psycho-Stalker**

1 0,000 - 2,200  
 2 2,201 - 4,400  
 3 4,401 - 8,900  
 4 8,901 - 17,000  
 5 17,001 - 25,000  
 6 25,001 - 35,000  
 7 35,001 - 51,000  
 8 51,001 - 75,000  
 9 75,001 - 100,000  
 10 100,001 - 150,000  
 11 150,001 - 200,000  
 12 200,001 - 250,000  
 13 250,001 - 325,000  
 14 325,001 - 400,000  
 15 400,001 - 500,000

**Songjuicer**

1 0,000 - 2,000  
 2 2,001 - 4,000  
 3 4,001 - 8,200  
 4 8,201 - 16,400  
 5 16,401 - 24,500  
 6 24,501 - 34,600  
 7 34,601 - 45,700  
 8 45,701 - 55,800  
 9 55,801 - 63,700  
 10 63,701 - 69,600  
 11 69,601 - 74,500  
 12 74,501 - 78,400  
 13 78,401 - 81,300  
 14 81,301 - 82,200  
 15 82,201 - 83,100

**Men of Magic****African Medicine Man**

1 0,000 - 2,110  
 2 2,111 - 4,220  
 3 4,221 - 8,440  
 4 8,441 - 16,880  
 5 16,881 - 24,880  
 6 24,881 - 34,880  
 7 34,881 - 48,440  
 8 48,441 - 68,440  
 9 68,441 - 92,480  
 10 92,481 - 128,480  
 11 128,481 - 178,480  
 12 178,481 - 228,880  
 13 228,881 - 278,880  
 14 278,881 - 324,480  
 15 324,481 - 388,880

**African Priest**

1 0,000 - 2,000  
 2 2,001 - 4,000  
 3 4,001 - 8,200  
 4 8,201 - 16,400  
 5 16,401 - 24,500  
 6 24,501 - 34,600  
 7 34,601 - 49,700  
 8 49,701 - 69,800  
 9 69,801 - 94,900  
 10 94,901 - 129,000  
 11 129,001 - 179,100  
 12 179,101 - 229,200  
 13 229,201 - 279,300  
 14 279,301 - 329,400  
 15 329,401 - 389,500



**African Rain Maker**

1 0,000 - 2,160  
 2 2,161 - 4,320  
 3 4,321 - 8,640  
 4 8,641 - 17,280  
 5 17,281 - 25,280  
 6 25,281 - 35,560  
 7 35,561 - 50,840  
 8 50,841 - 72,280  
 9 72,281 - 97,560  
 10 97,561 - 132,840  
 11 132,841 - 190,280  
 12 190,281 - 240,560  
 13 240,561 - 297,880  
 14 297,881 - 360,280  
 15 360,281 - 420,560

**African Witch**

1 0,000 - 1,950  
 2 1,951 - 3,900  
 3 3,901 - 7,800  
 4 7,801 - 15,600  
 5 15,601 - 30,200  
 6 30,201 - 45,400  
 7 45,401 - 60,600  
 8 60,601 - 85,800  
 9 85,801 - 110,200  
 10 110,201 - 150,400  
 11 150,401 - 210,600  
 12 210,601 - 265,800  
 13 265,801 - 325,200  
 14 325,201 - 375,400  
 15 375,401 - 450,600

**Animal Shaman****Plant Shaman****Mystic Warrior**

1 0,000 - 2,240  
 2 2,241 - 4,480  
 3 4,481 - 8,960  
 4 8,961 - 17,920  
 5 17,921 - 25,920  
 6 25,921 - 35,920  
 7 35,921 - 50,920  
 8 50,921 - 70,920  
 9 70,921 - 91,920  
 10 95,921 - 135,920  
 11 135,921 - 185,920  
 12 185,921 - 225,920  
 13 225,921 - 275,920  
 14 275,921 - 335,920  
 15 335,921 - 395,920

**Atlantean Monster Hunter**

1 0,000 - 2,500  
 2 2,501 - 5,500  
 3 5,501 - 10,500  
 4 10,501 - 21,500  
 5 21,501 - 32,000  
 6 32,001 - 47,000  
 7 47,001 - 65,000  
 8 65,001 - 87,000  
 9 87,001 - 115,000  
 10 115,001 - 170,000  
 11 170,001 - 220,000  
 12 220,001 - 300,000  
 13 300,001 - 400,000  
 14 400,001 - 500,000  
 15 500,001 - 600,000

**Battle Magus**

1 0,000 - 2,120  
 2 2,121 - 4,240  
 3 4,241 - 8,480  
 4 8,481 - 16,960  
 5 16,961 - 24,960  
 6 24,961 - 34,960  
 7 34,961 - 49,960  
 8 49,961 - 69,960  
 9 69,961 - 94,960  
 10 94,961 - 129,960  
 11 129,961 - 179,960  
 12 179,961 - 229,960  
 13 229,961 - 279,960  
 14 279,961 - 329,960  
 15 329,961 - 389,960

**Biomancer**

1 0,000 - 2,350  
 2 2,351 - 4,700  
 3 4,701 - 9,300  
 4 9,301 - 18,600  
 5 18,601 - 27,000  
 6 27,001 - 37,000  
 7 37,001 - 52,000  
 8 52,001 - 72,000  
 9 72,001 - 97,000  
 10 97,001 - 138,000  
 11 138,001 - 190,000  
 12 190,001 - 230,000  
 13 230,001 - 280,000  
 14 280,001 - 350,000  
 15 350,001 - 400,000

**Bishamon Fighting Monk****Sohei Warrior Monk**

1 0,000 - 2,200  
 2 2,201 - 4,400  
 3 4,401 - 8,800  
 4 8,801 - 17,600  
 5 17,601 - 24,000  
 6 24,001 - 35,000  
 7 35,001 - 50,500  
 8 50,501 - 72,500  
 9 72,501 - 98,500  
 10 98,501 - 140,500  
 11 140,501 - 200,500  
 12 200,501 - 250,500  
 13 250,501 - 325,500  
 14 325,501 - 400,500  
 15 400,501 - 450,500

**Born Mystic****The Gifted Ones****Gypsy Fortune Teller**

1 0,000 - 2,050  
 2 2,051 - 4,100  
 3 4,101 - 8,250  
 4 8,251 - 16,500  
 5 16,501 - 24,600  
 6 24,601 - 34,700  
 7 34,701 - 49,800  
 8 49,801 - 69,900  
 9 69,901 - 95,000  
 10 95,001 - 130,000  
 11 130,001 - 180,200  
 12 180,201 - 230,000  
 13 230,001 - 280,400  
 14 280,401 - 340,500  
 15 340,501 - 400,600

**Conjurer****Controller Magus**

1 0,000 - 2,200  
 2 2,201 - 4,400  
 3 4,401 - 8,800  
 4 8,801 - 17,600  
 5 17,601 - 27,800  
 6 27,801 - 37,900  
 7 37,901 - 55,100  
 8 55,101 - 75,200  
 9 75,201 - 100,300  
 10 100,301 - 145,500  
 11 145,501 - 190,600  
 12 190,601 - 245,700  
 13 245,701 - 295,800  
 14 295,801 - 345,900  
 15 345,901 - 415,100

**Corrupt****High Magus**

1 0,000 - 2,400  
 2 2,401 - 4,800  
 3 4,801 - 9,600  
 4 9,601 - 19,200  
 5 19,201 - 30,000  
 6 30,001 - 50,000  
 7 50,001 - 80,000  
 8 80,001 - 120,000  
 9 120,001 - 170,000  
 10 170,001 - 230,000  
 11 230,001 - 300,000  
 12 300,001 - 380,000  
 13 380,001 - 470,000  
 14 470,001 - 600,000  
 15 600,001 - 800,000

**Ectohunter**

1 0,000 - 2,000  
 2 2,001 - 4,000  
 3 4,001 - 8,200  
 4 8,201 - 16,400  
 5 16,401 - 24,500  
 6 24,501 - 34,600  
 7 34,601 - 49,700  
 8 49,701 - 69,800  
 9 69,801 - 94,900  
 10 94,901 - 129,000  
 11 129,001 - 179,100  
 12 179,101 - 229,200  
 13 229,201 - 279,300  
 14 279,301 - 329,400  
 15 329,401 - 389,500

**Elemental Shaman**

1 0,000 - 2,140  
 2 2,141 - 4,280  
 3 4,281 - 8,560  
 4 8,561 - 17,520  
 5 17,521 - 25,520  
 6 25,521 - 35,520  
 7 35,521 - 50,520  
 8 50,521 - 71,000  
 9 71,001 - 96,100  
 10 96,101 - 131,200  
 11 131,201 - 181,300  
 12 181,301 - 231,400  
 13 231,401 - 281,500  
 14 281,501 - 341,600  
 15 341,601 - 401,700

**Fetish Shaman****Mask Shaman**

1 0,000 - 2,300  
 2 2,301 - 4,600  
 3 4,601 - 9,200  
 4 9,201 - 18,400  
 5 18,401 - 26,500  
 6 26,501 - 36,600  
 7 36,601 - 51,700  
 8 51,701 - 71,800  
 9 71,801 - 96,900  
 10 96,901 - 137,000  
 11 137,001 - 188,100  
 12 188,101 - 229,200  
 13 229,201 - 279,300  
 14 279,301 - 340,400  
 15 340,401 - 400,000

**Fire Sorcerer****Gypsy Seer**

1 0,000 - 2,200  
 2 2,201 - 4,400  
 3 4,401 - 9,000  
 4 9,001 - 19,000  
 5 19,001 - 28,000  
 6 28,001 - 40,000  
 7 40,001 - 60,000  
 8 60,001 - 80,000  
 9 80,001 - 100,000  
 10 100,001 - 150,000  
 11 150,001 - 200,000  
 12 200,001 - 275,000  
 13 275,001 - 350,000  
 14 350,001 - 425,000  
 15 425,001 - 525,000

**Grey Seer**

1 0,000 - 2,100  
 2 2,101 - 4,200  
 3 4,201 - 8,400  
 4 8,401 - 17,200  
 5 17,201 - 25,400  
 6 25,401 - 35,800  
 7 35,801 - 51,000  
 8 51,001 - 71,200  
 9 71,201 - 96,400  
 10 96,401 - 131,600  
 11 131,601 - 181,800  
 12 181,801 - 232,000  
 13 232,001 - 282,200  
 14 282,201 - 342,400  
 15 342,401 - 402,600

**Gypsy Beguiler**

1 0,000 - 2,700  
 2 2,701 - 5,400  
 3 5,401 - 10,800  
 4 10,801 - 21,600  
 5 21,601 - 31,600  
 6 31,601 - 42,800  
 7 42,801 - 62,000  
 8 62,001 - 90,000  
 9 90,001 - 120,000  
 10 120,001 - 170,000  
 11 170,001 - 220,000  
 12 220,001 - 290,000  
 13 290,001 - 400,000  
 14 400,001 - 500,000  
 15 500,001 - 700,000

**Gypsy/Hidden Witch**

1 0,000 - 1,975  
 2 1,976 - 3,950  
 3 3,951 - 7,900  
 4 7,901 - 15,800  
 5 15,801 - 31,600  
 6 31,601 - 46,400  
 7 46,401 - 61,800  
 8 61,801 - 87,000  
 9 87,001 - 112,200  
 10 112,201 - 152,400  
 11 152,401 - 212,600  
 12 212,601 - 267,800  
 13 267,801 - 330,200  
 14 330,201 - 400,400  
 15 400,401 - 470,600

**Gypsy Wizard Thief**

1 0,000 - 2,700  
 2 2,701 - 5,400  
 3 5,401 - 10,800  
 4 10,801 - 21,600  
 5 21,601 - 31,600  
 6 31,601 - 42,800  
 7 42,801 - 62,000  
 8 62,001 - 90,000  
 9 90,001 - 120,000  
 10 120,001 - 170,000  
 11 170,001 - 220,000  
 12 220,001 - 290,000  
 13 290,001 - 400,000  
 14 400,001 - 500,000  
 15 500,001 - 700,000

**Healing Shaman**

1 0,000 - 2,050  
 2 2,051 - 4,100  
 3 4,101 - 8,250  
 4 8,251 - 16,500  
 5 16,501 - 24,600  
 6 24,601 - 34,700  
 7 34,701 - 49,800  
 8 49,801 - 69,900  
 9 69,901 - 95,000  
 10 95,001 - 130,100  
 11 130,101 - 180,200  
 12 180,201 - 230,300  
 13 230,301 - 280,400  
 14 280,401 - 340,500  
 15 340,501 - 400,600

**Herbalist****Woodland Druids**

**Blood Druids**  
 1 0,000 - 2,200  
 2 2,201 - 4,400  
 3 4,401 - 8,800  
 4 8,801 - 17,600  
 5 17,601 - 24,000  
 6 24,001 - 35,000  
 7 35,001 - 50,500  
 8 50,501 - 72,500  
 9 72,501 - 98,500  
 10 98,501 - 140,500  
 11 140,501 - 200,500  
 12 200,501 - 250,500  
 13 250,501 - 300,500  
 14 300,501 - 400,500  
 15 400,501 - 500,000

**Inuit Shaman/Angakoq**

1 0,000 - 2,140  
 2 2,141 - 4,280  
 3 4,281 - 8,560  
 4 8,561 - 17,520  
 5 17,521 - 25,520  
 6 25,521 - 35,520  
 7 35,521 - 50,520  
 8 50,521 - 71,000  
 9 71,001 - 96,100  
 10 96,101 - 131,200  
 11 131,201 - 181,300  
 12 181,301 - 231,400  
 13 231,401 - 281,500  
 14 281,501 - 341,600  
 15 341,601 - 401,700

**Japanese Imp****Ninja Techno-Wizard**

1 0,000 - 2,300  
 2 2,301 - 4,600  
 3 4,601 - 9,200  
 4 9,201 - 18,400  
 5 18,401 - 26,500  
 6 26,501 - 36,600  
 7 36,601 - 51,700  
 8 51,701 - 74,800  
 9 74,801 - 100,900  
 10 100,901 - 140,000  
 11 140,001 - 193,100  
 12 193,101 - 235,200  
 13 235,201 - 290,400  
 14 290,401 - 350,600  
 15 350,601 - 425,800

**Kreeghor Witch**

1 0,000 - 2,300  
 2 2,301 - 4,600  
 3 4,601 - 9,200  
 4 9,201 - 18,400  
 5 18,401 - 26,500  
 6 26,501 - 36,600  
 7 36,601 - 51,700  
 8 51,701 - 71,800  
 9 71,801 - 96,900  
 10 96,901 - 137,000  
 11 137,001 - 188,100  
 12 188,001 - 229,200  
 13 229,201 - 279,300  
 14 279,301 - 340,400  
 15 340,401 - 400,000

**Kwarla Mystic/Elder Sham-Man/**

**False Sorcerer**  
 1 0,000 - 2,240  
 2 2,241 - 4,480  
 3 4,481 - 8,960  
 4 8,961 - 17,920  
 5 17,921 - 25,920  
 6 25,921 - 35,920  
 7 35,921 - 50,920  
 8 50,921 - 70,920  
 9 70,921 - 95,920  
 10 95,921 - 135,920  
 11 135,921 - 185,920  
 12 185,921 - 225,920  
 13 225,921 - 275,920  
 14 275,921 - 335,920  
 15 335,921 - 395,920

**Larhold Shaman**

**Sun Priest**  
 1 0,000 - 2,050  
 2 2,051 - 4,100  
 3 4,101 - 8,250  
 4 8,251 - 16,500  
 5 16,501 - 24,600  
 6 24,601 - 34,700  
 7 34,701 - 49,800  
 8 49,801 - 69,900  
 9 69,901 - 95,000  
 10 95,001 - 130,100  
 11 130,101 - 180,200  
 12 180,201 - 230,300  
 13 230,301 - 280,400  
 14 280,401 - 340,500  
 15 340,501 - 400,600

**Ley Line Walker**

**Mind Melter**  
 1 0,000 - 2,240  
 2 2,241 - 4,480  
 3 4,481 - 8,960  
 4 8,961 - 17,420  
 5 17,921 - 25,920  
 6 25,921 - 35,920  
 7 35,921 - 50,920  
 8 50,921 - 70,920  
 9 70,921 - 95,920  
 10 95,921 - 135,920  
 11 135,921 - 185,920  
 12 185,921 - 225,920  
 13 225,921 - 275,920  
 14 275,921 - 335,920  
 15 335,921 - 395,920

**Millenium Druid**

1 0,000 - 1,900  
 2 1,901 - 3,700  
 3 3,701 - 7,400  
 4 7,401 - 14,800  
 5 14,801 - 22,100  
 6 22,101 - 31,200  
 7 31,201 - 41,300  
 8 41,301 - 54,400  
 9 54,401 - 75,500  
 10 75,501 - 105,600  
 11 105,601 - 140,700  
 12 140,701 - 190,800  
 13 190,801 - 240,900  
 14 240,901 - 292,000  
 15 292,001 - 335,000

**Mystic**

1 0,000 - 2,050  
 2 2,051 - 4,100  
 3 4,101 - 8,250  
 4 8,251 - 16,500  
 5 16,501 - 24,600  
 6 24,601 - 34,700  
 7 34,701 - 49,800  
 8 49,801 - 69,900  
 9 69,901 - 95,000  
 10 95,001 - 130,100  
 11 130,101 - 180,200  
 12 180,201 - 230,300  
 13 230,301 - 280,400  
 14 280,401 - 340,500  
 15 340,501 - 400,600

**Mystic Knight**

**Lord Magus**  
 1 0,000 - 2,300  
 2 2,301 - 4,600  
 3 4,601 - 9,200  
 4 9,201 - 18,400  
 5 18,401 - 26,500  
 6 26,501 - 36,600  
 7 36,601 - 51,700  
 8 51,701 - 74,800  
 9 74,801 - 100,900  
 10 100,901 - 140,000  
 11 140,001 - 193,100  
 12 193,101 - 235,200  
 13 235,201 - 290,400  
 14 290,401 - 350,600  
 15 350,601 - 425,800

**Mystic Ninja**

1 0,000 - 2,400  
 2 2,401 - 4,600  
 3 4,601 - 9,200  
 4 9,201 - 18,400  
 5 18,401 - 28,300  
 6 28,301 - 48,000  
 7 48,001 - 78,000  
 8 78,001 - 110,000  
 9 110,001 - 150,000  
 10 150,001 - 200,000  
 11 200,001 - 250,000  
 12 250,001 - 310,000  
 13 310,001 - 380,000  
 14 380,001 - 470,000  
 15 470,001 - 600,000

**Nazcan Line Maker**

1 0,000 - 2,240  
 2 2,241 - 4,480  
 3 4,481 - 8,960  
 4 8,961 - 17,920  
 5 17,921 - 25,920  
 6 25,921 - 35,920  
 7 35,921 - 50,920  
 8 50,921 - 70,920  
 9 70,921 - 95,920  
 10 95,921 - 135,920  
 11 135,921 - 185,920  
 12 185,921 - 225,920  
 13 225,921 - 275,920  
 14 275,921 - 335,920  
 15 335,921 - 395,920

**Necromancer**

1 0,000 - 2,200  
 2 2,201 - 4,400  
 3 4,401 - 8,800  
 4 8,801 - 17,600  
 5 17,601 - 27,700  
 6 27,701 - 37,800  
 7 37,801 - 53,900  
 8 53,901 - 75,100  
 9 75,101 - 100,200  
 10 100,201 - 140,300  
 11 140,301 - 200,400  
 12 200,401 - 250,500  
 13 250,501 - 300,600  
 14 300,601 - 350,700  
 15 350,701 - 425,800

**Phoenixi**

1 0,000 - 2,200  
 2 2,201 - 4,400  
 3 4,401 - 8,800  
 4 8,801 - 17,600  
 5 17,601 - 27,700  
 6 27,701 - 37,800  
 7 37,801 - 53,900  
 8 53,901 - 75,100  
 9 75,101 - 100,200  
 10 100,201 - 140,300  
 11 140,301 - 200,400  
 12 200,401 - 250,500  
 13 250,501 - 300,600  
 14 300,601 - 350,700  
 15 350,701 - 425,800

**Night Witch****Mystic Kuznya**

1 0,000 - 2,080  
 2 2,081 - 4,160  
 3 4,161 - 8,800  
 4 8,801 - 18,000  
 5 18,001 - 33,000  
 6 33,001 - 48,000  
 7 48,001 - 65,000  
 8 65,001 - 90,000  
 9 90,001 - 120,000  
 10 120,001 - 150,000  
 11 150,001 - 200,000  
 12 200,001 - 250,000  
 13 250,001 - 300,000  
 14 300,001 - 400,000  
 15 400,001 - 500,000

**Ocean Mage****Naut'YII Koral Shaper**

1 0,000 - 2,420  
 2 2,421 - 4,840  
 3 4,841 - 9,620  
 4 9,621 - 19,200  
 5 19,201 - 27,400  
 6 27,401 - 38,500  
 7 38,501 - 53,000  
 8 53,001 - 75,600  
 9 75,601 - 100,700  
 10 100,701 - 140,800  
 11 140,801 - 200,900  
 12 200,901 - 250,400  
 13 250,401 - 300,500  
 14 300,501 - 380,600  
 15 380,601 - 480,700

**Old Believer**

1 0,000 - 2,050  
 2 2,051 - 4,100  
 3 4,101 - 8,250  
 4 8,251 - 16,500  
 5 16,501 - 24,600  
 6 24,601 - 34,700  
 7 34,701 - 49,800  
 8 49,801 - 69,900  
 9 69,901 - 95,000  
 10 95,001 - 130,100  
 11 130,101 - 180,200  
 12 180,201 - 230,300  
 13 230,301 - 280,400  
 14 280,401 - 340,500  
 15 340,501 - 400,600

**Oni Mystic**

1 0,000 - 2,600  
 2 2,601 - 5,000  
 3 5,001 - 10,000  
 4 10,001 - 20,000  
 5 20,001 - 30,000  
 6 30,001 - 50,000  
 7 50,001 - 80,000  
 8 80,001 - 120,000  
 9 120,001 - 170,000  
 10 170,001 - 230,000  
 11 230,001 - 300,000  
 12 300,001 - 380,000  
 13 380,001 - 470,000  
 14 470,001 - 600,000  
 15 600,001 - 800,000

**Paradox Shaman**

1 0,000 - 2,500  
 2 2,501 - 5,000  
 3 5,001 - 10,000  
 4 10,001 - 20,000  
 5 20,001 - 28,500  
 6 28,501 - 38,500  
 7 38,501 - 52,000  
 8 52,001 - 72,000  
 9 72,001 - 105,000  
 10 105,001 - 140,000  
 11 140,001 - 190,000  
 12 190,001 - 235,000  
 13 235,001 - 290,000  
 14 290,001 - 350,000  
 15 350,001 - 520,000

**Phase Adept****Time Master****Wolfen Quatoria**

1 0,000 - 2,650  
 2 2,651 - 5,300  
 3 5,301 - 11,000  
 4 11,001 - 21,000  
 5 21,001 - 32,000  
 6 32,001 - 42,000  
 7 42,001 - 62,000  
 8 62,001 - 90,000  
 9 90,001 - 120,000  
 10 120,001 - 170,000  
 11 170,001 - 220,000  
 12 220,001 - 290,000  
 13 290,001 - 400,000  
 14 400,001 - 500,000  
 15 500,001 - 700,000

**Phase Mystic**

1 0,000 - 2,300  
 2 2,301 - 4,600  
 3 4,601 - 9,200  
 4 9,201 - 18,400  
 5 18,401 - 26,500  
 6 26,501 - 36,600  
 7 36,601 - 51,700  
 8 51,701 - 71,800  
 9 71,801 - 96,900  
 10 96,901 - 137,000  
 11 137,001 - 188,100  
 12 188,101 - 229,200  
 13 229,201 - 279,300  
 14 279,301 - 340,400  
 15 340,401 - 400,000

**Priests of Light**

1 0,000 - 2,200  
 2 2,201 - 4,400  
 3 4,401 - 8,800  
 4 8,801 - 17,600  
 5 17,601 - 27,800  
 6 27,801 - 37,900  
 7 37,901 - 55,100  
 8 55,101 - 75,200  
 9 75,201 - 100,300  
 10 100,301 - 145,500  
 11 145,501 - 190,600  
 12 190,601 - 245,700  
 13 245,701 - 295,800  
 14 295,801 - 345,900  
 15 345,901 - 415,100

**Pygmy Shaman**

1 0,000 - 2,050  
 2 2,051 - 4,100  
 3 4,101 - 8,250  
 4 8,251 - 16,500  
 5 16,501 - 24,600  
 6 24,601 - 34,700  
 7 34,701 - 49,800  
 8 49,801 - 69,900  
 9 69,901 - 95,000  
 10 95,001 - 130,100  
 11 130,101 - 180,200  
 12 180,201 - 230,300  
 13 230,301 - 280,400  
 14 280,401 - 340,500  
 15 340,501 - 400,600

**Rune Warrior**

1 0,000 - 2,300  
 2 2,301 - 4,500  
 3 4,501 - 10,000  
 4 10,001 - 20,000  
 5 20,001 - 30,000  
 6 30,001 - 42,000  
 7 42,001 - 65,000  
 8 65,001 - 85,000  
 9 85,001 - 110,000  
 10 110,001 - 160,000  
 11 160,001 - 210,000  
 12 210,001 - 285,000  
 13 285,001 - 370,000  
 14 370,001 - 450,000  
 15 450,001 - 575,000

**Russian Sorcerer****a.k.a. Ley Line Walker**

1 0,000 - 2,240  
 2 2,241 - 4,480  
 3 4,481 - 8,960  
 4 8,961 - 17,920  
 5 17,921 - 25,920  
 6 25,921 - 35,920  
 7 35,921 - 50,920  
 8 50,921 - 70,920  
 9 70,921 - 95,920  
 10 95,921 - 135,920  
 11 135,921 - 185,920  
 12 185,921 - 225,920  
 13 225,921 - 275,920  
 14 275,921 - 335,920  
 15 335,921 - 395,920

**Sea Druid**

1 0,000 - 2,100  
 2 2,101 - 4,200  
 3 4,201 - 8,400  
 4 8,401 - 16,800  
 5 16,801 - 25,000  
 6 25,001 - 35,000  
 7 35,001 - 50,000  
 8 50,001 - 70,000  
 9 70,001 - 95,000  
 10 95,001 - 130,000  
 11 130,001 - 180,000  
 12 180,001 - 234,000  
 13 234,001 - 285,000  
 14 285,001 - 345,000  
 15 345,001 - 410,000

**Sea Wolf****Sea Inquisitioner**

1 0,000 - 2,100  
 2 2,101 - 4,200  
 3 4,201 - 8,400  
 4 8,401 - 16,800  
 5 16,801 - 25,000  
 6 25,001 - 35,000  
 7 35,001 - 50,000  
 8 50,001 - 70,000  
 9 70,001 - 95,000  
 10 95,001 - 130,000  
 11 130,001 - 180,000  
 12 180,001 - 234,000  
 13 234,001 - 285,000  
 14 285,001 - 345,000  
 15 345,001 - 410,000

**Shifter**

1 0,000 - 2,120  
 2 2,121 - 4,240  
 3 4,241 - 8,480  
 4 8,481 - 16,960  
 5 16,961 - 24,960  
 6 24,961 - 34,960  
 7 34,961 - 49,960  
 8 49,961 - 69,960  
 9 69,961 - 94,960  
 10 94,961 - 129,960  
 11 129,961 - 179,960  
 12 179,961 - 229,960  
 13 229,961 - 279,960  
 14 279,961 - 329,960  
 15 329,961 - 389,961

**Spirit Warrior**

1 0,000 - 2,100  
 2 2,101 - 4,200  
 3 4,201 - 8,400  
 4 8,401 - 17,200  
 5 17,201 - 25,400  
 6 25,401 - 35,800  
 7 35,801 - 51,000  
 8 51,001 - 71,200  
 9 71,201 - 96,400  
 10 96,401 - 131,600  
 11 131,601 - 181,800  
 12 181,801 - 232,000  
 13 232,001 - 282,200  
 14 282,201 - 342,400  
 15 342,401 - 402,600

**Stone Master**

1 0,000 - 2,400  
 2 2,401 - 4,800  
 3 4,801 - 9,600  
 4 9,601 - 19,200  
 5 19,201 - 28,400  
 6 28,401 - 38,600  
 7 38,601 - 52,200  
 8 52,201 - 72,400  
 9 72,401 - 98,600  
 10 98,601 - 140,200  
 11 140,201 - 200,400  
 12 200,401 - 260,600  
 13 260,601 - 310,200  
 14 310,201 - 410,400  
 15 410,401 - 510,000

**Sunaj Assassin**

1 0,000 - 2,600  
 2 2,601 - 5,200  
 3 5,201 - 10,500  
 4 10,501 - 21,200  
 5 21,201 - 32,300  
 6 32,301 - 47,400  
 7 47,401 - 62,500  
 8 62,501 - 88,000  
 9 88,001 - 112,000  
 10 112,001 - 163,000  
 11 163,001 - 222,000  
 12 222,001 - 295,000  
 13 295,001 - 395,000  
 14 395,001 - 495,000  
 15 495,001 - 595,000

**T - Monster Men**

1 0,000 - 2,500  
 2 2,501 - 5,500  
 3 5,501 - 10,500  
 4 10,501 - 21,500  
 5 21,501 - 31,500  
 6 31,501 - 46,500  
 7 46,501 - 64,000  
 8 64,001 - 85,000  
 9 85,001 - 110,000  
 10 110,001 - 160,000  
 11 160,001 - 210,000  
 12 210,001 - 285,000  
 13 285,001 - 360,000  
 14 360,001 - 440,000  
 15 440,001 - 550,000

**Tattooed Men**

1 0,000 - 2,500  
 2 2,501 - 5,000  
 3 5,001 - 10,000  
 4 10,001 - 20,000  
 5 20,001 - 30,000  
 6 30,001 - 45,000  
 7 45,001 - 60,000  
 8 60,001 - 80,000  
 9 80,001 - 100,000  
 10 100,001 - 150,000  
 11 150,001 - 200,000  
 12 200,001 - 275,000  
 13 275,001 - 350,000  
 14 350,001 - 425,000  
 15 425,001 - 525,000

**Temporal Warrior**

1 0,000 - 2,200  
 2 2,201 - 4,400  
 3 4,401 - 8,800  
 4 8,801 - 17,600  
 5 17,601 - 27,800  
 6 27,801 - 37,900  
 7 37,901 - 55,100  
 8 55,101 - 75,200  
 9 75,201 - 100,300  
 10 100,301 - 145,500  
 11 145,501 - 190,600  
 12 190,601 - 245,700  
 13 245,701 - 295,800  
 14 295,801 - 345,900  
 15 345,901 - 415,100

**Temporal Wizard**

1 0,000 - 2,500  
 2 2,501 - 5,000  
 3 5,001 - 10,000  
 4 10,001 - 20,000  
 5 20,001 - 28,500  
 6 28,501 - 38,500  
 7 38,501 - 52,000  
 8 52,001 - 72,000  
 9 72,001 - 105,000  
 10 105,001 - 140,000  
 11 140,001 - 190,000  
 12 190,001 - 235,000  
 13 235,001 - 290,000  
 14 290,001 - 350,000  
 15 350,001 - 520,000

**Tribal Shaman**

**Totem Warrior**  
 1 0,000 - 2,050  
 2 2,051 - 4,100  
 3 4,101 - 8,250  
 4 8,251 - 16,500  
 5 16,501 - 24,600  
 6 24,601 - 34,700  
 7 34,701 - 49,800  
 8 49,801 - 69,900  
 9 69,901 - 95,000  
 10 95,001 - 130,100  
 11 130,101 - 180,200  
 12 180,201 - 230,300  
 13 230,301 - 280,400  
 14 280,401 - 340,500  
 15 340,501 - 400,600

**Undead Slayers**

1 0,000 - 2,500  
 2 2,501 - 5,500  
 3 5,501 - 10,500  
 4 10,501 - 21,500  
 5 21,501 - 32,000  
 6 32,001 - 47,000  
 7 47,001 - 65,000  
 8 65,001 - 87,000  
 9 87,001 - 115,000  
 10 115,001 - 170,000  
 11 170,001 - 220,000  
 12 220,001 - 300,000  
 13 300,001 - 400,000  
 14 400,001 - 500,000  
 15 500,001 - 600,000

**Voodoo Priest**

1 0,000 - 2,100  
 2 2,101 - 4,150  
 3 4,151 - 8,300  
 4 8,301 - 16,600  
 5 16,601 - 25,000  
 6 25,001 - 35,000  
 7 35,001 - 50,000  
 8 50,001 - 70,000  
 9 70,001 - 95,000  
 10 95,001 - 130,000  
 11 130,001 - 180,000  
 12 180,001 - 231,000  
 13 231,001 - 280,000  
 14 280,001 - 341,000  
 15 341,001 - 401,000

**Warlock & Witch**

1 0,000 - 2,175  
 2 2,176 - 4,300  
 3 4,301 - 8,400  
 4 8,401 - 17,500  
 5 17,501 - 24,600  
 6 24,601 - 36,700  
 7 36,701 - 44,800  
 8 44,801 - 57,900  
 9 57,901 - 94,000  
 10 94,001 - 130,000  
 11 130,001 - 190,000  
 12 190,001 - 240,000  
 13 240,001 - 280,000  
 14 280,001 - 330,000  
 15 330,001 - 400,000

**Warlock Marine**

**Magic Specialist**  
 1 0,000 - 2,200  
 2 2,201 - 4,400  
 3 4,401 - 8,900  
 4 8,901 - 18,000  
 5 18,001 - 26,000  
 6 26,001 - 36,000  
 7 36,001 - 52,000  
 8 52,001 - 76,000  
 9 76,001 - 100,000  
 10 100,001 - 150,000  
 11 150,001 - 200,000  
 12 200,001 - 275,000  
 13 275,001 - 350,000  
 14 350,001 - 425,000  
 15 425,001 - 525,000

**Wormspeaker**

1 0,000 - 2,150  
 2 2,151 - 4,300  
 3 4,301 - 8,600  
 4 8,601 - 18,600  
 5 18,601 - 26,600  
 6 26,601 - 36,600  
 7 36,601 - 54,600  
 8 54,601 - 75,600  
 9 75,601 - 99,600  
 10 99,601 - 135,600  
 11 135,601 - 185,600  
 12 185,601 - 240,600  
 13 240,601 - 290,600  
 14 290,601 - 343,600  
 15 343,601 - 423,600

**Yamabushi**

**Demon Queller**  
 1 0,000 - 2,500  
 2 2,501 - 5,000  
 3 5,001 - 10,000  
 4 10,001 - 20,000  
 5 20,001 - 30,000  
 6 30,001 - 50,000  
 7 50,001 - 80,000  
 8 80,001 - 120,000  
 9 120,001 - 160,000  
 10 160,001 - 190,000  
 11 190,001 - 240,000  
 12 240,001 - 300,000  
 13 300,001 - 370,000  
 14 370,001 - 440,000  
 15 440,001 - 510,000

**Techno-Wizard**

1	0,000-2,300	
2	2,301-4,600	
3	4,601-9,200	
4	9,201-18,400	
5	18,401-26,500	
6	26,501-36,600	11 137,001-188,100
7	36,601-51,700	12 188,001-229,200
8	51,701-71,800	13 229,201-279,300
9	71,801-96,900	14 279,301-340,400
10	96,901-137,000	15 340,401-400,000

**Men of Arms****Aero-Jock**

1 0,000 - 2,000  
 2 2,001 - 4,000  
 3 4,001 - 8,200  
 4 8,201 - 16,400  
 5 16,401 - 24,500  
 6 24,501 - 34,600  
 7 34,601 - 49,700  
 8 49,701 - 69,800  
 9 69,801 - 94,900  
 10 94,901 - 129,000  
 11 129,001 - 179,100  
 12 179,101 - 229,200  
 13 229,201 - 279,300  
 14 279,301 - 329,400  
 15 329,401 - 389,500

**Anti - Robot Headhunter  
Tundra Ranger Cavalry**

1 0,000 - 2,150  
 2 2,151 - 4,300  
 3 4,301 - 8,600  
 4 8,601 - 18,600  
 5 18,601 - 26,600  
 6 26,601 - 36,600  
 7 36,601 - 54,600  
 8 54,601 - 75,600  
 9 75,601 - 99,600  
 10 99,601 - 135,600  
 11 135,601 - 185,600  
 12 185,601 - 240,600  
 13 240,601 - 290,600  
 14 290,601 - 343,600  
 15 343,601 - 423,600

**Bandit O.C.C.**

1 0,000 - 1,860  
 2 1,861 - 3,600  
 3 3,601 - 7,000  
 4 7,001 - 14,400  
 5 14,401 - 23,400  
 6 23,401 - 34,400  
 7 14,401 - 44,400  
 8 44,401 - 60,400  
 9 60,401 - 80,400  
 10 80,401 - 110,400  
 11 110,401 - 145,400  
 12 145,401 - 195,400  
 13 195,401 - 245,400  
 14 245,401 - 290,400  
 15 290,401 - 340,400

**Borg****Head Hunter****Glitter Boy**

1 0,000 - 2,100  
 2 2,101 - 4,200  
 3 4,201 - 8,400  
 4 8,401 - 17,200  
 5 17,201 - 25,400  
 6 25,401 - 35,800  
 7 35,801 - 51,000  
 8 51,001 - 71,200  
 9 71,201 - 96,400  
 10 96,401 - 131,600  
 11 131,601 - 181,800  
 12 181,801 - 232,000  
 13 232,001 - 282,200  
 14 282,201 - 342,400  
 15 342,401 - 402,600

**Bounty Hunter O.C.C.****Mountain Giant R.C.C.**

1 0,000 - 2,120  
 2 2,111 - 4,240  
 3 4,291 - 8,480  
 4 8,441 - 16,880  
 5 16,881 - 24,880  
 6 24,881 - 34,880  
 7 34,881 - 49,880  
 8 49,881 - 69,880  
 9 69,881 - 94,880  
 10 94,881 - 129,880  
 11 129,881 - 179,880  
 12 179,881 - 229,880  
 13 229,881 - 279,880  
 14 279,881 - 329,880  
 15 329,881 - 389,880

**CAF Trooper**

1 0,000 - 2,150  
 2 2,151 - 4,250  
 3 4,251 - 8,850  
 4 8,851 - 17,000  
 5 17,001 - 25,000  
 6 25,001 - 35,000  
 7 35,001 - 50,000  
 8 50,001 - 70,000  
 9 70,001 - 95,000  
 10 95,001 - 130,000  
 11 130,001 - 180,000  
 12 180,001 - 230,000  
 13 230,001 - 280,000  
 14 280,001 - 330,000  
 15 330,001 - 400,000

**Combat Soldier****Police/Enforcement**

1 0,000 - 1,970  
 2 1,971 - 3,940  
 3 3,941 - 7,880  
 4 7,881 - 14,880  
 5 14,881 - 21,880  
 6 21,881 - 31,880  
 7 31,881 - 41,220  
 8 41,221 - 54,440  
 9 54,441 - 74,660  
 10 74,661 - 104,880  
 11 104,881 - 139,220  
 12 139,221 - 189,440  
 13 189,441 - 239,660  
 14 239,661 - 290,880  
 15 290,881 - 335,000

**Comm. Officer, Medical****Officer, Field Mechanic**

1 0,000 - 1,925  
 2 1,926 - 3,850  
 3 3,851 - 7,450  
 4 7,451 - 15,000  
 5 15,001 - 21,500  
 6 21,501 - 31,500  
 7 31,501 - 41,500  
 8 41,501 - 54,000  
 9 54,001 - 75,000  
 10 75,001 - 105,000  
 11 105,001 - 140,000  
 12 140,001 - 190,000  
 13 190,001 - 240,000  
 14 240,001 - 300,000  
 15 300,001 - 350,000

**Cosmo-Knight**

1 0,000 - 3,000  
 2 3,001 - 5,400  
 3 5,401 - 10,800  
 4 10,801 - 21,600  
 5 21,601 - 31,600  
 6 31,601 - 50,000  
 7 50,001 - 80,000  
 8 80,001 - 120,000  
 9 120,001 - 170,000  
 10 170,001 - 230,000  
 11 230,001 - 300,000  
 12 300,001 - 380,000  
 13 380,001 - 470,000  
 14 470,001 - 600,000  
 15 600,001 - 800,000

**Cossack, Wingrider****Heavy Machine**

1 0,000 - 2,150  
 2 2,151 - 4,300  
 3 4,301 - 8,600  
 4 8,601 - 18,600  
 5 18,601 - 26,600  
 6 26,601 - 36,600  
 7 36,601 - 54,600  
 8 54,601 - 75,600  
 9 75,601 - 99,600  
 10 99,601 - 135,600  
 11 135,601 - 185,600  
 12 185,601 - 240,600  
 13 240,601 - 290,600  
 14 290,601 - 343,600  
 15 343,601 - 423,600

**Crazy**

1 0,000 - 2,140  
 2 2,141 - 4,280  
 3 4,281 - 8,560  
 4 8,561 - 17,520  
 5 17,521 - 25,520  
 6 25,521 - 35,520  
 7 35,521 - 50,520  
 8 50,521 - 71,000  
 9 71,001 - 96,100  
 10 96,101 - 131,200  
 11 131,201 - 181,300  
 12 181,301 - 231,400  
 13 231,401 - 281,500  
 14 281,501 - 341,600  
 15 341,601 - 401,700

**Cyber-Samurai**

1 0,000 - 2,100  
 2 2,101 - 4,200  
 3 4,201 - 8,400  
 4 8,401 - 17,200  
 5 17,201 - 25,400  
 6 25,401 - 35,800  
 7 35,801 - 51,000  
 8 51,001 - 71,200  
 9 71,201 - 96,400  
 10 96,401 - 131,600  
 11 131,601 - 181,800  
 12 181,801 - 232,000  
 13 232,001 - 282,200  
 14 282,201 - 342,400  
 15 342,401 - 402,600

**Cyber-Knight****Crazy**

1 0,000 - 2,140  
 2 2,141 - 4,280  
 3 4,281 - 8,560  
 4 8,561 - 17,520  
 5 17,521 - 25,520  
 6 25,521 - 35,520  
 7 35,521 - 50,520  
 8 50,521 - 71,000  
 9 71,001 - 96,100  
 10 96,101 - 131,200  
 11 131,201 - 181,300  
 12 181,301 - 231,400  
 13 231,401 - 281,500  
 14 281,501 - 341,600  
 15 341,601 - 401,700

**Cyberai**

1 0,000 - 2,650  
 2 2,651 - 5,300  
 3 5,301 - 11,000  
 4 11,001 - 21,000  
 5 21,001 - 32,000  
 6 32,001 - 42,000  
 7 42,001 - 62,000  
 8 62,001 - 90,000  
 9 90,001 - 120,000  
 10 120,001 - 170,000  
 11 170,001 - 220,000  
 12 220,001 - 290,000  
 13 290,001 - 400,000  
 14 400,001 - 500,000  
 15 500,001 - 700,000

**CyberSlinger Cyborgs**

1 0,000 - 2,100  
 2 2,101 - 4,200  
 3 4,201 - 8,400  
 4 8,401 - 17,200  
 5 17,201 - 25,400  
 6 25,401 - 35,800  
 7 35,801 - 51,000  
 8 51,001 - 71,200  
 9 71,201 - 96,400  
 10 96,401 - 131,600  
 11 131,601 - 181,800  
 12 181,801 - 232,000  
 13 232,001 - 282,200  
 14 282,201 - 342,400  
 15 342,401 - 402,600

**Cyborg Shocktroopers**

1 0,000 - 2,500  
 2 2,601 - 5,000  
 3 5,001 - 10,000  
 4 10,001 - 20,000  
 5 20,001 - 30,000  
 6 30,001 - 40,000  
 7 40,001 - 55,000  
 8 55,001 - 80,000  
 9 80,001 - 105,000  
 10 105,001 - 150,000  
 11 150,001 - 200,000  
 12 200,001 - 250,000  
 13 250,001 - 310,000  
 14 310,001 - 380,000  
 15 380,001 - 450,000

**Cyborg Soldier**

1 0,000 - 2,150  
 2 2,151 - 4,300  
 3 4,301 - 8,600  
 4 8,601 - 18,600  
 5 18,601 - 26,600  
 6 26,601 - 36,600  
 7 36,601 - 54,600  
 8 54,601 - 75,600  
 9 75,601 - 99,600  
 10 99,601 - 135,600  
 11 135,601 - 185,600  
 12 185,601 - 240,600  
 13 240,601 - 290,600  
 14 290,601 - 343,600  
 15 343,601 - 423,600

**Descended Glitter Boy Pilot**

1 0,000 - 2,150  
 2 2,151 - 4,300  
 3 4,301 - 8,400  
 4 8,401 - 17,500  
 5 17,501 - 25,600  
 6 25,601 - 35,700  
 7 35,701 - 52,800  
 8 52,801 - 72,900  
 9 72,901 - 98,500  
 10 98,501 - 132,500  
 11 132,501 - 183,500  
 12 183,501 - 235,000  
 13 235,001 - 285,000  
 14 285,001 - 345,000  
 15 345,001 - 410,000

<b>Destroyer 'Borg</b>	<b>Ojahee 'Borg</b>	13 250,501 - 300,000	13 240,001 - 290,000
<b>Inca Warrior</b>	<b>Ultra - Crazy</b>	14 300,001 - 400,000	14 290,001 - 360,000
1 0,000 - 2,150	<b>Arkxon Spectral Hunter</b>	15 400,001 - 500,000	15 360,001 - 420,000
2 2,151 - 4,300	1 0,000 - 2,650		
3 4,301 - 8,600	2 2,651 - 5,300	<b>Glitter Force Trooper</b>	<b>Gunslinger</b>
4 8,601 - 17,200	3 5,301 - 11,000	1 0,000 - 2,200	<b>Wired-Gunslinger</b>
5 17,201 - 25,500	4 11,001 - 21,000	2 2,201 - 4,400	1 0,000 - 2,160
6 25,501 - 36,000	5 21,001 - 32,000	3 4,401 - 8,800	2 2,161 - 4,320
7 36,001 - 52,000	6 32,001 - 42,000	4 8,801 - 17,600	3 4,321 - 8,640
8 52,001 - 73,000	7 42,001 - 62,000	5 17,601 - 27,800	4 8,641 - 18,000
9 73,001 - 98,000	8 62,001 - 90,000	6 27,801 - 37,900	5 18,001 - 27,000
10 98,001 - 134,000	9 90,001 - 120,000	7 37,901 - 55,100	6 27,001 - 38,500
11 134,001 - 184,000	10 120,001 - 170,000	8 55,101 - 75,200	7 38,501 - 54,700
12 184,001 - 240,000	11 170,001 - 220,000	9 75,201 - 100,300	8 54,701 - 77,000
13 240,001 - 295,000	12 220,001 - 290,000	10 100,301 - 145,500	9 77,001 - 100,300
14 295,001 - 365,000	13 290,001 - 400,000	11 145,501 - 190,600	10 100,301 - 140,500
15 365,001 - 425,000	14 400,001 - 500,000	12 190,601 - 245,700	11 140,501 - 210,000
	15 500,001 - 700,000	13 245,701 - 295,800	12 210,001 - 250,700
		14 295,801 - 345,900	13 250,701 - 325,000
<b>Dragon Borg</b>	<b>Freedom Fighter</b>	15 345,901 - 415,100	14 325,001 - 395,500
<b>Japanese Borg</b>	<b>Imperial Security</b>		15 395,501 - 455,700
1 0,000 - 2,175	<b>Galactic Tracer</b>	<b>Glitter Girl Pilot</b>	
2 2,176 - 4,300	1 0,000 - 2,100	1 0,000 - 2,150	<b>Gypsy Enforcer</b>
3 4,301 - 8,400	2 2,101 - 4,200	2 2,151 - 4,500	1 0,000 - 1,900
4 8,401 - 17,500	3 4,201 - 8,400	3 4,501 - 8,800	2 1,901 - 3,800
5 17,501 - 24,600	4 8,401 - 17,200	4 8,801 - 18,000	3 3,801 - 7,300
6 24,601 - 36,700	5 17,201 - 25,400	5 18,001 - 26,000	4 7,301 - 14,300
7 36,701 - 44,800	6 25,401 - 35,800	6 26,001 - 36,300	5 14,301 - 21,000
8 44,801 - 57,900	7 35,801 - 51,000	7 36,301 - 53,500	6 21,001 - 30,000
9 57,901 - 94,000	8 51,001 - 71,200	8 53,501 - 74,500	7 30,001 - 40,000
10 94,001 - 130,000	9 71,201 - 96,400	9 74,501 - 100,000	8 40,001 - 53,000
11 130,001 - 190,000	10 96,401 - 131,600	10 100,001 - 135,000	9 53,001 - 73,000
12 190,001 - 240,000	11 131,601 - 181,800	11 135,001 - 185,500	10 73,001 - 103,000
13 240,001 - 280,000	12 181,801 - 232,000	12 185,501 - 237,500	11 103,001 - 138,000
14 280,001 - 330,000	13 232,001 - 282,200	13 237,501 - 297,500	12 138,001 - 188,000
15 330,001 - 400,000	14 282,201 - 342,400	14 297,501 - 357,500	13 188,001 - 238,000
	15 342,401 - 402,600	15 357,501 - 417,000	14 238,001 - 288,000
<b>Ojahee</b>			15 288,001 - 330,000
1 0,000 - 2,200	<b>Freelancer</b>	<b>Gun Brother,</b>	
2 2,201 - 4,400	<b>Symbiotic Warrior</b>	<b>Invincible Guard</b>	<b>Headhunter Assassin</b>
3 4,401 - 8,900	1 0,000 - 1,900	1 0,000 - 2,300	1 0,000 - 2,200
4 8,901 - 18,000	2 1,901 - 3,700	2 2,301 - 4,500	2 2,201 - 4,400
5 18,001 - 26,000	3 3,701 - 7,400	3 4,501 - 10,000	3 4,401 - 8,800
6 26,001 - 36,000	4 7,401 - 14,800	4 10,001 - 20,000	4 8,801 - 17,600
7 36,001 - 52,000	5 14,801 - 22,100	5 20,001 - 30,000	5 17,601 - 27,800
8 52,001 - 76,000	6 22,101 - 31,200	6 30,001 - 42,000	6 27,801 - 37,900
9 76,001 - 100,000	7 31,201 - 41,300	7 42,001 - 65,000	7 37,901 - 55,100
10 100,001 - 150,000	8 41,301 - 54,400	8 65,001 - 85,000	8 55,101 - 75,200
11 150,001 - 200,000	9 54,401 - 75,500	9 85,001 - 110,000	9 75,201 - 100,300
12 200,001 - 275,000	10 75,501 - 105,600	10 110,001 - 160,000	10 100,301 - 145,500
13 275,001 - 350,000	11 105,601 - 140,700	11 160,001 - 210,000	11 145,501 - 190,600
14 350,001 - 425,000	12 140,701 - 190,800	12 210,001 - 285,000	12 190,601 - 245,700
15 425,001 - 525,000	13 190,801 - 240,900	13 285,001 - 370,000	13 245,701 - 295,800
	14 240,901 - 292,000	14 370,001 - 450,000	14 295,801 - 345,900
<b>Fallam Battlemaster</b>	15 292,001 - 335,000	15 450,001 - 575,000	15 345,901 - 415,100
1 0,000 - 2,300			
2 2,301 - 4,500	<b>Full Conversion Bio - Borgs</b>	<b>Gunfighter</b>	
3 4,501 - 10,000	1 0,000 - 2,200	1 0,000 - 2,100	
4 10,001 - 20,000	2 2,201 - 4,400	2 2,101 - 4,200	
5 20,001 - 30,000	3 4,401 - 8,800	3 4,201 - 8,400	
6 30,001 - 42,000	4 8,801 - 17,600	4 8,401 - 16,800	
7 42,001 - 65,000	5 17,601 - 25,000	5 16,801 - 26,000	
8 65,001 - 85,000	6 25,001 - 35,000	6 26,001 - 36,400	
9 85,001 - 110,000	7 35,001 - 50,500	7 36,401 - 53,000	
10 110,001 - 160,000	8 50,501 - 75,500	8 53,001 - 74,000	
11 160,001 - 210,000	9 75,501 - 100,500	9 74,001 - 98,000	
12 210,001 - 285,000	10 100,501 - 150,500	10 98,001 - 138,000	
13 285,001 - 370,000	11 150,501 - 200,500	11 138,001 - 190,000	
14 370,001 - 450,000	12 200,501 - 250,500	12 190,001 - 240,000	
15 450,001 - 575,000			

**Headhunter Techno-Warrior**

1 0,000 - 2,100  
 2 2,101 - 4,200  
 3 4,201 - 8,400  
 4 8,401 - 17,200  
 5 17,201 - 25,400  
 6 25,401 - 35,800  
 7 35,801 - 51,000  
 8 51,001 - 71,200  
 9 71,201 - 96,400  
 10 96,401 - 131,600  
 11 131,601 - 181,800  
 12 181,801 - 232,000  
 13 232,001 - 282,200  
 14 282,201 - 342,400  
 15 342,401 - 402,600

**Highwayman O.C.C.****Justice Ranger, 1st Cavalry**

1 0,000 - 2,000  
 2 2,001 - 4,000  
 3 4,001 - 8,200  
 4 8,201 - 6,400  
 5 6,401 - 24,500  
 6 24,501 - 34,600  
 7 34,601 - 49,700  
 8 49,701 - 69,800  
 9 69,801 - 94,900  
 10 94,901 - 129,000  
 11 129,001 - 179,100  
 12 179,101 - 229,200  
 13 229,201 - 279,300  
 14 279,301 - 329,400  
 15 329,401 - 389,500

**Hospitaller Knights**

1 0,000 - 2,150  
 2 2,151 - 4,300  
 3 4,301 - 8,600  
 4 8,601 - 17,200  
 5 17,201 - 25,500  
 6 25,501 - 36,000  
 7 36,001 - 52,000  
 8 52,001 - 73,000  
 9 73,001 - 98,000  
 10 98,001 - 134,000  
 11 134,001 - 184,000  
 12 184,001 - 240,000  
 13 240,001 - 295,000  
 14 295,001 - 365,000  
 15 365,001 - 425,000

**Infantry Grunt****City Police**

1 0,000 - 1,925  
 2 1,926 - 3,850  
 3 3,851 - 7,450  
 4 7,451 - 15,000  
 5 15,001 - 21,500  
 6 21,501 - 31,500  
 7 31,501 - 41,500  
 8 41,501 - 54,000  
 9 54,001 - 75,000  
 10 75,001 - 105,000  
 11 105,001 - 140,000  
 12 140,001 - 190,000  
 13 190,001 - 240,000  
 14 240,001 - 300,000  
 15 300,001 - 350,000

**Intelligence Commando**

1 0,000 - 2,150  
 2 2,151 - 4,300  
 3 4,301 - 8,600  
 4 8,601 - 17,200  
 5 17,201 - 25,500  
 6 25,501 - 36,000  
 7 36,001 - 52,000  
 8 52,001 - 73,000  
 9 73,001 - 98,000  
 10 98,001 - 134,000  
 11 134,001 - 184,000  
 12 184,001 - 240,000  
 13 240,001 - 295,000  
 14 295,001 - 365,000  
 15 365,001 - 425,000

**Intelligence Officer**

1 0,000 - 2,100  
 2 2,101 - 4,200  
 3 4,201 - 8,400  
 4 8,401 - 16,800  
 5 16,801 - 25,000  
 6 25,001 - 35,000  
 7 35,001 - 50,000  
 8 50,001 - 70,000  
 9 70,001 - 95,000  
 10 95,001 - 130,000  
 11 130,001 - 180,000  
 12 180,001 - 234,000  
 13 234,001 - 285,000  
 14 285,001 - 345,000  
 15 345,001 - 410,000

**Knights (general)**

1 0,000 - 2,100  
 2 2,101 - 4,200  
 3 4,201 - 8,400  
 4 8,401 - 16,800  
 5 16,801 - 25,000  
 6 25,001 - 35,000  
 7 35,001 - 50,000  
 8 50,001 - 70,000  
 9 70,001 - 95,000  
 10 95,001 - 130,000  
 11 130,001 - 180,000  
 12 180,001 - 234,000  
 13 234,001 - 285,000  
 14 285,001 - 345,000  
 15 345,001 - 410,000

**Knights of Camelot****Royal Knights****Human Nexus Knights**

1 0,000 - 2,150  
 2 2,151 - 4,300  
 3 4,301 - 8,600  
 4 8,601 - 17,200  
 5 17,201 - 25,500  
 6 25,501 - 36,000  
 7 36,001 - 52,000  
 8 52,001 - 73,000  
 9 73,001 - 98,000  
 10 98,001 - 134,000  
 11 134,001 - 184,000  
 12 184,001 - 240,000  
 13 240,001 - 295,000  
 14 295,001 - 365,000  
 15 365,001 - 425,000

**Larhold Human Renegade****Plains 'Borg****Megaversal Trooper**

1 0,000 - 2,100  
 2 2,101 - 4,200  
 3 4,201 - 8,400  
 4 8,401 - 17,200  
 5 17,201 - 25,400  
 6 25,401 - 35,800  
 7 35,801 - 51,000  
 8 51,001 - 71,200  
 9 71,201 - 96,400  
 10 96,401 - 131,600  
 11 131,601 - 181,800  
 12 181,801 - 232,000  
 13 232,001 - 282,200  
 14 282,201 - 342,400  
 15 342,401 - 402,600

**Light Machine Cyborg**

1 0,000 - 2,100  
 2 2,101 - 4,200  
 3 4,201 - 8,400  
 4 8,401 - 16,800  
 5 16,801 - 25,000  
 6 25,001 - 35,000  
 7 35,001 - 50,000  
 8 50,001 - 70,000  
 9 70,001 - 95,000  
 10 95,001 - 130,000  
 11 130,001 - 180,000  
 12 180,001 - 234,000  
 13 234,001 - 285,000  
 14 285,001 - 345,000  
 15 345,001 - 410,000

**Mechanized Cavalry**

1 0,000 - 2,050  
 2 2,051 - 4,100  
 3 4,101 - 8,250  
 4 8,251 - 16,500  
 5 18,501 - 24,600  
 6 24,601 - 34,700  
 7 34,701 - 49,800  
 8 49,801 - 69,900  
 9 69,901 - 95,000  
 10 95,001 - 130,000  
 11 130,001 - 180,200  
 12 180,201 - 230,000  
 13 230,001 - 280,400  
 14 280,401 - 340,500  
 15 340,501 - 400,600

**Mindwerks Cyborg****Standard Crazy**

1 0,000 - 2,140  
 2 2,141 - 4,280  
 3 4,281 - 8,560  
 4 8,561 - 17,520  
 5 17,521 - 25,520  
 6 25,521 - 35,520  
 7 35,521 - 50,520  
 8 50,521 - 71,000  
 9 71,001 - 96,100  
 10 96,101 - 131,200  
 11 131,201 - 181,300  
 12 181,301 - 231,400  
 13 231,401 - 281,500  
 14 281,501 - 341,600  
 15 341,601 - 401,700

**Momano Headhunter**

1 0,000 - 2,150  
 2 2,151 - 4,300  
 3 4,301 - 8,600  
 4 8,601 - 17,200  
 5 17,201 - 25,500  
 6 25,501 - 36,000  
 7 36,001 - 52,000  
 8 52,001 - 73,000  
 9 73,001 - 98,000  
 10 98,001 - 134,000  
 11 134,001 - 184,000  
 12 184,001 - 240,000  
 13 240,001 - 295,000  
 14 295,001 - 385,000  
 15 385,001 - 450,000

**Naut'YII Soldier**

1 0,000 - 1,900  
 2 1,901 - 3,800  
 3 3,801 - 7,300  
 4 7,301 - 14,300  
 5 14,301 - 21,000  
 6 21,001 - 30,000  
 7 30,001 - 40,000  
 8 40,001 - 53,000  
 9 53,001 - 73,000  
 10 73,001 - 103,000  
 11 103,001 - 138,000  
 12 138,001 - 188,000  
 13 188,001 - 238,000  
 14 238,001 - 288,000  
 15 288,001 - 330,000

**Navy Marine**

1 0,000 - 1,970  
 2 1,971 - 3,940  
 3 3,941 - 7,880  
 4 7,881 - 14,880  
 5 14,881 - 21,880  
 6 21,881 - 31,880  
 7 31,881 - 41,220  
 8 41,221 - 54,440  
 9 54,441 - 74,660  
 10 74,661 - 104,880  
 11 104,881 - 139,220  
 12 139,221 - 189,440  
 13 189,441 - 239,660  
 14 239,661 - 290,880  
 15 290,881 - 335,000

**Ninja Borg****Ninja Crazy**

1 0,000 - 2,140  
 2 2,141 - 4,280  
 3 4,281 - 8,560  
 4 8,561 - 17,520  
 5 17,521 - 25,520  
 6 25,521 - 35,520  
 7 35,521 - 50,520  
 8 50,521 - 71,000  
 9 71,001 - 96,100  
 10 96,101 - 131,200  
 11 131,201 - 181,300  
 12 181,301 - 231,400  
 13 231,401 - 281,500  
 14 281,501 - 341,600  
 15 341,601 - 400,700

**Noro Mystic Warrior**

1 0,000 - 2,200  
 2 2,201 - 4,400  
 3 4,401 - 8,900  
 4 8,901 - 18,000  
 5 18,001 - 26,000  
 6 26,001 - 36,000  
 7 36,001 - 52,000  
 8 52,001 - 76,000  
 9 76,001 - 100,000  
 10 100,001 - 150,000  
 11 150,001 - 200,000  
 12 200,001 - 275,000  
 13 275,001 - 350,000  
 14 350,001 - 425,000  
 15 425,001 - 525,000

**Null Psyborg**

1 0,000 - 2,100  
 2 2,101 - 4,200  
 3 4,201 - 8,400  
 4 8,401 - 16,800  
 5 16,801 - 25,000  
 6 25,001 - 35,000  
 7 35,001 - 50,000  
 8 50,001 - 70,000  
 9 70,001 - 95,000  
 10 95,001 - 130,000  
 11 130,001 - 180,000  
 12 180,001 - 234,000  
 13 234,001 - 285,000  
 14 285,001 - 345,000  
 15 345,001 - 410,000

**Pecos Raider**

**a.k.a. Bandit**  
 1 0,000 - 1,860  
 2 1,861 - 3,600  
 3 3,601 - 7,000  
 4 7,001 - 14,400  
 5 14,401 - 23,400  
 6 23,401 - 34,400  
 7 34,401 - 44,400  
 8 44,401 - 60,400  
 9 60,401 - 80,400  
 10 80,401 - 110,400  
 11 110,401 - 145,400  
 12 145,401 - 195,400  
 13 195,401 - 245,400  
 14 245,401 - 290,400  
 15 290,401 - 340,400

**Pirate**

1 0,000 - 1,900  
 2 1,901 - 3,800  
 3 3,801 - 7,300  
 4 7,301 - 14,300  
 5 14,301 - 22,800  
 6 22,801 - 34,300  
 7 34,301 - 45,800  
 8 45,801 - 70,300  
 9 70,301 - 92,800  
 10 92,801 - 122,300  
 11 122,301 - 148,000  
 12 148,001 - 185,800  
 13 185,801 - 245,300  
 14 245,301 - 290,800  
 15 290,801 - 340,000

**Pirate, South America**

1 0,000 - 1,900  
 2 1,901 - 3,800  
 3 3,801 - 7,300  
 4 7,301 - 14,300  
 5 14,301 - 21,000  
 6 21,001 - 31,000  
 7 31,001 - 41,000  
 8 41,001 - 53,000  
 9 53,001 - 73,000  
 10 73,001 - 103,000  
 11 103,001 - 138,000  
 12 138,001 - 188,000  
 13 188,001 - 238,000  
 14 238,001 - 288,000  
 15 288,001 - 328,000

**Pirate Slaver**

1 0,000 - 2,120  
 2 2,111 - 4,240  
 3 4,221 - 8,480  
 4 8,441 - 16,880  
 5 16,880 - 24,880  
 6 24,881 - 34,880  
 7 34,881 - 49,880  
 8 49,881 - 69,880  
 9 69,881 - 94,880  
 10 94,881 - 129,880  
 11 129,881 - 179,880  
 12 179,881 - 229,880  
 13 229,881 - 279,880  
 14 279,881 - 329,880  
 15 329,881 - 389,880

**Police TRG**

1 0,000 - 2,140  
 2 2,141 - 4,280  
 3 4,281 - 8,560  
 4 8,561 - 17,520  
 5 17,521 - 25,520  
 6 25,521 - 35,520  
 7 35,521 - 50,520  
 8 50,521 - 71,000  
 9 71,001 - 96,100  
 10 96,101 - 131,200  
 11 131,201 - 181,300  
 12 181,301 - 231,400  
 13 231,401 - 281,500  
 14 281,501 - 341,600  
 15 341,601 - 400,700

**Power Armor Commando**

1 0,000 - 2,200  
 2 2,201 - 4,400  
 3 4,401 - 8,800  
 4 8,801 - 17,600  
 5 17,601 - 27,800  
 6 27,801 - 37,900  
 7 37,901 - 55,100  
 8 55,101 - 75,200  
 9 75,201 - 100,300  
 10 100,301 - 145,500  
 11 145,501 - 190,600  
 12 190,601 - 245,700  
 13 245,701 - 295,800  
 14 295,801 - 345,900  
 15 345,901 - 415,100

**Psi-Slinger**

1 0,000 - 2,150  
 2 2,151 - 4,300  
 3 4,301 - 9,600  
 4 9,601 - 18,200  
 5 18,201 - 28,400  
 6 28,401 - 38,600  
 7 38,601 - 54,800  
 8 54,801 - 75,200  
 9 75,201 - 100,400  
 10 100,401 - 132,600  
 11 132,601 - 185,800  
 12 185,801 - 240,200  
 13 240,201 - 295,400  
 14 295,401 - 365,600  
 15 365,601 - 425,800

**Psynetic Crazy**

1 0,000 - 2,250  
 2 2,251 - 4,400  
 3 4,401 - 8,800  
 4 8,801 - 17,600  
 5 17,601 - 24,000  
 6 25,001 - 35,000  
 7 35,001 - 50,500  
 8 50,501 - 72,500  
 9 72,501 - 98,500  
 10 98,501 - 140,500  
 11 140,501 - 200,500  
 12 200,501 - 250,500  
 13 250,501 - 300,500  
 14 300,501 - 400,500  
 15 400,401 - 500,000

**Reaver Bandit**

1 0,000 - 1,875  
 2 1,876 - 3,750  
 3 3,751 - 7,250  
 4 7,251 - 14,100  
 5 14,101 - 21,200  
 6 21,201 - 31,200  
 7 31,201 - 41,200  
 8 41,201 - 51,200  
 9 51,201 - 71,200  
 10 71,201 - 101,500  
 11 101,501 - 136,500  
 12 136,501 - 186,500  
 13 186,501 - 236,500  
 14 236,501 - 286,500  
 15 286,501 - 326,500

**Reaver Military Scout**

**Reaver Soldier**  
 1 0,000 - 1,925  
 2 1,926 - 3,850  
 3 3,851 - 7,450  
 4 7,451 - 15,000  
 5 15,001 - 21,500  
 6 21,501 - 31,500  
 7 30,501 - 41,500  
 8 41,501 - 54,000  
 9 54,001 - 75,000  
 10 75,001 - 105,000  
 11 105,001 - 140,000  
 12 140,001 - 190,000  
 13 190,001 - 240,000  
 14 240,001 - 300,000  
 15 300,001 - 350,000

**Republic Infantrymen**

1 0,000 - 1,950  
 2 1,951 - 3,900  
 3 3,901 - 3,800  
 4 8,801 - 17,600  
 5 17,601 - 35,600  
 6 35,601 - 50,600  
 7 50,601 - 70,600  
 8 70,600 - 95,600  
 9 95,601 - 125,600  
 10 125,601 - 175,600  
 11 175,601 - 225,600  
 12 225,601 - 275,600  
 13 275,601 - 325,600  
 14 325,601 - 375,600  
 15 375,601 - 425,600

**River Pirate**

**Privateer**  
 1 0,000 - 2,000  
 2 2,001 - 4,000  
 3 4,001 - 8,200  
 4 8,201 - 16,400  
 5 16,401 - 24,500  
 6 24,501 - 34,600  
 7 34,601 - 49,700  
 8 49,701 - 69,800  
 9 69,801 - 94,900  
 10 94,901 - 129,000  
 11 129,001 - 179,100  
 12 179,101 - 229,200  
 13 229,201 - 279,300  
 14 279,301 - 329,400  
 15 329,401 - 389,500

**Road Sentinel**

**Special Ops Soldier**  
 1 0,000 - 2,150  
 2 2,151 - 4,300  
 3 4,301 - 8,600  
 4 8,601 - 18,600  
 5 18,601 - 26,600  
 6 26,601 - 36,600  
 7 36,601 - 54,600  
 8 54,601 - 75,600  
 9 75,601 - 99,600  
 10 99,601 - 135,600  
 11 135,601 - 185,600  
 12 185,601 - 240,600  
 13 240,601 - 290,600  
 14 290,601 - 343,600  
 15 343,601 - 423,600

**Roadganger**

1 0,000 - 1,970  
 2 1,971 - 3,940  
 3 3,941 - 7,880  
 4 7,881 - 14,880  
 5 14,881 - 21,880  
 6 21,881 - 31,880  
 7 31,881 - 41,220  
 8 41,221 - 54,440  
 9 54,441 - 74,660  
 10 74,661 - 104,880  
 11 104,881 - 139,220  
 12 139,221 - 189,440  
 13 189,441 - 239,660  
 14 239,661 - 290,880  
 15 290,881 - 335,000



**Robot Combat Pilot**

1 0,000 - 2,250  
 2 2,251 - 4,400  
 3 4,401 - 8,800  
 4 8,801 - 17,600  
 5 17,601 - 24,000  
 6 24,001 - 35,000  
 7 35,001 - 50,500  
 8 50,501 - 72,500  
 9 72,501 - 98,500  
 10 98,501 - 140,500  
 11 140,501 - 200,500  
 12 200,501 - 250,500  
 13 250,501 - 300,500  
 14 300,501 - 400,500  
 15 400,501 - 500,000

**Robot Pilot****Police Officer**

1 0,000 - 2,120  
 2 2,121 - 4,240  
 3 4,241 - 8,480  
 4 8,481 - 16,960  
 5 16,961 - 24,960  
 6 24,961 - 34,960  
 7 34,961 - 49,960  
 8 49,961 - 69,960  
 9 69,961 - 94,960  
 10 94,961 - 129,960  
 11 129,961 - 179,960  
 12 179,961 - 229,960  
 13 229,961 - 279,960  
 14 279,961 - 329,960  
 15 329,961 - 389,960

**Robot Soldier**

1 0,000 - 2,500  
 2 2,501 - 5,000  
 3 5,001 - 10,000  
 4 10,001 - 20,000  
 5 20,001 - 30,000  
 6 30,001 - 50,000  
 7 50,001 - 80,000  
 8 80,001 - 120,000  
 9 120,001 - 160,000  
 10 160,001 - 190,000  
 11 190,001 - 240,000  
 12 240,001 - 300,000  
 13 300,001 - 370,000  
 14 370,001 - 440,000  
 15 440,001 - 510,000

**Russian War - Knight  
Bogatyr/Hero - Knight**

1 0,000 - 2,140  
 2 2,141 - 4,280  
 3 4,281 - 8,560  
 4 8,561 - 17,520  
 5 17,521 - 25,520  
 6 25,521 - 35,520  
 7 35,521 - 52,520  
 8 52,521 - 74,000  
 9 74,001 - 100,000  
 10 100,001 - 135,200  
 11 135,201 - 190,300  
 12 190,301 - 240,400  
 13 240,401 - 290,500  
 14 290,501 - 350,600  
 15 350,601 - 420,700

**Saddle Tramp**

1 0,000 - 1,825  
 2 1,826 - 3,450  
 3 3,451 - 6,900  
 4 6,901 - 13,800  
 5 13,801 - 19,200  
 6 19,201 - 29,200  
 7 29,201 - 39,200  
 8 39,201 - 49,200  
 9 49,201 - 70,300  
 10 70,301 - 99,500  
 11 99,501 - 130,500  
 12 130,501 - 180,500  
 13 180,501 - 230,500  
 14 230,501 - 280,500  
 15 280,501 - 320,500

**Sailor**

1 0,000 - 1,880  
 2 1,881 - 3,780  
 3 3,781 - 7,260  
 4 7,261 - 14,200  
 5 14,201 - 21,000  
 6 21,001 - 31,000  
 7 31,001 - 41,000  
 8 41,001 - 52,000  
 9 52,001 - 72,000  
 10 72,001 - 102,000  
 11 102,001 - 137,000  
 12 137,001 - 187,000  
 13 187,001 - 237,000  
 14 237,001 - 287,000  
 15 287,001 - 327,000

**SAMAS Samurai Pilot**

1 0,000 - 1,925  
 2 1,926 - 3,850  
 3 3,851 - 7,450  
 4 7,451 - 14,900  
 5 14,901 - 21,000  
 6 21,001 - 31,000  
 7 31,001 - 41,600  
 8 41,601 - 53,000  
 9 53,001 - 73,000  
 10 73,001 - 103,500  
 11 103,501 - 139,000  
 12 139,001 - 189,000  
 13 189,001 - 239,000  
 14 239,001 - 289,000  
 15 289,001 - 339,000

**Sheriff's Deputy**

1 0,000 - 1,900  
 2 1,901 - 3,800  
 3 3,801 - 7,300  
 4 7,301 - 14,300  
 5 14,301 - 22,800  
 6 22,801 - 34,300  
 7 34,301 - 45,800  
 8 45,801 - 70,300  
 9 70,301 - 92,800  
 10 92,801 - 122,300  
 11 122,301 - 148,000  
 12 148,001 - 185,800  
 13 185,801 - 245,300  
 14 245,301 - 290,800  
 15 290,801 - 340,000

**Sherriff/Lawman**

1 0,000 - 2,025  
 2 2,026 - 4,050  
 3 4,051 - 8,100  
 4 8,101 - 16,300  
 5 16,301 - 25,500  
 6 25,501 - 35,700  
 7 35,701 - 50,000  
 8 50,001 - 70,200  
 9 70,201 - 95,000  
 10 95,001 - 130,000  
 11 130,001 - 180,200  
 12 180,201 - 230,000  
 13 230,001 - 280,400  
 14 280,401 - 340,500  
 15 340,501 - 400,600

**Side Kick RPA****Reloader**

1 0,000 - 1,950  
 2 1,951 - 3,900  
 3 3,901 - 7,450  
 4 7,451 - 14,600  
 5 14,601 - 21,800  
 6 21,801 - 30,200  
 7 30,201 - 40,200  
 8 40,201 - 53,200  
 9 53,201 - 73,200  
 10 73,201 - 103,200  
 11 103,201 - 138,200  
 12 138,201 - 190,000  
 13 190,001 - 242,000  
 14 242,001 - 292,000  
 15 292,001 - 352,000

**Smoke Soldier****Reaver Assassin**

1 0,000 - 2,200  
 2 2,201 - 4,400  
 3 4,401 - 8,800  
 4 8,801 - 17,600  
 5 17,601 - 27,800  
 6 27,801 - 37,900  
 7 37,901 - 55,100  
 8 55,101 - 75,200  
 9 75,201 - 100,300  
 10 100,301 - 145,500  
 11 145,501 - 190,600  
 12 190,601 - 245,700  
 13 245,701 - 295,800  
 14 295,801 - 345,900  
 15 345,901 - 415,100

**Sovietski Police****Soldati/Soldier**

1 0,000 - 1,970  
 2 1,971 - 3,940  
 3 3,941 - 7,880  
 4 7,881 - 14,880  
 5 14,881 - 21,880  
 6 21,881 - 31,880  
 7 31,881 - 41,220  
 8 41,221 - 54,440  
 9 54,441 - 74,660  
 10 74,661 - 104,880  
 11 104,881 - 139,220  
 12 139,221 - 189,440  
 13 189,441 - 239,660  
 14 239,661 - 290,880  
 15 290,881 - 335,000

**Space Pirate**

1 0,000 - 1,960  
 2 1,961 - 3,950  
 3 3,951 - 8,900  
 4 8,901 - 17,700  
 5 17,701 - 26,700  
 6 26,701 - 35,700  
 7 35,701 - 50,700  
 8 50,701 - 70,700  
 9 70,701 - 95,700  
 10 95,701 - 125,700  
 11 125,701 - 175,700  
 12 175,701 - 225,700  
 13 225,701 - 275,700  
 14 275,701 - 325,700  
 15 325,701 - 375,701

**Special Forces Soldier****Master Assassin****Bounty Hunter**

1 0,000 - 2,120  
 2 2,121 - 4,240  
 3 4,241 - 8,480  
 4 8,481 - 16,880  
 5 16,881 - 24,880  
 6 24,881 - 34,880  
 7 34,881 - 49,880  
 8 49,881 - 69,880  
 9 69,881 - 94,880  
 10 94,881 - 129,880  
 11 129,881 - 179,880  
 12 179,881 - 229,880  
 13 229,881 - 279,880  
 14 279,881 - 329,880  
 15 329,881 - 389,880

**Tandori Assassin R.C.C.**

1 0,000 - 2,600  
 2 2,601 - 5,200  
 3 5,201 - 10,500  
 4 10,501 - 21,200  
 5 21,201 - 32,300  
 6 32,301 - 47,400  
 7 47,401 - 62,500  
 8 62,501 - 88,000  
 9 88,001 - 112,000  
 10 112,001 - 163,000  
 11 163,001 - 222,000  
 12 222,001 - 295,000  
 13 295,001 - 395,000  
 14 395,001 - 495,000  
 15 495,001 - 595,000

**Templar Knights**

1 0,000 - 2,100  
 2 2,101 - 4,200  
 3 4,201 - 8,400  
 4 8,401 - 16,800  
 5 16,801 - 25,000  
 6 25,001 - 35,000  
 7 35,001 - 50,000  
 8 50,001 - 70,000  
 9 70,001 - 95,000  
 10 95,001 - 130,000  
 11 130,001 - 180,000  
 12 180,001 - 234,000  
 13 234,001 - 285,000  
 14 285,001 - 345,000  
 15 345,001 - 410,000

**The Slayer**

1 0,000 - 2,100  
 2 2,101 - 4,200  
 3 4,201 - 8,400  
 4 8,401 - 16,800  
 5 16,801 - 25,000  
 6 25,001 - 35,000  
 7 35,001 - 50,000  
 8 50,001 - 70,000  
 9 70,001 - 95,000  
 10 95,001 - 130,000  
 11 130,001 - 180,000  
 12 180,001 - 234,000  
 13 234,001 - 285,000  
 14 285,001 - 345,000  
 15 345,001 - 410,000

**Tribal Warrior**

1 0,000 - 1,900  
 2 1,901 - 3,800  
 3 3,801 - 7,300  
 4 7,301 - 14,300  
 5 14,301 - 21,000  
 6 21,001 - 30,000  
 7 30,001 - 40,000  
 8 40,001 - 53,000  
 9 53,001 - 73,000  
 10 73,001 - 103,000  
 11 103,001 - 138,000  
 12 138,001 - 188,000  
 13 188,001 - 238,000  
 14 238,001 - 288,000  
 15 288,001 - 328,000

**True Samurai**

1 0,000 - 2,150  
 2 2,151 - 4,300  
 3 4,301 - 8,600  
 4 8,601 - 17,200  
 5 17,201 - 25,500  
 6 25,501 - 36,000  
 7 36,001 - 52,000  
 8 52,001 - 73,000  
 9 73,001 - 98,000  
 10 98,001 - 134,000  
 11 134,001 - 184,000  
 12 184,001 - 240,000  
 13 240,001 - 295,000  
 14 295,001 - 385,000  
 15 385,001 - 450,000

**Tundra Ranger****Headhunter Techno - Hound**

1 0,000 - 2,050  
 2 2,051 - 4,100  
 3 4,101 - 8,250  
 4 8,251 - 16,500  
 5 16,501 - 24,600  
 6 24,601 - 34,700  
 7 34,701 - 49,800  
 8 49,801 - 69,900  
 9 69,901 - 95,000  
 10 95,001 - 130,000  
 11 130,001 - 180,200  
 12 180,201 - 230,000  
 13 230,001 - 280,400  
 14 280,401 - 340,500  
 15 340,501 - 400,600

**Tundra Ranger Scout**

1 0,000 - 1,925  
 2 1,926 - 3,850  
 3 3,851 - 7,450  
 4 7,451 - 15,000  
 5 15,001 - 21,500  
 6 21,501 - 31,500  
 7 31,501 - 41,500  
 8 41,501 - 54,000  
 9 54,001 - 75,000  
 10 75,001 - 105,000  
 11 105,001 - 140,000  
 12 140,001 - 190,000  
 13 190,001 - 240,000  
 14 240,001 - 300,000  
 15 300,001 - 350,000

**TVIA Agent, CAF Fleet Officer****Imperial Legionnaire**

1 0,000 - 2,100  
 2 2,101 - 4,200  
 3 4,201 - 8,400  
 4 8,401 - 17,200  
 5 17,201 - 25,400  
 6 25,401 - 35,800  
 7 35,801 - 51,000  
 8 51,001 - 71,200  
 9 71,201 - 96,400  
 10 96,401 - 131,600  
 11 131,601 - 181,800  
 12 181,801 - 232,000  
 13 232,001 - 282,200  
 14 282,201 - 342,400  
 15 342,401 - 402,600

**Warlock Marine**

1 0,000 - 2,100  
 2 2,101 - 4,200  
 3 4,201 - 8,400  
 4 8,401 - 17,200  
 5 17,201 - 25,400  
 6 25,401 - 35,800  
 7 35,801 - 51,000  
 8 51,001 - 71,200  
 9 71,201 - 96,400  
 10 96,401 - 131,600  
 11 131,601 - 181,800  
 12 181,801 - 232,000  
 13 232,001 - 282,200  
 14 282,201 - 342,400  
 15 342,401 - 402,600

**Psychics****Burster****Psi - Stalker**

1 0,000 - 2,050  
 2 2,051 - 4,100  
 3 4,101 - 8,250  
 4 8,251 - 16,500  
 5 16,501 - 24,600  
 6 24,601 - 34,700  
 7 34,701 - 49,800  
 8 49,801 - 69,900  
 9 69,901 - 95,000  
 10 95,001 - 130,100  
 11 130,101 - 180,200  
 12 180,201 - 230,300  
 13 230,301 - 280,400  
 14 280,401 - 340,500  
 15 340,501 - 400,600

**Ecto - Traveler**

1 0,000 - 2,500  
 2 2,501 - 5,000  
 3 5,001 - 10,000  
 4 10,001 - 20,000  
 5 20,001 - 30,000  
 6 30,001 - 50,000  
 7 50,001 - 80,000  
 8 80,001 - 120,000  
 9 120,001 - 160,000  
 10 160,001 - 190,000  
 11 190,001 - 240,000  
 12 240,001 - 300,000  
 13 300,001 - 370,000  
 14 370,001 - 440,000  
 15 440,001 - 510,000

**ESP Specialist**

1 0,000 - 2,100  
 2 2,101 - 4,200  
 3 4,201 - 8,400  
 4 8,401 - 17,200  
 5 17,201 - 25,400  
 6 25,401 - 35,800  
 7 35,801 - 51,000  
 8 51,001 - 71,200  
 9 71,201 - 96,400  
 10 96,401 - 131,600  
 11 131,601 - 181,800  
 12 181,801 - 232,000  
 13 232,001 - 282,200  
 14 282,201 - 342,400  
 15 342,401 - 402,400

**Gypsy - The Gifted**

1 0,000 - 2,050  
 2 2,051 - 4,100  
 3 4,101 - 8,250  
 4 8,251 - 16,500  
 5 16,501 - 24,600  
 6 24,601 - 34,700  
 7 34,701 - 49,800  
 8 49,801 - 69,900  
 9 69,901 - 95,000  
 10 95,001 - 130,000  
 11 130,001 - 180,200  
 12 180,201 - 230,000  
 13 230,001 - 280,400  
 14 280,401 - 340,500  
 15 340,501 - 400,600

**Mind Bleeder**

1 0,000 - 2,130  
 2 2,131 - 4,260  
 3 4,261 - 8,580  
 4 8,581 - 17,160  
 5 17,161 - 24,910  
 6 24,911 - 34,190  
 7 34,191 - 49,290  
 8 49,291 - 67,390  
 9 67,391 - 93,490  
 10 93,491 - 131,590  
 11 131,591 - 182,690  
 12 182,691 - 225,790  
 13 225,791 - 272,890  
 14 272,891 - 333,190  
 15 333,191 - 399,690

**Mind Melter**

1 0,000 - 2,240  
 2 2,241 - 4,480  
 3 4,481 - 8,960  
 4 8,961 - 17,920  
 5 17,921 - 25,920  
 6 25,921 - 35,920  
 7 35,921 - 50,920  
 8 50,921 - 70,920  
 9 70,921 - 95,920  
 10 95,921 - 135,920  
 11 135,921 - 185,920  
 12 185,921 - 225,920  
 13 225,921 - 275,920  
 14 275,921 - 335,920  
 15 335,921 - 395,920

**Psi - Druid****Psi - Ghost**

1 0,000 - 2,060  
 2 2,061 - 4,160  
 3 4,161 - 8,520  
 4 8,521 - 16,900  
 5 16,901 - 25,600  
 6 25,601 - 35,900  
 7 35,901 - 50,500  
 8 50,501 - 70,900  
 9 70,901 - 95,500  
 10 95,501 - 130,900  
 11 130,901 - 190,500  
 12 190,501 - 240,900  
 13 240,901 - 290,500  
 14 290,501 - 350,900  
 15 350,901 - 400,500

**Psi - Nullifier****Psi - Warrior**

1 0,000 - 2,120  
 2 2,121 - 4,240  
 3 4,241 - 8,480  
 4 8,481 - 16,960  
 5 16,961 - 24,960  
 6 24,961 - 34,960  
 7 34,961 - 49,960  
 8 49,961 - 69,960  
 9 69,961 - 94,960  
 10 94,961 - 129,960  
 11 129,961 - 179,960  
 12 179,961 - 229,960  
 13 229,961 - 279,960  
 14 279,961 - 329,960  
 15 329,961 - 389,960

**Psi - Tech****Nega-Psychic, Zapper**

1 0,000 - 2,100  
 2 2,101 - 4,200  
 3 4,201 - 8,400  
 4 8,401 - 17,200  
 5 17,201 - 25,400  
 6 25,401 - 35,800  
 7 35,801 - 51,000  
 8 51,001 - 71,200  
 9 71,201 - 96,400  
 10 96,401 - 131,600  
 11 131,601 - 181,800  
 12 181,801 - 232,000  
 13 232,001 - 282,200  
 14 282,201 - 342,400  
 15 342,401 - 402,600

**Pucara Mind Mage**

1 0,000 - 2,050  
 2 2,051 - 4,100  
 3 4,101 - 8,250  
 4 8,251 - 16,500  
 5 16,501 - 24,600  
 6 24,601 - 34,700  
 7 34,701 - 49,800  
 8 49,801 - 69,900  
 9 69,901 - 95,000  
 10 95,001 - 130,100  
 11 130,101 - 180,200  
 12 180,201 - 230,300  
 13 230,301 - 280,400  
 14 280,401 - 340,500  
 15 340,501 - 400,600

**Scholars & Adventurers****Atlantean Vagabond**

1 0,000 - 1,900  
 2 1,901 - 3,600  
 3 3,601 - 7,200  
 4 7,201 - 14,400  
 5 14,401 - 24,500  
 6 24,501 - 35,000  
 7 35,001 - 45,000  
 8 45,001 - 65,000  
 9 65,001 - 85,000  
 10 85,001 - 115,000  
 11 115,001 - 145,000  
 12 145,001 - 185,000  
 13 185,001 - 250,000  
 14 250,001 - 310,000  
 15 310,001 - 375,000

**Average Outbacker**

**Merchant Trader**  
 1 0,000 - 1,875  
 2 1,876 - 3,750  
 3 3,751 - 7,250  
 4 7,251 - 14,100  
 5 14,101 - 21,200  
 6 21,201 - 31,200  
 7 31,201 - 41,200  
 8 41,201 - 51,200  
 9 51,201 - 71,200  
 10 71,201 - 101,500  
 11 101,501 - 136,500  
 12 136,501 - 186,500  
 13 186,501 - 236,500  
 14 236,501 - 286,500  
 15 286,501 - 326,500

**Body Fixer**

1 0,000 - 1,925  
 2 1,926 - 3,850  
 3 3,851 - 7,450  
 4 7,451 - 14,900  
 5 14,901 - 21,000  
 6 21,001 - 31,000  
 7 31,001 - 41,600  
 8 41,601 - 53,000  
 9 53,001 - 73,000  
 10 73,001 - 103,500  
 11 103,501 - 139,000  
 12 139,001 - 189,000  
 13 189,001 - 239,000  
 14 239,001 - 289,000  
 15 289,001 - 339,000

**Bushranger**

**Runabout**  
 1 0,000 - 1,925  
 2 1,926 - 3,850  
 3 3,851 - 7,450  
 4 7,451 - 15,000  
 5 15,001 - 21,500  
 6 21,501 - 31,500  
 7 31,501 - 41,500  
 8 41,501 - 54,000  
 9 54,001 - 75,000  
 10 75,001 - 105,000  
 11 105,001 - 140,000  
 12 140,001 - 190,000  
 13 190,001 - 240,000  
 14 240,001 - 300,000  
 15 300,001 - 350,000

**CAF Scientist**

1 0,000 - 2,000  
 2 2,001 - 4,000  
 3 4,001 - 8,300  
 4 8,301 - 16,500  
 5 16,501 - 25,000  
 6 25,001 - 35,000  
 7 35,001 - 50,000  
 8 50,001 - 70,000  
 9 70,001 - 95,000  
 10 95,001 - 130,000  
 11 130,001 - 180,000  
 12 180,001 - 230,000  
 13 230,001 - 280,000  
 14 280,001 - 330,000  
 15 330,001 - 390,000

**City Administrator**

**Cyber - Specter**  
 1 0,000 - 2,140  
 2 2,141 - 4,280  
 3 4,281 - 8,560  
 4 8,561 - 17,520  
 5 17,521 - 25,520  
 6 25,521 - 35,520  
 7 35,521 - 50,520  
 8 50,521 - 71,000  
 9 71,001 - 96,100  
 10 96,101 - 131,200  
 11 131,201 - 181,300  
 12 181,301 - 231,400  
 13 231,401 - 281,500  
 14 281,501 - 341,600  
 15 341,601 - 400,700

**City Rat**

**Vagabond**  
 1 0,000 - 1,875  
 2 1,876 - 3,750  
 3 3,751 - 7,250  
 4 7,251 - 14,100  
 5 14,101 - 21,200  
 6 21,201 - 31,200  
 7 31,201 - 41,200  
 8 41,201 - 51,200  
 9 51,201 - 71,200  
 10 71,201 - 101,500  
 11 101,501 - 136,500  
 12 136,501 - 186,500  
 13 186,501 - 236,500  
 14 236,501 - 286,500  
 15 286,501 - 326,500

**City Trader**

**Naval Sailor**  
 1 0,000 - 1,925  
 2 2,001 - 4,000  
 3 4,001 - 8,200  
 4 8,201 - 16,400  
 5 16,401 - 24,500  
 6 24,501 - 34,600  
 7 34,601 - 49,700  
 8 49,701 - 69,800  
 9 69,801 - 94,900  
 10 94,901 - 129,000  
 11 129,001 - 179,100  
 12 179,101 - 229,200  
 13 229,201 - 279,300  
 14 279,301 - 329,400  
 15 329,401 - 389,500

**Cowboy, Average Citizen**

1 0,000 - 1,900  
 2 1,901 - 3,800  
 3 3,801 - 7,300  
 4 7,301 - 14,300  
 5 14,301 - 21,300  
 6 21,301 - 30,000  
 7 30,001 - 40,000  
 8 40,001 - 53,000  
 9 53,001 - 73,000  
 10 73,001 - 103,000  
 11 103,001 - 138,000  
 12 138,001 - 188,000  
 13 188,001 - 238,000  
 14 238,001 - 288,000  
 15 288,001 - 328,000

**Cyber - Doc**

**Rogue Scholar**  
**Rogue Scientist**  
 1 0,000 - 2,000  
 2 2,001 - 4,000  
 3 4,001 - 8,200  
 4 8,201 - 16,400  
 5 16,401 - 24,500  
 6 24,501 - 34,600  
 7 34,601 - 49,700  
 8 49,701 - 69,800  
 9 69,801 - 94,900  
 10 94,901 - 129,000  
 11 129,001 - 179,100  
 12 179,101 - 229,200  
 13 229,201 - 279,300  
 14 279,301 - 329,400  
 15 329,401 - 389,500

**Cyberoid**

1 0,000 - 1,950  
 2 1,951 - 3,900  
 3 3,901 - 8,800  
 4 8,801 - 17,600  
 5 17,601 - 35,600  
 6 35,601 - 50,600  
 7 50,601 - 70,600  
 8 70,601 - 95,600  
 9 95,601 - 125,600  
 10 125,601 - 175,600  
 11 175,601 - 225,600  
 12 225,601 - 275,600  
 13 275,601 - 325,600  
 14 325,601 - 375,600  
 15 375,601 - 425,600

**Explorer**

1 0,000 - 1,925  
 2 1,926 - 3,850  
 3 3,851 - 7,450  
 4 7,451 - 15,000  
 5 15,001 - 21,500  
 6 21,501 - 31,500  
 7 30,501 - 41,500  
 8 41,501 - 54,000  
 9 54,001 - 75,000  
 10 75,001 - 105,000  
 11 105,001 - 140,000  
 12 140,001 - 190,000  
 13 190,001 - 240,000  
 14 240,001 - 300,000  
 15 300,001 - 350,000

**Freelance Spy**

**Smuggler**  
**Thief**  
 1 0,000 - 2,110  
 2 2,111 - 4,220  
 3 4,221 - 8,440  
 4 8,441 - 16,880  
 5 16,881 - 24,880  
 6 24,881 - 34,880  
 7 34,881 - 49,880  
 8 49,881 - 69,880  
 9 69,881 - 94,880  
 10 94,881 - 129,880  
 11 129,881 - 179,880  
 12 179,881 - 229,880  
 13 229,881 - 279,880  
 14 279,881 - 329,880  
 15 329,881 - 389,880

**Gambler**

1 0,000 - 1,875  
 2 1,876 - 3,750  
 3 3,751 - 7,250  
 4 7,251 - 14,100  
 5 14,101 - 21,200  
 6 21,201 - 31,200  
 7 31,201 - 41,200  
 8 41,201 - 51,200  
 9 51,201 - 71,200  
 10 71,201 - 101,500  
 11 101,501 - 136,500  
 12 136,501 - 186,500  
 13 186,501 - 236,500  
 14 236,501 - 286,500  
 15 286,501 - 326,500

**Gaicho**

1 0,000 - 1,900  
 2 1,901 - 3,800  
 3 3,801 - 7,300  
 4 7,301 - 14,300  
 5 14,301 - 21,000  
 6 21,001 - 30,000  
 7 30,001 - 40,000  
 8 40,001 - 53,000  
 9 53,001 - 73,000  
 10 73,001 - 103,000  
 11 103,001 - 138,000  
 12 138,001 - 188,000  
 13 188,001 - 238,000  
 14 238,001 - 288,000  
 15 288,001 - 328,000

**Gypsy Layer of Laws**

1 0,000 - 2,100  
 2 2,101 - 4,200  
 3 4,201 - 8,400  
 4 8,401 - 16,800  
 5 16,801 - 25,000  
 6 25,001 - 35,000  
 7 35,001 - 50,000  
 8 50,001 - 70,000  
 9 70,001 - 95,000  
 10 95,001 - 130,000  
 11 130,001 - 180,000  
 12 180,001 - 234,000  
 13 234,001 - 285,000  
 14 285,001 - 345,000  
 15 345,001 - 410,000

**Gypsy Thief**

1 0,000 - 1,900  
 2 1,901 - 3,800  
 3 3,801 - 7,300  
 4 7,301 - 14,300  
 5 14,301 - 21,000  
 6 21,001 - 30,000  
 7 30,001 - 40,000  
 8 40,001 - 53,000  
 9 53,001 - 73,000  
 10 73,001 - 103,000  
 11 103,001 - 138,000  
 12 138,001 - 188,000  
 13 188,001 - 238,000  
 14 238,001 - 288,000  
 15 288,001 - 330,000

**Jackaroo****Sportsman**

1 0,000 - 1,970  
 2 1,971 - 3,940  
 3 3,941 - 7,880  
 4 7,881 - 14,880  
 5 14,881 - 21,880  
 6 21,881 - 31,880  
 7 31,881 - 41,220  
 8 41,221 - 54,440  
 9 54,441 - 74,660  
 10 74,661 - 104,880  
 11 104,881 - 139,220  
 12 139,221 - 189,440  
 13 189,441 - 239,660  
 14 239,661 - 290,880  
 15 290,881 - 335,000

**Merchant Marine**

1 0,000 - 2,000  
 2 2,001 - 4,000  
 3 4,001 - 8,200  
 4 8,201 - 16,400  
 5 16,401 - 24,500  
 6 24,501 - 34,600  
 7 34,601 - 49,700  
 8 49,701 - 69,800  
 9 69,801 - 94,900  
 10 94,901 - 129,000  
 11 129,001 - 179,100  
 12 179,101 - 229,200  
 13 229,201 - 279,300  
 14 279,301 - 329,400  
 15 329,401 - 389,500

**Mining 'Borgs**

1 0,000 - 2,100  
 2 2,101 - 4,200  
 3 4,201 - 8,400  
 4 8,401 - 17,200  
 5 17,201 - 25,400  
 6 25,401 - 35,800  
 7 35,801 - 51,000  
 8 51,001 - 71,200  
 9 71,201 - 96,400  
 10 96,401 - 131,600  
 11 131,601 - 181,800  
 12 181,801 - 232,000  
 13 232,001 - 282,200  
 14 282,201 - 342,400  
 15 342,401 - 402,600

**Monk**

1 0,000 - 2,200  
 2 2,201 - 4,400  
 3 4,401 - 8,800  
 4 8,801 - 17,600  
 5 17,601 - 24,000  
 6 24,001 - 35,000  
 7 35,001 - 50,500  
 8 50,501 - 72,500  
 9 72,501 - 98,500  
 10 98,501 - 140,500  
 11 140,501 - 200,500  
 12 200,501 - 250,500  
 13 250,501 - 300,500  
 14 300,501 - 400,500  
 15 400,501 - 500,000

**Navy Seaman****Salvage Expert**

1 0,000 - 1,925  
 2 1,926 - 3,850  
 3 3,851 - 7,450  
 4 7,451 - 15,000  
 5 15,001 - 21,500  
 6 21,501 - 31,500  
 7 30,501 - 41,500  
 8 41,501 - 54,000  
 9 54,001 - 75,000  
 10 75,001 - 105,000  
 11 105,001 - 140,000  
 12 140,001 - 190,000  
 13 190,001 - 240,000  
 14 240,001 - 300,000  
 15 300,001 - 350,000

**Ordinary Seeron Human**

1 0,000 - 2,000  
 2 2,001 - 4,000  
 3 4,001 - 8,200  
 4 8,201 - 16,400  
 5 16,401 - 24,500  
 6 24,501 - 34,600  
 7 34,601 - 49,700  
 8 49,701 - 69,800  
 9 69,801 - 94,900  
 10 94,901 - 129,000  
 11 129,001 - 179,100  
 12 179,101 - 229,200  
 13 229,201 - 279,300  
 14 279,301 - 329,400  
 15 329,401 - 389,500

**Preacher (either)**

1 0,000 - 1,825  
 2 1,826 - 3,450  
 3 3,451 - 6,900  
 4 6,901 - 13,800  
 5 13,801 - 19,200  
 6 19,201 - 29,200  
 7 29,201 - 39,200  
 8 39,201 - 49,200  
 9 49,201 - 70,300  
 10 70,301 - 99,500  
 11 99,501 - 130,500  
 12 130,501 - 180,500  
 13 180,501 - 230,500  
 14 230,501 - 280,500  
 15 280,501 - 320,500

**Professional Gambler****Professional Thief****Smuggler**

1 0,000 - 2,110  
 2 2,111 - 4,220  
 3 4,221 - 8,440  
 4 8,401 - 16,400  
 5 16,401 - 23,200  
 6 23,201 - 32,400  
 7 32,401 - 48,200  
 8 48,201 - 68,400  
 9 68,401 - 92,200  
 10 92,201 - 127,400  
 11 127,401 - 178,200  
 12 178,201 - 228,400  
 13 228,201 - 278,200  
 14 278,201 - 328,400  
 15 328,401 - 388,200

**Raider, Technologist****Guide/Scout/Hunter****Bushman**

1 0,000 - 2,050  
 2 2,051 - 4,100  
 3 4,101 - 8,250  
 4 8,251 - 16,500  
 5 16,501 - 24,600  
 6 24,601 - 34,700  
 7 34,701 - 49,800  
 8 49,801 - 69,900  
 9 69,901 - 95,000  
 10 95,001 - 130,000  
 11 130,001 - 180,200  
 12 180,201 - 230,000  
 13 230,001 - 280,400  
 14 280,401 - 340,500  
 15 340,501 - 400,600

**Runner**

1 0,000 - 2,100  
 2 2,101 - 4,200  
 3 4,201 - 8,400  
 4 8,401 - 17,200  
 5 17,201 - 25,400  
 6 25,401 - 35,800  
 7 35,801 - 51,000  
 8 51,001 - 71,200  
 9 71,201 - 96,400  
 10 96,401 - 131,600  
 11 131,601 - 181,800  
 12 181,801 - 232,000  
 13 232,001 - 282,200  
 14 282,201 - 342,400  
 15 342,401 - 402,600

**Russian Hunter/Trapper****Mechanized Cavalry**

1 0,000 - 2,050  
 2 2,051 - 4,100  
 3 4,101 - 8,250  
 4 8,251 - 16,500  
 5 18,501 - 24,600  
 6 24,601 - 34,700  
 7 34,701 - 49,800  
 8 49,801 - 69,900  
 9 69,901 - 95,000  
 10 95,001 - 130,000  
 11 130,001 - 180,200  
 12 180,201 - 230,000  
 13 230,001 - 280,400  
 14 280,401 - 340,500  
 15 340,501 - 400,600

**Safecracker****Super-Spy****Forger**

1 0,000 - 2,200  
 2 2,201 - 4,400  
 3 4,401 - 8,800  
 4 8,801 - 17,600  
 5 17,601 - 25,600  
 6 25,601 - 35,600  
 7 35,601 - 50,600  
 8 50,601 - 70,600  
 9 70,601 - 95,600  
 10 95,601 - 130,600  
 11 130,601 - 180,600  
 12 180,601 - 230,600  
 13 230,601 - 280,600  
 14 280,601 - 330,600  
 15 330,601 - 390,600

**Saloon Bum****Saloon Girl**

1 0,000 - 1,875  
 2 1,876 - 3,750  
 3 3,751 - 7,250  
 4 7,251 - 14,100  
 5 14,101 - 21,200  
 6 21,201 - 31,200  
 7 31,201 - 41,200  
 8 41,201 - 51,200  
 9 51,201 - 71,200  
 10 71,201 - 101,500  
 11 101,501 - 136,500  
 12 136,501 - 186,500  
 13 186,501 - 236,500  
 14 236,501 - 286,500  
 15 286,501 - 326,500

**Sea Wolf**

1 0,000 - 2,100  
 2 2,101 - 4,200  
 3 4,201 - 8,400  
 4 8,401 - 16,800  
 5 16,801 - 25,000  
 6 25,001 - 35,000  
 7 35,001 - 50,000  
 8 50,001 - 70,000  
 9 70,001 - 95,000  
 10 95,001 - 130,000  
 11 130,001 - 180,000  
 12 180,001 - 234,000  
 13 234,001 - 285,000  
 14 285,001 - 345,000  
 15 345,001 - 410,000

**Spacer****Colonist**

1 0,000 - 1,900  
 2 1,901 - 3,800  
 3 3,801 - 7,300  
 4 7,301 - 14,300  
 5 14,301 - 21,000  
 6 21,001 - 30,000  
 7 30,001 - 40,000  
 8 40,001 - 53,000  
 9 53,001 - 73,000  
 10 73,001 - 103,000  
 11 103,001 - 138,000  
 12 138,001 - 188,000  
 13 188,001 - 238,000  
 14 238,001 - 288,000  
 15 288,001 - 328,000

**Story Teller****Priest****Warlord Cyber - Doc**

1 0,000 - 2,000  
 2 2,001 - 4,000  
 3 4,001 - 8,200  
 4 8,201 - 16,400  
 5 16,401 - 24,500  
 6 24,501 - 34,600  
 7 34,601 - 49,700  
 8 49,701 - 69,800  
 9 69,801 - 94,900  
 10 94,901 - 129,000  
 11 129,001 - 179,100  
 12 179,101 - 229,200  
 13 229,201 - 279,300  
 14 279,301 - 329,400  
 15 329,401 - 389,500

**Trapper - Woodsman**

1 0,000 - 2,050  
 2 2,051 - 4,100  
 3 4,101 - 8,250  
 4 8,251 - 16,500  
 5 16,501 - 24,600  
 6 24,601 - 34,700  
 7 34,701 - 49,800  
 8 49,801 - 69,900  
 9 69,901 - 95,000  
 10 95,001 - 130,000  
 11 130,001 - 180,200  
 12 180,201 - 230,000  
 13 230,001 - 280,400  
 14 280,401 - 340,500  
 15 340,501 - 400,600

**Tritonian Scientist**

1 0,000 - 1,970  
 2 1,971 - 3,940  
 3 3,941 - 7,880  
 4 7,881 - 14,880  
 5 14,881 - 21,880  
 6 21,881 - 31,880  
 7 31,881 - 41,220  
 8 41,221 - 54,440  
 9 54,441 - 74,660  
 10 74,661 - 104,880  
 11 104,881 - 139,220  
 12 139,221 - 189,440  
 13 189,441 - 239,660  
 14 239,661 - 290,880  
 15 290,881 - 335,000

**Turbo-Jockey**

1 0,000 - 2,100  
 2 2,101 - 4,200  
 3 4,201 - 8,400  
 4 8,401 - 17,200  
 5 17,201 - 25,400  
 6 25,401 - 35,800  
 7 35,801 - 51,000  
 8 51,001 - 71,200  
 9 71,201 - 96,400  
 10 96,401 - 131,600  
 11 131,601 - 181,800  
 12 181,801 - 232,000  
 13 232,001 - 282,200  
 14 282,201 - 342,400  
 15 342,401 - 402,600

**Villager**

1 0,000 - 1,875  
 2 1,876 - 3,750  
 3 3,751 - 7,250  
 4 7,251 - 14,100  
 5 14,101 - 21,200  
 6 21,201 - 31,200  
 7 31,201 - 41,200  
 8 41,201 - 51,200  
 9 51,201 - 71,200  
 10 71,201 - 101,500  
 11 101,501 - 136,500  
 12 136,501 - 186,500  
 13 186,501 - 236,500  
 14 236,501 - 286,500  
 15 286,501 - 326,500

**Wilderness Scout****Operator**

1 0,000 - 1,900  
 2 1,901 - 3,800  
 3 3,801 - 7,300  
 4 7,301 - 14,300  
 5 14,301 - 21,000  
 6 21,001 - 30,000  
 7 30,001 - 40,000  
 8 40,001 - 53,000  
 9 53,001 - 73,000  
 10 73,001 - 103,000  
 11 103,001 - 138,000  
 12 138,001 - 188,000  
 13 188,001 - 238,000  
 14 238,001 - 288,000  
 15 288,001 - 328,000

**Worldly Sasquatch**

1 0,000 - 1,925  
 2 1,926 - 3,850  
 3 3,851 - 7,450  
 4 7,451 - 15,000  
 5 15,001 - 21,500  
 6 21,501 - 31,500  
 7 31,501 - 41,500  
 8 41,501 - 54,000  
 9 54,001 - 75,000  
 10 75,001 - 105,000  
 11 105,001 - 140,000  
 12 140,001 - 190,000  
 13 190,001 - 240,000  
 14 240,001 - 300,000  
 15 300,001 - 350,000

**R.C.C.s****Agogwe & Crocodillians**

1 0,000 - 1,825  
 2 1,826 - 3,450  
 3 3,451 - 6,900  
 4 6,901 - 13,800  
 5 13,801 - 19,200  
 6 19,201 - 29,200  
 7 29,201 - 39,200  
 8 39,201 - 49,200  
 9 49,201 - 70,300  
 10 70,301 - 99,500  
 11 99,501 - 130,500  
 12 130,501 - 180,500  
 13 180,501 - 230,500  
 14 230,501 - 280,500  
 15 280,501 - 320,500

**Amorph****Psi-Slayer****Yhabbayar Bubblemaker**

1 0,000 - 2,200  
 2 2,201 - 4,400  
 3 4,401 - 8,800  
 4 8,801 - 17,600  
 5 17,601 - 27,800  
 6 27,801 - 37,900  
 7 37,901 - 55,100  
 8 55,101 - 75,200  
 9 75,201 - 100,300  
 10 100,301 - 145,500  
 11 145,501 - 190,600  
 12 190,601 - 245,700  
 13 245,701 - 295,800  
 14 295,801 - 345,900  
 15 345,901 - 415,100

**Amphib**

1 0,000 - 1,970  
 2 1,971 - 3,940  
 3 3,941 - 7,880  
 4 7,881 - 14,880  
 5 14,881 - 21,880  
 6 21,881 - 31,880  
 7 31,881 - 41,220  
 8 41,221 - 54,440  
 9 54,441 - 74,660  
 10 74,661 - 104,880  
 11 104,881 - 139,220  
 12 139,221 - 189,440  
 13 189,441 - 239,660  
 14 239,661 - 290,880  
 15 290,881 - 335,000

**Ancient-Inca Undead**

1 0,000 - 5,000  
 2 5,001 - 10,000  
 3 10,001 - 20,000  
 4 20,001 - 40,000  
 5 40,001 - 80,000  
 6 80,001 - 120,000  
 7 120,001 - 160,000  
 8 160,001 - 200,000  
 9 200,001 - 250,000  
 10 250,001 - 300,000  
 11 300,001 - 400,000  
 12 400,001 - 500,000  
 13 500,001 - 600,000  
 14 600,001 - 1 Million  
 15 1 Million - 2 Million

**Anti-Monster****Amazon**

1 0,000 - 2,600  
 2 2,601 - 5,000  
 3 5,001 - 9,000  
 4 9,001 - 18,000  
 5 18,001 - 25,000  
 6 25,001 - 35,000  
 7 35,001 - 60,000  
 8 60,001 - 85,000  
 9 85,001 - 100,000  
 10 100,001 - 150,000  
 11 150,001 - 200,000  
 12 200,001 - 270,000  
 13 270,001 - 370,000  
 14 370,001 - 470,000  
 15 470,001 - 670,000

**Apok**

1 0,000 - 2,200  
 2 2,201 - 4,400  
 3 4,401 - 9,000  
 4 9,001 - 19,000  
 5 19,001 - 28,000  
 6 28,001 - 40,000  
 7 40,001 - 60,000  
 8 60,001 - 80,000  
 9 80,001 - 100,000  
 10 100,001 - 150,000  
 11 150,001 - 200,000  
 12 200,001 - 275,000  
 13 275,001 - 350,000  
 14 350,001 - 425,000  
 15 425,001 - 525,000

**Arkhon****Amaki Stone Man**

1 0,000 - 2,120  
 2 2,121 - 4,280  
 3 4,281 - 8,480  
 4 8,481 - 16,960  
 5 16,961 - 24,960  
 6 24,961 - 34,960  
 7 34,961 - 49,960  
 8 49,961 - 69,960  
 9 69,961 - 94,960  
 10 94,961 - 129,960  
 11 129,961 - 179,960  
 12 179,961 - 229,960  
 13 229,961 - 279,960  
 14 279,961 - 329,960  
 15 329,961 - 389,960

**Asgardian Dwarves****Berserkers****Warriors of Valhalla**

1 0,000 - 2,200  
 2 2,201 - 4,400  
 3 4,401 - 9,000  
 4 9,001 - 19,000  
 5 19,001 - 28,000  
 6 28,001 - 40,000  
 7 40,001 - 60,000  
 8 60,001 - 80,000  
 9 80,001 - 100,000  
 10 100,001 - 150,000  
 11 150,001 - 200,000  
 12 200,001 - 275,000  
 13 275,001 - 350,000  
 14 350,001 - 425,000  
 15 425,001 - 525,000

**Azverkan Knight****Ugakwa Explorer**

1 0,000 - 2,150  
 2 2,151 - 4,300  
 3 4,301 - 8,600  
 4 8,601 - 18,600  
 5 18,601 - 26,600  
 6 26,601 - 36,600  
 7 36,601 - 54,600  
 8 54,601 - 75,600  
 9 75,601 - 99,600  
 10 99,601 - 135,600  
 11 135,601 - 185,600  
 12 185,601 - 240,600  
 13 240,601 - 290,600  
 14 290,601 - 343,600  
 15 343,601 - 423,600

**"Beast" Intruder**

1 0,000 - 2,600  
 2 2,601 - 5,000  
 3 5,001 - 10,000  
 4 10,001 - 20,000  
 5 20,001 - 30,000  
 6 30,001 - 39,000  
 7 39,001 - 52,000  
 8 52,001 - 70,000  
 9 70,001 - 100,000  
 10 100,001 - 140,000  
 11 140,001 - 190,000  
 12 190,001 - 240,000  
 13 240,001 - 290,000  
 14 290,001 - 350,000  
 15 350,001 - 520,000

**Bio-Freak****Glinerach****Dreadmaster**

1 0,000 - 2,240  
 2 2,241 - 4,480  
 3 4,481 - 8,960  
 4 8,961 - 17,920  
 5 17,921 - 25,920  
 6 25,921 - 35,920  
 7 35,921 - 50,920  
 8 50,921 - 70,920  
 9 70,921 - 95,920  
 10 95,921 - 135,920  
 11 135,921 - 185,920  
 12 185,921 - 225,920  
 13 225,921 - 275,920  
 14 275,921 - 335,920  
 15 335,921 - 395,920

**Black-Winged Monster Men**

1 0,000 - 2,600  
 2 2,601 - 5,200  
 3 5,201 - 10,500  
 4 10,501 - 21,200  
 5 21,201 - 32,300  
 6 32,301 - 47,400  
 7 47,401 - 62,500  
 8 62,501 - 88,000  
 9 88,001 - 112,000  
 10 112,001 - 163,000  
 11 163,001 - 222,000  
 12 222,001 - 295,000  
 13 295,001 - 395,000  
 14 395,001 - 495,000  
 15 495,001 - 595,000

**Blhaze Alien (modified****Mega-Hero Energy being!)**

1 0,000 - 3,000  
 2 3,001 - 6,000  
 3 6,001 - 10,000  
 4 10,001 - 20,000  
 5 20,001 - 35,000  
 6 35,001 - 50,000  
 7 50,001 - 75,000  
 8 75,001 - 100,000  
 9 100,001 - 150,000  
 10 150,001 - 200,000  
 11 200,001 - 275,000  
 12 275,001 - 350,000  
 13 350,001 - 425,000  
 14 425,001 - 500,000  
 15 500,001 - 575,000  
 16 575,001 - 650,000  
 17 650,001 - 725,000  
 18 725,001 - 800,000  
 19 800,001 - 875,000  
 20 875,001 - 1,000,000  
 21 1,000,001 - 1,500,000  
 22 1,500,001 - 2,000,000  
 23 2,000,001 - 2,500,000  
 24 2,500,001 - 3,000,000  
 25 3,000,001 - 3,500,000

**Brodkil (sub-demon)**

1 0,000 - 2,400  
 2 2,401 - 4,800  
 3 4,801 - 9,600  
 4 9,601 - 19,200  
 5 19,201 - 38,800  
 6 38,801 - 68,200  
 7 68,201 - 98,600  
 8 98,601 - 130,400  
 9 130,401 - 170,800  
 10 170,801 - 220,400  
 11 220,401 - 270,800  
 12 270,801 - 330,400  
 13 330,401 - 400,600  
 14 400,601 - 480,800  
 15 480,801 - 580,200

**Cactus People R.C.C.****Psi -Ponies (optional)**

1 0,000 - 1,935  
 2 1,936 - 3,870  
 3 3,871 - 7,750  
 4 7,751 - 15,400  
 5 15,401 - 20,000  
 6 20,001 - 30,000  
 7 30,001 - 40,000  
 8 40,001 - 60,000  
 9 60,001 - 80,000  
 10 80,001 - 110,500  
 11 110,501 - 140,000  
 12 140,001 - 180,000  
 13 180,001 - 230,000  
 14 230,001 - 280,000  
 15 280,001 - 350,000

**Centaur R.C.C.****True Sasquatch R.C.C.**

1 0,000 - 1,875  
 2 1,876 - 3,750  
 3 3,751 - 7,250  
 4 7,251 - 14,100  
 5 14,101 - 21,200  
 6 21,201 - 31,200  
 7 31,201 - 41,200  
 8 41,201 - 51,200  
 9 51,201 - 71,200  
 10 71,201 - 101,500  
 11 101,501 - 136,500  
 12 136,501 - 186,500  
 13 186,501 - 236,500  
 14 236,501 - 286,500  
 15 286,501 - 326,500

**Cernun Serpent****Ogeeyin**

1 0,000 - 2,500  
 2 2,501 - 5,000  
 3 5,001 - 10,000  
 4 10,001 - 20,000  
 5 20,001 - 28,500  
 6 28,501 - 38,500  
 7 38,501 - 52,000  
 8 52,001 - 72,000  
 9 72,001 - 105,000  
 10 105,001 - 140,000  
 11 140,001 - 190,000  
 12 190,001 - 235,000  
 13 235,001 - 290,000  
 14 290,001 - 350,000  
 15 350,001 - 520,000

**Chiang - Ku Dragon**

1 0,000 - 2,900  
 2 2,901 - 4,800  
 3 4,801 - 9,600  
 4 9,601 - 19,200  
 5 19,201 - 29,200  
 6 29,201 - 49,000  
 7 49,001 - 79,000  
 8 79,001 - 119,000  
 9 119,001 - 169,000  
 10 169,001 - 230,000  
 11 230,001 - 300,000  
 12 300,001 - 380,000  
 13 380,001 - 470,000  
 14 470,001 - 600,000  
 15 600,001 - 800,000

**Ancient Chiang - Ku**

16 800,001 - 1,000,000  
 17 1,000,001 - 1,250,000  
 18 1,250,001 - 1,500,000  
 19 1,500,001 - 2,000,000  
 20 2,000,001 - 2,500,000  
 21 2,500,001 - 3,000,000  
 22 3,000,001 - 3,500,000  
 23 3,500,001 - 4,000,000  
 24 4,000,001 - 5,000,000  
 25 5,000,001 - 6,000,000  
 26 6,000,001 - 7,000,000

**Cibola Pincer Warriors****Cibola Gatherers**

1 0,000 - 2,140  
 2 2,141 - 4,200  
 3 4,201 - 8,400  
 4 8,401 - 16,700  
 5 16,701 - 24,800  
 6 24,801 - 34,900  
 7 34,901 - 50,100  
 8 50,101 - 70,200  
 9 70,201 - 95,300  
 10 95,301 - 131,000  
 11 131,001 - 181,000  
 12 181,001 - 232,000  
 13 232,001 - 284,000  
 14 284,001 - 346,000  
 15 346,001 - 408,000

**Condoroid****Falconid****Achilles Mutant Capybara**

1 0,000 - 2,400  
 2 2,401 - 4,800  
 3 4,801 - 8,800  
 4 9,601 - 19,200  
 5 19,201 - 29,000  
 6 29,001 - 38,000  
 7 38,001 - 55,000  
 8 55,001 - 78,000  
 9 78,001 - 99,000  
 10 99,001 - 132,000  
 11 132,001 - 182,000  
 12 182,001 - 232,000  
 13 232,001 - 282,000  
 14 282,001 - 343,000  
 15 343,001 - 403,000

**Cyden, Klieid****Nikari, Lashreg**

1 0,000 - 2,100  
 2 2,101 - 4,200  
 3 4,201 - 8,400  
 4 8,401 - 17,200  
 5 17,201 - 25,400  
 6 25,401 - 35,800  
 7 35,801 - 51,000  
 8 51,001 - 71,200  
 9 71,201 - 96,400  
 10 96,401 - 131,600  
 11 131,601 - 181,800  
 12 181,801 - 232,000  
 13 232,001 - 282,200  
 14 282,201 - 342,400  
 15 342,401 - 402,600

**D - Bee Vagabond**

1 0,000 - 1,900  
 2 1,901 - 3,600  
 3 3,601 - 7,200  
 4 7,201 - 14,400  
 5 14,401 - 24,500  
 6 24,501 - 35,000  
 7 35,001 - 45,000  
 8 45,001 - 65,000  
 9 65,001 - 85,000  
 10 85,001 - 115,000  
 11 115,001 - 145,000  
 12 145,001 - 185,000  
 13 185,001 - 250,000  
 14 250,001 - 310,000  
 15 310,001 - 375,000

**Darkhound**

1 0,000 - 2060  
 2 2,061 - 4,160  
 3 4,161 - 8,520  
 4 8,521 - 16,900  
 5 16,901 - 25,600  
 6 25,601 - 35,900  
 7 35,901 - 50,500  
 8 50,501 - 70,900  
 9 70,901 - 95,500  
 10 95,501 - 130,900  
 11 130,901 - 190,500  
 12 190,501 - 240,900  
 13 240,901 - 290,500  
 14 290,501 - 350,900  
 15 350,901 - 400,500

**Demigods & High Elves**

1 0,000 - 2,400  
 2 2,401 - 4,600  
 3 4,601 - 9,200  
 4 9,201 - 18,400  
 5 18,401 - 28,300  
 6 28,301 - 48,000  
 7 48,001 - 78,000  
 8 78,001 - 110,000  
 9 110,001 - 150,000  
 10 150,001 - 200,000  
 11 200,001 - 250,000  
 12 250,001 - 310,000  
 13 310,001 - 380,000  
 14 380,001 - 470,000  
 15 470,001 - 600,000

**Demon - Dragonmage  
Zaayr Crystal Dragon**

**Lipoca Sun Demon**  
 1 0,000 - 3,000  
 2 3,001 - 5,000  
 3 5,001 - 10,000  
 4 10,001 - 20,000  
 5 20,001 - 30,000  
 6 30,001 - 50,000  
 7 50,001 - 80,000  
 8 80,001 - 120,000  
 9 120,001 - 170,000  
 10 170,001 - 230,000  
 11 230,001 - 300,000  
 12 300,001 - 380,000  
 13 380,001 - 470,000  
 14 470,001 - 600,000  
 15 600,001 - 800,000

**Demon Goblin  
Demon Hound Rider  
Ram - Rat & Sky Rider**

1 0,000 - 1,970  
 2 1,971 - 3,940  
 3 3,941 - 7,880  
 4 7,881 - 14,880  
 5 14,881 - 21,880  
 6 21,881 - 31,880  
 7 31,881 - 41,220  
 8 41,221 - 54,440  
 9 54,441 - 74,660  
 10 74,661 - 104,880  
 11 104,881 - 139,220  
 12 139,221 - 189,440  
 13 189,441 - 239,660  
 14 239,661 - 290,880  
 15 290,881 - 335,000

**Dolphin**

**Humpback Whale  
Gene - Splicer Mutants**  
 1 0,000 - 2,200  
 2 2,201 - 4,400  
 3 4,401 - 9,000  
 4 9,001 - 19,000  
 5 19,001 - 28,000  
 6 28,001 - 40,000  
 7 40,001 - 60,000  
 8 60,001 - 80,000  
 9 80,001 - 100,000  
 10 100,001 - 150,000  
 11 150,001 - 200,000  
 12 200,001 - 275,000  
 13 275,001 - 350,000  
 14 350,001 - 425,000  
 15 425,001 - 525,000

**Dragon**

1 0,000 - 3,000  
 2 3,001 - 5,000  
 3 5,001 - 10,000  
 4 10,001 - 20,000  
 5 20,001 - 30,000  
 6 30,001 - 50,000  
 7 50,001 - 80,000  
 8 80,001 - 120,000  
 9 120,001 - 170,000  
 10 170,001 - 230,000  
 11 230,001 - 300,000  
 12 300,001 - 380,000  
 13 380,001 - 470,000  
 14 470,001 - 600,000  
 15 600,001 - 800,000

**Ancient Dragon**

13 380,001 - 470,000  
 14 470,001 - 600,000  
 15 600,001 - 800,000  
 16 800,001 - 1,000,000  
 17 1,000,001 - 1,250,000  
 18 1,250,001 - 1,500,000  
 19 1,500,001 - 2,000,000  
 20 2,000,001 - 2,500,000  
 21 2,500,001 - 3,000,000  
 22 3,000,001 - 3,500,000  
 23 3,500,001 - 4,000,000  
 24 4,000,001 - 5,000,000  
 25 5,000,001 - 6,000,000  
 26 6,000,001 - 7,000,000

**Dragon - Ape**

1 0,000 - 2,000  
 2 2,001 - 4,000  
 3 4,001 - 8,200  
 4 8,201 - 16,400  
 5 16,401 - 24,500  
 6 24,501 - 34,600  
 7 34,601 - 49,700  
 8 49,701 - 69,800  
 9 69,801 - 94,900  
 10 94,901 - 129,000  
 11 129,001 - 179,100  
 12 179,101 - 229,200  
 13 229,201 - 279,300  
 14 279,301 - 329,400  
 15 329,401 - 389,500

**Dragon - Cat**

1 0,000 - 1,860  
 2 1,861 - 3,600  
 3 3,601 - 7,000  
 4 7,001 - 14,400  
 5 14,401 - 23,400  
 6 23,401 - 34,400  
 7 34,401 - 44,400  
 8 44,401 - 60,400  
 9 60,401 - 80,400  
 10 80,401 - 110,400  
 11 110,401 - 145,400  
 12 145,401 - 195,400  
 13 195,401 - 245,400  
 14 245,401 - 290,400  
 15 290,401 - 340,400

**Dragon Ray  
Sperm Whale  
Naut'YII Devastator**

1 0,000 - 2,050  
 2 2,051 - 4,100  
 3 4,101 - 8,250  
 4 8,251 - 16,500  
 5 18,501 - 24,600  
 6 24,601 - 34,700  
 7 34,701 - 49,800  
 8 49,801 - 69,900  
 9 69,901 - 95,000  
 10 95,001 - 130,000  
 11 130,001 - 180,200  
 12 180,201 - 230,000  
 13 230,001 - 280,400  
 14 280,401 - 340,500  
 15 340,501 - 400,600

**Dubugh**

**Earth & Star Child**  
 1 0,000 - 2,200  
 2 2,201 - 4,400  
 3 4,401 - 9,000  
 4 9,001 - 19,000  
 5 19,001 - 28,000  
 6 28,001 - 40,000  
 7 40,001 - 60,000  
 8 60,001 - 80,000  
 9 80,001 - 100,000  
 10 100,001 - 150,000  
 11 150,001 - 200,000  
 12 200,001 - 275,000  
 13 275,001 - 350,000  
 14 350,001 - 425,000  
 15 425,001 - 525,000

**Duelist**

1 0,000 - 2,300  
 2 2,301 - 4,500  
 3 4,501 - 10,000  
 4 10,001 - 20,000  
 5 20,001 - 30,000  
 6 30,001 - 42,000  
 7 42,001 - 65,000  
 8 65,001 - 85,000  
 9 85,001 - 110,000  
 10 110,001 - 160,000  
 11 160,001 - 210,000  
 12 210,001 - 285,000  
 13 285,001 - 370,000  
 14 370,001 - 450,000  
 15 450,001 - 575,000

**Entrancer**

1 0,000 - 2,200  
 2 2,201 - 4,400  
 3 4,401 - 8,800  
 4 8,801 - 17,600  
 5 17,601 - 24,000  
 6 24,001 - 35,000  
 7 35,001 - 50,500  
 8 50,501 - 72,500  
 9 72,501 - 98,500  
 10 98,501 - 140,500  
 11 140,501 - 200,500  
 12 200,501 - 250,500  
 13 250,501 - 300,500  
 14 300,501 - 400,500  
 15 400,501 - 500,000

**Ewaipanoma**

1 0,000 - 2,180  
 2 2,181 - 4,340  
 3 4,341 - 8,680  
 4 8,681 - 17,460  
 5 17,461 - 27,200  
 6 27,201 - 37,300  
 7 37,301 - 53,400  
 8 53,401 - 75,500  
 9 75,501 - 99,600  
 10 99,601 - 143,700  
 11 143,701 - 186,800  
 12 186,801 - 238,900  
 13 238,901 - 298,000  
 14 298,001 - 358,000  
 15 358,001 - 420,000

**Faerie Bot**

**Loup Garou  
Ogopogo**  
 1 0,000 - 3,000  
 2 3,001 - 5,000  
 3 5,001 - 10,000  
 4 10,001 - 20,000  
 5 20,001 - 30,000  
 6 30,001 - 50,000  
 7 50,001 - 80,000  
 8 80,001 - 120,000  
 9 120,001 - 170,000  
 10 170,001 - 230,000  
 11 230,001 - 300,000  
 12 300,001 - 380,000  
 13 380,001 - 470,000  
 14 470,001 - 600,000  
 15 600,001 - 800,000

**Fallam**

**Pucara Red Giant**  
 1 0,000 - 2,200  
 2 2,201 - 4,400  
 3 4,401 - 8,900  
 4 8,901 - 18,000  
 5 18,001 - 26,000  
 6 26,001 - 36,000  
 7 36,001 - 52,000  
 8 52,001 - 76,000  
 9 76,001 - 100,000  
 10 100,001 - 150,000  
 11 150,001 - 200,000  
 12 200,001 - 275,000  
 13 275,001 - 350,000  
 14 350,001 - 425,000  
 15 425,001 - 525,000

**Felinoid Mutant**

1 0,000 - 1,880  
 2 1,881 - 3,780  
 3 3,781 - 7,260  
 4 7,261 - 14,200  
 5 14,201 - 21,000  
 6 21,001 - 31,000  
 7 31,001 - 41,000  
 8 41,001 - 52,000  
 9 52,001 - 72,000  
 10 72,001 - 102,000  
 11 102,001 - 137,000  
 12 137,001 - 187,000  
 13 187,001 - 237,000  
 14 237,001 - 287,000  
 15 287,001 - 327,000

**Fennodi R.C.C.**

Advance in experience as per the  
 O.C.C. selected.

**Flame Panther****Flying Tiger****Oracle Cat**

1 0,000 - 2,200  
 2 2,201 - 4,400  
 3 4,401 - 8,800  
 4 8,801 - 18,000  
 5 18,001 - 26,000  
 6 26,001 - 36,000  
 7 36,001 - 52,000  
 8 52,001 - 72,000  
 9 72,001 - 97,000  
 10 97,001 - 132,000  
 11 132,001 - 182,000  
 12 182,001 - 232,000  
 13 232,001 - 282,000  
 14 282,001 - 343,000  
 15 343,001 - 403,000

**Gizmooteer****Blood Rider****Blood Lizard**

1 0,000 - 2,300  
 2 2,301 - 4,600  
 3 4,601 - 9,200  
 4 9,201 - 18,400  
 5 18,401 - 26,500  
 6 26,501 - 36,600  
 7 36,601 - 51,700  
 8 51,701 - 71,800  
 9 71,801 - 96,900  
 10 96,901 - 137,000  
 11 137,001 - 188,100  
 12 188,101 - 229,200  
 13 229,201 - 279,300  
 14 279,301 - 340,400  
 15 340,401 - 400,000

**Goblin Spider**

1 0,000 - 2,600  
 2 2,601 - 5,000  
 3 5,001 - 10,000  
 4 10,001 - 20,000  
 5 20,001 - 30,000  
 6 30,001 - 50,000  
 7 50,001 - 80,000  
 8 80,001 - 120,000  
 9 120,001 - 170,000  
 10 170,001 - 230,000  
 11 230,001 - 300,000  
 12 300,001 - 380,000  
 13 380,001 - 470,000  
 14 470,001 - 600,000  
 15 600,001 - 800,000

**Godling R.C.C.**

1 0,000 - 2,600  
 2 2,601 - 5,000  
 3 5,001 - 10,000  
 4 10,001 - 20,000  
 5 20,001 - 30,000  
 6 30,001 - 50,000  
 7 50,001 - 80,000  
 8 80,001 - 120,000  
 9 120,001 - 170,000  
 10 170,001 - 230,000  
 11 230,001 - 300,000  
 12 300,001 - 380,000  
 13 380,001 - 470,000  
 14 470,001 - 600,000  
 15 600,001 - 800,000

**Great Dream Snakes****Phantasms**

1 0,000 - 3,000  
 2 3,001 - 5,000  
 3 5,001 - 10,000  
 4 10,001 - 20,000  
 5 20,001 - 30,000  
 6 30,001 - 50,000  
 7 50,001 - 80,000  
 8 80,001 - 120,000  
 9 120,001 - 170,000  
 10 170,001 - 230,000  
 11 230,001 - 300,000  
 12 300,001 - 380,000  
 13 380,001 - 470,000  
 14 470,001 - 600,000  
 15 600,001 - 800,000

**Great Little Ones**

1 0,000 - 2,050  
 2 2,051 - 4,100  
 3 4,101 - 8,250  
 4 8,251 - 16,500  
 5 16,501 - 24,600  
 6 24,601 - 34,700  
 7 34,701 - 49,800  
 8 49,801 - 69,900  
 9 69,901 - 95,000  
 10 95,001 - 130,100  
 11 130,101 - 180,200  
 12 180,201 - 230,300  
 13 230,301 - 280,400  
 14 280,401 - 340,500  
 15 340,501 - 400,600

**Grimbor**

1 0,000 - 1,875  
 2 1,876 - 3,750  
 3 3,751 - 7,250  
 4 7,251 - 14,100  
 5 14,101 - 21,200  
 6 21,201 - 31,200  
 7 31,201 - 41,200  
 8 41,201 - 51,200  
 9 51,201 - 71,200  
 10 71,201 - 101,500  
 11 101,501 - 136,500  
 12 136,501 - 186,500  
 13 186,501 - 236,500  
 14 236,501 - 286,500  
 15 286,501 - 326,500

**Horune Pirate**

1 0,000 - 1,900  
 2 1,901 - 3,800  
 3 3,801 - 7,300  
 4 7,301 - 14,300  
 5 14,301 - 21,000  
 6 21,001 - 30,000  
 7 30,001 - 40,000  
 8 40,001 - 53,000  
 9 53,001 - 73,000  
 10 73,001 - 103,000  
 11 103,001 - 138,000  
 12 138,001 - 188,000  
 13 188,001 - 238,000  
 14 238,001 - 288,000  
 15 288,001 - 330,000

**Hunter Cat****Sekhmet**

1 0,000 - 2,250  
 2 2,251 - 4,500  
 3 4,501 - 9,000  
 4 9,001 - 18,500  
 5 18,501 - 27,500  
 6 27,501 - 38,000  
 7 38,001 - 54,000  
 8 54,001 - 76,000  
 9 76,001 - 100,000  
 10 100,001 - 145,000  
 11 145,001 - 190,000  
 12 190,001 - 240,000  
 13 240,001 - 300,000  
 14 300,001 - 360,000  
 15 360,001 - 420,000

**In'Valian "Robo - Jockeys"**

1 0,000 - 2,150  
 2 2,151 - 4,250  
 3 4,251 - 8,850  
 4 8,851 - 17,000  
 5 17,001 - 25,000  
 6 25,001 - 35,000  
 7 35,001 - 50,000  
 8 50,001 - 70,000  
 9 70,001 - 95,000  
 10 95,001 - 130,000  
 11 130,001 - 180,000  
 12 180,001 - 230,000  
 13 230,001 - 280,000  
 14 280,001 - 330,000  
 15 330,001 - 400,000

**Ixion Cyber - Horsemen**

1 0,000 - 2,150  
 2 2,151 - 4,300  
 3 4,301 - 8,600  
 4 8,601 - 18,600  
 5 18,601 - 26,600  
 6 26,601 - 36,600  
 7 36,601 - 54,600  
 8 54,601 - 75,600  
 9 75,601 - 99,600  
 10 99,601 - 135,600  
 11 135,601 - 185,600  
 12 185,601 - 240,600  
 13 240,601 - 290,600  
 14 290,601 - 343,600  
 15 343,601 - 423,600

**Jungle Elf**

1 0,000 - 2,100  
 2 2,101 - 4,150  
 3 4,151 - 8,300  
 4 8,301 - 16,600  
 5 16,601 - 25,000  
 6 25,001 - 35,000  
 7 35,001 - 50,000  
 8 50,001 - 70,000  
 9 70,001 - 95,000  
 10 95,001 - 130,000  
 11 130,001 - 180,000  
 12 180,001 - 231,000  
 13 231,001 - 280,000  
 14 280,001 - 341,000  
 15 341,001 - 401,000

**Keepers of the Desert**

1 0,000 - 2,110  
 2 2,111 - 4,220  
 3 4,221 - 8,440  
 4 8,441 - 16,880  
 5 16,881 - 24,880  
 6 24,881 - 34,880  
 7 34,881 - 48,440  
 8 48,441 - 68,440  
 9 68,441 - 92,480  
 10 92,481 - 128,480  
 11 128,481 - 178,480  
 12 178,481 - 228,880  
 13 228,881 - 278,880  
 14 278,881 - 324,480  
 15 324,481 - 388,880

**Killer Whale****Rurlel Eelman**

1 0,000 - 2,150  
 2 2,151 - 4,300  
 3 4,301 - 8,600  
 4 8,601 - 17,200  
 5 17,201 - 25,500  
 6 25,501 - 36,000  
 7 36,001 - 52,000  
 8 52,001 - 73,000  
 9 73,001 - 98,000  
 10 98,001 - 134,000  
 11 134,001 - 184,000  
 12 184,001 - 240,000  
 13 240,001 - 295,000  
 14 295,001 - 365,000  
 15 365,001 - 425,000



**Kittani**  
**Blind Warrior Women**  
1 0,000 - 2,140  
2 2,141 - 4,280  
3 4,281 - 8,560  
4 8,561 - 17,520  
5 17,521 - 25,520  
6 25,521 - 35,520  
7 35,521 - 50,520  
8 50,521 - 71,000  
9 71,001 - 96,100  
10 96,101 - 131,200  
11 131,201 - 181,300  
12 181,301 - 231,400  
13 231,401 - 281,500  
14 281,501 - 341,600  
15 341,601 - 401,700

**Kreel - Lok Warrior**  
1 0,000 - 1,925  
2 1,926 - 3,850  
3 3,851 - 7,450  
4 7,451 - 15,000  
5 15,001 - 21,500  
6 21,501 - 31,500  
7 30,501 - 41,500  
8 41,501 - 54,000  
9 54,001 - 75,000  
10 75,001 - 105,000  
11 105,001 - 140,000  
12 140,001 - 190,000  
13 190,001 - 240,000  
14 240,001 - 300,000  
15 300,001 - 350,000

**Kwarla Demon Hunter**  
1 0,000 - 2,200  
2 2,201 - 4,400  
3 4,401 - 8,800  
4 8,801 - 17,600  
5 17,601 - 27,800  
6 27,801 - 37,900  
7 37,901 - 55,100  
8 55,101 - 75,200  
9 75,201 - 100,300  
10 100,301 - 145,500  
11 145,501 - 190,600  
12 190,601 - 245,700  
13 245,701 - 295,800  
14 295,801 - 345,900  
15 345,901 - 415,100

**Larhold Barbarian**  
**Neo - Human**  
**Equinoid**  
1 0,000 - 2,600  
2 2,601 - 5,000  
3 5,001 - 10,000  
4 10,001 - 20,000  
5 20,001 - 30,000  
6 30,001 - 39,000  
7 39,001 - 52,000  
8 52,001 - 70,000  
9 70,001 - 100,000  
10 100,001 - 140,000  
11 140,001 - 190,000  
12 190,001 - 240,000  
13 240,001 - 290,000  
14 290,001 - 350,000  
15 350,001 - 520,000

**Lizard Man**  
1 0,000 - 1,900  
2 1,901 - 3,800  
3 3,801 - 7,300  
4 7,301 - 14,300  
5 14,301 - 21,000  
6 21,001 - 31,000  
7 31,001 - 41,000  
8 41,001 - 53,000  
9 53,001 - 73,000  
10 73,001 - 103,000  
11 103,001 - 138,000  
12 138,001 - 188,000  
13 188,001 - 238,000  
14 238,001 - 288,000  
15 288,001 - 328,000

**Lycanmorph**  
1 0,000 - 2,500  
2 2,501 - 5,000  
3 5,001 - 10,000  
4 10,001 - 20,000  
5 20,001 - 30,000  
6 30,001 - 50,000  
7 50,001 - 80,000  
8 80,001 - 120,000  
9 120,001 - 160,000  
10 160,001 - 190,000  
11 190,001 - 240,000  
12 240,001 - 300,000  
13 300,001 - 370,000  
14 370,001 - 440,000  
15 440,001 - 510,000

**Lyn - Srial Cloudweaver**  
1 0,000 - 2,150  
2 2,151 - 4,300  
3 4,301 - 9,600  
4 9,601 - 18,200  
5 18,201 - 28,400  
6 28,401 - 38,600  
7 38,601 - 54,800  
8 54,801 - 75,200  
9 75,201 - 100,400  
10 100,401 - 132,600  
11 132,601 - 185,800  
12 185,801 - 240,200  
13 240,201 - 295,400  
14 295,401 - 365,600  
15 365,601 - 425,800

**Lyn - Srial Sky - Knight**  
1 0,000 - 2,140  
2 2,141 - 4,280  
3 4,281 - 8,560  
4 8,561 - 17,520  
5 17,521 - 25,520  
6 25,521 - 35,520  
7 35,521 - 50,520  
8 50,521 - 71,000  
9 71,001 - 96,000  
10 96,001 - 131,200  
11 131,201 - 181,300  
12 181,301 - 231,400  
13 231,401 - 281,500  
14 281,501 - 341,600  
15 341,601 - 401,700

**Lyn - Srial**  
1 0,000 - 1,900  
2 1,901 - 3,800  
3 3,801 - 7,300  
4 7,301 - 14,300  
5 14,301 - 21,300  
6 21,301 - 30,000  
7 30,001 - 40,000  
8 40,001 - 53,000  
9 53,001 - 73,000  
10 73,001 - 103,000  
11 103,001 - 138,000  
12 138,001 - 188,000  
13 188,001 - 238,000  
14 238,001 - 288,000  
15 288,001 - 328,000

**Machine People**  
**Phantom Vacuum Wasps**  
1 0,000 - 2,300  
2 2,301 - 4,500  
3 4,501 - 10,000  
4 10,001 - 20,000  
5 20,001 - 30,000  
6 30,001 - 42,000  
7 42,001 - 65,000  
8 65,001 - 85,000  
9 85,001 - 110,000  
10 110,001 - 160,000  
11 160,001 - 210,000  
12 210,001 - 285,000  
13 285,001 - 370,000  
14 370,001 - 450,000  
15 450,001 - 575,000

**Man - Eagle (villain)**  
**Stone Giant (villain)**  
1 0,000 - 2,200  
2 2,201 - 4,400  
3 4,401 - 8,800  
4 8,801 - 17,600  
5 17,601 - 27,700  
6 27,701 - 37,800  
7 37,801 - 53,900  
8 53,901 - 75,100  
9 75,101 - 100,200  
10 100,201 - 140,300  
11 140,301 - 200,400  
12 200,401 - 250,500  
13 250,501 - 300,600  
14 300,601 - 350,700  
15 350,701 - 425,800

**Man - Monsters (villians)**  
1 0,000 - 2,300  
2 2,301 - 4,600  
3 4,601 - 9,200  
4 9,201 - 18,400  
5 18,401 - 26,500  
6 26,501 - 36,600  
7 36,601 - 51,700  
8 51,701 - 71,800  
9 71,801 - 96,900  
10 96,901 - 137,000  
11 137,001 - 188,100  
12 188,101 - 229,200  
13 229,201 - 279,300  
14 279,301 - 340,400  
15 340,401 - 400,000

**Mantaz Sectle**  
1 0,000 - 1,950  
2 1,951 - 3,900  
3 3,901 - 7,500  
4 7,501 - 15,000  
5 15,001 - 23,000  
6 23,001 - 32,100  
7 32,101 - 42,200  
8 42,201 - 55,300  
9 55,301 - 76,400  
10 76,401 - 106,500  
11 106,501 - 140,600  
12 140,601 - 190,700  
13 190,701 - 240,800  
14 240,801 - 294,000  
15 294,001 - 336,000

**Master Blood - Rider**  
**Achilles Serpentoid**  
1 0,000 - 2,250  
2 2,251 - 4,500  
3 4,501 - 9,000  
4 9,001 - 18,500  
5 18,501 - 27,500  
6 27,501 - 38,000  
7 38,001 - 54,000  
8 54,001 - 76,000  
9 76,001 - 100,000  
10 100,001 - 145,000  
11 145,001 - 190,000  
12 190,001 - 240,000  
13 240,001 - 300,000  
14 300,001 - 360,000  
15 360,001 - 420,000

**Men - Rall "Techmaster"**  
1 0,000 - 2,240  
2 2,241 - 4,480  
3 4,481 - 8,960  
4 8,961 - 17,920  
5 17,921 - 25,920  
6 25,921 - 35,920  
7 35,921 - 50,920  
8 50,921 - 70,920  
9 70,921 - 95,920  
10 95,921 - 135,920  
11 135,921 - 185,920  
12 185,921 - 225,920  
13 225,921 - 275,920  
14 275,921 - 335,920  
15 335,921 - 395,920

**"Mind Creature" Intruder**  
1 0,000 - 2,650  
2 2,651 - 5,300  
3 5,301 - 11,000  
4 11,001 - 21,000  
5 21,001 - 32,000  
6 32,001 - 42,000  
7 42,001 - 62,000  
8 62,001 - 90,000  
9 90,001 - 120,000  
10 120,001 - 170,000  
11 170,001 - 220,000  
12 220,001 - 290,000  
13 290,001 - 400,000  
14 400,001 - 500,000  
15 500,001 - 700,000

**Mokoloi Warriors**

1 0,000 - 2,120  
 2 2,121 - 4,240  
 3 4,241 - 8,480  
 4 8,481 - 16,960  
 5 16,961 - 24,100  
 6 24,101 - 34,200  
 7 34,201 - 49,300  
 8 49,301 - 70,400  
 9 70,401 - 96,500  
 10 96,501 - 132,600  
 11 132,601 - 190,700  
 12 190,701 - 240,800  
 13 240,801 - 290,900  
 14 290,901 - 350,100  
 15 350,101 - 400,200

**Monro R.C.C.****T'Zee R.C.C.**

Experience advancement will depend on the O.C.C. selected.

**Monster Brodkil****Sryynn Cannibal**

1 0,000 - 2,250  
 2 2,251 - 4,400  
 3 4,401 - 8,800  
 4 8,801 - 17,600  
 5 17,601 - 24,000  
 6 25,001 - 35,000  
 7 35,001 - 50,500  
 8 50,501 - 72,500  
 9 72,501 - 98,500  
 10 98,501 - 140,500  
 11 140,501 - 200,500  
 12 200,501 - 250,500  
 13 250,501 - 300,500  
 14 300,501 - 400,500  
 15 400,401 - 500,000

**Morphworm****Rumbler****Holy Terror**

1 0,000 - 2,900  
 2 2,901 - 4,800  
 3 4,801 - 9,600  
 4 9,601 - 19,200  
 5 19,201 - 29,200  
 6 29,201 - 49,000  
 7 49,001 - 79,000  
 8 79,001 - 119,000  
 9 119,001 - 169,000  
 10 169,001 - 230,000  
 11 230,001 - 300,000  
 12 300,001 - 380,000  
 13 380,001 - 470,000  
 14 470,001 - 600,000  
 15 600,001 - 800,000

**Mutant Rat**

1 0,000 - 1,900  
 2 1,901 - 3,600  
 3 3,601 - 7,200  
 4 7,201 - 14,400  
 5 14,401 - 24,500  
 6 24,501 - 35,000  
 7 35,001 - 45,000  
 8 45,001 - 65,000  
 9 65,001 - 85,000  
 10 85,001 - 115,000  
 11 115,001 - 145,000  
 12 145,001 - 185,000  
 13 185,001 - 250,000  
 14 250,001 - 310,000  
 15 310,001 - 375,000

**Mutants**

1 0,000 - 2,150  
 2 2,151 - 4,300  
 3 4,301 - 8,600  
 4 8,601 - 18,600  
 5 18,601 - 26,600  
 6 26,601 - 36,600  
 7 36,601 - 54,600  
 8 54,601 - 75,600  
 9 75,601 - 99,600  
 10 99,601 - 135,600  
 11 135,601 - 185,600  
 12 185,601 - 240,600  
 13 240,601 - 290,600  
 14 290,601 - 343,600  
 15 343,601 - 423,600

**Nazeer****Dreadlor**

1 0,000 - 2,400  
 2 2,401 - 4,800  
 3 4,801 - 9,600  
 4 9,601 - 19,000  
 5 19,001 - 27,000  
 6 27,001 - 37,000  
 7 37,001 - 52,000  
 8 52,001 - 72,000  
 9 72,001 - 96,000  
 10 96,001 - 131,000  
 11 131,001 - 180,000  
 12 180,001 - 229,000  
 13 229,001 - 278,000  
 14 278,001 - 337,000  
 15 337,001 - 396,000

**Noro Psychic****Promethean (First Stage)**

1 0,000 - 2,600  
 2 2,601 - 5,000  
 3 5,001 - 10,000  
 4 10,001 - 20,000  
 5 20,001 - 30,000  
 6 30,001 - 39,000  
 7 39,001 - 52,000  
 8 52,001 - 70,000  
 9 70,001 - 100,000  
 10 100,001 - 140,000  
 11 140,001 - 190,000  
 12 190,001 - 240,000  
 13 240,001 - 290,000  
 14 290,001 - 350,000  
 15 350,001 - 520,000

**Oni Ninja**

1 0,000 - 2,650  
 2 2,651 - 5,300  
 3 5,301 - 11,000  
 4 11,001 - 21,000  
 5 21,001 - 32,000  
 6 32,001 - 42,000  
 7 42,001 - 62,000  
 8 62,001 - 90,000  
 9 90,001 - 120,000  
 10 120,001 - 170,000  
 11 170,001 - 220,000  
 12 220,001 - 290,000  
 13 290,001 - 400,000  
 14 400,001 - 500,000  
 15 500,001 - 700,000

**Optional Monster****Races & Notes**

The Dark Priest, the Unholy, the Host, Air Fish, Beast Guards, Demon Hounds, Feathered Serpents, Skelter Bats, Worm Zombies, Parasites and Symbioses are NOT available as player characters.

**Pleasurer****Termite Engineers**

1 0,000 - 2,150  
 2 2,151 - 4,300  
 3 4,301 - 8,600  
 4 8,601 - 17,200  
 5 17,201 - 25,500  
 6 25,501 - 36,000  
 7 36,001 - 52,000  
 8 52,001 - 73,000  
 9 73,001 - 98,000  
 10 98,001 - 134,000  
 11 134,001 - 184,000  
 12 184,001 - 240,000  
 13 240,001 - 295,000  
 14 295,001 - 365,000  
 15 365,001 - 425,000

**Plumed Serpent****Ukt Water Serpent**

1 0,000 - 3,000  
 2 3,001 - 5,000  
 3 5,001 - 10,000  
 4 10,001 - 20,000  
 5 20,001 - 30,000  
 6 30,001 - 50,000  
 7 50,001 - 80,000  
 8 80,001 - 120,000  
 9 120,001 - 170,000  
 10 170,001 - 230,000  
 11 230,001 - 300,000  
 12 300,001 - 380,000  
 13 380,001 - 470,000  
 14 470,001 - 600,000  
 15 600,001 - 800,000

**Pneuma Biform: Dolphin****Pneuma Biform: Orca****Pneuma Biform: Whale**

1 0,000 - 2,600  
 2 2,601 - 5,300  
 3 5,301 - 10,700  
 4 10,701 - 20,700  
 5 20,601 - 30,600  
 6 30,601 - 41,800  
 7 41,801 - 61,000  
 8 61,001 - 90,000  
 9 90,001 - 120,000  
 10 120,001 - 170,000  
 11 170,001 - 220,000  
 12 220,001 - 290,000  
 13 290,001 - 400,000  
 14 400,001 - 500,000  
 15 500,001 - 700,000

**Pogtal Dragon Slayer**

1 0,000 - 3,000  
 2 3,001 - 5,000  
 3 5,001 - 10,000  
 4 10,001 - 20,000  
 5 20,001 - 30,000  
 6 30,001 - 50,000  
 7 50,001 - 80,000  
 8 80,001 - 120,000  
 9 120,001 - 170,000  
 10 170,001 - 230,000  
 11 230,001 - 300,000  
 12 300,001 - 380,000  
 13 380,001 - 470,000  
 14 470,001 - 600,000  
 15 600,001 - 800,000

**Power Leech**

1 0,000 - 2,400  
 2 2,401 - 4,800  
 3 4,801 - 9,600  
 4 9,601 - 19,200  
 5 19,201 - 30,000  
 6 30,001 - 50,000  
 7 50,001 - 80,000  
 8 80,001 - 120,000  
 9 120,001 - 160,000  
 10 160,001 - 200,000  
 11 200,001 - 250,000  
 12 250,001 - 300,000  
 13 300,001 - 400,000  
 14 400,001 - 500,000  
 15 500,001 - 600,000

**Psi - X Alien****Xiticix Killer**

1 0,000 - 2,200  
 2 2,201 - 4,400  
 3 4,401 - 9,000  
 4 9,001 - 19,000  
 5 19,001 - 28,000  
 6 28,001 - 40,000  
 7 40,001 - 60,000  
 8 60,001 - 80,000  
 9 80,001 - 100,000  
 10 100,001 - 150,000  
 11 150,001 - 200,000  
 12 200,001 - 275,000  
 13 275,001 - 350,000  
 14 350,001 - 425,000  
 15 425,001 - 525,000

**Psi-Bloodbound****Tri-Wolf**

1 0,000 - 2,100  
 2 2,101 - 4,200  
 3 4,201 - 8,400  
 4 8,401 - 16,800  
 5 16,801 - 25,000  
 6 25,001 - 35,000  
 7 35,001 - 50,000  
 8 50,001 - 70,000  
 9 70,001 - 95,000  
 10 95,001 - 130,000  
 11 130,001 - 180,000  
 12 180,001 - 234,000  
 13 234,001 - 285,000  
 14 285,001 - 345,000  
 15 345,001 - 410,000

**Psymbiote****Psi - Goblin**

1 0,000 - 1,925  
 2 1,926 - 3,850  
 3 3,851 - 7,450  
 4 7,451 - 14,900  
 5 14,901 - 21,000  
 6 21,001 - 31,000  
 7 31,001 - 41,600  
 8 41,601 - 53,000  
 9 53,001 - 73,000  
 10 73,001 - 103,500  
 11 103,501 - 139,000  
 12 139,001 - 189,000  
 13 189,001 - 239,000  
 14 239,001 - 289,000  
 15 289,001 - 339,000

**Quick Flex Rogue R.C.C.****Trimadore Mechanic R.C.C.**

1 0,000 - 2,300  
 2 2,301 - 4,600  
 3 4,601 - 9,200  
 4 9,201 - 18,400  
 5 18,401 - 26,500  
 6 26,501 - 36,600  
 7 36,601 - 51,700  
 8 51,701 - 74,800  
 9 74,801 - 100,900  
 10 100,901 - 140,000  
 11 140,001 - 193,100  
 12 193,101 - 235,200  
 13 235,201 - 290,400  
 14 290,401 - 350,600  
 15 350,601 - 425,800

**Ramen**

1 0,000 - 2,050  
 2 2,051 - 4,100  
 3 4,101 - 8,250  
 4 8,251 - 16,500  
 5 16,501 - 24,600  
 6 24,601 - 34,700  
 7 34,701 - 49,800  
 8 49,801 - 69,900  
 9 69,901 - 95,000  
 10 95,001 - 130,100  
 11 130,101 - 180,200  
 12 180,201 - 230,300  
 13 230,301 - 280,400  
 14 280,401 - 340,500  
 15 340,501 - 400,600

**Rithe**

1 0,000 - 2,400  
 2 2,401 - 4,800  
 3 4,801 - 9,600  
 4 9,601 - 19,200  
 5 19,201 - 28,400  
 6 28,401 - 38,600  
 7 38,601 - 52,200  
 8 52,201 - 72,400  
 9 72,401 - 98,600  
 10 98,601 - 140,200  
 11 140,201 - 200,400  
 12 200,401 - 260,600  
 13 260,601 - 310,200  
 14 310,201 - 410,400  
 15 410,401 - 510,000

**Sea Titan****Whale Singer**

1 0,000 - 2,500  
 2 2,501 - 5,000  
 3 5,001 - 10,000  
 4 10,001 - 20,000  
 5 20,001 - 30,000  
 6 30,001 - 50,000  
 7 50,001 - 80,000  
 8 80,001 - 120,000  
 9 120,001 - 160,000  
 10 160,001 - 190,000  
 11 190,001 - 240,000  
 12 240,001 - 300,000  
 13 300,001 - 370,000  
 14 370,001 - 440,000  
 15 440,001 - 510,000

**Seljuk****Kreeghor****Catyr**

1 0,000 - 2,200  
 2 2,201 - 4,400  
 3 4,401 - 8,900  
 4 8,901 - 18,000  
 5 18,001 - 26,000  
 6 26,001 - 36,000  
 7 36,001 - 52,000  
 8 52,001 - 76,000  
 9 76,001 - 100,000  
 10 100,001 - 150,000  
 11 150,001 - 200,000  
 12 200,001 - 275,000  
 13 275,001 - 350,000  
 14 350,001 - 425,000  
 15 425,001 - 525,000

**Shade**

1 0,000 - 2,500  
 2 2,501 - 5,000  
 3 5,001 - 10,000  
 4 10,001 - 20,000  
 5 20,001 - 28,500  
 6 28,501 - 38,500  
 7 38,501 - 52,000  
 8 52,001 - 72,000  
 9 72,001 - 105,000  
 10 105,001 - 140,000  
 11 140,001 - 190,000  
 12 190,001 - 235,000  
 13 235,001 - 290,000  
 14 290,001 - 350,000  
 15 350,001 - 520,000

**Shadow People**

1 0,000 - 2,500  
 2 2,501 - 5,000  
 3 5,001 - 10,000  
 4 10,001 - 20,500  
 5 20,501 - 32,000  
 6 32,001 - 47,000  
 7 47,001 - 62,000  
 8 62,001 - 82,000  
 9 82,001 - 112,000  
 10 112,001 - 160,000  
 11 160,001 - 220,000  
 12 220,001 - 300,000  
 13 300,001 - 380,000  
 14 380,001 - 460,000  
 15 460,001 - 540,000

**Shertar****Tarbull**

1 0,000 - 2,300  
 2 2,301 - 4,600  
 3 4,601 - 9,200  
 4 9,201 - 18,400  
 5 18,401 - 26,800  
 6 26,801 - 36,900  
 7 36,901 - 51,100  
 8 51,101 - 71,200  
 9 71,201 - 100,300  
 10 100,301 - 140,400  
 11 140,401 - 196,500  
 12 196,501 - 250,600  
 13 250,601 - 300,700  
 14 300,701 - 350,800  
 15 350,801 - 400,900

**Shrilt R.C.C.**

1 0,000 - 1,900  
 2 1,901 - 3,600  
 3 3,601 - 7,200  
 4 7,201 - 14,400  
 5 14,401 - 24,500  
 6 24,501 - 35,000  
 7 35,001 - 45,000  
 8 45,001 - 65,000  
 9 65,001 - 85,000  
 10 85,001 - 115,000  
 11 115,001 - 145,000  
 12 145,001 - 185,000  
 13 185,001 - 250,000  
 14 250,001 - 310,000  
 15 310,001 - 375,000

**Silhouette****Draconid****Repo-Bots**

1 0,000 - 2,200  
 2 2,201 - 4,400  
 3 4,401 - 9,000  
 4 9,001 - 19,000  
 5 19,001 - 28,000  
 6 28,001 - 40,000  
 7 40,001 - 60,000  
 8 60,001 - 80,000  
 9 80,001 - 100,000  
 10 100,001 - 150,000  
 11 150,001 - 200,000  
 12 200,001 - 275,000  
 13 275,001 - 350,000  
 14 350,001 - 425,000  
 15 425,001 - 525,000

**Simvan****Seeker**

1 0,000 - 1,925  
 2 1,926 - 3,850  
 3 3,851 - 7,450  
 4 7,451 - 15,000  
 5 15,001 - 21,500  
 6 21,501 - 31,500  
 7 30,501 - 41,500  
 8 41,501 - 54,000  
 9 54,001 - 75,000  
 10 75,001 - 105,000  
 11 105,001 - 140,000  
 12 140,001 - 190,000  
 13 190,001 - 240,000  
 14 240,001 - 300,000  
 15 300,001 - 350,000

**Simvan Monster Rider**

1 0,000 - 1,925  
 2 1,926 - 3,850  
 3 3,851 - 7,450  
 4 7,451 - 15,000  
 5 15,001 - 21,500  
 6 21,501 - 31,500  
 7 31,501 - 41,500  
 8 41,501 - 54,000  
 9 54,001 - 75,000  
 10 75,001 - 105,000  
 11 105,001 - 140,000  
 12 140,001 - 190,000  
 13 190,001 - 240,000  
 14 240,001 - 300,000  
 15 300,001 - 350,000

**Splugorth Conservator**

1 0,000 - 2,100  
 2 2,101 - 4,200  
 3 4,201 - 8,400  
 4 8,401 - 17,200  
 5 17,201 - 25,400  
 6 25,401 - 35,800  
 7 35,801 - 51,000  
 8 51,001 - 71,200  
 9 71,201 - 96,400  
 10 96,401 - 131,600  
 11 131,601 - 181,800  
 12 181,801 - 232,000  
 13 232,001 - 282,200  
 14 282,201 - 342,400  
 15 342,401 - 402,600

**Splugorth Overlord****Splugorth Powerlord****Splugorth Slaver**

1 0,000 - 2,600  
 2 2,601 - 5,200  
 3 5,201 - 10,500  
 4 10,501 - 21,200  
 5 21,201 - 32,300  
 6 32,301 - 47,400  
 7 47,401 - 62,500  
 8 62,501 - 88,000  
 9 88,001 - 112,000  
 10 112,001 - 163,000  
 11 163,001 - 222,000  
 12 222,001 - 295,000  
 13 295,001 - 395,000  
 14 395,001 - 495,000  
 15 495,001 - 595,000

**Supernatural Minions**

1 0,000 - 2,700  
 2 2,701 - 5,400  
 3 5,401 - 10,800  
 4 10,801 - 21,600  
 5 21,601 - 31,600  
 6 31,601 - 42,800  
 7 42,801 - 62,000  
 8 62,001 - 90,000  
 9 90,001 - 120,000  
 10 120,001 - 170,000  
 11 170,001 - 220,000  
 12 220,001 - 290,000  
 13 290,001 - 400,000  
 14 400,001 - 500,000  
 15 500,001 - 700,000  
 (Applicable to most inhuman min-  
 ions available as optional player  
 characters, unless otherwise  
 noted.)

**Sura - Kappa****Oni of the One Hundred**

1 0,000 - 2,000  
 2 2,001 - 4,000  
 3 4,001 - 8,200  
 4 8,201 - 16,400  
 5 16,401 - 24,500  
 6 24,501 - 34,600  
 7 34,601 - 49,700  
 8 49,701 - 69,800  
 9 69,801 - 94,900  
 10 94,901 - 129,000  
 11 129,001 - 179,100  
 12 179,101 - 229,200  
 13 229,201 - 279,300  
 14 279,301 - 329,400  
 15 329,401 - 389,500

**Talus****Seerman**

1 0,000 - 2000  
 2 2,001 - 4,000  
 3 4,001 - 8,200  
 4 8,201 - 16,400  
 5 16,401 - 24,500  
 6 24,501 - 34,600  
 7 34,601 - 49,700  
 8 49,701 - 69,800  
 9 69,801 - 94,900  
 10 94,901 - 129,000  
 11 129,001 - 179,100  
 12 179,101 - 229,200  
 13 229,201 - 279,300  
 14 279,301 - 329,400  
 15 329,401 - 389,500

**Tarlok****Lokdog**

1 0,000 - 2,120  
 2 2,121 - 4,240  
 3 4,241 - 8,480  
 4 8,481 - 16,960  
 5 16,961 - 24,960  
 6 24,961 - 34,960  
 7 34,961 - 49,960  
 8 49,961 - 69,960  
 9 69,961 - 94,960  
 10 94,961 - 129,960  
 11 129,961 - 179,960  
 12 179,961 - 229,960  
 13 229,961 - 279,960  
 14 279,961 - 329,960  
 15 329,961 - 389,961

**Temporal Raider**

1 0,000 - 2,700  
 2 2,701 - 5,400  
 3 5,401 - 10,800  
 4 10,801 - 21,600  
 5 21,601 - 31,600  
 6 31,601 - 42,800  
 7 42,801 - 62,000  
 8 62,001 - 90,000  
 9 90,001 - 120,000  
 10 120,001 - 170,000  
 11 170,001 - 220,000  
 12 220,001 - 290,000  
 13 290,001 - 400,000  
 14 400,001 - 500,000  
 15 500,001 - 700,000

**Tengu**

1 0,000 - 2,700  
 2 2,701 - 5,400  
 3 5,401 - 10,800  
 4 10,801 - 21,600  
 5 21,601 - 31,600  
 6 31,601 - 42,800  
 7 42,801 - 62,000  
 8 62,001 - 90,000  
 9 90,001 - 120,000  
 10 120,001 - 170,000  
 11 170,001 - 220,000  
 12 220,001 - 290,000  
 13 290,001 - 400,000  
 14 400,001 - 500,000  
 15 500,001 - 700,000

**Tokanii R.C.C.**

1 0,000 - 2,350  
 2 2,351 - 4,650  
 3 4,651 - 9,250  
 4 9,251 - 18,500  
 5 18,501 - 27,000  
 6 27,001 - 37,000  
 7 37,001 - 52,000  
 8 52,001 - 73,000  
 9 73,001 - 98,000  
 10 98,001 - 140,000  
 11 140,001 - 190,000  
 12 190,001 - 232,000  
 13 232,001 - 292,000  
 14 292,001 - 360,000  
 15 360,001 - 430,000

**Tree People****Pygmy Hunter**

**Tautons**  
 1 0,000 - 1,935  
 2 1,935 - 3,870  
 3 3,871 - 7,750  
 4 7,751 - 15,400  
 5 15,401 - 20,000  
 6 20,001 - 30,000  
 7 30,001 - 40,000  
 8 40,001 - 60,000  
 9 60,001 - 80,000  
 10 80,001 - 110,500  
 11 110,001 - 140,000  
 12 140,001 - 180,000  
 13 180,001 - 230,000  
 14 230,001 - 280,000  
 15 280,001 - 350,000

**True Inca**

1 0,000 - 2,400  
 2 2,401 - 4,600  
 3 4,601 - 9,200  
 4 9,201 - 18,400  
 5 18,401 - 28,300  
 6 28,301 - 48,000  
 7 48,001 - 78,000  
 8 78,001 - 110,000  
 9 110,001 - 150,000  
 10 150,001 - 200,000  
 11 200,001 - 250,000  
 12 250,001 - 310,000  
 13 310,001 - 380,000  
 14 380,001 - 470,000  
 15 470,001 - 600,000

**Two - Faced Star People**

1 0,000 - 2,100  
 2 2,101 - 4,200  
 3 4,201 - 8,400  
 4 8,401 - 17,200  
 5 17,201 - 25,400  
 6 25,401 - 35,800  
 7 35,801 - 51,000  
 8 51,001 - 71,200  
 9 71,201 - 96,400  
 10 96,401 - 131,600  
 11 131,601 - 181,800  
 12 181,801 - 232,000  
 13 232,001 - 282,200  
 14 282,201 - 342,400  
 15 342,401 - 402,600

**Vallax (alien)****Newcomer Android**

1 0,000 - 2,400  
 2 2,401 - 4,600  
 3 4,601 - 9,200  
 4 9,201 - 18,400  
 5 18,401 - 28,300  
 6 28,301 - 48,000  
 7 48,001 - 78,000  
 8 78,001 - 110,000  
 9 110,001 - 150,000  
 10 150,001 - 200,000  
 11 200,001 - 250,000  
 12 250,001 - 310,000  
 13 310,001 - 380,000  
 14 380,001 - 470,000  
 15 470,001 - 600,000

**Vanguard Brawler Thug**

1 0,000 - 2050  
 2 2,051 - 4,100  
 3 4,101 - 8,400  
 4 8,401 - 16,800  
 5 16,801 - 25,560  
 6 24,561 - 35,800  
 7 35,801 - 50,400  
 8 50,401 - 70,800  
 9 70,801 - 95,400  
 10 95,401 - 130,800  
 11 130,801 - 180,400  
 12 180,401 - 230,800  
 13 230,801 - 280,400  
 14 280,401 - 331,800  
 15 331,401 - 392,800

**Vyarnect**

1 0,000 - 1,900  
 2 1,901 - 3,600  
 3 3,601 - 7,200  
 4 7,201 - 14,400  
 5 14,401 - 24,500  
 6 24,501 - 35,000  
 7 35,001 - 45,000  
 8 45,001 - 65,000  
 9 65,001 - 85,000  
 10 85,001 - 115,000  
 11 115,001 - 145,000  
 12 145,001 - 185,000  
 13 185,001 - 250,000  
 14 250,001 - 310,000  
 15 310,001 - 375,000

**Wendigo R.C.C.**

1 0,000 - 1,950  
 2 1,951 - 3,900  
 3 3,901 - 8,800  
 4 8,801 - 17,600  
 5 17,601 - 25,600  
 6 25,601 - 35,600  
 7 35,601 - 50,600  
 8 50,601 - 70,600  
 9 70,601 - 95,600  
 10 95,601 - 125,600  
 11 125,601 - 175,600  
 12 175,601 - 225,600  
 13 225,601 - 275,600  
 14 275,601 - 325,600  
 15 325,601 - 375,600

**Werejaguars****Werepanthers**

1 0,000 - 2,050  
 2 2,051 - 4,100  
 3 4,101 - 8,250  
 4 8,251 - 16,500  
 5 16,501 - 24,600  
 6 24,601 - 34,700  
 7 34,701 - 49,800  
 8 49,801 - 69,900  
 9 69,901 - 95,000  
 10 95,001 - 130,100  
 11 130,101 - 180,200  
 12 180,201 - 230,300  
 13 230,301 - 280,400  
 14 280,401 - 340,500  
 15 340,501 - 400,600

**Wild or Civilized****Psi - Stalker**

1 0,000 - 2,050  
 2 2,051 - 4,100  
 3 4,101 - 8,250  
 4 8,251 - 16,500  
 5 16,501 - 24,600  
 6 24,601 - 34,700  
 7 34,701 - 49,800  
 8 49,801 - 69,900  
 9 69,901 - 95,000  
 10 95,001 - 130,100  
 11 130,101 - 180,200  
 12 180,201 - 230,300  
 13 230,301 - 280,400  
 14 280,401 - 340,500  
 15 340,501 - 400,600

**Worm Wraith**

1 0,000 - 2,250  
 2 2,251 - 4,500  
 3 4,501 - 9,000  
 4 9,001 - 20,600  
 5 20,601 - 35,700  
 6 35,701 - 45,800  
 7 45,801 - 60,900  
 8 60,901 - 85,100  
 9 85,101 - 110,200  
 10 110,201 - 160,300  
 11 160,301 - 220,400  
 12 220,401 - 280,500  
 13 280,501 - 340,600  
 14 340,601 - 400,700  
 15 400,701 - 500,800

**Zenith Moon Warper****Lanotaur Hunter**

1 0,000 - 2,150  
 2 2,151 - 4,300  
 3 4,301 - 8,600  
 4 8,601 - 17,200  
 5 17,201 - 25,500  
 6 25,501 - 36,000  
 7 36,001 - 52,000  
 8 52,001 - 73,000  
 9 73,001 - 98,000  
 10 98,001 - 134,000  
 11 134,001 - 184,000  
 12 184,001 - 240,000  
 13 240,001 - 295,000  
 14 295,001 - 385,000  
 15 385,001 - 450,000



# Running the Game

G.M. Advice from Bill Coffin.

You seemed to have had it all planned out. You had four of your friends lined up and confirmed to play, so there wouldn't be too many characters, but there wouldn't be a dearth of them, either. You'd lined up some killer 'za from your local hangout, and they even cut you a deal because you ordered so freaking many of them. You had chips and pretzels of every kind, and you had enough soda pop to fill a swimming

pool (except for that orange stuff which your friend always seems to make explode when he opens it, staining, well, your entire apartment). Heck, you even had some cool mood music set up to get everybody in an adventuring mood. It was going to be a great night of gaming.

So what happened? How come things stunk so badly, then? The players didn't get into the adventure, and you felt like the entire eve-

ning was both work and slow torture. Role-playing shouldn't be like this, you told yourself. It should be fun, even for me, the guy stuck G.M.ing.

You're right. Role-playing *should* be fun. It is entertainment, after all. And even though being the G.M. entails a bit of work and might not seem on the surface to be as fun as running a player character, the job still has plenty enough rewards if you know where and how to look for them.

There are literally hundreds upon hundreds of things that go into being a good G.M. As well as, things to do to avoid being a bad one. There is no way we can even cover 10% of these in the space of this sourcebook, so we decided to highlight what we consider to be the most common best and worst practices of G.M.ing. These are not exclusive to **Rifts**, either. These are things that pretty much apply to running any role-playing game. So sit back and relax, and hopefully by the end of this section you'll feel a little more comfortable and confident the next time you're required to run your favorite role-playing game.

## The Seven Deadly Sins

In some circles of thought, there are seven prime ways for one to stray from the path of righteousness. These are the *Seven Deadly Sins*. They are:

- *Pride*, the excessive belief in ones' own abilities.
- *Envy*, the desire for other's traits, status, abilities or situation.
- *Gluttony*, the inordinate desire to consume more than that which one requires.
- *Lust*, the inordinate craving for pleasure.
- *Wrath*, the spurning of friendship and kindness for fury and hostility.
- *Greed*, the excessive desire for material wealth or gain.
- *Sloth*, the avoidance of work.

The strange thing about these seven sins is they also have their own ways of applying to some of the more common ways G.M.s (especially those new to the job) tend to sabotage their own games. Nine times out of ten, if a role-playing session has gone poorly, it is because the Game Master, not the players, has let something go awry. This puts a lot of pressure upon the poor G.M., who more often than not is somebody who never volunteered for the job in the first place. But, this is also the nature of the job — carrying the weight of the game on your shoulders. So it is not surprising that with so much riding on the G.M., that the G.M. is so often his own worst enemy. There are a zillion ways a G.M. can submarine the very game he is running, but there are seven classic pitfalls that are crucial to avoid. These are the **Seven Deadly Sins** of G.M.ing.

### Pride: Railroading

A big part of being a Game Master is writing adventures for the players to experience. Writing an adventure is kind of like writing a story in that you need to have at least some kind of plot. Sometimes G.M.s will write out an adventure's entire plot, soup to nuts. This is a dangerous thing, because it inherently contradicts one of the fundamentals of role-playing: the players should be allowed to determine the pace and direction of the adventure. The Game Master may very well be the referee and narrator of the adventure, and he might have written the fundamental aspects of the adventure, but when it comes to game time, if the players are to actually enjoy themselves, they should be given a little self-determination. They should be given the ability to go through the adventure more or less as they see fit.

Having said that, there are always times when the G.M. will need to step in and get the game back on track. Otherwise, how many times would entire adventures be devoted to player characters getting drunk and starting tavern brawls? But there is a difference between periodically prodding the players back into an adventuring groove and simply *railroading* them along the entire adventure.

Railroading occurs when the G.M. simply writes too much plot for the adventure and then expects the players to abide by that plot, even if they don't know what the plot is. Inexperienced G.M.s do this a lot, probably because they get a great idea for an adventure and that spawns a host of other great ideas of how that adventure might play itself out. Before the G.M. knows it, he has crafted an entire adventure from start to finish that the players will surely love if only they have the sense to go through it the right way.

See the problem here? Somehow, the G.M. has basically robbed the players of their ability to play. Instead of taking their characters on a romp, they are basically relegated to going through the adventure, banging their heads on the wall until they figure out what the G.M. wants them to do and how the G.M. wants them to do it.

This is just plain bad G.M.ing. It is zero fun for the players, and it's usually pretty frustrating for the G.M. too. From the players' standpoint, they might as well ditch role-playing altogether and have the G.M. dictate to them the entire adventure. At least then they could relax and hear what might actually be a fun story without having the frustrating duty of figuring it out as they go along. From the G.M.'s standpoint, railroading is really frustrating, because the G.M. has a story he really wants to share with the players but chances are the players will have a hard time figuring it out, and as long as they are stumbling in the dark trying to find the story's true path, the story isn't getting told. Again, if telling a story to the players is the G.M.'s goal, he might as well ditch role-playing and simply tell them a story. Making the players figure the story out for themselves is tantamount to having something hidden in your hand and forcing your friends to guess *ad infinitum* what it is, even after their desire to guess has long since gone away.

The best way to avoid this is to not pre-write adventures so much. A good approach is to set up the beginning of an adventure and then figure out three or four different ways it could go. Knowing how your players play and what motivates their characters will help a lot with this, since you can use that knowledge to roughly predict how the adventure might turn out. ("If Karlo the Juicer takes the bait, which he probably will, the Coalition trap will succeed. But if Romulus the Scholar sees through the trap, the group will make it to Whykin in time to hijack the supply train.")

In the end, having a solid plot line is not nearly as important as being able to make up a decent plot line on the fly, taking the story elements you have already established, presenting them to the players, and playing off their reactions to them. If the course of the adventure and if the very storyline is "written in real time," based off the actions of the players, then the players are really driving the adventure, and they will probably have a lot of fun doing it. Now, this is not necessarily easy. You need to be familiar with the player characters and the playing styles of the players, but if you can do this, you'll not only get fun adventures, but writing the adventure will become more like a game for you, the G.M., as you must figure out where to take the story next after hearing what the player characters have most recently done with it.

### Envy: Stealing the Show

A lot of G.M.s will introduce "ride-along N.P.C.s" into a group of characters. Sometimes such N.P.C.s are just side characters the G.M. keeps around as a device to manipulate the adventure. They are characters who are always with the player characters and who the G.M. has 100% control over. The G.M. can never really exert 100% control over a player character without coming off as a tyrant and quite possibly, ruining the game. As a result, without total control of the players, the players might take the adventure off in a direction the G.M. is totally unprepared for, which makes *his* life considerably more difficult. Writing adventures on the fly, like described in the previous section, is tricky enough. Doing it when the adventure has veered into completely unfamiliar territory can be downright impossible. That is why it might be tempting for the G.M. to have a ride-along NPC in the group, because at least *that* character can go where the G.M. wants things to go. And this character can be a very useful tool to influence the players,

which can be a good thing. So long as the G.M. doesn't overuse this device or make the NPC just a mouthpiece for the G.M., this practice can be fun and useful. But it has dangers of its own: stealing the show. All of the main action should go to the player characters not the G.M.'s various NPCs. Otherwise the player characters are relegated to the sidelines, where they can do little else but watch.

For the players, this is like slow death. They didn't come here tonight to sit around and watch their characters do nothing. They came to get involved. The more the G.M. intervenes with his own characters, the less fun it is for the player characters (the *real* characters). In a worst case scenario, the game devolves into little more than a puppet show being put on by the G.M. to an audience who would probably rather be doing *anything* else.

The best way to avoid this is simply cutting back on how much any one NPC gets involved in the adventure. It's okay to have tons of different NPCs, and even to have a few NPCs who figure prominently in the adventure. Just remember that these characters should never be anything more than sidekicks or secondary characters to the player characters. The G.M.'s characters should never defeat the main villain, never make a practice out of saving the heroes from death, and never start making the player characters' decisions for them.

## Gluttony: Unjust Rewards

Part of being the G.M. is doling out various rewards to the player characters: treasure, experience points, and other perks for their actions within the adventure. Unfortunately for a lot of beginning G.M.s, many RPGs today do not have comprehensive, cut and dry rules for how to issue rewards to the player characters for a job well done. **Rifts**, for example, has nice Experience Points guidelines, but as far as determining treasure and other perks, the G.M. is left to determine an appropriate reward on his own. Sometimes G.M.s get caught up in the moment, or they simply lack a sense of restraint, and they begin assigning incredible, implausible rewards to the player characters. One billion credits as a reward for capturing a low-level bandit. An entire armada of Glitter Boys. The governorship of Phase World. Things like that.

This is not to say that incredible rewards should always be out of reach of the player characters. If the heroes have nothing to strive for, they lose an important motivation. Indeed, if the heroes really want a billion credits, a fleet of Glitter Boys or the governorship of Phase World, they should be able to obtain these things after they have spent enough time and overcome enough obstacles to do it. That is the key to determining just deserts — the value of any reward should be commensurate with the time, cost and obstacles involved. In other words, small challenges merit small rewards. Enormous challenges merit enormous rewards. So go ahead and grant your player characters governorship of Phase World, but ask yourself: do they *really* deserve it? What enemies did they vanquish for it? What stood in the way of obtaining this incredible goal? If the answers to these questions begin to flood in ("Well, they *did* stop the renegade Cosmo-Knights from destroying the universe..."), then chances are the reward is worthy. If not (and in your heart of hearts, you *know* if you're going overboard), then you might want to reconsider what you are awarding your players.

There are two real dangers with handing out unjust rewards (also known as "Monty Haul" gaming, which is a gaming reference probably older than most people reading this book...\*sigh\*). The first is that when other gamers learn of a "Monty Haul" campaign, they tend to make fun of it mercilessly. Now, paying attention to peer pressure is not the kind of thing Palladium Books likes to condone. Be your own person, do your own thing. but keep in mind that gaming is all about having *fun*, and unfortunately, gamers have this odd tendency to judge the quality of how other people run their games. You don't see this a lot with games like *Monopoly* or *Diplomacy*, but you sure see it a lot with role-playing. And gamers just *love* to hack on Monty Haul campaigns. There is just this nasty little pleasure about tearing into a bunch of players and a G.M. who have decided to give themselves the moon and the stars. This is unfortunate; gamers tend to get picked on as nerds

or geeks in the first place, so it's sad to see gamers treat other gamers like that. But more than that, when somebody directly criticizes how you play your game, it can really kill the fun of it. You would think people would know better than to rain on somebody else's parade, but they usually don't. So if your game gets out of whack with the rewards, it can bring down some bad vibes from other players. This, on its own, is no fun, but it can be even worse if those bad vibes later make it more difficult for you or your players to join another gaming group. ("You guys are power-mad twitch gamers who own Atlantis. Go scratch.")

But there is a greater danger to Monty Haul gaming, and that is boredom. If your players have the sun, the moon and the stars, they might not be able to consider what else their player characters want. It is the old image of the bored billionaire or conqueror who has everything, yet is more unsatisfied than ever because he has no more worlds to conquer, no more wealth to amass, no more challenges to face. It is always good to keep your players hungry so that they will want to adventure again and keep their player characters chasing after the elusive (if ultimately obtainable) goals. And the best way to not spoil a player character's appetite for adventure is by not giving him a mountain of rewards whenever he wants them. Be sparing, but be fair, and your deserts will be just indeed.

## Lust: Loving Details to Death

Although most RPGs come with their own settings to play in, there is hardly a G.M. a live who has not modified, tweaked or further developed the setting on his own. Sometimes the G.M. might even just write a whole new setting for himself from scratch. This is a great thing! Role-playing, at least in part, is about *imagination* and there are few imaginative endeavors more intense and rewarding than building an entire make-believe world or adding details to one that already exists. But one should be careful when doing this so that they don't drown in the details. Details are a good thing, they add dimension, color and depth to a world. But if there are too many of them, they can become stifling, constrictive, suffocating.

Typically, when a G.M. lays on too much detail, it is in establishing the game's setting. The G.M. falls in love with this world he has created, and he has no problem adding detail upon detail upon detail, making the world as rich and as intricate and as whole as can be. The problem with this is that G.M.s rarely are content to keep these details to themselves. So when player characters are brought into such an environment, many G.M.s will fall prey to railroading. They will craft an adventure not designed for fun or to challenge the player characters, but to force march them through a grand museum of the G.M.'s imagination, observing all of his hard (if skillful) work. Players don't want to walk through a museum, though. More often, they want to trash it, and if a G.M. is going to go to the trouble of creating a palatial game environment, he had better get used to the fact that the players are going to do what they want with it. That means they might very well wish to destroy the setting. Or worse, they might be happier ignoring the bulk of the detail the G.M. has worked so hard to supply. After all, the players are here for an adventure, not necessarily to build a world. If they were that much into world-building, they would probably be G.M.ing. As a result, they often don't care exactly how many rivets are in the warship they are driving, or what Lord Coake's favorite meal is, or exactly what color some Blind Ataran Warrior Woman's eyes are. These things don't contribute directly to the flow of an adventure, so to the players, they are dead weight bogging down the action. If these mean something to you, the G.M., then feel free to make them up, but only share with the player characters the bare minimum for playing through the setting. For one thing, it saves you work. For another, it doesn't bog the players down with too much detail. And for, another, it allows the player the leeway to imagine things as *they* would like to see them. Remember, role-playing is an exercise of imagination for the players, too, and it's not fair to rob them of that right by overburdening them with the minutiae of your personal imaginary landscape. Besides, the details the players come up with will impress them a lot more than the ones you

provide, frankly. Not that your details are bad, but the mind can paint a picture for itself better than anybody else can do it for them.



## Wrath: Us vs Them

The very nature of role-playing adventures requires the G.M. to be a little adversarial towards the player characters at times. After all, the G.M. is the one who provides the player characters with challenges and dangers to overcome. He assaults them with hostile villains and monsters, he provides difficult situations for the characters to get themselves out of, and he applies special circumstances that make it harder than usual for the player characters to triumph.

Conflict and adversity are fundamental concepts of role-playing. If the player characters have no challenges, what point is there for their existence? In real life, it's nice when we do not have to face any major drama or crisis. But player characters thrive off of danger and adversity, and a nice, quiet life is the last thing they want. So, the G.M. must provide them with the kinds of dangers and challenges that make adventures so much fun.

The problem is that some G.M.s confuse their role as supplier of adversity with a mandate to adopt a competitive attitude with the players. As a result, the G.M. becomes less of a narrator and referee as he does some cruel and vindictive god that exists only to make the player characters' lives miserable. As a result, the player characters often find themselves dying more than they should, their efforts failing more than they should, and their general quality of life dipping much lower than it should. This is the recipe for disaster, because it will usually result in one of two things: either the players will stop asking the G.M. to be part of the gaming group, or the players will simply stop playing the game because it is no longer any fun.

There is no need for G.M.s to adopt an "us versus them" attitude. As the G.M., it is not your job to "defeat" the player characters. It *is* your job to gauge the abilities of your players and their characters and to supply appropriately matched challenges and dangers. The player characters should always have a decent margin of victory or survival in any given crisis situation. It is okay if the players themselves think they might be in a hopeless situation, because that raises dramatic tension

and makes things more exciting for the players. It also makes it even more exciting for them when they triumph over whatever challenge or danger they were facing. And, if the players never perceive that their player characters are in serious trouble, they will grow bored of the game. That said, putting their backs against the wall with no way out is not good G.M.ing. And doing it over and over and over again through the course of an adventure is even worse G.M.ing. It is simply condemning the player characters to slow death. If you're going to do that, you might as well have a runaway truck run the party over in the first five minutes of the adventure and get it over with. Unless you are running a "victim game," in which case it is a given that the player characters will most likely die, enforcing a high casualty rate among your player characters will only kill everybody's ability to enjoy the game.

It should go without saying, but the G.M. should also *never* use his ability to shape the circumstances of the game to exact revenge upon another player, or to simply mess with a player for the heck of it. Doing this will only mark you as a bully and a jerk and people will no longer play with you. Be smart, be mature, and don't abuse your power as G.M.

## Greed: I Want It My Way

One of the beautiful things about role-playing is that there are so many different kinds of games to run and power levels to play. This is especially true of **Rifts**, which has grown into such an incredibly broad, diverse game. Though there is an established setting, and a loose feel or theme to this world, it ultimately falls upon the G.M. and players to establish the feel of their own game. This is one of those things that tends to evolve on its own; it can not be forced or manipulated or nobody will have any fun. Unfortunately, some G.M.s fail to recognize this, and they try to ignore the kind of game the players want to play and enforce upon them the kind of game the G.M. wants to play. If the players and G.M. don't see eye to eye on the type of game to play and power level at which to play it, major problems will arise. The best way to get around this is for the G.M. to compromise and make what he wants fit



better to what the players want, rather than having things be the other way around. Being a G.M. is a bit like having a service job. You'll get the best results thinking of your players as your customers or clients, and as the saying goes, the customer is always right. If you work harder at satisfying what your players want rather than what you want, things will run more smoothly. If you insist that the players adhere to the kind of game you want to run, things will fail. Players just won't do it. Better you swallow some pride and bow to the players on this one. It might not feel good, but sometimes it is better to make a sacrifice for the sake of a good game than to not have a good game at all.

It helps to learn the kind of game your players like to play. Do they like their games to primarily focus on character development, storylines, or combat? Do they like their games to feel as realistic or possible, or are they willing to sacrifice realism for over-the-top action? Do they like their games to feel dark and gritty, or do they want them to feel irreverent and maybe even a little zany? What kind of power level do they prefer? Do they like playing "squishie" characters with low or no M.D.C., or do they like playing obscenely powerful characters like Cosmo-Knights, or do they like playing something in between? Do they like one-shot adventures or do they prefer long, drawn-out campaigns?

These are the kinds of questions you must answer if you are to really know what your players want. And unless you know what your players want, you will always risk running the kind of game they are uninterested in. That is no fun for anybody. So do your homework, and see what the players expect of you and of the game. If you think there is going to be too much of a conflict of interests, you might consider handing off the G.M. position to somebody better suited to meet the needs of the group.

Sometimes, though, you are the only G.M. there is and will ever be. And you sure aren't going to leave your gaming group, either. In a situation such as this, it's important to remember the fine art of compromise. Try being flexible. If you want to run a **Rifts** game that focuses on the hardships of poking through the ruins of a post-apocalypse world and if your players want to focus on the war in Tolkeen, then try to find a way to bring both of those elements to light so everybody is happy.

## Sloth: Blind Obedience

Like it or not, the G.M. is an authority figure. He is the official purveyor of the rules of the game, be they the "official" rules in the RPG book or house rules that the playing group has abided by for years, or they are rules the G.M. has just made up on the fly to deal with a situation never before encountered. This is not always an easy role to fulfill. Every G.M. will eventually run into a "rules lawyer," that particular brand of player who 1) insists that the only rules that count are those printed in the rule book and 2) probably knows the rules better than you do and 3) has a nasty habit of bending and mangling the rules to his own ends. Or, he will run into a situation in which the rules contradict themselves. Or, he will rule on something one way and then issue a contradictory ruling on something else. These are the many pitfalls of being the rules master, but if you are the G.M., you must find a way of dealing with it. Handling the rules of any RPG requires a bit of energy, though. But if you don't do it, if you just let everything slide with no sense to consistency or plausibility, you are basically abdicating your position as the game's authority figure. It means letting the rules lawyer rampage all over the game and tell *you* how to run it. It means not making a ruling of any kind because the rules themselves contradict each other. It means going back and rewriting the course of an adventure to correct an error that should have been left well enough alone. It means, in essence, letting the game self-destruct.

The first and best thing to remember when dealing with the rules of any RPG is this: *all rules are optional*. This is important, so it bears repeating. *All rules are optional*. RPGs have rules to provide the players and the G.M. with a guideline for how to run things. But no set of rules can cover every possible thing that can happen in an RPG. That is why

the G.M. is expected to take the rules and use them as a series of official guidelines as he then takes the matter of ruling his game into his own hands. Invariably, every G.M. and gaming group finds rules they don't like or rules they wish were there but aren't. It is perfectly okay to tweak existing rules to better enable the kind of playing you want. Likewise, it is fine to add whatever rules you feel are necessary for everybody to enjoy themselves. This is a time-honored part of role-playing, and it will probably be like this for as long as RPGs exist.

Now, when changing the rules of the game, it is best to do it with the players' knowledge. If the players expect the rules to work one way and all of the sudden, they find they've been changed on them, well the players are liable to get a bit cranky. Giving players fair warning (i.e., before the gaming session starts) that you are making a rules change is a good course of action. An even better one is getting the players' input on an impending rules change. This should help insure that when you, as the G.M. make the final decision, it is the one that everybody can live with.

## Characters That Count

Characters, both player characters and NPCs, are the lifeblood of a role-playing game. Without these, there is no action, no drama, no nothing. As the G.M., understanding what makes a good, interesting character will go a long way to improving the quality of your game. If you understand what makes for an interesting character, not only will your NPCs be more compelling and interesting to the player characters, but you will have a better understanding of what makes the player characters themselves tick.

Characters are more than just a collection of statistics. They have to have ... well ... *character*. They should have the things that make us want to know them, as if they were a real person. If the characters have the kinds of attributes, priorities and motivations that we can relate to, then they become that much more real to us, that much more intriguing. Players often lavish such details upon their own characters, but that is to be expected. They are pretending to be those very characters, after all. And even if they do not, the details of the players themselves often become those of their character, so you end up having a fairly well rounded, three-dimensional character anyway. Plus, their job is simplified by the fact that they only need to make one character. Lucky them! You are the G.M. You have to come up with every other person in the game. While you probably don't have the time or energy to roll up every NPC as a character, affording them with just a little detail in crucial spots can give your NPCs a kind of accessibility and animation that breathes life into the rest of your campaign.

## Race & O.C.C.

This is the first step for just about any **Rifts** character. With literally hundreds of different character races, R.C.C.s and O.C.C.s, this simple determination will probably do more to distinguish a character in one single step than any other aspect of the character creation process.

Race alone carries huge weight because every race has its own culture. Humans, though often decried by players for their lack of special powers, are actually the best fodder for making *good* characters for a variety of reasons. First, we know humans better than any D-Bee. You can have a D-Bee with a 100 page description of every aspect of its culture, but you still will have lived among humans your whole life. You inherently know a human's subtleties on a level that you can never match with an imaginary player race. For that reason alone, human characters have the potential to resonate most strongly among players in terms of realism and depth. That said, the alien creatures and people of **Rifts** have their own strengths, too. Often times, their unusual abilities or traits are fodder for the imagination and automatically start generating details about a certain individual that might not have come out otherwise. An Octoman from the Splynn Dimensional Market is of a slave species. This alone speaks volumes for how he might look at the world and the people within it. It certainly distinguishes him from, say,

a Dragon Hatchling whose freedom and power enable him to view the world in an entirely different fashion than the Octoman. Just remember, the race of a character carries with it a ton of character-building potential. Ask yourself what are the things that make this race special. What do people of this race want, need, fear, and like? To what extent is the character you are making typical of his race? And who might characters of this race deal with characters of any other race?

The same goes for the character's R.C.C. or O.C.C. Why the character chose this walk of life is another volume in the character's personal history. Might a human Headhunter look at things differently than an Octoman Headhunter? Does the character's O.C.C. have a culture all its own, and how might that interact with the character's racial culture? Just mixing those two things — racial culture and occupational culture — make for endless possibilities when creating characters, so don't overlook it!

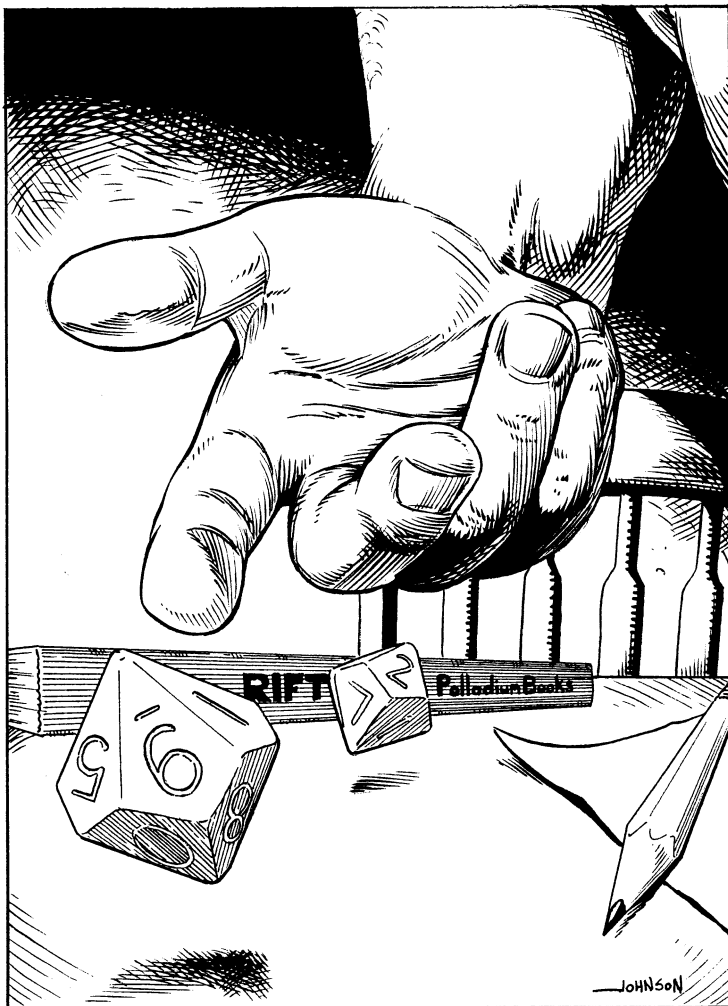

## Attributes

A lot of G.M.s never crunch out full statistics for their NPCs, especially those whose primary function in the game is as a faceless enemy the players will probably just shoot up anyway. That said, the very statistics of an NPC, even mundane ones like their H.P., I.Q. or height and weight, might offer some details to make the character more interesting. A Dead Boy who is unusually short might have been specially trained for "tunnel rat" duty at some point, which is very stressful, so as a result, he's really edgy and alert. Or a monstrous D-Bee with unusually low M.D.C. might mean that he is a chronically sick individual whose poor health makes him angry and ready to lash out at anybody. Or a City Rat with an unusually high I.Q. might be a genius of some kind who has found ways to put his incredible intellect to good use, despite the fact that he lives in the bad part of Chi-Town. Maybe the he

becomes a brilliant hacker, or maybe he is a wily entrepreneur, or maybe he plays people off each other all of the time to get what he wants. In all three cases — the Dead Boy, the M.D.C. monster, and the City Rat — we suddenly get a lot better idea of who these characters are just by extrapolating one of their simple details. And the nice thing about extrapolation is that the more you do it, the easier it gets. If we determine that Dead Boy is an edgy tunnel rat because of his height, we can bear that in mind when we determine his equipment, skills, etc. By the time you're done with the NPC, even if you've only spent a few minutes on making him, you will find yourself with something much more than a stock NPC. And the funny thing is, it's these quirky little NPCs with character and color that stick out in players' minds. For some weird reason, players will overlook the character you spent three days writing up a detailed history on, but they will love the slothful, Psi-Cola-swilling D-Bee you made up in less time than it took you to read this sentence.

## Skills & Abilities

What a character can *do*, in large part, determines who they are. When assigning skills for a character, consider why the character would have taken the skill in the first place. A Headhunter with the skill Dance probably has a different reason for taking it than a Rogue Scientist. The Headhunter might be a hard-partying slam-dancer who took the skill to really mix it up in Chi-Town's mosh pits. The Scholar might be a cultural anthropologist interested in the significance of ritual rain dancing among Native Americans or African tribesmen. If you apply this kind of thought to every skill, especially those that seem a little out of place for certain characters (like Dance for a Headhunter or Hand to Hand: Assassin for a Rogue Scholar), you will suddenly find your character is taking on a life of its own.

## Alignment

This is an often overlooked aspect of character creation. Some G.M.s don't bother giving their NPCs an alignment because the character may not be major enough to merit one, or because he doesn't want to spend the time considering the character's moral focus. Some G.M.s dislike playing with alignments because they force pre-conceived moral brackets around characters, and that is too limiting. Frankly, it is just as easy to see alignments as a kind of guideline that if used right, actually helps characters to flesh out, making them seem more alive and compelling. Take that Dead Boy tunnel rat we mentioned previously. If I go to the trouble of assigning him an alignment, he suddenly takes on a lot more color. Is he Principled, and views his hazardous specialty as a weird kind of crusade, or a sacrificial job he does to prevent his fellows from having to do it? Or is he Unprincipled, who only took the job of tunnel rat because he gets better pay for it and can loot enemy bodies in privacy? Or is he Diabolic, who enjoys the close-up killing that being a tunnel rat provides? Any of these three examples not only adds a new dimension to the character, but it can take him in one of three separate directions! At this point, if you took the same NPC and made three duplicates, each with a different alignment, you suddenly have three entirely different characters, all for not much effort. Some deal, huh?

The bottom line is alignment adds a lot to any character, big or small, good or evil, simple or complicated. Take the time to add an alignment to your NPCs, and just think for a second about how that will change the NPC's outlook on life, his motivations, and his general direction. You'll be glad you did.

## Disposition

The optional rules on p. 297 of *Rifts Ultimate Ed.* give a nice jumping-off point for this aspect of creating a character. The beautiful thing about disposition is that there doesn't have to be any reason behind it. A character might be a blabbermouth just because he has a natural proclivity to talk. Or, if you like, you can try to delve behind a character's disposition to get an even better idea of what makes him tick. Doing

this might give you a better idea of who this character is, where he comes from, and how he might act in any given situation. Let's take that Dead Boy tunnel rat again and apply the Blabbermouth disposition to him. Talking a lot doesn't make for very quiet sneaking around enemy tunnels, now does it? Maybe the character talks because he gets nervous. Or maybe he is so utterly fearless he talks during dangerous situations without regard of the safety risk it poses. Or maybe he is just a naturally talkative guy who can't shut up even when he knows it is dangerous for him not to. In each case, we learn a little more about the character. Perhaps not so much that the player characters will notice the moment they meet the NPC, but as *you* play him out, these little differences and details, now that you know them, might come to the surface during the course of the game, making the character feel more real and drawing the player characters even deeper into the game, forgetting, if just for a moment, that none of it is real. That is the magic of good G.M.ing — drawing somebody so deeply into the adventure that they almost forget they are really sitting around a table. Seemingly unimportant aspects of character personality, like their disposition, can be an important, if not obvious, key to unlocking that.

## Pros & Cons

Everybody has something good going for them and something bad going against them. Something that might not be a formal part of the character creation process, but is there nonetheless. This is a fun part of whipping up NPCs, because there are no rules for it whatsoever — you can just let your imagination fly and see where it takes you.

An NPC's Pros might be that he is unusually wealthy, has special contacts in a powerful organization, is himself part of a powerful organization, has an acute sense of some sort (like photographic memory), and so on. Or, he might have an incurable disease, be hunted by an unusual enemy, or might be haunted by a terrible memory of something. A lot of RPGs actually have detailed rules for these. They call them Advantages & Disadvantages, Pros & Cons, Perks and Flaws, whatever. All they do is formalize something that you already know if you've seen enough movies, or read enough books. And that is everybody has a particular circumstance that applies just to them, and they are all the more unusual for it. Don't be afraid to work this angle too, when crafting your NPCs. It adds dimension, depth, and direction. It makes them more compelling, or at the very least, more interesting.

## Internal Conflict

The world of **Rifts** is one of external conflict. Heroes versus villains, soldiers versus monsters, the Coalition versus Tolkeen, and so on. G.M.s usually have a pretty good handle on this kind of *external* conflict, even as it applies to individual characters. That Dead Boy tunnel rat, for instance. He's a Dead Boy, so he's all about external conflict, as he routinely fights his nation's enemies. But what of his *internal* conflict? What are the opposing forces inside his mind, his heart, his soul? These are the kinds of things that are rarely visible on the surface of a character (unless the character comes right out and tells people about them, but who does that, really?) but play a HUGE part in determining who that character is and how they act. What are the internal conflicts in our tunnel rat? Is he afraid of his job yet morally compelled to do it? Does he loathe the killing, even though he feels he must do it for his nation? Is he secretly afraid of tight spaces, even though his job requires him to go into them all the time? Is he a fanatic about keeping clean, despite a life of living in the dirt? These conflicts all take their toll or surface somehow in how a character acts, thinks and feels. Take the time to figure out how they do for your NPCs, and they'll intensify in ways you never imagined.

## History (Previous & Developed)

Finally, history. What has gone before for this character prior to his introduction to your game? People don't develop in a vacuum, and your NPCs shouldn't either. One's background can contribute a lot to their

personality, but it can also be a *great* source of adventure hooks. What did our tunnel rat do before he joined the army? Was he a criminal? A member of a privileged family? A wandering amnesiac with no sense of self? And of these things, which ones might connect the NPC with the player characters, or bring with it the potential for adventure? Did the tunnel rat steal from one of the player characters? Was he the one who killed one of the player characters' friends? Did he go to school with a player character?

## Motley Crews

One of the nice things about **Rifts** is all of the different characters one can make. There really are endless possibilities, as anybody who has ever tried writing an automatic character generation program for this game will tell you. Of course, all of this diversity can be a real bane to the G.M., who is faced with several disparate characters at the beginning of game time. Even if the G.M. is running a game in a particular corner of the **Rifts** world where only a relative handful of races and O.C.C.s are plausible, there still remains the possibility for a party of heroes to consist of a wildly diverse group. In terms of combat and problem solving, this is a good thing — a party's collective skills and abilities are like a Swiss Army knife. The more blades, the more challenges it can tackle. But with all of that diversity, it can be difficult for characters to find common ground, and that can ultimately hinder the adventure and ruin the game for everyone. As the G.M., it's your job to figure out how to avoid this. How to take your motley crew of players and make it so their differences end up helping the game play instead of hurting it.

## Role-Playing vs Roll-Playing

In any RPG, certain characters will gravitate more towards combat than others. Some will do it to the exclusion of developing their character or getting into the storyline of the adventure. Others will *avoid* combat or anything else that requires dice-rolling in favor of playing in character and interacting with the other players. Boiled down, this becomes a conflict between "roll-playing" and "role-playing." There is nothing wrong with either thing. Both are vehicles used by a lot of folks to have fun. Where either style of play becomes troublesome is when the players who practice them get in the way of each other having fun. To some extent, this is unavoidable. Face it: in a party with a human Juicer and Rulian Translator, the Juicer will want to pop caps and the Rulian will want to read books. Unless the G.M. provides ample opportunities for both characters to do their thing, somebody will get frozen out.

Something else to be mindful of is overzealous players who like applying their style of play where it might not be welcome. The Juicer's insistence on getting into a brawl with the librarian while the Rulian is attempting to research something is a trespass on the Rulian character's moment in the spotlight. If combat erupts in the library, the Rulian can get no research done and the game becomes all about the Juicer kicking ass. By the same measure, the Rulian's insistence on collating his research results in the middle of a gunfight, forcing a combat phase to pause while the G.M. answers the Rulian's questions, is a trespass on the Juicer. He's a Juicer, for crying out loud. No fair making him fight in slo-mo for the Rulian bookworm's sake of curiosity. As the G.M., try to keep these various styles of play compartmentalized a little so as to minimize the amount of trespass on other characters. Some trespass is inevitable. But there is no need for it to send the game into the death spiral of...

## Player vs. Player: Inter-Party Conflict

It was bound to happen. The Juicer and the Rulian have hated each other since the moment they met. The player characters are always at odds, and their goals run directly counter to each other. The time for

working things out has come to an end. Both characters are clearing leather and preparing to throw down (although the Rulian doesn't stand much of a chance; maybe he hired a 'Borg to fight for him). At any rate, the adventure has suddenly taken that odd turn where the heroes are no longer fighting the villains. They are fighting themselves and the most notorious of self-destruction — inter-party conflict — has beset the player characters.

Unless the G.M. keeps the player characters' conflicting desires and priorities in check, something like this is always going to happen. Some player groups *love* player vs. player combat and do anything they can to foster it. Other groups find this to be somewhat horrifying at worst, a pain in the butt at best. In both cases, though, players' characters are now on the line, and there's the chance somebody's going to lose their character. This can create bad blood between the players themselves, not to mention throwing a monkey wrench into the flow of the game. Where there was an adventure in progress, there now is a party that

looks like it stumbled into the last five minutes of *Reservoir Dogs*. G.M.s, if you want to avoid this, keep your eyes peeled for warning signs, because they *will* present themselves throughout the game. Are there characters who obviously contradict each other? The Dead Boy tunnel rat will probably not get along with the D-Bee mage in the party unless the players come to some kind of understanding for how their characters might conceivably get along. As the G.M., take the time to do a quick check of the characters in the party and see how they might come into conflict with each other. If there are any major conflicts in the mix, ask yourself how your adventure might bring those conflicts to a bubble. Ask the players if they wouldn't mind modifying their characters so they won't come to blows. Heck, why not ask the players if they wouldn't mind with a house rule that simply forbids inter-party conflict? Just make sure that if the players get ready to throw down against each other, you will have done everything you can to have prevented it in the first place.

---

## ADVENTURES & CAMPAIGNS

---

By Bill Coffin

One of the iron rules of writing large stories: start small. You know that cliché about a journey of a thousand miles starting with a single step? Well, it's true. Start small and work your way up into an epic adventure. Focus on the characters and the personalities. Their goals and ideas. Give each character a moment to shine and grow. All too often, we Game Masters get so worked up designing grandiose or elaborate adventures that we sometimes forget about the players — and after all, the player characters are (or should be) the focus of any good adventure or campaign. Or one gets so caught up in the nuances of detail that he "chokes" on the project and never finishes it. Or, what we do finish is a far cry from the glory and grandeur we initially envisioned.

But that doesn't mean it is not worth the trouble. And with time, one will develop a feel for just the right amount of detail and action. Take it step by step and let it take off on its own. After a few "little" adventures, you'll find that the story takes on a life of its own, and even the little stories take on epic proportions. How? Because the player characters are the unifying factor. The common denominator that ties it all together. The next thing you know, you'll be hearing things like, "Hey, remember when we took on those vampires in the old church," and "Remember that damn D-Bee thief who kept pestering us for a week? He sure came through in the end." And, "Yeah, but my favorite moment was ..." The point is, most true epics build and grow on their own. So forget about making it happen, just do good stories and have fun. It will happen on its own. Half the battle is focusing on the here and now, having fun and letting it all just unfold.

After all, epic campaigns are some of the coolest things you can pull off as a G.M. Let's look at the reasons why.

**One:** They play to every G.M.'s inner desire to tell a story. (Yes, even for those G.M.s who get drafted into their job by fellow players.) The Palladium game design makes G.M.ing a whole lot more interactive than for many other games. As far as I can tell, the **Palladium Fantasy RPG** was one of the first games to stress storytelling over cleaning out randomized dungeons. (Sure, other games stress storytelling, but to my knowledge, Palladium was doing it before all of them.) As a result, we Palladium G.M.s learn to weave narrative tapestries that (hopefully) take our players to another world for a few hours. Working this spell on an epic level is perhaps the greatest challenge the G.M. can face. As a result, if and when you manage to pull an epic campaign off, it gives you a uniquely thrilling sense of satisfaction.

**Two:** Epic campaigns add a sense of history to your game. If all you run are endless one-nighters with disposable characters, you're probably going to tire of it sooner or later. In my experience, players enjoy building up their characters over a long period of time, slowly gaining

power and experience while developing their personalities and bonds with the other folks in the group. Epic campaigns lasting weeks, months, or even years provide a great backdrop for this kind of character development. So, even if your characters go on to bigger and better things, or if you drop those characters altogether, you'll always have that one big adventure to remember. Having monumental adventures like that can change how you G.M. and how your players play. They end up being the landmarks for your progression as a player and creator of interactive stories. (Plus, it makes it easier for you and your friends to sit back and say "Remember when..." Trust me, as you get older, this becomes important for some reason. I still haven't figured out why.)

**Three:** They allow you and your players to live out the grand adventures found in the movies, novels and stories that inspire our role-playing in the first place. After all, what would be cooler than watching *The Matrix*®, *Braveheart*®, *The Road Warrior*® or the *Star Wars*® saga, then playing an adventure of equal scope and drama? That's right ... nothing!

**Four:** Your notes for an epic campaign can become the core material for something you might submit to Palladium for publication. The moment you begin making money off of your role-playing habit, the faster your folks will get off your back about spending so many sunny days hunched over rulebooks and polyhedra dice!

### Nuts and Bolts

Of course, coming up with an epic campaign isn't easy. This is no simple tavern brawl in the 'Burbs or a weekend jaunt to the Pecos Empire. This is something that should make a permanent mark on your own game setting and commit your characters to some life-altering endeavors. To do this, you'll need six critical components.

**1. A Backdrop:** You could also call this the context, the setting or the foundation of your campaign. Whatever word you use, this is what provides an environment in which your epic campaign takes place. Most importantly, it sets the stage for your players to do things they normally wouldn't (or couldn't) do in just one or two gaming sessions. A major military campaign, a regional or national crisis of some kind, a major supernatural crisis, an issue requiring divine intervention ... these are the kinds of things from which truly epic stories spring.

**2. A Plot:** Every good story has a good plot, and epic campaigns are no different. Like I said before, Palladium games stress a story-oriented style of adventure-writing, so most Palladium G.M.s are already familiar with coming up with a plot for their adventures. With an epic campaign, the trick is coming up with a plot that is simple enough for

everybody to follow, big enough to merit treatment, yet open enough to accommodate the constant changes and revisions that will happen as the epic campaign progresses. Throughout the epic campaign, you can have all sorts of side stories and tangents to take away from the main action, but that main action always has to be there in the background. Otherwise, the epic campaign will have very little cohesion and no sense of an ongoing drama.

**3. A Motivation:** This is the reason why the players willingly subject themselves to all of the hardships and trials of the epic campaign. Without this, there's no reason for there to be an epic campaign at all. Motivations fall into two basic categories: enticements and compulsions. Enticements are, to borrow a phrase from Psychology 101, a kind of positive reinforcement. In other words, for completing the epic campaign, the players will receive a reward. Just as with short adventures, treasure, experience, arcane knowledge, revenge, and gaining or repaying a favor are all classic enticements that work time and time again. Compulsions, on the other hand, are a form of negative reinforcement: if the players fail to complete the epic campaign, something bad will happen to them. Now, compulsion-driven epic campaigns work well in fiction. Take the movie *Alien* for example. The crew of the *Nostromo* must defeat or evade the alien creature or they will die. However, for role-playing, I don't think this kind of motivation works well at all. Compulsory adventures work well for one or two gaming sessions, but after that, they become a kind of elaborate prison for the players, no matter how interesting or well-written the campaign is. Thus, not only do the players need some kind of assurance that they'll be adequately compensated for their trouble, but they also need the assurance that they'll have the freedom to pursue the quest at hand however they like.

**4. A Theme:** This is the moral, emotional and psychological backdrop for the whole thing. Compare, for example, *The Terminator* against *Blade Runner*. Both stories are about destroying homicidal robots. *The Terminator* is lots of fun, but it doesn't have much to offer besides some cool special effects and lots of gunfire. *Blade Runner* has that too, but it has a lot more in terms of its theme. Unspoken is the issue of what exactly makes a human. If a person thinks he is a human, acts like a human, and is human except for his four-year life span and the fact that he was built, not born, what does that make him? In a world where any life form can be artificially replicated, what is there to prove to oneself that they have not been replicated, too? What if the future held not the promise of technological progress, but the emptiness of technological burnout? These are the kinds of things *Blade Runner* makes the viewer think about, so the story stays with them for a long, long time after the final credits roll. That is the power of a theme. A deep theme keeps the story alive in your heart the way a shallow theme doesn't. Now, you can have a long-term campaign without any appreciable theme, but it won't ever have that epic feel you and your players crave. For there to be real power to this thing, it's got to have some kind of a theme. Simple but compelling themes, like heroic sacrifice, avenging an ancient wrong, settling an endless war, etc., will work fine if you can't come up with something really earth-shattering. But just have a theme. It will make everything feel better.

**5. A Team:** If you really want an epic campaign to see through to the end, you'll have to make sure the group that's playing it will stick together through thick and thin. The best way to do this is to make sure everybody has roughly the same alignment. Often times, radically different alignments and dispositions make it impossible for adventurers to stick together for very long. Having different alignments in a group is great, of course. And a little inter-character tension can add plenty to the dramatic tension of the campaign. But if your group has a Principled, a Scrupulous, an Anarchist, a Miscreant and an Aberrant, chances are, the team will dissolve by the campaign's halfway point.

**6. Time:** Rome wasn't built in a day, and epic campaigns can't be played in one, either. If you want this thing to really work, you have to be sure that before you begin, you have a reasonable chance that your group can come together with reasonable frequency for the next few weeks or months. This is probably the toughest part about devising an

epic campaign. For most of us, school or work gets in the way, not to mention players moving away, getting married, quitting role-playing, or all the other upheavals that can happen. To some extent, you can't help this. If the real world intrudes, the real world intrudes. However, some pre-planning can help hedge your bets. Are you playing this thing while you're at college? Are your players living somewhere permanently? Are you going to have to stop playing in the foreseeable future, for any reason? Are you willing to let other players join the campaign to fill in for players who have left? And if all else fails, would you and your players be willing to carry on via e-mail, in a PBeM (Play By e-Mail), in a chat room, through a message board, by snail mail, etc.?

## Excuses, Excuses

Even if you have all of these things (or at least you think you do), there will always be other pitfalls. After one talks with enough G.M.s, certain common complaints about running epic campaigns come to the surface. Here's a sampling:

**"I don't have any good ideas!"** Writer's block is a terrible thing, isn't it? If you ask a hundred different writers what their cure for writer's block is, you'll get a hundred different answers. All I can offer is this: usually, when I get writer's block it's because I'm trying too hard and/or I need to let my creative batteries recharge. Step back from your project. Work on something else for a while. Or take some time off from designing altogether and play that new computer game you just got. Sometimes, reading non-RPG stuff is the best thing for me, because it gives me good ideas and lets me look at my campaign from a different angle. I can't tell you how many adventures of mine have sprung from reading the *Wall Street Journal* or *Atlantic Monthly*, or by catching a few good shows on *The Learning Channel*, *The Discovery Channel* or the *History Channel*. In the end, finding good ideas is not about actually finding good ideas. It is figuring out what are the kinds of things that really inspire you and get your creative gears turning. Most really creative people really don't need much aid in this, they get ideas from pretty much everything around them. For the rest of us, though, getting good ideas might take a little work, so seeking and using inspirational materials of any kind is a welcome course of action.

**"No matter what I do, it feels like I've ripped off some famous novel or movie!"** So what? You're not going for originality, per se. You're going for having fun with your players. Borrowing ideas only becomes a problem when your players can see right through your adventure because you're borrowing too heavily from a story that everybody's familiar with. ("Let me see...we're the custodians for some little kid who will one day grow up and become the military genius who will defeat the Mechanoids once and for all, but until he grows up, he must be protected from the human-looking Mechanoid assassins that have been sent after him?") Of course, given the unpredictable nature of role-playing, this problem often ends up solving itself when a player does something that didn't happen in the borrowed story. ("Well, guess what? This brat can take care of himself. We're dropping him off in the 'Burbs, and we're gonna sign up as mercenaries to fight in Tolkeen, where the real money is. How do you like them apples?")

The second problem that idea-borrowing creates is if you're designing an epic campaign for publication. There's a difference between being inspired by somebody else's work and simply ripping it off. All aspiring writers should know the difference. But, if you don't plan on trying to make a buck off your campaign, then by all means, borrow! Between comic books, novels, movies and video games, there is plenty of great source material out there. Undoubtedly, you have your favorites, right? Think back and see why you liked them so much. What was it about the story, the characters, the setting, the theme? Now, can any of that be used to fill in the blanks for your epic campaign? If so, go to it. I'm sure most of these authors would be flattered. (I know I would!)

**"My players don't want to get into a really big adventure!"** Some players just like the short, sweet nature of playing unconnected, one-night adventures. And some players are just wimps who are afraid to commit. Any player who resists joining in an epic campaign falls

into the latter category. (Just kidding!) Seriously, if this is a problem, then try running a series of loosely connected adventures under the same setting. After a while, you might find an epic campaign forming all by itself, standing on the shoulders of the short adventures that came before it.

**“At least some of my players are going to have to leave the game before this campaign ends!”** Don't you hate it when this happens? If real-world pressures are going to muck with your game, you probably can't do anything about it. The best defense is to have extra players in reserve to keep the number of characters constant and preserve the continuity of the campaign. For this, it helps to have pre-written segments describing the departure of a player and the inclusion of a replacement. This works especially well for Play By E-Mail campaigns (PBeMs) or message board-style Play by Post (PbP) games, both of which can have a number of non-playing “lurkers” monitoring the action and ready to jump in at any time.

**“It started out great, but now it's stalled!”** Ah, yes. The old “it looked good on paper” syndrome. What seemed like a good idea initially might not turn out to be so much fun after playing it for a few sessions. Or, maybe you've just run out of ideas for your current campaign. Or maybe your enthusiasm or your players' enthusiasm has waned. This might be a good time to take a break from the campaign itself, either with the same group of characters or with a whole new party. There's nothing wrong with taking your players on a couple unrelated adventures while your thoughts for the ongoing epic campaign sort themselves out. After a while, you'll either have come up with ways to bring your campaign back to life, or you will realize that it's just not going to work anymore. Either way, you'll have settled the issue.

## A Final Word

Well, if you've read this far, it's a safe bet that you are seriously considering writing an epic campaign. (It's either that or you have an enviable amount of free time on your hands!) If you're really wanting to take that big leap and construct a monumental adventure to shake the very foundation of your game, then more power to you! Epic campaigns entail lots of hard work, overcoming writer's block, dealing with game-play snafus and a host of other headaches. But, as they say, anything worth doing is also worth the hassle. That goes double for epic campaigns. In our book, they're one of the best things about role-playing. And after giving it a try yourself, we hope they become one of the best things in your book, too.

---

# 100 Rifts® Adventure Ideas

Below are 100 adventure hooks for **Rifts®**. These are not complete adventures. Heck, they're not even **Hook, Line & Sinkers™**! They are just little kernels of what could easily turn into an adventure if the G.M. fleshes it out, or they could blow up into a full-fledged campaign if the G.M. likes what he sees and really runs with it, either by taking one idea and expanding it to the Nth degree, or by stringing together a bunch of ideas and filling them out into something greater than the sum of its parts. Either way, the 100 entries presented here should at least give you G.M.s something to think about as you craft the next adventure for you and your gaming group. Have fun!

**Note:** The situations presented in these adventure ideas are just *hypothetical*. They are *not* official changes to the **Rifts®** setting, nor should they be interpreted as definite impending changes to be made to the **Rifts®** setting.

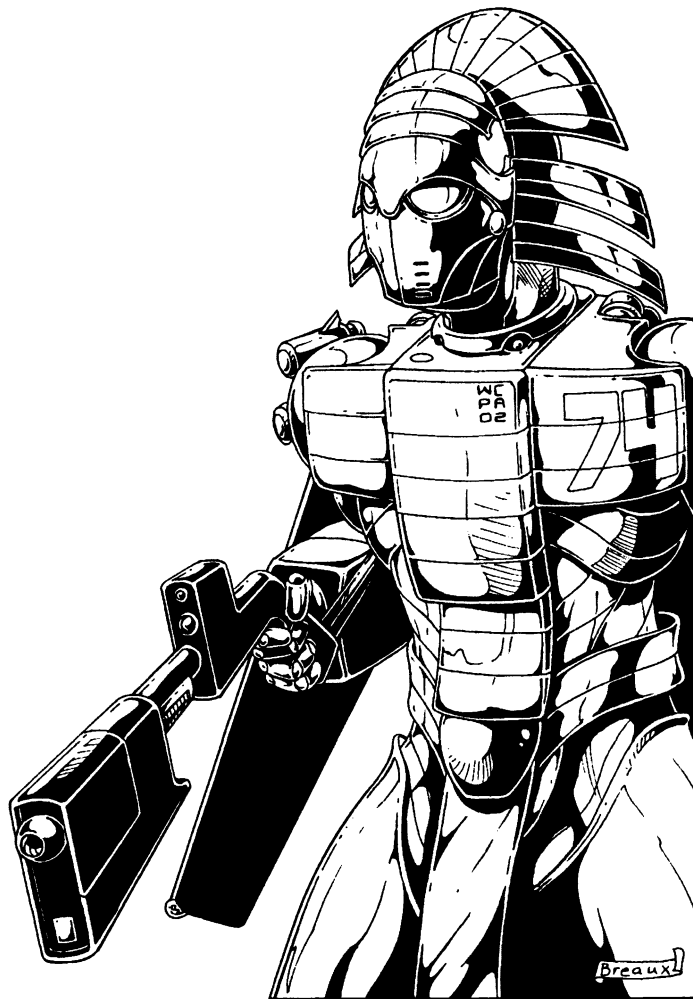

## North America

**#01:** The ruins of New York City, now referred to as *Mad Haven*, have become a terrifying jungle of ruined Mega-Damage skyscrapers poking out of the much-raised waters of the Hudson River and Long Island Sound. Deep beneath the water and the ground wreckage, however, lies a vast high-tech undercity. Most of this has already been flooded and is inhabited by a strange race of hostile, aquatic mutants. But there are rumors that a few blocks of the undercity never flooded and contain incredible stores of pre-Rifts technology. Care for a treasure hunt?

**#02:** The computer intelligence A.R.C.H.I.E. from the *Cyberworks* facility in Maryland is waging an ongoing war with an advance party of Mechanoids! Obscenely powerful, insane and sinister invaders from across the Megaverse, the Mechanoids intend to conquer absolutely everything that there is. If Earth is to survive, this advance party must be destroyed. A.R.C.H.I.E. can't do it himself. He needs help, and fast. The more the better.

**#03:** Deep in Dinosaur Swamp, some old coot is running exotic safaris where the gunners go into the swamp wearing funky suits of SAMAS-style power armor only with a huge airfan on the back, like old-fashioned swamp boats.

**#04:** A council of mages is holding an important and unscheduled conference in Lazlo in two weeks. Clearly, something important is going on, but nobody in the players' group has been invited. Not many people know about this yet, so if the heroes want to crash the party, they have ample time to set up a plan.

**#05:** The Coalition is tired of dealing with the Black Market, and is targeting them in a concerted military campaign. It just so happens a large Coalition field group hits a roving Black Market arms bazaar just as the player characters themselves are right in the middle of the place,

shopping around. Pandemonium erupts as the Coalition attacks this extraordinarily well armed enclave. What do the heroes do?

**#06:** In the New West, the player characters have killed a famous gunfighter, whether by accident or intentionally. Now, his entire clan of 60+ friends and family is looking for revenge.

**#07:** For various reasons, the player characters have ventured far to the north to confront the steadily growing Xitixic problem there. The heroes are ready for anything and prepared to carry out drastic measures to contain the aliens.

**#08:** All hell has broken out in the Lone Star genetic engineering facility! A terrifying monster from another dimension has broken its bonds here and is rampaging throughout the place.

**#09:** The Astral city of Psyscape has come back into focus, and for some weird reason it is temporarily visible to everyone who sees it, not just psychics. The city would not do this unless it faced some critical danger. What could possibly spook this city of champions so badly that they are looking for outside help?

**#10:** The Vampire Kingdoms of Mexico have all united under the unknown leadership of *King Julio Crusado*, a vampire of incredible age. If Crusado's legions hold, the vampires will not only carve a unified kingdom for themselves, but they will almost certainly wreak havoc with neighboring countries (i.e., the Pecos Empire, Lone Star.)

## South America

**#11:** The Republic of Colombia is under siege by an endless legion of vampires and their minions. They all just keep coming from the depths of the surrounding jungles in small but steady numbers. Eventually, the Republic will get worn down if the source of this endless army is not located and neutralized. The Republic has all of its resources tied up in immediate defense. Might the player characters be interested in taking the job?

**#12:** The alien Arkhon invaders, who have fought with various parties in South America for so very long, are suddenly vacating the continent altogether. Nobody is exactly sure why, but the prevailing theory is that some interstellar menace of the Arkhons' is on its way to Earth, and the Arkhons want to be as far as possible from South America — their own original landing spot, and what their enemies are probably homing in on.

**#13:** The Silver River Republics have ceased all formal contacts with each other and a nasty civil war is brewing. The reason is unclear to outsiders, but it seems to have something to do with not sharing military secrets among the various member states, and the recent assassination of numerous government officials among all of the Republics.

**#14:** The Lagarto Kingdom has become increasingly entrenched in its worship of the Dragon Gods who rule the country. Now those gods have commanded their legions of the faithful to clean out all of South America of those who are not Lizard Men or who will not convert to worshipping the Dragons.

**#15:** In the Empire of the Sun, the people of the cities and the people of the rural villages have drifted far apart from each other in terms of culture. Now, a wave of massacres among the rural villages have been blamed on the armies of the cities, and the entire country teeters on the brink of war unless somebody can determine who the *real* culprits behind the massacres are.

**#16:** Mutant animal exiles from the Achilles Republic have obtained extensive data on genetic modification pioneered by the Achilles Corp. Now these exiles, who are leaving their homeland for reasons they are reluctant to reveal, are hatching a plan to build a superfreighter that will take them from South America to the floating city of Tritonia, where the animals hope to parlay their technical data into letting the Tritonians accept them into their society.

**#17:** Deep in the jungle, a secret cult of Nazcan Line Makers is putting the finishing touches on a pattern so huge it can only be discerned from orbit! They have spent years putting it together, and they have

buried funky little Techno-Wizard batteries that when jointly detonated, will empower the pattern with the energy it needs. The question is, what will it *do*?

**#18:** The pirate nations of the Amazon River are under attack by the New Navy! It seems Nemo-2 has brought the *Ticonderoga* into the waterways and is launching his own bid to eradicate South America's sea dogs once and for all.

**#19:** The Megaversal Legion is looking for volunteers. All you need to join is to have a few kills under your belt and the urge to get a few more. Sound tempting?

**#20:** Somebody has found a new candidate for the Lost City of Gold. Dubbed *Goldenorb*, the city is a massive complex once inhabited by millions of magic-wielding humans, but now seems deserted. Only its indestructible golden buildings remain, a massive treasure nobody can seem to figure out how to plunder.

## Atlantis

**#21:** Coalition spies have been caught infiltrating the city of Splynn, and now there is a rescue effort underway to save them before the Splugorth have them all executed.

**#22:** By a weird twist of fate, the player characters have found themselves on sale as slaves in the Splynn Dimensional Market. The heroes could try to escape on their own (not hard) or they could stay and try to engineer a slave revolt that could shake Atlantis to its very foundation (hard but worth the challenge).

**#23:** Inexplicably, the Gargoyle Kingdom of Atlantis has refuted any and all allegiance to the Splugorth and have instead allied themselves with the island's vampire population! This has the Splugorth freaked to say the least, and an all-out war effort is underway to purge these hostiles from the island.

**#24:** The Kittani have decided, with Splugorth approval, to begin selling lower-grade versions of their weapons, power armor and fighting vehicles on the North American markets. If the stuff sells well, and it most likely will, the Splugorth and Kittani will embark on a massive push to sell their military technology all over North America and beyond. The aim is to push other arms merchants like the Naruni and Northern Gun out of business. Oh, yeah, the Sploogies figure they'll make a mint on this, too. And it'll get under the skin of the Coalition, which will bring a chuckle to Splynncryth's disgusting lips.

**#25:** A Rulian Translator from the Splynn Dimensional Market has obtained an alien book of runic magic. Using his unique translating and language abilities, the Rulian has unlocked the book's deepest secrets, and has been transformed into a god-like creature, crackling with energy and overflowing with knowledge. He does not want to leave Atlantis, and he does not want worshipers. He wants to recruit anybody who will join him on his crusade to destroy Lord Splynncryth and liberate all of Atlantis from the Splugorth forever.

**#26:** The player characters have obtained some bizarre form of treasure that they know is extremely valuable, but have been unable to sell anywhere. Then it hits them — if you can buy anything in the Splynn Dimensional Market, why can't you sell anything there, too? Thus begins the group's long trip to the greatest market in the Megaverse, where they might be made millionaires, or where they might just end up getting in a lot of trouble, as adventurers so often do.

**#27:** A mysterious benefactor has hired the player characters to infiltrate Atlantis and arrange for the escape of a dozen Blind Altaran Warrior Women who wish to leave their life of enslavement far behind them. There is just one problem. The Warrior Women are already on the lam, and there is a hefty reward out for any of them.

**#28:** After their capture by the Splugorth, the player characters now find themselves unarmed and running for their lives through the woods of the Atlantis hunting grounds, where the jaded nobility will hunt them as if they were animals. But can the heroes, using their natural abilities and teamwork, be able to turn the tables on their hunters and fight their way to freedom?

**#29:** The heroes learn that there is a bulk freighter filled with lost technology floating adrift in the Demon Sea. It has no main engine power, but its automated systems can keep the ship afloat during bad weather as well as keep the ship's robo-defenses up and running. If the heroes can capture the ship and salvage it, they will be set for life.

**#30:** The CS and NGR have teamed up to conduct a joint assault upon Atlantis. Both human nations are tired of Splynnerryth giving aid to their sworn enemies. The Splugorth must be punished, and punished severely. The question is, in an all-out war between these parties, who would win?



## Europe

**#31:** The New German Republic is putting its major war effort to destroy the Gargoyle Empire in motion. It is a massive effort that will tax the country's resources to the limit, and the counterattack it will draw from the Gargoyles might destroy the Germans themselves. They are willing to accept any human help to fight the Gargoyles, just as the Gargoyles are accepting help from the Phoenix Empire and Atlantis.

**#32:** The New German Republic is launching a last-ditch effort to forge a strategic alliance with the Coalition. To that end, they are sending a high-level diplomatic team to Chi-Town, via one of the Republic's fancy supersonic aircraft. The only problem is the aircraft suffers problems and must make an emergency landing somewhere between Europe and America. It is probably somewhere on the volcanic realm of Iceland or the icy wastes of Greenland. Both the NGR and the Coalition are launching search and rescue efforts to find the downed plane. Freelance adventurers are also looking for the craft, since its salvage worth is in the tens of millions, at least. If the thing is still in working order, any group who commands it has unfettered global travel ability.

**#33:** The Brodkil are on the move, and the only thing stopping them from spreading to the east and south is the small but valiant Kingdom of Tarnow. Possessing a tough but small army, the Tarnow defenders are openly shopping for adventurers willing to fight on the Kingdom's behalf to stem the Brodkil tide.

**#34:** All along the peninsula of Italy and the Mediterranean coastline, a new and potent nation called the *Maximus Imperium* has exploded in a wave of conquest and expansion. The Maximus Imperials are all members of various canine races, but mostly they are *Wolfen*, a masterful race of creatures found in numerous places throughout the Megaverse.

**#35:** The *Iberian Wilderness* covers everything from the south of France through the nations of Spain and Portugal. Until recently, the land has been devoid of any formal civilization, but in the last ten years, a trio of large and well organized trading centers have sprung up on the southern coastline. These are alien cities meant to be interdimensional trading points like the Splynn Dimensional Market. Exactly who or what is behind the cities is a mystery.

**#36:** A war in England between new Camelot and the Fomorian giants has erupted right along the waterways dividing England from Scotland. Known as *Hadrian's War*, since most of the fighting is near the ancient location of Hadrian's Wall, the fighting has been savage and bloody, with both sides taking terrible casualties.

**#37:** Ireland is known as a land of Faeries, but recently, a dark menace has gripped the Emerald Isle, making these days perhaps the last for the Faerie population. A new race of black-hearted Faerie Folk have come from another dimension and are bent on taking over all of Ireland, driving before them the current Faerie occupants. All throughout the island, pitched battles are soaking the ground with fey blood as an entire civilization hangs in the balance.

**#38:** Vampires in the Carpathian Mountains have gathered in force, but they have not made a move against any local settlements. Local kingdoms of humans and civilized D-Bees have grown very worried about this force of bloodsuckers and are trying to get some kind of intelligence on them. Rumor has it the vamps are in the process of summoning a vampiric god to this world who will transform all of its followers into godlings. Then and only then will the vampires take over the entire mountain chain, and then Europe, and then ... the world.

**#39:** The Warlords of Russia are locked in unending conflict with the hordes of demons who plague that country. They are also in conflict with each other, turning western Russia into one of the largest free-fire zones in the world! Anybody who wants to get involved can do so easily, either fighting for or with the Warlords, or hunting the supernatural menaces of the land.

**#40:** The Warlords of Russia have mastered cybernetics in a way no major nation has yet done. Until recently, nobody outside of Russia even knew of the mighty cyborg soldiers fighting in Russia, much less



what their capabilities are. However, Naruni spies have just finished collecting specimens of every major Russian cyborg model (from Light Machines to Cyborg Shocktroopers and everything in between), and they intend to sell these design schematics to any takers. Having not made the kind of money they were looking for on weapons sales, the Naruni reps on Earth hope to make a killing selling new weapons tech information to parts of the world that might not ordinarily get together in the first place. This Russian cyborg plan is the test pilot for the entire program. Time will tell how it all works.

## Africa

**#41:** Deep in the Serengeti, massive migrations of wildebeests and other animals continue just as it had in the days before the Rifts. Millions of animals travel through Kenya and Tanzania, with many of them not surviving the journey. Over the years, the gradual release of potential psychic energy by these dying animals has led to an instability in the fabric of the Megaverse in that part of Africa. Now, a massive super-Rift will open sometime during the next migration season unless somebody can somehow restabilize the Megaversal fabric there.

**#42:** The Phoenix Empire is heavily supporting the Gargoyle Empire in Europe with weapons and training personnel. The Phoenix Empire has little to gain from this except the satisfaction of helping contribute to the demise of a powerful human nation, the NGR. The NGR has had enough of the Phoenix Empire's meddling, and has sent a team of covert assassins to infiltrate the Empire and eliminate its leaders and other powerful members of the government. They might or might not even have a portable, experimental mini-nuclear device they intend to detonate in the heart of the Empire, turning the land into the kind of mildly radioactive place that supernatural creatures can not survive in.

**#43:** The Olduvai Gorge is where the oldest fossils of humanity have been discovered. Now, that fossil record has been lost as the Gorge mysteriously turned into a bottomless canyon! This appears to be the work of a sinister African Witch named *Mobu the Rainkiller*.

**#44:** Deep in the Congo jungles, an enormous but primitive civilization of Grimbor ape-men has formed in secret and now is slowly coming into contact with the tribes of humanity in the area. The Grimbor mean no harm, but they have this bad tendency to scare humans into attacking them. Thus, an enormous, low-tech war is brewing in the great jungle in the world for the fate of the nascent Grimbor nation as numerous human tribes assemble and ally in a joint effort to drive the Grimbor back into the shadows.

**#45:** The Splugorth are busily building new slave-cities along the western coast of the continent. However, a mysterious force of soldiers using both magic and technology have attacked one of the new outposts, destroying it completely. According to reports from the fighting, these mystery warriors employ some form of weaponry that puts their Kittani counterparts to shame.

**#46:** In the Ethiopian Highlands, a permanent portal between the worlds of **Rifts Earth** and **Wormwood** has grown in size and scope so that the entire Rift area is now nearly 100 square miles (259 sq. km)! As a result, *huge* numbers of Wormwood inhabitants are crossing through with alarming frequency. In fact, this portal area is actually transforming into a living planet area like Wormwood itself! Whether or not this "living planet phenomenon" will grow to encompass and transform all of **Rifts Earth** is unknown.

**#47:** The country of Uganda is rich in people and resources but it remains woefully low-tech. Just recently, a Ugandan adventurer named *Thrika Gdulu* has returned from an extensive visit to Europe and has become intrigued with the supertech of the NGR. Thrika also knows of the Phoenix Empire's supplying of high-tech weaponry to the monstrous Gargoyle Empire. Worried about the intent of the Phoenix Empire, Thrika now wishes to transform her homeland into a new African center of technology. If this is even remotely possible, how might she go about doing it, and what roles might her plan hold for the player characters?

**#48:** It is a little known fact that prior to the Rifts, an international space agency built a miles-long electromagnetic rail into the side of Mount Kilimanjaro with the intent of using it to launch ships into orbit without using chemical rockets. Since the mountain was so close to the equator, it would be easier to launch into orbit than from a higher latitude, like in Europe or North America. The project was never brought on-line due to the political collapse of the agency. But, it would take relatively little work to repair the electromagnetic rail and start launching things with it.

**#49:** A series of catastrophic earthquakes have torn apart immense stretches of western and southwestern Africa. Aside from the terrible cost of life this has caused, and the minor upsurge in Rifts activity, untapped veins of diamonds, gold and other mineral wealth have been brought to the surface. No major nation knows about this yet, but those who do will see an opportunity to plunder unheard-of amounts of mineral wealth. Should more than one nation learn of this untapped horde (and they will; they always do), there will be no small amount of fighting over who gets to lay claim to what.

**#50:** The Four Horsemen of the Apocalypse have assembled and are sweeping across the continent, bringing utter ruin wherever they go. This is the beginning of the end. Or is it?

## Asia

**#51:** What little is left of the Indonesian archipelago has been populated by a race of savage sub-humans whose bizarre forms of magic give them strange powers of shapeshifting. These people, collectively known as the *Komodo Empire*, are responsible for terrifying raids and massacres among the regional coastlines and islands. These attacks appear to be a dress rehearsal for a large, coordinated invasion, but of where?

**#52:** The *Bagh Nakh Republic* is a small and newly formed nation group located somewhere in the Indian wilderness. Whether these people are tiger-like humanoids, D-Bees or simply humans who are trying to emulate some non-human form is unknown. The Republic aspires to re-conquer all of India (a nearly impossible task). To purchase as much help as they can, the Republic is willing to pay in a most rare currency — weapons grade plutonium! Where did they get this stuff, and why are they willing to part with it so easily?

**#53:** In the last century, people have gradually repopulated the island of Taiwan. Utilizing tons of high-tech equipment and war machinery from various suppliers in Japan and the Free City of Hong Kong, the newly formed *Taiwan Sovereignty* was able to clear its island of supernatural predators in relatively little time. Now, the Taiwanese are building grand factories with the purpose of designing and producing their own lines of new weapons, armor, cybernetics, power armor, robot vehicles and combat vehicles. Most of this stuff will be made for export either to North America or Europe, both places of great conflict and where any new tech connection will be patronized heavily.

**#54:** Aside from the Free City of Hong Kong, China is a seemingly endless haven for supernatural evil and freakish magic of every kind. It remains an unknown area except to those within it. Periodically, a rogue explorer transmits a status report of the near-coastal area via short wave radio to both the Coalition and the NGR. Who this person is or where they are getting their information remains unsettled.

**#55:** Suddenly, the number of Oni demons populating Japan has improved ten-fold since this time last year. Imperial Japanese are concerned with this upswing in the Oni population, and many Imperial samurai report that these new Oni possess considerably more strength, wits and resolve than any Oni previously encountered.

**#56:** Icho Robotics has sent a small army of assassins and mercenaries in a desperate bid to destroy H-Brand Robotics. The two firms have been locking horns for a long time, and rather than figure out their differences, they have decided to go to war. This conflict will result in the utter ruin of one of the companies, and a short-term loss of technology across the country.

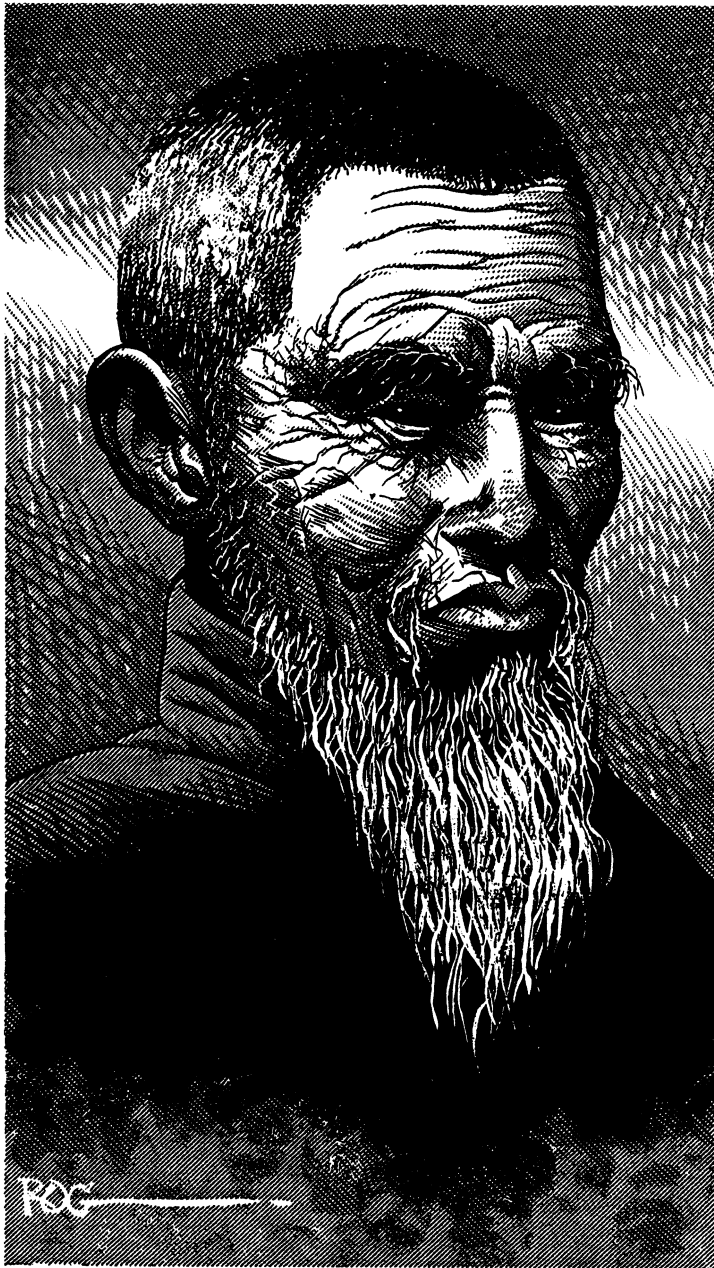

## Australia

**#61:** Road trains — mega-sized versions of tractor-trailer trucks have begun crossing the Outback with increasing frequency. These always fall under attack by bandits, and fierce running gunfights occur. Simply running these huge trucks is an industry of itself, with drivers and gunners making a killing for their work. The merchants who transport shipments successfully make even more money, especially when running goods between the Tech-Cities.

**#62:** A huge explosion of light has occurred over Ayer's Rock, a site of intense magical activity in Australia. Since this explosion of light, a pair of spectral tentacles can be seen waving about in the air over the rock, like a ghostly monster from another world trying to come through a Rift that is just not large enough to admit it into this world. The Aborigines ardently refuse to go anywhere near the rock, insisting that the appearance of this strange creature is a sign that the end of the world, or at least the end of the Dreamtime, is at hand.

**#63:** The Molokoi are moving closer and closer to the cities and other outback settlements in what looks like a move to provoke war with the human settlements in the area. In an odd move, they have begun selling large quantities of their unique Techno-Wizardry devices to whoever wishes to purchase them. Even more strange is the folks who are buying their hardware are the very ones most likely to end up fighting the Molokoi. What gives?

**#64:** Enterprising merchants are trying to establish a connection with any of the Japanese companies so they can import high-tech power armor and cyborg chassis into Australia. The Tech-Cities drool over this possibility, because the one that arms up first with such weaponry will have a distinct military advantage over the other. In the long run, there is no telling what kind of effect this sort of arms race will have on the country at large.

**#65:** A league of human and D-Bee pirates, commanding a fleet of assorted warships and civvie craft retrofitted for battle, have moved into the Inner Sea of Australia and laid claim to it. No shipping can traverse these waters without being attacked and plundered by this new and troublesome pirate nation.

**#66:** The Great Barrier Reef is growing! A teeming bank of life force, some mystic disturbance in the waters off the coast of the continent, are somehow spurring the coral reef to grow at an exponentially faster rate than usual. The huge amount of life being generated here is turning the reef into a kind of living P.P.E. battery, something any competent mage or Techno-Wizard could probably tap energy off of if they tried hard enough.

**#67:** Way out in the boondocks, there is a lonely oil-pumping station that is home to about 50 people. The station is under siege by a murderous band of roadgangers, and their only hope lies in the arrival of some outside warriors to lend their talents to the fight. Somehow, everybody involved in this drama, from the station personnel to the roadgangers, feel that this sort of thing has happened before.

**#68:** The squatters living in the Queensland Peninsula Space Port have stumbled upon an ancient store of space technology: the placement protocols for constellations of satellites. Using this data, one can plot the (theoretical) location of any satellite put into orbit prior to the Rifts.

**#69:** The EHRA has begun a dedicated effort not only to cleanse their sphere of influence of all roadganger activity, but they also intend to build a huge new highway system that will one day link all of the tech-cities and bring an inkling of civilization back to the frontiers of Australia. This is a national effort, requiring tons of soldiers, scouts and builders. The Roadgangers are having a field day because all the combat is giving them something to do, even if it's getting most of them killed.

**#70:** Tasmania is sinking! Every year, its average sea level goes down by a few more feet, and the coastline shrinks a little more. At this rate, in half a century the island will be all gone. The real concern is not Tasmania, which is largely uninhabited. It is Australia, where the same phenomenon is getting underway...

**#57:** The legendary swordsmith *Masamune Hideki* has returned from a lengthy stay in a temporal bubble that has removed him from the events of this world. Distressed at the ruin of his country, Masamune nevertheless has set up a workshop in Little Honshu, where he gladly teaches anybody willing to learn the secret of rune magic creation.

**#58:** The Domain of the Gods has been disturbed recently by human explorers, and now the creatures within the Domain have begun waging war on nearby human settlements!

**#59:** Using new and old designs, a new rogue tech firm in Japan intends to mass produce variants of SAMAS armor in such a way that suits could be sold anywhere on the planet.

**#60:** The Chinese city of *Xiaon Xan*, close to the border between China and Southeast Asia, brims with magical power. Its inhabitants are mostly D-bees recruited from afar by the immortal wizards who rule the city and constantly pioneer new and strange forms of magic. Unfortunately, the wizards have alienated any other settlements in the area. Now that Xiaon Xan is under attack by a strange and unidentified menace from the interior of the Chinese mainland, nobody will come to the embattled city's aid.

## The High Seas

**#71:** The NGR has begun patrolling the northern waters of the world extensively so that their new navy will have some experience when it deploys to batter the Gargoyle Empire from the Mediterranean Sea. So far, things have been quiet for the German warships, except they keep disappearing whenever they cross over the northernmost parallels of the globe, nearing the North Pole. The ships pop back into existence days or weeks later, as if they were only gone for a few minutes. Nobody quite knows what to make of this phenomenon, but it explains why since the Coming of the Rifts, nobody has ever successfully traveled to the North Pole.

**#72:** Tritonia is in a big expansion. Pressured by a growing population, the floating techno-city is looking for the materials with which it can build new segments onto itself. It is paying top credits for any building or salvage materials people can deliver.

**#73:** One by one, the Horune Dream Ships are being destroyed by a force no outsider is aware of. While the destruction of the Horune is cause for joy among many sea goers, some would like to know exactly what is killing the Horune, and will it only replace them with an even greater menace once they are gone?

**#74:** The New Navy's flagship *Ticonderoga* has weighed anchor off the coast of California, where it is commencing with a massive, joint land, sea and air strike against some kind of magical armed stronghold on the coast. Nobody outside of the New Navy even knew of this place before the fighting began, and word has it the New Navy is actually looking to capture this stronghold for its own use as a land-based refueling and resupply station.

**#75:** The Lord of the Deep and its many minions are stepping up their attacks on the world's oceans. One by one, large ships are being dragged to their watery grave. Minions routinely board and destroy passing vessels, regardless of size. Even an NGR patrol boat operating off the coast of the Kamchatka peninsula (eastern Russian coast) was assaulted. Somebody has to do something about this thing before it renders the entire world's oceans impassable.

**#76:** Ask any Dolphin, Killer Whale or Whale and they'll tell you: they can detect the approaching presence of something *massive* and sinister from deep space. They do not know any details, nor how it will actually come to Earth, but come to Earth it shall, and all life on the planet will be in danger. These creatures believe they will have the ability to foretell more about the oncoming aliens because they have some weird kind of precognitive link with them. How this works and why is unknown, just that the world has an early warning device in these sea mammals for a crisis few know about, much less have prepared for.

**#77:** In the Atlantic, a patch of Shimmering Water has appeared and continues to grow unabated, threatening to consume the entire ocean! In the Pacific, a Dead Pool of equal size threatens to do the same. What happens when both oceans are transformed? And once transformed, what will happen when these bodies of water meet?

**#78:** A hurricane of Mega-Damage capacity has formed in the Pacific ocean and is barreling right across the water. It is utterly huge, almost 1,000 miles (1,600 km) in diameter, and the path it is taking will put it on a round-the-world track but by the time the storm peters out (if indeed it ever will), it will have scoured all of the world's oceans and the ships that traverse them.

**#79:** A huge portal to the Elemental Plane of Fire has opened up in the Mid-Atlantic Ridge, and is slowly but surely boiling off the world's oceans. Unless this Rift is closed, Earth will one day be transformed into a desert world.

**#80:** After existing much longer than anybody expected, the world's polar ice caps are finally melting, forcing the world's ocean levels to rise once more. Again, the global coastlines stand to be rewritten by the unstoppable force of Mother Nature. Atlantis will be hit particularly hard, and the Splugorth are considering whether to abandon their Earth outpost or to build a new one on a continent where there is a human nation (which will inevitably start a war).

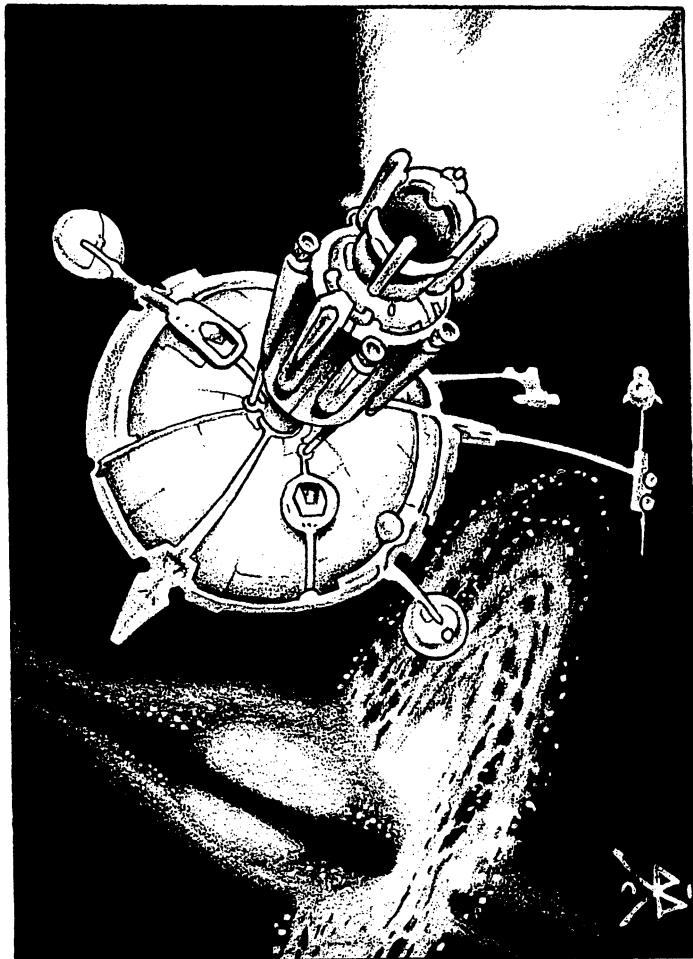

## Outer Space

**#81:** The corrupt KLS corporation has led a bloodless coup and taken formal control over Freedom Station. KLS wishes to transform the station into a politically neutral, purely commercial venture in the hopes of making a profit off any orbital wars that flare up. A group of Freedom Station exiles intend to return to the station and stage a revolution, putting some real leaders in charge.

**#82:** The life support systems on Laika Station have utterly and catastrophically failed. The entire station must be evacuated, but for the many residents of the station, where to go is a compelling question. None of the other stations are willing to take on a bunch of refugees for fear of overtaxing their own precious resources.

**#83:** Some yahoo out past the Asteroid Belt is advertising that he has built a space ark and with it, intends to travel to another star system where he will colonize the first Earth-type planet he comes across. Numerous ships are flocking to this ark site; some are curious, some want to go, and some want to capture the ark for themselves and plunder the revolutionary drive system it supposedly contains.

**#84:** Solar flares the likes of which nobody has *ever* seen before are steadily frying through the defenses of everything in orbit. The stations have less than three weeks before deadly radiation kills everybody in the space community. The only hope is the sun calming down (fat chance) or finding some place that is safe, like a planet.

**#85:** Strange radio communications are coming from the surface of Venus. Mathematical patterns, language-type patterns, patterns which signal the presence of an intelligence far beyond that which has developed on Earth...

**#86:** Rumor has it that Mercury, uninhabitable as it is, contains a huge stockpile of unclaimed treasure on its surface! Apparently there was an old effort to set up remote-operated super-solar cells on the planet that could collect solar energy and fire it back to earth in intense,

directed pulses. These pulses would be caught by receptor dishes and converted back into power for conventional use. The system never worked right, but those who salvage the equipment could no doubt use it to build a terrifyingly powerful energy weapon out of it that runs off the sun itself!

**#87:** The insects that have overrun Mars are now leaving the planet! Flying under their own strength, they have the ability to actually break into orbit and wing their way across the solar system to wherever they choose. What planet will next fall under their control?

**#88:** War amongst the orbital stations of Earth has always been a possibility, but with the recent sabotage bombing of the Yuro Station, tensions are at an all time high. Only a miracle can prevent the entire orbital community from going to war at this point.

**#89:** An alien menace (Splugorh? More Naruni? Arkhons? Something new?) is fast approaching Earth, and it is up to the orbital community to pull together and stop this thing. The automated defenses of the planet and the counter-orbital debris ring will not be enough. The orbiters must come up with something new, or the aliens will make planetfall and forever shatter the containment barriers surrounding Earth.

**#90:** The Cosmo-Knights have fallen under attack by a strange new force that draws upon elements of the Consortium of Civilized Worlds, the United Worlds of Warlock, and the Transgalactic Empire. Their aim is nothing short of the destruction of the Cosmo-Knights and the capture of the Cosmic Forge. The Cosmo-Knights are fighting a losing battle, for they are terribly outnumbered. They have been pushed back to the farthest reaches of the Three Galaxies, and now a small force of Cosmo-Knights prepare to make their last stand on the third planet of a small yellow star, a planet with way too much magical activity to be healthy for the Cosmo-Knights. A world already pushed to the brink of ruin. A world that really does not need to get drawn into an intergalactic fiasco like this one...

## Across the Megaverse

**#91:** The dark struggle on Wormwood continues as the forces of light try to cleanse their sickened world-organism of the evils that currently infest it. Since Wormwood has numerous portals connecting it to **Rifts Earth**, numerous Earth adventurers have gotten involved in the conflict and are even recruiting others to go across and get involved.

**#92:** On the world of Seeron, the struggle against the Tarlok Invaders has reached a new level. Super-powered freedom fighters, known as *Skrappers*, are leading the charge for freedom against this alien menace, but they are severely outnumbered and outgunned. One by one, adventurers from **Rifts Earth** have found themselves mysteriously transported to this far-flung alien battleground with the undeniable urge to get involved in the conflict. Though the conflict is important, what people really want to know is, what or who is shanghaiing adventurers from **Rifts Earth** to help the Seeronians fight the Tarlok?

**#93:** On the world of *Parallax*, an alternative version of **Rifts Earth** exists in which the Coalition States have succumbed to the Federation of Magic, the NGR and Atlantis are at war, the Lord of the Deep has spawned seven offspring, and the Four Horsemen of the Apocalypse have suddenly fallen very quiet, as if someone or something simply snuffed them out.

**#94:** On the world of *Jurukai*, a rebellious faction of Naruni Enterprises intends to secede from the company and use their considerable firepower to set up a Republic of their own, a gleaming techno-utopia where there shall be no poverty, where all can live in harmony, and every citizen will be required to live strapped into an In'Valian Robo-Jockey robot body. Just for security reasons, of course.

**#95:** In another alternate universe, the Coming of the Rifts never happens on Earth, and the non-Rifts version of that world, known as **Chaos Earth**, continues its dangerous, over-developed march into the future. At this point, the world has advanced to roughly the same point

in time as exists on **Rifts Earth**, only there has been no war or apocalypse to upset technological progress. As a result, though there is terrible division and localized poverty still in the world, the level of technology is on par with anything found on **Phase World**.

**#96:** The various elemental planes are merging together to form a new plane of super-elemental energy. Warlocks and those who can appreciate magical energy are unsure whether this will be the beginning of a new golden age for the elemental planes, or an apocalypse.

**#97:** In the world of *Xadthe Prime*, the Omegan Order has finally come out of hiding and is prepared to make its appearance on **Rifts Earth**. At last, they shall have their revenge on a world that nearly drove them to extinction...

**#98:** There once was a time when the people of **Rifts Earth** knew of a strange oceanic land known as *Lemuria*. Erin Tarn was supposed to have written a book about it, but it kept getting delayed year after year until many thought it would never come out. But now it is coming to light that the Lemurians actually do exist, only on another world, far across the Megaverse! Apparently, by some strange set of mystic circumstances, the Lemurian civilization keeps bouncing between **Rifts Earth** and this far-off alien world it currently inhabits. Its time to return to **Rifts Earth** will be at hand very, very shortly.

**#99:** The world of *Troud* is home to more Dragons than anybody on **Rifts Earth** could possibly imagine. Unlike Dragons elsewhere, these wyrms actually have an advanced and formalized society where there is a distinct pecking order and set of laws governing all, from the mightiest adult to the lowliest hatchling. The Troud High Council has been monitoring **Rifts Earth** for quite some time and feels that the Dragons there are living a barbarous life and need Troud's guiding hand. As such, an advance army of Troud shock troopers has been dispatched to **Rifts Earth** with the mission of capturing all Dragons and bringing them back to Troud where they might be given some kind of "civilizing influence."

**#100:** Between the layers of the Megaverse they wait and watch, just one of the many hidden powers whose job it is to make sure the Megaverse is not so badly put out of whack in any one spot that it threatens to destabilize the rest of it. **Rifts Earth** has long merited much observation, and at long last, there can only be one conclusion to draw. If the Hidden Ones are to prevent the Megaverse from eventual and total destruction, they must obliterate the entire planet of **Rifts Earth** and every living thing on it.



# Mini-Atlas of Rifts Earth



The Americas

The following are maps of *key* places in North America, Europe and other places. Much of the world has yet to be explored in the various Rifts® World Books so no maps are available (yet) for them. As Rifts Earth continues to be explored more maps will appear their respective World Books (China is in the near future), and *maybe* a few years down the road we will do a real, full-size atlas.

## Rifts Earth

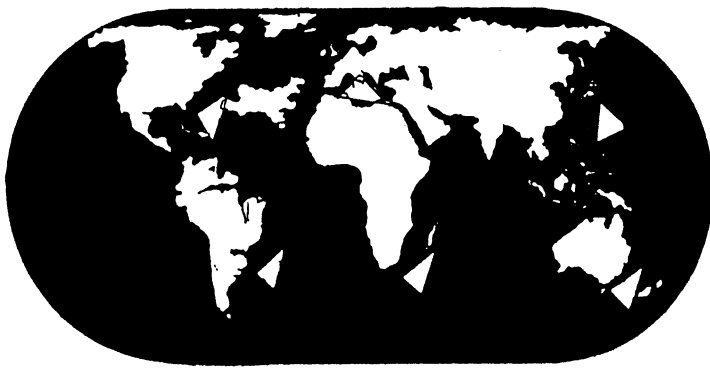

## Marianas Trench

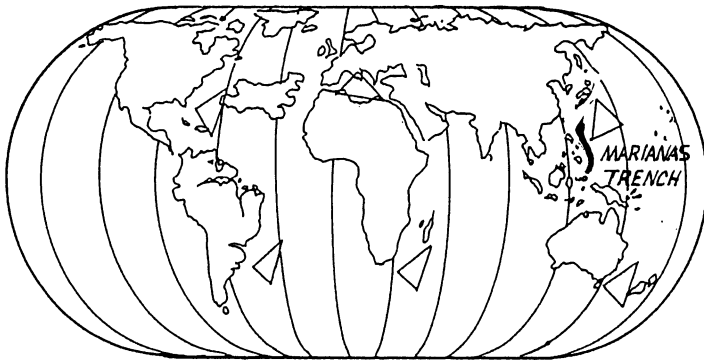

## Major Magic Triangles

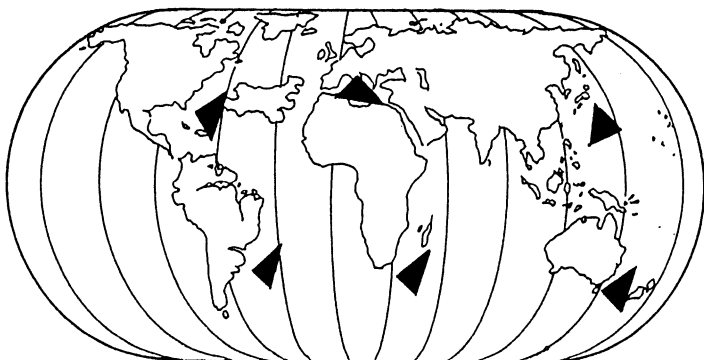

### Geographic Environments

**White indicates glaciers.** Temperatures range between 50 below during winter to 32 (freezing) degrees Fahrenheit in the summer. Rain/snowfall is about 50 to 250 mm.

**Black indicates tundra.** Vegetation consists of lichen, mosses, algae, grass, and scrub (small shrubs and weeds). Temperatures range from about 20 below zero to around freezing in the winter to around 60 degree Fahrenheit in the summer. Rainfall is about 100 to 500 mm.

**Angled Lines indicate coniferous forests** consisting of pine, spruce and fir trees, grass and scrub. Temperatures range from about 14 to freezing in the winter to 75 to 88 degrees Fahrenheit in the summer. Average rainfall a year is about 200 to 800 mm.

**Dots indicate mixed forests** of coniferous and deciduous trees, bushes, dog rose, flowers, and tall grass. Temperatures range from about 20 to 40 degrees in the winter to 75 to 92 degrees Fahrenheit in the summer. Average rainfall a year is about 500 to 1200 mm.

**Dark grey areas are subtropical and tropical forests.** Temperatures range from the 80's in the winter to the low hundreds of degrees Fahrenheit in the summer (average 98 to 120 degrees). Average rainfall a year is 1200 to 2000 mm.

**Horizontal broken lines indicate plains/grasslands or savannas.** The American plains are tall grass, scrub and tiny patches of scattered trees. It receives about 200 to 400 mm of rain. The savanna and steppes of Mexico are also grasslands with few trees, but receive less rainfall, about 100 to 300 mm, and experience short periods of drought. Average temperatures range from about 50 to 75 degrees in the winter to 90 to 105 in the summer.

**Stippled dots are deserts** consisting of wind-swept, dried earth or sand, stones and patches of cactus and scrub. Temperatures range from freezing (at night) to the hundreds during the day, throughout the year.

**Thatched areas in South America are steppes.** Steppes are grasslands with few trees and minimal rainfall, about 100 to 200 mm, and experience long periods of drought. Average temperatures range from about 60 to 80 degrees in the winter to 90 to 105 in the summer.

Copyright 1991 Kevin Siembieda

# North America

## Riffs Canada

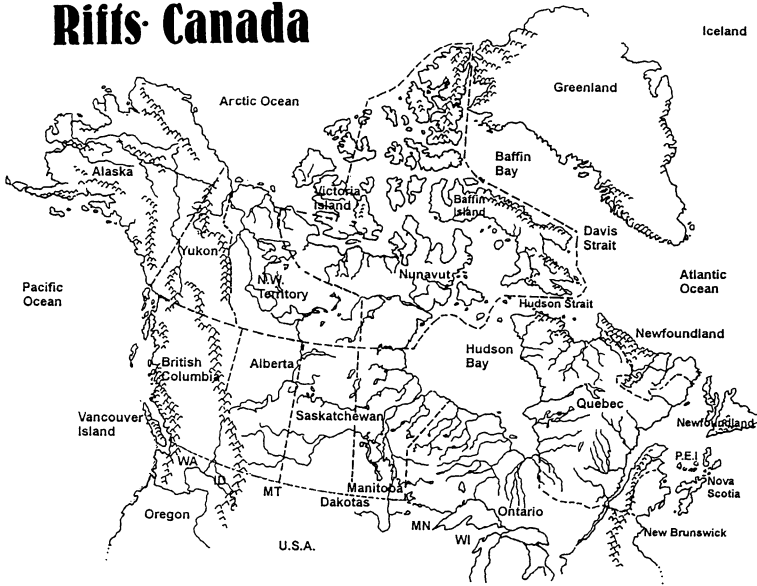

## Regions Strong with Magic & Ley Lines

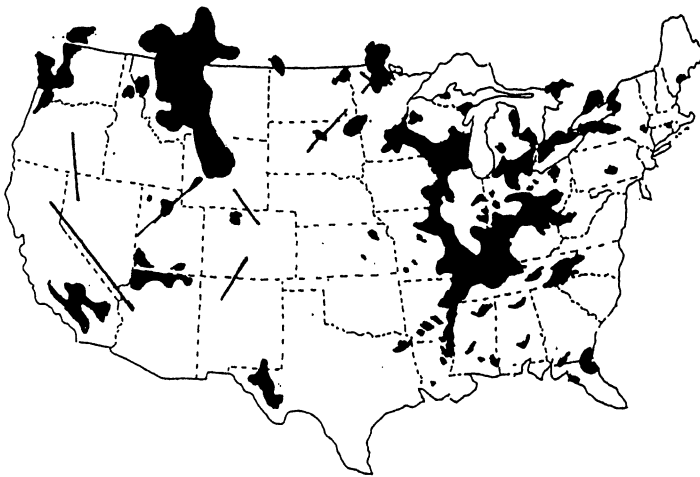

## Major Rivers

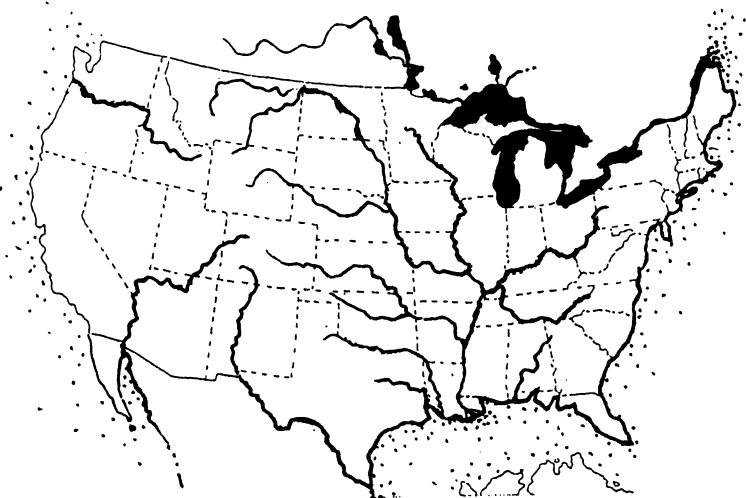

## The Original Coalition States

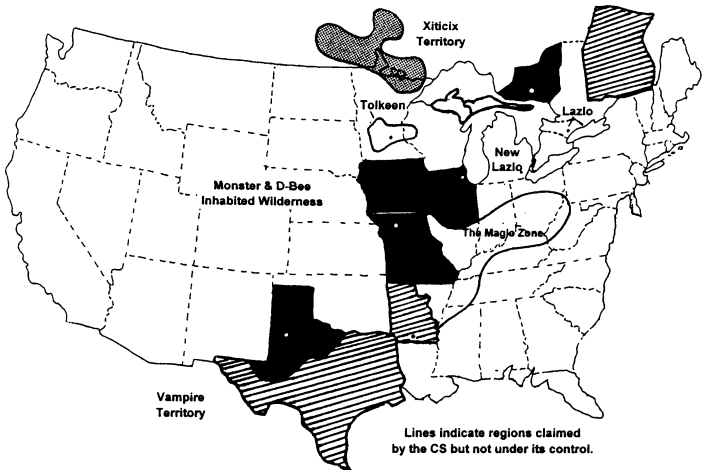
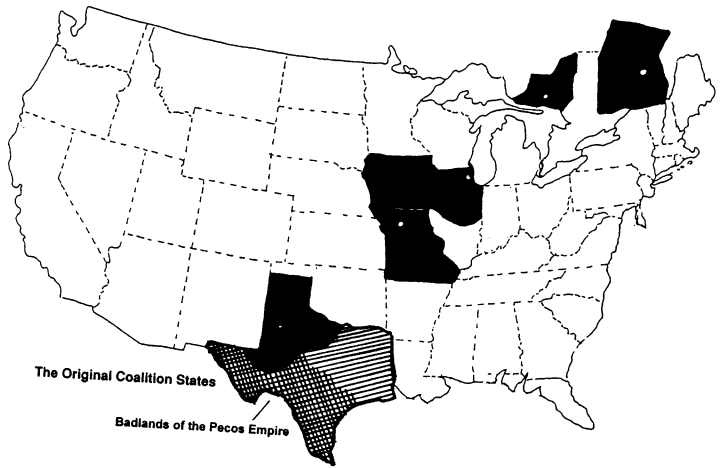

## The Domain of Man

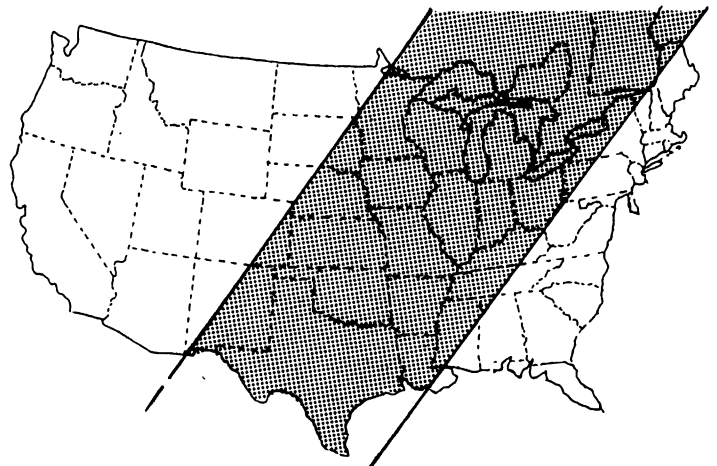

## All Around is Hostile Wilderness

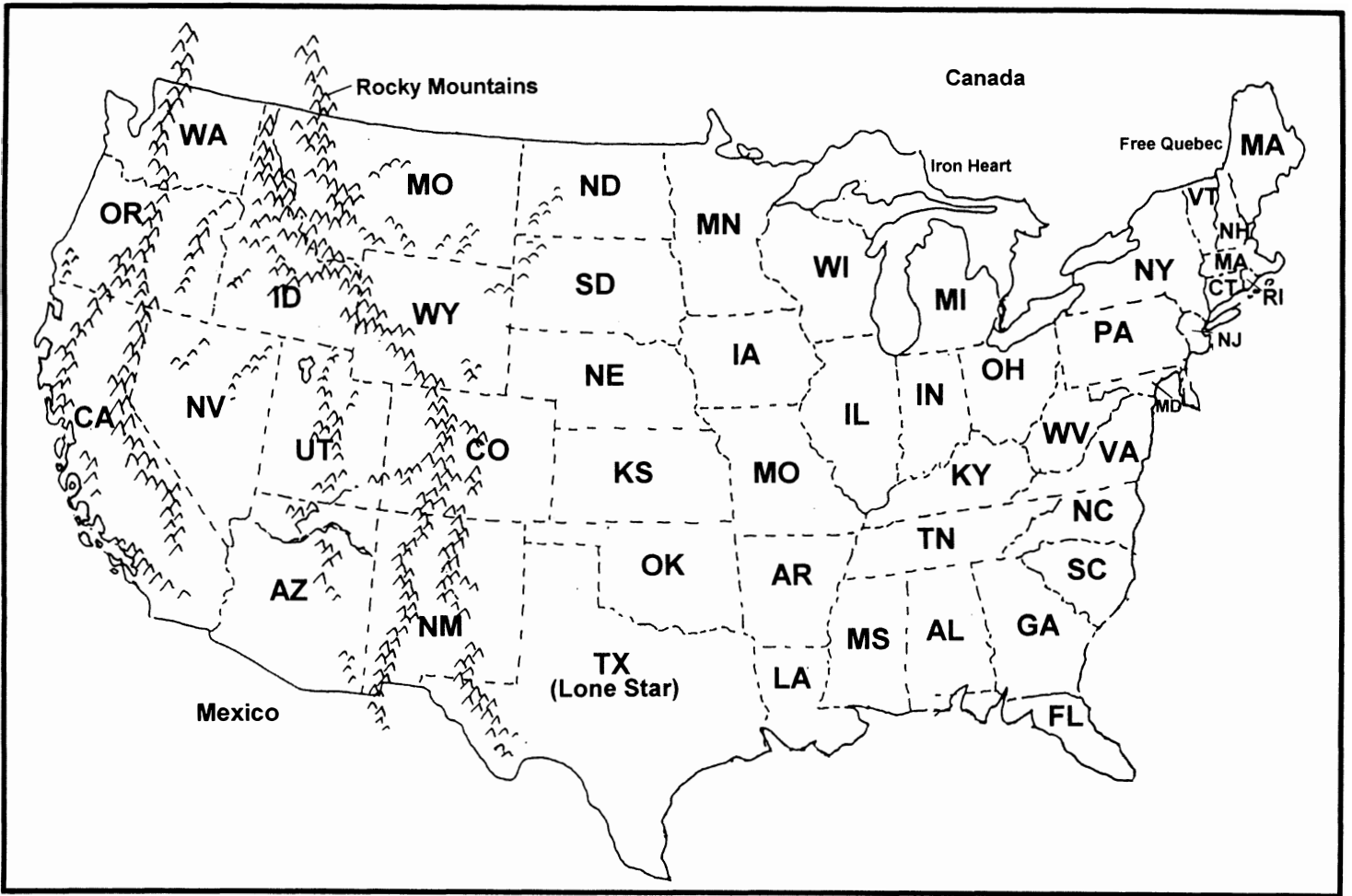

**Major Ranges of  
Psi-Stalker Activity**



**Major Simvan Ranges**



**Northern Gun and the Manistique Imperium**



## The Six Powers

Lazlo

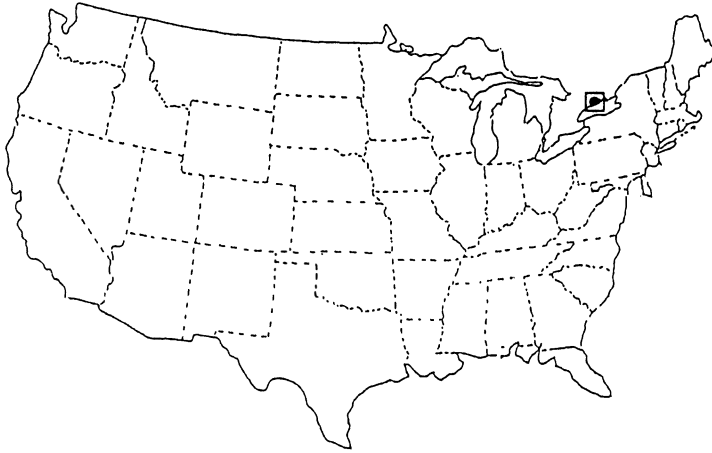

New Lazlo

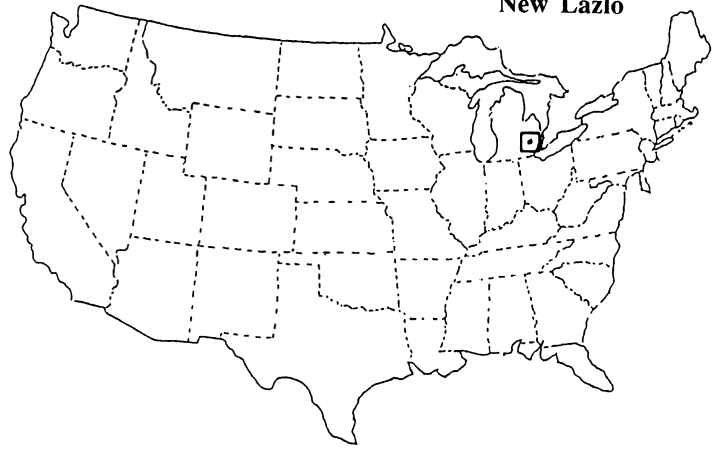

Northern Gun

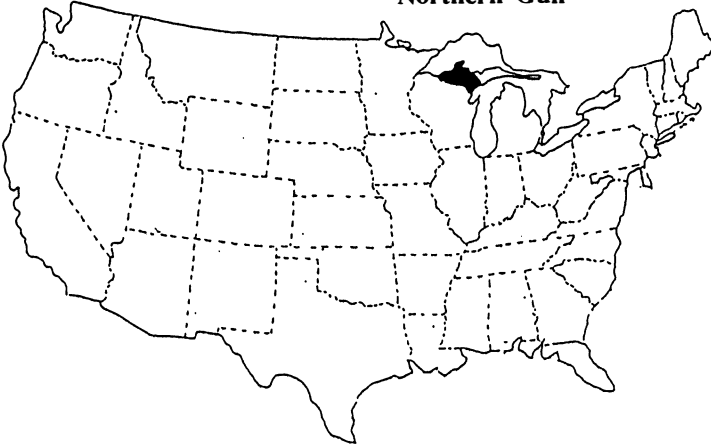

The Federation of Magic



Manistique Imperium

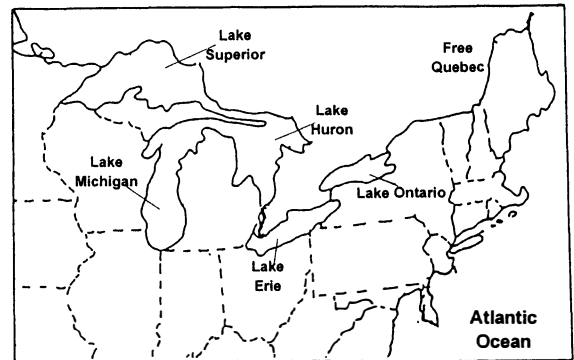
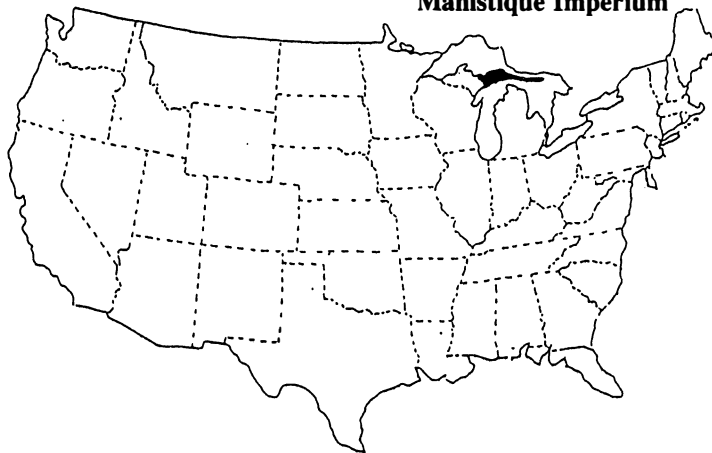

Tolkeen

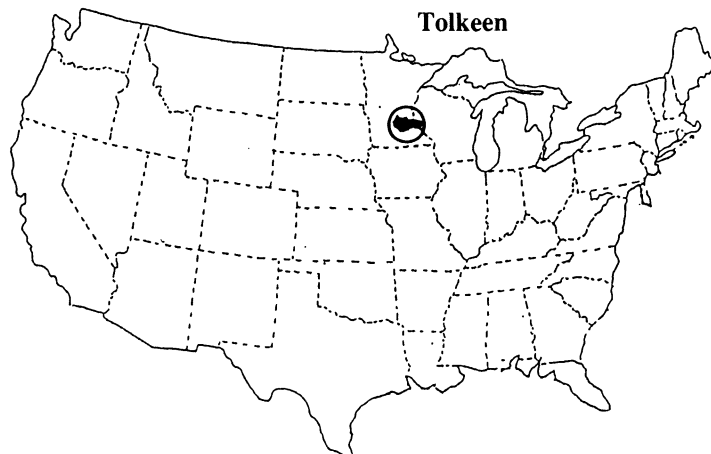

### Some Quick Lake Statistics

- **Lake Superior:** Measures 350 miles (560 km) in length, has a breadth of 160 miles (256 km), covers an area of 31,800 square miles (82,362 km), has a depth of 1333 feet (406 m), and is elevated 610 feet (183 m) above sea level.
- **Lake Huron:** Measures 206 miles (330 km) in length, has a breadth of 183 miles (293 km), covers an area of 23,010 square miles (59,595 km), has a depth of 750 feet (229 m), and is elevated 587 feet (176 m) above sea level.
- **Lake Michigan:** Measures 307 miles (491 km) in length, has a breadth of 118 miles (189 km), covers an area of 22,400 square miles (58,016 km), has a depth of 923 feet (281 m), and is elevated 587 feet (176 m) above sea level.
- **Lake Erie:** Measures 241 miles (386 km) in length, has a breadth of 57 miles (91 km), covers an area of 9,910 square miles (25,667 km), has a depth of 210 feet (64 m), and is elevated 578 feet (174 m) above sea level.
- **Lake Ontario:** Measures 193 miles (309 km) in length, has a breadth of 53 miles (85 km), covers an area of 7,550 square miles (19,555 km), has a depth of 802 feet (244 m), and is elevated 247 feet (74 m) above sea level.



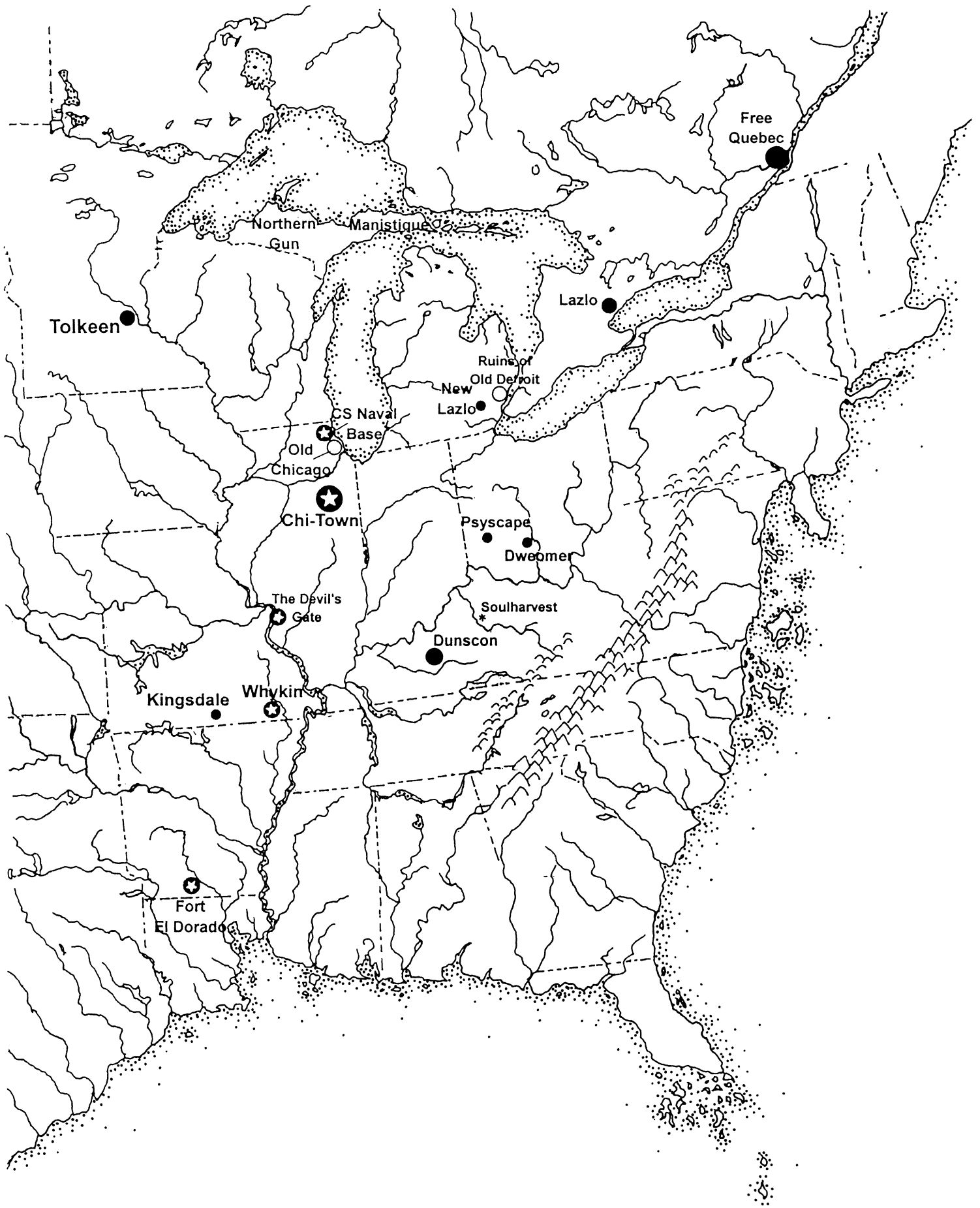



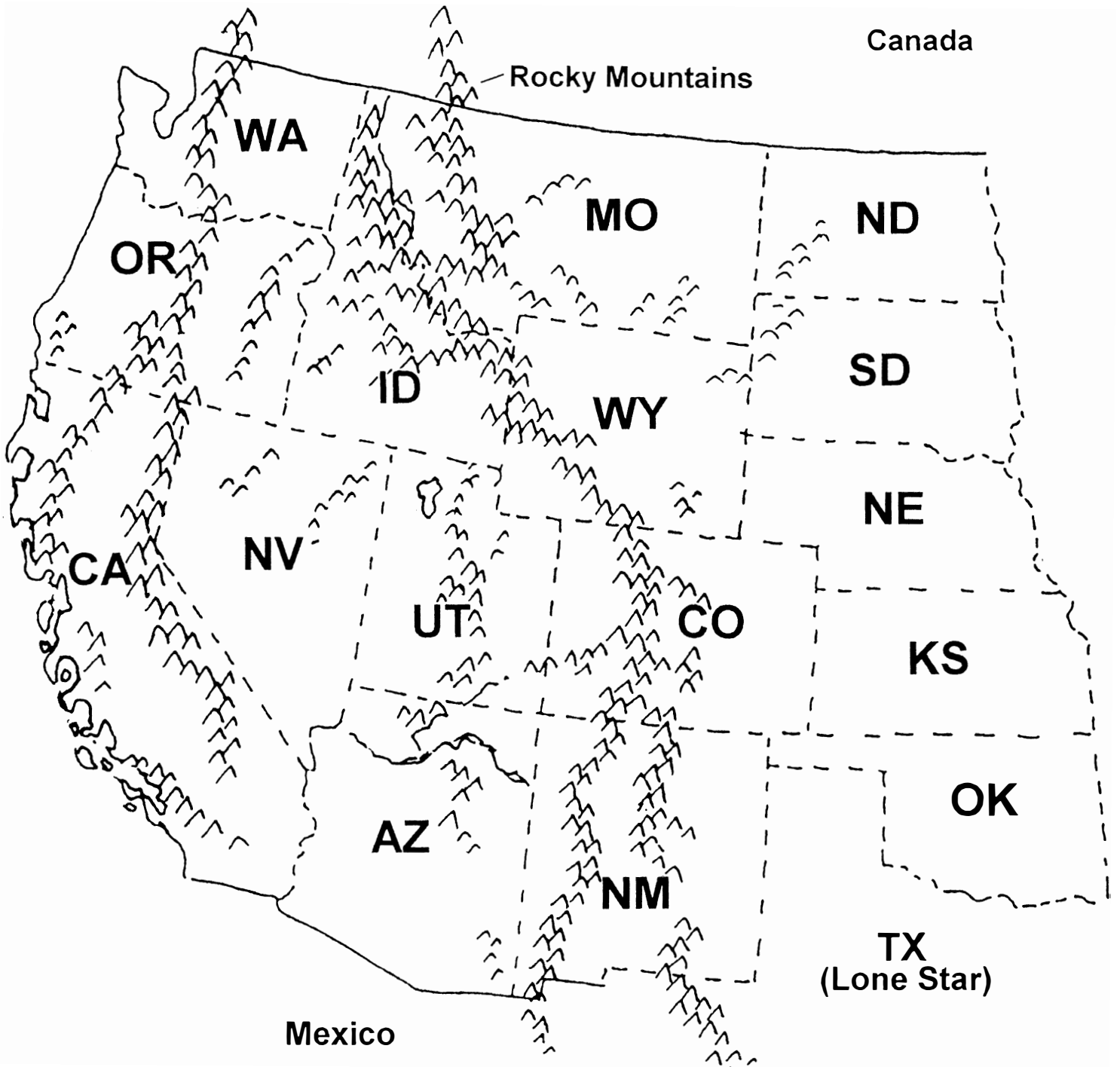

# New West Territories

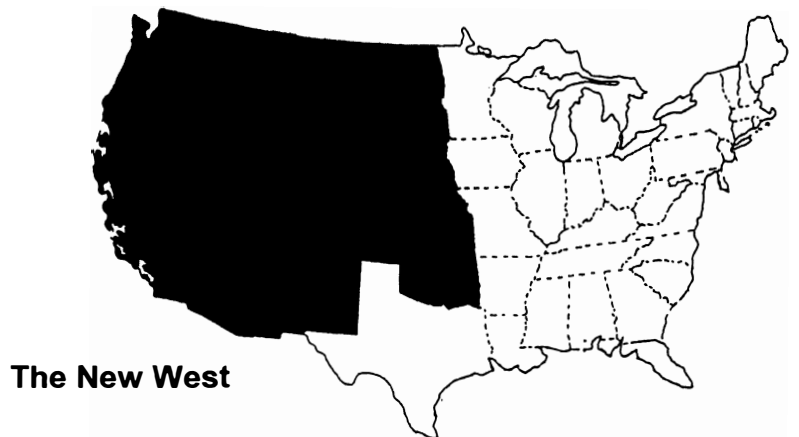

### Colorado Baronies

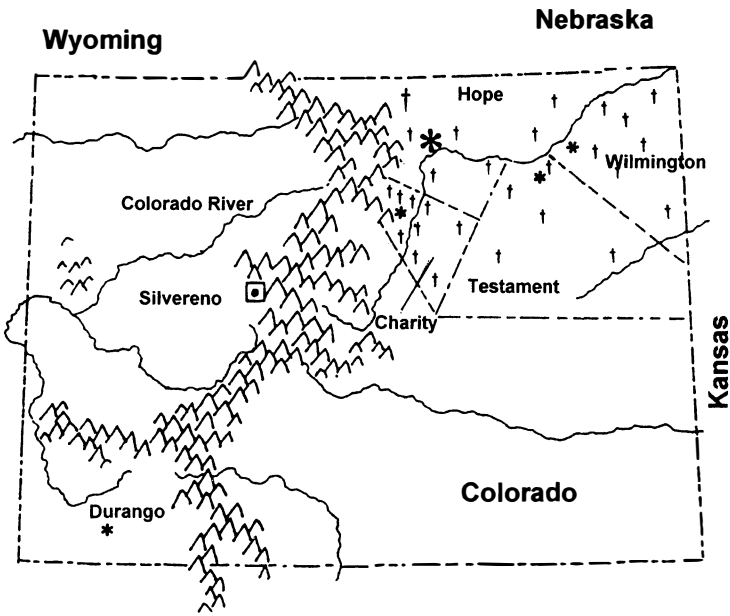

### Home Range of the 1st Cavalry

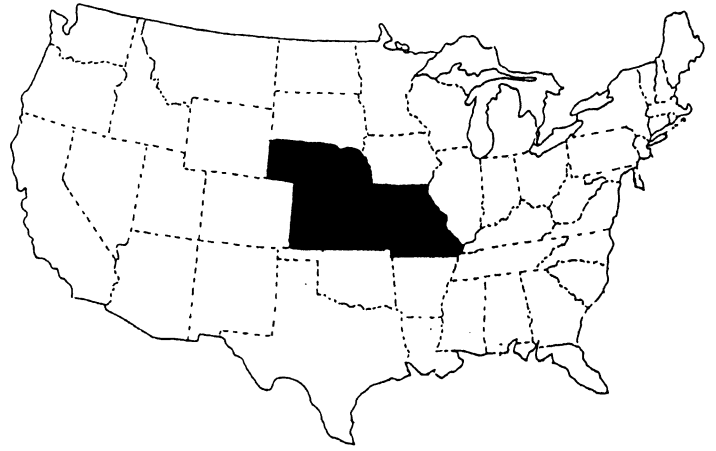

### Bandito Arms: The Legacy of Area 51

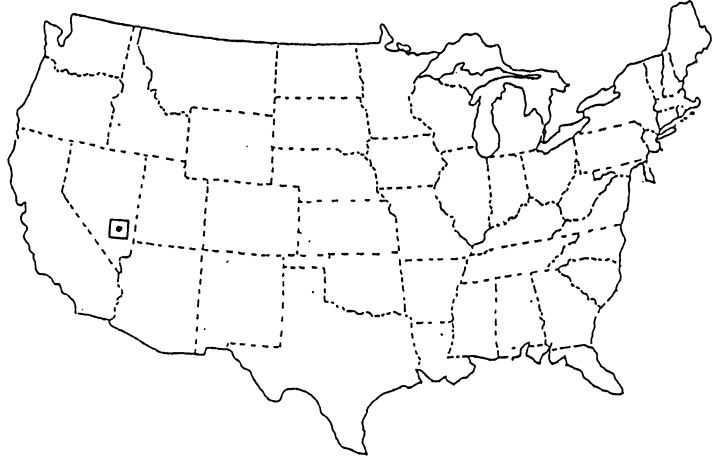

### Colorado

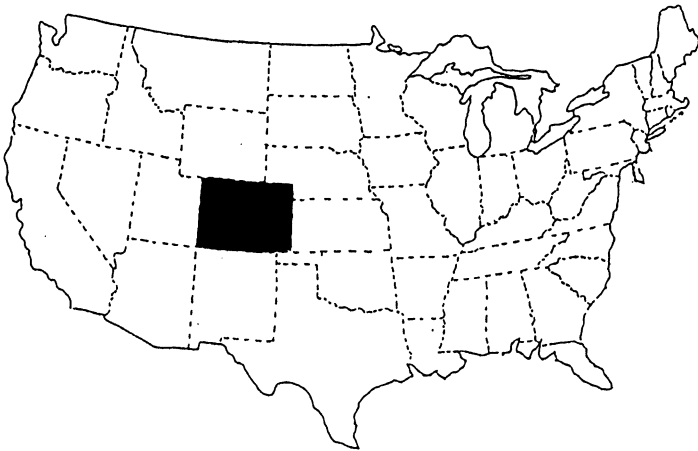

### North Dakota

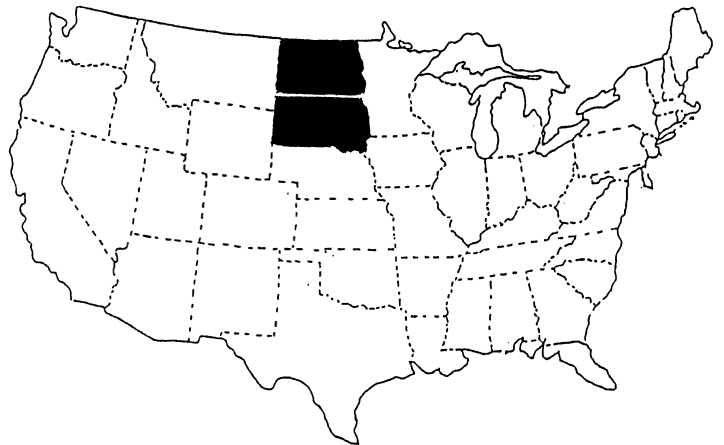

### The Colorado River

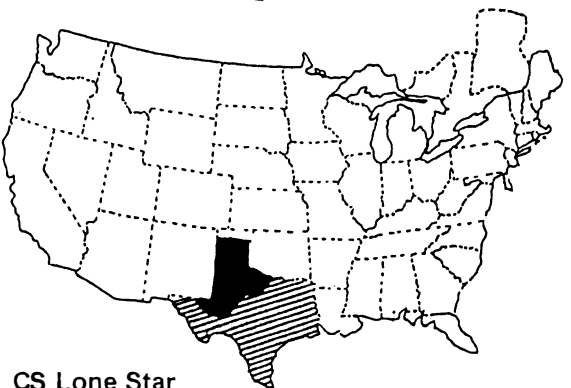

### CS Lone Star

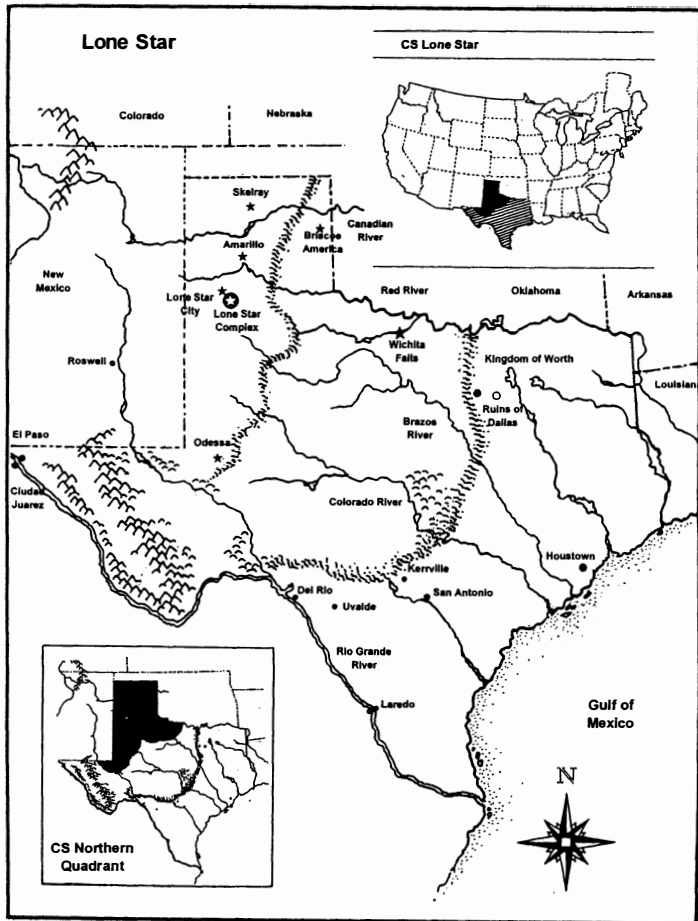

# The Pecos Empire

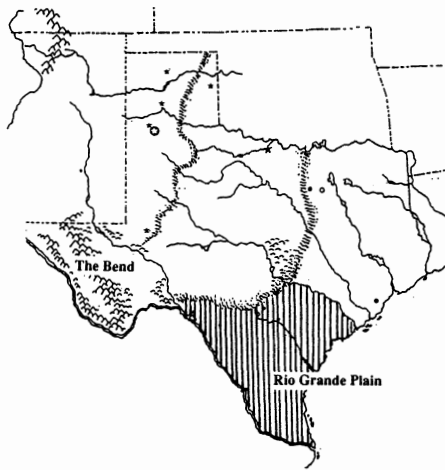
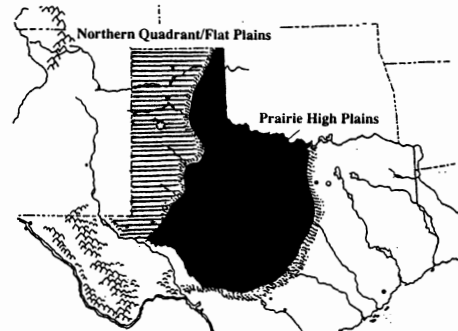
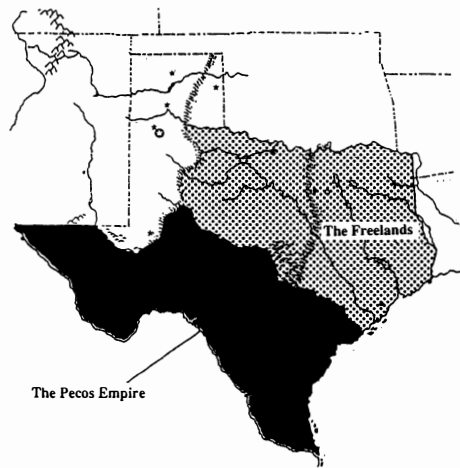

## Ley Line Locations in the Lone Star State

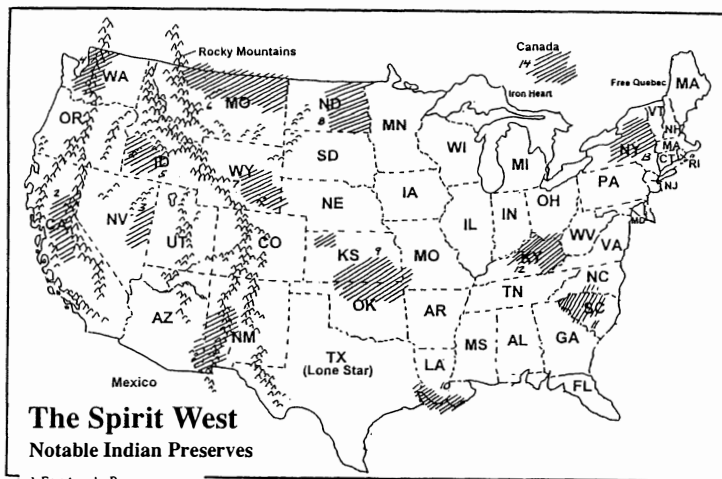

1. Fort Apache Preserve
2. The Valley Preserve
3. Shoshone Mountain Preserve
4. Water Point Preserve
5. Nimpip Preserve
6. Blackwall Preserve
7. Casper Preserve
8. Fort Dakota
9. Fort Comanche
10. Fort Sky
11. Camp Cherokee
12. The Central Preserve
13. The Longhouse Preserve
14. Fort Huron
15. Fort Alaska

# Vampire Kingdoms™



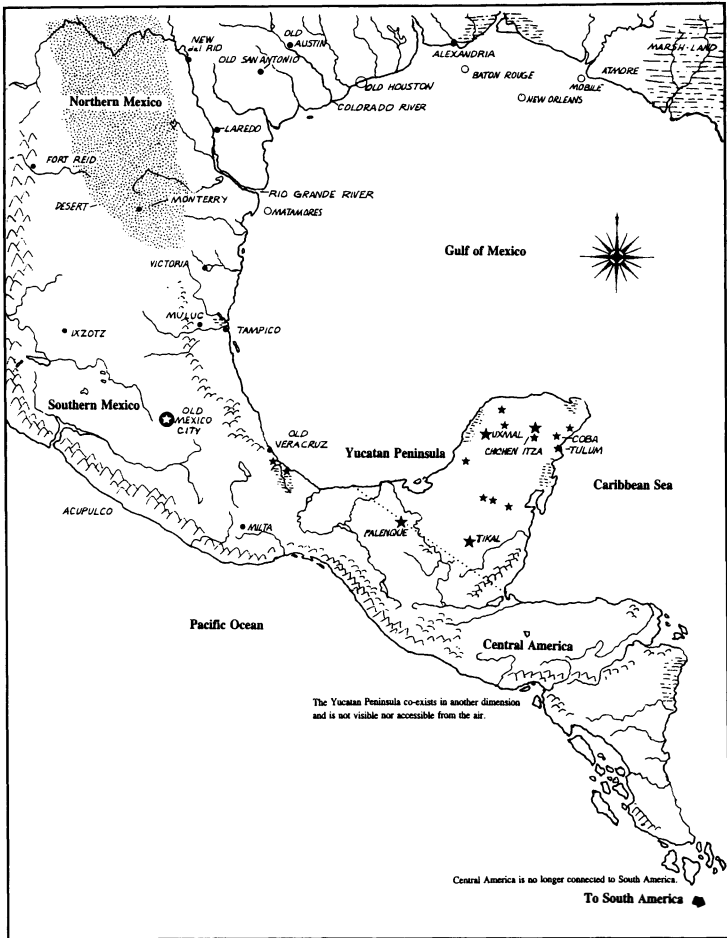

# The Yucatan Peninsula

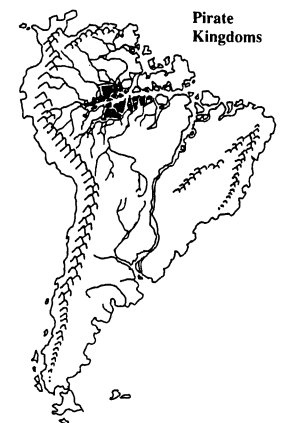
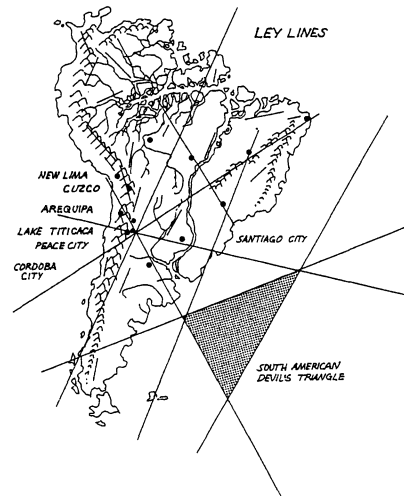
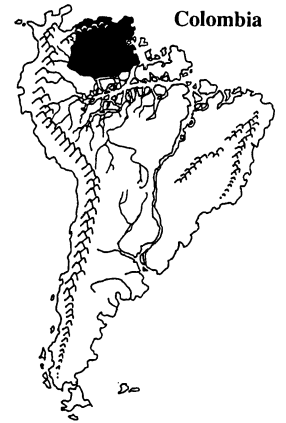
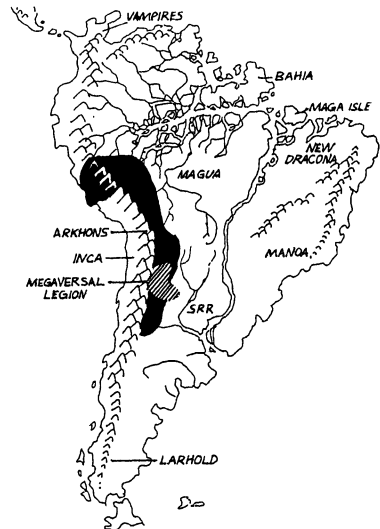
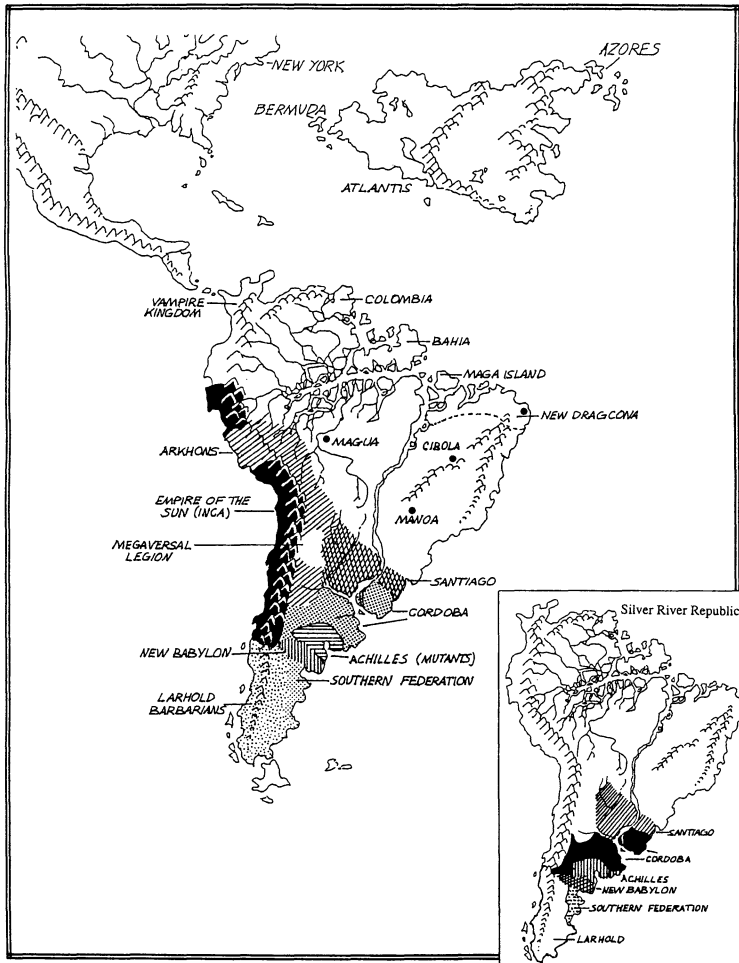
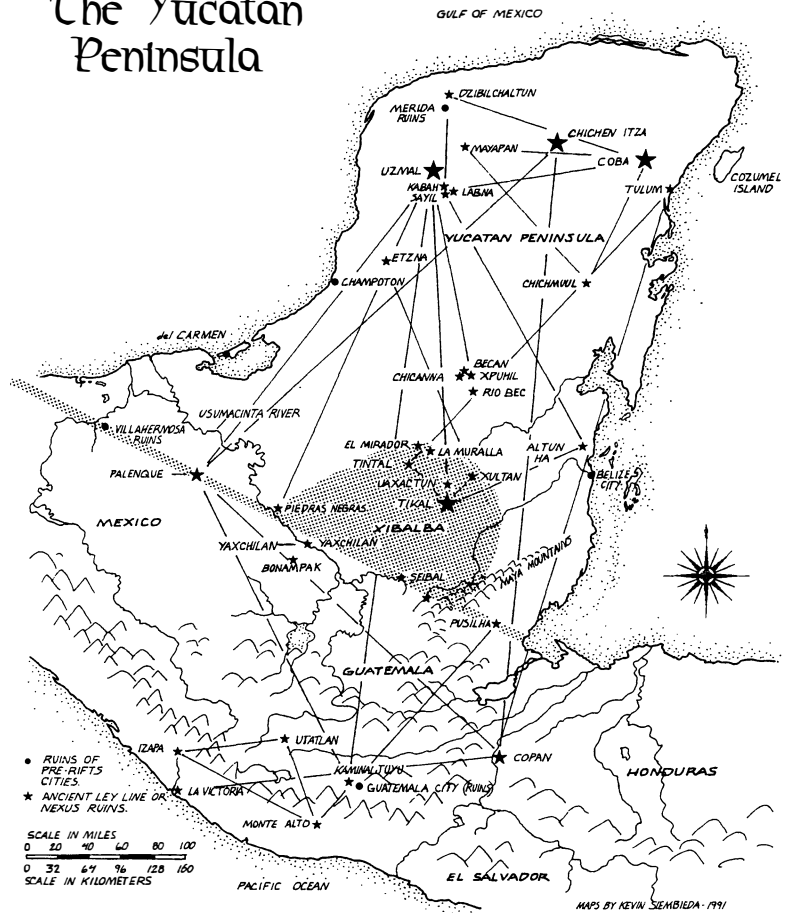

# Canada

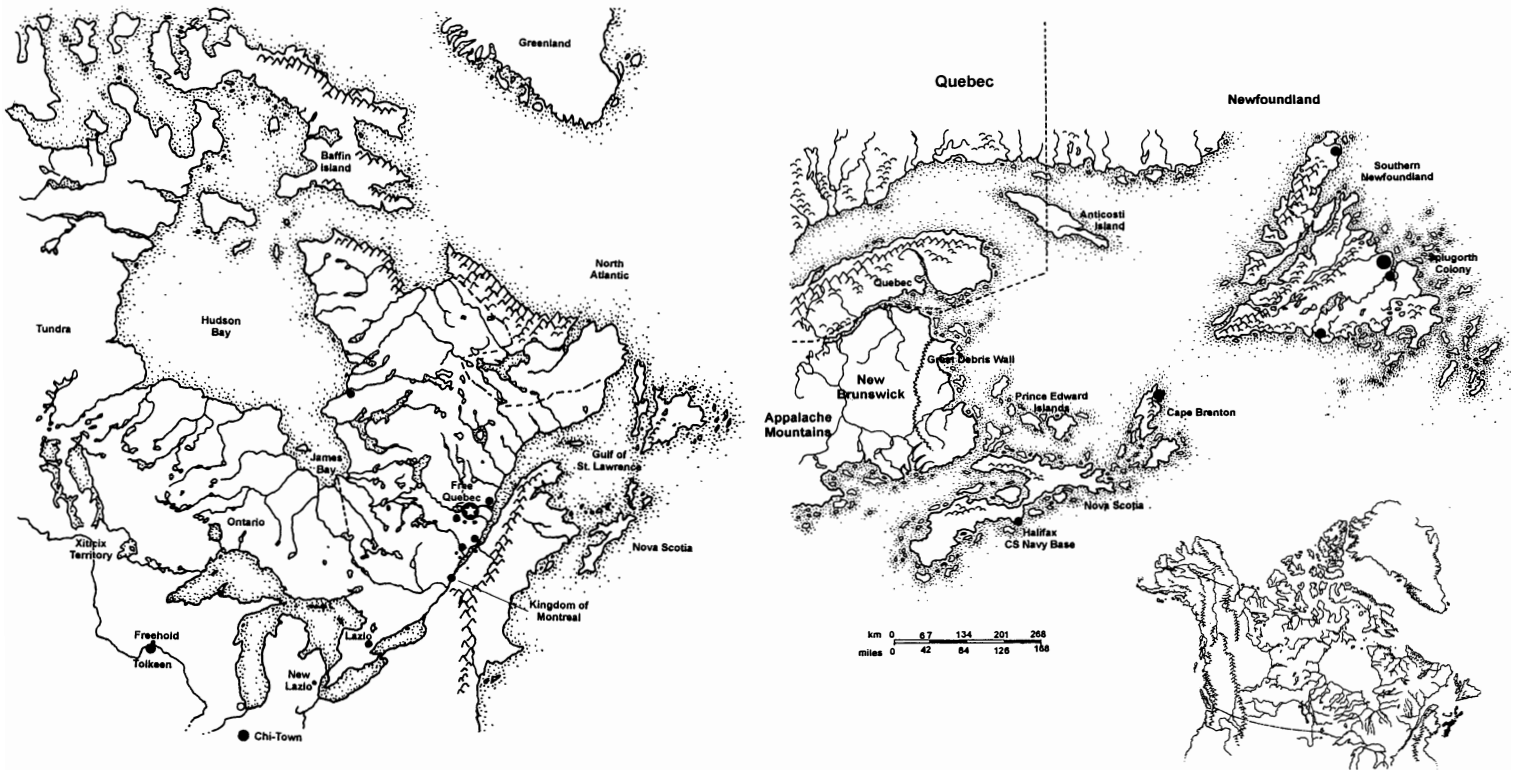
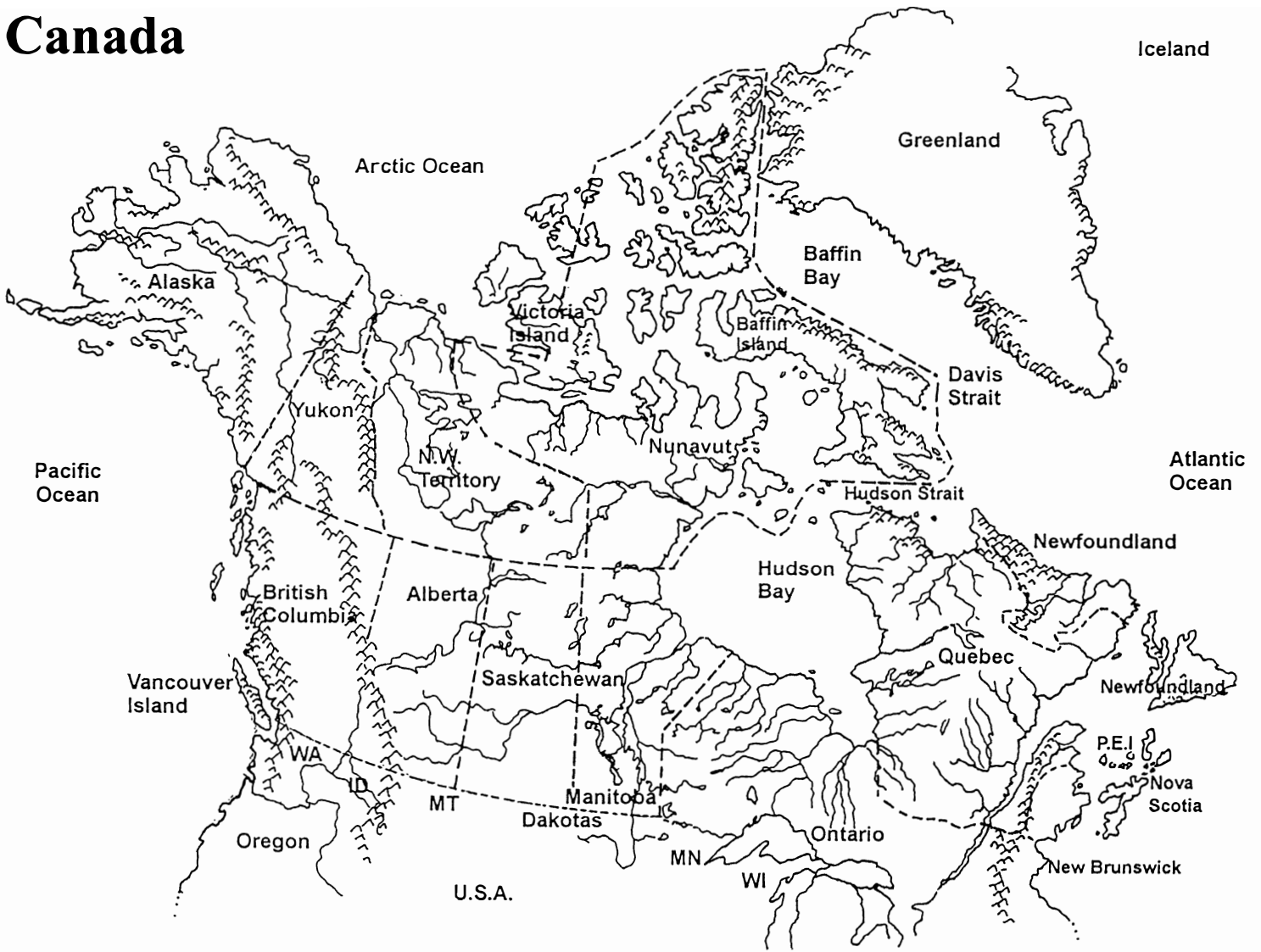



# Xitcix Territory & Surrounding Areas

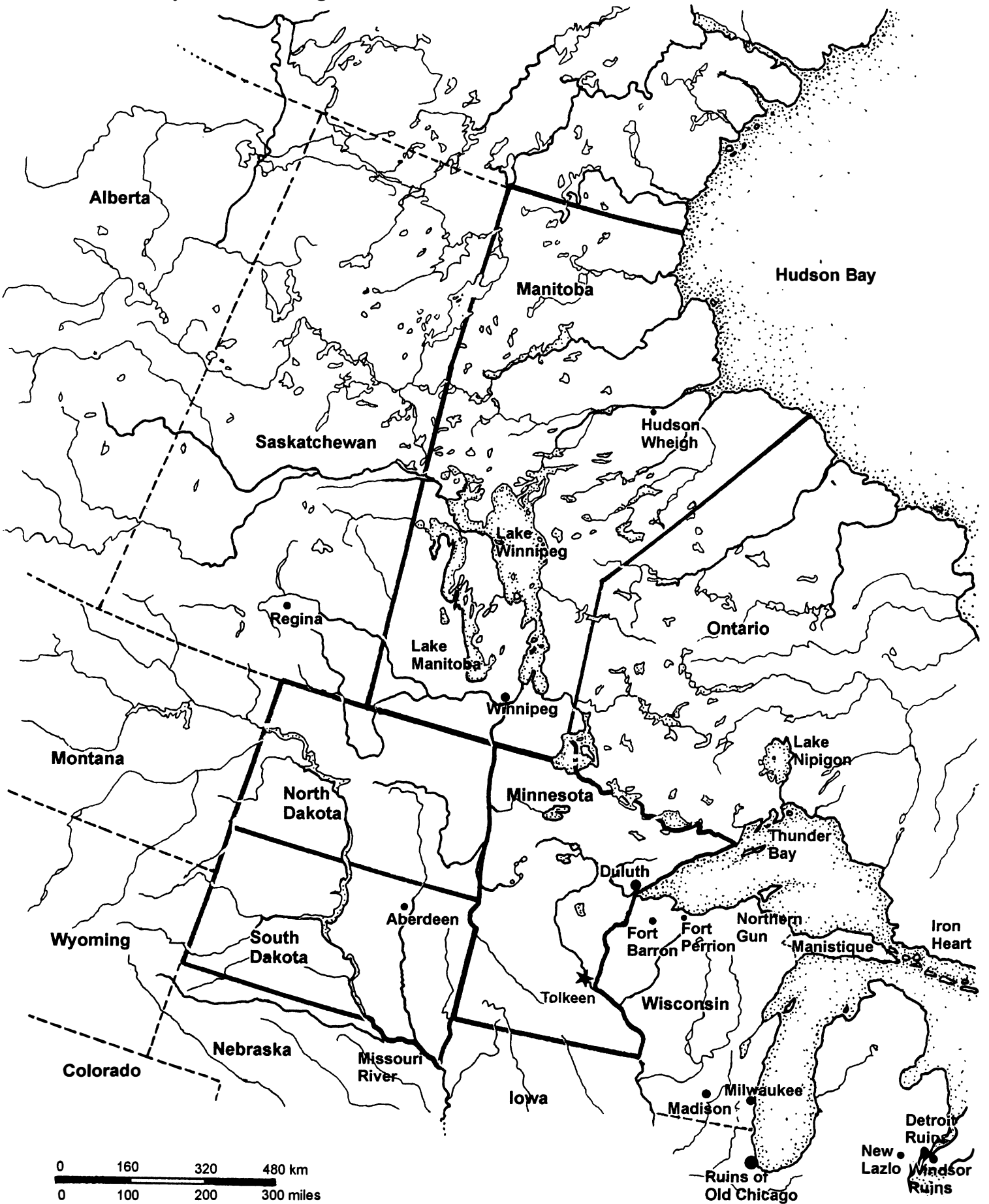

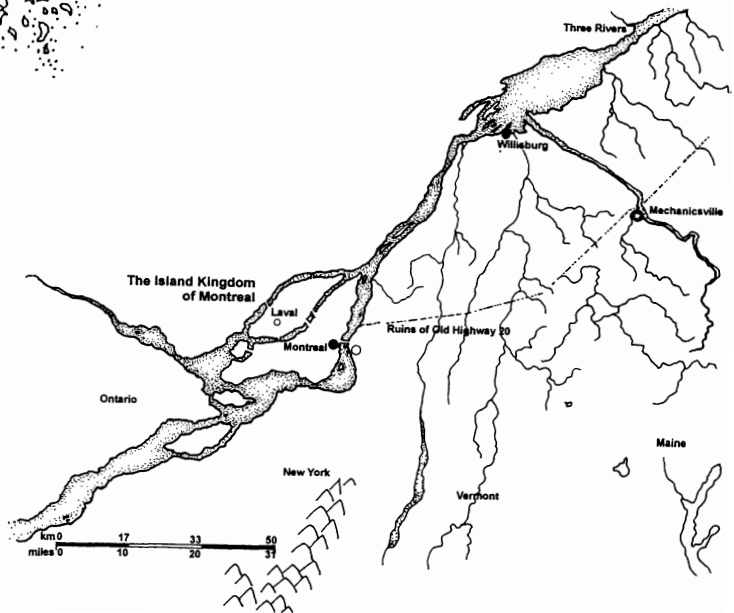
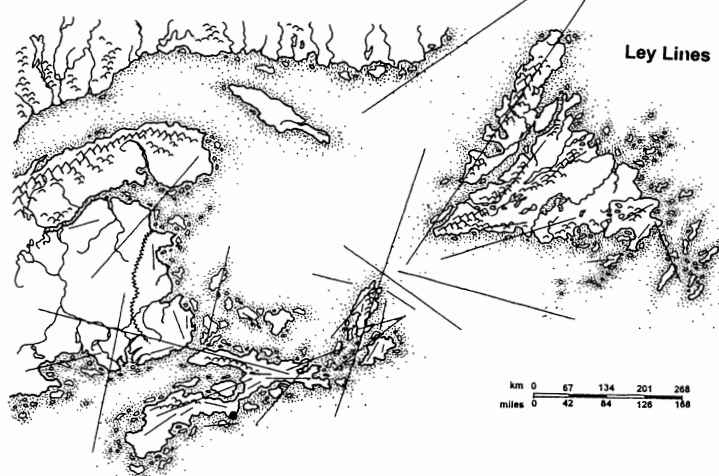
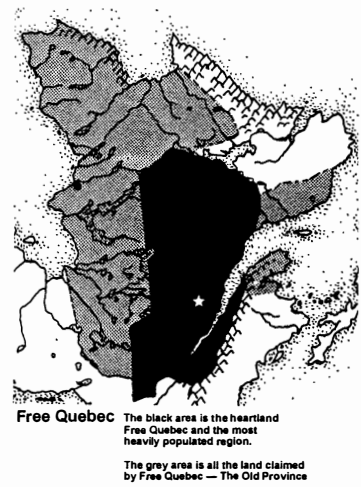
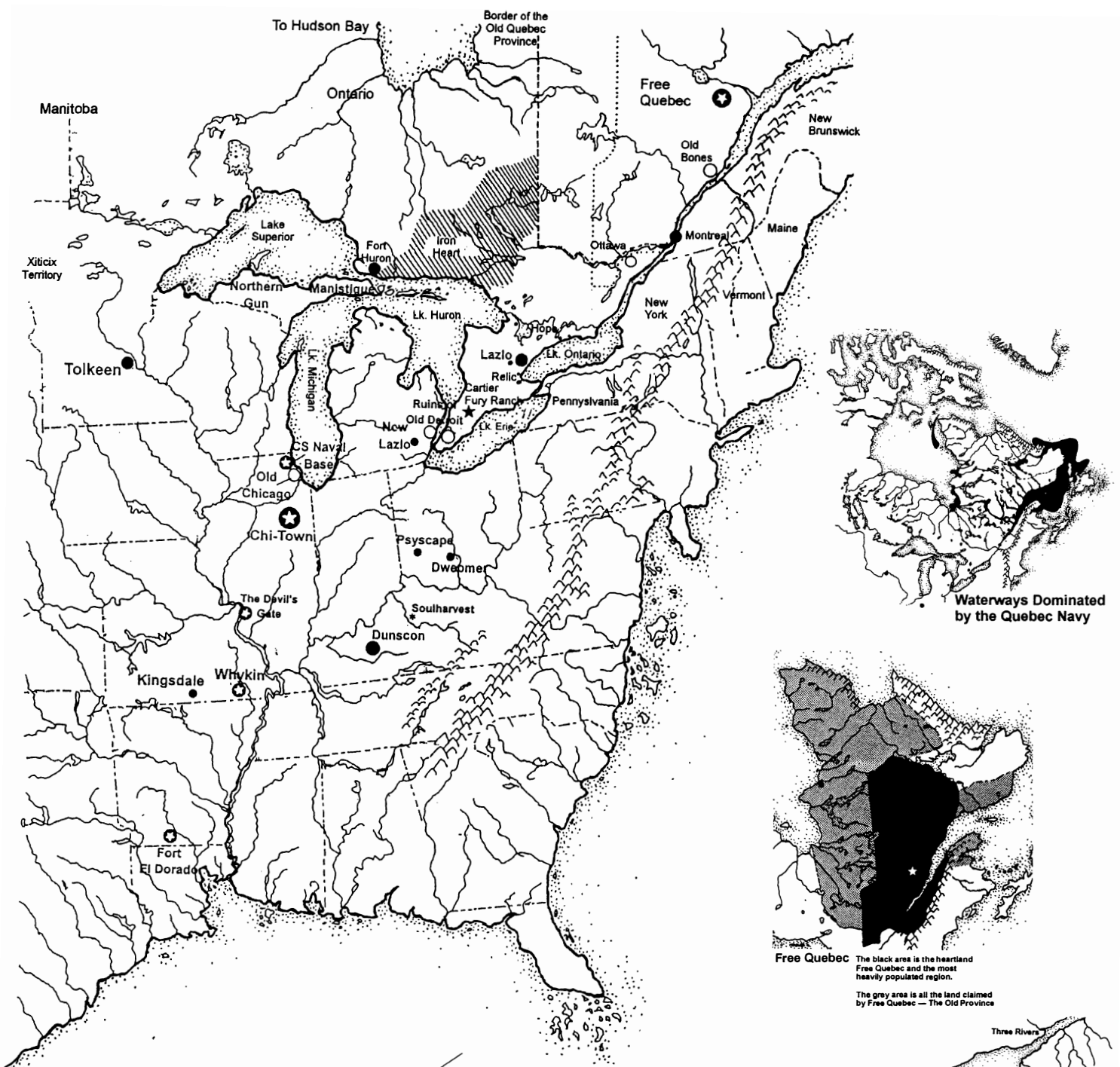

# Atlantis

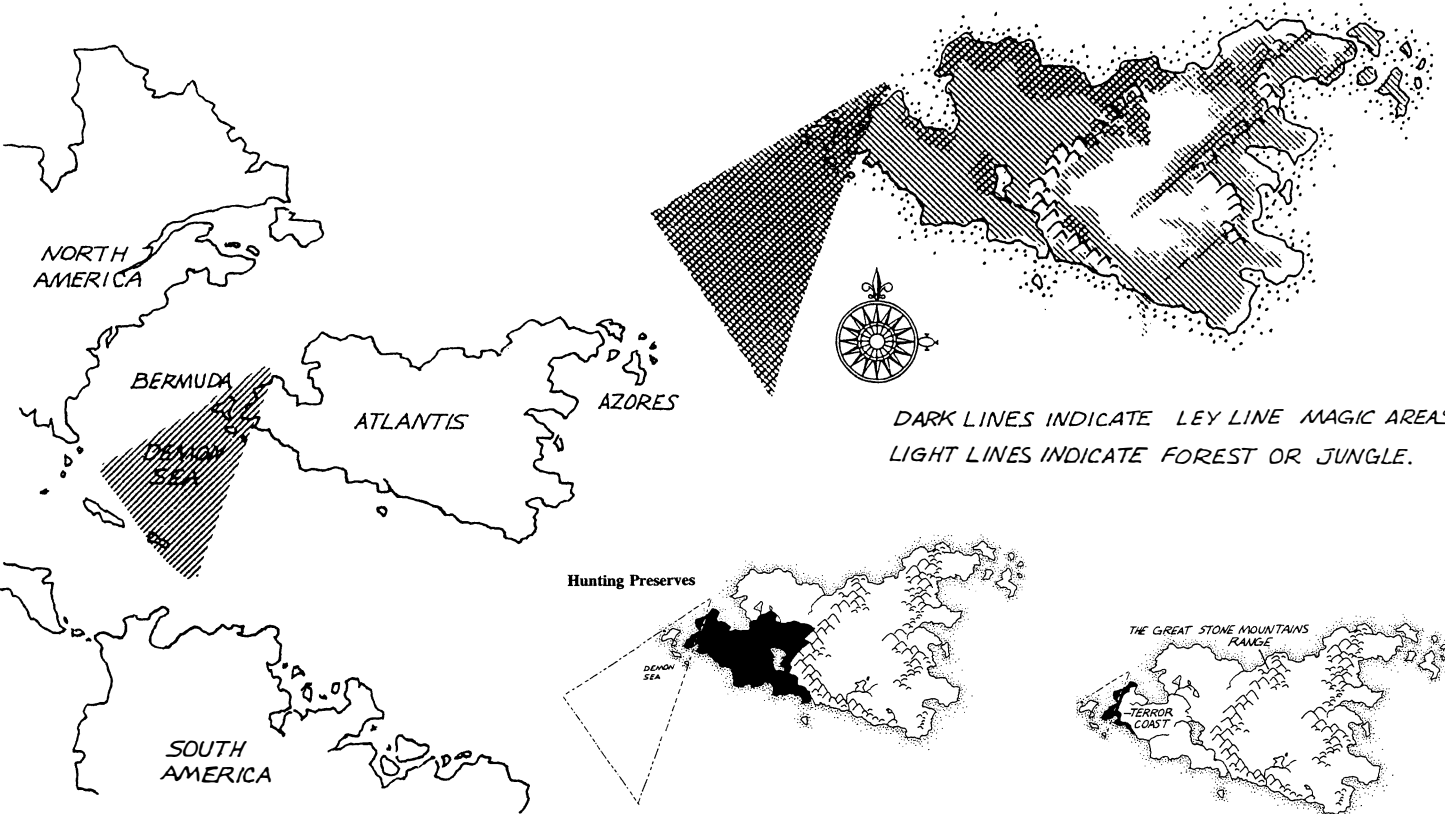
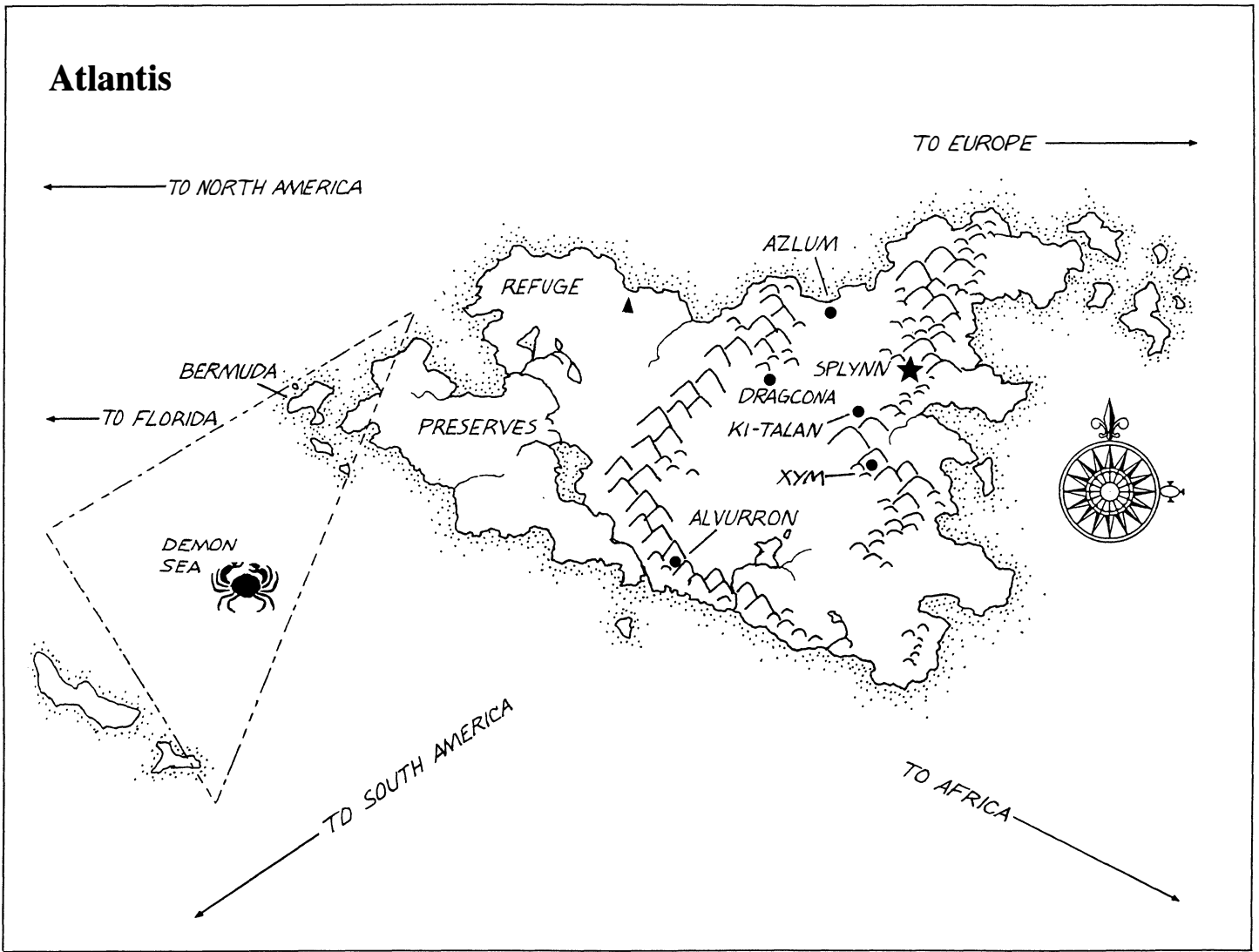

# British Isles

## Map of Key Nexus Points



# British Isles

## Map of Major Ley Lines

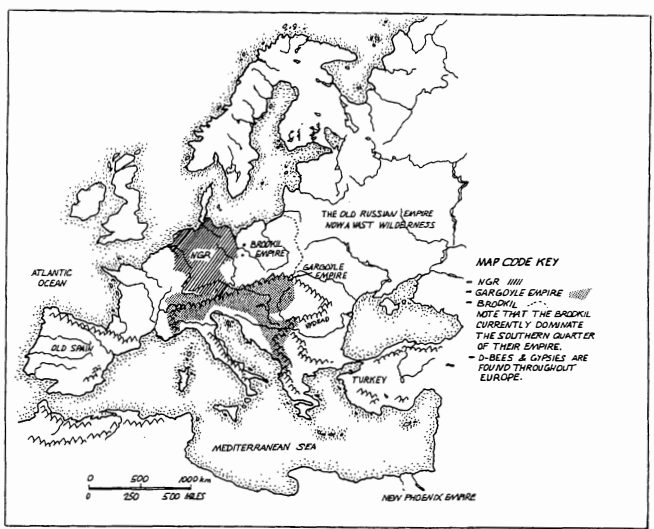
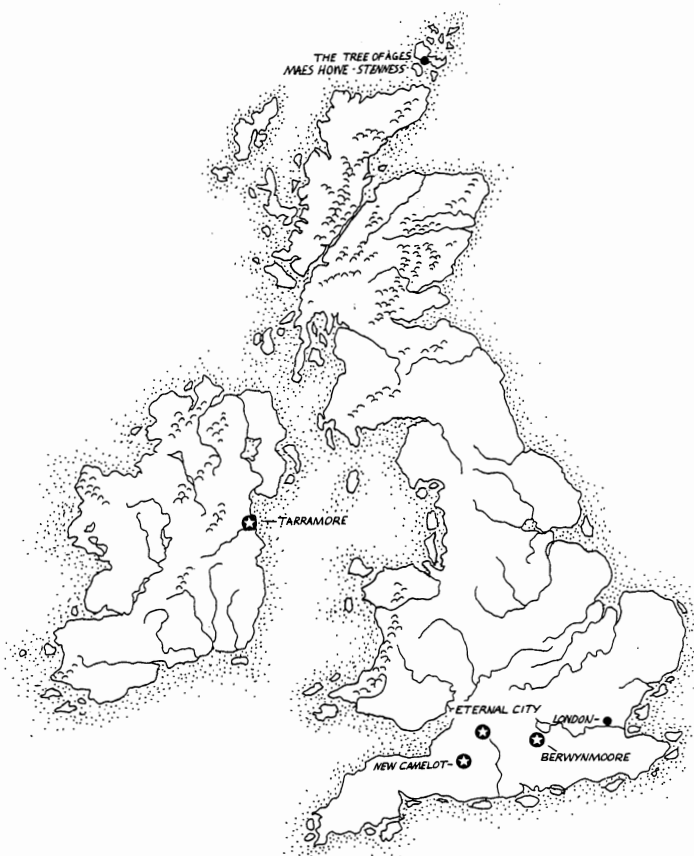
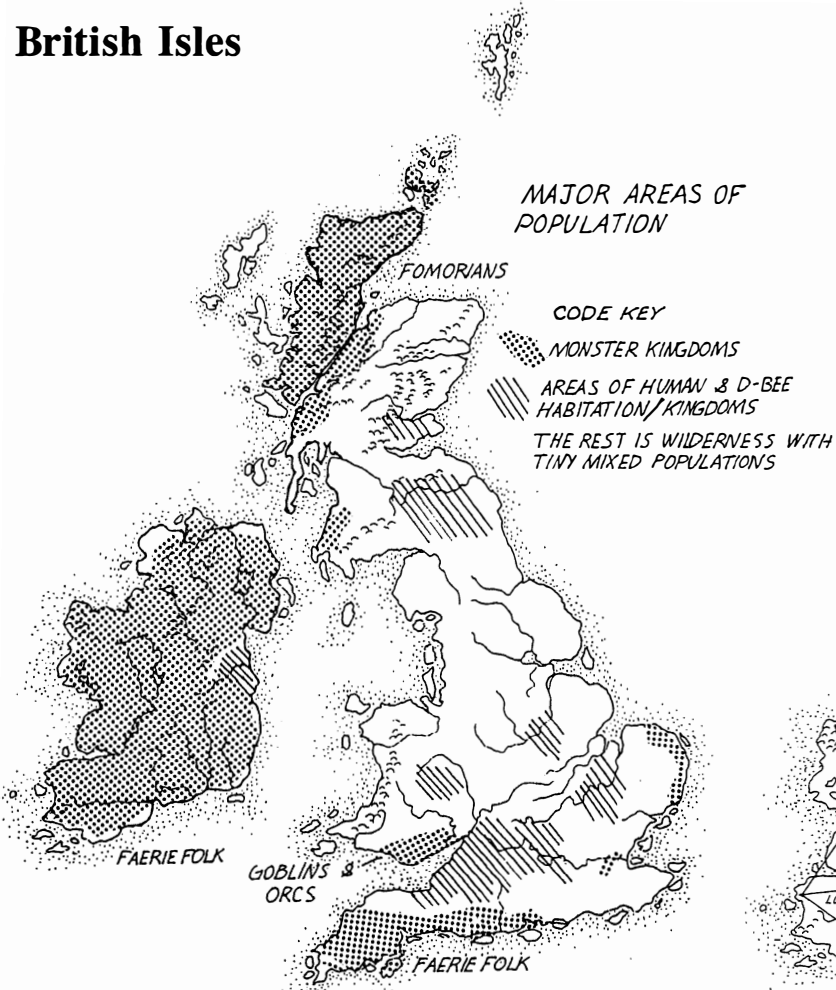



# Western & Central Russia

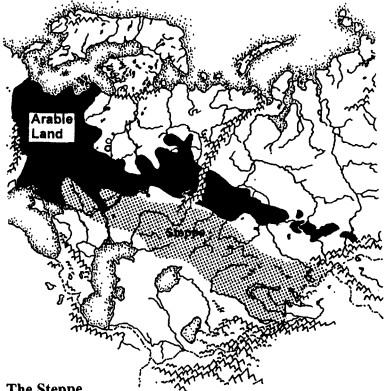

The Steppe

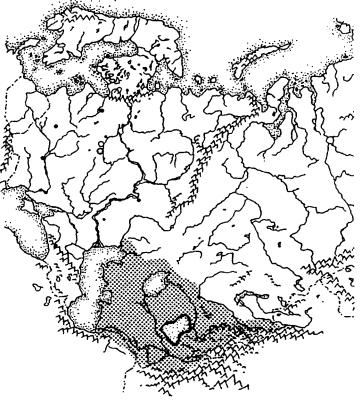

The Russian Desert of the Southwest

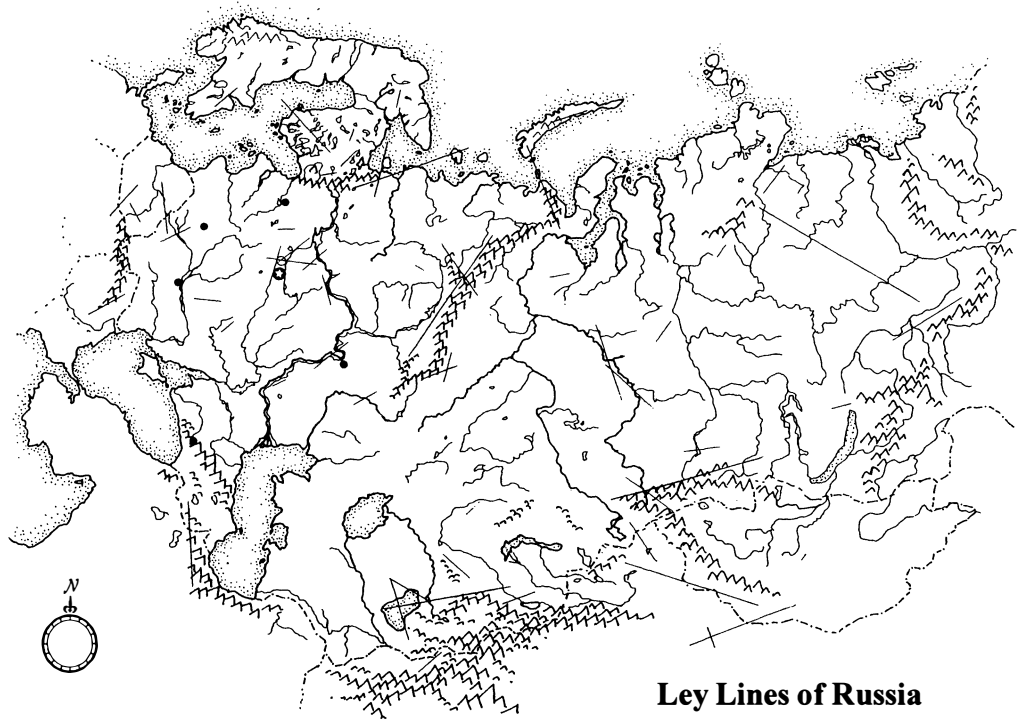

Ley Lines of Russia

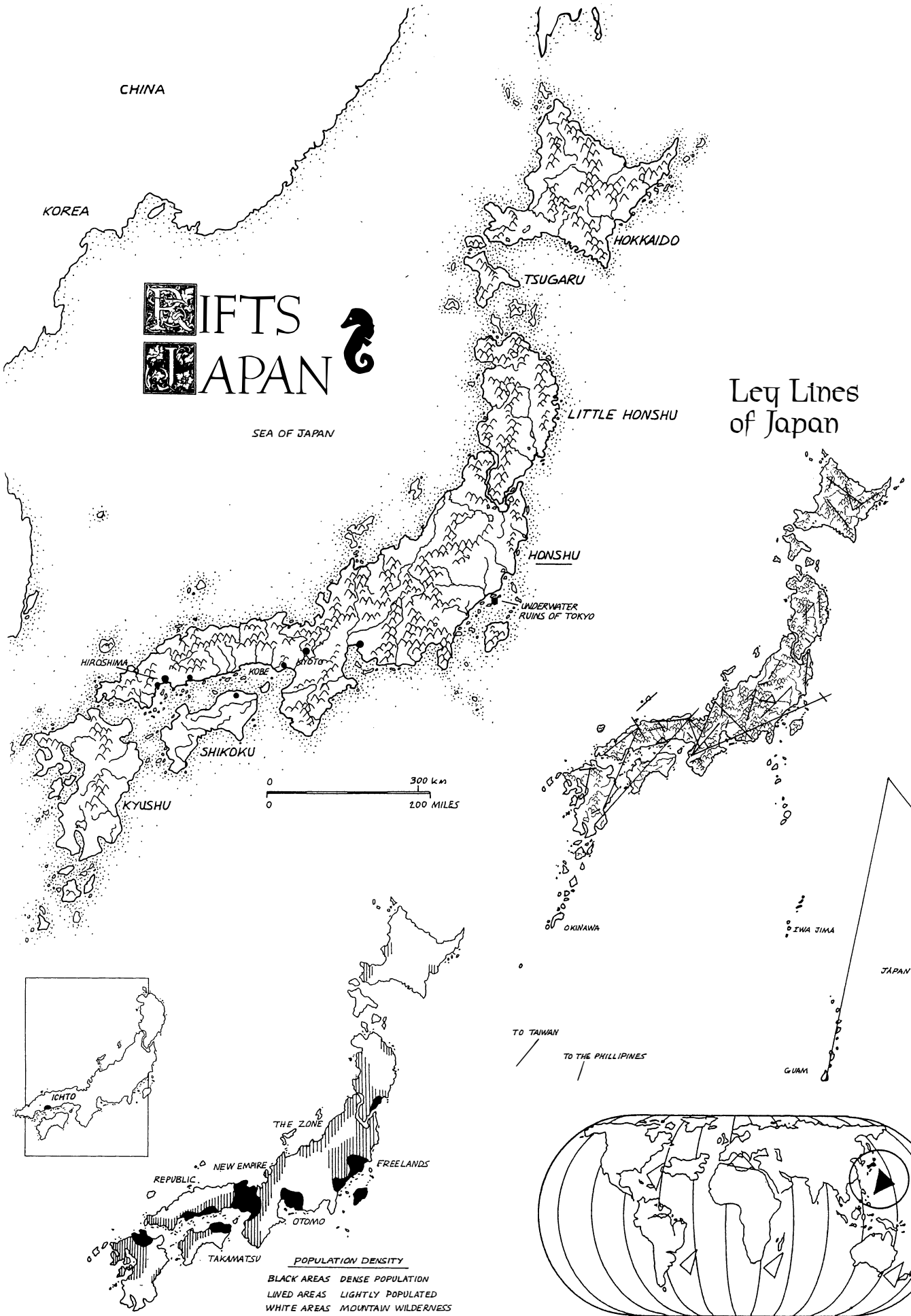



# Africa

PRE-RIFTS AFRICA

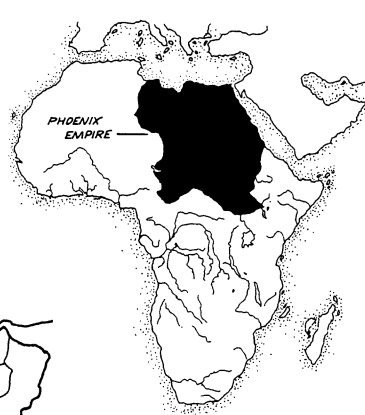

Phoenix Empire

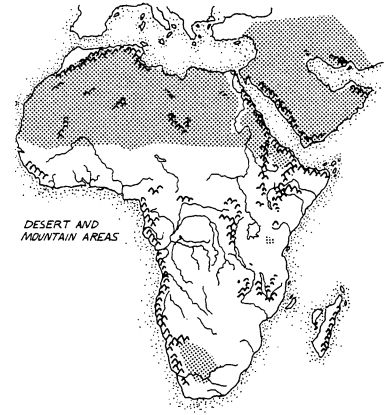

The Sahara Desert

# Australia

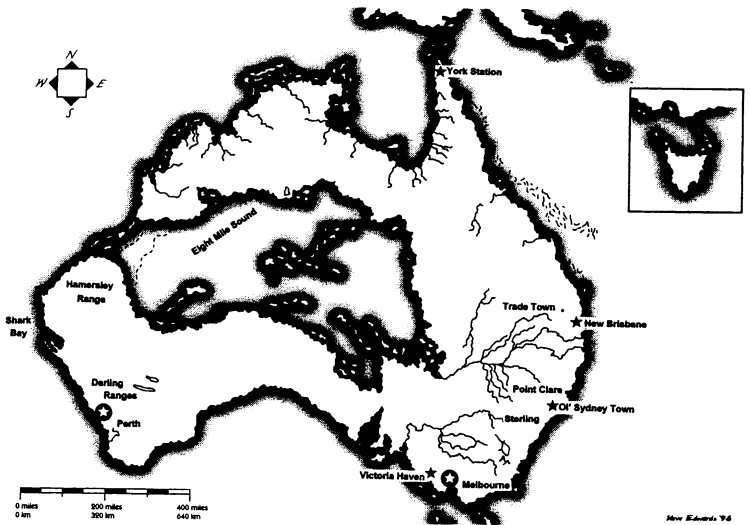

New Earth, 74

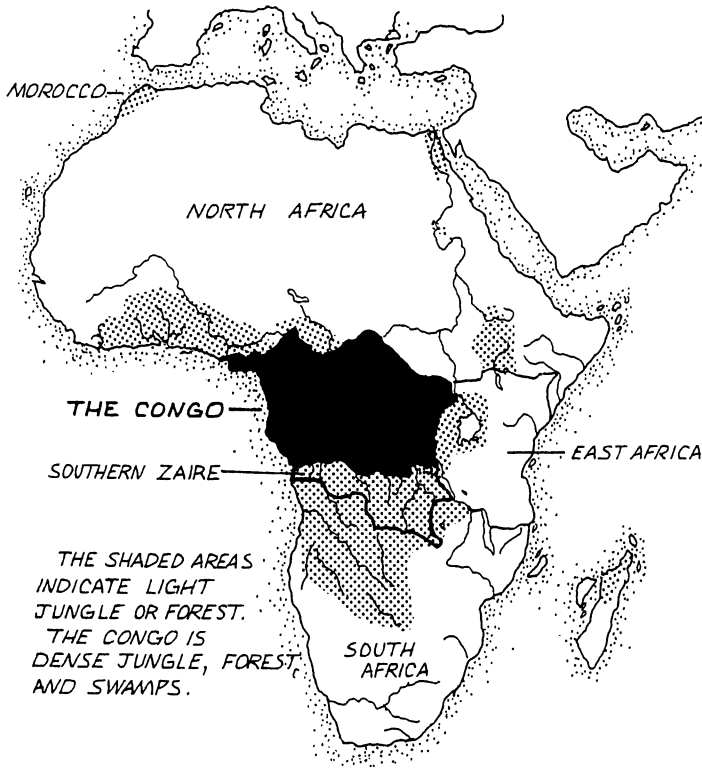

THE SHADED AREAS INDICATE LIGHT JUNGLE OR FOREST. THE CONGO IS DENSE JUNGLE, FOREST, AND SWAMPS.

Rifts Australia

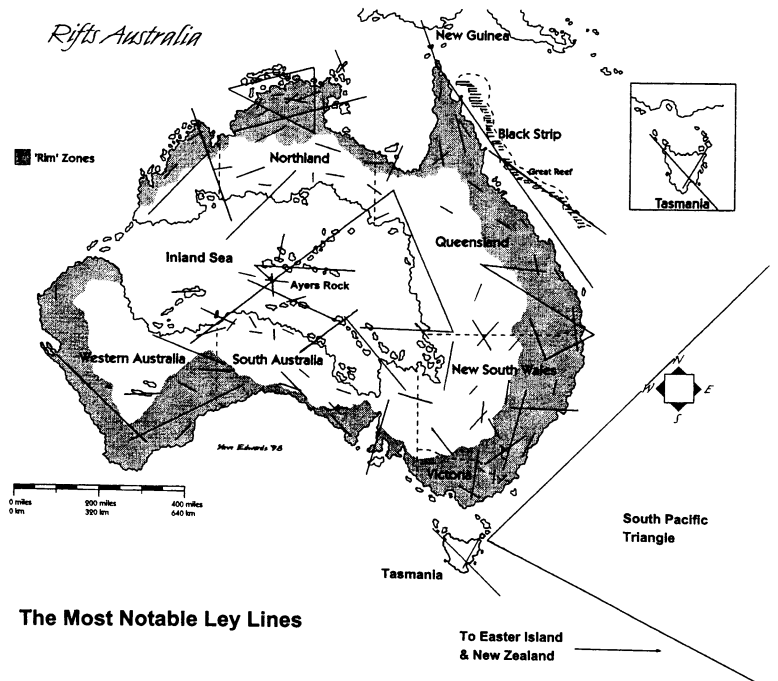

The Most Notable Ley Lines

To Easter Island & New Zealand



# RIFFTS®

- Imagine Earth transformed into an alien landscape.
- Humans exist – barely. And we are not alone.
- Aliens and monsters emerge from the Rifts – holes torn in the fabric of space and time, connected to countless worlds and realities.
- Ancient gods, demons and magic have returned.
- Magic and technology clash.
- Hundreds of character classes, many inhuman.
- *Rifts® Ultimate Edition* is the core RPG rule book.
- Expansive world setting with 90+ sourcebooks to draw upon.
- Rifts®, your portal to endless adventure.
- Limited only by your imagination.

[www.palladiumbooks.com](http://www.palladiumbooks.com)

© 2014 Palladium Books. Rifts®, Megaverse®, Nightbane® and other titles, slogans and likenesses are trademarks of Palladium Books, Inc. Palladium Books - 39074 Webb Court, Westland, MI 48185 USA - 734-271-2903 order line.

## Other RPG Worlds from Palladium Books®:

- *Rifts®* – the ultimate role-playing experience.
- *Rifts® Chaos Earth®* – Play the apocalypse as it happens.
- *Splicers®* – Weird science. Bio-tech battles insane robot legions.
- *Robotech® RPG* – All eras of the TV show brought to life.
- *Dead Reign® RPG* – Can you survive the Zombie Apocalypse?
- *Palladium Fantasy RPG®* – Unique world, monsters as player characters, magic and more.
- *Heroes Unlimited™ RPG* – Play any hero; mutants, aliens, cyborgs, superhumans, mages, immortals and more.
- *Nightbane® RPG* – Conspiracy, magic, horror and monsters.
- *Beyond the Supernatural™ RPG* – Modern horror and suspense.
- *Ninjas and Superspies™*, and more.



# ROBOTECH®

## Role-Playing Game and Sourcebooks

- **Four generations of heroes and mecha** • **Giant transformable robots** • **Alien invaders** • **Battle for control of the Earth** • **Combat takes to the stars** • **All presented in a core rule book and dynamic set of epic sourcebooks** • **Easy to learn** • **Fun to play** • **Quick character generation** • **Fast combat** • **Captures the action and adventure of the anime TV series** • **Isn't it time you joined the adventure?**

### **Robotech® "Core Rules" – Shadow Chronicles® RPG Hardcover**

All the rules and information a player needs to start a Robotech® role-playing campaign with Admiral Rick Hunter and the United Earth Expeditionary Force trekking across the galaxy.

- Human mecha: Alphas, Betas, Cyclones & much more.
- Five character classes. 25 different Military Specialties.
- Invid mecha, Haydonites, and alien enemies.
- Quick roll character tables. Make a character in 15 minutes.
- A complete, stand-alone RPG.
- 224 pages. Cat. No. 550HC. 8½ x 11 size, hardcover.

### **Robotech®: The Macross® Saga Sourcebook – Cat. No. 551**

A treasure chest packed with the iconic mecha, vehicles, weapons and characters that made Robotech® famous. Valkyries, Destroyoids, ground vehicles, aircraft, spacecraft, weapons, Zentraedi soldiers, Zentraedi mecha, alien invaders, heroes, villains, and more.

- All the iconic Macross mecha, vehicles, weapons & characters.

[www.palladiumbooks.com](http://www.palladiumbooks.com)

### **Robotech®: The Masters Saga™ Sourcebook – Cat. No. 552**

Tons of never before seen stats and descriptions for the many weapons, armor, mecha and robots of the Army of the Southern Cross.

- The Army of the Southern Cross™ – all 15 branches and their mecha!

### **Robotech®: New Generation™ Sourcebook – Cat. No. 554**

The battle for the liberation of Earth starts here.

- Kit-bashed mecha combining parts from different mecha.
- Invid Hives, world overview, key characters and adventure ideas.

### **Robotech®: Genesis Pits™ Sourcebook – Cat. No. 555**

The Invid Genesis Pits, their purpose, function.

- Inorganics and other war machines of the Invid Regent.
- Genesis Pit mutations and monsters.

### **Robotech®: Expeditionary Marines Sourcebook – Cat. No. 553**

Join the UEEF (United Earth Expeditionary Force) led by Admiral Rick Hunter as they travel across the galaxy liberating planets from the bondage of the Invid Regent, the Robotech Masters and other tyrants.

- New mecha, weapons, and character classes of the UEEF Marines.
- New alien species and allies. Planet hopping and more.



# ROBOTECH

RPG TACTICS™

## Main Boxed Game – Cat. No. 55100 – Available Now!

A fast-paced, strategy battle game that captures the speed and action of Robotech®. Play Earth defenders or Zentraedi invaders.

- Scalable from small squad skirmishes to mass battles.
- Turn-based system of play and uses D6. Two or more players.
- 34 highly detailed game pieces. 6mm scale.
- 112 page color rule book with paint guide and index.
- 53 laminated, color game cards.
- 24 custom dice, two decal sheets and more.
- Assembly and painting required. Glue not included.
- \$99.95 retail – Cat. No. 55100 – shipping now!
- Available in North and South America, the EU, Australia & New Zealand.

**Note:** Each product contains plastic game pieces requiring assembly and painting. Glue not included. This is not a toy. Small parts, not suitable for children under the age of 13. Adult supervision advised. Images shown here are not to scale.



### UEDF Valkyrie Wing™ – Cat. No. 55201

Build your fleet of Earth defenders with the Valkyrie Veritech Fighter; six game pieces total. **\$36.95 retail.**

- 2 Valkyries in Fighter mode.
- 2 Valkyries in Guardian mode.
- 2 Valkyries in Battloid mode.
- Multiple heads for making the VF-1A, VF-1J, VF-1R & VF-1S.



### UEDF Tomahawk/Defender Destroids™ – Cat. No. 55202

Expand your Destroid squad with these formidable walking tanks; four game pieces total. **\$32.95 retail.**

- 2 Tomahawk Destroids – the main battle tank of Destroids, brimming with powerful particle beam cannons for arms, and wielding a battery of missiles and an array of other weapons.
- 2 Defender Destroids – a long-range, anti-aircraft juggernaut capable of shooting down incoming Zentraedi Battlepods and Gnerl Fighters.



### UEDF Spartan/Phalanx Destroids™ – Cat. No. 55203

Add some long-range power and up-close punch to your army with these valuable Destroids; four game pieces total. **\$32.95 retail.**

- 2 Spartan Destroids – civil defense, riot control and deadly in hand combat.
- 2 Phalanx Destroids – a walking, long-range missile artillery unit.



### Zentraedi Regult Battlepods™ – Cat. No. 55401

Expand your Zentraedi forces with their main infantry battle mecha; six game pieces total. **\$36.95 retail.**

- 6 Regult Tactical Battlepods – the lightning quick Regults, armed with a pair of particle cannons and auto-cannons, attack in wave after wave.



### Zentraedi Artillery Battlepods™ – Cat. No. 55402

Give your Zentraedi legion greater firepower with these artillery and support Battlepods; four game pieces total. **\$36.95 retail.**

- 4 Zentraedi Support Battlepods, each of which can be made into:
    - Gluuhaug-Regult – Light Artillery Battlepod
    - Serauhaug-Regult – Heavy Artillery Battlepod
    - Telnesta-Regult – Experimental Particle Beam Battlepod
- Four game pieces total.**



### Zentraedi Glaug Command™ – Cat. No. 55403

This diverse pack provides your Zentraedi forces with greater tactical capabilities; three game pieces total. **\$36.95 retail.**

- 1 Glaug Officer's Battlepod – the fast and deadly mecha of Zentraedi field leaders.
- 1 Quel-Regult Scout Battlepod – the stealthy eyes and ears of your Zentraedi battle force; electronic warfare capabilities.
- 1 Quel-Gulnau Recovery Pod – enhances the Glaug's ability to bring in Battlepod reinforcements. **Note:** This figure has NEVER before been offered by any company.

[www.palladiumbooks.com](http://www.palladiumbooks.com)

© Palladium Books Inc. Robotech® is a Registered Trademark of Harmony Gold USA, Inc. Palladium Books, 39074 Webb Court, Westland, MI 48185-7606. Order line: 734-721-2903.

# Can YOU survive the Zombie Apocalypse?



## The Dead Reign® RPG series

**Dead Reign® RPG – “Core Rules.”** It is the aftermath of the *zombie apocalypse*. The dead reign and the living fight against impossible odds. Can you survive? Find out with this fast-paced horror game. Easy to learn. Fast character creation and combat.

- **Zombie combat and survival rules, vehicles and equipment.**
- **6 iconic Character Classes plus Ordinary People (40+ occupations).**
- **7 types of zombies, plus the Half-Living.**
- **101 Random Scenarios, Encounters, Settings and other tables.**
- **\$22.95 retail – 224 pages – Cat. No. 230. Available now.**

## Civilization Gone™ Sourcebook

Civilization has crumbled to nothing. There is no army. No government. No help coming. What now?

- **Madmen, Psychopaths, villains, heroes and protectors.**
- **House, home and survivor camp tables, resources & encounters.**
- **\$12.92 retail – 64 pages – Cat. No. 231. Available now.**

## Dark Places™ Sourcebook

Travel the rails and urban underground to move about undetected by zombies.

- **Worm Meat, Bug Boy, Sewer Crawler & Impersonator Zombies.**
- **Traveling the rails, sewers and other dark places.**
- **Random encounter tables, boxcar content tables, and much more.**
- **\$12.92 retail – 64 pages – Cat. No. 232. Available now.**

## Endless Dead™ Sourcebook

The zombies grow in number and strangeness. Can humankind survive?

- **Zombie amalgamations, tables and encounters.**
- **New player characters & timetables for your campaign.**
- **Weaponizing vehicles, vehicle combat rules, and military bases.**
- **Creating survivor caravans, hideouts, Safe Havens & more.**
- **\$16.95 retail – 96 pages – Cat. No. 233. Available now.**

## Other horror titles from Palladium Books®

**Beyond the Supernatural™ RPG**      **Nightbane® RPG**

© Copyright 2017 Palladium Books Inc. All rights reserved. Rifts®, Palladium Books®, Megaverse®, Nightbane®, Dead Reign®, Heroes Unlimited and other published book titles, names, slogans and likenesses are trademarks of Palladium Books Inc.

[www.palladiumbooks.com](http://www.palladiumbooks.com)

## Fear the Reaper™ Sourcebook

Heroes who, like knights of old, travel the highways fighting zombies and helping survivors.

- **Comprehensive background on the Road Reapers.**
- **Their code, missions, weapons, strategies and tactics.**
- **The Terror Zombie and more.**
- **\$12.95 retail – 48 pages – Cat. No. 234. Available now.**

## Graveyard Earth™ Sourcebook

The Zombie Apocalypse across the globe; provides a world overview and many adventure ideas.

- **Many tables for settings, encounters and adventure hooks.**
- **Random Safe Havens by region, and Survivor Leaders.**
- **How to get home from abroad, zombie threat levels & more.**
- **\$12.95 retail – 64 pages – Cat. No. 235. Available now.**

## Hell Followed™ Sourcebook

This big, 160 page sourcebook begins to redefine the zombie genre. It broadens the field of possibilities and expands upon the modern zombie mythos. It is full of twists and surprises you will not expect.

- **11 new types of terrifying zombies.**
- **7 player characters, plus Masked Lunatics – heroes or madmen?**
- **21 disasters to complicate survival, and urban survival.**
- **Government enclaves, conspiracy theories and more.**
- **\$20.95 retail – 160 pages – Cat. No. 236. Available now.**



# Palladium Books® Check List & Order Form

Dept. P-16, 39074 Webb Court, Westland, MI 48185

Name: \_\_\_\_\_ Address: \_\_\_\_\_

City: \_\_\_\_\_ State: \_\_\_\_\_ Zip/Postal Code: \_\_\_\_\_ Country: \_\_\_\_\_

Credit Card Number: \_\_\_\_\_ Expiration Date: \_\_\_\_\_  Visa  MasterCard

Telephone Number: \_\_\_\_\_ Signature: \_\_\_\_\_  AMEX  Other

## The Rifter® Series

- \_\_\_ 173 The Rifter® #73 – \$13.95
- \_\_\_ 174 The Rifter® #74 – \$13.95
- \_\_\_ 175 The Rifter® #75 – \$13.95
- \_\_\_ 176 The Rifter® #76 – \$13.95
- \_\_\_ 177 The Rifter® #77 – \$13.95
- \_\_\_ 178 The Rifter® #78 – \$13.95 (Spring)

## Splicers® Note: Sourcebooks coming soon.

- \_\_\_ 200 Splicers® RPG – \$23.95

## Dead Reign®

- \_\_\_ 230 Dead Reign® RPG – \$22.95
- \_\_\_ 231 SB 1: Civilization Gone™ – \$12.95
- \_\_\_ 232 SB 2: Dark Places™ – \$12.95
- \_\_\_ 233 SB 3: Endless Dead™ – \$16.95
- \_\_\_ 234 SB 4: Fear the Reaper™ – \$12.95
- \_\_\_ 235 SB 5: Graveyard Earth™ – \$12.95
- \_\_\_ 236 SB 6: Hell Followed™ – \$20.95

## Rifts® Novels

- \_\_\_ 301 Sonic Boom™ – \$9.95
- \_\_\_ 302 Deception's Web™ – \$9.95
- \_\_\_ 303 Treacherous Awakenings™ – \$9.95
- \_\_\_ 304 Tales of the Chi-Town 'Burbs™ – \$12.95
- \_\_\_ 305 Rifts® Path of the Storm™ – \$12.95

## Weapons Books

- \_\_\_ 401 Weapons and Armor™ – \$8.95
- \_\_\_ 402 Weapons and Castles™ – \$8.95
- \_\_\_ 403 Weapons and Assassins™ – \$9.95
- \_\_\_ 404 Weapons & Castles of the Orient™ – \$9.95
- \_\_\_ 409 Exotic Weapons™ – \$9.95
- \_\_\_ 410 European Castles™ – \$9.95

## Palladium Fantasy RPG®

- \_\_\_ 450 The Palladium Fantasy RPG® – \$26.95
- \_\_\_ 4500HC Palladium Fantasy RPG® 30th Anniversary Hardcover – \$50.00
- \_\_\_ 451 Dragons & Gods™ – \$24.95
- \_\_\_ 453 Old Ones™ 2nd Ed. – \$24.95
- \_\_\_ 454 Monsters & Animals™ 2nd Ed. – \$24.95
- \_\_\_ 455 Adventures on the High Seas™ – \$24.95
- \_\_\_ 458 Island at the Edge of the World™ – \$20.95
- \_\_\_ 459 Yin-Sloth Jungles™ – \$20.95
- \_\_\_ 462 Western Empire™ – \$24.95
- \_\_\_ 463 Baalgor Wastelands™ – \$24.95
- \_\_\_ 464 Mount Nimro™ – \$20.95
- \_\_\_ 465 Eastern Territory™ – \$24.95
- \_\_\_ 466 Library of Bletherad™ – \$20.95
- \_\_\_ 467 Northern Hinterlands™ – \$24.95
- \_\_\_ 468 Land/Damned 1: Chaos Lands™ – \$24.95
- \_\_\_ 469 LoD 2: Eternal Torment™ – \$24.95
- \_\_\_ 470 LoD 3: The Citadel – \$24.95 (coming)
- \_\_\_ 471 Wolfen Empire™ – \$20.95
- \_\_\_ 472 Mysteries of Magic™ One: Heart of Magic – \$16.95
- \_\_\_ 474 Bizantium/Northern Islands™ – \$20.95
- \_\_\_ 475 Garden of the Gods™ – \$16.95 (coming)

## Heroes Unlimited™ / After the Bomb®

- \_\_\_ 500-2 Heroes Unlimited™, 2nd Ed. – \$26.95
- \_\_\_ 5000HC Heroes Unlimited™ 30th Anniversary Hardcover – \$50.00
- \_\_\_ 501 Villains Unlimited™ Revised – \$24.95
- \_\_\_ 503 After the Bomb® RPG – \$24.95
- \_\_\_ 505 Road Hogs™ (After the Bomb® II) – \$9.95
- \_\_\_ 507 Mutants Down Under™ (AB III) – \$9.95
- \_\_\_ 511 Mutants of the Yucatan™ (AB IV) – \$9.95
- \_\_\_ 513 Mutants in Avalon™ (AB V) – \$16.95
- \_\_\_ 514 Mutants in Orbit™ (AB VI) – \$16.95
- \_\_\_ 515 Aliens Unlimited™ – \$24.95
- \_\_\_ 516 Heroes Unlimited™ G.M.'s Guide – \$24.95
- \_\_\_ 517 Century Station™ – \$24.95
- \_\_\_ 518 Gramercy Island™ – \$24.95
- \_\_\_ 519 Aliens Unlimited Galaxy Guide™ – \$24.95
- \_\_\_ 520 Mutant Underground™ – \$16.95
- \_\_\_ 521 Powers Unlimited® One – \$16.95
- \_\_\_ 522 Powers Unlimited® Two – \$16.95
- \_\_\_ 523 Powers Unlimited® Three – \$16.95
- \_\_\_ 525 Revised Ninjas & Superspies™ – \$20.95
- \_\_\_ 526 Mystic China™ – \$24.95
- \_\_\_ 527 Armageddon Unlimited™ – \$20.95

## Robotech® RPG

- \_\_\_ 550 Robotech® The Shadow Chronicles® RPG (manga size) – \$16.95
- \_\_\_ 550HC Robotech® The Shadow Chronicles® Deluxe Hardcover RPG – \$30.95
- \_\_\_ 5500HC Robotech® The Shadow Chronicles® Gold Ed. Hardcover RPG – \$70.00
- \_\_\_ 551 Robotech® Macross® Saga Sourcebook – \$16.95
- \_\_\_ 552 Robotech® The Masters Saga™ Sourcebook (NEW in 8½ x 11) – \$20.95
- \_\_\_ 553 Robotech®: Expeditionary Force Marines Sourcebook – \$20.95
- \_\_\_ 554 Robotech® The New Generation™ Sourcebook – \$16.95
- \_\_\_ 555 Robotech® Genesis Pits Sourcebook – \$16.95

## Robotech® RPG Tactics™ (New!)

- \_\_\_ 55100 Robotech® RPG Tactics™ – \$99.95
- \_\_\_ 55105 Robotech® RPG Tactics™ Rulebook – \$20.00
- \_\_\_ 55101 UEDF Dice Pack – \$12.00
- \_\_\_ 55102 Zentraedi Dice Pack – \$12.00
- \_\_\_ 55201 UEDF Valkyrie Wing – \$36.95
- \_\_\_ 55202 UEDF Destroid Pack – \$32.95
- \_\_\_ 55203 UEDF Spartan Pack – \$32.95
- \_\_\_ 55401 Zentraedi Regult Battlepods – \$36.95
- \_\_\_ 55402 Zentraedi Artillery Battlepods – \$36.95
- \_\_\_ 55403 Zentraedi Glaug Command – \$36.95

## Rifts® Chaos Earth®

- \_\_\_ 660 Rifts® Chaos Earth® RPG – \$20.95
- \_\_\_ 661 Rifts® CE Creatures of Chaos™ – \$12.95
- \_\_\_ 662 Rifts® CE The Rise of Magic™ – \$12.95
- \_\_\_ 665 Rifts® Chaos Earth® First Responders™ – \$16.95 (coming)
- \_\_\_ 666 Rifts® Chaos Earth® Resurrection™ – \$20.95

## Beyond the Supernatural™

- \_\_\_ 700 Beyond the Supernatural™, 2nd Ed. – \$24.95
- \_\_\_ 702 Tome Grotesque™ – \$20.95 (coming)
- \_\_\_ 703 Beyond Arcanum™ – \$24.95 (coming)

## Nightbane®

- \_\_\_ 730 Nightbane® RPG – \$24.95
- \_\_\_ 731 Nightbane®: Between the Shadows™ – \$20.95
- \_\_\_ 732 Nightbane®: Nighlands™ – \$20.95
- \_\_\_ 733 Nightbane®: Through the Glass Darkly™ – \$20.95
- \_\_\_ 735 Nightbane® Survival Guide™ – \$20.95

## Rifts®

- \_\_\_ 800HC Rifts® RPG Ultimate Edition – \$39.95
- \_\_\_ 801 Rifts® Sourcebook One Revised – \$20.95
- \_\_\_ 802-E Rifts® World Book 1: Vampire Kingdoms™, Revised – \$24.95
- \_\_\_ 803 Rifts® Conversion Book One™ – \$24.95
- \_\_\_ 804 Rifts® WB 2: Atlantis™ – \$20.95
- \_\_\_ 805 Rifts® Sourcebook 2: Mechanoids™ – \$16.95
- \_\_\_ 807 Rifts® WB 3: England™ – \$20.95
- \_\_\_ 808 Rifts® WB 4: Africa™ – \$20.95
- \_\_\_ 809 Rifts® Dimension Book 1: Wormwood™ – \$20.95
- \_\_\_ 810 Rifts® WB 5: Triax™ – \$24.95
- \_\_\_ 811 Rifts® Pantheons of the Megaverse® – \$24.95
- \_\_\_ 812 Rifts® Sourcebook 3: Mindwerks™ – \$16.95
- \_\_\_ 813 Rifts® Mercenaries™ – \$20.95
- \_\_\_ 814 Rifts® WB 6: South America™ – \$20.95
- \_\_\_ 815 Rifts® WB 7: Underseas™ – \$24.95
- \_\_\_ 816 Rifts® DB 2: Phase World® – \$24.95
- \_\_\_ 817 Rifts® DB 3: Phase World® Sourcebook – \$16.95
- \_\_\_ 818 Rifts® WB 8: Rifts® Japan™ – \$24.95
- \_\_\_ 819 Rifts® WB 9: South America Two™ – \$24.95
- \_\_\_ 820 Rifts® WB 10: Juicer Uprising™ – \$20.95
- \_\_\_ 821 Rifts® WB 11: Coalition War Campaign™ – \$24.95

- \_\_\_ 822 Rifts® WB 12: Psyscape™ – \$20.95  
 \_\_\_ 825 Rifts® WB 13: Lone Star™ – \$20.95  
 \_\_\_ 826 Rifts® WB 14: New West™ – \$24.95  
 \_\_\_ 827 Rifts® WB 15: Spirit West™ – \$24.95  
 \_\_\_ 828 Rifts® Sourcebook 4: Coalition Navy™ – \$16.95  
 \_\_\_ 829 Rifts® WB 16: Federation of Magic™ – \$20.95  
 \_\_\_ 830 Rifts® DB 4: Skraypers™ – \$20.95  
 \_\_\_ 831 Rifts® Index Volume Two™ – \$16.95  
 \_\_\_ 832 Rifts® WB 17: Warlords of Russia™ – \$24.95  
 \_\_\_ 833 Rifts® WB 18: Mystic Russia™ – \$20.95  
 \_\_\_ 834 Rifts® WB 19: Australia 1 – \$24.95  
 \_\_\_ 835 Rifts® WB 20: Canada™ – \$24.95  
 \_\_\_ 836 Rifts® WB 21: Splynn Dimensional Market™ – \$24.95  
 \_\_\_ 837 Rifts® WB 22: Free Quebec™ – \$24.95  
 \_\_\_ 838 Rifts® WB 23: Xiticix Invasion™ – \$20.95  
 \_\_\_ 839 Rifts® Coalition Wars®: Sedition™ – \$20.95  
 \_\_\_ 840 Rifts® Coalition Wars®: Coalition Overkill™ – \$16.95  
 \_\_\_ 841 Rifts® Coalition Wars®: Sorcerers' Revenge™ – \$16.95  
 \_\_\_ 842 Rifts® Coalition Wars®: Cyber-Knights™ – \$16.95  
 \_\_\_ 843 Rifts® Coalition Wars®: Shadows of Evil™ – \$16.95  
 \_\_\_ 844 Rifts® Coalition Wars®: Final Siege™ – \$24.95  
 \_\_\_ 845 Rifts® Game Master Guide™ – \$26.95  
 \_\_\_ 846 Rifts® Aftermath™ – \$24.95  
 \_\_\_ 847 Rifts® DB5: Anvil Galaxy™ – \$20.95  
 \_\_\_ 848 Rifts® Book of Magic™ – \$26.95  
 \_\_\_ 849 Rifts® Adventure Guide™ – \$24.95  
 \_\_\_ 850 Rifts® Bionics Sourcebook™ – \$16.95  
 \_\_\_ 851 Rifts® DB 6: Three Galaxies™ – \$20.95  
 \_\_\_ 852 Rifts® Dark Conversions™ – \$24.95  
 \_\_\_ 853 Rifts® Chi-Town 'Burbs™ – \$9.95  
 \_\_\_ 854 Rifts® The Tolkien Crisis™ – \$12.95  
 \_\_\_ 855 Rifts® The Black Vault™ – \$9.95  
 \_\_\_ 856 Rifts® The Vanguard™ – \$9.95  
 \_\_\_ 857 Rifts® WB 24: China One™ – \$20.95  
 \_\_\_ 858 Rifts® WB 25: China Two™ – \$20.95  
 \_\_\_ 859 Rifts® DB 7: Megaverse Builder™ – \$16.95  
 \_\_\_ 860 Rifts® DB 8: Naruni Wave Two™ – \$16.95  
 \_\_\_ 862 Rifts® WB 26: Dinosaur Swamp™ – \$20.95  
 \_\_\_ 863 Rifts® MercTown™ – \$20.95  
 \_\_\_ 865 Rifts® Merc Ops™ – \$20.95  
 \_\_\_ 866 Rifts® WB 27: Adventures in Dinosaur Swamp™ – \$20.95  
 \_\_\_ 867 Rifts® Mercenary Adventure Sourcebook – \$12.95  
 \_\_\_ 868 Rifts® WB 28: Arzno™ – \$20.95  
 \_\_\_ 869 Rifts® WB 29: Madhaven™ – \$16.95  
 \_\_\_ 870 Rifts® John Zeleznik Coloring Book – \$5.95  
 \_\_\_ 871 Rifts® Machinations of Doom™ – \$18.95  
 \_\_\_ 872 Rifts® DB 10: Hades™ – \$24.95  
 \_\_\_ 873 Rifts® DB 11: Dyval™ – \$24.95  
 \_\_\_ 874 Rifts® WB 30: D-Bees of North America™ – \$24.95  
 \_\_\_ 875 Rifts® DB12: Dimensional Outbreak – \$24.95  
 \_\_\_ 876 Rifts® Megaverse® in Flames™ – \$24.95  
 \_\_\_ 876HC Rifts® Megaverse® in Flames™ Gold Hardcover Edition – \$50.00  
 \_\_\_ 877 Rifts® Heroes of the Megaverse® – \$16.95  
 \_\_\_ 878 Rifts® Sourcebook: Shemarrian Nation™ – \$16.95  
 \_\_\_ 880 Phase World®: Fleets of the Three Galaxies™ – \$16.95  
 \_\_\_ 881 Rifts® WB 31: Triax™ Two – \$24.95  
 \_\_\_ 883 Rifts® DB 14: Thundercloud Galaxy™ – \$20.95  
 \_\_\_ 884 Rifts® Vampires Sourcebook™ – \$20.95  
 \_\_\_ 885 Rifts® WB 32: Lemuria™ – \$24.95  
 \_\_\_ 886 Rifts® Black Market™ – \$24.95  
 \_\_\_ 886HC Rifts® Black Market™ Hardcover Gold Edition – \$60.00  
 \_\_\_ 887 Rifts® WB 33: Northern Gun™ One – \$24.95  
 \_\_\_ 888 Rifts® WB 34: Northern Gun™ Two – \$26.95  
 \_\_\_ 889 Rifts® Sourcebook: Coalition States, Heroes of Humanity™ – \$20.95  
 \_\_\_ 890 Rifts® World Book: Secrets of the Atlanteans™ – \$24.95 (coming)  
 \_\_\_ 891 Rifts® World Book: Sovietski™ – \$24.95 (coming)  
 \_\_\_ 892 Rifts® Sourcebook: The Disavowed™ – \$16.95 (coming)  
 \_\_\_ 893 Rifts® CS: Heroes of Humanity™ Arsenal Sourcebook – \$16.95 (coming)  
 \_\_\_ 894 Rifts® Haunted Tech™ – \$16.95 (coming)  
 \_\_\_ 2510 Rifts® & The Megaverse® Art Book – \$22.95  
 \_\_\_ 2510-HC Rifts® & The Megaverse® Art Book, Hardcover – \$50.00  
 \_\_\_ 2510-CML Rifts® & The Megaverse® Art Book, Collector's Masterwork Edition – \$125.00
- Miscellaneous Products**  
 \_\_\_ 600 Deluxe Revised RECON® RPG – \$22.95  
 \_\_\_ 2537 Gamer Coffee Mug – \$10.00  
 \_\_\_ 2539 Rifts® Dice Bag – Black – \$8.00  
 \_\_\_ 2545 Dead Reign™ Coffee Mug – \$10.00  
 \_\_\_ 2554 Palladium Bookmarks, Set One – \$5.00  
 \_\_\_ 2555 Palladium Bookmarks, Set Two – \$5.00  
 \_\_\_ 2561 Property of Chi-Town Library Pencil – \$0.50 each  
 \_\_\_ 2562 Future Visions™ – The Artistry of Charles Walton II – \$13.95  
 \_\_\_ 2566 Glitter Boy Mouse Pad – \$9.95  
 \_\_\_ 2567 Old Ones Mouse Pad – \$9.95  
 \_\_\_ 2568 Zombie Graveyard Mouse Pad – \$9.95
- Note:** T-shirts and other products can be found online: [www.palladiumbooks.com](http://www.palladiumbooks.com)
- Rifts® Miniatures**  
 \_\_\_ MI8002 Xiticix Pack – \$18.00  
 \_\_\_ MI8004 Coalition Dog Pack – \$18.00  
 \_\_\_ MI8005 Men of Magic Pack #1 – \$18.00  
 \_\_\_ MI8006 Cyborgs Pack #1 – \$18.00  
 \_\_\_ MI8007 Simvan & Ostrosaurus Pack – \$18.00  
 \_\_\_ MI8008 Coalition Skelebots Pack #1 – \$18.00  
 \_\_\_ MI8009 Coalition SAMAS Pack #1 – \$22.00  
 \_\_\_ MI8010 Coalition Sky Cycle Pack – \$22.00  
 \_\_\_ MI8011 Coalition Dog Pack #2 – \$18.00  
 \_\_\_ MI8015 Damaged Skelebots Pack #1 – \$12.00  
 \_\_\_ MI8016 Cyber-Adventurers Pack – \$18.00  
 \_\_\_ MI8017 Rogues & Scout Pack #1 – \$18.00  
 \_\_\_ MI8018 Brodkil & Witchling Pack – \$18.00  
 \_\_\_ MI8019 Damaged Skelebots Pack #2 – \$18.00  
 \_\_\_ MI8020 Psi-Stalkers & Scouts Pack #1 – \$18.00  
 \_\_\_ MI8021 Shadow Beast – \$12.00  
 \_\_\_ MI8022 Mystic Knight – \$6.00  
 \_\_\_ MI8023 Lord Magus – \$6.00  
 \_\_\_ MI8024 High Magus – \$6.00  
 \_\_\_ MI8025 Coalition Psi-Stalker – \$6.00  
 \_\_\_ MI8026 Coalition Dog Boy in DPM-D1 Armor – \$6.00  
 \_\_\_ MI8027 Coalition Dog Boy #2 – \$6.00  
 \_\_\_ MI8028 Coalition Dog Boy #3 – \$6.00  
 \_\_\_ MI8029 Coalition Dog Boy #4 – \$6.00  
 \_\_\_ MI8030 Coalition Dog Boy #5 – \$6.00  
 \_\_\_ MI8031 Glitter Boy – \$20.00  
 \_\_\_ MI8032 Glitter Boy Pilot – \$6.00  
 \_\_\_ MI8033 Kydian Overlord – \$20.00  
 \_\_\_ MI8034 Dragonsaurus – \$10.00  
 \_\_\_ MI8035 Slaver and Slave (Atlantis) Set – \$10.00  
 \_\_\_ MI8036 Crazy – \$6.00  
 \_\_\_ MI8037 Juicer #1 – \$6.00  
 \_\_\_ MI8038 Juicer #2 – \$6.00  
 \_\_\_ MI8039 Cyborg #1 – \$12.00  
 \_\_\_ MI8040 Cyborg #2 – \$12.00  
 \_\_\_ MI8041 Cyborg #3 – \$6.00  
 \_\_\_ MI8042 Coalition Officer – \$6.00  
 \_\_\_ MI8043 Coalition Grunt #1 – \$6.00  
 \_\_\_ MI8044 Coalition Grunt #2 – \$6.00  
 \_\_\_ MI8045 Coalition Grunt #3 – \$6.00

**When placing an order by mail, please add money for shipping and handling.** Add \$5.00 for orders totaling \$1-\$50, \$10.00 for orders totaling \$51-\$95, and for orders totaling \$96-\$200 please add \$15.00 US. Double the amount for Canada, and *quadruple* it for overseas orders. For more shipping options, order online at [www.palladiumbooks.com](http://www.palladiumbooks.com).

Allow 2-4 weeks for delivery.  
 Make checks and money orders payable to: *Palladium Books*

**Check release dates for new products.** If the book you order has not been released yet, your order will be held as a backorder until the product is available. Please note that prices are subject to change without notice.

**Orders can also be placed by phone,** at (734) 721-2903 (order line only). Please have your credit card information when you call.

[www.palladiumbooks.com](http://www.palladiumbooks.com)

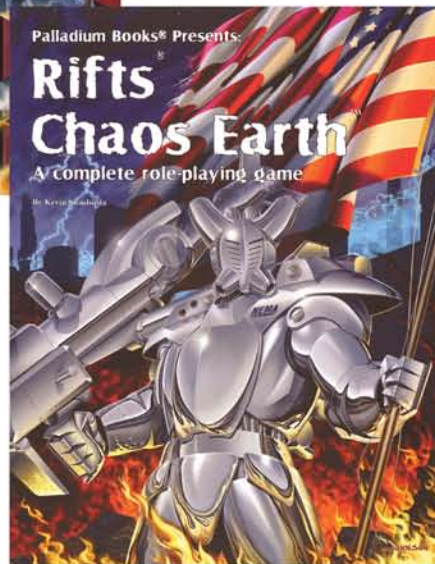
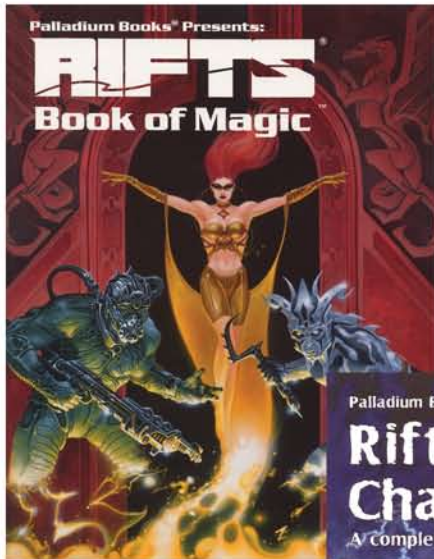

**Join the adventure.  
Explore the  
Megaverse®**

## Also from Palladium Books®

### Rifts® Book of Magic

- More than 850 spells of every variety.
- More than 370 magic items, weapons and devices.
- Warlock spells, Necromancy, Temporal Magic & others.
- Magic Tattoos, Biomancy, Magic Herbs, chants & songs.
- Techno-Wizardry devices, Rune Weapons, and more.
- 352 pages of magic and wonderment.

### Rifts® Adventure Guide

- Advice and tips on running and playing RPGs.
- Advice and tips on creating adventures.
- Tables for generating cities, organizations & Rifts.
- More than 150 adventure ideas and other notes and info.
- 192 pages by Siembieda, Wujcik and Coffin.

### D-Bees of North America®

- 86 inhuman beings (36 new – 50 others updated).
- Countless ideas for player characters and adventure.
- Art by Perez, Mumah, Dudley, Wilson and others.
- 224 pages by Kevin Siembieda and others.

### Rifts® Chaos Earth®

- The origin of Rifts Earth. See how it all began.
- Play through the Great Cataclysm as it is happening.
- NEMA military O.C.C.s, weapons and equipment.
- Power armor & robots – includes original Glitter Boy & SAMAS.
- Many sourcebooks to come. Rifts® compatible Mega-Damage setting.
- 160 pages by Kevin Siembieda. A complete role-playing game.

# Rifts® Game Master Guide

## The ultimate Rifts® reference and sourcebook

All the weapons, equipment, body armor, power armor, robots, vehicles, skills and psionics from *Rifts® World Books 1-22, Sourcebooks 1-4, and Siege on Tolkeen 1-6*, collected into one big reference. Plus, maps, lists of O.C.C.s and R.C.C.s, and more.

- 503 weapons, including explosives, plus E-Clips and ammo notes.
- 300 skills listed and described.
- 290 pieces of equipment
- 104 suits of body armor.
- 182 vehicles.
- 86 suits of power armor.
- 58 robots.
- New and optional combat rules and examples of play.
- Comprehensive index of O.C.C.s, R.C.C.s, P.C.C.s, and monsters.
- Experience tables for scores of character classes.
- Designer notes, rules clarifications and reference notes.
- Game Master tips and hints for running Rifts®.
- Maps, adventure ideas, and a lexicon of terms.
- 352 pages of reference material galore.

**Rifts®, endless possibilities  
limited only by your imagination!™**

\$26.95

Cat. No. 845

ISBN-10: 1-57457-067-6

ISBN-13: 978-1-57457-067-0

**Palladium  
Books Inc.**

www.palladiumbooks.com