

Palladium Books® Presents:

Rifts® Lone Star

World Book 13

By Kevin Siembieda



ZELEZNIK

UNISO

Warning!

Violence and the Supernatural

The fictional World of Rifts® is violent, deadly and filled with supernatural monsters. Other dimensional beings, often referred to as “demons,” torment, stalk and prey on humans. Other alien life forms, monsters, gods and demigods, as well as magic, insanity, and war are all elements in this book.

Some parents may find the violence and supernatural elements of the game inappropriate for young readers/players. We suggest parental discretion.

Please note that none of us at Palladium Books® condone or encourage the occult, the practice of magic, the use of drugs, or violence.



An epic world book for the Rifts® series.

Compatible with the entire Palladium Books® Megaverse®!

Dedicated to all the Rifts® fans for their enthusiasm, comments, input, and patience even when we're late on books (like this one) and for always being there. We appreciate it.

Kevin Siembieda — 1997

PDF Edition – February 2016

Copyright Palladium Books Inc. & Kevin Siembieda 1997

All rights reserved, world wide, under the Universal Copyright Convention. No part of this book may be reproduced in part or whole, in any form or by any means, without permission from the publisher, except for brief quotes for use in reviews. All incidents, situations, institutions, governments and people are fictional and any similarity, without satiric intent, of characters or persons living or dead, is strictly coincidental.

Palladium Books®, Rifts®, RECON®, and Megaverse® are registered trademarks owned and licensed by Kevin Siembieda and Palladium Books Inc., Coalition War Campaign, Coalition States, Emperor Prosek, Erin Tarn, Lone Star Complex, Death Wing, SAMAS, Skelebots, Spider Skull Walker, Dog Boys, Dog Pack, Psi-Hounds, Kill Hounds, K-9 Sniffer, Psi-Stalker, Simvan, Juicers, and other names and titles are trademarks owned by Kevin Siembieda and Palladium Books Inc.

Palladium Online: www.palladiumbooks.com – Also see us at [Facebook.com/PalladiumBooks](https://www.facebook.com/PalladiumBooks)

Rifts® World Book 13: Lone Star™ is published by Palladium Books Inc., 39074 Webb Court, Westland, MI 48185. Printed in the USA.

Palladium Books® Presents:

Rifts® Lone Star

World Book 13

Written & Created By: **Kevin Siembieda**

Additional Text & Ideas: **Julius Rosenstein**

Editors: **Alex Marciniszyn**
Jim Osten

Proofreader: **Julius Rosenstein**

Cover Painting: **John Zeleznik**

Interior Artists: **Wayne Breaux Jr.**
Ramon Perez Jr.
Martin McKenna
Scott Johnson
Brandon C. Clark
Mark Dudley
Ka Xiong
Christopher Morrill

Typography: **Maryann Siembieda**

Art Direction, Maps & Keylining: **Kevin Siembieda**



See our Website at: www.palladiumbooks.com

Special Thanks to Ramon Perez Jr. and Wayne Breaux Jr. for some truly action packed and ominous artwork. Martin McKenna, Scott Johnson, and the Drunken Style Studio for their art contributions. To John Zeleznik for his menacing depiction of a Xiticix Killer breaking loose from a lab at the Lone Star Complex. Also to Julius for his work on the Pecos Empire and some cool ideas, Erick Wujcik for turning me on to some wonderful references about canines and dog psychology, and to Maryann, Steve, Alex, Jim and all the Palladium madmen for their hard work and efforts.

Contents

| | | | |
|--|-----------|--|------------|
| Lone Star | 9 | Human Special Abilities Table..... | 97 |
| An Overview by Erin Tarn..... | 9 | Psi-X Aliens | 98 |
| Tarn Addendum | 11 | Notable CS Characters | 100 |
| CS Northern Quadrant | 12 | Desmond Bradford | 100 |
| CS Military Bases..... | 13 | General Loni Kashbrook | 107 |
| Map of Lone Star (the State of) | 14 | Brigadier General Ivan Kalpov | 110 |
| Lone Star City..... | 15 | Colonel Roger Collins | 114 |
| The Lone Star Complex | 16 | Colonel Buck Murphy | 115 |
| A bit of history | 16 | Major Winston Claval | 118 |
| An Overview of the Lone Star Complex | 17 | Doctor Frederick Alexander..... | 121 |
| Sector 357 | 20 | Doctor Laura Cunningham..... | 123 |
| The Dog Pack | 22 | Doctor Ammanda Santiago | 124 |
| Why Mutant Dogs?..... | 22 | Pecos Empire | 126 |
| Dog Boy Creation..... | 24 | Population Notes..... | 126 |
| The Program | 27 | Who Rules the Pecos Empire..... | 127 |
| Canine Psychology | 29 | Life as a Bandit..... | 128 |
| Dog Pack R.C.C..... | 32 | The Ways of the Nomad..... | 129 |
| Optional Dog Boy Tables | 37 | Modes of Transportation | 130 |
| “Feral” Dog Boys | 38 | Bandit Organizations | 131 |
| K-9 Sniffer | 41 | Settlements | 136 |
| Kill Hounds..... | 43 | Characters of Note | 138 |
| Dog Boy Equipment | 46 | Gray Fox | 138 |
| Electro-Stunners | 49 | King Macklin | 139 |
| CN-1 Net Gun..... | 51 | Orpheus The Titan | 142 |
| Dog Pack Body Armor | 52 | Zimchex — Simvan | 143 |
| Hovercycles..... | 54 | Lianna The Wild..... | 144 |
| CS Death Wing | 62 | Sundance..... | 145 |
| GED Mutant Experiments | 64 | Warlord Grange | 147 |
| Practical Genetic Engineering | 66 | Emperor Sabre Lasar | 148 |
| Simple Genetic Augmentation | 67 | Sabre Warriors | 149 |
| Longevity | 68 | Warlord Don Marco | 150 |
| Clones | 69 | Pecos Bandits | 153 |
| Animal Genetic Enhancements | 69 | O.C.C. & R.C.C. Notes..... | 153 |
| Instinctive and Behavioral Modifications | 70 | Pecos Raider O.C.C..... | 153 |
| Mutations Gone Wrong Table (optional)..... | 71 | Tokanii R.C.C. | 154 |
| Mutant Bears | 72 | Psi-Stalker R.C.C..... | 156 |
| Mutant Felines..... | 76 | Simvan Monster Riders | 162 |
| Battle Cats..... | 76 | Brodkil | 164 |
| Kill Cats | 79 | A Geographic Overview of the Lone Star State | 165 |
| Monkey Boys | 81 | Prairie High Plains | 165 |
| Monkey Boy Soldier..... | 83 | The Freelands | 166 |
| Monkey Boy Tech R.C.C. | 85 | Kingdom of Worth | 167 |
| Mutant Rodents..... | 85 | Haunted Ruins of Dallas..... | 167 |
| Mutant Rats..... | 85 | Houstown | 168 |
| Mutant Bat R.C.C. | 88 | The Pecos Empire | 170 |
| Xiticix Killer | 91 | The Bend — a.k.a. Trans-Pecos..... | 170 |
| Runaway Mutants | 93 | Crossroads..... | 171 |
| The Animal Underground..... | 95 | Uvalde..... | 172 |
| Other Areas of GED Research | 96 | New San Antonio | 172 |
| M.O.M. Technologies..... | 96 | Laredo..... | 173 |
| Mutant Humans | 96 | Raiders of the Gulf Coast..... | 174 |
| | | Experience Tables | 174 |
| | | Other Rifts® Books..... | 176 |

Quick Find

| | |
|---|-----|
| Bradford, Desmond | 100 |
| Bradford: Adventure Ideas | 106 |
| Bradford: Character Stats | 105 |
| Bradford: Clones (Dr. Santiago) | 125 |
| Bradford: Future Plans | 104 |
| Bradford & Joseph Prosek | 102 |
| Bradford & Karl Prosek | 104 |
| Bradford Quotes: Farewell to Emerson | 100 |
| Bradford Quotes: Sector 357 | 20 |
| Bradford Quotes: Why Dog Boys | 22 |
| Bradford Theory about Level Nine | 17 |
| Bradford: Xiticix Killer | 91 |
| Buckaroo Bonanza Rodeo, Uvalde | 172 |
| Buffalo Hunters, Simvan & Psi-Stalker Tribe | 130 |
| Clans | 132 |
| Construct Minor Animal Mutants | 69 |
| Crossroads/Kerrville | 171 |
| Crossroads Militia | 172 |
| CS Bases & Outposts | 13 |
| CS Characters of Note | 100 |
| CS Lone Star Complex | 16 |
| CS Northern Quadrant | 12 |
| CS Vendetta Squads | 18 |
| Dog Boys/Pack | 22 |
| Dog Boy: Abilities (special) | 33 |
| Dog Boy: Equipment | 46 |
| Dog Boy: General Stats | 24 |
| Dog Boy: Nurseries & Training | 27 |
| Dog Boy: Optional Abnormality Table | 38 |
| Dog Boy: Optional Tables (height & breed) | 37 |
| Dog Boy: Quiet Hunters, The | 119 |
| Electro-Stunners | 49 |
| Erin Tarn | 9 |
| Gangs, Bandit | 134 |
| Hovercycles | 54 |
| Joseph Prosek, Reports to | 102 |
| Kerrville/Crossroads | 171 |
| Psi-X Alien R.C.C. | 98 |
| Mutant Animal Modifications/Features | 69 |
| Mutant Runaways | 93 |
| Mutant Underground Railroad | 95 |
| Ostrosaurus Quick Stats | 163 |
| Pecos Empire | 126 |
| Pecos Empire: Leaders of Note | 138 |
| Pecos Empire: Settlements | 136 |
| Pervic, Simvan Tribe | 143 |
| Pervic, Leader: Zimchex | 143 |
| Pervic Territory: Grande Range | 171 |
| Sabre Lasar, Who Rules | 127 |
| Sabre Lasar, Stats | 149 |
| Settlements | 136 |
| Silver Dagger Gang | 150 |
| Silver Dagger Base: New San Antonio | 172 |

| | |
|--------------------------------|-----|
| Tarn: History of LSC | 9 |
| Tarn: Overview of Lone Star | 9 |
| Tarn: Pecos Empire | 11 |
| Tarn: Psi-X Aliens | 10 |
| Tarn: Vampires (addendum) | 11 |
| Tarn: Xiticix Killer | 10 |
| Tribes | 132 |
| Tribe: Gray Fox | 138 |
| Tribe: Simvan Leader Zimchex | 143 |
| Tribe: Tokanii | 154 |
| Uvalde: Home of Warlord Grange | 172 |
| Vibro-Blade Vambraces | 48 |
| Xiticix Killer NPC | 91 |

Maps

| | |
|---------------------|-----|
| Bend, The | 170 |
| Comanche Country | 13 |
| Eastern Forest | 167 |
| Grange Range | 170 |
| Ley Lines | 7 |
| Pecos Empire | 170 |
| Plains, Flat & High | 166 |
| Plains, Rio Grande | 166 |
| State of Lone Star | 14 |

O.C.C.s & R.C.C.s

| | |
|------------------------------------|-----|
| Bandit O.C.C./Pecos Raider | 153 |
| Brodkil (Optional R.C.C.) | 164 |
| Dog Boy Soldier R.C.C. | 32 |
| Dog Boy, Feral R.C.C. | 38 |
| Dog Boy, K-9 Sniffer R.C.C. | 41 |
| Dog Boy, Kill Hound R.C.C. | 43 |
| Dog Boy, Sea Dog (Navy) R.C.C. | 40 |
| Dog Boy, Wolf Division | 107 |
| Feline: Battle Cat R.C.C. | 76 |
| Feline: Kill Cat R.C.C. | 79 |
| Monkey Boy: Mini Monkey Spy R.C.C. | 81 |
| Monkey Boy: Soldier | 83 |
| Monkey Boy Tech R.C.C. | 85 |
| Mutant Bat R.C.C. | 88 |
| Mutant Bear R.C.C. | 72 |
| Mutant Rat R.C.C. | 85 |
| Notes on O.C.C.s & R.C.C.s | 153 |
| Pecos Raider O.C.C. | 153 |
| Psi-Stalker: CS & Civilized R.C.C. | 159 |
| Psi-Stalker: Wild R.C.C. | 160 |
| Psi-X Alien R.C.C. | 98 |
| Simvan Monster Rider R.C.C. | 162 |
| Tokanii R.C.C. | 154 |
| Ursa-Warrior (bear) R.C.C. | 72 |

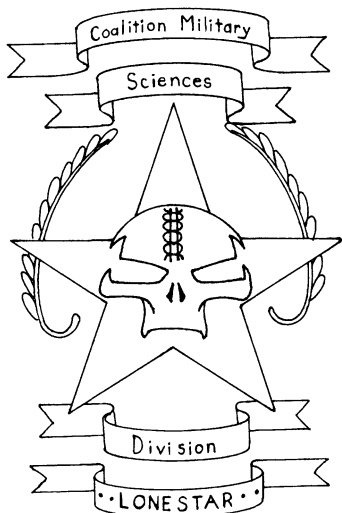

NPC Villains

| | |
|---|-----|
| Bandit: Lianna The Wild. | 144 |
| Bandit: Victor Macklin, King | 139 |
| Bandit: Macklin's Henchmen | 142 |
| Bandit O.C.C./Pecos Raider | 153 |
| Bandit: Sabre Lasar, Emperor. | 148 |
| Bandit: Sabre Warriors | 149 |
| Bandit: Silver Dagger Gang | 151 |
| Bandit: Sundance | 145 |
| Bandit: Warlord Allen Grange | 147 |
| Bandit: Warlord Don Marco. | 150 |
| Brodkil Demons | 164 |
| CS: Roger Collins, Colonel (Intel) | 114 |
| CS: Laura Cunningham, Doctor | 123 |
| CS: Frederick Alexander, Doctor | 121 |
| CS: Desmond Bradford, Doctor & LSC Admin. | 100 |
| CS: Winston Claval, Major. | 118 |
| CS: Loni Kashbrook, General. | 107 |
| CS: Ivan Kalpov, Brig. Gen. | 110 |
| CS: Buck Murphy, Colonel (RPA Elite) | 115 |
| Mutant Rats: Mitch & Glitch | 119 |
| CS: Quiet Hunters, The. | 119 |
| CS: Ammanda Santiago, Doctor. | 124 |
| CS: Wolf Division. | 107 |
| Psi-X Alien | 98 |
| Xiticix Killer | 91 |

Adventure Notes & Ideas

| | |
|--------------------------------------|-----|
| Bradford. | 106 |
| Brig. Gen. Kalpov | 114 |
| Buckaroo Bonanza Rodeo. | 172 |
| Colonel Collins (Intel) | 115 |
| Colonel Murphy (RPA Elite) | 117 |
| Doctor F. Alexander | 121 |
| Doctor Laura Cunningham | 123 |
| Doctor Santiago. | 125 |
| General Kashbrook | 109 |
| Laredo | 173 |
| Major Claval | 121 |
| Storm Riders, Dallas | 168 |

20 Year Plan for CS Expansion

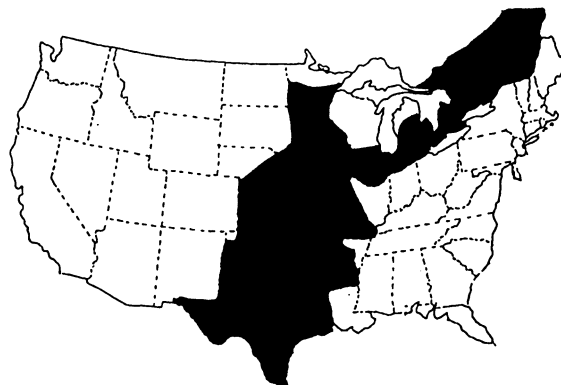

The Domain of Man

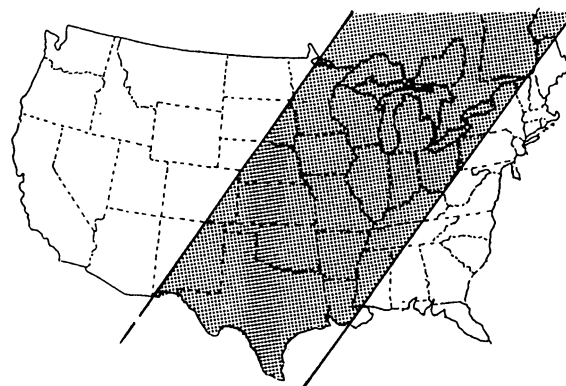

All Around is Hostile Wilderness

CS Lone Star

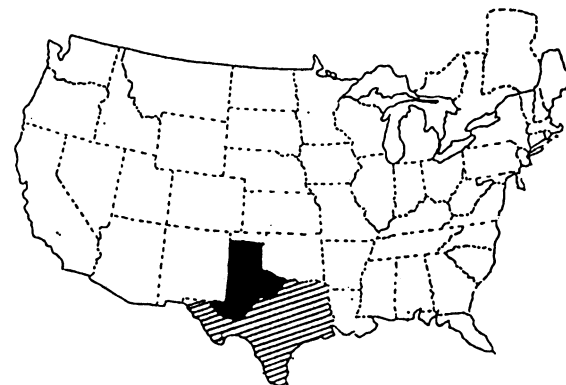

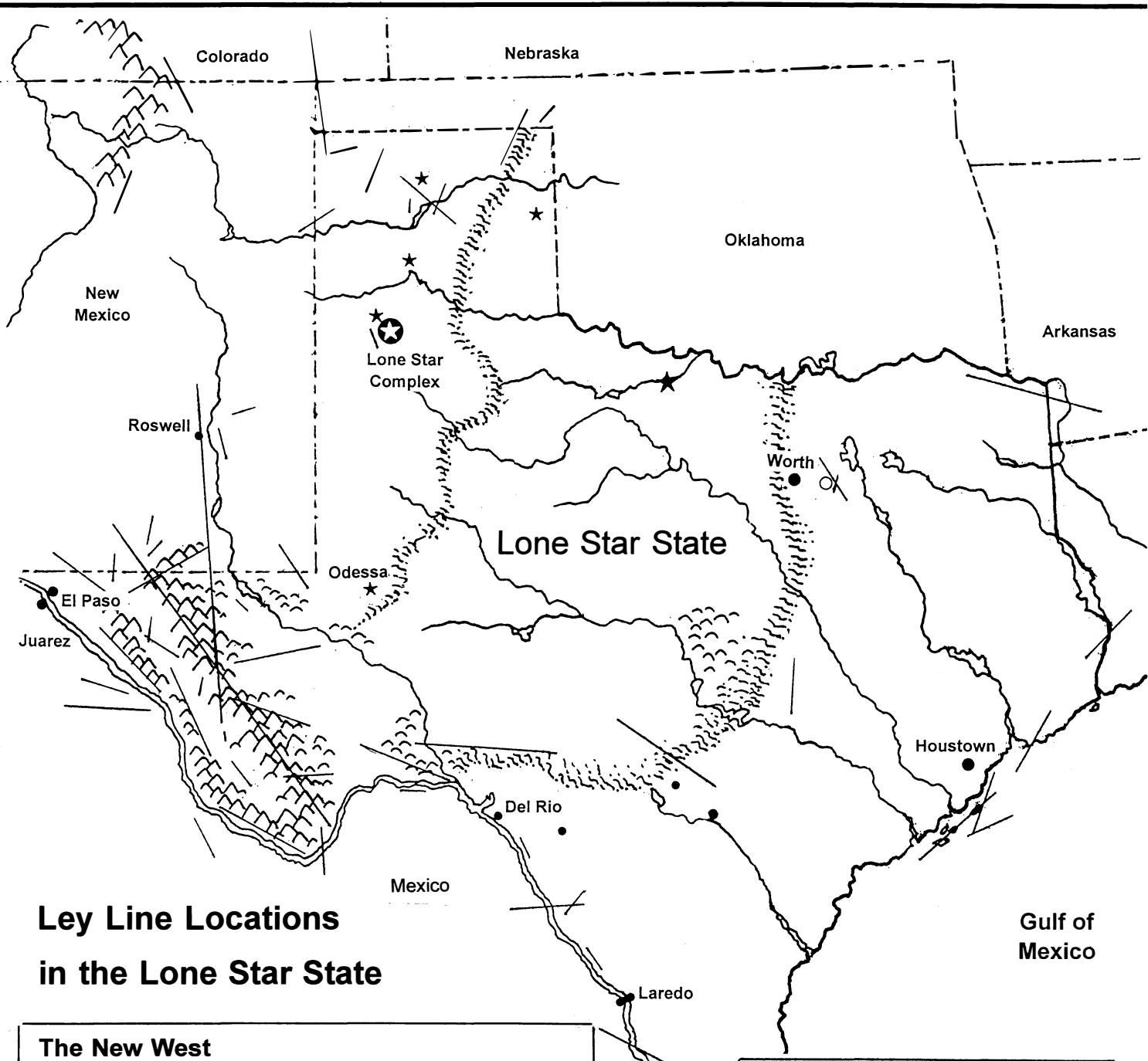

**Ley Line Locations
in the Lone Star State**

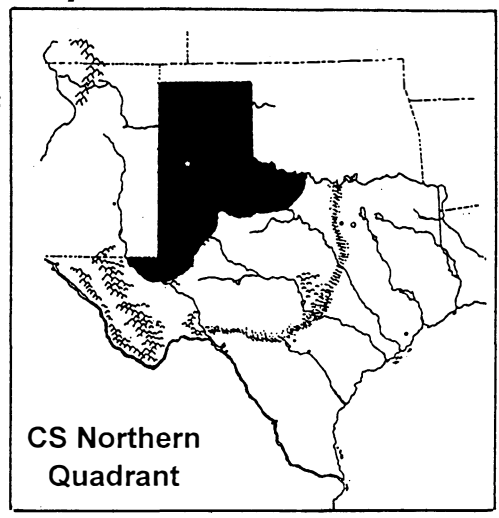
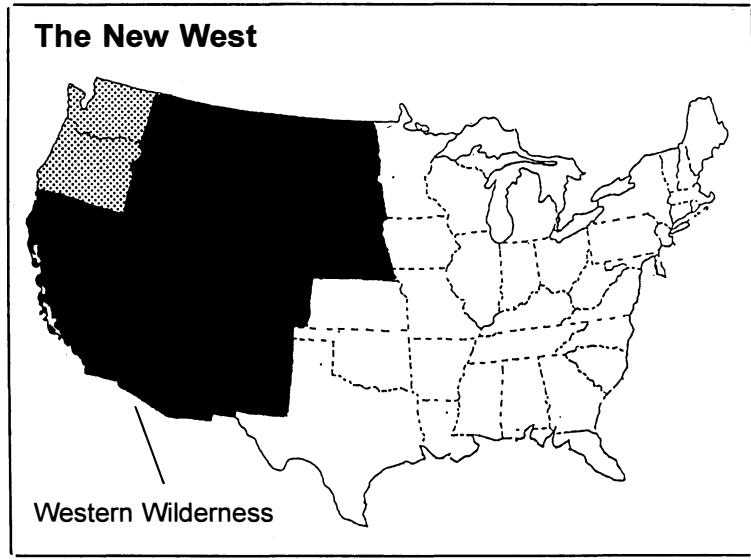



Origins

Rifts® World Book 13: Lone Star continues to look at the inner workings and structure of the Coalition States, its military and its leaders. But its scope is larger than that.

Rifts® Lone Star provides more insight about the Lone Star State, the Pecos Empire, and key people who inhabit this chaotic territory. For the first time, readers get a frightening glimpse inside the legendary Lone Star (military) Complex — a pre-Rifts relic that has survived the Great Cataclysm and laid hidden underground until CS explorers discovered it.

This book also tells a sort of creation saga. Not only is the *Lone Star Genetic Engineering Division* the birthplace of the fabled Dog Boys, but the secrets and resources of the *Lone Star Complex* are what helped the Coalition States come into being. Its ancient, pre-Rifts secrets, research, technology and creations helped to build the States, empower Emperor Prosek, and fuel his dreams of conquest and human supremacy. Without the Lone Star Complex, there would be no Dog Boys, cybernetics would be more primitive, the Coalition's level of technology (in general) would be dramatically reduced (at least 33%) and its reign of power would be tenuous at best. Furthermore, many of the surrounding tech-kingdoms such as Northern Gun, Ishpeming, Kingsdale, Whykin, El Paso, and others would be dramatically different, for much of the technology known and used in North America has been pirated and knocked-off (dissected, studied and copied) from the Coalition States!

Without the CS and the ancient pre-Rifts technology unearthed in the ruins of Old Chicago and the Lone Star Complex, technological levels would likely be half of what they are today, circa 105 P.A. — and North America would be a very different place. Chi-Town might have fallen to the Federation of Magic, Joseph Prosek and his family may have perished in the onslaught, Xiticix colonies (unchecked by the CS) could have dominated the Dakotas, Wisconsin and Illinois, while Free Quebec could likely have risen to become the mecca of science, technology and humankind.

In addition, **Rifts® Lone Star** launches an interesting threesome (they're not really a trilogy) of books (*Lone Star*, *New West* and *Spirit West*) that combine to make a larger picture of the western and south-western portion of Rifts America. I've also tried to provide more color, history, details and insight into key people, places and goings on in North America, with the Coalition States and the Prosek regime as a focal point. This should make for a fun read (I sure had a blast writing it) and provide more material from which Game Masters can weave exciting adventures.

Lastly, I want to apologize for many of Palladium's products being chronically late by 1-3 months (and a few completely rescheduled in the last year). There are three main reasons for these delays. One, events beyond our control such as artists or writers (sometimes both!) missing deadlines, manuscripts that don't meet our expectations, mechanical failure of equipment, illness and similar. Two, overreaching. We have so many great ideas and projects that we *want* to do, that we sometimes overload our schedules. Third, none of us at Palladium Books can bring ourselves to sacrifice quality just to bang out product. We care too much about **Rifts®** and all our game worlds to diminish them with rushed and second-rate products. More importantly, we care about our fans. We pride ourselves on the knowledge that our fans expect the best from Palladium. Consequently, we feel the disappointment of a delay followed by an excellent product is better than releasing rushed, hacked-out junk! Believe me, product delays cause Palladium more headaches than just disappointed fans. We love knowing that Palladium consistently produces some of the most exciting, enjoyable, fun and best selling role-playing games on the market. I think **Rifts® Lone Star** is another sourcebook that fits the bill. Enjoy.

— Kevin Siembieda, 1997

Lone Star

An Overview

by Erin Tarn

I find Lone Star allegorical of the Coalition States as a whole — it is a lie.

The CS claims the entire territory of Texas as an official "State" of the Coalition. They claim that it is a high-tech center and a valuable resource populated by humans and under the complete control and domination of the Coalition government. Nothing could be further from the truth. At best, the Coalition dominates the northern third of the State, but I would guess that it actually controls only the northern quarter. It is in this comparatively tiny "quarter" that the human population can be found. Military troops and pioneers are scattered throughout several fledgling communities, small towns and a score of military outposts.

At the heart of the CS dominated region is **Lone Star City**, the home of the infamous *Lone Star Complex* and its *Genetics Engineering Division (GED)*. The "complex" is a massive pre-Rifts military installation built by the old American Empire during the Golden Age of Science. My own research into the shattered history of that bygone era offers only sketchy hints about this place. It seems that the Lone Star Complex itself, was an experiment. This military complex was to serve three distinct functions:

- 1) Extensive research and development of new biological weapons, with an emphasis on genetic engineering. This apparently caused great social and political controversy, the details of which I am not completely certain, but definitely included concerns over creating new and dangerous life forms (Dog Boys, I wonder?), mutations, clones, science's moral responsibility and slavery.

- 2) A genetics factory (actually several, relatively small factories) where genetically engineered mutants, cyborgs and other types of "super-soldiers" (I suspect including Dog Boys, Juicers and MOM conversion test subjects) could be produced en masse.

- 3) A completely self-sufficient military city, 80% of which would be underground! This was to be a closed community that was not reliant on the outside world. As such, it would maintain and operate its own power plant(s), medical centers, research and development facilities, manufacturing and processing factories of all kinds! (weapons, ammunition, vehicles, clothes, food, etc.), underground gardens, entertainment facilities, housing for 12,000 troops, and the biggest, most advanced genetics engineering complex in the world. Only secondary features of the city were located on the surface: farms, cattle ranches, testing grounds, parks, visitors quarters' and a handful of military buildings, all enclosed by a mega-damage perimeter fence complete with watchtowers and anti-aircraft weapons. It is also my impression that the underground, military city was designed to grow, expand and adapt as a real city would.

According to my information, the Lone Star Complex was the largest and most controversial military operation the American Empire had ever undertaken on American soil in the name of national defense. The Canadian and many other world Empires lodged formal protests. The State of Texas (the old name for the Lone Star territory) was chosen because of its close proximity to the Empire of Mexico, although I'm not certain why. I do not see any evidence that the Mexican Empire opposed this installation, so it is possible that they were somehow involved, or were at least supportive. I believe the main reason for its ex-

act location, however, was that the people residing in the area welcomed the American Empire's offer of large sums of money and other "perks" —an old slang term for nonmonetary based incentives.

I'm afraid that's all history has revealed to me, although I'm certain it is more than enough to keep me in trouble with the Coalition States.

Nobody outside the CS knows exactly how large the secret complex actually is, or exactly what secrets it may hold. Undoubtedly, the Coalition Military has added its own touches to its reconstruction. For example, the current perimeter walls and towers were completely built by the Coalition. I would guess the old walls were probably torn down and used by human and D-bee settlers during the Dark Ages while the real treasure, ironically, laid hidden beneath the earth. I have no doubt that the *Lone Star Military Complex* is a treasure-trove of lost knowledge. My mind whirls at the thought of what marvels of pre-Cataclysm history, science and military engineering is locked within its walls. It also makes me tremble to think what horrors of the American Empire's powerful military are now held clenched in the iron fist of the Coalition States.

We know that the Psi-Hounds, more commonly known as "Dog Boys," were first "created" at the Lone Star Genetics Engineering Division (GED). Thousands, perhaps tens of thousands, have walked on two legs from this mysterious military compound to serve in the CS Military, ISS city police and Psi-Divisions. I also have it on excellent authority that numerous other "animal" experiments are conducted at GED. I have seen firsthand, some of the *mutants* spawned at Lone Star and (deliberately?) unleashed into the Pecos Empire, Mexico and the Western Wilderness. They have included intelligent, or at least semi-intelligent, and sometimes nightmarish, humanoid bears, wolves, coyotes, felines of all kinds, rodents, and even exotic "zoo" animals such as monkeys, apes and other animals native to Africa, South America and other lands. But the scientists have not stopped there. I have seen horrific monstrosities that resemble neither man nor beast. These ... "things" ... are sometimes intelligent, but more often than not, are aggressive monsters driven by a terrible lust for blood and carnage. Sources in the north have reported attacks against Tolkeen defenders by such bands of creatures, from as few as a dozen to the size of an Army Company. Many in the north believe these creatures are experimental prototypes specifically designed as inhuman and savage shock troopers (and nonhuman cannon fodder) sent to weaken and penetrate frontline defenders and to slaughter outlying wilderness villages and supply lines. Similar creatures have been reported along the Mexican border fighting vampires and Pecos Bandits (**Editor's note:** No such mutant shock troops have been deployed against Free Quebec, the Federation of Magic or any CS enemies in the East. Furthermore, the CS denies all accusations that have any connection to these creatures).

I've also heard a story that reports a Death's Head Transport sighted in Xiticix Territory depositing two score of the horrible white creatures locals call the "Xiticix Killers." Until this report, the Xiticix Killer was believed to be an alien monster or a race of D-bees from another world. Perhaps even a natural predator from the Xiticix' homeworld. This theory may still be the case, as there have been no other reports linking the strange beasts to the Coalition States. Indeed, my own investigations have convinced me that CS officials in the State of Iron Heart and Free Quebec know absolutely nothing about the monsters, although they welcome their appearance. Nor have I found anything at Chi-Town to suggest CS involvement, but then the Coalition States hold many dark secrets that I am not privy to.

The *Xiticix Killer* is a strange and elusive creature recently sighted in the Manitoba wilderness in 99 P.A. (**Editor's Note:** Remember, Erin wrote this text in 100 P.A.). It is a hulking, bipedal creature with a mega-damage tough, white hide ideal for stalking prey in the long, snowy winters. I have never seen one these creatures, except in an artist's sketch and a few blurred photographs, but I'm told they tower 12 to 18 feet (3.6 to 5.5 m) tall and have animal-like legs, but walk upright, unless on the prowl, in which case they may crawl on their bellies or run hunched over, close to the ground.

It is the Xiticix Killer's appendages that makes one consider the possibility that it is a bio-engineered creation. In addition to a powerful prehensile tail, used both for balance while running and as a slashing weapon during combat, the monster has a pair of strange arms. The upper arms are similar in shape and function as a humanoid's, but the forearms are monstrous. The right arm is always a long, thick, tentacle-like appendage but firm and powerful. Mounted near the elbow is a mechanical, presumably bionic, weapon of unknown origin and design. It seems to fire a short range energy blast that may be generated from the body of the creature itself! The left arm is capped with a mechanical housing that ends in a three fingered claw. The fingers of the claw are large blades used to cut, stab and punch through the Xiticix' natural armor. A comparatively small, thin, prehensile tentacle can extend from the center of the blade-hand and lash out at an opponent. This small tentacle is most often used to plunge into open wounds and tear up the Xiticix' innards from the inside out! Some have speculated that this appendage might also serve as a second tongue and feeds on the blood and gore of its opponents, perhaps even eating them alive from the inside. A horrible end even for a Xiticix.

Many people have believed these creatures to be a natural Xiticix predator from another world because the Xiticix Killer seems only to prey upon Xiticix, is found only in Xiticix territory, is incredibly alien/otherworldly in appearance, and has been observed as both the hunter (so bold as to invade hives) and as the hunted (tracked, cornered and slain by Xiticix warriors, and usually carried back to the hive, presumably for food or as a trophy). However, as more mutant monstrosities seem to emerge from the Lone Star Complex area, one must wonder.

Of course, the only link connecting them to the Coalition is that one alleged sighting of a CS transport releasing them into the wilderness. I must admit, I would normally be quick to disregard such a claim from one lone individual, but that claim comes from a Cyber-Knight of some repute and excellent character. Far fetched? Maybe. But while I am not a fan of the Coalition States or its leaders, I try to be objective. I'm not one of those who assumes the Coalition is responsible for every problem in the world or lurks behind every plot. Yet, I must wonder if these speculations are not grounded in some basis of fact. Case in point, some of the unusual creatures are found in and around the State of Lone Star. I am no scientist, but I know many who are, and they have evidence to suggest that the GED scientists are using D-bees and even humans in their genetic experiments.

Perhaps the most stunning example of this are the **Psi-X Aliens** who claim to be human mutations created by GED. The Psi-X can be found at New Del Rio, El Paso and Ciudad Juarez, as well as other communities in the Lone Star State/Pecos Empire and New Mexico. One clan elder told me they are the failed experiments of GED Director, *Doctor Desmond Bradford*, to advance human evolution in an attempt to bring forth superior psionic abilities in humans.

Frankly, I find this shocking, as I cannot believe Emperor Prosek would ever sanction the deliberate mutation of humans nor consider the use of D-bee mutants in the service of the Coalition States. However, the clan elder I spoke with insisted the experiments were conducted in secret and WITHOUT the knowledge or blessings of Emperor Prosek. If this Psi-X can be believed, there is an ultra-secret branch of genetic engineers at the Lone Star Complex engaged in illegal and dangerous genetic experimentation without the knowledge of the CS government. Accordingly, he insists such experiments have been underway for over a decade.

Of course, the CS adamantly denies these allegations, although I must admit that I have never been able to find any concrete evidence to support the claim, and many Psi-X don't seem to have any idea where they come from. Still, I find it curious that the Psi-X Aliens are found only in and around Lone Star, and that independent medical studies have confirmed that these beings appear to be 99% percent human in their genetic makeup. The fact that I have personally seen a score of other mutants which the CS has disavowed any knowledge of, or re-

sponsibility to, gives me pause to dismiss this story out of hand. This wouldn't be the first time that the Coalition States (or more to the point, the powers at Chi-Town) have engaged in deplorable activity.

The boundaries of the State of Lone Star encompass those of *pre-Rifts Texas*; once an important part of the Old American Empire. In fact, many of the old roadways, though cracked and battered, often with large sections buried in the dirt of centuries, or missing entirely, still remain, etched across the land like the bones of some great beast half sunken in the earth. Along some of these highways are the ghost towns of pre-Cataclysm cities, like the fabled and haunted ruins of **Dallas**. Of course, over the centuries, most of these great, ancient cities have been literally torn down, brick by brick, their remnants salvaged and used as the building blocks for new towns, villages and the occasional city.

Personally, I found the Lone Star State to be a savage and desolate land, fragmented and in constant conflict. Despite the claims of the Coalition States, Lone Star is mostly a baked wilderness of grassy plains, dust, parched Earth and frightening ruins. I found the summer heat to be as sweltering as any desert or the Wastelands of Mexico.

The Native American Indians I encountered during my short visit, call Lone Star, "The Land of a Thousand People." This is very appropriate because the territory is claimed by hundreds of clans, tribes, outlaw gangs, barbarians, D-bees, mutants and monsters of every race imaginable, as well as by the troops and settlers of the Coalition States. I honestly believe I saw virtually every race one can find in the Burbs of Chi-Town or Iron Heart, plus several dozen others I have only seen in the American West, and a few I have never seen before.

The Pecos Empire. The fact that most people east of the Mississippi believe that the so-called Empire is nothing more than an insignificant band of barbarians forced to live in the Badlands of Lone Star by the CS military is testament to the Coalition propaganda machine at Chi-Town. From what I have seen, the so-called Pecos Empire is composed of dozens, perhaps hundreds of savage and barbaric tribes and clans of Native American Indians, Psi-Stalkers, Simvan and other mixed communities of D-bees and humans, as well as gangs of human outlaws, Mexican Banditos, and Gunslingers. True cities or kingdoms/nations as we think of them in the East, are a rarity, although some of the tribes and a few of the gangs can number into the thousands. Instead, the Pecos Empire is dotted with tiny towns, villages and temporary camps of nomadic tribes, typically ranging from fifty to a few hundred. Still, from what I have seen and heard, the Coalition States has virtually no influence or control over these people. Nor does the CS have any military presence in the Badlands, other than occasional ground patrols and SAMAS or Sky-Cycle fly-bys.

Although pre-Cataclysm books and films would suggest otherwise, I found the Indians to be the most peaceful and "civilized" members of the Pecos Empire. Most other bands of people reminded me of stories I've read about the ancient barbarians of Europe. They are savage, cruel and wild. Their bases of operation seem to be small farms and sheep raising areas. They have no industry that I saw, and subsist with low technology, perhaps equal to the American 18th or 19th Century. Those who engage in banditry, which is the majority I am told, steal what they want or need, plundering neighboring communities, travelers, and even the Coalition Military. The Pecos Empire will attack as a mass army, but more typically sends out much smaller raiding bands of 10-60 members. The raiders are a wide mix of mutants, monsters, D-bees, and humans (less than 40% are human). Juicers, Crazyes, Headhunters, rogue Dog Boys, Psi-Stalkers, and brutes of all races ride among those of the Pecos Empire. The overall empire has been estimated at over a million people, but only about a third are barbarian raiders. Pecos Raiders have been known to travel as far north as Iowa, as far east as Alabama, and as far west as Nevada. They seldom travel beyond the Rio Grande River because there is nothing to steal and it is the domain of vampire bandits.

— Excerpted from Erin Tarn's book, *Traversing Our Modern World*

Tarn Addendum

Note: Until her journey to the Vampire Kingdoms of Mexico, Erin Tarn had limited firsthand experience of the Pecos Badlands. Consequently, her unauthorized book, **Traversing Our Modern World**, published in the year 100 PA, does have some errors concerning the size and composition of the Pecos Empire. During her excursion to Mexico in 101 PA, she spent several weeks in the Badlands and wrote the following in a letter to Plato of Lazlo:

My dear friend,

I fear my statements about the Pecos Empire as just printed in the unauthorized edition of my most recent book, are grievously wrong. Of course, this is why I wish people would not publish my writings without my permission. Don't worry, I won't start again on that old axe I grind.

We have made the mistake of believing the Coalition's propaganda about this place. How we fell for this I do not know. Certainly we have learned not to trust anything the Coalition States present as fact. It is something I will try to remember in the future.

To someone just passing through, the Pecos Empire would indeed seem to be a hot, inhospitable wilderness inhabited by scattered tribes and bandit gangs, most of them small in number. Even the typical towns and villages rarely exceed 500, and many have less than half that number. However, there are far more of these tiny communities and nomadic tribes and bands than I had originally believed. There are also several groups that number into the thousands, and a few budding kingdoms and tribes that also number into the thousands. The nomadic nature of these varied people makes it impossible, at least for me, to accurately estimate their numbers. There could easily be two to ten times more people here than we originally believed.

I have learned that while the official Pecos Empire is the southern third of the State, and is the region with the greatest number of permanent settlements, bandit bases, and large tribes, the eastern third is effectively the domain of bandits, nonhumans and lawlessness. Nomadic Indians, D-bees and Pecos Bandits are as likely to be found in this region as anywhere in the Pecos Empire. I find it amusing to note that the CS refuses to use the word "empire" and refers to the territory only as the "Pecos Badlands." These nomads and bandits have a much wider range of activity in the surrounding lands than we originally believed, and may travel as far as the Old Canadian Empire and the Magic Zone. They also raid Arkansas and the western Coalition States.

Never in my life have I seen such a diverse collection of cultures, societies and people. Virtually every group, whether they be bandits, Indians, D-bees, or humans — tribe, clan, town or gang — each and every one seems to have a different culture, with a different set of laws, morals, and leadership. Of course, many are similar, but even many of the smallest bands represent an independent organization. I have also found many of the nonbandit groups to be more self-sufficient, civilized and friendly than I had originally imagined. Most are extremely low-tech, mainly peasant farmers and raisers of cattle or other livestock. Others are nomadic hunters and gatherers with some farming thrown in for good measure. Only the bandits and tribes or clans who survive by raiding others, and some of the D-bee communities, are truly barbaric and deadly. Some of the Psi-Stalker and Simvan tribes are among the most feral, aggressive and violent I have encountered; much more so than their cousins east of the Mississippi. Generally speaking, the highest levels of technology are found among the bandits, particularly when it comes to vehicles, weapons and combat.

I also fear the vampire problem is far worse than any of us have imagined. It is too soon for me to make an accurate assessment, but you can be assured that you will hear more from me on this subject when I can address the matter with some authority.

— Erin Tarn, March 12, 101 PA

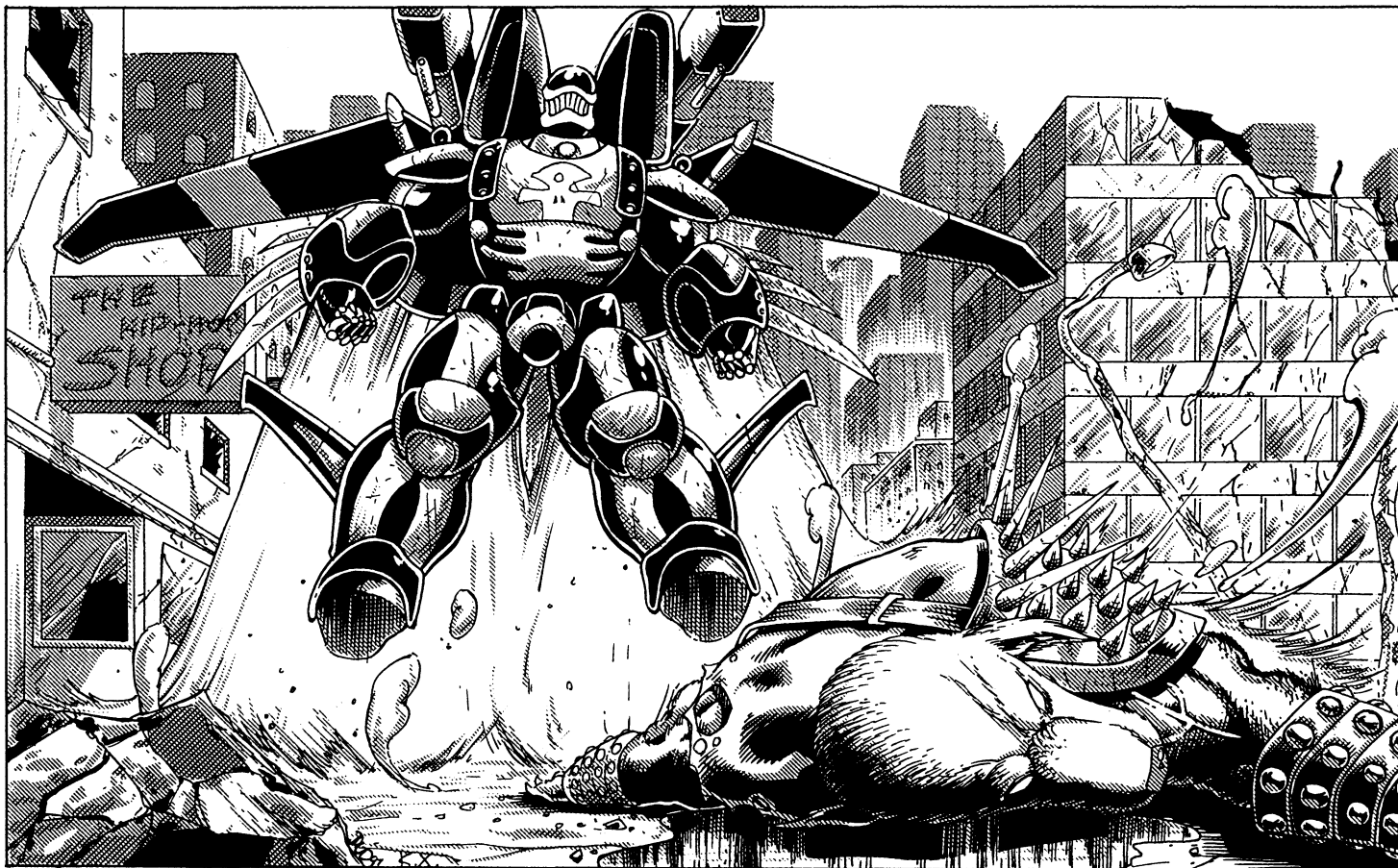

CS Northern Quadrant

The Northern Quadrant of the Coalition State of Lone Star covers the High Plains of Northern Texas. It is a long, table-top flat, featureless expanse of grass broken by patches of dust. Mile after mile, the flatlands look the same and never changing. Only the occasional CS outpost or city rises on the horizon, and they are few and far between. The summers are hot and dry with blast furnace heat (typically 86 to 92 degrees) and the winters cold, with light snow and/or ice; temperatures range from 20 to 45 degrees Fahrenheit.

Frankly speaking, the only reason Emperor Prosek has laid claim to Northern Texas and proclaimed all of Texas as the Lone Star State, is because of the incredible *Lone Star Complex*. In fact, unlike the other Coalition States, populated with a million to tens of millions of humans, the Lone Star State holds fewer than a quarter million CS citizens (mostly settlers and frontiersmen)! The rest are part of the military force assigned there. In this sense, the critics who claim that Lone Star is not a valid State, and nothing more than an extension of Chi-Town, are correct. It is the technology and vast resources of the Lone Star Complex that makes the State of Lone Star important to the Emperor and his power base at Chi-Town.

Even the other resources of the Northern Quadrant, copper, iron, coal, oil, natural gas, and an excellent environment for raising cattle and some farming, go mainly toward supporting the Lone Star Complex and military operations in that Quadrant. In the last decade, the Chi-Town authorities have made increasing overtures to populate Lone Star and has in the works, military campaigns to seize more of the country, how-

ever, it has been a slow and arduous task. It will be generations before Lone Star becomes a true State of the Coalition with great cities and civilian population centers.

Ancient Ruins

Thousands of cities and towns across the continent were obliterated by tornados, hurricanes, freak storms, earthquakes, floods, tidal waves, ley line storms, dimensional disturbances, and a host of other natural and dimension induced disasters. However, many of the small cities and towns of the Central United States (and Canada) survived the Great Cataclysm with comparatively little physical damage, but even the communities that were spared the devastation were left without power, communications, medicine, public transportation, and often without leadership. Resources were limited and finite. For all intents and purposes, they were effectively the survivors of a holocaust that in a matter of a few days, erased over 85% of human civilization from the American continents. Then the plagues came, and hundreds of thousands more died.

Survivors, left to fend for themselves, floundered, fell to anarchy or barbarism, and perished. The handful of communities that flourished became beacons in a dark and terrible time, attracting a multitude of desperate, frightened refugees who soon overwhelmed the communities and plunged them into ruin. The ecosystem would remain in havoc for decades, continuing strange weather patterns, devastating storms and natural disasters that added to the chaos and contributed to the destruction of survivors. Meanwhile, nightmarish *things* emerged from the Rifts — strange diseases, alien animal predators, monsters, and demons. All these things contributed to the fall of human civilization and the deaths of millions. This was the Dark Age after the Great Cataclysm, believed to have lasted 200 to 300 years.

These aftershocks that followed the Coming of the Rifts left hundreds of cities and towns standing, their inhabitants dead or gone, leaving the buildings and the things inside and creating ghost towns. As humans began to claw their way out of the darkness of barbarism, and

as D-bees entered the scene, some of these places were reinhabited while others were stripped for materials, tools and other resources and used to build new communities. The American West and Southwest (and parts of Canada), with the lowest population centers and away from the coasts and major bodies of inland water, have the largest number of towns and cities that survived structurally. These have often become the foundation for shanty towns and refuges for tribes, clans and gangs. Of course, they continue to be torn down for their raw materials and only valuables and artifacts hidden under the Earth have survived 300 years of scavengers.

Lone Star, *Kerrick, Etter, Dumas, Adrian, Waka, Pampa, Shellytown, Wheeler, Plainview*, and a dozen others, including *Amarillo*, all nestled up in the Texas High Plains, survived the Great Cataclysm and the plagues that followed, but most would fall during the Dark Ages, often razed to the ground. For example, all that remains of *old Amarillo* are the subterranean foundations of the city (basements, garages, buried relics of the past, etc.). Every last brick and girder was gone long before the year One P.A. Undoubtedly some were destroyed in battles and others were just left to deteriorate. Others served as human settlements for decades before they fell or were abandoned. **Dumas, Waka, Pampa, and Wheeler** continue to survive as frontier towns with farmers, cattle men and peasants trying to eke out a living in this harsh land (average population is 1D4×100+200). Predominately humans, they have welcomed the arrival of the CS, although they have yet to see much benefit from their presence.

Highway 87

Old Highway 87 ran from Amarillo through Lubbock and down to Big Spring and Highway 20. Much of it survived the Coming of the Rifts and has been used as a trail path for hundreds of years. When the CS laid claim to the region, they repaired much of the road and use it regularly.

Long, cracked stretches of **Highway 20**, running east and west, also remain intact, although equally long portions are missing or crumbled into gravel.

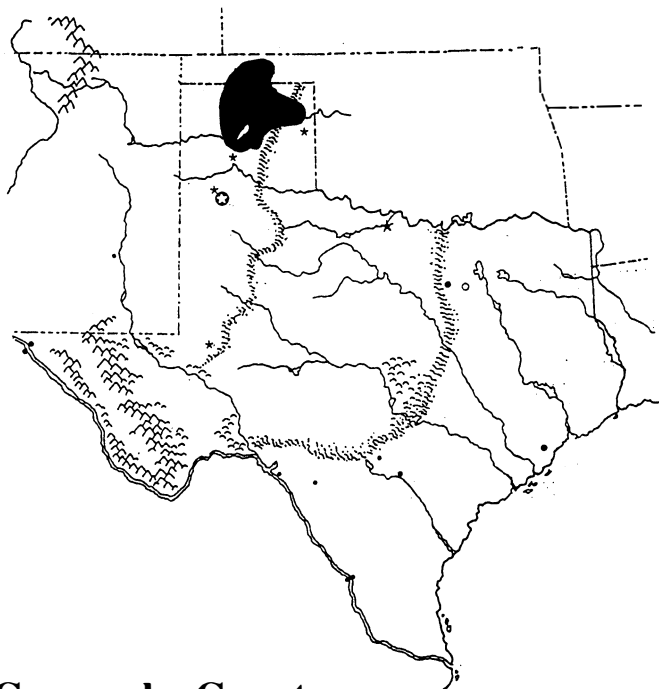

Comanche Country

A small tribe of about 600 Comanche, who have returned to the old ways of living off the land and mysticism, also inhabit part of the Northern Quadrant. They roam the plains north of the *Canadian River* and up into Oklahoma. Their favorite range is around *Lake Meredith* and the area of wilderness once known as the *Lake Meredith National Recreation Area* (around such pre-Rifts communities as Oil City, Four

Way, Masterson, Marsh, Pomeroy, Fritch, and Borger). They rarely bother the CS and are generally left alone by them.

Texas Freelands

The northeastern woodlands are not actually dominated by the CS or the Pecos Empire, so it has become a sort of unofficial no-man's zone. It is largely inhabited by the same peasants, bandits, gangs, clans and tribes found throughout Lone Star and much of the Southwestern wilderness.

The **Kingdom of Worth** and the Haunted Ruins of **Dallas** are both located in the Freelands, as well as the old pre-Rifts cities of Denton, Marshall, Tyler, and Waco, to name a few.

CS Military Bases & Settlements

Briscoe America

Briscoe America is one of the handful of pre-Rifts communities that survived the Great Cataclysm and the Dark Ages. It is a large community (for Lone Star) of 4,100 people, most of whom can trace their proud ancestry for hundreds of years. Part of that heritage is a reasonably accurate sense of pre-Rifts history and everybody at Briscoe can read and write American (English). All the residents refer to themselves as Americans and American Flags are seen hanging from porches and buildings everywhere.

Only a handful of old, pre-Rifts buildings survive, and they have been patched and restored dozens of times. Only a hundred or so pre-Cataclysm books and even fewer film records have survived the long, hard years.

The people have an intense dislike of D-bees and despise practitioners of magic, Indians (and their magic) and the supernatural. Consequently, they welcomed the CS with open arms. Since the arrival of the CS Military, the educated people of Briscoe America have been hired to assist the Military as skilled laborers and professionals. The CS has built a power plant, Skelebot factory, a modern hospital, two underground bomb shelters, and several mechanic shops, as well as a handful of community buildings, including a new City Hall and theater.

The **Briscoe Military Base** is located on the northeastern part of town near the Skelebot factory. A company of (160) infantry soldiers are stationed there, along with 200 support personnel and advisors. 400 Skelebots (with 2D4×100 available from the factory at just about any time) help keep the community, and factory safe —not that Briscoe America has had many problems.

Skelray

Skelray is built on the bones of *Sunray* which had been reclaimed by the wilderness long ago. Actually, "Skelray" is the nickname for *CS Infantry Outpost LS-7*, because it is manned by a skeleton crew of about two dozen mechanics/operators, a platoon of (40) Dog Boys and 288 Skelebots. The Skelebots are sent on regular patrols along the Lone Star/Oklahoma border and up and down Highway 87.

Amarillo

Amarillo is a military outpost built at the site where the pre-Rifts city of Amarillo, Texas once stood. All the buildings are long gone, although scavengers, "relic miners" (people who literally dig up, salvage and sell ancient artifacts and recyclable materials), CS scientists and rogue scientists and scholars (before CS occupation) have unearthed several sections of basements and other subterranean networks.

Lone Star

CS Lone Star

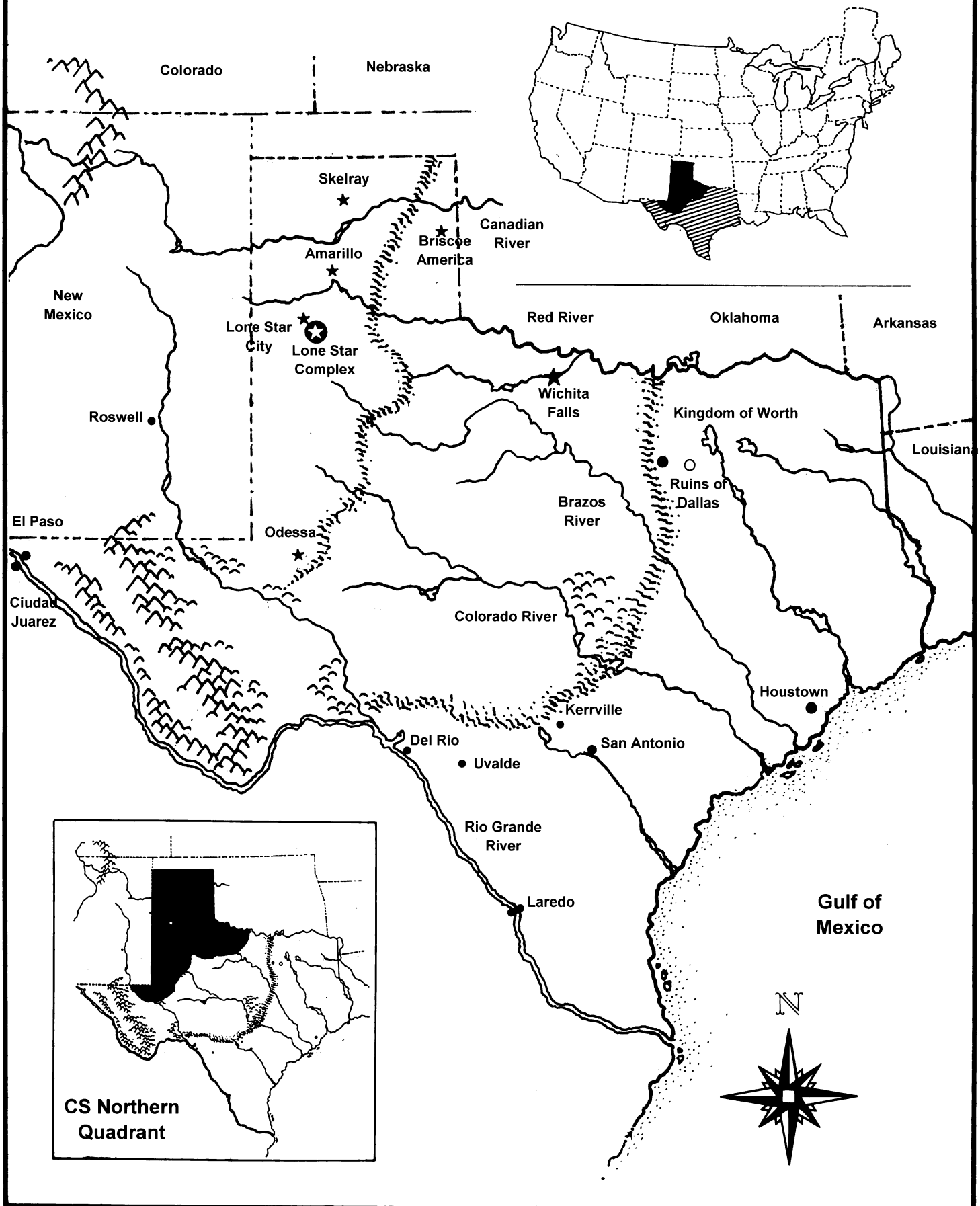

In the last 15 years, a human settlement of 1800 CS citizens have come to Amarillo to be part of the new “Coalition Frontier.” Most work the small oil field or at a small oil refinery. A few others endeavor to start farms or raise cattle, and a nice little town is beginning to take root.

Military troops consist of a Power Armor Company (160 troops; mostly SAMAS, Hellraisers, and Hellfires, with a few of the larger bots tossed in for support), an infantry company (human), a Dog Boy Company and 288 Skelebots.

Odessa Base

Established in 69 P.A., Odessa remained nothing more than a watering hole for Coalition troops — a pit stop. In 100 P.A., Odessa was a small, desolate military outpost manned by one human company and one Dog Pack company (approx. 300 total troops). Scattered around the base was a shabby shanty town of about a 1000 people, mostly farmers and peasants raising live stock.

In 105 P.A., Odessa is still a relatively small military outpost, but it has been restructured and expanded to become a viable frontier base. It serves as a base of operations at the edge of the Coalition dominated lands in the State. Daily reconnaissance squads and border defenders comprised mostly of SAMAS and Super SAMAS sweep the southern borders while ground patrols of Dog Boys prowl the prairies in search of signs of trouble. These patrols tend to treat all nonhumans as hostiles and either chase them south or destroy them without mercy. Squadrons of Death Wing pilots (sometimes accompanied by SAMAS or Skycycles) make long-range reconnaissance patrols deep into the Pecos Empire and occasionally into Mexico. These same squads are also sent out on Seek and Destroy missions to the Pecos Empire, Arkansas and the southwest, striking at known outlaws and D-bee encampments. Kill Hounds (small squads of 6-10 to platoons of 40) are sent out into the Pecos Badlands on “hunts” — Seek and Destroy missions designed to hit small groups of bandits splintered from their larger parent organizations in an attempt to “whittle down” the enemy. They are also sent to destroy “feral” Dog Boys and mutant mistakes, Simvan, and other non-human clans, tribes and bands. Sometimes these murderous Hounds are simply told to kill everybody they encounter (presumably everybody in the Badlands are enemies of the State).

Current Troops at Odessa

53rd LS Company: 160 human support troops (officers, supervisors, medical personnel, communications engineers, operators/mechanics, etc.). Average level of experience: 2-5th level +2 for officers.

122nd RPA/SAMAS Air Armored Company: 160 power armor troops, includes 60 Death Wing pilots, 60 SAMAS and 40 Super-SAMAS. Average level of experience: 1-4th level +1 for officers.

82nd Armored Mechanized Company: Tanks and APCs; 160 troops, 56 vehicles.

69th Dog Pack “Prairie Fox” Company: 160 seasoned Dog Boys. Average level of experience: 2-6th level, +2 for officers; mainly are wilderness scouts.

71st Dog Pack “Hunter” Company: 160 including 40 Sniffers and 80 Kill Hounds. Average level of experience for Dog Boy soldiers: 1-6th level, +1 for officers; Sniffers 1-6th level, Kill Hounds 1-4th level.

Coalition Expeditionary Force (CEF): A team of 30 advisors (humans).

Total: 830 combat troops (one full battalion and a company); 52% are human, 10% Psi-Stalker, 38% Dog Boys. Anywhere from 40 to 320 additional troops may be present at the Odessa Base for temporary support, war games, training, or as a rest stop on route to another location. **Plus:** Two platoons (80) of Skelebots.

Odessa’s Human Settlers

The shanty town still offers the troops illicit pleasures, booze and entertainment, but it too has changed and matured. Parts of the town have cleaned up their acts and represent honest, hard working people, from farmers and carpenters to merchants and professionals. Beyond

the outskirts of the growing town (now with a population of 1654) are a few large farms, but mostly ranchers who raise cattle or sheep and a smattering of other livestock (horses, pigs, chickens, etc.); much of which are sold to the military for food. Approximately 700 people live in the outlying areas around the base and the town.

Wichita Falls

Wichita Falls was a mid-sized military base that protected an oil field, cattle range (several ranches), a dairy plant and helped to defend the southeast corner of CS holdings. It has been expanded over the last five years to become a major military base and serves as *General Kashbrook’s* Base of Operations as she sends troops further southeast toward the Kingdom of Worth and the Dallas ruins. Chi-Town has committed one division (5760 troops) to this operation, joining the 59th (human) Infantry Brigade (1920 human troops), the nearly 1400 support personnel (humans), and the 44th “Sun Devils” Air Cavalry Battalion (640 power armor and aircraft troops), and the “Wichita Demon” Brigade of (1920) Dog Boys already stationed at the post. Five companies of Skelebots (800) are also among the Wichita forces.

Civilian population of Wichita Falls is 12,230; mostly ranchers and dairy farmers with 20% working the oil field. The area around the small city is surrounded by farmers (mainly peach tree groves, wheat, corn and cotton farms) with an estimated population of 6100 — 18,330 total, all humans and all loyal to the CS.

Satellite Military Outposts are located at or near the ruins of the pre-Rifts communities of *Wilbarger, Electra, Holliday, Clay, Archer, New Castle, Morton* and *Abilene*. Each of these desolate posts are in the middle of nowhere, with Wichita Falls being the closest population center. Typically each outpost consists of a single bunker, water tower, and a supply shack. Troops are limited to a platoon of Dog Boys, a squad of Robot Mechanized troops with 3-5 giant robots, typically 1-2 IAR-2 Abolishers and 1-3 IAR-5 Hellfire, and a platoon of (40) Skelebots.

Also see the description of *General Loni Kashbrook*.

Lone Star City

The beginnings of Lone Star City sprung up around the Lone Star Complex as a shanty town of peasants who sought the protection that a military presence gave the region. Initially, the CS did not want a population center around this valuable resource, because it made LSC a bigger target for enemies and endangered civilian lives. However, as the military installation grew and became more populated with scientists and researchers, as well as troops, their families wanted to move to the base to be closer to their loved ones. Not wanting a civilian population on base, the Military constructed a small town for the families and moved the inhabitants of the shanty town there as well (helping the 900 to become productive citizens). This development encouraged other researchers, scientists, and settlers who wanted to be part of the new “Coalition Frontier” to flock to the tiny town. Eventually, the CS hatched a plan to turn the Lone Star Complex site into a new mega-city, with the Lone Star Complex being its hidden cornerstone. If they were serious about turning the wilderness into a fully functioning Coalition State (populated by citizens), the government decided, “Why fight what the people want — let’s give them a city.” And not just any city, but what will become the jewel of the Lone Star State.

So far the plans have been drawn and construction started for what will someday become a new mega-city. The modular design allows for the city to be built out and up (like Chi-Town), so the current small city is safe behind mega-damage walls, but for the time being, there is little need to waste resources building

something huge to just sit, mostly empty. Currently, Lone Star City is located 15 miles (24 km) north of the LSC, covers only 15 square miles and has a population of about 33,000. Until there is reason to build more, construction has been halted. However, the city is like an oasis of technology and home — like a tiny piece of Chi-Town dropped on the Texas High Plains.

The strong CS Military presence at the Lone Star Complex (LSC), the remoteness of the location and the lack of dangerous hostile enemies (really, there are only small raiding parties, and few of them ever dare to hit the LSC) means the only real danger for the civilian population is boredom.

The Lone Star Complex

A bit of history

The Lone Star Complex was discovered in 68 P.A. by a geological survey team using sound echoes to search for oil and natural gas deposits. When they first discovered the underground bunker, they knew they had found something special because it covered a 30 square mile area. However, nobody could anticipate what awaited them.

The CS Military followed standard procedures and sent a full armored company (bots), a squad of SAMAS and a wing of Death's Head Transports to accompany the excavation team. The plan was to access the underground ruin, do a brief survey and to salvage and ransack the place as they had done at the old Lackland bases and many other pre-Rifts archeological sites. Whatever valuables could be recovered would be shipped back to Chi-Town. The door to a large cargo elevator had been uncovered, so entry was expected to be easy. However, three things became quickly apparent: One, the military complex was huge, covering 30 square miles underground! Two, it represented the most advanced pre-Cataclysm military post ever discovered (by anybody). And three, the old installation was in absolutely *pristine* condition! Many (85%) of the sections were sealed airtight and looked as if they were built yesterday. Both computer and paper data files were complete and intact, providing a vast array of information about the American Empire, its history, people, military, weapons, vehicles and technology. The massive complex was a veritable technological treasure trove the likes of which has never been seen before or since.

Three hours after the excavation team gained access and radio-scrambled their initial report to Chi-Town, the entire 4th Army was mobilized. Twelve hours later, the Army surrounded the area. Three months later, the old American State of Texas was declared the Coalition State of Lone Star!

The Lone Star Complex is the greatest archeological find in the history of the Coalition States, even dwarfing the wonders of the old Chicago finds. Just as Erin Tarn has reported, the Lone Star Complex was the largest and most controversial military operation the American Empire had ever undertaken. It is a completely self-contained, self-sufficient ecosystem with its own nuclear power plants (two of them, plus four small auxiliary units), factories, and vast medical research facilities. 80% of it is built underground so an enemy cannot know exactly how extensive it is.

The "complex" was built by the old American Empire during the Golden Age of Science. According to the base, data files, it was completed sometime in the year 2092 A.D. (roughly six years before the

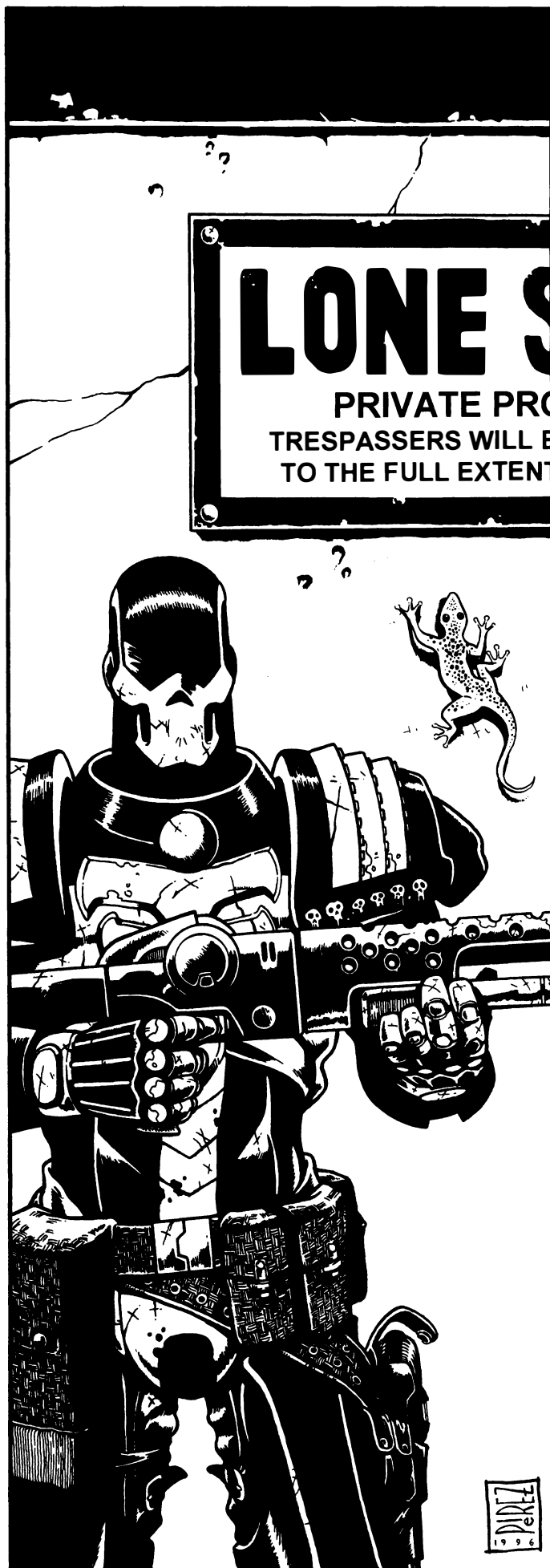

Great Cataclysm). All indications are that it was up and running for years before the ley lines erupted and the Rifts appeared, but everything stopped on December 22, 2098, the day that gave birth to the Great Cataclysm (or so Emperor Prosek, Doctor Bradford and the Coalition elite have learned — if the documents at Lone Star are accurate). Yet, the facility is in absolutely perfect condition, so it obviously survived the Great Cataclysm, which begs the question, what happened to the thousands of military and science personnel stationed here?

Virtually every inch of the 30 mile (48 km) complex (except for a few classified levels) have been scoured, but it's as if the entire population just vanished without a trace. A total of three skeletons clad in the rags of U.S. Army uniforms are all that have been uncovered. Furthermore, the power plants, life support systems, and everything else remains fully operational! Yet the complex was dormant when the CS stumbled across it, as if somebody (one of the three?) simply shut off all the systems, locked the doors, and turned out the lights for the next 260 years.

Only Desmond Bradford thinks he has a clue to the mystery, and he's not sharing it.

Bradford's Theory

Sub-Area Level Nine

The Lone Star Complex was an ultra-secret military research and development facility. It had become renowned for its cutting edge technology in the area of genetic research, cloning, and other related areas of biological research. However, the complex was developing and exploring several other weapons and avenues for military application. One was the field-testing of a prototype power armor that would become the Coalition's SAMAS — a secret the CS already had in its pocket, but the Lone Star Complex has provided them with another SAMAS manufacturing plant, easily modified to accommodate their design improvements. It also provided the CS with schematics and outlines for SAMAS variations that helped them to develop the new Super SAMAS and Death Wing.

Level Eight contains a prototype geothermic power plant that was never completed.

And then there's *Level Nine*, an area of top secret research so hush-hush that even the other departments at the Lone Star Complex had no records or information about it, other than its official designation: *Sub-Area Level Nine*. Being in charge of mapping and getting the Lone Star Complex back on line, it was easy for Desmond Bradford, as LSC Administrator, to conceal Sectors 357 and Sub-Area Nine (the entire 9th floor of the underground complex), by simply designating them as off limits. In fact, even now, 37 years later, the Complex is only around 75-80% operational, with most of Level 7 (with Sector 357), and all of Levels 8 and 9, off limits. Only Administrator Bradford, Emperor Prosek, Joseph Prosek II and a half dozen others in the Coalition States have security clearances high enough to access these levels (not counting Bradford's elite scientists and slaves who are cloistered away in Sector 357, but even they are not allowed on Sub-Level Nine).

The entire 9th level, with its 50 foot (15.2 m) ceilings and massive 40 foot (12.2 m) blast doors (1100 M.D.C. each), is devoted to one purpose, exploring dimensional travel. From what Bradford has gleaned, the scientists were working on a way to warp space and time as a means to travel to anywhere in the world, and beyond. They had discovered a new source of energy which seemed to open infinite possibilities. Bradford suspects they had finally rediscovered the psychic/mystic energy of ley lines; one of which lies only two miles (3.2 km) from the Lone Star Complex.

In the largest chamber of Level 9 is a massive wall of machinery and circuits that served as their key to opening a dimensional Rift. It even has its own (a third) nuclear power plant, so the cost in energy must have been incredible and the geothermal plant may have been intended to help alleviate the energy limitation. He has only been bold enough to try the machine once, and that one time met with disaster. It was his

opening of a pinhole Rift in space and time that caused the entire Complex to shudder and created the dimensional anomaly that allowed the cursed mutant rats to escape into the network of access tunnels on the lowest levels, and slung other rats hundreds of miles away in the Pecos Empire. It is his guess, that the scientists of Sub-Area Level Nine, were conducting a dimensional experiment on December 22, 2098 A.D., just before or during whatever it was that triggered the Great Cataclysm. The eruption of such tremendous energy, the close proximity of the ley line, and other intangibles (perhaps inherent problems with the dimension machine itself), would have had an unimaginable impact on their experiment. The ultimate effect, it would seem, was the dimensional displacement, or teleportation, of virtually all personnel at the Complex. Somehow, only three survived (were there more?). It is possible that they shut down the Complex and laid down to die (perhaps victims of one of their own biological experiments?). More likely, the dimensional anomaly was also responsible for a complete shutdown. So with everything off-line, the three were trapped and perished. Of course, this is pure conjecture on his part, but it is as good a theory as any.

An Overview of the Lone Star Complex

This overview is kept simple and brief because player characters are never likely to see more than some of the surface buildings and the Interrogation Center, and if they are real unlucky, one of the genetic engineering laboratories where they may become test animals. In addition, to completely map and describe the entire complex and all the key personnel would take another entire book, and we had enough trouble squeezing all this into one book that was under 200 pages (small type, more pages than advertised, etc.).

Areas and features of note are listed.

The surface — All CS Military

First, 80% of the fabled complex is underground. Like an iceberg in the ocean, the mega-damage perimeter walls, watchtowers, barracks, and troops visible on the surface is just the tip of this technological iceberg. 95% of these buildings and facilities are new, built by the Coalition Military.

- Defenses: Both overt and concealed — towers, bots, troops, etc.
- Troops (Infantry and elite squads currently on duty, SAMAS, Elite RPA, Special Forces)
- Visitors Area — a small building and rec. area with an attractive, walled courtyard and garden for low security clearance visitors to wait, meet and visit. Includes housing for 50 visitors.
- Administrative Offices (a small cluster of buildings)
- Infantry Troop Housing/Barracks (a cluster of buildings; 500 M.D.C. each)
- Communications Building & Tower (500 M.D.C. each)
- Radar and Air/Ground Scanning
- Giant Robot Hangaers (two large clusters of buildings, 1000 M.D.C. each)
- Aircraft Hangars (a cluster of buildings, 400 M.D.C. each)
- Motor Pool & Garages (a cluster of buildings; 1000 M.D.C. each)
- Medical Clinic (small; 600 M.D.C.)
- Mess Hall (2; 1000 M.D.C. each)
- Officers' Mess (2, small; 600 M.D.C. each)
- Recreation Areas
- Parade Grounds
- Training Grounds
- Demolitions Training Grounds and Disposal
- Military Stockade (1, small; 600 M.D.C.)

- Prison for D-bees and enemies of the State
- Airfield (actually aircraft can land without difficulty anywhere on the flat plateau that is the Northern Quadrant).
- Storage
- Open fields

Note: The complex has food storage to last nearly a year, and hydroponic gardens and farms that can feed approximately 2000 indefinitely. However, fresh supplies are shipped in from local farms and ranches in the Northern Quadrant. The Complex taps into an underwater reserve of water and natural gas (on level 7).

CS Troops

The 4th Army: 24,000 troops, including a Robot Brigade (1920 troops), an Armored Division (5760 troops; tanks and APCs, and a Power Armor Brigade), an Armored Air Brigade (Death Wings, Sky Cycles, Death's Head Transports), Special Forces Company, and two Dog Boy Divisions, among others.

Plus: Six Companies of Skelebots (960 total).

Note: Does not include the science and support personnel.

Secret CS "Vendetta Squad"

Vendetta Squads use the Lone Star Complex as their base of operation and serve under Brig. Gen. Kalpov. These Special Forces "hit" squads (often in disguise) are assigned to seek and destroy military targets and engage in espionage against known enemies of the Coalition States. They usually operate outside the borders of the Lone Star State, with the LSC as their home base. Thus, they can be incommunicado in the field, for months at a time.

Typical Team: 2-4 Special Ops officers (Commandos or Special Forces), 1-2 Psi-Stalkers, 2-4 Dog Boys (often include a Kill Hound and/or Sniffer; may include other mutants), 2 CS Juicers and one full conversion 'Borg.

Targets:

- Juicers, mercenaries and rebels who played a key roll in the Juicer Uprising, and who have refused the offer to join the CS (and anybody who gets in the way).
- Illegal arms dealers, especially those trafficking in Naruni weapons and technology, CS Military knock-offs, stolen/looted CS equipment, and techno-wizardry.
- Notorious Pecos Empire bandits, ideally key lieutenants and notorious outlaws, especially those known to attack and speak against the Coalition Military and States.
- Agents of Tolkeen.
- Agents of the Federation of Magic.

Lone Star Underground

Note: Remember, in addition to the open surface facilities, the underground complex covers 30 square miles, allowing for expansive and diverse sections and facilities. Elevators and emergency stairwells connect all levels. All entrances and exist are equipped with state of the art surveillance equipment, automatic defense systems (computerized and manned lasers and ion blasters), and all below Level Two have 2-4 guards (and sometimes an additional 2-4 Skelebot guardians). Each level can be completely sealed at several junctions on that level. Typical security doors have 120 M.D.C.; blast doors 1000 M.D.C.

Military Personnel with low security clearance are limited to Levels 1 & 2; those with high clearance, including Brig. Gen. Kalpov are limited to Level 4, the Factory Level. Most people are not cleared to go beyond Level Six.

Underground Level One: Military

- Military/Army Offices
- Logistics and Administration
- Dept. of Communications
- Dept. of Military Police
- Dept. of Water and Sanitation
- Dept. of Maintenance
- Dept. of Disease Control
- Dept. of Transportation
- Dept. of Law
- Military Stockades
- Interrogation area.
- Infantry Troop Housing (SAMAS, Elite RPA, Special Forces)
- Offices
- Military Medical Hospital
- Weapon Range
- Armory: Weapons
- Armory: Power Armor
- Hangar: Robots
- Hangar: Aircraft
- Motor Pool & Garage: Ground Vehicles
- Liquid Fuel Depot
- Mess Halls and Restaurants
- Recreation Areas & Theaters
- Storage of Parts
- Storage of Food
- Level One Life Support
- Auxiliary Power Plant
- Prison Area (accommodates 1200) for nonmilitary prisoners, Juicers, Crazies, 'Borgs, renegade mutant animals, D-bees and aliens. Most are awaiting execution, medical or genetic study, and/or experimentation.
- The Hunting Ground, an enclosed/fenced-in forest area used to train Dog Boys and/or observe new mutant and alien life forms in a natural, Earth wilderness setting.

Underground Level Two: Military

- Brigadier General Ivan Kalpov's administrative offices, assistants, and living quarters (large and posh).
 - Administrator Bradford's Office (place of business)
 - Offices of the Military Elite
 - Officers' Housing (1920 officers)
 - Officers' Library and Lounge
 - Housing for Special Forces Officers
 - Additional housing (640 troops)
 - Elite Troop Housing (SAMAS, Elite RPA, Special Forces)
 - Dept. of Intelligence
 - Dept. of Internal Security
 - Corps of Engineers
 - EOD Division
 - Mess Halls and Restaurants
 - Recreation Areas, Gyms & Theaters
 - A large mall area full of Stores and Shops, and a Park
 - Experimental Weapons Testing Facility and Range.
 - Weapon Practice Range (conventional weapons)
 - Armory: Weapons
 - Armory: Power Armor
 - Hangar: Robots
 - Motor Pool & Garage: Light Ground and Air Vehicles
 - Level Two Life Support
 - Nuclear Power Plant
-

Underground Level Three: Dog Boys

- Big section for Dog Boy nursery.
- Big section for early indoctrination and education facilities for young mutant canines (under age of two).
- Dog Pack Military Training Center (Big section) — Dog Boys are trained in the use of CS weapons and armor, identifying and tracking the supernatural, combat training and other basic military skills. Standard one year program (6 month emergency “short” program; a rarity).
- The Habitat: There are actually several different and separated “habitats,” enclosed and monitored, simulating environments from forest to urban streets, in order to observe Dog Boy trainees and/or new mutants and alien life forms.
- Dog Boy Weapons Training Range
- Numerous small Laboratories to monitor Dog Boys.
- Huge state of the art Hospital
- Large Military Cybernetics Center
- Small Juicer Augmentation Center
- Small RCSG Center for Rifts Containment Studies Group
- Small Interrogation area
- Stockade/Prison facility mainly for rogue mutants.
- Housing: Dog Boy Trainees
- Housing: Staff
- Mess Halls and Restaurants
- Food Storage; Supplemental
- Recreation Areas, Gyms & Theaters
- Level Three Life Support

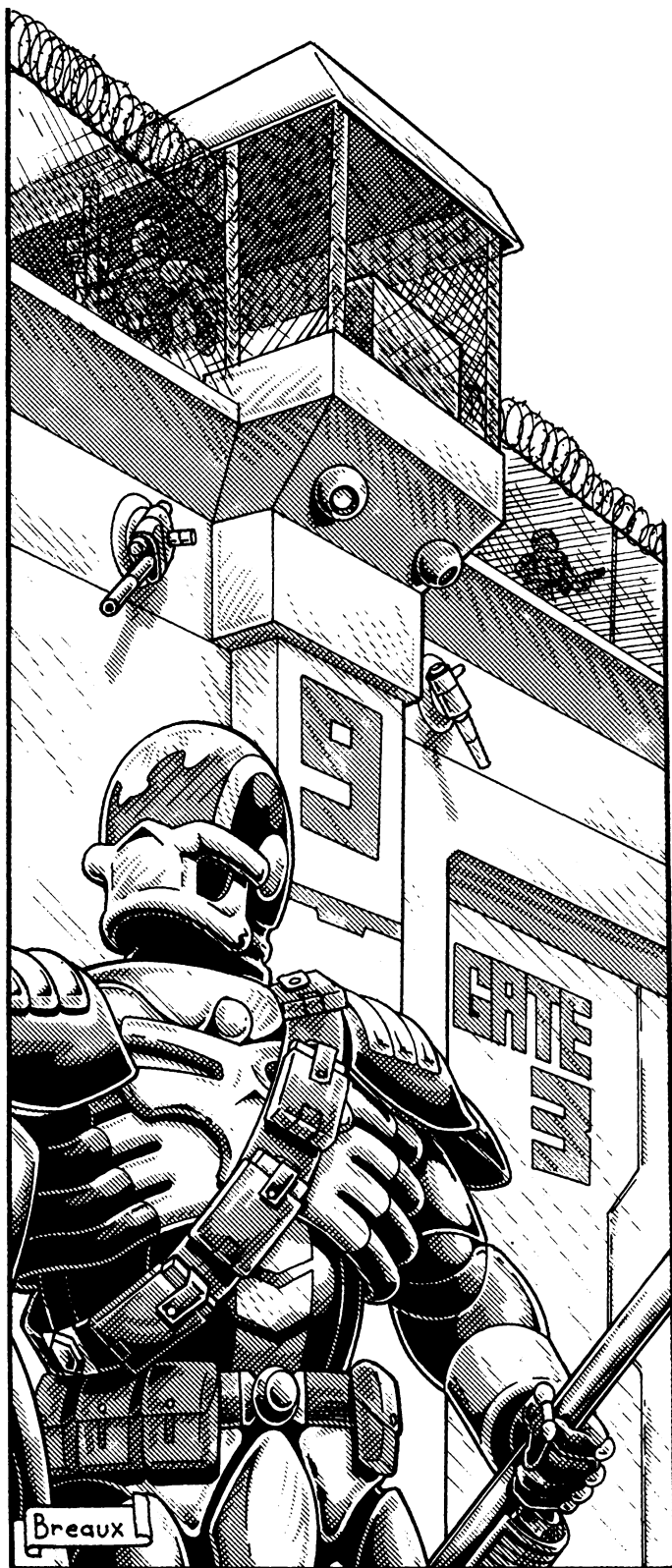

Underground Level Four: Factory Level

- Forge
- Clothing Factory
- Cybernetic Manufacturing Factories.
- SAMAS Power Armor Manufacturing Facilities.
- Small Skelebot Factory.
- Weapons Factory
- Canning and Packaging Facilities and Light Factories
- Other Factories
- Armory: Weapons
- Armory: Power Armor (ground and air)
- Armory: Skelebots
- Motor Pool & Garage: Light Ground Vehicles & Power Armor
- Storage (lots of it, parts, raw materials, etc.)
- Secondary Master Life Support System.
- Nuclear Power Plant

Underground Level Five:

GED (Genetics Engineering Division)

- Huge state of the art Genetics Research Facility subdivided into numerous small labs.
- Secondary Cloning Labs
- Forensic Medicine
- Cybernetic R&D Center (Experimental Works & Bio-Systems)
- Bionic R&D Center (experimental)
- Small Crazyes/MOM conversion Studies Center
- Confinement Hospital for Experimental Test Subjects, with isolation wards.
- Small Interrogation area.
- GECA (Genetic Experiment Containment Areas): Several small and large, prison-like housings and habitats mainly for experimental mutants and exotic animals for study; medium security.
- Zoo and Lab Animal Pens
- Housing for Science and Research Staff.
- Mess Halls and Restaurants
- Recreation Areas, Gyms & Theaters
- Level Five Life Support

Underground Level Six: GED

- Huge state of the art Genetics Research Facility subdivided into numerous labs.
- MAGL (Mutant Animal Genetics Labs): Huge facility, high security; experimental. This is where the Xitix Killer was created.
- Primary Cloning Facility subdivided into numerous small labs.
- Molecular Medicine Center
- GECA (Genetic Experiment Containment Areas): Several, small and large, prison-like housings and habitats. Access limited by security clearance; some off limits except by the elite or Doctor Bradford himself.
- Large state of the art Hospital with isolation wards.
- Small Confinement Hospital with isolation wards.
- Morgue: Pathology.
- Small Interrogation area.
- Housing for Science and Research Staff.
- Mess Hall and Cafeteria
- Recreation Areas, Gyms & Theaters
- Master Life Support System

Level Seven: Sector 357 — Off Limits

Level Seven has more advanced genetic, medical and research facilities. Although generally included as one of the unfinished levels, it is completely built and stocked, but needs to be cleaned and reconditioned. Since the Lone Star Complex already has more labs that it can use, the floor has been sealed off at several junctions and closed off from the rest of the Complex.

Only one third of it is known to be in use. It contains the *Infectious Disease Center* (Earth and D-bee/alien diseases and organisms) and *Sector 357*.

Sector 357 is Doctor Bradford's own private research institute and sanctum sanctorum. It is here that he conducts his illegal and dangerous genetics experiments with alien organisms, D-bees and humans kidnapped from the wilderness outside. The Psi-X aliens and a host of other monstrosities have been conceived and developed here. Also see the description that follows.

- MAGL (Mutant Animal Genetics Labs): A large facility; accessible only to Bradford's chosen elite.
- Secondary Cloning Facilities
- Morgue: Pathology
- Small state of the art Hospital with isolation wards.
- Small Confinement Hospital with isolation wards.
- GECA (Genetic Experiment Containment Areas): Several, small and large, prison-like housings and habitats mainly for experimental mutants and exotic animals for study; medium security.
- Small Interrogation area.
- Housing for elite Science and Research Staff.
- Doctor Bradford's Personal Quarters
- Mess Hall
- Recreation Areas, Gyms & Theaters
- Storage
- Level Seven Life Support System

Level Eight: Unfinished — Off Limits

Note: Most of Level 8 is closed down, not in use and off limits to all personnel but Administer Bradford and his elite.

One large section that is three quarters finished is a huge facility that was intended to tap into the Earth's core as a source of geothermal power (this technology is currently beyond the CS).

There are also additional cloning chambers and labs, numerous large, empty rooms with electricity and lighting, nothing more, and a three square mile area of roughed out construction tunnels, skeleton structures and construction equipment. This level is infested with savage, renegade mutant rats, and the occasional other experiment that got away. Note that the mutant rats have dug their own labyrinth of tunnels and lairs in and under the unfinished third of Level 8.

Sub-Area Level Nine

Top Secret — Off Limits

This is a comparatively tiny level, covering roughly 1.6 square miles. The entire level is devoted to dimensional research and the study of mystic energy and ley lines. One quarter of the facility is completely dedicated to the creation of a dimensional portal, known as the *Dimension Door Project*. The entire level is sealed and off limits to everybody, except Doctor Bradford. Only he knows about the *Dimension Door Project* and what data and equipment lie hidden on Level 9. He hasn't even hinted at it to Emperor Prosek.

Sector 357

A team of Lone Star Elite Guard (LSEG) were positioned and waiting at the huge, reinforced blast doors of Sector 357. A platoon of CS soldiers (half power armor troops) and a platoon of Dog Boys were frantically hustling to get into support positions behind them. All had come in response to the screaming alarm that warned them that some terrible thing had broken free of its containment and was running amok in the top secret laboratories that lay behind the door. Except for a handful of the Elite Guard, none of them had ever seen what laid beyond the Great Door—few ever wanted to.

Sector 357 contained the top secret labs where the most revolutionary and dangerous genetic experiments were performed. The blast door led to a reinforced airlock and a second, inner blast door. Despite all the precautionary measures, things still occasionally broke free from their confinement and once in a great while, actually escaped to the outside world.

When all the soldiers were in position, there was a moment of silence. All that could be heard was their own nervous breathing and the beating of their hearts. Only the screams and pleas of the scientists and security team that came over the radio hinted at the chaos beyond the door.

"For God's Sake, open the damn door!" shouted one of the less seasoned troopers. "People are dying back there!"

As if on cue, Administrator Bradford appeared, accompanied by two of his most trusted power armored elite. A wave of his hand and disapproval in his eyes silenced the rattled soldier. The troops parted before him like the Red Sea before Moses.

"Sir. Ready and able. Sir." barked the Squad leader of the LSEG.

"Thank you, Colonel." replied Administrator Bradford in a firm but calm tone. "Your mission is simple. Destroy anything and anybody that steps out of this door before I do."

"Sir!" responded the LSEG Squadleader with a salute in affirmation. He had received this order on two other occasions in the last five years and was one of the few who had gone beyond the door to battle a monster on a third occasion. He understood it and would obey.

"Administrator." The voice came from the Captain of the human support platoon. "I just want to be clear, Sir. Terminate anybody, including the scientists and military personnel?"

Administrator Bradford turned and faced the P.A. Captain. His cool, casual manner sent shivers up and down many of the soldiers.

"Yes, Captain. That's precisely what I mean."

"Sir, I ... isn't rescue part of this operation?"

Administrator Bradford's voice remained smooth and calm, although some would swear they saw the hint of a smile, as if bemused by the question.

"I appreciate your compassion, Captain. However, if I do not step back out from these doors, you cannot know what you may be unleashing upon the world. Terminate all life forms. Scientists, guardsmen, and Dog Boys included."

"And if you should be ... slain ... in the melee, sir? What of the others?"



"Terminate all life forms. I thought I was quite clear."

"Yes, Sir."

The voice of the grunt who spoke earlier rose above his comrades. He did not mean to speak so loudly. "God damn, this is crazy. Why doesn't he shut up and move his fat ass? People are dying in there! Cold bastard."

Administrator Bradford glared at the soldier. Any hint of amusement wiped from his face. He addressed the officer but his unblinking eyes tore into the outspoken soldier (if looks could kill ...).

"I suggest your first order of duty is to control your men. Unless you'd like me to do it for you."

As if taunting them, the Administrator waited while the soldier was chastised by his platoon leader, then turned, slowly walked to the door and stepped into the air lock. As the blast doors closed around him and his two companions like the maw of a giant metal monster, the Administrator turned for one last steely glance at the soldier who dared to criticize him.

It was an agonizing 96 minutes before Administrator Bradford emerged from Sector 357. His only words were to the two commanders, "You may stand down. The crisis has passed."

Two days later, the outspoken soldier was transferred to the Tolkeen frontline.

Even Coalition troops stationed at the Lone Star Complex don't know what happens behind the closed, steel doors of Sector 357. Only Administrator Desmond Bradford and his hand-picked Special Team are allowed access to this ultra-secret laboratory complex. Most actually live in Sector 357 and many have not been seen in years. It is believed that Administrator Bradford oversees the most guarded, top secret genetic experiments in this forbidden area of the Complex. In part, this is true. However, it is the unspoken presumption that these experiments are done with the approval (perhaps even at the request) of Emperor Prosek and the Coalition Army's High Command. It is not.

Sector 357 is Desmond Bradford's private monster factory. Beyond the mega-damage blast doors (1000 M.D.C.) are the monstrous progeny of his mad dreams and twisted imagination. These creations and areas of research are all expressly forbidden by the Coalition States and are intentionally locked away from prying eyes. The occasional creature that escapes is reported as an experiment gone awry — an unexplained mutation beyond their control. Doctor Bradford's power and persona is such that nobody questions him. In many cases, the incident never goes beyond the Lone Star Complex. The troops are unwitting accomplices in the cover-up because they remain silent in an attempt to avoid the ire of the Emperor. Everybody knows how Emperor Prosek hates embarrassing incidents and public scrutiny, so if the matter is taken care of and Administrator Bradford deigns to keep the matter quiet, or white-washes it in some manner (as to not trouble the Great Emperor), who are they to question otherwise? Bradford consciously recognizes and uses his people's apprehension and gratitude by making exaggerated overtures to defend and protect the troops "from the Emperor's concerns or misunderstandings." This charade of compassion and camaraderie has won Administrator Bradford the loyalty of many Lone Star scientists and troops, and in so doing, has created a web of complicity and silence that serves him well. It is a pact of silence and cooperation that perpetuates the myth that each person has done his job and serves his country well. Among the Dog Packs, there are some who know better, and others who suspect the worst, but it is not their place to speak out against their masters and creator. Even if they did, who among the human supremacists of the CS would believe the word of an *animal* over that of a *human*, particularly one as illustrious and trusted by the Emperor as Doctor Desmond Bradford?

The Dog Pack

Dog Boys — Mutant Canines

The Coalition States' genetically engineered Dog Boys (also known as Dog Packs and Psi-Hounds) are as recognized and notorious as the Coalition soldier's Deaths Head armor and Skelebots. These fur covered humanoids with the body of a bipedal human and the head of a canine are the product of pre-Rifts technology unearthed, reinstated and improved upon by Coalition scientists. The dogs have proven to be ferociously loyal to their creators and dedicated to defending and protecting humankind (i.e. CS citizens). Their inhuman stamina makes them ideal on the field of combat and their canine instincts and senses give the Dog Boys a decided advantage in reconnaissance, tracking, and against supernatural and psychic adversaries.

Originally introduced in 77 PA under the official name of *Psi-Hounds*, the likeable and dependable canine mutants were quickly dubbed "Dog Boys," a slang name that has stuck, much to the chagrin of the military leadership. Most military leaders opposed this euphemism for 20 years before giving up — they felt their mutant soldiers deserved a more menacing and official sounding name. However, the term "Dog Boy" is so widely used by both the civilian and military population that some citizens are actually confused when the canine troopers are referred to as "Psi-Hounds." Certainly, "Dog Boy" reflects the creatures' charm and their fond place among their human masters. Although less official and menacing sounding than Psi-Hounds, the Dog Boys have earned the love and respect of the people they serve, especially among the civilian population of the great mega-cities such as Chi-Town.

Why Mutant Dogs?

Desmond Bradford, Doctor of Genetic Engineering, Head of Research, Administrator of the Genetic Engineering Division (GED) at Lone Star, and personal friend of Emperor Prosek, had been asked the question a thousand times: "Why mutant dogs?" This time it came from Inspector Emerson, ironically, one of Joseph Prosek II's own lap dogs. Administrator Bradford had joined the Inspector in his tour of the GED facilities.

"Actually," chimed Administrator Bradford in a condescending, sing-song tone, "it was really the only logical choice."

"Why's that?" retorted Inspector Emerson. "I'd think there'd be any number of equally suitable animals. Even larger, more powerful creatures than dogs."

"Hmmm, yes, but bigger and more powerful is not always better, is it? Our initial goal was to create an intelligent, humanoid animal to assist humans in their battle against the pervasive onslaught of monstrous creatures from the Rifts. An interesting paradox, really — the creation of dutiful 'inhuman' servants to help us battle other inhuman creatures. As you might know, we continue to experiment with different animal mutations, including felines and rodents. However, they have proven to be much more aggressive, unpredictable and, frankly, bloodthirsty."

"What makes dogs so different?" Interrupted Inspector Emerson.

"Really, sir, I can't believe you haven't done your homework before coming here. Very well. Dogs. Domestic dogs, share a very long and unique history with humans. They are the only animals to have lived side by side with humans as helpers and companions rather than slaves or cattle. For over 15,000 years, dogs have been man's companion."

"In theory," interjected Inspector Emerson.

"Pardon me?" groaned Administrator Bradford with a pained and puzzled look on his face.



“The 15,000 years, I mean,” clarified Emerson. “Nobody can really be certain what happened before the Great Cataclysm, the fall of humankind, and the rise of the Coalition States.”

Administrator Bradford’s eyes twinkled as a toothy grin appeared on his face.

“My God. I see the bureaucrats at Chi-Town have sent a real *patriot* to look over my shoulder this time.”

“With all due respect, sir, facts are facts,” countered an annoyed Emerson.

“Please sir,” growled Bradford, his grin transforming into something menacing. “Your ignorance and pathetic grasp of State propaganda are showing. If you’ve been sent here to inspect my ... our ... facility, surely you must have some inkling of *real* history.”

Without waiting an instant for Inspector Emerson’s comment to his rhetorical question, Bradford waved his arms and trumpeted:

“Look around you! Virtually *everything* you see here is the product of man’s Golden Age of Science *before* the Great Cataclysm. The Dog Boys, our achievements here ... hell, the very backbone of Chi-Town and the foundation of the Coalition States you so dutifully serve are built upon the shattered bones of the old world. If their science is true and has enabled us to create such wonders as the Psi-Hounds and SAMAS power armor, surely then their recorded history must be reasonably correct. Wouldn’t you agree?”

Inspector Emerson stood dumbfounded by the Doctor’s frank, borderline treasonous statements of ... (conjecture or fact?).

“I will never understand why Karl (Emperor Prosek) would want to cultivate such brazen ignorance in his people. But that is something we have disagreed upon for decades.”

Administrator Bradford paused for a moment and turned his focus back on the original subject.

“As I was saying. It is widely known, in the *scientific community*, that domestic dogs have stood at the side of humankind for at least 15,000 years, possibly longer. The position they have held in human history is unique. Two predatory, meat-eating mammals sharing shelter, food, adversity and fortune. They have lived, worked and fawned over each other for thousands of years. Dogs have served man as hunters, guards, war-machines, guides, trackers, rescuers, companions and friends. Before the horse was domesticated, it was the dog who pulled the plow and wagon. No other animal shares such a long and successful place among humans. Not the cat or the horse.

“In many ways, the dog has changed and evolved, socially, as well as physically, alongside humans, as an active and living part of human society. One might even dare to suggest that they have been a sort of animal partner. We are as much a member of the dogs’ family or pack as they are ours. The animal gladly accepts humans into their lives, not as equal partners, but as their superiors. We are the dominant members of their extended family. We are their pack leader. For 15,000 years or more, the domesticated dog has looked to humans as their friend, companion and *master*.

“This inbred socialization ... this camaraderie and love, if you will, made the dog the perfect subject in creating a predominantly subservient race of mutant protectors and warriors. A race of beings who will gladly serve us because that has been their life for thousands of years! It is their destiny to serve us, not as slaves, but as willing companions dedicated to our defense and welfare above and beyond their own. A little tweaking on the genetic level helps to insure these valuable features and attitudes. Our training here and at similar institutions reinforces this behavior.

“Furthermore, the genes of the dog are very similar to those in humans. Each gene is at least 85 percent identical to those of us humans, in the language of the genetic code. This makes the genetic reengineering process necessary to create the intelligent, bipedal, humanoid animal the world knows as ‘Dog Boys’ easier to build than the rat, weasel or cat.

“Add to the equation, the canine’s natural superior senses, physical endurance, strength, diversity of breed, and their sensitivity to the supernatural, and *that* is why the ‘dog’ has been chosen as opposed to the lion, horse, buffalo, rat, dinosaur or D-bee abomination that may have crawled out of a Rift.”

Doctor Bradford paused and smiled mischievously, his eyes shining with personal satisfaction over his little dissertation, confident that Inspector Emerson had been put in his place (he didn’t like the man).

“I trust that answers your question. Generally speaking, of course.”

Dog Boy Creation

The science of creating Dog Boys has become an art executed to perfection with total success 99.6% of the time. The *animals* (the CS considers them “dogs” despite their human intelligence, personalities, and bipedal bodies) are inexpensive to create, maintain and train. Best of all, they are extremely loyal to humans in general (97.4%) and the CS (89.5%) specifically.

Dog Boys can be created and grown in the laboratory via genetic manipulation or born and raised through a normal birthing process; usually under strict CS supervision. In the latter case, there are females who are used as “breeders.” They are typically artificially inseminated to avoid any bonding and emotional attachment to a male partner. These breeders are pampered and cared for by their human masters. Most mutant canines consider it a privilege to help the Coalition States by bringing new, strong defenders of humankind into the world.

These females are usually actively involved in the care, teaching and training of canine children. After their child-bearing years, most females are expected to work in the areas of health and child care, as well as general assistants in the science, medical, research and housing industries. Some are given jobs in other areas, including the Dog Boys’ traditional areas of work in security, reconnaissance, and defense (police and military). Natural (well, relatively speaking) childbirth is much more cost effective and efficient than artificial birth and accelerated growth in a laboratory, although the Lone Star GED creates so many of these creatures that even this process is affordable, but it’s just not *as* cost effective as natural birth. The big advantages to the *natural* process is that the mothers, even while pregnant, can perform valuable work and service to the CS, require much less monitoring and professional attention, and take up less space. Still, one tenth of all Dog Boys are lab-grown, sometimes referred to as “Tube Dogs,” or “Hot Dogs.”

Males and females are sometimes given permission to mate and co-habitate, and even to bear offspring as a special privilege or reward for years of outstanding service. However, the parents are *NOT* allowed to raise their own children. All young are placed in the communal nurseries to be raised under the guidance of the CS. To mate without permission is treason punishable by death; exceptions are made for foolish “accidents,” but such indiscretions will remain a permanent blemish on the animal’s record; usually as an inability to control itself. Such indiscretions will limit its maximum rank and security clearance. To hide and try to raise one’s own children, something most loyal Dog Boys would never consider, is an even more serious crime that is likely to lead to indefinite house arrest and hazardous duty; depending on the situation, it is not uncommon for both parents to be destroyed.

Note: The mating of “feral” mutants, those who run away and live in the wild, is unrestricted and the rearing of the children is the responsibility of the parents, just as it is in human society. Runaways are considered dangerous traitors subject to a death sentence if captured (usually terminated on the spot). Feral young are also destroyed for fear of anti-social (anti-Coalition) contamination. Only those under a year and a half old *may* be spared, taken into custody and placed into “The Program.”

Some General Stats on CS Dog Boys

Sexual Diversity: 70% are males, because males tend to be more aggressive; 30% are female. Of the females, 50% are “breeders” and

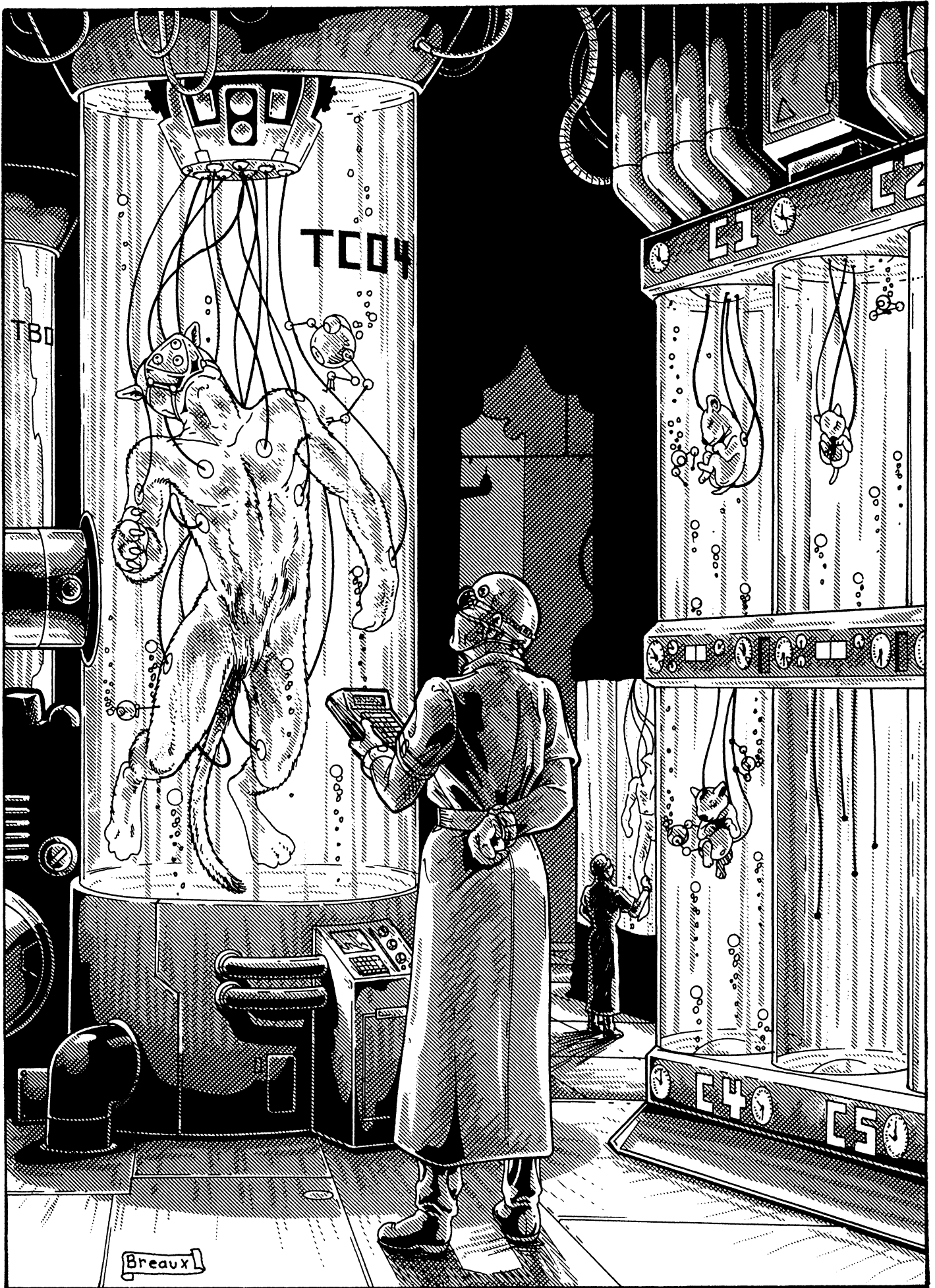



“nursemaids” — Psi-Hounds who participate in a regulated and frequent “birthing program” to keep specific breeds of Dog Boys in stock and who help care for, educate and tend to the young.

Most Common Breeds: Favored breeds tend to be traditional working dogs and hounds. *Workers* include the German Shepherd, Doberman, Boxer, Bullmastiff, Rottweiler, Akita, Malamute, and New Foundland (the latter represents 50% of the Dog Boys in the CS Navy), most types of *hounds* (sight and scent), “select” types of *terriers*, *pointers*, and *setters*, and various *mixed breeds* (typically of worker breeds and terriers, or workers or setters and hounds).

Average life span: Male: 32-45 years. A full 64% will die violently in the line of duty. The average number of years in service to the CS (typically starting at age six) is 26.5.

Females: 45-55 years. The oldest recorded female lived to 69, but 50 is the average. Only 20% die violently in the line of duty.

Temperaments: Varies with breed and genetic coding.



Birth Notes:

- Mutant dogs give birth to 1D4 young, with two being the average; 27% bear three young, 6% four, 2% five or six and 1% one.

- A female reaches full physical maturity by age three, but the CS usually does not allow breeding to start before age five to allow for emotional maturity.
- The typical breeder female will bear young once every 18 to 24 months. This rate of birth offers minimal wear and tear on the mother and maximum longevity of the female (average life span, 50 years). However, a female can give birth as often as every 14 months, but this will reduce her skill/work productivity by 40% and her life span by 30%-50%.
- The gestation period for mutant canines is five and a half to six months.
- Mutant puppies are born both blind and deaf. Their eyes open when they are about 12-15 days old and the ear canals clear around the same time.
- The newborns are taken from their mothers and placed in a community nursery of 15-20 young approximately 20 days after birth — around the time the infants begin to crawl. Within 30 days the pups can stand, walk and run, albeit in a clumsy, stumbling manner.
- The birth mother is typically an active participant in the care of young pups, although she is usually assigned to a different nursery than with her own, and may never see them again. The logic of this being: the mother will treat all the pups lovingly and equally, as if they were all her's, rather than dote on just her own.
- Young reach full, *physical* maturity within two and a half years (females can bear young by age three). This inhuman growth rate provides the CS with a constant reserve of adult mutants (and another reason the birthrate must be closely monitored and controlled).
- Male Dog Boys usually don't reach emotional maturity till age five or six; females around age four or five. Before then, their emotional immaturity typically results in young mutant workers and soldiers with a tendency to be easily distracted, a bit hyper, curious, careless, overconfident (takes foolish chances) and constantly looking for “action.”

The Program

Dog Boy Nurseries & Training

“The Program” is the precise and calculated order, methods, techniques and indoctrination used in the care and training of Dog Boys. The Program (every step closely monitored by humans) has been carefully designed and time proven to be extremely effective.

All mutant dogs, whether they be lab creations or born of mutant parents, undergo an extensive care and training program. Dog Boy pups are taken from their mothers as early as eight weeks, although most are allowed to remain with their mothers for 12 to 14 weeks. They are raised, indoctrinated and trained in group nurseries of 15-20 pups, which works wonderfully since the mutant canines are designed to be pack animals, are very social, and they learn to function within a group.

Mutant pups are cared for and placed around *humans* the moment they are born. The human (and Psi-Hounds) who raise these cuddly, energetic balls of fluff show the animals an immense amount of affection and attention in both play and education. In fact, Dog Boy pups enjoy more tenderness and personalized attention than most human children — but then human children don't reach physical maturity by the age of three and mental/emotional maturity by six. The animals' accelerated maturation means they learn early and quickly, making it necessary to begin training and teaching them everything from the moment they can see. All this attention and care is done, first, to reinforce the bonds between the mutant canine and humans, so that the animals accept humans immediately as part of their lives and family, and, second, to instill them with the proper values, loyalty and direction they'll need to best serve the Coalition States. They are also cared for and educated by fellow Psi-Hounds (predominantly females), but all their formal education/skills, orientation/indoctrination and military training comes primarily from humans.



Military Dog Pack Program

At age two, most (80%) male mutant dogs enter the *Military Dog Pack Program (DPP)*. The remaining 20% may be entered into special military programs or trained for special work as mundane as maintenance or as skilled as paramedic or laboratory assistant.

It is under this three year program that the canine mutants get their most intense training and preparations for life in the CS Military. Most of the canines take to the routine quickly and are eager to test their abilities and learn. Like their four-legged cousins, Dog Boys possess a greater physical endurance (twice that of humans and recover from fatigue twice as fast), love physical exertion (whether it be work or play), love to run/hike/chase, and aim to please their pack leaders and masters (humans). Most are slavishly obedient to their leaders (whether fellow canine, CS Psi-Stalker, or human) and forget or ignore orders only when distracted by more exciting prospects, angry or frightened — all things that these young warriors (pups really) usually outgrow by the age of five or six. To take advantage of the young animals' exuberance and inquisitive minds, the first year and a half of training focuses on obedience and physical training.

In some ways, the first year or so of training is like a long, extensive boot camp where the basics are ground into their young pliable minds. However, unlike traditional Army Boot Camp, the young mutants continue to receive a great deal of personal instruction and see a lot of patience and understanding in their teachers and trainers.

Obedience training includes learning self-control, containing aggressive feelings and instincts, working as a team, following orders, military protocol and the chain of command. Canines, being social, group animals with a hierarchy or chain of authority within their “pack,” generally take to military structure quickly and without consternation or jealousy. Problems enter the picture, especially with young recruits, when the leaders within the hierarchy of command are not strong, capable and worthy of their respect. In a dog pack, it is the strongest and most worthy canines to whom the others are submissive. Consequently, Dog Boys have difficulty accepting, obeying and following orders of a weak, indecisive leader. Ironically, while they may dislike an aggressive, cruel, cold-hearted leader or a petty, self-serving officer, Dog Boys will accept, obey and follow him without hesitation and without challenging his authority, provided he is strong. Dog Boys are incredibly loyal and obedient to strong leaders regardless of their motivation, brutality or pettiness. Of course, there is always the likelihood that a Psi-Hound will attack and possibly kill when pushed into a corner and/or frightened.

Problems with leadership and obedience are most evident among fellow Dog Boys. It is instinctive for canines to test and challenge each other, especially when they are young and testing themselves. For this reason, most leaders of even seasoned Dog Boy troops, from small squads to entire divisions, are usually *humans* or *CS Psi-Stalkers*.

Humans are perceived to automatically possess a level of authority above all canines. This superiority and acceptance of humans as their “masters” elevates human officers (and humans in general) to a position above a mere “animal,” and instantly removes (or at least greatly diminishes) any sense of rivalry, competition and aggression. Dog Boys just do not feel compelled to challenge them. Such feelings are generally reserved for *equals* and lesser species (D-bees), the latter of which are generally perceived as beneath both human *and* dog. It takes a particularly weak, indecisive or unfair human, or an extremely dominant and aggressive canine, to make a Dog Boy challenge even a low ranking human officer.

Psi-Stalkers are seen as below true humans (they are mutants, after all), but still a notch or two above mutant canines. The fact that most



Psi-Stalkers tend to be strong, forceful individuals makes them quickly accepted by the mutant canines as strong and decisive leaders — besides, Psi-Stalkers rarely exceed a rank higher than Chief Warrant Officer (and are more likely to hold the rank of Sergeant), so the Dog Boys recognize that the Stalker is enforcing the orders of a superior, “human,” commanding officer.

The first year of training helps the mutant canines playfully test and challenge each other to get a general idea of their place in the army and the chain of command. For most, this only takes a few months. Once they have learned their place, the typical Dog Boy is content with it (unlike humans). Again, this is a wonderful trait in a soldier, because even the most capable canine *follower* (generally one who is submissive to strong leaders) never wants for glory or promotion. The typical Dog Boy is content with both his position in the army and with his work/duty. It’s his pleasure to perform that duty to the best of his ability — that is his job and his life. Perhaps the only downside is that without a good leader, a submissive Dog Boy is not likely to assume the mantle of leadership in a crisis (instead looking for human guidance). Leaderless troops become easily confused and uncertain about how to proceed. Some will follow the last order to the death, some will try to do what they think is best (usually in a clumsy, chaotic and ineffectual way), while others will break rank and flee.

During the initial phase of obedience training, about 50% of all young Dog Boys will quickly learn their place and assume submissive and obedient posture in response to a stern look, strong command, or firm resolve (no nonsense demeanor) without any sort of challenge of authority. 40% of the others will show momentary flashes of defiance and aggression — clear challenges to one’s authority by standing their ground, pausing to stare defiantly into the order giver’s eyes before carrying out the command, questioning the command, requiring the order to be given more than once, slow to respond, ignoring a command completely, and/or growling. If a Dog Boy does not *immediately* respond to a command, it is a sign of defiance and a lack of respect. Such lack of respect is likely to escalate quickly into open defiance (slow response, ignoring orders, sloppy work, growls, jokes and complains in front of others). A dedicated and obedient Dog Boy will snap to attention, jump to answer a question or perform a command, show absolute respect, and never questions or challenges a command even if it is one which the mutant soldier disagrees with! Of course, acts of defiance and challenges are to be expected from the youngsters, so instructors are reason-

ably tolerant of chest thumping and youthful bluster — as long as the mutant animals surrender to their will, learn respect and obedience and show submission to their masters. Among themselves, physical and psychological confrontations are usually much more intense (anything from a staring contest and threats to wrestling and serious physical combat), although they rarely result in more than a bloody lip or a couple of nipping bites. **Note:** Animals who do not learn their place or exhibit too much aggression and a lack of self control are removed from the program. Roughly 6% washout of the DPP, meaning they are deemed unreliable (too wild, aggressive, careless, and/or disobedient), lazy, mentally or emotionally handicapped, or openly defiant. 10% of these washouts are used in further genetic, bionic, MOM and other experimentation. The rest are destroyed. Their termination is done discreetly and humanely to avoid upsetting or frightening the other animals.

An additional 10.6% will go AWOL or renegade during their lifetime of duty under the CS (typically 25-35 years); an outstanding success ratio.

Physical training starts off with a lot of *games* and is more like an intense “sports” training camp for athletes than military orientation. Games and rudimentary training includes speed running/sprinting, marathon and field running, running in formation, running in armor and full field packs, swimming (all Dog Boys are adequate swimmers, while a few particular breeds are exceptional), prowling, hide and seek games, body building, wrestling, baseball, football (American style), soccer, and similar. Playful games allow the mutant animals to burn off their incredible abundance of energy (easily eight times that of a human teenager), build their bodies and endurance, hone eye to hand coordination and reaction time, helps them learn to cooperate and function as a team, compete and challenge themselves and others without direct (one on one) confrontations, boosts their self-confidence, and serves as an orderly and constructive way to unleash feelings of aggression. Meanwhile, their trainers (humans and experienced Psi-Stalkers and Psi-Hounds) keep a watchful eye for animals who show leadership qualities, quick thinking, resourcefulness, and other strengths and weaknesses. Leaders among the Dog Boys are earmarked as potential candidates for Special Forces and low ranking noncommissioned officers (Dog Boys rarely exceed the rank of Sergeant Major).

These games slowly transcend into formal military exercises that include reconnaissance, tracking, capture, seek and destroy, sabotage, etc.

Combat Training. The second year and a half of training involves formal military training, use of weapons and equipment, marksmanship, wilderness survival, basic military strategy and tactics, reconnaissance, and exercises that reflect the mutants' role in military service, particularly the tracking and extermination of supernatural creatures, D-bees, psychics and practitioners of magic (See *Dog Pack R.C.C.* descriptions for specific details about skills, abilities and breeds).



or lengthy bouts of depression. Dog Boys are more easily satisfied and find enjoyment and pleasure in simple things humans often take for granted, such as companionship (they are very social), the beauty of the outdoors (as well as artwork, music and human beauty), running, rolling in the grass, the thrill of the chase and the hunt, and so on. They also dream, love, hate, cry, laugh, joke, play pranks, develop personality quirks and habits, wonder about life, have a strong sense of right and wrong (and personal honor), and have broad goals. Obviously, Dog Boys are *not* human, but they are sentient life forms with strong personal identities and many human traits.

Fear response: Aggression. In humans, the fear response typically prompts one to flee, hide, or submit/surrender. In most dogs and mutant canines alike, the response is aggression. The animal will growl, bark, lunge and snap at the object of its fear. Its ears will be tucked back and the tail tucked low to the ground. If a dominant or aggressive dog (size of the animal vs its opponent doesn't matter), the tail may be raised and the animal's actions more extreme; i.e. snort, howl, bark more fiercely, scratch the earth with its feet like a bull ready to charge, and it won't back down an inch. If given no other recourse — backed into a corner, attacked, or the belief that attack is imminent, the animal leaps to savagely attack — in order to defend itself. This same response may be elicited by a dog defending (at least in its mind) its territory, home, a favorite possession, food, mate, young, or its master or master's territory, home or possession.

About 10-25% of the time (depending on the breed; some are naturally more aggressive than others), the dog will fight until its opponent is slain or more likely, unconscious and crippled. However, most dogs will fight only until its opponent crawls or runs away and rarely fights to the death of its opponent or itself unless truly backed into a corner with no escape. Furthermore, most dogs are delighted if their potential opponent backs down and leaves. That's what all the barking, baring of teeth and foot stomping was all about in the first place; to scare or chase the intruder (human or animal) away. If the invader goes away (no sudden movements mind you; and going away probably means out of the animal's sight), the dog is content, proud and confident that it has done its job (guarding, defending, etc.). Since such confrontations are effectively duels of dominance and aggression, backing away is likely to prevent a physical attack (though not always), and it also tells the animal that "you" are afraid of it. This means that each submissive or frightened action of the person or animal it is confronting gives the dog more confidence. More confidence means the dog may become increasingly aggressive and encourages attack. Thus, one must try to show as little fear as possible while slowly moving away or around. Once 40 yards/meters or so away, the retreating individual may begin to move more quickly and decisively, although running (abject terror from the dog's viewpoint) may trigger the animal to give chase, biting and bumping its opponent. Depending on the breed and the degree of dominance and aggression of the animal, it *may* be satisfied with the intruder's flight and stand its ground (35% chance); or offer chase and give the flier a few good bites to remember it by, before giving up the chase (55% likelihood); or move in for the kill (10% chance). This scenario changes dramatically if the animal is trained to kill or incapacitate its prey/intruders.

Dog Boys respond very similarly when they feel threatened or cornered. Like their four-legged cousins, the typical Psi-Hound is not excessively savage or bloodthirsty. Unless their orders are to "kill," they are satisfied with repelling an enemy and successfully defending their post. In a fight, they are glad to accept surrender and take prisoners (unless orders are to the contrary). However, when afraid, whether by a challenge from an ominous foe or being backed into a corner, the ears fold down, teeth are bared and the canine soldier growls and barks warnings and threats, accompanied by an undisputably aggressive, combat-ready stance. If pushed, or somebody makes a threatening or sudden move, the Dog Boy will attack. He will strike to incapacitate or kill, and rarely shows restraint or mercy in these situations.

Canine Psychology & Instincts

It is important to understand some of the different perceptions, instincts and responses of the dog and mutant dog.

Dog Boys and emotions. Do Dog Boys possess the same emotions as humans? That is a subject of wide debate. The CS insists they are fundamentally bipedal "animals." Nothing more. As such, the CS insists that the mutants do not possess the same degree of understanding, intellect, range of emotions or a human soul (It is interesting to note that *Doctor Desmond Bradford* would disagree completely. On the other hand, he doesn't care).

It is likely the mutant canines (and other mutant animals) perceive and "feel" things differently than humans. Consequently, certain experiences and emotions *may* have a lesser or greater impact on them than a human. It's already been noted that they socialize differently and develop a sort of pecking order in their "pack" (whether the pack is a group of fellow Psi-Hounds, a mixed group of adventurers or bandits, or an entire army division). They are prone to intense feelings of loyalty, commitment and honor. They enjoy hard work and exercise, are more laid-back and accepting of what life hands them, and tend to have a bit more simplistic, black and white outlook on life, honor and duty. While these all make them *different* from humans, Dog Boys are much more than animals.

Dog Boys have a human level of intelligence, are imaginative (although not to the same degree as humans), and resourceful. They feel happiness and sorrow intensely, although they rarely suffer from serious

It's important to understand that a Dog Boy (and dogs) will feel cornered and threatened when pushed against an imaginary corner as well as a real one. Such imaginary corners are typically created from loyalty and dedication to duty. For example, hopelessly outnumbered, a lone Dog Boy will stand his ground in defense of his post. Even if the intruders remain calm, tell him that they don't want to fight or hurt him, make a genuine, safe path for his escape, and invite him to go unmolested, the dedicated dog soldier is not likely to stand down. Instead, he'll snarl a warning and remain ready to fight and die, especially if defending a life. To the Dog Boy, he is cornered. Why? Because he has been given two choices: One, follow orders (and die?) or, two, disobey orders (usually, not an acceptable option). Consequently, this isn't much of a choice, and the Psi-Hound feels cornered and will act accordingly.

The mutant soldier is likely to stand down and leave his post (or surrender) only if an officer commands him to do so, or a respected human can convince him he should. The intelligent Psi-Hound *might* also stand down and retreat or surrender if he sees an opportunity to help other captives, regroup and attack to reclaim/defend/avenge whatever is in jeopardy, or if he knows there is absolutely no point in resisting (i.e. the entire base has been captured by the enemy, all other soldiers are captured or killed, and his post is to guard an empty truck or comparatively insignificant item or location). However, a Dog Boy will never surrender if doing so will cause the death of a human — unless that human commands him to do otherwise, or the human is absolutely despised and not worth saving.

Note that it is the duty of every *captured soldier* to try to escape and/or undermine his captors. The Dog Boy's dedication to duty means he will do everything he can to escape, help others escape and/or hurt or confuse the enemy. Thus, the mutants make incorrigible, defiant and aggressive prisoners. Forced imprisonment, submissiveness, and slavery are so intolerable and painful to Dog Boys that it makes them savagely (sometimes insanely) aggressive. Some turn into wild beasts who lash out at their captors at every opportunity like a wounded animal, as if blood will somehow free them or wash away their shame (most captive mutants feel they have failed those who counted on them or at their duty — thoughts and feelings that constantly gnaw at them and encourage acts of revenge and unchecked aggression). Others will show more restraint, but are openly defiant and will take dangerous risks. In a prison break, Dog Boys will typically volunteer to stay behind to cover the escape of humans and canine officers. These defenders fight like demons (often to the death) to give their superiors ample time to make good their escape, and to extract vengeance against their captors.

Loyalty or Brainwashed Slaves? Many rogue scientists, philosophers and humanitarians outside the Coalition States, argue that the Coalition's use of mutant canines is nothing more than slavery. They insist that Dog Boys are not "animals" and should enjoy the same rights as any sentient being. Of course, this argument is a moot point, considering that the Coalition States don't recognize the equality or rights of any *nonhuman* race. In fact, by comparison, Dog Boys are treated with unprecedented kindness and compassion by these murderous bigots, although the mutant canines must serve the Empire or be destroyed.

Most Dog Boys don't feel enslaved or brainwashed. Nor do they feel equal or even near the equal of humans. According to Lone Star GED scientists, this is neither brainwashing or genetic manipulation, but the very nature of the animals and their relationship with humans. It is widely known that the geneticists select, enhance and combine the most favorable genetic traits of the canines, with loyalty being of extreme importance. One can also find arguments that the Dog Pack training program *is* a form of brainwashing. However, it has been impossible to produce evidence that the mutants are being somehow controlled or forced to serve the CS against their will. In fact, most Psi-Hounds, when given the opportunity to leave the CS and join other humans or nonhumans as equals, decline the offer and return to their Coalition masters. Furthermore, the offspring of "feral" Dog Boys who have deserted the CS and are being raised without "The Program," ex-

hibit a very similar intense loyalty (obsession?) to their family clan and the other humans and D-bees with whom they associate.

Whether free and "feral" or "programmed" by the CS, an astonishing 98% of Dog Boys and 63% of other mutant canines (the Wolfen and other alien races of canines not included) who originate from domestic dogs show an automatic (instinctive?) feeling of strong friendship and even kinship with human beings. Even 51% of mutants created from wild canines show a willingness to accept humans over other life forms. Even more curious, nearly the same number (93% of Dog Boys, 60% of other canine mutants, and 49% of wild canines) take an immediate dislike (sometimes hatred, other times, suspicion or fear) of supernatural beings and monstrous looking nonhumans! Is this a clear indication of the creatures' link to humans (on what level?), or, perhaps, the planet Earth and its ecosystem?

Loyalty. Loves humans. Some of this has been touched upon in the previous pages, but can't hurt repeating. The relationship that has been shared between humans and domestic dogs for over 15,000 years has created a union or symbiotic relationship between the dog and humans unlike any other animal in the world. The mutant canines share this bond (perhaps magnified through genetic engineering).

Unlike wolves and other wild canines, Dog Boys bred from domestic canines rarely challenge or disobey a human whom they have accepted as their leader, even if that human becomes physically incapacitated (injured, sick, etc.) or mentally unbalanced. Wolves on the other hand, would take advantage of the leader's debilitation, kill him and try to seize command. The loyal mutant dogs may recognize a problem, feel badly or worry about it, but remain loyal. For example, some have been known to follow obviously insane leaders to their doom rather than question or oppose their commands. Only the most dominant and aggressive males are likely to break rank.

The loyalty and deep affection Dog Boys show their leaders, especially humans, is without comparison. Likewise the Psi-Hound's dedication to duty is usually unwavering. This is why desertion and open rebellion among Dog Boys is so low. Less than 11% of all Dog Boys among field troops (those faced with frequent combat and typically assigned to the most hostile, inhospitable and D-bee infested places) and only 5.4% of those stationed at Coalition cities as ISS police or similar protectors of civilians will desert or turn against the CS.

Favoritism. It is important to note that the human commander who displays extreme favoritism will evoke the hatred and resentment of the Psi-Hounds under his command. Favoritism to other humans is barely noticed and ignored by the canine mutants, but favoritism toward select members of other Dog Boys in the group (especially if they are not officers) will magnify the sense of rivalry within the group and play havoc with the pecking order of the pack — at least as the Dog Boys see it. This will cause a wide range of disobedient behavior from the other dog soldiers (sloppy work, forgetfulness, slow to respond, snide remarks, etc.), as well as a lack of cooperation, pranks and brawls. When dealing with mutant canines, it is important to maintain the subtle hierarchy of the group and show fairness and appreciation to whomever deserves it for a job well done. To single out favorites for whatever reason can only lead to disaster.

The Supernatural Enemy. With the advent of the Rifts and the subsequent return of magical energy and supernatural creatures, it has been discovered that Dog Boys (and ordinary canines, both wild and domesticated) can *sense* them. This innate ability is one aspect of the mutants which the pre-Cataclysm humans were not aware. Even the CS scientists don't have a complete understanding of how or why canines possess this sensitivity. Again, it may have something to do with serving as the friends and protectors of humans for thousands of years (this ability is present, but less acute in wild canines — reduce abilities by half). It also has to do with the creatures' predatory nature, keen senses and the fact that magic energy was also present and reasonably strong until about 6000 years before the great cataclysm, so domestic canines were exposed to supernatural and magical forces for thousands of years.



This sensitivity to the supernatural is how the mutants got their original military name of *Psi-Hounds*, and is another reason they are so valuable to humans as allies and defenders against the supernatural.

It is important to note that it is part of the canine's instinct to recognize magic and the supernatural. That same instinct tells the canine to be wary of magic and that (generally speaking) supernatural beings are deadly enemies. Consequently, the Dog Boys don't "hate" supernatural beings per se, it's that they instinctively see them as natural enemies — demonic invaders, alien predators and destroyers who must be driven away or killed (It is interesting to note that the vast majority of supernatural beings are evil, cruel, and destructive). Supernatural beings also trigger the canines' aggressive fear response. This instant antagonism to the supernatural is probably also what makes Dog Boys leery of most nonhumans (their normal senses, especially their keen sense of smell, clearly identifies these races as different than humans or canines).

Swimming is another *instinct* possessed by most dogs and their two-legged mutant cousins. This basic, instinctual ability is roughly equivalent to the swimming skill at a 50% proficiency, and is limited to the "Dog Paddle," a stroke that is named after the dog's method of swimming to begin with.

Attracted to Motion. Most dogs and Dog Boys are attracted by movement — a predatory response. They also like to run and dig, which is how wild dogs hunt and capture prey. Consequently, a dog is inclined to chase people and prey that are running, and attack when they see a sudden movement.

Instinctive Hunters: Dog Boys love to chase and hunt prey (humanoid or otherwise). Of course, their human intelligence, humanoid bodies and opposable thumbs allow them to use weapons, tools and equipment of all kinds.

Instinctive pack animals. Loyal and group oriented, most mutant dogs work well in groups and prefer to be part of a group rather than alone. They are usually team players.

Work Ethics. Canines and their mutant cousins enjoy physical exertion whether it's through work or play. Like their four-legged cousins, Dog Boys possess a greater physical endurance and enjoy physical work and exertion. They love to run/hike/chase, wrestle, play sports, hunt, track and stalk, explore/reconnaissance, and engage in physically demanding work of all kinds (digging ditches, construction, shipping and receiving, etc.). Furthermore, most dogs strive to do their best, like challenges (provided they aren't incredibly difficult) and aim to please their pack leader and/or human masters. This, their loyalty and other abilities makes them ideal for the stress and rigors of frontline combat, wilderness assignments, and seek and destroy missions to flush out and destroy supernatural beings and enemies of the Coalition States.

Note: It is worth noting that the success of the Dog Boys in human society has nearly as much to do with human psychology as it does canine. The dog is an old friend that has been accepted by humans as workers, colleagues, companions and friends for over a dozen eons. Consequently, humans took an immediate liking to mutant dogs, finding it easy to accept and trust them. After all, dogs have been "man's best friend" for eons, and the Dog Boys only seem to breathe more truth into that old axiom. This acceptance and warm response by humans only serves to make the mutant animals feel loved, cherished, needed, and dedicated to the protection of their masters, as they are genetically inclined to do to begin with. This immediate bonding (and friendship) between the two races has made for a strange but strong union between man and his creation. It is this comfort level, familiarity and the fact that the CS refuses to acknowledge the Dog Boys as anything more than clever, loyal *animals*, that allows Emperor Prosek and all the human supremacists who live in the States (which is the majority) to not realize that they are putting their trust and wellbeing into the hands of *nonhumans* (the Dog Boys are equally unaware of the unique situation; they happily accept their position without much thought or question).

Humans (and many D-bees) have an automatic fear and/or revulsion response to mutants spawned from animals they see as scavengers, disease carrying or sinister, such as rats, mice, bats, weasels, and reptiles. Furthermore, they seem to have a great deal of trouble bringing themselves to accept or trust such vilified animals. Even cats, bears and other likeable predators are viewed with some measure of uncertainty, distrust and fear because of their reputations for being cunning predators, powerful and/or independent/lone hunters/stalkers.

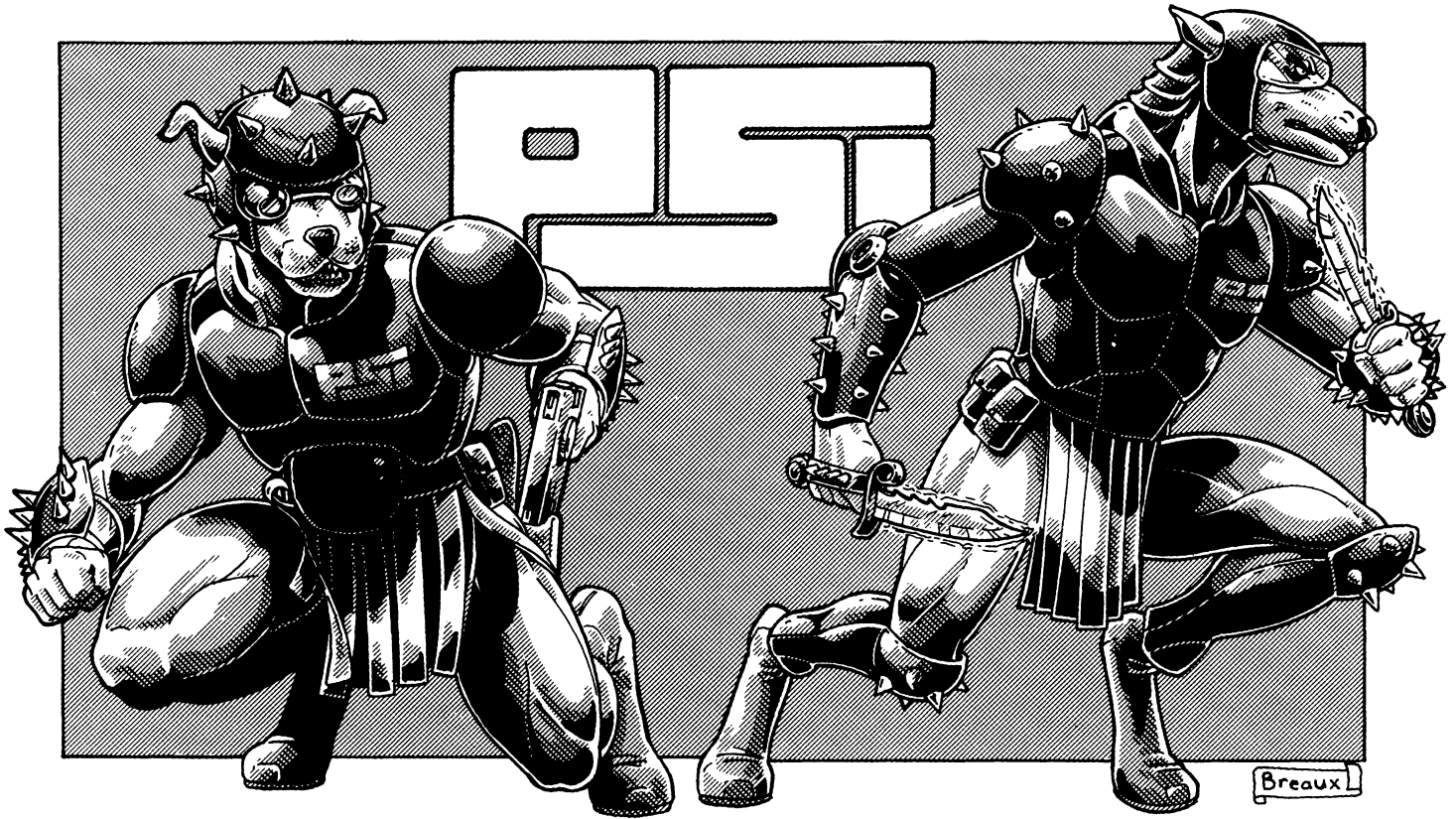

Dog Pack R.C.C.

Dog Boys or Psi-Hounds

The typical Dog Boy soldier or Police Officer

Coalition Dog Packs are a formal part of the CS Armed Forces and receive the same basic military training as the Coalition grunt. However, the Dog Pack also receives special training in honing their tracking abilities and psychic powers. The purpose of the canine mutants is to be sort of low level Special Forces operatives and watchdogs against assaults by psychics, magic, and the supernatural. A typical squad or “pack” is 4-10 canine mutants led by a Psi-Stalker (one in eight are led by a human officer). Larger groups of Dog Boys (platoons, companies, etc.) will have capable human commanders and officers, with Psi-Stalkers and experienced Psi-Hounds holding positions as low ranking non-commissioned officers (Sergeant and lower ranks). Those assigned to the various ISS city defense divisions are typically the most obedient and expert at “sniffing” out the inhuman. ISS teams patrol CS cities, military bases, and entrances to the city or military bases ever vigilant for the distinctive presence of the paranormal (see **Rifts® World Book 11: Coalition War Machine** for more details about the ISS, PSINET and other posts that utilize Dog Boys).

Individual members of Dog Pack troops are given free rein to wander the city or military base to keep an eye out for, and investigate, any

suspicious activity or individuals. To rebuke the inquiries of a Dog Boy will mean a full Dog Pack, led by a Psi-Stalker, arriving moments later to enforce a full (and unpleasant) investigation. A Dog Pack and Psi-Stalker have the authority to enter any civilian establishment or home if they have reasonable cause, and sensing the presence of magic or the supernatural is “probable cause” for these psychic sensitives. Most CS citizens and human soldiers are comfortable with the loyal and courteous Dog Boys, welcome their presence and cooperate with them to the fullest.

City Dog Packs are used to track criminals, especially magic and psionic criminals, D-bee intruders, and supernatural menaces, as well as used as a general police force. In the military, they serve as guards against supernatural and magical spies, saboteurs and intruders, and as frontline troops used primarily for reconnaissance/exploration, escort, rescue, sabotage, surgical strikes, and seek and destroy missions.

In the wilderness, troops of Dog Pack soldiers (or other mutant animals) may be dispatched into areas of conflict. Like the US Marines of old, the Dog Pack is often the first to be sent into a trouble zone for reconnaissance and/or initial assault. Dog Boys are also sent into the Burbs and wilderness communities as scouts and spies to sniff-out covert operators — translation: find groups and individuals who practice the arts of magic, consort with nonhumans, are inhuman, supernatural, or involved in forbidden activities (i.e.: study ancient books/ruins, education, preaching equality for all life forms, speaking against the CS, enemy sympathizers, etc.). The Dog Boy may be assigned to a human team or part of an entirely mutant animal squad, or an individual on a solo assignment.

Individual Dog Boys are frequently sent into the wilderness to pretend to be runaways or mercenaries. This subterfuge enables them to observe and/or secretly subvert the activities of real mercenaries, adventurers, “feral” mutant animals, and enemies of the Coalition States. Of course, some mutant dogs will forsake the Coalition when they discover the freedom that other societies and groups offer. Or are simply enticed to wander the world to personally explore all its marvels. This too, is anticipated by the Coalition and is part of an exercise to see how many Dog Pack soldiers remain loyal when placed under varying conditions of freedom, stress, or danger (generally under 11% leave).

Since they are seen as specially bred and trained “animals,” the mutant dogs are generally considered to be an expendable commodity. A human might feel a bit of a loss over the death of a favorite hunting dog killed by a wild animal, but one simply discards the dead body and goes out to purchase a new dog. This is the general attitude of the Coalition military and most citizens. The mutant canines are just big doggies that walk on two legs, sport arms and hands, and talk instead of bark. If a job is too dangerous for a human, send in a mutant animal. If it dies, a new one can always be purchased, bred, or grown. An attitude that is not shared by the Psi-Stalkers who act as the team leaders of most Dog Packs or squads. As noted previously, most Dog Boys don’t see anything wrong with how they are treated, and tend to concur that they *are* expendable, rather than jeopardize valuable human lives. This also means that they rarely feel cheated or abused, and are happy to be part of the human pack.

Special Dog Boy Powers & Abilities

Note: The following are typical of the average Dog Boy. Some things will vary according to the breed of the dog and there are a couple of sub-divisions of mutant dogs with special abilities and/or heightened senses.

1. Sense Psychic and Magic Energy: Basically identical to the Psi-Stalker, although not quite as developed. Like a bloodhound smelling a familiar scent, the Psi-Hound can detect the presence of psychic energy; specifically fellow psychics (I.S.P.) and magic energy (P.P.E. used as a spell, in magic devices and large amounts in people; 80 or more points). The ability is constant and automatic, just like the ability to see and smell.

The Psi-Hound can sense whenever a psionic ability is used within the range of sensitivity. If the energy is being continually expended, like a series of magic or psionic attacks, or is of a duration/effect longer than one melee round (15 seconds), the Dog Boy can trace it with relative ease to the source (i.e. the character or creature using the psionics). Several psionic or magic characters using their powers in the same general area will lead the canine to that location, but he will not be able to discern and remember (recognize) any of their *psychic scents* at a later time. Several psionic or magic characters using their powers over a large, scattered area of the Dog Boy’s sensing range will confuse the senses. The mutant canine will be able to tell that there are several emanations and have a fair idea of which direction most are located, but will only be able to accurately follow the most powerful emanations of energy.

Base Skill: 40% +5% per level of experience (roll once every melee round). Reduce by half when multiple sources are scattered throughout the sensing range.

Range: Sensitivity to a fellow psychic or magic practitioner *not* using his powers is 50 feet (15.2 m) +5 feet (1.5 m) per each additional level of experience. Sensitivity to psionic and magic powers being *used* is 400 feet (121 m)+50 feet (15 m) per level of experience. Roll percentile dice every 1000 feet (305 m) to see if the hunter is still on the trail. A failed roll means the scent is lost.

I.S.P.: None, automatic ability.

2. Recognize Psychic Scent: It is also possible for the Dog Boy to recognize the *psychic scent* of specific races/monsters, and even specific individuals well known to the Psi-Hound.

A *psychic scent* is the particular signature that emanates from the psychic, practitioner of magic or supernatural being every time they use their psionic powers or cast magic. The emanation from each individual is unique and distinct, like a psychic fingerprint. Unfortunately, the Psi-Hound’s ability to sense and recognize these psychic signatures is less developed than the Psi-Stalker’s. Still, the mutant canines *may* recognize the general type of creature (human, Burstler, Simvan, Psi-Stalker, etc.), and even the psi-scent of specific individuals that the Psi-Hound has encountered on numerous occasions and knows well.

Base Skill: 10% +4% per additional level of experience to recognize the *psychic scent* of general races. Also see number three, *Sense Supernatural Beings*).

8% +2% per additional level of experience to recognize a specific individual. +10% bonus if the mutant has a bit of hair, skin, blood, or an article of recently worn clothing (4 hours or less). The ability to follow the psychic trail gets a bonus of +10% if it is somebody the character knows well.

Range: 50 feet (15 m) +5 feet (1.5 m) per level of experience.

Duration: Automatic and constant.

I.S.P.: None, automatic ability.

3. Sense Supernatural Beings: Identical in basic function and principle to the ability, *Sense Psychic and Magic Energy*, described in number one, above, except the mutant dog is much more sensitive to the very distinctive psychic scent of the supernatural.

Base Skill: 62% +2% per level of experience to identify the specific type/race of paranormal creature and includes alien intelligences, gods, demigods, demons, vampires, and dragons. This ability can also detect whether a person is possessed by supernatural beings.

Base Skill at tracking by this scent: 35% +5% per level of experience. 70% +3% per level of experience *if* the supernatural being is also using psionics or magic.

Range: Sensitivity to the presence of a supernatural being who is not using its powers is 100 feet (30.5 m) per level of experience. Sensitivity to the supernatural creatures or magic being used is 1000 feet (305 m) +100 feet (30.5 m) per additional level of experience. **Duration:** Automatic and constant. **I.S.P.:** None, automatic. **Note:** Close proximity to ley lines and nexus points disrupts the psychic senses.

4. Other Psionic Powers: The Dog Pack character automatically gets the following *psychic sensitive* powers: Sense evil, sense magic, sixth sense, and empathy (receiver only, not transmission), plus the choice of one additional sensitive power.

5. Psi-Bonuses: Dog Boys are effectively master psionics with special psionic sensitivity as described above and below. This means the Psi-Hound needs to roll a 10 or higher to save versus psionic attack and enjoys a bonus of +1 to save vs psionic attack and all forms of mind control. **I.S.P.:** To determine the character’s initial amount of Inner Strength Points, take the number of M.E. as the base, roll 1D6×10 and add it to the base number. The character gets another 10 I.S.P. for each additional level of experience. Considered a master psionic. I.S.P. is regained at the rate of two per hour of activity, or 12 per hour of meditation or sleep!

6. Physical Bonuses: All Dog Boys, regardless of breed, get the following bonus rolls and attribute modifications. +2 on initiative roll, +1 to strike, parry, and dodge, +2 to save vs disease, +2 to save vs possession, +1D4 to P.E. attribute, 1D4 to P.S. attribute, +2D6 to speed attribute. Also see *Optional Character Tables* and *notes on different breeds* for possible additional bonuses and considerations.

The physical endurance of the Dog Boys is twice that of the average human when it comes to resisting fatigue and lifting weight. Mutant canines with a P.S. under 17 can *carry* 20 times their P.S. in pounds; those with a P.S. of 17 or higher can carry 40 times their P.S. in pounds. In all cases, characters can *lift* twice as much as they can carry. The typical Dog Boy can work or play at an intense but even pace for two hours before he starts to feel the serious effects of fatigue (humans tire in an

BREAU



hour). Extremely exhausting tasks such as running full tilt without pause or fierce hand to hand combat can be done for a full 40 minutes before the mutant canine becomes exhausted. Exhaustion penalties are the same as humans (-2 on Spd., -2 on initiative, -2 to damage and -1 to strike, parry and dodge; double the penalties for each additional 15 minutes without appropriate rest). However, Dog Boys and most mutant animals recover in about 15 minutes of rest or light work (half the time a human needs).

7. Superior sense of smell. The olfactory ability of mutant dogs is as superior to humans as their four legged cousins —roughly one million times better than a normal human. The Dog Boy can follow a scent trail that is four days old (provided it hasn't been washed away) and recognize an odor from smelling only a few molecules! This is possible because the canine olfactory center is constructed differently than humans and is 40 times larger and more sensitive. For example, a human has roughly five million sensory cells in the olfactory membrane, while a Dachshund has 125 million, most Terriers around 150 million and a German Shepherd 220 million! Thus, the average Dog Boy can smell odors (that aren't sealed in airtight containers) up to 12 inches (0.3 m) underground and up to two feet (0.6 m) under snow. Those bred from "hounds," especially bloodhounds, are particularly expert in recognizing and following scents.

A trained tracker can identify and follow the "scent image" of specific individuals from their sweat (every individual human's sweat — and most D-bees' — is unique to him, like a fingerprint). Their olfac-

tory senses are so great and they have become so expert in tracking by scent that the canine mutant (and ordinary hounds) can deduct from the evaporation of the sweat and various other ingredients of the smell, which scents are freshest, what direction they are leading and even let the Dog Boy guess which way the person may have gone when the trail breaks or runs cold. The wet nose actually helps in smelling by dissolving molecules floating in the air, bringing them into contact with the olfactory membrane and cleaning old smells away.

Common and strong scents: Recognize and accurately identify general/common/known smells, including gases, food, animals, and the path used by a group of humans, mutant animals, D-bees or monsters, as well as other strong and/or distinctive odors.

Base Skill: 70% +3% per level of experience.

Range: 100 feet (30.5 m) per level of experience.

Identify specific odors: Including the scent of specific individuals (specific characters), poisons or drugs mixed into food or drink, unique and usual scents. The Dog Boy must be familiar with the target subject and/or have a piece of clothing, hair, blood, etc., that the tracker can use as a reference.

Base Skill: 54% +2% per level of experience.

Range: 25 feet (7.6 m) per level of experience.

Track by smell alone! This means the mutant canine relies entirely on his sense of smell (if blinded, he cannot follow physical tracks/footprints or any other visible trail). This also means that a Psi-Hound can sniff his way through total darkness if there is a scent that can be fol-

lowed, and the character suffers only *half* the normal penalties to strike, parry, and dodge when blinded or in total darkness. When combined with the Dog Boy's superior sense of hearing and ability to *sense* magic and psychic energy and the supernatural, this formidable hunter can usually put together an incredibly accurate picture of who or what it is tracking and just how near or far it may be.

Base Skill: 40% +4% per level of experience.

A few notes about tracking by scent: In most cases, the Dog Boy character should roll once for every 1000 feet (305 m) to see if he or she stays on the trail (half that distance if the scent is unusually light or if the trail is covered in light rain or snow). A failed roll means the trail has been temporarily lost. Two successful rolls out of three tries means the trail has been rediscovered. Two failures means the trail is lost. **Note:** The Psi-Hound can smell a scent that is as much as four days old (96 hours), as long as the trail has not been washed away. Can *NOT* track through water, nor smell Astral Beings, Ghosts or energy beings, although he can probably "sense" their presence and general locale if nearby. Also, despite what many people may think, a dog can *NOT* see any better in the dark than humans. However, their exceptional sense of smell and keen hearing helps compensate for their lack of night sight.

8. Keen Sense of Hearing. Dogs and Dog Boys alike, have exceptional hearing compared to humans and even cats and many other animals. The mutant canines can hear into a higher range of sound and can register sounds of 35,000 vibrations per second compared to 20,000 in humans and 25,000 in cats. Additionally, their large ears work like external sound receivers that can prick up and swivel to focus in on the sound of the noise (thanks to 17 ear muscles). They can also shut off their inner ear to filter the general din of noise to zero in on the sound they want to concentrate on.

9. Good Sight. The field of vision in short-nosed canines (like boxers and terriers) is 200 degrees, in long-nosed breeds (like the German Shepherd and hounds) 270 degrees; compared to the human's 100 degrees. Dog Boys see color in a similar range as humans, but the colors are a bit dulled. Farsightedness and other eye problems common to humans are a rarity in Dog Boys.

10. Sense of Taste and Biting. Dog Boys have only a fair to good sense of taste. This is probably a blessing of evolution for true dogs because they are both carnivores who eat what they catch (usually on the run) and scavengers who eat old and decaying food of all kinds.

The bite of a Dog Boy will vary with the breed (see specific bonuses in the section about various breeds). A typical nipping or warning bite from most breeds (including German Shepherd and most setters and pointers) typically inflicts 1D6 S.D.C. damage, while a full strength bite does 2D6 damage — more in some of the larger or more powerful breeds, including wolf, coyote, Wolfhound, Rottweiler and Pit Bulls. **Note:** Dog Boys are discouraged from using biting attacks because the CS is nervous about encouraging such savage and primal action, and because such attacks open the mutant warriors to serious injury to the mouth, throat and head.

11. Sensitivity to Ley Line energy. Ley lines and nexus points impair and even obliterate the Psi-Hound's psychic and supernatural sensing abilities. This means the Dog Boy cannot use these abilities to locate magic or supernatural prey or to sense their appearance when on a ley line or near a nexus. However, the creature's normal physical senses, especially smell, are not affected and the other psychic sensitive abilities are enhanced (as usual). Still, the mutant canines are leery around places of magic and often show uncharacteristic signs of being nervous and on edge. They are afraid (some are terrified) during *Ley Line Storms* which actually cause physical discomfort to Dog Boys — headaches, crackling sounds in the ears, and static electrical build-up/shocks, plus they are two times more likely to be struck by ley line energy and lightning.

Abilities Note: The instincts, attributes and abilities of specific breeds of mutant canines, genetically manipulated and designed for special tasks, may have different stats. See **Canine Special Forces**, the *Sea Dog* and *Kill Hound* in particular.

Dog Boy R.C.C.

R.C.C. Requirements: None, other than must be an intelligent, loyal and obedient mutant dog to be a CS operative. All substandard creations (physically or mentally) never reach full maturity; they are destroyed.

Player Character Note: Player characters who are *not* CS agents (spy, infiltrator, on reconnaissance, etc.) must either be "feral" renegades (runaway mutants/deserters) or the offspring of runaway mutants. In the first case, they are considered dangerous traitors in need of termination. In the latter case, the mutant is considered to be a hopelessly corrupt and dangerous "feral free born" and is also destroyed whenever encountered. Mutant canines who may have been created by Doctor Bradford as part of some experiment and then secretly released, will either be considered one of the above and destroyed (stories about being released from Lone Star are not believed), or seen as inhuman D-bees and destroyed! Remember, all nonhumans are considered invaders and enemies of the Coalition States.

Alignments: Any, but most lean toward good, unprincipled or aberrant evil. Characters who are anarchist, miscreant, or diabolic, tend to be loners, mean, and do not work well in a group unless they can be the leader.

Average Attribute Range (Standard Dog Boy): I.Q. 3D6, M.E. 3D6, M.A. 3D6, P.S. 3D6, P.P. 3D6, P.E. 3D6, P.B. 3D6, Spd 3D6 running — 1D6 digging.

Hit Points: Standard: P.E. attribute number plus 1D6 per level of experience.

S.D.C.: 20 plus those gained from physical skills; some breeds may get S.D.C. bonuses.

Average Weight: Varies according to the breed. Average weight is around 140 to 180 lbs (63 to 81 kg).

Average Height: Varies with the breed, with an average height of around 5-6 feet (1.5 to 1.8 m); the smallest is four feet (1.2 m), the largest seven (2.1 m); these two extremes tend to be unusual (less than 15%).

General Physical Appearance: Human looks, none, other than being bipedal and having two arms and legs. 85% have human legs while 15% have canine-like (or Wolfen) legs; the latter being part of a genetic experiment in variations of physiology. The head/face is that of a canine, the body is fur covered, and there is a tail. Hands: Fully articulated fur covered hands with human-like opposable thumbs, although most have long canine fingernails. Bipedal stance that enables the mutant canines to stand erect and walk and run the same as humans, although some are partial to running on all fours, in a loping movement.

Human Speech: Partial to full. Speech is a bit guttural and the character still has a tendency to growl, whimper, and howl when excited.

Average Life Span: 32-45 years; add 10 years to females.

Natural Abilities: See special abilities above.

Magic: None. Even most "feral" and "free born" Dog Boys tend to distrust and avoid magic and magic items, including weapons.

Average P.P.E.: Most of the individual's P.P.E. has been expended in the development of psychic abilities. The remaining *Permanent P.P.E.* Base is 3D6.

Psionics: See Special Abilities above.

R.C.C. Skills of a Coalition Dog Boy: With rare exception, all mutant canines, even mercs and nomads, began life as a Coalition Dog Boy, created, conditioned, and trained as a Coalition soldier. The following military skills are part of *most* Psi-Hounds.

Speaks American and Dragonese at 90% efficiency.

Intelligence (+6%)

Radio Basic (+10%)

Pilot Hovercraft (+10%)

Read Sensory Equipment (+10%)

Weapon Systems (+10%)

Climbing (+10%)

Running
 Land Navigation (+10%)
 Wilderness Survival (+10%)
 W.P. Energy Pistol
 W.P. Energy Rifle
 W.P. one of choice
 Hand to Hand: Martial Arts

R.C.C. Related Skills: At first level the Dog Boy can select five “other” skills, plus one skill at levels 3, 6, 9 and 12. **Note:** Dog Boys in the service of the CS are never taught to read, not even officers.

Communications: Any (+5%)
 Domestic: Any (+5%)
 Electrical: Basic Electronics only.
 Espionage: Any (+5%)
 Mechanical: Basic Mechanics and Automotive only (+5%).
 Medical: First Aid only (+5%)
 Military: Any (+10%)
 Physical: Any, except acrobatics and boxing.
 Pilot: Motorcycle, hovercylce, jet pack, truck and motorboat only (+5%).
 Pilot Related: Any
 Rogue: None
 Science: None
 Technical: Any (+5%), except computer operation & programming.
 W.P.: Any
 Wilderness: Any (+5%)

Secondary Skills: The character gets eight secondary skills from the list, excluding those marked “None,” at level one and two additional at levels 2, 4, 8, and 12. These are additional areas of knowledge that do not get the advantage of the bonus listed in parentheses. All secondary skills start at the base skill level.

Standard Equipment for CS Dog Boys: A suit of light (30 M.D.C.) or heavy (50 M.D.C.; standard) Dog Pack DPM Riot armor (full environmental armor is generally reserved for officers, Dog Boy Special Forces and special assignments), a uniform, dress uniform, tinted goggles or nonenvironmental helmet with or without visor, PDD pocket audio recorder, pocket laser distancer, flashlight, pocket mirror, cigarette lighter, 100 ft (30.5 m) of lightweight rope, small hammer, four spikes, 1D6 animal snares, infrared distancing binoculars, portable language translator, survival knife, a pair of vibro-knives or vibro-claws (many also have a vibro-saber or neuro-mace), C-18 laser pistol, a choice of a C-14 “Fire Breather” assault rifle or CP-40 laser rifle both with telescopic sight and nightvision scope, four additional E-clips for the weapon, plus knapsack, backpack, utility belt, air filter, gas mask, and canteen.

Equipment Available Upon Assignment: Hand grenades, smoke grenades, 1D4 signal flares, other types of explosives, heavy weapons, optical enhancements, camera equipment, light vehicle, food rations and non-regulation weapons and armor (mainly for the purpose of disguise and infiltration into enemy territory). The new full environmental DPM-Dead Boy armor (old style) may also be made available to Dog Boy officers and for special assignments.

Money: The Dog Pack soldier gets a roof over his head, access to military facilities, food, clothing, medical treatment, basic supplies and equipment, and all other basic needs provided in exchange for his or her loyalty and lifetime of service to the CS. The Dog Boy’s quarters is a nice dormitory arrangement shared by eight mutants, divided into pairs. Each pair of roommates get a bedroom/study complete with CD stereo system, television and VCD, mini-refrigerator, desk, dresser, and comfortable bed.

A modest monthly salary of 200-300 credits is also provided to Dog Pack soldiers and 700 a month to officers. Player characters start off with two months pay.

Cybernetics: None to start and most mutant canines would prefer to avoid them. However, the CS has experimented with bionic limbs

(especially weapon hands/arms and weapon systems), M.O.M. implants, as well as implants and prosthetics necessary for medical purposes.

Identification Coding (I.C.): All *official* Dog Boys and animal experiments are “tagged” with a dual identification system similar to the one used to I.C. psychics living in the Coalition States. A postage stamp sized bar-code is tattooed behind the ear or at the base of the jaw. In addition, a scannable I.C. chip is implanted in the skin, usually at the base of the skull. The implant provides scannable information and also serves as a tracking device (one mile/1.6 km range). Both the bar code and the implant shows the creature’s place of creation, class, date of birth, and similar basic data. Additional bar-codes and implants can be placed on the animal to indicate its history, offenses, problems, and experiments to which it has been subjected.

Implants have also been used to influence, track and control other types of mutant creations. All “officially” sanctioned genetic creations/experiments must be recorded, tagged and documented. Each and every Dog Boy ever made (or born) is registered and has a detailed data file that follows the mutants wherever they go (unless they “go feral”). Illegal mutants do NOT have these identification and tracking features so they can’t be traced back to Lone Star.

Note: A Dog Boy who has gone AWOL and is not hunted down and terminated within a week, is generally left alone unless he or she takes direct action against the CS. Those who act or conspire against the Coalition States (including openly associating with nonhumans, learning to read, teaching others, speaking against the CS even if it’s a true or historical fact denied by the CS, and so on) are considered hostile renegades and are hunted down and destroyed without hesitation or regret! Loyal Dog Boys view deserters as traitors to the human race and as such, are low-life-scum, never to be trusted nor treated with respect.

Typical Dog Boy Missions:

- City: ISS Duty, including Net-Set and Psi-Net.
- Field: Reconnaissance
- Field: Wilderness Scout
- Field: Tracking/Hunting/Assassination/Sabotage
- Field: Seek and Destroy
- Field: Rescue
- Field: Escort
- Field: Anti-Magic & Supernatural — Seek & Destroy
- Field: Identification & Verification (via scent to identify D-bees, magic, psionics, and the supernatural)
- Field: Guard Duty
- Field: Infantry
- Field: Special Forces (15%)
- Other: Typically as an assistant to military personal (5%)

Typical Tours of Duty/Stations: ISS Duty, Frontline/Infantry, Wilderness Posts and Exploration.

Maximum Rank: Noncommissioned officer: Warrant Officer, but few exceed the rank of Sergeant Major. Dog Boys *never* command human troops.



Optional Dog Boy Character Tables

The following are optional rules one can use to determine the specific size, breed, and any special bonuses or abilities of their Dog Boy. Either select one from each category or randomly roll using percentile dice.

Dog Boy's Height

- 01-10 Four feet (1.2 m)
- 11-30 Five feet (1.5 m)
- 31-50 Five feet, six inches (1.7 m)
- 51-65 Five feet, 10 inches (1.78 m)
- 66-80 Six feet (1.8 m)
- 81-90 Six feet, four inches (1.9 m)
- 91-00 Six feet, eight inches (2 m)

Type/Breed of Dog

Below are some of the most common and interesting breeds of dog used by the Coalition States for the creation of Dog Boys.

01-05 Irish Water Spaniel. Good tracker, excellent swimmer (base skill 90%); has a coat of fur that's almost totally waterproof.

06-10 Wolfhound. Tracks by sight, not scent; -40% to track by smell, but add 30 to S.D.C., 1D4 to P.E. and P.S. attributes, +3D6 to spd attribute, and +2 on initiative. Bite does +2D6 damage.

11-15 Irish or English Setters. Good tracker, add 2D6 S.D.C. and +1 to P.E. attribute, and fair swimmer (55%).

16-20 Coonhound. Originally bred to hunt raccoons; a superior sniffer, +2% to track by smell.

21-25 Golden Retriever. Good tracker, hardy, add +3D6 S.D.C., add +1 to P.S. and P.E. attributes; natural swimmer: base skill 80%.

26-30 Cocker Spaniel. Excellent tracker: +4% to track by smell, hardy, add +2D6 S.D.C., and an excellent swimmer: base skill 80%.

31-35 Airedale Terrier. Very good tracker, +2% to track by smell, excellent hunter, alert and aggressive; +1 on initiative, add 10 to S.D.C., fair swimmer: base skill 40%.

36-40 Beagle or Foxhound. Excellent trackers: +6% to all tracking by smell skills, but reduce average size by 10% (never taller than 4 ft/1.2 m), and its bite does 1D4 on a nip and 2D4 on a full strength bite.

41-50 German Shepherd (aka: Alsatian). Good tracker, alert, highly intelligent and loyal. Add 1D6 to I.Q., P.E., and Spd attributes, plus add 15 to S.D.C. and +1 on initiative. Good swimmer (60%). Note: Loves to help/work with humans and has a friendly disposition. Extremely loyal.

51-55 Bloodhound. The super-scent tracker; +12% to all scent abilities, +1D6 to S.D.C., fair swimmer (45%).

56-60 Boxer. A very good tracker: +4% to all track by smell skills; stocky but powerful, with a strong neck and powerful leg and back muscles, capable of jumping great distances. Mutant Boxers can leap 15 feet (4.6 m) high or long after a short running start. Add +1 to I.Q. attribute, +1D4 to P.E. and P.S. attributes, and +20 to S.D.C. The creature's bite is also more powerful than most, inflicting 2D4 on a nip and 3D6 S.D.C. damage on a full strength bite.

61-65 Bull Terrier/Pit Bull. Reduce size by 10% (never taller than 5 ft/1.5 m), but add +2D6 to P.E. attribute, add 2D4 to P.S. attribute and add 40 to S.D.C.! Bite inflicts 2D6 S.D.C. damage from a nip and 4D6 from a full strength bite. -30 to track by smell; only a fair tracker.

66-70 American Water Spaniel or Setter. Very good tracker: +2 to track by smell; very good swimmer (70%); and add +1D6 S.D.C. to the Spaniel and 2D6 to the Setter; good natured and loyal, but tend to show an independent spirit.

71-75 Elkhound or Malamute. Good tracker, also big and powerful; add 20 to S.D.C., +1D4 to P.S. and P.E. attributes, +2 on initiative, 3D6 to Spd attribute and +1D6 to bite. Elkhounds are typically 1D6+1 inches above six feet (1.8+ m)

76-80 Lakeland Terrier. Reduce size by 10% (rarely taller than 4 ft/1.2 m), but tough and aggressive, +2 initiative, +1 to strike, add 2D6 to S.D.C., fair swimmer (40%).

81-85 Greyhound. Tracks by sight, not scent (equal to the human sight tracking skill of 74%); -40% to track by smell penalty. Add 1D4x10 to spd attribute, +1D4 to initiative and +1D4 to P.E. attribute.

86-90 Bull Dog and Bullmastiff. Poor trackers, -30% to track by smell penalty, but tough and powerfully built. Add 20 S.D.C., +1D6 to P.S. and P.E. attributes. Reduce spd attribute by 1D4 points. Add 1D6 damage to the bite of the Bullmastiff.

91-95 Rottweiler or Doberman. A fair tracker by smell (-5%), but powerfully built and ideal for outdoors work and as a guard dog. Add +1 to I.Q. attribute, +1D6 to P.S. and P.E. attributes, +2D6 to spd attribute and +20 to S.D.C. Works well with humans and is very clever and loyal.

96-00 Wolf. A good tracker and powerfully built; add 30 S.D.C., add +1D6 to P.S. attribute, 2D4 to P.E. attribute, 3D6 to spd attribute, and +2 on initiative. Bite does 2D6 damage from a nip and 4D6 from a full strength bite.

Note: Mutant wolves and wild canines are not a regular part of the Psi-Hound forces, except for a tiny handful of *experimental* mutant wolves, coyotes, and breeds of domestic dogs mixed with wolves. Pure breeds are sometimes used in other experiments but they are just too aggressive, dominant, unpredictable and will challenge authority, human or otherwise. Wolves and most wild canines do not show humans or

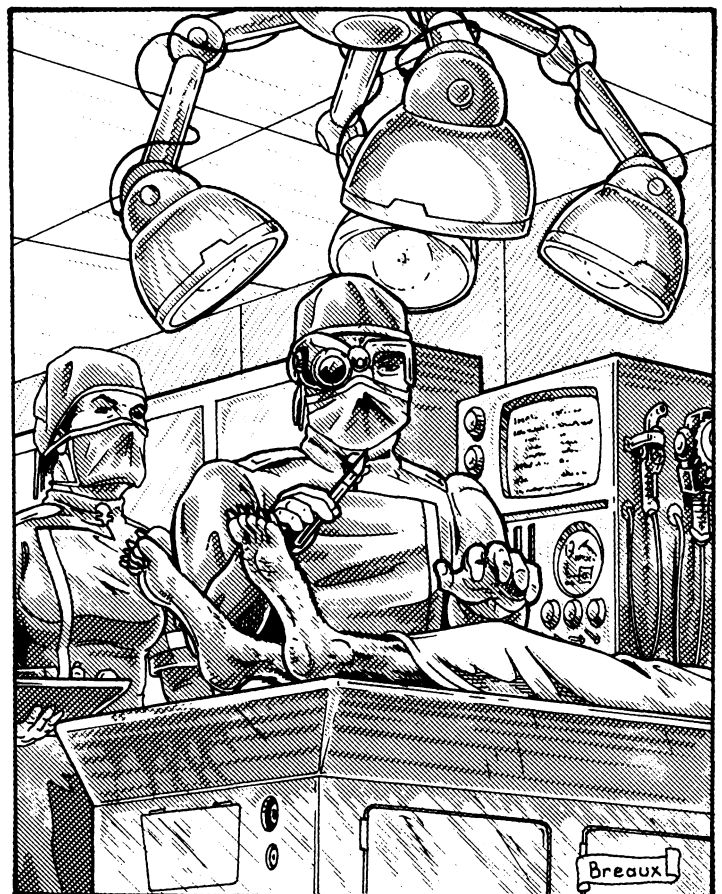

any other race the same reverence and loyalty Dog Boys exhibit, and will challenge a weak or injured leader (often forcing the character to leave the group or die) in order to seize the dominant position/take leadership for itself.

Mutation Abnormality

This optional table has been slightly adjusted and changed from the table that appeared in the **Rifts® RPG**, with additional abnormalities and details.

01-15 Unusually small. Three feet, four inches tall (one meter), about 45 lbs (20 kg); add bonus of +5% to prowl and climbing skills if applicable.

16-30 Unusually large. Seven feet, three inches tall (2.2 meters), 400 lbs (180 kg); add a bonus of 2D6+10 to physical S.D.C. and +2 to P.S. attribute.

31-35 Nearly a full human appearance, large pug nose, minimal to no body hair, excellent color vision, and full human speech. Reduce scent skill abilities 25%.

36-40 Exceptional sense of direction and balance; +20% to land navigation skill, +10% to wilderness survival and +5% to gymnastic skills.

41-45 Heightened (even for a canine) sense of smell with a unique focus on disease. +10% to track by scent and recognize scent, plus can smell (and sense?) chemical changes in the body of humans and fellow canines (not D-bees) to identify and locate cancer cells and malignant tumors, as well as the diseases of epilepsy, diabetes and brain damage (birth defects and physical trauma). Also has the psionic ability to perform psychic diagnosis. May be recruited to the Dog Boy “Sniffer” Special Forces.

46-50 Ambidextrous: Can use both the right and left hand with equal skill and dexterity; paired weapon skill is automatic. Add one additional attack per melee, +10% to climbing skill, +5% to pick locks, pick pockets, palming, and concealment skills.

51-60 Tough, thick or scaly skin, adds 30 to S.D.C.

61-65 Keen 20/20, color vision, alert and observant; +1 on initiative.

66-70 Rat catcher, +10% to tracking and prowling skills, +2 on initiative and +4 to damage when hunting rats and rodent like creatures, including rodent-like D-bees.

71-75 Super-predator! Built like a rock: +3D6 to hit points, +16 to S.D.C., plus one additional attack per melee round, +1D6 S.D.C. damage to punches, kicks and bites, and +6 to save vs horror factor, but mean tempered, quick to brawl (loves combat), and is incredibly aggressive, strong willed, defiant and independent.

76-80 Long, thick fur with unusual hair color; stark white, light green, bright red, grayish blue, metallic silver, etc. (pick one color); water resistant and provides exceptional insulation that keeps the mutant canine warm up to 30 degrees below zero (without additional clothing or armor), but hot and uncomfortable when exposed to temperatures above 72 degrees Fahrenheit.

81-85 Supernatural endurance; can lift and carry 100 times their P.S. attribute number and rarely fatigues (can be active for six hours without tiring) and is +3 to save vs poison, drugs and disease.

86-90 Additional psionics, choose one more psychic sensitive powers and add 2D6 to I.S.P.

91-95 Great psionic power, choose three additional psychic sensitive powers and add 2D6+6 to I.S.P.

96-00 Recessive gene fluke; instead of psychic sensitive powers, the mutant has *no* sensitive powers (including sense supernatural, sense magic and sense/track by psychic scent)! The character may select seven *physical* psionic powers or one super psionic power and three physical.

“Feral” Dog Boys

A Note about Runaways. Runaways are said to have “gone feral.” The term, “feral,” as used by the CS, means the mutants have become wild, uncontrollable and rebellious against the Coalition States, its people and all the CS represents. The term is used broadly and can refer to murderers who genuinely become violent and deranged, but more typically refers to animals who have simply forsaken the Coalition and its teachings, and have run away to live free in the wilderness. Feral renegades are considered *extremely dangerous TRAITORS!* After all, they are inhuman monsters created by the CS, trained as soldiers, and know a good deal about CS military operations, especially those involving Psi-Hounds and other mutants. Perhaps even more important, these lowly animals have dared to defy and/or betray their masters (the very act of desertion is both an act of defiance and betrayal); it is an act that cannot be tolerated.

Animals “gone feral” are hunted down and destroyed with a sense of urgency and crisis. Ironically, fellow Dog Boys and Psi-Stalkers are usually given the task of locating and terminating these rogues. As wild, dangerous “animals,” they are hunted and destroyed on the spot, along with any clansmen, mate or young (unless infants). There is no need for capture, trial and sentencing because Dog Boys have *no* “human” rights. They are animals. Anybody who helps or associates with the feral rogues are regarded as criminal or subversive allies and also enemies of the State. It is within the power of the Dog Pack hunting squad’s leader to decide whether or not those associated with the renegade did so in ignorance (and may be spared) or as a deliberate act against the Coalition States. If the latter is arbitrarily determined, all associates of the rabid animal are also destroyed without a trial. And when in doubt its best to exterminate; why take chances?

Note: Just because a Dog Boy wanders away from his group or goes missing for a few days, or even a few weeks, does not automatically brand the soldier as a runaway. The CS will listen and often accept stories from loyal Psi-Hounds who claim to have gotten separated from their squad, lost, injured (and forced to find sanctuary until healed), or captured and escaped, especially if the Dog Boy is the one who makes an effort to rejoin the ranks of the CS military. Depending on how plausible the story is, and the animal’s previous record (i.e. no disappearances or behavioral problems in the past) the canine soldier may be accepted back with open arms or placed on probation and watched.

Similarly, exuberant young Dog Boys in training are sometimes lured away or run off in search of adventure, which is a bit different than running away from the Coalition. These scamps are rounded up, dragged back, humiliated in front of the troops, punished (usually KP duty, scrubbing latrines, digging ditches, etc.) and put back into training. However, it is made clear to them that while this *one* incident may be forgiven, future problems will lead to expulsion from the program — which means being experimented upon or terminated!

Feral offspring, commonly known as “Free Born,” are generally considered wild and dangerous freethinkers, contaminated by their traitorous parents — tragic victims of their deranged parents. Creatures to be pitied, because without the guidance and training of the Coalition States, they are lost souls. Free Borns are often shot on sight, especially when in the company of feral renegades (parents or others), but may only be harassed and/or challenged (from staring contests and brawls to fights to the death) when in the company of humans or a mixed group of adventurers and mercenaries.

“Feral” Dog Boys

R.C.C. Notes: All skills and basic equipment will be the same as the standard Dog Boy, as “Feral” Hounds are typically just Psi-Hounds who have deserted from the CS military. Some of the character’s later skill selections, armor and equipment may reflect the Dog Boy’s new lifestyle, but that’s all — the character is still a Dog Boy, just a runaway Dog Boy (and a hunted criminal).

Feral Offspring — “Free Borns”

Free Borns are effectively Dog Boys, with all the same basic alignments, attributes, appearance, Psi-Hound abilities, and stats. The main difference is that they have not gone through the CS training and weeding out program, so some Free Borns may be more aggressive and independent than the typical CS Dog Boy, have certain physical or mental defects (a rarity), and a bit more distinctive personality, complete with quirks and habits.

Some will be taught to fear or hate Coalition Soldiers, including (or especially) Dog Boys, although most still retain a high regard and respect for humans and a dedication to friends, and a personal sense of honor, duty and goals. Most will become adventurers, explorers and mercenaries.

Others may actually regard the CS with respect and admiration, either as a worthy enemy or as a lost opportunity, wishing that they were part of its greatness and their people (the CS Psi-Hounds). Some may even resent their parents for running away from the CS and betraying their heritage (and the CS). These uncommon and unusual “wannabes” may eventually become spies or serve in mercenary forces that sometimes work for the CS military or Coalition allies, but that’s as close as they can get to the CS. The Coalition military *never* accepts feral renegades or their offspring into their ranks. Only infants under the age of 16 weeks may be considered for adoption into the Dog Boy Corps.

Basic Stats: Same as the traditional CS Dog Boy trooper.

Typical Free Born O.C.C.s: Males tend toward Wilderness Scouts, Spies, Headhunters, Mercenary warriors/soldiers/grunts, City Rats (in the Burbs and independent kingdoms), Vagabonds, and ... well, *Dog Boys*. A full 50% learn the same fundamental Dog Boy soldiering skills/R.C.C. as their parents or forefathers, only they are trained by a parent, grandfather, uncle, friend or mercenary. Rumor has it that Lord Coake has accepted three Free Born Dog Boys into training to become *Cyber-Knights*. **Females** tend toward the occupations of scout, vagabond, rogue scholar, rogue scientist and the occasional body fixer or operator. Most mutant canines, male and females, have an innate distaste for magic and avoid the mystic O.C.C.s. Likewise, most mutant canines avoid Juicer, M.O.M. and bionic augmentation. When cybernetic prosthetics become a necessity, most Dog Boys prefer *bio-systems* over the mechanical.

R.C.C. Skills of a Free Born Dog Boy: Varies with the occupation that is selected (see tendencies above).

R.C.C. Related Skills: Varies with the occupation that is selected (see tendencies above).

Secondary Skills: Regardless of the O.C.C. selected by the Free Born, these characters get eight secondary skills, excluding those marked “None” in their chosen area of endeavor at level one and two additional at levels 2, 4, 8, 10 and 12. These are additional areas of knowledge that do not get the advantage of the bonus listed in parentheses. All secondary skills start at the base skill level.

Standard Equipment: Varies dramatically with the wealth and resources of the Free Born’s family. Typically very little: A set of clothes, boots, perhaps a light suit of M.D.C. armor or DPM armor, backpack, sleeping bag, a couple of sacks, utility/ammo-belt, sunglasses or tinted goggles, air filter or gas mask, and personal items. Weapons will include one vibro-blade (Dog Boys love these weapons), and two other weapons of choice. No vehicle; the character walks and runs to get where he’s going, which mutant canines don’t mind doing.

Money: The character starts out with no credits, but has 4D6×1000 in sellable black market items.

Cybernetics: Starts with none. Tend to avoid implants in favor of natural abilities. If cybernetics are used, they are usually limited to sensory or optical enhancements and necessary medical systems.

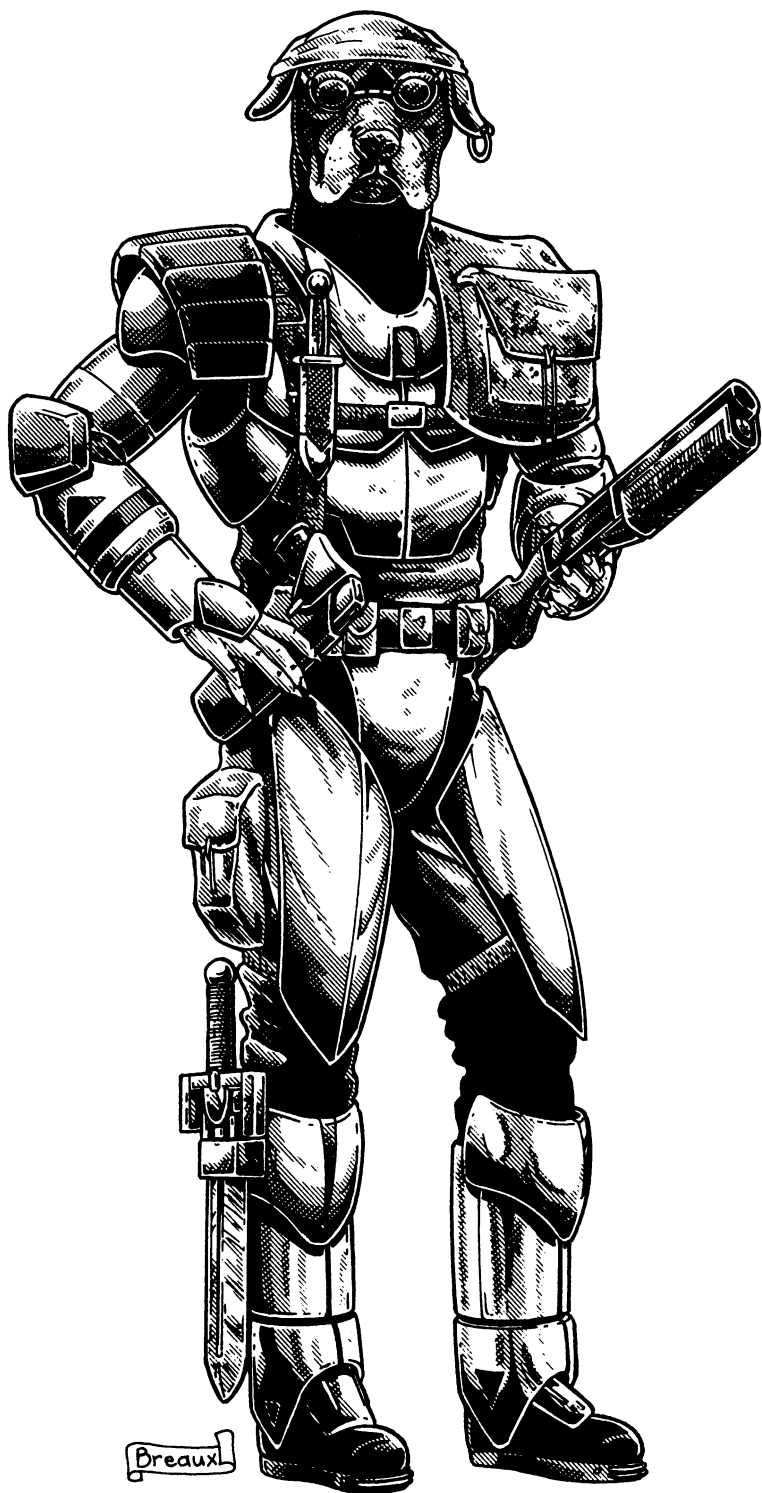

Adventurer who is no longer a member of the CS Dog Pack:

May or may not wear clothing or mega-damage body armor (may be Coalition armor or other types to avoid friendly fire). Other typical equipment includes backpack, sleeping bag, a couple of sacks, utility/ammo-belt, sunglasses or tinted goggles, air filter or gas mask, and personal items. Weapons will include vibro-blades (Dog Boys love these weapons), neuro-mace, and two other weapons of choice. May use techno-wizardry weapons too, but most Psi-Hounds tend to avoid magic and magic items. Vehicles may be military or nonmilitary, and may include hover vehicles, jet pack, or souped-up motorcycles or cars. No power armor or robots.

Dog Boy

Special Forces R.C.C.s

The Dog Boy Special Forces use particular breeds selected for specialized work and abilities that differ from the average Dog Boy. Most are very similar to the typical Dog Boy in their basic appearance, indoctrination and training, only the specific details (specialties) of the *breed* and *skills* differ.

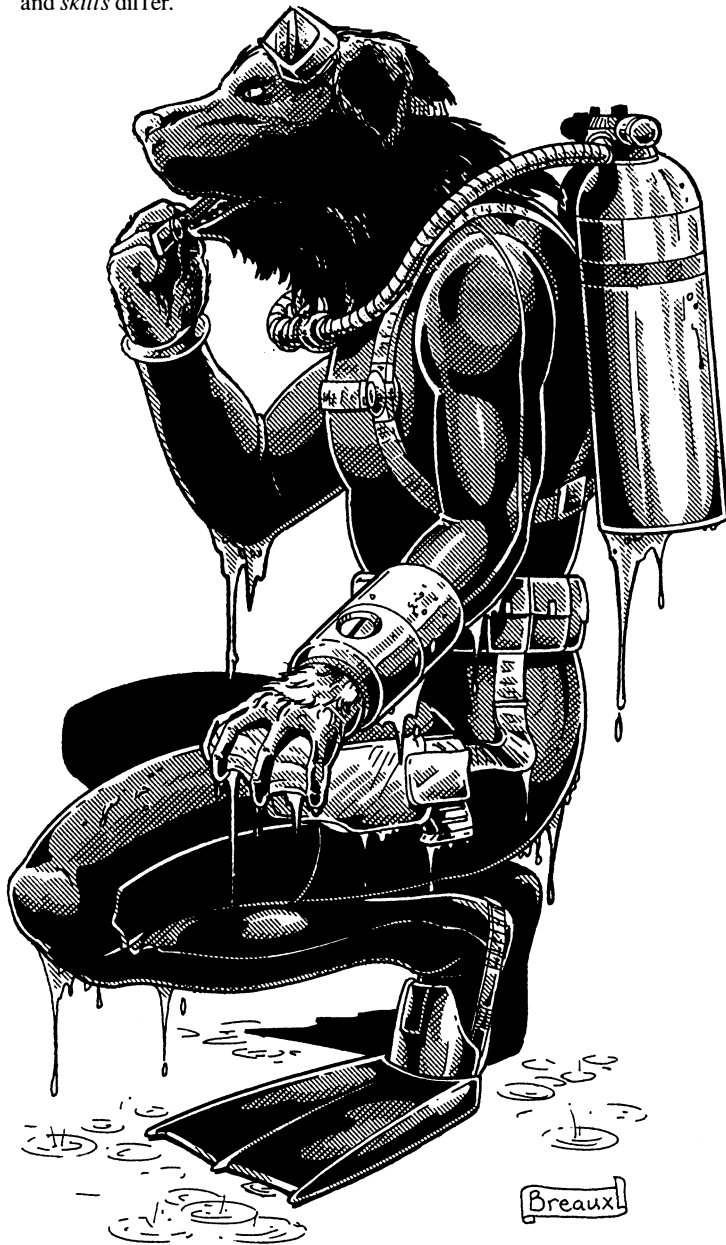

Navy “Sea Dogs”

The Newfoundland canine has been genetically engineered into a humanoid Dog Boy for use primarily in the Coalition Navy. The Newfoundland was chosen because of its love for water, its swimming aptitude, endurance and incredible work ethics — it is one of the hardest working and loyal Dog Boys ever developed. At the same time, it is a gentle, friendly creature with an even disposition and a love for humans, particularly children. Before the Great Cataclysm, the web-footed ca-

nine was a favorite companion of sailors and an outstanding sea-rescue dog — some pre-Rifts historians credit the Vikings for the original breed of dog (it was also used as a draught animal in early times).

The mutant version of this animal has all the dog’s best qualities combined with the versatility of the human form. Sea Dogs are superb, natural swimmers who take to the water with amazing strength, grace and ability. They love to swim and are used in sea-rescues, reconnaissance, guard duty, sailing, salvage, and combat. Sea Dogs are loyal, obedient and give of themselves to a fault. They jump to attention and don’t hesitate to come to the aid of a human in distress. Their Psi-Hound abilities to sense the supernatural and magic is a great help in sensing the approach of unnatural storms, the presence of entities, sea monsters and the supernatural.

Although known as “Sea Dogs,” the fledgling Coalition Navy has had minimal experience on the open seas. Most of their action has been on the Great Lakes and, recently, in the Gulf of Mexico. The Newfoundland mutants, with their natural swimming abilities and love of water, are actually better equipped and ready for sailing the oceans than most of the “green,” human sailors. The Sea Dogs’ confidence, skills and enthusiasm has served as a settling and positive influence on the inexperienced human sailors. **Note:** 90% of all Newfoundland Psi-Hounds are specifically created for the navy.

Sea Dog R.C.C.

R.C.C. Requirements: Newfoundland or Newfoundland mixed breed, and loyalty and obedience to humans of the CS.

Player Character Note: Player characters who are *not* CS agents must either be “feral” renegades (runaway mutants/deserters) or the Free Born offspring of runaway mutants; same as the Dog Boy R.C.C.

Alignments: Any, but most Sea Dogs lean toward principled, scrupulous or aberrant. Characters who are anarchist, miscreant, or diabolic alignments tend to be loners and do not work well in a group unless they can be the leader.

Attributes (Newfoundland): I.Q. 3D6, M.E. 3D6+4, M.A. 3D6+6, P.S. 3D6+6, P.P. 3D6, P.E. 3D6+6, P.B. 3D6, Spd 3D6 running or swimming — 1D6 digging. Attribute bonuses noted above are in addition to others listed under the Dog Boy R.C.C. *Special Dog Boy Powers & Abilities.* Do not roll on the optional tables for size or breed; rolling on the *Mutation Abnormality Table* “may” still be an option, check with the G.M.

Hit Points: 10 +P.E. attribute number and 1D6 per level of experience.

S.D.C.: 30 plus those gained from physical skills.

Average Weight: Average weight is around 190 lbs (85.5 kg); mostly muscle.

Average Height: 5 ft, 9 inches to 6 ft, 3 inches (1.7 to 1.82 m).

General Physical Appearance: A thick waist and bulky, solid build.

The fur is coarse, straight, and flat, with an oily, water resistant quality; typically black, chocolate brown or white with black markings (Landseer markings). The eyes are brown, the muzzle short, ears are set back and lay flat. The hands and feet are large and broad with webbing between the fingers and toes for better swimming. Bipedal stance and full human legs; bushy tail.

Human Speech: Partial to full.

Average Life Span: 32-45 years; add 10 years to females.

Natural Abilities: Fundamentally the same as the *Dog Boy R.C.C.*, with the following exceptions: Natural instinctive swimmers who love the water (98% swim skill), can hold breath for 1D4+2 minutes, resistant to cold (half normal damage), and has water resistant fur, but sense of smell and tracking by scent are -20%.

Magic: None.

Average P.P.E.: 3D6

Psionics: See Special Abilities of Dog Boy R.C.C.

R.C.C. Skills of a Coalition Sea Dog:

Speaks American & Spanish at 90% efficiency.

Basic Math (+10%)

Radio: Basic (+10%)

Read Sensory Equipment (+10%)
Paramedic (+15%)
Pilot: Warships and Patrol Boats (+10%)
Pilot: Water Scooters (+10%)
Pilot: Water Skiing and Surfing
Advanced Fishing (+10%)
Track & Hunt Sea Animals (+10%)
S.C.U.B.A.

Climbing
Land Navigation (+10%)
Wilderness Survival (+10%)
W.P. Energy Pistol
W.P. Energy Rifle
W.P. one of choice
Hand to Hand: Expert
Hand to hand: Expert can be changed to martial arts at the cost of one other skill.

R.C.C. Related Skills: At first level the Sea Dog Boy can select five “other” skills, plus one skill at levels 3, 6, 9 and 12. **Note:** Mutant canines in the service of the CS are never taught to read, not even officers. Sea skills can be found on page 210 of *Rifts® Underseas* and again in *Rifts® Sourcebook Four: Coalition Navy*.

Communications: Any (+5%)
Domestic: Any (+10%)
Electrical: Basic Electronics only.
Espionage: Any, except sniper
Mechanical: Basic Mechanics and Automotive only.
Medical: None, other than the R.C.C. skill.
Military: Any (+10%)
Physical: Any, except acrobatics and boxing.
Pilot: Sail and motor boats (but not big ships or submersibles), motorcycle, hovercycle, jet pack, and truck (+5%).
Pilot Related: Any
Rogue: None
Science: None
Technical: Any (+5%), except computer operation & programming.
W.P.: Any
Wilderness: Any (+5%)

Secondary Skills: The character gets four secondary skills from the list, excluding those marked “None,” at level one, and two additional at levels 3, 6, 9, and 12. These are additional areas of knowledge that do not get the advantage of the bonus listed in parentheses. All secondary skills start at the base skill level.

Standard Equipment for CS Dog Boys: Basically the same as the Dog Boy R.C.C., plus a wet suit and diving gear.

Money: Same as the Dog Boy R.C.C. but lives on a boat or a Navy base.

Cybernetics: None to start and most mutant canines would prefer to avoid them. However, the CS has experimented with bionic limbs (especially weapon hands/arms and weapon systems), M.O.M. implants, as well as implants and prosthetics necessary for medical purposes. **Identification Coding (I.C.):** Same as Dog Boys.

K-9 “Sniffers”

K-9 Agents, also known as “Sniffers” and “K-Nines,” are Dog Boys chosen for their excellent scent and tracking abilities, as well as their stamina and intelligence, and given special *scent training*. “Sniffers” are not just hunters but specialists in sniffing out a number of other unique and distinctive scents, including explosives, drugs, (concealed) bionic implants and even cancer, as well as supernatural creatures, psychics, and practitioners of magic.

Bomb and drug sniffing dogs were trained at the old American Empire’s *Lackland Air Force Base*. This base and its data on training methods, techniques and exercises were unearthed and claimed by the CS. A new CS base has been erected on the foundation of the old and is now known as *The Cabot & Dog Boy Training Grounds*. It is at base Cabot where elite, Special Forces Psi-Hound “Sniffers” and “Kill Hounds” are trained — they are also trained at the Lone Star Complex and Chitown.

The human intelligence and canine focus of the K-9 Sniffers has made them all the better equipped for understanding their mission, memorizing scents and recognizing specific smells. They are also excellent manhunters.

K-9 Agents, more commonly known as “Sniffers.”

R.C.C. Requirements: I.Q. 10 or higher, plus a dog breed with an excellent sense of smell; includes German Shepherds, Basenjis, Beagles, Bloodhounds, Wolfhound, Elkhound, other types of hounds and mixed breeds. As always, loyalty and obedience to the humans of the CS is also critical.

Player Character Note: Player characters who are *not* CS agents must either be “feral” renegades (runaway mutants/deserters) or the Free Born offspring of runaway mutants; same as the Dog Boy R.C.C.

Alignments: Any, but most Sniffers lean toward principled, scrupulous or aberrant. Characters who are anarchist, miscreant, or diabolic alignments tend to be loners and do not work well in a group unless they can be the leader.

Attributes (“Sniffers”): I.Q. 3D6+2, M.E. 3D6, M.A. 3D6, P.S. 3D6, P.P. 3D6, P.E. 3D6+4, P.B. 3D6, Spd 3D6 running — 1D6 digging. Attribute bonuses noted above are in addition to others listed under the Dog Boy R.C.C. under *Special Dog Boy Powers & Abilities*. Do not roll on the optional tables for size or breed; rolling on the *Mutation Abnormality Table* “may” still be an option, check with the G.M.

Hit Points: Standard; P.E. attribute number and 1D6 per level of experience.

S.D.C.: 22 plus those gained from physical skills.

Average Weight: Average weight is around 150 lbs (67.5 kg).

Average Height: 5 to 6 ft, 6 inches (1.5 to 1.95 m).

General Physical Appearance: Varies with the breed; typically a long muzzle, and large ears (pointed for the Basenji and Shepherds; large and floppy for most hounds). Mutant hounds are generally tall and lean, but muscular and strong with excellent endurance. The fur is coarse, short, and flat; typically tan, black and tan, grey and tan or tan with white and black markings. The eyes are dark brown to hazel. Bipedal stance and full human legs; long tail.

Human Speech: Partial to full.

Average Life Span: 32-45 years; add 10 years to females.

Natural Abilities: Fundamentally the same as the *Dog Boy R.C.C.*, with the following exceptions: Natural, instinctive hunters with a keen focus on following scents, tracking, hunting, giving chase and pinpointing or catching prey. The mutant dogs are typically the best of the canine scent hounds, intelligent, relentless and cooperative — work well in packs and as a member of a team.

Tracking Bonus: +6% to that breed’s normal olfactory identification and tracking skills.

Specialized Scent Training: Pick *two* areas of expertise.

1. Cancer: The keen olfactory sense of these canine mutants can locate cancerous cells in skin cancer, lung cancer and malignant tumors.

Base Skill: 70% +3% per level of experience in finding and identifying malignant tumors and cancer cells in the brain, muscles, skin and organs. A failed roll means that the tumor or patch of cancer has been missed; roll for each one.

Penalties: -10% when trying to pinpoint cancer in the bones and internal organs such as the lungs, colon, liver, intestines, etc.

Optimum Range: Touch (with nose) to one foot (0.3 m).

Note: Untrained Dog Boys (and ordinary dogs) with a very good to excellent sense of smell *may* also be able to locate tumors and advanced skin cancer, but at only 20% of their usual scent recognition ability.

2. Drugs: The K-9 Agent is trained to recognize, by scent, over four dozen different types of illegal substances, including several synthetic drugs/chemicals, poisons, herbs and alien spores.

Base Skill: 77% +3% per level of experience. Roll once to recognize the unique and special scent of the chemical and again to pinpoint its exact location or to follow a scent trail. This sense of smell is so keen that the K-9 can smell the residue of such drugs and chemicals on the fingers (under the nails and in the pores of the skin) unless the perpetrator has washed thoroughly (and the K-9 will be able to smell the soap or disinfectant).

Penalties: -10% when trying to locate drugs that are concealed and *cannot* smell substances in airtight containers unless there is some chemical residue (even a pinch) on the outside of the container or spilled in the hiding place.

Optimum Range: Touch (with nose) to one foot (0.3 m) per level of experience.

Note: Untrained Dog Boys (and ordinary dogs) with a very good to excellent sense of smell *may* also be able to recognize the smell of various substances, especially those with a strong smell, but at half their usual scent recognition and tracking abilities.

3. Explosives: The K-9 Agent can recognize, by scent, over four dozen different types of explosive compounds, including gunpowder.

Base Skill: 77% +3% per level of experience. Roll once to recognize the unique and special scent of the explosive/chemicals and again to pinpoint its exact location or to follow a scent trail. This sense of smell is so keen that the K-9 can smell the residue of such chemicals on the fingers (under the nails and in the pores of the skin) unless the perpetrator has washed thoroughly (and the K-9 will be able to smell the soap or disinfectant).

Penalties: -10% when trying to locate explosives that are concealed and *cannot* smell substances in air tight containers unless there is some chemical residue (even a pinch) on the outside of the container or spilled in the hiding place.

Optimum Range: Touch (with nose) to one foot (0.3 m) per level of experience.

Note: Untrained Dog Boys (and ordinary dogs) with a very good to excellent sense of smell *may* also be able to recognize the smell of some explosives and locate them, especially those with a strong smell, but at half their usual scent recognition and tracking abilities.

4. Robotics, bionics, & implants: As real looking as artificial cybernetics and bionic prosthetics, parts and implants may be, they are not organic (typically artificial components and synthetic cells) and have a distinct scent. Even *bio-systems* are not quite the same as the original article and can be identified by Sniffers trained to recognize them. K-9's trained in this area of *scent recognition* can pinpoint the exact location of implants and artificial prosthetics and augmentation. Can tell if a character is a partial or full conversion 'Borg in an instant. This skill can be important in ferreting out spies and assassins.

Base Skill: 80% +3% per level of experience in finding and identifying nonorganic cybernetic and bionic augmentation and implants, as well as identifying 'Borgs and 'Bots. A failed roll means that implant or limb has been missed; roll for each item.

Penalties: -40% when trying to pinpoint cybernetic *bio-systems* and other artificial organic replacements and implants (heart, lung, kidney, etc.). -20% when trying to sniff out bio-wizard symbiotic organisms, living parasites, and androids. In addition, the scent becomes less distinct and difficult to smell the further the K-9 is from the subject; -10% for every foot (0.3 m) beyond one.

Optimum Range: Touch (with nose) to one foot (0.3 m).

Note: Untrained Dog Boys (and ordinary dogs) with a very good to excellent sense of smell can also smell the difference between an ordi-

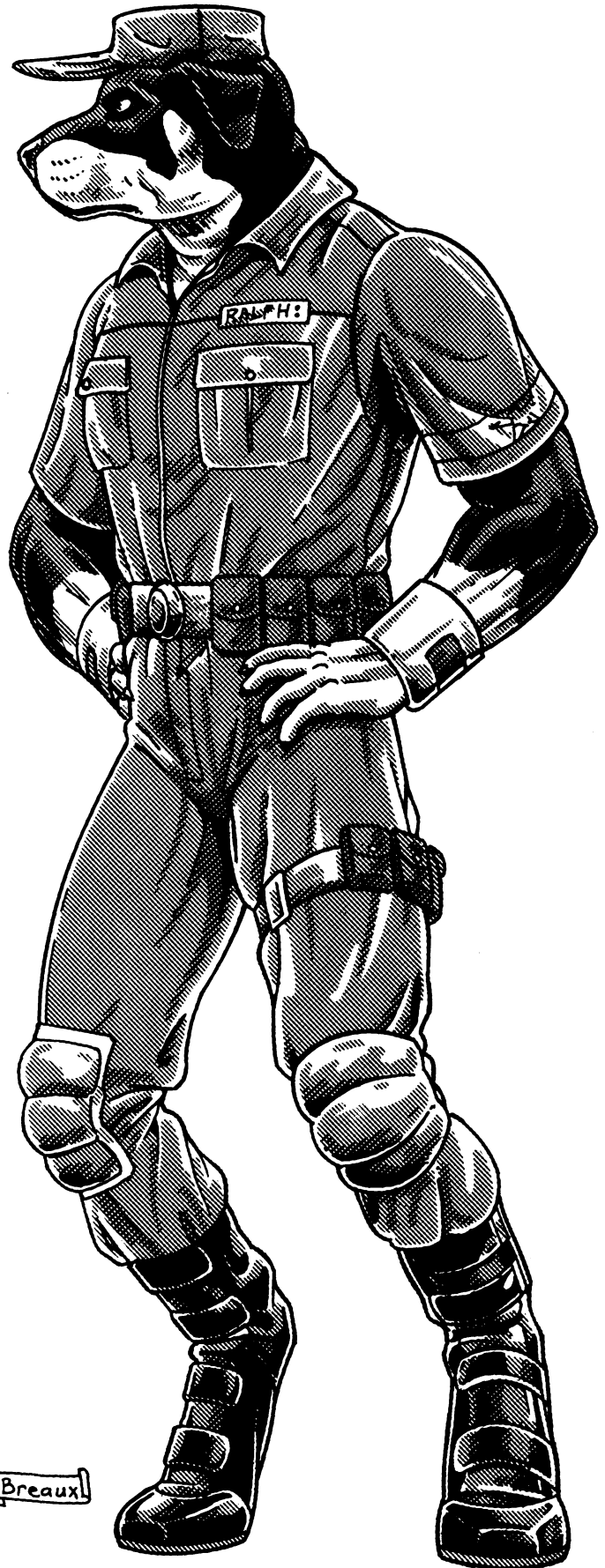

nary human and a full or partial 'Borg, but at half their usual scent recognition ability.

5. Sense Impending Natural Disasters: This is the ability to recognize and sense the approach of thunder and electrical storms, ley line storms, earthquakes and changes in the electromagnetic field as much as 2D4 hours before they occur. The K-9 Sniffer can tell the direction of the disturbance, where it is headed/coming to, approximately when it will arrive/strike (accurate within 6D6 minutes) and whether it will be relatively moderate or severe. The length of the disturbance cannot be determined; not applicable to floods, fire, or famine. Furthermore, the Sniffer can tell whether the disturbance was natural or not — not being induced by magic, the supernatural, or man-made (i.e. the shock waves of a powerful explosion may seem like the tremor of an earthquake to humans, but the K-9 can tell the cause was an explosion, not an earthquake).

Base Skill: 70% +3% per level of experience. A failed roll means that the K-9 may miss the coming of a disturbance entirely or has miscalculated the severity of the disturbance and its time of arrival by 3D6x10 minutes. **Note:** Roll once to sense the danger coming and a second time to estimate when it will hit and the severity.

Penalties: -20% when trying to pinpoint the time and severity of an earthquake. +20% to sense ley line storms when standing on or near a ley line.

Optimum Range: 1D6 hours before the occurrence and can sense the approach of storms up to 600 miles (960 km) away.

Note: Untrained Dog Boys (and ordinary dogs) with a very good to excellent sense of smell can also sense the approach of storms up to 2D4x10 minutes before they arrive, but not earthquakes.

Magic: None.

Average P.P.E.: 4D6

Psionics: See Special Abilities of Dog Boy R.C.C.

R.C.C. Skills of a Coalition Sniffer:

Speaks American and Spanish at 90% efficiency.

Basic Math (+15%)

Radio: Basic (+10%)

Read Sensory Equipment (+10%)

Track (by sight/skill; +15%)

Intelligence (+10%)

Pilot Motorcycle/Hovercycle (+5%)

Climbing

Running

Land Navigation (+20%)

Wilderness Survival (+15%)

W.P. Energy Pistol

W.P. Energy Rifle

W.P. one of choice

Hand to Hand: Expert

Hand to hand: Expert can be changed to martial arts at the cost of one other skill.

R.C.C. Related Skills: At first level the Sniffer can select five “other” skills, plus one skill at levels 3, 6, 9 and 12. **Note:** Mutant canines in the service of the CS are never taught to read, not even officers.

Communications: Any (+5%)

Domestic: Any (+10%)

Electrical: Basic Electronics only.

Espionage: Any, except sniper

Mechanical: Basic Mechanics and Automotive only.

Medical: None, other than the R.C.C. skill.

Military: Any (+10%)

Physical: Any, except acrobatics and boxing.

Pilot: Sail and motor boats (but not big ships or submersibles), motorcycle, hovercycle, jet pack, and truck (+5%).

Pilot Related: Any

Rogue: None

Science: Any, except chemistry.

Technical: Any (+5%), except computer operation & programming.

W.P.: Any

Wilderness: Any (+5%)

Secondary Skills: The character gets six secondary skills from the list, excluding those marked “None,” at level one and two additional at levels 3, 6, 9, and 12. These are additional areas of knowledge that do not get the advantage of the bonus listed in parentheses. All secondary skills start at the base skill level.

Standard Equipment for CS Dog Boys: Basically the same as the Dog Boy R.C.C.

Money: Same as the Dog Boy R.C.C.

Cybernetics: None to start and most mutant canines would prefer to avoid them, except for medical reasons.

Identification Coding (I.C.): Same as Dog Boys.



Kill Hounds

Kill Hounds are one of the GED’s latest variations on mutant canines, introduced in 104 P.A. Kill Hounds are intended to be frontline shock troopers and wilderness hunter-killers of D-bees and monstrous animals, as well as guards and escorts. They were specifically designed with the siege on Tolkeen in mind, and though the CS would probably deny it, to literally rip D-bees and magic users to shreds. They were first successfully tested in the Juicer Uprising where they fared amazingly well against the chemically augmented Juicers.

These mutant canines are huge, hulking beasts with powerful builds, bristling muscles and a lust to hunt, fight and kill —that is what they live for. Unlike the intelligent, loyal, obedient, and self-controlled Dog Boys, Sea Dogs and K-9 Sniffers, *Kill Hounds* are allowed (even encouraged) to keep their predatory instincts and savage side honed. Kill Hounds are genetically designed and trained to love to *fight* and to be fearless. In this regard, they are more animalistic: narrowly focused on their purpose (i.e. fight and kill), aggressive (be alert, fight and kill), and reasonably strong-willed (don’t back down, fight and kill)! They are even encouraged to fight and kill with their powerful jaws and often allowed to eat a portion of their (D-Bee and monstrous) prey. A favorite attack against S.D.C./H.P. enemies is to rip out their throats with their

teeth or a vibro-blade. They especially enjoy being given a seek and destroy mission and then let loose to do their job. A squad of 8-10 has been known to slaughter lightly defended D-bee villages that outnumber them three to one. Even well armed adventure groups, mercs and bandits equal in number to the Kill Hounds, usually fall to these savage canine monsters.

Most Kill Hounds are supremely confident, cocky, and bold individuals who tend to have a pack or mob mentality; meaning the larger the group of Kill Hounds, the bolder, meaner and more murderous they become. Even their Coalition masters sometimes have trouble controlling them, especially when the mutant canines are wounded or caught in a bloodlust. In addition to the human or Psi-Stalker squad leader, Dog Packs of Kill Hounds always have a pecking order, with one alpha and beta Hound along with an internal order of submissiveness of the others — a sort of unspoken, unofficial ranking and power structure within the group, with the Alpha Hound having the most power and influence over the other Kill Hounds. If anything should happen to the human leader, the Alpha Hound instantly assumes command without protest by the others.

Although aggressive and prone to give icy stares, snarls, back talk and slow response (all acts of defiance and little tests of power) when given an order the Kill Hounds don't like, they do respect and honor their human masters (Psi-Stalkers have a bit more trouble handling them). However, they never hesitate at a chance to hunt, track or kill.

Kill Hounds

R.C.C. Requirements: I.Q. 5 or higher, P.S. 20 or higher, plus an enjoyment of fighting, hunting and killing. The most common breeds include Mastiff, Rottweiler, Wolfhound, Elkhound, Rhodesian Ridgeback, Akita, Bouvier Des Flandres, Wolves and mixed combinations of these breeds, sometimes with terriers. Loyalty and obedience to CS officers (and humans in general) is required but these savage hunters are allowed to be more independent, defiant and aggressive, which can make them brutal and unpredictable.

Player Character Note: Player characters who are *not* CS agents must either be “feral” renegades (runaway mutants/deserters) or the Free Born offspring of runaway mutants; same as the Dog Boy R.C.C.

Alignments: Any, but most Kill Hounds lean toward unprincipled (20%), anarchist (22%) and aberrant (20%) alignments, with a much larger number than any other officially endorsed mutants being miscreant (20%) and diabolic (13%); 5% other.

Attributes (Kill Hounds): I.Q. 2D6+3, M.E. 3D6+6, M.A. 2D6, P.S. 4D6+12, P.P. 3D6+6, P.E. 4D6+4, P.B. 3D6, Spd 3D6+12 running — 2D4 digging. Use these attributes, special bonuses and stats in place of those provided under the Dog Boy R.C.C., unless stated otherwise. The Kill Hound is a very different “animal” compared to the beloved Dog Boy.

Hit Points: P.E. attribute number x2 and 1D6 per level of experience.

S.D.C.: 44 plus those gained from physical skills.

Average Weight: Average weight is around 200 lbs (90 kg).

Average Height: 6-7 ft (1.8 to 2.1 m).

Gender: 90% are male, 10% female.

General Physical Appearance: Varies with the breed; typically a long muzzle, medium to large ears (pointed or folded), generally tall, barrel-chested, muscular and strong with excellent endurance and powerful jaws. The fur is coarse, medium to long, and often disheveled/unkept looking; typically black, black and tan, dark grey, or dark brown (may have grey, tan or white markings). The eyes are generally dark brown to hazel. Bipedal stance and full human legs; long tail.

Human Speech: Partial to full.

Average Life Span (estimated): 6-15 years; 97% will be slain in combat.

Natural Abilities: Fundamentally the same as the *Dog Boy R.C.C.*, with the following exceptions: Natural, instinctive hunters and killers

who love to give chase, intimidate/bully, torture, fight, maim and kill (by tearing apart their opponents). They are relentless and savage hunters and killers, who, like the Canadian Mountie of Old, never rest until they have caught (and in this case, probably kill) their man.

Limited Olfactory Sense: Reduce all scent and scent tracking abilities by half — these Hounds use sight and tracking *skills* as much as scent, and their olfactory senses are not as keen as other breeds of Dog Boys.

Bite damage: 3D6+6 S.D.C./hit points. Punch and kick damage: 2D6 S.D.C./H.P. plus P.S. bonuses.

Leap: 15 feet (3.6 m) high or lengthwise from a standing still position and 30 feet (9 m) high or long with a running start.

Supernatural endurance: Lift and carry 100 times their P.S. attribute number and rarely fatigues (can be active for six hours without tiring) and is +3 to save vs poison, drugs and disease.

Kill Hound Bonuses: Use in place of the Dog Boy R.C.C. Physical Bonuses (#6): +5 on initiative, +2 to strike, +2 to save vs disease and poison, +2 to save vs possession, +10 to save vs horror factor.

Personality/Behavioral Problems: In addition to being aggressive, dominant, self-oriented and murderous (possibly with an evil alignment), Kill Hounds commonly suffer from the following problems.

Ignore Pain: While this may sound like a good thing, these mutant canines will often fight, ignoring pain, injury and blood loss (and without noticeable physical penalties/incapacitation) till they collapse (i.e. when down to one hit point). This, of course, can lead to severe injury, complications and death, even when seeking medical help could have stopped bleeding and prevented further damage. Kill Hounds tend to be very macho, in stupid ways.

Sloth: Unless it involves intimidating people, rough-housing, sports, a challenge, beating up people, fighting, hunting or killing, the Kill Hound isn't interested. This means work and assignments involving the mundane are either ignored entirely or done quickly and sloppily. Some Kill Hounds are so lazy about “details,” as they call them, that they forget to pack sufficient food rations, water, a key piece of equipment, or extra ammunition before they go on a mission. Likewise, Kill Hounds often “forget” details of an assignment. This is not deliberate, their genetic make-up, intelligence and instincts are such that they forget details and complex instructions, instead remembering the “essence” of what needs to be done, especially the fighting part. Consequently, it is wise for an officer to check their gear before they leave and keep Kill Hound assignments simple, linear (A-B-C-the end) and uncluttered with “details.”

Extreme Aggression: Most Kill Hound bullies and thugs who want to be the “Top Dog,” so to speak, and will fight (not necessarily to kill) over the slightest insult or altercation unless the perpetrator backs down and apologizes profusely. Some will even throw a punch or nip at their commanding officer. This means harmless brawls (no serious injury) among the Kill Hound Pack/Squad are frequent, but serious, often deadly, fights can erupt with humans who are not CS citizens, D-bees, and supernatural creatures. This extreme aggression also means the Kill Hounds (like Juicers and Crazies) find it difficult to resist any sort of challenge regardless of how dangerous (and stupid) it may be to the participants and/or spectators or innocent pedestrians.

Bloodlust: Kill Hounds can become temporarily obsessed with revenge and killing to the point that all other instructions and orders are forgotten. The mutant has just one goal: kill! While in bloodlust, the beast doesn't hear (and/or ignores) orders and is barely aware of what is happening around him. It may take a gunshot, explosion, psionic message or bolt of magic to catch his attention, and one or more humanoids may have to physically pull him off his opponent and restrain him to stop the Hound from killing the target of his bloodlust. While in this state, and only semi-aware of the most immediate things around him, the Kill Hound can recognize friend from foe and react to other things (a scream for help, an attack from the side, etc.).

Bloodlust occurs as a result of a fighting frenzy usually brought on by anger, frustration, fear, or, ironically, success in battle (gets so caught up in fighting he forgets all else).

Berserker Rage: This is a blind rage where the Kill Hound is oblivious to everything around him, friend, foe, danger, etc. The berserker rage ends only when the character's opponent is slain, or the Kill Hound is slain or knocked unconscious. Anybody attempting to pull the Hound away from the target of his rage will be attacked without restraint, although the enraged Kill Hound's goal is to get away and back to the task of finding and killing his target of the rage. The enraged mutant canine ignores all orders and everything around him. While lost to this berserk rage, the character will fight to the death, or fight a pointless battle while bigger objectives are lost, or those around him have need of his help. This blind rage occurs only when the Kill Hound faces a hated enemy, is provoked beyond reason, or as an intense fear response. During this enraged state, the Kill Hound gets one additional melee attack per round and is +6 to damage.

Rage Syndrome: Roll percentile. A roll of 01-20 means the character suffers from sudden and irrational bouts of rage and bloodlust that leads to brutal fights, sometimes for no apparent reason. In most cases, the character won't even remember the fight let alone why, or how he got injured. He is also more easily inclined to fall into Berserker Rages. Rage Syndrome is actually caused by a chemical imbalance and the rage and unprovoked attacks are part of a seizure. A Rage Syndrome attack is forewarned by glazed eyes and dull (out of it) expression on the Psi-Hound's face; 1D4 minutes later he'll savagely attack. The attack will last 2D4 minutes in a peaceful setting and 4D4 minutes in a combat situation. During this entranced state the Kill Hound gets one additional melee attack and is +6 to damage. Afterward, the character is exhausted and a bit dazed, reduce all combat bonuses by half and attacks per melee by one for 1D6x10 minutes.

Jekyll and Hyde Syndrome: Roll percentile. A roll of 01-33 means the character suffers from dramatic mood and character swings, often at the drop of a hat. One minute the Kill Hound is Doctor Jekyll, laughing and being the life of the party, fun and pleasant, perhaps even gentle and helpful. The next minute, he becomes Mr. Hyde: surly, mean, bossy, and looking for a fight. Typically, Mr. Hyde appears in response to a comment or joke he didn't like, a bump and an apology that didn't come fast enough, an insult, or a snide challenge. Mr. Hyde also tends to be the general disposition when tired, sick, injured or imprisoned.

Magic: None.

Average P.P.E.: 2D6

Psionics: See Special Abilities of Dog Boy R.C.C.

R.C.C. Skills of a Coalition Kill Hound:

Speaks American and Spanish at 85% efficiency

Radio: Basic (+10%)

Track Humanoids (by sight/skill; +15%)

Track Animals (by sight/skill; +10%)

Escape Artist (+5%)

Pilot Motorcycle/Hovercycle (+5%)

Climbing

Running

Boxing

Land Navigation (+10%)

Wilderness Survival (+20%)

W.P. Energy Pistol

W.P. Energy Rifle

W.P. Knife or Sword (vibro-blades)

W.P. two of choice

Hand to Hand: Martial Arts or Assassin (pick one)

R.C.C. Related Skills: At first level the Kill Hound can select four "other" skills, plus one skill at levels 4, 8, and 12. **Note:** Mutant canines in the service of the CS are never taught to read, not even officers.

Communications: Any

Domestic: Any (-5 penalty)

Electrical: None

Espionage: Any (+5%)

Mechanical: None

Medical: None

Military: Any (+10%)

Physical: Any, except acrobatics.

Pilot: Any simple ground vehicle and jet pack.

Pilot Related: None

Rogue: Any, except Hacking (+10% to Streetwise; +5% to all others).

Science: None, except basic math (-10% penalty).

Technical: Any, except computer operation & programming.

W.P.: Any

Wilderness: Any (+10%)

Secondary Skills: The character gets four secondary skills from the list, excluding those marked "None," at level one and one additional at levels 3, 6, 9, and 12. These are additional areas of knowledge that do not get the advantage of the bonus listed in parentheses. All secondary skills start at the base skill level.

Standard Equipment for CS Dog Boys: Basically the same as the Dog Boy R.C.C.; adore vibro-blades of all kinds, grenades and heavy damage inflicting energy weapons. Kill Hounds *usually* get heavy DPM armor or full environmental armor, although they often remove the helmet so they can bite, keeping it in their pack or hooked on a belt so they can use it when they feel it necessary (fear of gas or disease, vacuum, to hide underwater, etc.).

Money: Same as the Dog Boy R.C.C.

Cybernetics: All have a clock calendar, gyro-compass and toxic filter. Others commonly include: Razor fingernails (each nail adds one point of S.D.C. damage), finger gun or explosive finger segments (one artificial finger, three explosive joints; typically the pinky finger on the left hand), bionic lung, built-in language translator, built-in radio receiver and transmitter (implant in the jaw and ear); pick one. Prosthetic limbs (usually mechanical rather than bio-systems) and implants for medical reasons are also available. Those with artificial arms and hands will have 1-3 weapons built into them. Experimental Personality Modifiers (brain implants) may also be used in some test subjects.

Identification Coding (I.C.): Same as Dog Boys.

Typical Kill Hound Special Forces Missions:

Field: Seek and Destroy

Field: Commando Style Raids

Field: Commando Style Rescue

Field: Tracking (without killing the target)

Field: Assassination/Hunting and/or Sabotage

Field: Anti-Magic & Supernatural Ops — Seek & Destroy

Field: Purges or Cleansing Operations: The all-out slaughter of an enemy, including entire D-bee villages with women and children.

Field: Escort (occasionally)

Field: Guard Duty (occasionally)

Field: Infantry (occasionally, usually reserved for special operations).

Note: *Never* assigned to ISS Duty, except for special (bloody) Seek and Destroy missions in the Burbs ("Don't worry," snarls the Kill Hound Alpha Dog with a grin, "we'll get those D-bee terrorists. You just stand ready to take care of any that happen to slip past us. You never know what you might flush out when you raid one of their nests." And chuckles, eyes sparkling in anticipation).



Dog Boy Equipment

For decades the CS Military leaders feared issuing long-range energy rifles, rail guns and heavy equipment to the canine mutants, believing it safer to arm the Dog Boys with short-range pistols, vibro-blades and similar "light" weapons in case of insurrection. With over 25 years of outstanding service and an ever increasing need for frontline combat troops, in 102 P.A., the CS High Command finally decided to allow Dog Boys and Canine Special Forces to use heavier riot armor, full environmental armor, and long-range energy weapons, i.e. assault rifles. The Dog Boys are generally limited to the older models, but new, heavy weapons are available to Dog Packs for special assignments and to the Dog Boy Special Forces. Likewise, the new, full environmental DPM "Dead Boy" armor and a variety of canine helmets are finally becoming widely available to the Dog Packs. Ironically, most Psi-Hounds, especially those in the ISS, prefer the lighter and less confining half suits of riot armor for which the Dog Boys are most recognized.

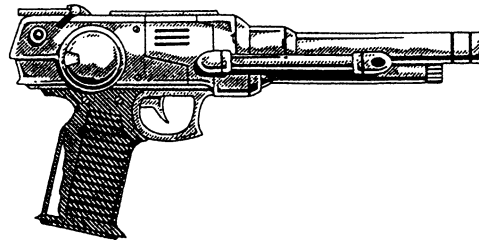

C-18 Laser Pistol — Old Style

The C-18 has been the standard energy weapon of the Dog Packs since their inception in 71 P.A. Among human officers, this was the standard issue sidearm of the Coalition Army, but is being replaced by the C-20 and CP-30 laser pistols (see **Coalition War Campaign** for the latest innovations in CS weaponry).

Weight: 4 lbs (1.8 kg)

Mega-Damage: 2D4 M.D.

Rate of Fire: Standard, see Modern Weapon Proficiency Section.

Effective Range: 800 feet (244 m)

Payload: 10 shots (less efficient energy delivery system).

Black Market Cost: 12,000 credits.

Standard Dog Boy Assault Weapons

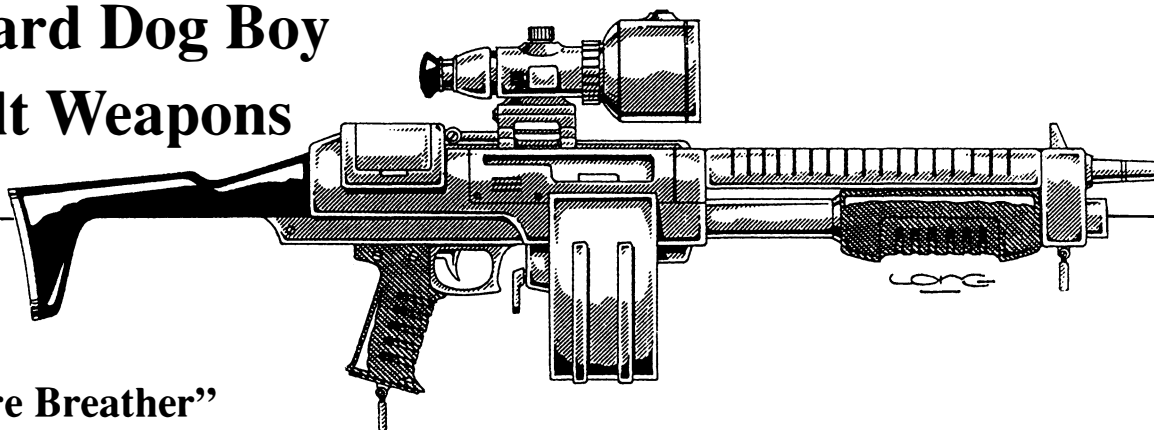

C-14 "Fire Breather"

Assault Laser & Grenade Launcher — Old Style

This is another "old" style CS infantry weapon that has been replaced by the CP-50 and other new weapons with greater damage, or range, and payload capacities. A favorite among human troops, the C-14 Fire Breather will remain in service for at least another 5-10 years throughout the Army, but is being slowly phased out. Meanwhile, the C-14 has become "the" frontline assault rifle of the Dog Packs since 102 PA. The C-14 has quickly become a favorite of the Dog Boys as well — they like its versatility and firepower, often adding a vibro-knife or sabre as a detachable bayonet. The C-14 is standard issue to every infantry canine in the campaigns against Tolkeen and Free Quebec, as well as those assigned to the American Western Wilderness and Magic Zone.

This heavy infantry weapon has high marks for durability and reliability in action. A laser comprises the top portion of the weapon and a pump-action grenade launcher is built under the laser barrel. Standard issue includes a passive nightvision scope.

Weight: 10 lbs (4.5 kg)

Mega-Damage: Laser is 3D6 M.D., Grenades 2D6 M.D. to a blast area of 12 feet (3.6 m); vibro-knife (1D6 M.D.), vibro-sabre (2D4 M.D.).

Rate of Fire: Laser: Equal to the number of combined hand to hand attacks of its user (usually 3-6).

Grenades: One aimed per each melee attack/action of the user or four fired in rapid succession (burst if all at same target, wild if sprayed into an area).

Effective Range: Laser is 2000 feet (610 m).

Grenade Launcher is 1200 feet (365 m)

Payload: Laser is 20 blasts, Grenade Launcher is 12.

Reloading the Launcher: Requires one full melee, 15 seconds, to manually reload the grenade launcher. As always reloading an E-Clip takes about five seconds or equal to one melee action/attack.

Black Market Cost: 30,000 credits and a hot commodity not commonly available. Grenades cost 550 credits apiece or 4500 a dozen. An E-Clip canister can not be added to this weapon.

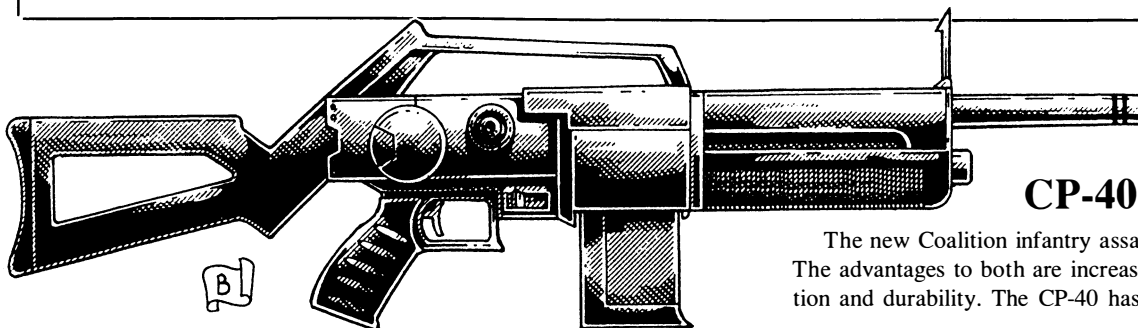

CP-40 Pulse Laser Rifle

The new Coalition infantry assault rifles are the CP-40 and CP-50. The advantages to both are increased firepower, rapid pulse firing action and durability. The CP-40 has four settings, two S.D.C. and two

M.D. The rifle can also be set to fire a single shot or a pulse of three nearly simultaneous blasts. It comes standard with a passive nightvision scope and laser targeting. It is often assigned to Dog Boys who often have need for both an S.D.C. and a Mega-Damage weapon. Available to Psi-Hound officers, Special Forces and upon special assignment.

Weight: 9 lbs (4.1 kg)

Mega-Damage: 2D6 M.D. per single laser blast or 6D6 M.D. per rapid-fire pulse (three simultaneous blasts fired one microsecond after the other).

S.D.C. Damage: The weapon can also be set to fire a single S.D.C. blast that does 3D6 S.D.C. damage or a rapid-fire pulse that does 1D6×10 S.D.C. Thirty single S.D.C. blasts use up the equivalent energy of a single M.D. blast, while six S.D.C. pulse blasts count as one M.D. blast.

Rate of Fire: Equal to the number of combined hand to hand attacks of its user (usually 3-6); each single shot or pulse counts as one of the user's melee attacks.

Effective Range: 2000 feet (610 m).

Payload: 21 blasts (7 pulse) per standard E-Clip, 30 blasts (10 pulse) per long E-Clip. In the alternative, the CP-40 can be connected with an energy cable to a portable hip or backpack carried energy canister (both are the same small size). The energy canister provides 60 single blasts or 20 triple blasts. The weight of the standard energy canister, pack included, is four pounds (1.8 kg). A dual backpack is also available, with two energy canisters; when one is used up, the connector cable is removed and reattached to the second, full canister (takes one full melee round/15 seconds).

Black Market Cost: 40,000 credits and a hot commodity not commonly available.

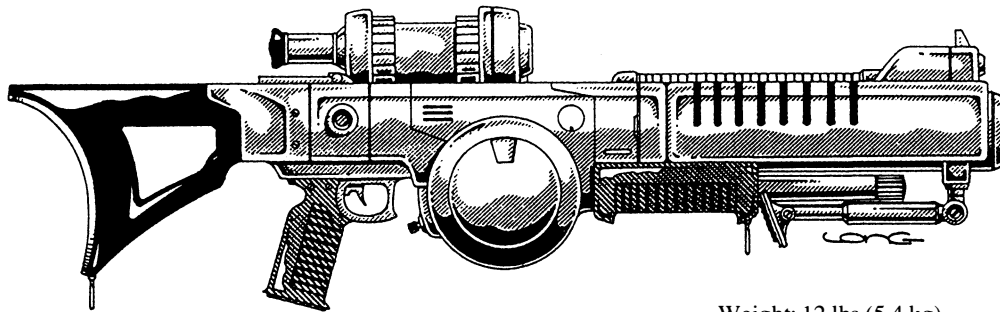

C-27 "Light" Plasma Cannon — Old Style

The C-27 plasma cannon has been reclassified from a heavy support infantry weapon to "light." It is dependable and inflicts high levels of damage. It is ideal against light to heavy body armor troops and light vehicles. Standard issue includes a telescopic and laser distancing scope. Plasma cannons, the C-14, and the CP-40 are favorites among *Kill Hounds*.

Weight: 12 lbs (5.4 kg)

Mega-Damage: 6D6 M.D. per blast.

Rate of Fire: Equal to the number of attacks of the user; each blast counts as one melee action/attack.

Effective Range: 1600 feet (488 m).

Payload: 10 blasts per energy canister; hooked into the underside of the weapon.

Targeting Scope: Add a bonus of +1 to strike on an aimed shot.

Black Market Cost: 32,000 for the rifle which can only be used with an E-Clip Canister which costs 10,000 credits new and fully loaded. A recharge is 2000 credits.

Other CS Weapons

Other new and old CS weapons are assigned to Dog Boys for special missions with increasing frequency. Depending on the mission and the Commanding Officer, virtually any of the CS weapons can be assigned to a Dog Boy with a spotless military record. Mutant canines with a history of discipline trouble or having gone AWOL even for a day, will be regarded with prejudice and are *not* likely to get any assault weapons other than those above.

Explosives available to Dog Boys

CS Hand Grenades

Small explosive canisters designed for throwing and exploding.

Fragmentation: 2D6 M.D. to a 20 foot (6 m) area.

Light High Explosive: 3D6 M.D. to a 6 foot (1.8 m) area.

Heavy High Explosive: 4D6 M.D. to a 6 foot (1.8 m) area.

Plasma: 5D6 M.D. to a 12 foot (3.6 m) area.

Note: Micro-fusion grenades that inflict 6D6 M.D. to a 12 foot (3.6 m) diameter blast area are available only as rifle launched rounds.

Effective Range Throwing a Grenade: About 40 yards/meters.

Black Market Cost: 250 credits for fragmentation, 200 credits for light high explosive, 275 credits for heavy high explosive, and 350 credits for plasma.

Fusion Blocks: These powerful explosives are made available only to Dog Boys with years of loyal service.

Riot Control & Pyrotechnics (12 pt)

Stun/Flash Grenade: This riot/antiterrorists weapon is designed to disorient and confuse criminals who are holding hostages in confined places. The grenade makes a loud exploding boom and emits a bright flash followed by a shower of white-hot sparkettes and some white smoke. The flash, burning sparks, and smoke should blind and startle any character without environmental armor or protective goggles. The victims of a stun/flash grenade are -8 to strike, parry and dodge, -1 on initiative and lose one melee attack/action for the next 1D4 melee rounds (15 to 60 seconds). Even those in armor should be momentarily distracted for 1D4 seconds and lose initiative. Cost: 100 credits.

Tear Gas Grenades: The gas will instantly affect all characters without protective masks or environmental body armor. The eyes burn, sting and water profusely, causing great discomfort and makes seeing clearly impossible. The gas also makes breathing difficult and irritates exposed skin. The effects last for 3D4 minutes. The 25 foot (7.6 m) cloud dissipates in about five minutes unless blown away by wind (dissipating more quickly in 1D4 minutes). The victims of tear gas are -10 to strike, parry and dodge, -3 on initiative and lose one melee attack/action for each of the next 1D6+1 melee rounds. Those in environmental armor are completely safe and not affected. Cost: 200 credits.

Smoke Grenades: This type of grenade releases a thick cloud of smoke that covers a 20 to 40 foot (6 to 12 m) radius. The smoke obscures vision in and through the cloud from those on the outside of it. Infrared cannot penetrate a smoke cloud or be used inside a smoke cloud. Those inside the cloud will be blinded and have trouble breathing. Those who are not protected by environmental suits or gas mask and goggles will be -5 to strike, parry and dodge and -1 on initiative. Attackers firing into/through the cloud are shooting wild. Note that passive nightsight scopes will work in a smoke cloud. Cost: 50 credits.

Hand-held Flare: This is the type of item truck drivers and road patrols use to signal for help or to warn others of an accident or danger. The flare burns for 20 minutes. Cost: One credit each.

Parachute Flares: This pyrotechnic device usually comes in a hand-held, throw-away launch tube. Three seconds after launching, the flare ignites into a bright sparkling light that slowly drifts back down to earth. While in the air, the flare burns for 60 seconds and illuminates an area of roughly 150 feet (45.7 m) in diameter. Cost: 10 credits each. Note: This is NOT a weapon, but if shot into a person, the flare does 6D6 S.D.C. each melee round for one minute (four rounds). There is also a 50% chance of causing combustibles to catch fire.

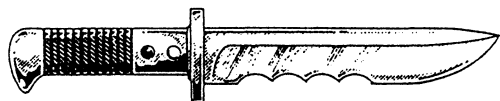

Vibro-Blades & Other Hand Weapons

Vibro-blades were originally designed by the Weapons Research and Development Division at Chi-Town. Since their introduction, their these weapons have become extremely popular not only among the CS military, but among armed forces, mercenaries and adventurers throughout the continent. “Knock-offs” of the CS vibro-blades are produced by virtually every weapon manufacturer in the Americas.

Vibro-knives, claws and sabers are standard issue to Dog Boys in the military and ISS. The blades are ideal for the Dog Pack squads assigned to urban duty (where, until recently, a full 60% of all Dog Boys are assigned). The weapons provide close combat mega-damage capabilities without the potential danger of long-range weapons which are incredibly hazardous to both human life and property. All Dog Pack city patrols are issued either two vibro-blades of choice, or a blade or claws and a neural mace, along with their DPM armor and spikes. Some Dog Boys have as many vibro weapons as a pair of vibro-claws or vambraces (one for each arm), a vibro-knife and a vibro-sword. Vibro-blades are one of the Psi-Hounds’ favorite weapons both in urban and frontline combat situations. Other arms may be issued as needed. Dog Boys in the field often add/purchase other unofficial, non-Coalition weapons for their personal equipment.

All vibro-blades are blade weapons surrounded by an invisible high-frequency energy field that gives them mega-damage capabilities.

Vibro-Knife: 1D6 M.D. Cost: 7000 credits.

Vibro-Saber (short sword): 2D4 M.D. Cost: 9000 cr.

Vibro-Sword (large, one-handed sword): 2D6 M.D. Cost: 11,000 cr.

Giant-Sized Sword: 3D6 M.D.; usually used by over-sized power armor suits or by giant robot vehicles. Cost: 18,000 cr.

Vibro-Forearm Claws: 2D6 M.D., usually two or three hooked blades attached to a forearm gauntlet or protective plate. Great for parrying and slashing. Cost: 11,000 cr.

Note: The ancient weapon proficiency skill and bonuses apply to the vibro-blades. Claws fall into the W.P. Knife category. Black Market costs are typically

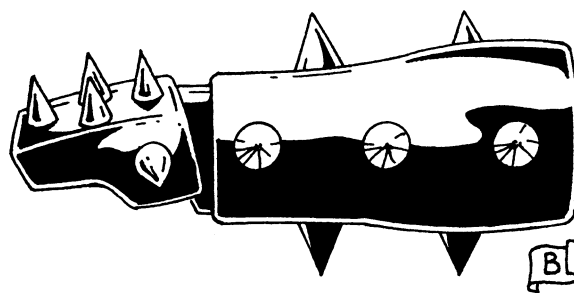

Vibro-Blade Vambraces

Dog Boys have forearm vambraces available to them with a variety of vibro-blades, large and small. These vambraces can be part of the DPM Riot Control Armor (half suits) or the full environmental suit.

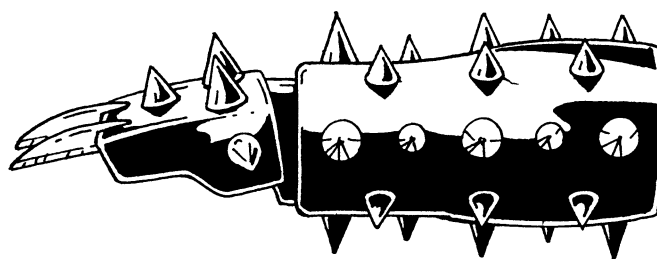

Short, Spiked Blade Handguard: Two short, sharp vibro-blades with serrated edges. Ideal for slashing and stabbing attacks, as well as sawing/cutting or chipping through light M.D.C. wire, plastic, and ceramics, or S.D.C. metal and concrete; does 2D4 M.D. Cost: 9,000 credits.

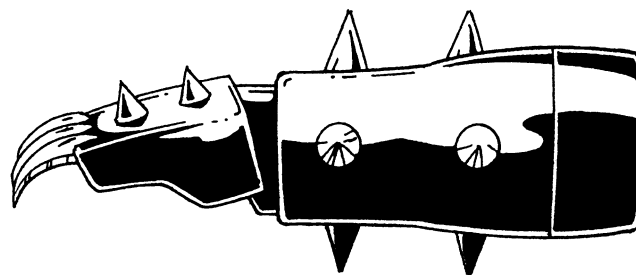

Triple Bladed “Cat’s Claw” Handguard: Three curved, claw-like vibro-blades, sharp on one or both sides, serrated or not, do 3D4 M.D. Cost: 11,000 cr.

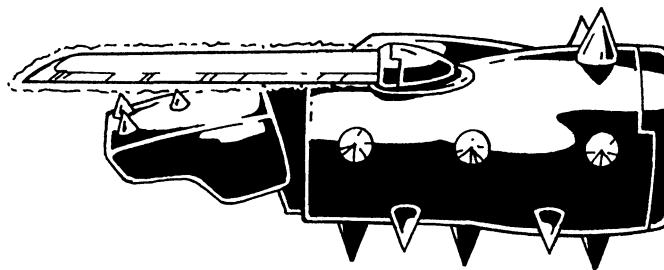

Dual Long-Blade Handguard (2): A pair of long, sharp vibro-blades that are partially retractable (half length), maximum length is 10 inches (0.29 m). Ideal for slashing, stabbing and parrying. Inflicts 2D6 M.D. Cost: 11,000 cr. **Note:** The illustration shows the combination of armor with the handguard long-blades and a pair of partially retractable forearm sabres.

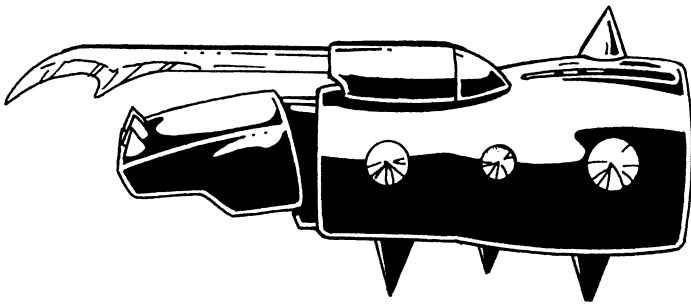

Hooked Forearm Vibro-Blades (2): The vambrace or forearm plate has a pair of hooked vibro-blades that are partially retractable (half length), maximum length is 20-24 inches (0.58 to 0.6 m). Excellent for slashing, parrying and hooking weapons and disarming opponents. They are also suitable for climbing (+5% to climb skill). Inflicts 2D6 M.D. and is +1 to parry and +2 to disarm. **Cost:** 14,500 cr.

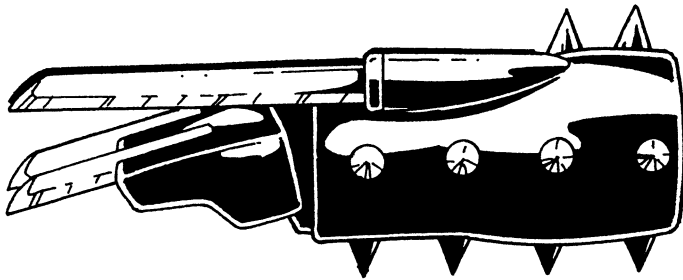

Sabre Forearm Vibro-Blades: The vambrace or forearm plate has a pair of straight vibro-blades that are partially retractable (half length), maximum length is 24 inches (0.6 m). Excellent for slashing, parrying, stabbing and parrying. Inflicts 2D6+2 M.D. and is +1 to parry. **Cost:** 16,000 cr.

Note: Having armor or a vambrace with both forearm and handguard blades does not increase the overall damage, because only one set of blades can be used at a time; hand or forearm.

Dog Pack Spikes

One of the Dog Pack's patented images is spikes. This is largely a stylistic gimmick to evoke a feeling of fear and power. Spiked collars, arm and wrist bands, knee pads, gloves and armor vambraces are all available in a large variety of different stylings. **Damage** for all spikes is S.D.C./hit point damage. The spiked gloves are weighted, sap gloves, and add 1D6+1 S.D.C. damage to punches. The knee pads have the weight and power of the leg behind it and add 1D6 S.D.C. to knee kicks. All others inflict 1D4 S.D.C. damage. The hand and arm spikes can also be used to parry normal S.D.C. attacks; +1 bonus when parrying with spiked arm bands or glove only. Ideal in urban, civilian situations where mega-damage weapons are not appropriate.

Cost: Varies; 50 to 200 cr.

Neural Mace

The Neural Mace is effectively a stun weapon that releases an energy charge that temporarily short-circuits the nervous system. It is standard issue to Dog Boys who serve in the ISS (city police) and frequently used by mutant canines assigned to riot control, Military Police, prison guards, or GED animal control and containment (usually dangerous mutant animals and runaways).

Damage: Nonlethal; the *stunned* victim is -8 to strike, parry, and dodge plus reduce the characters speed and number of attacks per melee round by half.

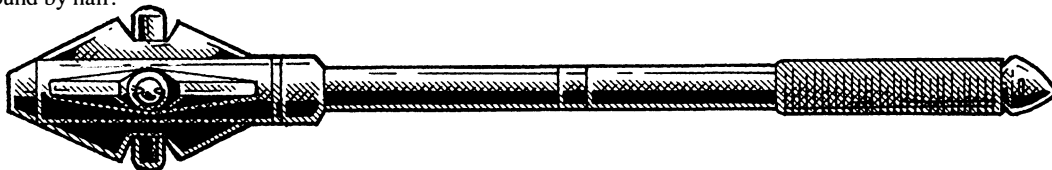

The accumulative effect on the nervous system of the body being repeatedly struck and stunned may knock the victim unconscious, even if he has previously saved. After being struck more than *four times*, the unprotected character may be stunned into unconsciousness for 2D4 melee rounds. When he recovers, he will suffer the stun penalties for 1D4 minutes. Roll to save, a failed roll means there is a 01-42% chance of being rendered unconscious. Note that in this case, even if the individual remains conscious, the energy charge will impair his movement as per the penalties previously described.

Physical Damage: 2D6 S.D.C. plus P.S. attribute bonus when used as a clubbing weapon; 1D6 S.D.C. from jabbing attacks. However, the mace is an M.D.C. structure and can be used to parry M.D. attacks from vibro-blades, 'Borgs, 'bots and power armor. Has 100 M.D.C. **Duration of Stun Effects:** 2D4 melee rounds. The duration of the impairment is increased 2D4 melee rounds for every hit by the mace in which the character does not save.

Save vs Neural Mace: 16 or higher; the same as saving against non-lethal poison. The character must save each time he or she is struck. A successful save means the character loses initiative and one melee attack/action that round but is otherwise okay.

Payload: 100 stun attacks — rechargeable.

Size: 3-4 feet (0.9-1.2 m) long.

Cost: 8,000 cr.

Note: The mace is *ineffective* against environmental, M.D.C. body and power armor, but is effective against Dog Pack armor and half suits, or body armor without a helmet (not fully environmental without the helmet attached).

Electro-Stunners

The Lone Star Complex has developed a number of cattle-prod like weapons for use in the control, capture, containment and handling of animals and mutants (and D-bees). Although most common at Lone Star, these weapons are frequently used by ISS and the CS military for handling crowds, apprehending criminals and torture in the Burbs, and occasionally for riot control and prisoner control. Both *Northern Gun* and the *Manistique Imperium* produce and sell knock-offs of Electro-Stunners and Vibro-Blades.

ES-10 Electro-Stun Hand Prod

Nicknamed the "Motivator," the short rod can be used as a club or to jab prisoners, jammed into the mouths of animals to prevent them from biting and to shock and motivate the animals and test subjects to behave, move, and follow commands. To inflict damage, the front, "tooth" end of the stick must touch the intended target. Physical contact will unleash a short, sudden shock with varying degrees of power and damage potential. The electrical burst will penetrate ordinary metal armor (an excellent conductor) and most types of S.D.C. armor, inflicting damage to the character inside but doing no damage to the armor. It is powerless against most insulated mega-damage environmental armor, power armor and M.D.C. robots and bionics.

Shock Damage: Three energy settings (all generally nonlethal):

1. Light shock: 1D4 S.D.C./hit point damage.
2. Moderate: 2D6 S.D.C./hit point damage.
3. Strong (lethal): 5D6 S.D.C./hit point damage plus a 01-33% chance of stunning humans, D-bees and small animals for 1D4 melee rounds; 01-03% chance against large or inhumanly powerful animals, including *Kill Hounds* who have supernatural endurance.

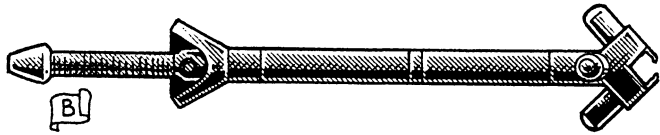

Victims can roll to save vs stun. A successful roll means they suffer half damage and only lose initiative and one melee attack for the round.

Stunned victims are -6 to strike, parry, and dodge plus reduce the character's speed and number of attacks per melee round by half.

The accumulative effect on the nervous system of the body being repeatedly shocked may knock the victim unconscious, even if he has previously saved. After being shocked on the "strong" setting more than *five times*, or when hit points are below half (S.D.C. gone), the character may be stunned into unconsciousness for 2D4 melee rounds. When he recovers, he will suffer the stun penalties for one minute. Furthermore, if all S.D.C. are gone and hit points are reduced to 8 or less, there is a 01-60% likelihood that the character will lapse into cardiac arrest and die within 1D4 minutes unless CPR is applied immediately (or roll to save vs coma and death). The heart is likely to be started again with minimal effort but the victim will feel like he was run over by a truck and suffer the stun penalties for 2D4×10 minutes.

Physical Damage: 2D4 S.D.C. plus P.S. attribute bonus when used as a clubbing weapon, 1D4 S.D.C. when used as a jabbing weapon. However, the rod is an M.D.C. structure and can be used to parry M.D. attacks from mega-damage animals (bites and claws) vibro-blades, 'Borgs, 'bots and power armor. It has 50 M.D.C.

Duration of Stun Effects: 1D4 melee rounds. The duration of the impairment is increased 1D4 melee rounds for every hit by the Electro-stunner in which the character does not save.

Save vs Electric Shock: 15 or higher. The character must save each time he or she is struck with a strong/lethal shock; the lower settings do not cause the stun affect nor cause cardiac arrest. A successful save means the character takes half damage, loses initiative and one melee attack/action that round but is otherwise okay.

Payload: 50 strong blasts or 100 moderate — rechargeable.

Size: 2 feet (0.6 m) long.

Cost: 6,500 credits.

Note: The Electro-Stunner is *ineffective* against environmental, M.D.C. body armor or power armor, bots and 'Borgs, but is effective against Dog Pack riot armor and half suits, or body armor without a helmet (not fully environmental without the helmet attached).

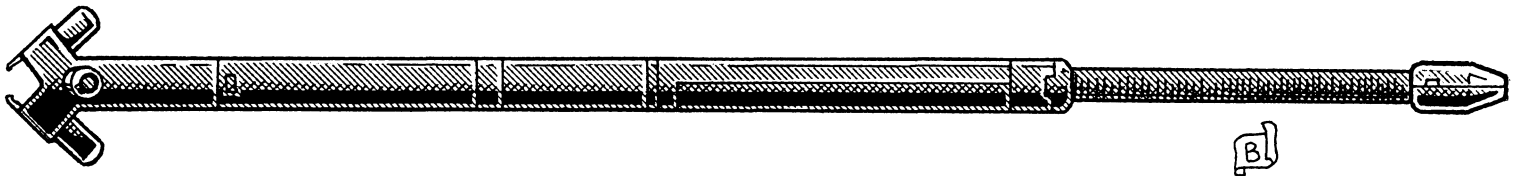

ES-20 Electro-Stun Spear

A long, spear-like version of the electro-prod. This electro-shock weapon has been designed for use against dangerous or large animals and test subjects where distance between the animal and the keeper is necessary or desired. Its function is basically the same as the small prod, only it delivers a more powerful shock.

Damage: Three energy settings:

1. Light shock: 1D6 S.D.C./hit point damage.
2. Moderate: 3D6 S.D.C./hit point damage.
3. Strong (lethal): 1D4×10 S.D.C./hit point damage plus a 01-65% chance of stunning human, D-bee and small animal victims for 1D4 melee rounds; 01-20% against giant or inhumanly powerful animals, including *Kill Hounds* who have supernatural endurance.

Victims can roll to save vs stun. A successful roll means they suffer half damage and only lose initiative and one melee attack for the round.

Stunned victims are -8 to strike, parry, and dodge plus reduce the character's speed and number of attacks per melee round by half.

The accumulative affect on the nervous system of the body being repeatedly shocked may knock the victim unconscious, even if he has previously saved. After being shocked on the "strong" setting more than *three times*, or when hit points are below half (S.D.C. gone), the character may be stunned into unconsciousness for 2D4 melee rounds. When he recovers, he will suffer the stun penalties for one minute.

If all S.D.C. are gone and hit points are reduced to 12 or less, there is a 01-70% likelihood that the character will lapse into *cardiac arrest* and die within 1D4 minutes unless CPR is applied immediately (or roll to save vs coma and death). The heart is likely to be started again with minimal effort but the victim will feel like he was run over by a truck and suffer the stun penalties for 2D4×10 minutes.

Physical Damage: 2D4+2 S.D.C. damage plus P.S. attribute bonus when used as a clubbing weapon; 1D6 S.D.C. when used as a jabbing weapon. However, the spear is an M.D.C. structure and can be used to parry M.D. attacks from mega-damage animals (bites and claws), vibro-blades, 'Borgs, 'bots and power armor. It has 80 M.D.C.

Duration of Stun Effects: 1D4 melee rounds. The duration of the impairment is increased 1D4 melee rounds for every hit by the Electro-stunner in which the character does not save.

Save vs Electric Shock: 15 or higher. The character must save each time he or she is struck with a *strong/lethal shock*, the lower settings will not cause the stun response or cardiac arrest. A successful save means the character takes half damage, loses initiative and one melee attack/action that round but is otherwise okay.

Payload: 50 lethal blasts or 100 moderate — rechargeable.

Size: 6 ft, 6 inches (1.95 m) long.

Cost: 12,000 cr.

Note: The Electro-Stun Spear is *ineffective* against environmental, M.D.C. body armor, power armor, bots and 'Borgs, but is effective against Dog Pack riot armor and half suits, or body armor without a helmet (not fully environmental without the helmet attached).

Rope Pole

The Rope Pole, also known as the "Strangle Rod," is used to capture and control animals and mutant test subjects. It is also sometimes used on human and D-bee prisoners. The shank of the rod is made of a light, durable mega-damage material. Inside is a line of mega-damage cord with a test strength/weight capacity of 800 pounds (360 kg) — a P.S. of 35 or higher is needed to snap the line. At the end of the pole is a noose loop. Adjustment controls near the handle are used to make the noose large or smaller, tighter or looser. A strangle knot automatically tightens the loop if the captive struggles or pulls. It can also be tightened with the controls. A strangle noose may be necessary to control or momentarily render some test subjects unconscious.

Damage: It generally takes 2-3 minutes to strangle an average human enough to render him unconscious, however, during that time, the

combat bonuses of the choking, strangling (panicking?) victim are reduced by half and the character loses one melee attack per round. Another 1D4 minutes of strangulation will usually kill the person (save vs coma/death?). Loosening the noose after unconsciousness will see

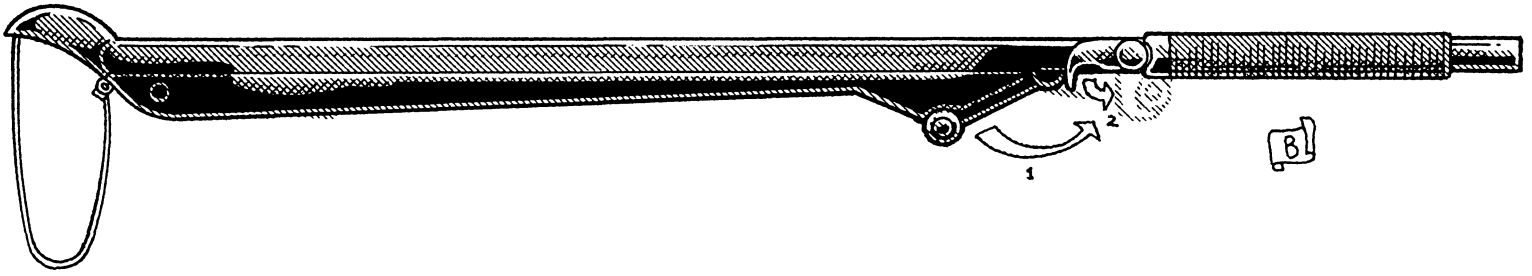

the victim recover within 1D4 minutes. Large animals and mutant subjects will take 1D4+1 minutes to render unconscious (sometimes twice as long or not at all) and they recover in a minute or two. It is difficult to snap the neck using the Rope Pole (it's designed to capture and control, not kill), but the user of the pole can jerk, shake and push their captive around or down on his knees. Note that often two humans or Dog Boys will handle a single Rope Pole to insure control of the subject.

Physical Damage: 1D6 S.D.C. damage plus P.S. attribute bonus when used as a clubbing weapon; 1D4 S.D.C. when used as a jabbing weapon. Furthermore, the Rope Pole is a light M.D.C. structure with a hollow center, making it more prone to being snapped in half, although it can be used to parry M.D. attacks from mega-damage animals (bites and claws), vibro-blades, 'Borgs, 'bots and power armor. The pole has a total of 35 M.D.C., while the cord effectively has one M.D.C. per square inch (susceptible to being bitten through if a mega-damage creature can get its teeth on the cord).

Size: 6 ft, 6 inches (1.95 m) long. A 20 foot (6 m) length of cord is contained inside the pole.

Cost: 2500 credits, mainly because of the M.D.C. materials.

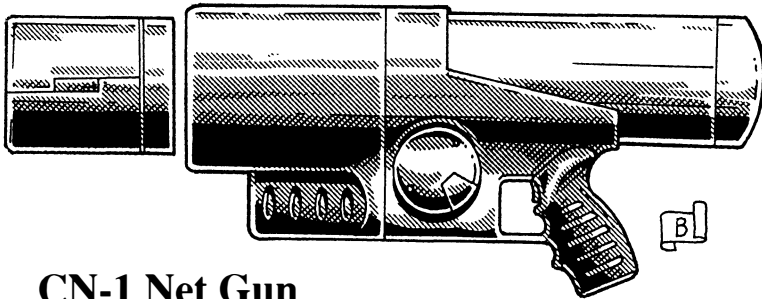

CN-1 Net Gun

Another tool for capturing escaped mutants and test animals is the Net Gun. This is a large, bulky, but surprisingly lightweight gun that fires an exploding cartridge that releases a mega-damage net. The net is large enough to cover an animal or mutant twice the size of a human or Dog Boy. Against human-sized targets, the extra size helps to weigh down and entangle the target subject. The netting is made from a light mega-damage material similar to the one used in the Rope Pole.

Weight: 10 lbs (4.5 kg)

Damage: None; designed to capture and entangle. It takes the average person 1D4 minutes to work his way loose; 3D4 minutes for most animals, but 5D6 seconds for most supernatural beings.

Note: The netting effectively has one M.D.C. point per square inch. It is susceptible to being bitten or clawed through by mega-damage creatures, supernatural beings, or cut by M.D. blades (takes at least two melee rounds/30 seconds to cut a hole big enough and to get untangled).

Effective Range: 40 feet (12 m).

Rate of Fire: Once per melee round, possibly two if the user can quickly reload a net cartridge (takes 2-3 melee actions).

Payload: One net canister, but the propellant cartridge can fire six nets before needing to be replaced or recharged with compressed air.

Reloading: The net cartridge is reloaded in the front of the weapon and counts as 2-3 melee actions. Reloading the air cartridge (in the rear of the weapon) requires one full melee round, 15 seconds.

Cost: 8,000 credits for the gun with two compressed air launch cartridges. An M.D.C. net with reusable firing cartridge costs 4000 cred-

its; an S.D.C. net (two S.D.C. points per square inch) and firing cartridge costs 800 credits each; Northern Gun offers net guns. Nets can only be repacked into the firing cartridge at the factory, cost is 300 credits for the S.D.C. net and 1000 credits for the M.D.C. net. One must typically wait 2D4 hours to get 1-12 cartridges repacked at the factory (Northern Gun's is at Ishpeming in Upper Michigan) or 2-6 weeks using a courier delivery service.



Mutant Animal Restraining Harness

Mutant Animal Restraining Harnesses are basically CS versions of *straight jackets* reinforced with mega-damage steel and ceramic clamps, braces and cords. The M.D.C. materials means the restrained creature needs a P.S. of 40 or higher (supernatural beings a P.S. of 22 or higher). It folds and holds the arms, preventing the confined individual from throwing punches, using claws or picking up a weapon. Actions/attacks per melee are reduced by half and speed/running is reduced by 33%. The muzzle prevents biting and talking. Characters with the *escape art-*

ist skill are -30% to escape. The muzzle is optional, but is used on all creatures deemed aggressive and dangerous, and can be fitted with a slow release tranquilizer gas to keep the captive dazed: no initiative and reduce combat bonuses, attacks per melee, spd and skill performance by half, unless a successful save vs nonlethal toxins (16 or higher) is made. A successful save must be made once every minute. A successful save means the character still has no initiative and combat bonuses are at half, but speed, attacks and skill performance are unimpaired. The harness has a total of 40 M.D.C. **Cost:** 2000 cr. mainly because of the M.D.C. materials. Not commonly available to adventurers and when it is, often costs 20-40% more.

Dog Pack Body Armor

Dog Pack DPM Light Riot Armor

The Dog Pack force has proven to be an invaluable addition to the Coalition Armed Forces. They have also proven to be so loyal that their light armor has been upgraded slightly and Special Psi-Hound NTSET operatives are allowed to wear full suits of the old-style Dead Boy armor. The head shapes of the different breeds of dogs' prevents them from wearing the standard environmental helmet worn by humans, so they are given a skullcap, goggles and air filter to protect the head.

The DPM armor offers none of the environmental systems of the full Dead Boy suits and serves mostly as protection against gunfire.

- M.D.C.: 50
- Weight 10 pounds (4.5 kg)
- Full mobility, no prowling penalty.

DPM D1 & D2 Dog Boy Armor Modified Old Style "Dead Boy" Armor

The decision of 102 P.A. by the CS Military High Command to allow Dog Boys and Canine Special Forces to use full environmental armor and long-range energy weapons dramatically increased the availability of resources to, and the survivability of, Dog Boys. As might be expected, the CS Military was cautious and slow to implement these changes. At first, only trusted officers and seasoned troops were offered the full environmental armor as an alternative to the light DPM riot armor. Over the next year or so approximately 40% of all infantry troops were provided with environmental armor. By the year 105 P.A., and due to the increasing need for frontline combat troops, approximately 75% of all Infantry Dog Pack troops are provided with DPM D2 light environmental armor with elite squads, seasoned veterans, officers and Special Forces all given the DPM D1 heavy armor.

The traditional DPM Riot Control Armor (half suit) is also standard issue to all Dog Boys. It is used for the dual purpose of light combat operations (guard duty, reconnaissance, etc.) and as part of their formal dress uniform. Most ISS Dog Boys (city defenders/police) prefer the old DPM Riot Armor, changing into DPM-D2 light environmental armor (officers in DPM-D1 heavy armor) for SWAT style operations, raids and assaults against powerful supernatural monsters.

Since the regular, human army is switching to the new, skeleton environmental armor, it has been easy to supply growing numbers of mutant canine troops with the full environmental armor. Although given the armor class designations of DPM (Dog Pack Military) D1-Heavy and D2-Light, the body armor is nothing more than the old CA-1 and CA-2 "Dead Boy" environmental armor with a different helmet. The helmets are designed with the shape of the canine head in mind, with a few variations for size, short and long muzzles (67% of all Psi-Hounds have long muzzles). Many Dog Boys find the helmets a bit too confining and carry them in backpacks or hooked to a belt, wearing the old riot control helmets or the helmet without the face plate instead. The

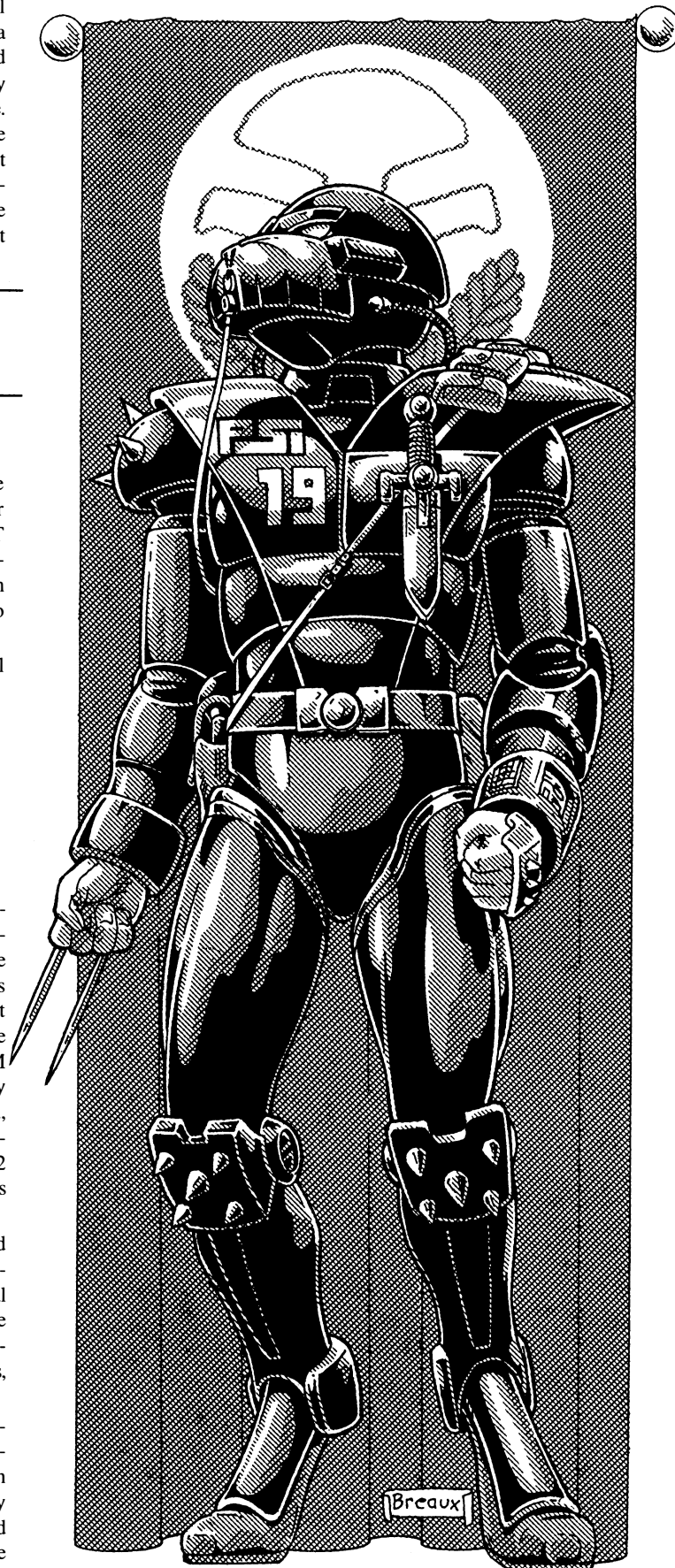

Dog Boys slap on the full environmental helmets and seal the suits when entering into combat or as necessary. This is a bit dangerous, because it leaves them vulnerable to attacks by snipers, gas, disease, etc., but has become standard practice.

Note: The illustrations depict the current three types of environmental helmets available to Dog Packs. The canine Death's Head with spikes is the standard helmet for the Dog Pack soldier, the slick one is the officer's helmet (rank of sergeant to warrant officer) and the light helmet with the full face visor is used by the *Sea Dog* Navy Hounds. The *Sea Dog* helmet is sometimes used by reconnaissance teams because its wide visor offers optimum use of peripheral vision which is roughly double that of humans.

The full figure illustration shows a Dog Boy in DPM D1 Officer's armor. The officer's armor has the same styling as the human officers once had to better distinguish them from the troops.

Class: D1-Heavy and D2-Light environmental Dog Boy armor (effectively modified CA-1 heavy and CA-2 light body armor).

Size: Human equivalent.

Weight: Heavy: 18 pounds (8.1 kg) or light: 9 pounds (4 kg).

Mobility: Heavy: Good; -10% to climb and -25% to prowl, swim, acrobatics and similar physical skills/performance. Light: Very good; -5% to climb and -10% to prowl, swim, acrobatics and similar physical skills/performance.

M.D.C. by Location:

Head/Helmet — 50

Arms — 35 each

Legs — 50 each

Main Body — 80 (D1 heavy) or 50 (D2 light)

Special Weapon Systems or Features: Both forearms have a pair of fully retractable Vibro-Sabres (2D6 or 2D6+2 M.D. depending on type). Spikes may also be added to the arms, shoulders and lower legs of the armor.

Market Price: Not available; exclusive to the CS military.

All Coalition "Dog Boy" environmental body armors have the following properties:

Complete environmental battle armor suitable for use in all hostile environments, including space.

Computer controlled life support system.

Internal cooling and temperature control.

Artificial air circulation systems, gas filtration, humidifier.

Computer controlled, independent oxygen supply and purge system that automatically engages in low oxygen or contaminated air environments. Five hour oxygen supply.

Insulated, high temperature resistant shielding for up to 300 degrees centigrade. Normal fires do no damage. Nuclear, plasma, and magic fires do full damage.

Radiation shielded.

Polarized and light sensitive/adjusting tinted visor.

Built-in loudspeaker; 80 decibels.

Directional, short-range radio built into the helmet. Range is five miles (8 km).

Helmet face plate is removable.

Wrist Mini-Comp: A small multi-purpose miniature computer and display that will indicate system errors within the armor, damage levels, and oxygen supply, as well as direction (compass), time, and date.

Ammo and supply waist belt, shoulder belts, and shoulder holster. Pilots and officers have choice of shoulder or hip holster.

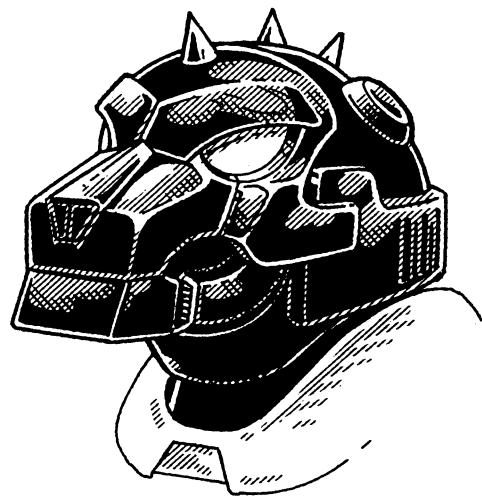

Standard Dog Boy Helmet

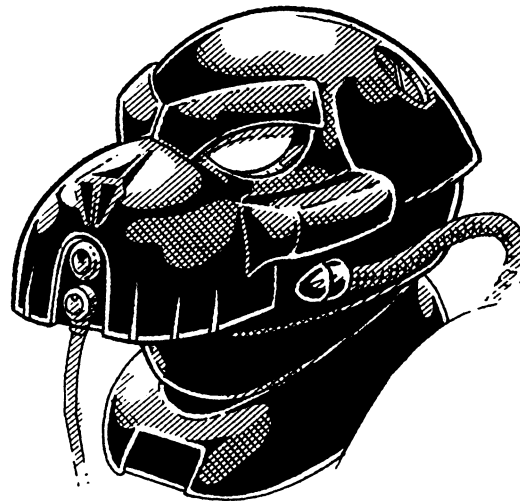

Dog Boy Officers
Hill Hounds & Special Forces

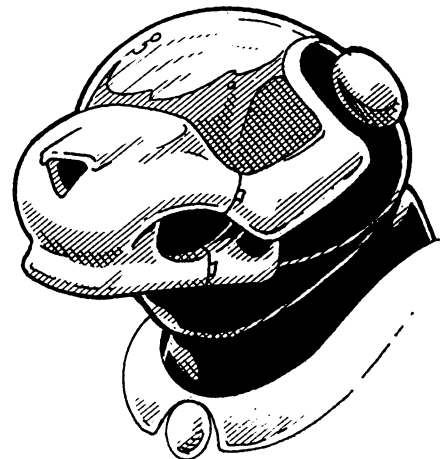

Sea Dog & Reconnaissance

Hovercycles

Hovercycles are one of the most popular and least expensive modes of transportation on Rifts Earth. They are especially fancied by adventurers, mercenaries, spies, thieves, assassins, vagabonds, and people living outside the borders of the Coalition States.

In the CS military, combat hovercycles are used for reconnaissance, seek and destroy missions, patrols, escorts and couriers, and general transport. Dog Boys love these small, fast, sleek vehicles for work and play (they love to race them). Reconnaissance teams and Special Forces like them because they are fast, comparatively silent, small and easy to hide/camouflage. **Note:** Hovercycles are all-terrain ground vehicles that hover on a cushion of air and propelled by a variety of different air and rocket jets.

The CS Military uses the *CS Scout Rocket Cycle*, *Warbird Rocket Cycle*, and the old and new style *Sky Cycles* as one-man, low flying combat vehicles, but they also have a need for more conventional *hovercycles*. The CS has found it cheaper and more expedient to supplement its pool of low-end military hovercycles by purchasing existing *Northern Gun combat bikes* than to manufacture their own (The NG offers a wonderful wholesale price for such mass quantities). After all, although combat versions are used, hovercycles are a basic, secondary transport vehicle as far as the military is concerned. CS mechanics inspect and adjust all new purchases and make any modifications necessary or desired (occasionally add a pair of dual mini-missile launchers or a medium to heavy laser). The only modification made to all the hovercycles is they are painted the traditional blue-black with a light grey skull painted on the front and I.D. and serial numbers painted on the sides. 60% are standard models, 40% the deluxe armored bikes. 40% use combustion engines, 40% electric, 20% (deluxe) use nuclear. The Turbo and Stinger are the most commonly used by the CS

NG-300 "Speedster" Hovercycle

The Speedster, produced by Northern Gun, is one of the fastest, most maneuverable and affordable hovercycles on the market. It is fairly quiet, extremely reliable (can take a beating and keep on going), requires very little maintenance, and is capable of Vertical Take-Offs and Landings (VTOL), hover in mid-air, and handles like a dream. Northern Gun's masterful sales campaign, the vehicle's unique styling, excellent handling and frequent (typically 2-4 times a year) special promotions offering the vehicle at a 10-20% discount (for a limited time only!) and/or with an easy payment plan have made it common throughout the North American continent, outselling the nearest competitor 4 to 1.

Vehicle Type: Hovercycle

Crew: One rider, and one passenger can sit behind the driver, but will not be comfortable on long trips.

Special Bonuses: The NG-300 handles so well that it gives the driver a +10% bonus to his piloting skill, +1 on initiative (to take evasive action) and +1 to dodge.

Maximum Speed: 220 mph (352 km)

Maximum Altitude: 120 feet (36.5 m) and can handle drops of up to 600 feet (183 m).

Maximum Range: 800 miles (1280 km)

Engine: Typically combustion or electric engine; nuclear is available.

Length: 9 feet (2.7 m)

Weight: 700 lbs (315 kg)

M.D.C. by Location:

* Rear Hover Jets (2) — 35 each

* Front Hover Jet (1) — 40

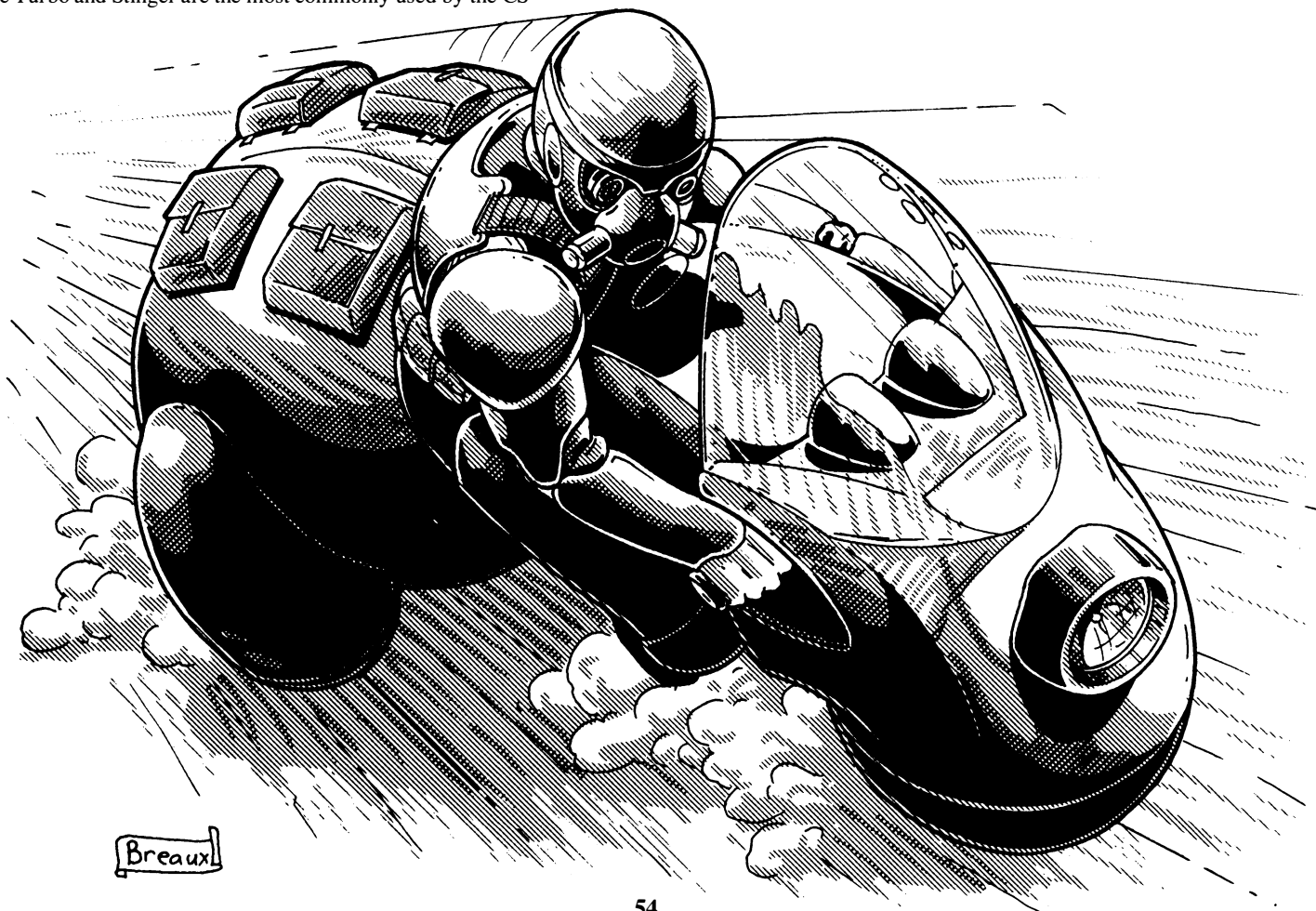

* Forward Headlight (1) — 5

Windshield (1) — 15

Main Body — 75

* Optional Weapons typically have 2D6+14 M.D.C.

Add 30% to all M.D.C. for the deluxe, armored model, but also add 30% to the cost.

A single asterisk indicates small and/or difficult targets to hit and requires the attacker to make a “called shot,” but even then the attacker is -3 to strike. The driver, hunched down, low to the body of the hovercycle, is equally difficult to hit.

Cost: 98,000 credits gasoline engine or 110,000 credits for electric, or 450,000 nuclear with a 10 year life. Weapons cost extra.

Weapons (optional): Weapon extras are *never* part of the special discount offers — full price applies even during sales.

Light Laser: 1D6 M.D., range is 1200 feet (366 m), payload is 20 shots. Cost: 11,000 credits. Add 5000 cr to double payload.

Heavy Laser: 2D6 M.D., range is 2000 feet (610 m), payload is 20 shots. Cost: 25,000 cr. Add 5000 cr to double payload (40 shots).

Double-Barrel Heavy Laser: 2D6 M.D. per single shot, 4D6 damage per simultaneous double shot, range is 2000 feet (610 m), payload is 40 shots. Cost: 58,000 cr.

Machinegun: 1D4 M.D. per burst of 50 rounds, range: 2000 feet (610 m), payload is 600 rounds (12 bursts). Cost: 4000 cr.

Mini-Missile Launchers: As many as two launchers can be added; one on each side. The small launchers fire two mini-missiles each, payload is two each; manual reloading (not possible while moving).

Cost: 55,000 credits. The multi-shot missile pods don't fit on this hovercycle.

Note: This vehicle is never purchased or used by the CS.

MI-3000 “Firefly” Hovercycle

The Firefly is the Manistique Imperium's answer to the ever popular NG-Speedster. It has taken the market by storm in its first six months of sales but is still nowhere near the sales of the Speedster (sales have slowed and settled down where they'll probably stay). However it threatens to become the number two bike on the market (about 50-60% the sales of the NG Speedster).

The Firefly is a small, fast, one-seater — a second person can try to sit behind the driver but may fall off at high speeds or when performing stunts and evasive maneuvers, and cramps the driver, imposing a -5% driving penalty. Its small size enables it to fit in small places and through narrow passages, and makes it easy to conceal. The ball-action hoverjet in the rear is a new innovation that provides the pilot with absolute control, superior handling and full VTOL capabilities. The ball action enables the driver to adjust the speed, angle, position and movement of the vehicle in a heartbeat. In fact, the Firefly is able to adjust pitch, angle, speed and precise air cushion so quickly and accurately, that it can actually drive along the sides of walls for up to three minutes! As well as execute jumps and stunts with amazing ease. The engineers at Northern Gun were so impressed that they have already pirated the technology, improved upon it and incorporated the design into the NG-480 “Turbo.” Four (comparatively) large directional jets are built into the lower front housing (with another four in the undercarriage) and four small ones in the front and two on the side (rear) provide excellent maneuverability, control and stopping power. The Firefly comes standard equipped with a forward laser mini-turret (can rotate side to side 180 degrees and has a 40 degree arc of fire) and side mounted mini-missiles (the launcher can rotate 360 degrees).

Vehicle Type: Hovercycle

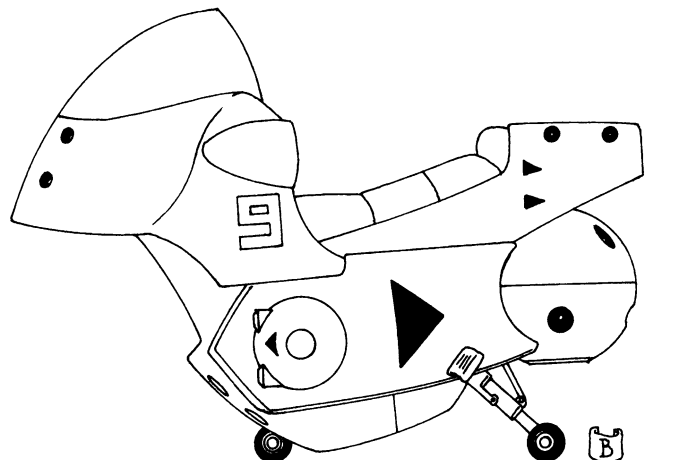
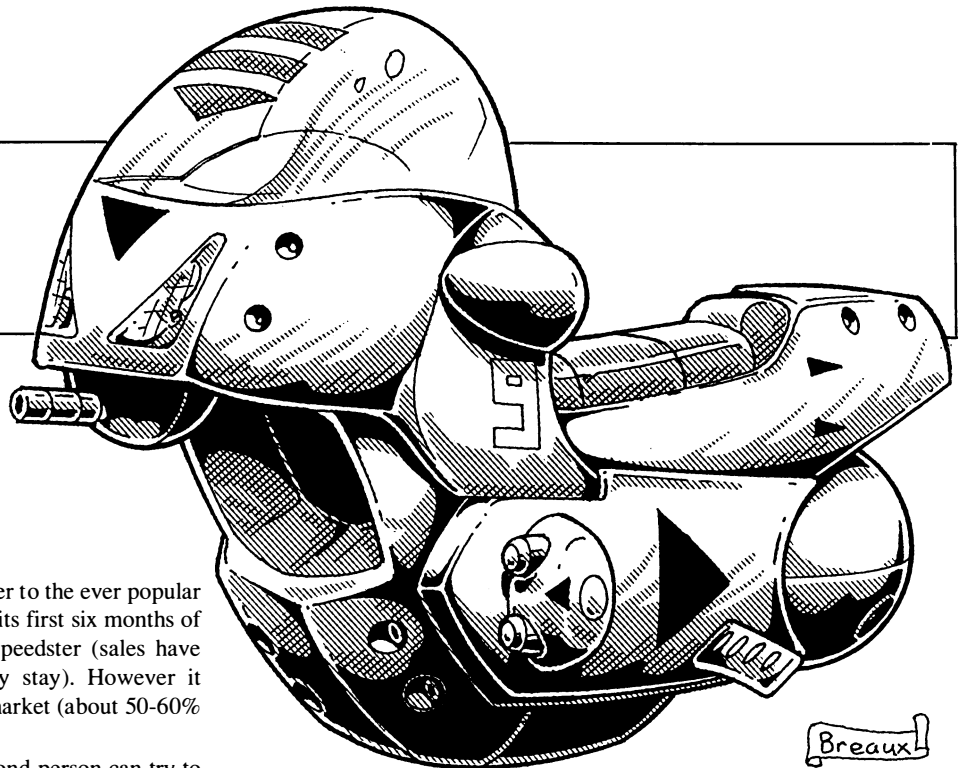

Crew: One rider, and one passenger can sit behind the driver, but it makes for a cramped ride and is not comfortable even on short trips and imposes a -5% piloting skill penalty.

Special Bonuses: The MI-3000 handles so well that the driver gets a +10% bonus to his piloting skill and +1 to dodge.

Maximum Speed: 190 mph (304 km)

Maximum Altitude: 60 feet (18.3 m) and can handle drops of up to 400 feet (122 m).

Maximum Range: 800 miles (1280 km)

Engine: Combustion or electric engine.

Length: 5 feet, 6 inches (1.65 m)

Weight: 330 lbs (148.5 kg)

M.D.C. by Location:

- * Rear Hover Ball Jet Housing (1) — 40
- * Forward Directional Jets (4) — 4 each
- * Undercarriage Directional Jets (4) — 4 each
- * Forward Headlights (2) — 3 each
- * Forward Laser Turret (1) — 28
- * Side Mini-Missile Launchers (2; one per side) — 20 each
- Reinforced Windshield (1) — 15
- Main Body — 72

Add 30% to all M.D.C. for the deluxe, armored model, and add 30% to the cost.

A single asterisk indicates small and/or difficult targets to hit and requires the attacker to make a “called shot,” but even then the attacker is -4 to strike. The driver, hunched down, low to the body of the hovercycle, is equally difficult to hit.

Cost: 148,000 credits for gasoline combustion engine or 164,000 for electric. Nuclear not available. Weapons are standard.

Weapons (Standard): Comes equipped with the following:

Light Laser: 1D6 M.D., range is 1200 feet (366 m), payload is 20 shots. Cost: 11,000 credits. Add 5000 cr to double payload.

Heavy Laser: 2D6 M.D., range is 2000 feet (610 m), payload is 20 shots. Cost: 25,000 cr. Add 5000 cr to double payload (40 shots).

Double-Barrel Heavy Laser: 2D6 M.D. per single shot, 4D6 damage per simultaneous double shot, range is 2000 feet (610 m), payload is 40 shots. Cost: 58,000 cr.

Mini-Missile Launchers: One launcher on each side; can rotate 360 degrees. The small launchers fire two mini-missiles each, payload is two each; manual reloading (not possible while moving). Cost: 55,000 each. The multi-shot missile pods don't fit on this hovercycle.

Note: This vehicle is never purchased or used by the CS.

MI-1010 Desert Fox

The Desert Fox is another small, maneuverable hovercycle that has been popular in the Manistique Imperium for almost 30 years. The vehicle is specifically designed for desert and prairie travel, with engines that can take a beating from the heat, sand and dust without fear of clogging or overheating. These reliable, low maintenance vehicles are extremely popular (along with the NG-300 Speedster) in Lone Star and the Western Wilderness, especially among the Pecos Empire, bandits, and adventurers. Disadvantages, compared to the Speedster, are its light armor, and comparatively slow speed. Its size and design makes it difficult to add more than one weapon (most have none). However, its small size enables it to fit in small places and through narrow passages, and makes it easy to conceal.

Vehicle Type: Hovercycle

Crew: One rider, and one passenger can sit behind the driver, but it makes for a cramped ride and is not comfortable even on short trips and imposes a -5% piloting skill penalty.

Special Bonus: The MI-1010 handles so well that the driver gets a +10% bonus to his piloting skill.

Maximum Speed: 170 mph (272 km)



Maximum Altitude: 80 feet (24.4 m) and can handle drops of up to 600 feet (183 m).

Maximum Range: 700 miles (1120 km)

Engine: Combustion or electric engine.

Length: 6 feet (1.8 m)

Weight: 400 lbs (180 kg)

M.D.C. by Location:

* Rear Hover Jets (2; upper) — 30 each

* Main Jet (1; lower body) — 55

* Large Lower Directional Jets (2) — 15 each

* Forward Headlights (2) — 2 each

* Small Windshield (1) — 5

Main Body — 65

Add 30% to all M.D.C. for the deluxe, armored model, but also add 30% to the cost.

A single asterisk indicates small and/or difficult targets to hit and requires the attacker to make a “called shot,” but even then the attacker is -4 to strike. The driver, hunched down, low to the body of the hovercycle, is equally difficult to hit.

Cost: 90,000 credits for gasoline combustion engine or 105,000 for electric. Nuclear not available. Weapons are extra.

Weapons (optional): Weapon extras are full price even during sales.

Light Laser: 1D6 M.D., range is 1200 feet (366 m), payload is 20 shots. Cost: 11,000 credits.

Heavy Laser: 2D6 M.D., range is 2000 feet (610 m), payload is 20 shots. Cost: 25,000 cr.

Dual Mini-Missile Launchers: As many as two launchers can be added; one on each side or undercarriage. The small launchers fire two mini-missiles each, payload is two each; manual reloading (not possible while moving). Cost: 55,000 credits.

Note: This vehicle is never purchased or used by the CS.

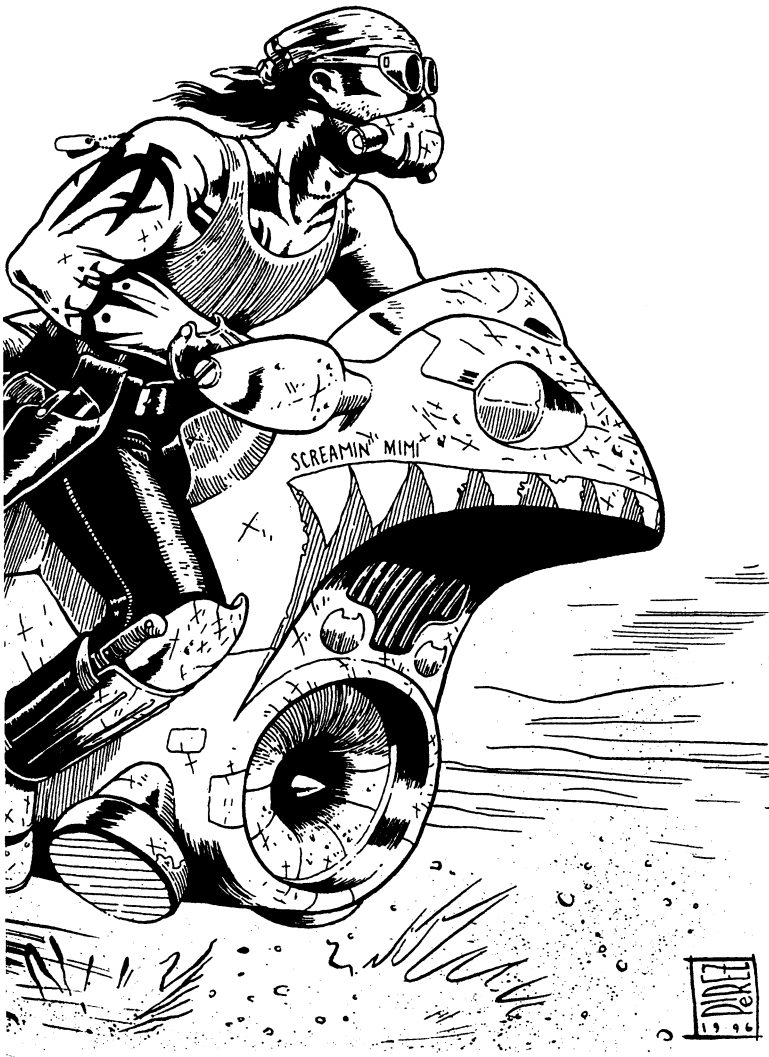

Northern Gun Combat Bikes

NG-220 Rocket

The Rocket is a hovercycle with four small rocket engines in the rear section. It is designed more for speed than for mobility and is best for straight-aways, prairies, deserts and flatlands. A pair of short-range ion blasters are disguised as ports for directional jets — two are real, two are guns (one on each side). Additional weapons may be added. This older style bike is being overshadowed by the newer Turbo, Stinger and the old, reliable prowler. Consequently, the current price is about 40% of what the hovercycle used to cost and it *may* be phased out of production in the next 5-10 years. The new low price and exceptional speed (versus handling) has made the NG Rocket a favorite among the Pecos Bandits.

Vehicle Type: Rocket propelled Combat Hovercycle.

Crew: One rider, and one passenger can sit behind the driver, but will not be comfortable on long trips.

Special Penalties: The NG-220 handles so poorly that the driver suffers a penalty of -15% to his piloting skill and -30% when making sudden stops, sharp turns or stunts. Reduce the piloting skill by another 10% when flying at 300 mph (482 km) or faster.

Maximum Speed: 340 mph (544 km)

Maximum Altitude: 1000 feet (305 m) and handle drops of up to same.

Maximum Range: 600 miles (960 km) with gas or electric, indefinite with nuclear engine.

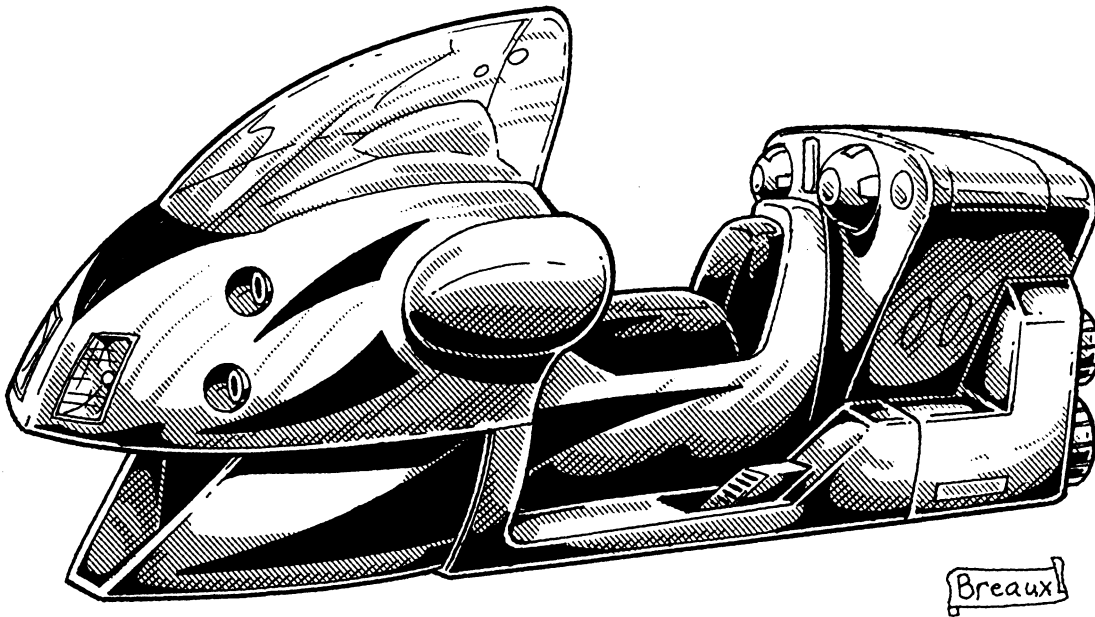

Engine: Typically combustion or electric engine; nuclear is available.

Length: 12 feet (3.6 m)

Weight: 850 lbs (382.5 kg)

M.D.C. by Location:

- * Rear Hover Rocket Jets (6) — 25 each
- * Front Directional Jets (2) — 5 each
- * Undercarriage Directional Jets (6) — 5 each
- * Forward Headlights (2) — 5 each
- * Forward Ion Blasters (2; disguised as mini-jets) — 6 each
- Windshield (1) — 18
- Main Body — 84

* Optional Weapons typically have 2D6+14 M.D.C. each.

Add 30% to all M.D.C. for the deluxe, armored model, but also add 30% to the cost.

A single asterisk indicates small and/or difficult targets to hit and requires the attacker to make a “called shot,” but even then the attacker is -3 to strike. The driver, hunched down, low to the body of the hovercycle, is equally difficult to hit.

Cost: 120,000 credits gasoline engine or 135,000 credits for electric, or 675,000 nuclear with a 10 year life.

Weapon (standard): Two concealed ion guns disguised as a pair of small jet ports. 3D6 M.D. per single blast or 6D6 per dual blast, range, is 500 feet (152 m), payload is 60 shots each.

Weapon Extras (optional): Weapon extras are full price even during sales.

Light Laser: 1D6 M.D., range is 1200 feet (366 m), payload is 40 shots. Cost: 16,000 credits.

Heavy Laser: 2D6 M.D., range is 2000 feet (610 m), payload is 40 shots. Cost: 30,000 cr.

Machinegun: 1D4 M.D. per burst of 50 rounds, range: 2000 feet (610 m), payload is 1200 rounds (24 bursts). Cost: 5000 cr.

Dual Mini-missile Launchers: As many as four dual launchers can be added; two on each side (front, rear or undercarriage). The small launchers fire two mini-missiles each, payload is two each; manual re-loading (not possible while moving). Cost 55,000 credits each.

Mini-Missile Pod (Multi-Shot) Launcher: Payload: 12 mini-missiles. Rate of fire: one at a time or 2, 4, or 6 simultaneous. The size, sleek shape and sturdy frame allows for the use of missile pods that stick out from the body. However, these pods cause some drag and reduces maximum speed to 310 mph (496 km) and adds another -10% to the piloting skill when travelling faster than 200 mph (321 km). Cost: 110,000 each.

Note: A total of three lasers weapons (or two machineguns with ammo drums) and four dual mini-missile launchers or two multi-shot launchers can be installed on the heavy, sleek body of the NG-220 Rocket bike; six dual launchers or four dual and two multi-launchers if used in place of two lasers.

Note: This vehicle is never purchased or used by the CS.

NG-230 Prowler

The Prowler is another old, reliable, Northern Gun favorite, especially among adventurers and explorers. It is a bit slower than some other models but handles extremely well, can stop on a dime and is designed to fly silently. Its small size makes it easy to conceal. The “whisper” feature makes the vehicle completely silent except for a barely perceptible hissing when travelling at speeds below 36 miles per hour (57.6 km). This enables those with the prowl skill to effectively move the hovercycle silently, the same as their prowl skill! Of course, no amount of muffling or prowling ability will hide the pilot when out in the open — ideal for urban and woodland settings.

Vehicle Type: Combat Hovercycle

Crew: One rider; no space for a passenger.

Special Bonuses: +5% to piloting skill. Prowl ability: The driver can apply his prowl skill (if he has one) to the driving of the NG-230 Prowler whenever he’s trying to be quiet and drive unnoticed (close to the ground, along ground cover, in shadow, etc.). If the pilot doesn’t have a prowl skill, the base ability of the vehicle is 20%. In all cases, to prowl, the speed of the vehicle cannot exceed 35 mph (56 km). Note that the side mounted booster jets and stabilizers with the whisper feature are often mistaken for mini-missile launchers. Two shot mini-missile launchers are sometimes mounted on the front sides or sides of the seat near the tail. Comes standard with a nose laser turret with 300 degree rotation and a 40 degree arc of fire.

Maximum Speed: 190 mph (304 km)

Maximum Altitude: 700 feet (210 m) and handle drops of up to 900 feet (274 m).

Maximum Range: 900 miles (1440 km)

Engine: Typically combustion or electric engine; nuclear is available.

Length: 7 feet, 3 inches (2.2 m)

Weight: 700 lbs (315 kg)

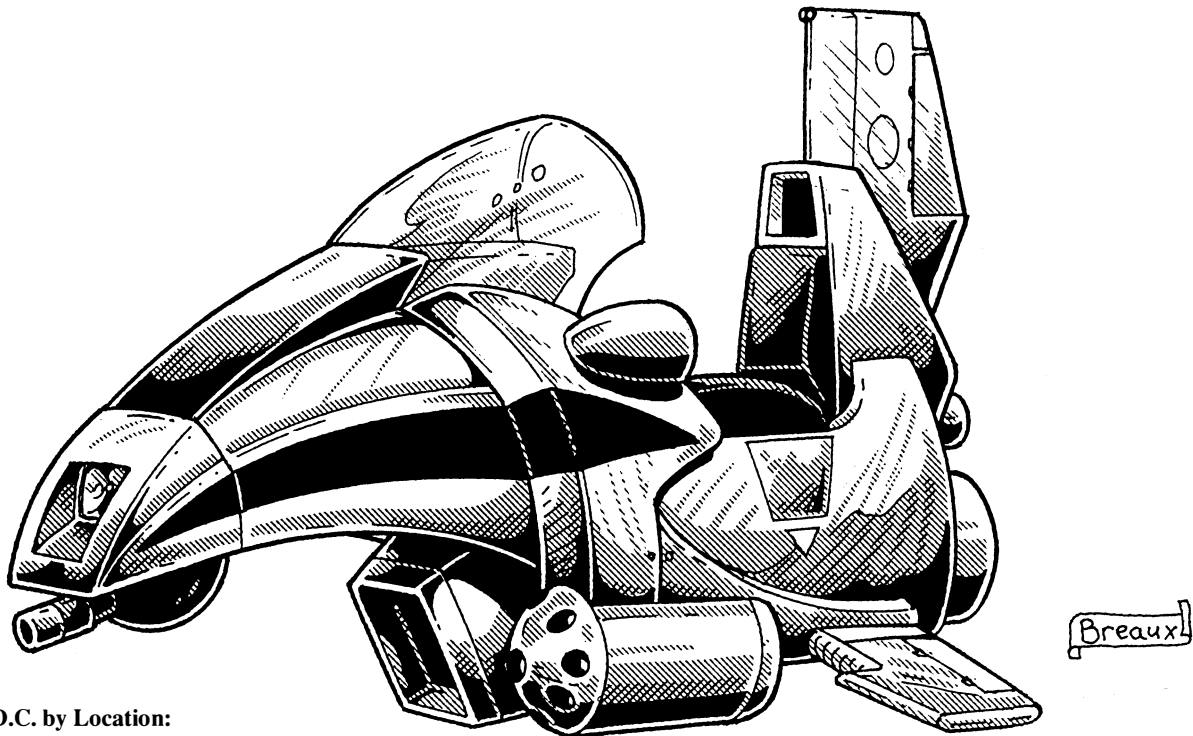

M.D.C. by Location:

- * Large Hover Jet (1; rear) — 38
- * Small Hover Jet (1; rear) — 15
- Side Hover Jets (2) — 30 each
- * Undercarriage Directional Jets (4) — 5 each
- * Side Stabilizing wings (2) — 18 each
- * Tail Fin (1; large) — 28
- * Forward Headlights (1) — 4
- * Forward Laser Turret (1) — 6 each

Windshield (1) — 18

Main Body — 80

* Optional Weapons typically have 2D6+14 M.D.C. each.

Add 30% to all M.D.C. for the deluxe, armored model, but also add 30% to the cost.

A single asterisk indicates small and/or difficult targets to hit and requires the attacker to make a “called shot,” but even then the attacker is -4 to strike. The driver, hunched down, low to the body of the hovercycle, is equally difficult to hit.

Cost: 182,000 credits gasoline engine or 195,000 credits for electric, or 875,000 nuclear with a 10 year life.

Weapon (Standard): Comes equipped with the following:

Heavy Laser: 2D6 M.D., range is 2000 feet (610 m), payload is 40 shots.

Weapon Extras (optional): Weapon extras are full price even during sales.

Light Laser: 1D6 M.D., range is 1200 feet (366 m), payload is 40 shots. Cost: 16,000 credits.

Heavy Laser: 2D6 M.D., range is 2000 feet (610 m), payload is 40 shots. Cost: 30,000 cr.

Machinegun: Not suitable for the Prowler.

Dual Mini-missile Launchers: As many as two launchers can be added; one on each side. The small launchers fire two mini-missiles each, payload is two each; manual reloading (not possible while moving). Cost: 55,000 credits.

Weapon Note: The large multi-shot missile pods or more than three weapon systems reduces the speed by 10%, reduces the prowl ability by -20% and negates the +5% piloting bonus.

Note: This vehicle is only occasionally purchased and used by the CS Military.

NG-400 Stinger

The NG-400 is a sleek, low profile hovercycle with good handling and speed. The illustration shows the two most popular weapon combinations, a double-barrelled laser (or machinegun and laser combo) and a pair of multi-shot mini-missile pods. Two additional small weapons, like a pair of dual mini-missiles or a pair of side mounted (single barrel) lasers could be mounted on the sides of the forward section, but would reduce speed by 10%.

Vehicle Type: Combat Hovercycle

Crew: One rider; no space for a passenger.

Special Bonuses: Low profile makes it a bit more difficult to hit: +1 to dodge and see “called shot” penalties under M.D.C. by location.

Penalties: -5% on piloting skill roll when making sudden stops or elaborate stunts. Speed penalties from weapon mounts (-20% maximum piloting skill penalty); -10% for multi-shot missile pods and another -10% for any weapon systems beyond three.

Maximum Speed: 250 mph (400 km)

Maximum Altitude: 200 feet (61 m) and can handle drops of up to 600 feet (183 m).

Maximum Range: 800 miles (1280 km)

Engine: Typically combustion or electric engine; nuclear is available.

Length: 12 feet (3.6 m)

Weight: 850 lbs (382.5 kg)

M.D.C. by Location:

- * Rear Hover Jets (2) — 25 each
- * Concealed Directional Jets (6) — 5 each
- * Undercarriage Directional Jets (4) — 5 each
- * Forward Headlights (2) — 5 each

Tail Fin (1) — 28

Windshield (1) — 18

Main Body — 90

* Optional Weapons typically have 2D6+14 M.D.C. each.

Add 30% to all M.D.C. for the deluxe, armored model, but also add 30% to the cost.

A single asterisk indicates small and/or difficult targets to hit and requires the attacker to make a "called shot," but even then the attacker is -5 to strike. The driver, hunched down, low to the body of the hovercycle, is equally difficult to hit.

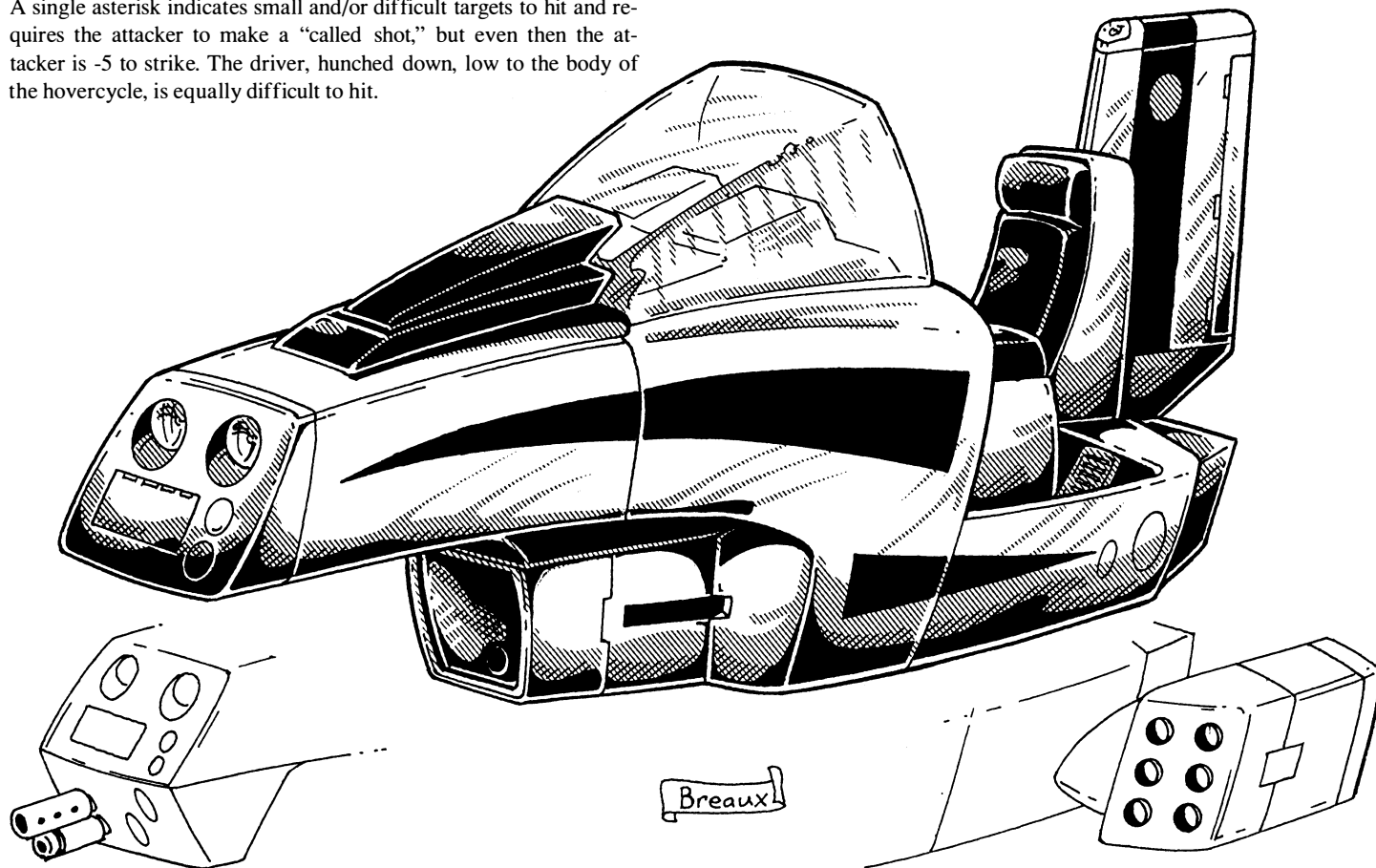

Cost: 180,000 credits gasoline engine or 200,000 credits for electric, or 795,000 nuclear with a 10 year life.

Weapon Extras (optional): Weapon extras are full price even during sales.

Light Laser: 1D6 M.D., range is 1200 feet (366 m), payload is 40 shots. Cost: 16,000 credits.

Heavy Laser: 2D6 M.D., range is 2000 feet (610 m), payload is 40 shots. Cost: 30,000 cr.

Double-Barrel Heavy Laser: 2D6 M.D. per single shot, 4D6 damage per simultaneous double shot, range is 2000 feet (610 m), payload is 40 shots. Cost: 58,000 cr.

Machinegun: 1D4 M.D. per burst of 50 rounds, range: 2000 feet (610 m), payload is 1200 rounds (24 bursts). Cost: 5000 cr.

Dual Machinegun & Heavy Laser: Same stats as above, just combined into one weapon housing; only available for the nose. Cost: 34,000 cr.

Dual Mini-missile launchers: As many as four dual launchers can be added; two on each side (front, rear or undercarriage). The small launchers fire two mini-missiles each, payload is two each; manual reloading (not possible while moving). Cost: 55,000 credits each.

Mini-Missile Pod (Multi-Shot) Launcher: Payload: 12 mini-missiles. Rate of fire: one at a time or 2, 4, or 6 simultaneous. The size, sleek shape and sturdy frame allows for the use of missile pods that stick out from the body. However, these pods cause some drag and reduces maximum speed to 225 mph (360 km). Cost: 100,000 each.

Note: A total of three lasers weapons (or two machineguns with ammo drums) and four dual mini-missile launchers or two multi-shot launchers can be installed on the heavy, sleek body of the NG-400; six dual launchers or four dual and two multi-launchers if used in place of two lasers.

Note: This vehicle is frequently purchased and used by the CS Military, with hundreds of thousands in service.

NG-480 Turbo

The latest and most advanced of the combat bikes is the 480 Turbo. It sacrifices speed for handling and maneuverability nearly the equal of the NG-300 Speedster. Although it does not offer the *prowl* ability, the Turbo runs quietly, and performs Vertical Take-Offs and Landings (VTOL), hovers in mid-air, and handles like a dream. It some comes standard with a double-barrel, ball laser turret that can turn side to side 180 degrees and up and down in a 45 degree arc of fire. Like the MI-3000 Firefly, the Turbo features a pair of ball-action hoverjets in the rear (knock-offs of the MI design). The two ball-action hoverjets provide excellent handling and mobility, while the two jets above it can be kicked in at any time to provide maximum speed. If there is a design flaw, it's that the Turbo tends to be nose heavy, making stunts and jumps a bit tricky.

Vehicle Type: Hovercycle

Crew: One rider, and one passenger can sit behind the driver, but it makes for a cramped ride and is not comfortable even on short trips and imposes a -5% piloting skill penalty.

Special Bonuses & Penalties: The Turbo handles well and the driver gets a +1 to dodge and a +5% bonus to his piloting skill for basic driving and maneuvers. However, it is -10% when executing jumps and special stunts.

Maximum Speed: 220 mph (352 km)

Maximum Altitude: 400 feet (122 m) and can handle drops of up to 400 feet (122 m).

Maximum Range: 800 miles (1280 km)

Engine: Combustion or electric engine.

Length: 11 feet (3.3 m)

Weight: 1000 lbs (450 kg)

M.D.C. by Location:

- * Rear Hover Ball Jet Housing (2) — 40
- * Rear Jet Boosters (2) — 35 each
- * Undercarriage Directional Jets (8) — 4 each
- * Forward Headlight (1) — 5
- * Forward Laser Turret (1) — 32
- Reinforced Windshield (1) — 20
- Main Body — 92

Add 30% to all M.D.C. for the deluxe, armored model, but also add 30% to the cost.

A single asterisk indicates small and/or difficult targets to hit and requires the attacker to make a "called shot," but even then the attacker is -4 to strike. The driver, hunched down, low to the body of the hovercycle, is equally difficult to hit.

Cost: 225,000 credits for gasoline combustion engine or 240,000 for electric, or 850,000 cr. nuclear with a 10 year life.

Weapon (Standard): Comes equipped with the following:

Double-Barrel Heavy Ball-Laser: The nose-gun does 2D6 M.D. per single shot, 4D6 damage per simultaneous double shot, range is 2000 feet (610 m), payload is 60 double shots or 120 single. Cost: 80,000 cr.

Weapon Extras (optional): Weapon extras are full price even during sales.

Light Laser: 1D6 M.D., range is 1200 feet (366 m), payload is 40 shots. Cost: 16,000 credits.

Heavy Laser: 2D6 M.D., range is 2000 feet (610 m), payload is 40 shots. Cost: 30,000 cr.

Double-Barrel Heavy Laser: A second double-barrel system is not possible on this vehicle.

Machinegun: Not appropriate for this vehicle.

Dual Mini-missile Launchers: As many as two dual launchers can be added; one on each side. The small launchers fire two mini-missiles each, payload is two each; manual reloading (not possible while moving). Cost: 55,000 credits each.

Mini-Missile Pod (Multi-Shot) Launcher: Payload: 12 mini-missiles. Rate of fire: one at a time or 2, 4, or 6 simultaneous. The size, sleek shape and sturdy frame allows for the use of missile pods that stick out from the body. However, these pods cause air drag, reducing maximum speed by 15% and can only be mounted on the front, increasing the nose-heavy problem (which negates the piloting bonus and makes doing stunts -15%). Cost: 100,000 each.

Note: A total of two additional weapon systems can be added.

Note: This vehicle is frequently purchased and used by the CS Military, with a few hundred thousand in service.

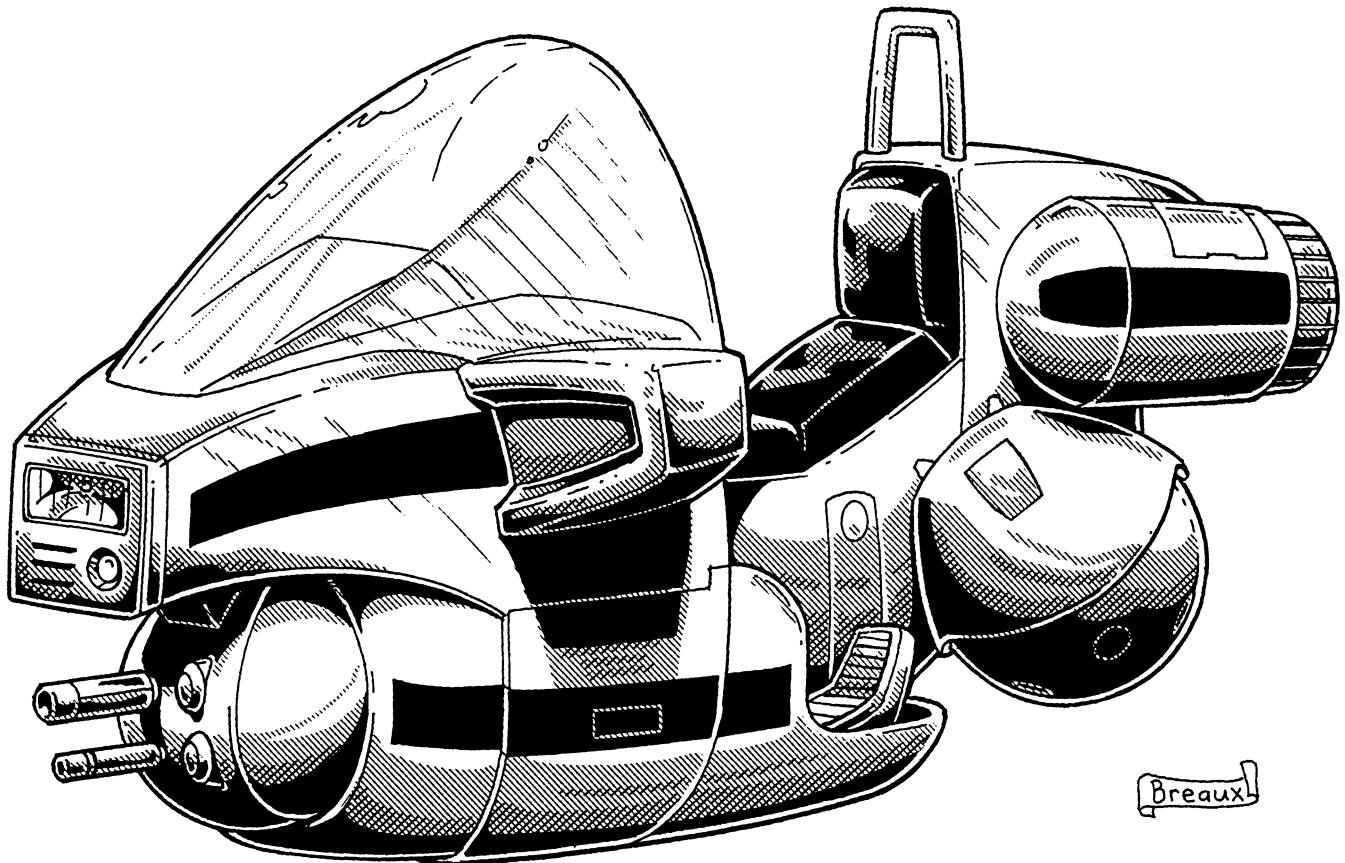

Breaux!

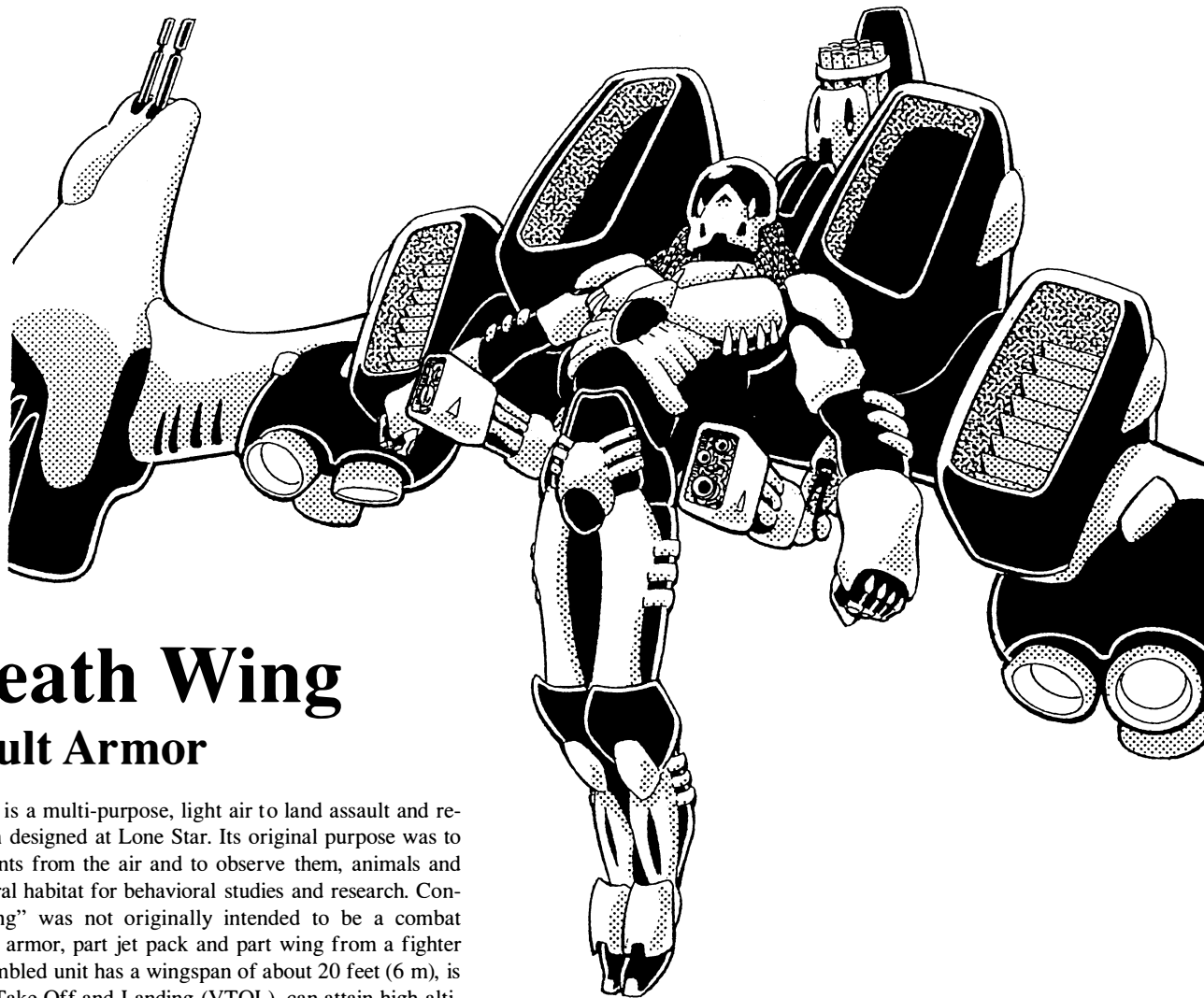

CS Death Wing

Air Assault Armor

The Death Wing is a multi-purpose, light air to land assault and reconnaissance system designed at Lone Star. Its original purpose was to track runaway mutants from the air and to observe them, animals and D-bees in their natural habitat for behavioral studies and research. Consequently, “the Wing” was not originally intended to be a combat weapon. Part power armor, part jet pack and part wing from a fighter aircraft, a fully assembled unit has a wingspan of about 20 feet (6 m), is capable of Vertical Take-Off and Landing (VTOL), can attain high altitude (where it can observe subjects through telescopes without them knowing it) and has impressive speed and mobility. Its speed is enough to match some jets’.

The Wing was in use at Lone Star for six years before one of the engineers at Chi-Town recognized its potential as a weapon for war. Since then, the Wing has been modified for combat, bristles with weapons, re-named the Death Wing, and has been put into mass production — although there are infinitely fewer Death Wings than SAMAS, perhaps as many as one for every 50 Sams. Some suspect that the Vallax Aliens, under the guise of Ultra-Tech Industries (UTI) at New Town (before they were destroyed during the Juicer Uprising), got the idea for the *Icarus Flight System* from Lone Star’s flying Wing. Ironically, the Death Wing, although slower than the Icarus, proved to be a fairly good countermeasure against the Icarus Flight System and was one of many reasons to increase the production and distribution of the Death Wing.

The “wing” portion of the CS flight pack is detachable and can be worn normally for flight, or it can be operated via remote control. Experienced pilots can direct the jet pack by remote control from the ground, ordering it to attack designated targets while they hide among ground cover at a safe distance. The pack is attached to the pilot’s armor by a special magnetic seal, and can be removed in a matter of seconds (detaching from the Death Wing counts as one melee attack/action). However, unlike the flamboyant Juicers, the majority of CS pilots usually stay “Jacked-in” to their flying wing the entire time. The moment the magnetic seals lock, connectors from the wing to the armor automatically engage, linking the power armor flight suit to the onboard computer of the wing. This instant connection gives the pilot complete control over the entire wing, its engines, speed, weapons, cameras — everything. The computer responds to verbal commands and codes

as well as an emergency, manual override (the controls are concealed in the left forearm of the power armor).

The special Death Wing Power Armor is a lightweight suit with reinforced mega-damage ceramic plates (light but hard as steel). The legs, waist and back can lock into one solid piece — like a board — to prevent unnecessary stress on and to the spine and back muscles, especially when travelling at high speeds. The armor can detach from the wing at any time, enabling the pilot to drop, paratrooper like, from the flying wing at low speeds or while hovering. The remote control aspect of the wing (using the concealed arm controls) enables the pilot to make the wing hover low enough for him to lean into or hop into connection position. **Note:** The armor has 180 M.D.C., a P.S. of 28, doubles the wearer’s normal running speed (he can leap up to 10 ft/3 m high or across), and weighs about 160 lbs (72 kg).

The helmet is equipped with several sound muffling measures to muffle the sound of the jet engines, and it still sounds like a dull roaring in the ears. All regular Death Wing pilots also have the cybernetic *sound filtration* system and *headjack*, as well as *clock calendar*, *gyro-compass* and *oxygen storage cell*. The one-way visor (the pilot can look out, but others can’t look in and see his face) is designed with the most advanced Heads Up Display (HUD) system which displays computer data, speed, altitude, damage levels, etc., but also enables the pilot to see everything seen by the telescopic eyes and cameras of the two *robot arms* — split screen can show two different directions at once. In fact, the pilot usually does most of his “seeing” through the cameras of the robot arms. The arms have telescopic, macro, infrared, passive night-vision and thermo-optic systems (4x, 10x, 20x, and 40x magnification; 6000 ft/1830 m range). One of the Death Wing’s most unique features

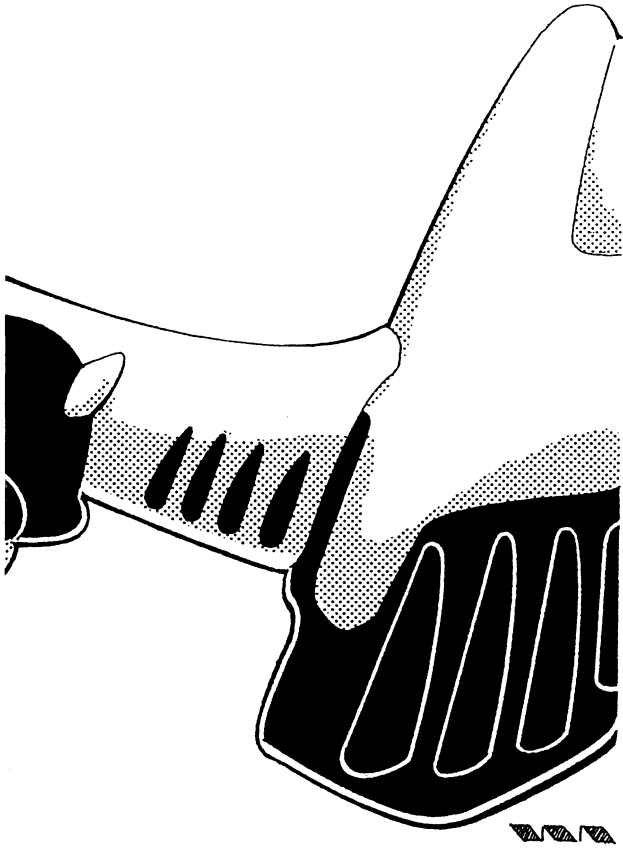

is its robot arms. Each arm contains a multi-optic sensor system and cameras with long-range telescopic lenses and 24 hour video film capabilities. A laser is also contained in each arm for additional protection.

The Death Wing is best suited for aerial combat and escort, air to ground travel, combat and reconnaissance in open country (plains, prairies, deserts, etc.) where there is little or no tall trees. The wide wing span makes it virtually impossible to fly through woodlands without smashing through trees and tree branches. Striking large trees can cause weapons to become unaligned (-4 to strike), and bent (cannot shoot), or scratch and dent the mega-damage wing, and clog the air vents and jets. More importantly, it shakes and batters the pilot, inflicting minor to major damage (the power armor suit only affords so much protection), vision is obscured by the vegetation and shaking/battering, and the smashing branches makes enough noise to wake the dead, giving animals ample warning to flee and humanoid quarry time to run or hide. On the open plains, the Death Wing (and to a slightly lesser degree, SAMAS') are fast and deadly, earning their title.

Disassembled (3 pieces), the modular wing section of the vehicle can fit in the bed of a pickup truck, allowing for easy transport, storage and concealment.

Model Type: AAA-Combat Wing Models PA-101W (combat) and PA-102W (reconnaissance)

Class: Wing Combat Flight System

Crew: One

M.D.C. by Location:

*** Wings (2) — 210 each

Main Thrusters (2; center, near pilot's body) — 100 each

Directional VTOL Thruster Pods (2; center, near pilot) — 60 each

Secondary Thrusters (2; wing tips) — 130 each

* Twin Lasers (2; in Secondary Thrusters) — 22 each

* Top Mounted Weapon System (1; rail gun or missiles) — 80

* Robot Arms (2) — 40 each

** Main Body of Wing — 290

* Pilot in AAA Power Armor — 180

* A single asterisk indicates small or otherwise difficult targets to hit. A "Called Shot" is needed to hit it and the shooter is -3 to strike.

The pilot of the Death Wing is in the open, and can be targeted by a "Called Shot." However he is a small target protected by the jet ports, wings and robot armor, making him a difficult target to hit: -4 to strike on a Called Shot. The pilot's M.D.C. body armor protects as normal. Killing the pilot will cause the wing to switch to autopilot and return to its base of origin at maximum speed. The wing's computer constantly monitors the pilot and knows when he is severely injured or dead. The same happens if the pilot gives a homing command (return to base) or falls unconscious.

** Depleting the M.D.C. of the main body causes the aircraft to crash.

*** Destroying one side/half of the wing (145 M.D.C.) will cause it to spin and crash. Destroying one of the Secondary Thrusters has no obvious effect; destroying both reduces speed by 10% and inflicts a penalty of -1 to dodge. Destroying one of the main thrusters reduces speed by 25%; destroying both reduces speed by 50% and inflicts a -4 to dodge and -3 on initiative/response time. Destroying one of the directional thrusters reduces speed by 15%; loss of both reduces speed by 30% and makes precision maneuvers difficult; -2 to dodge, -2 on initiative.

Speed:

Driving on the ground: Not possible.

Flying: Up close to Mach One, 600 mph (960 km)! Only the special AAA power armor or a Juicer, 'Borg or supernatural creature could survive the G-forces and stress placed on the pilot. Cruising speed is usually 200-400 mph (321-640 km); VTOL capable.

Range: Although the nuclear power supply lasts for years, the jets need cooling off after 18 hours of continuous use at cruising speeds, or nine hours at maximum speed.

Maximum Altitude: 16,000 feet (4876.8 m)! Can fly as low as two feet (0.6 m) above the ground with the pilot in a prone/flat position. Sensors enable the Death Wing to follow the contour of the ground while adjusting and maintaining the two foot (0.6 m) height even at maximum speed, although most pilots seldom dip below four feet (1.2 m). Flying in the prone/flat position makes the wing and especially the pilot, difficult, high speed, moving targets to hit (pilot, called shot at -4 to hit and -2 to hit the Death Wing in general).

Statistical Data:

Height: 7 feet (2.1 m)

Width/Wingspan: 20 feet (6 m full wingspan).

Length: 5 feet, 5 inches (1.65 m)

Weight: 1.3 tons

Cargo: None.

Power System: Nuclear; average energy life is five years.

Market Cost: 4.3 million credits. Not available on the Black Market, but see the Icarus Flight Wing for a similar Juicer/'Borg system (**Rifts® Juicer Uprising**, page 86-88, for details).

Note: With UTI (the Vallax Alien's human front) gone, it is rumored that Northern Gun, the Manistique Imperium and/or Kingsdale will be manufacturing the Icarus. The Coalition has issued a strong request to their new allies, Northern Gun and Manistique Imperium, *NOT* to manufacture the Icarus because it is a powerful combat vehicle outlawed by the CS and used by rebels and bandits (including the Pecos Empire). The two nations are weighing whether they should respect the request (probably) or move forward with production. Whether *Kingsdale* really has the technology and plans to build the popular Icarus is unknown at this time (the CS believes they are).

Weapon Systems

1. High-Powered Wing Laser Guns (2): A pair of double-barrelled lasers are built into both of the wing tips where the Secondary Thrusters are located. These weapons point forward but can be raised and lowered in a 25 degree arc of fire. They can be used to strafe ground targets and engage in aerial combat.

Primary Purpose: Anti-aircraft

Secondary Purpose: Anti-personnel and ground vehicles.

Mega-Damage: 4D6 M.D. per single blast, 8D6 (or 1D4×10+8) per simultaneous double blast (counts as one melee attack) from one wing, 2D4×10+12 from a quadruple blast from *both* wing guns, but the target must be at least 22 feet (6.7 m) wide for both wing guns to hit (counts as one melee attack).

Rate of Fire: Equal to the number of hand to hand attacks of the pilot.

Effective Range: 4000 feet (1220 m)

Payload: Effectively unlimited.

2. Short-Range Robot Arm Lasers (2): A pair of lasers are built into the robot arms. These are comparatively short-range lasers used in dog fights, strafing runs and precision targeting. The robot arms can be raised and lowered, flipped forward and backward 300 degrees, providing a huge arc of fire. They can also swivel side to side in a 180 degree arc of fire.

Note: The main purpose of the robot arms is to be the eyes of the pilot and for observation/reconnaissance.

Primary Purpose: Anti-aircraft

Secondary Purpose: Anti-personnel and ground vehicles.

Mega-Damage: 2D6 M.D. per single blast, 4D6 per simultaneous double blast (counts as one melee attack) from both arms.

Rate of Fire: Equal to the number of hand to hand attacks of the pilot +1 attack per melee.

Effective Range: 2000 feet (610 m)

Payload: Effectively unlimited.

3. Top Mounted Weapon System (1): This can either be a rail gun or mini-missile launcher. Both can turn side to side 180 degrees and up and down in a 45 degree arc of fire. This is a main battle weapon ideal for anti-aircraft, anti-missile and dog fights. Pick one: Rail gun is standard, missile launcher optional.

CAAA-60R Rail Gun (1): This is standard equipment for the Death Wing, but can be substituted with a mini-missile launcher.

Primary Purpose: Assault

Secondary Purpose: Defense

Weight: Gun: 150 lbs (67.5 kg), with built-in Ammo-Drum: 250 lbs (112.5 kg).

Mega-Damage: A Burst is 40 rounds and inflicts 1D4×10 M.D., one round does 1D4 M.D.

Rate of Fire: Equal to number of combined hand to hand attacks (usually 4-6).

Maximum Effective Range: 4000 feet (1200 m)

Payload: 6000 round drum, that's 150 bursts. Reloading a drum will take about five minutes and requires a small crane or SAMAS power armor.

Mini-Missile Launcher (optional): Used in place of the rail gun.

Primary Purpose: Anti-aircraft

Secondary Purpose: Defense

Mega-Damage: Varies with missile type.

Rate of Fire: One at a time, or in volleys of 2, 4, or 6 mini-missiles.

Effective Range: About one mile (1.6 km).

Payload: 18 total.

4. Hand-Held Weapons: The AAA Death Wing pilot typically has an ordinary survival knife and a vibro-knife locked and concealed in the boots. An energy rifle can be slung over the chest and a side-arm at the waist, but in both cases, flying at speeds above 350 mph (560 km) is likely to pull the weapons loose (or out of one's hand), causing them to fall to the earth.

5. Other features of Note: Basically the same standard features of all CS power armor.

6. Bonuses: In flight and while attached to the Death Wing: +2 on initiative, +1 to strike, +2 to dodge, +1 attack per melee round (from robot arms) — all in addition to power armor combat training bonuses and abilities. None for the light power armor without the Death Wing.

GED Mutant Experiments

The Coalition's obsession with maintaining the purity of the "true" human race is the motivation for the creation and enslavement of mutant animals. This sentiment also prevents more radical experimentation (except for those conducted in secret by Desmond Bradford). The idea is to create an ignoble, inferior race of beings that can serve (and die for) the sake of the Coalition States. This purist mentality makes it illegal to conduct anything other than a very narrow spectrum of human genetic manipulation. Experimentation involving genetic alteration on humans, even enemies of the States, is strictly forbidden. Mutant animals, on the other hand, are created as laborers, soldiers, and special operatives, especially useful in combat and the taming of the vast wildernesses of North America. They are usually dispatched to areas where the threat to **human** life is deemed too great — why endanger human life when an "animal" can pave the way? It is important to mention again, that the humans of the Coalition Military, government and States consider these intelligent, humanoid mutants to be nothing more than souped-up — enhanced — animals. The mutant's training, orientation and genetic construction is all (generally) designed to reinforce this belief, the most successful of which are the Dog Boys. Although outsiders and enemies of the CS contend this is nothing more than cruel arrogance and slavery, the CS asks, one, how can one enslave an animal, and two, if the animal is happy and does not consider itself a slave (if they are even capable of such a distinction), is it a slave or a willing partner? The vast majority of Dog Boys (over 85%) contend they are willing and happy partners. A paradox that may never be unravelled. The most famous of the Coalition's mutant animal creations are the nefarious Dog Pack. Although other mutant animals exist, especially in and around the Lone Star Complex, GED, the City of Lone Star and the State of Lone Star, the one animal used above all others is the dog (typically outnumbering all other mutants combined by 3000 to one). The canine has proven to be the most intelligent, loyal, reliable and desirable of all animals for several reasons. There is a less complete understanding of the DNA and behavior of other animals, making it infinitely more difficult to create the desired effects, particularly in the areas of control and obedience.

Where do exotic test animals come from?

Exotic animals like apes, hyenas, vampire bats, tigers, leopards and African lions are available to the CS in North America from *zoo* animals that escaped and survived the Great Cataclysm (many of which, such as the tiger, have adapted well and thrive in the Americas). Exotic animals can also be captured or purchased and imported from distant lands for the purpose of research.

Remember, through the perfection of the **cloning process**, the scientists at GED only need *one* animal in order to create hundreds. Additionally, it is easy for the genetic engineers to "tweak" the clone's genetic structure to make a member of the opposite sex for the purpose of conventional breeding.



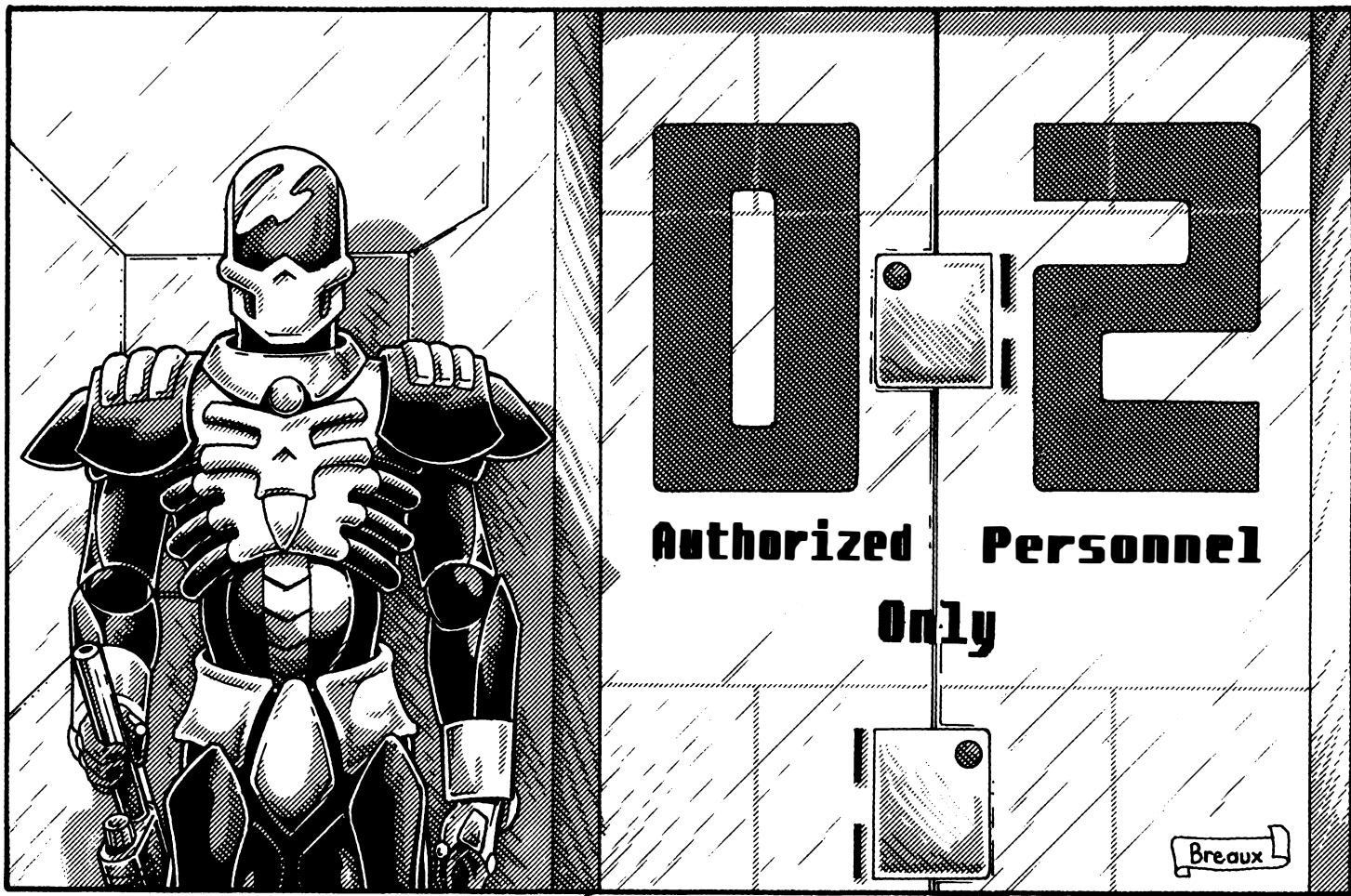

Well Kept Secrets

The secrets of genetic engineering is the Coalition States' most highly guarded secret. Only Lone Star and Chi-Town have genetic institutes that are *allowed* to explore this area of science. Most researchers in these Divisions are among the best minds in the nation and all must participate in an unbelievably rigorous program of security and secrecy. The slightest impropriety will bring the individual under the scrutiny of their authorities and constant surveillance. Those even suspected of military or industrial espionage, or treason, are brutally interrogated (physical and emotional torture, mind probes, drugs, etc.). The lucky ones are mind wiped by CS Mind Mages or via brain surgery or implants, and placed in low positions, away from military secrets and monitored for the rest of their days (another bad step means execution). Those who know too much may be imprisoned and periodically interrogated for life, while those found guilty of espionage or treason are executed. Only Desmond Bradford's direct link to Emperor Prosek and the absolute power over GED at the Lone Star Complex given to him by the Emperor enables the madman to get away with things nobody else could ever dream of. If the Emperor should ever learn about what's going on at GED, he will be shocked and horrified, and the entire program at Lone Star will be shut down until an extensive investigation and purge can be completed. All those who worked willingly with Bradford will be executed, Bradford included. Of course, the public will never hear a word about any of this. **Note:** Nobody (not even the Emperor) has any inkling of just how advanced (or how far Bradford has taken) the Coalition's knowledge and expertise in genetics really is.

Practical Genetic Engineering

The mutants presented throughout this book, from Dog Boys to the Xiticix Killer, are all extreme examples of genetic engineering, manipulation and research that have effectively created new species of intelligent, humanoid life forms. However, there are hundreds of more subtle and amazing things that can be done through genetic engineering. This book touches only lightly upon some of them.

The Coalition States entered the arena of genetic engineering with a bang when they discovered the Lone Star Complex. Not only did they have a hundred and fifty years of American scientific research dropped in their laps, but they had the US Military's most advanced, top secret Genetics research and development facility at their disposal. Virtually untouched by the Great Cataclysm, the CS recovery teams, under the supervision of the (mad) genius, Desmond Bradford, had a relatively easy time bringing the installation back on line. The US Military had the Dog Boy program in full swing (99% finished) and were about to embark on the creation of their first mutant canines when the Rifts erupted and obliterated the civilization around the world. In fact, the most time consuming aspect of the "Psi-Hound Program" was not the creation of the mutant canines, but determining the best program for raising and training, controlling and regulating them; not to mention the political hot potato and public relations campaign necessary to introduce these *inhuman* beings into a society of human supremacists.

Over decades of research, the whiz-kids at GED have finished mapping (many were 50% to 90% done by the old American scientists) the DNA of dozens of animals and have developed ways to alter them in a hundred precise ways, from the color of their eyes or fur, to whether or

not they like (and instinctively know how) to swim. Their exact structure can be replicated with a 99.6% level of accuracy in clones, 94.8% accuracy in individual genetic reconstruction and manipulation, and 89.7% in careful, selective breeding with a pair of genetically ideal “seed” parents.

Simple Genetic Augmentation

The more *practical* use of genetic manipulation has nothing to do with creating new life forms or human-like mutants, but *improving* animals and humans in small but *significant* ways. The following list indicates just some of the things they can do with *animals*. **Note:** 95% of all these things have been kept completely secret from the public, although they may be used or available in everyday life without the average person knowing it. Others are secrets locked away and *seldom* used, except for limited Military purposes. The reasons are simple and insidious:

1. They don’t want others to learn about genetics or have access to the benefits of genetic based science and medicine, because it is a source of incredible power (and luxury).

2. They don’t want people to try to duplicate them. Currently nobody in North America and few anywhere in the world (other than the enigmatic aliens known as Gene-Splicers) are involved in genetic research and development — and those who do are light years behind the CS (the technological equivalent of a ball and musket firearm compared to the latest CS laser rifle).

3. They don’t want to help D-Bees or humans outside the Coalitions States. The Coalition States’ prosperity and strength helps to demoralize the enemy.

4. It helps the CS government to keep their people happy and complacent, as well as attract potential allies who would like to benefit from what the CS has to offer.

Think about it, why create a genetically enhanced animal and release it on the open market? Such improvements can only *help* CS enemies and those whom the CS is trying to subjugate.

Some examples of small changes that can make a huge impact on the lives and survival or independence of people include: Bigger, meatier, healthier cattle; crops resistant to specific (past) insect predators or diseases (a bigger yield); crops or animals that are bigger (reduce food prices and risk of famine); horses with double their normal stamina (can run at full speed twice as long and carry greater weight), or bigger and stronger horses to carry or pull larger loads (and carry giant-sized D-bees); or increased animal intelligence so that a dog, horse, etc., has a better comprehension of language, giving it a larger vocabulary so that it may be able to understand phrases and even simple sentences and follow simple instructions (i.e. plow the field like I showed you)!

Even if these genetically improved animals were “designed” so that their unique traits could not be bred through offspring (making them sterile is probably the easiest), their unique appearance, traits and features will make them obviously different and encourage others to find out why and duplicate them.

This is a perfect example of how knowledge translates into power. The Coalition States expertly uses their superior knowledge and technology (and the power they breed) to their maximum advantage. They use it to manipulate, control and influence others. All the wonderful (secret) benefits of their genetic science are among the things that have the most obvious and long reaching benefits. Without the benefits of this

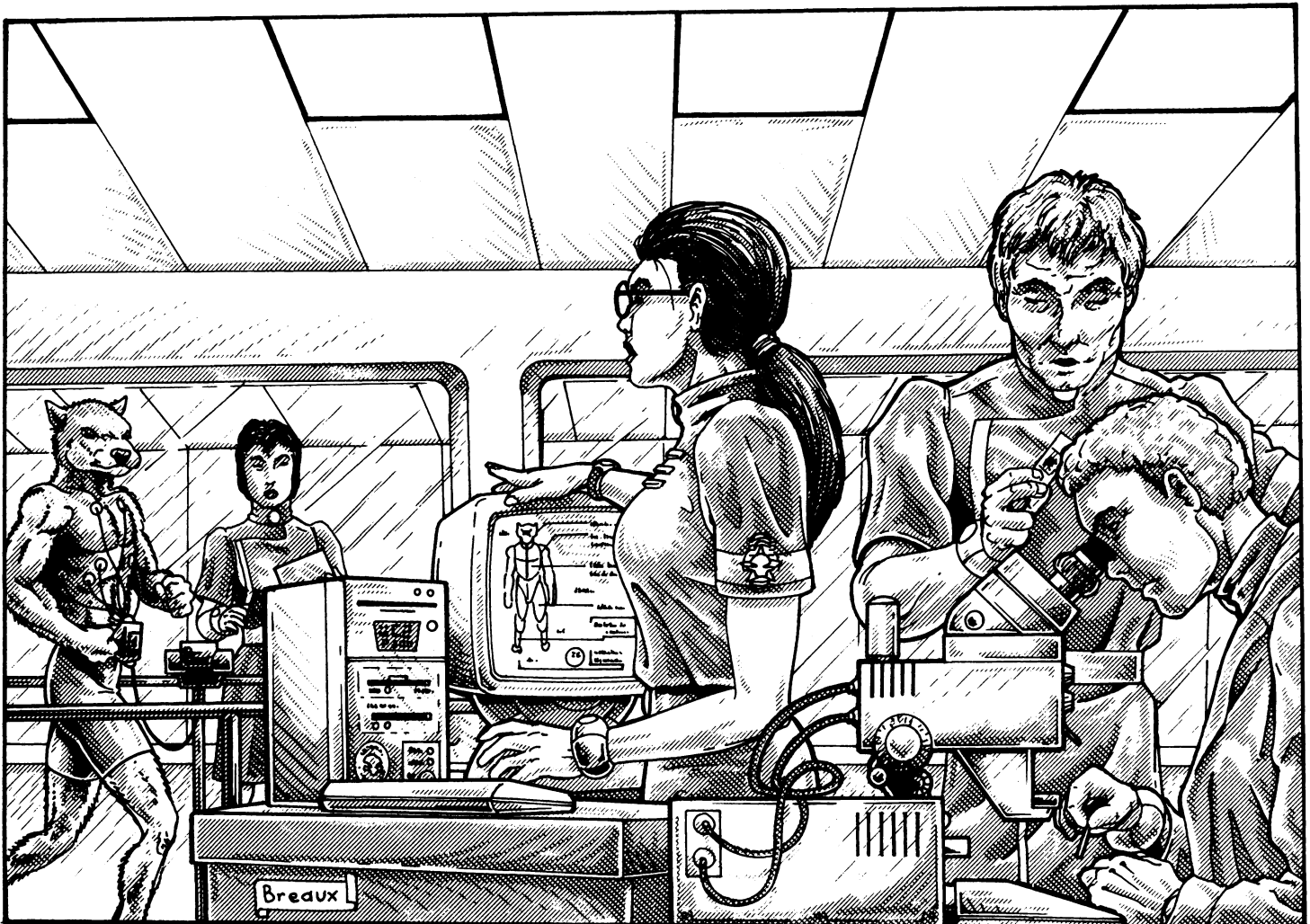

and other knowledge, CS enemies and independent kingdoms have a much more difficult time. It is hard to maintain a community, let alone keep peace or grow, when the people are starving or killing themselves with backbreaking labor. It is difficult to explain the benefits of remaining independent of the CS when the people have to struggle. It is even more difficult for a leader to watch his people die from a plague (perhaps secretly induced by the CS), knowing that the Coalition will gladly offer the cure and other assistance, provided the current government steps down and lets the people join the Coalition States (or provides a precious resource, betrays an ally, turns over a wanted criminal, etc.).

The Coalition's secrets of DNA gives them incredible knowledge and a tremendous power, not just over their enemies, but over their allies and their very own citizens! Even the elite citizens of the States don't know anything about these things. They don't know or care that the CS government controlled cattle ranches have genetically improved cattle (larger, healthier, tastier). Nor do the ranch or slaughterhouse workers, or anybody outside the CS, because genetic enhancements are used subtly and secretly. All the CS citizens know is that Coalition beef is plentiful, inexpensive and "DEEE-licious."

This carefully executed program of ignorance and complacency is all part of Emperor Prosek's master plan. A happy and complacent people don't condemn their leaders or question what they take for granted. Furthermore, by keeping the people blissfully uneducated and illiterate, they don't know what questions to ask or where to find answers for any questions they might raise. This creates blind faith and total dependency on their leaders and the infrastructure their leaders have created (government, military, communications system, etc.). Such dependency leads to an intense and desperate "need" to *preserve* everything they have, which in turn gives their leaders even more power over them — CS citizens are known to fight tooth and nail to preserve their nation and way of life.

How could the citizens of the CS have let this happen? Get real. The separation of fundamental knowledge and the average person who uses it occurs to varying degrees in every advanced civilization. Let's take a look at ourselves for a minute. Probably half the people reading this book know how to use a computer, but how many know how to program one? Probably a third as many as users. Now, how many actually understand how the computer works, well enough to fix hardware? Probably less than 5%. Okay, how many know how to make the microchips and processors and could build a computer? Probably zero. Along those lines, how many know how electricity works or even think about it when we turn on a light? Probably only when you lose electrical power and must wait by candle light until somebody else restores it. This can be said about almost everything. Do you know how your refrigerator works? How about your TV, or wristwatch, or the preservatives in your food? I don't. Probably 90% of those reading this book can drive (or plan to drive) an automobile, but probably less than 1% know how to repair one. If our car breaks down, we go to a repairman — we count on somebody else to fix our things or buy a new one. If there was nobody to fix the car and no way to buy one, we would walk or ride a bike — a sudden and dramatic drop in technology, and infinitely less efficient (more time consuming, tiring, etc.). This same basic principle applies to the world of Rifts Earth.

Emperor Prosek and the leaders of his regime have simply taken this principle (armed with super-technology) to the extreme. Keep people so uneducated, misinformed, distracted, complacent and dependent that they are easy to influence and control. In the case of the CS, the average citizen is dependent on the government for everything, from history to the latest news, to the manufacturing of everything they need or want, from entertainment, food and housing to medicine, science and military protection. Those in power have no intention of giving up that power, so they sure as hell aren't going to share or let leak the secrets of genetic engineering and all the related sciences.

Molecular Medicine

Likewise, CS citizens don't question why they don't get the same diseases that plague communities outside the States. Heck, most of them have never even heard of diseases like Parkinson's disease, Alzheimer's, Diabetes, muscular dystrophy, MS, AIDS, various types of cancers, and other diseases and ailments which the CS has learned to eliminate or control with drugs and treatments discovered from their genetic research. Even obesity and dieting is a thing of the past, at least for citizens of the Coalition States. **Note:** 80% of these cures or advancements in medicine were part of the treasure-trove of knowledge unearthed at the Lone Star Complex. They were commonplace in the American Empire and other advanced, pre-Rifts nations for decades before the Great Cataclysm.

Longevity

A note about life expectancies and aging: The existing level of medicine combined with the use of cybernetics (mechanical and bio-systems), nano-technology and medical treatment in the Coalition States provides the typical *human* citizen an average life span of 100-130 years (100-140 in Lazlo, 120-150 years in the NGR, and 140-200 years in the Republic of Japan), compared to an average life span of 45-90 years in the wilderness and "uncivilized" places (by CS standards, that's any place outside the States), even with medical and magical treatment. It is important to note, however, that this substantially lower range for life expectancy is largely due to the likelihood of *premature* death as the result of physical violence, murder, war, and disease. Another factor is the widely varying levels of technology (high and low), magic (high and low), comforts of life (from high to low), and exposure to intruding alien/D-bee bio-systems; from predators and disease to competing humanoids and alien animals. Life outside the Coalition States (and actually, we really mean life outside the Coalition Cities) is full of hardships that physically and mentally wears one down.

Through the wonders of modern medicine, with cybernetics, organ transplants, nano-mechanized medicine, and advanced medicine, the Coalition States (and in the last few decades, other independent kingdoms like Kingsdale and the Free State of Lazlo) possess the means to maintain a healthy body to at least 130 years old. Magic also serves some as a means to heal and slow the advance of aging.

Most of these (comparatively) simple techniques restores muscle and bone density, skin elasticity and keeps the neurological channels to the brain and body unclogged and lively. This gives the person a more youthful appearance and energy (typical of a person half his true age), in addition to a sharp memory and keen thought processes undiluted by age. However, maintaining the human mind has always been a more tenuous proposition. As the body ages, so does the mind. Replacing old and worn out internal organs, eyes and even entire limbs will help the body function across the board, and certain drugs can help adjust chemical imbalances, slow-downs, etc., but the functions of the brain still slowly deteriorate. Electrical impulses slow down or become too faint to be read properly or completely. Brain cells die and are not replaced as quickly as in the past and other things combine in a domino effect of deterioration. Even with the advanced technology and medicine of the Coalition, signs of mental deterioration usually became apparent around the age of 90-100.

At its simplest, old age (in this case, 90+ years) will lead to some level of forgetfulness and a slowing of the thought processes, problem solving, and quick response (reduce skill performance by -2D4%). This is usually accompanied by a marked decline in physical energy and endurance (tires more easily and prone to illness, etc.). As the deterioration continues, the person may suffer from short or long term memory loss, periodic confusion and even slower mental responses (-1D4x10% on skill performance). The worst case results in severe memory loss and forgetfulness (can't remember people, places, events, skills, etc.), delusions (don't know where they are, hallucinations, etc.), loss of body control (the shakes, bladder control, convulsions, etc.), and debilitating

maladies such as Alzheimer's and Parkinson's disease. In addition, the level of energy is at low ebb and the individual is easily fatigued and prone to illness (reduce skill performance by 2D4x10%). Of course, everybody ages differently, so there are some people in better condition at age 105 and those suffer from only the simplest deterioration till the day they die, age 150+.

A new lease on life. Before the Great Cataclysm, the life expectancy of the average American (and most of the old Empires) was 200! A person around 100 looked and felt like a person in their late thirties. A person between 120-150 looked to be in his forties or fifties and those approaching 200 looked to be in their sixties. More importantly, the mind stayed clear, sharp and vibrant till the end! This technology grew from man's understanding of his own genetic code and how the body works on a molecular level.

This fabulous technology has been in the possession of the Coalition States, or more to the point, Emperor Prosek, for 30 years. It has been locked away as *top secret* and for being too experimental (hardly; but it's a good cover). The Emperor has reserved its use for himself and his most trusted, elite heads of government, including, but not limited to, *General Cabot* (currently 83, looks 63 and has the vitality of a man half his age; he could live and serve the CS for another 50 years, as could the Emperor), *General Ross Underhill*, *General Charles Reed Baxter*, *General Loni Kashbrook*, *General Thomas Lopez*, and *General Apollo Lucitonis*, as well as Karl Prosek's wife (who thinks she's taking special vitamins), and *Doctor Desmond Bradford*. Of course, Joseph Prosek II will be eligible for (and knows of) this life extending treatment, but its not generally necessary till a person reaches his late fifties.

The "new treatment" is just one of the miracles to come out of the Lone Star Complex. It effectively revitalizes the body and cures/prevents/negates even the slightest mental deterioration that usually accompanies old age. Consequently, a 180 year old will look to be a healthy and spry 60 year old with a mind as sharp as a youth in his/her 20s, but with the experience of 180 years!

Clones

The science of life replication, or "cloning," was another of the wonders unearthed inside the Lone Star Complex — one can begin to see just how pivotal the discovery of Lone Star has been to the Coalition States. Of course, it has been Karl Prosek's brilliant use and distribution (or not) of this knowledge that has made the CS what it is today.

Cloning is the science of asexual reproduction/creation of multiple living organisms from a single group of cells. The organism, whether it be a bacteria or a Dog Boy, can be grown in a test tube or a surrogate mother. Through the cloning process, hundreds of identical life forms can be created from a single embryo or any proper sampling of cells taken from a test subject's body. This asexual procreation of multiple, identical individuals is generally reserved for use on animals and for scientific and military purposes.

On a simple level, the creation of identical clones is ideal for scientific research because of the uniformity of the cloned animals (little variation from one test subject to another), which means one tenth the number of animals are needed in research (compared to the past where 30 different animals might be required). Additionally, the cloning process enables the scientists to literally "recreate" successes and to grow test animals on demand (especially rodents and other simple animals that reach maturity in a month or two). Another, practical use of clones is to grow a large number of animals with the exact qualities one wants. Using the cattle example, the genetically altered animals, designed for the perfect steak, can be grown quickly by creating a hundred of them from a single source, and all grown simultaneously. Since most *animals* have a short gestation period and reach maturity in a few years (in the case of small animals, like rodents, in several weeks), the animal population or food supply can be replenished in an amazingly short period of time. These clones can be used to restock food reserves or as breeding stock for mating and the continuation of the herd through more conventional (and less expensive) means.

The cloning of humans is absolutely forbidden under any circumstance, although rumors and tales of human clones constantly circulate, especially among conspiracy theorists outside the CS.

Note: Physically identical clones will look exactly the same and possess many of the same personality traits and inclinations as the original model, however, each animal (just like twins to quintuplets) is individual and will develop its own quirks, likes, dislikes and personality traits. Such variations are not remarkable or noticeable in lab mice or cattle, but are evident in dogs, cats, horses, monkeys, primates, and other animals who associate closely with humans and already exhibit a more developed level of intelligence and personality.

Animal Genetic Enhancements

The following list indicates just some of the things the CS geneticists can do with *animal* embryos. Some of these alterations may have residual side-effects in the sense that it may slightly alter the animal's appearance, and in some cases, dramatically change it. For example, increased stamina or physical strength may make the animal look a bit bulkier/heavier and/or muscular. On the other hand, increased mass will be very obvious, making the creature look heavy and overweight.

Also note that such manipulations are performed at the embryo stage of development, and the animal grows to adulthood with the new genetic traits. For game purposes, as many as six genetic modifications can be made in any one test subject; blue eyes instead of brown is one, greater stamina is two, and so on.

Bradford and his maniacs have tried altering the genetic structure of adult and young animals with minimal success. The process is hideously painful, has a half dozen (negative) side-effects and works only 1% of the time.

Note: Game Masters and players can use the following list of genetic modifications to construct minor, augmented animal companions and pets, or as guidelines to help devise their own mutants, animals and humanoids. However, since the CS conceals these genetically altered animals and uses genetic augmentation very sparingly, such animals (and humanoid mutants) will be extremely rare. Furthermore, whenever the CS authorities recognize such GED creations, they are likely to confiscate or kill such genetic experiments on the spot and arrest the animal's owner as a thief and/or enemy of the Coalition States. After all, such animals could only be created by the CS and are therefore CS property.

For the basic stats and characteristics of over 200 different animals, check out Palladium's book of **Monsters & Animals, 2nd Ed.** Although specifically created for the fantasy RPG, the real life animals can be used in any game, and in addition to specific stats, there is a general stat guide for other animals of that kind. A peek at the **Ninja Turtles RPG** and various sourcebooks may also provide more ideas, powers and abilities for animal mutants.

Animals: Physical Modifications

Perfect color vision: The animal, such as a dog who sees in black and white, can be given color vision and 20/20 sight.

- **Night Sight:** The animal (or humanoid mutant) is given eyes that look and function like those of a cat's, with the slit appearance and passive light amplification (like a nightvision scope) — can see in *near* total darkness, but cannot see in total darkness. Not to be confused with true *nightvision* in which the creature (often supernatural) can see in total darkness.
- **Increase and decrease mass (10% to 50%):** Typically disproportional weight/mass for its size. The animal is husky, even fat looking. This can be used to make bigger and meatier cattle. Proper adjustments in its DNA code can even be made to enhance the flavor of the processed meat. Increase or decrease S.D.C. and hit points by the same percentage, but reduce speed, P.E. and attacks per melee by half!

- **Increase and decrease size (10% to 50%):** This is a proportional increase of height and weight/mass to match body size. This might be done to make a horse bigger to accommodate a larger rider, or to make a dog more menacing looking. A small size might be done to make the animal more suitable (and manageable) as a pet, attractive as to a particular consumer group or for special work (like travelling through small openings/tunnels, etc.). Adjust P.S., P.E. and other attributes and damage from attacks, proportionally. Also increase or decrease S.D.C. by the same percentage; hit points are not changed.
- **Increase stamina/Physical Endurance (10% to 200%):** This can be proportional or disproportional with the animal's size. For example, a horse or other work animal (dog, ox, mule, camel, etc.) may have normal stamina doubled so it can run at full speed twice as long and carry greater weight, or pull heavier loads, work the fields longer, etc. The animal would also require less care in regard to concerns about fatigue. Adjust P.E., Spd. and S.D.C. proportionally with the animal's stamina (up or down).
- **Supernatural Physical Endurance:** This seems to work only on *huge animals* that are at least twice the size and 3-5 times the mass of humans, such as tigers, bears, elephants, rhinos, bulls, dinosaurs, and giant-sized mutants (see the Ursa-Warriors). This phenomenal endurance means the animal can work, run or fight for hours with little or no sign of physical exhaustion; ideal for hauling heavy loads and strenuous work.
- **Increased Physical Strength (10% to 50%):** The animal's usual P.S. attribute can be increased up to 50%. Adjust the P.S. attribute and damage bonuses proportionally (i.e. a P.S. of 14 is increased by 50% to P.S. 21 and now has a damage bonus of +6).
- **Supernatural Physical Strength:** This seems to work only on *predatory animals* that are bigger and have more mass than humans by at least 50%, such as African lions, tigers and bears (large mutants too, see the Ursa-Warrior). Effectively gives the animal supernatural strength, which means the animal can inflict mega-damage from its bites, claw attacks, punches, and kicks.
- **Increased Speed (20% to 50%):** The running speed of the animal can be enhanced, but does not affect the endurance. The animal can also leap 20% farther and higher, with a running start.
- **Sprinter:** The animal can run at double his normal speed for 1D4 minutes before dropping back to normal speed and tires after another 2D4 minutes. Only running half the animal's maximum normal running speed (not the doubled sprint) can be maintained for a prolonged time. For example: An animal with a speed of 36 can run in a brief burst of speed (like a cheetah) at a speed of 72 for 1D4 minutes (roll for every run) and then drops to a speed of 36 for 2D4 minutes, but can only run at a speed of 18 for long periods
- **Elimination of genetic defects and aberrations:** Certain animals and breeds suffer from one or two genetic weaknesses that either cause or make them susceptible to certain diseases, such as seizures, heart disease, hip displacia, blindness, deafness, etc. Through genetic reconstruction these weaknesses are eliminated, making the animal effectively cured/impervious to them.
- **Resistance to diseases and toxins in general:** This can include everything from head colds to rabies and heart worm: +4 to save vs disease, +3 to save vs poisons.
- **Reduced fat:** The animal's metabolism runs faster and burns up calories to keep the animal thin and trim (works on humanoid mutants and humans too). Reduces the life span of small animals by 2%.
- **Secondary physical features can be selected and adjusted:**
 - The color of the eyes.
 - The color of the hair or fur.
 - Special markings/patterns (patterns of color in the fur)
 - The type and texture of the fur (coarse, soft and fluff, etc.; thick, long, short, etc.).
 - Water resistant fur or oils in the fur.
 - Hairless

Fatty tissue to help insulate against the cold (half damage).

Large or small ears

Short or long tail

Extra large teeth (increase damage by 50%)

Extra small teeth (decrease damage by 50%)

And similar ...

Instinctive and Behavioral Modifications

- **Instinctive ability to climb:** The animal loves to climb and is reasonably good at it. Animals equipped for climbing/natural climbers (i.e. animals like cats, raccoons, squirrels) get a base skill of 85%/75%. Animals not well equipped for climbing/are not natural climbers (dogs, horses, etc.) get a base skill of 35%/0%.
- **Instinctive ability to swim:** The animal loves the water and likes to swim. It automatically has a base skill ability of 50% +1D4x10%.
- **Instinctive hunter:** Likes to hunt and kill; finds waiting for, lurking around, chasing and stalking prey tons of fun. Adds a +10% bonus to all tracking skills, intelligence, prowl and climb skills. Most animals, like cats, need to learn the actual skills for hunting (in the wild they learn from parents), the instinct just makes the animal much more intense and dedicated to learning these fun and important skills (practices them a lot).
- **Instinctive dislike of the supernatural:** The animal doesn't like supernatural beings — this is actually an instinct in most Earth animals that has been amplified. It does not offer any special sensing abilities, but most animals can recognize supernatural beings by their alien scent, taste and mannerisms. Watchdogs (cats, dogs, monkeys and even pigs and hawks) will bark warnings, growl, hiss and can be trained to attack the supernatural.
- **Decreased aggression and dominance:** Not assertive, passive, and easy going, to extreme submissiveness/obedience, easily cowed; tends to be a follower. Also tends to be lazy and complacent.
- **Increased aggression and dominance:** Confident and aggressive, doesn't back down easily, questions authority, is assertive and tends to be a leader or rogue loner. Many are also surprisingly curious, imaginative and resourceful, rarely lazy or complacent. In fact, some become quite fastidious in the performance of tasks/duty, or perfectionists who lose patience with those who are not.
- **Extreme Aggression:** Like most Kill Hounds, the animal is a bully and a thug who wants to be number one, questions and defies authority, and fights (not necessarily to kill) to get its way, prove it is dominant and/or over the slightest altercation unless the perpetrator backs down (shows submissiveness). Some will even take a nip at and even bite their master and fight with other dominant animals. It may even interpret a loud, confident voice/command or bold action, especially those directed at it, as a challenge or attack. The *animal* is +2 on initiative, +1 to strike and +3 to save vs horror factor and mind control (humanoid mutants are only +1 on initiative, and +1 to save vs H.F. and mind control).

This dangerous trait may be desirable in animals being set loose in the wild or used as vicious guards, watchdogs and hunter-killers (provided the master doesn't mind the occasional bite).

- **Increased intelligence:** The animal is still an animal, with an animal's instincts and basic intelligence, however, this boost of intellect makes it smarter, giving the creature a greater comprehension of language and problem solving skills. A dog or horse with increased intelligence has a longer attention span and better comprehension of language, giving it a larger vocabulary that it can understand. For example, the average dog can learn and understand about 200 or so words, a horse about 120. Those with an increased intelligence understand double to triple the number of words and even phrases and short, simple sentences. This means a real dog could be like Lassie and understand and obey any command like, "Rex, go find Bob and bring him here." or "Stay here and protect Little Nell until I get back." and so on. Please note that the animal cannot count, perform

math or speak, although these animals are usually more vocal (growl, bark, or whinny, as the case may be) and have even more personality and human-like traits than ordinary animals of that species. Increased intelligence at this level is only noticeable with higher animals who are fairly smart to begin with: dogs, cats, horses, pigs, monkeys, apes, etc. **Note:** Increased intelligence also tends to make the animal more independent, a bit more aggressive and self-aware. Cats, in particular, tend to ignore orders and do as they please, monkeys (not apes) are also less obedient, uncooperative and self-serving.

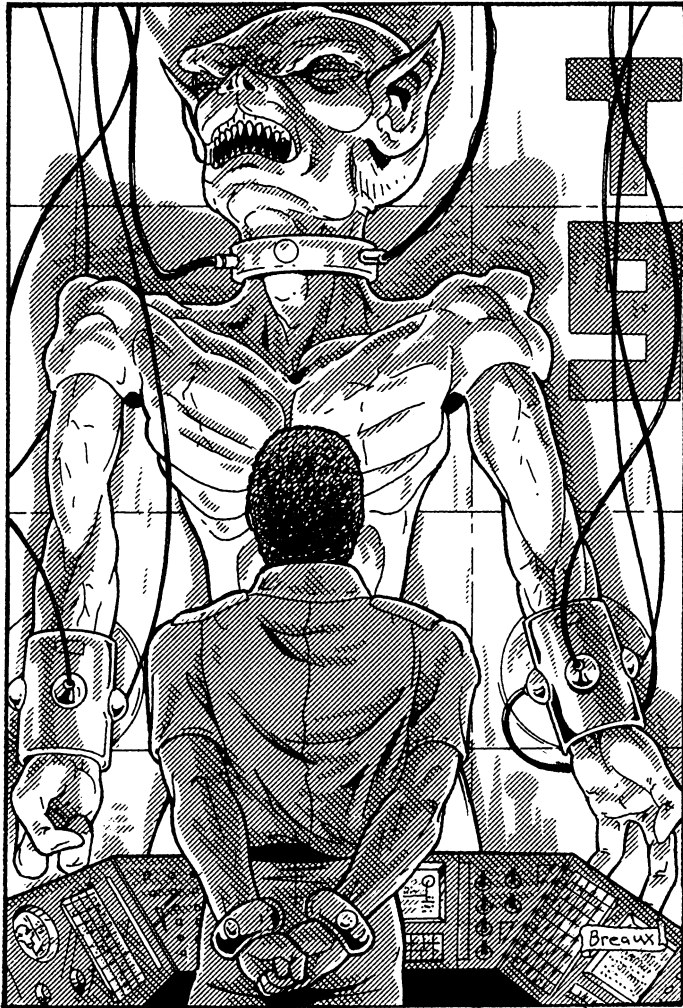

Other Notable CS Mutant Creations

The focus of the following section is on the *extreme* genetic mutations created by the insane Doctor Desmond Bradford and company. Many, like the Ursa-Warrior, Kill Cats, mutant rats and even the Xiticix Killer, among others, are “officially” sanctioned by the Coalition States, usually for military applications or the pursuit of science. Some are unsanctioned, illegal and created in secret by Doctor Bradford and his elite secret unit. What other wonders and monstrosities may be created in the future (or hidden away someplace) are yet to be seen (G.M.s are invited to create their own mutants).

Mutations Gone Wrong Table

This *optional* table should be used sparingly on mutation experiments with *humanoid mutants* other than canines. Even then, only one in 10 mutants will have gone wrong in some way. Roll percentile dice

once for a random mutation or pick one when applicable (G.M.’s discretion). Of course, CS experiments that intentionally try to instill a variety of new traits (these and/or others) in a mutant animal (NPC) will suffer from many problems (roll twice on this table), including random insanity (roll once on the table in the **Rifts® RPG**, pg. 19).

10-10 Suffers from Insanity: Either make a random roll or the G.M. can assign one that seems appropriate (phobia, obsession, neurosis, etc.).

11-20 Animal Mind: Despite the dramatic change in the creature’s physical appearance and abilities, the brute retains its animal intelligence, cunning and instincts. Thus, it has a predatory animal mind. The number of skills normally available to the mutant is reduced by half, it gets no skill bonuses and in most cases, the base skill proficiency is reduced by half. The mutant is best suited to physical and wilderness skills (start at the base skill proficiency without bonuses); the simpler and more direct the better, such as running, swimming, weapon proficiencies (point, shoot, kill), and so on.

21-30 Hidden Intelligence: The creature appears very brutish (even dumb) and animal-like. Speech is guttural and the mutant hisses, growls and howls when frustrated, angry or happy. Like the *animal mind*, its first reaction to life is to keep things simple and direct, but this mutant can think with human intelligence. The hidden intelligence manifests itself in situations that require deductive reasoning (i.e. how to open a window or door, etc.), when stalking prey (will hide and wait, play dead, set up traps, use tricks, attack in coordinated groups, etc.), when it is necessary to improvise, and despite its instinctive desire to keep things simple and linear, to learn and imagine. If encouraged through necessity or by others, this mutant can become almost as clever and capable as a human. It can learn all the O.C.C./R.C.C. skills at half the usual bonuses and half the normal amount of O.C.C./R.C.C. Related Skills and Secondary Skills are usually available at first level; all subsequent skills are as follows: two Related Skills at levels 3, 6, 9, and 12; two Secondary Skills at levels 2, 4, 6, 8, 10, and 12.

31-40 Super-Predator! Built like a rock: +3D6 to hit points, +4D6 to S.D.C., plus one additional attack per melee round, +1D6 S.D.C. damage to punches, kicks and bites, and +6 to save vs horror factor, but mean tempered, quick to brawl (loves combat), and is incredibly aggressive, strong willed, defiant and independent.

41-50 Hulking Monster: Applicable only to large animals to begin with. Twice as large as normal or twice the size of a human, which ever is greater. Double height, weight, and damage inflicted from bite, punch/claws and kick. In addition, +3D6x10 hit points, +2D4x100 S.D.C. (effectively a light M.D.C. creature), +2D6 to P.S., +1D6 P.E., and Armor Rating (A.R.) is 18, but reduce speed attribute and prowl, acrobatics, gymnastic, and pick pocket skills (as are applicable) by half. The giant size and weight also makes the mutant a likely target of attacks and other problems (may be too big or too heavy to fit inside a vehicle or even a room, etc.).

51-60 Gentle and Passive: The mutant may supposed to be a fierce predator, but is gentle, compassionate, loving and considerate of others. It doesn’t like to hunt, stalk, or kill, although it will battle courageously to defend itself and others. This doesn’t necessarily mean the mutant is a failure, quite the contrary, the aberrant mutant may be valuable for further study and research, and/or may fit ideally into a special niche. +1 to I.Q. and M.A.

61-70 Extreme Aggression: Like most Kill Hounds, the mutant is a bully and a thug who wants to be number one, questions and defies authority, and fights (not necessarily to kill) over the slightest insult or altercation unless the perpetrator backs down and apologizes profusely. Some will even take a punch or nip at their commanding officer. Brawls are frequent, and the extreme aggression also means the mutant finds it difficult to resist any sort of challenge regardless of how dangerous (and stupid) it may be to the participants and/or spectators or innocent pedestrians. Unlike Dog Boys, and even Kill Hounds, the mutant has little regard for the welfare of its companions, humans, and innocent by-

standers. In this case, +1 on initiative, and +1 to save vs horror factor and mind control.

71-80 Bloodlust: The mutant animal becomes temporarily obsessed with revenge and killing to the point that all other instructions and orders are forgotten. The mutant has just one goal: kill!

While in bloodlust, the beast doesn't hear (and/or ignores) orders and is barely aware of what is happening around him. It may take a gunshot, explosion, psionic message or bolt of magic to catch his attention, and one or more humanoids may have to physically pull the mutant off his opponent and physically restrain him to stop him from killing the target of his bloodlust. While in this state, the character is only semi-aware of the most immediate things around him. The mutant *can* recognize friend from foe and react to other things (a scream for help, an attack from the side, etc.), but it comes to him through a haze.

Bloodlust occurs as a result of a fighting frenzy usually brought on by anger, frustration, fear, or, ironically, success in battle (gets so caught up in fighting he forgets all else).

81-90 Latent Psionic. The character is a latent psychic whose psionic powers appear slowly with the passage of time. The first power doesn't manifest itself until the character reaches 2nd level experience. At second level, one psi-power can be selected from the sensitive or physical category. Each subsequent level, the character can pick one new power from one of the categories: healing, sensitive, or physical. I.S.P. is M.E. times two, plus 1D6 per level of experience. Effectively a major psionic.

91-00 Supernatural Strength: The mutant has the equivalent of supernatural P.S., which means its bites, claw attacks, punches and kicks inflict mega-damage (see M.D. for supernatural strength on page 26 of **Rifts@ Conversion Book One** or **Juicer Uprising™** on page 34). 01-50% chance the creature also has supernatural P.E.

Mutant Bears

The Ursa-Warrior

Bears are cousins to canines and have many of the same basic abilities and attitudes. Although not pack animals, mutant Black Bears and Polar Bears adjust well to group dynamics, especially when the GED team includes the dog's genes for loyalty and pack behavior/socialization. Grizzly Bears and Brown Bears are more aggressive and independent, and even with genetic manipulation, tend to be unreliable and dangerous.

With the exception of the Polar Bear and Brown Bear, most mutant bears are lazy, dull-witted and easily distracted by the simplest things. They are most effective in small, tight-knit squads (lots of personal attention) where the other members are friends who watch out for each other and/or have a strong leader. Mutant bears tend to follow the lead of those around them, so if their comrades are excited, aggressive and ready to fight, so is the Ursa-Warrior. If the others are nervous, frightened or timid, so is the bear. In many ways, the majority of Ursa-Warriors have the mental capacity, attention span and emotional maturity of a 7-10 year old child. On the downside, this means they are easily manipulated, tricked and confused, which is why they look to a strong, trusted leader or friends for guidance and follow their lead ("My friend said D-bees are bad," or "Lieutenant said never use rail gun unless he said to. Where's Lieutenant? I can't use the rail gun unless he says it's okay").

When angry, endangered or his comrades are endangered or under attack, the mutant bear flies into an aggressive frenzy that can sometimes turn into a berserker rage like that of the Kill Hounds. Thankfully, berserker rages tend to occur only when his comrades are in danger of destruction, have fallen (leaving the Ursa-Warrior alone or with only one or two teammates) and when cornered and alone.

Although genetically altered to respond well in groups, many Ursa-Warriors are content to be left alone for days at a time. However, like youngsters, they get bored easily, and get into mischief unless supervised. Their mischief is also child-like, i.e. going someplace where they were told not go, taking a look at something they weren't supposed to see, getting into food (especially sweets), forgetting to do their assignments (or doing them sloppily), deserting their post (to see or do something else), falling asleep on duty, playful wrestling, and similar. It's important to note that successful experiments to increase the mutant bear's intelligence override the encryptions of other more favorable traits such as sociability and teamwork. Intelligent mutant bears tend to be dominant, aggressive, rebellious and prefer to be loners. Their behavior is unpredictable and they tend to be incredibly cunning, manipulative and duplicitous. At least for the moment, the military is looking at the dull-witted, but relatively loyal and easy to control and manipulate mutant bears for their raw strength as combat support and pack mules in the field. Currently, there are a total of 50 Ursa-Warrior test subjects in active duty with Dog Packs in the State of Lone Star (typically one mutant bear per squad of 10), 20 additional are in training, and 60 veterans (7 year olds) have been deployed as members of special Dog Packs in the Tolkeen campaign.

Special Bear Powers & Abilities

Note: These abilities are typical of the average mutant bear, or Ursa-Warriors as they are called. Some things will vary according to the breed, but all generally have the following special abilities and/or heightened senses.

1. Sense Psychic and Magic Energy: Same ability as the Dog Boys, but not as developed.

Base Skill: 20% +5% per level of experience (roll once every melee round). Reduce by half when multiple sources are scattered throughout the sensing range.

Range: Sensitivity to a fellow psychic or magic practitioner *not* using his powers is 20 feet (12 m) +5 feet (1.5 m) per each additional level of experience. Sensitivity to psionic and magic powers being *used* is 200 feet (61 m) +20 (6 m) per level of experience. Roll percentile dice every 400 feet (122 m) to see if the hunter is still on the trail. A failed roll means the scent is lost.

I.S.P.: None, automatic ability.

Note: Cannot Recognize Psychic Scent.

2. Sense Supernatural Beings: Same as the Dog Boy, but not as acutely developed.

Base Skill: 40% +2% per level of experience to identify the specific type/race of paranormal creature and includes alien intelligences, gods, demigods, demons, vampires, and dragons. This ability can also detect whether a person is possessed by supernatural beings.

Base Skill at tracking by this scent: 15% +5% per level of experience. 53% +3% per level of experience *if* the supernatural being is also using psionics or magic.

Range: 100 feet (30.5 m) per level of experience to sense the presence of a supernatural being when it is not using any special, magical or psionic powers.

1000 feet (305 m) +100 feet (30.5 m) per additional level of experience when the supernatural force is actively using its supernatural powers, magic or psionics.

Duration: Automatic and constant.

I.S.P.: None, automatic.

Note: Close proximity to ley lines and nexus points disrupt the psychic senses.

3. Other Psionic Powers: Pick two from the *physical category*.

4. Psi-Bonuses: Ursa-Warriors are effectively major psionics with special psionic sensitivity as described above. This means the bear needs to roll a 12 or higher to save versus psionic attack and enjoys a bonus of +1 to save vs psionic attack and all forms of mind control.

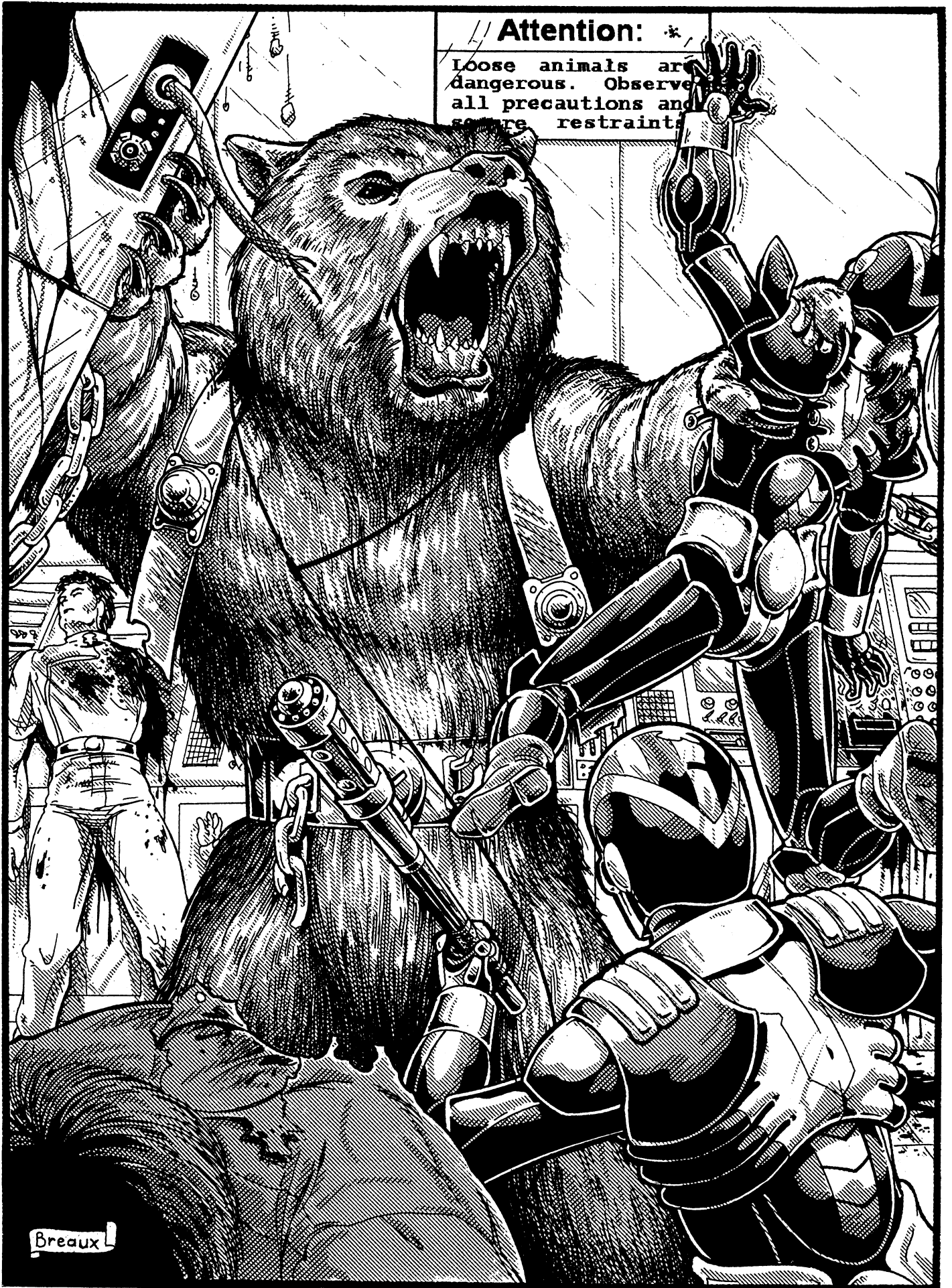

Attention: *
Loose animals are dangerous. Observe all precautions and secure restraints.

Breaux

I.S.P.: To determine the character's initial amount of Inner Strength Points, take the number of M.E. and double it. Add 2D4 per each additional level of experience. I.S.P. is regained at the rate of two per hour of activity, or eight per hour of meditation or sleep!

5. Physical Bonuses: The attributes of the average bear are presented under the R.C.C. description. The bonuses listed here are in addition to those basic attributes. Additional bonuses may also be gained from certain skill selections.

Black Bear: +1 on initiative roll, +1 to strike and parry, +3 to save vs disease, and +3 to save vs horror factor. Attribute bonuses: I.Q. +1D4, M.A. +1D6, P.P. +1D6 and +3D6 to Spd, but reduce their size by 20%. Nightvision 200 feet (61 m), +20% to climb ability, and love sweets, especially honey and chocolate. Bite does 6D6 S.D.C. damage (despite supernatural P.S.).

Brown Bear: +3 on initiative, +2 to strike and parry, +4 to save vs disease, +6 to save vs horror factor, +5D6 to hit points, +1D6x10 S.D.C., and increase size (height and weight) by 30%. Attribute bonuses: I.Q. +1 point, P.S. +2D6, P.E. +1D6, Spd +2D6; natural wrestlers (same as the human physical skill). Bite does 1D4 M.D. damage (supernatural strength).

Grizzly Bear: +2 on initiative, +3 to strike, +2 to parry, +1 attack per melee round, +4 to save vs disease, +8 to save vs horror factor, +1D6x10 to hit points, +2D4x10 S.D.C., and increase average size (height and weight) by 40%. Attribute bonuses: P.S. +3D6, P.E. +2D6; +10% to swimming skill, -10% to climbing skill. Bite does 1D6 M.D. damage (supernatural strength).

Polar Bear: +3 on initiative, +4 to strike, +1 to parry and dodge, +1 attack per melee round, +4 to save vs disease, +7 to save vs horror factor, +1D4x10 to hit points, +1D6x10 S.D.C., and increase average size (height and weight) by 25%. Attribute bonuses: I.Q. +1D6, P.S. +3D6, P.E. +2D6, Spd. +2D6. Natural, expert swimmer (96% skill proficiency, can hold breath underwater for six minutes, dive 20 feet/6 m) and is resistant to cold (does half damage); its dense fur keeps it warm in temperatures -40 degrees Fahrenheit. Bite does 1D4 M.D. damage (supernatural strength).

Note: The P.S. and P.E. of mutant bears are always considered to be supernatural and most attacks do mega-damage. Same basic maturity rate as Dog Boys. The *Mutation Abnormality Table* and other *Optional Character Tables* available for Dog Boys are NOT available to mutant bears. However, the *Mutation Gone Wrong Table* may be appropriate pending approval by the G.M.

6. Bears have a good sense of smell, taste and hearing, but nowhere near as good as a canine's. The sense of hearing is only a little better than a human's, while the sense of taste and vision (the field of vision is 200 degrees) are about the same as the canine. The sense of smell is a third to half as keen and efficient as a Dog Boy's olfactory abilities, but 10 times better than a human's.

Common and strong scents: Recognize and accurately identify general/common/known smells, including gaseous odors, food, animals, and the path used by a group of humans, mutant animals, D-bees or monsters, as well as other strong and/or distinctive odors. **Base Skill:** 43% +3% per level of experience.

Range: 100 feet (30.5 m) per level of experience.

Identify specific odors: Including the scent of specific individuals (specific characters), poisons or drugs mixed into food or drink, unique and usual scents. The mutant must be familiar with the target subject and/or have a piece of clothing, hair, blood, etc., that the character can use as a reference.

Base Skill: 26% +2% per level of experience.

Range: 25 feet (7.6 m) per level of experience.

Track by smell alone! This means the mutant bear relies entirely on his sense of smell (blinded so he cannot follow physical tracks/footprints or any other visible trail). This also means that a mutant can sniff his way through total darkness if there is a scent that can be followed,

and also that the character suffers only *half* the normal penalties to strike, parry, and dodge when blinded or in total darkness.

Base Skill: 20% +4% per level of experience.

A few notes about tracking by scent: In most cases, roll once for every 500 feet (152 m) to see if he or she stays on the trail (half that distance if the scent is unusually light or if the trail is covered in light rain or snow). A failed roll means the trail has been temporarily lost. Two successful rolls, out of three tries, means the trail has been rediscovered. Two failures means the trail is lost. **Note:** The mutant bear can smell a scent that is as much as a day old (24 hours), as long as the trail has not been washed away. Can *NOT* track through water, nor smell Astral Beings, Ghosts or energy beings, although he can probably "sense" their presence and general locale if nearby. Also, despite what many people may think, a bear can *NOT* see much better in the dark than humans (about 30% better). However, their keen sense of smell and hearing compensates.

7. Natural climbers: All bears can climb at the base skill of 60%/40% (plus bonuses for certain species).

8. Natural Swimmers: All bears are fair swimmers with a base skill of 50% (plus bonuses for specific species). The polar bear is an exceptional swimmer with a base skill of 96%!

9. Sprinters: The mutant bear can run at double his normal speed for 1D4 minutes before dropping back to normal speed.

10. Sensitivity to Ley Line energy. Ley lines and nexus points obliterate the Ursa-Warrior's psychic and supernatural sensing abilities and give it a headache. They try to avoid these places. This means the mutant cannot use these abilities to locate magic or supernatural prey or to sense their presence when on a ley line or near a nexus. However, the creature's normal physical senses, especially smell, are not affected and the other psychic abilities are enhanced (as usual). Most mutant bears are leery around places of magic and often show uncharacteristic signs of being nervous and on edge. They are afraid (some are terrified) during *Ley Line Storms* which actually cause physical discomfort to them the same as Dog Boys — headaches, crackling sounds in their ears, and static electrical build-up/shocks, plus they are two times more likely to be struck by ley line energy and lightning.

Ursa-Warrior R.C.C.

R.C.C. Requirements: None, other than the bear must be a relatively intelligent, loyal and obedient mutant (80% are female because they are less aggressive than the males). All substandard creations (physically or mentally) are destroyed.

Player Character Note: Player characters who are *not* CS agents (spy, infiltrator, scout, soldier, etc.) must either be "feral" renegades (runaway mutants/deserters) or the offspring of runaway mutants. In the first case, they are considered dangerous traitors in need of termination. In the latter case, the mutant is considered to be a hopelessly corrupt and dangerous "feral free-born" and destroyed whenever encountered.

Alignments: Any, but most (65%) lean toward anarchist and miscreant. Characters who are diabolic tend to be loners, mean, and do not work well in a group unless they can be the leader.

Average Attribute Range (Standard Ursa-Warrior): I.Q. 2D6, M.E. 2D6, M.A. 2D6, P.S. 5D6, P.P. 3D6, P.E. 4D6, P.B. 2D6, Spd 4D6 running — 2D4 digging.

Hit Points: P.E. attribute number x5 plus 2D6 per level of experience.

Some species get bonus hit points.

S.D.C.: P.E. attribute number plus 2D4x10 plus those gained from physical skills; some species get S.D.C. bonuses.

Average Weight: 700-900 pounds.

Average Height: 7 feet (2.1 m)

Armor Rating: 10+1D6 (an attacker must roll above the A.R. to inflict hit point/S.D.C. damage; mega-damage weapons automatically blast through S.D.C. based A.R.).

General Physical Appearance: No human looks — animal appearance with only vague human, bipedal appearance. 85% have short legs and long, powerful arms, broad chests and upper bodies, while 15% have more equally proportional limbs and a comparatively slender build. The head/face is that of a bear, the body is fur covered and there is a tiny tail. Hands are only partially articulated, with a human-like opposable thumb, although most have short, thick fingers and long, claw-like nails. A bipedal stance enables the mutant canines to stand and walk erect, although most (85%) run on all fours, in a loping movement.

Human Speech: Partial and guttural. The character still has a tendency to growl, whine, and howl when excited, angry or scared.

Average Life Span: Estimated 30-45 years.

Natural Abilities: See special abilities above.

Magic: None. Even most “feral” and “free borns” tend to distrust and avoid magic and magic items, including weapons.

Average P.P.E.: Most of the individual’s P.P.E. has been expended in the development of psychic abilities. The remaining *Permanent P.P.E. Base* is 3D6.

Psionics: See Special Abilities above.

R.C.C. Skills of a Coalition Ursa-Warrior: With rare exception, all mutant bears, even mercs and nomads, began life as a Coalition agent/slave, created, conditioned, and trained as a Coalition soldier. The following military skills are known to *most* Ursa-Warriors. Also see the Special Abilities and Bonuses, previously described.

Speaks American at 80% efficiency.

Radio: Basic (+10%)

Running

Land Navigation (+10%)

Wilderness Survival (+15%)

W.P. Energy Pistol

W.P. Energy Rifle

W.P. Heavy Energy

W.P. of choice.

Hand to Hand Expert

R.C.C. Related Skills: At first level the mutant can select four “other” skills, plus one skill at levels 4, 8, and 12. **Note:** Ursa-Warriors in the service of the CS are never taught to read.

Communications: Any

Domestic: Any (+5%)

Electrical: None

Espionage: Any

Mechanical: Basic Mechanics and Automotive only.

Medical: First Aid only (+5%)

Military: Any

Physical: Any, except acrobatics.

Pilot: Hovercraft, Truck and sail and motorboat only (+5%).

Pilot Related: Any

Rogue: Any, except computer hacking, and palming, and concealment; pick locks and pick pockets are available, but at half the normal skill proficiency.

Science: None

Technical: Any (+5%), except computer operation & programming.

W.P.: Any

Wilderness: Any (+10%)

Secondary Skills: The character gets four secondary skills from the list, excluding those marked “None,” at level one and one additional at levels 2, 4, 8, and 12. These are additional areas of knowledge that do not get the advantage of the bonuses listed in parentheses. All secondary skills start at the base skill level.

Standard Equipment for Ursa-Warriors: A large suit of (50 M.D.C.) Dog Pack style DPM Riot Armor (full environmental armor is *NOT* available, although a larger, heavier version of the riot suit is being developed for these giants; 100-200 M.D.C.). A uniform may be provided, but most are given shorts or a simple jumpsuit and a collar

— most experimental mutants are *not* considered an “official” part of the Dog Pack or any portion of the active military, they are living *experiments* being field tested.

Basic equipment for Ursa-Warriors includes tinted goggles or nonenvironmental helmet with or without visor, radio, flashlight, pocket mirror, comb, 100 ft (30.5 m) of lightweight rope, four spikes, portable language translator, survival knife, a pair of Vibro-knives or Vibro-claws (many also have a Vibro-saber or Neuro-Mace), knapsack, backpack, utility belt, air filter, gas mask, and two gallon-size canteens.

Equipment Available Upon Assignment: Energy weapons, rail gun, heavy weapons, hand grenades, smoke grenades, signal flares, light vehicle, food rations and non-regulation weapons and armor. Because of their size and supernatural strength and endurance, the Ursa-Warrior is often used to carry heavy weapons, extra ammunition, extra communications equipment and other gear — they don’t generally mind, especially if convinced it is a great responsibility that only they can be entrusted with.

Money: All the mutant’s basic needs are provided for by the CS military; a place to sleep, food, clothing, medical treatment, basic supplies and equipment, and limited access to military facilities. They are also given a token monthly salary of 60-100 credits for personal items and edible goodies. Unlike the Dog Boys, mutant bears do not have the same freedoms, privileges or trust. They are experimental “animals” kept under close observation.

Cybernetics: Generally, none to start, although as experimental animals, about 15% have 1D4+2 bionic extras and 10% are partial conversion ‘Borgs’.

Identification Coding (I.C.): The same dual I.D. system as the Dog Boys (unless they are part of Doctor Bradford’s secret creations).

Note: Ursa-Warriors who go AWOL or “feral” are hunted down and terminated.

Typical Ursa-Warrior Missions: One or two Ursa-Warriors are assigned to a Dog Pack for field training and observation, so they generally handle the same mission as Dog Packs.

Maximum Rank: Non-Commissioned officer up to Sergeant, but most never advance past Corporal.



Mutant Felines

Battle Cats

Most mutant humanoid cats are suspicious of others, careful but curious, and coy. This is especially true of their relationship with humans, but most will eventually allow themselves to become friends with humans who prove themselves in the cats' eyes (i.e. humans who prove to be genuinely honest, truth worthy, caring and reliable over a long period of time). Even when the mutant cats care deeply about a nonfeline companion, most (not all) openly display a restrained affection, although in private, the mutant cat may be much more open and frank. This is all just part of the mutant feline's nature. Except for those created from African Lions (which are more demonstrative and social), most prefer not to show what they are thinking or feeling regardless of the situation, and often keep their innermost thoughts and feelings to themselves. Only a trusted mate is likely to have true insight into the heart and mind of their companion. Some felines take this to the extreme and are paranoid, secretive and tight-lipped about everything. Their alert quietness also gives the mutant cats what humans often consider a grim, cold and determined demeanor, sometimes eerily so (mutant cats usually win staring contests without coming close to blinking). However, when a cat does speak its mind, it's either because what s/he has to say is very important (and needs to be heard) or because the cat feels comfortable with those to whom it is speaking. Most felines are not usually duplicitous or shy and speak directly and to the point. Their blunt comments, observations and opinions are typically presented plainly and without much consideration for diplomacy or other people's feelings. They are also excellent at cutting a person down with snide remarks, have a rapier wit and use belittling comments (often based on observations).

Although most cats would deny it, many enjoy the company of other humanoids. While dogs prefer the company of other canines and humans above all others, most felines will accept anybody who meets their individual approval, human and nonhuman, fellow feline mutant or supernatural being — a trait the CS finds disturbing.

Generally speaking, feline mutants tend to be loners who keep to themselves or assemble into small family clans — typically, spouse and children. Even those who are active members of large groups, feline or otherwise, tend to retain a strong measure of independence, and will come, go and do as they please. Many will leave the group permanently if their personal freedoms and ability to express themselves are curtailed or stepped upon too often. According to most feline mutants, it is *they* who have *chosen* to join a particular group, and the group better appreciate this distinction. A feline who feels taken for granted, and/or unappreciated or devalued is likely to leave or even betray the group! Either she's part of it or she's not, and if she's not, old loyalties have little meaning. In fact, it is likely to be the feline who feels betrayed ... and any treachery on her part is revenge.

Unlike dogs, cats are *not* easily trained. Like fickle humans, they need incentives, choices, and a sense of satisfaction, not just reward, although that's good too. The CS has found that to assign mutant felines to dull drudge work, office work, guard duty, or confinement to base will create a frustrated and unhappy soldier who does shabby work (at best, a 50% effort), and who becomes increasingly defiant, rebellious, disruptive and annoying. Battle Cats perform at their best when entrusted on their own or in small teams (2-10) and allowed to do what they do best, hunt and prowl. Consequently, all mutant cats love wilderness assignments, reconnaissance, seek and capture, seek and rescue, seek and destroy, and all sorts of intelligence and espionage missions (spying, sabotage, assassination, etc.). *Kill Cats*, described in the next few pages, are the ultimate hunter-killers.



Special Cat Powers & Abilities

Note: These abilities are typical of the average mutant cat. Some things will vary according to the breed, but all generally have the following special abilities and/or heightened senses.

1. Sense Psychic and Magic Energy: Same ability as the Dog Boys, but not as developed.

Base Skill: 30% +5% per level of experience (roll once every melee round). Reduce by half when multiple sources are scattered throughout the sensing range.

Range: Sensitivity to a fellow psychic or magic practitioner *not* using his powers is 40 feet (12 m) +5 feet (1.5 m) per each additional level of experience. Sensitivity to psionic and magic powers being *used* is 300 feet (91 m) +20 (6 m) per level of experience. Roll percentile dice every 400 feet (122 m) to see if the hunter is still on the trail. A failed roll means the scent is lost.

I.S.P.: None, automatic ability.

Note: Cannot Recognize Psychic Scent.

2. Sense Supernatural Beings: Same as the Dog Boy, but not as acutely developed.

Base Skill: 54% +2% per level of experience to identify the specific type/race of paranormal creature and includes alien intelligences, gods, demigods, demons, vampires, and dragons. This ability can also detect whether a person is possessed by supernatural beings.

Base Skill at tracking by this scent: 10% +2% per level of experience. 23% +3% per level of experience *if* the supernatural being is also using psionics or magic.

Range: 100 feet (30.5 m) per level of experience to sense the presence of a supernatural being when it is not using any special, magical or psionic powers.

1000 feet (305 m) +100 feet (30.5 m) per additional level of experience when the supernatural force is actively using its supernatural powers, magic or psionics.

Duration: Automatic and constant.

I.S.P.: None, automatic.

Note: Close proximity to ley lines and nexus points disrupt the psychic senses.

3. Other Psionic Powers: Pick two from the *sensitive category*.

4. Psi-Bonuses: Battle Cats are effectively major psionics with special psionic sensitivity as described above. This means the mutant felines need to roll a 12 or higher to save versus psionic attack and enjoy a bonus of +2 to save vs psionic attack and all forms of mind control.

I.S.P.: To determine the character's initial amount of Inner Strength Points, take the number of M.E. and double it. Add 2D6 per each additional level of experience. I.S.P. is regained at the rate of two per hour of activity, or eight per hour of meditation or sleep!

5. Physical Abilities & Bonuses: All cats are natural, meat-eating predators and instinctive hunters, although they must be taught and develop many skills through practice and experience. Favorite weapons include Vibro-Blades and laser weapons (long range and silent).

The attributes of the average feline are presented under the R.C.C. description. The bonuses listed here are in addition to those basic attributes. Additional bonuses may also be gained from certain skill selections; all bonuses are cumulative.

Lynx/Bobcat: +3 on initiative roll, +1 to strike and parry, +3 to dodge, +2 to save vs disease, and +4 to save vs horror factor. Attribute bonuses: P.P. +1D4, +1D6 to Spd and can leap 20 feet (6 m) across or 15 feet (6 m) up from a standing position, but reduce their size by 20%. +20% to climb ability and +10% to acrobatics. Bite does 2D6 S.D.C. damage, claw attack does 2D6 S.D.C. damage plus P.S. bonus, or by weapon.

Puma/Cougar/Mountain Lion: +2 on initiative, +2 to strike and parry, +2 to save vs disease, +5 to save vs horror factor, +4D6 to hit points, and +5D6 S.D.C. Attribute bonuses: I.Q. +1D4, P.S. +1D6, and can leap 40 feet (12 m) across or 20 feet (6 m) up into the air from a standing position. +10% to prowl, climb and swim. Bite does 3D6 S.D.C./hit point damage, claw attack 3D6 S.D.C. plus P.S. bonus, or by weapon.

Leopard/Panther: +4 on initiative, +3 to strike, +1 to parry, +3 to dodge, +1 attack per melee round, +3 to roll with impact, +1 to save vs disease, +3 to save vs horror factor, +3D6 to hit points, and +4D6 S.D.C. Attribute bonuses: I.Q. +1D4, P.S. +3D6, P.P. +1D4, and can leap 30 feet (9 m) across or 20 feet (6 m) up into the air from a standing position (increase distance by 20% for a running start). +15% to prowl, +10% to acrobatics, and +30 to climb. Bite does 3D6 S.D.C./hit point damage, claw attack 2D6 S.D.C. plus P.S. bonus, or by weapon. **Note:** Increase size (height and weight) by 20% for snow leopards and add another +1D6 to H.P., +2D6 S.D.C. and +1D6 to P.S. to those listed above for ordinary leopards. Snow leopards can leap 50 feet (15.2 m) across and 20 feet (6 m) high. All other bonuses and notes are the same as the leopard. A black panther is just a leopard with black fur.

African Lion: +2 on initiative, +2 to strike, +3 to parry, +1 attack per melee round, +4 to save vs disease, +6 to save vs horror factor, +6D6 to hit points, +1D6x10 S.D.C., increase average size (height and weight) by 40% (typically 7 ft/2.1 m). Attribute bonuses: P.S. +3D6, P.E. +1D6, and Spd +2D6; it can leap 20 feet (6 m) across or 15 feet (4.6 m) up into the air from a standing position, and its roar can be heard up to one mile (1.6 km) away. +10% to swim, +10% to prowl, +5% to climbing, and +10% to tracking skills. Bite does 3D6 S.D.C./hit point damage, claw attack 4D6 S.D.C. plus P.S. bonus, or by weapon.

Tiger: +4 on initiative, +3 to strike, +2 to parry, +1 attack per melee round, +4 to save vs disease, +6 to save vs horror factor, +1D4x10 to hit points, +2D4x10 S.D.C., increase average size (height and weight) by 60% (typically 8 ft/2.4 m). Attribute bonuses: I.Q. +1D4, P.S. +4D6, P.E. +2D6, and Spd. +1D6; it can leap 30 feet (9 m) across or 15 feet (4.6 m) up into the air from a standing position and its roar can be heard up to 1.5 miles (2 km) away. Natural swimmer (86% skill proficiency), +5% to climbing, +15% prowl, and +15% to tracking skills. **Note:** Siberian tigers are resistant to cold (does half damage).

Note: The P.S. and P.E. of mutant African lions and tigers can be genetically improved to be supernatural. Bite attacks do 1D6 M.D. and claw attacks do 3D6 M.D. for lions, 4D6 M.D. for tigers. Same basic maturity rate as Dog Boys. The *Mutation Abnormality Table* and other *Optional Character Tables* available for Dog Boys are NOT available to mutant cats. However, the *Mutation Gone Wrong Table* may be appropriate pending approval by the G.M.

6. Excellent vision and passive night sight: All felines have excellent, 20/20 color vision with a field of vision of 220 degrees. In addition, their eyes work like passive light amplification optic systems that enable them to see in the dark —cats can see in darkness 6-7 times better than humans. However, just like a starlight scope or an owl, the cats must have some degree of *ambient* light (from the moon, stars, the dim reflection of night clouds) in order to see. In total darkness, they are as blind as a human, except they can use their sense of smell, keen hearing and long, sensitive whiskers (like antennae) to negotiate in the darkness better than humans (2-3 times better; penalties for blindness are -4 to strike, parry and dodge). A cat's vision is its most important sense.

7. Excellent sense of hearing: The sense of hearing is the cat's second most important sense. The mutant feline can hear into a higher range of sound and can register sounds of 25,000 vibrations per second compared to 20,000 in humans, though not as high as 35,000 in dogs. However, they have even greater control over their ears than dogs. Like external sound receivers, they can prick and swivel to focus in on the sound of a noise. Cats have approximately 30 ear muscles and have the ability to discriminate between two sounds separated by an angle of five degrees with an accuracy level of 75%. In addition, a feline can hear sounds up to two octaves higher than the highest note humans can hear, a half octave higher than a dog. Special hearing abilities include:

Judge distance and precise location of source: 80%+2% per level of experience. Reduce the level of accuracy -10% for every 50 yards/meters (roughly 150 ft/45.7 m) between the feline and the sound source/prey.



Recognize and identify prey by sounds: 72%+2% per level of experience; -20% when dealing with artificial sounds (bots, 'Borgs, the whine of a jet pack, the rumble of a hovercycle, etc.). This ability enables the mutant cat to identify the animal (or machine) making the noise (rabbit, raccoon, snake, cat, buffalo, dog, Dog Boy, Simvan, human, etc., or in the case of a machine, an NG-Turbo, CS Rocket bike, SAMAS or two or five, Skelebot, etc.). Reduce the level of accuracy by -10% for every 50 yards/meters (roughly 150 ft/45.7 m) distance between the feline and the sound source/prey.

8. Fair to good sense of smell: Most cats (but not all) have an olfactory ability about twice as good as a human's, but nothing compared to a canine's. A tiger relies primarily on its vision and hearing, so its sense of smell is on par with a human's.

9. Natural climbers: All cats can climb at the base skill of 60%/40% (plus bonuses for certain species).

10. Natural Swimmers: All cats are fair swimmers with a base skill of 50%. Tigers are natural swimmers who love to swim and play in water; base skill of 86%!

11. Sprinters: The mutant cat can run at double his normal speed for 1D4 minutes before dropping back to normal speed.

12. Sensitivity to Ley Line energy. Ley lines and nexus points obliterate the mutant cat's psychic and supernatural sensing abilities and gives it a headache. They try to avoid these places. This means the character cannot use his psychic sensing abilities to locate magic or supernatural prey, or to sense their presence when on a ley line or near a nexus. However, the creature's normal physical senses, especially sight, are not affected and the other psychic abilities are enhanced (as usual). Most mutant cats are leery around places of magic and often show uncharacteristic signs of being nervous and on edge. Cats are not vulnerable to ley line storms like canines.

Battle Cats R.C.C.

R.C.C. Requirements: None, other than the mutant must be relatively intelligent, loyal and obedient (60% are female because they tend to work well in small groups and aggressive, active hunters). All sub-standard creations (physically or mentally) are destroyed.

Player Character Note: Player characters who are *not* CS agents (spy, infiltrator, scout, soldier, etc.) must either be "feral" renegades (runaway mutants/deserters) or the offspring of runaway mutants. In the first case, they are considered dangerous traitors in need of termination. In the latter case, the mutant is considered to be a hopelessly corrupt and dangerous "feral free-born" and destroyed whenever encountered.

Alignments: Any, but 35% lean toward anarchist and 25% toward aberrant. Characters who are diabolic tend to be loners, mean, and do not work well in a group unless they can be the leader.

Average Attribute Range (Standard Battle Cat): I.Q. 3D6, M.E. 3D6, M.A. 4D6, P.S. 4D6, P.P. 4D6, P.E. 4D6, P.B. 4D6, Spd 4D6+6 running (reduce by 10% when climbing).

Hit Points: P.E. attribute number x2 plus 2D6 per level of experience. Some species get bonus hit points.

S.D.C.: P.E. attribute number plus 1D4x10 plus those gained from physical skills; some species get S.D.C. bonuses.

Average Weight: 200-300 pounds (90 to 135 kg).

Average Height: 5 feet (1.5 m)

Armor Rating: 9+1D4; an attacker must roll above the A.R. to inflict hit point/S.D.C. damage; mega-damage weapons automatically blast through S.D.C. based A.R.

General Physical Appearance: No human looks — animal appearance with only vague human, bipedal appearance. 85% have human legs, arms and builds, 15% have animal-like legs. Most have powerful, muscular but comparatively slender builds. The head/face is that of a cat, the body is fur covered and there is a tail. Hands are usually (90%) fully articulated with a human-like opposable thumb, although most (90%) have thick fingers and retractable claws. A

bipedal stance that enables the mutant canines to stand and walk erect, although some (25%) run on all fours.

Human Speech: Typically partial and guttural. The character still has a tendency to hiss, growl, and roar when excited, angry or scared.

Average Life Span: Estimated 40-55 years.

Natural Abilities: See special abilities above.

Magic: None. However, "feral" and "free borns" are fascinated by magic and may study magic (particularly the arts of the Shifter and Ley Line Walker, rarely Techno-Wizardry or other magic. If a mutant feline is a "free born" mage, it forsakes many of its natural hunter/military skills (of this R.C.C.); select the skills of the appropriate magic O.C.C. and natural abilities still apply.

Average P.P.E.: Most of the individual's P.P.E. has been expended in the development of psychic abilities. The remaining *Permanent P.P.E. Base* is 3D6.

Psionics: See Special Abilities above.

R.C.C. Skills of a Coalition Battle Cat: With rare exception, all mutant cats, even mercs and nomads, began life as a Coalition agent/slave, created, conditioned, and trained as a Coalition soldier. The following military skills are known to *most* Battle Cats. Also see the Special Abilities and Bonuses, previously described.

Speaks American at 90% efficiency.

Basic Math

Radio: Basic (+10%)

Acrobatics

Climbing

Running

Prowl

Track Animals (+10%)

Track Humanoids (+10%)

Land Navigation (+20%)

Wilderness Survival (+15%)

W.P. Knife (Vibro-Blade)

W.P. Energy Rifle

W.P. one of choice.

Hand to Hand: Expert or Assassin (depending on what the CS wants).

R.C.C. Related Skills: At first level the mutant can select four "other" skills, plus one skill at levels 3, 6, 9, and 12. **Note:** Mutant felines in the service of the CS are never taught to read.

Communications: Any

Domestic: Any

Electrical: None

Espionage: Any (+10%)

Mechanical: Basic Mechanics and Automotive only.

Medical: First Aid only (+5%)

Military: Any (+5%)

Physical: Any

Pilot: Hovercraft, truck and sail and motorboat only (+5%).

Pilot Related: Any

Rogue: Any, except computer hacking (+5%)

Science: None

Technical: Any (+10%), except computer operation & programming.

W.P.: Any

Wilderness: Any (+10%)

Secondary Skills: The character gets six secondary skills from the list, excluding those marked "None," at level one and two additional at levels 2, 4, 8, and 11. These are additional areas of knowledge that do not get the advantage of the bonuses listed in parentheses. All secondary skills start at the base skill level.

Standard Equipment for Battle Cats: Basically the same as Dog Boys, although full environmental suits are rarely available.

Basic equipment includes DPM riot armor, tinted goggles or nonenvironmental helmet with or without visor, radio, flashlight,

pocket mirror, comb, 100 ft (30.5 m) of lightweight rope, four spikes and a hammer, portable language translator, survival knife, a pair of Vibro-knives or Vibro-claws (many also have a Vibro-saber or Neuro-Mace), knapsack, backpack, utility belt, air filter, gas mask, and a canteen.

Equipment Available Upon Assignment: Basically the same as the Dog Boys, although the availability of heavy weapons, explosives, environmental armor, vehicles and special equipment is much more limited and restricted to mutants who have proven themselves in years (at least two) of service.

Money: All the mutant's basic needs are provided for by the CS military; a place to sleep, food, clothing, medical treatment, basic supplies and equipment, and limited access to military facilities. They are also given a token monthly salary of 90-130 credits for personal items and edible goodies. Unlike the Dog Boys, mutant cats do not have the same freedoms, privileges or trust, especially on base. They are experimental "animals" kept under close observation, unless unleashed into the field as hunters and seek and destroy operatives. In that case, these big cats are usually left to their own devices, checking in once every 4-8 weeks and living off the land (also see Kill Cats).

Cybernetics: Generally, none to start, although as experimental animals, about 10% have 1D4+2 bionic extras and 10% are partial conversion 'Borgs.

Identification Coding (I.C.): The same dual I.D. system as the Dog Boys (unless they are part of Doctor Bradford's secret creations).

Note: Any Battle Cat who goes AWOL or "feral" is hunted down and terminated, although because most (70%) are special agents operating alone or in small groups in the wilderness and hostile enemy territory, they can be AWOL for days or weeks (and often long gone) before anybody notices.

Typical Battle Cat Missions: Reconnaissance, espionage, and intelligence, especially seek and destroy missions.

Maximum Rank: Non-Commissioned officer up to Sergeant Major; rank may be increased if these test animals work out.

Note: There are approximately 3,200 Battle Cats in CS military service, half of which are located in the State of Lone Star, a third on the front lines at Tolkeen and the rest in the wilderness of the American West.

Kill Cats

Kill Cats are usually the big powerful cats, *snow leopards*, *African lions* and *tigers*. They are selected for their size and power, and given the most aggressive traits (very similar to Kill Hounds). They are typically unleashed into the wilderness to seek and destroy the enemy or to patrol expansive territories. Kill Cats typically function as *lone hunters* and are assigned a "hunting ground" (their territory shared by 2D6 other Kill Cats) and a simple task: Kill all nonhumans who are not CS personnel (or escorted by/in the service of the CS) who enter the area!

If the nonhuman intruders are in a group that the Kill Cats cannot manage, the mutant felines are to observe and assess their strengths, operations and intentions. If they represent little danger (bandits, adventurers or clans passing through, hunting, etc.), the big cats can take whatever action they desire; i.e. pick them off one by one (hit and run tactics, often over a number of days), kill the most vulnerable prey and let the others escape, frighten them away, sabotage their vehicles, steal equipment/valuables, follow and observe them/reconnaissance, solicit the assistance of other mutant felines in the area to destroy them, or other cat and mouse games. If the group seems completely harmless and the cats decide to let them pass unmolested, that's usually okay too, although most Kill Cats feel it's better to be safe (destroy them or frighten away) than sorry. If the intruding group seems to represent a serious threat to CS security or are dangerous, known criminals or feral mu-

tants, the Kill Cats are to observe, follow without revealing their presence and request an investigation or intervention of better equipped CS forces such as squads or even platoons of Kill Hounds, Dog Packs, SAMAS or other CS troops, which the felines may join in the effort to capture or destroy the enemy.

Typically, most mutant felines operate as lone individuals, sometimes temporarily teaming up to stalk prey in pairs or small groups of 1D4+2, rarely larger. Kill Cats created from leopards, tigers, and the snow leopard are the most notorious "lone hunters," seldom gathering even in temporary groupings of more than three. **Note:** Puma/mountain lion based Kill Cats often like to hunt in pairs. Mutant African Lions often hunt and work in "prides" — groups of 4 to 16. The largest groups (12-16) typically have 1-4 males as leaders and the rest females, but even African lions will splinter off to hunt alone or in small groups of 2-5. Mutant African lions prefer operations in grasslands/savannas, prairies, scrub lands, light forests and deserts — they love assignments in the American southwest, Lone Star and Mexico. This has earned African Lions the nickname, "Plains Hunters."

Kill cats are also sent out as lone hunters, in pairs and small groups (seldom larger than six) on "hard target" seek and destroy missions, i.e. the job of hunting down a specific enemy (individual or group) and killing him/them.

Kill Cat Hunter-Killer R.C.C.

R.C.C. Requirements: None, other than the mutant must be a relatively intelligent, loyal and obedient (70% are male because they are larger, a bit more powerful and aggressive). All substandard creations (physically or mentally) are destroyed.

Player Character Note: Player characters who are *not* CS agents (spy, infiltrator, scout, soldier, etc.) must either be "feral" renegades (runaway mutants/deserters) or the offspring of runaway mutants. In the

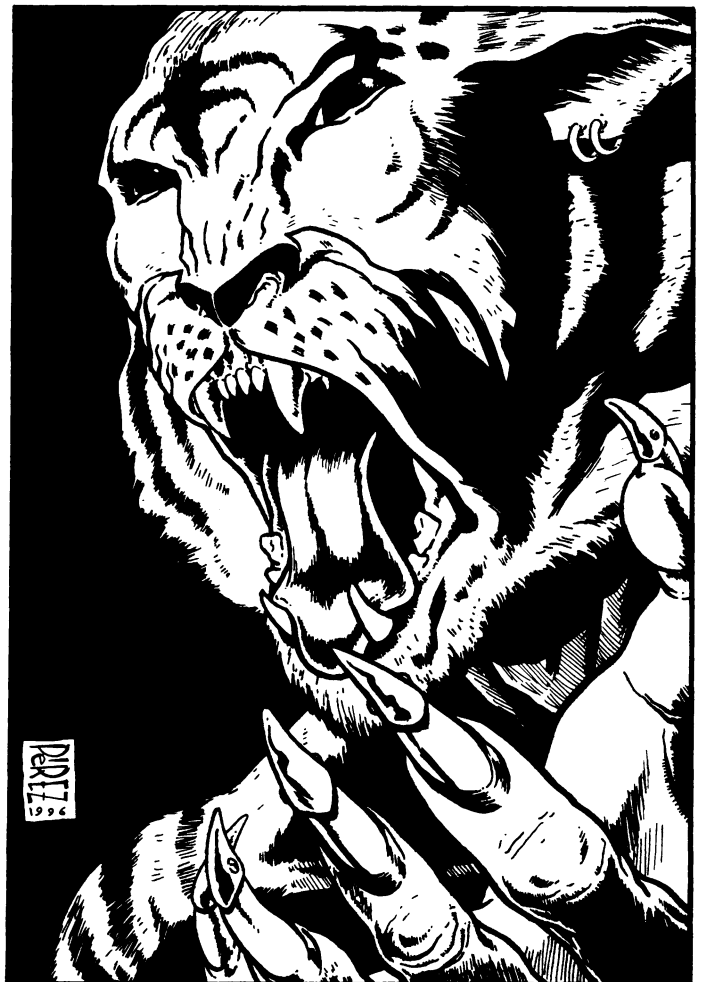

first case, they are considered dangerous traitors in need of termination. In the latter case, the mutant is considered to be a hopelessly corrupt and dangerous “feral free-born” and destroyed whenever encountered.

Alignments: Any, but 25% lean toward anarchist, 25% aberrant, and 20% miscreant. Characters who are diabolic tend to be dedicated loners, mean, and do not work well in a group, even as the leader.

Average Attribute Range (Standard Kill Cat): I.Q. 3D6, M.E. 3D6, M.A. 3D6, P.S. 4D6+6, P.P. 4D6, P.E. 4D6, P.B. 3D6, Spd 4D6+6 running (reduce by 20% when climbing). Bonuses and size varies by species, as listed under the Battle Cat, and all abilities common to mutant felines are unchanged, all bonuses are cumulative. The main difference between Kill Cats and Battle Cats is that the Killers are larger, have slightly more powers and are more powerful. 33% have supernatural P.S. and P.E.

Hit Points: P.E. attribute number $\times 3$ plus 2D6 per level of experience. Some species get bonus hit points.

S.D.C.: P.E. attribute number plus 1D6 $\times 10$ plus those gained from physical skills; some species get S.D.C. bonuses.

Average Weight: 500 pounds (90 to 135 kg).

Average Height: 6 feet (1.8 m)

Armor Rating: 9+1D6; an attacker must roll above the A.R. to inflict hit point/S.D.C. damage; mega-damage weapons automatically blast through S.D.C. based A.R.

General Physical Appearance: Same as Battle Cats.

Human Speech: Typically partial and guttural. The character still has a tendency to hiss, growl, and roar when excited, angry or scared.

Average Life Span: Estimated 30-50 years.

Natural Abilities: Same as Battle Cats. All bonuses are cumulative.

Personality/Behavioral Problems: In addition to being aggressive, dominant, self-oriented and hunter-killers (they love nothing more than to hunt and kill), about 50% of all Kill Cats commonly suffer one or two of the same aggression based behavioral problems as *Kill Hounds*. This problem with them is less obvious because the Kill Cats operate for long periods of time in the wilderness, and often “hunt” alone or in small groups of 2-4 other mutant cats, so conflict is minimal. Those who won’t submit to the will of the leader will be forced out of the group to work alone or to start his own team. However, these ill-tempered and violent rogues usually end up as lone hunters.

Magic: None. Even “feral” and “free borns” avoid the study of magic (they are hunter-killers), but may study magic weapons, charms and devices.

Average P.P.E.: Most of the individual’s P.P.E. has been expended in the development of psychic abilities. The remaining *Permanent P.P.E. Base* is 2D6.

Psionics: Same as Battle Cats.

R.C.C. Skills of a Coalition Kill Cat: With rare exception, all Kill Cats, even mercs and nomads, began life as a Coalition agent/slave, created, conditioned, and trained as a Coalition soldier. The following military skills are known to *most* Kill Cats. Also see the Special Abilities and Bonuses, previously described for the Battle Cat. Speaks American at 90% efficiency.

Basic Math

Radio: Basic (+10%)

Climbing

Running

Prowl

Intelligence (+10%)

Escape Artist (+10%)

Track Humanoids (+10%)

Land Navigation (+20%)

Wilderness Survival (+20%)

Trap Construction (+14%)

Sniper

W.P. Knife (Vibro-Blade)

W.P. Energy Rifle

W.P. one of choice.

Hand to Hand: Martial Arts or Assassin (depending on what the CS wants; roughly a 50/50 split).

R.C.C. Related Skills: At first level the mutant can select three “other” skills, plus one skill at levels 3, 6, 9, and 12. **Note:** Mutant felines in the service of the CS are never taught to read.

Communications: Any

Domestic: Any

Electrical: None

Espionage: Any (+10%)

Mechanical: Basic Mechanics and Automotive only.

Medical: First Aid only (+5%)

Military: Any (+10%)

Physical: Any

Pilot: Hovercraft, truck and sail and motorboat only (+5%).

Pilot Related: Any

Rogue: Any, except computer hacking.

Science: None

Technical: Any (+10%), except computer operation & programming.

W.P.: Any

Wilderness: Any (+10%)

Secondary Skills: The character gets four secondary skills from the list, excluding those marked “None,” at level one and two additional at levels 2, 4, 8, and 11. These are additional areas of knowledge that do not get the advantage of the bonuses listed in parentheses. All secondary skills start at the base skill level.

Standard Equipment for Kill Cats: Basically the same as the Dog Boys and Battle Cats, except rail guns and heavy weapons are made available to these lethal hunter-killers. Also, special DPM riot style armor (70 M.D.C.) is necessary for these oversized cats (7 to 9 ft/21 to 2.7 m on average), and full environmental suits are occasionally made available.

Basic equipment includes DPM riot armor, tinted goggles or nonenvironmental helmet with or without visor, radio, flashlight, pocket mirror, comb, 100 ft (30.5 m) of lightweight rope, four spikes and a hammer, portable language translator, survival knife, a pair of Vibro-knives or Vibro-claws (many also have a Vibro-saber or Neuro-Mace), knapsack, backpack, utility belt, air filter, gas mask, and two canteens.

Equipment Available Upon Assignment: Basically the same as the Dog Boys, although the availability of explosives, environmental armor, vehicles (they love fast hovercycles) and special equipment is much more limited and restricted; generally reserved for mutants who have proven themselves in years of service (at least two).

Money: The CS provides basic supplies and direction (missions and agendas), but Kill Cats are usually sent out to live in the wild and to live off the land for months at a time. They check in once every two weeks by radio (more frequently if necessary), and may not come to and stay at a military base for more than a week, two or three times a year. They usually rendezvous with Dog Pack or SAMAS patrols, as needed, to pick up new supplies; mainly E-clips, ammo, and medical supplies. Kill Cats prefer this rough, wilderness existence and dislike the *restraints* and confinement of life on a military base or in a town or city. Of course, the CS military provides (and replaces) all basic equipment, medical treatment, and limited access to military facilities. They are also given a token monthly salary of 30-60 credits for personal items. This money usually accumulates in their bank accounts for years at a time.

Cybernetics: Generally, none to start, although as experimental animals, about 10% have 1D4+1 bionic extras and 5% are partial conversion ‘Borgs.

Identification Coding (I.C.): The same dual I.D. system as the Dog Boys (unless they are part of Doctor Bradford’s secret creations).

Note: Any Kill Cat who goes AWOL or “feral” is hunted down and terminated, often by a Kill Cat. Ironically, most of these aggressive hunter-killers rarely leave the CS (less than 2%). Then again, there are under 600 in active duty, compared to thousands of Battle Cats and tens

of thousands of Dog Boys. Kill Cats who “disappear” are presumed dead rather than having “gone feral.” It will take a reliable report that the cat is alive and AWOL before a hunting party is sent to get it. Those who stay away from the Coalition (living in the American Western Wilderness, American Eastern Forests, Canada, Mexico or South America) are not likely to ever be found and can live out their life without fear of reprisal. Those who linger in or around CS territory can expect to be hunted by the CS, mercenaries, and bounty hunters.

Typical Kill Cat Missions: Espionage and intelligence, but mainly seek and destroy missions, purges (against D-bees and bandits) and assassinations.

Maximum Rank: Non-Commissioned officer up to Sergeant Major; rank may be increased if these test animals work out, but these lone operatives don't really care.



Monkey Boys

The GED researchers are currently experimenting with increasing the intelligence and humanness of primates, both monkeys and the great apes (chimpanzee, gorilla, etc.; humans also fall into the family of primates).

Mini Monkey Spies

There are two levels of experiments being conducted with primates, one is the increase of the animal's I.Q. to low human intelligence. This is done to squirrel-sized and slightly larger monkeys to create interesting and obedient companions/pets and CS spies. In this case, nothing

else about the monkey is altered. Its size, tail, feet, abilities, and instincts are all left unchanged because they are desirable. As spies, these “Minis,” as they are called, can slip into places that would be difficult for larger animals and people to access. They can climb up balconies, drain pipes, brick buildings, along wires and in trees branches to peer through windows, slip through open windows and chimneys, or other small openings, scamper down tunnels (air ducts, pipes, etc.), and hide in small and obscure spaces. They can also be sent ahead to scout in a wilderness and are especially good at this in forest and jungle settings. Their small size and agility makes them difficult targets to see or shoot at, and their added intelligence makes them all the more sneaky and clever — wonderful spies.

An intelligent “Mini” can be taught to use simple, small still and video cameras (especially those with self-adjusting focus; point and click), recording and communications equipment, surveillance devices (plant bugs and tracer devices), and simple tools, as well as following/tailing people (often from trees or rooftops), searching rooms, pick pockets, and stealing small items. These I.Q. boosted monkeys can learn to squeak out a dozen or so simple words (no, yes, go, stop, come, help, good, bad, men, and so on) and even use short two or three word phrases (no go, bad man, many bad, etc.). However, their speech is somewhat difficult to understand. Writing, reading and computer operation is out of the question and never taught. Not because they couldn’t be taught some grade school level abilities, but because the CS thinks it unwise.

Mini Monkey Spies adapt amazingly well to urban settings, especially cities and burbs with tall buildings and lots of places to hide above ground. One must remember that most monkeys are vegetarians who gather and eat fruits, vegetables, roots, nuts, leaves, bark and occasionally insects. They are *NOT* predators and consequently tend to be vulnerable to ordinary cats, dogs, and other predators, as well as humans and D-bees. Of course, their increased intellect and the use of armor, weapons, and tools gives minis an advantage, but they are still small, comparatively slow on the ground, and vulnerable. On the ground, without ample cover, Minis are lunch or target practice waiting to happen.

Mini Monkey Spies R.C.C.

R.C.C. Requirements: None, other than the mutant animal must be relatively intelligent, loyal and obedient (70% are female because they are smaller and less aggressive). All substandard creations (physically or mentally) are destroyed or used in other areas of research as lab test animals.

Player Character Note: Mini Monkey Spies can be fun to play, especially as a Non-Player Character (NPC) for the G.M., but they are not ideally suited for most player characters, especially hack and slash players who are used to combat and action. See *Penalties and Other Considerations* and *Natural Abilities and Bonuses*.

Player characters who are *not* CS agents (spies and urban scouts) must either be “feral” renegades (runaway mutants/deserters) or the offspring of runaway mutants. They are seldom hunted, but destroyed if encountered.

Alignments: Any, but 25% lean toward unprincipled, 25% anarchist, and 25% aberrant. Characters who are diabolic tend to be vindictive, mean and self-serving.

Average Attribute Range (Mini Monkey Spy): Average I.Q. 7 (roughly human), M.E. 3D6, M.A. 3D6, P.S. 1D6+4, P.P. 3D6+6, P.E. 2D6+8, P.B. 3D6, Spd 2D6+10 running (double in trees).

Hit Points: P.E. attribute number plus 1D4 per level of experience. Some larger species may get bonus hit points (1D6 or 2D6).

S.D.C.: P.E. attribute number +3D6 (+5D6 for larger species).

Average Size: Minis are small monkeys usually not much larger than a North American squirrel, although their prehensile tail is often twice as long. They can sit on a person’s shoulders or head and hide inside a backpack or duffle bag.

Average Weight: 5-10 pounds (2.3 to 4.5 kg).

Average Height/length: 2 feet (0.6 m), plus tail (another 2-3 feet/0.6 to 0.9 m).

Armor Rating: Not applicable.

General Physical Appearance: Looks like a typical monkey. Note that there are 45 species of “typical” monkeys (redtail monkey, mangabeys, macaques and others), 30 capuchin monkeys and over 140 different monkeys overall (does not include lemurs and bush babies).

Human Speech: None to a dozen words, but can understand 600+ words and can follow simple to moderate instructions and use simple tools and machines (cameras, tape recorders, light switches, flashlights, etc.). Typically chatter, grunt, hiss and squeal.

Average Life Span: Estimated 20-30 years.

Natural Abilities & Bonuses: Natural, skill-like abilities are in addition to R.C.C. specialized skill training.

Swim 30%

Climb 95%/90%

Acrobatics 90%

Prowl 56%+2% per level of experience.

Can leap 5 feet (1.5 m) up and 10 feet across (increase lengthwise leaps by 50% with a running or swing start). Furthermore, they can dive down through branches up to 20 ft (6 m).

Can run, leap and swing through trees at double their running speed! Identify “edible” plants, fruits, nuts, leaves and roots 80%; edible for monkeys that is.

Attacks/melee actions per round: 2 to start, +1 at levels 3, 6, 9, and 13.

Prehensile feet and tail.

+2 on initiative.

Dodge: +2 on the ground or +4 in trees.

Roll with fall or impact +4.

Magic: None; these are animals, remember.

Average P.P.E.: 4D6

Psionics: None

R.C.C. Skills of CS Mini Monkey Spies: With rare exception, all Minis, even free borns, mercs and nomads, began life as a Coalition agent/slave, created, conditioned, and trained as a Coalition spy or scout. The following military skills are known to *most* Minis. Also see the *Natural Abilities and Bonuses*, previously described.

Understands American at 80% efficiency; can speak only a few words.

Radio: Basic (+10%)

Optic Systems (+5%)

TV/Video (basic, no bonus)

Surveillance Systems (and Tailing, not tracking; +5%)

Pick Pockets (+5%)

Land Navigation (+20%)

Wilderness Survival (+15%)

W.P. Knife (scalpel and laser scalpel)

Hand to Hand: Not applicable.

R.C.C. Related Skills: At first level the mutant can select three “other” skills, plus one skill at levels 3, 6, 9, and 12. **Note:** Mutant monkeys in the service of the CS are never taught to read, they are not good at tracking, and some skills have penalties rather than bonuses. Most Minis don’t advance beyond 8th level.

Communications: Any

Domestic: Any (-5%)

Electrical: None

Espionage: Any (+5%), except sniper, forgery, tracking and intelligence.

Mechanical: None

Medical: First Aid only

Military: Camouflage only (+5%)

Physical: Swim only.

Pilot: None

Pilot Related: None

Rogue: Any, except computer hacking and card shark.

Science: None

Technical: Art (-5%), language (-10%) and photography only.

W.P.: Blunt, paired weapons and pistol only.

Wilderness: Identify plants (+10%) and track animals (-5%) only.

Secondary Skills: The character gets one secondary skill from the list, excluding those marked “None,” at levels 1, 2, 4, 8, 10, 12 and 14. These are additional areas of knowledge that do not get the advantage of the bonuses listed in parentheses. All secondary skills start at the base skill level.

Penalties and Other Considerations: While their small size has many advantages, especially in hiding, prowling and spying, it limits the monkey to a small selection of tools, weapons and equipment. While strong for their size, they are puny compared to humans, and while they may be able to lift or carry an energy pistol or Vibro-Blade (and drag a rifle), they cannot point and shoot with any measure of accuracy (no bonuses applicable and -5 to strike). It is impossible for a Mini to drive a vehicle, and mega-damage body armor must be *custom made* (11 M.D.C. for Dog Boy riot control style, preferred by Minis because it's not too restrictive and confining; 20 M.D.C. for full environmental armor, but speed, leaping distance, prowl, climbing, and acrobatics are all reduced by 20%).

The ideal weapons for Minis are regular S.D.C. pocket knives and scalpels, and M.D. laser scalpels. Hand grenades and flares are also excellent (throwing range of the former is about 40 feet (12 m) and -2 to strike).

Another weakness is that monkeys are used to warm climates and don't fare well in cold climates with long, freezing (and below) winters even if given a tiny coat and gloves to wear. Snow and ice also reduce their abilities: -20% skill penalty to prowl, climb and acrobatic skills and reduce speed and leaping distances by 30%.

Standard Equipment for Minis: Limited by the animal's size and strength as above. Typically includes a light armor (11 M.D.C.), an S.D.C. scalpel, a laser scalpel, two flares, pair of small binoculars, small radio, pen flashlight, pocket mirror, comb, small canteen, small backpack, utility belt and air filter.

Equipment Available Upon Assignment: Surveillance equipment, hand grenades, more and different flares, and other odds and ends.

Money: The CS provides for all the animals' needs; food, treats, shelter, equipment, medical treatment and so on.

Cybernetics: Generally, none.

Identification Coding (I.C.): The same dual I.D. system as the Dog Boys (unless they are part of Doctor Bradford's secret creations).

Typical Mini Monkey Spy Missions: Surveillance, tailing, spying, general observation, theft, planting bugs, and similar spy stuff.

Maximum Rank: Not applicable.

Note: "Minis" are considered a complete success and are being used with increasing frequency in military intelligence and espionage operations. There are over 200 at Lone Star, 300 at Chi-Town, 60 deployed at Tolkeen and a hundred or more at Free Quebec on both sides of that conflict.

Monkey Boys

The second level of experimentation is with the great apes, dubbed, "Monkey Boys." These include chimpanzees, orangutans and gorillas given human-level intelligence and, in the case of chimps and orangs, often given larger, more human/Dog Boy like bodies.

Apes (and monkeys) were selected for mutation experiments as possible troops and laborers because they, like dogs, are looked upon favorably by most humans, and because these "higher primates" are social animals who gather in small groups (4-40) and work together to gather food, rear and protect young, and to protect the group. However, the enhancement or humanizing of the great apes is a grey area that the CS authorities are not particularly happy with. Chimps, in particular, just seem too human-like to begin with, they have similar personalities, the same levels of aggression, and tendencies for competition and war. Boosting their intelligence only makes them more human-like. Thus, the number of intelligent humanoid test subjects for Military applications are low (about 30), but Bradford and his geneticists have found Monkey Boys most useful as the test subjects in (inhumane) experimentation with M.O.M. implants, personality modifiers and bionic systems not yet perfected for human applications, other medical purposes. A half dozen, brilliant chimpanzees (I.Q. 20-24) work in the labs as laboratory assistants, computer operators, researchers and clerks. Two dozen are operatives in special units (Dog Packs, etc.) of the CS Army.

Experiments to make chimpanzees and gorillas powerful, intelligent infantry grunts have only met with limited success. Most gorillas are not aggressive in the same way as humans, chimps, cats or dogs. In the wild, they generally fight to protect themselves and to assert dominance. Most are happy if an intruder or opponent runs away, hence the displays of chest thumping, baring of fangs and screeching. Attempts to make them more aggressive usually go too far, making the mutant gorilla aggressive to the point of daily berserker rages, destructive tantrums, extreme aggression and little ability to be controlled.

Chimpanzees as warriors — an ape version of Dog Boys — have been much more successful, but they too tend to be aggressive, difficult to control, and insubordinate. In addition, they are clever, sneak around and are eager to learn, particularly things they are not allowed to learn; chimps are very curious.

Chimpanzees represent 95% of all Monkey Boys. Although most are trained for military duty as grunts, Doctor Bradford considers this a tragic waste. Chimpanzees have a surprising aptitude for numbers/mathematics, tools, repairs, building/mechanical engineering, and welcome working with others, sharing their ideas, willing to work an exhausting number of hours if the chore is intellectually challenging and are gregarious extroverts who make the workplace fun and exciting. However, the CS authorities believe it is both dangerous and imprudent to educate an intelligent mutant animal better than the average human citizen and then place human technology and science in its "monstrous" hands. Bradford thought that with the assurances of artificial personality modifiers (brain implants) to keep the Monkey Boys in check, it would change their minds (which is why he started that project) but it has not. Of course, this hasn't stopped Bradford from using them in his own secret laboratory and research. 40 loyal and hard working Monkey Boy Techs, all chimpanzees, work for him night and day on the secret level of GED. There is no record of these creatures existing and, ironically, they are not bound to him through any artificial means. They are free thinking scientists and engineers.

Monkey Boy Soldier R.C.C.

R.C.C. Requirements: None, other than the mutant animal must be relatively intelligent, loyal and obedient (60% are female because they are smaller and less aggressive). All substandard creations (physically or mentally) are destroyed or used in other areas of research as lab test animals.

Player Character Note: Player characters who are *not* CS agents (spy, infiltrator, scout, soldier, etc.) must either be "feral" renegades (runaway mutants/deserters) or the offspring of runaway mutants. In the first case, they are considered dangerous traitors in need of termination. In the latter case, the mutant is considered to be a hopelessly corrupt and dangerous "feral free-born" and destroyed whenever encountered.

Alignments: Any

Average Attribute Range (Monkey Boy/Apes): I.Q. 2D6+7, M.E.

3D6, M.A. 2D6+8, P.S. 4D6+10, P.P. 2D6+6, P.E. 2D6+8, P.B.

2D6+2, Spd 2D6+6 running. Gorilla test subjects are often given supernatural P.S. and P.E.

Hit Points: Chimpanzees and orangutans: P.E. attribute number plus 1D6 per level of experience. Gorillas: P.E. attribute number x2 plus 2D6 per level of experience.

S.D.C.: Chimpanzees and orangutans: P.E. attribute number x2. Gorillas: P.E. attribute number +2D4x10.

Average Weight: Chimpanzees: 70-90 pounds (31.7 to 40.8 kg); orangutans: 90 to 140 pounds (40.8 to 63 kg); gorillas: 200 to 300 pounds (90 to 135 kg) and proportionally higher for giant-sizes (up to half a ton). The weight for genetically altered, larger, more human-like apes is typically doubled.

Average Height: 3-4 feet (0.9 to 1.2 m) without genetic alteration, 5-6 feet (1.5 to 1.8 m) with. Gorillas without genetic manipulation are 5.6 to 5.9 feet (1.65 to 1.7 m) tall — up to 6 feet, 6 inches (1.95 m)

tall standing completely erect on its hind legs! 7-12 feet (2.1 to 3.6 m) with alteration — up to 15 ft (4.6 m) erect.

Armor Rating: Applicable to gorillas only; 1D4+5.

General Physical Appearance: Looks like a typical chimpanzee, orangutan or gorilla. Those with special genetic modifications may be taller, stand straighter and have a bit more human proportioned bodies, but are otherwise unchanged.

Human Speech: Very good to excellent, better than most Dog Boys; often almost human. However, they may still chatter and howl when angry or excited.

Average Life Span: Estimated 40-55 years.

Natural Abilities & Bonuses: Natural, skill-like abilities are in addition to R.C.C. specialized skill training.

Climb 75%/65% (-20% for gorillas)

Gymnastics 60% (-10% for gorillas)

Sense of smell is 50% better than humans.

Can leap 4 feet (1.2 m) up and 8 feet (2.4 m) across (increase length-wise leaps by 20% with a running or swing start).

Can run, leap and swing through trees at double roughly the same speed as they can run; about half speed for gorillas.

Identify “edible” plants, fruits, nuts, leaves and roots 70%; edible for ape’s that is.

Prehensile feet; no tail.

Double jointed.

+1 attack melee per round.

+2 on initiative.

Dodge: +2 on the ground or in trees; not applicable to gorillas.

Roll with fall or impact +3

Magic: None. However, “feral” and “free born” chimpanzees are fascinated by magic and may study the mystic arts (any). If a mutant chimpanzee is a “free born” mage, it forsakes the CS military (of this R.C.C.) and selects, instead, the skills of the appropriate magic O.C.C.; natural abilities still apply.

Average P.P.E.: 6D6

Psionics: Roughly the same as humans.

R.C.C. Skills of Monkey Boy CS Soldiers: With rare exception, all Monkey Boys, even free borns, mercs and nomads, began life as a Coalition soldier/slave, created, conditioned, and trained as a Coalition trooper. The following military skills are known to *most* Monkey Boys. Also see the *Natural Abilities and Bonuses*, previously described.

Speaks American at 90% efficiency

Basic Math (+20%)

Radio: Basic (+10%)

Radio: Scrambler (+10%)

Military Etiquette (+10%)

Escape Artist (+10%)

Intelligence (+10%)

W.P. Pistol

W.P. Energy Rifle

W.P. one of choice.

Hand to Hand: Expert or Assassin (depending on what the CS wants)

R.C.C. Related Skills: At first level the mutant can select four “other” skills, plus two additional skills at levels 3, 6, 9, and 12. **Note:** Mutant primates in the service of the CS are never taught to read, pilot vehicles, mechanical or science skills, track or wilderness survival as a means to limit and control them.

Communications: Any (+10%)

Domestic: Any

Electrical: None

Espionage: Any (+5%), except sniper, forgery, and tracking.

Mechanical: None

Medical: First Aid only

Military: Camouflage, find contraband, military etiquette and the various demolition skills only.

Physical: Any, except boxing and acrobatics.

Pilot: None (just in case of insurrection).

Pilot Related: None (just in case of insurrection).

Rogue: None

Science: Math only (+15%)

Technical: None

W.P.: Any

Wilderness: Land Navigation only.

Secondary Skills: The character gets four secondary skills from the list, excluding those marked “None,” at level one, and two additional at levels 2, 4, 8, 10, 12 and 14. These are additional areas of knowledge that do not get the advantage of the bonuses listed in parentheses. All secondary skills start at the base skill level. **Note:** Free borns and runaways may learn to pilot any vehicle humans can, as well as select rogue and wilderness skills as secondary skills.

Penalties and Other Considerations: Chimpanzees and most primates do not flourish or do their best when they are trapped in very restrictive environments like the CS military. The only exception is when they are given a certain amount of trust and freedom, which most of the paranoid CS commanders won’t allow. Consequently, the majority of the Monkey Boy grunts are stuck with boring or tedious duties and do half-hearted work, are not particularly loyal or happy, and tend to be listless, depressed, and cranky. However, even these depressed individuals will show sparks of enthusiasm and cleverness during combat and when given the opportunity to excel, whether it’s during play or work.

Standard Equipment for Monkey Boy Grunts: Basically the same as Dog Boys, although full environmental suits are rarely available.

Basic equipment includes DPM riot armor, tinted goggles or nonenvironmental helmet with or without visor, radio, flashlight, pocket mirror, comb, 100 ft (30.5 m) of lightweight rope, four spikes and a hammer, portable language translator, survival knife, a Vibro-Blade or Neuro-Mace, an energy pistol and rifle, knapsack, backpack, shovel, utility belt, air filter, gas mask, and a canteen.

Equipment Available Upon Assignment: Basically the same as the Dog Boys although the availability of heavy weapons, explosives, environmental armor, vehicles and special equipment is much more limited and restricted to mutants who have proven themselves in years (at least two) of service, or for very special assignments.

Money: All the mutant’s basic needs are provided for by the CS military; a place to sleep, food, clothing, medical treatment, basic supplies and equipment, and limited access to military facilities. They are also given a token monthly salary of 60-100 credits for personal items. Unlike the Dog Boys, mutant primates do not have the same freedoms, privileges or trust, especially on base. They are experimental “animals” kept under close observation.

Cybernetics: Generally, none to start, although as experimental animals, about 10% have 1-4 bionic extras, 2% are partial conversion ‘Borgs, and 5% are Crazies (have experimental M.O.M. implants)!

Identification Coding (I.C.): The same dual I.D. system as the Dog Boys (unless they are part of Doctor Bradford’s secret creations).

Note: Any Monkey Boy who goes AWOL or “feral” is hunted down and terminated.

Typical Monkey Boy Grunt Missions: Infantry, guard duty and labor; the lucky ones will find themselves assigned to Dog Packs or companies that allow them to participate in reconnaissance, rescue, escort, espionage, intelligence, and other missions.

Maximum Rank: Non-Commissioned officer up to Sergeant Major. This rank will never be increased, and CS Military authorities want Monkey Boys taken out of the GED program (too dangerous).

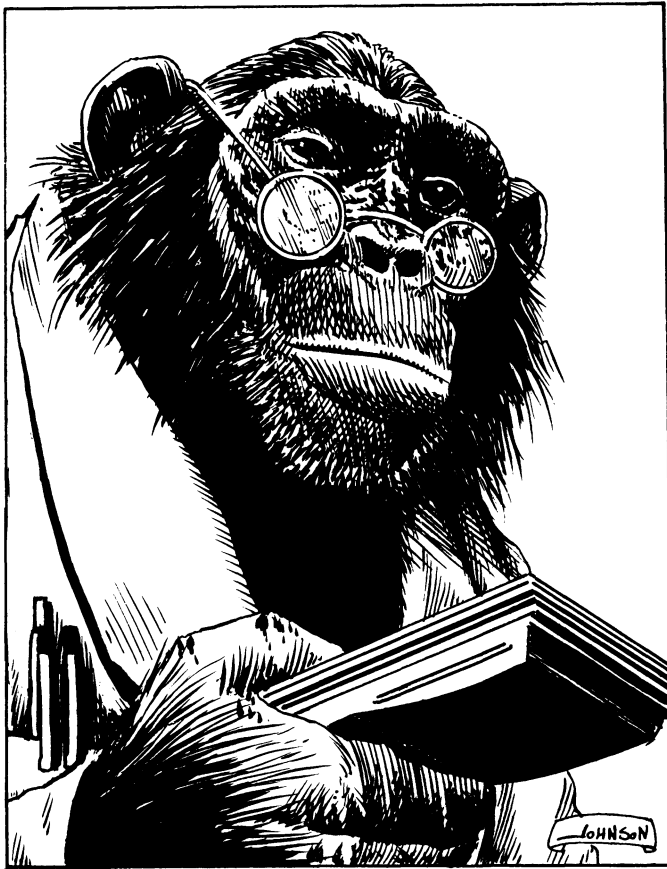

Monkey Boy Tech R.C.C.

Illegal, unauthorized, and secret cadre of mutants

Monkey Boy Techs are fundamentally the same as the Monkey Boy Grunts, with the following modifications:

Race: Genetically enhanced chimpanzees.

Attribute Bonuses: I.Q. +1D6+1, M.A. +1D4, M.E. +1D4

Psonics: 30% are minor psonics and 10% are major; roughly the same as humans.

R.C.C. Skills of Monkey Boy Techs: Also see the *Natural Abilities and Bonuses*, previously described under the Monkey Boy Grunt.

Speaks and is *literate* in American at 98% efficiency

Language: speaks one of choice (+20%)

Basic Math (+30%)

Advanced Math (+20%)

Radio: Basic (+10%)

Three Medical or four Mechanical skills of choice!

Two Electrical skills of choice.

Biology (+20%)

Chemistry (+20%)

W.P. one of choice.

Hand to Hand: Basic; no others are available.

R.C.C. Related Skills: At first level the Tech can select five "other" skills, plus one skill at levels 3, 6, 9, and 12.

Communications: Any (+10%; +15% to cryptography)

Domestic: Any

Electrical: Any (+15%)

Espionage: Forgery (+10%) and intelligence (+5%)

Mechanical: Any (+15%)

Medical: Any (+10%)

Military: Etiquette only.

Physical: Any, except boxing, acrobatics and hand to hand.

Pilot: None (just in case of insurrection)

Pilot Related: None

Rogue: Any, except streetwise (+10% to computer hacking).

Science: Any (+10%)

Technical: Any (+10%; +15% to language skills).

W.P.: Any

Wilderness: None

Secondary Skills: The character gets five secondary skills from the list, excluding those marked "None," at level one, and an additional two skills at levels 2, 4, 8, 10, 12 and 14. These are additional areas of knowledge that do not get the advantage of the bonuses listed in parentheses. All secondary skills start at the base skill level. **Note:** A runaway or free born can learn to pilot any vehicle a human can, and learn any wilderness or rogue skills. However, thus far, no Monkey Boy Tech has ever escaped (95% don't want to leave, they like it there).

Equipment: Complete access to the secret GED facility of Doctor Bradford.

Mutant Rodents

Generally speaking, the GED scientists and CS Military have found little use for humanoid mutant rodents, although ordinary mice and rats, created and cloned for research and tests, have proven invaluable. As human-like mutants, rodents don't really offer anything that canines and felines don't already provide, and on a better, higher level. Most rodents are lone scavengers, herbivores and insectivores, so their hunting instincts and abilities (tracking, prowling, sense of smell, etc.) are inferior to the larger meat-eating predators. The bottom line is that intelligent mutant rodents are just not practical, so they aren't done. The only two exceptions are recent (in the last five years) experiments with intelligent humanoid *rats* and *bats*.

Mutant Rats

The military liked the idea that intelligent, humanoid mutant rats could breed quickly, typically 3D4 young per litter, and reach full physical maturity within one year. The plan was to create a swarming army of mutant soldiers to assail the enemy, softening their ranks before the real troops followed. Humans tend to look at rats, mutant and otherwise, as ugly, frightening, germ carrying vermin. Loathsome creatures who humans didn't care to associate with, making them (in a twisted train of thought) the perfect infantry fodder. Nobody would feel badly if thousands of rat troopers were slain in combat, in fact, good riddance. Perhaps needless to say, this idea backfired.

The rats, observant and cunning creatures, quickly came to recognize the humans' intentions, and didn't much care for it. This bred deep resentment that spread through the rodents' ranks like wildfire. Whatever chance the Military may have had to earn the creatures' loyalty and trust were lost and subtle insubordination and rebellion followed. In short, mutant rats regard humans with the same loathing and disgust that humans view them. Any cooperation between the two is at best, temporary and self-serving in some way, even if it is as basic as: "I must obey or they'll destroy me." However, this means the rats take every opportunity to embarrass and hurt their human masters and their stupid puppets (Dog Boys, felines and other mutants) whenever they can; sometimes with petty, spiteful but insignificant attacks, other times, cruel and terrible. They also make good their escape whenever they can. Of all the mutant test animals, humanoid rats have the highest rate of desertion, 39.8% (a disturbing 11% of which remain at large).

To make matters worse, rodents, especially rats, seem to be anarchist by nature, and their new, large size, humanoid bodies and intelligence seems to make most mutant rodents more aggressive than ordinary ones. Doctor Bradford has gone on record as saying *mutant rats* "are



the most human-like in their cunning and viciousness, but show absolutely no allegiance to others, even fellow members of their kind.”

Indeed, humanoid mutant rats show little loyalty to anybody other than themselves, and to a lesser degree, other rat mutants. Although they tend to congregate in “Rat Packs,” most individuals have their own agenda and look out for themselves. So while a mutant rat may join a group, swear undying allegiance and encourage a particular train of thought or action by the group, the rat will be the first to abandon ship/desert, and will betray his comrades to save his own neck, or sometimes just for profit.

The CS Military had hoped the mutant rats’ sense of self-preservation and view of the dark aspects of life would make them excellent undercover officers, spies and assassins. In some ways, this is true. Humanoid rats make great spies, stool-pigeons, extortionists, confidence artists, smugglers, thieves and assassins — provided it’s worth their while. Unfortunately, the opportunistic creatures are attracted to the seedy side of things and tend to join the criminal underworld and/or sell out to the highest bidder.

Consequently, life in the military is too restrictive and not to their liking. The rat is a master of adaptation and thrives on change and challenge. More importantly, the military doesn’t provide enough opportunity. The mutant rat wants to be a General, or at least a Big Shot. They want fame, glory and fortune! They dream of having people (especially humans and Dog Boys) bow and scrape at their feet, and they want to be filthy rich — for them, too much is *never* enough. In fact, such a cretinous villain will betray a colleague if he *feels* he is not getting the recognition/glory and/or reward he deserves, even if he’s getting the biggest share. This makes them unpredictable cutthroats who always have an eye toward the future and a new partnership.

The mutant rat’s idea of solidarity and cooperation is safety in numbers. The more people in the rat’s group, or the more powerful those people, the braver, meaner and nastier the mutant rat becomes. This lynch mob mentality (and the ever present delusion that numbers mean power and might makes right) frequently gets mutant rats into serious trouble. The rats in a large group, whether other rats or different races, will push their luck, make loud demands and threats, egg each other on, and attack without accurately weighing the situation or their opponents. This leads to brutal confrontations that could have been avoided, taking foolish risks, pointless firefights and needless bloodshed. Likewise, the rats become incredibly cruel and bold when they face an inferior, weak, injured or defeated foe, often engaging in torture, rape, murder and wanton destruction for the sheer pleasure of it, and because there’s nobody to stop them.

Two years ago, the mutants’ vile and treacherous nature made the Coalition Military leaders declare this undertaking to be a terrible failure. They feared the existence of these foul, vengeful mutants threatened the security of Lone Star, as well as threatened to unleash one more “monster” in the world. Thus, it was decided to quietly gather these miscreants and terminate them. Only a few hundred would be kept, sterilized, and placed for use as special espionage operatives (spies, assassins, etc.). These are the ones that are assigned to special units (Dog Packs, reconnaissance teams, Special Forces, etc.).

In a freak, inexplicable incident, a random Rift appeared in the middle of a mutant rat containment area. Being the eternal opportunists that these maniacs are, hundreds leaped headlong into the gaping opening to who knows where. Once a handful made the plunge, others followed en masse (the mob mentality in action). Before CS troops could stop the insane exodus, 1119 leaped through the Rift. As fate would have it, approximately 313 appeared within the sewers, and lower, secret and unfinished levels of the Lone Star Complex and continue to be a problem to this day — Dog Packs constantly hunt them (mutant felines are not trusted to do the job), but as long as only one male and female evades extermination, they can multiply their numbers quickly and in less than three years, infest the place. It seems an estimated 400 were Rifted to the Badlands of the Pecos Empire, where they have bred ... well ... like rats. In two years, their population has exploded to eight times their



original number, roughly 3200! Even many bandits and Psi-Stalkers have begun to wage wars and extermination campaigns against them. Nobody knows what happened to the rest of the escapees.

Experiments with mutant rats have been abandoned, and one of the assignments of mutant felines is to seek and destroy them. Dog Packs, SAMAS and most CS troops know to exterminate mutant rats whenever they are discovered.

Note: Doctor Bradford was inadvertently responsible for the appearance of the Rift. One of the ultra-secret sectors of the Lone Star Complex is a laboratory and machine designed to explore the possibilities of dimensional travel — a super-secret project of the old American Empire (nobody knew). It was during Bradford's test of the device that triggered a dimensional anomaly and created the Rift that freed so many of the hated rodents. That's also why a few hundred were Rifted to the lower levels. Bradford hasn't gone back to this sector since and sometimes sends his own mutant operatives into the Badlands to hunt and destroy these foul creatures.

CS Mutant Rats

R.C.C. Requirements: None, other than the mutant must be relatively intelligent, loyal and obedient (60% are female because they tend to work well in small groups and are aggressive, active hunters). All substandard creations (physically or mentally) are destroyed.

Player Character Note: Player characters who are *not* CS agents (spy, infiltrator, scout, soldier, etc.) must either be "feral" renegades (runaway mutants/deserters) or the offspring of runaway mutants. In the first case, they are considered dangerous traitors in need of termination. In the latter case, the mutant is considered to be a hopelessly corrupt and dangerous "feral free-born" and destroyed whenever encountered.

Alignment: Any, but the very nature of the rat makes *anarchist* (30%), *miscreant* (30%) and *diabolic* (30%) the most common. They also tend to live for the moment and seek instant gratification.

Average Attribute Range (Typical Mutant Rat): I.Q. 2D6+6, M.E. 2D6, M.A. 2D6, P.S. 3D6, P.P. 2D6+8, P.E. 3D6, P.B. 2D6, Spd 4D6+6 running (reduce by 30% when climbing).

Hit Points: P.E. attribute number plus 1D6 per level of experience.
S.D.C.: P.E. attribute number plus 4D6 plus those gained from physical skills.

Average Weight: 120-160 pounds (54 to 72 kg).

Average Height: 5 feet (1.5 m)

Armor Rating: Not applicable.

General Physical Appearance: No human looks — animal appearance with only a vague human, bipedal appearance and rat-like head. 85% have human legs, arms and builds, 15% have animal-like legs; all have a long, hairless tail. Most are thin and wiry. Hands are fully articulated with a human-like opposable thumb, with long, sharp nails. They have a bipedal stance and walk upright.

Human Speech: Typically full but a bit guttural. The character still has a tendency to hiss, growl, and squeal when excited, angry or scared.

Average Life Span: Estimated 20-30 years.

Natural Abilities:

Climb 85%/80%

Swim 75%

Prowl 60% +2% per level of experience.

Identify scents: 44% +2% per level of experience.

Track by scent: 40% +2% per level of experience.

Can leap 6 feet (1.8 m) up and 10 feet (3 m) across (increase lengthwise leaps by 30% with a running or swing start).

Damage: Bite does 2D6 S.D.C./H.P., claw strike (with fingernails) does 2D4 S.D.C. damage, punch 1D6, kick 2D6.

The tail is *not* like prehensile feet.

Double jointed

Ambidextrous

+1 attack melee per round.
+3 on initiative.
+1 to dodge
+1 to pull punch
+2 to roll with fall or impact.
Plus any skill bonuses.

Rats and most rodents must chew on wood, concrete, or metal to wear down their ever growing teeth, otherwise their fangs will grow through their jaws.

Magic: None. The study of magic doesn't appeal to mutant rats, although they like magic items and weapons.

Average P.P.E.: Most of the individual's P.P.E. has been expended in the development of psychic abilities. The remaining *Permanent P.P.E. Base* is 3D6.

Psionics: 01-25% are minor psionics; select four sensitive powers.

R.C.C. Skills of a Coalition Mutant Rat: Those who have escaped into the wild can learn a number of new secondary skills, and "free borns" can select any adventurer or men of arms O.C.C. they want, but reduce the selection of "other" skills by half — rats tend to be less educated and live for the moment.

Speaks American at 90% efficiency.

Radio: Basic (+10%)

Escape Artist (+20%)

Intelligence (+10%)

Pick Locks (+10%)

Pick Pockets (+10%)

Land Navigation (+20%)

Wilderness Survival (+10%)

Sniper

W.P. Knife (Vibro-Blade)

W.P. Energy Rifle

W.P. one of choice.

Hand to Hand: Assassin

R.C.C. Related Skills: At first level the mutant can select four "other" skills, plus one skill at levels 3, 6, 9, and 12. **Note:** Mutant rats in the service of the CS are never taught to read.

Communications: Any

Domestic: Any

Electrical: Basic electronics only.

Espionage: Any (+10%)

Mechanical: Basic Mechanics and Automotive only.

Medical: First Aid only.

Military: Any (+5%)

Physical: Any

Pilot: Hovercraft, truck, sail and motorboats only (+5%).

Pilot Related: None

Rogue: Any, except computer hacking (+10%)

Science: None

Technical: Any (+10%), except computer operation & programming.

W.P.: Any

Wilderness: Any (+5%)

Secondary Skills: The character gets six secondary skills from the list, excluding those marked "None," at level one and two additional at levels 2, 4, 8, and 12. These are additional areas of knowledge that do not get the advantage of the bonuses listed in parentheses. All secondary skills start at the base skill level.

Standard Equipment for Mutant Rats: Basically the same as Dog Boys, although full environmental suits are *never* available.

Basic equipment includes DPM riot armor, tinted goggles or nonenvironmental helmet with or without visor, radio, flashlight, pocket mirror, comb, 100 ft (30.5 m) of lightweight rope, four spikes and a hammer, portable language translator, survival knife, a pair of Vibro-knives and/or Vibro-claws, C-12 assault laser rifle, knapsack, backpack, utility belt, air filter, gas mask, and a canteen.

Equipment Available Upon Assignment: Basically the same as the Dog Boys, although the availability of heavy weapons, explosives, environmental armor, vehicles and special equipment is much more limited and restricted to mutants who have proven themselves in years (at least two) of service.

Money: All the mutant's basic needs are provided for by the CS military; a place to sleep, food, clothing, medical treatment, basic supplies and equipment, and limited access to military facilities. They are also given a token monthly salary of 50-70 credits for personal items. Unlike the Dog Boys, mutant rats are not given the same freedoms, privileges or trust. They are experimental "animals" kept under close observation, and carry with them the stigma of treachery.

Cybernetics: None.

Identification Coding (I.C.): The same dual I.D. system as the Dog Boys.

Note: Any mutant rat who go AWOL or "feral" are hunted down and destroyed with extreme prejudice.

Typical Mutant Rat Missions: Reconnaissance, undercover, extortion, espionage, and intelligence.

Maximum Rank: Non-Commissioned officer up to Sergeant.



Mutant Bats

The GED's other experiment with small mammals is with the bat. The idea was to take a creature that has always frightened humans (although most are harmless fruit and insect eaters) and turn it into a servant of humanity. However, mutant bats are not particularly powerful or scary compared to other creatures that walk Rifts Earth. Ironically, these giant, intelligent bats have proven to be reliable, trustworthy and friendly, but not particularly effective as night spies or predators. Enemies armed with modern optics, sensor systems, and high-powered

weapons find the giant humanoid bat to be a slow moving, albeit silent, night flyer who is all too visible and vulnerable to technology. Even their much vaunted echolocation powers alert high-tech foes to their presence. Consequently, this is another program that has been discontinued.

Approximately 240 mutants are in the service of the Coalition Military. Most are used for night reconnaissance against the low-tech Simvan and bandits of the Pecos Badlands, and guard duty at Lone Star City and the Lone Star Complex. They get along well with Dog Boys and mutant felines, and hate the treacherous rats. They will be allowed to live out their lives serving the CS.

CS Mutant Bats

R.C.C. Requirements: None, other than the mutant must be relatively intelligent, loyal and obedient (70% are males).

Player Character Note: Player characters who are *not* CS agents (spy, infiltrator, scout, soldier, etc.) must either be “feral” renegades (runaway mutants/deserters) or the offspring of runaway mutants. In the first case, they are considered dangerous traitors in need of termination. In the latter case, the mutant is considered to be a hopelessly corrupt and dangerous “feral free-born” and destroyed whenever encountered.

Alignment: Any, but most are scrupulous (30%) and unprincipled (30%).

Average Attribute Range (Typical Mutant Bat): I.Q. 2D6+4, M.E. 2D6, M.A. 3D6, P.S. 3D6, P.P. 2D6+9, P.E. 3D6, P.B. 2D6, Spd 2D6 on the ground or climbing; 6D6+6 flying.

Hit Points: P.E. attribute number plus 1D6 per level of experience.

S.D.C.: P.E. attribute number plus 3D6 plus those gained from physical skills.

Average Weight: 100-120 pounds (45 to 72 kg).

Average Height: 5 feet (1.5 m) with a 10-15 foot (3 to 4.6 m) wingspan.

Armor Rating: Not applicable.

General Physical Appearance: No human looks — animal appearance with only a vague human, bipedal appearance, large bat wings and bat-like head. 85% have human legs, arms and builds, 15% have animal-like legs. Feet are semi-articulated and the hands are part of their massive membrane wings. Bipedal but stand and walk (waddle) crouched/hunched over; climb with all fours.

Human Speech: Typically partial and guttural. The character still has a tendency to hiss, growl, and squeal when excited, angry or scared.

Average Life Span: Estimated 20-30 years.

Natural Abilities:

Climb 75%/70%

Prowl 50% +2% per level of experience.

Keen hearing, similar to the Battle Cat, only +10% to pinpoint and identify sounds and to track/locate by sound.

Identify scents: 46% +2% per level of experience.

Track by scent: 42% +2% per level of experience.

Echolocation (radar/sonar) to visualize surroundings in total darkness.

Weak day vision, about 40 ft (12.2 m) range without sunglasses.

Damage: Bite does 1D6 S.D.C./H.P., claw strike (with feet) does 2D4 S.D.C. damage, punch/wing swat 1D6.

Tiny tail

Double jointed

Ambidextrous

+1 attack melee per round.

+3 on initiative.

+3 to dodge when flying (no dodge bonus when grounded)

+3 to roll with fall or impact.

Plus any skill bonuses.

Magic: None.

Average P.P.E.: 3D6.

Psionics: None

R.C.C. Skills of a Coalition Mutant Bat: Also see natural abilities, above.

Speaks American at 80% efficiency.

Sing (+15%)

Radio: Basic (+20%)

Surveillance Systems (+10%)

Intelligence (+10%)

Detect Ambush (+10%)

Detect Concealment (+10%)

Land Navigation (+20%)

Wilderness Survival (+10%)

W.P. Knife (Vibro-Blade)

W.P. Energy Rifle

W.P. one of choice.

Hand to Hand: Basic (others not available).

R.C.C. Related Skills: At first level the mutant can select four “other” skills, plus one skill at levels 3, 6, 9, and 12. **Note:** Mutants in the service of the CS are never taught to read.

Communications: Any

Domestic: Any

Electrical: None

Espionage: Any (+5%)

Mechanical: None

Medical: First Aid only.

Military: Any (+5%)

Physical: Any

Pilot: None

Pilot Related: None

Rogue: Any, except computer hacking

Science: None

Technical: Any (+10%), except computer operation & programming.

W.P.: Any

Wilderness: Any (+5%)

Secondary Skills: The character gets four secondary skills from the list, excluding those marked “None,” at level one and two additional at levels 2, 4, 8, and 12. These are additional areas of knowledge that do not get the advantage of the bonuses listed in parentheses. All secondary skills start at the base skill level.

Standard Equipment for Mutant Bats: Basically the same as Dog Boys, although full environmental suits are *never* available to it.

Basic equipment includes DPM riot armor, tinted goggles or helmet with a visor, radio, flashlight, pocket mirror, comb, 100 ft (30.5 m) of lightweight rope, net (for snaring ground animals and people), portable language translator, laser distancer, three flares, six hand grenades, three smoke grenades, survival knife, a Vibro-Blade of choice, C-12 laser rifle, or C-14 Fire Breather, backpack, utility belt, air filter, gas mask, and a canteen.

Equipment Available Upon Assignment: Basically the same as the Dog Boys, except for environmental armor and vehicles.

Money: All the mutant’s basic needs are provided for by the CS military; a place to sleep, food, clothing, medical treatment, basic supplies and equipment, and limited access to military facilities. They are also given a token monthly salary of 70-100 credits for personal items. Like the Dog Boys, mutant bats *are* given the same freedoms, privileges and measure of trust; they have proven themselves to be loyal soldiers (average bat is 5-9 years old; 3-5th level experience).

Cybernetics: None.

Identification Coding (I.C.): The same dual I.D. system as the Dog Boys.

Note: Any mutant bats who go AWOL or “feral” are hunted down and terminated.

Typical Bat Missions: Reconnaissance and intelligence.

Maximum Rank: Non-Commissioned officer up to Lieutenant.



Breaux!

Xiticix Killer

The *Xiticix Killer* (pronounced “zeye-tick-icks killer”) is one of Doctor Desmond Bradford’s greatest successes and a personal triumph. In 92 P.A., Emperor Prosek asked Doctor Bradford if he and his genetic engineers could create a predatory monster to combat the Xiticix hordes in the north. The Emperor explained that these tenacious and incomprehensible insect-like invaders were encroaching on human territories and represented a genuine threat to humankind. The Emperor’s dilemma, however, was that he could not spare enough men to launch a military attack against the Xiticix. Furthermore, estimates placed the Xiticix’s population in the millions, which meant any assault against them would require at least a million troops and years of conflict (and a very real possibility the CS could lose). The estimated cost in human and Dog Boy lives and CS resources was too high. Still, the Emperor wanted to launch some sort of offensive against the alien invaders, beside border patrols and the occasional surgical strike against insurgents who slipped into Wisconsin. To this end, he thought a specially engineered *mutant* designed specifically to hunt and destroy Xiticix might be ideal.

The task was complicated by the fact that Emperor Prosek needed the creation to look “as alien as possible.” This was important for a couple excellent reasons.

1. The Xiticix were incredibly aggressive, so any assaults against them had to be limited to small, border hive colonies. To do otherwise would literally stir up a hornets’ nest. If the Xiticix felt threatened on a large scale, the several hive communities of a million plus would mobilize against the Coalition States and all humanoids in general, D-bees and humans alike. However, if their attacker was something clearly *in-human*, the insectoids could not make the connection to the Coalition States, and CS people would be spared their wrath. Meanwhile, the CS could continue a covert campaign against the Xiticix.

2. The Emperor did not want CS enemies to know they were engaged in any offensive against the Xiticix, and certainly didn’t want the outside world to realize just how advanced the CS really was in the area of genetic engineering. Most CS enemies seemed to console themselves with the belief that the Dog Boys were the product of old pre-Rifts technology and science beyond the Coalition’s understanding. Good. Emperor Prosek liked being underestimated and didn’t want to lose that edge.

The Ultimate Rat Catcher ... if your rat is a Xiticix, that is.

Two dozen living and dead Xiticix were sent to the Lone Star Complex for extensive study; Doctor Bradford and his team needed to understand the insect-beings before they could devise an efficient killer. Bradford reasoned that they needed the equivalent of a rat catcher — that is to say, a large predator whose natural instinct was to hunt and prey upon Xiticix. Inspired by the “rat” analogy, Bradford began to twist mutant cats. Of course, this was insufficient, especially in regard to making the Xiticix Killer look extremely alien. In a bold move, Doctor Bradford had his team begin to genetically fuse several different animal species together while simultaneously “pooling” seemingly incongruous physical features. Although the look was coming together, the animal wasn’t quite there. Something was missing.

In most cases, their creation was likely to be outnumbered, so the Xiticix Killer had to be large, fast and strong in order to successfully battle the Xiticix and survive. It had to be a solitary hunter because the Xiticix could easily track and exterminate a pack of animals. Ideally, the Killer needed the cunning, prowling and stalking abilities of a cat with a battery of weapons at its disposal — tooth and claw wouldn’t be enough against the Xiticix.

The final combination of genetic features drew on every life form imaginable, from felines to predatory dinosaurs, but the final ingredient was something from another world. One of the dead Xiticix specimens came frozen in a block of ice. The accompanying report noted that the body was recovered after a battle in which a hundred or so Xiticix appeared through a dimensional portal. When the corpse was defrosted at Lone Star, an alien organism was found literally attached to the Xiticix specimen. A quartet of large, muscular tentacles encircled the Xiticix’s body, while a pair of smaller tentacles had pierced the body. The autopsy revealed that the small tentacles had penetrated open wounds and had torn the innards of the man-sized insect to shreds. The Xiticix warrior had probably died in less than a minute, although to look at his exoskeleton, the wounds appeared to be superficial. Doctor Bradford liked what he saw and incorporated it (without Emperor Prosek’s knowledge) into his killing machine.

The end result of six years of intense research was nothing sort of miraculous. The Xiticix Killer is a hulking beast with a thick, mega-damage hide similar to dinosaurs. It has animal-like legs, but is bipedal and walks upright. Its two, large toes are prehensile and able to grasp the limbs of its prey and the limbs of trees. A long, powerful, prehensile tail provides additional balance, is used as a rudder when running or swimming, can curl around tree branches for additional support, and can lash out at enemies and pursuers like a whipping club.

The upper arms are similar in shape and function to a humanoid’s, while the forearms are, as Doctor Bradford puts it, “unique.”

The left arm is capped with a mechanical housing that ends in a three-fingered claw. The fingers of the claw are large blades capable of cutting, clipping, stabbing and punching through the Xiticix’s chitinous exoskeleton. Once the armor is punctured, a small, thin, prehensile tentacle can extend from the center of the blade-hand and lash out at an opponent. Although it can be used to ensnare a limb, strangle, or grab hold of a branch, it is typically used as a devastating offensive weapon. The small tentacle is plunged into open wounds and tears apart Xiticix innards from the inside out! Just as some have speculated, this appendage is a sort of second tongue that feeds on the internal organs (through absorption of the blood and gore) as it shreds its opponent’s insides. Against soft animals and humanoids who might corner the beast and engage it in battle, the small tentacle will lunge for the mouth (snaking down the throat and ripping up the esophagus, larynx and lungs), eyes, or ears — the attack is an instinctive one. However, the Xiticix Killer has no interest in other creatures and attacks non-Xiticix life forms only in self-defense, and then usually with escape, not murder, on its mind.

The right arm is always a long, thick, tentacle-like appendage but firm and powerful. The tentacle provides the Xiticix Killer with a reach equal to the length of its body. It is used as a whipping weapon but can also jab, snare, entangle, and strangle. However, it is typically used to hold and entangle its prey while it attacks with its clawed hand, horns or even mouth to create one or more puncture wounds — holes in the Xiticix’s natural, armored exoskeleton. The entangling ability combined with the strength of the limb and the upper arm enables the predator to leap from tree tops, rocks, rooftops and hiding places on a Xiticix hive to ensnare a Xiticix while in mid-flight (the favored attack). Its powerful legs and two large, grasping prehensile toes can also be used to hold and entangle prey. Then while suspended in mid-air, and usually before the insectoid has a moment to react, it penetrates the natural body armor with its claw hand or rhino-like head horns, plunges the small tentacle of the left hand into the (often small) entry wound, and tears apart the Xiticix’s innards. This standard attack usually kills a Xiticix in 30 seconds (two melee rounds) or leaves the insectoid mortally wounded and incapable of retaliation (dies within 1D4 melee rounds). The attack is so swift and deadly that the insect-alien seldom has the opportunity to make more than one or two retaliatory strikes in its defense. The moment the Xiticix is dead, the Killer drops its prey and prepares to attack another or flees to fight another day. Unless seriously injured (down to 30% or less of its M.D.C.), the Xiticix Killer is eager to keep fighting. A CS Reconnaissance team caught a Xiticix Killer in action on film; the

only such footage known to exist. It showed the monster slay five Xiticix and injure a sixth before three other warriors were finally able to kill it. The entire battle lasted 94 seconds (roughly six melee rounds).

Mounted near the elbow of the right arm is a bionic weapon that enables the Xiticix killer to fire bolts of energy (1D4 M.D.) for short distances (about 100 feet/30.5 m)! These energy bolts are the equivalent of *psionic* energy blasts (probably a combination of electromagnetic energy and ambient P.P.E.) focused and directed through the bionic attachment.

The brain is encased in a thick skull, covered in tough, flabby hide. Atop the head is a crest or crown of long, spiked quills which the creature can raise and lower with a thought. The quills can also be fired one or two at a time (2D6 S.D.C. damage per quill). A raised crown of quills means the Xiticix Killer is frightened or angry and ready to battle. Lowered quills indicates a submissive or relaxed state of mind. Located between the eyes and where the nose should be, are a pair of rhino-like horns used to jab and puncture Xiticix body armor.

Although reputed to stand 15 to 20 feet (4.6 to 6 m) tall, the Xiticix Killer stands 12 to 14 feet tall (3.6 to 4.2 m) fully erect, but usually stalks and runs in a hunched position, low to the ground. Like a cat, it has great balance, agility and can leap 25 feet (7.6 m) high or 50 feet (15.2 m) across from a standing still position; increase by 50% with a running start. Also like a cat, it exhibits incredible patience, waiting for just the right moment to strike. But like a dog, it has incredible endurance and can run at top speed for an hour before it begins to tire (reduce speed by 30% for the next hour).

The creature is hairless. In the winter, its skin is a snow white color with some light gray or blue-grey tones and highlights. In the summer, the skin changes color to a light grey with white and grayish green highlights. Its tracks are easily recognizable because of the two large toes, but the animal leaps from ground to trees, to ground, back into trees and into streams, so it is often impossible to track the creature for more than a few hundred yards.

The Xiticix Killer is equally quick and adept in the trees as it is on the ground. In the trees, it seems to swing and leap from one tree to another like a giant, grayish white grasshopper. It can also scale the resin hive pillars, struts and bridges of the Xiticix's dwellings with ease. Its is interesting to note that the Xiticix's hide is roughly the same grayish white color as the exterior of the Xiticix hives and a Killer crouching in a crease, crevice or on a hive rooftop is difficult to see. The Xiticix Killer is so bold that it will actually go inside and raid the hive, and sometimes packs of 6-16 will slaughter scores of the insectoids.

To prevent the Xiticix Killer from ever being a threat to humankind, it is genetically designed to hunt and feed on *only* Xiticix! This means if the Xiticix are ever completely destroyed or chased back to their home dimension, the Xiticix Killer will die from starvation — no Xiticix, no food. Over the last seven years, approximately 29,820 Xiticix Killers have been created in the laboratory and secretly released into Xiticix territory. Although the animals can bear offspring, they are so driven to hunt and battle Xiticix that half of the Killers are slain before they ever bear young. Consequently, it is an ever dwindling population despite the fact that an estimated 4500 free borns have joined the lab clones (currently only 7200 are believed to hunt in the northern woodlands).

Xiticix Killers bear 1D4 offspring, which reach physical maturity within 10 months and reach sexual maturity within 16 months. The young have roughly half the M.D.C., attacks, bonuses and skill level of the adults, and do not have the artificial appendages or energy weapons.

Xiticix Killer

Top Secret GED Hunter-Killer of Xiticix.

Alignment: Animal, effectively anarchist by human perception, probably seen as evil by the Xiticix on whom it preys upon.

Average Attribute Range: I.Q. 2D4+3 (high animal intelligence, M.E. 2D6+4, M.A. 2D6, P.S. 3D6+14, P.P. 3D6+10, P.E. 3D6+6, P.B. 2D6, Spd 6D6+12 on the ground or climbing. P.S. and P.E. are *supernatural* so the beast inflicts mega-damage from its punches and other attacks.

Hit Points & S.D.C.: Not applicable; a mega-damage being.

M.D.C.: P.E. attribute number x3 +1D6x10.

Average Weight: 400 pounds (180 kg) of muscle and rage.

Average Height: 14 feet (4.3 m).

Human Speech: Animal hiss, growls, grunts and roars.

Average Life Span: Estimates indicate it should live to be 50, but its violent lifestyle gives the average creature a life span of 2-8 years.

Natural Abilities & Bonuses: A creature of instinct. Bonuses are in addition to attribute bonuses.

Acrobatics 80% on all abilities that come with this skill.

Climb 95%/90%

Swim 65% (Xiticix can't swim)

Hold breath underwater for 1D4+2 minutes.

Prowl 60% +2% per level of experience.

Good sense of hearing

Hawk-like vision (can see Xiticix flying two miles (3.2 km) away).

Identify scents: 46% +2% per level of experience (+30% to recognize Xiticix scent).

Track Xiticix by scent: 70% +2% per level of experience. Other scents at half.

Leap 25 feet (7.6 m) high or 50 feet (15.2 m) across from a standing still position; increase by 50% with a running start.

An incredibly patient hunter.

Prehensile tail

Double jointed

Ambidextrous

Seven attacks per melee per round!

+4 on initiative.

+3 to strike and parry.

+4 to dodge

+3 to roll with fall or impact.

+3 to save vs poison and disease.

+10 to save vs horror factor.

Never uses weapons, other than the bionic ones built in.

Special: Resistant to Magic Energy: Magic energy (fire ball, lightning, etc.) attacks do half damage, but other types of magic have full effect. In addition, these strange creatures are totally unaffected by Ley Line Storms.

Special: Heals quickly: Recovers 2D6 M.D.C. points per day.

Special: Bio-Regeneration: Regrows tentacles, tail, tongue and quills, but not legs or upper arms. It takes about 2D4+10 days to regrow them completely.

Types of Attacks & Damage:

- **Head Quills:** 2D6 S.D.C./H.P. damage per quill. Range: 30 feet (9 m).
- **Head Horns:** 2D4 M.D. per head butt. A roll of 5 or higher means a penetrating blow that will poke a small hole in a Xiticix exoskeleton or artificial body armor. The wound itself is minor and comparatively insignificant, but opens an opportunity for the small tearing tentacle to penetrate the armor and tear at the body from the inside, destroying internal organs and causing massive hemorrhaging.
- **Mouth & Fangs:** 2D6 S.D.C./H.P. damage from a restrained attack, 6D6 S.D.C. damage on a normal full strength attack or 1D4 M.D. on a power bite attack!
- **Left Arm Claw Hand: Claw:** 3D6 M.D. +P.S. damage from a slash or stabbing attack. Double damage from a power punch, or 1D6 M.D. from a clubbing, blunt attack. In the former two *penetrating* attacks, if the damage is 12 or higher, it means the attack poked a hole in the Xiticix's exoskeleton or artificial body armor. The wound itself might be relatively minor, but creates an opening for the small tearing tentacle to penetrate the armor and rip apart its opponent from the inside, destroying internal organs and causing massive hemorrhaging. **Note:** Consequently, most attacks with the left arm are directed at the belly or throat of its opponent.

Runaway Mutants

- **Left Arm Tentacle:** The tentacle does 1D4 M.D. from external attacks but 6D6 M.D. from slashing and tearing attacks to the insides of its victim as it thrashes around wildly. The agony and horror of this attack causes the victim to lose initiative (if he had it) and half his normal melee attacks per round! **Note:** Once inside its prey, the tentacle has three independent attacks per melee round. These attacks cannot be avoided or prevented unless the tentacle is physically pulled out of the body, which causes 6D6 damage or is chopped off. However, chopping the tentacle from the hand of the Xiticix Killer is difficult because it is protected by the metal claw (requires a called shot of 19 without modifiers or a natural 20). The tentacle has 10 M.D.C. Note that the portion left inside the victim will continue to thrash for one more attack, doing 4D6 M.D. damage and internal injury is likely to be mortal — the only hope for survival being immediate medical attention and either magical restoration (healing touch is insufficient) or extreme bionic reconstruction or full conversion.
- **Right Arm Tentacle:** Supernatural P.S. damage. Reach: 16 feet (4.9 m).
- **Right Arm Energy Attacks:** 1D4 M.D. per blast, rate of fire: two per melee round (each counts as one melee attack), range: 100 feet (30.5 m), payload: A maximum of eight blast per 20 minutes.
- **Tail:** Supernatural P.S. damage. Reach: 16 feet (4.9 m).
- **Kick Attacks:** Supernatural P.S. damage.

Magic: None.

Average P.P.E.: 6D6

Psionics: None

R.C.C. Skills: Also see Natural Abilities, above.

Detect Ambush (+5%)

Detect Concealment (+5%)

Land Navigation (+15%)

Wilderness Survival (+20%)

R.C.C. Related Skills: None, an instinctive hunter.

Secondary Skills: If exposed to the player characters a Xiticix Killer can learn four secondary skills from the list below, plus two additional per every other level exposed to them. All secondary skills start at the base skill level and get no bonuses. Only the available skill categories are listed.

Domestic: Any

Espionage: Tracking only.

Military: Camouflage only.

Physical: Running, wrestling only.

Technical: Can learn to understand (not speak) any language or learn basic lores.

Wilderness: Identify plants and track animals only.

Standard Equipment: None, other than the two bionic limbs.

Money: None.

Cybernetics: Two, see previous descriptions.

Identification Coding (I.C.): None. Officially the Lone Star Complex doesn't know anything about this "alien creature" and emphatically denies any claims to the contrary. Most people believe the Xiticix Killer is a D-bee.



The howls of the Dog Pack tore through the air like a relentless screeching horn. Their bloodlust was an audible part of the noise. They would be upon her any time. Shee-la was a runaway mutant feline — north American puma — mountain lion. She had made her successful escape over a year ago with seven others. She shouldn't have come back.

It was like the runaways always warned:

"Forget your past. Forget your birthplace. Run quickly, run far, and never return! Or else you'll fall prey to the evil and madness that gave you life."

They were right. A lesson Shee-la feared she may have learned a bit too late.

The howling changed to a combination of explosive barks and growls that rung in her ears like mortar fire. They were closing fast now ... she could never escape. While she was faster in the short sprint, the Psi-Hounds were too tough, too relentless. Their stamina kept them on her trail, and now that she was tiring, they were gaining quickly.

Suddenly, the rush of trees gave way to the tall grass and bushes of the field before the ravine. The ravine! If she could just make it a little farther.

Shee-la dared not to look behind her even when she could hear them crash through the foliage behind her, their barking now sounded like the rapid-fire of a rail gun. She gasped for air and kept running forward without even the slightest sideways glance. To look back would be her undoing. She couldn't afford to stumble or lose a single step. No. Keep the eyes toward the ravine! It was only a hundred yards now! She could make it! She knew she could!!

The last twenty yards Shee-la imagined she could actually feel the breath and spittle of the dogs on her naked heels. "No! Don't look back!" her mind screamed again and again. It had to be her imagination, otherwise the dogs were only toying with her. If they were that close they could have pounced on her at any time. Of course, they were known for their hunting games. If they had wanted her dead they would have blasted her with lasers the moment she broke into the open.

The ravine! Inches now!

Leap!!

The powerful legs of the humanoid feline rocketed her into the sky as if she had been launched from a cannon. Shee-la knew the dogs could never make the 30 foot (9 m) leap across the ravine. The only problem was, she wasn't so sure she could either. Not after her five minute foot race with the dogs.

A sigh of relief slipped from her lungs as her clawed hands dug deep into the soil of the other side. She had cleared the ravine with a foot to spare. Another leap sent her tumbling behind a giant boulder amidst bolts of searing light. Chunks of rock and dirt flew all around her as the Dog Boys on the other side of the ravine let loose with their C-14 laser rifles. It didn't matter now. They should have gunned her down when they had the chance. The boulder could take a hundred blasts before being pulverized by their onslaught (they'd give up long before then). Besides, she

would slip away in a minute ... or two ... as soon as she caught her breath.

This time, she vowed, she would never return to the Lone Star Complex. She had only returned to rescue her two sons, but realized now that such a feat was impossible. They might already be dead anyway. Or turned into monsters, or worse. She tried not to think about the horrors she had seen and the fate of her two boys. Regardless of their fate, her death wouldn't help them one way or the other. Funny, when Shee-la had begun her self-appointed mission, she thought she didn't care whether she lived or died. But when faced with death, she suddenly wanted to live. She was still young, only ten years old. She wanted to escape, live free and start a new family somewhere in the wilderness that lay before her. She would never forget her sons and would pray that they would find a way to escape just as she had ... but they were on their own now.

Shee-la ran for a long time before she finally collapsed from exhaustion. The howl of an animal in the distance startled her for a moment, before she realized that it was not the Coalition Dog Soldiers. The words of the Lone Star renegades rung in her ears as sleep finally gave her a moment of peace.

"Forget your past. Forget your birthplace. Run quickly, run far, and never return! Or else you'll fall prey to the evil and madness that gave you life."

The fact that mutant animals escape from the Lone Star Genetics Complex is neither carelessness or sloth on the part of the soldiers assigned to that post. Less than two percent truly escape of their own volition. The vast majority are secretly released (often the product of secret experiments to begin with) or allowed to escape. Administrator Desmond Bradford, or one of his cronies are usually behind these "escapes." Bradford and the scientists who regularly engage in *unauthorized* (even treasonous) genetic experiments, engineer the escapes so that they can monitor the success or drawbacks of their creations "in the field." Many are lost through such field tests, because conventional identification tagging and scientific monitoring cannot be done without drawing attention to their illegal handiwork. Remember, many of these creations and experiments are not sanctioned by the CS and are conducted in secret. However, approximately 10-15% can be successfully monitored in secret, and an additional 20-25% resurface at a later date as a captured test subject, aberration or D-bee slain or captured in the wild. Dead or alive, the scientists get the chance to study the body and glean information from it. Of course, a living subject can reveal infinitely more, but even a corpse of, or a Reconnaissance or Intelligence report about, the creature provides valuable information.

The Coalition States and Lone Star Complex often refer to these runaways as "feral" mutants, referring to the fact that they have broken with the "civilized" Coalition States to live in the wild, presumably in a wild or "feral" state. However, despite the odious label, these so-called "feral" mutants rarely become the savage, animal-like predatory hunters the CS would like people to believe. Most retain their intelligence, civility, and Lone Star training, and many join small, orderly clans or communities of

Mutant Animal Escapees



people who are willing to accept them. Intelligent mutant animals are embraced among many Native American Indian tribes as “god’s children” and are often adopted as full members of the tribe. Mutant animals are also welcomed in most Simvan tribes, and to a lesser degree, Wild Psi-Stalkers. They also join human and D-bee adventurers, mercenaries, bandits, cowboys, settlers and farmers. Who they join and how well they get along within that social group (large or small) will depend on both the mutant and the people it wishes to join.

Many attempts to join an existing social group don’t work. The cause can be fear and suspicion with either or both parties, misunderstandings about the mutant’s nature and intent, social incompatibility and a variety of other things. Depending on their experiences at the Lone Star Genetics Complex, they may regard humans as potential friends and allies, or as cruel and treacherous enemies — both sentiments are common. Canines are among the most accepting of humans, even when they’ve been subjected to inhumane treatment by them. Felines, rodents, and those bonded with alien organisms, are among the coldest and least likely to trust humans — rats are downright evil.

The Animal Underground

Some mutant animals prefer to stay with their “own kind” and long to escape the tyranny of the Coalition States. This has led to the creation of a mutant animal underground — a network of “feral” mutants themselves, individuals and small groups (4-16) dedicated to helping other runaway mutants (and sometimes D-bees) escape from the State of Lone Star. There are factions of humans and D-bees who also try to help “feral” mutants, but trusting them is far more dangerous than those operated by fellow mutants — the CS has captured and killed countless mutants by having CS undercover agents, bounty hunters and mercenaries *pose* as members of the underground.

Where to go? Most mutant runaways are directed west and northwest where they should be able to find other mutants and make a new life for themselves. Of course, life in the wilderness is a hard one, but at least they have a chance, and they can live and die free.

Those with a vendetta against the Coalition States are either directed to the Pecos Empire where they can join any number of gangs who regularly raid CS troops, outposts and settlements, or north to Tolkeen. The Kingdom of Tolkeen, under increasing siege by the CS, welcomes anybody willing to stand against the Coalition. They find feral mutants especially good as scouts, assassins and advisors because many have some understanding of CS tactics and how they think.

Help along the way. Genuine members of the underground railroad (humans, D-bees and mutants) offer services that may seem insignificant, but can be the difference between life and death. Most undergrounders provide the runaways with a place they can hide and rest for 1-4 days, food and water, basic supplies (a canteen or water skin filled with fresh water, a few days’ food rations, a blanket, hat, knife, and similar inexpensive and ordinary things; only the rare person can offer an energy weapon or even an extra E-Clip or the ability to recharge an E-clip). They also provide news and directions: how to get to the next agent (if any; usually verbal rather than a physical map), directions to a particular place or territory, and warnings about *known* dangers, including CS, mercenary, or bandit activity, tribal wars,

monsters, treacherous terrain, a price on the character(s) head, and so on. Their helpers also offer advice, often in the way of sayings and mottos like:

“Forget your past. Forget your birthplace. Run quickly, run far, and never return! Or else you’ll fall prey to the evil and madness that gave you life.”

“The future is ahead of you. Always look forward. Never Look back.”

“Vengeance only leads to death.”

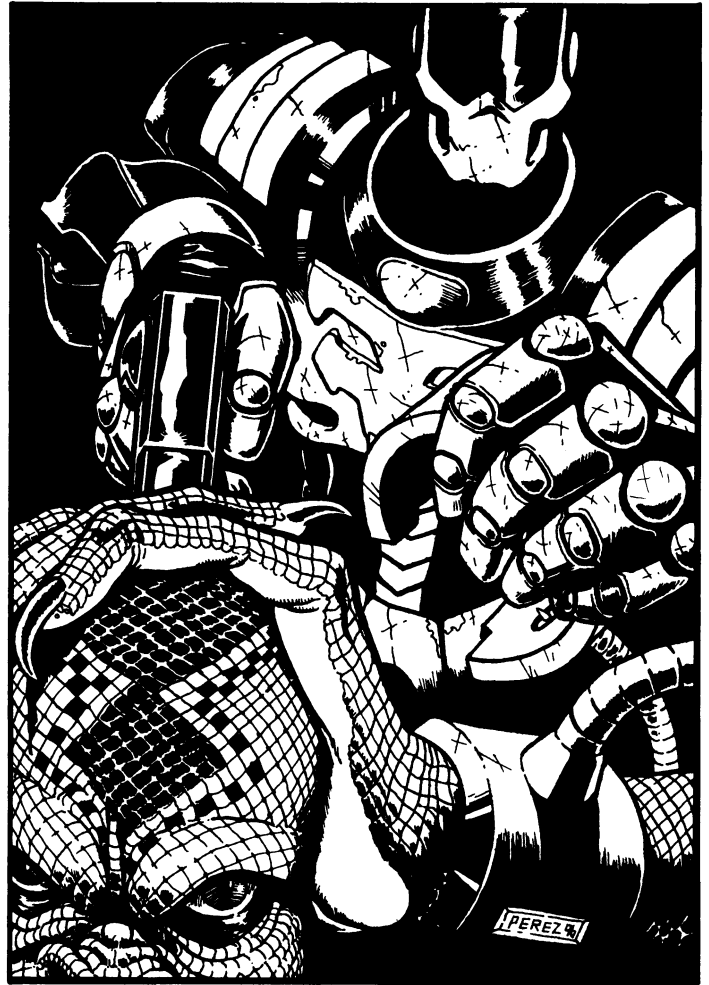

Mutant Communities

Tiny clans, groups and communities of mutant runaways and free borns can be found scattered throughout the Wilderness of the American West and the Pecos Empire. These are gatherings of mutants who generally avoid humans and D-bees and live among their own kind.

The term “own kind” can be very broad, meaning all genetic mutants or animal looking races and even misfits from any races. On the other hand, it can be so narrowly defined as to include specific types/species of mutants and may even exclude specific breeds. For example, many feline mutants only associate with mutants of their own species; i.e. tigers with tigers, pumas with other pumas, and so on. Rats never join mixed groups with any sincerity and only associate with other races to get something from them or to use or kill them. On the other hand, most mutant canines, African lions, and apes are often (but not always) accepting of other races, especially those of their same species and humans.

Most family clans are usually tiny, ranging from 3-12 members. So-called tribes seldom number over 80 (usually 20-50), and these are usually the ones with an openness to many different mutant species and may even include a handful of friendly D-bees, Psi-Stalkers, and humans. Mutant canines gather in some of the largest groups, but then there are many times more Dog Boys than any other mutant groups. Their family clans usually range from 20 to 100, and tribes may have 150 to 200 members (a rarity). However, Kill Hounds tend to be antisocial and rarely join any group larger than 20. Only the devious mutant Rats gather in family clans of 100-400 (common), and tribes that can number into the thousands (only two of them so far, both in the Pecos Empire).

Other Areas of GED Research



M.O.M. Technologies

Bradford and his team have been engaged in *authorized* experiments involving M.O.M. implants in Dog Boy test subjects. There are actually three levels of testing.

1. To identify and correct (if possible) the negative side-effects exhibited in the so-called “Crazies” for the possible, safe use of M.O.M. Conversion or similar implants in humans. Such hopeful results are decades away, if possible at all.

2. The study and perfection of a new system of brain implants to create a supersoldier and improve human life. This is generations away from any substantive applications (if possible at all).

3. Develop Personality Modifiers for possible use in Dog Boys and humans.

So far, most have met with failure. Dog Boys react even more strongly and negatively to M.O.M. “Crazies” conversion than humans. Most immediately become hyper, aggressive and mean. They have trouble sleeping, performance of skills other than physical ones are -10%, and their sensitivity to the supernatural becomes so amplified (double range, +15% to abilities) that it makes them paranoid (toward everybody), often obsessive about finding and destroying the supernatural, and drives them mad — 50% will kill themselves or engage in some activity that will lead to their deaths within 10 months of receiving the brain implants. Another 15% “zone out” and either fall into a catatonic state or run in circles chasing their tails until they collapse. When they awaken, the chase begins anew. These tail chasers cannot think, talk or function on any level without immense amounts of tranquilizers, and they last only a short while.

However, some other experiments look promising and may result in augmented Dog Boys.

Personality Modifiers

The idea here is to use brain implants to create a desirable behavioral response that may be contrary to the subject’s normal nature. Such behavioral controls have been put in place within the very genetic nature of the Dog Boys and other mutants for years. Such things as loyalty, tolerance of humans, the appreciation and ability to sing or swim are all elements present within the genetic code of each individual animal, although environment, training and positive reinforcement all contribute to how far the individual develops these natural inclinations.

The Personality Modification program dares to take this in a different direction by circumventing the natural inclinations to create an entirely different, and completely controlled response. Bradford has considered such manipulation on a genetic level, but fears that such a step is even beyond him and could be opening the proverbial Pandora’s box. Consequently, he focuses on the use of artificial implants, which can be removed or changed as desired, to get the same effects. His teams of scientists’ in-depth understanding of genetics and behavioral study made them the logical candidates to spearhead this program.

Mutant Humans

The genetic engineering (or more to the point, re-engineering) of humans is strictly forbidden by the Coalition States, as is cloning. The punishment for breaking this edict is death! Not that this has stopped Desmond Bradford and his fanatical (and enslaved) colleagues.

Special Human Traits & Abilities

Before we jump into human mutants, it’s important to realize there are ordinary people all around us who have *special aptitudes*, “knacks” or “talents.” More likely than not, many of these “talents” are the results of genetic strengths and weaknesses. In humans they are often unnoticed unless the person is in the public eye. Exceptional athletes like Michael Jordan, Tiger Woods, Jim Thorpe, and countless others, use their natural “talents” and

hone them with training, practice and skill — a combination that makes them exceptional. Others ignore or squander their talents, or simply enjoy and use them in simple ways.

Doctor Bradford is trying to find the genes that make some people excel in certain areas or blessed with special ability. He has learned that some things, like sixth sense, empathy, telepathy and total recall, are psionic abilities that have remained elusive (he cannot yet deliberately create a person with specific psionic abilities), but there are other unique traits, like those described below, that he's also trying to find and replicate on demand. These abilities are present in some individuals as seemingly random "talents." These people are not mutants, per se, but individuals who display what are probably recessive traits. Aptitudes possessed by one in a hundred thousand, or one in a million.

If the Game Master allows it, any *human* character can roll on the following tables for extra (minor) abilities. Certainly any *human mutant* created by, or altered by, Doctor Bradford or his colleagues should roll on this table.

Number of Abilities Table

01-60 No special abilities if a normal human. One if a mutant.

61-80 Roll once if human, twice if a human mutant.

81-00 Roll twice if human, roll three times if a human mutant.

Human Special Abilities Table

Roll percentile dice for random determination or pick. All bonuses are in addition to attribute, O.C.C. and skill bonuses.

01-05 Perfect 20/20 vision and observant: Perfect short and long distance vision; +1 on initiative and +1 to dodge; tends to notice and remember details, +5% to land navigation skill.

06-10 Double Jointed: +5% to escape skill and +1 to roll with impact or fall.

11-15 Aggressive and Driven: +1 on initiative, +1 to save vs horror factor, +2 to save vs possession; tends to take foolish risks and may be a hot head or careless.

16-20 Excellent Memory: Far from total recall, but this ability enables the character to remember important things (to him) very clearly; plus +5% to 1D4 skills of choice (favorites or important), and +5% to land navigation.

21-25 Ambidextrous: The character can use his right and left hands with equal (or close to) skill and coordination; i.e. can write, shoot, play pool, etc. with either hand. Automatically gets the paired weapon skill, add one additional attack per melee round, +10% to climbing skill, +5% to pick locks, pick pockets, palming, and concealment skills.

26-30 Alert and Quick Response: The character is very alert and observant, and able to respond quickly to events and stimuli; excellent reaction time. +1D4 to initiative, +5% to detect ambush and palming skills (when applicable).

31-35 Resistance to Horror Factor: +1D4+1 to save vs horror factor.

36-40 Resistance to disease: The character just doesn't get sick; +2D4 to save vs disease and +5% to save vs coma/death.

41-47 A Head for Numbers: The character isn't necessarily brilliant, clever or capable of common sense, he or she simply has an affinity for numbers and mathematics. +15% to all math skills. Plus the character remembers telephone numbers, I.D. numbers, numerical codes, and number sequences of all kinds

after hearing or seeing them once or twice. The recollection skill for new or seldom used number sequences is 66% +2% per level of experience; numbers used all the time are automatically recalled without error.

48-52 An Eye for Art: The character has a deep appreciation and talent for the visual arts (drawing, painting, sculpting, photography, etc.). +10% to all appropriate skills. Writing is not included.

53-59 Exceptional Endurance (when motivated): If it is something the character really wants to do (or needs to do to survive), he can draw on a hidden reserve of energy that enables him or her to function with four hours of sleep a night for 1D6 nights (24 hour periods), continue to function at 90% capacity for 2D4×10 minutes beyond the normal level of fatigue, and is +3 to save vs disease and poison/toxins he may be exposed to during that (limited) period.

60-67 Speed Thrill Junkie: Loves to go fast and excels at piloting; +10% on all piloting skills of fast vehicles of all kinds (land, air, water) — fast being 90 mph/144 km (or much) faster.

68-74 Insatiable Desire to Learn: This character loves to experience and learn new things. Can learn one new Secondary Skill at levels 2, 4, 6, 8, 10, 12, 14 and every other level beyond; no bonuses apply to these skills. May also like to travel and his curiosity may get the better of the character (leading to trouble).

Or, in the alternative, the character can make skill selections from *any* skill categories, even those not usually available to that O.C.C./R.C.C., and select three additional skills at level one (above and beyond those normally allotted) and one new skill for each subsequent level of experience! However, *NO* skill bonuses apply to any of the skills, not even O.C.C. skills (the only exception is a possible I.Q. bonus). Thus, *ALL* are the equivalent of *Secondary Skills* — a Jack of All Trades but a master of none.

75-80 Defined Talent: The character is exceptionally skilled in one particular area — a natural. Add a +20% bonus to two skills but both skills must be related (i.e. computer programming and hacking, or mechanical engineering and robot mechanics, etc.). If two weapon proficiencies are selected, the character gets one extra attack per melee when using those two particular types of weapons and can tell if a weapon of those types is of inferior or superior quality. If two physical skills, other than hand to hand combat, are selected, double the usual bonuses (in the case of swim, S.C.U.B.A., prowl, and similar, add the +20% skill bonus). If one of the defined talent selections is applied to hand to hand combat, the character is +1D4 on initiative (roll once), +1 to save vs horror factor (roll once), +3 to pull punch (excellent control), +1 to roll with impact, and does an extra +1D6 damage from punches and kicks.

81-86 Dominant Personality: Tends to excel when he or she is the man in charge or in the limelight (+5% to all skills) but has a nasty habit of being a bossy braggart, arrogant, and a glory hound who thinks he's better than everyone else. This also means that the character is unhappy when embarrassed, left out, or not in charge (-15% to all skills). Furthermore, the character is likely to be lazy, uncooperative and a whiny complainer when he can't get his way (i.e. be in charge/run the show).

87-93 Exceptionally Charismatic: Most people instantly find the character attractive (even if not physically beautiful), and are inclined to trust and believe him, at least until they get to

know him (can be used for good or evil). Raise the character's M.A. to 20 +1D4.

94-00 Indomitable will: This character is so strong willed that he is +6 to save vs possession, +2 to save vs mind *control* (psionic, drugs, and magic illusions/domination/and similar), +1 to save vs horror factor, and in a emergency, can go without sleep for 48 hours without skill penalties or loss of alertness, and lift and hold 50% more than normal for 1D4 minutes.



Psi-X Aliens

Since he was a young man, he has been fascinated with the concept of psychic powers. With the vast amount of psychic/mystic energy unleashed by the coming of the Rifts, psionic abilities have been magnified and become commonplace. Science was able to confirm their existence and study them. From a geneticist's point of view, it seemed to Bradford that psychic abilities must be a tangible aspect of the human genetic structure. This would explain why many alien life forms did not have psychic powers, while others did. Like a so-called talent, or genetically encoded aptitude, some humans seemed to possess no (or no discernable) psychic "talent," while others showed varying degrees of ability from minor to expansive.

One of his burning goals has been to identify and manipulate these genetic blocks to unleash the full human potential (or failing that, achieve a much better understanding and control over psionic powers). Unfortunately, the psionic building blocks, as well as other creative and mental talents, have proven to be far more elusive than those governing physical traits. Bradford has

had one extensive group of GED scientists exploring the psychic aspects of Dog Boys for 25 years — his plan is that if they can be identified in the mutant canines (who consistently possess greater sensory psionic abilities than humans), they can then be more easily found in humans (remember, the genetic structure of canines is fairly similar, in many aspects, to humans). However, they have been without success.

Meanwhile, Bradford conducts his own, secret, illegal research and experiments, often taking great leaps of faith and utilizing guesswork to get results, most of which have been disastrous.

The Psi-X Aliens are one such bold and dramatic leap, and a terrible failure. Bradford personally led this area of research in Sector 357, and he considers it his greatest, personal failure. Not one to give up, he continues to putter around with new theories, techniques and experiments. Because the Psi-X were humans, used illegally and against their will (many of them youngsters between the ages of 13 and 20, when psychic potential seems greatest in humans), Bradford could not bring himself to destroy them like animals. Over 150 were secretly let loose in the Pecos Badlands. Most have survived and have begun to mate and propagate.

Doctor Bradford assigned the mutants the name "Psi-X Alien," after one of his young victims screamed about how he had been turned into a bug-eyed, Roswell alien. They are small, and have weak physical frames and slight builds which are the result of some genetic flaw that Bradford failed to catch. It didn't become immediately evident because most of the test subjects, and subsequent clones, were youngsters and physically undeveloped. Furthermore, they were imbued with D-bee and Psi-Stalker DNA that had unpredictable side-effects, one of which being their somewhat less than human appearance.

Like Psi-Stalkers, Psi-X Aliens are completely hairless and possess impressive levels of psionic ability, however the degree and range of those powers varies dramatically from individual to individual. They are so dependent on their psionic powers that they tend to avoid physical exercise, tire easily (one third the endurance of normal humans) and tend to see the world through very different eyes than humans. Despite their huge heads, they have very narrow skill ranges where they are geniuses in some areas and others where they are completely ignorant and incapable of learning. Worse, they are prone to substance abuse and are easily addicted to alcohol and drugs.

Psi-X Alien R.C.C.

Optional Player Character — and a great NPC Villain

Race: Genetically Altered Human

Alignment: Any, but tend to vary in extremes, i.e. 30% are principled, 30% diabolic, 30% anarchist, and 10% other. Evil Psi-X are evil to the extreme and are masters at manipulation, torture and murder.

Attributes: I.Q. 3D6+6, but special (see skills), M.E. 3D6, M.A. 2D6 (+2 if a good alignment), P.S. 2D4+4, P.P. 2D4+4, P.E. 2D4+1, P.B. 2D4+2 (by human standards), Spd. 2D6+4

Hit Points: P.E.x2 plus 1D6 per level of experience.

S.D.C.: 2D6+2

Weight: 90 to 130 lbs (40.5 to 58.5 kg)

Height: 4 to 5.6 feet (1.21 to 1.7 m)

Average Life Span: 60-90

P.P.E.: P.E.x10

Natural Abilities: All Psi-X have the following abilities and psi-powers:

Nightvision 3000 ft (914 m), hawk-like color vision, can see in the infrared and ultraviolet spectrums of light, can also see electromagnetic energy and see the invisible (automatic ability; includes Astral beings, entities and energy beings).

See aura, sense magic, detect psionics, bio-regeneration (healing) and all have the unique, telekinetic related ability to hover and move 1-4 feet (0.3 to 1.2 m) above the ground rather than use their legs to walk. This is the Psi-X's natural mode of transportation (same speed as attribute) and they have to concentrate to negate it and walk on their own two legs.

See the **psionics** listing for special powers.

Bonuses: +5 to save vs horror factor, +5 to save vs magic illusions.

Attacks Per Melee Round: One physical at levels 1, 2, 4, 8, and 12, or two via psionics at levels 1, 3, 6, 10, and 15.

Penalties of Note: Besides the obvious, Psi-X have terrible day vision (40 ft/12 m) and their eyes are so sensitive to light that they must wear some sort of tinted protective coverings over them; blinded by bright sunlight, flashbulbs, and other bright lights.

Psionic attacks that use bio-manipulation or empathic transmission do double damage and last twice as long.

Ley lines increase the psychic's powers as usual, but also increases the character's level of confidence, aggression and other base emotions.

Insanity: Randomly roll or determine three phobias and one obsession.

Magic: None.

Psionics: Random Psi-Powers; roll percentile dice.

01-12 Kinetesis: Has all kinesis abilities, including telekinesis (super), telekinetic force field, levitation, electrokinesis, hydrokinesis, pyrokinesis.

13-24 Psi-Sensitive: All sensitive abilities at double the normal range.

25-37 Energy Conduit: Psi-sword, psi-shield, electrokinesis, pyrokinesis, mind bolt, summon inner strength, and impervious to fire (even mega-damage fire).

38-49 Intuitive: Telemechanics, clairvoyance, object read, presence sense evil, sense magic, sixth sense, and psychic diagnosis.

50-61 Spiritualist: See aura, clairvoyance, object read, telepathy, astral projection (+20% to find way home) and ectoplasm.

62-73 Manipulator: Empathic transmission, empathy, telepathy, hypnotic suggestion, mentally possess others, mind wipe, and induce sleep.

74-85 Healer: All healing powers; healing touch does double the usual level of healing and +30% to perform exorcism.

86-97 Closed Mind: Mind block, group mind block, P.P.E. shield, and is *impervious* to empathy, empathic transmission, mind bond, mind wipe and possession.



98-00 Mind Melter!

I.S.P.: Roll to determine random level of power.

01-20 M.E. ×10 +8 per level of experience.

21-40 M.E. ×5 +2D6 per level of experience.

41-60 M.E. ×2 +12 per level of experience.

61-80 M.E. ×3 +1D6 per level of experience.

81-00 M.E. +4D6 per level of experience.

Disposition: Varies with alignment and powers, good characters tend to be up-beat, cheerful and innocent. Selfish characters tend to be secretive, sneaky, cocky, braggarts, and obviously self-serving. Evil characters tend to seem brooding and sinister, mock and bully others, and don't trust anybody.

O.C.C. Skills of Psi-X Aliens: Speaks two languages of choice at 98% plus select one of the following skill categories; all

those skills are known at +20%. Available categories are: Communications, electrical, mechanical, medical, pilot related, rogue, science, technical: languages and lore (all), technical: others (all, except language and lore).

R.C.C. Related Skills: None.

Secondary Skills: The character can select four secondary skills (no bonuses) from the categories of domestic, pilot and W.P. at level one and one additional at levels 3, 5, 9, and 11.

Standard Equipment: May use light armor and prefer light, rapid-fire energy weapons or magic items.

Typically the character starts with a survival knife, one energy weapon of choice, 1D4 additional E-clips for the weapon, plus a backpack, knapsack, utility belt, air filter, protective eye goggles, universal translator, cigarette lighter, note pad, and canteen.

Notable CS Characters

Desmond Bradford

The following narrative and events speak volumes about Doctor and Administrator Desmond Bradford — the man who heads the **Lone Star Genetics Engineering Division** (GED) and serves as general Administrator of the entire, massive military complex. He is the man who created the first Dog Boys and continues to experiment with other genetic mutations.

Inspector Emmerson flipped mindlessly through a magazine as he waited in the reception suite adjoining Administrator Bradford's office. He was eager to leave the Institute and make his report. He felt uncomfortable with the entire situation: the genetics research, the people and most of all, Administrator Bradford. He didn't need a degree in psychology to know that the Administrator was teetering on the brink of madness, if not already both feet over the edge.

Inspector Emmerson jumped when the Administrator's secretary called his name. He hoped she didn't notice, smiled nervously and followed her into the Administrator's "chambers," as he called his office. The secretary closed the door behind him as she exited. Administrator Bradford gestured to Emmerson to sit down and flashed him a toothy smile that reminded the young inspector of a shark.

"Ah, Inspector Emmerson, leaving us so soon?"

"Yes, I've seen everything I ... uh ... came to see." he couldn't believe he almost said, "everything I care to see." The Inspector smiled and continued, "You and your staff have been exceedingly cooperative. On behalf of the Coalition States, I ..."

A still smiling Administrator Bradford interrupts, "Come, come now, Inspector, you can forego the formalities. So tell me, what do you think of our facility?"

"It's absolutely amazing, sir!" Emmerson hoped that sounded convincing.

"Really? Yet you do not approve of our research do you?"

"It isn't my job to approve or disapprove of the genetics program, sir. The Dog Boys have proven to be exceptional and loyal soldiers. Your research here with the mutant dogs and experiments with other animals are an invaluable service to your country and ... well ... simply amazing. Sir."

Emmerson feared his response was too stiff, but he always felt on edge with Administrator Bradford. Always felt the man was sizing him up like one of his lions, stalking and waiting to pounce.

The administrator's smile expanded as he leaned back in his chair, the leather softly moaning as it relented against his great bulk. "Tell me this young man, which animal in the world do you think is the most perfect predator?"

"Um, I'd guess the lion, um, cat family." The young inspector thought a minute and added, "In the ocean, it be the shark, I'd imagine."

Administrator Bradford put his hands behind his head and replied, "Yet, human beings dominate the animal kingdom. Why do you think that is?"

"Well, there are many reasons, sir." Emmerson paused, hoping that his feeble response would be sufficient, but the Administrator just sat there with his sinister smirk, waiting for more.

"Okay. The human brain is larger than most animal's."

"The dolphin's is bigger," interjected Bradford.

"Humans have an opposable thumb and can make tools."

"All the great apes use simple tools, rocks and sticks, did you know that? As do many monkeys and even some squirrels and birds." cooed the Administrator.

Inspector Emmerson frowned. He was growing tired of Bradford's intellectual contests. In the hope of putting the matter to rest and getting the hell out of there, the Inspector bit his tongue and growled. "You are infinitely more qualified than me, sir. I ..."

Administrator Bradford interrupted his companion again, leaning forward and saying with an air of condescension, "I'm so sorry, young man, I know it's rude of me to keep interjecting my comments. I'm breaking your train of thought. I'd just like to know what you think. Please continue. Please ..."

"Uh, thank you, sir." Those were the words that came out of Inspector Emmerson's mouth, but "more games" is what he thought.

"Very well. I would imagine that human beings are superior to animals because our brains are capable of deductive and analytical reasoning. Humans can communicate, learn, and adapt. We *build* tools, not just use sticks and rocks, ... we create and use sophisticated weapons to protect ourselves and to master our environment. Furthermore, we are self-aware and ..."

Administrator Bradford flails his hands in mock excitement, "I'm sorry, I must really interrupt you again." The grin still etched across his face.

"I can see you are an educated man. You must have paid attention in Officer's School and even read some books, eh?" The Administrator rises from his chair, winks and continues.

"The opposable thumb, the ability to make tools and all the rest are, for the most part, the proper, accepted, textbook response. In fact, I'd dare to say that many scholars and scientists would agree with your rather simple ... but to the point, summation. What would you say if I told you that you were wrong? All of you are wrong?"

The large black man positioned himself to the front of his desk, sitting on the edge, and leans into Inspector Emmerson's face, waiting for an answer. His ever present smirk curling the sides of his mouth.

Emmerson finds himself involuntarily pulling back, away from the leering Administrator.

"I ... I don't understand sir."

Bradford leans back and shakes his head. "No, I don't imagine you do."

A sigh of genuine disappointment rushes from his lungs before he continues. His expression is suddenly serious and contemplative.

"The greatest minds in science to the lowliest street beggar all feel 'superior' to animals. Why? Animals are stronger, faster, possess heightened senses, perhaps even psychic senses, yet man is superior? When I created the first Dog Boys, people were afraid, because they feared that we were tampering with nature. But mainly because they feared we were giving wild, ferocious, powerful animals a human brain.

"Do you know why humans are superior, not just on Earth but throughout what the Mystics and D-bees call the Megaverse? Because the human animal is the deadliest of predators."

Inspector Emmerson squirmed in his seat. The maniacal smile was back on the Administrator's face and his eyes seemed to burn with enlightened madness.

"Not because of the opposable thumb or larger brain or deductive reasoning ... oh, these things all contribute to the success of the human animal, but there are hundreds of species physically superior to man! No, humans thrive because they are the ultimate predator.

"Animals, even my wonderful mutants are controlled ... limited by nature. They have instincts and genetic codes that are like an unbreakable computer program. The animal is forced to follow that blueprint. Instincts tell animals who their natural enemies are and combined with genetic coding, limits their responses and even their skills and abilities. They are hunters. Yes. But they hunt to eat and survive. It is the rare animal that hunts and kills for pleasure or vengeance. It is the rare animal that preys on its own kind. When a dog fights its own, it fights for a position within its social group, and these skirmishes are seldom battles to the death. Or else they fight to protect their territory, family, a favorite toy or possession, their life, or in fear. If their opponent backs down and leaves, they consider it a victory. Even the great monsters of the sea are driven by motives based on survival.

"Man on the other hand, kills with gay abandon. We, as the ultimate predators, don't need a simple motive like survival. We kill to eat, we kill to protect our possessions, but we also kill in anger and hatred, kill in envy, kill for revenge, kill for pleasure, and," leaning forward again, and in a softer, menacing tone, "may kill just because he doesn't like your face.

"Humans love conflict. That's what makes humankind so adaptive. We thrive on conflict and change. We are exhilarated by it like the dog in the hunt, only we don't stop and turn tail when the opponent proves to be more powerful. Our cunning, predatory minds work all the harder in finding a way to win! And winning is a far cry different than mere survival. It is humankind's burning desire to be the dominant force that makes us this way. We'll send armies of thousands against an enemy and watch those thousands die, yet if victory is finally won, we feel triumphant and the loss of life is justified. A dog, my friend, most any animal, would retreat under such circumstance. They would not sacrifice the entire pack unless literally backed into a corner with no other way

out. What we humans do isn't survival. It's conquest! It's complete domination of all life forms. And when there are no others to dominate, we turn against each other, killing in anger and on whim."

Bradford chuckles as he seats himself behind his desk. He leans back, arms folded behind his head in a supreme act of confidence.

"You," he coos like the cat who just ate the canary. "You, Inspector are a prime example. You find these little talks disturbing. Even hateful. I know. If you were a dog or even a Dog Boy, you wouldn't be stirred by these emotions. You'd simply accept me as your leader, and assume your position within the pack without anxiety or feelings of anger or resentment. But you're not a dog. You're human. And being the pathetic soldier boy you are, you look for direction ... 'words' and 'reason' to make sense of your actions. 'Slogans and patriotic sentiment' to justify your aggression and the killing. But that's okay. You cannot stop what you feel, it's part of human nature. In fact, I'd hazard to guess that if you did not have your self-imposed military code and protocol, and, ... well, the fact that you fear me, you'd leap from your seat and try to tear my throat out."

Inspector Emmerson grit his teeth while his mind raced in search for an appropriate response. The madman was right, each and every meeting with Bradford cut into his gut like a knife. He felt belittled, chided and put in his place. This resulted in anger boiling in his belly like molten lava. And now, Bradford's pointing out his feelings, made the young Inspector feel naked, somehow violent and helpless and all the more angry.

"There's no reason to answer, Inspector. It's not a question, but a statement of fact. You might want to retort ... deny what I've said, but the truth is difficult to deny, isn't it? You see, civilization is not the thin veneer that separates us from the animals. I think you see now, that humankind is greatly removed from our animal cousins. No, civilization and culture are the *illusions* that keep us from completely destroying ourselves. It allows us to give our madness the veneer of purpose. By convincing ourselves that we are part of some higher order — and by the way, I'm not saying we aren't — but it enables us to live with ourselves. It enables us to pretend that we are more than savage creatures who like to kill and dominate other life forms. It's just that we sometimes come to believe in the illusion so strongly that we forget the reality of who and what we are. I find that quite funny. So you see, it's really that elusive human element that I try to put into some of our genetic experiments — not the Dog Boys of course, but some of the others. The human element to make them more vicious and relentless.

"As for myself. I accept what I am, without shame or self-recrimination. I am human. I am superior. I will kill to serve myself and I will kill for pleasure. So, you can imagine that I won't hesitate for an instant to protect myself. Oh. I'm not a sporting man. I'm very calculating and methodical. I do what must be done. I enjoy the challenge, but I don't take foolish chances. I like the power I hold and I won't jeopardize it by giving my prey or my enemy a 'sporting' chance. Just some parting thoughts, Inspector."

Inspector Emmerson sat silently for a minute. There was no mistaking Bradford's words. There was no "veiled" threat here. This wasn't some arrogant suggestion that he (Emmerson) turn in a favorable report or face the consequences. He was a dead man. He knew it. That being the case, he thought about trying that lunging attack and finding out who was the better man, yet somehow his legs failed him. He sat there in the interminable silence, "if not kill this S.O.B., at least make some smart, parting remark," he thought to himself, but nothing came. Finally, Inspector Emmerson rose to his feet.

Finally, Emmerson spoke, "If that will be all, I'll be taking my leave." Hardly the wit he had searched to find words for.

"Yes. That is all."

With weak legs and a heavy heart, Inspector Emmerson took his leave. The next hour of his life, Emmerson weighed the madman's words, trying to find something to argue with. In the end, he only hoped Bradford was wrong. That humans were more — or could make themselves into something more — than the ultimate predators.

Recon-Team LS-676

Eyes Only Report: Colonel Joseph Prosek II

Team LS-676 was the first on the scene, as it was our duty to rendezvous with Special Agent Emmerson for immediate extraction and direct transport to Chi-Town. All parties were dead: Inspector Emmerson, his aides and the escort squad from Lone Star. There were no survivors.

A complete survey of the battlefield (see attached video documentation) suggests that the assault was the work of vengeful Juicers. The slogans: WE SHALL RISE AGAIN and YOUR LAST CALL were spray painted on the sides of vehicles and on the face plate of one of the slain soldiers (see attached video documentation). Both are well known slogans used by Juicers since the Newtown Uprising. However, our conclusions were not made on these obvious indicators alone.

A complete and thorough study and investigation of the scene confirmed the following:

- There is absolutely no evidence that Psi-Hounds or other mutant animals were involved in the attack. Our own Psi-Hounds confirm this.
- There is no evidence that the attack may have been at the hands of an illegally operating faction of the CS Military.
- The attack pattern, weapons and vehicles used by the attackers are consistent with Juicer raids.
- Forensics confirmed that the causes of death were by weapons commonly associated with rebellious Juicers.
- Acts of Juicer aggression against the Coalition States' Military has continued in this area unabated since the Newtown Uprising.
- Only weapons and food rations were taken, again, consistent with Juicer raids.
- Inspector Emmerson's data disk report was recovered and sent directly to Chi-Town for analysis (see attached disk). No audio or video recording was recovered. There is no evidence such items existed.
- The Lone Star support team arrived 20 minutes after our radio transmission. They seemed genuinely concerned and conducted a search over a 50 mile (80 km) radius around the attack site.

Conclusion: The Emmerson Team was destroyed in a surprise attack by Juicer bandits.

The Disk

Eyes Only Report: Colonel Joseph Prosek II

Only Joseph Prosek II and a handful of his closest henchmen know that Lieutenant Louis Emmerson was an Intel operative, hand-picked by Joseph and sent, undercover, to take a close look at Administrator Desmond Bradford and GED operations. Emmerson was selected for three main reasons:

1. His background in psychology meant he could better assess the mind and behavior of Bradford than a regular agent.
2. Lt. Emmerson's appearance. The young officer had a sharp, predatory mind with an eye for detail, all hidden behind the soft face of a innocent-looking cadet. His disarming looks and boyish charm had served Joseph Prosek II and Intel Corp well on numerous undercover assignments.
3. Lt. Emmerson's dedication to the Intelligence Corps and loyalty to the Coalition States (and to Joseph) were unshakable —the young Prosek had high hopes for this dedicated soldier.

Colonel Prosek feared that Bradford's genius had teetered over the brink to insanity, and that he was conducting forbidden, treasonous experiments within the compound. As Head of Propaganda, Col. Joseph Prosek II, had information that even many members of the Military High Command did not. Of grave concern to him were reports of *animal-like D-bees* and *feral mutant animals*. The feral mutants were, presumably, runaway mutants and the offspring of runaways from the Lone Star Complex. Unfortunately, their numbers, admittedly low, were far greater than those officially reported by the GED. Furthermore,

many supposed D-Bees and alien life forms were (in post-mortem studies) recently discovered to be of a decidedly Earthly origin. Chi-Town's own Genetics Engineering Division found that a full 83.7% of all animal-like humanoids collected from the western States and Western Wilderness (and whom were considered to be D-bees — dimensional beings, by the casual observer; i.e. life forms from other worlds in other dimensions) were in fact, genetic mutations of Earth animals! This was a full 74% higher than in other parts of the country. Worse, there is a preponderance of evidence to suggest that the *Psi-X Aliens* (and perhaps others) are indeed the product of illegal genetic experimentation on *human beings*. Rumors to this effect circulate in the State of Lone Star, the territory of old New Mexico and along the Mexican border. Most people don't believe the Alien story, largely because nobody can believe Emperor Prosek or any of the human supremacists running the Coalition States would ever authorize human experimentation. This is true. The very idea is abhorrent and is yet another reason for young Prosek's concern over Bradford.

Unfortunately, Desmond Bradford is one of Emperor Prosek's few blind spots. The Emperor holds Desmond Bradford above reproach and would not authorize any sort of secret investigation of his old friend and colleague. Of course, this hasn't stopped Joseph, although it both disturbs and hampers his efforts to get to the bottom of things at GED in Lone Star. Perhaps, most of all, Joseph hates that he cannot trust his father's judgement in this matter, which begs the question that gnaws at him: If the Emperor's judgement cannot be trusted in this matter, what else might there be where the Great Man is wrong? The dutiful son tries to push such thoughts from his mind, directing the anger born from the frustration and doubt that it spawns to the real (potential) enemy, Administrator Desmond Bradford.

Lt. Emmerson was to observe and determine whether or not Bradford exhibited any psychosis, attitudes, or behavior which might make him prone to conduct independent, dangerous and subversive activities. With the loyal agent dead and nothing but his written log on computer disk, Colonel Prosek feels thwarted and vexed.

The Chi-Town Intelligence Department authenticated Emmerson's computer files, but were quick to point out that anybody could have created a false document. After all, such disks are simply the hand-typed computer file (a video record was deemed too dangerous — young Prosek did not want to tip off Administrator Bradford that he was being subtly investigated).

Assuming the document is genuine, Lieutenant Emmerson, assigned as acting Chi-Town Protocol Inspector of the GED facility, found *nothing* inappropriate or suspect about the Lone Star Genetic Engineering Division (GED) or its Administrator, Doctor Desmond Bradford. To Joseph Prosek II's thinking, this in itself is suspicious. Special Operative Lt. Emmerson and his aides (all hand-picked Military Specialists) were selected because they shared his concerns about Bradford and the feral mutants, and they disliked Desmond Bradford. It's human nature (and as head of Propaganda, Joseph understood human nature) to criticize even the smallest things about somebody you dislike, and with Lt. Emmerson's attention to details, there should have been numerous, if petty, entries criticizing the Administrator. Yet, the only comments that could be construed as negative were, in part:

"I personally find Administrator Bradford's demeanor to be condescending and deliberately challenging. He tests and weighs the merit of every person with whom he comes in contact, and runs the complex as he deems fit."

And, in Emmerson's closing summary:

"There can be no doubt that Administrator Bradford is eccentric and driven beyond the norm. At the same time, I suspect it is these eccentricities and intense dedication to his duty that makes the GED program such a continuing success. I cannot report anything that I would consider improper, slothful, or out of the ordinary. If we consider Doctor Bradford's overzealousness a crime, then half our officers are guilty of the same crime. I must give the Administrator and the Lone Star GED program a clean bill of health."



In his gut, Joseph Prosek II, knows the disk is a fake. Lt. Emmerson disliked Bradford as much as he did. If anything, the report should have shown attention to all kinds of little details, petty to be sure, but they should have been there, and all with a distinct bias against the man. And the comment about “overzealousness,” Joseph recognized that as Bradford’s “signature” and a dig at him. Lt. Emmerson couldn’t see past his own zeal if his life depended on it. Furthermore, if he had, he’d consider it a virtue.

Although disappointed by the death of a promising officer and the lack of concrete evidence, the disk and the incidents surrounding the death of Lt. Emmerson revealed several important things to the Head of Propaganda. Among them:

1. Desmond Bradford *is* a genius. He continues to hide his illegal genetic experiments from the CS, was able to mastermind the assault on Lt. Emmerson, plant the false document, and continue to manage the Complex without missing a beat or leaving the slightest bit of evidence pointing back to him.

2. Even more than Bradford’s murder of Lt. Emmerson and his aides, the killing of the Lone Star escorts (his own men) clearly exhibited how far the Administrator had slipped into madness. It was one thing to conduct unauthorized genetic experiments, and even to experiment on human test subjects (who Joseph was certain were culled from the enemies of the Coalition States), but to kill his own men to protect his dark secrets — this makes Bradford an extremely dangerous man. As far as Colonel Prosek is concerned, Bradford’s high position within the Empire and the blind trust bestowed upon him by the Emperor, makes the madman “the” most dangerous man in the Coalition States.

3. Bradford obviously has connections with Juicers or more likely, pawns — stooges — available to do his dirty work.

4. He cannot be operating alone.

5. Most important, these events revealed a leak within the Intelligence Division. Joseph is convinced that word of Lt. Emmerson’s being an Intel undercover officer was *leaked* to Bradford in advance of his arrival. Of course, it is possible (although extremely unlikely) that Lt. Emmerson blew his cover or leaked the information that found its way to Bradford, in which case his death was his just desert. It was also possible that Bradford was able to see through the disguise, but this is an equally unlikely scenario. Finding the source of the leak has just become Joseph’s first order of business. Only a handful of people shared the information (not even the Emperor knew), so it would be a relatively quick, easy matter for him to find and eliminate (or, better still, use) this fool.

Desmond Bradford

**Administrator of the Lone Star Complex;
Doctor of Genetic Engineering and Cybernetics;
Head of the Genetics Engineering Division (GED) at Lone Star**

It is hard to say just how insane (and dangerous) Desmond Bradford really is. While it’s true he is cold, aloof, driven, and sees himself as removed from human society, he does know the difference between right and wrong, which is what makes Bradford evil. He, better than many of those around him, is completely aware of the consequences of his actions. They are his choices, right or wrong, inhumane or murderous, and he is willing to live with those choices. In this regard, Bradford is a sociopath. He sees himself as the enlightened superior over most other men (Emperor Prosek being regarded as one of his few equals), and as such is removed from them. Thus, their rules, laws, and morals don’t apply to him. Their lives have less importance and meaning than his, and it is his duty to quietly, subtly, lead them from the darkness of their ignorance — kicking and screaming if necessary. To this end, Doctor Bradford engages in many unauthorized and illegal genetic experiments with animals, D-bees and humans. His old friend Karl Prosek, might overlook the first two, but could never condone the mutation of humans (maybe he’s not an equal after all?), so Bradford works in secret, while

the Emperor chooses to turn a stubborn, blind eye to it, refusing to look at the evidence and suspicions of his own son (“Hmm, maybe Karl is my equal?”).

Bradford’s megalomania is reflected in his self-elevation to godhood and his conviction that he possesses superhuman intelligence and wisdom beyond the comprehension of mere humans. He cannot be shaken from this resolute delusion. He knows it’s true and expects the poor, ignorant masses to deny and fear what they do not understand (i.e. him). The one thing that restrains Bradford, and keeps him a valuable and relatively loyal servant of the Coalition States, is that Emperor Prosek is included in the madman’s delusions as a “fellow god” and friend; these two go back 40 years, when both were young men.

From Bradford’s perspective, Karl was one of the few to recognize his (Bradford’s) greatness and embrace him when most others feared and tried to destroy him. Likewise, he saw in Karl Prosek a fellow giant among men ... an equal ... a god. As Karl Prosek grew to power (as was his destiny), he never forgot his friend and fellow god (Bradford). When the right time came, he turned to the one man/god (Bradford) who he knew he could trust, and the only one up to the task, and placed in Bradford’s keeping the very technological heart of the Coalition States — *The Lone Star Complex*. And Bradford has risen to the challenge as only “a god” could.

Bizarrely enough, this extreme perspective is largely based on a twisted view of the truth. When Coalition forces discovered the secret pre-Rifts Lone Star Complex, Karl Prosek knew only one man who could unravel its secrets and deliver them to him without considering stealing them to build his own empire. That man was Desmond Bradford. Amidst outcries of protest and concern (Bradford has never been liked by his colleagues and is feared by most military leaders, including General Cabot), Doctor Bradford was named the Lone Star Administrator and Head of the Genetics Engineering Division. The Lone Star Complex was a secret, underground military base and factory of the old American Empire. A base untouched by the ravages of the Great Cataclysm or time. Locked among its cache of lost knowledge, the secrets of genetic engineering and an experimental program for creating intelligent, humanoid, canine soldiers. The level of knowledge and proven scientific data was light years beyond anything possessed by the CS, and confirmed many of Bradford’s theories (which were often ridiculed by colleagues). Furthermore, the pre-Rifts facilities and laboratories were state of the art, and perfectly preserved in the underground vaults and bunkers of the sprawling military complex. In fact, it is a mystery as to why it was abandoned — it should have been an ideal resource for survivors of the Great Cataclysm, and one would think that at least a skeleton crew of a thousand men must have been posted at the time of the holocaust (Bradford has his theories about this too).

Knowing nothing else would suffice, Karl Prosek gave Doctor Bradford near absolute power over the facility, making him Administrator and Head of Genetic Research. His job: Not only restore the complex to full working order, but to unravel its secrets in the area of genetic engineering. Desmond Bradford’s first report to Prosek stated, “My dear friend, you have handed me the keys to creation.”

Many dissenters of Doctor Bradford insisted the task was too much for 20 of the top minds in the Coalition States to coordinate and supervise, let alone one man, and predicted it would take at least 30 years to get even half the complex functioning. In only 10 years, Administrator Bradford had 70% of the facility mapped, 40% of the overall complex up and running, and 80% of the Genetics Engineering Department on line and working. Four years later, in 77 P.A., he produced the first “Dog Pack” for the scrutiny of Karl Prosek. The rest, as they say, is history.



Present & future excursions into the unknown

Doctor Bradford has no patience for small-minded fools and well-intentioned meddlers (like Colonel Prosek and Lt. Emmerson). Consequently, he efficiently does whatever is necessary to “remove” these obstacles from his way — including murder and treachery.

Doctor Bradford is a man obsessed with knowledge. The power that he wields as a result of that knowledge is secondary, and serves primarily to preserve and continue his research and discoveries. Doctor Bradford has never played by the rules or concerned himself with petty limitations like ethics and morality. His conduct and experiments at Lone Star are no different. Many of the officially sanctioned genetics experiments on other animal species overstep the set parameters established by the Counsel of Science and the CS Military, but Bradford has learned that impressive results will usually erase such trivial indiscretions (besides, he’s above such concerns). These experiments include:

1. New Mutants. The creation of other mutant animals for use as servants and soldiers in the CS Army.

Phase One has been a success; several different animals have been transformed into intelligent, bipedal humanoids, similar to the Dog Boys.

Phase Two continues to prove elusive; that is, the creation of loyal, cooperative servants like the Dog Boys. This is where some of the personality modification experiments may be most applicable.

2. R&D in Genetics & Cloning. The continuing quest to develop a better and more complete understanding of the genetic structure of all living things, the manipulation of that structure and the creation of life.

3. Genetic & Molecular Medicine. Techniques and methods for preserving, protecting and improving the human body and life. It is this branch at Lone Star that discovered the means to extending human longevity without mental or physical deterioration.

4. M.O.M. technologies. One of Doctor Bradford’s teams work tirelessly on trying to overcome the problems inherent in M.O.M. (or Crazies) augmentation. A subset of this research, conducted by a separate team, is the development of a personality modification system through brain implants. Test subjects are typically mutant canines who washed out of the Dog Boy training program and other mutant animals.

5. Advanced Bionics. The development of new and improved bionic combat prosthetics and implants (again, usually tested on mutant animals).

Among others.

The Forbidden

One of Doctor Bradford’s most burning desires is to completely unravel the mysteries of human genetics. To this end, he has conducted a hundreds of experiments involving *human* test subjects! All humans used in these experiments have been Indians, bandits and vagabonds wandering the Pecos Badlands. Still, the use of humans in any type of mutation or debilitating experimentation is expressly forbidden by the Coalition States. The penalty for disobeying this prime directive is death! Bradford doesn’t care — the Emperor couldn’t include him in this decree. Being nobody’s fool, Doctor Bradford has created an ultra-secret research level of the complex for his forbidden experiments. These experiments are responsible for the Psi-X Aliens and several other abominations. Most such *failures* never see the light of day — destroyed and incinerated. However, the good Doctor did not see the Psi-X Aliens as complete failures, so he arranged to have the entire test batch (nearly one hundred) released into the Pecos Empire. He has his agents keep an eye on their activities and maintains a log on their adaptation and progress in the world.

Other studies include experiments in combining the genetic codes of different species; dogs and cats, animals and humans, D-Bees with humans and/or animals, and so on. The study of D-bee and alien life forms

is considered a gray area that most human supremacists consider taboo and avoid. The combining of alien DNA with life forms indigenous to Earth, human and animal, is clearly forbidden. Thus far, Doctor Bradford and his elite team have unravelled and mapped much of the genetic code of the Psi-Stalker, Simvan, and Quick-Flex Aliens, as well as humans, a half dozen other D-Bees and 100 different animal species.

Really, it's Emperor Prosek's fault that Doctor Bradford has begun to intermix the traits of multiple species. This was something Bradford had considered doing for years. He and his elite team studied and labeled the genetic structure of select D-bees and alien organisms (even attempting to understand vampires and Brodkil; so far, undecipherable). Doctor Bradford formulated theories and plans for the beings he might be able to create with this knowledge. However, Bradford never dared to combine them in actual, living test subjects. He was unsure of himself and questioned whether he, a god or no, should take that next giant step.

It was the Emperor's request to develop the *Xiticix Killer* (see the section on *Other Mutants* for details), that nudged Doctor Bradford into the creation of the inhuman. Once he started work on the project, the infinite possibilities filled his mind and expanded his dreams. Never accepting boundaries and always testing the limits of his abilities, Doctor Bradford began work on several unauthorized projects. The success of the Xiticix Killer and the Emperor's praise only fueled the mad Doctor's ambitions. During the Xiticix project, Bradford simultaneously began eight unauthorized projects as well. One was the Psi-X Aliens, others were more terrible. These experiments have met with varying degrees of success, and many of these "new breeds" have also been released into the world. Since then, he has engaged in a dozen new creation experiments. After all, isn't it a "god's" duty to create new life?

Desmond Bradford

Real Name: Desmond Bradford

Species: Human

Alignment: Aberrant

Hit Points: 71; **S.D.C.:** 20

Height: 6 feet, 2 inches (1.9 m)

Weight: 210 lbs. (95 kg)

Age: 69; looks to be in his late thirties.

P.P.E.: 15

Horror/Awe Factor: 14

Attributes: I.Q. 27, M.E. 21, M.A. 18, P.S. 19, P.P. 15, P.E. 14, P.B. 11, Spd. 15

Disposition: Doctor Bradford is a genius who has little tolerance for ignorance or stupidity in others. He demands the utmost from all who work under him and tends to belittle those who fail him more than once. He rides his people hard and expects them to possess the same intense (insane) drive, dedication and endurance that he possesses; most do not, which annoys him. He is constantly frustrated by the limitations, small minds and lack of vision in the supposedly "best minds" in science. All this helps to create Bradford's feeling of detachment from and superiority over mere mortals.

Desmond Bradford *is* quite insane. He believes he is a god who can give and take life without consequences. He is out of control and dangerous. Bradford has gone far beyond anything the Coalition States has authorized. His worsening delusions of godhood and increasingly bizarre and dangerous genetic mutations may soon jeopardize the Lone Star Complex. Worse, there is a genuine possibility that if Emperor Prosek should ever condemn Bradford's work and stand against him, the Doctor will reject him as a fellow god (and friend), or decide that the Emperor is insane, and openly rebel against him and the CS.

It is only Bradford's delusion that the Emperor is a fellow god (and perhaps even a slightly more powerful god) that keeps him in check (at least to some degree). If that bond is ever severed, there can only be disaster. Ninety percent of the troops and personnel at the Lone Star facility are loyal to their Emperor and Country, and fear Administrator

Bradford, so they will not join the madman in any action of defiance against the CS. However, Bradford knows the secret complex better than anybody else and knows things that only a tiny handful of others know. Consequently, the madman could hide within the complex and avoid searches for months. Perhaps even continue some of his experiments! The horrors he could unleash and the damage he might inflict on the complex (destroying years of secret and official research and data bases, computer and biological viruses, sabotage, etc.) could be incredible.

Desmond Bradford is himself a human aberration with a brilliant mind and imagination the likes of which the world sees only once every thousand years. He is incredibly imaginative, resourceful, adaptive, cunning and calculating. His mind works quickly, enabling him to instantly see the big picture (although not necessarily the complete picture; he may miss small aspects, especially those involving random human elements and things he considers irrational). Bradford is a master at problem solving and adaptation. He understands human and animal psychology, instincts and nature on levels unparalleled by most others, with the possible exception of some Mind Melters and psychic sensitives. This means nine out of ten times he will be able to second guess his opponents, be prepared for whatever they have in store for him, avoid their traps and plans of attack, and usually be ten steps ahead of them. He is truly a master villain who is likely to avoid capture and return frequently to thwart his foes and extract vengeance. His only weakness is that all other mortals are beneath him and he sometimes underestimates them or overlooks the obvious.

Desmond Bradford insures the loyalty of his elite team of 112 scientists (many of the brightest and best), 50 assistants, and approximately 130 mutant creations (who also serve as assistants, aides, and protectors; including mutant canines, bears, felines, rats and Psi-X Aliens), along with 20 Crazyies and 30 Kill Hounds, with threats and intimidation (many of the scientists have explosive implants in their skulls), through experimental personality modifiers, and sheer force of will. See the section on *Other Mutants* for examples of possible mutant minions. Other than Emperor Prosek, Doctor Bradford has no friends. At best, he has a cordial, somewhat aloof business relationship with General Kashbrook and a tiny handful of others.

Experience Level: 20th level Cyber-Doc and Genetic Engineer, 10th level Administrator.

Skills of Note: Speaks American, Spanish and Gobblely at 98%, literate in American and Spanish at 98%, knows all medical and science skills as well as swimming, S.C.U.B.A., pilot hover craft (ground), computer operation, computer programming, computer hacking, and radio: basic, all at 98%. He also knows the following skills at approximately 85% skill proficiency: Interrogation techniques, intelligence, streetwise, find contraband, palming, computer repair, horsemanship, land navigation, and wilderness survival. W.P. knife/surgeon skill is at 20th level, W.P. energy pistol 10th level, W.P. energy rifle at 6th level.

Combat Skills: Hand to Hand: Expert, 10th level

Number of Attacks: Seven

Bonuses: +2 on initiative, +2 to strike, +4 to parry and dodge, +11 to S.D.C. damage, +3 to pull/roll with punch, fall or impact, kick attack (1D6 damage), critical strike on 18-20, judo-style body throw/flip, paired weapons.

Magic Knowledge: None

Psionic Knowledge: None

Weapons and Equipment: Has access to virtually anything he needs or wants from the CS Government and Military.

Highest security clearance and has access to all levels and facilities at the Lone Star Complex.

Favorite weapons include laser scalpels, vibro-knives and Dog Boy Vambraces with two claws and/or double sabers, Electro-Stun hand prod and spear, as well as a variety of drugs and implants (used in others to control them). Wears Heavy, old-style Dead Boy armor in the field.

Standard equipment usually in the Doctor's possession or nearby includes the latest hand-held computer, portable language translator, pocket laser distancer, PDD audio recorder and player, and medical bag with all standard first-aid/doctor equipment, laser scalpel, RMK Knitter nano-bots, IRMS surgeon nano-bots, compu-drug dispenser, and a small set of lock picking tools (for emergencies). Of course he has access to all other types of medical, cybernetic, bionic, M.O.M. and laboratory equipment and facilities.

Cybernetics: Clock calendar, gyro-compass, and universal headjack and ear implant.

Money: As the Administrator of the Lone Star Complex, Desmond Bradford has access to billions of credits for research and access to hundreds of trillions of credits worth of equipment and facilities.

Personal Resources: Always one to plan ahead, Bradford has four million dollars in universal credits, 4D6x one million credits worth of pre-Rifts artifacts (most looted from the Complex) and over 50 million credits worth of genetics, medical and lab equipment at an underground hideout in Ciudad Juarez. He also has caches of basic travel and medical equipment (vehicle, armor, weapons, medical bag) and debt cards of 100,000 universal credits scattered at a half dozen secret locations in the State of Lone Star.

Adventure Notes

Administrator Desmond Bradford is a nefarious character who the player group may *never* meet or confront directly (although it could happen). The reason is that Bradford rarely leaves the confines of the Lone Star Complex and because he is a mover and shaker from behind the scenes.

A direct meeting (confrontation) *might* occur if Doctor Bradford goes on a field study to observe some native, alien, D-bee or mutant life form. This may be an official operation with military escorts (human soldiers and/or Dog Boys), or a secret one with a few (controlled) assistants and/or mutant monstrosities accompanying him.

The Doctor will find any mutants, aliens or strange life forms in the group particularly fascinating and may ask if they'd allow him to examine them. This is likely to be a sincere request with no intention to capture or harm the individual(s). He or one of his assistants may also engage the characters in polite conversation about science, the CS, and Pecos Empire, as well as news and rumors, especially those concerning nonhumans, sightings of new creatures, Psi-X Aliens, the Xiticix and Xiticix Killers, Dog Boys, mutants, Gene Splicers (he'd love to meet these alien masters of genetics; he's only heard about them), etc. During this discussion, the player group will be mentally examined (perhaps tested) and sized-up for any number of possible uses.

- Bradford may be looking for pawns to help him in any number of schemes. He might enlist their aid in protecting him and his colleagues in "these dangerous wastelands," or manipulate them to destroy an enemy (a member of the CS as well as others). He may also convince them to attack a "dangerous monster terrorizing the poor locals," or a group of monsters (in either case his mutant creations), so that he can watch, study (and probably video tape) the creatures' reactions to the attack. If members of the player group are injured or killed, he really doesn't care.
- Another possibility might be getting the group to capture a particular (alien, D-bee, monster) specimen needed for his (secret?) research.
- Or, he may entice the player group and other mercenaries to hunt down and either capture and bring to him, or destroy, some dangerous monster or being (one of his mistakes that got away, or a mutant creation that combines the DNA of more than one life form). He may fail to mention (or not) that a squad(s) or platoon(s) of Coalition soldiers are also looking for this creature. It is important that he "acquire" or destroy this being (an evil monster or innocent; animal or intelligent) because if the CS captures it, they will have proof of his experiments using human and/or nonhumans in his genetic re-

search. Of course, this could lead not only to a race against time with CS adversaries (Rangers, SAMAS, Dog Boys, Kill Hounds, etc.), but the target of the search may get captured by the CS before (or after) the player characters can find it, and they will have to attempt a rescue (and be pursued?). In addition, the group must deal with other denizens of the wild and woolly Lone Star State, from other mutants and bandits to wild Psi-Stalkers and Indian mystics. However, their employer (Doc Bradford) *will* make it worth their while, offering 50,000 to 100,000 credits per each man in the group as payment!

To complicate matters even more, the subject of the this "monster hunt" may be a gentle, peace-loving creature who only wants to be free (having the player characters find it in time to see it rescue or heal a little child, etc., would help drive home the mutant's generous and good nature). If intelligent, the mutant will try to reason with the group and even tell them (if it knows) that it is the creation of GED, that their mysterious employer is an agent of Lone Star and that he/she will be destroyed if turned over to him.

Note: In all these potential scenarios, the man will never reveal his true identity or ties with the CS.

A raid on the Lone Star Complex might also lead to a meeting with the mad doctor. However, the Lone Star Complex is first and foremost, a military installation crawling with thousands of troops and protected by numerous failsafe systems and defense mechanisms. The chance of penetrating the compound's outer defenses and defenders is slim and none. If by some miracle (or magic) the player group actually gets inside, their getting out alive is unlikely, and finding Administrator Bradford even less likely. Note that the Administrator never bothers with such mundane tasks as interrogating bandits and foolish spies.

More likely encounters. The player characters are much more likely to tangle with the creations of Doctor Bradford without any involvement or secret plots involving their creator. This can include attacks from Kill Hounds on seek and destroy missions, "feral" Dog Boys and other mutant runaways, monsters, etc.

All sorts of storylines can arise from GED, Lone Star, Bradford and his/their creations. Just a few examples might include:

- Fight mutants or monsters terrorizing a village or town. Do these beasts need to be hunted down and exterminated?
- Conflicts with powerful mutants or deranged Crazies (well, crazier and quirkier than usual) that form a gang or are part of a gang. They can be swashbuckling crooks (but not murderers), Robin Hood style country heroes (steal from the Coalition and give to the poor, or other mutants, or just themselves — but when easy CS targets aren't around, they also hit adventurers and merchants). Or these bandits might be predators who give in to their bloodthirsty, animalistic desires and kill with the slightest provocation. Or anything in between.
- Traumatized mutant canines (or others) who either fear and distrust humans and subsequently use, trick, cheat and rob them. Or mutant creations from Lone Star who hate *all* humans and kill them whenever they can.
- Innocent mutants or feral Dog Boys who simply want to live free. They've never hurt anybody, but they are persecuted (robbed, beaten, raped, enslaved, hunted and killed — use any one or all) by ... fill in the blank. Their persecutors could be the Coalition Army, bandits, mercenary group, a Simvan or Psi-Stalker clan, or fellow mutants. Will the group help them? Even against CS forces?
- One or more runaway mutants, fleeing the Coalition (Kill Hounds, Boy Boys, Death Wings, CS grunts, or bounty hunters), accidentally lead their pursuers to the player group. The animals run through in a panic, leaving the group to face their pursuers. If the player characters are known criminals or enemies of the States (which many adventurers, mercs, men of magic, and free-thinkers are often considered), the Coalition forces are likely to turn their attention to them — a more immediate and dangerous problem.

- CS troops, especially Kill Hounds, look unkindly to any runaways or “ferals” in the group and will want to take them into custody or destroy them on the spot. Any resistance, even a strong argument, is likely to be construed as interfering with the law and harboring a wanted fugitive/enemy of the State. This will brand the entire group as dissidents and as criminals or enemies of the State as well. Lethal force will be used on all parties. Note that werewolves, Wolfen, and other beings with canine or animal features may be mistaken for rogue mutants.

The Mastermind. The player characters may also find themselves pitted against Desmond Bradford in strategic or tactical battles in which they inadvertently or deliberately interfere with the madman’s plans. From behind his desk, Bradford will dispatch troops or mutants against them, set traps and seek retribution like some insane chessmaster out to manipulate and destroy his opponents. Depending on the circumstances, he may even come to see the player characters as worthy (and regular) adversaries on which he enjoys testing his own cunning, skills and resourcefulness (especially if he usually comes out on top). This could even lead to a strange respect for them — not that it will stop him from framing or destroying the characters in the future. And beware of making Desmond Bradford angry. If made to look foolish or fallible (i.e. human), those responsible will earn his eternal hatred and he *will* seek retribution — probably something hideous, slow, and painful.

In short, Doctor Bradford makes an excellent, reoccurring, master villain and plotter behind the scenes — a catalyst for countless adventures involving his mutant monstrosities, experimental Crazies, Lone Star and the Coalition. Remember, Bradford considers most people in the CS as fools to either be used as he sees fit or who annoy and frustrate him. This means he regularly manipulates, uses, and defies members of the Coalition States (government officials, fellow scientists, etc.) and the Coalition Military (from Generals on down). This can lead to all kinds of subplots and undercurrents.

General Loni Kashbrook

Head of Lone Star (the State) Operations & Administration

General L. Kashbrook is one of Emperor Prosek’s most trusted members of the *Executive Counsel* and *Coalition Military High Command*. Twelve years ago, General Kashbrook was given the daunting task of securing the northern quadrant of the State of Lone Star.

In two years, under General Kashbrook’s guidance and firm hand, she reorganized all active military outposts, reshuffled troops, resources and leadership, established new outposts, instituted new procedures and made the CS troops a force to be feared. Ten years later, she has complete control over the northern quarter of the Lone Star State, the Lone Star Complex is 100% secure, civilian settlements are thriving, she has launched successful actions to slowly and carefully push into the southern and eastern regions of the State (encroaching on the Pecos Empire), and the Pecos Bandits (Warlord Grange and his Pecos Riders in particular) know she is a deadly force with which to be reckoned. General Kashbrook has successfully repulsed attacks by the Pecos Bandits, rampaging Juicers, Tolkeen Death Squads, and numerous other threats to the Lone Star State, including spies, saboteurs, mutants, and alien invaders.

With a little help from the Chi-Town propaganda machine, Lone Star is considered one of the jewels of the Coalition States (Chi-Town being another). The General successfully maintains the illusion that the CS dominates the entire region. As far as General Kashbrook is concerned, her only real triumph is the defense of the Lone Star Complex and the stronger perimeter along the borders of the northern quadrant, dotted with a handful of new military bases and outposts. Although the

settlers do seem to be thriving under her watchful eye, they are blissfully unaware of the General’s uncertainty that her forces could adequately protect them against a full-scale invasion. *Fort El Dorado* in Arkansas and all the CS outposts in Texas/Lone Star are assigned the latest weapons, armor and technology the Coalition States has to offer. Squadrons of the new SAMAS, Super-SAMAS and Special Forces PA-08A SAMAS are in place and ready to scramble on a moment’s notice. Likewise, her mechanized forces includes an army of Skelebots, Hell-raisers, Hellfires, all manner of Spider-Skull Walkers, the experimental Scorpion Walker, Skycycles and armored transports, plus her Special Teams often field test weapon prototypes.

The Wolf Division (6000 troops; 3 brigades) is an active part of her troops and is the largest, active, single unit of Dog Boys (98%) currently in operation any where in on the continent. The escalating wars with Tolkeen and Free Quebec will certainly see a greater overall number of canine troops committed to the conflict, but they will be broken down into smaller units, rarely exceeding one full brigade (1920 Dog Boys) under a single command. The full size and composition of the Wolf Division is a little known secret to the outside world. Even the Pecos Bandits don’t realize its true size and scope, although they have come to loathe the CS Psi-Hounds “who seem to be everywhere!” Also under General Kashbrook’s command are the **Coyote Brigade** who patrol the northern border and make excursions into the old American State of Oklahoma, and Pecos Hunter Company (160 Dog Boys; 25% Sniffers, 30% Kill Hounds) operating out of a secret base near the ruins of *Irion*, in the Pecos Empire (with support from Odessa). She also has mobile forces (human and Dog Boy) operating in and around Fort Worth, currently known as the Kingdom of Worth, and the haunted ruins of Dallas (where there is another secret base, this one a cyborg platoon, a Dog Boy platoon and a dozen Skelebots; 80 live troops). Unknown to King Macklin, this area is targeted for CS expansion in the upcoming months.

The General has used the Kill Hounds, among others, with frightening efficiency to help “rid the world of the vermin that infest this land.” These vermin are unallied humans, bandits, D-bee tribes, Native American Indians who have forsaken technology and the CS, and nonhuman “squatters” who inhabit the State of Lone Star and seek refuge in the Pecos Empire.

A 28 year veteran (graduated from officer’s school at age 20), General Kashbrook has distinguished herself in countless battles, helped to build and organize the CS military, and has proven herself to be a valuable supporter of the Prosek regime (both father and son). She is a natural born leader; a firm disciplinarian who abides by the rules and brooks no nonsense, yet is fair, understanding and well liked by the troops under her command. Perhaps more importantly, General Kashbrook is a good tactician, an excellent strategist, and a master at logistics. She knows how to get things done and keep them working smoothly and efficiently. Joseph Prosek II has admitted that he doesn’t know if any “one” person, other than Kashbrook, could handle the overwhelming task of running military operations in the State of Lone Star, supervising and protecting the civilian settlements, making (small but) solid advances into hostile territory and maintaining the illusion that the CS has everything under control throughout the entire State.

General Kashbrook is even respected by Lone Star Complex Administrator Bradford; she’s not his equal, but does have a brilliant military mind worthy of his respect and association. In fact, General Kashbrook was selected to head Military and Administrative operations (effectively *governing*) of the State of Lone Star, in part, because she and Desmond Bradford liked each other and got along. Emperor Prosek knew that Bradford would not cooperate with anybody he didn’t respect (like the last four poor fools given this assignment, and who failed miserably). The Emperor knew that Kashbrook and Bradford would be supportive of each other without stepping on each other’s toes. General Kashbrook was also selected for her sound reasoning, diplomacy and expertise in strategy and logistics. Emperor Prosek knew if anybody could keep a lid on the turbulent cauldron that is the Lone Star State and make it look

like the CS was really in control, General Kashbrook was that individual.

Again, Emperor Prosek's uncanny ability to recognize and accurately assess the capabilities of his Secondary Leaders (one of the things that makes him such a potent and effective leader) is evident in his selection of General Kashbrook. The General inherited a military position in utter anarchy, improperly utilized, ineffective, and overwhelmed by the enemy (namely the Pecos Bandits and independent raiders from neighboring territories). The only stable zones were the Lone Star Complex and (arguably) Wichita Falls.

General Kashbrook's primary base of operation is the **Wichita Falls** base, rather than the *Lone Star Complex* or *Lone Star City*. This was done to avoid attracting the enemy to these places and risking invaluable resources. From here, she can also oversee operations to advance into the southeast "Freelands." The Lone Star Complex is her secondary command post, a fall-back position of incredible power, defenses and resources (see the *Lone Star Complex* for more details).

Real Name: Loni Kashbrook (no middle name)

Species: Human

Alignment: Aberrant

Hit Points: 57; **S.D.C.:** 32

Height: 6 feet (1.8 m)

Weight: 150 lbs. (67.5 kg)

Age: 48; looks to be in her mid to late thirties; physically fit.

P.P.E.: 6

Horror/Awe Factor: 12

Attributes: I.Q. 17, M.E. 21, M.A. 23, P.S. 21, P.P. 14, P.E. 14, P.B. 18, Spd. 19

Disposition: General Kashbrook is a career soldier with 28 years of active service and who plans to be soldiering for another 40. She has never been married, although she's had a number of suitors, and has countless admirers, but she's married to the military; her career means everything.

Since she's a go-getter, hands on kind of person who feels comfortable among her troops, she is always in the thick of things, visible to her troops and is often on the field of combat. As a highly placed CS officer, she has studied pre-Rifts military history and admires US Generals Patton and Bradley, and Roman General Julius Caesar.

General Kashbrook radiates confidence and is an excellent negotiator. She is quick thinking, decisive and resourceful, but never commits her men to any campaign she doesn't believe she can win and rarely takes foolish chances. Nor does she bluff — she's always ready to back up her position with action. The General is a consummate professional, cool under fire, and leads by example. She expects her troops to follow the rules and procedures of military protocol, but is flexible, understanding and adaptive when she needs to be. She demands a high level of discipline, respect, honor and order — and usually gets it.

The General is a hero of the Coalition States and the defender of the weak, innocent and downtrodden. Although tough and decisive, she is compassionate and considerate of others, a rare combination in a military leader. However, these wonderful traits are extended exclusively to the citizens of the Coalition States. General Kashbrook is a fervent human supremacist who sees Emperor Prosek as a magnificent, capable and consistent leader worthy of her support and respect. His views of the world are only slightly harder and more extreme than her own. Consequently, General Kashbrook will torch a D-bee village and gun down every male, female and child without hesitation or regret. She views nonhumans as alien invaders and a threat to human survival. In her mind, the Coalition States has made it clear that they are not wanted, must leave, and have been given every opportunity to do so. If they stay, or dare question, speak or act against the Coalition States, they are the enemy and must be destroyed. However, she is not a bloodthirsty zealot looking for people

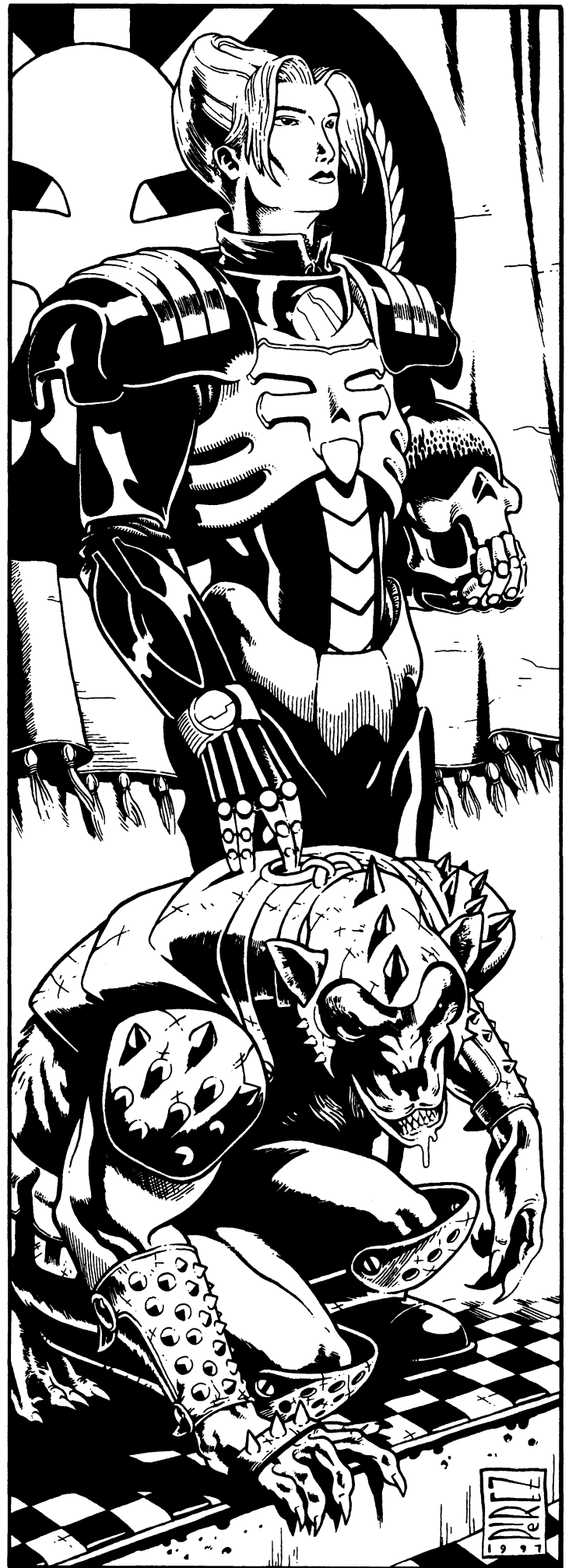

to destroy, and prefers to strike against military targets and professional soldiers.

Experience Level: 12th level Military Specialist; 3-Bar General.

Skills of Note: Speaks American and Spanish at 98%, literate in American and Spanish at 98%, detect ambush, detect concealment, intelligence, interrogation techniques, wilderness survival, camouflage, Military etiquette, military fortification, recognize weapon quality, pilot: jet pack, pilot: robots combat elite, pilot: hover vehicles (she loves hovercycles), computer operation, and radio: basic, all at 98%. Plus, demon and monster lore 73%, D-Bee lore 73%, prowl at 60% and streetwise at 59%. W.P. energy pistol, and W.P. energy rifle, both at 12th level proficiency and W.P. automatic pistol at 7th level.

Combat Skills: Hand to Hand: Expert, 12th level

Number of Attacks: Five

Bonuses: +2 on initiative, +2 to strike, +5 to parry and dodge, +9 to S.D.C. damage, +2 to pull/roll with punch, fall or impact, kick attack (1D6 damage), critical strike on 18-20, judo-style body throw/flip, paired weapons, +3 to save vs psionic attack, 40% to charm and impress, and 75% to evoke a feeling of trust.

Magic Knowledge: None

Psionic Knowledge: None

Weapons and Equipment: Has access to virtually any military weapons and equipment she needs.

Highest security clearance and has access to all levels of Chi-Town and most (70%) of the levels at the Lone Star Complex.

Favorite weapons include the old C-14 “Fire Breather” assault rifle, and new CP-50 “Dragonfire” assault rifle, and CP-30 laser pistol. Wears a variety of old and new style Dead Boy armor in the field (uses the armor that seems best for the situation).

Other equipment includes standard military gear, a hand-held computer, portable language translator, and pocket laser distancer.

Cybernetics: Clock calendar, gyro-compass, radiation detector, and universal headjack and ear implant.

Money: As Head of Lone Star Military Operations, Loni Kashbrook has access to billions of credits worth of military equipment and troops.

Personal Resources: 1.2 million in savings and a military pension.

Note: The General likes Doctor Bradford, but is acutely aware that he teeters on the edge of insanity. Accepting the faith Emperor Prosek has in Bradford, and the fact that there is often a thin line between genius and madness, she tries to stay out of the affairs of the Lone Star Complex. Instead, she focuses on the defense and security of the Complex and other military matters in the State.

As for Brigadier General Kalpov, she respects his experience and past accomplishments, but considers him to be an old war dog who prefers a straightforward and bloody approach to war, focusing on abstract objectives rather than the lives of his men. While this mindset may have been necessary 50 years ago, with the Coalition’s technological superiority and firepower, she finds it unnecessary and foolish to waste “human” lives. She prefers more complex strategies, feints and diversions that confuse, divide and weaken the enemy before an all-out attack. While Kalpov calls this approach weak, the General usually wins her objectives in the estimated time allotted and with less casualties than any other General in the Coalition Army. One of her fears is that if the Complex is ever put under siege, Kalpov will use it as an excuse for a blood bath, taking no prisoners. While he will be victorious, such a massacre can only magnify tensions in the State and the surrounding territories a hundred-fold. If she had her wish, Kalpov would be retired.

She regards Colonel Collins and Kalpov’s other henchmen as dangerous fanatics.

Kashbrook Adventure Notes

General Loni Kashbrook is a character that the player group could run into on the field of combat or accidentally, as either friend or foe.

A **friendly direct meeting (confrontation)** *might* occur if the group is thrown together with her in a situation against mutual enemies, forcing them and her (and any of her troops) to join forces against a greater evil. As professional soldiers, the group may be amazed at her keen insight, leadership and cooperation, even with practitioners of magic, D-bees and criminals — she’s not a fool or a zealot and will do whatever is necessary to save herself and her troops and/or succeed in her mission. If that means temporarily throwing in with undesirables, so be it.

General Kashbrook will have respect for honorable and courageous characters who follow orders and work as a team toward a common goal (she can do without glory hounds and fools). Those who fight admirably, honorably and hold up their end of any deal will earn her respect — and mercy. This means at the end of the conflict, she will announce the end of their alliance, thank them for their cooperation (courage, etc.), perhaps even offer medical assistance and basic resupplies. She’ll then warn them in a tone that cannot be mistaken, that they are not friends, the group must leave, and the next time they meet they will be regarded as enemies of the CS and given no quarter.

There are also several, common enemy scenarios that could enable the player characters to catch a glimpse of or work with General Kashbrook. For example:

- The player characters may be fighting monsters, mutants, alien invaders, bandit warlords, evil sorcerers, trying to close a Rift, or any number of situations in which the General or officers under her command have the same agenda. One might find other helping them or working to the same objective, although possibly from different angles.
- Similarly, the players (or the CS troops) find themselves fighting to protect or defend CS citizens, innocent humans, scientists, or soldiers — perhaps a losing battle — only to be rescued (and thanked?!) by General Kashbrook’s troops or the General herself, or vice versa.
- The player group might also catch glimpse of her at work with her forces as wilderness scouts, mercenary hirelings, informers or special agents.

Conflicts are much more likely. The player group is more likely to be working at cross purposes or directly against the General and the CS. They are likely to cross paths and battle over the acquisition of precious or forbidden knowledge or resources; tangles with Doctor Bradford and/or the Lone Star Complex; and any work to foil her plans of military expansion into the Texas Freelands (including the rescue of those under attack).

The two opposing sides will clash when the player characters attempt to rescue a captive from the clutches of the CS, interfere with a CS operation, fend off CS troop when they attack a D-bee stronghold or innocent tribe, help refugees and feral mutants escape the CS, or engage in banditry against the CS. The player characters will also come to odds with the CS troops in Lone Star by associating with known bandits or enemies of the States (including teachers, scientists, and D-bees), or even passing through or near the CS dominated Northern Quadrant. Furthermore, adventurers operating in the Lone Star State are likely to stumble across CS operations of all kinds, from research operations and reconnaissance teams to archeological excavations to secret missions and hidden caches of equipment. Most heroic characters who believe all intelligent life forms have a right to life and the pursuit of happiness will find themselves at odds with the CS and the Coalition’s primary henchman in the State, General Kashbrook. Adventurers in the State will frequently encounter troops, mercenaries and bounty hunters operating in the Texas Freelands and Pecos Badlands. Squads of Kill Hounds, CS Juicers, Crazies, and Dog Boys are constantly sent out on seek and destroy missions or purges in which any nonhuman and/or hu-

mans suspected of banditry or acts of subversion are hunted down and slaughtered. Skelebots are frequently sent into the vast wilderness of the Northern Quadrant, Freelands and Pecos Empire with the simple mission of "kill all nonhumans and anybody who interferes." SAMAS and Death Wings sweep the skies and strafe the unsuspecting in hit and run raids. There is better than a 95% likelihood that any CS soldiers encountered in the State of Lone Star are under her jurisdiction, if not the General's direct command.

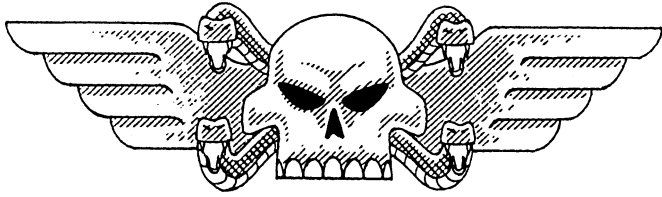

CS Military Divisions & Departments

The Coalition Army

- Infantry — Regular Army with several subdivisions, departments and corps.
- Dog Pack Infantry Corps
- Rangers Corps (Infantry and Intel) — Humans, Dog Boys and Psi-Stalkers.
- RPA Airborne Armored Corps (RPA-AAC Infantry) — SAMAS and all flying Power armor.
- RPA Robot Mechanized Corps (RPA-MC Infantry) — All ground based giant robots, power armor like the UAR, IAR, G.B. Killer, etc.
- Armored Mechanized Corps (AMC) — Tanks, APCs, and other ground vehicles.
- Medical Corps
- Skelebot Deployment Force (SDF)
- Rapid Deployment Force (RDF) — 4 combat divisions (23,000 troops prepared to assemble at a moment's notice).
- Coalition Expeditionary Force (CEF)
- CS Intelligence Division (CSID) — Military Intel
- CS Military Technologies (CSMT) — Operators/mechanics, scientists, engineers, construction, etc.

Department of Special Divisions (DSD)

An umbrella organization within the Coalition Military that oversees and coordinates Special Military Operations and Corps, including:

- Special Forces: Commandos, spies, and all other Special operatives and operations.
- Coalition Cyborg Division — Special Infantry combat troops.
- Juicer Division — Special Infantry combat troops.
- Explosive Ordnance Division (EOD)
- Rifts Control Study Group (RCSG)
- Kill Hound Battalion (KH-Bat)
- K-9 "Sniffer" Battalion (K-9 Bat)
- Psi-Battalion (Psi-Bat) — Special Forces

Other CS Military Branches

- Air Force — Transports, Sky Cycles, Death Wings, and all flying vehicles and aircraft (also utilizes SAMAS and other power armor), and includes the RPA "Fly Boy" Ace.
- Naval Advisory Commission (NAC); see *Coalition Navy* source-book.

Civil Defense Forces

- Internal Security Specialists (ISS) — Police & Civil Defense
- Net-Set (NTSET) Division
- Psi-Net (PRP) Division

Brigadier General Ivan Kalpov

Brigadier General Kalpov is a tough, old warhorse who has given 35 years to the Coalition Military. He is in charge of the Military defenses and forces stationed at the Lone Star Complex, one of the largest standing armies in the Coalition States. He is a diligent, capable leader and excellent commander. His men both respect and, a little bit, fear him.

His grandfather fought along side Joseph Prosek the First and died in his arms during the Federation of Magic's siege on Chi-Town in 12 P.A. Ivan's father served in the military till 62 P.A., retiring at the age of 92. Thus, he follows in his forefathers' footsteps and four of his six sons carry on the tradition, each a graduate of Officer's School and well regarded in the military. However, it is Brig. Gen. Ivan Kalpov who has earned the highest distinction of any member of his family. He is one of the bonafide heroes of the Coalition States and something of a living legend. He is sometimes (usually fondly) referred to as "Old Blood & Circuits" by his troops, because he has lost so many body parts in war, all replaced with mechanical bionics, and he always returns.

He has been party to over a hundred major battles, is the third most decorated officer in the Coalition Military, and is one of the few high ranking officers who rose through the ranks. Despite his colorful war record, accomplishments and hero status, Old Blood and Circuits is bitter and frustrated. War has made him as hard and cold as his bionic prosthetics. He feels he has worked harder and proven himself more times than many others who have risen to ranks higher than his own. Though he respects General Loni Kashbrook, he believes that he should have been appointed Head of Lone Star Military Operations, instead of "baby-sitting a kennel." He grudgingly recognizes the strategic importance of his post and the honor of the position, but he'd much rather be in the field of combat leading the charge against Tolkeen, Quebec or the Pecos Empire. He often grumbles among his trusted officers that General Kashbrook is too conservative and soft. That if he were Head of Lone Star Military Operations, the Texas plains would run red with the blood of the bandits, D-bees and animals who openly defy the CS in the Pecos Empire. He claims, with the proper support from Chi-Town, that he could conquer the Pecos Empire and seize control of the entire State in less than three years. Ivan would jump at the chance to engage in some serious combat, and would love to take over as the Head of Military Operations in Lone Star (the State). However, he has resigned himself to the task at hand, and does everything in his power to keep the Lone Star Complex safe and secure.

Administrator Bradford considers Brigadier General Kalpov a dull-witted ape with the repressed aggression of a Kill Hound (his only redeeming quality). The two men dislike each other and stay out of the other's way. This arrangement of ignoring each other works well for them because it provides each with the freedom to do as they please without interference from the other (and enables both to have their little secrets).

Kalpov is a proponent of an increased presence of cyborg soldiers in the military and has under his command, two companies (320) of Coalition Cyborgs. He also has a company of (160) CS Juicers as well as RPA pilots, Special Forces and thousands of grunts and Dog Boys. The Brigadier General often participates in war games and border patrols, sometimes in disguise (i.e. body armor and a bionically altered voice that conceals his rank and identity), to better assess the performance and moral of his crack troops.

Name: Ivan Thomas Kalpov

Species: Human

Alignment: Aberrant

Hit Points: 72; **S.D.C.:** 29

Height: 5 feet, 10 inches (1.75 m)

Weight: 200 lbs. (90 kg) of muscle, metal and hate.



Age: 54; looks his age.

P.P.E.: 4

Horror/Awe Factor: 12

Attributes: I.Q. 15, M.E. 19, M.A. 18, P.S. 22 (bionic), P.P. 20 (bionic), P.E. 14, P.B. 8, Spd. 44 (30 mph/48 km; bionic). The Brigadier General is a partial reconstructed cyborg, with bionic replacements for limbs lost in combat, plus deliberate augmentation.

Disposition: Brigadier General Kalpov is a career soldier with 35 years of active service. He is tough, resourceful, stubborn and tenacious like a bull dog. He a strong, capable leader, respected and feared by his men. He enjoys combat and is violent and aggressive by nature. Although he has dozens of impressive victories to his credit, his command also holds the record for the highest number of casualties. To Ivan Kalpov, victory is all important, and all too often they are won with the blood of his soldiers. This uncompromising, headstrong and violent approach to winning and resolving conflict is both a strength and weakness: when the High Command has a dirty, bloody job, they know they can turn to Kalpov. On the other hand, it is also what has held him from advancing higher up the Military ladder — too often the price of his victories are too high to pay.

Sadly, the years of conflict and wear and tear on both his mind and body has made Brig. Gen. Kalpov bitter, mean and frustrated. This makes him all the more brutal and cruel, especially towards the enemy. He is a firm disciplinarian who takes out his frustration by riding his troops hard and hammers anybody who dares to openly defy him. Bored and frustrated, he tends to overreact to acts of aggression and *potential* dangers, often atomizing small groups of outlaws, Juicers, mercenaries, D-bees, and even groups of travelers whom he considers suspicious. He shows nonhumans and practitioners of magic no mercy and is especially savage in his dealings with them. As a result, all inhabitants of the Lone Star State know to stay at least a hundred miles (160 km) away from the Lone Star Complex and most stay out of the Northern Quadrant entirely — so in a way, Kalpov's mad dog tactics *have* successfully secured the area.

Kalpov is positively brutal during interrogations of intruders, suspected spies, traitors, runaways, renegade mutants, and deserters (especially humans), frequently engaging in torture and beatings. For "sport," he'll take a squad of trusted soldiers (typically 3 cyborgs, 2 grunts, 2 Kill Hounds, 2 Dog Boys and a Psi-Stalker) into the Freelands or Pecos Badlands and slaughter whoever they encounter, with an eye open for monstrous D-bees, monsters, mutants and sorcerers — he hates sorcerers above all others.

The dutiful soldier, he accepts his position and works diligently to fulfil his duty. He *never* shirks from his responsibilities or acts carelessly, or turns a blind eye to trouble. He would die before he'd let the Lone Star Complex fall into enemy hands.

Experience Level: 14th level Military Specialist; Brig. General.

Skills of Note: Speaks American, Spanish and Gobblely at 98%, literate in American at 98%, detect ambush, detect concealment, intelligence, interrogation techniques, find contraband, trap construction, Military etiquette, recognize weapon quality, swimming, climbing, track (humanoids), wilderness survival, pilot: tanks and APCs, pilot: robots combat elite, pilot: hover vehicles, computer operation, and radio: basic, all at 98%. Plus, demon and monster lore 80%, disguise 60%, and streetwise at 64%. W.P. energy pistol and W.P. energy rifle, both at 14th level proficiency and W.P. heavy energy weapons at 7th level.

Combat Skills: Hand to Hand: Martial Arts, boxing and wrestling, all at 14th level proficiency.

Number of Attacks: Seven

Bonuses: +3 on initiative, +5 to strike, +10 to parry and dodge, +11 to S.D.C. damage, +3 to pull punch, +5 to roll with punch, fall or impact, kick attack (1D6 damage), critical strike on 18-20, judo-style body throw/flip, paired weapons, +2 to save vs psionic attack, +7 to save vs horror factor and 55% to evoke a feeling of trust or intimidation.

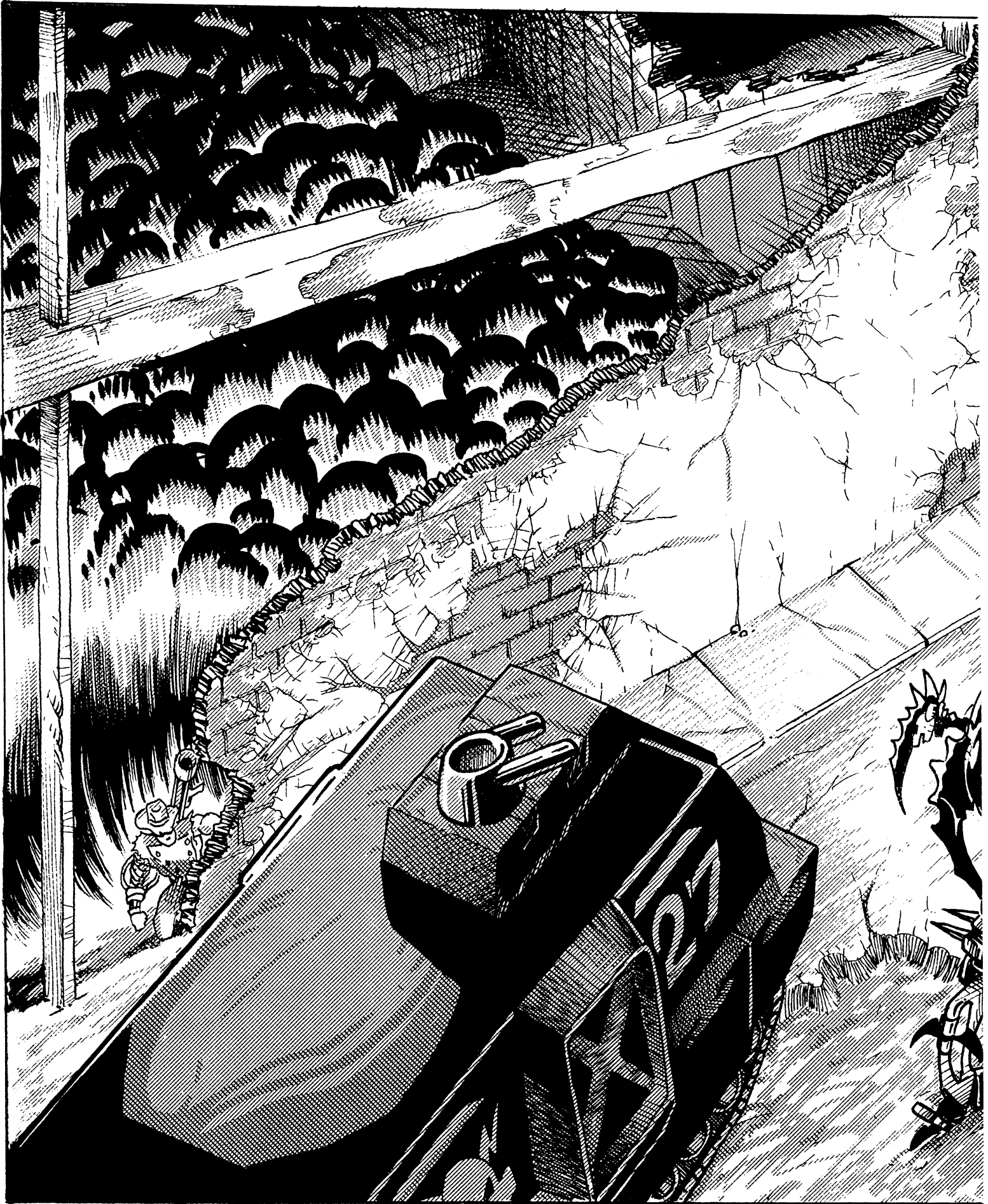



Magic Knowledge: None
Psionic Knowledge: None

Weapons and Equipment: Has access to virtually any military weapons and equipment he needs.

High security clearance and has access to all military levels and facilities at the Lone Star Complex, but only has low level clearance at GED and other science/research areas.

Favors heavy energy weapons and rail guns. Wears CA-6C cyborg body armor (200 M.D.C.) unless in disguise or incognito (any armor, uniform or clothing).

Other equipment includes standard military gear, a vibro-saber, a hand-held computer, portable language translator, and pocket laser distancer.

Cybernetics: Although considered a *partial* conversion 'Borg, Kalpov is more machine (65%) than flesh and blood. Clock calendar, gyro-compass, radiation detector, universal headjack and ear implant with ultra-ear and sound filtration system, built-in radio receiver and transmitter, loudspeaker, built-in language translator, modulating voice synthesizer, bionic lung with gas filter and oxygen storage cell, multi-optics eye, bionic legs, and bionic arms.

The right arm has a retractable vibro-blade (2D6 M.D.) and a garrote wrist wire, the hand a fingerjack and utility finger laser (1D6 or 3D6 S.D.C.).

The left arm has a concealed arm laser (1D6 M.D.), the left hand has a finger camera and E-Clip port. Each leg has one medium-sized secret compartment that usually holds a half dozen grenades, a vibro-blade and other small items.

Money: Kalpov has access to billions of credits worth of military equipment and troops.

Personal Resources: 500,000 in savings and a military pension.

Note: Kalpov likes Colonel Murphy, although he thinks he's still a bit green.

Ivan Kalpov Adventure Notes

This guy is real trouble. He's mean, powerful and has an axe to grind. Ironically, he'll regard any trouble the player characters may cause as a relief from the doldrums of the daily routine and welcome the challenge. However, he hits quick, hard and to kill! Because Kalpov likes to fight, he may join the fray or decide to take on the group personally. However, he is not a fool and will not jeopardize his life or the safety of the Lone Star Complex (his men are another story). Also, because he likes to go into the field incognito, it is possible that the player characters could stumble across him under almost any circumstance involving CS troops in Texas. They will most certainly face his men, strategies and tactics if they try to sneak into the Lone Star Complex, and, if captured, may have the unpleasant experience of being interrogated by Kalpov.

Colonel Roger Collins

Intelligence Corps

Colonel Collins is head of Intelligence and one of Brigadier General Kalpov's proteges. Like his mentor, Capt. Collins is a mean spirited hardcase who operates down and dirty to get the job done. His attitude is the end justifies the means. Thus, he is not shy about using threats, blackmail, surveillance, entrapment, drugs, torture, violence and murder to extract information and maintain security. He is a zealot when it comes to the sanctity of the CS, the honor of the Emperor, and human supremacy. He is so pro-humanity and anti-nonhuman that Colonel Collins isn't even particularly fond of, or comfortable with, Psi-Hounds (He refuses to call them Dog Boys because "boy" implies some semblance to humans, and he thinks it best that people remember they are mutant "animals" — not "boys").

Colonel Collins is among Kalpov's most trusted officers, and one of his confidants.

Name: Roger Bertrum Collins

Species: Human

Alignment: Miscreant; but steadfastly loyal to Brig. Gen. Kalpov and the Coalition States.

Hit Points: 62; **S.D.C.:** 42

Height: 5 feet, 9 inches (1.7 m)

Weight: 160 lbs. (72 kg) of muscle and anger.

Age: 39

P.P.E.: 5

Horror/Awe Factor: 10

Attributes: I.Q. 15, M.E. 20, M.A. 9, P.S. 20, P.P. 18, P.E. 17, P.B. 9, Spd. 17.

Disposition: Colonel Collins has 17 years of active service and a long career ahead of him. He is intelligent, cunning, tough, resourceful, and relentless. He's also spiteful, mean, petty and vindictive. He has a good mind for understanding the criminal underworld and a keen eye for deception, duplicity and espionage. His specialty is espionage and counter-espionage. In fact, the more complicated, dirty and vicious a situation, the more he likes it, because he can pull out all the stops and respond in kind, something he's very good at.

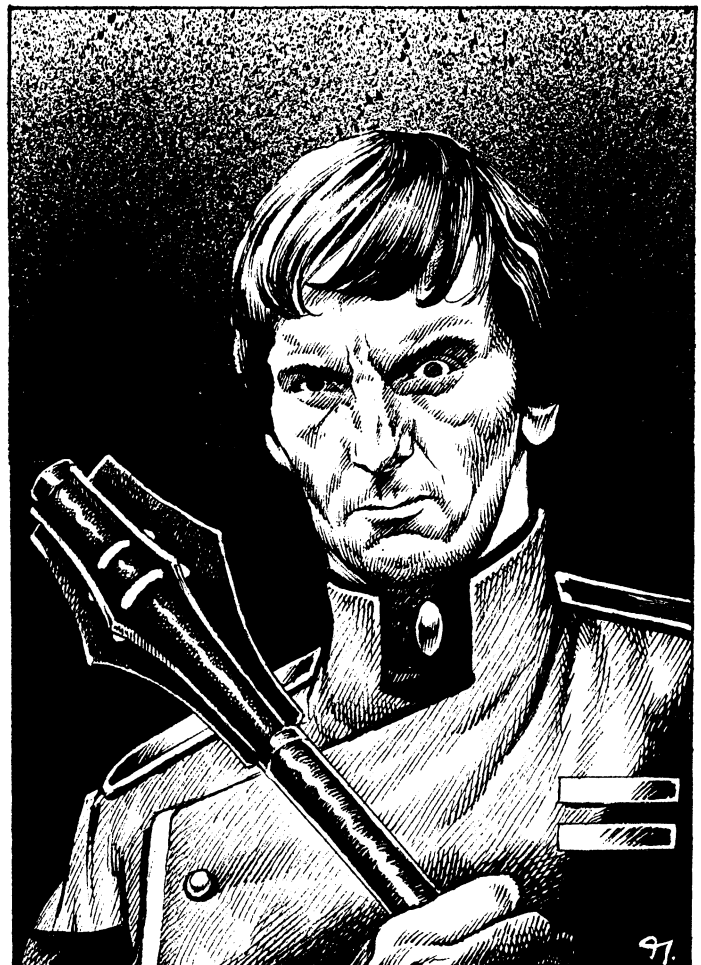

Col. Collin's greatest weaknesses are his inability to control his anger and his fanatical devotion to his commander and the Coalition States. Collins will obey orders from Brig. Gen. Kalpov or other CS superiors without question, hesitation or regret, unless they conflict with his loyalty to specific people, and even then a good story may coerce him into action. The super-patriot that he is, Collins has en-

gaged in acts of sabotage, extortion, falsifying evidence (frame jobs), and assassination to protect the *reputations* of his superiors, CS heroes (like Kalpov and Prosek) and the Coalition States. A dangerous man, he often takes it upon himself to protect his heroes and has cunningly manipulated the transfer of officers (above and below him) and sometimes manufactured evidence for the court martials of individuals who he felt represented a threat to him, his heroes, or the CS, or whom simply didn't share the same patriotic vision (i.e. they weren't fanatics).

Nothing gets under Collin's skin like criticisms against the people and dogma to which he has dedicated himself. Fellow human soldiers who are lucky, will find themselves in a heated argument, the less fortunate will find themselves in a brawl (broken bones and internal injuries at his hands is not uncommon), while the least fortunate will find themselves on Colonel Collin's "shit-list." These unfortunate souls will suddenly find themselves getting the foulest and most dangerous assignments, and/or be put under surveillance by the Intelligence Corps for suspicion of treason.

Experience Level: 10th level Military Specialist; Colonel.

Skills of Note: Speaks American at 98%, literate in American at 98%, knows all espionage skills at the base skill +45% (averaging at 65-85%), plus interrogation techniques 65%, find contraband 72%, radio: basic 98%, radio: scramblers 80%, electronic countermeasures 85%, surveillance systems 75%, optic systems 75%, TV/video 61%, cryptography 60%, imitate voices/impersonation 74%/54%, military etiquette 95%, pilot: robots combat elite, pilot: hovercraft, computer operation 98%, and streetwise at 48%. W.P. energy pistol, W.P. energy rifle, W.P. blunt and W.P. knife, all at 10th level.

Combat Skills: Hand to Hand: Assassin and boxing, all at 10th level.

Number of Attacks: Seven

Bonuses: +1 on initiative, +4 to strike, +7 to parry and dodge, +9 to S.D.C. damage, +3 to pull punch, +5 to roll with punch, fall or impact, kick attack (1D6 damage), critical strike on 19-20, knockout on 17-20, +3 to save vs psionic attack, +1 to save vs magic and poison/drugs, and +5 to save vs horror factor.

Magic Knowledge: None

Psionic Knowledge: Minor psionic with 73 I.S.P. and the powers of sixth sense and object read.

Weapons and Equipment: Has access to virtually all basic weapons, surveillance equipment, vehicles and other equipment, men and resources he may need for his investigations; 320 Intelligence soldiers at the Lone Star Complex work under his direct command.

He has high security clearance and access to all military levels and facilities at the Lone Star Complex, but only has low level clearance at GED and other science/research areas.

Favorite weapons include the Neuro-Mace, Electro-Stunner prod and spear, knives and high payload energy rifles. Wears any new style Dead Boy armor he feels is appropriate, unless in disguise or incognito (any armor, uniform or clothing); often works undercover.

Other equipment includes standard military gear, tracers, surveillance and recording equipment, a hand-held computer, portable language translator, and pocket laser distancer.

Cybernetics: Clock calendar, gyro-compass and universal headjack and ear implant.

Money: Collins has access to millions of credits worth of military equipment and troops.

Personal Resources: 51,000 credits in his "official" savings and a military pension. He has also managed to secrete away 250,000 universal credits (mainly through blackmail and smuggling) and has 4D6x1000 credits worth of ancient artifacts hidden away at any given time. In addition, Collins has a cache of weapons, armor, a hovercycle and 30,000 universal credits in case of an emergency.

Colonel Collins Adventure Notes

In any campaign that lasts a while in the Lone Star State, it is inevitable that the player characters encounter Colonel Collins or some of his agents. The circumstances may vary but the encounter will almost certainly be an unpleasant one. The wicked and vengeful weasel that he is, Collins is almost certain to escape any confrontation to return (repeatedly?) with a vengeance and murder in his heart. Characters who he comes to hate (which can be a quick and easy thing, especially if he is embarrassed by them, or they are predominately nonhumans) will not only find themselves wanted enemies of the Coalition States, but framed for crimes, raids and acts they never committed. Some are lies fabricated to hurt them and/or their reputations, others to cover his own indiscretions or reputation, and still others to lure them out of hiding and into his hands.

If the player characters should kill this bigoted monster, they will be permanently branded as murderers (even if in self-defense) and dangerous enemies of the CS to be shot on sight! They can also expect an ongoing manhunt whenever their presence is reported to Coalition authorities. Colonel Collins may be a blackhearted pig, but he is highly regarded in the CS military and particularly by Brig. Gen. Kalpov who will *demand* that those responsible for the Colonel's death (crippling, etc.) be brought to justice. Kalpov's anger over the loss of this trusted comrade and friend may result in a campaign of retribution that could see the slaughter of hundreds of innocent people. Whether this turns the D-bees, bandits and other peoples living in the freelands or Pecos Empire against them will depend on the circumstances and how the player characters react to this. They may become so "hot" that nobody is willing to help them and they might be chased out of the territory, or captured and turned over to the CS! On the other hand, they may be regarded as heroes or bold gangsters embraced by bandits, mercenaries and freedom fighters, whether or not they want this kind of celebrity and ever increasing associations with criminals and forces who may be as evil and contemptible as Colonel Collins. Game Masters, explore these entanglements and other consequences that may result from this and other actions taken by the characters.

Colonel Buck Murphy

Commander of the 93rd RPA Airborne Armored Cavalry

Colonel Buck "Ironsides" Murphy is the commander of the 93rd RPA Air Cavalry — SAMAS and Death Wings. Buck is a decorated Ace and oversees operations of the only active field unit at Lone Star. The 93rd Battalion conducts air reconnaissance, pacification of hostiles (raids into the Freelands and Pecos Empire), rescue, seek and destroy, and general support of all military forces operating in the State of Lone Star. This means he works with both General Kashbrook and Brigadier General Kalpov. This sometimes puts him in the middle of these two strong leaders and their very different views, agendas and approaches to the military presence in the State.

The Colonel is renowned as the classic, swashbuckling hero —charismatic, charming, sophisticated and flamboyant. Talk among those in the know at Chi-Town sing his praises and it's commonly accepted that there hasn't been such a charismatic and beloved military hero like Buck "Ironsides" Murphy since Karl Prosek first made his appearance some 40 years ago. The Emperor and Coalition High Command have great aspirations for this young commander.

Unfortunately, the great "Ironsides" Murphy is not the man of iron most believe him to be. Despite his reputation and young age, Colonel Murphy is suffering from burn-out. He has lost his enthusiasm, zest for life, and is just plain tired. Whether a leave of absence or a change of venue would make a difference is hard to say. A loyal officer in the elite



Name: Buck "Ironsides" Murphy

Species: Human

Alignment: Unprincipled; loyal to the CS.

Hit Points: 62; **S.D.C.:** 42

Height: 6 feet (1.8 m)

Weight: 160 lbs. (72 kg)

Age: 27

P.P.E.: 8

Horror/Awe Factor: 10

Attributes: I.Q. 14, M.E. 10, M.A. 24, P.S. 19, P.P. 23, P.E. 17, P.B. 22, Spd. 16

Disposition: Colonel Murphy is an intelligent, deeply passionate man.

He is a courageous and daring warrior gifted in aerial acrobatics and combat. Nothing escapes his notice and he is quick to respond to it. Without question, he is the greatest ace the CS has ever seen. "Ironsides" Murphy is fearless (in the air) and seemingly invincible. The Ace never worries about his own life or safety and has won victories against overwhelming odds a dozen times. His swift actions and reactions have saved thousands (perhaps millions) of lives. His selflessness and charm has won him the trust and respect of his men and the adoration of the public. In addition, he has a good head for strategy and tactics, adapts quickly to change and the unexpected, and remains cool under fire. This would seem to make Colonel Murphy a natural leader and helped him rise in the chain of command to a position of leadership.

Colonel Murphy has been, and remains, committed to the defense and expansion of the Coalition States, but the constant stress, pressure, and physical and emotional exertion of battle has worn him out. The intensity of emotion, the excitement of new challenges and the thrill of winning have all become dulled. Since becoming a commanding officer, the constant fighting, life and death struggles, the loss of good men and the savagery of combat weighs on his mind and soul. There was a time where he felt invincible and charged into combat unafraid for his life or the welfare of his men — he loved to soar through the heavens in power armor or aircraft, face death with smile, and come out alive and a winner. He still loves to fly and he still feels like a winner. In fact, in some ways Colonel Murphy is more sure of himself and his abilities than in the past. It is the welfare of his men and their deaths that haunts him. He finds it astonishing that they trust him implicitly and cheerfully put their lives in his hands. It eats away at him that it is "his" decisions, commands and mistakes that send these fine, exuberant lads to their deaths.

Death. He has come to hate it, yet that all that is his life is about. That's all he delivers. Somehow it's different for him when he faces a genuine monster (demon, dragon, etc.; even the Xiticix) or an opponent who is equally matched. These face-offs seem fair and good — two warriors pitting themselves against each other, or a pitched battle against a foe(s) who is undeniably a monster and who has no place in this world. It's the battles and subsequent slaughter of D-bees, men, women and children, outmatched and helpless before the might of the Coalition, that gnaws at him. He knows they are invaders from another world. He knows they represent a threat to humankind and the Coalition States. He knows that most of the enemies he and his men battle would like nothing more than to tear out their hearts. He knows what he does is right. So why, he wonders, does he feel like a murderer? Must they *all* be killed? Can't they be chased back through a Rift? Back to their homeland or some other place to infest? Is it any wonder these aliens hate the Coalition and fight them? If he was one of them, he would hate the enemy who sought their extermination, and he would fight them like a demon.

It is these doubts, self-recriminations, and the shame they bring, that gnaw at him the worst. He worries that these thoughts alone enough to make him a traitor. He questions his own patriotism and wonders if he is deserving of the trust placed in him. He worries that so many people count on him and that he may, one day, fail (or betray) them. Concerns that he dare not express to anyone. Nobody else seems to worry about

Coalition Airborne, Colonel Murphy continues to perform his duty to the best of his ability. Only his closest aides and fellow officers recognize their friend's sorry state. They try to do what they can to help, but unfortunately there's not much they can do. "Colonel Buck," as he's often called by his men ("Ironsides" is too informal), puts on a brave and bold face for his men, who absolutely adore him and would follow him into the gates of hell. In fact, they effectively have. One of the stories about "Ironsides" is how he led his company of (160) SAMAS to repel a Xiticix swarm by flying headlong into them and pushing them back through the Rift from which they had emerged. The battle began over the ruins of old Chicago, but soon took the champions into the Rift and to the Xiticix's homeland. Startled and confused by the fearless aggression of the SAMAS, the swarm (estimated to have outnumbered Buck and his men 50 to one) retreated. It's believed that his quick actions and heroism saved Chi-Town from what could have been a devastating battle. As it was, only half his men perished (the casualties would have been infinitely worse if the bugs hadn't been pushed back) and Murphy came out with only a few scratches in the paint — which is how he got the nickname "Ironsides." This is just one of his daring acts of heroism.

The young Ace has risen quickly through the ranks and the tales of his exploits in the air, on the ground and with the ladies, are legendary. However, this rising star *may* have hit its zenith too soon. Yet, even burned-out and uninspired, the Colonel runs his command efficiently. His officers are loyal and keep an eye open for any signs of trouble with Buck or the men. They are encouraged by flickering glimpses of the swashbuckler they once knew when Colonel Murphy meets an attractive lady or when he jokes around and gets a little silly while relaxing with them after a day's work. Best of all, in the air he seems to come alive. The sparkle in his eyes returns as he suits up for flying. If his reflexes are slowed and his concentration broken, it is not evident from the ground or the air — however, Murphy knows (or at least feels) otherwise.

these things, so why should he? He fears that something is wrong with him. Perhaps he is weak. Perhaps his mind has been influenced by one of those damn D-bees. For a brief while, Colonel Murphy even wondered if he was possessed. He realizes now such notions were stupid. Instead, he wonders if he is going mad. Such is the plight of a Coalition Officer with a conscience.

Experience Level: 8th level RPA “Fly Boy” Ace; Colonel (and under consideration for promotion to Brigadier General).

Skills of Note: Speaks American at 98%, literate in American at 98%, knows all espionage skills at the base skill +45% (averaging at 65-85%), plus interrogation techniques 65%, find contraband 72%, radio: basic 98%, radio: scramblers 80%, electronic countermeasures 85%, surveillance systems 75%, optic systems 75%, TV/video 61%, cryptography 60%, imitate voices/impersonation 74%/54%, military etiquette 95%, pilot: robots combat elite, pilot: hovercraft, computer operation 98%, and streetwise at 48%. W.P. energy pistol, W.P. energy rifle, W.P. blunt and W.P. knife, all at 10th level.

Special Abilities: Ambidextrous and exceptionally alert and quick to respond (see initiative bonus)

Combat Skills: Hand to Hand: Basic and boxing all at 8th level.

Number of Attacks: Five

Bonuses: +5 on initiative, +5 to strike, +8 to parry and dodge, +2 to S.D.C. damage, +2 to pull punch, +3 to roll with punch, fall or impact, kick attack (1D6 damage), Judo-style throw (1D6), +3 to save vs psionic attack, +1 to save vs magic and poison/drugs, and +5 to save vs horror factor.

Magic Knowledge: None

Psionic Knowledge: Minor psionic with 44 I.S.P. and the powers of sixth sense and presence sense. Colonel Murphy isn’t aware that he has these abilities; they manifest themselves as hunches and feelings, especially in combat situations.

Weapons and Equipment: Has access to virtually all military weapons, equipment, and all types of SAMAS, Skycycles, Death Wings and hovercycles, and select combat aircraft (jets and Death’s Head transports). He also has access to select special equipment, men and resources; 320 Intelligence RPA Fly Boys are under his command at the Lone Star Complex.

High security clearance and has access to all military levels and facilities at the Lone Star Complex, but only has low level clearance at GED and other science/research areas.

Favorite weapons include the Special Forces “Striker” SAMAS, the Super SAMAS, both Skycycles and the various weapon systems that come with them. When not flying, he prefers the light, old-style Dead Boy armor and likes rapid-fire, high payload laser weapons.

Other equipment includes standard military gear, a hand-held computer, portable language translator, and pocket laser distancer.

Cybernetics: Clock calendar, gyro-compass and universal headjack and ear implant.

Money: Colonel Murphy has access to billions of credits worth of military equipment, SAMAS, aircraft and troops.

Personal Resources: 75,000 credits in savings and a military pension.

Colonel Murphy Adventure Notes

Everybody has heard of the famous Colonel Murphy, and even characters on the opposite side of the law may be in awe of him. In any campaign that lasts a while in the Lone Star State, it is inevitable that the player characters will encounter Colonel Murphy (and have numerous encounters with troops under his command). They are most likely to meet the man himself if the group is involved in aerial combat or trying to cause trouble in or around the Lone Star Complex — the most dangerous looking character (ideally a flyer) will be targeted by the Colonel, first.

Colonel Murphy has great respect for noble opponents and men of honor and will show them the greatest mercy; typically with a quick, relatively painless, death. If his power armor or aircraft is disabled and

such a noble opponent makes good his escape, the Colonel may smile, nod or even salute him for besting him this day. He will likewise acknowledge courage, valor and personal sacrifice to save others, even nonhumans. These traits may also entice Colonel Murphy to let good and noble adventurers to escape —nobody will question him if he claims his guns jammed, they were out of range, used magic to conceal themselves, or any other story he might fabricate. On the other hand, those who he finds to be contemptuous and/or wicked will be pursued and destroyed without hesitation or regret.

Some adventure possibilities, beside the obvious combat encounters, might include the following:

The Colonel takes a day or two leave of absence to be by himself and think. He goes into the safe wilderness of the Northern Quadrant; probably incognito in non-CS power armor or body armor and a hovercycle, and equipped with Triax or Northern Gun weapons and equipment. There he is captured or (more dramatically) is drawn into events that involve D-bees and our heroes. He might temporarily join up with the player characters to see how they look at things and to talk about the CS, life, duty, honor, loyalty, D-bees (and their rights, if any), and other things of a introspective and/or philosophical nature. He will take a back seat to the player characters unless (or until) they are drawn into a serious life and death struggle. This could lead to him helping D-bees survive a natural disaster, disease, fight Splugorath Slavers from the coast, fight bandits who rape and pillage these innocent people, an evil sorcerer or demon, etc.

Similarly, Colonel Murphy might learn the group is planning to raid, sabotage or attack the CS for some reason, or are out to get or do something that will help the CS’s enemies (mutant runaways, D-bees, Tolkeen, etc.). His initial plan is to go along and sabotage them!

Or perhaps he is attacked, hurt or psionically affected, so that he suffers from temporary (as long as the G.M. wants) amnesia; loses his identity and joins the group (who presumably tries to help him or who have need of his weapons and skills, or who get tossed together by events beyond their control. Note that although his past and identity are lost to him, he retains his skills, combat abilities and expertise).

In any case, through the course of the adventure, Colonel Murphy (ideally) learns to respect and like the player group and gets to think more about and questions his life in the CS, the rights of nonhuman (they’re people too), and the entire human supremacy movement. Ultimately, he will walk away (perhaps without our heroes ever learning his true identity, which could make for a surprise in the future) with greater insight and probably more conflicted than ever.

Of course, another possible outcome (not so ideal, but equally amusing and poignant) is that he learns to hate the player group (or most of them), and sees D-bees (mutants, mages, and/or whoever) as vile monsters. He sabotages the characters and/or calls for reinforcements, and thanks to our heroes(?) finds renewed conviction that all nonhumans are terrible creatures who must be eradicated from the face of the planet for the sake of humanity! He is reborn into a human supremacist without a conscience and with a renewed certainty that Emperor Prosek and the Coalition Military are right, just, and humankind’s only chance for survival. Ultimately, the player characters will have created their own monster.

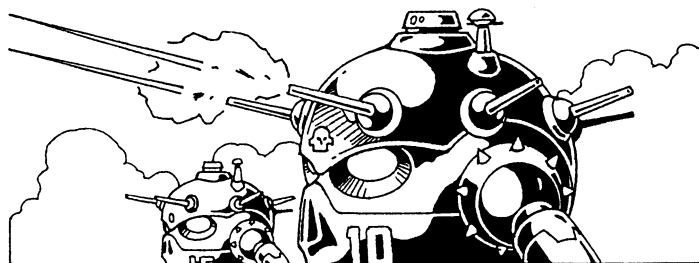

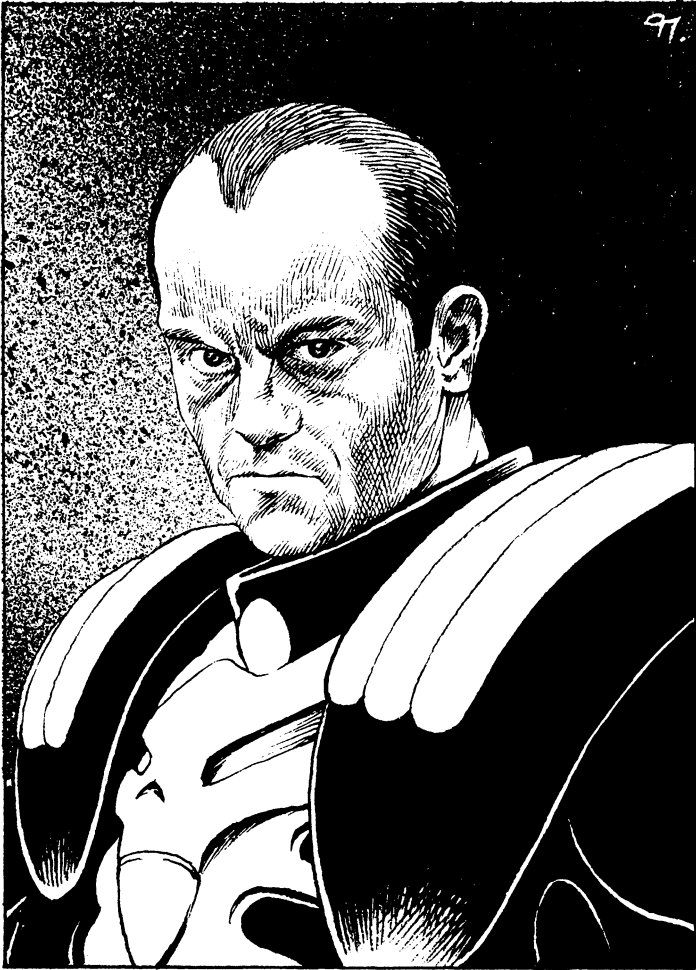

Major Winston Claval

Head of Mutant Containment and Retrieval

Claval is an interesting character: aggressive, tough, hard as nails, mean and consumed with a frightening single-mindedness to duty. He is a boxer, brawler, and heavy drinker with a mean streak that entices him to be petty and vindictive. He'll cheat at cards, roll drunks, beat up helpless victims (including fellow officers), make life hell for those he doesn't like and blackmail officers he does not respect or fear. Yet despite these character flaws, or perhaps because of them, he fulfills his duty as *Head of Mutant Containment and Retrieval* with relentless determination and success.

It is his responsibility to corral, control and contain the mutant and animal test subjects used and created by the GED. This includes safe transportation of test subjects/prisoners, "putting down" (termination) old, diseased or uncontrollable subjects, and the capture and return or destruction of escaped test subjects. He and his MCR troops are also responsible for hunting down and capturing or destroying recent run-aways, AWOL Dog Boys and mutants "gone feral."

Many consider him a neanderthal who is as brutal and predatory as the animals who serve him. This also leads many to marvel that he and Administrator Bradford seem to get along so well. The truth is, Bradford sees an inferior version of himself in Major Claval. Because of the Major's stern (even frightening) antisocial behavior and hard looks, people regard him with fear and revulsion — they underestimate and disregard him. However, Doctor Bradford recognizes and nurtures Major Claval's strength of character, quiet passion for his job, and intelligence, cunning and resourcefulness that is hidden to most under his dark, brooding facade. In fact, Major Claval is one of the few people Bradford trusts and respects (on a sort of mortal level), and the feelings

are mutual. Consequently, Claval is one of a tiny handful of people not under Doctor Bradford's control via implants or blackmail. He knows that the Doctor is engaged in some serious, dangerous and illegal genetics experiments, because he and his most trusted MCR agents (mostly mutant animals) are the ones who help contain and dispose of them when they have outlasted their usefulness or escape.

Major Claval is "officially" ex-Special Forces (still Special Forces O.C.C. and continues to develop those skills and experience). He requested a transfer because he didn't like most of his teammates and, more so, because he felt like a pawn used by the politicians. In Special Forces, he was never sure what was up or down, black or white, and hates playing undercover games and dirtying himself with inhuman scum and traitors. Despite his personal feelings, he performed admirably among Special Forces for 11 years, before finally being transferred. It was his antisocial behavior that helped him get his transfer, because Claval was "scary" even to other members of Special Forces. He floated around from one position to another before finally getting assigned at Lone Star. He quickly proved exceptional in this job (using many of his Special Training skills and abilities to great advantage) and was elevated to his current position six years ago; he's been at Lone Star for nine years.

Name: Winston Jason Claval

Species: Human

Alignment: Aberrant; loyal to the CS and Doctor Bradford. He dislikes Brigadier General Kalpov, and regards Colonel Collins (who he has to cooperate with from time to time) as the human embodiment of a mutant rat (the only good one is a dead one; he hates mutant rats, including Mitch and Glitch — they were assigned to him for observation in the field). He likes General Kashbrook and considers Colonel Murphy to be a living saint.

Hit Points: 62; **S.D.C.:** 42

Height: 6 feet (1.8 m)

Weight: 160 lbs. (72 kg)

Age: 38

P.P.E.: 8

Horror/Awe Factor: 10

Attributes: I.Q. 14, M.E. 15, M.A. 8, P.S. 21, P.P. 14, P.E. 17, P.B. 8, Spd. 18

Disposition: In his own words, he: "don't take shit from nobody." There are scores of soldiers and officers alike who will confirm this and add that the Major *never* smiles and hates the world. Indeed, Claval's stern, dispassionate, street-tough demeanor seems to be more than just a professional persona for show. He genuinely seems to have icy water in his veins and is positively fearless.

When it comes to the fulfillment of his duty, Major Claval is a no nonsense, hard-boiled workhorse. He is efficient, methodical, meticulous and relentless. Whether it's because he honestly hates the world or it's just part of his job, he kills rogue mutants, D-bees, human spies and enemies of the CS without batting an eye. If they are marked for termination, he finds 'em and kills 'em. Nuff' said.

Despite rumors to the contrary, Major Claval enjoys his life and his work. He's always had a "knack" for hunting and killing, so his job is perfect as Head of Mutant Containment and Retrieval. He doesn't hate the world either, its just that he sees the world as a grim, dark place filled with beings (including humans) who will lie, cheat, steal, hurt and kill if it is to their advantage. Like Desmond Bradford, Claval regards humans as the ultimate and most treacherous predators in the Megaverse. He doesn't like people much and has little respect for them in general, including most officers and foot soldiers. He is especially intolerant of human arrogance, bragging, and political game playing. Claval likes to hear it straight, without sweet talk or bull, whether he likes what he hears or not. Consequently, he prefers the company of mutant animals, because they tend to be very up front, honest and genuinely loyal (and why he hates the conniving mutant rats).

Experience Level: 9th level CS Special Forces; current rank is Major; he's a 20 year veteran.

Skills of Note: Speaks American and Spanish at 98%, literate in American at 65% (taught by Doctor Bradford), radio: basic 98%, radio: scramblers 85%, prowl 80%, streetwise 68%, interrogation techniques 75%, find contraband 75%, intelligence 74%, escape artist 85%, land navigation 78%, wilderness survival 85%, lore: demons & monsters 75%, pilot hovercraft (loves hovercycles) 98%, pilot jet pack (another favorite) 84%, pilot robots and power armor 90%, robot combat elite: SAMAS. Plus, W.P. energy pistol, W.P. energy rifle, W.P. energy heavy (loves P-beams, plasma and rail guns), W.P. blunt, and hand to hand: commando, all at 9th level.

Special Abilities: Resistant to horror factor and indomitable will.

Combat Skills: Hand to Hand: Commando and boxing, all at 9th level.

Number of Attacks: Seven

Bonuses: +3 on initiative, +2 to strike, +2 to parry and dodge, +1 on automatic dodge, +8 to S.D.C. damage, +6 to pull punch, +3 to roll with punch, fall or impact, +2 to disarm, karate kick attack (2D6 damage), jump kick, Judo-style throw (1D6), Death Blow on 18-20, can go 48 hours without sleep, +6 to save vs possession, +2 to save vs mind control and illusions, +3 to save vs psionic attack, +1 to save vs poison and magic, and +8 to save vs horror factor.

Magic Knowledge: None

Psionic Knowledge: None

Weapons and Equipment: Has access to virtually all military weapons, equipment, and all types of SAMAS, hovercycles, and hover vehicles (ground). He also has access to select special communications and surveillance equipment, men and resources; one full company (160 troops; 100 Dog Boys, 40 humans and 20 other mutants). In a crisis situation, Claval could be given command of a full battalion (640 troops).

Medium-High security clearance giving him access to all but the highest military levels and facilities at the Lone Star Complex. In these areas, Major Claval must answer to the military chain of command under Brig. Gen. Kalpov.

Maximum security clearance to all GED and other science/research areas. In this area of jurisdiction, Major Claval answers directly to Administrator Bradford.

Favorite weapons and equipment include the Special Forces "Striker" SAMAS, the Super SAMAS; Prowler, Rocket and Turbo hovercycles; rail guns and heavy energy weapons, especially particle beam and plasma rifles, and the dual system C-14 and CP-50 laser and grenade launcher rifles.

Other equipment includes standard military gear, a hand-held computer, portable language translator, and pocket laser distancer.

Cybernetics: Clock calendar and gyro-compass.

Money: Major Claval has access to millions of credits worth of military equipment, SAMAS, and troops.

Personal Resources: 56,000 credits in savings and a military pension.

The Quiet Hunters

Major Claval's *elite MCR Retrieval Team* is known as the Quiet Hunters because they rarely make their presence known until they are ready to pounce (and because of their cool, calm demeanor). They include the following (the 1st five are depicted in the accompanying illustration):

Thomas "Bat" Masterson, the only human on the team, other than Claval. Attributes of note: I.Q. 14, M.E. 17, P.S. 20, P.P. 18, P.E. 13, and speed 18. Hit points 43, S.D.C. 39; 8th level Commando. Alignment: Aberrant.

Lt. Rex "Crackshot," a male German Shepherd Dog Boy with lightning reflexes (P.P. 24) and a crack shot with any laser rifle. Attributes of note: I.Q. 19, P.S. 21, P.P. 24, speed 28. Hit points 41, S.D.C. 33; 7th level Dog Boy. Alignment: Aberrant.

Sgt. Robert "Claw," a male Bloodhound "Sniffer" whose favorite weapons are vibro-blade claws. Skills of note: Track by scent, track by sight (humanoids and animals), hunt, fish, land navigation, wilderness survival, climbing and wrestling. Attributes of note: I.Q. 9, P.S. 20, P.E. 24, speed 28. Hit points 48, S.D.C. 30; 6th level K-9 Sniffer Dog Boy. Alignment: Miscreant.

Corp. "Lady" Ann, an experimental feline mutant who loves the thrill of the hunt and who is as fond of and loyal to Major Claval as any Dog Boy. Alignment: Anarchist. Attributes of note: I.Q. 13, P.S. 24, P.P. 20, speed 22. Hit points 56, S.D.C. 48; 5th level CS scout/Ranger. Alignment: Anarchist.

Corp. Big Bear, not only a successful experiment in mutations of bears, but also an experiment in mutant bionics. Attributes of note: I.Q. 7, P.S. 34, P.P. 11, P.E. 30, speed 17; P.S. and P.E. are considered *supernatural* (4D6 M.D. from punch, 1D4x10 on power punch). Hit points 112, S.D.C. 93; stands 11 feet (3.3 m) fully erect (tends to hunch over and runs on all fours). Horror Factor: 12. Equal to a 3rd level CS Grunt (male). Alignment: Anarchist.

Bionic systems (some experimental) include: Bionic eye with thermo-optics and telescopic vision, bionic lungs with gas filter and oxygen storage cell, bionic jaw (2D6 M.D. from bites; experimental) with built-in loudspeaker (making his growls sound all the more terrifying), built-in radio receiver and transmitter, *modular weapon forearm* that includes claw blades (the most natural feeling for the bear, adds 3D6 M.D. to P.S. damage), cannon-like ion blasters (6D6 M.D., 1200 ft/366 m range, each has a 60 shot payload and recharges 1D6 blasts per hour), Electro-Stun baton paws (same jolt and damage as the ES *spear*; +2D4 M.D. to P.S. damage as huge, club-like appendages).

Note: Elite members not shown in the illustration:

Sgt. "Ears" Rippley, a female German Shepherd/Collie mix. Attributes of note: I.Q. 17, P.S. 18, P.P. 16, P.E. 12, speed 32. Hit points 36, S.D.C. 38. 5th level Dog Boy, loyal, obedient, and a mutant abnormality that makes her a Rat Catcher (+10% to tracking and prowling skills, +2 on initiative and +4 to damage when hunting rats and rodent-like creatures, including rodent-like D-bees). 5th level Dog Boy. Alignment: Unprincipled.

Corp. "Savage" Mike, Rottweiler. Attributes of note: I.Q. 10, P.S. 24, P.P. 22, speed 30. Hit points 47, S.D.C. 50; 4th level Kill Hound. Alignment: Miscreant.

Corp. Raphael (everybody calls him "Ralphy Boy"), a surprisingly even-tempered and laid-back mutant wolf in relaxed situations, but in combat, Ralphy Boy becomes a holy terror —aggressive and deadly. He loves nothing more than to hunt and kill, except intimidate and bully others with mean looks, toothy grins and evil threats (he's an excellent interrogator). Attributes of note: I.Q. 10, P.S. 24, P.P. 22, P.E. 25, speed 36. Hit points 44, S.D.C. 57; 4th level Kill Hound. Alignment: Aberrant. Boxing and hand to hand: assassin; five attacks per melee round, +2 on initiative; bite does 2D6 S.D.C. damage from a nip and 4D6 from a full strength bite.

Mitch and Glitch are two mutant rats placed with Major Claval for observation in the field as potential CS espionage agents (he doesn't trust or like either one). *Mitch* is the brains of these two brothers. Attributes of note: I.Q. 12, P.S. 14, P.P. 18, P.E. 19, speed 24. Hit points 24, S.D.C. 37; 2nd level thief with espionage training. Alignment: Miscreant; aggressive, cunning, clever, resourceful, a great plotter at weaving traps and ambushes. Skills of note: Detect ambush, camouflage, intelligence, palming, concealment, pick locks, pick pockets, prowl, climb, and streetwise, all at 2nd level and each with a +10% skill bonus. *Mitch* is secretly learning how to read and operate a computer. Currently both skills are at below base proficiency of about 30%. Hand to hand: assassin; four attacks per melee round, +1 on initiative; bite does 1D6 S.D.C. damage from a nip and 2D6 from a full strength bite.

Glitch is a moron with lightning reflexes and a fearlessness born from aggression and stupidity. He follows his brother without question and suffers from *bloodlust*. Attributes of note: I.Q. 5, P.S. 16, P.P. 22,

The Quiet Hunters

Appena



P.E. 15, speed 25. Hit points 23, S.D.C. 26; 2nd level thief with espionage training. Alignment: Miscreant; aggressive, cruel and mischievous.

Both are liars, thieves and misanthropes who have no loyalty to Claval or their teammates. For now, they behave (mostly) and bide their time for a chance to “go feral.” Their dream is to form their own gang of outlaws and get rich and famous.

Note: 1-4 additional Psi-Hounds (any R.C.C.) may be added to the group depending on the assignment; typically 3rd to 6th level.

Major Claval Adventure Notes

The adventure possibilities with Major Claval and his MCR team are many. All are incidents that might involve or attract the player characters.

- Undoubtedly, any player character or NPC with the player group is a mutant animal who ran away from Lone Star or Chi-Town, and he is known to Claval and the MCR Company as a dangerous rogue and a traitor. If the mutant ran away in the past few months, the character is still being actively hunted, and his very presence in the group is likely to lead more than one MCR Seek and Destroy Squad (and possibly bounty hunters and mercs) into bloody conflicts with the rest of the group. This can also lead to the mutant character getting captured, needing rescue, etc. If more than two MCR groups are defeated (or worse slaughtered) at the hands of the player characters, they will draw the personal attention of Major Claval and his elite team.
- If the group is predominantly composed of nonhumans (especially animal or monstrous looking), they are likely to draw the attention of the MCR and/or Claval’s team. This is particularly true if they are operating in or near the Northern Quadrant.
- Any raids against, or infiltration of, the GED will involve Major Claval and his elite team.
- Working with the mutant animal underground railroad, to help mutants escape into the world, may involve Claval and his team.
- The mutant rats, Mitch and Glitch, might draw the player characters into a deliberate trap, or use them as contacts or informers for their own illicit activities. If the rats get caught, they’ll try to frame the player group as the real culprits and pretend to have been undercover trying to ferret out these “brigands.”
- In fact, Mitch and Glitch are likely to instigate all kinds of trouble: egging on other members of the MCR (especially Kill Hounds to cheat, brawl, fight and kill), manipulating Big Bear, start arguments and brawls, plant false evidence, steal, etc. —and not just for personal gain, but to be mean or spiteful. These two ... rats(!) may also engage in extortion of other mutants (“we won’t reveal your hiding place,” or “we won’t sic our teammates on you, if you” ... pay or do whatever). Additionally, the rat brothers might sell valuable information about the MCR, GED, Bradford, Lone Star, etc., to the player characters (some true, some half true, some rumors, and some lies). Sooner or later, Claval will suspect something and go to investigate.
- Another scam involving Mitch and Glitch or some other unscrupulous MCR operatives, might be a con game in which they *pretend* to be corrupt CS soldiers (not much of a stretch for the rats) who help mutant animals and/or other prisoners or refugees escape the Lone Star Complex (or the State). In reality, these evil characters lead those who turn to them (and pay their price) into traps where they are ambushed, murdered, their bodies looted, and dumped in the wilderness or destroyed. First, the player group will hear rumors about this scam or find a survivor. Second, our heroes will discover or suspect who’s responsible and go to stop them. Perhaps time is of the essence because an NPC friend has gone to these cutthroats and will be killed unless the bad guys can be found before they kill again (good guys to the rescue). Third, Major Claval will also learn of this

reprehensible practice (it’s dishonorable and not straightforward) and start his own investigation. Forth, just as our heroes corner the culprits (before or after the villains do away with some or all of their latest victims), Major Claval or some of his men (elite or not) enter the scene. At this point, Claval and/or his honest troops may find themselves working with (or rescued by) the player characters, or the heroes may find themselves stuck between two deadly opponents (will the real villains try to frame the good guys?). Or, just after a battle with the bad guys and a successful rescue of their friend(s) or innocent people, Major Claval and his elite group (or other MCRs) arrive on the scene. Claval and other authorities may listen and believe the story about the MCR traitors (laying dead on the ground), but that doesn’t change the fact that the player character are either mutants and criminals themselves or outlaws and mutant sympathizers. In either case, his and any MCRs’ course of action is clear: contain and destroy the enemy!

- Claval will investigate any crimes at the Lone Star Complex and Lone Star City suspected of having been committed by feral or traitorous mutants, including D-bees, werebeasts, Wolfen, shape changers and others who may resemble mutant animals.
- Claval will do everything in his power to protect and defend the life and reputation of Doctor Desmond Bradford (including taking action against fellow CS officers and agents). If Bradford is slain or forced into hiding, Claval will use his resources to first, conceal his own involvement in any wrongdoing (Bradford will not deliberately betray his friend) and, second, find those responsible (both in and outside the CS) and quietly terminate them!
- In an all-out siege against Doctor Bradford or the GED, Major Claval will release many of the experimental mutants and send some, lead others, against the attackers.
- The murder of Major Claval, especially if while helping Bradford, will earn those responsible the mad doctor’s lifelong enmity; and he will see vengeance served.

Doctor Frederick Alexander

Doctor Alexander is a brilliant surgeon, cyber-doc and genetic engineer. He is also one of Doctor Bradford’s unwilling slaves, forced to create what he considers to be “horrible abominations.” Doctor Alexander “knows” what they are doing is morally reprehensible, against the laws of the CS, and immensely dangerous. He believes that Doctor Bradford and the others are playing with forces that they do not completely understand and may unleash terrible genetic mutations into the world. He is never allowed outside the top secret GED facilities (he hasn’t seen the sky in 13 years) and is believed to have died in a freak accident — Doctor Bradford personally handled the autopsy and informed the family of this great tragedy.

Doctor Alexander is controlled by threats and an explosive implant at the base of his skull. The good doctor has made it his mission to try to keep the Bradford’s mad men from straying into areas that he thinks are far too dangerous, and has secretly sabotaged a few completed experiments and creation experiments. So far, these acts of subtle sabotage have gone unnoticed. In the meanwhile, he maintains a level of work that seems reasonable and tries to work slowly on things he feels are dangerous or morally wrong. He knows that Bradford has never been satisfied with his performance and suspects that he may soon be a candidate for the experimental personality modifying implants.

If the player characters should ever penetrate this secret level, deep in the GED area of the Lone Star Complex, or be brought there for examination, experimentation or as slaves, Doctor Alexander could become a useful ally. He can tell them many of the place’s dark secrets,



warn them about monsters and minions, warn them about Bradford and others, direct them to creatures that need destroying, places to sabotage, and help them escape/point to exits. However, unless he is positive they can destroy Bradford and his key henchmen and mutant protectors, he'll be extremely cautious to avoid being implicated in any of the player characters activities for fear of being killed or worse. His greatest fear is being subjected to brain implants and losing his sense of identity and will power.

Name: Frederick Philip Alexander, Jr.

Species: Human

Alignment: Scrupulous, although a human supremacist and loyal servant of the CS Military.

Hit Points: 62; **S.D.C.:** 42

Height: 5 feet, 8 inches (1.65 m)

Weight: 160 lbs. (72 kg)

Age: 53

P.P.E.: 7

Horror/Awe Factor: Not applicable.

Attributes: I.Q. 22, M.E. 17, M.A. 12, P.S. 11, P.P. 20, P.E. 10, P.B. 9, Spd. 10

Disposition: A sanguine individual whose spirit is diminished but far from broken. He is an unhappy slave of a madman, with little hope for escape. He's been informed that his family thinks him dead these past 14 years, so he knows they have moved on with their lives without him. This combined with his slavery and loathing for what he is made to do ravages the Doctor's spirits. He has contemplated suicide several times, and suffers from bouts of depression frequently. He'd drink or take pills if his keepers would let him.

He hates Doctors Bradford, Cunningham and Santiago (he doesn't know about Major Claval) and longs for the day he can see their madness put to an end. He hates them so much that if he *knew* he could destroy them in some way, he'd sacrifice his life to do so. Bradford and the ladies suspect as much and keep him on a short leash. Cunningham in particular, keeps a close eye on him, and there are numerous "special projects" that Doctor Alexander knows nothing about.

Experience Level: 12th level Cyber-Doc and Genetic Engineer.

Skills of Note: Speaks and is literate in American at 98%, knows criminal science & forensics, medical doctor, M.D. in cybernetics, pathology, genetics (special), chemistry, chemistry: analytical, biology, botany, anthropology, basic and advanced math, computer operation, computer programming, pilot hovercraft (ground), and radio: basic, all at 98%. He also knows W.P. knife/surgeon skill at 12th level, and W.P. energy pistol 9th level.

Combat Skills: Hand to Hand: Basic, 6th level

Number of Attacks: Five

Bonuses: +4 to strike, +6 to parry and dodge, +2 to S.D.C. damage, +2 to pull/roll with punch, fall or impact, kick attack (1D6 damage), critical strike on 19-20, judo-style body throw/flip, and +1 to save vs psionic attack.

Magic Knowledge: None

Psionic Knowledge: None

Weapons and Equipment: Only has access to the genetic and lab facilities and basic medical equipment allowed by his keepers.

Cybernetics: Clock calendar, gyro-compass, and universal headjack and ear implant.

Money: None; a captive. All his basic needs are provided for by Bradford and the others.



Doctor Laura Cunningham

One of Bradford's elite and super-secret scientists

If one can imagine it, Doctor Cunningham is crazier than Doctor Bradford. She considers Bradford a visionary and a god who is light years ahead of anybody else in the field of Genetic Research and Manipulation. Doctor Cunningham's area of expertise is genetic reconstruction and the blending of molecular coding from several species into one creation. She was pivotal in the creation of the *Xiticix Killer* and works with fanatical devotion on several new monstrosities. She is also a fine surgeon and medical doctor.

Doctor Cunningham is one of Bradford's few associates whom he trusts, confides in, and is not controlled by implants or blackmail. She is so devoted to "their" work and to Doctor Bradford that she is willing to say and do anything (including murder) to protect them. She would even sacrifice her own life if it meant Bradford could continue their work.

Name: Laura Cunningham

Species: Human

Alignment: Diabolic and insane. She'll kill anybody she even suspects is a threat to Bradford or his secret experiments.

Hit Points: 69; **S.D.C.:** 20

Height: 5 feet, 7 inches (1.65 m)

Weight: 125 lbs. (56.2 kg)

Age: 45; looks 35.

P.P.E.: 11

Horror/Awe Factor: Not applicable.

Attributes: I.Q. 23, M.E. 7, M.A. 10, P.S. 14, P.P. 20, P.E. 15, P.B. 9, Spd. 21

Disposition: Doctor Cunningham is a wild-eyed individual with a strange and frightening intensity and immediacy about her. She obviously sizes up everybody she meets and leaves most people with the impression she's trying to figure out how to best use them as a pawn or in one of her experiments.

She is obsessed with her cutting edge work in genetic engineering, manipulation and cloning. She will fight to the death to protect this work and "god" Desmond Bradford, and has killed more than once to preserve their secrets.

She sees the Brigadier General as a hawkish neanderthal, Colonel Collins as a pig and most others as pawns, fodder, or enemies.

Experience Level: 12th level Cyber-Doc and Genetic Engineer.

Skills of Note: Speaks and is literate in American at 98%, knows criminal science & forensics, medical doctor, M.D. in cybernetics, pathology, genetics (special), chemistry, chemistry: analytical, biology, botany, anthropology, basic and advanced math, computer operation, computer programming, pilot hovercraft (ground), pilot hovercycle, and radio: basic, all at 98%. She also knows W.P. knife/surgeon skill at 12th level, and W.P. energy rifle, 9th level.

Combat Skills: Hand to Hand: Basic, 9th level

Number of Attacks: Five

Bonuses: +4 to strike, +6 to parry and dodge, +2 to S.D.C. damage, +2 to pull/roll with punch, fall or impact, kick attack (1D6 damage), critical strike on 19-20, judo-style body throw/flip, and +1 to save vs psionic attack.

Magic Knowledge: None

Psionic Knowledge: None

Weapons and Equipment: Has access to all of GED, including the secret area, and all the science, genetics, and medical equipment and assistants she needs. Cunningham has a variety of surgical implements (scalpels, laser scalpel, etc.), and frequently has a Vibro-knife and Electro-Stun Prod on her person. She almost never leaves the top secret level of GED.

Cybernetics: Clock calendar, gyro-compass, and universal headjack and ear implant.

Money: 4.3 million in universal credits.

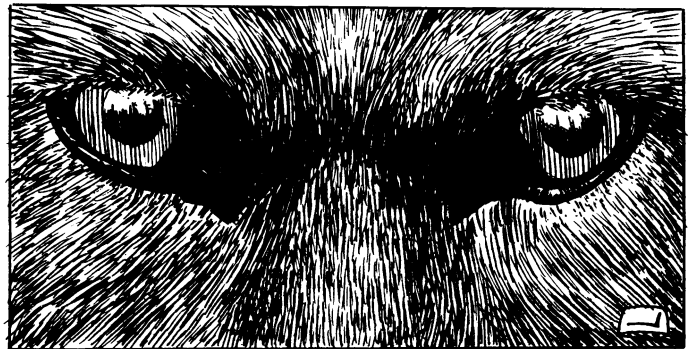

Cunningham Adventure Notes

The player characters are not likely to encounter this misanthrope unless they invade or come to work (or be enslaved) at GED. As stated previously, she is quite mad and will destroy anybody who threatens her, Doctor Bradford, or their secret research. Likewise, she will reap a terrible vengeance upon those who take Bradford and her precious research away from her. Such vengeance won't be anything as quick and attractive as death, she'll torture then experiment on her victims, using them in mutation and surgical experiments (i.e. a human brain in the body of a monstrous or crippled mutant, and experimental 'borg, a slave of personality modifiers, an altered state on a molecular level that changes the mind and emotions as well as deforms and/or hurts the physical body, etc.). She is not a nice lady.



Doctor Ammanda Santiago

One of Bradford's elite and super-secret scientists

This is a menacing woman with the soul of a demon, the mind of a cold, calculating machine, and the face and outward appearance of an angel. Her sweet, gentle disposition is so disarming that many an opponent has found a knife in their belly before realizing its handle rested in the hand of the smiling angel before them. Then as they lay bleeding, Santiago whispers vengeful words in their ears (sweet sounding yet filled with venom) while stroking her victim's brow with one hand and twisting the knife with the other.

This maleficent witch is another one of Bradford's trusted associates. She is a dedicated scientist and loves to push the genetics envelope. Her specialties are cloning, psychology and behavioral studies. Her current project has been the development and perfection of personality modifier implants with minimal side effects.

Doctor Santiago believes Bradford is a true genius and revolutionary thinker, but she also recognizes that he is insane: delusional, megalomaniacal, sociopathic, and homicidal, among other things. Still, like a moth drawn to flame, she is fascinated by him and can't bring herself to do anything to hurt or stop him. 15 years ago, she began to wonder what made him the person he is. Of course, the cross of being so brilliant, an only child, and being so obviously different had a lot to do with his emotional development and feelings of loneliness and loss (which in turn led to his becoming an antisocial loner). But there had to be more. What about his parents (Doctor Bradford never speaks about them or his childhood)? What if he had loving parents and/or a sibling? What if his interests were focused on athletic competition rather than science? How would any of these things have changed the man?

Although loyal to Bradford and hard working, she has developed her own twisted agenda (obsession?) which she secretly maintains. Brilliant in her own right, and an expert in human behavior and psychology, she masterfully wears many masks, showing people what they want to see and easily uses, manipulates, misdirects and fools everybody around her, including Doctor Bradford and Major Claval.

Name: Ammanda Maria Santiago

Species: Human

Alignment: Miscreant

Hit Points: 51; **S.D.C.:** 25

Height: 5 feet, 6 inches (1.6 m)

Weight: 130 lbs. (58.5 kg)

Age: 41; looks 30.

P.P.E.: 5

Horror/Awe Factor: Not applicable.

Attributes: I.Q. 21, M.E. 13, M.A. 23, P.S. 14, P.P. 19, P.E. 15, P.B. 15, Spd. 12

Disposition: Doctor Santiago is usually smiling, pleasant and motherly.

Her touch is gentle, her voice soft and comforting, her eyes bright and full of life. She has a wonderful (sometimes sadistic) sense of humor and finds people very interesting. She enjoys playing mind games and misleading and manipulating people. She has become a master at disguising her true feelings, so she may say one thing and seem genuinely sincere about it, but really be thinking something completely different. Thus, she is a consummate liar and a marvelous actor. Ultimately, she watches out for herself and her own agenda. Unlike Doctor Cunningham and other associates of Doctor Bradford, Santiago prefers to use cunning, trickery and deception to get what she wants, rather than brute force. She always has a plan or trick up her sleeve.

Although she loves her work at GED under Doctor Bradford, she will not risk her own life to save him or any of the others, or the research. Instead, she will try to grab what she can and make good her own escape. Doctor Santiago has made duplicate files of every project she has worked on, and has an extensive library full of cutting edge data on cloning, genetic manipulation, Dog Boys and a variety of other mutant experiments. She has also begun to build a modest laboratory facility in the basement of her home in Arkansas.

Experience Level: 10th level Medical Doctor/Psychologist and Genetic Engineer.

Skills of Note: Speaks and is literate in American and Spanish at 98%, knows criminal science & forensics, medical doctor, pathology, genetics (special), psychology (special), chemistry, chemistry: analytical, biology, botany, anthropology, basic and advanced math, computer operation, computer programming, pilot hovercraft (ground), pilot hovercycle, pilot boat, and radio: basic, all at around 92%, plus prowl 72% and streetwise 59%. She also knows W.P. knife (surgeon skill) and W.P. energy pistol, both at 9th level.

Combat Skills: Hand to Hand: Basic, 9th level

Number of Attacks: Four

Bonuses: +3 to initiative (bionic ear), +3 to strike, +5 to parry, +6 to dodge, +2 to S.D.C. damage, +2 to pull/roll with punch, fall or impact, kick attack (1D6 damage), critical strike on 19-20, and judo-style body throw/flip.

Magic Knowledge: None

Psionic Knowledge: None

Weapons and Equipment: Has access to all of GED, including the secret area, cloning facilities, her own private lab (with cloning facilities for eight individuals) and all the science, genetics, and medical equipment and assistants she needs. Santiago usually has a laser scalpel in her boot (uses it as a weapon), and a Vibro-knife, Neuro-Mace and CP-30 laser pulse pistol on her belt. She has a life above and below ground

Cybernetics: Clock calendar, gyro-compass, universal headjack and ear implant with amplified hearing.

Money: Doctor Santiago has one million in universal credits available to her at Lone Star, plus another 1.8 million credits, one million credits worth of pre-Rifts artifacts and tens of millions of credits worth of genetic research information in a secret hiding place (not her home). However, she's not likely to sell her precious data directly, because she couldn't control its use or make as much money.

Santiago Adventure Notes

Once or twice a month, Doctor Santiago goes traveling. Just outside of the Lone Star Northern Quadrant, she rendezvous with six individuals who look like mercenaries or CS Special Forces undercover. One is a husky mutant chimpanzee, two are large, mutant felines and three are Dog Boys (all are her secret creations and unknown to the CS). All are armed to the teeth with Triax and CS weapons and Triax body armor. Two drive Turbo hovercycles, one an NG Stinger, while the Doctor and the others ride in a CS "Skull" Patrol Car painted in camouflage (200 M.D.C.; see Coalition War Campaign for stats).

Doctor Santiago's first stop is to a small farming village in southern Missouri. There she visits a loving, middle-aged black family on a small farm and examines a pair of happy, identical twin boys. They are cheerful, courteous and well educated (more educated than your average farmer).

A cursory and careful investigation of the place reveals a wealth of expensive equipment not common to a farmer. A close (secret) investigation of the farmhouse where the boys live will reveal a secret basement full of books on one inch computer disks. The subjects are primarily science, medical, genetics, and behavioral studies (human and animals, and history). The two boys are around 12 or 13 years old, but most of the texts are college level.

The boys, Karl and Desi (as in short for Desmond), of the Cormack family, are never left alone. Auntie Breann (who's really an extremely human looking, mutant Doberman Pincer) and a pair of ordinary (looking) collies (mutants with low human-like intelligence) are in the constant company of the youngsters. Auntie Breann is also their private tutor. **Note:** The parents and Auntie are suspicious of strangers and keep the boys away from them. The (adoptive) parents, farm hands, Aunt and dogs will all fight to the death to protect the children.

Other than these things, there is nothing particularly out of the ordinary about the family or the boys.

The Doctor's second stop is to a semi-permanent outpost near the Arkansas-Missouri border. Here she makes another visit to a young lad who looks to be about 14 or 15. He looks remarkably like the twins, only a bit older and with a more physically developed body. It is clear from the lad's physique, clothing, weapons and bold, haughty attitude that he is being trained as a mercenary fighter. A subtle investigation will reveal that the young lad is (allegedly) the orphaned son of some distinguished scientist who died in the east. The rumors suggest the father was some sort of an outcast so the boy had to be taken outside the CS for his own safety. Nobody knows anything about the mother.

Unlike the earlier setting, the boy is unguarded and player characters may get the chance to talk directly to him. He is cocky, confident, observant and extremely smart. His name is Brad Spartan. The right questions will reveal that he already has a good grasp of strategy and tactics, military organization, and a keen eye for identifying weapons, their manufacturer, and overall quality. He loves to hunt, wrestle, box and brawl. He's not sure how he feels about the Coalition States. He probably should hate them for the persecution of his father, which led to his death, but he finds many things to admire about them and Emperor Prosek. He finds people interesting, but at the same time he finds many to be "stupid, lazy, deceitful and treacherous, so he tends to be a bit of a lone wolf." "You gotta stay three steps ahead of everybody else," he says, "People will find some reason to hate you — the color of your skin, your brains, your father being a CS official, ... just about anything. The only person you can ever really count on is yourself."

Characters who nose around too much will attract the attention of some tough mercs, thugs, Juicers and crazies who don't like strangers looking into any of their business. They aren't particularly protective of the boy, they just don't appreciate nosy strangers, especially if they start asking questions about the CS, the infamous Doctor Bradford or anybody from the CS military or scientific community. In fact, they are likely to begin to suspect that the player characters are Coalition spies. It's interesting to note that they know Doctor Santiago as Patricia Lamanta, who they believe is some old family friend or relative of Brad Spartan who checks on him once every few months.

Santiago's third stop is to a squalid, D-bee infested town in southern Arkansas. Here she watches a gang of street toughs running through the streets. One of the boys is a 12 or 13 year old who resembles the first two children, although it's hard to tell for certain through the dirt covering his face and his long dreadlocks. The gang of eight kids, mixed races, knock over an elderly D-bee, steal his groceries and wrist-watch and jump into a stolen car, driving away in a thunder of laughter and thrumming engine. Casual inquiries reveal that most of those "kids" are orphans and street punks who run wild in the streets. The human with the dreadlocks is a known pick pocket and computer hacker, a City Rat with potential for real trouble. **Note:** If the player characters manage to track the boy down (this can be an adventure in itself), he has nothing to say (at least not for free, and he may assume the player characters are the law, members of a rival gang, or outsiders looking for trouble). His name is "Fast Ford." He never knew his parents, has never heard of Doctor Santiago, Bradford, or even the Lone Star Complex. He doesn't know anything about science, medicine, mutants or combat. However, he's taught himself how to read American, loves electronics, fast vehicles, computers and hacking almost as much as stealing and conning people, and the group can rest assured the punk will steal several items from them (E-clip, vibro-blade, credit card, etc.) before he takes his leave (already a 3rd level, thieving City Rat). If hassled too much, his fellow gang-bangers will come to his aid.

After the thugs disappear, Doctor Santiago travels to the better side of town, stopping at a small, but well kept house. As she steps through the barbed wire gate of the front yard, a handsome, well groomed 12 year old boy bolts through the front door, arms waving (behind him in the shadows of the doorway is a servant). "Mom! Mom you're home! Can you stay for more than a day this time? I hate it when you have to leave so soon. I feel so alone." The lad is the spitting image of the twins and could be the brother (if not identical twin) of the other boys as well. He is not accessible to the outside world.

What's going on? As players may suspect, these young boys are clones of Doctor Desmond Bradford. However, this is not his handiwork. Oddly enough, he's never considered cloning himself (as a loner and a self-perceived god, why would he?). This is Doctor Santiago's own, twisted little experiment in genetic engineering, cloning and behavioral study. Each child is exact, only Brad Spartan is a year or two older than the rest (one of her earliest recreations of Bradford). Her plan is to make several clones, each with identical DNA, and place them in different environments and see how they come out. Will they gravitate toward the sciences? Will they all be loners? Will they see themselves as superior to their peers? If so, will they develop delusions of grandeur and godhood like Bradford? Will those taught science and medicine become great genetic engineers? And many other questions.

Already she can see some similarities and differences. Except for Fast Ford, all of the clones tend to be loners or feel isolated, different from those around them; and even Fast Ford tends to be less a part of the group than other gang members, although he usually initiates their antics and most follow his lead. All are brilliant, clever, curious and resourceful. All have found something they are good at and focus on it. However, one third are truly antisocial and Brad has no (present) interest in academia. Of course they are young and will change immensely over the next decade.

The other thing Santiago is interested in seeing is how several different Desmond Bradford's might change the world.

G.M. information: Desmond Bradford knows nothing about Doctor Santiago's little experiment with clones based on his genetic structure. Should Bradford ever find out, he'll be furious and may kill her and his ill conceived progeny. Her attempts to save one or more of the clones (particularly the one she's raised as her son) could be another series of adventures. If one or more should live to adulthood, it is possible that one or more could become a great leader or madman and oppose the Coalition States, direct a siege against Lone Star and eventually fight and kill Desmond Bradford — ultimately (and perhaps unwittingly) fighting an aspect of himself! Likewise, one or more may join the Coalition States and may outshine the original Bradford, although both Karl and Joseph Prosek will recognize these younger, second comings of the great Desmond Bradford.

Other questions (perhaps better left unasked): What do the player characters do when they figure out what's going on? Do they leave the youngster alone to develop? Do they try to take one or more under their wing to guide the child-genius(s) to become better people than the original? What do they do with the others? Or do they decide it's better to destroy them all before they can reach their potential, whatever it may be; good or evil? **Note:** If Doctor Santiago learns her secret has been uncovered, she will take action to hide and protect at least half of her creations (notably including her adopted son and the twins), but

she is likely to never see them again and keep herself within the Lone Star Complex.

There is at least one more frightening question that begs to be answered, are these five all the clones of Bradford? Or could there be others? It's possible, but where could they be? One could be a student of sorcery in the Federation of Magic, another might be the son of a Coalition officer, another a slave or Tattooed Man of the Slugorth, and on and on. Thankfully, it's unlikely that Santiago could have created more than a dozen without risking discovery by Bradford or Claval.

Or, could there be any clones of Karl Prosek or Joseph Prosek?!

Other Adventure Possibilities: Of all of the geneticists in collusion with Doctor Bradford, Santiago is the most likely to be encountered away from the Lone Star Complex and even away from the Coalition States. Half the time she will be involved in some observational study for Bradford and the other half on her own experiments or research. She might manipulate and use a gullible player group for almost any purpose, from her own amusement to witting participants in her experiment, to tricking them into destroying an enemy or hiding evidence. She's so good at this that the player characters may never realize they have been duped. Furthermore, she is so outwardly kind, caring and pleasant that the characters may consider her a friend or ally for months or years before they see her true colors.

The Pecos Empire

By Kevin Siembieda & Julius Rosenstein

Pecos Empire Population Breakdown

Chi-Town Census Estimate, 104 P.A.

445,000+ Humans
195,000 Psi-Stalkers
170,000 Simvans
145,000 Quick-Flex Aliens
140,000 Vanguard Brawlers
71,000 Brodkil
60,000 Vampires*
55,000 Tokanii
31,000 Mutant Animals (CS rogues)*
335,000 Other nonhumans

Total Population: Approximately 1.64 million; roughly 550,000 are career bandits.

* The official estimate of the *vampire population* given above, is deliberately low. The Coalition State of Chi-Town has done so for two reasons: 1. To avoid causing concern among its people (especially troops assigned to the State). 2. To create a sense that the CS is in greater control of the State of Lone Star than it really is. In actuality, the State is a place of chaos and turmoil with the CS dominating approximately one-quarter of the entire territory. The number of vampires active in Texas, mostly in the southern half, is probably triple! Roughly 65% are wild vampires, 35% Secondary.

Likewise, the number of *rogue mutant animals* (50% Dog Boys) is easily triple (possibly five times greater than) those officially acknowledged by the Coalition States. In this case, it is Chi-Town who is being duped by Doctor Desmond Bradford, Director of the Lone Star Genetics Institute.

Population Notes

There is not a great deal of information about the Pecos Empire that is common knowledge to the outside world. What little is available can

only be found in the classified, CS files at *Chi-Town* and *Lone Star* itself, and in the excellent book, **Traversing Our Modern World**, by Erin Tarn.

Although normally very accurate in her observations, the estimable Erin Tarn was slightly off in her estimation of the size and power of the outlaw "barbarians" when she suggested they numbered only about 330,000. Erin visited the Pecos Empire during a comparatively quiet period and an area not overrun by the bandits. As a result, she could not accurately estimate their full strength. Likewise, until her excursion into the vampire infested land of Mexico, she had greatly underestimated the extent of the vampire problem, but even now agrees with the Coalition's 60,000 as a "reasonable guesstimate."

According to the CS, an estimated 60% of the overall population actively participates in banditry and crimes against the Coalition States and its people, particularly those located in Lone Star and at border towns and military operations around the State. They further estimate that 90% of the people support and harbor these criminals. Both estimates are exaggerations born from the CS's prejudice toward nonhumans and to paint a terrible picture of lawlessness and vice so nobody will question the military's extreme actions to "contain and eradicate" the *Pecos Barbarians* — the CS considers them all to be savage, chaotic barbarians incapable of civilized thought or action.

According to Erin Tarn, approximately 25% to 30% are professional bandits, thugs and mercenaries (approximately 550,000 people), while roughly another 30% are peace-loving people who occasionally engage in theft of supplies, vandalism, and comparatively petty crimes against the CS because they are regarded as hostile enemies and invaders. At least 60% of the inhabitants of the Pecos Bandit territory, and 80% of the communities, are *regularly* victimized by one to two dozen roving gangs, and do not support the bandits or the commission of crimes in or outside the territory. However, most are helpless to defend themselves and have come to accept living at the mercy of the gangs. Still, many of these good people prefer the abusive rule of the bandits than to face en-

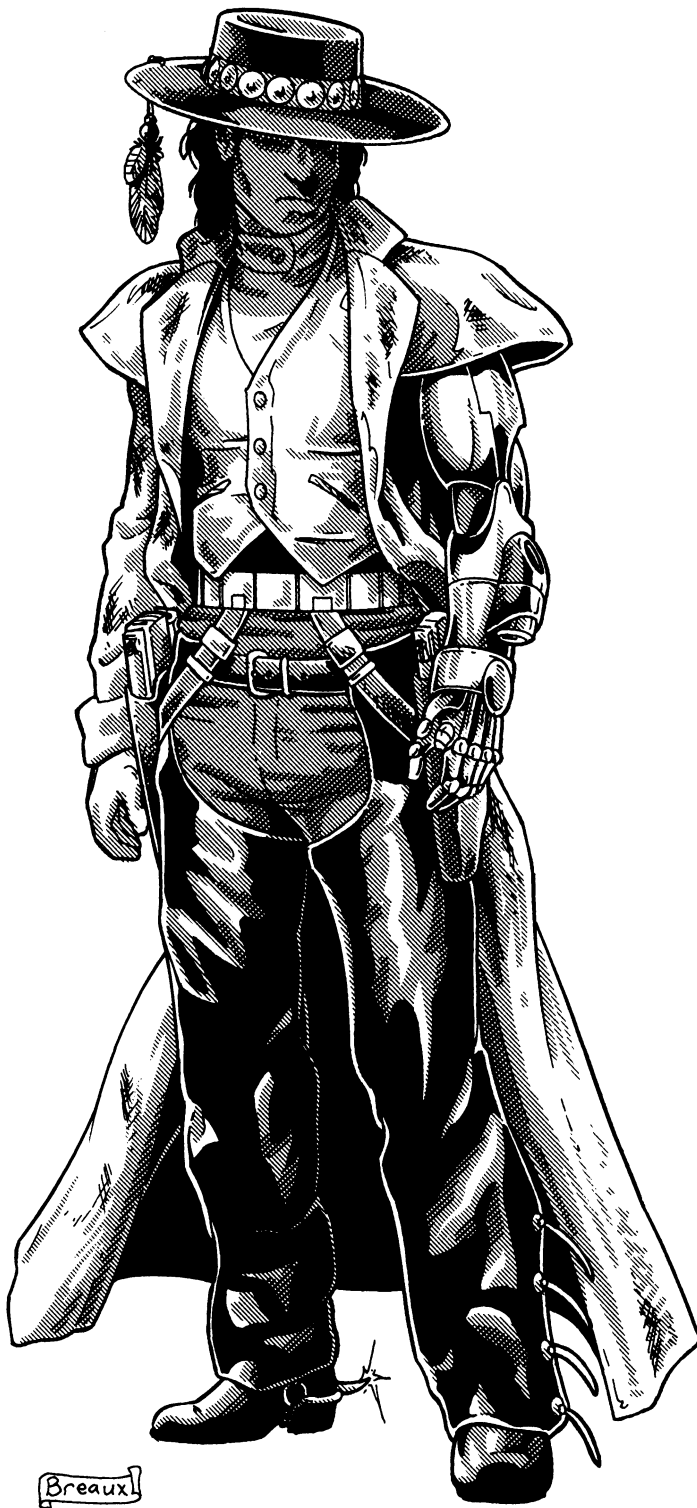

number of the outlaw groups engage in banditry or other exploits outside of the State of Lone Star (typically Mexico, New Mexico, Arizona, Utah, Colorado, Oklahoma, Kansas, Arkansas and Louisiana), their overall numbers in the State can *drop* by as much as 50%! Thus, their population waxes and wanes unpredictably.

Most leaders of the Pecos Empire prefer things this way because it confounds their enemies and helps to create an aura of mystery and fear around them. Consequently, some deliberately lie about their numbers and strengths, sometimes exaggerating high to impress or terrorize, and other times low, to mislead and entrap. This being the case, it is quite possible that Ms. Tarn was deliberately led astray by her guides.

Although the Pecos Empire is a melting pot society where customs may vary from one tribe, clan, gang and community to another, overall they are known for their wild ways, acts of villainy and tolerance toward D-Bees. Since 60% of the Empire's population are D-Bees, the latter is hardly surprising.

Who Rules the Pecos Empire

The Pecos Empire is an "empire" in name only. The Coalition States refuse to accept it as a political entity of any kind, let alone as a nation, and even most independent kingdoms fail to recognize it as a nation. This is fair, because the so-called Pecos Empire is actually a loose-knit conglomeration of a dozen independent kingdoms, scores of villages and towns, and over a hundred roving bands, clans, tribes and gangs of bandits, outlaws and nomadic scavengers. There is no one, central government, or even one leader, but hundreds! Generally, *most* bandit clans and organizations defer to the might of **Sabre Lasar**, Warlord of the largest, most powerful and aggressive gang. It is Warlord Lasar who has proclaimed himself "Emperor," coined the name, "Pecos Empire," and who has actively promoted the *notion* of one large, united force, but even he does not pretend to speak on behalf of all the Pecos Bandits.

In truth, the various gangs constantly bicker and clash. A few have ongoing feuds that have spanned generations. There is often dissension even within the same organization, with individuals vying for greater power or unwilling to cooperate fully with the current gang leaders.

The Pecos bandits are united only when a serious danger threatens their existence as a whole, such as a military campaign from the Coalition States or other kingdom. In the past when this occurred, one *Central War Chief* would be chosen from the warlords among them (most bandit gangs are led by a "warlord"). The War Chief serves as a General to command the united gangs as one army. Having one supreme leader/General to coordinate such campaigns allows the various other leaders to work together without losing face by having to obey one of their peers or rivals. The creation of a War Chief also creates one voice of the people to offer focus and direction in combat and to make quick decisions. The remaining warlords serve as the commanding officers of their respective gangs or clans.

As there is no set period of office, the authority of this General and the union of the gangs usually only lasts until the crisis is over. At that time, the bandit army splinters back into small, unallied groups and old rivalries are renewed. Of course, heroics and luck during the conflict may elevate one or more gangs or individual gang members in power or garner them greater respect; reputation often means everything to these warlike factions. Likewise, misfortune in war will inevitably devastate some gangs, opening opportunities for newcomers, or for old gangs to absorb leaderless survivors to increase their strength and standings in the community.

As for the General, he can either step down and retain his dignity, or attempt to assert himself as the master of all. The latter has never worked, and the fool who tries to do so becomes somewhat of a laughingstock as he sees his former "subjects" ignore his commands and go

slavement by human supremacists or genocide at the hands of the Coalition States. Thus, when push comes to shove, most of the inhabitants of the disputed Pecos Empire *will* grudgingly support the very brigands who rob and molest them.

Accurately estimating the true numbers of these outlaws is virtually impossible for Ms. Tarn, the Coalition States and most outsiders. The reasons are that 70% of the self-proclaimed Empire's population is nomadic, and the numerous gangs and clans are frequently joined by other outlaws, mercenaries and refugees for short periods of time. For example, after the *Juicer Uprising*, the number of "freelance" mercenaries, bandits and displaced people caused the Empire's numbers to swell by 50%, but eight months later, the numbers had dropped back down to only slightly higher than average (about 10% higher). Similarly, when a

back to their former lifestyles (often even his own men will only half-heartedly try to enforce his will over the other gangs). In the past, a different War Chief was selected for different conflicts, however **Warlord Sabre Lasar** has become the man of the hour during periods of crisis. He has been chosen War Chief six out of the last seven times. He is so charismatic, capable and respected that Lasar has successfully *earned* the “title of Emperor” (grudgingly from some rival gangs). “Emperor” Sabre Lasar keeps his title because of his phenomenal success as a Central War Chief (a superb military mind), his status as a war hero, the power of his gang, the Sabre Warriors (strong enough to rebuff incursions by the CS Military), the reputation of fear and power his exploits has garnered for all the Pecos Bandits, his self-appointment as unofficial spokesman for the Pecos Bandits, and the fact that while he calls himself Emperor, he has *never* tried to force any of the independent gangs (no matter how small) to officially join his gang — he could easily crush 90%. Consequently, Emperor Lasar’s magnanimous and heroic conduct has won him the respect and favor of most (80%) bandits who call the Empire their homeland. This means that few challenge his authority or title, usually back down to his “requests” and grant him “favors” when they are asked. Furthermore, if Emperor Lasar calls for the gangs to unite against a common threat, most will come running. Likewise, most (80%) will support, help, hide, etc., the famous Warlord and his bandit minions in any way they can, even when it is not a time of unity. He has become the bandits’ hero and most treat him with the respect deserving of an Emperor. Perhaps needless to say, this has earned the powerful bandit leader the hate and enmity of some other gang leaders who envy him or seek such power for themselves. See the section on *Emperor Sabre Lasar* and other characters of note, for more information.

Life as a Bandit

The life of a bandit is not the glamorous one so often depicted in comics, books and film. The typical bandit, whether he is a Pecos bandit or a western outlaw, part of a gang or a loner, is basically a drifter and a fighter. The terms “bandit” and “banditry” are reserved to describe a *group* of people engaged in criminal activity, typically armed attacks and raids against towns, villages, merchant caravans and travelers, as well as armed robbery of all kinds, cattle-rustling and so on. When not actively engaged in banditry, most *bandits*, and even gunslingers, will take whatever “work” seems challenging or fun, pays well, and utilizes their skills as fighters and thieves, or in some cases, a job that simply utilizes their daring and/or meanness. Thus, they often take work as mercenaries for hire, bodyguards, spies, smugglers, wilderness scouts, vampire hunters, and even as (corrupt or brutal) lawmen. Many also “take time off” or temporarily “retire” after a big score (make a lot of money), during which the outlaw may spend his time gambling, working at or investing in and running a casino, saloon, brothel, gunshop, ranch, farm, or take on other, even more respectable, work.

When times are lean, or when on the run, even famous and truly powerful desperadoes may find themselves forced to take shelter among a larger gang and follow orders like the rest of them, or conceal their true identity and work sweeping out stables, as a shop clerk, or common laborer. Of course, individual bandits may draw the line at some types of jobs.

Despite these layoff periods and temporary sidelines, a bandit is typically a member of a gang or clan of outlaws who regularly engages in criminal activity, fighting and killing. In fact, the bandit might be considered a *criminal mercenary* of a selfish or evil alignment. Whether the bandit fancies himself (and has training as) a thief, card shark/gambler, assassin, soldier, spy, scout, Juicer, or whatever, the character is ultimately a person (male or female, human or not) who supports himself by fighting and the commission of crimes. The degree of viciousness and the types of crimes committed will depend largely on the alignments and disposition of the gang members, as well as taking advantage of opportunities and chance when they come along. Some bandits

will specialize in only a couple types of crimes, usually because they’re easy for them or something they like to do, while others will say and do anything.

Although modern yarns paint *some* of these bandits as “Robin Hoods” who steal from the evil Coalition or inhuman monsters, or as bloodthirsty madmen so mean that they’ll shoot somebody for snoring, these extremes are a rarity, with the truth usually somewhere in between. Generally, most bandits are bullies who get what they want through force and by striking fear into their victims (robbery at gun point, beating up somebody and threatening to do worse to anybody who stands in their way, etc.). Many are antisocial and some are downright psychotic or schizophrenic. The most vile and despicable will bully and abuse others (verbally and physically) for fun and self-gratification, and engage in brawling, battery, robbery, smuggling, blackmail, arson, vandalism, rape, torture, murder and anything else that will earn a buck, get them revenge, or make them feel powerful. The vast majority (95%) are illiterate, uneducated and come from impoverished wilderness people or D-bees. Many see few options for themselves (a narrow view that is seldom the case), and have little value for life (especially their own), law, art and personal freedom. Thus, many live by the credo, “Ride hard, live fast and die a good looking corpse.” The average age of a Pecos Bandit is 16-35 years old. **Note:** See **Rifts® Mercenaries** for O.C.C.s like the Smuggler, Thief, Spy and others.

It is important to remember that the Pecos Empire is not a single entity and is divided by a hundred political, cultural, social and racial differences. Thus, there is almost always some degree of visible internal fighting going on. Most of this fighting is in the form of blood feuds, vendettas, or small wars between the scores of different gangs, clans and factions. Although the terms describing these skirmishes are often used interchangeably and are sometimes blurred, they generally refer to the following:

1. Wars. Full-scale battles fought between tribes, rival gangs, and other factions. Wars are usually the most violent and deadly conflicts, with vast numbers of casualties and destruction of property. Frequently, the motive of a war is to completely eradicate the opposing side. The cause of such wars may be over resources, water, land, power, avenging a wrong (sometimes avenging an insult), or any number of other reasons.

2. Civil Disputes. Conflicts and fighting *within* a particular community, tribe, clan or gang. Such civil wars rarely directly involve outside groups unless one faction brings in gangs or clans as mercenaries to fight on their side or on their behalf. If the other side counters by hiring their own mercenaries, the civil dispute *may* escalate into a full-blown war. Individuals, business owners, ranchers, and families may have blood feuds and vendettas but the fighting is usually not expansive or bloody enough to be called a war, although they too sometimes escalate into wars.

3. Vendettas. These are usually bloody, but isolated campaigns of revenge, and are typically fought at the family, clan, gang, or tribal level, but *may* escalate into a clan or tribe feud and occasionally, into a full-scale war (a rarity). Vendettas are usually caused by a terrible wrong or an insult (real or imagined) committed by an individual, gang or group, but can also result from political or economic reasons. Although vendettas often result in bloodshed, they can sometimes be settled if the guilty party publicly apologizes and/or pays for his crime or makes amends in some other way to the satisfaction of the wronged party.

4. Blood feuds. This conflict is typically isolated to one region and is typically fought between two families, clans, gangs, or rivals, and occasionally includes tribes or communities. Feuds usually start as a vendetta that escalates into a blood feud and can last for generations. Matters are often complicated in feuds that have lasted for years or generations, in that both sides are often accused of starting the feud and of committing atrocities against the other (the latter is usually true). Like vendettas, blood feuds may be the result of something as simple as an insult or as terrible as rape or murder. They can also be the result of



claims over land, water, property, cattle rustling, and so on. However, blood feuds are always serious, violent affairs born of unreasoning hatred and which almost always result (or end) in bloodshed. Payments, punishment and concessions that would settle many a vendetta are considered inadequate to settle a debt of blood.

5. Rivalry. A rivalry can range from a friendly competition and a grudging respect for one another to bitter rivalry involving vandalism, theft, attempts to ruin the other's reputation and dirty tricks. Although brawls are common, bloodshed is not. In fact, murder or destruction of valuable property can lead to a vendetta or escalate into a blood feud. Rivalry can exist between businesses, or between one town and another, as well as between tribes, clans, gangs and individuals.

General Note: Because of the many differences (sometimes extreme differences) in the customs, laws, morals and racial composition of the many people, groups and communities in the Pecos Empire, there are often misunderstandings and contained clashes (typically rivalries, vendettas and blood feuds) between them, as well as with outsiders. In fact, some groups will consider a blood feud or vendetta as legitimate grounds to slay a foe and/or seize his possessions without punishment, whereas other groups will consider the slaying of an opponent because of a vendetta or blood feud as murder, and taking his property as robbery.

Furthermore, each group may have different and often extreme measures of punishment or restitution to right a wrong — cash or trade of goods is usually not satisfactory. Psi-Stalkers, Simvan and some American Indians settle disputes in combat, often to the death, and/or scar, disfigure or cripple the perpetrator for wrongdoings, such as amputating a hand for stealing from the tribe or clan, or castration for the rape of a group member. **For example:** Among the Simvan, someone who slays a Simvan in fair and honorable combat *may* find other family

or clan members coming after him either to avenge their fallen comrade or for the honor of battle. However, if the slayer makes amends (sometimes as simple as showing sincere respect to his slain opponent and regret for having to have kill such a great warrior), the Simvan will usually accept it. If at some later date, this person becomes an ally of the Simvan, he will be accepted as a fellow warrior. On the other hand, any outsider (non-Tokanii) who kills a brutish Tokanii for *ANY* reason, including self-defense, is likely to find himself as the target of a vendetta or blood feud with all the Tokanii of that clan! Since the Tokanii have a such a strong clan mentality, any friends and associates of the outsider responsible for the crime are likely to be perceived as part of his "clan" and also subject to the vendetta. Unlike the Simvan and most other cultures, the animalistic Tokanii cannot be appeased with apologies, valuables or punishment — they will settle for nothing less than that person's (or people's) death!

The Ways of the Nomad

Most of the Pecos Empire is open territory. Cities and large towns are few and far between. Since many of the bandit groups are nomadic, the tendency is toward temporary quarters that can be quickly disassembled for travel and transient hang-outs like saloons, gambling halls, brothels and boarding houses.

The most nomadic are *constantly* on the move, travelling, hiding, engaging in robbery or other crimes, and moving on again. Even if their activities are localized to one comparatively small region, the typical bandit group will continue to move around to avoid getting caught off-guard by rival gangs, outsiders, the CS, or those seeking retribution — what passes for the law in the Pecos Empire is seldom a threat to most Pecos Bandits. The typical nomadic bandit will rarely spend more than a few weeks in any one place, settling down for a month or two at one

locale only during the most inclement weather. Parts of the winter and hurricane season are the worst in southern Texas where the Empire is located. In the northern territory and Canada, winter is the worst time, and bandits either hunker down for the duration or travel south to better climates.

Meanwhile, even the most nomadic bandits will have favorite places to victimize, as well as “hide-outs” and “watering holes.” The latter two will include favorite (usually lawless, helpless or submissive) towns and villages, as well as wilderness sites selected because of particular benefits (a good water supply, an ample amount of game for hunting, concealed or secluded location, easily defensible, good for ambushes, or the group just thinks it’s pretty and quiet, etc.).

The migratory nature of the nomadic life gives the bandits a good lay of the land and allows them to respond quickly to changing conditions and dangers in their current area or territory of activity. Many gangs frequently travel to places beyond the State of Lone Star in search of victims to plunder, and can be gone for a few weeks, months or years. Opportunists in the extreme, most raiding gangs and clans will stay wherever there is “easy pickings” (resources easy to plunder) and/or is fun for them. When resources dwindle, or their victims begin to put up too much of a fight, they will move on in search of greener pastures and easier plunder. However, sooner or later, they are almost certain to return, be it months or years later; fun times and easy pickings are never forgotten.

It is important to note that most Pecos Bandits operating outside the borders of the Lone Star State regard the territory known as the Pecos Empire as a safe haven, and flee to it for sanctuary when pursued by outsiders they can’t handle. The Empire is so rife with villains, D-bees and monsters that many lawmen and pursuers will not travel deep into the territory and seldom stay longer than a few days — it’s just too dangerous. A big deterrent is that most bandits are hostile toward “outsiders looking to stir up trouble,” which includes most lawmen, CS soldiers and other military troops. Even rival and feuding gangs may intercede and attack interlopers in pursuit of a gang they hate. This is not done out of any sense of camaraderie or twisted loyalty, but simply because all bandits see the Pecos Empire as “their (communal) land” and no outsider, especially officers of the law, or stooges of the military, better dare to trespass, start a fight, or tell them what to do. Another deterrent is the frightening number of inhuman D-bees, vampires and other monstrous beings that inhabit the land.

Note: Adventurer groups and mercenaries are generally regarded as folks just passing through, potential new recruits, a rival gang, spies/lawmen, or as victims to plunder. Which label a band of outlaws may place on the players’ group will depend on their O.C.C.s, equipment and how they conduct themselves.

Modes of Transportation

The three favored modes of travel among the Pecos Raiders are by hover vehicles, motorcycles, and horseback; or in the case of Simvan Monster Riders and Psi-Stalkers, an animal mount that may be a dinosaur or beast from another dimension. Although cars, especially jeeps, trucks, and all terrain vehicles are very useful and popular, there is something about the favored three that appeals to the temperament of most Pecos bandits. If offered a choice between driving a motorcycle or a tank, the vast majority of raiders would willingly sacrifice the superior firepower and protection of the tank for the speed, maneuverability, and overall feeling of freedom inherent to the motorcycle, hover vehicle or horseback. The advantages and disadvantages of them will greatly determine how tribes or raider bands are equipped.

Hover vehicles are the fastest, have mega-damage protection, and (with the ability of limited flight) can often bypass defenses and get into places insurmountable by other means of travel. Unfortunately, hovercraft are also the hardest vehicles to obtain and the hardest to maintain. Also, it is not uncommon for the pilots of hovercraft to find themselves the primary targets in a fight.

Motorcycles are also fast and often have mega-damage protection. They are much more plentiful than hover vehicles and, in some respects, the most maneuverable of the trio. However, unless a fuel supply is available, they have the shortest range (in the long-run) and are the noisiest of the three, making stealth a virtual impossibility.

Horses and other animals are typically the slowest and most vulnerable of the three. However, they are the easiest to care for, they can keep going as long as there is land to graze on and water to drink, and they are by far, the most quiet when stealth is required. In addition, a riding animal provides some measure of companionship and can alert the rider to dangers beyond his notice or senses. For example, *horses* are keen to recognize vampires and werebeasts, whining and rearing up when one is within 200 yards/meters. Horses can also sense many types of demons, faerie folk, mutant animal predators, and flares of magic energy (same range as vamps). Dragons, Changelings and most D-bees are not among the creatures a horse can sense.

Power armor, robot vehicles and other high-tech apparatus are desired but not readily available in this low-tech environment. Furthermore, most of the uneducated people of the Pecos Empire don’t have the skill or knowledge to pilot complex vehicles or operate advanced equipment.

There are also other, less common ways that bandits and raiders travel. Among the most notable are other steeds, such as bison, Rhino-buffalo, Ostrosaur and other D-bee creatures. There are thousands of Simvan and Psi-Stalkers in the Pecos Empire (parts of the American West) who have tamed these otherwise intractable creatures. One notorious tribe that calls the Pecos Empire home, but wanders along the Rio Grande and up into New Mexico, includes both Simvan and Psi-Stalkers (other races are excluded), and is called the **Buffalo Hunters** because they have domesticated a small herd of bison (about 100 head) and rhino-buffalos (approx. 40+ head) and ride them for hunting and battle. Total size of the tribe is approximately 440, with about 150 male hunters and defenders, although when talking Psi-Stalkers and Simvan, the females are just as deadly as the males.

Among most Simvan tribes and clans, *Ostrosaur*s are valued far more highly than horses or buffalo. These creatures have skin that is mega-damage tough, can inflict mega-damage with their bite and claws, and fight with a ferocity that even the most aggressive warhorse can only envy. In fact, during some raids, Simvan riders have been known to dismount and send their steeds into battle independently, while they engage enemies elsewhere. Ostrosaur are as fast as most horses and also possess the ability to make prodigious leaps of up to 70 feet (21 m). Simvan Monster Riders will often outmaneuver and ride (leap) rings around faster and better armored high-tech vehicles. As one CS Sergeant, a survivor of a Simvan raid, has this to say about a Simvan raiding party:

“Those things were all over the place! If you tried to take a pot-shot at one, it suddenly leaped 50 feet (15.2 m) out of the way! If you tried to shoot one by tracking it, another one would plow into you from your blind side! Or you’d find yourself shooting wild. I doubt more than 20% of our shots hit beast or rider. I tell ya, those things were everywhere! Even our Juicers were bewildered, although able to respond, dodge and retaliate better than most of the men.

“How those D-bee madmen stay saddled or even control the Ostrosaur is beyond me. Intelligence claims a psionic link or rapport, which must be true, because one of our Juicers leaped on the back of an Ostrosaur, dismounted its rider, and suddenly found himself riding a whirlwind. Nothing he did could calm or control the monster. I was amazed he held on as long as he did (several minutes). When the bucking monster finally threw him off, it lunged at him with a vengeance. He claims he could have slain it with his vibro-blades, he had lost his rifle and other gear while hanging on to the beast, but I seriously doubt it. Only the whistle of its Simvan master turned the beast from its prey and sent it obediently running to him.

“I’m telling you, I don’t know if any of the platoon would have survived if the Super-SAMAS squadron didn’t save our hides. I regret to say that I must wholeheartedly concur with Lieutenant Willis, CS ground troops — even Juicers or ‘Borgs — would have to outnumber Simvan on Ostrosaurs by at least two to one, and can still expect high casualties, maybe 50 or 60 percent. You’d have to outnumber them by at least four to one to assure a decisive victory with minimal casualties, perhaps 15%. The great equalizer is our flying power armor troops. The Sams can outspeed and match these crazy, dinosaur riding warriors’ agility, plus they can stay out of reach and shoot from the air, giving them clear superiority. I’ve heard tell of SAMAS squads decimating Simvan clans, and I believe it by the way they fled when the Sams arrived. However, the Simvan realize this and immediately take to the trees or other cover the moment SAMAS come within sight.”

Despite these notable advantages, Ostrosaurs have not become as popular as horses (the genuine animal and robot imitations) or hovercycles among the Pecos bandits for three reasons:

1. There are so few of them. Wild Ostrosaurs are not indigenous to Texas, only the domesticated breeds and animals brought from the west by Simvan can be found in the Empire. Despite the Simvan’s success at breeding them, they are far less common than horses, except among the Simvan clans and tribes.

2. For all their speed and leaping ability, Ostrosaurs have a lower speed endurance than horses. When Ostrosaurs prey on horses, they make their kill quickly. If the animal misses on his first attack and is forced to pursue the horse, the horse will ultimately pull away when the Ostrosaur starts to tire (after 20 to 30 minutes).

3. Ostrosaurs are very hard to tame and need large quantities of meat; in the wild, they prey on large herd animals such as buffalo and Rhino-Buffero, as well as small groups of humanoids! Thus far, only the Simvan and a few Psi-Stalkers have managed to tame and ride these fierce predators.

Bandit Organizations

| | |
|--------|-------------|
| Tribes | Gangs |
| Clans | Settlements |

There are four types of communal groups operating in the Pecos Empire: tribes, clans, gangs and settlements (permanent villages, towns, cities and kingdoms). The first three are typically nomadic and the most likely to regularly engage in banditry. The latter is a permanent settlement, or, in the case of bandits, a base of operation dominated by the bandits and from which they launch their raids and other dubious activities.



Tribes

Approximately one-quarter of the Pecos Bandits are tribal in nature. Most tribes in the Pecos Empire, including bandit tribes, consist of a group of people, often from different racial ancestries, but who share a *common* occupation, interest, habits and culture. All members of the tribe live by the laws and edicts of that particular tribe and accept the leadership of the tribe's Chieftain and/or Shaman. While many of the tribes may have similarities, each is a separate, autonomous entity and some have dramatically different laws and cultures. Likewise, not all of the tribes in the Pecos Empire engage in banditry and some are exclusive to a particular race or ancestral/family lineage. Many tribes of Psi-Stalkers, Simvan and some D-bees and American Indian tribes will not allow "outsiders" of any kind (in this case, any other race), for any reason, to become official members of their tribe.

Generally, tribesmen born into their tribe remain members of that tribe throughout their lives (**Note:** The term "tribesmen" will be used generically for men, women, and D-bees. No chauvinism is intended, this is just for ease of description). However, it is not an uncommon practice for tribes to *adopt* new members. This will most commonly occur when two people of different tribes marry one another; the woman will usually join her husband's tribe but, sometimes, the man will join his wife's people. Factors such as each party's wealth and status within the tribe may affect the couple's ultimate tribal allegiance. Once allied, the spouse is expected to adopt the tribe and its people as his or her own, and live by the laws and customs of that tribe. To do otherwise will lead to punishment and eventually, to expulsion from the tribe, or death.

A tribe also may *adopt* new members to keep up their strength after it has suffered severe losses from disease or war. Likewise, lost or abandoned children (children are rarely stolen from their parents as the CS would like people to believe) are often adopted and raised as full members of the tribe (in these cases, the younger the child, the better). Occasionally, a tribe will accept submissive and obedient members of other tribes or refugees into their community, but they are usually treated as second-class citizens without voice in, and little value to, the tribe for many years, possibly their entire lifetime. Only after years of loyal and obedient service to the tribe *may* an "outsider" be deemed worthy of adoption into the tribe. Only 10-20% ever become full members of the tribe, although 50% of their children born while with the tribe are accepted as tribesmen.

Those born into a tribe remain a member of it for life. It is his or her heritage and the birthright of his children. This is true even if the character leaves the tribe to wander, explore or adventure on his own for decades. The only way one loses his tribal heritage is through marriage and adoption into another tribe, and by banishment/expulsion for the commission of some terrible crime. Such crimes are typically betrayal of the tribe by helping or fighting on the side of the tribe's enemies, but can also include the rape or murder of fellow tribesmen.

The size of a tribe can be as small as 100 or number up into the thousands (see random size table below). The largest individual tribes in the Pecos Empire are seldom larger than 10,000 although some *tribal nations* that consist of more than one related tribe can greatly exceed this number when counted as one or when they join to defend their nation. This is particularly true of Psi-Stalkers and Simvan, as well as native American Indians outside the State of Lone Star.

At least 50% of all tribes are nomadic and wander throughout the Pecos Empire (the southern half of Texas) as well as Northern Mexico and other territories around the State of Lone Star. However, most regard the Pecos Empire as their homeland and will spend most of their time in that region. A third are semi-nomadic, roaming a comparatively small region that they occupy on a full-time basis and consider their territory. They are also likely to make camp and stay at one location for months at a time, moving to a different location only when resources dwindle, the area becomes dangerous, or to avoid foul seasons of weather (i.e. move south in the winter). Outsiders who pass through the

tribe's territory are not regarded as a threat, but those who try to settle in or claim some portion as their own are driven away, enslaved or slain. Many of the small to medium nomadic tribes rely entirely on hunting and raiding. They are also more likely to prey upon other tribes and people within the State of Lone Star. The most aggressive and bloodthirsty are also likely to be "purged" by other tribes, clans and gangs. Such purges will see the slaughter of seventy to one hundred percent of the tribe; every man, woman and child, although occasionally a small number of females and/or toddlers may be captured and either enslaved or adopted into the tribe.

Approximately 20% of the tribes, particularly the largest, have settled in one area where they have established a cluster of *permanent* villages or towns. Most of the large and/or peaceful tribes grow crops and raise animals (cattle, sheep, pigs, chickens, etc.). They engage in banditry only to supplement their resources and usually direct such attacks against enemies and outsiders, with the Coalition States and their troops being primary targets. This also means that raiding parties (typically 6 to 60 warriors or bandits; usually males) may ride hundreds or even thousands of miles from the tribe's homeland (or present location of nomadic tribes where the families are camped) to engage in raids and the commission of crimes.

Random Size Table for Tribes

| | |
|-------|----------|
| 01-40 | 1D6×100 |
| 41-60 | 3D4×100 |
| 61-80 | 5D6×100 |
| 81-89 | 1D6×1000 |
| 90-96 | 2D6×1000 |
| 97-00 | 3D6×1000 |

Clans

Generally speaking, clans may be considered small, family-based tribes. In this case the community consists entirely of family members. The immediate family (parents and children) are often among the clan leaders and nobility and the extended family (siblings, aunts, uncles, cousins, nephews, nieces, grandparents, grandchildren, and other distant relatives who are still blood relations) compose the rest of the clan.

Marriage into an enemy clan is forbidden. To defy this basic law can lead to expulsion for life or being branded a traitor and killed. Marriage into a friendly or acceptable clan (subject to the approval of the clan elders in both groups) does not unify the two clans as one. As with most tribes, the spouse, in this case typically the woman, is adopted into the clan of her husband. Their offspring are members of the husband's clan and encouraged to marry from within their own clan. However, the bond of friendship and camaraderie with the wife's clan is likely to strengthen, and, while a separate political and family entity, the two may become allies for generations. On the other hand, feuds between rival and enemy clans are usually bloodier than tribal and gang wars and the animosity endures for generations.

Although a clan can be made up of any number of families and other allied people, most are built around a single, strong family unit. The leaders of a clan are typically a *Counsel of Elders* who create and enforce the rules, laws and conduct of the clan. They also mete out punishment, settle disputes, offer advice, arrange and/or approve marriages, arrange truces, and declare war and other actions against enemies. In the case of war, one or more warlords usually coordinate the actual military campaign, the elders only declare war when war or retribution is necessary, establish the terms of war, and make truces or arrange settlements to end the conflict as well as deciding how the spoils (land, title and property) are divided among the victors.

Like tribes, the society, culture and laws of each clan is usually unique to that particular clan, although many have similar practices and viewpoints. In most cases, the word of the clan elders is law! To defy their edicts, especially openly, is to be branded a traitor and banished. If the crime is great enough (most notably, betrayal of and/or serious dam-



age to the clan), the offender's entire family will be banished from the clan, or the offender slain and his family (alleged accomplices or cowards too weak to stand against him and with the clan) forever banished. Banishment is typically for life, unless the offending party makes some great overture as an act of contrition and begs for forgiveness and readmittance into the family clan. Furthermore, word about those banished from a clan spreads like wildfire and the individual is typically regarded as an honorless rogue who, if he could betray his clan, is likely to betray anybody! Thus, they are total outcasts among even enemy clans and regarded as the lowest of the low. They will never be accepted into another clan as anything but a slave, stooge or lackey and even most tribes will avoid dealing with this disreputable character. Only bandit gangs and mercenaries will ignore the traitor's past and welcome him or her into their fold. Of course, they too, are likely to be disreputable and honorless brigands.

The size of a clan is usually comparatively small with most numbering 40 to 160, but some number into a thousand or more (see random size table below). Most clans rarely join forces with other clans, even in times of great calamity. In addition, many clans have loose alliances with bandit gangs and are more likely to join forces with them than rival family units; Emperor Sabre Lasar counts 30 clans among his most trusted allies.

At least 40% of all clans are nomadic and most are semi-nomadic. Unlike tribes and gangs, most clans seldom travel beyond the borders of the Pecos Empire (the southern half of Texas) except to conduct raids or to serve as mercenaries in other lands. The only other exception is individuals who decide to make a life as an adventurer or mercenary, but even these world travelers will return to visit their clan on a regular basis. Family bonds are extremely strong among most clansmen and even the happiest wanderer will come home to visit kin for special occasions like weddings, births, funerals, and events special to the clan or the immediate family. Likewise, a clansman will rush to his family in times of

trouble and stand with his clan in times of conflict. This also means that most clansmen will seek revenge and/or retribution for any wrong perpetrated against his clan, especially grievous wrongs and those committed against a loved one. It is said that it is better to face a Coalition platoon than the vengeance of one lone clansman.

Bandit Clans. For one reason or another, a vast majority (87%) of the clans in the Lone Star State regularly engage in banditry, particularly raids against the Coalition States' forces, outposts, and border towns. This is due in large part to the clans' regard of the CS as a dishonorable and evil invader encroaching on their territory and threatening their very existence (all pretty much true). In fact, 50% of the bandit *clans* only strike against the CS, rival clans and those who dare to invade or threaten them! This makes many clans likeable rogues who are often perceived more as freedom fighters than criminals — at least by adventurers and the enemies of the Coalition States. It is also among the clan bandits that "Robin Hood-like" stories are born, telling of the noble Pecos Bandit with his indomitable, wild spirit and who battles oppression, and steals from the evil Coalition to help and defend his people. **Note:** The alignment of the clansmen who predominantly victimize the CS are frequently good, selfish and aberrant. Note however, that many of the bandit clans are as evil and cruel as any other.

Random Size Table for Clans

| | |
|-------|---------|
| 01-10 | 2D4×10 |
| 11-30 | 3D4×10 |
| 31-60 | 4D4×10 |
| 61-80 | 4D6×10 |
| 81-90 | 1D6×100 |
| 91-95 | 3D4×100 |
| 96-00 | 6D6×100 |



THE
MID
1999

Bandit Gangs

Bandit gangs are groups of bandits generally smaller than tribes and typically clan-sized or smaller. Most of them have from 10 to 60 raiders, with large bands having several hundred members and the largest having thousands (see random size table). However, there are only a handful of gangs with more than a few hundred members, the Sabre Warriors being the most notable.

Bandit gangs and raiders are almost always criminals of evil or selfish alignment, and are always *nomadic* — the very nature of their “business” forces them to constantly be on the run, even if it’s only moving around from place to place in a couple different communities. Most of the small groups (100 or less) are plains drifters never staying in one place for more than a few weeks, and usually with some percentage (10-33%) of its members drifting in and out of the overall group to strike out on their own. These *satellite* or splinter groups typically range from as few as three or four to as many as a dozen, and usually consist of friends/old riding buddies, family members (brothers, uncles, cousins, etc.) and newcomers who have decided to “ride along,” provided it’s okay with the rest of the group (it usually is until the newcomer proves to be annoying, reckless, or gets the group into trouble, at which point he may be asked to leave, is abandoned, or even shot). These small, satellite groups usually last for a limited time (a few weeks to several months), but almost always return to the larger, “official” and more formalized gang.

Members of bandit groups will return to the larger, “official” gang when they miss the camaraderie of their fellow bandits, are down on their luck, need their protection, or hear that the group needs their help or has something big in the works. They will also return whenever they get word that the gang (overall), or a gang member, is being hunted by the law, engaged in gang warfare, or needs their help in any matter

whatsoever. Gangs, large and small, are effectively a *fraternity* that serves as an extended family group, and “nobody messes with family without expectin’ trouble.” In fact, most of the Pecos bandits and other outlaws throughout the wilderness of the American west and northwest, exhibit outlandish levels of loyalty to their gang; only clansmen can be more overzealous. This loyalty often manifests itself in acts of revenge (“you hung Clem, lawman, now you gonna pay”), lawlessness and camaraderie that involves all kinds of criminal activity with fellow gangsters, even when the fellow gangster isn’t liked. This can include breaking a fellow gang member out of jail, hiding gang fugitives from the law, beating up or shooting somebody who bad-mouthed a brother gangster or the reputation of the gang, vandalism, terrorism, and so on. On occasion, all the splinter groups are called to join forces to form a small army to defend or avenge the gang or a specific gang member. However, these large groups and coordinated assaults can rarely be maintained for more than 1D6 months.

Unlike tribes and clans, there is often nothing that passes for laws, rule or order, other than “might makes right.” In most cases, a gang is ruled by a “warlord” or a warlord and his most trusted associates or “posse,” often a combination of old friends and family. These Warlords and their posse typically rule through brute strength, force of will and intimidation. Those who speak against the Warlord are bullied or beaten into submission. Those who challenge the Warlord or his posse either face a duel or brawl that may or may not be to the death, and if the defeated does not openly show respect and support, he and his supporters will be executed!

The level of brutality and structure within a gang will rely entirely on the Warlord and what he allows or encourages. Thus, the band can be a group of wild, uncontrolled miscreants given to drunkenness, murder and stupidity, or a well organized, cooperative, even military structured group of professional gunmen and thieves. Likewise, the level of cruelty, brutality and vindictiveness will depend on what the leaders condone. If the leader turns a blind eye or encourages, torture, rape and murder, then his men will engage in all sorts of cruelty and atrocities. Thus, one bandit gang may be bloodthirsty killers who take no prisoners and loot and pillage without restraint, while another gang may be controlled and go out of their way not to harm the victims of their crimes. Some of the most flamboyant, cocky and likeable make truly humorous jokes during their robberies, or playfully make fools out of the law, or act the gentleman, right down to defending women and children.

As a general rule, most bandits are not actively pursuing a blood feud or vendetta, and are not blood-crazed killers. Most will try to keep bloodshed to a minimum. For one thing, killing and hurting people is the easiest way to make enemies and to get the law or revenge driven family members, Cyber-Knights or heroes on your tail. Simple robbery (where people may be frightened but nobody gets hurt) and raids leveled at mutually disliked foes (such as the CS) are the least likely to create an uproar or vendetta, and the most likely to be ignored — low priority is a good thing in crime. For another, panicking victims can only create an atmosphere of chaos where one cannot see everything happening around him, where danger can appear out of the most unlikely places without warning, and where somebody is likely to get hurt by accident.

Many Pecos Bandits adhere to the policy that, “You can only steal from a dead person once!” Often, raiders will allow their victims to keep some resources (granted, it may not be much) and avoid senseless destruction of homes, livestock and crops. This isn’t out of some strange act of chivalry or compassion, but practicality, especially when dealing with farmers, villages and towns. After all, if you take everything and create too much hardship, the people will suffer and either perish or move away, eliminating a valuable resource. Thus, many gangs are careful not to overly abuse and hurt the people they are robbing. Some even develop a network of places to raid and likely targets to plunder that they hit on a regular circuit.

Although their crimes, strategy and tactics can vary from band to band, most bandits rely on surprise, speed, sudden attacks and on in-

timidating their victims. The large gangs may also rely on superior numbers and firepower, especially in regard to frightening and intimidating potential victims.

Only a small percentage of gangs limit its members to a particular race, or family members (clannish in nature), the majority allows any gunman, thief, thug and low life who will follow orders and serve the gang into its group. The most important things gangs look for in their members is honor and loyalty to the gang and gang leader(s). Most other character flaws can be overlooked or appropriately punished and brought in line. The typical band of outlaws, raiders and bandits may attract the whole gamut of potential recruits ranging from outlaws, malcontents, gunslingers, Juicers, Crazyies, ‘Borgs, Psi-Stalkers, clansmen, and tribesmen exiled for crimes, to anarchist adventurers, gunmen, mercenaries in between wars, and those who seek fame and fortune through a life in crime and/or terrorism. Others start out as misguided youths, or people who desperately want out of their current situation and seek joining a gang and a life of crime as a way to do it. Many thugs and peasants desperate to improve their status see joining a gang as a means to power and/or respect (often mistaking fear or loathing as respect).

Most bandit groups avoid dealings with tribes, unless it’s to raid them, cause trouble, or solicit tribal outcasts and slaves to join them. However, many gangs will associate with *clans* on good terms and are likely to have friends and a place to stay among some of them. Many clans encourage their young men to join cattle rustlers, mercenary groups, bandits and raiders for a few years to gain combat experience and to see the world. Many bandits also associate with or have friends, family, or connections with other *gangs*. These friendly gangsters are likely to have similar codes of conduct, an understanding between them (if not a formal truce), and a strong leader(s) so they don’t feel threatened by each other, or one is clearly submissive to the other. Some such gangster buddies will be friendly rivals or occasional cohorts in crime. On the other hand, serious gang rivalry can be violent and bloody — often ending only when the last rival is dead.

Some of the largest, strongest and meanest gangs exist in “settled” areas. These thugs typically control a section of or position in a village, town or other community. In towns where two or more gangs share the “turf,” rivalry and bloody feuds are at their greatest. The largest gangs, like the **Silver Dagger Gang**, often have numerous smaller bands of 10 to 100 men engaged in criminal activity throughout the Lone Star State and surrounding territories. They are also likely to control or dominate a specific town used as the gang’s *base of operations* and may have influence over other villages, towns, ranchers and people in one or more areas. To survive for any length of time, large gangs usually require strong leadership, a chain of command and definite structure within the organization. The Silver Dagger gang is so structured, experienced and capable that it borders on organized crime, with its fingers involved in all sorts of vice and crime from prostitution and gambling to rustling cattle, smuggling, running guns, extortion, and many less subtle criminal activities. This strong organization and network of crime, with its thieves, spies, informers and strongmen, makes the large, structured gangs the most powerful, political and dangerous. Fortunately, there are only a half dozen large, powerful gangs currently operating in the Pecos Empire.

Random Size Table for the Average Bandit Gang

| | |
|-------|----------|
| 01-15 | 2D4+2 |
| 16-30 | 3D4+6 |
| 31-45 | 1D4×10 |
| 46-60 | 2D4×10 |
| 61-80 | 3D6×10 |
| 81-90 | 1D6×100 |
| 91-95 | 2D6×100 |
| 96-00 | 1D4×1000 |

Settlements

Not all bandits are nomads. Some like to settle down at a set location either because the group is too large to keep on the move (complete with families) while others prefer the security or power base that only a village, town or city can provide. Others just prefer city life. The Pecos Empire has two types of *bandit settlements*, one is a community made up predominantly of bandits and their families (a rarity), or an already established village or town that becomes the home of one or more gangs (common). In the latter case, a gang typically controls one particular area/neighborhood, or a particular type of business — usually businesses of ill repute, such as gambling halls, saloons, brothels, drug dens, arms dealers, pawnshops/fences, protection rackets, etc., as well as more secretive criminal operations such as cattle rustling, theft or smuggling, assassination/hit men, etc. Note that if a village, town or city has one gang, it is likely to have 1D6 other gangs. These city gangs can number a few dozen to a few hundred, and may include City Rats. The gangs may be a powerful force (in some cases, even influencing or controlling business or the government) and operate more like organized crime, but most are small-time operators who engage in acts of bullying, intimidation, brutality, vandalism and crimes, most of which are waged against the very communities they live in. The average citizen usually loathes these gangland thugs and longs for a way to eliminate them. Gang rivalry, vendettas and blood feuds are extremely common among these local gangs, with innocent bystanders often getting caught in the crossfire.

Communities that are established by, or openly dominated by outlaws, are typically chaotic, rough and tumble places with lots of saloons, pawnshops and places of vice. Most are also open to other outlaws, bandits, gunslingers and gunmen (provided they don't try to muscle in on their territory) as a place for rest and relaxation, and a comparatively safe haven or hide-out, especially from the law. Cyber-Knights, lawmen, righteous adventurers and Coalition troops are viewed with disdain, and it is made abundantly clear that they are not welcome. In fact, lawmen and heroes are likely to find themselves called out for gunfights, dragged into brawls, insulted and spit upon. They are also likely to find no beds available at boarding houses and may be charged 30-100 percent more on most purchases.

Both types of city bandits are likely to send out small raiding bands and individuals away from their "turf" to engage in criminal activity in other communities or the wide open country (robbing travelers, raiding tribes, cattle rustling, etc.).

It's interesting to note that most outlaws anchored to a community view most tribes, clans and primitive people as dangerous rivals and often prohibit them from their community. Tribes and clans are also frequently victimized by these bandits.

At any rate, in the Pecos Empire, large permanent urban areas are the exception rather than the rule.

Relationships

1. Each other. The relations between the various tribes, clans, gangs and factions of the Pecos Empire are an ever changing and mercurial thing. The fact that each small organization or community has its own set of rules, laws, ethics and leaders is a constant source of friction, misunderstandings and clashes. Furthermore, their alliances and loyalties frequently shift, so today's friend may be tomorrow's enemy (and vice versa). Many of the gangs (and to a lesser degree, clans and tribes), frequently prey upon each other (some more than others), and often engage in bloody feuds and vendettas. Since resources such as energy weapons, vehicles, high-tech and magic equipment are generally in high demand within the Empire, there are frequent raids and clashes over such booty.

However, all and all, the Pecos bandits have a reasonably good understanding of where each other stands and how to avoid crossing one another (unless they want to). In addition, don't forget that the bandits see the territory they call the Pecos Empire as *all* of theirs', and will band together to defend and keep it.

Emperor Sabre Lasar and his Sabre Warrior gang continues to make subtle moves and overtures to win the respect, admiration and support of the smaller bands. Approximately 80% of gangs, 60% of the clans and 30% of the tribes consider the man an outlaw hero and a military genius who they can turn to in times of crisis. Inevitably, Emperor Lasar *should* be able to unite a large number of the smaller factions under his leadership and begin to build a strong nation. However, this is years away and may *never* come to pass, unless some outside danger or events push the smaller bands to turn to him (something the CS recognizes and hopes to avoid). **G.M.'s Note:** Currently, in addition to the usual amount of raiding, *King Macklin* is *trying* to manipulate himself into the position of emperor by pitting the various tribes and bands against each other.

2. The Coalition States and the Pecos Badlands. The Pecos "Badlands" (the CS refuses to use the term "Empire") has been a thorn in the Coalition's side for over 40 years, and has become increasingly irritating and sometimes painful, since the bandit warlord and self-proclaimed Emperor, Sabre Lasar, stepped to the forefront of the damnable barbarian society, 10 years ago.

Some might wonder why the CS doesn't just send in its army and wipe out the Pecos Bandits. Well, the situation is more complicated and touchy than it may appear at first glance.

First, compared to other hot spots like Tolkeen, Free Quebec, and the Federation of Magic, the Pecos Empire is low priority.

Second, the so-called "Pecos Empire" is so fragmented and divided that they currently pose no serious threat to the Coalition States or their outposts and possessions in the State of Lone Star. The Coalition's most valuable resource, the *Lone Star Genetics facility and military complex*, is an impregnable fortress that even the Sabre Warriors have been unable to scathe. On the other hand, any obvious push to eradicate the Pecos Empire might actually serve to unite the many tribes, clans and gangs into a formidable nation of warrior bandits. This kind of development is something the CS would like to avoid, especially when they currently have their hands full with Tolkeen and Free Quebec.

Third, the CS sees *Emperor Sabre Lasar* and his *Sabre Warriors* as the only serious force in the Pecos Badlands with a chance of uniting the people of that region into a genuine nation. Thus, the CS Intelligence at Chi-Town plan to "remove" Sabre Lasar at the first opportunity. To this end, a dozen CS spies are already infiltrated among the Sabre Warriors, collecting valuable information and trying to get close to the infamous "Emperor" (three previous assassination attempts have failed and the spies currently know very little of value about Emperor Lasar or his top men). The CS also recognizes the growing strength and organization of the *Silver Dagger Gang* and have infiltrated it as well, and with greater success — one of Warlord Don Marco's top aides is a psychic, CS agent. One plan currently on the table is to encourage Warlord Don Marco to strike out against his hated rival, Sabre Lasar, and secretly support his gang in this effort, and then quietly assassinate Marco and replace him with a CS agent to undermine the entire organization.

Fourth, a military campaign into the Pecos Badlands would raise awareness of the true level of the *vampires'* presence, while the eradication of the Pecos Bandits would drop the vampire problem right into the Coalition's lap. Currently, the CS is using the bandits as a buffer between the vampires of Mexico and the Coalition States and Territories in the North. The Pecos bandits regularly engage in battles and purges against vampires. However, even the CS does not fully comprehend the full magnitude of the vampire threat, or just how much the bandits help to curb vampire incursions into North America.

3. The Bandits and the CS. Generally speaking, the Coalition States is the number one enemy of the Pecos Empire (vampires are number two). The bandits (and heroes) of the Pecos Badlands frequently raid CS outposts, military bases, settlements, and troops in the State of Lone Star, as well as the surrounding States and territories. Only the expansive, fortified and heavily defended Lone Star City and military complex is left unmolested (the few attacks leveled against it



have failed miserably, with the attackers suffering huge numbers of casualties). **G.M.'s Note:** *King Macklin* has begun secret negotiations with the State of Lone Star for their assistance in his bid for power. Macklin has kept these dealings very hush-hush, allowing only a few of his most loyal supporters in on this until he is prepared to strike. If these

dealings were made public, it is likely that many of the other tribes would band together and come after Macklin, assuming that his own men did not turn against him and lynch him first.

4. Los Alamo. Although Los Alamo has traditionally been an enemy of the Pecos Empire, recent diplomatic tensions between Los Alamo and the Coalition States has caused some Empire leaders to rethink their earlier attitudes. Los Alamo is known for its high technology and large number of *Juicers*. Not only do these two factors generally make it a difficult adversary to overcome, but also makes it a natural target for the Coalition's inevitable expansion attempts. The events surrounding the recent Juicer Uprising, and Emperor Prosek's declaration of war against Free Quebec, the Tolkeen Campaign and the launch of his new military offensive known as the *Campaign of Unity* through military aggression and the genocide of nonhumans (see **Coalition War Campaign** for full details on these developments) has prompted Los Alamo to take action to protect itself. Sharing a possible common enemy in the Coalition States has forced the Kingdom of Los Alamo into a dangerous unofficial alliance and treaty with numerous factions of the Pecos Empire.

This has been done by declaring itself a *neutral country* and opening its doors to any Pecos faction, bandit and otherwise, who agree to a truce, abide by Los Alamo law, behave peacefully, and ignore old gang rivalries while within its borders. Several gangs and clans have accepted their offer. So far, this has worked amazingly well — the bandits and other Pecos groups desperately need a link to the high-tech world. For these reasons, most members of the Pecos Empire are making a special effort to get on good terms with Los Alamo.

Emperor Sabre Lasar has accepted an offer to personally visit the "enlightened" Kingdom of Los Alamo and is expected to acknowledge their neutrality, welcome their free trade agreement, and acknowledge their *friendship* on behalf of the Sabre Warriors and encourage the other Pecos factions to do likewise. His approval will win over a huge number of the other groups, along with his/their protection. In exchange, Los Alamo will be the *first* notable kingdom to officially recognize the Pecos Empire as a sovereign nation! In addition, the kingdom will sing the praises of Emperor Lasar and that only through his cooperation and support are they able to remain a neutral country. As a "friend" of the Pecos Empire, the Sabre Warriors will pledge their *protection* and support of Los Alamo and encourage others to do the same, "lest they fall to the tyranny of the Coalition States."

The factions of the Pecos Empire are encouraged to trade raw materials, furs, precious metals, and stolen goods acquired as booty in raids in exchange for Los Alamo's technology and manufactured goods. Los Alamo's sales of weapons, armor, vehicles, and electronics has already increased by 80% and Juicer technology by 20% — these numbers are expected to quadruple when Emperor Sabre Lasar announces his support of Los Alamo's neutrality. This increased income will help the Kingdom to build better defenses and increase the size of its army, in addition to the protection afforded by becoming a member in the brotherhood of bandits of the Pecos Empire.

Note: The CS is not yet aware of Los Alamo's new trade policies and unofficial alliance with Emperor Sabre Lasar. Needless to say, this turn of events will not please them and Los Alamo will be placed on the "Enemies List." However, their neutrality and association with the bandits and other independent kingdoms and heroes *will* prevent the Coalition from making any moves against them and preserves the kingdom's autonomy and freedom, at least for the next several years. Also note that Warlord Marco and his Silver Dagger gang are not pleased by this union, either. It muscles in on his smuggling and sales of technology and gives his arch-rival, Sabre Lasar, greater power and recognition. However, he is not likely to raise his hand against Los Alamo or Lasar. At least not yet.

5. New Del Rio is an annoyance. They are not considered powerful enough to constitute a threat or wealthy enough to be worth raiding, but attracts refugees, traitors and outcasts who will often take refuge there. It is also rumored that CS spies use the place as a base of operations.

Bandits (individually and in small groups) will enter the city at times to settle old scores or in search for diversions (“slumming” as it were) but, thus far, no one has approached New Del Rio with enough force to be considered an invasion.

6. Reid’s Rangers. The reputation of these vampire fighters is such that Reid’s Rangers are regarded as heroes even by the worst bandits and are generally left alone to pursue their own business. In fact, members of clans, tribes and even bandits and raiders (usually young ones out to make names for themselves or to extract revenge) have joined these famous Rangers in the pursuit and destruction of vampires. On one occasion, a vendetta between two warring tribes was put on hold to allow a number of raiders from both tribes to accompany the Rangers on one of their quests. Reid’s Rangers are so respected (and in some cases, feared) that most gangs give them a wide berth, and most communities welcome them. **Note:** *Vampire hunting* in the Pecos Empire is a necessity that many consider a common pastime and some do for fun and sport.

7. Mexico. Except for a few notable places like Ciudad Juarez, there isn’t much worth stealing and there’s always an abundance of vampires looking for prey to feed upon. The country south of the border is generally considered a desolate, vampire infested hell-hole that is avoided, unless some unique opportunity arises, the reward is worth the danger, the group is out to kill vampires, or someone is so desperate that he’ll take his chances. Thus, few gangs, clans or tribes travel more than a hundred miles or so into Mexico. Of course, some fool is always lured to take his chances by stories of gold, lost treasure, and other opportunities for the acquisition of wealth or power.

Meanwhile, the vampires regard the Pecos Empire and the Lone Star State in general, as a dangerous place filled with beings dedicated to their destruction — Reid’s Rangers, tribes and bands of Psi-Stalkers, and Psi-Hounds/Dog Boys (and other mutants) among the most notable.

8. Tolkeen. As a whole, the Pecos bandits don’t really give a damn about what’s happening up north. Only the occasional outlaw band on the run, or down on its luck, will travel north in search of adventure, work and opportunities in crime.

9. The old states of Arizona, New Mexico, Colorado, Kansas, Oklahoma, Arkansas, Southern Missouri, and Louisiana are all areas plagued by raiding parties, clans, bandit gangs, gunmen and outlaws from the Pecos Empire. Most brigands sweep the countryside and use hit and run tactics along with simple guerrilla tactics. Most are constantly on the move. **Note:** Lawmen and other criminal factions in these regions often clash with raiders from the Pecos bandits, but rarely invade the Pecos Empire. The presence of a rival or enemy outlaw band in Pecos territory is asking for trouble.

10. The Indian Nations. Dozens of Native American Indian tribes have arisen in the American West, Southwest and Northwest. Most have resumed the “old ways” and use magic and mysticism, although some also use high-technology. Bandits, scouts, and adventurers who know enough to respect the Indians, their culture and gods, and avoid antagonizing them, can travel the Western Wilderness and peacefully associate with them without fear of danger from most of the tribes and clans. Those who attack, molest, cheat or endanger the people of a tribe can expect fierce resistance and deadly retribution. Most Cyber-Knights, rogue Dog Boys and other mutant animals are counted among most tribes as friends and allies. Strangely enough, many tribes of Psi-Stalkers and Simvan consider the American Indians to be rivals and enemies.

Not surprisingly, the Coalition States consider *all* Indians to be savage, retro-tech humans who have been seduced by magic and evil supernatural forces. As such, they are traitors to humanity and marked for genocide. However, currently the CS has no campaign against the Indians and greatly underestimates their mystic strength and numbers.

Characters of Note

Leaders of the Pecos Empire

By Julius Rosenstein & Kevin Siembieda



Gray Fox

Chief Gray Fox is the leader of the largest tribe in the Pecos Empire — the Apaches. A mixture of humans and D-Bees, this tribe was named after a famous pre-Rifts tribe (one, coincidentally, that Gray Fox himself is descended from). The “Grand Old Man” of the Pecos Empire, Gray Fox once reigned for almost two years during a time of plague and then willingly stepped down.

Gray Fox began his career as a scout for his tribe and went on his share of raids. Although he felt that raiding (whether for supplies or for honor) was sometimes necessary, he eventually decided that peaceful solutions were often preferable.

Although Gray Fox was not considered particularly brilliant or outstanding by his comrades, he was regarded to be highly competent and very dependable. Gray Fox rose to a position of authority more through

diligence and determination than anything else. His sagely wisdom, experience, and renown for fairness and integrity makes him a legendary figure. He is one of the very few leaders the Simvans, Psi-Stalkers and many diverse clans and tribes (Apache and others) respect and to whom they will listen. Consequently, he is in much demand as an advisor and mediator to over two dozen different tribes of various peoples.

Real Name: Yakima Gray Fox

Species: Human; **Age:** 63

Alignment: Scrupulous

Hit Points: 64; **S.D.C.:** 40

Height: 5 feet, 8 inches (1.7 m)

Weight: 170 lbs. (77 kg)

Attributes: I.Q. 11, M.E. 15, M.A. 10, P.S. 12, P.P. 8, P.E. 15, P.B. 11, Spd 11

Disposition: Gray Fox is like the “Great Father” to his tribe and often addresses his people as “My Children.” A responsible, sober leader, Gray Fox went on raids as a young man but now tries to keep his tribe off the warpath. A conservative who feels that the old ways are the best, he sometimes acts as a countering influence to young bucks like *Warlord Grange*, who he admires, but worries that he is too wild and aggressive, and may bring trouble to all the people of the prairies. Probably the most respected man in the entire Pecos Empire, the chief is loved by his people and admired by his enemies. His voice is one of the few most listened to when the chiefs meet in council, and Gray Fox is usually the first person considered for advice whenever important events take place. Even Sabre Lasar has come to Gray Fox for advice, and both men like and respect each other. King Macklin only respects the Indian’s reputation and sees him only as a means to an end.

Experience Level: 14th level Wilderness Scout

Skills of Note: Speaks Apache, American, and Spanish at 98%, literate in American and Spanish at 98%, history of the land (Lone Star — the last 300 years plus old stories and legends of the Apache before the Great Cataclysm; includes rumors and legends of pre and post Rifts Earth), horsemanship, land navigation, wilderness survival, cooking, climbing, identify plants, fishing, prowl, track animals, and geomancy lore, all at 98%, hunting, athletics, W.P. Knife, W.P. hunting rifle, W.P. energy rifle, W.P. archery.

Combat Skills: Hand to hand: expert

Number of Attacks: Six

Bonuses: +1 on initiative, +2 to strike, +5 to parry and dodge, +3 to damage, +2 to pull/roll with punch, fall or impact, critical strike on 18-20, knockout/stun on 18-20, critical strike or knockout/stun from behind, kick attack (1D6 damage), judo-style body throw/flip, paired weapons.

Magic Knowledge: None

Psionic Knowledge: None

Weapons and Equipment: Gray Fox does not wear armor unless he knows that he is going into battle. For those occasions, he has a suit of CA-1 Dead Boy armor. This suit is old and has sustained some damage (only 57 M.D.C. remaining) but because of its sentimental attachment (Gray Fox took this armor from a defeated enemy in his first raid), the chief won’t hear of replacing it with better armor. Gray Fox is armed with a Wilk’s 447 Laser Rifle and a vibro-knife in addition to conventional weapons such as a hunting rifle, bow and arrows, and knife.

Description: A Native American in his early 60’s with dark eyes and shoulder length, gray (formerly black) hair. To anyone who has seen pictures of noted Apache chiefs from pre-Rift times (such as Cochise and Geronimo), Gray Fox could fit in with these earlier chiefs and not look out of place.

Money: As chief of the largest Native American tribe in the Pecos Empire, Gray Fox has immediate access to several hundred thousand credits, and, pending approval from his Tribal Council, can obtain several million more if he deems it necessary.

Note: Although Gray Fox and his people follow the old traditions and live off the land (farmers and hunters), he and his warriors have a range of modern Coalition and Northern Gun weapons and armor, as well as some magic talismans, charms and weapons. In keeping with tradition, about 50% ride horses, the rest ride hovercycles, especially the Northern Gun Speedster and Turbo.

King Macklin

The Legend

Victor Macklin is something of a legend in the Pecos Empire. He is known for being shrewd, bold, and ruthless to his enemies, and for possessing astounding luck and an uncanny instinct of being in the right place at the right time. Macklin is already king over a large section of eastern Texas and may be on his way to becoming the emperor of a “united” Pecos Empire — that is his dream.

Macklin’s legendary career began at an early age. The youngest of five sons to a tribal warlord, Macklin was given over as a hostage to a neighboring tribe at the age of 12. The son of a hated enemy, the boy suffered all manner of injustice and hardship, but it made him stronger and it taught him to understand his enemy and wait for revenge. After four years, the two rival tribes signed a peace treaty and the young Macklin was returned to his family. However, at the celebration feast, the other tribe sprang a trap and Macklin’s father and brothers were all murdered. He alone managed to escape and rally his tribe. Although only 16 years old, Macklin had the natural instincts of a war chief and led his people effectively in a campaign of guerilla warfare. The rival tribe was vanquished and several other clans and small tribes offered favorable terms for peace, before he could turn his attention to them. It was not until after the lad’s victory that he paused from his two year campaign and realized he had amassed an army of seasoned warriors who all looked to him as their Warlord. The sanction of the other clans made him the overlord of an expansive territory and people (about 3800, a lot for the Pecos Empire). At the ripe old age of 18, his troops and people declared him “King.”

During the next few years, King Macklin divided his time between ruling his tribe and leading raids. The Coalition State of Lone Star was a favorite target and his renown as a warrior king spread with each successful raid against them — and there were many. His success attracted many other bandits, mercenaries and raiders to join his infamous band, **The Pecos Raiders**, and twice as many, mostly small clans and nomads, stay out of his way or pay him tribute for any incidental transgressions.

King Macklin spent the next several years recruiting more followers (especially bandits and raiders), winning countless small skirmishes and consolidating his rule. However, his critics insist that most of these conflicts were against opponents considerably weaker than his forces and were easily won, lopsided battles.

For the last three years, King Macklin has been calling for the other leaders of the Empire to unite under *his* leadership and drive back the forces of Lone Star. Although the Pecos Raiders are known for their independent nature, Macklin’s fame as a strategist, warrior, and leader has many of the smaller clans and bandit gangs considering the benefits of such a course of action. Others who have good reason to hate the Coalition States are also willing to join this famous warlord. However, it would take Emperor Sabre Lasar and Gray Fox combined forces to unite the people of the Empire against the CS, and neither is willing to do so.

The Truth — G.M.’s Eyes Only

Note: Players who read this section about King Macklin may ruin some of the enjoyment and mystery surrounding encounters with this character.



DRIZZ
7 6 6 1

Macklin's *legend* has already been presented — this is the true story.

When he was a boy, Victor Macklin realized that as the youngest of five brothers, his chances of becoming chief of his tribe were very slim unless he did something about it. He actually volunteered to become a hostage of the rival tribe to take advantage of the opportunities it presented. Despite the legends of how he suffered great hardship at the rival's hand, the boy was treated as the son of a great war chief. Over the years, it was Macklin who came up with the plan to trick and destroy his father and brothers, and outlined the strategy for the battle plan and taking control of his people — a plan that took a lot of convincing, but finally was accepted.

As part of the plan, he was allowed to escape. He had assured his secret partners that he, as the last surviving son of the Warlord, could lead his people to surrender, provided he could be their puppet leader. After some token battles that were essentially set-ups to allow Macklin to gain a reputation and the respect of his people, Macklin was to agree to a cease-fire. Instead, Macklin rallied his people and turned against his secret partners. Caught unawares, the young warrior dealt his opponent a lethal blow by killing that tribe's Warlord (shot him in the back after a friendly meeting, and ambushed his best warriors). The next two years of hit and run tactics gave the members of his tribe increasing confidence and slowly whittled away at the enemy. Without the expert leadership of their old warlord, the tribe finally surrendered to Macklin and became subjugated under his tribe.

Over the next few years, Macklin carved out a name for himself as a very successful raider, particularly against Coalition troops in the northern quadrant of Lone Star. Part of his success was due to raids of large forces against substantially fewer CS troops (i.e. 60-100 Raiders against 10-30 CS soldiers). The other part of his success come from a deal that he made with Doctor Desmond Bradford (Macklin doesn't know he's been dealing directly with the famous Doctor). Macklin hires out his men to Bradford as mercenaries for "special jobs" (for example, the hit on *Lieutenant Emmerson* was handled by 20 of Macklin's best men). These special jobs have included hunting down and terminating mutants, creating distractions, theft (of a particular item), and assassinations (of Bradford's enemies; Macklin does not ask who or why his benefactor wants somebody killed, he just does it), and frequently includes CS targets. Since the Pecos Raiders have "inside" information (exact number of troops, their route, etc.), they are able to use ambushes and surprise to great effect, giving Macklin and his men an undeserved reputation as strategic and tactical geniuses. Typically these "jobs" pay well (universal credits or surplus weapons, E-clips and equipment), plus Macklin's Raiders are allowed to take and keep whatever spoils they can carry. Meanwhile, Macklin looks good because he has been ridding the Pecos Empire of Coalition troops. The backstabbing opportunist that he is, King Macklin has tried to make a few shady deals with his CS contact (whom he knows only as Mr. Gene), including them throwing in together to usurp control of the Northern Quadrant and ruling the State of Lone Star as partners (yeah, right).

In the interim, Macklin has (by fair means and foul) eliminated a number of people whom he considers threats to his ultimate goal — the throne of a united Pecos Empire. He is using the "common cause vs Lone Star" as a theme to recruit more followers to further his ambition.

As for the actual "war" with Lone Star, King Macklin and his Raiders regularly strike against CS troops and settlements in the State of Lone Star and the Arkansas territory. However, neither he or his men have ever faced more than a platoon or two (of 40-80 CS soldiers) and honestly have no idea what it is like to fight the Coalition infantry. Most of what comes out of King Macklin's mouth is bluster and ego, however, since he is a charismatic, energetic and infamous personality in the State, he has caught the attention of thousands of potential allies.

Note: Warlords Sabre Lasar, Don Marco and Gray Fox all recognize King Macklin as the conniving, loudmouth glory-hound that he really is. Each (as well as other leaders of various factions) has spoken loudly and clearly against such a "war." In fact, self-proclaimed Emperor

Lasar, arguably the most respected and powerful of the bandit warlords, has turned the "Boy King" and his "mad quest for war" into a running joke that has swept the badlands and embarrassed the King. These two gangs have clashed on more than a few occasions (small skirmishes) and the Sabre Warriors have won every time. Furthermore, Sabre Lasar has never taken Macklin seriously, and, in King Macklin's mind, treats him with disrespect. In truth, Lasar thinks King Macklin has potential, but sees the young man as an impatient hothead willing to sacrifice thousands of lives in what can only be a massacre. He also recognizes that Macklin is treacherous in the extreme and will have nothing to do with him.

However, all of King Macklin's bluster, talk of war and raids against the CS troops *has* caught the attention of the Coalition Military. Unknown to King Macklin, General Kashbrook, a true military genius, is coordinating Coalition forces and establishing base camps along the eastern border of the CS northern quadrant (Wichita Falls down) for a major offensive against him, his raiders and his outlaw Kingdom of Worth (the old Fort Worth area).

Real Name: Victor Macklin

Species: Human

Alignment: Diabolic

Hit Points: 51; **S.D.C.:** 30

Height: 5 feet, 11 inches (1.8 m); **Age:** 29

Weight: 210 lbs. (95 kg) of muscle and meanness.

Attributes: I.Q. 11, M.E. 15, M.A. 10, P.S. 23, P.P. 12, P.E. 14, P.B. 10, Spd 15

Disposition: Macklin is a scheming, paranoid megalomaniac. He prefers to let others do his fighting for him, although he can fight in a pinch. His weapons of choice are deceit and treachery, both of which he uses masterfully to weasel his way out of trouble and into power. When forced to fight his own battles, he will utilize every advantage he can get, he fights dirty and, though he may pretend otherwise, offers no mercy — many of his opponents have died from gunshots in the back or after they foolishly showed Macklin mercy. No tactics, evil or sacrifice of others is too low or too great if it gets him what he wants. Macklin also has sadistic tendencies and enjoys inflicting emotional, mental and physical torture.

Experience Level: 10th level Pecos Raider/Mercenary Fighter

Skills of Note: Speaks American and Spanish at 98%, literate in American and Spanish at 75%, pilot motorcycle 98%, fishing 95%, horsemanship 96%, wilderness survival 85%, land navigation 82%, prowl 85%, palming 80%, identify plants 80%, track animals 75%, athletics, sniper, hunting, W.P. sword, W.P. energy pistol, W.P. energy rifle, W.P. automatic pistol.

Combat Skills: Hand to hand: expert

Number of Attacks: Six

Bonuses: +1 on initiative, +2 to strike, +4 to parry and dodge, +11 to S.D.C. damage, +3 to pull/roll with punch, fall or impact, kick attack (1D6 damage), critical strike on 18-20, judo-style body throw/flip, paired weapons.

Magic Knowledge: None

Psionic Knowledge: Major psionic; needs a 12 or higher to save vs psionic attack; I.S.P.: 51. Psi-powers include mind block, empathy, sixth sense, clairvoyance, see the invisible, bio-regenerate (self), and resist fatigue — all of which contribute to his reputation for astounding luck and an uncanny instinct for being at the right place at the right time.

Weapons and Equipment: Macklin has a set of old-style SAMAS power armor that he "conveniently found" on one of his Lone Star raids. He is armed with a C-14 Assault Laser, a C-18 Laser Pistol, and a vibro-saber in addition to an array of other weapons.

Description: A saturnine man in his late 20's with dark eyes and dark, shoulder length hair. Macklin has a moustache and goatee deliberately trimmed to look sinister. He enjoys intimidating others and will often stare at a person (refusing to answer their simplest questions or

to otherwise acknowledge them in any way) just for the sadistic pleasure of making them sweat.

Money: Macklin has access to several million in credits.

Henchmen of Note: Matthew Brehan, a renegade CS Major, diabolic 8th Level RPA SAMAS pilot (he too has an old-style SAMAS with rail gun and particle beam rifle); Nick Bastone, a 7th level, miscreant Juicer; Robert "Death don't scare me" Bastone, Nick's little brother, an anarchist, 5th level Juicer; Big Bob, a 6th level miscreant Mega-Juicer; and Lord Faltennal (elf), 6th level Ley Line Walker of anarchist alignment. These five men are part of King Macklin's elite warriors and most trusted cohorts.

The average bandit under his command is 3-6th level; 10% are Juicers, 20% Headhunters, 20% Wilderness Scouts, 20% thieves/bandits, 3% Crazies, 4% 'Borgs, and the rest vary.

Note: Also see the *Kingdom of Worth* for more about King Macklin.

Orpheus The Titan

Orpheus the Titan is originally from the Palladium world. After years of adventuring in his native world, he came upon an open dimensional portal leading to Rifts Earth. This Rift was caused by an excess of magical energy being cast during a battle between two sorcerous factions within the Federation of Magic. The Rift brought Orpheus straight into the fight and the warring sides stopped battling each other to jointly attack this newcomer in their midst.

Despite his best efforts at defense, the giant would have been overwhelmed had it not been for the timely intervention of two strangers who drove off the attackers and saved Orpheus. These two adventurers, Gilgamesh the Wanderer and Endiku Longhair (presented in **Pantheons of the Megaverse**, pages 62-65), invited the titan to accompany them on their travels.

Orpheus remained with the pair until he learned enough about this new world to determine his own goals. After frequent and extended meditation, the titan finally divined that his destiny lay to the south. Orpheus' parting was amicable, the trio remain friends and any of them will rush to the aid of the others should they learn of their friend's plight.

His travels eventually brought him to the Pecos Empire and the budding community of Houstown. At that time, Houstown was a coastal town with a population of several thousand. However, it was a town under siege. Sea monsters from the nearby Gulf of Mexico were destroying the fishing boats and, on a few occasions, coming ashore to prey on the townspeople.

The town's previous champions had been killed on an ill-fated expedition to rid Houstown of these creatures and the remaining townsfolk were fragmented and unable to establish an effective defense. Orpheus took command of the situation and rallied the townsfolk behind him. Inspired by the titan's leadership (and aided by his not inconsiderable prowess), the people banded together, slew the most bold and dangerous of the sea serpents and built better defenses. Afterward, it seemed only natural that they should proclaim Orpheus as their leader.

After accepting the position of Mayor, Orpheus sought out alliances with his neighbors and actively recruited new citizens from among the nearby clans, tribes and bandits. Due to his efforts, people began to regard Houstown as a safe community and a trade town. Slowly at first, but then, as word began to spread, people, by the hundreds, began to make the city their home. Within a couple of decades, Houstown has become the jewel of the Pecos Empire and one of the truly thriving cities not under CS control.

As Houstown started to grow, Orpheus eventually added "Lord" to his title of Mayor; a title of authority recognized by most of the nomads, tribal leaders and warlords. **Note:** See the description of *Houstown* for more details.

Real Name: Orpheus Stonewalker

Species: Palladium Titan

Alignment: Principled

Hit Points: 55; **M.D.C.:** 160; **Age:** 180

Height: 13 feet (3.9 m)

Weight: 700 lbs. (317 kg)

Attributes: I.Q. 13, M.E. 10, M.A. 12, P.S. 21, P.P. 25, P.E. 26, P.B. 20, Spd 12

Disposition: Orpheus is basically a nice person who has been forced by circumstances to become somewhat aloof from the people he is trying to assist. The titan accepted his present position because he felt (correctly) that there was no one else available who could do the job as well as him. A leader by example, Orpheus is trying to act as a role model for his people but, thus far, has only achieved limited success in his efforts to change their attitudes.

Although many people respect the giant for his abilities and strength of character, his views are considered too radical, particularly among the Pecos Raiders ("What? Raiding is wrong?? That's blasphemy!").

Experience Level: 9th level Warrior and Mystic.

Skills of Note: Speaks Elf/Dragonese, Troll/Giant, and American at 98%, literate in Elf/Dragonese at 98% and in American at 80%, dance 90%, monsterness 86%, wilderness survival 90%, holistic medicine 75%, streetwise 61%, lore: demons/monsters 75%, hunting, W.P. sword, W.P. knife, W.P. Heavy, W.P. heavy energy weapons.

Combat Skills: Hand to Hand: martial arts

Number of Attacks: Seven (7)

Bonuses: +2 on initiative, +7 to strike, +8 to parry and dodge, +6 to damage, +3 to pull/roll with fall or impact, +6 vs poison, +9 vs magic, +22% vs coma/death, 50% to charm/impress, +4 vs horror factor, entangle, kick attack (2D6 damage), critical strike on 18-20, paired weapons, judo-style body throw/flip, jump kick, leap attack.

Magic Knowledge: Spells: Globe of daylight, climb, concealment, levitation, mystic alarm, see aura, thunderclap, fingers of wind, turn dead, armor of ithan, charismatic aura, resist fire, trance, cure minor disorders, shadow meld, superhuman strength, superhuman speed, cure illness, tongues, globe of silence, invulnerability, wisps of confusion, oracle, mute, speed of the snail, mystic portal, and control/enslave entity. +2 to spell strength (opponents need a 14 or higher to save). **P.P.E.:** 141

Psionic Knowledge: Major psionic. Psi-powers include: Clairvoyance, exorcism, sixth sense, astral projection, see the invisible, sense magic, induce sleep, psychic purification, and P.P.E. shield. Can also Sense supernatural evil (390'/118.9 m) 95%, and Open oneself to the supernatural 95%. Needs 10 or better to save vs. psionics. **I.S.P.:** 79.

Weapons and Equipment: Although he relies primarily on his magic for protection in combat, Orpheus does wear a suit of giant-sized chain armor for sentimental reasons (it was a gift from his father on Orpheus's coming of age day). The armor has 90 M.D.C. Orpheus is usually armed with an NG-202 rail gun and a giant-sized Vibro-Sword (4D6 M.D. damage).

Description: A muscular giant with silver hair and dark eyes.

Money: Orpheus has almost two million credits readily available and can obtain another 8 million with a few days notice.

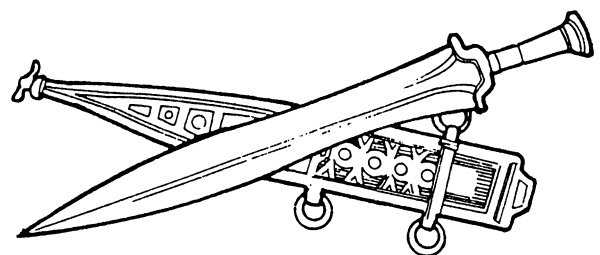

Zimchex — Simvan

Zimchex is the tribe leader of the **Pervic Simvans** of the Grande Range, as was his father and grandfather before him. However, Zimchex, as a younger sibling, would not have become chief if his older brother had not been slain by the Coalition.

The Grande Range is renowned as fine horse breeding country and the Simvan who live there have found horse trading throughout the Pecos Empire (and beyond) to be a very profitable endeavor. The Grande Range is also infested with small carnivorous dinosaurs, like the *Ostrasaurus*, which is not a problem for these famous, monster riding and taming D-bees.

Several years ago, a Pervic trading expedition near Fort El Dorado was ambushed and nearly wiped out by a Coalition force returning to Lone Star. Among the casualties was Zimchex's brother who was leading the expedition, and the heir apparent to lead the tribe. Warriors dying in battle is common among the Simvan and considered an honorable fate. However, Zimchex's brother was on a peaceful mission to sell some horses and, according to non-Coalition witnesses, was gunned down from behind and without warning. More important than any of Zimchex's feelings for the loss of his brother, is the loss of honor in the manner of his brother's death. Since that time, Zimchex has become an implacable foe to the Coalition (especially to Lone Star). He and elite warriors of his tribe are constantly using hit and run tactics against CS troops foolish enough to venture south of Odessa, and frequently send dangerous wild animals (dinosaurs, Rhino-Buffalo, etc.) into the Coalition's northern quadrant. Because it vexes the CS, he and his people also help runaway mutant animals defect from the CS Military and make a new life in the American Southwest. Consequently, 2% of the tribe are mutant animals, mostly Dog Boys. The Pervic Tribe are also renowned vampire slayers and friends with *Reid's Rangers*.

Although they will trade with humans and a variety of D-bees, and have sold horses and tame animals to virtually every outlaw group and many tribes in the Pecos Empire and Freelands, the Pervic Tribe keeps to itself and is composed entirely of Simvan and a small percentage (3%) of renegade CS mutant animals. They have a number of minor feuds with rival Simvan clans and Indian tribes, but have a long-running and bloody vendetta with the *Long Knives Tribe* (Psi-Stalkers). This feud has lasted nearly four generations, and although Zimchex generally respects and likes Psi-Stalkers, this tribe is a hated and ancient enemy.

After his brother's death, Zimchex was accepted as chief of the tribe and has led them ever since. Other than the inevitable challenges from ambitious young bucks, there have been no serious threats to Zimchex's reign of office.

Real Name: Zimchex

Species: D-Bee: Simvan

Alignment: Unprincipled

Hit Points: 68; **S.D.C.:** 108

Height: 5 feet, 10 inches (1.79 m)

Weight: 180 lbs. (82 kg)

Attributes: I.Q. 12, M.E. 15, M.A. 6, P.S. 15, P.P. 18, P.E. 23, P.B. 7, Spd 27

Disposition: Zimchex is a gung-ho type who enjoys a good fight and is always at the forefront of his troops during a battle. He takes his responsibilities as Tribal Chieftain seriously, and always tries his best to keep his tribe prosperous. The only thing that sometimes clouds his judgement is his vendetta against the Coalition Army and Long Knives Tribe. Although he is the leader of his tribe, Zimchex considers his position to be simply the "first among equals" and will readily accept advice from his warriors and the tribal elders (although he may not necessarily act upon it). Zimchex is tolerant of other races (he likes most Tokanii and Psi-Stalkers) and accepts just about any enemies of the Coalition as his friends.

Experience Level: 8th level Simvan Monster Rider

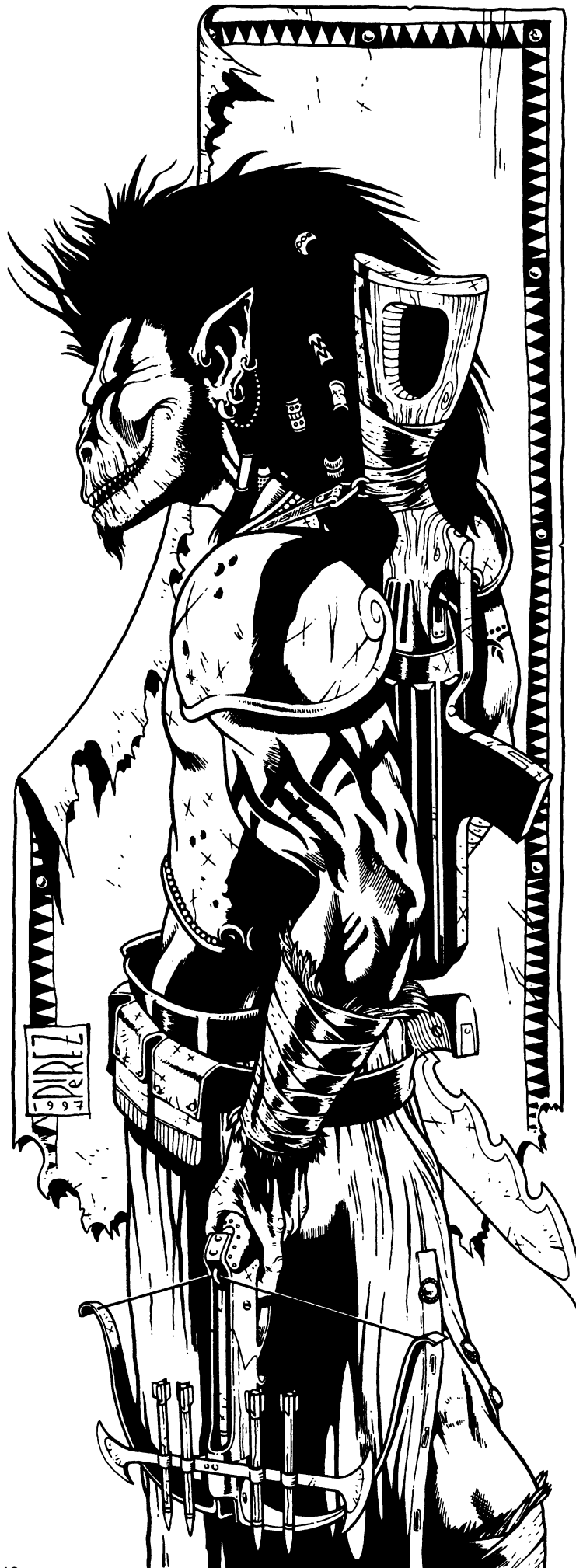

Skills of Note: Speaks American at 85%, literate in American at 65%, ride exotic animals (monsters) 98%, wilderness survival 95%, land navigation 88%, carpentry 80%, prowl 80%, identify plants 80%, radio: basic 80%, track humanoid 80%, track animals 75%, climbing 75%, faerie lore 60%, athletics, body building, running, hunting, W.P. knife, W.P. energy pistol, W.P. energy rifle, W.P. archery & targeting, W.P. automatic rifle, W.P. blunt.

Combat Skills: Hand to hand: assassin

Number of Attacks: Seven

Bonuses: +4 vs poison & magic, +16% vs coma/death, +4 to strike, +6 to parry and dodge, +4 to pull/roll with punch, fall or impact, knock-out/stun on 17-20, entangle.

Magic Knowledge: None

Psionic Knowledge: Major psionic; psi-powers include: empathy, telepathy, sixth sense, mind block, and mind bond (super), as well as a psychic affinity with animals similar to those of the Psi-Stalker (see *Rifts® RPG*, page 106, #8). **I.S.P.:** 85

Weapons and Equipment: Zimchex wears lightweight Simvan body armor (45 M.D.C.) and is armed with an NG-L5 laser rifle, an NG-33 laser pistol, and a vibro-knife in addition to conventional weapons; such as a crossbow and arrows for fighting vampires, a Techno-Wizard six-shooter that fires energy bolts (1D6 M.D. per blast; more on them in *Rifts® New West*), and others.

Description: Zimchex is a Simvan of average build. His looks would not be considered out of the ordinary except for a scar running down the left side of his face.

Money: Although the horse trade has been very lucrative for his tribe, often the Simvans are paid off through bartering of food supplies, weapons, equipment, building materials, fabric, and other supplies and/or services. Consequently, there is not usually a lot of ready cash on hand. Also, most of the bartered supplies and equipment are distributed among the members of the tribe. However, in a pinch, Zimchex can throw enough cash and equipment together for a value of 450,000 credits (give or take) on the Black Market.

Lianna The Wild

Lianna San Doria was born and raised in the Pecos Empire in one of the small villages near the Mexican border. Lianna comes from a prominent family and, had circumstances been different, could have looked forward to a life that consisted of an arranged marriage and raising a respectable family. Instead, when Lianna was 17, her village was attacked and sacked by bandit raiders. Lianna herself was carried off and given to the leader as his mistress.

Realizing that resistance was futile (at least for the moment), Lianna feigned acceptance of her situation and lulled her master into a sense of security through flattery and catering to his every whim. The leader indulged her by allowing Lianna to learn how to ride and shoot. She learned the skills of a Pecos Raider as she bided her time and awaited her opportunity for revenge.

Her chance came after an unsuccessful raid in a series of unsuccessful raids. Their bellies empty and hard times making life miserable, many of the bandits were unhappy with their leader and in a rebellious mood. The leader sneered and issued a challenge for anyone who wanted his position to step forward and fight him, winner take all! To the astonishment of everyone there, Lianna stepped forward.

The raider chief was so dumbfounded by this, he laughed and did not take his opponent seriously. This proved to be a fatal mistake as her quick draw beat his, and sent his brains flying across the parched Texas desert. Although some of the bandits objected to a woman being their new leader, there was enough support for Lianna to allow her the chance to show if she could handle the job.



Lianna again surprised everyone by being a very capable leader and very good tactician. Relying greatly on boldness and bravado, Lianna's first few raids were so successful that most of her opposition melted away. After a couple of holdouts were beaten in duels, Lianna became the undisputed leader of the band. She has renamed the gang "the *She-Devils*," and has held the respected position of gang Warlord ever since.

Like most nomadic outlaws, the She-Devils are go wherever spoils are plentiful and plunder is easy. However, her main range or circuit for raids is the Freelands west from the (not so) secret CS spy outpost in the ruins of Colorado City, east through the Kingdom of Worth, the Haunted Ruins of Dallas and into Arkansas and Louisiana. Her favorite place to rest and relax is Houstown.

Real Name: Lianna San Doria

Species: Human

Alignment: Aberrant

Hit Points: 44; **S.D.C.:** 39

Height: 5 feet, 8 inches (1.7 m)

Weight: 110 lbs. (50 kg)

Age: 28

Attributes: I.Q. 14, M.E. 12, M.A. 13, P.S. 11, P.P. 21, P.E. 17, P.B. 15, Spd 15

Disposition: Lianna is a woman who definitely knows her own mind.

She may listen to advice from others but the final decision will be hers. Lianna can be extremely stubborn but if she realizes that a course of action is not working, she can change her plans without hesitation. As a leader, Lianna relies more on inspiration than on advance planning (the one occasion that she was forced to bide her time was enough to last her a lifetime). Although she sometimes maintains a gruff exterior and bullies and curses out her men, she is very protective of them and will risk her own life for any of them without a second thought. Lianna is also very caring of innocents and will not allow any of her henchmen to harm them. Her outlaws never engage in rape or torture of women or children, and they rarely kill for the sake of killing. When robbing from the poor (something she regrets), she always tries to leave them enough food and supplies to avoid hardship. Although she can actually be quite sentimental and compassionate when she chooses, Lianna will probably punch out anyone foolish enough to say this to her face.

Experience Level: 9th level Gunslinger

Skills of Note: Speaks American and Spanish at 98%, literate in American and Spanish at 85%, horsemanship 98%, cooking 80%, pilot hovercraft 82%, wilderness survival 80%, land navigation 78%, prowl 80%, identify plants 75%, track animals 70%, athletics, hunting, W.P. Knife, W.P. Energy Pistol, W.P. Energy Rifle, W.P. Automatic pistol.

Combat Skills: Hand to hand: martial arts

Number of Attacks: Six (+1 when using handguns).

Bonuses: +7 on initiative, +7 to strike, +6 to parry and dodge, +3 to pull/roll with punch, fall or impact, kick attack (2D4 damage), +1 vs poison & magic, +5% vs coma/death, jump kick, entangle, leap attack, critical strike on 18-20, paired weapons.

Magic Knowledge: None

Psionic Knowledge: Minor psionic; psi-powers: resist hunger, resist thirst. **I.S.P.:** 50

Weapons and Equipment: Lianna is partial to wearing full environmental body armor. She will usually try to get the finest set of non-powered armor that she can obtain (she prefers Gladiator and Crusader but will wear the best thing available). Lianna is armed with a TX-43 laser assault rifle (3 settings: 6D6 S.D.C., 2D6 or 4D6 M.D.; 20 shots, 2000 ft/610 m range), NG-56 ion pistol (2D6 M.D.), a TX-5 Pump Pistol, and a pair of heavy Techno-Wizard six-shooters that fire energy bolts (2D6 M.D. per blast; more on them in **Rifts® New West**), and a vibro-knife in addition to conventional weapons.

Description: A fiery Latino beauty with flashing eyes and dark, shoulder length hair.

Money: Lianna usually carries around 2D4×10,000 credits in a combination of universal credits, gems, and other items. She can also tap into her emergency funds for another 270,000. If she really needs money, as a last resort, her men can chip in for another hundred thousand.

Note: Her high P.E., lightning quick guns (high P.P.) combined with her psionic abilities, and intelligent leadership have made Lianna a legend among her men. As one of the few female gunslingers and bandit leaders of the Pecos Empire, her name and reputation is known throughout most of the American West and Southwest as well as throughout the Coalition States — three popular, Clint Eastwood style films have been made based on her name and stories about her (70% fictitious) but they are almost as outlandish as the real life character. Although her outlaw band is not a large force (only 70-100 riders at any given time, plus another 200 family members usually left behind), they are totally loyal and would ride into the jaws of hell if Lianna was leading them.

Lianna's She-Devils consist of 70 regulars (another 10-30 transients will come and go), but they often splinter into smaller groups of 10-20; they rendezvous regularly and ride at full strength. Despite the gang's name, 70% are males — 19% are wilderness scouts, 17% thieves, 14% bounty hunters, 12% Gunslingers, 10% Gunmen, 10% headhunters and the rest vary; 80% are human, the rest are Simvan, Psi-Stalkers and a few others. Average level of experience is 4th to 8th level.

Sundance

Sundance, also known as the *Sundance Kid*, as in the "original" Sundance Kid of pre-Rifts 19th century — is an honest to god, living legend. Sundance was born and raised in the Old West of pre-Rifts times. He and his best friend *Butch Cassidy* were the leaders of an outlaw gang known as the *Wild Bunch*. The Wild Bunch flourished for several years, robbing banks and trains, making both Butch and Sundance famous, or notorious, as you will.

After the gang disbanded, the pair continued their outlaw career. Eventually, with the manhunt for them becoming more intense, the two friends were forced to flee the country. They eventually ended up in the nation of Bolivia (on Rifts Earth, an area now occupied by the Megaversal Legion). There, according to legend, the local troops caught up with the duo, and, after a hard fought battle, Butch and Sundance were killed when they fell off a cliff and into a river. Their bodies were never found.

What really happened was that upon leaping off the cliff, Butch and Sundance got separated. Instead of drowning, Sundance was swept by the river through a dimensional portal and was Rifted through space and time to Bolivia of Rifts Earth, circa 97 P.A. After some initial disorientation, Sundance eventually made his way north to the Pecos Empire.

The gunslinging outlaw has adapted quickly and well to the strangeness of this "future" Earth (a concept he still has trouble believing, especially with all them monsters and all). In some ways, he likes the American West and southwest better than his time period, because he thrives on the absolute anarchy. He loves the wild and unpredictable nature of the world and even the strange and monstrous men and creatures that now inhabit it. He also gets a kick out of handguns that can blow a hole completely through a horse with a single shot — although he can't get used to weapons that don't make a loud noise and don't have a recoil. Magic is a concept he still finds amazing and vampires and the supernatural sends shivers up and down his spine. "They ain't natural! I hate 'em."

He has quickly earned a reputation as a genuine "hero" from the legendary Old West; although some suspect he's a D-bee or a fraud. Sundance has managed to convince a number of outlaws of his genuine credentials and a number of them convinced him to rebuild the Wild Bunch. The charismatic gunslinger now holds a position of some



authority as leader of the (new) Wild Bunch Gang, a raiding band some 500 strong. Within six short years (it took him two to get from Bolivia to Texas — he refuses to call it Lone Star, although he kinda likes the name Pecos Empire), he has become nearly as famous as he was in the past. This time, a lot of his notoriety comes from the fact that most people believe he *is* the Sundance of old. The Coalition doesn't know what to make of this character. Most assume he's a lunatic, confidence man with a wonderful act, or a D-bee fraud — they cannot believe he is a human from the days before the Great Cataclysm. One of the scientists at GED has suggested that body chemicals and other aspects of his physiology might be able to prove or disprove whether he really is from Earth's past, but no one in authority has taken him up on the offer (Bradford couldn't care less). Sundance and the Wild Bunch have become a thorn in the Coalition's side, hitting cargo transports with increasing impunity. More worrisome, is how fast and completely he's been accepted into the Pecos Empire's culture. The CS fears that this alleged "living legend" could eventually become so popular that he could unite the Pecos outlaws into a real Empire. Of course, this cannot be allowed.

Real Name: Harry Longabaugh

Species: Human from pre-Rifts Earth.

Alignment: Anarchist (with aberrant tendencies)

Hit Points: 54; **S.D.C.:** 31

Height: 6 feet, 2 inches (1.9 m)

Weight: 195 lbs. (88 kg)

Age: 40

Attributes: I.Q. 13, M.E. 15, M.A. 19, P.S. 14, P.P. 22, P.E. 16, P.B.

15, Spd 12

Disposition: Sundance is a clever, amazingly resourceful and likeable brigand, with loads of charm, a quick wit and supreme confidence. He tends to be a straight shooter (no pun intended) and deals with

most people in a very straightforward way. Back when Sundance was in the original Wild Bunch, he preferred to handle the shooting and let Butch Cassidy make the decisions. Now, he has been saddled with a position of responsibility. Although Sundance has been handling it well, he will still defer to the suggestions of his men if they seem to know what they are talking about. In many cases, he's just along for the ride.

Sundance has the conviction (true or not) that if he survived the journey to Rifts Earth, then so did Butch Cassidy. Sundance has an open offer of 50,000 credits to anyone who can provide him with information that will lead him to find his best friend (G.M.s: Here is a plot device to run with).

Experience Level: 10th level Gunslinger

Skills of Note: Speaks American and Spanish at 98%, literate in American 75%, literate in Spanish 65%, horsemanship 98%, wilderness survival 95%, tracking 90%, gambling 85%, detect ambush 85%, land navigation 72%, pilot hovercraft 75%, first aid 65%, radio: basic 65%, hunting, athletics, W.P. revolver, W.P. bolt-action hunting rifle, W.P. energy pistol, W.P. energy rifle, W.P. sharpshooting -Revolver, W.P. sharpshooting: hunting rifle, W.P. sharpshooting: energy pistol, W.P. sharpshooting: energy rifle, W.P. knife.

Combat Skills: Hand to hand: expert

Number of Attacks: Six, plus one extra shooting attack if using a specific weapon of expertise.

Bonuses: +6 on initiative, +6 to strike, +7 to parry and dodge, +3 to damage, +2 to pull/roll with punch, fall or impact, critical strike on 18-20, knockout/stun on 18-20, paired weapons, kick attack (1D6 damage), judo-style body throw/flip. Special bonuses for shooting.

Magic Knowledge: None

Psionic Knowledge: None

Weapons and Equipment: Sundance finds armor confining and would ideally prefer not to wear it at all. However, he is pragmatic enough to realize that for most fights on Rifts Earth, not wearing armor would be tantamount to suicide. For this reason, when he is forced to wear armor, he typically wears something lightweight like Plastic-Man or Huntsman (preferring quickness to brute strength). As for weapons, Sundance's favorite weapon is his old, reliable Colt .45 pistol, but since arriving on Rifts Earth, he has mastered energy sidearms. Generally, Sundance will have a laser rifle, 1D4+1 hand grenades, 1D4 flares, a pair of laser pistols, his Colt .45, and a vibro-knife on his person. A pair of small Vibro-Blades (1D4 M.D.) are concealed in the tips of his boots and are used as a last resort, surprise attack when he needs them. He also keeps a hundred rounds or so of silver bullets, and a silver plated dagger in case of vampires. He hates vampires and tries to avoid the Mexican border for that reason.

Description: A moustached man in his 40's with long, blond hair that comes down to just above the shoulders. Several pre-Rifts film buffs among the raiders have noticed that Sundance bears a striking resemblance to an old-time actor named Redford ... or are they seeing more than what's really there?

Money: Sundance usually carries around 20,000 to 30,000 credits in cash, gems, and other items. If he needs to tap into the funds he has salted away, he can get another 300,000.

Note: Although many of the Pecos bandits have accepted Sundance's origin at face value, there are those who think that he is either delusional or just cashing in on a fake story. After all, if Sundance really is from the 19th century Wild West, he should be familiar with many of the other famous cowboy heroes of that era. Yet Sundance claims that certain heroes known from pre-Rifts times, such as Gene Autry, the Lone Ranger, and the Man with No Name/Clint Eastwood, weren't real — at least he never met them.

Warlord Grange

Warlord Grange is the commander of the nefarious **Pecos Riders**, one of the largest, most powerful and infamous gangs of bandits operating in the Pecos Empire and the surrounding southern and southwestern territories. Like most outlaw bands, his organization is almost always splintered into dozens (if not hundreds) of small bands. Warlord Grange is always in command of a force of several hundred Riders (2D4x100; typically 2-5th level; humans and D-bees).

Allen Grange was born and raised in the loose-knit confederation of bandits, rogues and barbarians known as the Pecos Empire. Like many a young man in the Empire, he joined a gang and became an outlaw. Unlike most, Grange was not content to simply do as he was told. Whenever he was given an order, Grange would question if the way that they did things was for the best. Although he often drove his Raider leader and comrades to distraction with his unconventional ways of doing things, most of the time he was correct. His methods, though sometimes unorthodox, were usually innovative and more effective than the standard ways his comrades used.

Although some of his more conservative fellow raiders had no use for these methods (or for Grange himself), several of his comrades (usually the ones who benefitted the most from his innovations) encouraged him and said that he was the kind of leader that they wanted. This inspired Grange to take his next bold step. When Grange's term of service was over, he decided to start his own gang.

With only a few comrades to begin with, Grange's fledgling band soon made a name for themselves. A natural leader and tactical genius, Grange led his men over obstacles that would have deterred larger raiding bands and often defeated enemies against great (sometimes overwhelming) odds. As word began to spread about this brilliant young

commander, other bandits and mercenaries began to join his band. Within a few years, Grange was a rising star of the Pecos Empire and "Grange's Riders," also known as the "Pecos Riders," (because 60% of his gang rode horses and other animals) was becoming famous. Grange turned out to be a gifted organizer as well, and soon established a small but thriving kingdom in the southern part of the Empire, at Uvalde, to serve as his home base of operations.

Today the core members of his gang number into the hundreds, with transients and hangers-on that can increase the size of his band by 30-50%. In addition to his followers, there are a number of other smaller bands with whom he has made alliances or otherwise brought into his sphere of influence. In times of great need, these bands would willingly join forces with him, effectively giving access to a small army of 7000-11,000 warriors. All this has made the young warlord one of the prime movers and shakers of the Pecos Empire. He has also made some of the elder warlords nervous and sees Warlord Sabre Lasar as his only true rival. The men have met and fought alongside each other several times. Both have the utmost respect for the other, but both believe they should be the ones to unite and rule the Pecos Empire. Whether these two powerhouses will ever face each other on the battlefield as enemies is hard to say. Only time will tell.

Warlord Grange

Real Name: Allen Grange

Alignment: Aberrant

Hit Points: 54; **S.D.C.:** 47

Attributes: I.Q. 14, M.E. 16, M.A. 17, P.S. 14, P.P. 12, P.E. 13, P.B. 12, Spd 12

Height: 6 feet, 1 inch (1.8 m)

Weight: 175 lbs. (79 kg)

Age: 36

Disposition: Having been raised in the Pecos Empire, Grange does not see anything morally wrong with raiding his neighbors nor are these raids motivated by any ill will toward his prospective victims ("It's just a job!"). In most cases, he is not resentful of any of his victims who fight back, even when they foil his plans or hurt him or his men ("Hey, that's their job! It's just the breaks of the game!"). However, there are certain unspoken rules that Grange goes by and when these rules are violated, it becomes a personal matter.

In his younger days, Grange preferred to lead by example. Although this is not always possible. He is still a "hands-on" leader when the opportunity arises, but with the large number of men under his command and/or influence, it is hard to personally handle all the affairs of his growing power base. Even now, after all that he has accomplished, Grange still continues to question the traditional. He is constantly looking for new solutions to old problems. The old adage, "If it isn't broke, don't fix it!" has never applied to Allen Grange.

Experience Level: 11th level Wilderness Scout

Skills of Note: Horsemanship, fishing, climbing, wilderness survival, all at 98%, speaks American, Spanish, Dragonese/Elf, 98%, literate in American, Spanish, 95%, land navigation 96%, identify plants 95%, cook, prowl, track animals, all at 90%, W.P. Knife, W.P. Sword, W.P. Energy Rifle, W.P. Hunting Rifle.

Combat Skills: Hand to hand: expert

Number of Attacks: Five

Bonuses: +2 to strike, +3 to parry and dodge, +3 to damage, critical strike on 18-20, knockout/stun on 18-20, paired weapons, kick attack (1D6 damage).

Magic Knowledge: None

Psionic Knowledge: None

Weapons and Equipment: Grange has access to a number of weapons and armors. He prefers Huntsman armor for most situations but has a set of Crusader armor for when he knows he is going into a battle. He generally carries a TX-11 Laser Rifle and a vibro-sword.

Description: A bearded man in his mid-30's with reddish-brown hair cropped short. Grange is alert, clever, resourceful and thinks quick.

Money: As a warlord of the Pecos Empire, Grange has access to a not so small fortune (loot from many years). He can readily lay his hands on 350,000 credits and can get triple that amount within 24 hours (larger amounts can be obtained but may take longer).

Emperor Sabre Lasar

The man who would be Emperor

Sabre Lasar is the self-proclaimed “Emperor” and “Supreme Leader” of the so-called Pecos Empire. He is “the” most notorious, flamboyant and, arguably, powerful bandit leader in the Pecos Empire. Without question, he commands the largest and most powerful legion of cutthroats, mercenaries, thieves and miscreants in the State of Lone Star. Furthermore, Warlord Lasar has proven himself to be a strong and decisive leader with excellent military strategy and tactical skills that have enabled him to assail villages and towns (it is said that even the cities of El Paso and Ciudad Juarez tremble when Lasar and his men come to town) and even a full CS armored division (5760 troops)! However, even the great and powerful Sabre Lasar really only has approximately 6000 men among his regular and most loyal troops. This number can swell by 50% and rarely drops below 5500, so he has at his beck and call the equivalent of one military division — an impressive number, but hardly an empire.

Why Warlord Lasar’s dreams of empire building have a real glimmer of hope is that many smaller gangs, clans and tribes turn to him for guidance, advice and help. They are also quick to join him in special operations and consider him one of the great (if not the greatest) leaders of the land. Furthermore, many of the other gangs have turned to Warlord Lasar to lead them during times of war (typically a CS siege) and during other crises requiring military strength and strong leadership.

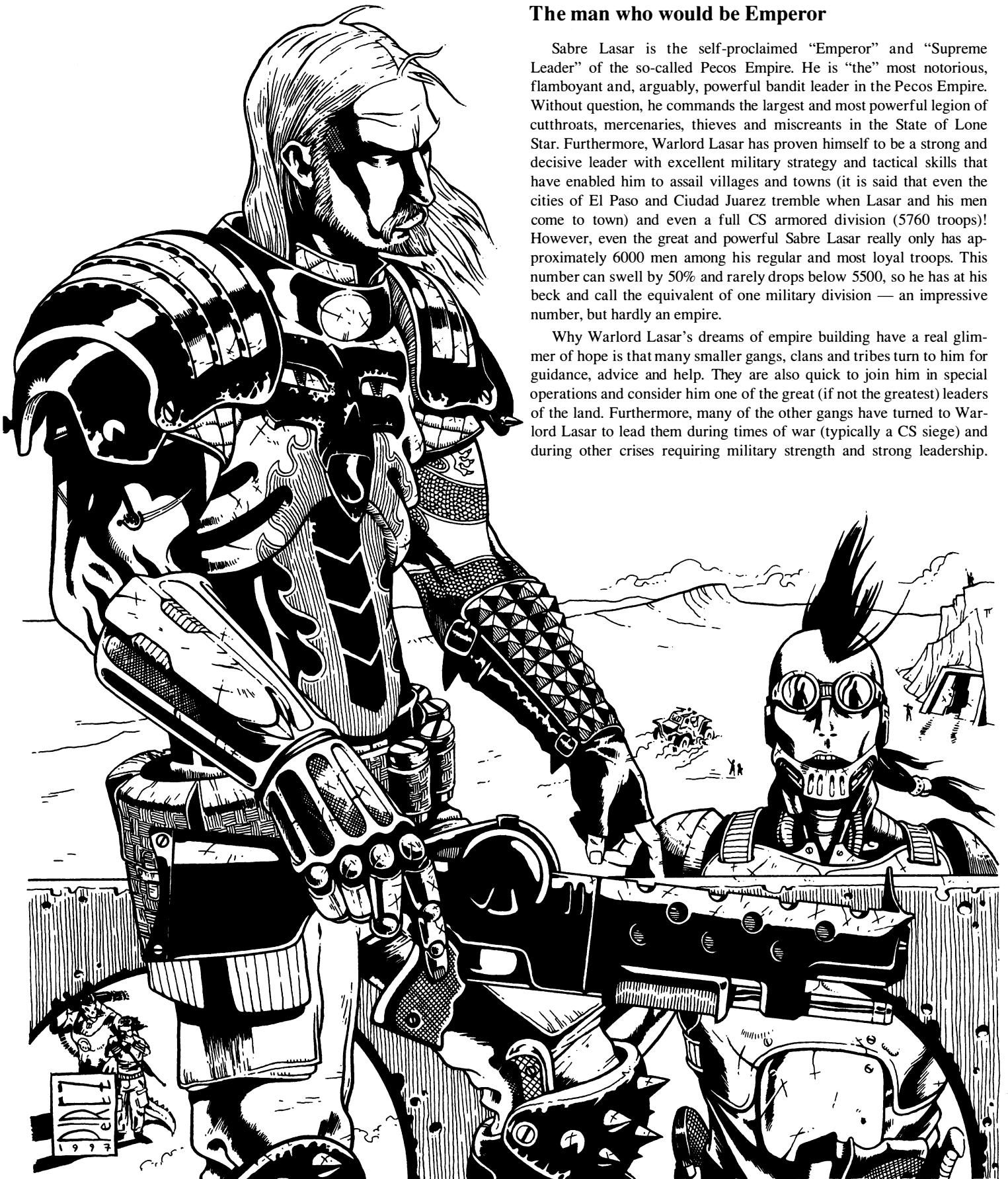

During such periods of crisis, the feuds and rivalries between the different gangs are (mostly) abandoned while temporarily united against a common foe. Emperor Lasar has led six out of nine such campaigns (he did not participate in three early battles because he was not asked to lead, and two ended in disasters). Typically, roughly one third to half the people unite — fifty thousand combat troops (plus families, for a support group of approx. 260,000) is the largest number of bandit troops Lasar has ever commanded.

His self-proclamation of “Emperor” is a half-hearted one that he does not take too seriously, although it is his ultimate goal.

Sabre Lasar

Human Identity: Sabre Lasar (pronounced Say-bur Lah-Sahr)

Real Name: Unknown

Alignment: Aberrant

G.M. Note: Sabre Lasar is really a young adult *fire dragon*. Nobody knows his secret, and he is always disguised as a human.

Attributes: I.Q. 20, M.E. 19, M.A. 20, P.S. 34, P.P. 18, P.E. 22, P.B. 14 in human guise (26 as a dragon), Spd 20 (or so he pretends as a human, but really 90 running and 150 flying). Supernatural P.S. and P.E. — He usually tries to pretend to be an unusually strong (even super-strong) human. Some suspect he may be an experimental Crazy with hidden implants, others suspect magic is at work, and others suspect he is a runaway mutant from the Lone Star Complex; rumors run rampant about this “man.”

Damage: Restrained punch 4D6 S.D.C. damage plus P.S. bonus, full strength punch does 4D6 M.D., power punch 1D6×10 M.D. (counts as two attacks), kick or slashing tail attack 5D6 M.D., bite does 4D6 M.D., or fire breath: range 200 feet (61 m), six feet wide (1.8 m), inflicts 6D6 M.D. and can be used as often as four times a melee.

Hit Points/S.D.C.: Pretends to be a mortal man with 80 or so hit points and 60 S.D.C. — he’s become quite expert at acting mortal and feigning human frailty.

Mega-Damage (dragon): 3000

Height (human): 6 feet, 8 inches (1.95 m)

Weight (dragon): 20 tons

Age: Appears to be in his early 40s (741 years old).

Horror Factor/Awe: 10 as a human (really 16 as a dragon).

Disposition: He is an impressive looking individual, full of confidence and tough as nails. Little seems to scare him and he often acts as if he’s invincible (compared to humans, he is). Sabre Lasar is usually in the thick of combat with his men, and his human (or so they believe) courage is an inspiration to all who see him. He can be cold, merciless to those whom he despises, and yet has his own code of honor and ethics that makes him honorable and surprisingly merciful (if the person is deserving of his mercy). Although he can be stern and serious, there is a likeable playfulness about him as well. He often jokes and makes light of insults and rivals that other men would almost certainly take offense from. He enjoys life and likes to have fun. In fact, when it’s time to party, he is the first to break into song and laughter, swilling booze and acting silly; although he never seems to get drunk and is always alert and ready for action.

Lasar is fond of magic and is rumored to have several powerful magic items that protects him, including a medallion that imparts the Armor of Ithan (this is really a cover story he started to explain why he can withstand an extra 200-300 M.D.C. in combat).

He has no love for the Coalition, or any brutal tyrant, but unlike others, he is not consumed with hatred and obsessed with their destruction. Instead of destroying, he is trying to build something. His men may be wild and violent, but even they see that their leader has bigger plans and that they are part of something special.

Despite his true inhuman nature, Sabre Lasar enjoys the company of humans, and to a slightly lesser degree, Simvan and other mortal D-bees. He seldom jeopardizes his men’s lives foolishly and sincerely hopes to turn the thousands of splintered Pecos Bandits into a united kingdom of multi-ethnicity.

Experience Level: 10th level Line Walker/Dragon.

Skills of Note: Basic and advanced math 98%, literate in American, Spanish, Dragonese/Elven 98% and speaks them plus Gobblely and Euro 98%, demon & monster lore 90%, faerie lore 40%, basic electronics 92%, computer operation 92%, climb 90%/80%, swim 90%, prowl 80%, palming 75%, pick pockets 80%, streetwise 66%, pilot hovervehicles (90%; loves the fastest hovercycles), demolitions 90%, demolitions: disposal, W.P. knife, W.P. sword, W.P. energy rifle, W.P. Heavy (rail guns, plasma, etc.) and paired weapons.

Combat Skills: Hand to hand: expert, or so he pretends.

Number of Attacks: Eight

Bonuses: +3 on initiative, +6 to strike, +5 to parry and dodge, +3 to pull punch, +3 to roll with impact, +3 on all saving throws, +6 to save vs horror factor.

Magic Knowledge: All wizard spells from levels 1-8, plus mute, water to wine, mystic portal, metamorphosis: superior, anti-magic cloud, remove curse, summon fog, time hole, protection circle: superior.

P.P.E.: 600

Psionic Knowledge: All sensitive and physical psionic abilities.

I.S.P.: 70

Weapons and Equipment: Sabre Lasar has access to virtually any weapons and equipment he may personally want. He wears modified, new style Dead Boy armor, and typically wields both a C-29 “Hellfire” plasma cannon and a C-40R SAMAS rail gun, plus a half dozen plasma grenades and 2-4 type two or three fusion blocks.

Description: A big, muscular, tough looking human bandit with long, reddish blond hair and fiery eyes.

Bionics: None, ever.

Money: As one of the most powerful warlords of the Pecos Empire (and a dragon), Warlord Lasar has easy access to a million in universal credits and his army has millions of credits worth of weapons and vehicles. Lasar also has a (dragon’s) treasure hoard worth in excess of 100 million credits (gems, gold, magic items, ancient artifacts, etc.; only a third is in universal credits) hidden in the rocky desolation of Big Bend.

Note: See *Rifts® Conversion Book (One)*, page 121, (or *Dragons & Gods*, or *Rifts* and the *Palladium Fantasy RPG*) for complete stats on the Fire Dragon.

Breakdown of the Sabre Warriors

Unlike most other outlaw bands, the Sabre Warriors have few western gunmen, gunslingers or bounty hunters. Instead, most are old-fashioned men at arms, with a healthy helping of practitioners of magic and psychics (including Psi-Stalkers, Dog Boys, and others).

Total Number: Approximately 6000 (give or take 5%-10% at any given time); double during times of trouble when Lasar calls upon his allies, and increase by 1D4+4 times during emergencies where the Pecos Empire is endangered and hundreds of gangs, clans and communities unite to fight a common enemy.

Racial Breakdown

40% Human

22% Psi-Stalkers

14% Simvan

16% Other D-bees

3% Mutant animals

5% Supernatural and creatures of magic (dragons, Brodkil, etc.)

Breakdown by Occupation:

23% Mercs/Grunts/fighters of all kinds.

10% Headhunters/Partial Cyborgs

7% Full Conversion ‘Borgs

8.5% Juicers

5% Crazies

10% Wilderness Scouts

10.5% Thieves

- 3% Operators
- 0.5% Mind Melters
- 2% Other Psychics
- 3% Mystics
- 3% Line Walkers
- 1% Techno-Wizards
- 0.5% Shifters
- 2% Other Practitioners of Magic
- 6% Other O.C.C.s & R.C.C.s
- 5% Supernatural (dragons, demons, others)

Note: Including Wilderness Scouts, approximately 63% are some type of warrior specifically trained for combat (74% if one includes thieves).

Typical level of experience for men of arms and thieves is 1D4+4 (6th level average). Typical level of practitioners of magic and most others is 1D4+2 (4th level average). Leaders, specialists and experts within the group tend to be 1D4 levels higher than the average (typically 7-10th level).

Alignment Breakdown:

- 32% Miscreant
- 24% Aberrant (54% of the leaders are aberrant)
- 13% Diabolic
- 28% Anarchist
- 3% Other

Warlord Don Marco

Leader of the Silver Dagger Gang

Warlord Don Marco is more like a Mafia Kingpin than the classic, hard riding, frontline commander that most people think of when they think of a Pecos Warlord or tribal war chief. The vast majority of nomadic bands travel throughout the territory, often on a regular circuit, always moving from one place to another. They may have a secret hide-out or favorite watering hole, but they have no truly permanent base of operation. Warlord Don Marco and his Silver Dagger gang represent a new breed of calculating bandits operating from (and maintaining) permanent settlements, towns and cities. Such places serve as permanent bases where the bandits' families live, work and raise children just like any other city person. These bandit communities even look and function like a normal town or city, with schools, churches, places of business, and merchants. Of course, they are usually rough and tumble frontier towns that cater to fellow bandits and offer a number of vices and places of ill repute (gambling casinos, drug dens, lots of saloons, houses of prostitution, pawnshops, fences, etc.). From the bandit town, the warlord and his chief advisors plot waves of crime that stretch away from the community like a spider web. Numerous criminal bands of 10 to 100 men ride out to engage in criminal activities throughout the Lone Star State and surrounding territories to engage in ravaging distant communities, robbing stage coaches and travelers, plundering merchant transports, hitting CS squads, cattle rustling, smuggling, kidnapping, blackmail, and all the rest. These foot soldiers (often called "soldiers") are only the most obvious extensions of the evil criminals riding along the web of this criminal organization, and may represent as little as 40% of the overall operations. Such is true of the Silver Dagger gang who has its fingers in more subtle and profitable ventures. Warlord Don Marco's organized crime family runs all the gambling halls, drug dens and places of vice in his city, plus many similar "institutions" and influence in other villages, towns, ranches and people in one or more areas. For example, a full third of all stolen goods fenced in the Pecos Empire pass through the hands of the Silver Dagger gang (at a nice profit), and Don Marco coordinates a lucrative smuggling operation. The criminal organization also buys and sells information, sells illegal Juicer aug-

mentation, recharges E-clips, sells and runs guns, and offers the repair, conversion and modification of bionics — some of the best body-chop-shops in the territory. The right people can put out the word and help men and women with "special talents" (hit men, bounty hunters, spies, smugglers, gunslingers, mutant animals, etc.) find prospective employers looking for freelance troubleshooters. The Silver Dagger gang also engages in local protection rackets, manages the police force, handles a network of stool pigeons and spies in the city and other neighboring communities, and runs most of the city — Don Marco is the Mayor! Don Marco is such a good organizer and has such an excellent mind for details that he makes such an operation look easy. The Silver Dagger gang is so structured, experienced and capable that they can outmaneuver the local branch of the Black Market.

This strong criminal network, with its thieves, spies, informers and strongmen, is one of the most structured, political and influential gangs in the Pecos Empire. It is one of only a half dozen such organizations, and is by far, the largest and most powerful.

If there are downsides to such a criminal network, one is that the permanent base camp is a stationary vulnerable target, and so is the Warlord who resides there. Another is that many of the organization's activities are so subtle, spread out and/or disguised, that most people don't realize that one man runs the entire operation. Thus, Warlord Don Marco lives in comparative anonymity, while flamboyant rogues like *Sabre Lasar* (his most hated rival) and even weasels like *King Macklin*, steal the limelight and the hearts and minds of the people. This infuriates Warlord Don Marco who dreams of making a power bid at uniting and controlling the Pecos Empire for himself. Unfortunately, most people don't think of him as a great (military) leader, and many consider him an arrogant and dangerous "arm chair" general.



The Coalition Military is one faction who recognizes and appreciates Don Marco's success. Since his greatest influence is at the heart of the Pecos Empire (his base of operation is in *San Antonio*), he, presently, represents little direct danger to the CS operations in the north. However, General Kashbrook has taken measures to infiltrate the organization in hopes of getting to Don Marco and using him as a pawn. One of Warlord Don Marco's top aides, a powerful psychic, is really a CS agent. One plan currently on the table is to encourage Warlord Don Marco to strike out against his hated rival, Sabre Lasar (whom the CS sees as their greatest threat from among the Pecos bandits). Should Don Marco move in that direction, the CS Military will secretly support his efforts by making needed weapons and supplies more easily attainable through criminal channels (i.e. poorly guarded supply depots, careless escort operations, leaking info about weapon caches, etc.). The CS will also apply greater military pressure against Lasar so that he will feel squeezed and make mistakes.

Once Don Marco and his gang have eliminated Lasar, the CS will quietly assassinate Marco and place a CS agent as the new leader to undermine the entire organization.

Warlord Don Marco

Real Name: Lorenzo Don Marco

Alignment: Miscreant

Attributes: I.Q. 15, M.E. 21, M.A. 20, P.S. 17, P.P. 19, P.E. 12, P.B. 9, Spd 14

Hit Points: 45

S.D.C.: 28

Height: 6 feet (1.8 m)

Weight: 160 pounds (72 kg)

Age: 38

Horror Factor/Awe: 10

Disposition: Warlord Don Marco is a capable leader, but also a magnificent organizer and manager with a head for numbers, details and systems management. He is extremely ambitious and dreams of someday ruling, or at least secretly controlling, all of the Pecos Empire. He is cunning, calculating and manipulative. He likes pulling strings from the shadows, but is frustrated that nobody, other than his minions, recognize his genius and the full extent of his powers. He is envious of Sabre Lasar and longs to see the "creature" suffer and die at his hands (Don Marco knows Lasar is more than human, he just doesn't know what he is — yet).

The Warlord is at his most dangerous when angry. This is when his sadistic side comes out. Don Marco likes to make those he's angry with (or hates) to suffer before he kills them, and as a Mind Melter, there are countless things he can do that make physical torture seem like a pleasant alternative. Many of his men fear him more than they respect him

Experience Level: 9th level Mind Melter

Skills of Note: Basic math 98%, speaks and is literate in American and Spanish 98%, computer operation 85%, computer programming 75%, pick pockets 70%, streetwise 57%, pilot hover vehicles 90%, horsemanship 77%, W.P. knife, W.P. energy rifle and paired weapons.

Combat Skills: Hand to hand: assassin.

Number of Attacks: Six

Bonuses: +2 on initiative, +4 to strike, +5 to parry and dodge, +3 to pull punch, +3 to roll with impact, +3 to save vs horror factor and +3 save vs psionic attack. Needs a 10 or higher to save vs psionic attacks.

Magic Knowledge: None

P.P.E.: 3

Psionic Knowledge: All sensitive and physical psionic abilities, plus detect psionics, psychic diagnosis, psychic surgery, bio-regeneration (super), bio-manipulation, empathic transmission, mind wipe, hypnotic suggestion, psi-sword, psi-shield, telekinesis (super), telekinetic force field, and telemechanics.

He adores telekinesis and uses it in a variety of ways to intimidate, hurt and kill. A favorite ploy is to use telekinesis to hurl 2-5 of his Vibro-Blades at his enemies, often from more than one angle. He also uses ectoplasm with his blades and other types of attacks.

I.S.P.: 231

Weapons and Equipment: Don Marco has access to virtually any weapons and equipment he may personally want. He is always armed with 4-6 Bowie-knife styled Vibro-Blades (2D4 M.D. each), a TX-5 pump pistol, and Techno-Wizard sub-machinegun that fires telekinetic rounds (1D6 M.D. per burst of six rounds, range: 2000 feet/610 m, I.S.P. cost: 8 points per burst, payload: 10 bursts at a cost of 80 I.S.P.). He wears modified, new style Dead Boy armor when going into combat.

Description: A tall, thin man with a wild look in his eyes, shaggy brown hair and a somehow frightening, youthful exuberance intermingled with a disturbing intensity.

Bionics: None.

Money: As one of the most powerful warlords of the Pecos Empire, Warlord Don Marco has easy access to 1D6x10 million in universal credits at any given time and ten times as much in manpower and resources. He has 36 million in universal credits hidden away in case of early retirement.

Note: Don Marco knows about the psychic CS infiltrator, and two mutant canines who are also CS spies. He just hasn't figured out what to do with them yet.

Breakdown of the Silver Dagger Gang

Total Number: Approximately 1200 "foot soldiers" and another 3200 city operatives/hoods/crooks (give or take 10% to 20% at any given time); double during times of trouble when Don Marco marshals all his forces.

Racial Breakdown

40% Human

12% Psi-Stalkers

4% Simvan

40% Other D-bees

3% Mutant animals

1% Supernatural and creatures of magic (demons, Brodkil, etc.)

Breakdown by Occupation:

20% Mercs/Grunts/fighters of all kinds.

10% Headhunters/Partial Cyborgs

5% Full Conversion 'Borgs

5% Gunslingers

3% Bounty Hunters

2% Super Spies

5% Juicers

1% Crazyes

10% Wilderness Scouts

10% Smugglers

8% Thieves

2% Forgers

5% Operators

1% Mind Melters

1% Mystics

3% Line Walkers

1% Techno-Wizards

1% Other Practitioners of Magic

6% Other O.C.C.s & R.C.C.s

1% Supernatural (dragons, demons, others)

Alignment Breakdown:

42% Miscreant

14% Aberrant

15% Diabolic

26% Anarchist

3% Other

Typical level of experience for men of arms and thieves is 1D4+4 (6th level average). Typical level of practitioners of magic and most others is 1D4+2 (4th level average). Leaders, specialists and experts within the group tend to be 1D4 levels higher than the average (typically 7-10th level).



Pecos Bandits

O.C.C. & R.C.C. Notes

A **Pecos Bandit** can be any number of O.C.C.s. Being “bandits” and “outlaws,” the vast majority are either criminals or men of arms who have turned to armed robbery and/or worse. The most common O.C.C.s include the following:

Soldier/Warrior/Fighter (roughly equivalent to a CS Grunt)
Glitter Boy Pilot (or pilot of any other type of power armor)
Wilderness Scout

Headhunter

Juicers

Crazies

‘Borgs

Vagabonds (wandering thugs and thieves)

City Rats (particularly common among organized crime families who control and dominate towns and cities; what few cities there are in Lone Star).

* Bounty Hunters

* Forgers

* Professional Thief

* Safecrackers

* Smugglers

* Special Forces

* Spies

** Gunslingers

** Wired Slinger

** Psi-Slinger

** Gunmen

** Saloon Bum

** Saddle Tramp

But can be virtually any other Men at Arms or Adventurer and Scholar O.C.C.s.

Plus D-bees and mutants who are often limited to skills and abilities of a specific Racial Character Class (R.C.C.), with a majority of *Psi-Stalkers*, *Simvan*, *Tokanii*, *Brodkil* and *feral Dog Boys* in Lone Star.

Note: A single asterisk indicates O.C.C.s found in the sourcebook **Rifts® Mercenaries**, those with two asterisks are O.C.C.s found in **Rifts® New West™**, plus other appropriate O.C.C.s and R.C.C.s may be found in **New West™** and **Spirit West™**.

Of course, **psychics**, **practitioners of magic** and **supernatural beings** (dragons, Brodkil, werebeasts, etc.) can also be active members of gangs, clans and tribes, but they represent only 5% of the overall outlaw population of the Pecos Bandits.

Leadership typically goes to the *strongest*. However, in a *gang* situation, the strongest is likely to be the man or woman who has the respect and support of the largest number of people. Thus, a character who is intelligent and cunning, and/or resourceful and charismatic, is more likely to lead a gang than Bruno the Terrible with a P.S. 32, P.P. 20, but an I.Q. of 8 and the personality of a dead fish.

Bandits aside, the vast majority of the people living and working throughout the Pecos Empire and surrounding wilderness territories are *NOT* bandits or evil. Although the world at large, and the CS in particular, may consider the Pecos Empire and *all* who live there to be evil, gunslinging bandits, savages and ruthless barbarians, it is not true. The 100,000 to 150,000 active bandits get a great deal of notoriety for obvious reasons, and this lawless wilderness attracts a good number of other outlaws and unsavory characters for equally obvious reasons, but at least 60% of the people who live in the Empire are not bandits! Most of

this 60% don't like the bandits and barbarians any more than any law abiding or peaceful people, and many are the frequent victims of these outlaws. Furthermore, only 15% of the inhabitants in the Pecos Empire are *career outlaws*, the rest are American Indians, frontier settlers, refugees, D-bees and mutants who occasionally engage in raids and feuds against rival tribes, clans and communities, or who plunder outsiders, intruders and/or the CS, who most consider to be their mortal enemy. The rest of the time is spent raising crops and cattle, hunting, building homes, raising children and protecting their families. Even some of the bandits are comparatively decent souls who see robbery, intimidation and brutality as a way of life, but who are not mad dog murderers. Many bandit leaders, and even entire gangs, live by their own, often twisted and harsh, rules, laws and codes of ethics. While many may steal from everybody (the CS, travelers, other gangs, ranchers and peasant farmers), many only kill in self-defense (i.e. shooting some poor slob who comes running out of his house with a P-Beam rifle to protect his possessions), and avoid torture and wanton destruction. Of course, others are just looking for an excuse to kill, and enjoy being hated and hunted by everybody — it gives them a sense of power, fame or even purpose.

Of course, the Coalition States' point of view is that every last one of the people who live in the Pecos Empire are either inhuman monsters or ruthless criminals. As fanatical human supremacists, this is true because even the most innocent peasant human has been tainted by their association with D-bees, feral mutants and outlaws — or simply because they have chosen a life outside the Coalition, making them dangerous free thinkers and, probably, hate-filled rebels and anarchists. As for the D-bees, it doesn't matter whether they are peace-loving and innocent of any crimes against the States, their very presence on Earth is an affront to humankind — they are alien invaders who must be obliterated!

Pecos Raider O.C.C.

The following are stats for the average Pecos Raider, typically a vagabond thug. These characters have almost always been born of and raised by peasants, and see a profession as a bully and bandit as a viable career, as well as a way to become “somebody” important. Most (98%) are uneducated and less than 1% are even partially literate. Despite what most people think, the majority are not very good at wilderness survival because they travel in groups and pool their skills and resources. They typically travel from one town, village or camp to another, stealing what they need along the way. They can be human or D-bees, but the vast majority of bandits are male (85%).

Pecos Raider/Bandit/Thug/Vagabond Crook

R.C.C. Requirements: None

Player Character Note: Player characters who are Pecos Raiders, especially those who are recognized as having ridden with a notorious gang or gang leader, are likely to be wanted criminals with a price on their heads. This means encounters with Coalition troops and lawmen will inevitably turn ugly. Furthermore, Bounty Hunters may hunt this character for a reward, and the bandit will undoubtedly have many enemies (from the CS and other authorities to townsfolk). This may affect the credibility of the entire player group — guilt by association, leading to conclusions like, “if so and so is a friend/comrade, then they all must be bandits and cutthroats” (and can't be trusted and may not be wanted).

Alignments: The typical thug and bandit is Anarchist or any evil alignment. Robin Hood types and those who plunder only the CS as an enemy of D-bees and all people who dream of living free may be any alignment, including *good*.

O.C.C. Bonuses: +2D6+10 S.D.C.

O.C.C. Skills:

Speaks American and Spanish at 90% efficiency.

Cook (+10%)

Fish (+10%)

Swim (+10%)
 Climb (+10%)
 General Athletics
 Horsemanship or Horsemanship: Exotic Animals (+24%)
 Pilot Hovercraft (+10%, but +20% when it's a hovercycle)
 Land Navigation (+12%)
 W.P. Energy Pistol
 W.P. Energy Rifle
 W.P. Two of choice
 Hand to Hand: Basic
 Hand to hand: basic can be changed to hand to hand: expert at a cost of two O.C.C. related skills, or martial arts or assassin for the cost of three skills.

O.C.C. Related Skills: At first level the Raider can select five "other" skills, plus one skill at levels 3, 6, 9 and 12.

Communications: Radio: Basic and Scrambler only.

Cowboy (see *Rifts® New West*)

Domestic: Any (+10%)

Electrical: None

Espionage: Tracking and Wilderness Survival only.

Mechanical: Basic Mechanics and Automotive only (+5%).

Medical: First Aid only.

Military: Recognize Weapon Quality only (+5%).

Physical: Any, except acrobatics.

Pilot: Any, except military vehicles, power armor, and robots (+5%).

Pilot Related: None

Rogue: Any (+10%)

Science: None

Technical: Any, except computer operation & programming.

W.P.: Any

Wilderness: Any (+5%)

Secondary Skills: The character gets four secondary skills from the list, excluding those marked "None," at level one, and two additional at levels 3, 5, 7, and 11. These are additional areas of knowledge that do not get the advantage of the bonus listed in parentheses. All secondary skills start at the base skill level.

Standard Equipment: Typically some type of body armor, from gladiator and Bushman to modified Coalition Dead Boy and Dog Boy armor (the latter is extremely common). Other common equipment includes tinted goggles or nonenvironmental helmet with or without visor, flashlight, cigarette lighter, pack of cigarettes, comb, pocket mirror, 100 ft (30.5 m) of lightweight rope, binoculars, wooden dagger and 2D4 stakes (for fighting vampires), survival knife or hatchet, one (or more) vibro-knives, a pistol (energy or other), a rifle (energy or other), 1D4+1 additional E-clips/ammo clips for the weapons, plus knapsack, backpack, utility belt, air filter, and two canteens. Starts with a fair to good quality horse or a battered looking, standard Speedster or Firefly hovercycle (reduce the usual M.D.C. by 3D4%).

Additional Equipment: Hand grenades, flares, magic items, special weapons, souped-up vehicles, better armor, etc., must be acquired later as the character gets booty or steals items.

Money: Starts with 3D4x10 in tradeable goods and 50 in universal credits.

Cybernetics: None, and most can't afford any later.

Tokenii R.C.C.

By Julius Rosenstein & Kevin Siembieda

One of the several races of D-Bees that inhabit the Pecos Empire, the Tokenii (pronounced "Toe-Kah-Knee") originally came from a planet covered with jungles and filled with man-sized to T-Rex sized dinosaurs and other predatory monsters. They had achieved the equivalent of a Bronze Age culture when disaster struck (literally). A huge asteroid crashed into the planet with enough force to totally disrupt the environment. Clouds of ash and dirt blotted the sun from the sky, earthquakes shook the planet and strange storms unleashed torrents of acid rain and bolts of lightning poured down from the heavens. Temperatures dropped, crops withered, livestock perished and disease ran rampant.

Millions perished in the initial bombardment. Hundreds of thousands more perished in the aftermath, and all seemed doomed. Finally, two tribes joined forces to have their shamans combine their powers to open up a dimensional portal to flee to a different land. The Rift opened and the Tokenii made a literal leap of faith to parts unknown. Considering that Rifts Earth has become a sort of dimensional nexus, it is not surprising that the Tokenii ended up here. In this case, the fugitives appeared in the Lone Star territory, near the mountains and canyons known as *The Bend*. The aliens quickly fled this desolate and frightening place and headed north into Coalition Territory. The Coalition Military had only recently discovered the Lone Star Complex and didn't react kindly to a hundred thousand alien beings suddenly sweeping through the plains. In typical fashion, the Coalition troops moved in and slaughtered the Tokenii without mercy.

Although pitted against modern weapons, the Tokenii, by virtue of their numbers, mega-damage bodies and sheer ferocity (and aided by whatever magic their shamans could muster), managed to put up a valiant fight giving a few thousand a chance to escape. When the tribe finally took sanctuary in the eastern forest, they counted their numbers at less than 10,000. Here too, they encountered hostile forces in some of the tribes, bandit raiders and monsters. However, there were also tribes and bandits who befriended and helped the fugitives, instead of plundering and killing them.

That was 49 years ago. Their mega-damage bodies and orientation as warriors in a hostile environment made it easy for them to adapt, once they got the lay of the land and learned about mega-damage weapons. Today there are three main tribes: The Tokae (pronounced Toe-Kay) and the Kreenae (pronounced Kree-Nay), both members and descendants of the two original tribes that fled through the Rifts, and the Ronii (pronounced Roe-Knee) who splintered away from the Kreenae and have befriended the Pervic Simvan tribe.

Population Breakdown:

Tokae: 24,000; subdivided into 22 clans.

Kreenae: 19,500; subdivided into 20 clans.

Ronii: 11,500; subdivided into six clans.

The **Tokae** live primarily in the Eastern forests of Texas/Lone Star, Louisiana and Arkansas (where they constantly raid CS outposts and human settlements).

The **Kreenae** are among the most savage, warlike and aggressive. The range they roam is largely the lower, southern forested areas in the east (around Austin, Temple, Bryan, Huntsville, Tyler, and Trinity) and the Gulf Coast and lower Louisiana. They sometimes ride into the plains and desert, but (having been jungle people) prefer the eastern forests. **Note:** All Tokenii have a strong clan mentality, so any outsider (and his friends/associates — i.e. "clan") responsible for a crime or insult against the clan, a clan leader or warrior of note, will be challenged or attacked, usually in a fight to the death or become the subject of a vendetta. Unlike the Simvan and most other cultures the animalistic Tokenii cannot be appeased with apologies, valuables or punishment — they will settle for nothing less than that person's (or people's) death! These brutish warriors all have this twisted sense of honor, camaraderie and justice, but the Kreenae are the most murderous and unforgiving. In

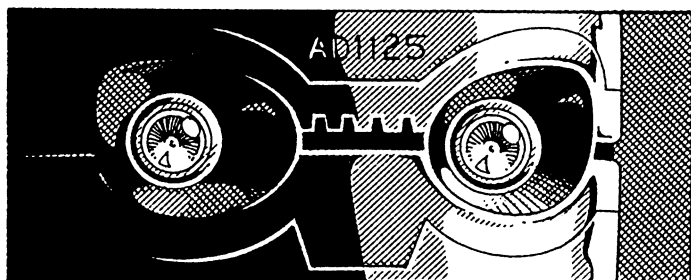



A young Tokanii warrior and his bandit teammates.

fact, most wilderness people consider them (and sometimes all Tokanii) terrible monsters to be avoided or destroyed. The Kreena Tokanii are also partially responsible for the Pecos Empire's reputation for barbarism.

The **Ronii** (Roe-Knee) are the only Tokanii who have abandoned their life in the forest for the plains and prairies. This was due in part to get away from their vindictive cousins, the *Kreenae* (there are hard feelings between the two tribes, because their division weakened the original tribe and the Kreenae feel betrayed), and in part due to their friendship with the *Pervic Simvan*. The Ronii and Pervic Simvan are strong allies and the Simvan have taught the Ronii warriors to be excellent riders of both the horse, and exotic four-legged monsters. The Ronii aren't too bad at riding the ostrosaurus, but don't care to tame bipedal dinosaur predators, but they do love to hunt and eat them (another reason to become a plain's people, because that's where the dinosaurs are). **Note:** Most other Tokanii are ground and tree dwellers who seldom learn to ride animals or vehicles.

The Ronii Tokanii are among the most civilized, tolerant and adaptable of the three tribes. They have forsaken many of their old beliefs and ways (like forest dwelling and refusal to ride animals), to better adapt to their new environment. They are anxious to learn more about the varied people and places of their new homeland and welcome new experiences and education. **O.C.C. Note:** A Ronii is the only Tokanii who can deviate from the Tokanii Warrior R.C.C. and select any Men at Arms O.C.C., Wilderness Scout, or any Practitioner of Magic O.C.C. (although less than 1% have taken up the study of magic, but this may change with new generations).

The Tokanii resemble demonic skeletons or black-skinned demons covered in an exoskeleton of tan to warm gray bone plates. A pair of large horns rise from the forehead of their long, skeletal face, and a mane of jet black hair crowns their head and neck. The eyes are round and tiny, and flash like a cat's at night. The mouth is long and filled with six to eight inch long teeth that are visible from the outside — part of the exoskeleton. Their arms are thick, muscular and oversized for the

rest of their body. The Tokanii's hands are even larger, at least six times the size of a human's and twice the size of its head. Short, retractable cat's claws come out of their fingertips and (3) toes — evolved for climbing giant jungle trees twice the size of an American Redwood tree and the sheer cliff facings. Their demonic appearance makes their life easy, and they constantly frighten just about everybody who sees them. The Tokanii's reputation for savagery only makes them seem all the more dangerous.

Tokanii clans are ruled by the strongest and/or most cunning warriors. The clan chieftains must answer all challenges or be deposed. Since each combatant may bring whatever weapons he wants to these contests, the victory frequently goes to whomever has the superior armament and skill. The loser is usually killed, and all his possessions, wife and family become the property of the victor.

Tokanii Warrior R.C.C.

— Optional Player Character

Alignment: Any, but most are anarchist or evil — only the *Ronii* tribe have about 10% scrupulous, 28% unprincipled, 20% anarchist, 22% aberrant and the rest various evil alignments.

Attributes: I.Q. 2D6+3, M.E. 3D6, M.A. 2D6+3, P.S. 4D6, P.P. 3D6+3, P.E. 4D6+3, P.B. 2D4 (by human standards), Spd. 3D6+6

Note: The Tokanii have the equivalent of supernatural P.S. and P.E. (although not supernatural in and of themselves) and inflict mega-damage from their punches, kicks and bites. A bite does 1D6 M.D., a head butt 1D6 M.D., and a running ram with their horns does 2D6 +P.S. M.D.

Hit Points & S.D.C.: Not applicable because they are mega-damage beings.

Mega-Damage: P.E. attribute number x3 +4D6 M.D.C. per level of experience. The older and more experienced they are, the tougher they get, so also add 10 M.D.C. for every 20 years of age. The bones of their exoskeleton represent 90% of their overall M.D.C., so when a Tokanii's M.D.C. is reduced by 80%, he knows he is in mortal danger.

Weight: 350 to 550 lbs (160 to 250 kg)

Height: 7 to 9 feet (2.1 to 2.7 m)

Average Life Span: 180-240 years. Player characters start out as young warriors between the age of 20 and 40 — they reach physical maturity around age 20 but most are effectively energetic and risk-taking teenagers until about the age of 70.

Magic: Typically none. Only Tokanii Shamans (effectively Mystics) and members of the Ronii tribe can select a magic O.C.C.

P.P.E.: 4D6

Psionics: Standard; roughly the same as humans.

Horror Factor: 13

Natural Abilities & R.C.C. Bonuses: Nightvision 300 ft (91.5 m), hawk-like color vision, climb 95%/90%, +1 attack per melee round, +3 to save vs poison and drugs, +3 to save vs disease, +8 to save vs horror factor, superior sense of smell (twice as keen as humans), and fire/heat resistant (does 1/2 damage).

Special: Bone Regeneration: Tokanii are covered in mega-damage bones that serve as a natural body armor (80% of their M.D.C. is in these bones). This was a product of evolution on their homeworld to help protect them against the hundreds of man-sized to skyscraper tall dinosaurs that dominated the jungle. Any horn or bone that is broken or damaged in any way, will regenerate at a rate of 2D6+4 M.D.C. per day.

Special: Regenerate Hands and Feet: The only parts of the Tokanii's body that aren't protected by bones are their hands and feet. Consequently, when these appendages are lost (roughly 10 M.D.C. each), they can be completely regrown in a matter of 1D4+2 weeks!

Disposition: Many Tokanii are bold, confident and alert warriors who take risks and love to fight and compete. The older ones tend to be irritable, rude and belligerent. However, most of them will not go out of their way to harass others (even outsiders) if they are shown the proper degree of respect. Those who don't, or those who dare to challenge, insult or attack them (verbally or physically), are beaten, tortured and killed (sometimes eaten)!

Because of their mega-damage bodies, fighting prowess and ferocity, Tokanii are in great demand as shock troops for raiding bands and bandits. Since this often gives the Tokanii the opportunity to pick up better weapons, many (especially young warriors) join outlaw gangs to prove themselves as warriors, for the fun and challenge of combat and to come home with a collection of weapons and equipment (a sign of wealth and power).

R.C.C. Skills of Tokanii Warriors: Also see natural abilities.

Speaks American at 80% efficiency.

Radio: Basic (+10%)

Running

Swim (+10%)

Identify Plants & Fruits (+15%)

Land Navigation (+15%)

Track Animals (+15%)

Skin & Prepare Animal Hides (+15%)

Wilderness Survival (+20%)

W.P. Blunt

W.P. Energy Rifle

W.P. Three of choice

Hand to Hand: Expert

Ronii Exclusive: All Ronii Warriors also get Horsemanship and Horsemanship: Exotic Animals (+30% each) and *can* select any skills from communications, military, piloting and rogue. Remember too, Ronii Tokanii can select other O.C.C.s.

R.C.C. Related Skills: At first level the character can select four "other" skills, plus one skill at levels 2, 5, 8, and 12. **Note:** Other than Ronii, most Tokanii care nothing about learning to read or higher education.

Communications: Radio: Basic and Scrambler only.

Domestic: Any (+10%)

Electrical: None

Espionage: Any

Mechanical: None

Medical: First Aid and Holistic Medicine only (+5%).

Military: None

Physical: Any, except gymnastics.

Pilot: Truck, Hovercraft and horsemanship only, but most (99%) have no interest in piloting skills.

Pilot Related: None

Rogue: Any (+5%), except computer hacking.

Science: None

Technical: Any (+5%), except computer operation & programming.

W.P.: Any

Wilderness: Any (+10%)

Secondary Skills: The character gets four secondary skills from the list, excluding those marked "None," at level one and one additional at levels 2, 4, 8, and 12. These are additional areas of knowledge that do not get the advantage of the bonuses listed in parentheses. All secondary skills start at the base skill level.

Standard Equipment: Never use armor or power armor or most high-tech equipment. Mainly interested in weapons, with heavy energy weapons, Vibro-Blades, prods, spears and maces being their favorites.

Typically the character starts with a survival knife or hatchet, one or two Vibro-Blades, an energy rifle, 1D4 additional E-clips for the weapon, plus a knapsack, utility belt, air filter, and two canteens.

Ronii also start with a good quality horse *or* exotic riding animal.

Additional Equipment: Additional weapons and equipment must be acquired through combat or theft, and magic weapons, especially rune swords, spears, axes, flaming swords, etc., are the most coveted and prestigious.

Allies and Enemies: Due to the violent treatment they received upon arrival on Rifts Earth, the Tokanii have an "us-versus-them" attitude toward most strangers. Even rival Tokanii clans will break off their own battle to jointly fight outsiders, especially the Coalition Army. Although individuals may be looked on as friends, the Tokanii are suspicious of other races in general. Only the Pervic Simvan and Ronii Tokanii are true friends and allies.

Psi-Stalker™ R.C.C.

Reprinted in part from the Rifts® PRG, with new material.

The Psi-stalker is a mutant human who, during the Dark Age after the Great Cataclysm, evolved to feed on psychic energy and developed psychic sensitive powers. Fallen to barbarism, most Psi-Stalkers have survived for over two centuries as hunters of the supernatural and practitioners of magic. Unlike normal humans, the Psi-Stalker is a natural predator and P.P.E. vampire! The predator senses the use of psychic/magic energy (I.S.P. and P.P.E.), and can follow the distinctive energy trail like a bloodhound following a specific scent. Even though all creatures have a certain level of potential psychic energy (P.P.E.), the Psi-Stalker can tell the subtle differences between normal energies and psychic and magic energies. Some innate instinct draws the Stalker to those creatures who are psionic or magical. This same instinct makes the mutant want to *kill* his prey and drink its P.P.E. (which, for a brief instant, doubles when the victim dies). Fortunately, Psi-Stalkers can resist their bloodlust and train themselves not to kill. However, even these "restrained" and "civilized" Psi-Stalkers love the thrill of the hunt and would prefer to kill when they feed. If nothing else, it makes life easier to kill the prey and the amount of P.P.E. released at the moment of death is a bigger rush and much more satisfying!

The Coalition States have trained these *mutant humans* with the Psi-Stalker instincts and abilities to become an elite military police force, specializing in hunting down psychic and magic criminals, supernatural beings, and paranormal interlopers. In addition to the Stalkers natural abilities, the warriors are trained in basic military procedure and combat skills. They are also trained to control their urge to kill. The Coalition Psi-Stalkers will not kill unless the soldier is given authorization to use deadly force, which is always approved when stalking a demon or other supernatural being, and frequently when in pursuit of dangerous criminals. Because of the Coalitions stand against nonhumans, Psi-Stalkers can never achieve the same rank as true humans, and they can be distinguished from other Coalition soldiers by their spiked helmet and the letters "PSI" emblazoned on the chest of their armor and uniforms. ALL Psi-Stalkers are registered psychics with the IC and bare the IC bar code and implant.

Coalition Psi-Stalkers generally lead Dog Packs, or are part of a Special Forces team or other special operation, especially those involving practitioners of magic, psychics, monsters and the supernatural. A full 15% of the Coalition Army is composed of Psi-Stalkers. Although most are obedient and loyal to the CS, many are bolder, more officious and disrespectful of officers they don't like. This is due, in part, to their "Second-Class Citizen" stature within Coalition society (many normal citizens fear them) and their more aggressive nature.

Psi-Stalkers *are* different from true humans. In addition to their famous psychic powers and the fact that they live on psychic energy rather than solid food, they are strikingly different in physically appearance. Average height is more consistent at 6 to 6.6 inches tall, half are ambidextrous, neither male or female has any body hair (not on their

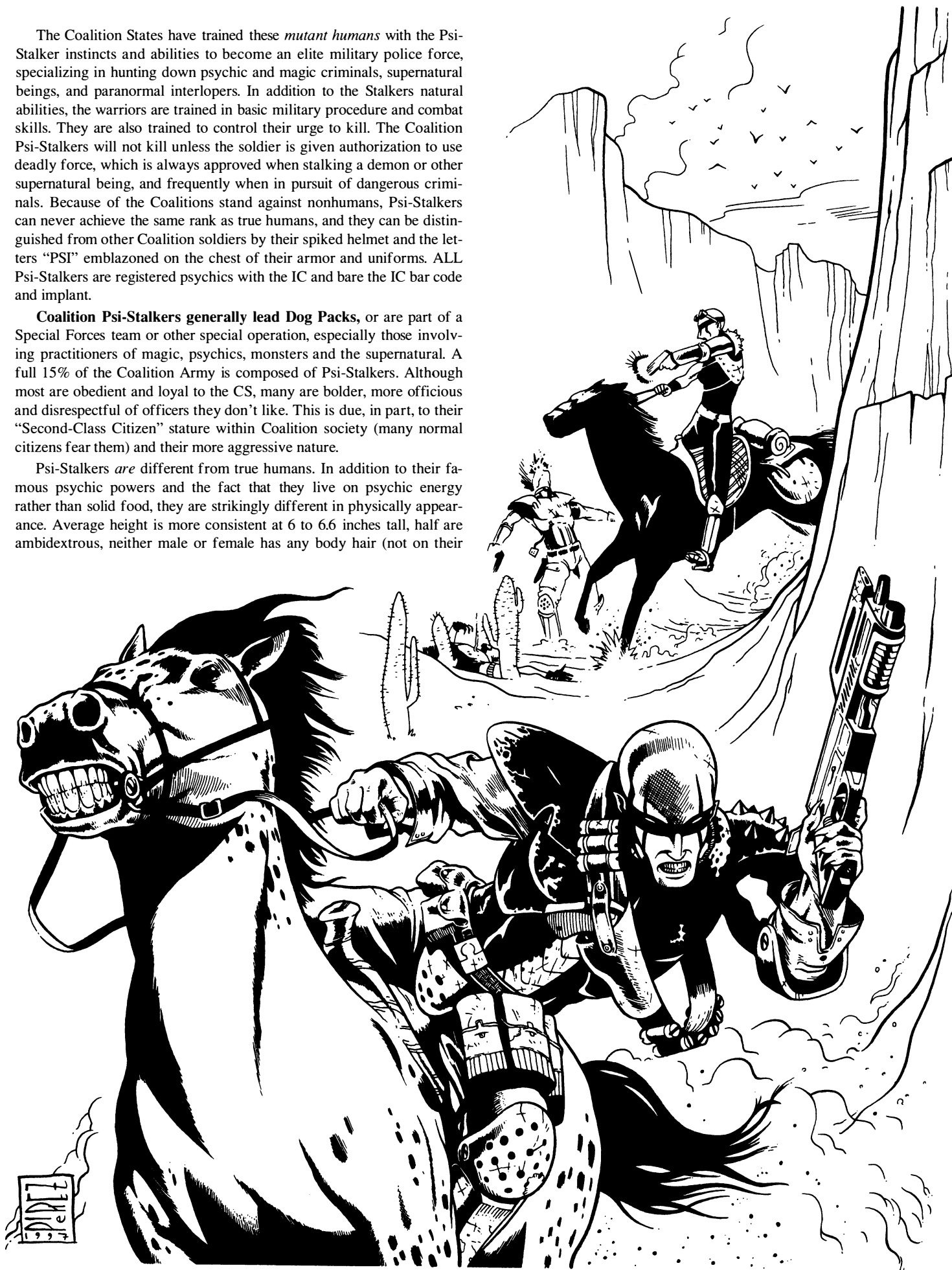

heads, arms, legs, or anywhere), and their skin is a pale, powder white with faint hints of pink around their lips and eyes. Their eyes are typically a piercing blue or a smoldering gray. Most Psi-Stalkers suffer from a certain amount of hypertension and like to be physically active. *Wild Psi-Stalkers* (and some CS) often adorn their bodies with tattoos or war paint, and like to look more menacing than they really are.

Special Powers & Abilities of the Psi-Stalker

Note: The following powers are different or more powerful than some of the common psionic powers which these abilities may resemble and are limited to the Psi-Stalker R.C.C. All Psi-Stalkers, CS, civilized or wild, have the same natural abilities, only their level of self-control, availability of skills and equipment vary.

1. Sense Psychic and Magic Energy: Like a bloodhound smelling a familiar scent, the Psi-Stalker can detect the presence of psychic energy; specifically fellow psionics (I.S.P.) and magic (P.P.E. specifically oriented toward magic, Techno-Wizardry, and magical devices). The ability is constant and automatic. The moment a psychic "scent" is within the character's range, he or she will recognize it. For example: If a psychic (minor, major, or master) enters the room, the Psi-Stalker will instantly sense it, as well as be able to trace it to the specific individual.

Furthermore, the Stalker has a chance of recognizing that specific person's psychic scent again. This ability also enables him to stalk/track a specific psychic scent. **Base Skill:** 20% +5% per additional level of experience. If the Psi-Stalker has a bit of hair, skin, blood, or an article of clothing recently worn (4 hours or less) by the subject being hunted, the ability to follow the psychic trail enjoys a bonus of +20%.

If psionic powers or magic is being used within the Psi-Stalker's range of sensitivity, he will sense that too. The psychic impression will indicate whether the energy source is far or near, up or down, and whether it is a small or great amount of energy. If the energy is being continually expended, like a series of magic spells or psionic attacks, or a long duration effect, the predator can track it to the source with ease. **Base Skill:** 60% +5% per level of experience (roll once every melee). It is also likely that the character will recognize the scent again if encountered at some other time; 20% +5% per level of experience.

The presence of other P.P.E. sources may confuse the scent and inflicts a -10% skill penalty (-20 if numerous sources). Close proximity to a ley line (2 miles/3.2 km) will reduce the ability to track a specific psychic scent by half. Close proximity to a ley line nexus point (4 miles/6.4 km) will completely obliterate the scent, making it impossible to find or pick up later. This is one reason why Psi-Stalkers are rarely found near a ley line unless a large number of prey inhabit the area. Of course, this also means that a Psi-Stalker can sense ley lines or a nexus point from up to 10 miles (16 km) away, plus one mile (1.6 km) per level of experience.

Ranges: Sensitivity to a fellow psychic or magic practitioner *not* using his powers is 50 feet (15 m) +20 feet (6 m) per each additional level of experience.

Sensitivity to psionic and magic powers being used is 600 feet (182 m) +100 (30.5 m) per level of experience.

When tracking a psychic scent, roll percentile dice every 1000 feet (305 m) to see if the hunter is still on the trail.

Duration: Automatic and constant.

I.S.P.: None, automatic ability.

2. Sense supernatural beings: Identical in function to the previous ability, except one senses the super-distinctive psychic scent of the supernatural. The ability to identify the specific type of paranormal creature is a **Base Skill:** 40% +5% per level of experience, and includes demons, vampires, and entities.

Tracking by psychic scent alone is a **Base Skill** :30% +5% per level of experience. 70% +3% per level of experience if the supernatural being is expending psionic or magic energy while the Stalker is on his trail.

Ranges: Sensitivity to the presence of a supernatural being *not* using its powers is 50 feet (15 m) per level of experience. Sensitivity to supernatural magic or psionics being expended through spell weaving or psi-attacks, is 1000 feet (305 m) +100 feet (30.5 m) per additional level of experience.

Duration: Automatic and constant.

I.S.P.: None, automatic.

Note: Close proximity to ley lines and nexus points always have the exact same adverse effects.

3. Psi-Bonuses: As a master psionic, the Psi-Stalker needs to roll a 10 or higher to save versus psionic attack, and enjoys a bonus of +5 to save (additional bonuses from M.E. not applicable). This means the character must roll a 6 or higher to save vs psionics! +5 to save vs mind control and mind altering drugs; +6 to save vs horror factor!

4. Magic Bonuses: Natural magic resistance provides a bonus of +1D4 to save versus magic attacks of any kind.

5. Physical Attributes & Bonuses: Roll 3D6 for each attribute plus the following bonuses: +1D6 to M.E. attribute (psionic saving bonuses are not cumulative), +1D6 to P.E., +2D6 to speed attribute, +10 to physical S.D.C., +1 attack per melee round, ambidextrous, and paired weapons. Can leap six feet (1.8 m) high or 10 feet (3 m) long (add 20% to length with running start), and has excellent balance (80% +2% per level of experience). Remember, needs little solid food and water to live, subsists on P.P.E.

6. Nourishment: The Psi-Stalker must feed on a minimum of 50 P.P.E. or I.S.P. a week, preferably 80 to 100. To feed without killing, the predator must hunt down a psychic, practitioner of magic, or supernatural creature, physically capture the prey, cut it, and psionically drain *all* its available P.P.E. points. Other than the cut (1D6 S.D.C. damage) the victim suffers, he temporarily loses all P.P.E.; a potentially dangerous situation for any magic user, but hardly life threatening.

Psychics temporarily lose *half* their I.S.P. from a Psi-Stalker energy drain, as well as *all* their P.P.E. Once the Psi-Stalker begins to feed, he cannot stop until all the P.P.E. has been absorbed. The absorption process is instantaneous (about 5 seconds). P.P.E. and I.S.P. will recover naturally, but temporarily disrupts the victim's psychic essence and mages are left with no personal P.P.E. to draw upon to cast magic.

Note: The Psi-Stalker can *not* feed on the P.P.E. of beings who are not psychic, practitioners of magic, or supernatural in nature. They can, however, absorb mystic ley line energy, but the taste is bad, like sour milk, and the ley lines disrupt the character's senses.

The preferred form of nourishment, even among civilized Psi-Stalkers, is to hunt and kill one's victim. The victim can be a psychic, practitioner of magic, creature of magic (faerie folk, dragon, etc.) or supernatural being. At the moment of death, the victim's P.P.E. is doubled. The stalker can absorb the energy of his kill from as far as 300 yards/meters away.

No need for normal food or water! As P.P.E. energy vampires, Psi-Stalkers have little need to consume solid food or water. The mutant does not require more than one pound (0.45 kg) of meat and eight ounces of water a week to remain healthy and strong. Furthermore, the character can go without solid food or water for up to three weeks, if necessary, without the slightest ill effect. However, being deprived of the proper P.P.E. energy will inflict physical damage and the character will die of starvation within three weeks.

P.P.E. Base: 2D6; needs to consume a minimum of 50 P.P.E. per week to function without fatigue, weakness or penalty. For every week with less than 50 P.P.E., the Psi-Stalker suffers 6D6 points of damage to both hit points and S.D.C., down to a minimum of two points each, and reduce all bonuses and attacks per melee by half. After three weeks of starvation the character will be so weak that unless P.P.E. becomes available he will die within 1D6 days.

7. Other Psionic Powers: Choose six psi-powers from the *sensitive* category. **I.S.P.:** M.E. attribute number +1D6x10 plus an additional 10

I.S.P. for each level of experience. Considered a master psionic. I.S.P. is regained at the rate of two points per hour of activity, or 12 per hour of meditation or sleep.

8. Psionic empathy with animals. Psi-Stalkers automatically have an affinity with animals of all kinds. Domesticated animals will always take an immediate liking to them and will do their best to please them. This empathy automatically gives the mutant the ability to ride any horse (wild or tame) or any other nonpredatory animal at +15% bonus to ride them and/or work with any domestic animals.

Wild animals, with the exception of felines and mutant or alien predators, will react to the Psi-Stalker as if he was a fellow woodland creature and allow him to walk among them without fear. This ability enables Psi-Stalkers to operate in the wild without causing animals to react to their presence; birds do not fly away, animals do not run, and therefore, do not indicate the approach of an intruder. Even watchdogs will not sound a bark of alarm at their presence, and Dog Boys and mutant bears usually get along with them famously. **Note:** The affinity with animals means that the character will hunt and eat meat only for food, never for pleasure, and feels sadness whenever he sees an animal in distress.

Most feline, mutant and alien predators seem to see the Psi-Stalker as a fellow hunter and a threat. Wild cats and mutant felines will frequently select a Psi-Stalker as their first target in battle, and will not respond to the character in a positive manner regardless of how nice the Psi-Stalker may be. Psi-Stalkers are the only creatures that the Xiticix Killer will attack, other than the Xiticix insectoids.

Coalition Psi-Stalkers & “Civilized” Mercenary Psi-Stalkers

Attribute Requirements: None. A high M.E. and P.P. are suggested but not required. Roll 3D6 for each of the eight attributes as normal plus bonuses listed under the *Special Powers and Abilities of the Psi-Stalker*. Some skills may provide additional attribute bonuses.

R.C.C. Skills: The civilized stalker has undergone some formal education and basic military training. Also see natural abilities.

Speaks American and one other language at 96%.

Radio: Basic (+10%)

Pilot Hovercraft (+10%)

Robot Combat: Basic

Read Sensory Equipment (+10%)

Weapon Systems (+10%)

Body Building

Climbing (+5%)

Running

Prowl (+10%)

W.P. Energy Pistol

W.P. Energy Rifle

W.P. two of choice

Hand to Hand: Expert

Hand to hand: expert can be increased to assassin if the character is anarchist or evil, and at the cost of one R.C.C. related skill.



R.C.C. Related Skills: At first level the character can select four “other” skills, plus one new skill at levels 2, 5, 9 and 13. **Note:** Even “civilized” Psi-Stalkers rarely care much about learning to read or higher education.

Communications: Any (+5%)

Domestic: Any (+5%)

Electrical: Basic only (+5%)

Espionage: Tracking and Wilderness survival only.

Mechanical: Basic and automotive only.

Medical: First Aid only (+5%).

Military: Any (+5%)

Physical: Any, except acrobatics.

Pilot: Any (+5%)

Pilot Related: Any

Rogue: Any (+5%), except computer hacking.

Science: Basic and Advanced Math only.

Technical: Any (+5%), except all computer skills.

W.P.: Any

Wilderness: Any (+5%)

Secondary Skills: The character gets eight secondary skills from the list, excluding those marked “None,” at level one, and two additional at levels 3, 8, and 12. These are additional areas of knowledge that do not get the advantage of the bonuses listed in parentheses. All secondary skills start at the base skill level.

Standard Equipment: Coalition Psi-Stalker: Coalition “Dead Boy” armor, weapons, equipment, money, and cybernetics are all the same as the *Coalition Grunt*. Plus a few of the Dog Pack special hand to hand weapons such as the neuro-mace, Vibro-Knife, and fist spikes.

Standard Equipment: Civilized Mercenary: Coalition “Dead Boy” armor if an ex-soldier, otherwise light or heavy mega-damage armor (probably the latter), a couple sets of clothing, sleeping bag, back pack, extra sack or pack for stowing equipment, utility/ammo-belt, canteen, sunglasses or tinted goggles, air filter or gas mask, and personal items.

Weapons will include a knife or two, two energy or heavy weapons and 1D6 ammo-clips for each, plus one non-energy weapon; player’s choice. Vehicle is limited to nonmilitary means of transportation, and may include hover vehicles or souped-up hovercycle, motorcycle or car — they like to go fast.

Money: The mercenary starts out with 6D6×100 in credit and 4D4×1000 in sellable black market items. Note that Psi-Stalkers can often make big dollars as exterminators in areas plagued by supernatural beings, magic, or psychics.

Coalition Troopers get the same benefits and pay as the Coalition Grunt, plus special hazardous duty pay and bonuses for jobs well done. Those assigned to the ISS make the same as an ISS Inspector and CS Psi-Officers who lead a Dog Pack are treated and paid the same as a low ranking CS Military Specialist.

Cybernetics: Starts with none. Tend to avoid implants in favor of natural powers.

Wild Psi-Stalkers

Wild Psi-Stalkers are humanoid predators usually encountered in the wilderness and among the ruins of ancient cities. Fifty percent are cannibals who eat part of their victims or tear them to shreds. The act of cannibalism, or unnecessary violence, is a manifestation of the predatory killing instinct and aggression, because Psi-Stalkers have minimal need for flesh and blood nourishment. Even those occasional Psi-Stalkers who live along a ley line where P.P.E. is available without killing, are instinctively driven to hunt for living prey. The Coalition scientists hypothesize that the Psi-Stalker is an evolutionary answer to the proliferation of psychic and magic creatures on Earth. No one really knows how these humans became something more (or less, depending on how one looks at things).



With rare exceptions, they *never* hunt or kill a fellow Psi-Stalker, but they do engage in friendly and not so friendly competitions, feuds and vendettas with rival tribes and clans. Furthermore, most Wild Psi-Stalkers consider their Coalition counterparts and any “civilized” Psi-Stalker, a weakling and a sissy — even a coward. Wild ones love to chide and insult CS Stalkers whenever they encounter them, and generally regard them as an unlikable rival tribe rather than outright enemies. Part of this reaction is jealousy, because the CS Psi-Stalkers have an easier life and fun toys like environmental body armor, Vibro-Blades and guns without having to steal or barter for them. Likewise, “civilized” Psi-Stalkers tend to regard their wild kin as barbarians and troublesome riffraff beneath their notice. Whether socialized or wild, Psi-Stalkers tend to be very primal beings who are aggressive, strong-willed, emotional and combat oriented. Consequently, encounters between wild and civilized Psi-Stalkers almost always result in contests of one-up-manship, threats, steely-eyed stares, brawls, firefights and even bloodshed.

Even the most intelligent and socialized Psi-Stalker is rarely literate. Most are interested in skills that are generally physical in nature or deal with piloting, weapons and combat. This is doubly true with Wild Psi-Stalkers. The Wild Psi-Stalker has less formal education than most “civilized” ones, having spent nearly all of his time learning to hunt humanoids and supernatural prey. The typical Wild Psi-Stalker is cunning, sneaky, selfish, and silent; often a solitary hunter (loner) who uses his powers and fighting abilities rather than skills and machines, other than weapons. The clans in the Pecos Empire are among the most savage and murderous on the continent. This may be a response to the high level of competition from bandits and other intelligent life forms (in the Psi-Stalkers’ minds, they have stepped up to the challenge), not to mention the presence of large monsters, mutants, the CS and other dangers.

Wild Psi-Stalkers in the State of Lone Star are most numerous around the Haunted Ruins of Dallas, The Bend and along the Rio Grande River (where they prey extensively on vampires). However, these mutants can be found as lone individuals, pairs and in small groups (1D4+2) throughout the State, as well as the wilds of Mexico, Arkansas, Louisiana, the Magic Zone and the Eastern Forests. They are least common in the American southwest (one tenth as many) but their numbers begin to increase dramatically in the Northwest, particularly in and around the old Canadian Province of Calgary (lots of Rift activity and supernatural beings to stalk). Furthermore, Psi-Stalkers frequently join bandits and adventurer groups, especially if the group is predominantly human. They are also fascinated with *Cyber-Knights* and often join or assist them on their crusades, although most Psi-Stalkers are too undisciplined to become one. Nobody knows with certainty how many Wild Psi-Stalkers consider Lone Star their homeland, but CS estimates place their number at around 200,000.

Wild Psi-Stalker

Attribute Requirements: None. A high M.E. and P.P. are suggested but not required. Roll 3D6 for each of the eight attributes as normal plus bonuses listed under the *Special Powers and Abilities of the Psi-Stalker*. Some skills may provide additional attribute bonuses.

R.C.C. Skills of Wild Psi-Stalkers: Also see natural abilities.

Speaks American at 90% efficiency. Most speak in low, guttural tones, and have a habit of grunting and growling.

Language: Two other languages of choice at 70% proficiency.

Detect Ambush (+5%)

Escape Artist (+5%)

Prowl (+10%)

Climbing (+5%)

Horsemanship (15%)

Horsemanship: Exotic animals (+15%)

Land Navigation (+10%)

Tracking (humanoids, not animals, +10%)

Wilderness Survival (+30%)

W.P. Three ancient of choice

W.P. Two modern of choice (including energy weapons).

Hand to Hand: Basic

Hand to hand: basic can be increased to expert at the cost of one R.C.C. related skill or assassin for two.

R.C.C. Related Skills: At first level the character can select four “other” skills, plus one new skill at levels 5 and 10. **Note:** Most Wild Psi-Stalkers care nothing about learning to read or higher education.

Communications: Radio: Basic and Scrambler only (+5%).

Domestic: Any (+5%)

Electrical: None

Espionage: None

Mechanical: None

Medical: First Aid and Holistic Medicine only (+5%).

Military: None

Physical: Any (+5% where applicable)

Pilot: Any (+5%), except power armor, bots and military vehicles.

Pilot Related: Any

Rogue: Any (+5%), except computer hacking.

Science: Basic Math only.

Technical: Any (+5%), except all computer skills.

W.P.: Any

Wilderness: Any (+10%)

Secondary Skills: The character gets five secondary skills from the list, excluding those marked “None,” at level one, and three additional at levels 3, 8, and 12. These are additional areas of knowledge that do not get the advantage of the bonuses listed in parentheses. All secondary skills start at the base skill level.

Standard Equipment: May or may not wear clothing, usually wears mega-damage body armor, and has a backpack, a couple of sacks, utility/ammo-belt, gun holster, sunglasses or tinted goggles, air filter or gas mask, and personal items.

Weapons will include a couple of (S.D.C.) knives and/or Vibro-Blades, and four other weapons of choice. They love Vibro-Blades, rapid-fire energy weapons, and magic weapons, but don’t start with anything magical.

Vehicles are limited to a good quality horse or other riding animal mount (has an affinity with all *nonpredatory* animals, including alien animals), or non-military vehicle (may include hover vehicles or souped-up hovercycle, motorcycle or car). May use a techno-wizard vehicle too, but not to start with.

Allies and Enemies: Most Psi-Stalkers regard all other Psi-Stalkers and humans as “kin,” and are the most willing to trust and befriend them. Outside the Pecos Empire where they and the Simvan are locked in an inexplicable feud, Psi-Stalkers usually feel a closeness and friendship toward the Simvan and intelligent mutant animals, especially Dog Boys.

Most other races are viewed with suspicion and disdain, while all *supernatural creatures* are regarded as natural enemies, as are many creatures of magic.

For some reason, the Wild Psi-Stalkers of Lone Star have taken a dislike that borders on hatred toward most of the Simvan tribes in this region. This is unusual, because Simvan and Psi-Stalkers usually get along well and often become good friends and strong allies. If there was a particular incident that caused these hard feelings, neither any living Simvan or Psi-Stalker seems to know what it is. So outsiders have speculated that whatever the reason, it has been long forgotten and the regional clans simply continue to feud because that’s what they have done as long as they can remember. It is also likely that the high level of competition in the regions with other gangs, monsters and races, has caused both races to view the other as their chief rivals and the hard feelings and bloodshed are the result of increased competition between them.

Psi-Stalkers also dislike most Tokanii, even though these mega-damage beings do not register as being supernatural. It is possible that the Tokanii’s demonic appearance is enough to make the Psi-

Stalkers instantly hate them. Remember too, that most of the Tokanii have invaded the forests that the Psi-Stalkers have considered "theirs" for centuries.

Money: The character starts out with no credit and 4D6×1000 in sellable black market items.

Cybernetics: Starts with none. Tend to avoid implants in favor of natural powers. If cybernetics are used, they are usually sensory or optical enhancements.

The Simvan Monster Riders

Reprinted in part from the *Rifts*® Sourcebook, with new material.

An alien menace that originated from the *Calgary Rift* is the Simvan Monster Riders. The Simvan are a race of intelligent humanoid cannibals. They are nomadic warriors who travel in clans or tribes that number as few as 1D4×100 to 4D6×100 members. Their culture is not unlike most nomadic societies; the men are the builders, hunters and protectors, while the women are the homemakers who bear and raise children, prepare food, make clothes, etc. The women are also the healers and possess natural psionic healing abilities (males do not possess such powers).

The tribe will settle in one area for weeks or months at a time. Sometimes they may inhabit the same area as long as a year, but will eventually move when the hunting grows poor (usually seasonal) or the environment becomes threatening (weather, monsters, the Coalition, etc.).

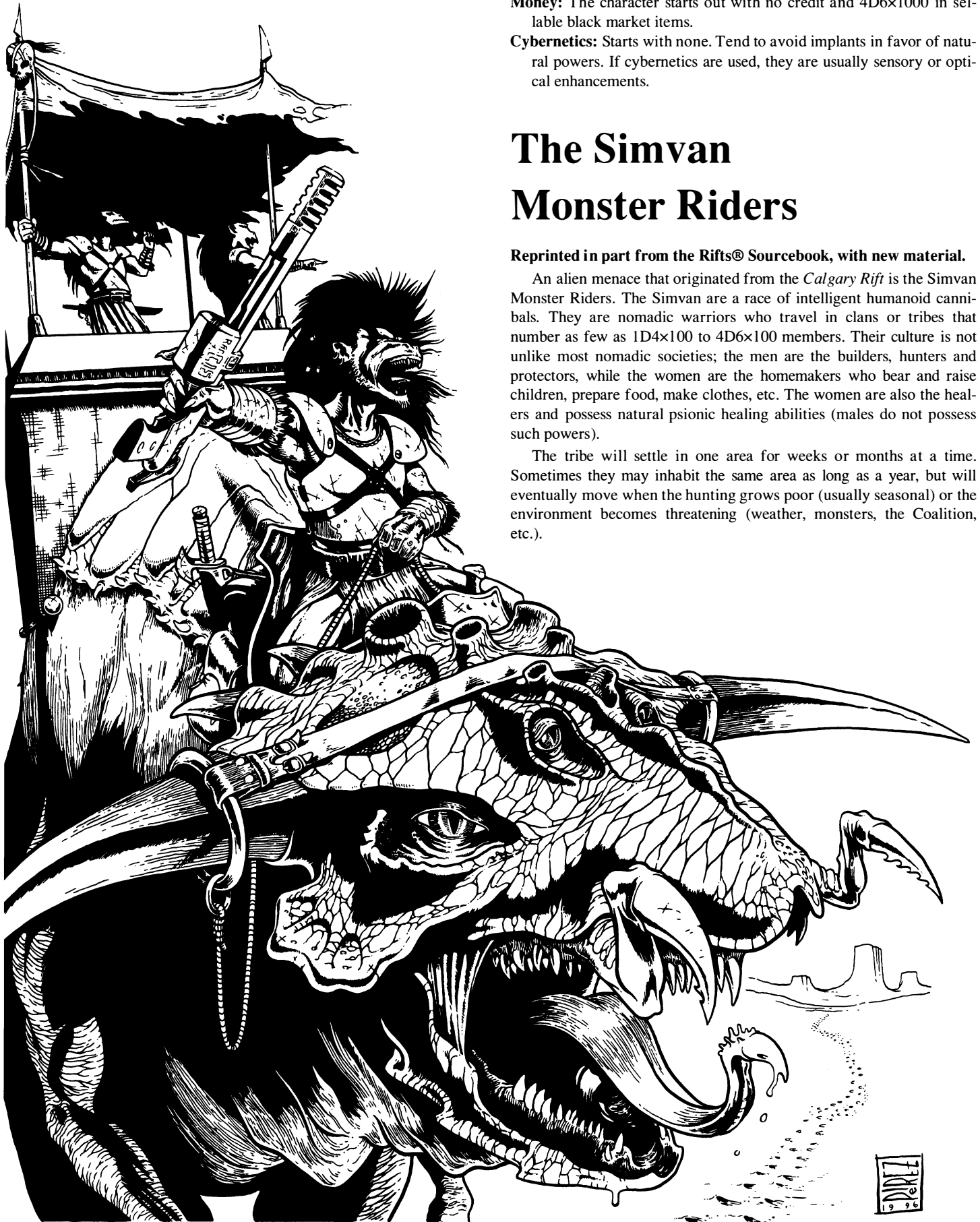

Both the males and females are aggressive, quick tempered and violent, although the acts of violence within the same tribe and between family members rarely draw blood. Among their own, the Simvan are amazingly gentle, patient, kind, considerate, cooperative and always cheerful and laughing. They are a strong community, loyal to each other and the tribe as a whole. However, they are aggressive, belligerent, demeaning, arrogant and deadly dangerous toward other humanoids. It must be understood that the Simvan see only themselves as true people, one with the land; all others are generally seen as fools or food. The Simvan are meat eaters with a definite preference for human and humanoid flesh.

The men are capable and merciless hunters and warriors. Their skills as trackers and hunters outshine the wilderness scout and as warriors are nearly equal to any Headhunter. All Simvan, including the males, have a wild, devil-may-care attitude toward life and love to take risks and accept challenges that will test their strength and skills. The warriors see combat as a means of proving their own courage, strength, skills and making life exciting and worth living. Courage, combat skill, and honor to one's people are the most respected and valued attributes a person can possess. As cannibals, the ultimate triumph and honor is to vanquish and eat (or be eaten by) a valiant and worthy opponent.

The Simvan are known as "Monster Riders" because they have an uncanny ability to tame monsters and use them as mounts and beasts of burden. The monsters selected are frequently creatures believed to be untameable and almost always carnivorous. Their most famous and favorite mount on Rifts Earth is a dinosaur-like creature known as the *Ostrosaurus*, but the Simvan have also used many other creatures, including the Rhino-Buffalo (except it eats too much) and other predatory animals and monsters. Tribe members will also have wolves, bears, and mountain lions as pets and guard animals.

The Simvan are not stupid and will not attack enemies with vastly superior numbers or power, unless defending the tribe or family. However, they love to fight and encourage settling disputes or proving one's honor through combat with the opposing or accusing person. For example: A tribesman who has been disgraced in combat (cowardice or accused of treachery) must fight his accuser, often to the death. If many accuse him, the offender is banished from the tribe but can redeem himself by going into the wilderness with no armor and only ancient type weapons to fight and slay a terrible beast (bear, lion, monster, etc.). If he returns with its head, he is allowed back into the tribe. Likewise, outsiders who wish to speak to the shaman or tribe leader may be forced to prove themselves in hand to hand combat (not usually to the death).

Although cannibals, the Simvan do not necessarily attack and eat anybody they happen to encounter. They frequently trade with humans and other humanoids, offering animal furs, wild and tamed horses (and other animals), as well as their services as a scout, hunter, bodyguard, hit man, etc. They usually barter for mega-damage weapons, E-clips, body armor and supplies. Likewise, they are often acquaintances (and even friends) with the mountain men and wilderness scouts in the area. In most territories outside the Pecos Empire, the Simvan's favorite humanoid associates are Psi-Stalkers and intelligent mutant animals. The two races are often allowed official admittance into each other's tribes as long as they obey tribal laws and customs. The Simvan's favorite humanoids to "eat" are *humans* and those most like humans.

In the Pecos Empire, the Simvan are among the most feared of all the tribes and bandits. They are feared as warriors, but also because of their monstrous appearance, the monsters they ride and the fact that they are cannibals. Most can be found in the high plains of the Lone Star State, The Bend and the Rio Grande Plain (where Zimchex and the Pervic Simvan live). Simvan can also be found throughout the plains and deserts of the American West, parts of Northern Mexico (though much fewer in number due to battles with vampires) and Calgary, although most prefer plains and prairies to the northern or eastern forests.

Simvan Monster Riders — Optional Player Character

Alignment: Aberrant evil, or any. As NPC villains likely to be anarchist, aberrant or other evil alignment.

Horror Factor: 12

Size: 5 feet, 7 inches (1.7 m) to six feet (1.8 m) tall.

Weight: 150 to 200 pounds (67 to 90 kg)

Attributes: The number of six-sided dice are indicated as follows. I.Q.: 3D6, M.E.: 4D6, M.A.: 2D6, P.S.: 4D6, P.P.: 4D6, P.E. 5D6, P.B.: 2D6, Spd. 4D6

P.P.E.: 4D4 in males, 4D6 for females.

Hit Points: 1D4×10;S.D.C.: 2D6×10

Natural Abilities: Keen vision, nightvision 120 feet (36.5 m), and psionics.

Psionic Powers, Males: I.S.P.: 2D4×10+M.E. Empathy, telepathy, sixth sense, mind block, and mind bond (super), as well as a psychic affinity with animals similar to those of the Psi-Stalker.

Psionic Powers, Females: I.S.P.: 4D4×10+M.E. Powers include: Detect psionics, deaden pain, exorcism, healing touch, increase healing, psychic diagnosis, psychic surgery and one healing ability of choice.

Combat: Two attacks per melee round plus those of the hand to hand training. Most Males are 3rd to 9th level fighters (roll 2D4+1).

Skills of Males: All wilderness skills (+20% bonus on all), wilderness survival (+30%), track (humanoids; +20%), horsemanship (and, in this case, monsterness; +20%), dance and sing. Physical skills: Hand to hand: assassin, body building, general athletics, running, climbing, and select three others (boxing and acrobatics are *not* available). Weapon Proficiencies: Archery and Targeting, Knife, Energy rifle, and three of choice.

Skills of Females: All domestic (+30% on all) and wilderness skills (+10%), wilderness survival (+15%), horsemanship (and, in this case, monsterness), holistic medicine (+20%). Physical skills: Hand to hand: basic, running, climbing, and select two others. Weapon Proficiencies: Blunt, knife, and select two others.

Player characters (or more elaborate NPCs), male or female: Select a total of six skills from the following: Radio: basic, escape artist, pick pockets, palming, concealment, pilot motorcycle, pilot automobile, pilot hover craft, pilot sail or motor boat, monster lore, faerie lore, any languages and art. No bonuses applicable.

Standard Equipment: Knife and two energy weapons, and perhaps bow and arrows. Favorite weapons include the vibro-blades, mega-damage arrows, and powerful energy weapons. They tend toward short range items for the joy of combat, so magic hand-held weapons are especially coveted.

Other equipment includes light mega-damage body armor, backpack, a couple of sacks, utility/ammo-belt, gun holster, binoculars, air filter or gas mask, and personal items. Player characters will start with a horse or *Ostrosaurus* for a riding animal.

Allies and Enemies: As noted in the description of Pecos Psi-Stalkers, they and the Simvan tribes of the Pecos Empire have a long-running feud that leads to frequent, vendettas, massacres and incidents of violence. Outside the Pecos Empire, and even in the Northern Quadrant, Simvan and Wild Psi-Stalkers are friends and allies.

Simvan also welcome all types of intelligent mutant animals, as well as werebeasts.

Ostrosaurus Quick Stats

Just one of the many dinosaur-like creatures that roam the wilderness of the American and Canadian west and American southwest. They prey on buffalo, horses, deer and other dinosaurs. The animals tend to run in loose-knit packs of 3-12, but are as likely to be aggressive solitary hunters. The *ostrosaurus*' typically prey on herd animals so they tend to be migratory, following the herds. This is especially true of *ostrosaurus* packs. They prefer hot climates (80-100 degrees Fahrenheit).

Alignment: Animal predator, considered anarchist or miscreant.

Horror Factor: 12

Size: Approximately 12 to 15 feet (3.6 to 4.6 m) long from buttock to nose tip. The thick tail adds another six feet (1.8 m) to the overall length. Standing erect, the beast measures about 15 feet tall (4.6 m).

Weight: 1600 lbs (720 kg) average.

Typical Attributes: High animal intelligence and instincts. Most attributes are not particularly applicable other than those listed. P.S.: 28, P.P.: 18, P.E. 24, P.B.: 4, Spd. 88

Speed: Running: 60 mph (96 km) maximum; runs loping on all fours. Leaping: The animals legs are strong and capable of great leaps. Leaps are approximately 15 feet (4.6 m) high and 40 feet (12 m) lengthwise. A running leap at speeds in excess of 40 mph (64 km) will enable the monster to leap an additional 30 feet (9 m).

Mega-Damage Creature: 1D6×10+40

P.P.E.: 3D6

Attacks Per Melee: Four. The creature's standard method of attack is by bite and powerful rear legs/claws. The front claws are used for dissecting its prey and cutting meat. +4 to strike, +6 to parry, +8 to dodge, +3 on initiative.

Damage:

Front Claws: 1D6 M.D.

Rear Claws: 3D6 M.D.

Bite: 2D6 M.D.

Slap with tail: 6D6 S.D.C.; 70% likelihood that the victim is knocked down, or hurled 12 feet (3.6 m), and loses one melee attack. Leap attack with claws: 4D6 M.D., but counts as two attacks. Opponents who are 10 feet (3 m) tall or smaller are likely to be knocked down (80% chance), losing one melee attack and may be pinned and unable to move/attack/dodge (40% chance). The monster can bite or slice its pinned victim with its teeth and claws until it is forcibly removed or attracted by a different target.

Natural Abilities: Terrible swimmers 20%, excellent climbers 80%, track by scent 35%, recognize the scent of human blood 60%, superior vision: can see a rabbit a mile away. A carnivorous predator that preys on smaller, slower dinosaurs and animals, including humanoids.

The Brodkil

A Demon from the Rifts

In all likelihood, the Brodkil are a race of giant *sub-demons* who are natural M.D.C. creatures. They are apparently of supernatural origin, but do not possess significant powers other than superhuman strength, endurance, M.D.C. bodies, and the ability to turn invisible at will. The Brodkil are incredibly aggressive and war-like; fortunately, they are nomadic scavengers with no technology of their own nor organized society. The typical tribe will range from 20 to 100, while raiding bands can be as few as three. The average band of raiders will number from 4-24 and frequently include the members of other races.

In the Pecos Empire, they are members of human and D-bee gangs, but prefer the company of Simvan, Tokanii, Ogres, vicious mutants and other large, powerful beings. Most have submitted themselves to partial bionic reconstruction and are among the most ruthless and brutal bandits around. They are a wild and barbaric lot, but are not careless in battle. They seldom fight to the death and can be incredible cowards against a superior enemy. Against weaker opponents they are bullies and arrogant, although they are not known for deliberate acts of depravity or needless torture.

The nomadic warriors travel the wilderness, attacking travelers, villages, and towns to acquire the things they want or need. They are fair hunters but would rather steal livestock or waylay and eat some unsuspecting travelers than spend time stalking wild game. The Brodkil are

meat-eating predators who feast on the flesh of humanoids, as well as animals. They are lazy, and hate to learn complicated skills or skills that do not directly impact on their lives as warriors and thieves. Consequently, most of their skills are combat oriented.

The Brodkil — NPC Villain — Optional Player Character

Alignment: Selfish or Evil.

Horror Factor: 10

Attributes: The number of dice to roll are as follows: I.Q.: 2D6+3, M.E.: 4D6, M.A.: 3D6+1, P.S.: 5D6+5, P.P.: 3D6+4, P.E. 4D6, P.B.: 2D6, Spd. 6D6; supernatural P.S. and P.E.

Hit Points & S.D.C.: Not applicable.

Mega-Damage: 250

Height: Approximately 9-10 feet (2.7 to 3 m).

Weight: 350 lbs (103 kg)

P.P.E.: 2D4×10

Attacks per Melee: Five

Bonuses: +2 on initiative, +4 to strike, +6 to parry and dodge, +15 S.D.C. damage, +2 to save vs psionics and +4 to save vs magic.

Damage:

Restrained Punch: 4D6+15 (P.S.) S.D.C.

Full Strength Punch: 2D6 M.D.

Bionic Arm Power Punch: 3D6 M.D.

Tear: 2D6 M.D.

Crush: 1D6 M.D.

Bite: 1D4 M.D.

Body Flip/Throw: 6D6+15 (P.S.) S.D.C.

Natural Abilities: M.D.C. body, impervious to normal fire and cold, prowls 40%, turn invisible at will, bio-regenerate 2D6 M.D.C. per hour.

Magic Powers: None.

Psionics: None.

Average Level of Experience: 3rd to 5th level; lazy.

Skills of Note: Hand to hand: basic or expert, boxing, wrestling, climbing, tracking, intelligence, radio: basic, pilot hover craft, three languages, W.P. knife, sword, blunt, and energy rifle. Game Masters may add skills from the categories of weapon proficiencies, communications, technical, domestic, and wilderness (no bonuses).

Bionics: Will always be partial reconstruction, never full conversion. The most common types of bionic features include one or two arms, occasionally an extra limb, forearm blasters, vibro-blades, and retractable claws/blades. Implants include the gyro-compass, and amplified hearing.

Weapons: Favorite weapons include heavy energy rifles, bionics, and magic weapons. Also use optical enhancements and the occasional hover vehicle.

Note: Because the Brodkil have no supernatural, psionic, or magic powers, they can benefit from bionic weapons and implants without ill effect other than losing the ability to turn invisible. The Brodkil love bionics.

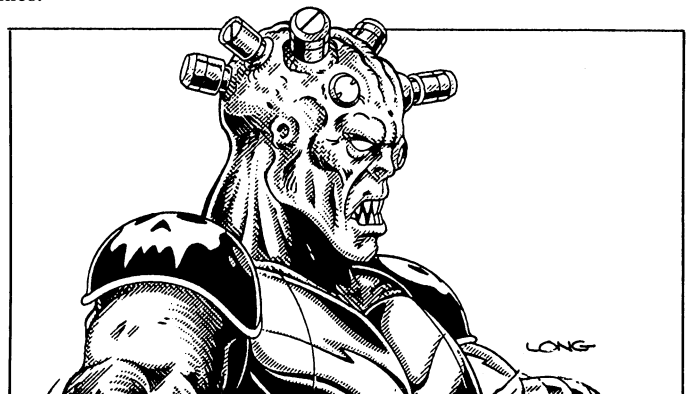



A Geographic Overview of the Lone Star State

By Julius Rosenstein & Kevin Siembieda

Lone Star, or what the old American Empire called *Texas*, is a massive expanse of land that covers 267,300 square miles — so big that when the Republic of Texas was annexed in 1845, the United States reserved the right to subdivide Texas into *five* smaller States! Although many think of Texas as a hot, prairie land, that's just one piece of the bigger picture. Texas has always been a land of diverse geology and climate. Since the Great Cataclysm (300+ years before) much of Lone Star has returned to the way it was before the invasion of cattle ranches and oil derricks, high-tech cities and sprawling suburbs. The eastern lowlands (including Dallas/Fort Worth and parts east) have returned to a forest of pine and oak, the great central plains teem with vast herds of animals on the lush grass, and along the Gulf Coast the lowland coast is now green and beautiful.

Llano Estacado — The Northern Quadrant

Except for the area around Lake Meredith and sparse woodlands along the Canadian River, Llano Estacado is a wide, table-top flat grassland that looks endlessly the same. It is interrupted by two rivers, the Canadian, with its numerous patches of quicksand, and the Red River (the Prairie Dog Town Fork and other smaller tributaries) which form the Palo Duro Canyon. The top soil is only a few inches deep and

the wind swept plains arid, so only grass grows easily. However, with proper irrigation (water lies deep below the Caprock) crops of corn, oats, wheat, and sorghum are possible (windmills were used in pre-Rifts days to pump the water up from the ground). Mostly, these grasslands are ideal for cattle ranching. There also remain deposits of oil, natural gas and iron to be mined. Flint (and old, pre-Rifts Indian flint quarries) can be found on a bluff near Lake Meredith.

Comanche Country

A small tribe of about 600 Comanche have returned to the old ways of living off the land and mysticism. They roam the CS Northern Quadrant, north of the *Canadian River* and up into Oklahoma. Their favorite range is around *Lake Meredith* and the area of wilderness once known as the *Lake Meredith National Recreation Area* (around such pre-Rifts communities as Oil City, Four Way, Masterson, Marsh, Pomeroy, Fritch, and Borger). They rarely bother the CS and are generally left alone by them.

Prairie High Plains

Cutting Lone Star in half, from north to south, between the Caprock Escarpment in the west and the Balcones Escarpment to the east are the grassy rolling hills of the prairies. This expansive region of grass and scrub is broken by the occasional patch of thin, sparse woodlands, farm-

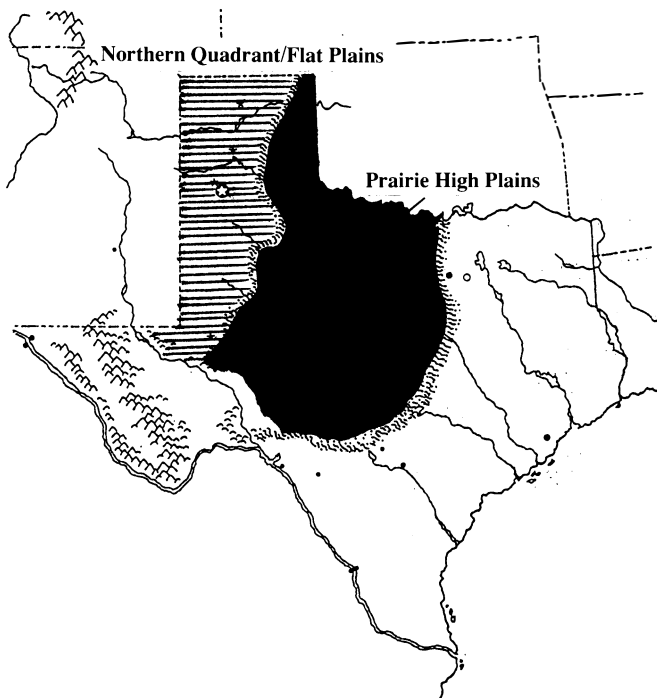

lands and cattle ranches. However, the overgrazing of cattle from pre-Rifts times marks the grassland with parched limestone, granite and dust. Herds of *buffalo*, *Rhino-Buffalo*, grazing dinosaurs and the predators that stalk them (*Ostrosarus* and similar) have reclaimed the land. *Ostriches*, *wildebeests*, *aoudad*, and *rhinoceros* are also now part of the fauna of the plateau and the high plains. They are the descendants of livestock brought to the region by American ranchers who raised exotic breeds from Africa. This was possible because the terrain of region resembled the high plains of East Africa. They in turn are hunted by Simvan, Indians and others. These animals can also be found in the northern highlands (Comanche Country), but most migrate to the warmer prairies in the winter.

Farther south is **Edward's Plateau**, just south of Abilene. Here the plains turn rocky and more treacherous. Large herds of *buffalo*, *Rhino-Buffalo* and their predators are found in the low rocky hills and grassy plains. Deer, goats and other cloven-hoofed creatures also thrive on the rocky terrain, and the nomads who live here raise goats and sheep as well as wildebeests.

Hundreds of streams pour down from the plateau, through the Hill Country, lowlands and into the Gulf of Mexico. **Note:** Notable animals and monsters common to the American West and Southwest can be found in **Rifts® New West**.

Rio Grande River

The Rio Grande River, its waters once dammed and syphoned for the irrigation of farmlands, has returned to being a wild river, second in length only to the Mississippi. It still serves as a natural dividing line between Texas/Lone Star and the vampire infested lands of the old Mexican Empire. It is universally accepted by all mortal inhabitants on both sides of the Rio Grande, that bridges across the river are forbidden.

Vampires cannot cross the moving waters, so the Rio Grande of Rifts Earth functions as a natural barrier against these loathsome creatures. Those found building a bridge are beaten and any bridges are instantly destroyed. Anyone making a second attempt at building a bridge will be summarily executed. Even operators of boats and ferry boat services across the river are viewed with concern and suspicion. Despite the best efforts of all the people living or travelling along the great river (with admittedly vast lengths uninhabited and unguarded), vampires still manage to make their way to the Pecos Empire.

Groups of bandits, adventurers, and family clans of Good Ol' Boys frequently come down to the Rio Grande to hunt vampires for fun and

sport. Six families near Laredo have a friendly rivalry to see which can kill the most "bloodsuckers" every year (with friendly disputes over the accuracy of the accounting). Members of **Reid's Rangers**, as lone riders, pairs and small groups of 1D4+3 (sometimes in small armies of 60-160), also ride along the Rio Grande, purging the land of vampires and other supernatural menaces, although they usually avoid known bandit settlements and dens of iniquity like *El Paso*, *Laredo* and *Ciudad Juarez*. See **Rifts® World Book One: Vampire Kingdoms** for more about the Vampires of Mexico, the city of El Paso, Ciudad Juarez, travelling shows and Reid's Rangers — Vampire Hunters (Fort Reid is located in Mexico). Many tribes, bands and farmers grow citrus trees and raise a variety of fruit, and other crops, including oranges, grapefruit, lemons, grapes, melons, spinach, rice, peanuts and cotton.

The southwest are deserts, mountains and canyons of the **Trans-Pecos**, also known as *The Bend*.

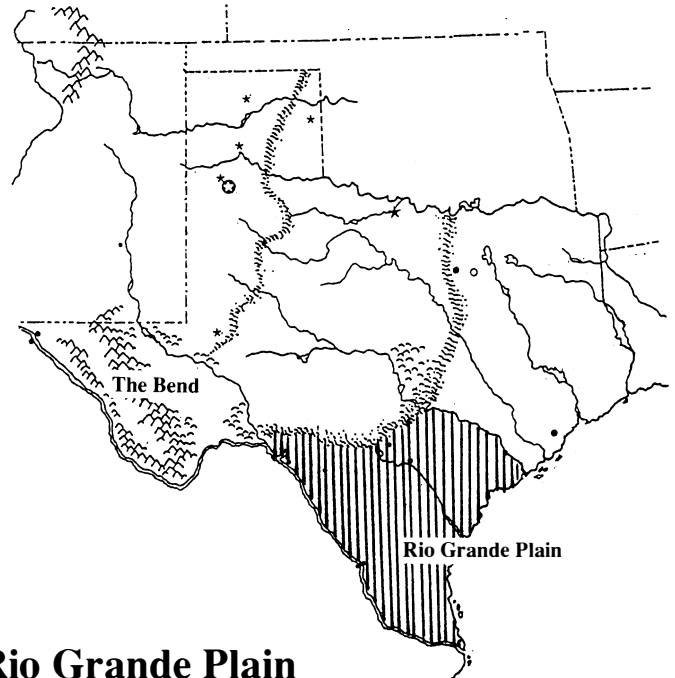

Rio Grande Plain

The **Rio Grande Plain** in the southwest is a subtropical zone filled largely with dust, sand, dry grass, cactus, and scrub. Only along the Rio Grande River itself is there green grassland, flowering fields, palm trees, grapes, and citrus fruit (in the era before the Great Cataclysm plantations of citrus fruit were plentiful). On Rifts Earth, the land bordering the river is coveted for the farming of groves of fruit trees and grape vineyards. Unfortunately, these beautiful areas are also the areas most haunted by the undead, as well as populated by Pecos Bandits.

The Freelands

This a vast expanse that cuts a horizontal swath across the central and eastern portions of Texas. Called the Freelands by most local inhabitants, neither the Coalition States nor the Pecos Bandit hold sway over it, but both claim it as part of their territory. Several independent kingdoms, including Houstown and the Kingdom of Worth, are located in this part of the State.

The Eastern Forests

The lush forests of East Texas (all part of the Freelands), once cleared of trees by lumber mills and cattle ranchers, has returned as a vast expanse of pine and oak. The forest covers most of the land from Fort Worth to Dallas, south to the Brazos River and all the way east un-

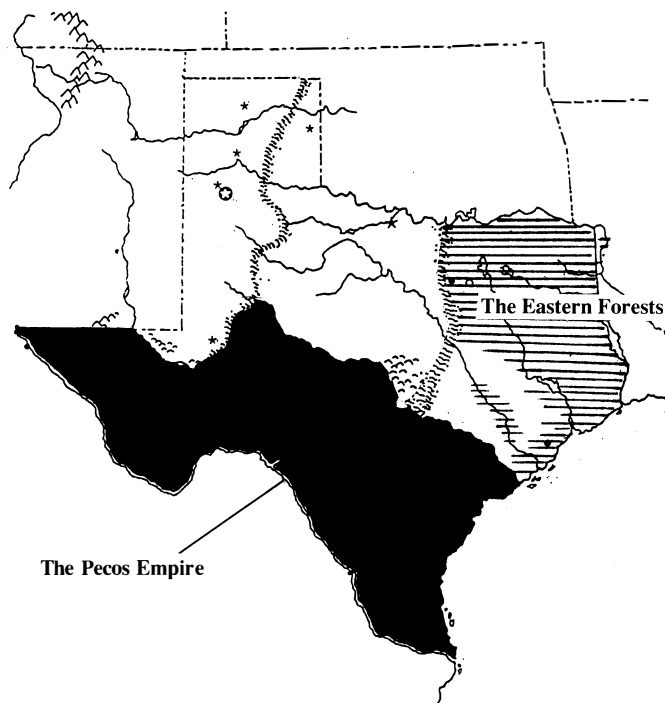

til it merges seamlessly with the Southern Appalachian Woodlands of Louisiana and southern Arkansas. In this forest region, rainfall is heavy, 60 inches annually, and the summers are hot and humid (95-100 degrees Fahrenheit); winters are cold to moderate with temperatures ranging from near freezing (34 degrees, rarely below) to 54 degrees Fahrenheit.

A few patches of prairie land and the ruins of some pre-Rifts cities and towns break the landscape. However, already human and D-bee settlers from the Pecos Empire chip away at the forest for lumber, especially around the Kingdom of Worth, while the CS views this area as a valuable resource for the future. For now, it remains mostly untouched, inhabited mainly by nomadic clans and tribes of Native American Indians (Apache and Comanche), Psi-Stalkers, a variety of D-bees, and some humans. It is also a refuge for mutant animals (especially felines) who flee the Lone Star Complex in the west, hunters and trappers, and bandits on route to CS territories in the northeast or hiding from the law. Like most of Lone Star (post-Rifts Texas), the region is mostly uninhabited wilderness with fewer than two people (human or otherwise) per every 50 square miles.

Kingdom of Worth

Worth is a relatively new kingdom founded by King Macklin. It is located on the ruins of a large pre-Rifts city named *Fort Worth* in the northeast of the State of Texas, at the feet of the Balcones Escarpment.

When Victor Macklin was named king, he decided it was only fitting that a king have a kingdom. He had always liked the name "Worth" so he decided to ride North to the fledgling city of Worth to make it his own. Along the way he unified several small tribes and ordered them to come to his "new kingdom." When King Macklin and his *Pecos Raiders* arrived, Worth was already a growing town of nearly 5000 — 5000 that now faced an army of 10,000. King Macklin met with the leaders of the community and informed them that he would have Worth as his kingdom no matter who dared to oppose him. He pointed to the multitude of bandits, warriors, tribesmen and the hopeful who had followed him and offered the peace-loving city council the option of seeing their city destroyed or joined with "his people" to become greater than they had ever imagined. Word of this bold, young warlord had filled the talk of all the people in the region for several years. King Macklin's (undeserved) reputation as an undefeated conqueror and unifier of tribes had preceded his arrival. The city counsel knew that many of their own people considered the man a hero, and might rise up to join his ranks. In an effort to keep peace and save lives, the counsel welcomed King Mack-

lin's "invitation" to join his new kingdom, and so it was that the Kingdom of Worth came into being.

Since that fateful day, the legendary King has attracted thousands of people desperately searching for a glimmer of hope in building a genuine nation, free of the tyranny of the Coalition States and the ravages of the independent bandits. Located in the Freelands, and joined by thousands of other people, humans and D-bees who all shared the same dream, the Kingdom of Worth has grown beyond anything that King Macklin had ever imagined. His original move against the tiny, poorly defended city was an act of pure arrogance fueled by a series of treacherous and shallow victories and the exuberance of youth (he was only 19 years of age at the time). The "Boy King's" bravado and cleverly crafted "legend" have taken a life of their own and are far greater than the petty little man who started it all.

Although King Macklin revels in the greatness associated with "his" kingdom, he is well aware that it is the ideals of Worth that the multitudes flock to, and not its king. His masterfully crafted lies, feigned sentiments and empty words have somehow created hope that has given birth to a nation. However, fool that he is, King Macklin feels angry and cheated. He doesn't see his own immortality as a man who gave hope to lost people and gave birth to a nation, he sees only a lie. He is envious of his own runaway creation. Each new triumph, each new refugee who joins the dream sticks a dagger in his soul. It is *he* they should flock to, worship and adore, not some stupid dream! Vile, selfish and petty, to his thinking, he, the man, is greater than any damn ideal.

It is this constant source of frustration and consternation that has compelled him to destroy that dream, although he doesn't realize it. This is what has prompted him to speak of freedom, unity and war against the Coalition. Inspired by the heady successes of Worth and blinded by the (callously empty) words of their revered founder, King Macklin, the people of Worth and tens of thousands of other hopefuls believe they have a chance against the Coalition War Machine and sing of war and everlasting freedom.

32,000 people thrive in the city proper. Another 11,000 people live and work in the villages, farms, ranches and camps around the city, which are all part of the overall Kingdom. Moreover, Macklin's talk of freedom, unity and efforts to expand his domain through alliances and recruiting brings hundreds of new people every week, and has resulted in a kingdom that is poised on the verge of greatness.

Among the currently unallied tribes and raider bands, there are as many as 60,000 to 80,000 more people who are considering joining Worth but are still a bit leery of committing themselves. It is only a matter of time before they cast aside their misgivings and join, and when they do, the Kingdom of Worth will have become the largest, independent Kingdom in the American southwest! If they stopped there, and continued to build on the strong foundation (regardless that is was built upon lies), the nation would flourish, and even the Coalition States would have to give pause to the miracle. Once this great kingdom existed, it would only be a matter of time before the majority of the Pecos Empire truly united and became a power that even the Coalition States might not be able to bully or destroy.

Sadly, that day will never come, for King Macklin's insatiable quest for glory, worship and immortality will pit the Kingdom of Worth against the Coalition in war that never had to be, and one that they can never hope to win. Already the Coalition States, under the watchful vigilance of General Kashbrook, is preparing for war and making preparations for the obliteration of Worth, before the 90,000 sitting on the fence decide to hop off and join the kingdom. Although Saber Lasar, Warlord Don Marco and countless other tribes and groups may organize to repel the Coalition invaders (at least for the moment), the Kingdom of Worth will be razed to the ground and when it perishes, so will the dream of lasting unity and freedom for all.

These events will come to pass within the next 6-10 months. Whether King Macklin lives or dies, won't really matter. He will have squandered his only real chance for greatness, and will always be re-

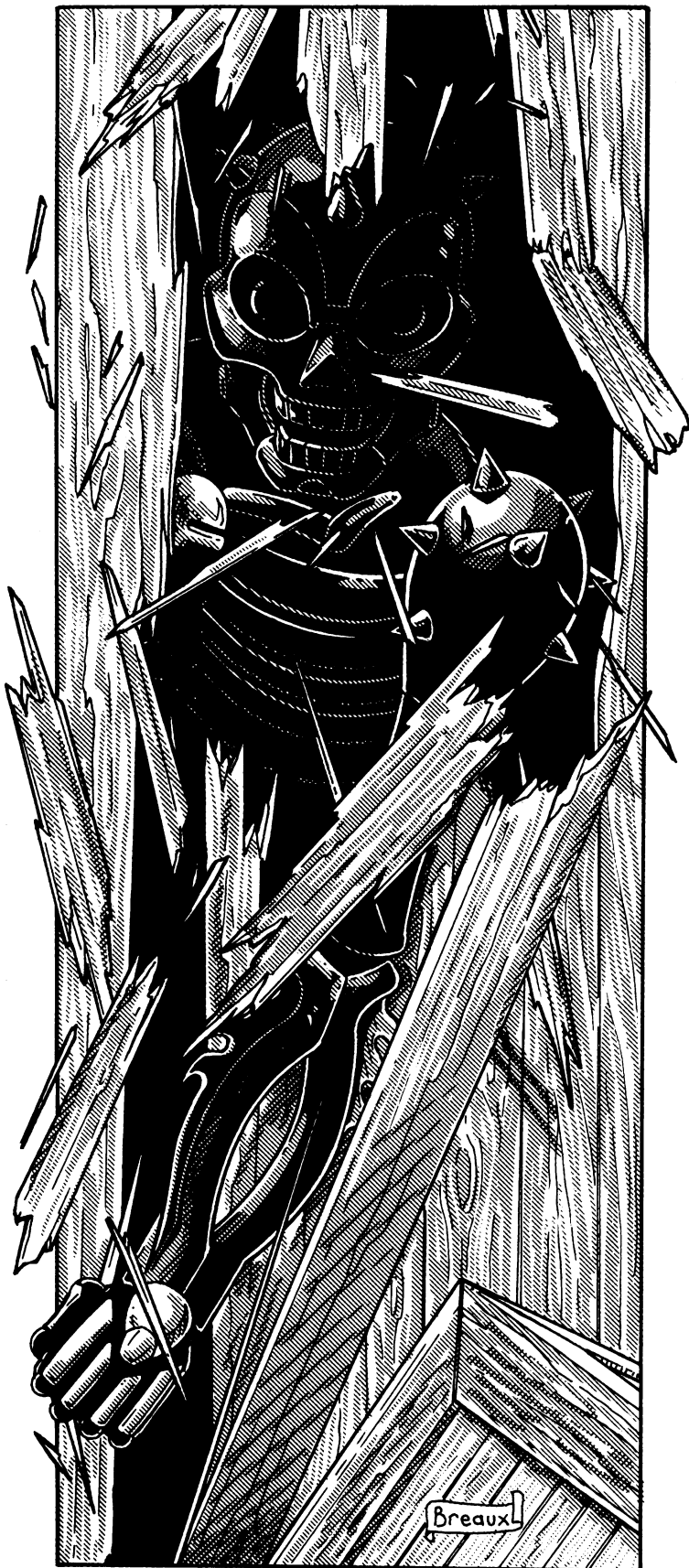

The Haunted Ruins of Dallas

The full name of this frightful place is “The Haunted Ruins of Dallas,” because ghosts, demons and monsters are said to infest the ancient ruins of this once great pre-Rifts city. Actually, this is a bit of a misnomer. After the Great Cataclysm, a flood of entities and demons poured through a Rift in the heart of Dallas. For the next hundred years, dark forces and haunting spirits inhabited the ruins and fell upon all who came within 20 miles (32 km). One legend claims a bold Warlord and a thousand men rode into the ruins, intent on claiming the treasure of the lost world. All were among the most experienced and notorious bandit in the land, yet every last one fell to the soul-eating spirits that claim Dallas for their own. According to the tale, the slain bandits refused to surrender and in death joined the spirits that slew them and appear during the worst storm to ride in a vendetta against the living. Although stories of their appearance are fewer with each passing generation, there are many who claim these **Storm Riders** are real! Despite countless tales of ghosts, demons, curses, and misfortune that surround the ruins of Dallas, whatever demonic forces that once inhabited the shattered city are long gone. However, to this day the legends have kept even many of the bravest young warriors and daring bandits away. In fact, any appearance of demons, entities or bad luck in or around the ruins are attributed to the vengeful ghost and evil spirits said to linger. Neither the Comanche or the Apache will ride with 100 miles (160 km) and warn that the **Kingdom of Worth** is *doomed* because of its close proximity. However, in the last 60 years, much of the easy artifacts have been removed by scavengers, adventurers and fortune hunters bold enough or foolish enough to risk their lives for money.

Although demon hordes and legions of ghostly spirits no longer fill every inch of the ruins, there is something peculiar about old Dallas. Dog Boys and psychics report that the ruins of Dallas are intermingled with some sort of supernatural evil that they cannot quite identify, and warn that it is best to steer clear of it. Poltergeists, Haunting entities and Tectonic entities are constantly present in these ruins with 3D4 of each present at all times. Possessing entities are also comparatively common, with a hundred tales of demonic possession reported in the last 50 years.

Likewise, demons *do* appear, from time to time, among the ruins, and the place has a long, bloody history of death and destruction.

G.M. Note: One of the forces adding credence to these legends is a small band of six secondary and two wild vampires who make their home in the ruins and stalk, as a gang, unsuspecting prospectors and artifact hunters or adventurers who come to Dallas, or spend a night on the trail too close by. They avoid the temptation of hunting in the Kingdom of Worth for fear that such activity would draw attention to themselves. These careful and cunning undead have existed in the ruins for 112 years, but there are some nights when even they decide it is better to stay indoors, safe in their underground sanctuary than to venture out — they to whisper about strange occurrences, demons, ghost and a touch of evil.

Among the more recent and *human* denizen of the Haunted Ruins of Dallas, is a secret CS outpost whose troops (10 Special Forces, 10 undercover agents, 10 Dog Boys, and 10 Skelebots) reconnoiter the area and send undercover agents into the Kingdom of Worth to keep an eye and ear on what’s happening there. Also, the notorious Oklahoma gang known as *Los Amigos Gang* have a secret underground hideout in the ruins with a cache of weapons, equipment and treasure (more on them in **Rifts® New West**). A number of other, small bandit groups and members of the Federation of Magic have secret hideouts or places they are excavating for ancient artifacts in the ruins of Dallas.

membered as the man who led a hundred thousand to their doom and destroyed the Pecos Empire’s best chance for sovereignty and freedom from the Coalition States.

Houston

Population Breakdown: 28,000 total.

| | |
|--------------------|---------------|
| 9,000 Humans | |
| 6,400 Psi-Stalkers | 200 Tokanii |
| 600 Simvan | 11,800 others |

The free city of Houstown is somewhat unusual within the Empire in that it is neither tribal in nature nor organized for raiding. Like the Kingdom of Worth, the citizens have become a melting pot of humans and D-bees trying to bring civilization to the rest of the Pecos Empire. Unlike Worth, its hopes and dreams are predicated on sincerity and careful planning.

It is located in the disputed *Freelands* 50 miles (80 km) northeast of the Pecos Empire dividing line that is the Colorado river. Built on the ruins of pre-Rifts Houston, the city of Houstown has a population of 28,000 and another 2D4x1000 transients in the city at any time. Outside the city are farmers and shepherders. Along the coast are fishing villages. All totaled, they add another thousand to the overall population count. It considers itself part of the Pecos Empire and is the most densely populated *permanent* city in the Empire.

The city is rapidly becoming a major center for trade within the Pecos Empire and it has been suggested by locals that it should be made the official capital of the Pecos Empire. Of course, since the Empire is composed of hundreds of independent, mostly non-allied and often diametrically opposed factions, it is impossible to get a consensus agreement. However, many factions have come to welcome Houstown as a budding new kingdom in the Badlands, and a nice place to do business. It is clean, new looking, friendly, peaceful and a place where one can see and feel the prosperity. One of the services offered by the city is a neutral ground for tribes and gangs to meet and resolve their differences without violence. An impartial mediator is always available to those who want one, and even Lord Mayor Orpheus is willing to sit in on disputes where he can be of service.

Under the firm but tolerant rule of Lord Mayor Orpheus (see separate entry), Houstown has gone from a small coastal town to a city that may someday rival Los Alamo in size and power, although that day is still years away. Despite the diversity of its inhabitants, the government

of Houstown is run in a somewhat tribal/feudal manner. Essentially, the city is governed by a Mayor (now Lord Mayor) who has very broad executive powers. He appoints the heads of various city departments (law enforcement, the different utilities, financial, etc.) and allocates the city treasury. The Lord Mayor is assisted by an *Advisory Council* which consists of the city department heads, experts in various fields (magical, technological, and/or psionic), and local representatives. These representatives can represent neighborhoods, economic interests, and ethnic/cultural backgrounds.

In order to get on the Advisory Council, the local representative must file a petition with the signatures of 1,000 citizens and pass a Council vote with a majority of at least two thirds. The department heads and technical experts are appointed by the Lord Mayor. However, these experts must also pass the Council vote by a two thirds majority, while the department heads are appointed to the Council.

The Advisory Council does just that — they give advice! The Lord Mayor is under no obligation to follow their advice and is legally justified to ignore it if he so chooses. However, the Council does have the right to call for a new mayoral election at any time they wish. Although it is the Advisory Council that decides if there should be a new election for mayor, the election itself is decided by popular vote. All citizens of Houstown are eligible to vote. Once a mayor is elected (or reelected), he cannot be ousted for at least six months.

Before the arrival of Orpheus, mayors were elected every six years, however, there was no limit to how many consecutive terms a mayor could serve. Since Orpheus was acclaimed as mayor, the term of office has become indefinite. Houstown could go for decades without a mayoral election (remember, Orpheus has a life span that could measure centuries). During his term of office, Orpheus has been a benevolent dictator. He accepted the office of Mayor because he felt that he was the person best suited for the job and has held the position ever since. The



titan has been a very popular mayor and has only had to run for reelection once.

Psi-Stalkers. Of special note is the high concentration of Psi-Stalkers in Houstown (over 6000). In fact, a major faction of the city law enforcement is an elite guard unit consisting of some 300 Psi-Stalkers (levels 4-7). Because of the large number of Psi-Stalkers, there is a constant demand for P.P.E. donors and a brisk business is done in P.P.E. selling. Like the Coalition Stalkers, the local Psi-Stalkers have been trained to resist the urge to kill their victims; the laws of Houstown are quite severe regarding that offense. Instead, they find donors who are willing to be drained of their P.P.E. for a price. Newcomers to the city, especially those with high amounts of P.P.E., like practitioners of magic, will be approached by hungry and anxious Psi-Stalkers willing to pay for their P.P.E. Some locals even have a regular arrangement for the taking of their mystic energy. For those willing, or desperate enough, they can actually make a fair living as P.P.E. donors.

Practitioners of Magic are welcome at Houstown and a small community of them has taken residence. There are a handful of Ley Line Walkers and Techno-Wizards, with rumors that a TW school and manufacturing center may be established in town.

The Pecos Empire

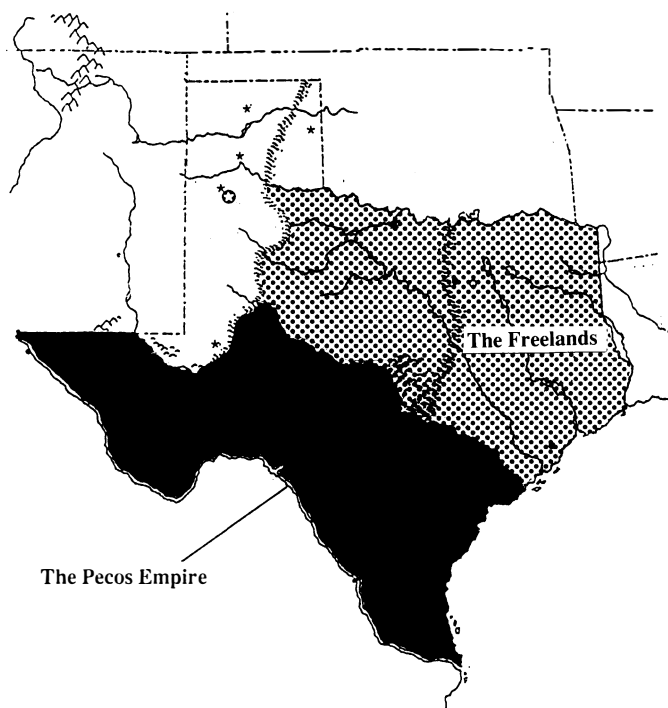

Apache Country

The Apache's traditional homelands are Arizona, Colorado and New Mexico, but these nomads often travel as far east as Lone Star. Although small clans and hunting parties can be found throughout the State, they are most commonly encountered in the western portion in The Bend/Trans-Pecos Badlands and the High Plains of the CS controlled Northern Quadrant. They may also be encountered along the Pecos and Rio Grande Rivers. Approximately 4,600 consider The Bend to halfway to Amarillo their hunting grounds. At least 30,000 to 40,000 live in the neighboring plains and deserts of New Mexico and may come to aid and support their eastern cousins.

The Apaches are nomadic and generally consider their territory to be wherever the wind takes them. Trespassers on Apache territory are almost as likely to be allowed to stay unmolested as they are to be driven off. If the trespassers respect the Apaches' land and people, and are not

destructive and do not plunder or destroy the land (including flora and fauna) or the people, they are usually allowed to stay. However, the Apache usually let people know they are aware of their presence by sending a party of 8-24 warriors to stand defiance in the distant observing them for long minutes (sometimes an hour and sometimes they return every few days) to let the people know they are being watched and no trouble will be tolerated.

When Apaches fight, it is usually for resources, glory, honor, or self-defense. Apache warfare is fierce and savage but, if the fight is against an honorable and worthy adversary, or just for resources, defeated foes are usually shown mercy afterward. The Apaches are more concerned with impressing their foes than with annihilating them. This attitude has allowed them to establish a hegemony over their former enemies.

However, if the fight is over a matter of honor or against someone not considered worthy (such as most Coalition troops), there are few foes more implacable than an Apache warrior. Overall, within the Pecos Empire, the Apaches are regarded as relentless but honorable warriors.

The Bend — a.k.a. Trans-Pecos

The Bend is an area due west of New Del Rio that borders the southern curve of the Rio Grande. An area of mountains and deserts in pre-Rift times, this was one of the American Empire's national parks and was famous for its breathtaking 1500 foot (457 m) tall canyons. It is located in the southwesternmost portion of Lone Star. South of the Pecos

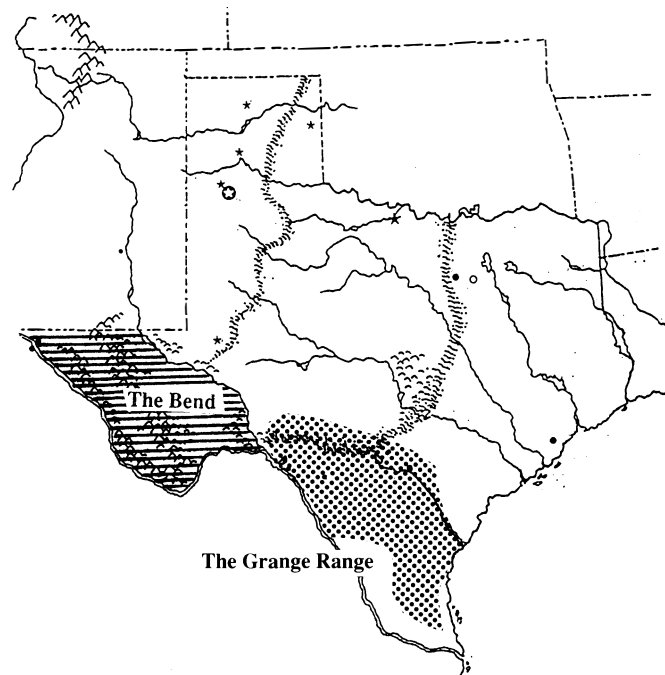

River and north of the Rio Grande River is a beautiful, arid land of stony desert, mountains, jutting rock, buttes, deep canyons, orange-tinged mesas, sparkling arroyos, cactus and endless blue sky — the classic Southwestern scenery. Seventy foot (21.2 m) sand dunes are found in the eastern Trans-Pecos, and in places along the mountains one can find "bolsones" (large drainage basins that hold rainwater runoff from the mountains, and often the only source of water) and salt flats. Flowering cactus, plants and scrub push up through the sand and parched earth to add to the colors and variety of the rocky terrain. The upheavals caused by the Coming of the Rifts wrought amazing changes in the Bend.

There is now a spectacular labyrinth of caverns within the mountains. Also, unlike the rest of Texas which has a dearth of Ley Line activity, there is a large amount of local ley lines and nexus points within the mountains (and along the Rio Grande River). This Ley Line activity is little known because, for some reason, the mountains prevent this energy from being detected. Even a nearby Ley Line Walker or True Atlantean outside the caverns would probably not detect this energy;

however, a Line Walker who entered the caverns would probably gasp at the amount of ambient magical energy present.

Rattle and coral snakes abound in this region, so travelers need to beware. This desolate, largely uninhabited region is the hiding place of outlaws on the run, and is visited by nomadic tribes of Apache, Psi-Stalkers and Simvan. Although there are a few small tribes who manage to eke out a living in the canyons between the mountains, the mountains themselves are given a wide berth because of exceptional amounts of supernatural activity, random Rifts, poltergeists and other entities (a lot of tectonic entities for some reason), monsters and Simvan Monster Riders.

Note: Across the Rio Grande into Mexico is the Chihuahuan Desert. An equally inhospitable, stony desert and the home of vampires.

The Grande Range Home of the Pervic Simvan

The Grande Range is the area between New Del Rio and the Gulf of Mexico. There are no permanent settlements of note; nothing beyond a hundred or so tiny villages and nomadic clans (seldom exceeding 100 people) and very little farming goes on in this region. Instead, the open ranges are used as grazing lands for animals. Although sheep (and some cattle) are raised here, the Grande Range is noted as ideal for horse breeding.

Much as the Native Americans of pre-Rifts times relied on the bison for much of their needs, the nomadic tribes that roam these plains rely heavily on their animals for food, clothing, fuel (animal dung), and barter with other tribes. Among many of these tribes, livestock (of whatever breed) is a measure of one's wealth.

Although there are a number of nomadic tribes that consider the southern Grande Range their home, of particular note are the **Pervic Simvans**. Led by their chief, Zimchex (see separate entry), the Pervic are the most influential tribe in the Range. The tribe numbers around 1600 Simvans and 50 runaway mutant animals, which is a fairly large tribe by Simvan standards. However, they have also established a hegemony among their neighbors and have nearly another 10,000 nomads (mostly D-Bees) as allies. Also, although the Pervics are breeders of horses, and have acquired a fair share of wealth from horse trading, they also have a herd of ostrosaurs and other monstrous animals. The heart and soul of the Pervic "army" is a cavalry force of some 300-400 Monster Riders mounted on ostrosaurs (riders are levels 2-8). Even in the Pecos Empire where excellent horsemanship is commonplace, these riders stand out.

In the past, representatives from raider bands have come from far and wide to try and recruit these magnificent warriors. Although it is extremely rare for the Pervics to allow more than a few of the monster riders to go off as mercenaries at any given time, this has proven to be a secondary source of income for the tribe. They also sometimes engage in banditry against rival gangs, clans and tribes.

Crossroads

Crossroads is a town with a regular population of just under 11,000 plus 1D6x1000 transient visitors at any given time (changes every two weeks). It is located near where pre-Rifts **Kerrville** used to be, and, for the Pecos Empire, is a relatively modern and safe community. The town gets its name for being in the geographical center (more or less) of the Pecos Empire.

Since it is relatively large (as Empire towns go) and is close to Los Alamo (Indeed, much of the trade between Los Alamo and the Empire comes from Crossroads), it was the major trade center in the Pecos Empire until the recent growth of Houstoun and the rebuilding of Worth.

To help bring in (paying) visitors, Crossroads has tried to become what it considers to be the cultural and entertainment center of the Pecos Empire. There is a thriving community of artists and craftsmen in

town. In addition to staging performances (primarily comedies, historical dramas, and song and dance) and musical events (such as concerts and recitals), there is a full-time movie theater that offers a good selection of pre and post-Rifts films and will pay top dollar for more. In fact, one can always find a purchaser of pre-Rifts artifacts at a good price in Crossroads. There are two dozen pawnshops, large and small, plus a handful of shops that specialize in artifacts — Crossroads does a brisk trade in souvenirs and pre-Rifts and alien artifacts.

In addition to pottery and various knickknacks, consumers can purchase and/or commission objects of art, such as paintings and sculpture or specialty items; for example, custom-made saddles, saddlebags, and boots with ornate or unique designs, gang insignias, etc., are in high demand among the Pecos Bandits. Over a dozen tattoo parlors also thrive at the town.

Crossroads is also the winter home to *Dr. Genius's Carnival of Wonders* (see description in **Rifts® New West**). Although it is common knowledge that the carnival is put on a retainer by the town as a tourist attraction, the carnival is talented in its own right and most visitors do not feel that they are being ripped off.

In its attempt to appeal to a wide variety of customer tastes, Crossroads also has gambling halls (for games of skill and chance) and a sporting arena that seats over 8000. Besides gambling, these halls provide a variety of entertainment in much the same manner as the saloon halls of the pre-Rifts Wild West once did.

Although Crossroads prides itself as being the cultural leader of the Pecos Empire and tries to promote "Family entertainment," there are still those who prefer diversions of a less than wholesome nature. For those given to such pastimes, there is a red light district with brothels, pits for cockfighting and dogfighting, drug dens, houses of illusion, psychic experiences and a host of unique pastimes, for reasonable money.

Despite attempts in the past to close down these activities, they (especially the girls) bring in a good portion of revenue to Crossroads. However, these activities are strictly regulated and illegal outside of the red light district. Since fines are very high, the owners of these estab-

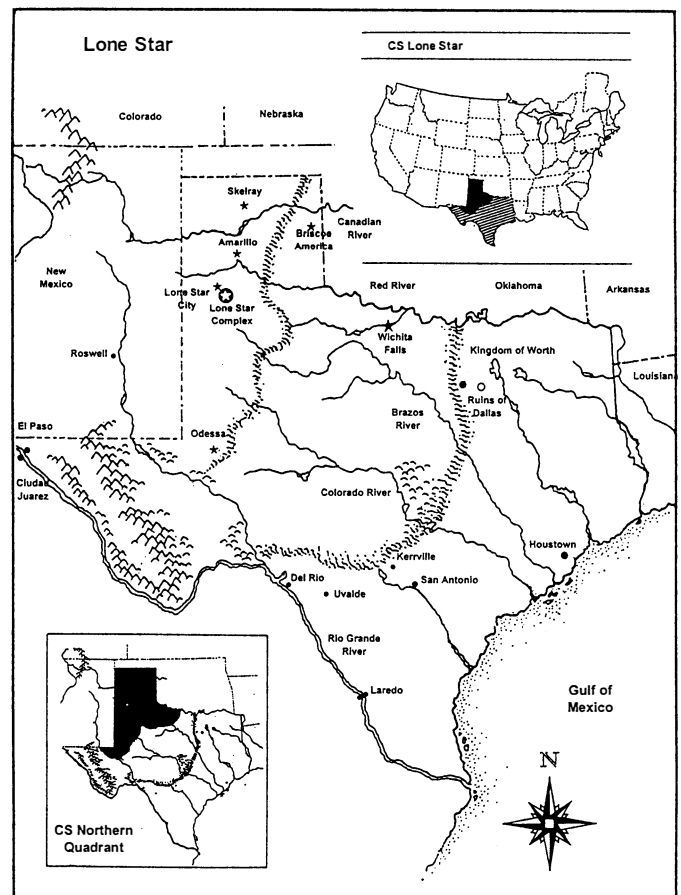

ishments make sure that they stay within their designated areas and crime overall is reasonably low (unlike Laredo and Ciudad Juarez, where anything goes).

Some activities, such as hover vehicle racing, and Juicer games, are not allowed within town but will often take place outside city limits. The authorities know about these events but look the other way (except for the members of the militia who come to observe and place their own wagers on the outcome).

However, Crossroads draws the line at *bloodsports*. These are strictly forbidden anywhere near Crossroads. The militia has standing orders to apprehend anyone they see involved in bloodsports, even if it takes place miles outside the city (even if this requires deadly force). The town has a reputation to uphold and does not want to scare off visitors.

All in all, if any place could be considered the “Las Vegas” of the Pecos Empire, Crossroads is it.

Politically, the city is a plutocracy run by a Board of Commissioners. Its official name, “The Board of Culture,” has given rise to many less than humorous comments, primarily based on the obvious pun (“culture, what culture?” “Well, you know how they grow cultures, don’t you ...,” etc.). The Board members make all the major policy decisions that affect Crossroads. The Board is selected in a unique manner designed to garner funds for the town. Every year (in late October), “donations” (i.e. bribes) are elicited from eligible residents (anyone residing in Crossroads for at least four months). These “donations” are presented to the headquarters of the town guard in sealed envelopes and then become the property of the city of Crossroads. When the envelopes are opened up, the eleven highest donors will comprise The Board of Culture for the following year (all the other donors just get thank you notes and are invited to a complimentary dinner for their generous efforts — “tough luck, suckers”).

The Board members’ terms of office are from January 1 to December 31. Seniority on the Board is determined by the size of the donation — the larger the donation, the greater the seniority. The length of previous Board service (if any) will also affect seniority with each previous year of service counting as 20,000 credits toward establishing seniority. **Note:** Previous Board service will not affect the initial bribe; it will only make a difference in the rank and position one holds after the “election.”

Seniority on the Board carries two major benefits: A) Board members start off with a base salary for the year. The senior member gets 85,000 credits and each succeeding Board member gets 5000 less until the least senior member gets 35,000; and B) In addition to the base salary, the Board members get a percentage of profits from the various businesses and enterprises in Crossroads. This is where the potential for profit really comes into play. Since these business concerns are selected by a senior going first basis, the higher one is on the Board, the more likely the chance of seeing a profit. Naturally, if the business doesn’t turn a large enough profit (or, worse, takes a loss), the board member could suffer a financial setback.

Aside from other considerations (prestige, power, etc.), being on the Crossroads Board of Culture can be either a financial boon or nightmare.

The Crossroads militia. To protect its citizens and guests, Crossroads has a freelance militia force. The operation of the militia is typical of the Crossroads mindset. Anyone wishing to join the militia must apply and serve a two year “apprenticeship” in the town guard. This is a low-paying position with long hours. The apprenticeship doesn’t really teach the fledgling militia man much except the laws and the layout of the town; it is primarily a means for Crossroads to get cheap labor for security service (average level of experience is 1-3).

After the two years are over, the militia candidate is given full citizenship rights and is licensed to work in the city as a militiaman. Although some militiamen remain in the town guard (the pay and benefits get better with increased rank and seniority), many will freelance them-

selves out as bodyguards or get a position with a private firm like the carnival or one of the gambling halls.

It is illegal for unlicensed persons to act as guards in Crossroads or for the various businesses to use unlicensed personnel; the penalties are stiff fines. Thus, a militia license can be the key to making a lucrative living in Crossroads.

This system has worked out so well that in a town with a population of approximately 11,000, there are currently some 1300 licensed militiamen. Of these, 600 are powerful augmented humans (‘Borgs, Juicers, and Crazies primarily; average level is 4-6). With a force like this, most bandits think twice before attempting to cause trouble in Crossroads. Visitors are allowed to carry weapons and wear body armor in town, but if they cause any trouble, they will have to deal with the militia.

Population breakdown: Humans 30%, Augmented humans (Borgs, Juicers, Crazies, etc.) 8%, D-Bees 62%

Uvalde

Home of Warlord Grange & his Pecos Riders

There are a number of places scattered throughout the Pecos Empire that combine permanent structures with wagons, tents, teepees, and other mobile and/or portable living areas. Uvalde, the headquarters and winter home to Warlord Grange, is the largest of these sites.

Uvalde was somewhat lucky during the Time of the Rifts in not being totally ravaged by the Cataclysm and still has a few pre-Rifts structures intact. This helped it to become a population center (albeit small), with a makeshift fort, homes, shops, and saloons. It is surrounded by several dozen small farms and ranches, all of which are part of the overall community. The town has a summer population of some 3000-5000, but during the winter, when Grange, his Pecos Riders (5000-6000 men), along with allies and other bandit groups camp there, the population of Uvalde can grow to 20,000 to 30,000. However, it is more of a watering hole for transients than it is a true city, and, except for the businesses of the downtown area and surrounding cluster of wood and brick homes, is composed mainly of a sea of tents, wagons, vehicles and other portable structures.

Although not a major trade city, Uvalde has served as a trading center for horses, furs, food and stolen goods from throughout the Badlands. In addition to being the headquarters for Warlord Grange, Uvalde is known throughout the Empire for the Buckaroo Bonanza Rodeo it holds annually (around late May or early June).

The Buckaroo Bonanza Rodeo is the biggest, most elaborate rodeo held in the Pecos Empire and rivals many of the “Big Events” held in Crossroads. Pecos Raiders come from all parts of the Empire to compete in this rodeo, for both fame and glory and for the cash prizes. Others come just to watch the wild, six day spectacle. Many Bandit leaders and ranchers come to the Rodeo in hopes of recruiting new talent, and others use the event as an annual meeting place to visit with old friends and settle things with old enemies. Warlord Grange and his elite lieutenants always attend the rodeo for all three purposes, to find new recruits, meet old friends, and enjoy the fanfare. As many as 30,000 will come to this event, with spectators and contestants beginning to arrive five weeks before the rodeo show begins. See **Rifts® New West** for data about Rodeos.

New San Antonio

Home of the Silver Dagger Gang

New San Antonio is a large, sprawling metropolis that more resembles the burbs of Chi-Town than a modern city. The heart of the city is Fort Sam Houston and Brook Army Medical Center (burn trauma center), a pre-Rifts military installation of the American Empire. The Silver Dagger gang has rebuilt Fort Sam and uses it as their center of opera-

tions. This provides them with a number of mega-damage buildings, barracks and other basic military facilities; however, the old base was ransacked and plundered decades before they claimed it.

Through cunning, threats and brute power, 58 years ago, the Silver Dagger Gang united the five small communities that already existed around the ruins of old San Antonio and melded them into one large city known as *New San Antonio*. When Warlord Don Marco came to power after the death of his father, 16 years ago, he inherited a vast criminal network that controlled the city and had underground criminal operations throughout it and beyond (including Crossroads and Los Alamo, and a few tenuous operations in Houstown and Laredo).

Within the city, Warlord Don Marco's organized crime family runs all the gambling halls, drug dens and places of vice, plus they have their fingers in the affairs, of and influence over, many other villages, towns, ranches and people in the area. A full third of all stolen goods fenced in the Pecos Empire pass through the hands of the Silver Dagger gang, and Don Marco coordinates a lucrative smuggling operation. The criminal organization also buys and sells information, offers illegal Juicer augmentation, recharges E-clips, runs guns, and has some of the best (and only) body-chop-shops in the territory.

Except for the area around Fort Sam, which caters to bandits, gunmen, smugglers, gunslingers and adventurers from outside the Silver Dagger Gang (come to New San Antonio for rest and relaxation, to sell goods or in search of work), the rest of the city is pretty tame and orderly — mostly family neighborhoods and legitimate businesses. Around the city are 30 small to medium farms and a dozen cattle and sheep ranches. The population of the entire community is roughly 20,000; one of the largest cities in Lone Star and the largest in the Pecos Empire proper.

Laredo

Laredo is a shanty town of vagabond thugs, murderers, and bandits that is divided by the Rio Grande — half of the town is in Mexico and half in Lone Star. It is a festering cancer that makes the worst Coalition Burbs look like paradise. According to rumors, even vampires won't come near this cesspool of sin and violence.

It is a unique place because there is no one leader, instead it is divided into 20 "districts," each operated and controlled (more or less) by one particular gang of outlaws or a family clan. One might think this arrangement would make life difficult, with different laws and authorities in each district, except there is no "law" in Laredo. The ruling clans have little control over their "turf," and lawlessness is the rule of the land. Drugs, prostitution, gambling, drunkenness, brutality and murder are found everywhere. Nearly a hundred saloons light up the muddy streets littered in garbage and the occasional body. Bloodsports are common at most gambling casinos and many saloons (cockfights, dog-fights, boxing, duels, etc.). A shabby, gladiatorial style arena on the Mexican side is a popular hangout among Juicers, Crazyes, 'Borgs, Simvan bandits and bloodthirsty nonhumans. However, there is as much action on the streets and in the saloons as the arena. Gunfights, duels, showdowns, brawls, and small riots are common, daily occurrences. The degree of violence will usually depend on the disposition, tolerance and power of the gang that controls that particular sector versus those causing the trouble. As a rule, when a large or powerful group of bandits rides into town, they take over the place. Typically, the people who run this insane place don't care who gets hurt, maimed or killed, or about stolen or destroyed goods and property, provided the people getting hurt and the property being destroyed does not belong to them.



Laredo is at its worse when several gangs stop and stay for awhile, especially when pickings are thin and the bandits are feeling ornery. Nights are always the worst, although the morning hours before noon are usually quiet and comparatively tranquil. Every gang, band, clan, tribe and race are welcome — except for Coalition troops.

The permanent population is only about 1600 people, but the transient population represents the bulk of the population. In any given week, the transient population varies from an additional 800-2400 in the summer, to 3000-4200 in the winter.

The level of technology is relatively low, roughly equal to that of the American Old West in the 1860's. Although the gangs who run their districts have energy weapons, mega-damage power armor, and modern hover vehicles (as well as horses and other riding animals), less than 25% of the buildings in the sprawling slums are mega-structures. The ones that are M.D.C. structures are usually small places made out of mega-damage vehicles (cars, trucks, gutted APCs) or patchwork constructions made from the stripped parts of giant robots, wrecked vehicles, stolen CS building materials and pre-Rifts slag dug out of the ground. Furthermore, less than half have running water, only 70% have electricity, 40% have air conditioning (it's 95-110 degrees here in the spring and summer) and only 30% have heat (winter nights can drop down to 40 degrees, although winter days are typically 64-68 degrees). Some districts rely more on magic than technology, but the level of magic is generally moderate, with few mages, dragons and supernatural creatures higher than 7th level (most are 2-5th).

Laredo has the *only* bridge allowed on the Rio Grande river. It is a *drawbridge* with the operator and controls on the Lone Star side. It is raised and lowered as needed, and left up/open when not in use to help keep out vampires. The drawbridge control station is heavily guarded by a squad of Psi-Stalkers, a 4th level Juicer, a 3rd level Ley Line Walker and 5th level thunder lizard dragon hatchling. The Rio Grande at Laredo is also patrolled by border guards on both sides of the river.

On the northern outskirts of the town is the site of the old pre-Rift city of Laredo. There are typically a dozen "claims" going at any given time, with 1-12 prospectors working each. They are in search of pre-Rifts artifacts and valuable salvage, and while every so often, somebody strikes a mother lode that has been missed, the site has been thoroughly plundered — there is little to find. In fact, the site looks like a cluster of quarries with one gigantic, 15 square mile one that goes 150 feet (45.7 m) deep, a dozen medium-sized ones covering about one or two square miles and 50 feet (15 m) deep, and thousands of small, shallow pits the size of a car to a house to an entire city block, seldom more than 20 feet (6 m) deep. Some are 100 to 200 years old, while others are only a few years old and others are new "digs." Of course, as one might suspect, mining and salvage operations here are extremely dangerous with robbers and claim jumpers a fact of life, not to mention drunk thugs looking for fun at other people's expense.

Raiders of the Gulf Coast

Along the Gulf coastline is some of the nicest, tropical country in all of Lone Star. Houstown is just the largest and most sparkling jewel in a number of tiny, quiet, coastal communities. Farmers and fishing villages dot the coastline with deceptive looking serenity, for in addition to hurricanes and terrible storms, the coast is plagued by sea monsters and Raiders from Atlantis! *Splugorth Slavers* and other minions come from the sea in their magic ships to the coast of Lone Star in search of human and D-bee slaves. And rumors suggest they have a secret camp somewhere off the coast (of what's left) of Louisiana.

In addition, the Coalition States have established a Naval presence in Lone Star where they are training sailors and are testing new sea vessels, power armor and equipment. For once, the unallied coastal people of Lone Star welcome the presence of the CS, for since their arrival, the *Splugorth Slavers* come less often.

Experience Tables

Note: Most runaway mutants and Feral Dog Boys use the R.C.C./O.C.C. table under which the character was originally created/trained, i.e. Dog Boy, Kill Hound, Battle Cat, etc.

Freeborn mutant animals can often select an O.C.C. (area of training) although it is often the same as their parent(s).

Intelligent mutant animals, who are still basically *animals* with a boosted intelligence, like the *Monkey Mini Spy*, can be used with limited effectiveness as a player character (Game Master's option). If such an off-beat character is played, use the experience table entitled **Most Intelligent Mutant Animals**. However, such characters are probably best as Non-Player Characters (NPCs).

| | |
|------------------------------------|-----|
| Bandit/Pecos Raider O.C.C. | 153 |
| Brodkil (Optional R.C.C.) | 164 |
| Dog Boy Soldier R.C.C. | 32 |
| Dog Boy, K-9 Sniffer R.C.C. | 41 |
| Dog Boy, Kill Hound R.C.C. | 43 |
| Dog Boy, Sea Dog (Navy) R.C.C. | 40 |
| Feline: Battle Cat R.C.C. | 76 |
| Feline: Kill Cat R.C.C. | 79 |
| Monkey Boy: Mini Monkey Spy R.C.C. | 81 |
| Monkey Boy: Soldier R.C.C. | 83 |
| Monkey Boy Tech R.C.C. | 85 |
| Mutant Bat R.C.C. | 88 |
| Mutant Bear/Ursa-Warrior R.C.C. | 72 |
| Mutant Rat R.C.C. | 85 |
| Pecos Raider/Bandit O.C.C. | 153 |
| Psi-Stalker: CS & Civilized R.C.C. | 159 |
| Psi-Stalker: Wild R.C.C. | 160 |
| Psi-X Alien R.C.C. | 98 |
| Simvan Monster Rider R.C.C. | 162 |
| Tokanii R.C.C. | 154 |

Ursa-Warrior (Bear)

| | |
|----|-----------------|
| 1 | 0,000-1,900 |
| 2 | 1,901-3,800 |
| 3 | 3,801-7,300 |
| 4 | 7,301-14,300 |
| 5 | 14,301-30,000 |
| 6 | 30,001-45,000 |
| 7 | 45,001-65,000 |
| 8 | 65,001-90,000 |
| 9 | 90,001-110,000 |
| 10 | 110,001-130,000 |
| 11 | 130,001-180,000 |
| 12 | 180,001-230,000 |
| 13 | 230,001-280,000 |
| 14 | 280,001-340,000 |
| 15 | 340,001-390,000 |

**Dog Boy (CS Soldier),
Sea Dog (CS Navy)**

- 1 0,000-1,950
- 2 1,951-3,900
- 3 3,901-8,800
- 4 8,801-17,600
- 5 17,601-25,600
- 6 25,601-35,600
- 7 35,601-50,600
- 8 50,601-70,600
- 9 70,601-95,600
- 10 95,601-125,600
- 11 125,601-175,600
- 12 175,601-225,600
- 13 225,601-275,600
- 14 275,601-325,600
- 15 325,601-375,600

Dog Boy: K-9 Sniffer

- 1 0,000-2,100
- 2 2,101-4,200
- 3 4,201-8,400
- 4 8,401-16,800
- 5 16,801-25,000
- 6 25,001-35,000
- 7 35,001-50,000
- 8 50,001-70,000
- 9 70,001-95,000
- 10 95,001-130,000
- 11 130,001-180,000
- 12 180,001-234,000
- 13 234,001-285,000
- 14 285,001-345,000
- 15 345,001-410,000

**Dog Boy: Kill Hound,
Feline: Kill Cat**

- 1 0,000-2,150
- 2 2,151-4,300
- 3 4,301-9,600
- 4 9,601-18,200
- 5 18,201-28,400
- 6 28,401-38,600
- 7 38,601-54,800
- 8 54,801-75,200
- 9 75,201-100,400
- 10 100,401-132,600
- 11 132,601-185,800
- 12 185,801-240,200
- 13 240,201-295,400
- 14 295,401-365,600
- 15 365,601-425,800

**Monkey Boy Soldier
Battle Cat CS Soldier**

- 1 0,000-1,900
- 2 1,901-3,600
- 3 3,601-7,200
- 4 7,201-14,400
- 5 14,401-24,500
- 6 24,501-35,000
- 7 35,001-45,000
- 8 45,001-65,000
- 9 65,001-85,000
- 10 85,001-115,000
- 11 115,001-145,000
- 12 145,001-185,000
- 13 185,001-250,000
- 14 250,001-310,000
- 15 310,001-375,000

**Monkey Boy Tech,
Simvan Monster Rider**

- 1 0,000-1,925
- 2 1,926-3,850
- 3 3,851-7,450
- 4 7,451-15,000
- 5 15,001-21,500
- 6 21,501-31,500
- 7 31,501-41,500
- 8 41,501-54,000
- 9 54,001-75,000
- 10 75,001-105,000
- 11 105,001-140,000
- 12 140,001-190,000
- 13 190,001-240,000
- 14 240,001-300,000
- 15 300,001-350,000

**Monkey Mini Spy & Most
Intelligent Mutant Animals**

- 1 0,000-1,800
- 2 1,801-2,600
- 3 2,601-5,200
- 4 5,201-15,000
- 5 15,001-25,000
- 6 25,001-35,000
- 7 35,001-45,000
- 8 45,001-75,000
- 9 75,001-95,000
- 10 95,001-150,000
- 11 150,001-200,000
- 12 200,001-250,000
- 13 250,001-300,000
- 14 300,001-350,000
- 15 350,001-450,000

**Mutant Bat,
Mutant Rat**

- 1 0,000-1,900
- 2 1,901-3,600
- 3 3,601-7,200
- 4 7,201-14,400
- 5 14,401-24,500
- 6 24,501-35,000
- 7 35,001-45,000
- 8 45,001-65,000
- 9 65,001-85,000
- 10 85,001-115,000
- 11 115,001-145,000
- 12 145,001-185,000
- 13 185,001-250,000
- 14 250,001-310,000
- 15 310,001-375,000

**Psi-X Alien,
Xiticix Killer**

- 1 0,000-2,200
- 2 2,201-4,400
- 3 4,401-9,000
- 4 9,001-19,000
- 5 19,001-28,000
- 6 28,001-40,000
- 7 40,001-60,000
- 8 60,001-80,000
- 9 80,001-100,000
- 10 100,001-150,000
- 11 150,001-200,000
- 12 200,001-275,000
- 13 275,001-350,000
- 14 350,001-425,000
- 15 425,001-525,000

**Wild or Civilized
Psi-Stalker**

- 1 0,000-2,050
- 2 2,051-4,100
- 3 4,101-8,250
- 4 8,251-16,500
- 5 16,501-24,600
- 6 24,601-34,700
- 7 34,701-49,800
- 8 49,801-69,900
- 9 69,901-95,000
- 10 95,001-130,100
- 11 130,101-180,200
- 12 180,201-230,300
- 13 230,301-280,400
- 14 280,401-340,500
- 15 340,501-400,600

**Pecos Raider, a.k.a.
Bandit O.C.C.**

- 1 0,000-1,860
- 2 1,861-3,600
- 3 3,601-7,000
- 4 7,001-14,400
- 5 14,401-23,400
- 6 23,401-34,400
- 7 34,401-44,400
- 8 44,401-60,400
- 9 60,401-80,400
- 10 80,401-110,400
- 11 110,401-145,400
- 12 145,401-195,400
- 13 195,401-245,400
- 14 245,401-290,400
- 15 290,401-340,400

Tokanii R.C.C.

- 1 0,000-2,350
- 2 2,351-4,650
- 3 4,651-9,250
- 4 9,251-18,500
- 5 18,501-27,000
- 6 27,001-37,000
- 7 37,001-52,000
- 8 52,001-73,000
- 9 73,001-98,000
- 10 98,001-140,000
- 11 140,001-190,000
- 12 190,001-232,000
- 13 232,001-292,000
- 14 292,001-360,000
- 15 360,001-430,000

Brodkil (sub-demon)

- 1 0,000-2,400
- 2 2,401-4,800
- 3 4,801-9,600
- 4 9,601-19,200
- 5 19,201-38,800
- 6 38,801-68,200
- 7 68,201-98,600
- 8 98,601-130,400
- 9 130,401-170,800
- 10 170,801-220,400
- 11 220,401-270,800
- 12 270,801-330,400
- 13 330,401-400,600
- 14 400,601-480,800
- 15 480,801-580,200

The Rifter® Subscription

The Rifter® is your doorway to unlimited imagination and numerous Palladium role-playing worlds. It offers new heroes, powers, weapons, magic and adventure for your games. It presents new villains, monsters and dangers to battle, and new ideas to consider.

It helps you unlock your imagination by showing you what gamers, just like *you*, have created. That's right, many of the articles and source material are written by ordinary gamers and fans like *you*. Other articles are by freelance writers and staff.

The Rifter® is made for you, our fans. Each issue presents unofficial (and sometimes official) source material, adventures, characters, monsters, villains, powers, weapons, equipment, ideas and fiction for **Rifts®**, **Chaos Earth™**, **Splicers®**, **Beyond the Supernatural™**, **Heroes Unlimited™**, **Ninjas & Superspies™**, **Palladium Fantasy RPG®**, **Nightbane®**, and/or any variety of other Palladium games and world settings. It's also a place where we test new ideas, and showcase new games, like *Dead Reign* and the upcoming *Mechanoids® Space*.

It is also a way to get the latest news, coming attractions, and sneak previews of upcoming Palladium products, events and secret projects.

Sourcebook

As a **sourcebook**, each issue of **The Rifter®** presents optional and/or official source material for a variety of Palladium's role-playing settings – **Rifts®**, **Phase World®**, **Palladium Fantasy RPG®**, **Heroes Unlimited™**, **Nightbane®**, **Beyond the Supernatural™**, and other titles such as **After the Bomb®**, **Ninjas & Superspies™**, **Rifts® Chaos Earth™**, **Splicers®**, and others. Every issue includes material for 3-6 different Palladium RPG lines.

Magazine

As a **magazine**, each issue includes the latest news and goings on at Palladium Books, information on new product, our schedule of releases, convention appearances, special offers, and even sneak previews and extra “official” material for new Palladium games or sourcebooks.

Talent Show

The Rifter is unlike anything on the market because it is a way for *you*, the fan, the unpublished writer and hopeful young artist to get published and break into the industry.

No other game company does that, so take advantage of the opportunity to see *your* work and *your* name in print! You'll get a small payment (about \$10 per printed page of text), four free copies of the issue your work appears in, and bragging rights to all your friends. Best of all, you get to share your ideas with thousands of other Palladium gamers.

Think it can't happen to you? Think again. Many of Palladium's artists and writers got started in **The Rifter®**, including *Apollo Okamura*, *Brian Manning*, *Mike Mumah*, *Carl Gleba*, *Todd Yoho*, *Brandon Aten*, *Taylor White*, *Jason Richards*, and *many others*.

Palladium is always looking for written material for **Rifts®**, **Chaos Earth™**, **Beyond the Supernatural™**, **Nightbane®**, **Palladium Fantasy RPG®**, **Heroes Unlimited™**, **Ninjas & Superspies™**, **After the Bomb®**, and all our game lines. We'd also like to see cartoons and comic strips.

Send your “article/source material” (5-30 pages) or art samples (photocopies, never original art), to *The Rifter® Submissions Dept*, 39074 Webb Court, Westland, MI 48185.

Subscribe Today

Lock in the current price and discount

The price of **The Rifter®** is \$13.95 retail (a steal for 96 pages of RPG source material and adventures), but a subscription saves you even more money, and you have the convenience of delivery right to your door. All prices are in U.S. dollars.

- **\$39.80 – that's only \$9.95 each**, a savings of \$16, and Palladium picks up the shipping cost. **Note:** This rate is *limited* to subscribers in the USA only.
- **\$61.80 – Canada.** Our apologies, but Palladium Books can no longer cover the increased cost of postage to other countries. We hope you understand.
- **\$75.80 – Overseas:** Overseas subscriptions *are* charged an additional fee for overseas shipping costs. Sorry. We are only passing along the additional postage costs, but it is hefty. Our apologies.
- **Free Shipping anywhere in the USA.**
- **Great Savings.**
- **A Megaverse® of adventure and fun.**
- **How to order.** *Send mail orders* with a check or money order (for \$39.80 in the USA) to:

The Rifter® Subscription Dept.
39074 Webb Court
Westland, MI 48185

Credit Card Orders: Can be made on our web site (www.palladiumbooks.com) or by telephone 734-271-2903 (this is an order line *only*).

Check or Money Orders: Send them to the address above with a note indicating which issue number you want your subscription to start.

Please indicate what issue number you'd like your subscription to start (i.e., last issue, current issue, next issue, or when your current subscription ends).

This offer is good till December 31, 2016.

© Copyright 2012 Palladium Books Inc.

www.palladiumbooks.com



RIFTS®

- Imagine Earth transformed into an alien landscape.
- Humans exist – barely. And we are not alone.
- Aliens and monsters emerge from the Rifts – holes torn in the fabric of space and time, connected to countless worlds and realities.
- Ancient gods, demons and magic have returned.
- Magic and technology clash.
- Hundreds of character classes, many inhuman.
- *Rifts® Ultimate Edition* is the core RPG rule book.
- Expansive world setting with 90+ sourcebooks to draw upon.
- Rifts®, your portal to endless adventure.
- Limited only by your imagination.

www.palladiumbooks.com

© 2014 Palladium Books. Rifts®, Megaverse®, Nightbane® and other titles, slogans and likenesses are trademarks of Palladium Books, Inc. Palladium Books - 39074 Webb Court, Westland, MI 48185 USA - 734-271-2903 order line.

Other RPG Worlds from Palladium Books®:

- *Rifts®* – the ultimate role-playing experience.
- *Rifts® Chaos Earth®* – Play the apocalypse as it happens.
- *Splicers®* – Weird science. Bio-tech battles insane robot legions.
- *Robotech® RPG* – All eras of the TV show brought to life.
- *Dead Reign™ RPG* – Can you survive the Zombie Apocalypse?
- *Palladium Fantasy RPG®* – Unique world, monsters as player characters, magic and more.
- *Heroes Unlimited™ RPG* – Play any hero; mutants, aliens, cyborgs, superhumans, mages, immortals and more.
- *Nightbane® RPG* – Conspiracy, magic, horror and monsters.
- *Beyond the Supernatural™ RPG* – Modern horror and suspense.
- *Ninjas and Superspies™*, and more.



ROBOTECH®

Role-Playing Game and Sourcebooks

- **Four generations of heroes and mecha** • **Giant transformable robots** • **Alien invaders** • **Battle for control of the Earth** • **Combat takes to the stars** • **All presented in a core rule book and dynamic set of epic sourcebooks** • **Easy to learn** • **Fun to play** • **Quick character generation** • **Fast combat** • **Captures the action and adventure of the anime TV series** • **Isn't it time you joined the adventure?**

Robotech® "Core Rules" – Shadow Chronicles® RPG Hardcover

All the rules and information a player needs to start a Robotech® role-playing campaign with Admiral Rick Hunter and the United Earth Expeditionary Force trekking across the galaxy.

- Human mecha: Alphas, Betas, Cyclones & much more.
- Five character classes. 25 different Military Specialties.
- Invid mecha, Haydonites, and alien enemies.
- Quick roll character tables. Make a character in 15 minutes.
- A complete, stand-alone RPG.
- 224 pages. Cat. No. 550HC. 8½ x 11 size, hardcover.

Robotech®: The Macross® Saga Sourcebook – Cat. No. 551

A treasure chest packed with the iconic mecha, vehicles, weapons and characters that made Robotech® famous. Valkyries, Destroyers, ground vehicles, aircraft, spacecraft, weapons, Zentraedi soldiers, Zentraedi mecha, alien invaders, heroes, villains, and more.

- All the iconic Macross mecha, vehicles, weapons & characters.

www.palladiumbooks.com

Robotech®: The Masters Saga™ Sourcebook – Cat. No. 552

Tons of never before seen stats and descriptions for the many weapons, armor, mecha and robots of the Army of the Southern Cross.

- The Army of the Southern Cross™ – all 15 branches and their mecha!

Robotech®: New Generation™ Sourcebook – Cat. No. 554

The battle for the liberation of Earth starts here.

- Kit-bashed mecha combining parts from different mecha.
- Invid Hives, world overview, key characters and adventure ideas.

Robotech®: Genesis Pits™ Sourcebook – Cat. No. 555

The Invid Genesis Pits, their purpose, function.

- Inorganics and other war machines of the Invid Regent.
- Genesis Pit mutations and monsters.

Robotech®: Expeditionary Marines Sourcebook – Cat. No. 553

Join the UEEF (United Earth Expeditionary Force) led by Admiral Rick Hunter as they travel across the galaxy liberating planets from the bondage of the Invid Regent, the Robotech Masters and other tyrants.

- New mecha, weapons, and character classes of the UEEF Marines.
- New alien species and allies. Planet hopping and more.



ROBOTECH

R P G < T A C T I C S™

Main Boxed Game – Cat. No. 55100 – Available Now!

A fast-paced, strategy battle game that captures the speed and action of Robotech®. Play Earth defenders or Zentraedi invaders.

- Scalable from small squad skirmishes to mass battles.
- Turn-based system of play and uses D6. Two or more players.
- 34 highly detailed game pieces. 6mm scale.
- 112 page color rule book with paint guide and index.
- 53 laminated, color game cards.
- 24 custom dice, two decal sheets and more.
- Assembly and painting required. Glue not included.
- \$99.95 retail – Cat. No. 55100 – shipping now!
- Available in the USA, Canada, EU, Australia & New Zealand.

Note: Each product contains plastic game pieces requiring assembly and painting. Glue not included. This is not a toy. Small parts, not suitable for children under the age of 13. Adult supervision advised. Images shown here are not to scale.



UEDF Valkyrie Wing™ – Cat. No. 55201

Build your fleet of Earth defenders with the Valkyrie Veritech Fighter; six game pieces total. **\$36.95 retail.**

- 2 Valkyries in Fighter mode.
- 2 Valkyries in Guardian mode.
- 2 Valkyries in Battloid mode.
- Multiple heads for making the VF-1A, VF-1J, VF-1R & VF-1S.



UEDF Tomahawk/Defender Destroids™ – Cat. No. 55202

Expand your Destroid squad with these formidable walking tanks; four game pieces total. **\$32.95 retail.**

- 2 **Tomahawk Destroids** – the main battle tank of Destroids, brimming with powerful particle beam cannons for arms, and wielding a battery of missiles and an array of other weapons.
- 2 **Defender Destroids** – a long-range, anti-aircraft juggernaut capable of shooting down incoming Zentraedi Battlepods and Gnerl Fighters.



UEDF Spartan/Phalanx Destroids™ – Cat. No. 55203

Add some long-range power and up-close punch to your army with these valuable Destroids; four game pieces total. **\$32.95 retail.**

- 2 **Spartan Destroids** – civil defense, riot control and deadly in hand combat.
- 2 **Phalanx Destroids** – a walking, long-range missile artillery unit.



Zentraedi Regult Battlepods™ – Cat. No. 55401

Expand your Zentraedi forces with their main infantry battle mecha; six game pieces total. **\$36.95 retail.**

- 6 **Regult Tactical Battlepods** – the lightning quick Regults, armed with a pair of particle cannons and auto-cannons, attack in wave after wave.



Zentraedi Artillery Battlepods™ – Cat. No. 55402

Give your Zentraedi legion greater firepower with these artillery and support Battlepods; four game pieces total. **\$36.95 retail.**

- 4 **Zentraedi Support Battlepods**, each of which can be made into:
 - Gluuhaug-Regult** – Light Artillery Battlepod
 - Serauhaug-Regult** – Heavy Artillery Battlepod
 - Telnesta-Regult** – Experimental Particle Beam Battlepod**Four game pieces total.**



Zentraedi Glaug Command™ – Cat. No. 55403

This diverse pack provides your Zentraedi forces with greater tactical capabilities; three game pieces total. **\$36.95 retail.**

- 1 **Glaug Officer's Battlepod** – the fast and deadly mecha of Zentraedi field leaders.
- 1 **Quel-Regult Scout Battlepod** – the stealthy eyes and ears of your Zentraedi battle force; electronic warfare capabilities.
- 1 **Quel-Gulnau Recovery Pod** – enhances the Glaug's ability to bring in Battlepod reinforcements. **Note:** This figure has NEVER before been offered by any company.



Can YOU survive the Zombie Apocalypse?



Dead Reign™ RPG

It is the aftermath of the *zombie apocalypse*. Civilization is gone, the dead reign, and the living fight to survive against impossible odds. Tales of zombies, human survival and horror as a fast-paced, easy to learn game and sourcebooks.

- **Zombie combat rules, vehicles and equipment.**
- **Six iconic Apocalyptic Character Classes and Ordinary People with 40+ occupations to choose from.**
- **Seven types of zombies plus the Half-Living.**
- **Secrets of the Dead and tips on fighting zombies.**
- **Death Cults, their Priests, power over zombies and goals.**
- **101 Random Scenarios, Encounters and Settings.**
- **100 Random Corpse Searches and other tables.**
- **Quick Roll Character Creation tables (10 minutes).**
- **A complete role-playing game by Siembieda and others.**
- **\$22.95 retail – 224 pages – Cat. No. 230. Available now.**

Civilization Gone™

Dead Reign™ Sourcebook One

It has been months since the dead rose to attack the living. Civilization has crumbled. There is no army, no government, no help coming. You are on your own and things are only getting worse.

- **Madmen and Psychopaths including the *Zombie Master, Ghost Walker, Backstabber, Messianic Leader, Zombie Lover, Deathbringer* and others.**
- **Bandits and Raiders who prey upon other survivors.**
- **Street Gang Protectors and their mission to save lives.**
- **Phobia and Obsession tables. Many adventure ideas.**
- **House and home resource and encounter tables.**
- **Random encounter and survivor camp creation tables.**
- **Additional world information and survival advice.**
- **\$12.92 retail – 64 pages – Cat. No. 231. Available now.**

Dark Places™

Dead Reign™ Sourcebook Two

Secrets of survival, including using railroad tracks and the urban underground to travel unseen and undetected by zombies.

- **Worm Meat, Bug Boy, Sewer Crawler and Impersonator Zombies.**
- **“Live Bait” zombie lures with human beings as bait.**
- **Traveling the rails and boxcar encounter tables.**
- **Traveling sewer tunnels, steam tunnels & other dark places.**
- **The pitfalls and dangers of the urban underground.**
- **Diseases, infection and additional world information.**
- **Random encounter tables, boxcar content tables, and more.**
- **\$12.92 retail – 64 pages – Cat. No. 232. Available now.**

Endless Dead™

Dead Reign™ Sourcebook Three

The zombie hordes grow in number and strangeness. Can humankind survive? Where is the military?

- **New types of zombies like Fused Zombies and Walking Mass Grave.**
- **New O.C.C.s including Wheelman and Zombie Hunter.**
- **Info & tables for weaponizing vehicles and vehicle combat rules.**
- **Random encounter tables for military bases, police stations, gun stores, buildings, suburbs, industrial parks, small towns, farmland and wilderness.**
- **Tables to make Survivor caravans, hideouts, Safe Havens & more.**
- **Timetable for setting zombie campaigns & many adventure ideas.**
- **\$16.95 retail – 96 pages – Cat. No. 233. Available now.**



Other horror titles from Palladium Books®

Fear the Reaper™

Graveyard Earth™

Beyond the Supernatural™ RPG

Nightbane® RPG series

© Copyright 2012 Palladium Books Inc. All rights reserved. Rifts®, Palladium Books®, Megaverse®, Nightbane®, Heroes Unlimited, Dead Reign and other published book titles, names, slogans and likenesses are trademarks of Palladium Books Inc.

www.palladiumbooks.com

Palladium Books® Check List & Order Form

Dept. P-16, 39074 Webb Court, Westland, MI 48185

Name: _____ Address: _____

City: _____ State: _____ Zip/Postal Code: _____ Country: _____

Credit Card Number: _____ Expiration Date: _____ Visa MasterCard

Telephone Number: _____ Signature: _____ AMEX Other

The Rifter® Series

- ___ 090 Best of The Rifter® – \$12.95
- ___ 170 The Rifter® #70 – \$13.95
- ___ 171-172 The Rifter® #71 & 72 – \$24.95
- ___ 173 The Rifter® #73 – \$13.95
- ___ 174 The Rifter® #74 – \$13.95 (Spring)

Splicers®

- ___ 200 Splicers® RPG – \$23.95
- Note:** Sourcebooks coming soon.

Dead Reign®

- ___ 230 Dead Reign® RPG – \$22.95
- ___ 231 SB 1: Civilization Gone™ – \$12.95
- ___ 232 SB 2: Dark Places™ – \$12.95
- ___ 233 SB 3: Endless Dead™ – \$16.95
- ___ 234 SB 4: Fear the Reaper™ – \$12.95
- ___ 235 SB 5: Graveyard Earth™ – \$12.95
- ___ 236 SB 6: Hell Followed™ – \$20.95 (coming)

Rifts® Novels

- ___ 301 Sonic Boom™ – \$9.95
- ___ 302 Deception's Web™ – \$9.95
- ___ 303 Treacherous Awakenings™ – \$9.95
- ___ 304 Tales of the Chi-Town 'Burbs™ – \$12.95
- ___ 305 Rifts® Path of the Storm™ – Screen-play & Sourcebook – \$12.95

Weapons Books

- ___ 401 Weapons and Armor™ – \$8.95
- ___ 402 Weapons and Castles™ – \$8.95
- ___ 403 Weapons and Assassins™ – \$8.95
- ___ 404 Weapons & Castles of the Orient™ – \$8.95

Palladium Fantasy RPG®

- ___ 450 The Palladium Fantasy RPG® – \$26.95
- ___ 4500HC Palladium Fantasy RPG® 30th Anniversary Hardcover – \$50.00
- ___ 451 Dragons & Gods™ – \$24.95
- ___ 453 Old Ones™ 2nd Ed. – \$24.95
- ___ 454 Monsters & Animals™ 2nd Ed. – \$24.95
- ___ 455 Adventures on the High Seas™ – \$24.95
- ___ 458 Island at the Edge of the World™ – \$20.95
- ___ 459 Yin-Sloth Jungles™ – \$20.95
- ___ 462 Western Empire™ – \$24.95
- ___ 463 Baalgor Wastelands™ – \$24.95
- ___ 464 Mount Nimro™ – \$20.95
- ___ 465 Eastern Territory™ – \$24.95
- ___ 466 Library of Bletherad™ – \$20.95
- ___ 467 Northern Hinterlands™ – \$24.95
- ___ 468 Land/Damned 1: Chaos Lands™ – \$24.95
- ___ 469 LoD 2: Eternal Torment™ – \$24.95
- ___ 470 LoD 3: The Citadel – \$24.95 (coming)
- ___ 471 Wolfen Empire™ – \$20.95
- ___ 472 Mysteries of Magic™ One: Heart of Magic – \$16.95
- ___ 474 Bizantium/Northern Islands™ – \$20.95
- ___ 475 Garden of the Gods™ – \$12.95 (coming)

Heroes Unlimited™ / After the Bomb®

- ___ 500-2 Heroes Unlimited™, 2nd Ed. – \$26.95
- ___ 5000HC Heroes Unlimited™ 30th Anniversary Hardcover – \$50.00
- ___ 501 Villains Unlimited™ Revised – \$24.95
- ___ 503 After the Bomb® RPG – \$22.95
- ___ 505 Road Hogs™ (After the Bomb® II) – \$9.95
- ___ 507 Mutants Down Under™ (AB III) – \$9.95
- ___ 511 Mutants of the Yucatan™ (AB IV) – \$9.95
- ___ 513 Mutants in Avalon™ (AB V) – \$16.95
- ___ 514 Mutants in Orbit™ (AB VI) – \$16.95
- ___ 515 Aliens Unlimited™ – \$24.95
- ___ 516 Heroes Unlimited™ G.M.'s Guide – \$24.95
- ___ 517 Century Station™ – \$24.95
- ___ 518 Gramercy Island™ – \$24.95
- ___ 519 Aliens Unlimited Galaxy Guide™ – \$24.95
- ___ 520 Mutant Underground™ – \$16.95
- ___ 521 Powers Unlimited® One – \$16.95
- ___ 522 Powers Unlimited® Two – \$16.95
- ___ 523 Powers Unlimited® Three – \$16.95
- ___ 525 Revised Ninjas & Superspies™ – \$20.95
- ___ 526 Mystic China™ – \$24.95
- ___ 527 Armageddon Unlimited™ – \$20.95

Robotech® RPG

- ___ 550 Robotech® The Shadow Chronicles® RPG (manga size) – \$16.95
- ___ 550HC Robotech® The Shadow Chronicles® Deluxe Hardcover RPG – \$30.95
- ___ 5500HC Robotech® The Shadow Chronicles® Gold Ed. Hardcover RPG – \$70.00
- ___ 551 Robotech® Macross® Saga Sourcebook – \$16.95
- ___ 552 Robotech® The Masters Saga™ Sourcebook (manga size) – \$16.95
- ___ 553 Robotech® Expeditionary Force Marines Sourcebook – \$20.95
- ___ 554 Robotech® The New Generation™ Sourcebook – \$16.95
- ___ 555 Robotech® Genesis Pits Sourcebook – \$16.95

Robotech® RPG Tactics™ (New!)

- ___ 55100 Robotech® RPG Tactics™ – \$99.95
- ___ 55105 Robotech® RPG Tactics™ Rulebook – \$20.00
- ___ 55101 UEDF Dice Pack – \$12.00
- ___ 55102 Zentraedi Dice Pack – \$12.00
- ___ 55201 UEDF Valkyrie Wing – \$36.95
- ___ 55202 UEDF Destroid Pack – \$32.95
- ___ 55203 UEDF Spartan Pack – \$32.95
- ___ 55401 Zentraedi Regult Battlepods – \$36.95
- ___ 55402 Zentraedi Artillery Battlepods – \$36.95
- ___ 55403 Zentraedi Glaug Command – \$36.95

Rifts® Chaos Earth®

- ___ 660 Rifts® Chaos Earth® RPG – \$20.95
- ___ 661 Rifts® CE Creatures of Chaos™ – \$12.95
- ___ 662 Rifts® CE The Rise of Magic™ – \$12.95
- ___ 665 Rifts® Chaos Earth® First Responders™ – \$16.95 (coming)
- ___ 666 Rifts® Chaos Earth® Resurrection™ – \$20.95

Beyond the Supernatural™

- ___ 700 Beyond the Supernatural™, 2nd Ed. – \$24.95
- ___ 702 Tome Grotesque™ – \$20.95 (coming)
- ___ 703 Beyond Arcanum™ – \$24.95 (coming)

Nightbane®

- ___ 730 Nightbane® RPG – \$24.95
- ___ 731 Nightbane®: Between the Shadows™ – \$20.95
- ___ 732 Nightbane®: Nighlands™ – \$20.95
- ___ 733 Nightbane®: Through the Glass Darkly™ – \$20.95
- ___ 735 Nightbane® Survival Guide™ – \$20.95

Rifts®

- ___ 800HC Rifts® RPG Ultimate Edition – \$39.95
- ___ 801 Rifts® Sourcebook One Revised – \$20.95
- ___ 802-E Rifts® World Book 1: Vampire Kingdoms™, Revised – \$24.95
- ___ 803 Rifts® Conversion Book One™ – \$24.95
- ___ 804 Rifts® WB 2: Atlantis™ – \$20.95
- ___ 805 Rifts® Sourcebook 2: Mechanoids™ – \$16.95
- ___ 807 Rifts® WB 3: England™ – \$20.95
- ___ 808 Rifts® WB 4: Africa™ – \$20.95
- ___ 809 Rifts® Dimension Book 1: Wormwood™ – \$20.95
- ___ 810 Rifts® WB 5: Triax™ – \$24.95
- ___ 811 Rifts® Pantheons of the Megaverse® – \$24.95
- ___ 812 Rifts® Sourcebook 3: Mindwerks™ – \$16.95
- ___ 813 Rifts® Mercenaries™ – \$20.95
- ___ 814 Rifts® WB 6: South America™ – \$20.95
- ___ 815 Rifts® WB 7: Underseas™ – \$24.95
- ___ 816 Rifts® DB 2: Phase World® – \$24.95
- ___ 817 Rifts® DB 3: Phase World® Sourcebook – \$16.95
- ___ 818 Rifts® WB 8: Rifts® Japan™ – \$24.95
- ___ 819 Rifts® WB 9: South America Two™ – \$24.95
- ___ 820 Rifts® WB 10: Juicer Uprising™ – \$20.95
- ___ 821 Rifts® WB 11: Coalition War Campaign™ – \$24.95

___ 822 Rifts® WB 12: Psyscape™ – \$20.95
___ 825 Rifts® WB 13: Lone Star™ – \$20.95
___ 826 Rifts® WB 14: New West™ – \$24.95
___ 827 Rifts® WB 15: Spirit West™ – \$24.95
___ 828 Rifts® Sourcebook 4: Coalition Navy™ – \$16.95
___ 829 Rifts® WB 16: Federation of Magic™ – \$20.95
___ 830 Rifts® DB 4: Skraypers™ – \$20.95
___ 831 Rifts® Index Volume Two™ – \$16.95
___ 832 Rifts® WB 17: Warlords of Russia™ – \$24.95
___ 833 Rifts® WB 18: Mystic Russia™ – \$20.95
___ 834 Rifts® WB 19: Australia 1 – \$24.95
___ 835 Rifts® WB 20: Canada™ – \$24.95
___ 836 Rifts® WB 21: Splynn Dimensional Market™ – \$24.95
___ 837 Rifts® WB 22: Free Quebec™ – \$24.95
___ 838 Rifts® WB 23: Xiticix Invasion™ – \$20.95
___ 839 Rifts® Coalition Wars®: Sedition™ – \$20.95
___ 840 Rifts® Coalition Wars®: Coalition Overkill™ – \$16.95
___ 841 Rifts® Coalition Wars®: Sorcerers' Revenge™ – \$16.95
___ 842 Rifts® Coalition Wars®: Cyber-Knights™ – \$16.95
___ 843 Rifts® Coalition Wars®: Shadows of Evil™ – \$16.95
___ 844 Rifts® Coalition Wars®: Final Siege™ – \$24.95
___ 845 Rifts® Game Master Guide™ – \$26.95
___ 846 Rifts® Aftermath™ – \$24.95
___ 847 Rifts® DB5: Anvil Galaxy™ – \$20.95
___ 848 Rifts® Book of Magic™ – \$26.95
___ 849 Rifts® Adventure Guide™ – \$24.95
___ 850 Rifts® Bionics Sourcebook™ – \$16.95
___ 851 Rifts® DB 6: Three Galaxies™ – \$20.95
___ 852 Rifts® Dark Conversions™ – \$24.95
___ 853 Rifts® Chi-Town 'Burbs™ – \$9.95
___ 854 Rifts® The Tolkeen Crisis™ – \$12.95
___ 855 Rifts® The Black Vault™ – \$9.95
___ 856 Rifts® The Vanguard™ – \$9.95
___ 857 Rifts® WB 24: China One™ – \$20.95
___ 858 Rifts® WB 25: China Two™ – \$20.95
___ 859 Rifts® DB 7: Megaverse Builder™ – \$16.95
___ 860 Rifts® DB 8: Naruni Wave Two™ – \$16.95
___ 862 Rifts® WB 26: Dinosaur Swamp™ – \$20.95
___ 863 Rifts® MercTown™ – \$20.95
___ 865 Rifts® Merc Ops™ – \$20.95
___ 866 Rifts® WB 27: Adventures in Dinosaur Swamp™ – \$20.95
___ 867 Rifts® Mercenary Adventure Sourcebook – \$12.95
___ 868 Rifts® WB 28: Arzno™ – \$20.95
___ 869 Rifts® WB 29: Madhaven™ – \$16.95
___ 870 Rifts® John Zeleznik Coloring Book – \$5.95
___ 871 Rifts® Machinations of Doom™ – \$18.95
___ 872 Rifts® DB 10: Hades™ – \$24.95

___ 873 Rifts® DB 11: Dyval™ – \$24.95
___ 874 Rifts® WB 30: D-Bees of North America™ – \$24.95
___ 875 Rifts® DB12: Dimensional Outbreak – \$24.95
___ 876 Rifts® Megaverse® in Flames™ – \$24.95
___ 876HC Rifts® Megaverse® in Flames™ Gold Hardcover Edition – \$50.00
___ 877 Rifts® Heroes of the Megaverse® – \$16.95
___ 878 Rifts® Sourcebook: Shemarrian Nation™ – \$16.95
___ 880 Phase World®: Fleets of the Three Galaxies™ – \$16.95
___ 881 Rifts® WB 31: Triax™ Two – \$24.95
___ 883 Rifts® DB 14: Thundercloud Galaxy™ – \$20.95
___ 884 Rifts® Vampires Sourcebook™ – \$20.95
___ 885 Rifts® WB 32: Lemuria™ – \$24.95
___ 886 Rifts® Black Market™ – \$24.95
___ 887 Rifts® WB 33: Northern Gun™ One – \$24.95
___ 888 Rifts® WB 34: Northern Gun™ Two – \$26.95
___ 889 Rifts® Sourcebook: Heroes of Humanity™ – \$16.95 (coming)
___ 890 Rifts® World Book: Secrets of the Atlanteans™ – \$24.95 (coming)
___ 891 Rifts® World Book: Sovietski™ – \$24.95 (coming)
___ 892 Rifts® Sourcebook: The Disavowed™ – \$16.95 (coming)
___ 2510 Rifts® & The Megaverse® Art Book – \$22.95
___ 2510-HC Rifts® & The Megaverse® Art Book, Hardcover – \$50.00
___ 2510-CML Rifts® & The Megaverse® Art Book, Collector's Masterwork Edition – \$125.00

Miscellaneous Products

___ 600 Deluxe Revised RECON® RPG – \$22.95
___ 2536 Rifts® Coffee Mug – \$10.00
___ 2537 Gamer Coffee Mug – \$10.00
___ 2539 Rifts® Dice Bag – Black – \$8.00
___ 2545 Dead Reign™ Coffee Mug – \$10.00
___ 2554 Palladium Bookmarks, Set One – \$5.00
___ 2555 Palladium Bookmarks, Set Two – \$5.00
___ 2560 Palladium Fantasy® Coffee Mug – \$10.00
___ 2561 Property of Chi-Town Library Pencil – \$0.50 each
___ 2562 Future Visions™ – The Artistry of Charles Walton II – \$13.95

Note: T-shirts and other products can be found online: www.palladiumbooks.com

Rifts® Miniatures

___ MI8002 Xiticix Pack – \$18.00
___ MI8004 Coalition Dog Pack – \$18.00
___ MI8005 Men of Magic Pack #1 – \$18.00
___ MI8006 Cyborgs Pack #1 – \$18.00
___ MI8007 Simvan & Ostrosaurus Pack – \$18.00

___ MI8008 Coalition Skelebots Pack #1 – \$18.00
___ MI8009 Coalition SAMAS Pack #1 – \$22.00
___ MI8010 Coalition Sky Cycle Pack – \$22.00
___ MI8011 Coalition Dog Pack #2 – \$18.00
___ MI8015 Damaged Skelebots Pack #1 – \$12.00
___ MI8016 Cyber-Adventurers Pack – \$18.00
___ MI8017 Rogues & Scout Pack #1 – \$18.00
___ MI8018 Brodkil & Witchling Pack – \$18.00
___ MI8019 Damaged Skelebots Pack #2 – \$18.00
___ MI8020 Psi-Stalkers & Scouts Pack #1 – \$18.00
___ MI8021 Shadow Beast – \$12.00
___ MI8022 Mystic Knight – \$6.00
___ MI8023 Lord Magus – \$6.00
___ MI8024 High Magus – \$6.00
___ MI8025 Coalition Psi-Stalker – \$6.00
___ MI8026 Coalition Dog Boy in DPM-D1 Armor – \$6.00
___ MI8027 Coalition Dog Boy #2 – \$6.00
___ MI8028 Coalition Dog Boy #3 – \$6.00
___ MI8029 Coalition Dog Boy #4 – \$6.00
___ MI8030 Coalition Dog Boy #5 – \$6.00
___ MI8031 Glitter Boy – \$20.00
___ MI8032 Glitter Boy Pilot – \$6.00
___ MI8033 Kydian Overlord – \$20.00
___ MI8034 Dragonsaurus – \$10.00
___ MI8035 Slaver and Slave (Atlantis) Set – \$10.00
___ MI8036 Crazy – \$6.00
___ MI8037 Juicer #1 – \$6.00
___ MI8038 Juicer #2 – \$6.00
___ MI8039 Cyborg #1 – \$12.00
___ MI8040 Cyborg #2 – \$12.00
___ MI8041 Cyborg #3 – \$6.00
___ MI8042 Coalition Officer – \$6.00
___ MI8043 Coalition Grunt #1 – \$6.00
___ MI8044 Coalition Grunt #2 – \$6.00
___ MI8045 Coalition Grunt #3 – \$6.00

When placing an order by mail, please add money for shipping and handling. Add \$5.00 for orders totaling \$1-\$50, \$10.00 for orders totaling \$51-\$95, and for orders totaling \$96-\$200 please add \$15.00 US. Double the amount for Canada, and *quadruple* it for overseas orders. For more shipping options, order online at www.palladiumbooks.com.

Allow 2-4 weeks for delivery.

Make checks and money orders payable to:
Palladium Books

Check release dates for new products. If the book you order has not been released yet, your order will be held as a backorder until the product is available. Please note that prices are subject to change without notice.

Orders can also be placed by phone, at (734) 721-2903 (order line only). Please have your credit card information when you call.

www.palladiumbooks.com

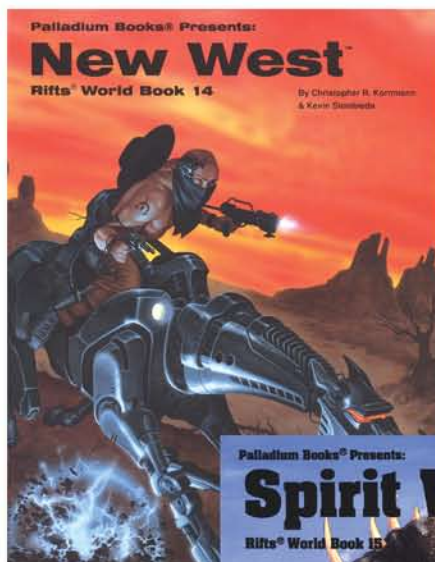

Also from Palladium Books®

Rifts® World Book 14: New West™

At last, the Western Wilderness (a no man's zone forbidden to citizens of the CS) is outlined and explored.

- Gun Slinger, Psi-Slinger, Indian warriors and mysticism.
- Techno-Wizard magic that turns ordinary gunpowder weapons into Mega-Damage weapons.
- Wilk's Inc. and a new array of special weapons.
- The Law — or what passes for it.
- Notable bandits, outlaws, Cyber-Knights and D-Bees.
- Notable towns, villages, badlands and world information.
- Written by Kevin Siembieda and Chris Kornmann.
- 224 pages.

Rifts® World Book 15: Spirit West™

An in-depth look at the *new* American Indian, various tribes, cultures, magic, and gods. While the White Man wars with D-Bees, sorcerers and his brothers in the East, the Red Man is quietly building new nations in the West.

- Indian warriors, spirits, gods and mysticism.
- Spirit magic, animal totems, psionics, and beliefs.
- 11 new O.C.C.s, including mystics, shaman and totem warriors.
- Indian fetishes/magic items that call upon animal spirits.
- Notable Indian nations, places, maps and world information.
- Written by Wayne Breaux Jr. with Kevin Siembieda.
- 208 pages.

Available at stores everywhere

Palladium Books® Presents:

Rifts® Lone Star – World Book 13

The inner workings of the legendary Lone Star Complex. Plus more information about the Coalition, its plans for the future, madmen, mutant animals and hints of things to come.

Highlights Include:

- The mysterious Lone Star Complex, notable characters, villains, madmen, mutants and dark secrets.
- Forbidden experiments and horrific creations.
- Loads of information about *Dog Boys* and other data.
- Additional mutant creations, including the Kill Hound, Sea Dog, Psi-X Aliens, Xiticix Killer, and others, plus general mutation rules and guidelines.
- The Pecos Empire, its notable leaders, tribes and gangs.
- World information, adventure ideas and hints of things to come.
- 176 pages.

\$20.95

Cat. No. 825

ISBN-10: 1-57457-000-5

ISBN-13: 978-1-57457-000-7

**Palladium
Books Inc.**

www.palladiumbooks.com