

Palladium Books® Presents:

Rifts® Mercenaries™

By C.J. Carella



Warning!

Violence and the Supernatural

This book may be inappropriate for young readers.

The fictional World of Rifts® is violent, deadly and filled with supernatural monsters. Other dimensional beings, often referred to as “demons,” torment, stalk and prey on humans. Other alien life forms, monsters, gods and demi-god, as well as magic, insanity, and war are all elements in this book.

Some parents may find the violence and supernatural elements of the game inappropriate for young readers/players. We suggest parental discretion.

Please note that none of us at Palladium Books® condone nor encourage the occult, the practice of magic, the use of drugs, or violence.

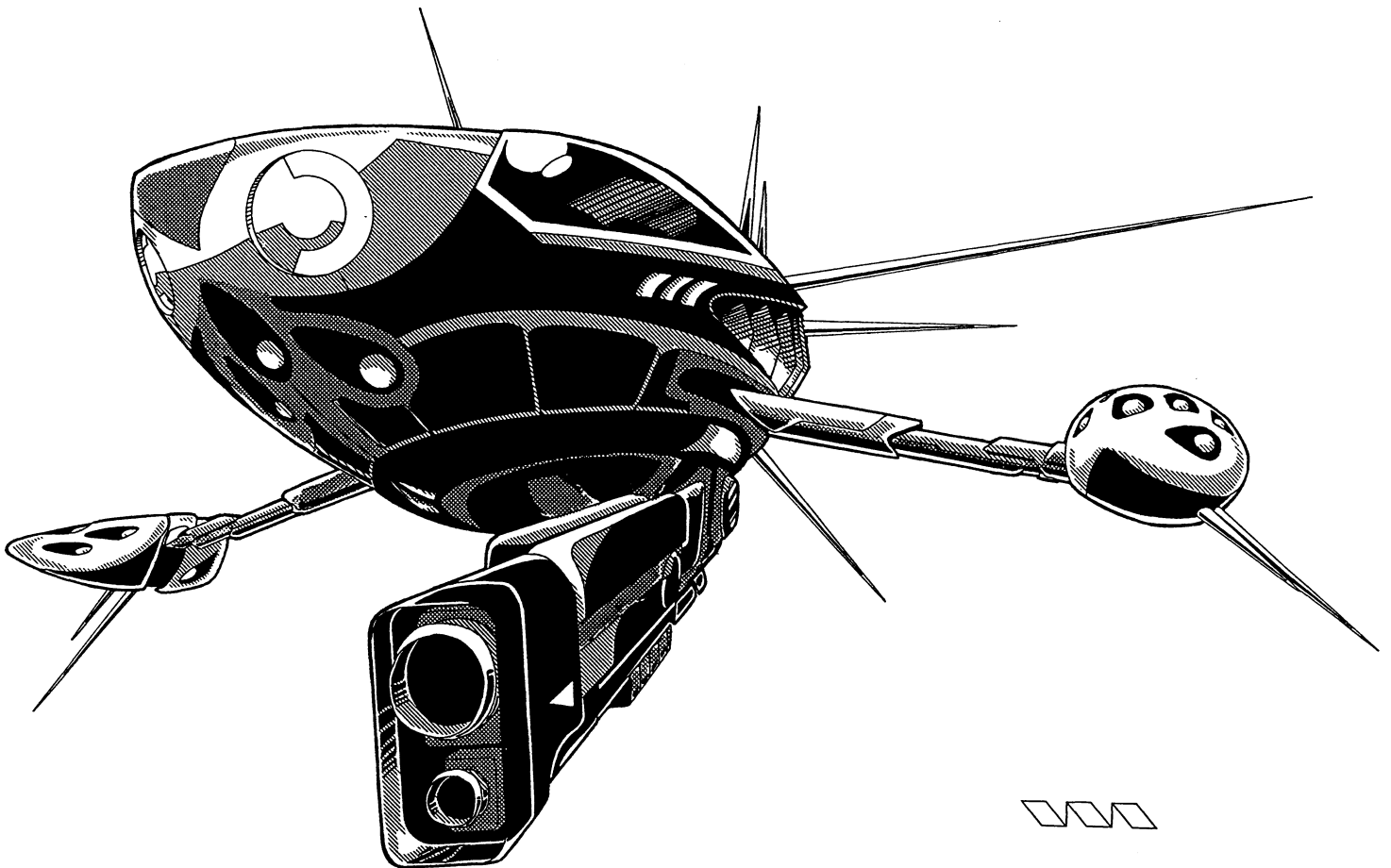

**A supplement for the Rifts® RPG.
Compatible with the entire Palladium Books® Megaverse®!**

Dedication:

To **Steve Jackson**, who gave me my first break in the writing business and without whom I'd still be an amateur.

Special Thanks to Scott Coady, for his ideas and suggestions, Joan Masters, for her unwavering support, and Carlos and Carmella Martijena, parents extraordinaire.

C.J. Carella

PDF Edition – October 2016

Copyright © 1994 Palladium Books Inc. and Kevin Siembieda

All rights reserved under the Universal Copyright Convention. No part of this book may be reproduced in part or whole, in any form or by any means, without permission from the publisher, except for brief quotes for use in reviews. All incidents, situations, institutions, governments and people are fictional and any similarity, without satiric intent, of characters or persons living or dead, is strictly coincidental.

Palladium Books®, Rifts®, The Mechanoids®, and Megaverse® are registered trademarks owned and licensed by Palladium Books Inc. and Kevin Siembieda.

Heroes Unlimited, Naruni Enterprises, Triax, Skelebots, the Coalition States, Triax, Cyber-Knight, Juicer, Glitter Boy, Dog Boy, Psi-Stalker, Splugorth, and other names and titles are trademarks owned by Palladium Books Inc. and Kevin Siembieda.

Palladium Online – www.palladiumbooks.com – also see us at [Facebook.com/PalladiumBooks](https://www.facebook.com/PalladiumBooks)

Rifts® Mercenaries is published by Palladium Books Inc., 39074 Webb Court, Westland, MI 48185. Printed in the USA.

Palladium Books® Presents:

Rifts[®] Mercenaries[™]

Written By: **C.J. Carella**

Additional Text & Concepts: **Kevin Siembieda**

Senior Editor: **Kevin Siembieda**

Editors: **Alex Marciniszyn**
Thomas Bartold
James A. Osten
Julius Rosenstein

Cover Painting: **Kevin Long**

Interior Artists: **Wayne Breaux**
Vince Martin
Scott Szczesniak
John Livesay
Kevin Long

Art Direction & Keylining: **Kevin Siembieda**

Typography: **Maryann Siembieda**

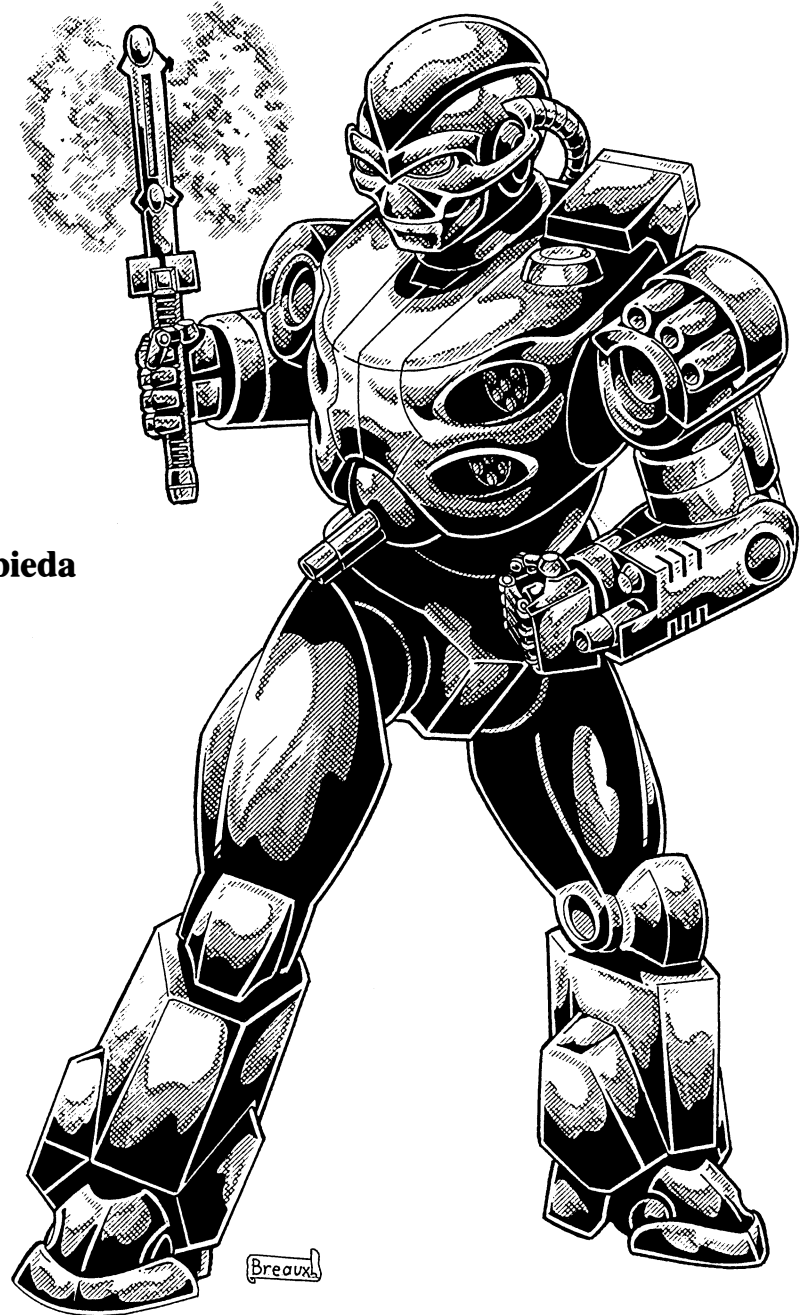

Special Thanks to C.J. Carella for another excellent contribution to the Rifts saga. And to Maryann, Wayne, Vince, Jim, Alex and the usual gang of Palladium wizards for another exciting Rifts sourcebook. I also want to introduce two talented newcomers to the Palladium Megaverse : penciler Scott Szczesniak and inker John Livesay. they did a handful of spot illoes for Mindwerks, but this is their first major publication as an art team. I suspect we'll see more of their work in the future.

Table of Contents

Author's Note	7	Tolkeen: A Prelude to War	37
Mercenaries	7	Whykin/CS vs Kingsdale	37
Mercs in Rifts Earth	7	Attacks by the Vampire Kingdoms	38
Mercs in Your Campaign	7	The Coalition vs The Vampire Kingdoms	38
Designing Player & NPC Mercenary Companies	9	The Xiticix Problem	39
Step One: The Size and Orientation	9	The Danger of Atlantis	39
Step Two: Mercenary Company Features	10	The Mechanoid Threat	39
A. Sponsorship	10	Role-Playing Battles	39
B. Outfits	12	Mercenary Groups	40
C. Equipment	12	DemonBusters, Inc.	40
D. Vehicles	13	Tactics	41
E. Weapons, Power Armor & Bots	13	DemonBusters' Colors and Banners	41
F. Communications	14	General Smith	41
G. Internal Security	15	Cutter	42
H. Permanent Bases	15	Brother Lance	43
I. Intelligence Resources	16	Lightdancer	44
J. Special Budget	16	Fireteam Alpha	45
K. General alignment of personnel	16	Lady Arson	46
L. Criminal Activity	16	Zippo	47
M. Reputation/Credentials	17	Delgado	48
N. Salary	18	The Dreamer/The Lost Ones R.C.C.	49
New Mercenary O.C.C.'s	19	Lieutenant Paul Konrad	50
Bounty Hunter O.C.C.	19	Other Personnel	52
Forger O.C.C.	21	Weapons & Equipment	52
Freelance Spy O.C.C.	22	Adventure Ideas	52
Master Assassin O.C.C.	23	Trapped!	52
Safecracker O.C.C.	24	Doctor Reid, I presume.	52
Smuggler O.C.C.	25	Transdimensional Employment	53
Special Forces O.C.C.	26	Crow's Commandoes	53
Super-Spy O.C.C.	27	Tactics	53
Professional Thief O.C.C.	28	Company Colors and Banners	53
Experience Tables	29	Lieutenant Damian Crow	53
New Pilot Combat Pod Skill	30	Leila Martinez	54
Designing a Merc Campaign	30	Sgt. 1st Class Wilhelm Kratz	55
Finding Clients	30	Mr. Green — Tauton Merc	56
Controlled Cities	30	Sonya "The Face" Schultz	57
Streetwise in the Big City	31	Kinoshi — Master of Martial Arts	58
Mercenary Havens	31	Curtis "The Shadow-Man" Roberts	59
The Average Town	32	Other Personnel	60
Mercenary Contracts	34	Weapons, Equipment & Resources	61
Mercenary Pay	34	Adventure Ideas	61
Pay Adjustments and Considerations	34	Scarecrows	61
Mercenary Assignments	35	King of the Mountain	61
One-Shot Missions	35	Braddock's Bad Boys	61
Raids and Military Expeditions	35	Colonel Braddock	61
Wars!	35	Lieutenant Janet Braddock	62
Long-Term Assignments	36	Lieutenant Lars Richardson	63
Piracy and Privateering	36	Dawud al-Jahiz	65
Other Common Jobs for Mercenaries	36	Other Personnel	66
Hot Spots on Rifts Earth	37	Weapons, Equipment & Resources	66
War in Minnesota	37	Adventure Ideas	66
		Braddock's Last Stand	66

Robot Control	67	M.D.C. Modified Large Trucks	97
Tactics	68	M.D.C. Modified Small & Medium Trucks	97
Company Colors and Banners	68	M.D.C. Modified Automobiles & Jeeps	98
Captain Lucia Chen	68	M.D.C. Modified Motorcycles	98
Arrak Chrome — D-bee Cyborg	69	M.D.C. Modified Aircraft	98
Sgt. Luigi “Va-Ba-Boom” Grimaldi	71	Modifying M.D.C. Vehicles	98
Grunt, The Giant	71	Weapons, Extra Features & Notes	98
Grunt's Power Armor — The Pulverizer	73	Northern Gun Weapons	99
“Tinker Bell” Eowyna	73	NG-56 Light Ion Pistol	99
“Trader Joe” — Naruni Sales Rep/Uteni R.C.C.	74	NG-E4 Plasma Ejector	99
Other Personnel	75	NG-E12 Heavy Plasma Ejector	100
Weapons, Equipment & Resources	76	NG-LG6 Laser Rifle & Grenade Launcher	100
Adventure Ideas	76	NG Hand Grenades	100
Robot Madness	76	NG Plastique Explosives & Others	100
Spies, Spies Everywhere	76	NG Mines	101
Armageddon Unlimited	77	NG-S2 Basic Survival Pack	101
Tactics	77	NG-EX10 Gladius Light Battle Armor	101
Company Colors and Banners	78	Wellington Industries	102
General Ursus/Dysasha R.C.C.	78	MP-10 Caseless Pistol (S.D.C.)	103
Colonel N'iall — Raksasha	79	MP-23A Caseless SMG	103
Urlik Blackhand — Ogre Tattooed Man	80	WI-2E Explosive Rounds	103
Leon Pasquali — Witch, Major Pact	81	WI-10 Ramjet Rounds	103
Sargon the Hunter	82	WI-20 Heavy Ramjet Rounds	103
Other Personnel	83	WI-23 Missile Launcher	104
Weapons, Equipment & Resources	83	WI-GL4 Revolving Grenade Launcher	104
Adventure Ideas	83	WI-GL20 Automatic Grenade Launcher	105
Larsen's Brigade	84	WI-40M Super-Heavy Missile Launcher	105
Tactics	84	Wellington Land Mines	106
Company Colors and Banners	84	Sensor Controlled Anti-Vehicle	
Colonel Marcus Larsen	84	Weapon Systems (SAWS)	106
Antonio Giordano — Juicer	86	Iron Heart Armaments, Inc.	107
Major Perrin — Dog Boy Officer	86	Iron Hammer Main Battle Tank	107
Ralph the Destroyer — Holy Terror	87	Iron Fist Medium Tank	109
Other Personnel	88	Iron Bolt Missile Vehicle	110
Weapons, Equipment & Resources	88	Iron Maiden APC-10	111
The Shadow Warriors	89	Iron Heart Aircraft	112
Tactics	89	Grey Falcon Attack Jet	113
Company Colors and Banner	89	AC-29 Air Castle Bomber	114
Commander Grey	89	Iron Eagle Attack Helicopter	116
Captain Myriam	91	Iron Heart Watercraft	117
Soll-Thull — Brodkil Warrior	91	Iron Heart Torpedoes	117
Anaconda — Kittani Warrior	92	Black Eel Torpedo Boat	117
Other Personnel	93	Triton Patrol Boat	118
Weapons, Equipment & Resources	93	Sea King Missile Cruiser	120
Adventure Ideas	93	Naruni Enterprises	121
The Pecos Empire	93	Interdimensional Arms Dealers	122
Splugorth vs Splugorth	94	NE-10 Plasma Cartridge Rifle	122
On a Clear Day, You Can See Wormwood	94	NE-4 Plasma Cartridge Pistol	123
New Equipment	95	NE-50 Particle Beam Rifle	123
Golden Age Weaponsmiths	95	NE-200 Plasma Cartridge Machinegun	123
Retooling Old Weapons	96	NE-1000 “Modified” Plasma Ejector Rifle	124
Retrofitting Pre-Rifts Vehicles	96	NE-C20 Camouflage Variable Armor	124
M.D.C. Modified M48A3 Main Battle Tank	97	Camouflage Sheets	125
M.D.C. Modified Bradleys	97	Personal Force Fields	125
M.D.C. Modified Armored Cars & Light APCs	97	N-F12A Light Force Field	125
		N-F20A Medium Force Field	125

N-F40A Heavy Force Field	126
N-F50A Superheavy Force Field	126
Naruni Vehicles	126
NE-010 Destructo-Drone	126
NE-020 Combat Drone	127
NE-030 Spy Drone	128
NE-300 OMAV Combat Pod	128
Weapon Systems of the OMAV Combat Pod	129
Carnivore Mark I — Light Hover Tank	130
Juggernaut — Heavy Hover Tank	132
Naruni Robots & Powered Armor	134
Mecha-Knight Medium Powered Armor	134
Death-Knight Assault Robot	137
Nomad Scout Robot	139
Crescent Moon Delta-Wing Spaceplane	139
Boomerang Attack Aerodyne	140
Angrar Robotics	141
Angrar Mark II Power Armor	141
Angrar Assault Robot	142
Chipwell Armaments, Inc.	143
Chipwell Series Power Armor	143
CAI-50 Challenger Light Combat Armor	144
CAS-30 Chipwell Assault Suit	145
CAI-100 Warmonger Combat Suit	145
New Coalition Vehicles	146
Coalition Air Defense Systems	146
Main Battle Tank	147
Missile Launcher Vehicle	148
Coalition Nightwing Attack Aircraft	149
Casualties of Peace	151
Scenario Outline	151
Getting Started	151
Hope City	151
Government	151
Military Forces	151
Benford Town	152
Government	152
Military Forces	152
The Conflict	154
Help Wanted	154
Bad Omens	155
The War Begins	155
Random Encounter Table	155
News and Occurrences	156
The Battle	156
After Effects	157
The Cave	157
Guardian of the Caves (Supernatural Minion)	158
The Thing at the End of the Tunnel	158
The Last Battle	159
The Price of Failure	159
The Conqueror — Alien Intelligence	159
The Rewards of Victory	160

Quick Find Tables

Mercenary Companies

Armageddon Unlimited	77
Braddock's Bad Boys	61
Crow's Commandoes	53
DemonBusters, Inc.	40
Larsen's Brigade	84
Robot Control	67
The Shadow Warriors	89

O.C.C.s (optional)

Assassin: Master	23
Bounty Hunter	19
Forger	21
Safecracker	24
Smuggler	25
Special Forces	26
Spy: Super	27
Spy: Freelance	22
Thief: Professional	28

R.C.C.s (optional)

The Lost Ones R.C.C.	49
Uteni Alien R.C.C.	74
Dysasha Demon R.C.C.	78

Weapon Manufacturers

Angrar Robotics	141
Chipwell Armaments, Inc.	143
Coalition - New Vehicles	146
Golden Age Weaponsmiths	95
Iron Heart Armaments, Inc.	107
Naruni Enterprises	121
Northern Gun Weapons	99
Wellington Industries	102

Author's Note

I first became fascinated by mercenaries when I read David Drake's "Hammer's Slammers" novels and short stories. Drake's mercenaries were people who had refined war into both an art and a science, and who have lost a part of their humanity in doing so. Hated and feared by their employers, second-guessed by civilians who don't understand what they are doing, and fighting amateurs (all the more dangerous because of their inexperience), the mercs bear it all and still get the job done, whatever the cost. In these novels, there is always a sense of irony about the hatred and distrust civilians feel for the mercenaries; their contempt for them as hired killers when it is they who are doing the hiring and paying them to do the things that disgust them so.

A mercenary can be a heroic figure, a sympathetic enemy, or a black-hearted villain. As soldiers of fortune, they go to the trouble spots, the war zones, and disputed lands — business is always good there. In the world of Rifts, they have to deal with magic and the supernatural in addition to the usual dangers of their career. I think that the mercenary player character (from the archetypal Headhunter to even more exotic varieties) offers a great deal of adventuring opportunities to players and Game Masters alike. Mercs will be at the heart of many of the conflicts on Rifts Earth. My hope is that, after reading this book, you will agree.

— C.J. Carella

Mercenaries

Mercenaries are soldiers for hire. They fight for their pay rather than under forcible recruitment or the usual claims of patriotism, justice, politics, or high ideals. Mercenaries have existed since the appearance of organized armies and have played an important part in the wars of Earth for thousands of years.

Where do mercenaries come from? Their origins are varied. The first mercenaries were usually veterans of an "official" war. Sometimes, after a war was over, the veterans were unable or unwilling to return to civilian life. In some cases they found themselves stranded in a foreign land, far from home. Often, they decided they liked the life of the warrior, or realized that they were only skilled in the arts of war, and they had to hire out their services or face starvation. These armies of displaced veterans would gather together and try to sell their services to anybody who was willing to pay.

This was the usual beginning of a mercenary company (a typical modern military company is 160 troops divided into four 40 man platoons which were in turn divided by 10 man squads). As the group grew in size, it attracted different types of people — outlaws, criminals, refugees, disinherited noblemen, escaped slaves as well as, the young and naive adventurer often joined these mercenary armies. Some wandered the world looking for jobs. Renaissance Europe was plagued by bands of errant soldiers who often turned to banditry when they could not secure a military assignment.

Many governments found it convenient to hire professional soldiers whenever they needed them, rather than train and maintain a large standing army of their own. For one, it was generally cheaper (soldiers during times of peace are often seen as an unproductive expense). Also, some rulers thought it was safer to hire outsiders than to trust their own countrymen with weapons because they might decide to rebel. Since mercenaries were for the most part foreigners, there was little chance that they could overthrow the government, because they would have little support from the nation's people.

Throughout history, one thing remained constant — mercenaries were always feared and distrusted, and frequently hated, by their employers. The civilian population was terrified of these violent men. Regular soldiers envied the higher pay mercenaries commanded and

hated working with them because of it. Sometimes this distrust was justified. There were many instances where mercenary armies switched sides, sometimes in the middle of a battle, when the other side made them a better offer. Most of the time, however, it was the mercenaries' employers who betrayed the soldiers of fortune. The most common acts of betrayal were either refusing to pay them after they had fulfilled the job or actually destroying them. Even if they were paid, most countries made it clear that they didn't want the mercenaries to stay after their services were no longer needed. Mercenaries were almost always outcasts, shunned and persecuted unless a war was going on.

The life of these soldiers was often brutally short. They had few places they could call home, and few friends other than their comrades in arms. Civilians could not understand their ways. A mercenary saw more combat than most soldiers. Unlike normal soldiers, they needed a constant state of war to make a living. From the mercenary armies of the Persian and Carthaginians to the mercs in 1960s' Africa, these soldiers-for-hire have played a role in the wars of history, and have been romanticized, reviled and feared.

Mercs in Rifts Earth

Pedro watched the "parade" with unbelieving eyes. Two years ago, when he was but a child — Pedro was thirteen now, a year shy of being a "real" man — a detachment of Coalition troops had marched through the town. He'd never forget the shiny black uniforms and armor of the disciplined soldiers as they moved with perfect coordination. He'd never seen men so organized, so clean and heroic.

By contrast, this group of so-called soldiers before him was nothing of the sort. The men sitting on top of the rolling vehicles or the ponderous robots were dirty and unkempt. No two uniforms or suits of armor were the same. Their "colors" were uniform only inasmuch as most of them were covered in the yellowish-brown dust of the desert outside the town. The mercenaries did not keep order, or pace, but walked or rode as they wished, only careful of not bumping into each other. Pedro shook his head. "Why is Father hiring these men?" he asked incredulously.

"You have a lot to learn, Pedro," Arlington said. Pedro accepted the reproach silently. Arlington was his father's man-at-arms, a tough veteran warrior who now was teaching Pedro the art of the gun, the sword, and the robot. Pedro all but worshipped the man.

"You're thinking of them nice 'n clean Coalition soldier boys, aren't you?" After Pedro's nod, Arlington continued. "Do you think that the way a soldier looks will matter in a real fight?"

Pedro considered this. One of the first things Arlington had taught him was, there are no rules in war, only winners and losers. "I guess not, but..."

"Mebbe you think they look dirty and unkempt, they probably don't take care of themselves, eh? Look at their weapons, their equipment." Pedro did so, and noticed that, slovenly as the mercenaries looked, there was nothing wrong with their sidearms and vehicles. The armor was patched in places, the weapons had been modified — some had their stocks sawed off, others had coupled two or more weapons into heavy, intimidating combinations — but all of them looked functional, and relatively clean.

"These men, they know how to fight. Them Coalition boys, they burn down an unarmed D-Bee village, they call it a battle. Once in a while, they attack people who fight back, but even then, they have the edge in way of numbers and technology. These mercs are used to fighting when the odds are against them — they make up for it with tactics. And imagination."

"But... you mean that these men are always better than normal soldiers, than our own Royal Guard?"

Arlington smiled. "No, not all of them, my Prince. Only the ones who survive."

The world of the rifts is an ideal breeding ground for mercenary companies. This chaotic, anarchic world where monsters lurk in the shadows, and each township can be a kingdom unto itself, needs skilled warriors. There is also a huge technological gap: Some places have a primitive technological base, often below 20th-century standards, while at the same time there are giant robots with energy weapons sold in the open markets of large cities. The expense involved in maintaining and training a modern army is far too high for most small nations. It is much cheaper to "rent" such an army whenever it's needed. This is where mercenaries come in.

Even large, organized nations like the Coalition States and the NGR sometimes hire mercenaries. This may occur when a situation arises that cannot be handled by local loyal forces. The Coalition often hires mercenaries (all unofficial, of course) for operations outside their range of control, to "soften up" the enemy, and to perform covert and seek and destroy missions against enemies such as The Federation of Magic, Tolkeen and D-bees. Why jeopardize good, loyal CS troops against inhuman or treacherous scum when there are mercenaries willing to do it for you? Similarly, moving and supplying an army to a trouble spot is expensive, and sometimes there simply isn't enough time. Far better, then, to hire a band of local or wandering warriors to deal with the problem. It's also cheaper, in the long term, to hire mercs than to keep a huge army sitting around on the border — especially when the army may be needed to maintain internal order.

The market for warriors-for-hire is large and varied. Supernatural threats need to be dealt with by experienced, highly trained professionals. If no cyber-knights are at hand, the locals need to pay somebody to get rid of the demons, monsters or D-Bee invaders threatening their lands. Even conventional wars are best left to the professionals. Two budding city-states at war with each other may need to build an army quickly. Since raising and training an armed force takes too much time, they often have to hire mercenaries. Mercs can instigate a war, launch an assault, maintain a siege, defend a kingdom, raid an enemy/rival, perform acts of sabotage or assassination, serve as special forces, or train local volunteers to become a militia; just to name some areas of their "special" talents.

Not all mercenaries have the same goals. The majority are in it for the money, but some have other reasons such a love for combat, or a lust for glory and fame and all the perks that come with it. Some are bullies, show-offs or self-proclaimed heroes who have something to prove. Some hope to earn and save enough money to support a family, start a business or retire. Others fight (or at least start fighting) out of a sense of revenge/hatred toward a particular nation, politics, or people. Others may fight for a belief (political, religious, or personal ideal) or some other personal reason.

Some may be selling their services as a cover for a different mission. Historically, many governments have used mercenaries as their secret agents. Rifts Earth is no exception. If a ruler does not want to get his hands dirty, he may hire mercs to do the dirty work for him (the CS is infamous for this). Some of the inhuman forces on the Earth may employ mercenaries as their pawns; sometimes without the warriors ever realizing they are being used for dark purposes!

The transdimensional nature of Rifts Earth also allows for the possibility of the ultimate mercenary organization: The multi-dimensional soldier of fortune! These ultra-powerful warriors span the Megaverse, wandering through different worlds like the ancient Earth mercenaries wandered through nations. The largest outfits may have a central base from which they direct operations in many different places. Their powers and equipment will often be the most advanced, and also the most expensive. Only the most powerful groups or nations will be able to afford the services of multi-dimensional mercs. Sometimes, such dimension spanning troops may not reveal the final price tag until it's too

late to do anything but paying it. This payment might include a permanent land grant or the enslavement of a whole nation! Dealing with mercenaries, especially alien mercs who have no sense of allegiance to the planet or the races who inhabit that world, is always a risky proposition.

Mercs in Your Campaign

Governor Ryan ignored the sweat dampening his forehead. It was hot and stifling inside the canvas tent, but that was only partly to blame for the perspiration. Being surrounded by an army of killers accounted for the rest. He punched numbers in the hand computer he had placed on the empty ammo box that Larsen used as a field desk. Larsen regarded him with cold amusement, his cybernetic eye making whirring noises as it followed the governor's movements.

"All right," Governor Ryan finally said. "I've calculated all possible expenses, the expected length of the campaign, and the risks involved. I'm being conservative, of course. The Xitixix presence in the area is deemed to be minimal. We're just being careful." He turned the computer so its screen faced the mercenary leader. "I trust that this offer will be satisfactory. It's the highlighted entry in the lower right corner."

Larsen leaned over the computer. "May I?" Without waiting for assent, his metal arm started typing something on the computer. When he was done, he turned the computer back toward the Governor.

"You... you erased my projections!" Ryan stammered. "You..." He contained himself when he remembered where he was. His bodyguard was standing right behind him, but Larsen's man was also in the tent — a Juicer from the looks of him. Should violence erupt in the tent, the Governor's bodyguard would be as effective as a hay roof against a tornado. Ryan forced himself to look at the computer. The only thing left there was a number, neatly centered in the screen. "That's... that's twice the amount I offered you," he said in a hoarse whisper. Larsen turned toward the Juicer.

"Pedro, show Mr. Ryan what you found outside his city." The Juicer picked a bag off the ground and shook its contents over the field desk. Ryan gave a startled cry when the severed insectoid head hit the table and bounced into his lap. With a groan of disgust, he flung it away.

"The Xitixix are at your gates, Governor," Larsen continued. "You simply don't have the resources to push them back. Within a week, they'll knock down your walls, overrun the city, and have you and the entire population for lunch. And I mean that literally, Governor. This particular hive has decided that humans are a good source of protein.

"Now, I'm sure you can work something out with the king of Utah City. He'll send you some help — but then he'll probably want to stay, take some land away, maybe settle down permanently. Or you can evacuate your city and settle someplace less dangerous; not that I can imagine where such a place might be. It'll be tough for your government. Most common folk don't take kindly to authorities that can't protect them. If you're lucky, the people will only toss you out on your ear. You should survive ... somewhere, as a refugee. Or..." Larsen leaned over the desk until his half-metallic face was only inches away from Governor Ryan's. "You can pay up and shut up. I have an armored force two days away from the Xitixix Hive. Air support, artillery, the whole bit. We can go in and shut them down within a week. If you want us to do garrison duty, we can do that too, but then the Xitixix will only grow stronger, and you'll never get rid of them ... or us, 'cause you'll need a permanent garrison just to survive. If the credits are transferred into my accounts by tonight, it'll all be over by the end of the week and we can all move on. Your choice." He leaned back and lit a stinking cigar.

Ryan wiped the rivers of sweat running down his face. Paying this amount would deplete the Treasury and his own personal accounts. He would have to pressure some of the more prominent city fellows to pay part of it, and doing so would gain him no friends. But ... he glanced at the corner of the tent where the Xiticix head had landed face up. He saw how sharp its insectoid lateral mandibles looked, even in the poor light. His mind conjured the image of those mandibles closing over his screaming face. "All right," he whispered harshly. "All right, damn you. You'll get your money."

Larsen blew smoke towards the ceiling. "Pleasure doing business with you, Governor."



Mercenary outfits can be either adversaries or allies of the player characters, or both. A mercenary campaign fits perfectly in the Rifts world. Besides the Headhunter O.C.C., most player character classes can sell their services. Going mercenary is an ideal way to pay the bills. The upkeep of all those robot suits, not to mention all the E-clips the characters burn, adds up after awhile. It can also provide a focus for many adventures and campaigns. Rather than travelling aimlessly down the Road of Random Encounters, the player characters are members (or even in charge) of an organization with definite goals. They will have to seek out clients, fulfill jobs and slowly grow in power and prestige. This does not need to be the main element of the campaign, however. Being a mercenary is only the characters' job. Their personal life can be the source of many other adventures. Maybe one or more of the characters had to become a mercenary when he was betrayed, framed for a crime, or found himself on the losing side of a political or military conflict. For the time being, he has nowhere else to go. Alternatively, the forming of a mercenary company may be the first step in returning home or to get revenge or justice.

Not all mercs are hardened businessmen. Most have their own rough but strict code of honor. Some may only take on jobs that fulfill certain conditions and will refuse assignments that go against their beliefs. A mercenary outfit, for example, could specialize in fighting supernatural creatures (see **DemonBusters, Inc.**, for such an example), and refuse any job that does not involve transdimensional monsters, vampires, or the like. Others might be thinly veiled anti-Coalition rebels and only undertake missions that will somehow damage the CS.

Each mercenary group will have its own peculiarities, habits and eccentricities. Some will be highly professional, honorable groups, while others are no better than street gangs and brigands; violent and untrustworthy. They will vary in size from a handful of warriors to huge forces able to match a national army. The membership may be made up mostly of humans, or the group could be a motley crew of D-Bees, supernatural creatures and open-minded Earthlings. Many outfits will be in direct competition with each other; this may be a friendly, honorable sort of competition, where they will fight each other one week and get together for drinks on the next, or may devolve into a savage series of ambushes and betrayals.

In the pages that follow, the steps for designing a mercenary company and then using it in a campaign will be detailed fully. A brief overview of the world of Rifts Earth from a mercenary viewpoint is also provided, as well as a list of possible clients, conflicts and different types of jobs. Lastly, those hardware junkies will find scores of new weapons, armor, bots, and vehicles commonly produced by the likes of Northern Gun, Iron Heart and others in North America.

Designing Player & NPC Mercenary Companies

The term **Free Company** was used during the Late Medieval period in Europe to describe bands of independent soldiers who fought for any nation as long as they were paid on time. On Rifts Earth, the term has become popular once again. Any independent (or at least seemingly independent) group that sells its services for money can be called a Free Company.

Free Companies vary greatly in size, power and influence. Some are about the size of a typical player character adventurer group (4-8 characters), while others are large armies that can fight in several different conflicts at the same time. Their strength, influence/reach, equipment and organization are highly variable. Such factors will affect the role a Free Company will play in a campaign. There is also the question of who actually controls the merc outfit. Many seemingly independent organizations are the agents or dupes of other more powerful forces in the Rifts world, such as the Coalition States, the Splugorth, etc.

The following rules are guidelines on how to create any mercenary company. The Game Master (GM) may create them himself or, if the players are to be key members or founders, they can also participate. For the most part, a player-controlled company should not be very large or powerful; i.e., it should be selected from the company types 1-4. For Non-Player Character (NPC) agencies, the GM can pick and choose as he sees fit, or roll randomly.

Step One: The Size and Orientation

This will determine how much raw power will be available to the Free Company. The GM can roll 1D6 to select the type of Company, or may decide which size will work best for the adventure/campaign. Remember that these are simply guidelines and the GM may modify them in any reasonable way he sees fit.

The points listed under each category is the total available points for all company features. The GM *may* assign an extra 10-100 points to a company to reflect any special financing or equipment. For example: A small company with a lot of expensive firepower could have an extra 50 points to spend on weapons and vehicles.

Even with 540 points (the typical maximum), selecting company features can be difficult. If no points are spent on a particular feature (A through N), then the company automatically has the lowest rating of level 1 (None!), in that particular feature. This means some mercenary companies may have incredible strengths and resources in some categories (areas of specialty) and no or limited resources in others. Likewise, some companies may be more well balanced in many categories with no great strength or weakness in any category.

1. Small-time Company or Squad. This is the smallest mercenary band available, and the most appropriate for player characters. This small band consists of six to twelve people, including both front line and support personnel (which usually means that the medic and mechanic will also double as fighters when the time comes, and they both better do well!). These companies run on a shoestring budget, and will have few resources (for the most part what each member brings along with him) and even less political influence.

60 POINTS are available, plus an additional 10 POINTS for vehicles and 10 POINTS for weapons. **Note:** The additional 10 points must be

applied only to those specific features. Additional points can be spent from the general point pool. Organization designers can spend the general points (in this case, 60) wherever they desire.

2. Minor Company. A slightly larger band with 20-40 members, including support personnel who can also double as front line troops. Sometimes, these companies work for one or two employers on a regular basis or have a sponsor who provides the funds necessary for the maintenance of the company. On the other hand, this could be a small-time outfit that acquired resources through a stroke of luck, a big job, and/or combat situations. These groups can be formidable if properly equipped, but are still no match for any major government.

95 POINTS are available, plus add an additional 10 POINTS for equipment and 10 POINTS for vehicles.

3. Free Company. This is a good-sized group, equivalent to an army company or small brigade. About 100-400 members total; 60% of these are likely to be support personnel, not expected to fight except in an emergency. Usually well-armed and equipped, this group is able to destroy a town or threaten a small city. The leaders of the group are often experienced men-at-arms, but can also include supernatural creatures, powerful magicians, cyborgs and/or psychics.

145 POINTS are available, plus 10 POINTS for vehicles, 10 POINTS for outfits, and 10 POINTS for weapons.

4. Large Company. This mercenary organization is a small army in its own right. It has about 400-1,000 members; about 60% will be support personnel, not expected to fight. This is the largest size commonly found on Rifts Earth. It's very difficult to support a bigger group in this underpopulated, impoverished and dangerous world. Furthermore, armies that get any larger often become targets of fearful governments, including the paranoid Coalition States. A company this size can take on the garrison of most typical cities and win. Even though they may be outnumbered, their weaponry and training will usually more than make up for the difference. Hiring such an outfit may make the difference between winning or losing a war. These groups will have some political power, especially if they have settled in one area. If the company has a home base, 30% of the personnel will always stay behind to provide security and maintenance. The company will probably control or be a major player in the politics of the region where they have established their headquarters. Most mercenary "armies" are made up of a temporary alliance between two or more large companies, or one large company and several smaller ones.

200 POINTS are available, plus 10 POINTS for vehicles and 20 POINTS for budget.

5. Mercenary Army. An army in its own right, with at least 2,000 effective (line soldiers) and 3,000 support personnel. Total size of the army can range from 5,000 to 10,000, with 60% of the troops engaged in support activities. This force will have heavy weapons and some air support. There will be at least one platoon (40 members) of "specialty" agents: magicians, psychics and super-powered operatives (up to 5% of the total size of the army can be composed of these "special" operatives). Typically, only the largest national governments can match these forces; keep in mind that a highly trained and well-equipped mercenary army will be able to defeat any typical army twice its size and a militia or inexperienced army three or four times its size. Mercenary armies this size are a rarity on Rifts Earth, especially in North America and Atlantis. However, several transdimensional armies that operate throughout the Megaverse might make an appearance on Earth.

Frequently, a company this size sells its services to many different clients at once, fighting several small wars in different places. In that case, the total number of effective forces is broken into 2-50 sub-units, each usually equal to a #3 or #4 size company. An army of this size can play an important part in the political field. Its raw power cannot be ignored by any government because such an army could conquer almost any typical kingdom or small nation.

300 POINTS are available, plus 20 for budget or weapons and 20 for outfits.

6. Large Mercenary Army. This Free Company can take on any kingdom and nation on Rifts Earth, with the possible exception of the Coalition States, The NGR and Atlantis. It consists of a multi-divisional army (at least 20,000+ effective, 40,000+ support personnel) and can have as many as one million total members! This army will have several hundred super-powered and magically or psionically adept agents. It will also have enormous resources and equipment, most of which will be technologically equal or superior to the CS or Triax. It will have land, air, and possibly sea support. A Free Company of this size is probably able to dictate terms to most governments.

No group of this size is known on Earth. Only a transdimensional mercenary outfit from another dimension may be of this size and become involved on Earth. However, very few nations could afford to hire an army this size. Consequently, one is more likely to encounter a visiting branch from this dimension travelling mercenary force (typically troops ranging in size from #1 to #4).

500 POINTS are available plus 20 for vehicles and 20 for budget.

Step Two: Mercenary Company Features

A. Sponsorship

Exactly who is controlling the mercenary company, providing them with leadership, goals and their real source of funds? Select one. There is no cost for this necessary feature.

1. NONE. Independent Operative: The company is owned and operated by the mercenaries themselves. The owners could be the leader or leaders (officers), or maybe every single merc is a shareholder. The objective of the company is to make money, and the owners are responsible for upkeep and payment of non-owners. All the money left after expenses is divided among the owners/shareholders. He (they) answer to no one and go where they please. Add 10 points wherever desired.

2. Secret. Most of the members have no idea who is really behind the organization, or what hidden motives there might be in their assignments. The group is given clients and may be told not to sell their services to certain potential clients. The features and equipment of the company are paid for by the mysterious benefactor.

Add 10 Points in Equipment, 10 Points in Outfits, and 10 Points wherever desired. Keep in mind that the members don't know who they are working for or toward what purpose. The characters may find themselves given assignments they do not want, or told to do things that may compromise their morals (especially if the sponsoring agency is corrupt or evil). G.M.s should take advantage of this as a continuing story subplot.

3. Criminal. Small-Time Bandits: The mercs are actually a band of brigands who will engage in criminal acts whenever they cannot find gainful employment, or when crime is more profitable than military service. Their mercenary reputation is used as a cover for illicit activities from smuggling to looting battlefields to outright banditry. Add 10 Points to Criminal Activity and 10 Points wherever desired.

4. Criminal. Organized Crime: The company is a big-time crime outfit engaged in everything listed in number three but on a larger and more covert scale. This mercenary company may only pretend to sell its services to an employer and tend to betray those who hire them whenever it is convenient. Their goals have little to do with warfare, but with the acquisition of power and wealth for their organization. The Thugees of India and the Ninja of Japan are examples of two ancient sects of criminal specialists and assassins for hire, but who

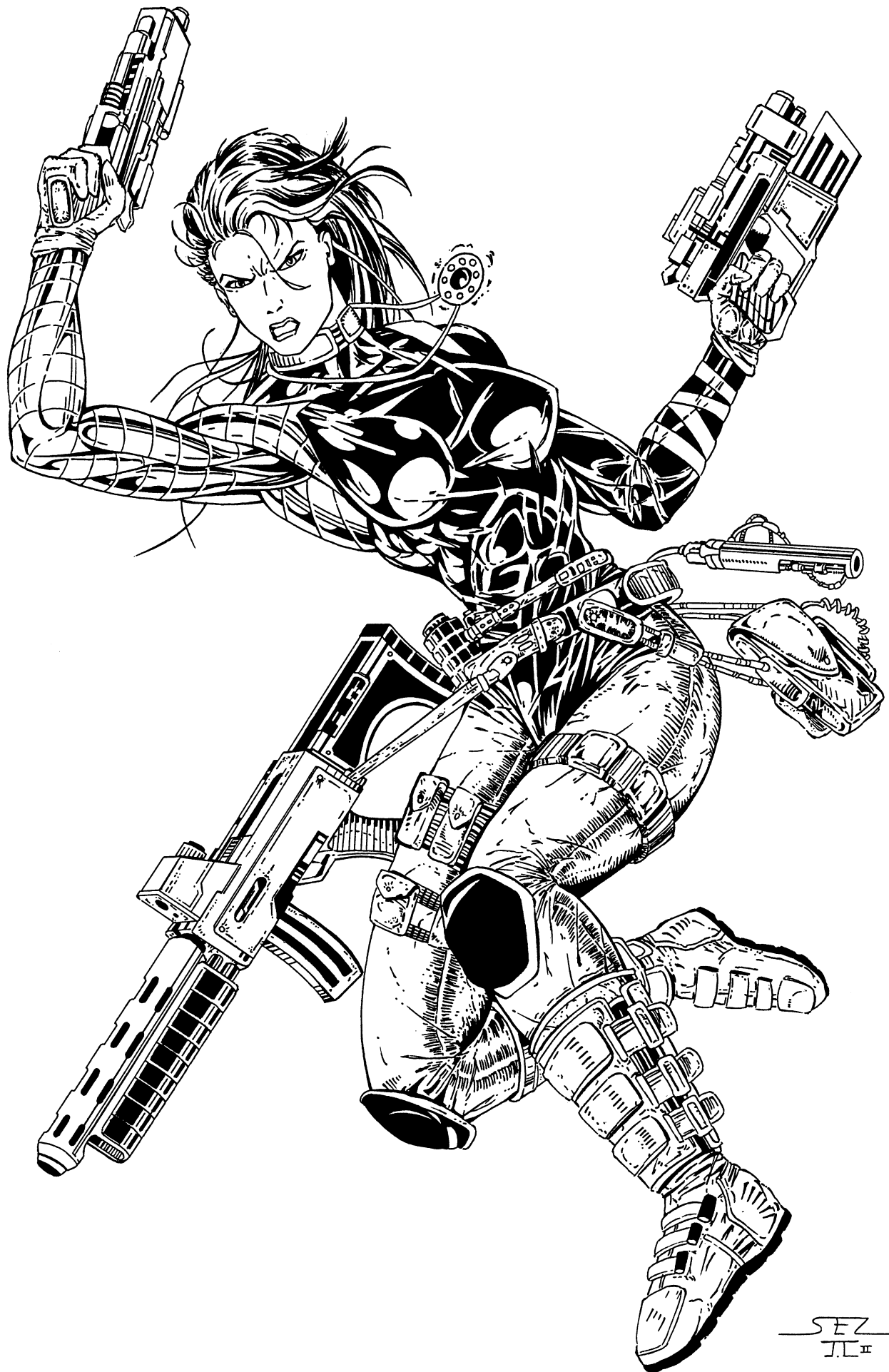

represented a powerful organization in their own right.

Add 20 Points to Intelligence Resources, 20 Points to Criminal Activity, and 10 Points wherever desired.

5. Government. The company is secretly sponsored by an official government, usually one of the smaller kingdoms, and is covered by the government's legal framework. This was a common practice in Earth's history. When a government could not make war directly on another, it often equipped private armies who would then take offensive action. In the sea, they were known as privateers. Frequently, the merc company is used as a covert form of aid to an ally at war (rather than send official troops to the aid of the ally and risking that nation getting involved in a war it doesn't want). The government secretly hires (or arranges the hiring of the army) and supplies the merc company, which is then sent to aid their ally.

In other cases, the mercenary company may be a source of revenue for the government, maybe even the most important money-maker for the kingdom! Instead of exporting normal goods or services, the nation is offering its warriors as hirelings to other, non-threatening, kingdoms. This is likely to be troops of professional soldiers who are predominately good and anarchist in nature and who live by a military code of ethics; they are not necessarily evil or heartless destroyers (but they can be).

Add 20 Points in Outfits, 20 Points in Equipment, and 20 Points wherever desired.

6. Coalition Front (or NGR, Splugorth, Gargoyle Empire or similar major government/world power). Sponsored, controlled and secretly owned by a powerful evil government! 75% of management will be agents of the government (military officers or major minions), 20% of the support personnel are government agents, and 50 to 75% of the line soldiers are members of the government. This company will try to appear autonomous and try to hire itself out to enemies of the sponsoring government. Their sole intention is to spy, sabotage, conquer or destroy the enemy who has unwittingly hired them.

Small companies and squads will most likely engage in spying and sabotage. Larger troops will be sent far away from their area of origin to engage in covert actions or even open war against any enemy forces.

Coalition-controlled merc groups will try to undermine or destroy all non-human nations, Tolkeen, The Federation of Magic and even Atlantis, as well as try to neutralize any perceived threats to the Coalition they may encounter. The organization should be primarily composed of fanatical human supremacists and evil characters.

Splugorth-sponsored companies will be used mostly as spy cells, providing information to their master and thieves (stealing rare and valuable articles; especially magic items); they will also be involved in the slave trade, sending prisoners to Atlantis through magic. The organization should be predominantly evil.

In all cases, add 20 Points to Outfits, 20 Points to Equipment, 20 Points to Weapons, 10 Points to Budget, and 10 Points wherever desired.

B. Outfits

Uniforms and body armor that the Free Company distributes among members. Uniforms may not be mandatory among all but the largest armies.

1. None. The characters are responsible for their own clothing and armor. Officers have to make or buy their own insignias or badges of office, if any. No replacements of any kind are available. Company Cost: None.

2. Utility Outfits. The company has a standard uniform for all personnel. This is typically an inexpensive one-piece coverall, jump suit or shirt, pants and jacket. The shirt and jacket may have a simple emblem or insignia denoting membership in this particular group. Members must provide their own body armor but can paint it in the same colors and use the official insignia (if there is one). The company has

plenty of replacements, in standard sizes, and also provides free laundry service. Company Cost: 5 Points.

3. Open Wardrobe. In addition to a basic uniform, a complete range of clothing, uniforms and costumes are available. Standard uniforms are made up of light M.D.C. padded armor (30 to 40 M.D.C.); officers may have the heavier composite and/or plate types. Other individual members can purchase heavier armor at their own expense. Company Cost: 10 Points.

4. Specialty Clothing. Standard uniforms are provided as well as medium mega-damage body armor (usually 40-55 M.D.C.), with heavy armor (60-80 M.D.C.) available for elite assault units and officers. Special gear, such as SCUBA/diving suits and equipment, radiation suits, and contamination suits, are also available. Availability, replacement suits and repairs are reasonably good. Company Cost: 20 Points.

5. Gimmick Clothing. A full range of uniforms and body armor, plus concealed body armor (such as Triax "Plain Clothes" armor), specialty suits and helmets with advanced electronic, communications, homing devices, optics and surveillance gadgets are available. Light exoskeleton battle armor/power armor may be provided to high ranking officers and special operatives. Availability, replacement suits and repairs are reasonably good. Company Cost: 30 Points.

6. Unlimited Clothing. High quality uniforms with flashy insignias/emblems and mega-damage armor of all kinds are available (rare and exotic items are the only exceptions). Standard armor is equivalent to Dead Boy heavy armor (80 M.D.C.). Common types of light power armor and/or magic armor and clothing are available to high ranking officers and elite troops. Specialty outfits and forgeries (used for infiltration) can be requested and provided within 1D4 + 1 days. Excellent availability, replacements suits and repairs for common items, good availability for the expensive and uncommon items. Company Cost: 50 Points.

C. Equipment

This describes the general equipment and supplies provided free of charge by the owners/commanders of the mercenary company. Replacement of any lost or damaged equipment is usually automatic. **Special Note:** Unlike other categories, it is possible to pay points to purchase more than one of the following equipment features. For example, by spending 15 points, a company would provide both electronic (#3) and medical (#4) equipment as described below.

1. None. The characters are responsible for buying and replacing their own equipment. Company Cost: None.

2. Cheap Gear. Each character has a commonly available energy rifle, sidearm (energy or not), three clips for each weapon, a survival knife and up to 5,000 credits' worth of equipment available at the start of an operation. Damaged or lost items may not be easily replaced, especially expensive things like cybernetic implants or heavy weapons. Company Cost: 2 Points.

3. Electronic Supplies and Good Gear. One cybernetic implant (if desired) and good quality gear is provided. Available equipment includes sensors, communications, computers, translators, recorders, video, camera, surveillance, basic cybernetic implants and miscellaneous equipment; up to 25,000 credits' worth of items per mercenary soldier. This will always include communications gear, a vital element of military operations. Company Cost: 5 Points.

4. Medical Equipment. First-aid and paramedic type equipment and pharmaceuticals are available. Includes antibiotics, painkillers, anesthetic, protein healing salve, sodium pentothal (truth serum), dosimeter, E.K.G. and E.E.G. machines, portable lab, bio-scan, oxygen, all commonly available robot medical kits (RKM, IRMSS, Compu-drug dispenser, etc.) and two basic life support units. Plus a budget of 750,000 for emergencies requiring hospitalization and cybernetic organs or prosthetics. Company Cost: 10 Points.

5. Medical Clinic. The company is equipped with full medical facilities equal to a small medical clinic. A full-time doctor (M.D. or Holistic) and one psychic healer are on staff and assisted by four nurses and two paramedics. In addition, the company has an emergency medical budget of 1D4 + 2 million credits for cybernetics and hospitalization. There is also a small veterinary facility for any combat, riding or work animals. Replacement of lost or damaged equipment is automatic, but the total amount of medical equipment can never exceed 10 million credits. Company Cost: 20 Points.

6. Magic Technologies: This company's emphasis is on magic, particularly magic weapons, armor, vehicles, healing, augmentation/enhancements (bio-wizardry and magic herbs/potions). 30% of these warriors will have 1D4 + 1 minor techno-wizard/magic weapons/wands/potions/items or bio-wizardry weapons/parasites/microbes or one major item. All high ranking officers and elite troops will have a rune weapon or bio-wizard device or other very powerful magic items. 5% will be techno-wizards, 5% will be ley line walkers, and 5% will be others (temporal wizards, stone wizards, shamans, dragons, D-bees, etc.). Company Cost: 40 Points

7. High-Tech Augmentation (Bionics, Juicers, Crazyies): This company's emphasis is on high-tech augmentation. 30% will be either full conversion borgs or juicers, 20% will be headhunters or partial reconstruction borgs and 10% will be crazyies, juicers or other high-tech creations (including mutants, D-bees/aliens or foreign technology). Company Cost: 40 Points

8. Unlimited Equipment. The company is a high-tech operation equipped with high quality electronics, computers, communication systems, sensors, optics, cybernetics, bionics and all equipment needed for the operation and logistics of the company. High ranking officers and special elite troops can have a personal vehicle of choice and 1D4 + 2 cybernetic implants (conventional and black market); 10% are partial reconstruction borgs, juicers, crazyies or robots.

In addition, there is a superb mobile mini-hospital that can accommodate as many as 40 patients, has six life support systems, three surgery rooms and one cybernetic surgery unit (cybernetics can be repaired and replaced safely). Two medical doctors, one psychic healer, two cyber-docs, eight paramedics and twelve nurses comprise the medical staff. Plus one million credits' worth of common cybernetic items in stock and an emergency medical fund of 20 million credits. Company Cost: 50 points.

D. Vehicles

Transportation provided by the company to the characters. Also includes information on the company's fleet of vehicles.

1. None. Can you run? Fly? Swim? We hope so, because you're not going to get any kind of ride from the company. Company Cost: None.

2. Basic Transportation. The company has just enough vehicles to accommodate its needs. A third are horse-drawn wagons, a third are trucks and motor-home trailers, and the remaining third are old hover trucks and used military jeeps and other heavy-duty vehicles. Transports are usually unarmed and unarmored (i.e., they are low M.D.C. or S.D.C. structures) and are not expected to see combat — not if they plan to survive! The company will cover ground slowly, due to the poor quality of their transports. Company Cost: 3 Points.

3. Fleet Vehicles. The company maintains a fleet of trucks, trailers, motor-homes, and light Armored-Personnel Carriers (APCs; 4D4 × 10 M.D.C. main body). They are fairly new and well-maintained. Half the hover and all terrain vehicles have one light laser or machinegun weapon (1D6 or 2D4 M.D. per blast; 2000 feet/610 range). The other half are not outfitted for combat and serve only as a means of transportation. In addition, individual characters of officer rank will be assigned their own personal hover car, hover cycle, jeep or land rover (all with one or two weapon mounts). An expense account of 500,000 credits

is set up for special travel needs (such as hiring additional transportation, fuel and repairs). Company Cost: 10 Points.

4. Combat Cars. As above, but ALL vehicles are outfitted for combat! 70% have mega-damage armor and light to medium weaponry (machinegun, beam weapons, mini-missiles). 10% are heavy combat vehicles such as tanks and heavily armored vehicles, and 10% are aerial combat vehicles such as the Sky King, helicopters and jet packs. If the merc outfit uses magic, up to 20% can be techno-wizard or other type of combat vehicle. Company Cost: 20 points.

5. Specialty Vehicles. This fleet contains a number of specially designed vehicles, and most vehicles are military or paramilitary. This includes 2D4 heavy robots or tanks, 3D6 medium or light robots or tanks, and two dozen suits of powered armor with flight capabilities. 20% of all other more conventional vehicles are outfitted with additional armor (+ 30% of the normal armor), special sensory (radar), electrical (computer), surveillance (camera and bugs), and security systems (locks and alarms) worth about 100,000 credits each. 70% are outfitted with short-range radios (6 mile range/9.6 km). Also, a variety of conventional vehicles and luxury vehicles (for officers) are available. Air support exists in the form of 4D4 air vehicles (typically Sky King or similar; half that number if combat jets are available). All vehicles are of top quality, heavy-duty construction and constantly maintained (ten million credits budget). A team of mechanics is employed full-time and includes: one techno-wizard (if the company has no bias against magic), 2D4 operators (with robotics and weapon system skills), 12 mechanics, and 12 assistant mechanics. Company Cost: 30 Points.

6. Unlimited Vehicles. Any existing vehicle is available, including tanks, robots, aircraft, jet packs, and techno-wizard vehicles. This includes 3D4 + 4 heavy robots or tanks, 3D6 + 6 medium or light robots or tanks, and four dozen suits of powered armor with flight capabilities. 50% of all conventional vehicles are outfitted with additional armor (+ 50% more than normal armor; robots not included), special sensory, electrical, surveillance, security and weapons systems, or may be modified to techno-wizard systems. Up to 500,000 credits may be spent on an important vehicle. Common, insignificant vehicles such as motorcycles, jeeps, land rovers, and small A.T.V. trucks and cars are automatically replaced. All vehicles are outfitted with short-range radios (6 mile range/9.6 km) and about 25% with long-range radios. The full-time staff of mechanics is double that of number five. Company Cost: 50 Points.

E. Weapons, Power Armor & Bots

The actual weaponry issued to both line soldiers and specialty troopers. They include powered armor suits, robots and combat vehicles (cumulative with the Vehicles entry, above).

1. None. Members of the company are expected to provide their own weapons and equipment, and fend for themselves when it comes to repairs. Company Cost: None.

2. Basic Equipment. Members provide most of their weapons, but simple repairs, spare parts and reloads/bullets/rail gun ammo and recharging of E-Clips are provided by the company. A simple and inexpensive assault weapon is provided as standard issue (something equivalent to an NG-L5 laser rifle). Company Cost: 5 Points.

3. Basic Weaponry. All members are issued one common type of energy rifle and an energy pistol or vibro-blade (only 10% are heavy weapons like particle beams and plasma ejectors). 10% of the group will be issued some type of common/inexpensive powered armor. One combat robot will be available for every 20 line soldiers. Company Cost: 10 Points.

4. Advanced Weaponry. As above, but all members are also issued grenades, and 1-in-5 have a heavy weapon (particle beam rifle, plasma weapon, rail gun, missile or grenade launcher, etc.). 20% of the group will be issued power armor suits (30% if light and/or very cheap suits



are used), plus one combat robot or tank for every 10 line soldiers. Weapons are all of good quality (unless quantity is stressed over quality) and damaged or lost items are immediately repaired or replaced (20 million credit budget). Company Cost: 20 Points.

5. Extensive Weaponry: High-quality energy weapons are issued to all personnel, including 1D4 grenades, energy rifle, and energy sidearm (pistol or other). 40% have heavy weapons including missile launchers, rail guns, particle beam and plasma weapons, etc. 30% of the group will be issued powered armor suits (50% if very cheap suits are used). At least a company of 3D6 + 6 assault robot vehicles or tanks will be on service with full crews, or one fighting vehicle for every 5 line soldiers, whichever is greater. Techno-wizard and alien/D-bee equipment may also be available. All weapons are of the highest quality and damaged or lost items are immediately replaced or repaired. E-clips are recharged as quickly as possible and ammunition is readily available (35 million credit budget). Company Cost: 40 Points

6. Maximum Firepower: The unit is as well-armed, soldier by soldier, as any outfit on the planet. Weapons of all kinds, including explosives, heavy and special weapons are available. There is even limited availability of magic and techno-wizard items (roughly enough for 10 to 20% of the troops). 60% of the soldiers are issued a suit of good quality power armor and heavy weapons, plus there is a robot vehicle or two tanks for every 5 line soldiers. Ammunition is plentiful. Weapons and equipment are of the best quality and damaged or lost items are immediately repaired or replaced (50 million credit budget). Company Cost: 60 Points

F. Communications

This is a measure of how good the communications network and devices are in the agency.

1. None. Characters must buy their own and/or relate messages by word of mouth. Company Cost: None.

2. Basic Service. The company has one long-range, wide band radio (500 mile/804 km range), one portable language translator and a walkie-

talkie (3 mile/4.8 km range) in each vehicle. No scramblers or bug detectors available. Company Cost: 2 Points.

3. Secured Service. Two long-range radios, all personnel have a walkie-talkie or other short-range type radio, all with scramblers, six language translators, two mini-radar systems, one PC-3000 pocket computer, and a portable video camera and player. Company Cost: 10 Points.

4. Full Range System. Every tent and major vehicle is equipped with a short-range (6 mile/9.6 km) radio and language translator, plus there are four long-range radios on line, and all personnel have a short-range walkie-talkie available to them. All radios have scrambler capabilities and one of the long-range radios has a laser booster system that doubles its range (1000 miles/1600 km). All senior officials have a full size computer as well as the PC-3000 and a language translator, other officials have only the PC-3000. Soldiers have reasonable access to a variety of commercial audio and video disk recorders and players.

A public announcement system is wired throughout the camp, and a full sound and video recording studio trailer monitors and controls the music and announcements piped through the PA system. Two full-time communications specialists, two electrical engineers and five assistants are on staff. All equipment is good quality and well maintained. Company Cost: 15 Points.

5. Deluxe Communications Network. Identical to number four, except that all the equipment is of the highest quality, the communication staff is twice as big, and equipment is more plentiful and readily available. Company Cost: 25 Points.

6. Superior Communications. Not only does the company have everything provided in number five, but it has a communications command center (triple the number of communication staff) able to coordinate the actions of the whole company at once. All officers have full size and pocket size computers and language translators. Company Cost: 40 Points.

G. Internal Security

This is the level of internal infiltration that the company is vulnerable to. Note that this is the only thing that prevents spies and intruders from already having been placed in the organization. Enemy agents, moles, “turned” employees and supernatural interlopers can only be prevented with high levels of internal security. **Note:** This is the security provided to the company while it is out “in the field” while on a campaign.

1. None. No security, anyone can walk in or out and company members are not screened or given background checks. No supernatural safeguards other than the characters’ own awareness or powers. Company Cost: None.

2. Lax. A pair of security guards at all main entrances check visitors in and out. A patrol goes around the camp’s perimeter. Only the officers’ quarters and important vehicles and facilities have locks or alarms. 25% chance of a company member being an infiltrator working for himself or for another organization. No mystic safeguards other than the player characters’ own awareness and powers. Company Cost: 2 Points.

3. Tight. Alert security guards, electronic alarms, and roving patrols secure the company site from intruders. A watch is organized and operates 24 hours a day. In potential combat situations, the whole camp is in a state of readiness (soldiers sleep with their weapons at hand, at least 25% of all company members are “on duty” at all times, etc.). A rigid check of possible employees reduces the chance of enemy infiltrators to 15%.

Supernatural safeguards include security teams familiar with common supernatural and magic occurrences and how to handle them (items such as silver crosses, garlic and holy water are available). The security detail will have at least some psi-stalkers/Dog Boys, or other magic and psychically sensitive soldiers, including at least one magician. Company Cost: 10 Points.

4. Iron-Clad. Every entrance and exit is under constant video monitoring and guarded by a security team. Besides the precautions outlined in #3, picket lines and outside guard-posts provide a security blanket as far out as several miles around the camp site, including air reconnaissance.

Other security measures include high-quality locks and alarms in all vehicles and facilities, hidden compartments/safes, floodlights, emergency generators, motion detectors, heat sensors, mini-radar, and camera surveillance of areas of importance. Magic wards of alarm or incapacitating magic are strategically placed with an eye toward stopping supernatural infiltration. Magic/supernatural security is otherwise as above. Company Cost: 20 Points.

5. Paranoid. Top security and then some; all the measures taken in number four plus. Suspicious characters may be strip-searched or denied entrance, and no one can so much as enter a bathroom without surveillance. Multiple layers of defense are set up to detect enemy forces at least 10 miles (16 km) away from the main camp site. Several psychics and sensitives are employed as part of the security force. The average level of the security force is 1D4+3. At least 25% of the company forces will be under arms all the time, including robot and combat vehicles.

Supernatural safeguards include a dozen protection circles, amulets and scrolls (including negate magic, dispel magic barrier, turn dead, exorcism, constrain being, remove curse, globe of silence, globe of daylight, locate, negate poison, purification, and apparition; 1D4 of each). The commanding officers’ rooms are protected by a sanctum spell and several mystic alarms. Superior protection circles, wards and similar safeguards are scattered throughout the compound. Company Cost: 40 Points.

6. Impregnable. A vast amount of time and resources have gone into this security system; similar to number five, only with the absolute best locks, alarms, equipment, supernatural safeguards and experienced

personnel (add one experience level to each NPC member of the security force and double the number of psychics and mages). The security force has developed a system of secret verbal signals and hand signs and countersigns to warn each other of danger and trouble. A reaction force is always on alert to counter any intrusion. Surveillance cameras, motion detectors, heat sensors and other measures protect the facilities and quarters. The perimeter fence includes a microwave fence and full radar and ground sensor system. There is only a 2% chance of an infiltrator being found anywhere in the company. Company Cost: 60 Points.

H. Permanent Bases

The mercenary company that has a permanent secure base for the company will select numbers 2-6. Many companies have no permanent base and are nomadic or semi-nomadic groups, travelling around the continent looking for work.

1. None. The group has no permanent home or fortification to retreat/go home to or hide out at. They travel around and stay in temporary camps (NOTE: the security in these temporary camps can be as high as the company wishes it to be; see “G” above). Company Cost: None.

2. Partial Headquarters. The company has a semi-permanent base of operation located on land that they own/claim or have purchased or leased from a nearby community. This facility can be as little as some office space and a few apartments, or several acres of land where vehicles are kept and tents are pitched. The only permanent structures are likely to be a few storage shacks and a run-down looking barracks building. Personnel can stay at this simple facility to recover from wounds, illness, to await their next assignment, or just to relax and rest. Likewise, the characters can engage in training, teaching, recruiting, etc. The entire compound can only hold a maximum of 20% of the total troops at any one time; most of the company is on the road and away from the partial HQ. Company Cost: 2 Points.

3. Headquarters. The Company owns a large tract of land, usually close to a friendly town or city, where the whole organization can establish camp. There are a few permanent facilities built in the area, such as a saloon, a few sturdy barracks, some storage buildings and a field hospital (none are likely to be mega-damage structures; if they are, they’ll have light M.D.C.). The land is primarily a safe place to park one’s vehicle and pitch a tent when the company is not involved in a campaign. The government of the nearest civilized area (farm, village, town, city, etc.) is usually friendly and sells supplies and equipment to the troops. Company Cost: 10 Points.

4. Fortified Headquarters. A permanent headquarters with several permanent buildings, including barracks (enough for half the troops), shooting range, garage (for vehicle and bot repair), meeting hall also with smaller conference room(s), several storage buildings, commissary and arsenal (at least half are light to medium M.D.C. structures). The place is surrounded by a wall or fence, and has a security equivalent to Internal Security #4, above (this applies only to the headquarters, and not to the company when it is on the road). The location can house 80% to 100% of its troops and has enough supplies to last a twelve-month siege. Company Cost: 20 Points.

5. Company Town. The company owns a whole town! This is usually true only of the larger mercenary companies. The town’s facilities are mostly dedicated to serving and entertaining the mercenary company (70% of all town trade is related directly to meeting the company’s needs; the remaining revenues may be made up in smuggling, slave trade, weapons manufacturing, tourism and other businesses). The town is heavily fortified. In many cases, all or part of the town is fortified and may be enclosed by protective walls and have several clock, bell or obvious watchtowers (as well as radar dishes and communication towers on the roofs of buildings). A permanent home guard equal in size to 40% of the total company force; this guard is not expected to join the mercs on most campaigns and may be made up of former mercenaries who want a (relatively) peaceful billet.

Security for the whole town is roughly equivalent to Internal Security #3, with level #4 at most mercenary-operated areas and #5 at vital military points. About two years' worth of food, weapons and supplies for the entire population are stockpiled in several secure spots/caches around the town. Company Cost: 40 Points.

6. Company City. Same as #5 except that the company is large enough to support a whole city (often, several associated mercenary companies combine their resources to fund such a city). Mercenary related businesses are an important part of the city's economy; roughly 50% of all trade is directly related to the mercenary trade. Security is also typically equal to #5. The city could survive several years of siege, and is designed to be defensible against a much larger force. Company Cost: 60 Points.

I. Intelligence Resources

These are the types of intelligence-gathering methods and systems available to the mercenary company. This includes scouts, spy networks, and informants. Intelligence is very important for all military operations. **Special Note:** It is possible to pay points to purchase more than one of the following intelligence resources.

1. None. The company has no designated scouts or spies, and relies on the talents of individual members. Company Cost: None.

2. Scout Detachment. The company has formed a scout group to gather information about enemy positions. They are typically wilderness scouts, rangers/huntsmen, knights, psi-stalkers, dog boys or headhunters with wilderness and tracking skills (espionage skills can be very helpful, but are not a requirement). Company Cost: 5 Points.

3. Special Military Operatives. The company has a team of trained spies. Applicable O.C.C.s include the CS and Triax military specialist, elite robot or power armor pilots, borgs, juicers, crazies, bounty hunters, spies and all of the new O.C.C.s presented in this book. These special operatives are not only used to gather information, but to infiltrate, spy on, sabotage, confuse and engage the enemy in covert operations. Company Cost: 10 Points.

4. Psionic and Magic Operatives. Magicians and psychics are used as scouts, spies and saboteurs. Likely candidates for this position can include the line walker, mystic, temporal raider or wizard, and other practitioners of magic, druids, dragons, faerie folk, creatures of magic, mind melters, mind bleeders, and major and master psychics. Company Cost: 20 Points.

5. D-Bee Specialists. Similar to #4, except these characters are from another dimension. They must have a background in tracking, wilderness scouting and/or espionage or have unique, superhuman or supernatural powers and may have alien weapons and technology. Such beings may include psi-stalkers, mutant animals, simvan monster-riders, tattooed men, mechanoids, vampires, shape-changers, teleporters, and other beings with strange abilities as described in **Rifts Conversion Books, World Books** and **Sourcebooks** (see **Atlantis** and **England** in particular). Company Cost: 20 Point.

6. Infiltration Network. In addition to having 2D4 squads of scouts, 1D4 squads of special military operatives and 1D4 magic and/or psionic operatives, the company has an entire network of secret agents, infiltrators, and moles! There is a 12% chance that the mercs have 1D4 agents in two or more of the Coalition States (excluding Lone Star), Tolkeen, Lazlo and 1D4 other major forces/communities on the continent. There is also a 17% chance of having spies among 1D4 + 1 rival mercenary/bandit outfits or enemy organizations. There will be 1D4 "safe houses" or hideouts in each of the infiltrated communities. Furthermore, the mercs know about (20% chance of having dealings with) smugglers, weapon dealers, body-chop-shops, the Black Market and underground organizations operating within each of the infiltrated communities. **Note:** At the G.M.'s option, there is a 5% chance that a specific low ranking employee of a rival or criminal organization is working with/for the player characters. Company Cost: 50 Points.

J. Special Budget

This category reveals the money available for any kind of special projects, not for regular operating costs. For example, if a covert team needed cash to buy weapons in an area beyond the company's normal supply line or needed special weapons or transportation, bribes, etc., this section determines just how much cash the company can afford to spend.

1. None. No money available for any special projects. Characters are on their own. Company Cost: None.

2. Nickels and Dimes. Up to 10,000 or even 20,000 credits are available for any one operation. But it better be a success! Company Cost: 5 Points.

3. Small Potatoes. The company can dig up as much as 100,000 credits. Company Cost: 15 Points.

4. Large Loans. The company has up to one million credits to kick into any important missions. Company Cost: 25 Points.

5. Big Bucks. Up to 100 million credits can be made available. Company Cost: 45 Points.

6. Mega Bucks. The company has up to 1.5 billion credits available! Company Cost: 60 Points.

K. General alignment of personnel

The majority (80%) of the company's personnel falls into this category. Player characters and specific NPCs may be the exception.

1. Evil. Miscreant and Diabolic. Company Cost: None.

2. Evil. Miscreant and Aberrant. Company Cost: None.

3. Anarchist. Company Cost: 2 Points.

4. Anarchist and Unprincipled. Company Cost: 4 Points.

5. Unprincipled and Scrupulous. Company Cost: 7 Points.

6. Scrupulous and Principled. Company Cost: 10 Points.

L. Criminal Activity

Mercenaries often have a reputation for engaging in banditry and other criminal acts as well as (or even instead of) military activities. Many companies will engage in the looting of enemy camps, strongholds and allied civilian communities/sympathizers.

The following are some of the special personnel skilled in the criminal arts and who supplement the company's income with illegal services like assassination, blackmail, and coercion. **Note:** Several of the criminal activities can be purchased and the same activity can be purchased as often as four (4) times.

1. Con Man (1). An expert fast-talker who fools people into financing wild schemes, granting bad loans, or otherwise parting with their hard-earned money. May also be used to sell substandard weaponry or equipment (useful for moving bad stock the company has somehow acquired). Company Cost: 5 Points.

2. Prostitutes (3). Ladies of the night who sell sexual favors. They usually serve the company members (which reduces the dangers for soldiers in enemy territory), but may also sell their services to outsiders if the company commander allows it. Prostitutes are also used in blackmail schemes, information gathering and spying. All three have a P.B. attribute of 10 + 2D8, but M.A. is only 6 + 1D6. Company Cost: 5 Points.

3. Cyber-Doc (1). A cyber-doc and one assistant/nurse illegally practice the science of cybernetic and bionic augmentation. Company Cost: 10 Points.

4. Gang of Robbers. Travelling some distance away from the company, a gang of 2D4 + 2 thieves and thugs rob isolated houses and communities, or mug people in the alleys and dark shadows. There is a 50% chance that this activity is not officially sanctioned, but is a racket organized by low-level officers, unknown to their superiors. The

thieves try not to seriously injure or kill anybody, but beatings are commonplace. The gang members try not to use the same equipment or uniforms as the company and often wear civilian clothes or other disguises, and carry captured or stolen weapons. Company Cost: 10 Points.

5. Smugglers and Sellers of Contraband. A travelling mercenary company is an ideal front for smuggling. How many customs inspectors will dare to mess with a small army? Travelling with the company are 1D6+2 specialists in smuggling with 1D4+3 levels of experience. They buy, sell, and transport scarce, illegal, or dangerous goods; most notably poisons, drugs, pre-rifts artifacts, magic, weapons, cybernetics, bionics and fugitives. They will also protect, hide and deliver secret packages, contraband and information for outside clients (including other crooks, the Black Market, or a government like the Coalition). Most smugglers will have good contacts with the Black Market and can be useful when the company needs to find some illegal or scare commodity. See the new Smuggler O.C.C. elsewhere in this book. Company Cost: 15 Points.

6. Expert Assassin (1). An evil, 1D4+4 level, warrior who specializes in murder; can be any Men of Arms O.C.C., including borgs, crazies, juicers, psi-stalkers, wilderness scouts, and particularly the new master assassin and bounty hunter O.C.C.s. Company Cost: 15 Points.

7. Psychic Enforcer (1). A psychically powered individual whose job is to enforce the wishes of the commander and the needs of the company. Assignments include torture, interrogation, frightening and hurting people, ferreting out spies, detecting supernatural menaces, working as an elite bodyguard, protection and murder. Typically a 1D4+2 level mind melter, mind bleeder (see **Rifts Africa**) or burster. Company Cost: 15 Points.

8. Special Forces. In this instance, a pair of super warriors used for special missions such as assault/raids, sabotage, and murder. This group

is treated as a special unattached unit under the direct control of the company command. Typically a pair of 1D4+3 level crazies, juicers, borgs, or a dragon (or other supernatural powerhouse) and a psychic or mage. Company Cost: 20 Points.

9. Safecracker/Locksmith (1). A demolitions expert and mechanical engineer who uses his talents to "crack" safes, open security doors, break out of jail, avoid/bypass or disarm security systems and similar feats. See the new safecracker O.C.C. Company Cost: 25 Points

10. Forger (1). A brigand with a knack for art and forgery. He will use his skills to create false passports, citizen's papers, identity cards, credit cards, invoices, and other documents. This rogue is also familiar with photography and video/film equipment and recording. See the new forger O.C.C. elsewhere. Company Cost: 30 Points.

M. Reputation/Credentials

Just what is the reputation of the company? The credentials determine how much respect or fear the characters can command, how much the company can charge for their jobs, etc.

1. Hunted. The company is rumored to be trouble and/or composed of criminals, cutthroats or fugitives (for any reason, real or trumped up). All members of this mercenary band are viewed with great suspicion by everybody who encounters them. The authorities of several towns and cities are hunting them because they supposedly reneged on a contract, owe money for damages they caused or because they are known scoundrels wanted by the law, the Coalition States or some other kingdom! There is a 1-40% that a hunting party (CS, military, merc, or adventurer), bounty hunter(s), or a messenger spreading word that they are wanted criminals, will show up whenever the company/characters stays in a town for more than a week.

Most potential employers will see the company as a liability and may not hire them or pay 1D6 × 10% less than normal. Only unscrupulous



or desperate employers will pay more for the company's services. Many employers won't hesitate to betray the mercs if it benefits them in any way. Most people will shrug off such betrayal with words like "They had it coming," all because of their unsavory reputation. Company Cost: None.

2. Scoundrels. The company is viewed with suspicion. They have a reputation for being overly violent and untrustworthy. They may also have a history of being as damaging to their employers as the enemy they were hired to fight. Nobody is actively pursuing the company, but there is a good chance that employers will short-change or betray the mercs if they think they can get away with it. Company Cost: 1 Point.

3. Unknown. No one has ever heard of the company (usually because it has just been formed). Would-be employers try to be fair and give the company the benefit of the doubt and reasonable pay. However, employers are likely to believe the worst about the company if the information comes from a reputable source. Contracts will be easy to come by, but the pay will not be as high as for better-known armies. Company Cost: 5 Points.

4. Known. The company has developed a reputation as a reasonably effective unit that gets the job done and keeps its side of the bargain, unless justified to do otherwise. Many employers will be reluctant to betray this company, because doing so will damage their own reputations, may evoke the mercenaries' wrath, and other mercenary companies may decide not to work for them. The company will be paid above-average rates for their services (about 20% more than unknown or trouble mercs). Company Cost: 10 Points.

5. Excellent Reputation. The company has a reputation for being reliable, efficient, and lethal. This reputation is likely to mean that the company has rarely lost an engagement, are excellent fighters, rarely fail at their assigned tasks, and may be known for some heroic, impressive or daring feat(s).

The company has a reputation for always fulfilling their contracts and can be trusted by their employers. By the same token, any employer that betrays the company knows that he will be branded as a treacherous fiend, causing most other reputable mercenaries to avoid him like the plague. Furthermore, this mercenary group may decide to teach him a lesson and/or extract justice (and payment) by any means they deem necessary. The company with an excellent reputation commands much more for their services and gets it (50% to 60% more than the average soldier of fortune, but they are worth it!). Company Cost: 25 Points.



6. Famous! The company is known as "one of the best" in the business and have a reputation for being extremely successful, organized, resourceful, dangerous, heroic and/or deadly. They are also recognized as highly trustworthy and reliable. Lesser mercenaries, freelance troubleshooters and adventurers may hesitate to take up a contract that puts them at odds against this outfit. In fact, 25% will refuse such a contract or flee from combat when they are actually pitted against them (50% chance of fleeing if the "famous" warriors start off strong and/or are beating the tar out of the opposing forces). The rates for a famous mercenary company are among the highest on the market and the leaders rarely engage in haggling or price reduction. If these mercs are as good as their reputation, the employer is acquiring the best there is and winning is almost assured. Double the typical level of pay. Note:

If the famous company suffers two or more terrible defeats in combat their reputation will drop to "excellent" or "known." If they lose and show acts of betrayal, cowardice, incompetence or repeatedly appear to be weak or buffoons, their reputation will change to "scoundrels" or the "hunted!" It will take a great deal to recapture their reputation once it is lost. Company Cost: 50 Points.

N. Salary

The amount of money received weekly by the mercenaries will vary depending on the size, reputation and quality of the company. Note that operating as a freelance army or strike force means that even the best mercenary forces may have to endure periods of little or no pay; especially between jobs. The "average week's pay" listed below reflects the average pay of a typical mercenary troop when work is plentiful and payment is on time.

1. None. The company members share the pay/profits and the expenses equally. Each merc gets a fair share of the profits from whatever is left after meeting expenses. Depending on the outfit, leader and circumstances, pay and booty may be shared equally by all members, with officers and specialists taking only a slightly higher cut (10% to 20%), or it may be based on performance, seniority or whatever the leader decrees. An Average Week's Pay: 3D6 × 10 credits for line soldiers and 1D4 × 100 for officers and special operatives, plus a portion of the profits whenever there are any. Weapons, equipment and other goods may be offered in place of cash payment. Company Cost: None.

2. Freelance. Same as none, described above, but a little more structure and some operating cash. The management of the company tries to supply food, ammunition, and basic supplies on a regular basis. They also provide limited access/use of the company's basic resources (whenever available), such as use of vehicles, special equipment, medicine, repairs, and similar. Company members have no binding contract and can be fired or can quit with a moment's notice. Average Week's Pay: 1D4 × 100 credits for line soldiers, 1D6 × 100 for officers and specialists. Company Cost: 2 Points.

3. Pittance Salary. The company employs the characters on a full-time basis with regular set wages rather than sharing in the profit. The company also consistently provides food, basic supplies, ammunition, recharging of weapons, and uniforms free of charge. It also offers reasonable access to other facilities and benefits at no charge, such as vehicle repair and maintenance, doctors and medical treatment, hide-outs, base camps, access to vehicles, the use of special equipment, explosives, and similar (such use must be authorized by the company commander). Soldiers usually sign for a one to four year stretch with an option to reenlist when the contract expires. Average Week's Pay: 300 credits for line soldiers, 500 to 600 for officers and 500 to 800 for special operatives. Bonuses may be given when the company hits a big payoff. Company Cost: 5 Points.

4. Good Salary. In addition to the basic items listed under "pittance salary," the quality of the food, supplies, services and facilities are better, plus the warriors receive a good salary. All personnel sign a two to four year contract. In case of death or dismemberment, the family or beneficiaries are paid a compensation equal to three months' (13 weeks) salary. Average Week's Pay: 400 credits for line soldiers, 500 to 550 for noncommissioned officers, 600 to 700 for medium-grade officers (Lieutenant, Captain), and 800 to 1500 credits for higher-grade officers and special operatives. Bonuses of 1D4 × 1000 credits are paid to officers every quarter during which the company is under contract. Combat troops can receive a hazardous duty bonus of 1D4 × 100 a month depending on the circumstances and bonuses or special equipment/weapons/armor may be given when the company has windfall profits. Company Cost: 10 Points.

5. Excellent Salary. In addition to all the standard supplies and needs of a mobile army and access to the company's good facilities, the mercenaries receive an excellent salary. Soldiers sign on for a three

to six year period. **Average Week's Pay:** 500 credits for line soldiers, 600 to 700 for noncommissioned officers, 700 to 900 for medium-grade officers, and 2000 to 5000 for high ranking officers and special operatives. Hazardous duty bonuses of $1D6 \times 100$ is paid to the troops every month (double for officers and specialists), plus all soldiers receive a $1D4 \times 1000$ credits bonus on successful completion of a contract ($2D6 \times 1000$ for officers and specialists). A pension for soldiers killed or incapacitated on duty may also be available to the soldier or his beneficiaries; this is equal to 30% of his standard pay for 3D4 years. Company Cost: 20 Points.

6. Outrageous Salary! All the usual accommodations, supplies, facilities and perks plus spectacular pay! **Average Week's Pay:** 700 credits for line soldiers, 900 to 1200 for noncommissioned officers, 1,200 to 2,000 for medium-grade officers, and 4,000 to 8000 for superior officers and special operatives. Hazardous duty bonuses of 1000 credits is paid to the troops every month (double for officers and specialists), plus all soldiers receive a $2D6 \times 1000$ credits bonus on successful completion of a contract ($1D4 \times 10,000$ for officers and special operatives). A pension for soldiers killed or incapacitated on duty is paid to the soldier or his beneficiaries; this is equal to 50% of his standard pay for 10 years, plus a one time, lump sum payment of $1D4 \times 10,000$ credits (double for officers). Company Cost: 40 Points.

Other Information of Note

Each mercenary company should have a name; traditionally, the name includes the team leader's last name. Most will also have a logo/insignia, and banners. It's a good idea to come up with an owner/

commander, the commanding officers, and a few other key characters. Remember that interesting mercenaries, officers, medics, special operatives (like smugglers and spies) and other personnel can make the company and adventuring much more interesting. Mercenary companies, like all groups of people, will have a network of personal relationships, from respect and love to envy and hatred. The more colorful the detail, the greater the atmosphere.

A **modern military Army "squad"** is 10 soldiers. A squad can be sent on reconnaissance, seek and destroy missions, sabotage, escort, guard duty or "Special Operations." A mercenary squad (6 to 10 Soldiers of Fortune) can operate as a reconnaissance, etc. squad for a larger outfit, or as an independent, small mercenary force. On Rifts Earth, even a handful of warriors can wield a great diversity and amount (sometimes staggering) of power.

A **modern military Army "platoon"** has 40 troops typically divided into four squads of 10 soldiers each.

A **modern military Army "company"** has 160 troops divided into four platoons (40 soldiers) with four squads per platoon.

A **modern military Army "battalion"** has 640 troops, one H.Q and four or more companies.

A **modern military Army "brigade"** has 1920 troops, one H.Q and three or more battalions.

A **modern military Army "division"** has 5760 troops, one H.Q and three or more brigades.

A **modern military Army "corp"** has 11,320 troops, one H.Q and two or more divisions.

New Mercenary O.C.C.s

Described in the pages that follow are several new Occupational Character Classes that might be found in a mercenary company or campaign (or any other type of campaign, for that matter).

Mercs/Special Operatives

Bounty Hunter
Forger
Freelance Spy
Master Assassin
Safecracker
Smuggler
Special Forces Soldier
Super-Spy
Thief, Professional

Bounty Hunter O.C.C.

By Kevin Siembieda

The bounty hunter is a combination city rat, spy and wilderness scout who specializes in tracking down wanted criminals, desperados, and fugitives — dead or alive. These manhunters are often cold, unmerciful men and women with some past military or combat experience. They can be members of a mercenary company, adventurer group, team of bounty hunters, bandits, or can act as a lone-wolf operative.

Attribute Requirements: I.Q. 7, P.S. 12, P.E. 12 or higher; a high physical prowess and speed are helpful but not required.

Alignment: Any, but some are as evil as the villains they hunt. Good characters will be far more discriminating about who they hunt.

O.C.C. Bonus: +2 on initiative, and +2 to pull punch.

O.C.C. Skills:

Basic Math (+10%)
Radio: Basic (+10%)
Surveillance Systems (+5%)
Intelligence (+15%)
Tracking (+15%)
Land Navigation (+10%)
Wilderness Survival (+15%)
Detect Ambush (+10%)

Climbing
Running
W.P. Energy Pistol
W.P. Energy Rifle
W.P. One of Choice
Hand to Hand: Expert

Hand to Hand: Expert can be changed to Hand to Hand: Martial Arts at the cost of one "other" skill (or assassin if an evil alignment).

O.C.C. Related Skills: Select two piloting skills and five other skills, but at least two must be selected from espionage. Plus select two additional skills at level three, two at level six, one at level nine, and one at level twelve.

Communications: Any (+5%)
Domestic: Any
Electrical: None
Espionage: Any (+5%)
Mechanical: Basic and Automotive only (+5%)
Medical: Paramedic only.
Military: Any (+5%)
Physical: Any
Pilot: Any (+10%)
Pilot Related: Any (+5%)
Rogue: Any (no bonuses except +8% on streetwise)



Science: Math and chemistry only (+10%)

Technical: Any

W.P.: Any.

Wilderness: Any

Secondary Skills: The character also gets to select four secondary skills from the previous list. These are additional areas of knowledge that do not get the advantage of the bonus listed in parentheses. All secondary skills start at the base skill level. Also, skills are limited (any, only, none) as previously indicated in the list.

Standard Equipment: A suit of personalized mega-damage body armor (any kind, including Coalition armor), a set of dress clothing, black and/or camouflage fatigues, a gas mask and air filter, tinted goggles, and an NG-S2 Basic Survival Pack. The character also owns a vehicle such as a hover cycle, motorcycle or land rover, an extra suit of light M.D. armor, one energy handgun and rifle, three additional weapons of choice, 1D6 grenades, robot medical kit, IRMSS, infrared distancing binoculars, language translator, passive night-sight scope for rifle, 2D4 sets of handcuffs or manacles, 50 feet of strong cord/rope, utility belt, backpack, knapsack, and 1D4 sacks.

Special Equipment: Pick one (must have appropriate skill)

1. **Armor and Cash:** Black Market Triax T-10 or T-11 Cyclops armor (100 M.D.C.) with jet pack and 1D6 × 1000 extra credits.

2. **Power Armor Suit:** Titan, T-C20 Terrain Hopper, Predator, Triax T-31 Super Trooper, Northern Gun or Kittani types.

3. **Magic Armor:** One techno-wizard or other magic armor and magic weapon (keep the items reasonable). Or one major bio-wizard parasite, 1D4 microbes and a minor magic weapon.

4. **Special Vehicle:** A souped-up motorcycle, hover cycle, hover vehicle, land rover, jeep or small truck with double the usual M.D.C., an energy weapon mounted on it, radar and long-range radio. Or a robot horse may be selected.

Money: The character starts off with 2D6 × 100 in credits, and has a black market item that will garner another 1D6 × 1000 credits.

Cybernetics: Can have up to 1D4 cybernetic implants of the player's choice.

Forger O.C.C.

By Kevin Siembieda

A brigand with a knack for art and forgery. This character uses his skills to create false passports, citizen's papers, identity cards, credit cards, invoices, and other documents. He or she is also able to recognize/identify other forgeries. The forger is also usually familiar with the use of computers, cameras and video/film equipment. The latter is vital for reference purposes. Like the safecracker, although this character may be a criminal and work with thieves, con-men, and smugglers, the character typically has few or basic thief/rogue skills.

Note: This tends to be a thinking man's character who plans ahead and whose real power lies in his non-combat abilities more than anything else.

Special Forgery Abilities

Characters of the forger O.C.C. have the basic espionage skill as found in the **Rifts RPG**. The following is a list of specific areas of forgery with bonuses and penalties applicable only to this Occupational Character Class. The base espionage skill is 20% + 5% per level of experience.

Bonuses:

- Forge signature: +10%
- Forge handwriting (much more demanding than a mere signature): +5%
- Forge common business documents, letterhead and stationary, business cards, invoices, receipts, shipping papers, and forms that do NOT have any special crests, embossing, holograms, or other imprints: +15%

- Forge simple government documents, including birth and death certificates, deeds, papers of ownership, passports, simple photo identification cards, advertisements, legal documents, police and military I.D., badges, etc.: +10%
- Forge elaborate government and security documents including any or all of the following: photographic identification, holograms, crests, stamps, embossed stamps, seals, etc.: +5%
- Forge commercial and government logos, insignias, emblems, patches, artwork, tickets, labels, packaging for products, and similar: +5%
- Make paper or material look old or used: +10
- Repair damaged/torn documents to look only slightly used: +5%
- Recognize forgeries: Automatic for flawed forgeries, +5% from forgers who are at levels 1-5, +2% from forgers levels 6-8, -5% from experienced masters levels 9-11, -10% levels 12-14, and -15% if the forger is level 15 or higher.

Note: A failed roll to create a perfect forgery means the item is flawed. There is only a 35% chance that a flawed forgery will fool an average person and no chance of fooling any character with the forgery skill or who is familiar with the genuine item, including signatures, handwriting, insignias and forms.

Game masters should require the forger to spend more time on complex forgeries and may make the character roll under his/her skill two, three or four times to make a perfectly crafted item. This is especially true of holograms, currency, artwork, and elaborate or secret govern-



ment documents. Even one failed roll ruins the fake with the same results as described in the previous paragraph.

A failed roll to recognize a fake means the character can't tell the difference between the fake and the genuine article.

Penalties — Some penalties may be accumulative:

- Rush job: -10%
- Inadequate references: -10%
- Wrong materials: i.e. the materials such as paper, fabric, color/dyes/

inks/paints, weight, thick or thinness, texture, may all be close but not exact or perfectly identical: – 10%

- Credit cards, bank cards, and types of currency/money (paper and coin): – 5%
- Jewelry, sculptures and works of art: – 15%
- Magic symbols/runes, wards, scrolls, circles, etc. – 15%
- Audio and/or film forgeries (alter, mix, or imitate audio and/or video/film recordings): – 10%
- Top secret and maximum security cards, including clearance/entry and identification cards, top security/secret government documents, computer documents, and similar: – 15%.

Note: The forger cannot make articles of clothing but can make emblems, patches, insignias and minor alterations. Similarly, he/she can supervise a skilled tailor or armorer to make a very close replica (at least in appearance); – 5% for clothing, – 10% for mega-damage armor (the replica may not even be made of an M.D.C. material).

Attribute Requirements: I.Q. 13, P.P. 14 or higher; a high M.A. can't hurt either.

Alignment: Typically anarchist or evil.

The alignment of a criminal character is restricted to anarchist or evil. These brigands use their skills to trick, rob, blackmail and use others for personal gain.

Characters of an unprincipled or *good* alignment will only use his/her skills against the enemy. The character will NEVER use his abilities to rob, hurt, trick or endanger good or innocent people. Nor will they be willing to do anything that will enable others around them to do so.

O.C.C. Skills:

Literacy: Two languages of choice (+ 20%)

Languages: Three of choice (+ 20%)

Basic Math: (+ 25%)

Art (+ 15%)

Forgery (+ 15%)

Disguise (+ 5%)

Radio: Basic (+ 10%)

T.V./Video (+ 15%)

Photography (+ 15%)

Computer Operations (+ 15%)

Computer Programming (+ 10%)

Computer Hacking (+ 5%)

W.P.: Two of choice

Hand to Hand: Basic

Hand to Hand: Basic can be changed to expert at the cost of two "other" skills or martial arts (or assassin if evil) for the cost of three skill selections.

O.C.C. Related Skills: Select five other skills. Plus select one additional skill at level three, two at level six, one at level nine, and two at level twelve. All new skills start at level one proficiency.

Communications: Any (+ 5%)

Domestic: Any (+ 5%)

Electrical: Basic only

Espionage: Intelligence only.

Mechanical: Basic and automotive only.

Medical: First aid only.

Military: None

Physical: Any, except boxing and acrobatics.

Pilot: Any (+ 5%)

Pilot Related: Any

Rogue: Any

Science: Any (+ 5%)

Technical: Any (+ 10%; +20% on literacy and language)

W.P.: Any

Wilderness: None

Secondary Skills: The character also gets to select five secondary skills from the previous list. These are additional areas of knowledge that do not get the advantage of the bonus listed in parentheses. All

secondary skills start at the base skill level. Also, skills are limited (any, only, none) as previously indicated in the list.

Standard Equipment: A suit of personalized (usually light or medium) mega-damage body armor, a set of military fatigues, and a set of dress clothing (forgers usually have money and dress very smartly). Also a pocket magnifying glass and/or jeweler's loupe, micro-film camera (fits in the palm of the hand and easy to conceal), 35 mm camera (with telephoto, macro and micro lenses), video/film recorder, PC-3000 hand-held computer, a full size portable computer, PDD pocket audio recorder, portable microscope, pocket laser d-tancer, pocket flashlight, pen flashlight, sketch pad, gas mask and air filter, tinted goggles, set of carving and cutting/X-Acto knives, 1D4 scalpels, one laser scalpel, heat gun, various glues and waxes, fine jeweler's tools, a handgun and energy rifle, knapsack, backpack, canteen and a carrying case or satchel with paints, pencils, pens, and other art supplies, and some personal items.

Forgeries: 1D4 different photo identity cards (all with aliases), fake birth certificate, and fake citizen I.D. to one Coalition State or other major Kingdom.

Money: 1D4 × 1000 in credits, black market items worth 1D4 × 1000 credits, and reasonably good forgeries of universal credit cards or currency with an apparent value of 4D4 × 1000 credits (the character will try to "pass" bad funds whenever he thinks he can get away with it, but there is always the risk of getting caught).

Cybernetics: None to start. The forger may opt to get some simple implants or optical enhancement but that's all. A bionic/mechanical hand or arm inflicts a – 25% forgery skill penalty. A bio-system prosthetic will have a – 10 penalty on the forgery skill.

Freelance Spy O.C.C.

By C.J. Carella

Spies are becoming commonplace on Rifts Earth. The half dozen large nations of North America, the dozens of medium-sized kingdoms, and powerful corporations all want to get information on each other, as well as on other groups, like large mercenary forces, dragons, gangs, and rebels that may threaten their operations. This is where professional spies come in; men and women who make their living infiltrating governments and corporations and stealing their secrets. Through theft, bribery, seduction, confidence games, keen observation and the use of surveillance equipment, they penetrate the target's security and get the information they seek. The ideal spy is a combination of actor, con-man, master thief and soldier. Freelance spies are no strangers to combat, but they prefer to use subtle methods to get what they want. If shots are fired, that probably means the mission has taken an unexpected turn or has failed.

Spies are a subset of the mercenary trade. Both jobs involve the sale of semi-legal (or downright illegal) services. Many mercenary companies have a small team of spies working full-time for them. Some spies hire small mercenary groups to serve as back-up in case something goes wrong. And many freelancers do both spying and mercenary work, depending on what jobs are available at the moment.

Attribute Requirements: I.Q. 9, P.E. 10

Alignment: Any

O.C.C. Bonus: +1 on initiative and +2 to roll with impact or fall.

O.C.C. Skills:

Radio: Basic (+ 10%)

Basic Math (+ 20%)

Literacy: One of choice (+ 10%)

Languages: Two of choice (+ 15%)

Intelligence (+ 10%)

Pick Locks (+ 15%)

Disguise (+ 10%)



Forgery (+10%)

Prowl (+10%)

Computer Operations (+10%)

Computer Hacking (+10%)

W.P. Energy Pistol

Hand to Hand: Expert

Hand to Hand: Expert can be changed to Hand to Hand: Martial Arts at the cost of one "other" skill (or assassin if an evil alignment).

O.C.C. Related Skills: Select 8 other skills, but at least two must be selected from espionage and two from rogue skills. Plus select two additional skills at level three, two at level six, one at level nine, and one at level twelve. All new skills start at level one proficiency.

Communications: Any (+10%)

Domestic: Any

Electrical: Any

Espionage: Any (+5%)

Mechanical: Any

Medical: Paramedic only.

Military: Any (+5%)

Physical: Any

Pilot: Any (+5%)

Pilot Related: Any

Rogue: Any (+10%)

Science: Math and chemistry only (+10%)

Technical: Any

W.P.: Any

Wilderness: Any (+5%)

Secondary Skills: The character also gets to select eight secondary skills from the previous list. These are additional areas of knowledge that do not get the advantage of the bonus listed in parentheses. All secondary skills start at the base skill level. Also, skills are limited (any, only, none) as previously indicated in the list.

Standard Equipment: Black fatigues or jump suit (for prowling at night) and a small wardrobe. Portable compact disc recorder/player and headphones, video disc player, portable language translator,

hand-held computer and micro-printer, 35 mm camera (still photos) and a dozen discs of film, disc camera (moving pictures) with a dozen discs of film, micro-film camera (fits in the palm of the hand), pen flashlight, large flashlight, backpack, knapsack, utility belt, ammo-belt, canteen, sunglasses and goggles, walkie-talkie radio, air filter, gas mask, and lock picking tools.

Weapons: Can include just about anything. Starts with a survival knife (1D6 S.D.C. damage), two energy weapons of choice and four E-clips for each, plus select two S.D.C. weapons. Body armor can be of any type, but tends to use lightweight armor (no or low prowl penalties).

Money: The freelance spy will have 2D6 × 1000 in credit and an additional 4D6 × 1000 in black market saleable artifacts.

Cybernetics: The character may have 1D4 + 1 cybernetic implants. It is entirely up to the player to decide whether his or her character has any implants, and if so, which ones. The initial implant selection is restricted to black market cybernetics (excluding cyber-armor) and sensory (any). The character is likely to add to his augmentation throughout his life.

Master Assassin O.C.C.

By C.J. Carella

Assassins for hire are also making a comeback on Earth. Many of them are ex-military or ex-security force members who have only one truly valuable skill: killing people. Unlike most mercenaries, they kill not in the battlefield but in the unlikely places, such as along city streets, at parties and private quarters. Most (90%) Master Assassins will be miscreant or aberrant, with the rest either anarchist or diabolic. Some anarchist and aberrant assassins will only kill targets that "deserve it" (at least in their opinion) and may never accept a job where innocent people will be harmed. Miscreant, diabolic and many anarchists don't care who the target is or who else might get hurt. The aberrant assassin is probably the most trustworthy of the lot, provided the employer does not cheat, betray or repulse him/her. Many mercenary companies have one or more master assassins used to eliminate targets of designated and paid "hits," enemy commanders, and other strategically important individuals. Often one well placed shot, eliminating a key individual, can cripple or divide an enemy force.

Attribute Requirements: I.Q. 11, M.E. 10, P.P. 10.

Alignment: Restricted to anarchist or evil characters only!

O.C.C. Bonus: +3 on initiative, +1 to save vs mind control.

O.C.C. Skills:

Radio: Basic (+10%)

Literacy: Choice of one (+10%)

Language: Choice of two (+20%)

Detect Ambush (+10%)

Intelligence (+10%)

Demolitions (+10%)

Demolitions Disposal (+10%)

Tracking (+15%)

Sniper

Prowl (+20%)

Concealment (+12%)

Computer Operations (+10%)

W.P. Energy Pistol

W.P. Energy Rifle

W.P. Three of Choice

Hand to Hand: Assassin (or Martial Arts)

O.C.C. Related Skills: Select seven other skills. Plus select two additional skills at level three, two at level six, one at level nine, and one at level twelve. All new skills start at level one proficiency.

Communications: Any (+5%)
 Domestic: Any
 Electrical: Any
 Espionage: Any (+10%)
 Mechanical: Any
 Medical: Paramedic only.
 Military: See O.C.C. skills
 Physical: Any
 Pilot: Any (+10%)
 Pilot Related: Any (+5%)
 Rogue: Any (+10%)

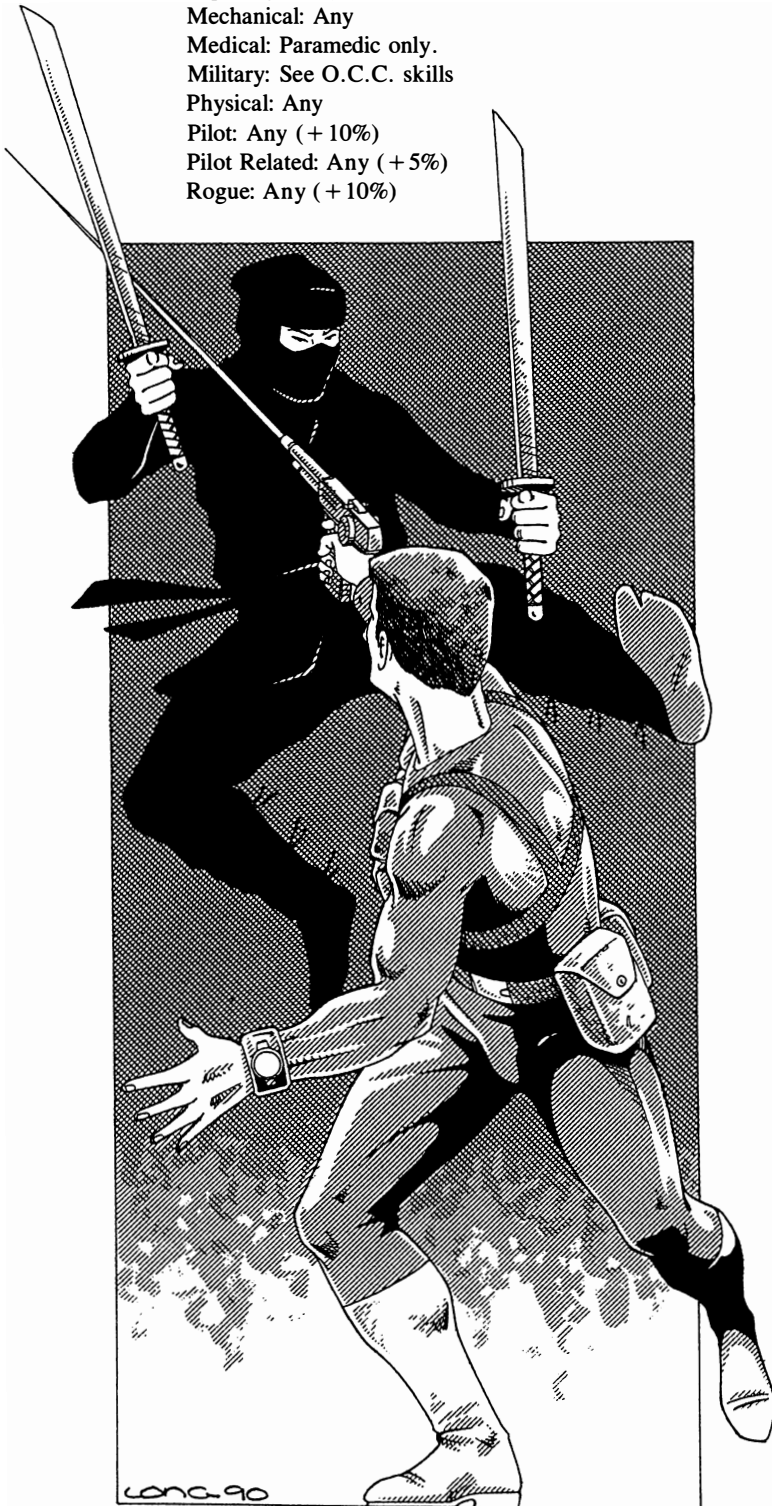

Science: Math and chemistry only
 Technical: Any (+5% for most, +10% on language & literacy)
 W.P.: Any
 Wilderness: Any (+10%)

Secondary Skills: The character also gets to select six secondary skills from the previous list. These are additional areas of knowledge that do not get the advantage of the bonus listed in parentheses. All secondary skills start at the base skill level. Also, skills are limited (any, only, none) as previously indicated in the list.

Standard Equipment: A suit of personalized mega-damage body armor (usually light), black jump suit, military fatigues, a set of camouflage clothing, dress clothing, and a small wardrobe. Also a gas mask and air filter, tinted goggles, knives (1D4), an energy sniper rifle, an energy handgun and rifle of choice (including CS, Triax or contraband items), six extra ammo-clips for each, a vibro-blade, survival knife and three additional weapons of choice, robot medical kit and IRMSS, knapsack, backpack, canteen, and some personal items.

Money: 3D6 × 1000 in credit, and black market items worth 1D6 × 1000 credits; assassins tend to live for the moment and spend money extravagantly on life's many pleasures.

Cybernetics: Has 1D6 + 1 cybernetic implants of choice.

Safecracker O.C.C.

By Kevin Siembieda

A safecracker is a demolitions expert and mechanical engineer who uses his special "talents" to "crack" safes, open security doors, break in and out of prisons, pick locks, avoid/bypass or disarm security systems and similar feats. They can use their abilities to such precision that they can "blow" the lock off a safe, security door, safe deposit box and similar without creating a big, area effect explosion or inflicting massive amounts of damage. This means delicate, flammable or valuable contents of a safe or container or person/item behind a door may be shaken up a bit but not damaged or injured. The blast and subsequent damage is concentrated and directed at disabling locks and opening doors.

This skill can also be used for precision demolition and sabotage. The character is an expert in the use of all types of explosives, incendiary devices, blasting caps, and timing devices. He or she is also a mechanical engineer with a basic knowledge of electronics and computers.

Although the safecracker may use his demolitions expertise to steal the contents of a safe (for criminal/selfish reasons or as an espionage specialist) and use documents and data gotten from safes as evidence against others or blackmail, the character seldom knows any rogue or thieving skills. He's a safecracker — a specialist, not a common crook.

Note: See alignment requirements for details regarding conduct and restrictions.

Attribute Requirements: I.Q. 10, M.E. 14, P.P. 14 or higher.

Alignment: Typically anarchist or evil.

The criminal safecracker is restricted to an anarchist or evil alignment. These evildoers use their skills to rob, acquire documents for blackmail or to destroy others, free comrades from jail, and endanger others.

The Safecracker O.C.C. can include characters of a *good* alignment, but only if the character is using his unique skills to fight evil, free/help the innocent and right injustice; typically a freedom fighter type. Safecrackers of a good alignment will NEVER use their abilities to rob, hurt or endanger good or innocent people. Nor will they be willing to do anything that will enable others around them to do so. Likewise, principled safecrackers will NEVER steal, even from evil characters (unlike Robinhood). Scrupulous and unprincipled characters will be more inclined to take the enemies' valuables and use them to help others, but NEVER keep their ill-gotten gains for themselves (give to the poor, good and needy).

O.C.C. Skills:

Literacy: One of choice (+15%)
 Basic Math (+20%)
 Radio: Basic (10%)
 Basic Electronics (+15%)
 Computer Operations (+10%)
 Mechanical Engineer (10%)
 Pick Locks (+15%)

Locksmith (+15%)
Demolitions (+15%)
Demolitions Disposal (+15%)
Pilot Hovercraft (+15%)

W.P.: One of choice

Hand to Hand: Basic

Hand to Hand: Basic can be changed to expert at the cost of two "other" skills or martial arts for the cost of three skill selections.

O.C.C. Related Skills: Select seven other skills. Plus select two additional skills at level three, and one at levels six, nine, and twelve. All new skills start at level one proficiency.

Communications: Any

Domestic: Any

Electrical: Any (+10%)

Espionage: Intelligence and wilderness survival only (+5%).

Mechanical: Any (+10%)

Medical: First aid only.

Military: See O.C.C. skills

Physical: Any; except gymnastics and wrestling.

Pilot: Any (+5%)

Pilot Related: Any (+5%)

Rogue: Streetwise and computer hacking only (+4%).

Science: Math and chemistry only (+10%)

Technical: Any (+5%; +10% for literacy and language skills)

W.P.: Any

Wilderness: None

Secondary Skills: The character also gets to select five secondary skills from the previous list. These are additional areas of knowledge that do not get the advantage of the bonus listed in parentheses. All secondary skills start at the base skill level. Also, skills are limited (any, only, none) as previously indicated in the list.

Standard Equipment: A suit of personalized, light, medium or heavy (usually medium) mega-damage body armor, a set of black clothing,



a set of dress clothing, fine leather gloves, a box of disposable surgical gloves (100 per box), ski-mask, tinted goggles, a doctor's stethoscope, PC-3000 hand-held computer, PDD pocket audio recorder, pocket laser dancancer, pocket flashlight, portable tool kit, automatic lock pick/release gun, and lock picking set. Also a Wilk's laser scalpel, an energy handgun and energy rifle of choice, two additional E-clips for each weapon, knapsack, backpack, canteen, gas mask and air filter, and some personal items.

Explosives: 1D4 + 1 explosive hand grenades, 2D4 smoke grenades, 2D4 shape charges/plastique, and one fusion block of choice!

Money: 4D6 × 1000 in credit and gems or black market items worth 1D6 × 1000 credits.

Cybernetics: None to start, but augmented hearing, sight and sensor hands are common. Also see **Rifts: Triax & the NGR** for additional types of cybernetics.

Smuggler O.C.C.

By Kevin Siembieda

The smuggler is fundamentally a combination confidence man and thief. The character makes a living acquiring illegal items, hiding them from the authorities or those looking for them, and selling and/or transporting the items to the purchaser. The smuggler may also engage in the acquisition and selling of information and the hiding and/or transporting of fugitives. These brigands learn to think on their feet, use words carefully and to their advantage (many are masterful liars), and develop a poker face. Most have spent hours practicing how to try to remain calm, innocent and composed looking when facing down the law or an accuser.

While some smugglers may be considered freedom fighters, helping D-bees, rebels and underground networks by acquiring, hiding and selling weapons, food and supplies, most are selfish mercenaries and thieves who don't take sides and sell to the highest bidder. The most cutthroat, resourceful and daring may cooperate with both sides of a conflict! After all, the longer a conflict lasts and the more heated it becomes, the greater the potential for profit (and greater the danger for all parties involved, as well as the cost in lives).

Depending on the situation, contraband can include books, food, and medical supplies to weapons, cybernetics and drugs. Despicable smugglers may work with body-chop-shops and encourage, create or make "acquisitions" from cyber-snatchers. Most smugglers don't ask questions about the history of an item or the ethics of the supplier. These villains will smuggle and sell anything or anybody for the right price, without regard to whom it may hurt. While many smugglers may have skills in thievery, most operate as con-men and middle men, hiring other thieves and mercenaries to actually procure the item. However, depending on the character's disposition and abilities they can be active thieves, spies and fighters.

Attribute Requirements: I.Q. 10, M.E. 10, and M.A. 13 or higher.
Alignment: Typically anarchist or evil.

The alignment of a criminal character is restricted to anarchist or evil. They use their skills and connections for personal gain with little or no regard to who may get hurt.

Characters of an unprincipled or *good* alignment will only use his/her skills against the enemy. The character will NEVER use his abilities to rob, hurt, trick or endanger good or innocent people.

O.C.C. Bonus: +1 on initiative, but only when palming, or involving streetwise or concealment.

O.C.C. Skills:

Literacy: One language of choice (+20%)

Languages: Speaks four of choice (+20%)

Basic Math: (+30%)

Detect Ambush (15%)



Detect Concealment (+10%)
 Escape Artist (+5%)
 Disguise (+10%)
 Concealment (+10%)
 Palming (+10%)
 Streetwise (+16%)
 Radio: Basic (+15%)
 Radio: Scramblers (+10%)
 Cryptography (+10%)
 Computer Operations (+15%)
 W.P.: Two of choice
 Hand to Hand: Basic

Hand to Hand: Basic can be changed to expert at the cost of two "other" skills or martial arts (or assassin if evil) for the cost of three skill selections.

O.C.C. Related Skills: Select three piloting skills and three other skills. Plus select one additional skill at level three, two at level six, one at level nine, and one at level twelve. All new skills start at level one proficiency.

Communications: Any (+10%)
 Domestic: Any (+5%)
 Electrical: Basic only
 Espionage: None, other than O.C.C. skills
 Mechanical: Basic and automotive only
 Medical: First aid only
 Military: None
 Physical: Any, except boxing and acrobatics
 Pilot: Any (+5%)
 Pilot Related: Any
 Rogue: Any
 Science: Any
 Technical: Any (+10%; +20% on literacy and language)
 W.P.: Any
 Wilderness: None

Secondary Skills: The character also gets to select four secondary skills from the previous list. These are additional areas of knowledge that do not get the advantage of the bonus listed in parentheses. All secondary skills start at the base skill level. Also, skills are limited (any, only, none) as previously indicated in the list.

Standard Equipment: A suit of personalized mega-damage body armor (any kind), military fatigues, and a wardrobe of casual, dress and travel clothes (wardrobe can be worth $2D4 \times 1000$ credits; probably only a fraction is taken on trips or military assignments). Also a PC-3000 hand-held computer, a full size portable computer, language translator, PDD pocket audio recorder, pocket flashlight, note pad, pens or markers, gas mask, air filter, tinted goggles, knapsack, backpack, canteen and some personal items.

Weapons: A vibro-blade or neuro-mace, handgun and energy rifle of choice. The weapons can be Coalition, Triax, magic or other uncommon or difficult to find items.

Money: $2D4 \times 100$ in credits and black market items worth $3D4 \times 1000$ credits.

Cybernetics: None to start. The smuggler may opt to get some simple implants, optical enhancements or black market items; few have bionics, but that's a personal choice.

Special Forces O.C.C.

By C.J. Carella

Special Forces soldiers are given special training not available to regular troopers. This is because their missions are more difficult and hazardous than those of normal soldiers. Special Forces troops are expected to operate with very little support from the rest of the army and engage in "covert" operations that are secret and may have no official support or acknowledgement. Among their assignments, these troopers have to scout enemy positions, engage in sabotage, train or fight guerrilla or terrorist groups, engage in kidnapping, or rescue hostages.

The Coalition Military Specialist O.C.C. is a Special Forces class. This new O.C.C. applies for the most part to non-Coalition armies in city-states like Ishpeming or the Manistique Imperium. Only large armies can afford the specialized training that produces Special Forces characters. Mercenaries love to recruit these soldiers because their training makes them ideal for the low resources that most merc companies can afford. When they leave the military, these soldiers may become independent operatives, adventurers or market their services as elite bodyguards, protectors, troubleshooters and even as lawmen/sheriffs. Many wilderness towns, cities and kingdoms are interested in such "specialists."

Attribute Requirements: P.S. 10, P.P. 10, I.Q. 10.

O.C.C. Bonus: +2 on initiative, +2 to roll with impact or fall, and +2 to pull punch.

O.C.C. Skills:

Radio: Basic (+10%)
 Literacy: Choice of one (+10%)
 Computer Operation (+5%)
 Intelligence (+15%)
 Pilot: Robots and Power Armor
 Pilot: Robot Combat: Elite
 Pilot Tank (+10%)
 Weapon Systems (+15%)
 Read Sensory Equipment (+10%)
 Running
 W.P. Energy Pistol
 W.P. Energy Rifle
 Hand to Hand: Expert
 Hand to Hand: Expert can be changed to Hand to Hand: Martial Arts at the cost of one "other" skill (or assassin if an evil alignment).

O.C.C. Related Skills: Select 12 other skills, but at least two must be selected from espionage. Plus select two additional skills at level three, two at level six, one at level nine, and one at level twelve. Communications: Any (+10%)

Domestic: Any

Electrical: Any

Espionage: Any (+10%)

Mechanical: Any (+5%)

Medical: Paramedic only.

Military: Any

Physical: Any

Pilot: Any



Pilot Related: Any (+5%)

Rogue: Any (+8%)

Science: Math and chemistry only (+10%)

Technical: Any (+5%)

W.P.: Any

Wilderness: Any

Secondary Skills: The character also gets to select six secondary skills from the previous list. These are additional areas of knowledge that do not get the advantage of the bonus listed in parentheses. All secondary skills start at the base skill level. Also, skills are limited (any, only, none) as previously indicated in the list.

Standard Equipment: A suit of personalized, light or heavy mega-damage body armor, including Coalition armor. A set of dress clothing, and a set of camouflage clothing for covert operations. Also a gas mask and air filter, tinted goggles, and an NG-S2 Basic Survival Pack. Owns either 1 robot vehicle or one suit of power armor, one energy handgun and rifle, three additional weapons of choice, 1D6 grenades, hand-held computer, robot medical kit, IRMSS, grappling hook, pair of handcuffs, and 50 feet (15.2 m) of rope. At the G.M.'s option, this character may have a suit of light and quick power armor, ideally with flight capabilities.

Money: The character starts off with 1D6 × 1000 in credit, and has a black market item that will garner another 1D6 × 1000 credits.

Cybernetics: Can have up to 1D6 cybernetic implants of player's choice, including black market items.

Super-Spy O.C.C.

By C.J. Carella

The Super-Spy is the same basic type of character as the Freelance Spy, but he or she has an edge. This edge may be magical, cybernetic or psionic (player's choice). Essentially, the character was a budding mage, psychic or D-bee with unique powers who underwent the arduous training of a professional spy (and thus is less proficient than a dedicated magic practitioner or psychic). Or he/she may be a spy who had the connections and resources to get extensive cybernetic and bionic systems. Super-spies are the most deadly members of their profession, combining their skills with paranormal abilities to achieve the impossible.

Attribute Requirements: I.Q. 11, P.E. 10, M.E. 12.

O.C.C. Skills:

Radio: Basic (+10%)

Radio: Scramblers (+10%)

Cryptography (+10%)

Basic Math (+20%)

Literacy: One of choice (+10%)

Languages: Two of choice (+20%)

Intelligence (+15%)

Pick Locks (+10%)

Disguise (+10%)

Forgery (+5%)

Prowl (+10%)

Computer Operations (+5%)

W.P. Energy Pistol

W.P. One of choice

Hand to Hand: Basic

Hand to Hand: Basic can be changed to Hand to Hand: Expert at the cost of one "other" skill, or to Hand to Hand: Martial Arts at the cost of two "other" skills.

O.C.C. Related Skills: Select four other skills. Plus select two additional skills at level three, two at level six, one at level nine, and one at level twelve. All new skills start at level one proficiency.

Communications: Any (+10%)

Domestic: Any (+5%)



Electrical: Any
 Espionage: Any (+5%)
 Mechanical: Any
 Medical: Paramedic only.
 Military: Any
 Physical: Any
 Pilot: Any
 Pilot Related: Any
 Rogue: Any (+6%)
 Science: Math and chemistry only
 Technical: Any
 W.P.: Any.
 Wilderness: Any (+5%)

Secondary Skills: The character also gets to select four secondary skills from the previous list. These are additional areas of knowledge that do not get the advantage of the bonus listed in parentheses. All secondary skills start at the base skill level. Also, skills are limited (any, only, none) as previously indicated in the list.

Special Powers (Select ONE):

Magic Abilities: The character is a minor wizard, able to cast spells, but without most of the abilities of a real ley line walker. Select three spells from each level 1-3 (for a total of 9). Each additional level of experience, the character will be able to acquire/select one new spell equal to his own level of achievement/experience. Additional spells and rituals of any magic level can be learned and/or purchased at any time regardless of the wizard's experience level. The character has Ley Line abilities #2 and #3 ONLY (can only sense and read ley lines). **P.P.E.:** P.E. attribute + 1D4 × 10 + 20. Add 2D6 P.P.E. per level of experience.

Alternately, the character could be just about any of the magic O.C.C.s (provided the G.M. allows it), including the temporal wizard, temporal warrior, shifter, mystic, stone mage, druid, necromancer, rainmaker or priest. However, the character cannot use cybernetics and is permanently frozen at second level.

Psionic Abilities: The character is a master psionic. At first level, he can select three powers from each of the categories of Sensitive, Physical and Healing powers, and one Super psionic power. Every level after the first, the character can select one psychic power from any of the categories. **I.S.P.:** 1D6 × 10 + M.E. attribute. Gains 10 I.S.P. per level of experience. **P.P.E.:** 3D6 (it's been spent in the development of psychic abilities).

Cybernetics and Bionics: The character has Partial Bionic Reconstruction and 1D6 + 4 bionic features or cybernetic sensors.

D-Bee or Mutant Powers: The super-spy could be a D-bee race that has natural abilities beyond those of normal humans, such as the power of the changeling to shape-change, the simvan to control animals and so on.

As an alternative, the character may be a D-bee or mutant with *super powers* such as those described in **Heroes Unlimited** (and in part, **Rifts Conversion Book One**). If this is the case, the player can select one major and one minor super power or three minor super powers. As always, the G.M. has the final say whether or not super powers are allowed and which ones are acceptable for his game.

Standard Equipment: Black fatigues or jump suit (for prowling at night) and a small wardrobe. Portable compact disc recorder/player and headphones, video disc player, portable language translator, hand-held computer and micro-printer, 35 mm camera (still photos) and a dozen discs of film, disc camera (moving pictures) with a dozen discs of film, micro-film camera (fits in the palm of the hand), pen flashlight, large flashlight, backpack, knapsack, utility belt, ammo-belt, canteen, sunglasses and goggles, walkie-talkie radio, air filter, gas mask, and lock picking tools.

Weapons: Can include just about anything. Starts with a survival knife (1D6 S.D.C. damage), two energy weapons of choice with four E-clips for each, plus select three S.D.C. weapons of choice. Body armor can be of any type, but tends to use lightweight armor (no or low prowl penalties) or concealed armor.

Psychic or wizard spies can select one techno-wizard weapon instead of an energy weapon. Body armor can be of any type, including magic or symbiotic, but tends to be lightweight armor (low prowl and mobility penalties).

Money: Starts with 2D6 × 1000 credits and 1D4 × 1000 in black market items.

Cybernetics: See special powers above; otherwise most super-spies tend to avoid cybernetics except for prosthetic reasons. Practitioners of magic and psychics avoid them because they interfere with their powers.

Professional Thief O.C.C.

The professional thief is a cut above the two-bit hoodlum most people picture when they think of thieves. They are more like cat-burglars and surveillance experts. This character rarely engages in muggings and petty robbery. They set their sights on larger, more challenging targets.

Attribute Requirements: I.Q. 10, P.P. 14 or higher; a high M.A. and Spd can't hurt either.

Alignment: Typically anarchist or evil.

The alignment of a criminal is restricted to anarchist or evil. These thieves use their skills to trick, rob, and blackmail for personal gain and pleasure.

Characters of an unprincipled or *good* alignment are a rarity. These unusual crooks will only use their skills against the enemy. The character will NEVER use his/her abilities to rob, hurt, trick or endanger innocent

people or characters of a good alignment. Nor will they be willing to do anything that will enable others around them to hurt or use others.

O.C.C. Bonus: +1 on initiative.

O.C.C. Skills:

- Literacy: One of choice (+15%)
- Languages: Two of choice (+20%)
- Basic Math: (+25%)
- Disguise (+10%)
- Radio: Basic (+15%)
- Surveillance (+15%)
- T.V./Video (+10%)
- Computer Operation (+15%)
- Palming (+15%)
- Pick Locks (+10%)
- Pick Pockets (+15%)
- Acrobatics (+5%)
- Climbing (+10%)
- W.P.: Two of choice
- Hand to Hand: Basic
- Hand to Hand: Basic can be changed to expert at the cost of two "other" skills or martial arts (or assassin if evil) for the cost of three skill selections.

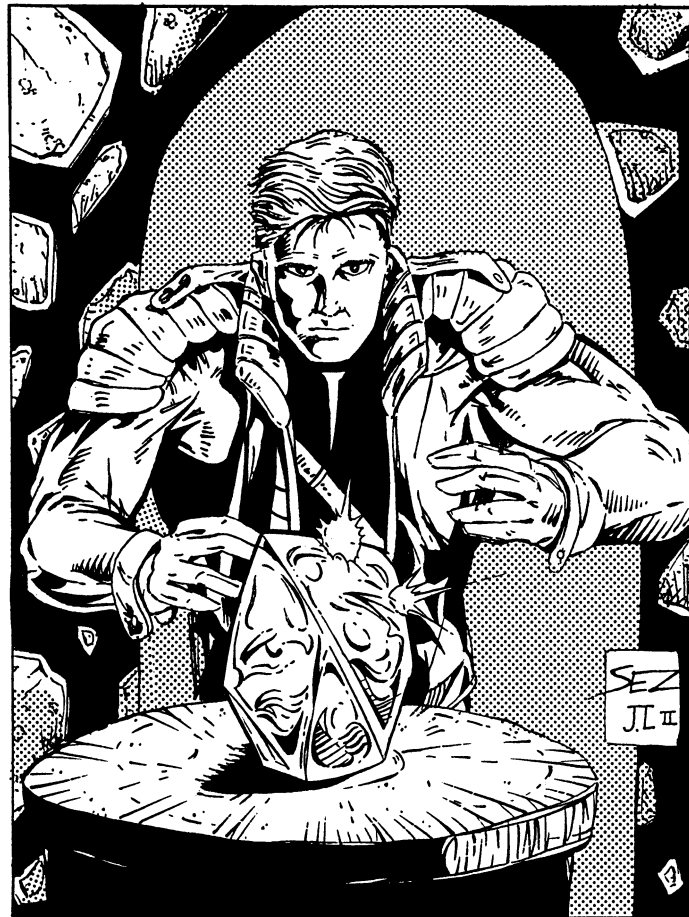

O.C.C. Related Skills: Select six other skills. Plus select two additional skills at level three, two at level six, one at level nine, and two at level twelve. All new skills start at level one proficiency.

- Communications: Any (+10%)
- Domestic: Any (+5%)
- Electrical: Basic only
- Espionage: Escape artist, forgery, and intelligence only.
- Mechanical: Basic and automotive only.
- Medical: First aid only.
- Military: Any (+3%)
- Physical: Any, except gymnastics.

- Pilot: Any (+5%)
- Pilot Related: Any
- Rogue: Any (+10%)
- Science: Any (+5%)
- Technical: Any (+10%; +15% on literacy and language)
- W.P.: Any
- Wilderness: None

Secondary Skills: The character also gets to select five secondary skills from the previous list. These are additional areas of knowledge that do not get the advantage of the bonus listed in parentheses. All secondary skills start at the base skill level. Also, skills are limited (any, only, none) as previously indicated in the list.

Standard Equipment: A suit of personalized mega-damage body armor (usually light or medium), a black jump suit, and a set of dress clothing. Also a pocket magnifying glass and/or jeweler's loupe, PC-3000 hand-held computer, a full size portable computer, PDD pocket audio recorder, pocket laser distancer, large flashlight, pen flashlight, 100 feet (30.5 m) of super strong/super lightweight cord, grappling hook, 1D4 + 1 spikes, roll of wire, gas mask and air filter, tinted goggles, one laser scalpel, lock picking tools, knapsack, backpack, carrying case or satchel, knife, a handgun and energy rifle, and personal items.

Forgeries: 1D4 different photo identity cards (all with aliases), fake birth certificate, and fake citizen I.D. to one Coalition State or other major Kingdom.

Money: 1D6 x 1000 in credit and jewelry or black market items worth 3D6 x 1000 credits.

Cybernetics: 1D4 cybernetic implants of the character's choice. Professional thieves tend toward sensors, lung implants and bio systems. A bionic hand or arm of any kind inflicts a -5% skill penalty.

Experience Tables

Freelance Spy, Smuggler, & Thief

1	0,000-2,110
2	2,111-4,220
3	4,221-8,440
4	8,201-16,400
5	16,401-23,200
6	23,201-32,400
7	32,401-48,200
8	48,201-68,400
9	68,401-92,200
10	92,201-127,400
11	127,401-178,200
12	178,201-228,400
13	228,401-278,200
14	278,201-328,400
15	328,401-388,200

Safecracker, Super-Spy, & Forger

1	0,000-2,200
2	2,201-4,400
3	4,401-8,800
4	8,801-17,600
5	17,601-25,600
6	25,601-35,600
7	35,601-50,600
8	50,601-70,600
9	70,601-95,600
10	95,601-130,600
11	130,601-180,600
12	180,601-230,600
13	230,601-280,600
14	280,601-330,600
15	330,601-390,600

Special Forces Soldier, Master Assassin, & Bounty Hunter

1	0,000-2,120	9	69,881-94,880
2	2,121-4,240	10	94,881-129,880
3	4,241-8,480	11	129,881-179,880
4	8,481-16,880	12	179,881-229,880
5	16,881-24,880	13	229,881-279,880
6	24,881-34,880	14	279,881-329,880
7	34,881-49,880	15	329,881-389,880
8	49,881-69,880		

New Pilot Skill

Combat Pod: This is a new Pilot Skill. Training includes maneuvering, and controlling remote-control drones, evasion and combatpod combat strategies. **Base Skill:** 40% + 4% per level of experience. The skill gives the user a +2 to strike, parry and dodge while inside the machine.

Designing a Merc Campaign

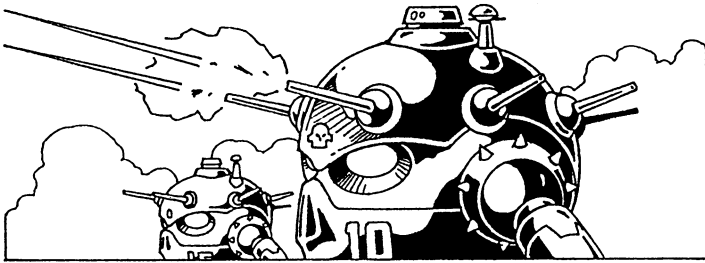

With a loud screech, the Abolisher robot fell to its knees. Captain Serrano knew that the sound was the robot's metal superstructure, stressed beyond its capabilities and collapsing under its own weight, but it felt as if the mechanical beast was bellowing its death scream. The advancing Ulti-Max units did not give the dying robot any chances to strike back, nor any mercy other than a quick killing. With militaristic precision, the twelve soldiers in powered armor stopped their serrated advance and opened up with concentrated rail gun bursts. In a matter of a few seconds, the last of Serrano's mechanized units — and the men inside — became so much scrap.

As Serrano watched the destruction from his APC's cupola, he felt the presence of Lieutenant Schultz behind him. "Captain, we are going to be overrun." Serrano's aide said. Even with the Dead Boy helmet on, Serrano could sense the man's fear. "We should withdraw, shouldn't we? Sir?"

"An excellent suggestion, lieutenant," Serrano replied. "Now if you could give me any suggestions as to where we should retreat to? I'm open to any ideas you might have."

"Uh, headquarters..."

"Has been destroyed, you fool!" Serrano snapped, finally losing his temper with the lieutenant. "We have been tricked! The false alarm sent the garrison out here into this ambush. Don't you recognize the colors of those Ulti-Max suits? We've been set up by Larsen's Brigade. I don't see any jet planes or any of his helicopters, so this is only a fraction of his forces. If my guess is correct, the rest of Larsen's Brigade is becoming acquainted with Major Harrison back at HQ. There is nowhere to run, even if you want to try and outrace the Ulti-Maxes with our Mark V."

Schultz said nothing for about five seconds. During that time, the last Skelebot holding the rear perimeter, too dumb to know when to quit, was blasted to smithereens. "So what are we going to do?"

"Surrender, of course. Oh, don't look so stricken, lieutenant. Even if we could get away, I don't think either of us would relish explaining to Emperor Prosek how his supply lines for the spearhead regiments of the Minnesota invasion have been utterly destroyed by an enemy Military Intelligence we didn't even know was out here. Obviously, somebody at Tolkeen decided to put up the money they needed to get the job done. Larsen's Brigade is not cheap."

He looked down into the bowels of the APC. "Radio our surrender to the enemy." The pilot inside nodded, his head bobbing with exhaustion and probably relief that his commander wasn't ordering a futile last stand.

"Who knows," Serrano concluded, as the Ulti-Max troopers advanced slowly and the larger and heavier bots that had supported them began to climb out of their concealed positions. "Larsen might turn us back over to our troops, rather than have us locked away in some Tolkeen prison camp. Actually, I feel sorry for 'him.' He's stayed out of the Coalition's way and prospered all these years. Throwing in with these rabble can only lead to his ruin. Don't you agree?"

A mercenary campaign may be a little more structured than the typical Rifts campaign. Mercs almost always have two constant objectives: finding contracts and fulfilling them. This means the Game Master will need to have a great deal of information at hand, to be prepared for the questions his players will ask. The politics of the area will be very important for a mercenary campaign. Mercenaries need wars, or at least some sort of military conflict, to make a living. While rifts-ravaged Earth is plagued by constant warfare and violence, not all of it will benefit a Free Mercenary Company. Some wars will involve opponents who have no need or desire to hire mercenaries. Others may be conducted by dangerous or alien forces that are not to be trusted. This chapter will detail some of the basics of the mercenary business and provide some possible trouble spots on Rifts Earth which would make for an ideal marketplace for mercenaries and adventurers.

Finding Clients

WANTED: Experienced, well-equipped Soldiers of Fortune, able to travel, for a punitive Expedition against Marauding Vampires. Experience in handling the Undead preferred, but not required. Now hiring Individuals or Small Groups. Pay commensurate with proven skill; basic expenses and ammunition paid. Applicants will be interviewed on the outskirts of the city, by the West Wall, Saturday, May 12. Novices, humans over the age of 50 years and non-humanoids need not apply.

— Flier posted on the walls of Los Alamos

All right, so the player characters have started their own little mercenary outfit. They have all their bots, ray guns and magic scrolls neatly lined up. Now what? Finding prospective clients can be as hard (or as easy) as the Game Master sees fit. Usually, the place to start is a medium to large city, the Burbs, or any place rumored to have trouble that a merc can fix. It's much harder to find work in the wilderness because communities are scattered far apart and while small villages might need a force of defenders, protectors or special operatives, they probably can't afford to pay for them. In peaceful areas, cities are the only places where a merc can find individuals or corporations wealthy enough to hire a group of soldiers.

Controlled Cities

Many city governments will not want private citizens engaging the services of heavily armed mercs. For one, mercenaries are often seen as a threat to peace and as little more than paramilitary criminals. Also, if a mercenary company is hired by a third party in a city and then attacks somebody, the victims might blame the city for condoning the transaction. Many places will, therefore, ban mercenaries from conduct-

ing business with anybody except the city government itself or require special government sanction (pay a flat fee to the city). In such cities, mercenaries continue to conduct business, but they do it covertly, through the underworld, Black Market and city rat networks. Characters with the Streetwise skill will be very useful in those areas.

Being “connected” is very important for conducting business in the underworld. Smalltime mercenary companies and adventurer groups with no reputation will need to prove themselves and establish contacts before they can “advertise” in the area. It helps if one or more of the characters was raised in the city in question (a native City Rat turned merc would be a big bonus).

Streetwise in the Big City

The first time a mercenary party tries to do business in a city where such activities are illegal, have the character make a few streetwise rolls. Roll against the highest streetwise skill level in the party if working as a group, or for each individual if they break up and try to find work separately (splitting up can increase their chances of both success and finding big trouble!). A success means the characters make the right connections. Spreading some cash around might help some: Add 1% to the skill for every 500 credits spent in this way (maximum +20%). Add +10% if one of the player characters is a local, but only if the character uses his Streetwise skill. Reduce the skill anywhere between -5% to -50%, depending on whether the city is hostile to mercenaries or non-humans (assuming some of the mercs are easily identifiable as D-Bees). No streetwise skill means the character(s) are at the mercy of fate.

The GM should also role-play the search, giving bonuses or penalties to the roll (plus or minus 5 to 20%) depending on the way the characters behave. For best results, the GM should run the attempt, then roll secretly against the group’s streetwise skills, so they don’t know if their attempt works or not until the GM tells them what happened.

OPTIONAL: On a failed streetwise roll, refer to the following table, or pick an appropriate result:

1-30%: No Result. The local underworld becomes suspicious of the characters’ questions and feigns ignorance. “Jobs? Sure, I’ve got some jobs for you — here’s a broom and a mop.” “Mercenary work? That’s illegal, you know.” “I only work here, man.” The characters can try again in a day or two, with no penalty as long as they go to some other part of town.

31-50%: Faux Pas: The player characters mistakenly offend somebody with connections, or act in such a way that the locals become convinced that they are undercover cops or enemy spies. Not only do they get no results, but attempts elsewhere in town are -20% (word spreads and less people are willing to talk). Conversations stop when the mercs walk into an establishment and people are unfriendly, even hostile, if they are pressed for information. If the player characters push too much or say the wrong thing (like jokingly implying they “are” cops or spies) they may find themselves getting into a brawl, beaten up, robbed and so on.

51-70%: Merc Scam: Our heroes seem to have found a contact for likely employment, but it turns out to be a trap set up by the city’s authorities (or bounty hunters, bandits or rival mercs). The characters walk into a room chocked full of police officers (or other equally dangerous opponents). The most likely result is that the mercs will be questioned, threatened, fined (1D4 × 1000 credits or robbed), escorted (thrown) out of the city and told not to return. If the characters want to fight the city police force, that’s fine, but as fugitives, such action may get them imprisoned or killed. And it will certainly get them nowhere in their search for a job!

71-90%: Big Oops: The mercs give a really bad impression to the leaders of the underworld. Maybe the obnoxious guy they beat up at a bar turns out to be the son of the local “Godfather,” or they unwittingly lead the police to an illegal gambling establishment, or some similar

complication brought about by the characters’ actions. In the alternative, the adventurer group could be a party of well meaning fellows who inadvertently beat up undercover cops, or interfere with a police or military operation by inadvertently helping a criminal who they thought was an innocent victim. The result of a very unlucky coincidence can lead into all kinds of trouble. In any case, the characters may have overstayed their welcome and should leave the city as soon as possible or they’ll get into deeper trouble.

91-100%: Shanghaied! The characters are “hired” for a job which turns out to be a trap. A gang of slavers (possibly working for the Splugorth), bandits or police trick the player characters into signing onto an operation and later uses drugs or magic to subdue or frame them, or to capture and sell them into slavery. The mercs should have a chance to notice the trap, or escape once it’s been sprung, but it could take an entire adventure and lead to all sorts of trouble and/or intrigue. If they manage to distinguish themselves in overcoming this obstacle, their reputation in the city could grow as a result. On the other hand, they might end up as next week’s entertainment at Dragcona!

Also note that while the practice of hiring mercenaries or even allowing them within city limits, may be frowned upon in *Controlled Cities*, as long as the mercenaries do not enter town, do not interfere with the local authorities, or harm the city, and engage in activities beyond the city’s borders, most people will look the other way. Consequently, a corporation, rich individual, or even a city official may hire a mercenary band or adventurer group for all kinds of work. Assignments may include escorting and protecting a merchant convoy, sabotage an opponent, recover a stolen article or kidnapped person, hunt down bandits or monsters troubling the area, exterminate D-bees in the area, attack a competing corporation or town away from the city, CS trouble, espionage, smuggling, etc. A rendezvous place will be established outside of town and the characters may be told that they are NEVER to enter the city or address their employer in public.

Mercenary Havens

Not all cities are closed to the mercenary trade. The economies of some cities are based partially or completely on commerce brought to them by mercenaries. The most common havens are border towns, sections of ‘Burbs around larger cities and wilderness kingdoms outside of the Coalition States. A typical haven set-up consists of a free town with a lot of empty land around it. The mercenary companies set up camp around the town and send small groups of negotiating officers and soldiers on leave into the haven. All heavy weapons, bots and power armor are typically left at the camps.

These “havens” tend to be lawless places, with minimum security and minimal law enforcement. In addition to attracting mercenaries and adventurers, they also attract bounty hunters, gunslingers, con-men, dark carnivals (see **Vampire Kingdoms**), drug traffickers, smugglers, slavers, bandits, assassins, travelling gangs, D-bee refugees, warriors-for-hire and all types of outlaws. Soldiers of fortune are welcomed, but may find stiff competition for the same jobs. Ultimately, this works to the advantage of the employer who may find five or six mercenary groups trying to bid under each other to get the job — of course, the potential employer should remember that he who hires the cheapest mercs may be getting exactly what he paid for. For some jobs it is wise to hire only the best.

Still, such places (they don’t have to be whole cities, they can be forts, villages, towns, seedy sections of a large city or the burbs) provide excellent opportunities for short-term and long-term employment. Typically, the area will have a number of taverns, drug dens, gambling halls, body-chop-shops, magic shops, fortune tellers, healers and pawnshops that cater to soldiers of fortune and help prospective employers find capable freelancers. These “mercenary hangouts” usually have military themes, with trophies like pieces of robots, tanks, and the



skulls of monsters decorating the walls (some of the decorative weapons might turn out to be in good working order if someone messes with the place). Old or handicapped veterans often work behind the bar. Some are fronts for the Black Market or other criminal organizations.

Finding a job at such “hangouts” can be as easy as walking up to the bartender and asking him if anything’s new, or if he’s heard of anybody hiring mercs. Prospective clients often send their agents to these places to find individuals and groups right for the job. It’s a matter of simply matching the characters and their skills to the assignment at hand. The mercenaries’ reputation may be a big influence in finding quick work at good pay. Nobody will refer the characters to a job unless

they think they can handle it. Mercs with a reputation for being cowards or unreliable may get kicked out of these establishments or steered to very dangerous and unrewarding jobs.

Even at mercenary havens, military weapons and vehicles may not be allowed inside the town’s walls. For one, these are places where mercenaries go to relax, which often involves getting drunk. Nobody wants to see what happens when an angry drunk goes on a rampage armed with a rail gun or driving a giant robot. Many mercenary groups are rivals or have had run-ins with local gangs which can lead to disputes and physical violence to settle their differences. Brawls are constant occurrences at the most orderly locations. Shootings and duels are also commonplace, but nothing heavier than a laser pistol or vibro-blade is likely to be allowed. Indiscriminate shootings, hurting bystanders and destruction of property is likely to bring retribution at the hands of local authorities, shop owners, bounty hunters, or other mercs hired to extract vengeance or recompense for damages.

The Average Town

Some more ideas by Kevin Siembieda

Most communities, large or small, regard mercenaries with a certain amount of suspicion and fear. In general, soldiers of fortune have a reputation for having loose morals (they’ll do anything for the right price), getting into trouble (brawls being the least of it), attracting trouble (old opponents looking for revenge and new adversaries to challenge them) and attracting undesirables (bounty hunters, D-bees, CS troops, etc.). Consequently, most communities are not overjoyed to have mercs hanging around, even if they are complying with the law.

Work for mercenaries at these communities is probably limited to escort, protection, defense, and investigative jobs. However, other opportunities may become available. Rival businesses may hire mercs to get “dirt” on their competitors, or have the mercenaries frame their rival for a crime, or engage in blackmail, or sabotage and spying to undermine their competitor’s operations (even hire an assassin or need protection from one). Watch the reruns of Dallas or any daytime soap-opera for ideas and double-dealings.

Other opportunities may involve the Coalition States or other kingdoms and have the mercenaries engaged in smuggling, selling/having contraband items, associating with criminals, rogue adventurers and/or D-bees (or just the opposite, be hired to find and/or stop smugglers, bandits, contraband or criminals and D-bees). Mercs may also be hired to defend against (or to protect) D-bees, rogue scholars, and men of magic. Depending on the town, they might get into trouble because of local prejudice — hanging with humans, or non-humans, or men of magic, or supernatural beings, etc. Or they may get hired to do a job because of who they associate with.

Remember, just about any place, at any town can provide leads for adventure or possible employment. I’ve noticed that the majority of games use the old stand-by of the “tavern/bar/saloon” as the stereo-typical location to get information and make contacts. That works, but there are a lot of other possibilities, especially in **Rifts Earth**. The more seedy places for opportunity include the lower levels of fortified CS cities, the Burbs, body-chop-shops, drug dens, pawn shops, smuggling rings, fortune-telling shops, dark carnivals, and any den of iniquity.

Less dangerous people and places for finding opportunities and information include some of these:

Vehicle, bot, and armor repair shops: These operators see and learn a great deal from the vehicles that pass through their shops. They can tell whether or not there’s been combat or other trouble in the area by the types of vehicles that have passed through the garage and the volume of work that they’ve had. The type of damage a vehicle has suffered or the modification requested may also provide valuable clues. Even mercs can probably tell the difference from damage inflicted by

an energy rifle or a magic fire ball. The operators also *meet and see* the owners of the vehicles and may recognize the faces of bounty hunters, known mercs, local bandits and other details — especially if the person had some unusual trait.

Hospitals and healers: These proprietors also have more frequent contact with mercs, adventurers and transients than the average merchant. They may recognize faces and features (tattoos, scars, injuries, D-bee traits, etc.) as well as identify what may have caused the injury. Furthermore, they are sometimes witnesses to death bed confessions, stories about who or what is responsible for the patient's condition, dark secrets, and strange occurrences (including demonic possession). Even an occasional artifact, weapon, magic or alien item may fall into their possession — although such things are usually turned over to the authorities within 48 hours.

Magic, alchemist, and herbalist shops: The proprietor and workers may recognize faces and identifying features, but more importantly, they may notice evidence of magic or the supernatural. For instance, a sorcerer could tell whether a tattoo covered warrior was a True Atlantean with magic tattoos. He or she might notice that a patron carried a rune staff or wore a magic talisman, or wore the colors of a particular magic or religious sect, and so on. A practitioner of magic may also recognize people plagued by curses, possession, magic illness, faerie magic and other mystical afflictions. Furthermore, most magic shops not only sell but trade and purchase magic items. Stolen magic items may find their way to such places and the shopkeeper may know the character's name, reputation and whereabouts. They can also be helpful with information about lore and identifying items acquired by the player characters — for a price.

Libraries, rogue scholars and scientists: Information is a valuable commodity and these are the folks who hold it. A library may contain all kinds of secrets and information if one has the patience to look for it and the ability to read.

Scholars and scientists are likely to know local history and legends, local politics and commerce, info about key figures and celebrities (current and past), trouble spots, locations of D-bee communities, the locations of military outposts and operations, the locations of merchants and other establishments, and so on. Many are tapped into the underground information network and know the latest local and regional news, gossip, and rumors. If they don't have the info at their fingertips, most have the capabilities to research and get the data in a few hours.

One of the scholar's most basic services is reading. Remember, the majority of people in North America are illiterate. Thus, they bring flyers, posters, labels, letters, books, etc. to the scholar so he or she can read it and tell the character what it says. Many scholars don't charge anything to read a label or letter and most other fees are usually priced fairly.

Scientists and, to a lesser degree, scholars may be able to identify ancient Earth and D-bee artifacts, unusual items, identify or analyze D-bee equipment, study samples of chemicals, compounds, bacteria, wildlife and D-bees, and so on. They may be able to report about strange phenomena, supernatural activity/dangers, disease, alien aberrations, facts and speculation about D-bee and supernatural beings, etc. Some may also offer (for a fee) such services as medical treatment, recharge energy clips, repair damaged equipment and may sell or trade medicine, lab equipment, computers, computer programs, language translators, machine parts, E-clips, maps, and other high-tech odds and ends or informational resources.

Rogue scholars and scientists may also be connected with smugglers, thieves and city rats since their precious books, disks and knowledge are often considered illegal (or very valuable) in many parts of North America. Furthermore, rogue scholars and scientists may have a need for mercenaries to help protect them from criminals, bounty hunters, assassins, rivals and/or the law, transport or protect "illegal" items like books and artifacts (sometimes these artifacts are extremely valuable

or magic), find or retrieve artifacts (perhaps protected by an evil monster or powerful humanoid), defend them or others from unjust persecution, destroy information that has fallen into the wrong hands, and so on.

Merchants and shops: Merchants meet a lot of people. Like the operator/mechanic, they hear and notice things about the visitors who patronize their shops. They are also likely to know a good deal about local commerce, trade routes, storage areas, the authorities, crime, wealthy merchants and people, notable personalities and the locations of many businesses, services, hotels and other establishments. Some may know about "bad" parts of town and rumors about criminal activity, but honestly don't know how to find them and avoid contact with the criminal element. Others may not only know of such people and places but associate with them. Merchants, both respected and disreputable, may have need of the mercenary's skills — especially in the areas of protection, investigation and escorting the transporting of goods. They are also among the few who can afford to hire mercenaries.

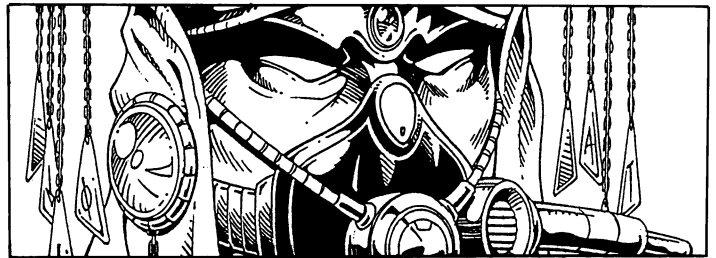

Practitioners of magic: Wizards and their ilk always seem to know what's going on. Sometimes this is through magic, but more often it is through contact with other sorcerers, creatures of magic, adventurers and mercenaries. Like the rogue scholars and merchants, they may have need of the mercenary's special talents.

City rats, criminals and gang members: These people are usually pretty well connected and know what's happening on the streets. Hackers may even have secret information! Many will also be able to direct mercenaries to the authorities, body-chop-shops, bounty hunters, gang leaders, criminals, drug dealers, scoundrels and members of the Black Market whom may have use for soldiers of fortune. They can also direct these people to the player characters.

Vagabonds, nomads, scouts, mercs and adventurers: People who travel throughout the territory see and hear things that local townfolk do not. In addition to their own firsthand observations, they may be privy to news and rumors. The problem is weeding through what is fact and what is exaggeration, extrapolation, lies and meritless rumors and speculation.

Note: Often times, just keeping an ear open to what's being said can lead characters to find employment or follow a lead to employment, adventure and unexpected opportunities. For example, the authorities, suspected of having ties with the Coalition States, insist there are no CS troops within 500 miles. Furthermore, everything is quiet — no trouble. Yet over the next few hours, various player characters "hear" a number of things that prove otherwise. An operator recently worked on a CS vehicle or power armor (The owner claimed to have stolen it). Another mechanic at the same shop noticed that damage supposedly caused by passage through a sudden ley line storm looked more like laser and plasma blasts than electrical discharges. Later, the characters overhear a farmer buying supplies at the market or seeing a doctor to get sleeping pills, complaining about how the lights, engine sounds and soldiers tromping around the woods by his farm are frightening his cattle and keeping him up all night. The farmer curses and asks, "What the hell are them Dead Boys doin' out there every night?" What indeed?

Restaurants, saloons, dance halls, hunting lodges, stores, ball parks, gladiatorial arenas, festivals, city streets or any public place can be the source of information, leads and adventure. Use your imagination, some common sense, and run with it.

Mercenary Contracts

Once a mercenary company accepts a job, a price must be determined. Several factors will affect the payment: The level of risks involved, the length of service, and the reputation and size of the company. The desperation of the clients or the mercs are also important elements. If no other companies are available, the only one left might be able to set whatever price it wants regardless of reputation. On the other hand, a band of soldiers of fortune who are in dire need of money may take any job that they can find, no matter how low-paying it is.

To be successful, a company needs to make more money than it spends. A million credits sounds like a lot of money, but what if the soldiers lose a robot that costs 20 million? Unless the contract signed includes a vehicle or equipment replacement clause, the mercs just lost 19 million credits!

The costs of a company include travel, food, repairs, general maintenance, supplies, housing, salaries and bonuses. It should be assumed that even if a vehicle is not damaged, its yearly maintenance costs will be anywhere between 1-20% of its base cost. Some contracts have clauses which indicate that if a vehicle is destroyed in battle, the client has to compensate the mercenaries for it; this is only reserved to the companies with the best reputations, however. Otherwise, it would be too easy for unscrupulous mercenaries to cheat their clients by claiming nonexistent or faked "combat losses."

Typically, a company will charge enough to cover all *estimated* operating expenses for that job, plus an additional amount that should cover any equipment that is used up or destroyed in the operation. Example: A company has about 100 million credits' worth of equipment, and is hired for a six month military campaign. The company estimates the cost in salaries for the six month period, plus food, supplies, and maintenance. The commander figures that he could lose as many as one-tenth of his vehicles in this operation, so he adds a 10 million "safety net" to his calculation. To this, he add a two million credit profit margin. Total cost for the six month campaign might range between 20 or 30 million credits — but note how much cheaper it is to hire a mercenary army than to buy equivalent equipment and train soldiers. If something goes wrong and the company loses 30% to 50% of its equipment they won't have made enough to replace the loss after covering other expenses. That's just one of the risks of the business. Negotiation skills will be very important for the company. Most clients will try to pay as little as possible and want the mercs to assume all the risks.

Mercenary Pay

Unknown mercs and especially adventurers hungry for work are often seen as an opportunity come walking on two (or more) legs. These desperate or "green" soldiers of fortune are frequently hired at a third of the pay a known mercenary or merc group is paid. This is especially true of missions that are not of paramount importance and/or will take the characters far away from their employer's hometown. If a cheap, no-name freelancer is killed, who cares? If the adventurer(s) is successful, great; the employer gets what he wants at bargain basement prices and the mercenary(s) has started to build a reputation for himself.

Usually, mercenaries prefer cash as payment. This is not a problem when dealing with a small group or even a platoon of warriors, but fees can run into the hundreds of millions when hiring an entire brigade or army. Many employers don't have that kind of cash lying around. Sometimes, payment is made in trade and can be something as basic as food, a place to sleep and supplies, or an exchange of services for magic items, weapons, vehicles, bionics, ancient artifacts or special services. A town with a good industrial base might offer to pay some of its debt by offering free repairs and parts for a period of several years. A weapons manufacturer might offer millions of dollars' worth of equipment and power armor. Gold, jewelry, magical items, deeds

to land or buildings (residences and commercial holdings), and even livestock ("You are now the proud owner of 5,000 heads of the finest giant bison in the plains.") are frequently offered (and accepted) in lieu of a cash payment.

GM Note: Adventures might even develop around the characters' attempts to turn the items they accepted in trade into cash. Imagine a mercenary company of giant robots herding 5,000 giant bison towards the nearest meat market. If they are smart and lucky, they might end up making more money than if they'd been paid in cash. Many mercenary companies end up becoming part-time traders in this way and many become very successful at it. There are hundreds of stories about mercenaries lucking into valuable property and alien, magic and ancient artifacts. Such items may be uncovered during the course of an assignment (most merc contracts allow the soldiers to keep such spoils of war) or given away by clients who know what they have, but don't need or want it, or offered as either partial payment or bonus/reward for a job well done.

Pay Adjustments and Considerations

The mercenary soldier brings with him a certain amount of equipment and expertise. These will affect where he is placed in the chain of command and how much he is paid. The salaries described in the **Free Company Creation Section** can be used as a guideline for salaries but the Game Master will have to adjust pay depending on the characters' special abilities, skills, equipment and the circumstances of the time. A highly skilled mercenary may command tens of thousands for a mission from a rich kingdom in need of somebody with his skills, while the same warrior may settle for a handful of gold and a warm meal under less favorable conditions.

Here are some other rules of thumb in determining pay bonuses:

Note: An experienced character is typically 5th to 8th level. A high level character is typically 9th level (sometimes 8th) or higher. A plus sign followed by a number and percent symbol is how much more that character's pay/salary/bonus will be than the average grunt.

Low (levels 1-3) characters of any O.C.C.: None to -10%.

The average fighter/soldier/warrior/mercenary: None

The average support personnel, vagabond, laborer, driver, cook, tailor, scholar, city rat, and most other O.C.C.s: -20%.

Mercenaries who don't have any piloting skills: -15%.

Mercenaries who don't have any robot or power armor skills, or any special powers: -25%.

Mercenaries who bring their own power armor/bot vehicle: +20% to 40% to the salary depending on the type of bot/armor. The merc company is also likely to pay at least half of the cost of repairs and upkeep; wealthy ones will pay for it all. The most powerful power armor like a Triax Dyna-Max, Ulti-Max, SAMAS or bot vehicles like the Naruni OMAV might get an additional 10% to 30%.

Glitter Boys with armor: +20% to 50%, plus maintenance and repairs are free.

Borgs & Headhunters: +10 to 40% for partial reconstruction borgs with no or few weapon systems and +20% to 80% for full conversion military borgs (often includes reasonable maintenance and repair costs). The exact percent increase depends, as always, on the character's abilities, performance and experience.

Juicers, Crazies & Cyber Knights: +10% to 60% depending on abilities and experience.

Experienced Wilderness Scouts: +10% to 40%; considering most mercs operate in wilderness areas, they are important but are often considered a dime a dozen. However, a truly skilled and high level scout is always valuable anywhere and may get bonuses on top of his pay.

Experienced thief, city rat/hacker, or smuggler: +10% to 40%

Experienced spy, safecracker, forger, or bounty hunter: +20% to 100%, depending on the level of skill and experience.

Experienced/Expert Operator: +20% to 60%.

Experienced Body Fixer or Cyber-Doc: +10% to 60%

Practitioners of Magic: +10% to 40% for Ley Line Walkers, Mystics, Techno-Wizards, Temporal Wizards, Stone Mages, and other spell casters of reasonable skill. Powerful, high level spell casters (8th and higher) and high level dragons (8th+) can get as much as triple normal pay and sometimes a percentage of the spoils/profits. **Note:** Some mercenary companies don't want practitioners of magic no matter how powerful.

Psychics: +5% for minor psionics, 10% to 20% for major psionics and experienced Dog Boys, +20% to 40% for experienced Psi-Stalkers and Burstlers, and +50% to triple for high level (8th or greater) Mind Melters and Mind Bleeders (see **Rifts Africa**).

Hatchling Dragons: 10% to 50% (frequently: 10% per level of experience).

Adult Dragons (rare): Starts at two or three times the normal salary and goes up from there (sometimes includes 10% to 40% of the profits). An adult dragon can double an army's firepower and is usually worth every penny.

Super-powered beings (have supernatural strength, powers from Heroes Unlimited, Earth Child or Star Child R.C.C.'s, and D-Bees with superior physical powers/M.D.C. beings): increase by 70% to 100%, depending on the usefulness of the powers.

D-Bees and inhuman aliens: Pay for these beings varies dramatically. Many make 20% to 60% LESS! This is especially true of organizations who are predominantly human supremacists or who dislike non-humans. Some mercenary companies don't want non-humans no matter how powerful or skilled the creatures may be. On the other hand, some companies will pay all of their troops equally, based on performance and rank. Others may pay D-bees with special powers and experience double to triple normal pay (and sometimes a percentage of the spoils/profits). It really depends on the company and the owner's regard for non-humans. **Note:** Mercenary outfits who are composed entirely of D-bees and mutants may be prejudiced toward humans and human-looking beings in the same way.

Supernatural beings, creatures of magic, and so-called demons can get paid 20% to 50% LESS to double or triple normal pay (and sometimes a percentage of the spoils/profits) — it really depends on the company and the owner's regard for non-humans. **Note:** Some mercenary companies don't want creatures of magic or supernatural beings no matter how powerful.

Mercenary Assignments

Outlined below are some typical mercenary jobs with standard rates of pay and terms of service.

One-Shot Missions

These are the easiest jobs to find, but they typically pay the least money. The mercenaries are hired to perform a concrete short-term mission, something that will last less than one month. Some examples include forming a posse to capture an escaped criminal (or perform a jail break), stopping a marauding monster or other such threat, or acting as escorts for a merchant caravan or travellers that will travel for a week or so. These jobs pay a flat rate, usually 25% to 50% less than a normal month's pay — bonuses are optional and usually used as an incentive. A bonus may be paid to each participating mercenary, to individuals who provide a particular service or who distinguish themselves in some way, or as a larger flat bonus to the whole company, regardless of how many members it has (or regardless to how it is divided up). The company sometimes gets salvage rights on any unspecified equipment, magic or property seized during the operation.

Such jobs will be profitable if the company doesn't spend a lot of time and equipment accomplishing the mission. Most small-time companies spend their time going from one small job to the next.

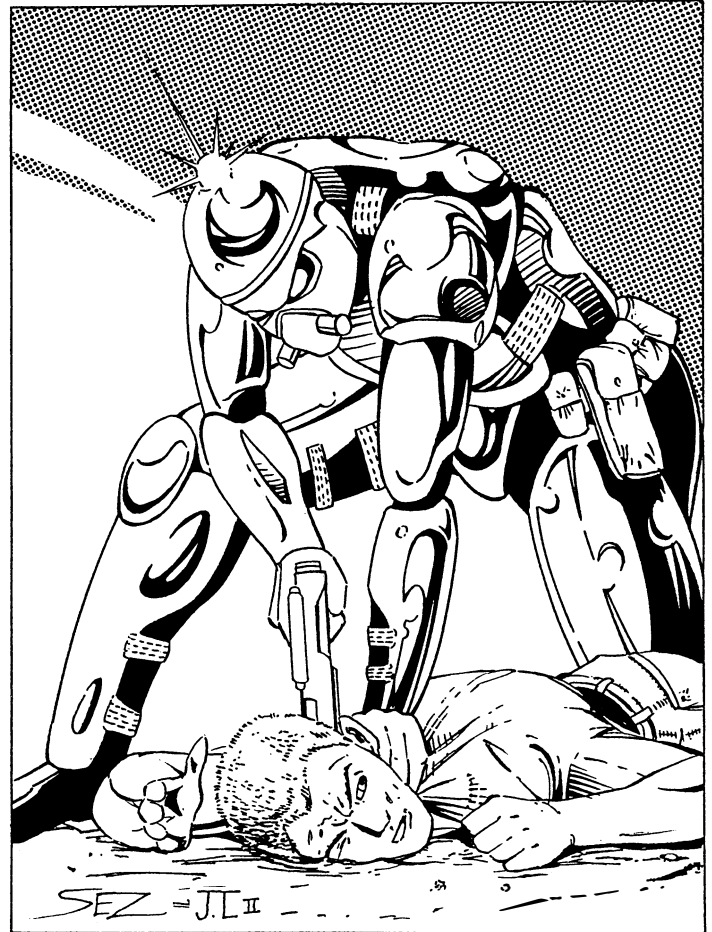

Raids and Military Expeditions

These missions are one step below a full-fledged war. The mercenary company (or companies) are charged with launching an attack against an enemy. In most cases, such an enemy may have an army or supernatural defenders but has resources seldom exceeding that of a small nation or city-state. These military expeditions might include routing bandit gangs, terminating xitoxic or vampires, chasing away marauding D-Bees, locating and eliminating a dangerous cult (mystic or religious in nature), fighting a dragon or tribe of demons, fighting a maniacal wizard or powerful group of sorcerers, mind mages or other supernatural danger.

A raid is a swift attack on a city-sized or smaller target, but without any intention of capturing the area; it's simply a destructive attack. The mission usually involves driving off or decimating the target (no interest in captives). Unlike a war, the objectives are fairly simple: Find the target, attack it and eradicate it. The job isn't necessarily easier than a "real" war; pursuing, locating, and reaching the enemy may take weeks or months, and many battles and skirmishes could be fought before the mission is successful.

Pay for raids and military expeditions is usually a large lump sum of 50,000 to several million credits, more or less equal to two months of combat pay (total salaries, plus 20-30% of the company's equipment value, per month).

Wars!

This is the bread-and-butter of mercenaries, but full-fledged wars are rare, even in the chaotic world of Rifts Earth. Mercenaries are often hired in expectation of a war, but negotiations and diplomacy may

allow the parties to reach an agreement before actual battles are fought. A war can last a few days, or several years. On Rifts Earth, all but the largest conflicts are resolved in less than a year, although numerous smaller skirmishes are commonplace. Pay in those cases is divided into normal pay (company's total salaries plus 5% of the value of their equipment, per month) and combat pay (total salaries, plus 5% of the company's equipment value, per week). Food and lodging may be deducted from pay unless the company members pay for it on their own (most do that). Besides the monthly pay, the company usually receives an advance payment of 10,000 to 1.5 million credits, depending on the size and prestige of the company. Often, this advance payment is the only cash the company sees until the end of the campaign, unless the war lasts over three months.

In a war, the company can either fight independently, or follow the orders of a military leader in charge of the whole conflict; usually the employer's Commander in Chief or the commander of the largest or most experienced mercenary force. If the company disobeys orders, it may forfeit its pay (unless they have enough muscle to make the government pay anyway). On many occasions, the mercenaries are simply told who the enemy is, given a deadline, and they decide how to deal with it — after all, they are the professionals.

Long-Term Assignments

Mercenaries can be hired for permanent or semi-permanent posts, lasting a year or more. For example, many villages, towns and cities hire mercenaries as city guards, garrison troops, law enforcement officers/sheriffs, special defense force or combatants against supernatural menaces. Since most of these jobs do not involve constant combat, the pay is lower, and the work is a lot more secure. Pay is typically equal to total salaries of the mercenary group or company, plus 2% of the value of their equipment per month. If there is combat or a dangerous mission during a given period, the mercenaries receive combat pay or predetermined bonuses.

This is the least eventful job for player characters (depending on the situation), but it doesn't mean that opportunities to get into trouble won't be available. As city officers or militia, they can become embroiled in all kinds of criminal investigations, crime busting, city corruption, unearthing spies or supernatural cults, participating in political conspiracies, thwarting assassinations, robbery and other crimes, defending the community from bandits, monsters and supernatural invaders and so on. Unlike most adventurers, though, the characters will usually have an obligation to stay in the community (that doesn't mean they will, of course). They'll also have a good deal of free time, during which they can get into plenty of trouble.

Piracy and Privateering

In a campaign set along the coast of a large lake, sea or ocean, mercenaries with watercraft or aircraft/flying power armor can engage in piracy, attacking boats and coastal villages and seizing their valuables. This is a purely illegal activity, however, not condoned by most governments or characters of a good alignment. On the other hand, there is a mercenary form of piracy called privateering. Privateers are hired/granted a license by a particular government to attack the ships, vehicles and lands of an enemy kingdom. The mercenaries are not paid, but are given the right to claim all the property and valuables they loot. In return, they are given a safe port to camp, purchase equipment and make repairs. For many governments, this is a cheap way to conduct a war or border skirmishes. Of course, the enemy may hire its own mercenaries, adventurers or supernatural forces to defend or retaliate, often escalating the conflict.

Privateering does not have to be restricted to the sea. Land-bound kingdoms can also hire companies to commit acts of banditry, sabotage and vandalism against a rival. Again, there is no pay, simply a place of refuge and the right to keep all the booty they steal. Typically, only mercenary squads and small companies will accept such jobs. As one

might expect, privateering campaigns often degenerate into a series of atrocities, including looting, vandalism, arson, wanton destruction, rape, murder and wholesale slaughter.

Other Common Jobs for Mercenaries

Besides the ones listed previously, some other possible jobs for a mercenary include:

Bodyguard: Wealthy individuals can hire a group or small or even medium-sized company as bodyguards. Pay is the same as in long-term assignments.

Bounty Hunters: Alone merc, squad or small company may engage in tracking and capturing or slaying a wanted criminal, group of criminals, monsters or D-bees in return for a reward. There is no weekly or monthly pay, just the reward payable upon proof of accomplishment. A typical bounty reward ranges from 1,000 to 24,000 credits, but some can be tens of thousands and occasionally million credits! The hunted can be an individual, gang, tribe, cult, mercenary company, D-bees or monsters. The bounty hunters usually has to bring back the criminal alive or produce a recognizable body (sometimes a head will do) to claim the reward. If the subject is unrecognizable, payment may be withheld unless other substantial proof can be produced. Note that rewards may stipulate that the hunted be brought back "alive" (no reward if dead) and may require the captive or corpse to be brought to a particular place and/or person (who administers the reward). Bring 'em back alive can lead to more adventures (the captive causes trouble, he/she escapes, his/her gang comes to free him, etc).

Exploring and Scientific Missions: Some nations, like Lazlo and New Lazlo, engage in scientific and research missions into wilderness areas, ancient ruins, enemy kingdoms and sometimes to other world via a dimensional rift. Mercenaries are sometimes hired to provide security for or to join such missions. Pay is the same as for a war, due to the dangers and possible hardships, but can vary widely.

Crime: There is always old fashioned criminal activities as a way to make a living. This will range from smuggling weapons and valuables for the Black Market to "protection rackets" where money is extorted from a city or neighborhood, to outright banditry and looting. Often there is no pay, just what the company can sell, cheat, or steal.

Note however, that sometimes a crime in the eyes of some may be justice, freedom or a noble quest for others. For example: Owning ancient books and teaching D-bees to read are "crimes" in the territories occupied by the Coalition States. So is coming to the aid or defense of a D-bee or practitioner of magic; especially if the character is innocent and being beaten, tortured or molested by CS troopers. Aiding such horrible criminals as Erin Tarn, rogue scholars, rogue scientists, body fixers, citizens of Tolkeen, D-bees and other undesirable are criminal acts in the Coalition States, and may brand any merc who helps them a criminal as well.

Training: Mercenaries can be hired to train a local militia or army. This is a fairly safe way to earn a living, of course, training accidents and disgruntled trainees and office can lead to injury or trouble. Training typically involves a basic course in fundamental combat procedures, hand to hand training, the use of one or two weapons, piloting, going on maneuvers and mock combat exercises. Pay will be the same as per a long-term assignment.



Hot Spots on Rifts Earth

Described below are some areas on Rifts Earth (mostly but not exclusively in North America) where the services of mercenaries would be needed. These are optional situations. The GM is the final judge as to whether the conflicts described here are actually taking place or happening in the manner described. The GM is free to ignore, elaborate upon or change in any way he or she desires. The events briefly suggested here may also inspire the GM to come up with his own conflicts and sub-plots.

War in Minnesota

The Coalition has been preparing an invasion for a long time. The cities that stand in their way will probably spare no expense trying to defend themselves. Larsen's Brigade, for example, has been hired by one of the city-states in Tolkeen (or by the kingdom itself) to help defend them. Many other mercenaries may be hired as well. The Coalition States may also hire some mercenary units, bounty hunters and spies to support their war efforts, although in a comparatively small way -- for the most part the CS will rely on their own troops and vast resources. The Coalition States have more troops, resources and equipments than every civilized settlement in the area.

Any mercenary groups that fight the CS will be branded as traitors to humankind and persecuted now and later, whenever they encounter CS troops, especially along the Coalition's borders. Mercs who fight against Tolkeen will face elemental, supernatural and magic forces the like of which have never been unleashed on the planet Earth. These conditions should make many mercenaries hesitant, despite the high pay that may be offered.

The Xiticix (see the **Rifts RPG**, page 253) are a wild card element. They are entrenched in some areas of Minnesota and will attack any humanoids who come near their borders. There will also be other monsters, D-bees and evil humans who will play both sides against the other and/or conduct their own raids, looting, and pillaging against one or both sides for their own profits. Low life scum will have no hesitation at robbing graves, beating and plundering the sick and injured or hurting women and children for their own pleasure and profit. Remember too, that the misery and opportunity offered by war will also attract supernatural fiends, including grave ghouls, banshees, dybbuks, Dar'otas, night mares, poltergeists (all types), the undead and others. Furthermore, the forces of magic may, at some desperate moment, summon forth and unleash demonic monsters and mystic forces that may run amok and devastate one or both sides of this conflict. **GM Note:** War is inevitably brutal and ugly. Characters may find themselves hard pressed to live up to the morals of their alignments or to show mercy and compassion — which can be a dynamic subplot of courage and intrigue and the molding of "true" heroes.

Tolkeen: A Prelude to War

Tolkeen and the CS may not have officially declared war, and the CS propaganda machine may claim to be in complete control, but there are raids, acts of sabotage and combat skirmishes constantly waged by both sides along the border. Over a hundred Coalition troops have been slain and several hundred have been injured. Nearly a thousand people (humans and D-bees) living along the borders of Tolkeen have been killed, several thousand injured, and ten thousand people turned into homeless refugees when their villages and farms were commandeered by the CS troops or burned to the ground. Either the Coalition must back down or full-fledged war will erupt at any time. **Note:** We are leading up to the world book tentatively entitled, **Siege on Tolkeen** (scheduled for mid or late 1995 release). Until this book hits the store shelves, the Game Master may want to hold off on having the CS wage war against Tolkeen. This giant sourcebook will detail all the key

factions and elements involved and depict the incredible magic and D-bee war machines at the disposal of this kingdom of magic.

There are many possible operations in this war. Tolkeen will start paying a bounty for captured CS equipment (up to 40% higher than normal Black Market purchase prices) to entice mercenaries, daring adventurers and greedy bandits to attack isolated CS units. An ingenious merc company might try to engineer a clash between the CS and the Xiticix (GMs, this will be difficult without getting caught in the middle). Scouting teams of Dog Boys or Skelebots could be ambushed, captured and interrogated. More important targets include supply convoys; no matter how powerful the Coalition troops are, they cannot fight if the troops aren't fed or their guns aren't loaded. Attacks on encampments, even if they don't do much damage, will cause confusion and may hurt the troops' morale. Waking up and finding the sentries hog-tied or slain, for example, will break many troopers' confidence and create a feeling of insecurity and vulnerability. A distracted and/or frightened soldier is not at his best performance level.

Stand-up fights are probably a bad idea. If the player characters stay in one place too long, they might first fight a small reconnaissance team or combat patrol squad, but another squad will soon join them and they may be quickly followed by an air squadron, and/or an infantry platoon (with bots and power armor?), and maybe even a company or a brigade (definitely with bots, SAMAS and sky cycles). The CS will quickly try to crush any pockets of resistance. They'll send in the fliers (SAMAS & Sky cycles), as well as dog boys and skelebots, with more troops airdropped by Death's Head Transports (probably behind the characters, or from all sides to cut them off from any avenues of escape) and try to pin the enemy down and overwhelm them. Heavy troops and armored infantry will include skelebots, large combat robots and/or Spider Walkers and tanks to finish the job. Skelebots and Dog Boys frequently compose the front-line troops to "soften up" the enemy with a minimal loss of human life.

If resistance causes this limited border war to last more than another year, Emperor Prosek may decide to cut his losses and settle for whatever territory he has conquered. This is especially likely if major trouble arises with others, most notably Naruni Enterprises, the Federation of Magic, the Pecos Empire, Kingsdale, the Mechanoids or other dangers from other dimensions. Emperor Prosek and his son may be evil megalomaniacs but they are not stupid or insane. As strange as it may sound, they genuinely care about the welfare of CS citizens and humans in general and will not foolishly jeopardize the welfare of the Coalition States on any war of vengeance or expansion. A demoralizing defeat in an open battle might also convince the Emperor that his troops are not ready to fulfill his dreams of conquest. Remember the wars of Vietnam and Afghanistan? In both cases, a technologically inferior but determined foe successfully defended against a more powerful invader. The result will be a temporary truce (lasting 2D6 years) and some withdrawal of troops (not more than half) while Prosek purges his officer corps, improves the army, dispatches more spies and develops new strategies.

Whatever the outcome, the Coalition's campaign will be proclaimed a military victory and woe to anybody who says differently.

Whykin/CS vs Kingsdale

These two small nations are described in the **Rifts RPG**, page 142. Whykin is a human-controlled, anti-magic nation, while the slightly smaller Kingsdale has a large population of mutants and magical practitioners. The Coalition States want Whykin to join the States and Kingsdale to go away. It is likely that Coalition agents will try to precipitate a war between the two kingdoms. Whykin is generally self-reliant militarily and does not often hire large groups of mercenaries but may hire small groups and adventurers.

Kingsdale's army is made up mostly of mercenaries, with a large number of Juicers among them.

If war erupts, Kingsdale might step up the hiring of both individual mercs and entire units. The danger of fighting for Kingsdale is that if the mercenaries do too well, they might force Whykin into joining the Coalition States. Such an official alliance would see the CS dispatch troops and bots to help the kingdom. However, the Coalition is unlikely to commit a large force to this front because they are planning the Minnesota Campaign. Also, Whykin is fiercely independent and would prefer aid in the way of weapons, supplies and money to hire and maintain their own mercenaries rather than submit to Coalition domination. Despite what some might think, the CS understands and appreciates this sentiment and will try to comply — Whykin has proven its loyalty to humanity and has earned the Coalition's compassion.

Given the size of the two armies, a few thousand on either side, the war is not likely to last more than a year and would most likely consist of several skirmishes with one or two big, decisive battles. A large enough army could break through the other kingdom's defenses and seize its capital city, which would end the war.

Another possibility is that the CS will attack Kingsdale on its own, with or without support from Whykin. In that case, the war will resemble the Minnesota campaign, only shorter and much more likely to fall in the Coalition's favor. Kingsdale has less resources than Tolkeen, so its situation will be even more desperate.

Attacks by the Vampire Kingdoms

As the vampire kingdoms expand, they will eventually start to threaten the larger human settlements near the Mexican border, including Ciudad Juarez and El Paso (see **Rifts World Book One: Vampire Kingdoms**). Most communities won't have enough troops to resist a determined vampire assault, so they may turn to mercenaries, bounty hunters, practitioners of magic and demon slayers for help. Most won't want to join the Coalition States, so they'll avoid turning to them for aid even under the most dire circumstances.

Wars against vampires will be a combination of anti-guerrilla operations and conventional warfare. The wild vampire gangs will be used as front-line infantry troops and cannon fodder. They will show surprising discipline and organization under the control of secondary and master vampires, but will fall to disarray if their master(s) is slain. Secondary vampires will quickly infiltrate and sabotage the cities by mind controlling select military and government authorities and other strategic personnel. Packs of wolves, dogs and rodents will also be counted among the hellspawned troops and are especially excellent for causing confusion and distractions.

During the day, the human's major operations must concentrate on locating and destroying the vampires in their resting places while they sleep. This can be very difficult. Since vampires can travel a long distance in a short while, they will keep their lairs in remote and secure locations far from the battle site. The smartest will place their homes in areas that can only be reached in mist form or through flying — difficult or inaccessible to humans on foot. Also, secondary and master vampires have large numbers of mortal retainers, mind slaves, and lesser vampire minions. They may also work with demons and evil practitioners of magic.

The night battles will be the worst part of this war. Any merc units enlisted into the war will have to modify their weaponry to match the vampires' invulnerabilities — water guns, bows and arrows and converted wood-firing rail guns are the most useful, as well as magic and techno-wizard devices. Even so, organized vampire bands pose a serious tactical threat. In mist or bat form, vampire commandoes can penetrate troop perimeters and then strike the human soldiers from behind. Few places will be safe from attack or infiltration, so troops must be deployed to guard every possible danger spot, leaving less soldiers available to fight the enemy.

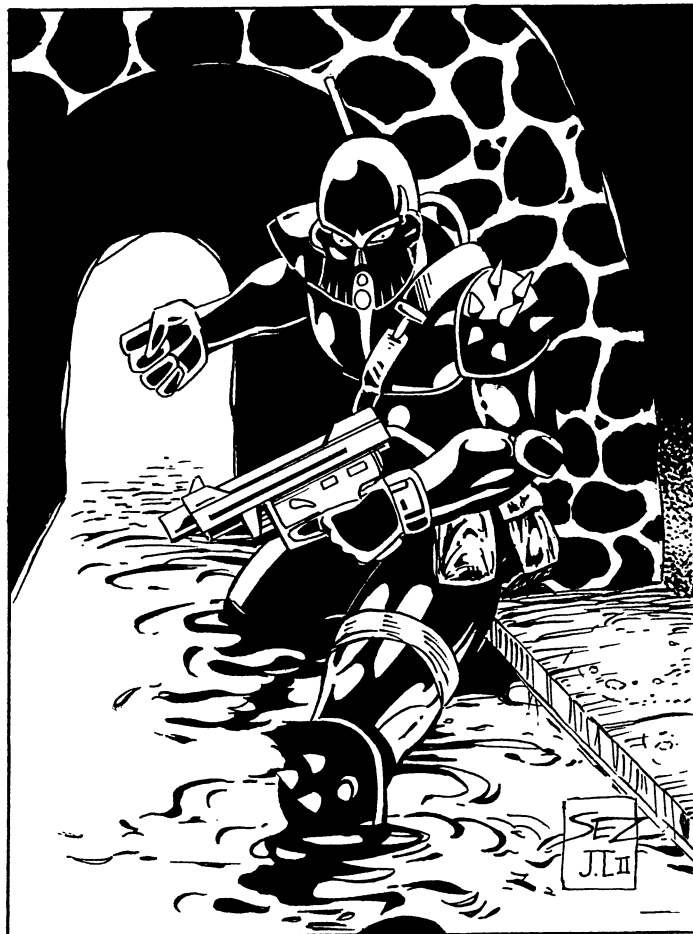

The Coalition vs The Vampire Kingdoms

If the Coalition military finds proof that there is indeed an Undead Empire to the South (maybe the player characters could be instrumental in making that discovery), there will be a strong reaction. The siege against Tolkeen will be postponed and a military campaign of some sort will be undertaken in Mexico. This can be a massive armored assault into the Mexican heartland (this might include the elimination of the Pecos Empire and certainly the absorption of many independent kingdoms and cities in the area), or limited to a series of intelligence probes or raids into the South. In either case, the CS is likely to hire "auxiliaries," mercenaries, who have the expertise and know-how necessary to deal with vampires (a tactic that also avoids placing CS troops in danger and keeps the States' defenses at maximum strength). The CS might even stoop so low as to work with practitioners and creatures of magic (let the monsters destroy themselves).

This campaign could become a long, tortuous affair, causing the vampires to retaliate in savage fury. The Vampire Kingdoms will use every resource at their disposal to stop the invasion/persecution, forgetting their differences with other supernatural beings to deal with a common enemy: humans! The Coalition States are certain to underestimate the vampires. They will never imagine the huge number of intelligent, civilized vampires that exist in old Mexico City, and they may suffer their worst military defeats in history at the hands of these fanged monsters.

The CS might receive help from an unexpected quarter — Atlantis. Lord Splynncryth's enmity towards the Kingdoms may become a factor in the war. For Lord Splynncryth, the vampires are a worse threat than the Coalition States, because vampires can live for thousands of years and threaten to dominate people that make excellent slave stock. If he

thinks that the humans are mounting a serious effort to destroy the kingdoms, he might offer a tentative alliance or simply send several small attack teams from Atlantis to join the fray.

The Xiticix Problem

The insectoid creatures (described in *Rifts*, page 253) are steadily growing in numbers and power. Eventually, their population explosion will lead to large-scale attacks on human settlements, especially those in mountain and forest regions. All attempts to reason with the creatures have failed, so most have decided the only way to deal with the monstrous D-bees is to destroy them. Other than vampires, there is no other race of creatures who are more hated and systematically exterminated by humans and D-bees alike. The presence of xiticix can lead several small kingdoms to assemble/hire mercenary companies, volunteer armies and adventurers (or even invite the CS Army) to conduct search-and-destroy missions in Xiticix territory.

It would seem that the xiticix in most humanoid dominated lands don't have enough numbers or power to repel a massive human counterattack, but continued conflicts will lead to an escalation in hostilities, bringing xiticix hordes from the north. Rumors from the north suggest the xiticix have other TW weapons and giant insectoid warriors at their disposal.

The Danger of Atlantis

For the time being, Lord Splynncryth, the ruler of Atlantis, is not trying to expand beyond his island continent. With the exception of small-scale raids, sporting expeditions (hunting humans) and supplying weapons to the gargoyles and other enemies of the NGR in Europe, Lord Splynncryth has no intention of invading other lands. He is content to rule his part of the world and quietly spread his tendrils of influence in subtle and sinister ways. However, other enemies (humans, D-bees, supernatural beings, and transdimensional competitors) may feel threatened by their very presence and launch missions of infiltration, spying and sabotage. Some may even try to wage a full-fledged war!

An armed conflict will involve large armies of Kittani and Kydian warriors (Overlords and Power Lords), with the support of the monstrous Metzla, Tattooed Men and other minions. High Lords will act as the commanders of the army. Slavers, Conservators and Blind Women

Warriors would act as scouts and agents for covert operations. Remember, the forces in Atlantis are only *part* of Lord Splynncryth's forces. If necessary he can bring in millions of Overlords and other minions, as well as call upon the resources of other Splugorth allies.

The Mechanoid Threat

Now that some of the Mechanoids have found their way to Earth, it is possible that others will follow. An all-out invasion by billions of cyborgs and their planetoid-sized spaceships could completely annihilate Earth, even if everybody cooperated against the threat. However, the Mechanoids realize the vast potential of Rifts Earth with its many dimensional portals and are much more likely to try to conquer it and use it as a doorway to find and destroy a thousand worlds.

Another alternative: The first wave that arrived (see *Rifts Sourcebook Two*) was not completely wiped out. What if enough survived to start manufacturing and cloning more robots and cyborgs? In a few years, enough Mechanoids would have been created to threaten neighboring kingdoms, leading to a limited war where mercenaries would fit right in.

The Mechanoids are a tough foe, having enough firepower and flexibility to match any other armed force on the planet. Their psionic powers are also something to be reckoned with. Magic is the only area where they have deficiencies — but if they ally themselves with inhuman D-Bees like dragons and alien intelligences, they will get plenty of magical support (not likely to study and master magic; very tech oriented). Adventurer groups and small mercenary companies can fight comparable numbers of Mechanoids, but only large armies have a prayer of inflicting serious damage against a Mechanoid nation.

Role-Playing Battles

In a military campaign, large-scale battles may take place in the course of a game. The Palladium system is not a war-gaming system, however, and a conflict involving more than a dozen or so characters would take hours and hours to resolve. Therefore, it is recommended that only the parts of the battle that directly involve the player characters be played out. The rest is resolved "off-camera." The GM should have a clear idea of what forces are involved and who will be the tentative winner, but the player characters should be in a position where their actions could change the outcome of the battle. If the battle is lost they may play a key role in helping survivors and/or establishing a second offensive or rescue mission.

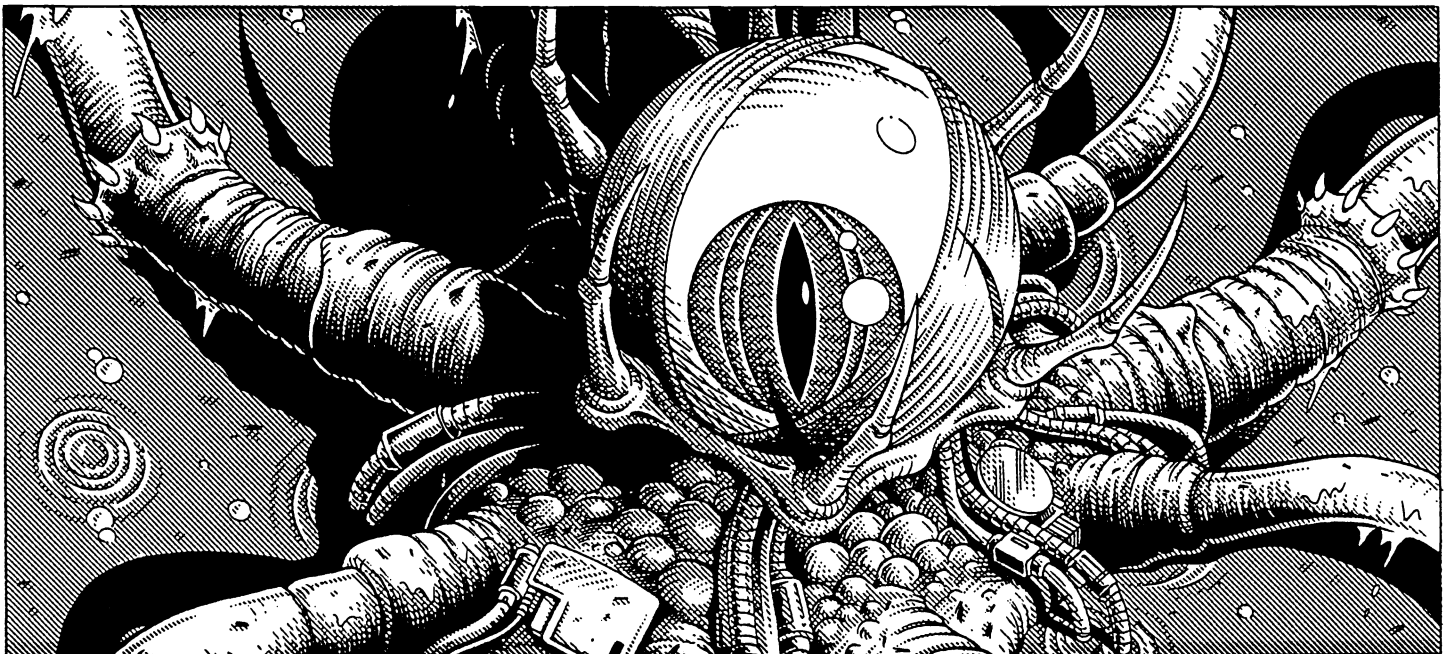

Mercenary Groups

This section describes several sample mercenary companies. Player characters could be members of one of these companies, or be independent adventurers who can run into them in the course of an adventure. Some ideas for adventures are given with each of these mercenaries companies.

DemonBusters, Inc.

"Target at two o'clock."

Cutter nodded slightly and adjusted the sights on his variable laser rifle. *"Yup. I see 'em. It's a big 'un."*

The monster's glistening tentacles dangled from the humanoid upper half, but didn't quite touch the ground. The floating creature levitated slowly through the ruins. The fat man impaled on the spikes that protruded from the Neuron Beast was still moving. Cutter decided the twitching had to be a reflex. Nothing human could survive that kind of damage. The creature had managed to get a whole cult to worship and protect it, but all the members had either surrendered or been slain. Cutter grit his teeth and checked his aim. The fat man would be the last human sacrifice for this beastie.

A radio call-sign chirruped in Cutter's ear. "Lightdancer's in position." Another followed a few seconds later. "Fireteam Alpha's in position."

"Took 'em long enough," Cutter mumbled. He didn't particularly trust the elven magician, or the two human fireflies. Sometimes it felt like working with the enemy. Well, almost. Cutter would never completely trust anything that wasn't human. He had seen his wife and kids go down the gaping maws of something that had seemingly crawled out of the ground. A monster that was impervious to the puny weapons that he and his fellow villagers tried to use against it. Since then he had witnessed many acts of treachery at the hands of human-looking and inhuman D-bees. No, he'd put his trust in himself and his arsenal.

Cutter centered the digital crosshairs on the creature's chest. This one's for my kids, he told himself. "Ready when you are."

"Go."

The laser beam seemed to appear out of nowhere, for an instant linking Cutter and the monster across the thousands of feet separating hunter from prey. Completely startled, the creature recoiled, giving a hoarse howl of anger and pain. From the East, Lightdancer and his squad, previously hidden by the elf's spells, became visible and opened up with plasma guns, particle beams and missile launchers. A split second later, the creature seemed to explode in flames — Fireteam Alpha, doing their stuff! A few seconds later, the aerial squad composed of a half dozen troopers in light flying armor, swept down, raining death from above.

Cutter fired away. The continual barrage kept the monster off balance. It managed to get off a lightning bolt spell, but it failed to penetrate Lightdancer's defenses. The firefight lasted less than a minute. By the time it took the Glitter Boys to get a clear shot and open up with their massive guns the creature was nearly finished. To Cutter, the boom of their guns was like the thunder of a vengeful god. As the echoes from the six mega-rail guns died down, the tentacled beast collapsed. Its body consumed by the conflagration.

"Cease fire. Subject is down. Repeat, cease fire." Despite the radioed order, Cutter put a few more blasts into the creature, just on general principles, before rising from his concealed position. By the time he got to the monster, Lightdancer and his team had surrounded the charred

remains and had started taking pieces from it. Some would go to the eggheads that studied these critters, but most would become trophies and souvenirs. Lightdancer held a spiny point in his hand as if it was a microphone, and started singing.

"When a monster's got a cult, who you gonna call?"

"Shut up," Cutter interrupted. Showing the elf that stupid, old movie had been a bad idea. The slightly modified song was becoming the company's unofficial anthem.

At least the General had stopped Lightdancer from painting that ridiculous logo on the company's vehicles.

- A. Sponsorship: None. 0 Points
 - B. Outfits: Specialty Clothing. 20 Points
 - C. Equipment: Medical Clinic. 20 Points
 - D. Vehicles: Specialty Vehicles. 30 Points
 - E. Weapons: Extensive Weaponry. 40 Points
 - F. Communications: Secured Service. 10 Points
 - G. Internal Security: Iron Clad. 20 Points
 - H. Permanent Bases: None. 0 Points
 - I. Intelligence Resources: Psionics and Magic. 20 Points
 - J. Special Budget: Large Loans. 25 Points
 - K. General alignment of personnel: Anarchist and Unprincipled. 4 Points.
 - L. Criminal Activity: None. 0 Points
 - M. Reputation/Credentials: Excellent Reputation. 25 Points
 - N. Salary: Good Salary. 10 Points
- Total Points Spent: 224 POINTS

Size & Orientation: Large Company

DemonBusters was founded several years ago by "General" Smith, an occultist and supernatural investigator. The organization specializes in fighting supernatural threats, including possessing entities, other entities, vampires, werebeasts, so-called demons and similar dangers. Dragons and other creatures of magic, xitix, and monsters of all kinds are also considered for extermination. However, DemonBusters does NOT persecute or attack D-Bees indiscriminately. In fact, many members are D-Bees! Only inhuman creatures who prey on humans are targeted for elimination. This organization travels around North America, in a convoy, moving from city to city. Scouting parties march ahead, stopping at cities and towns looking for potential jobs. Their primary territory of operation is expansive and includes what was once the Midwest and eastern portions of the old American Empire and the lower, southern portions of the old Canadian Empire. They occasionally travel farther west and deeper south on special assignments or when things are slow in their usual territory. They have never travelled into Mexico, or Central or South America.

The company's fees are large but reasonable. DemonBusters charges anywhere from 10,000 to millions of credits per job, depending on the risks involved and the size of the operation (may require a squad, platoon or entire division). Although they specialize in dealing with monsters and supernatural beings, the group has occasionally been hired to fight humans and D-bees, but General Smith will only accept such assignments if there is no other alternative available. The group also makes a lot of money selling the magical loot they find among the supernatural beings they fight.

The team relies on heavy firepower and magic and psionic countermeasures to destroy or capture the target. Smith *always* tries to find out whether the creatures in question are truly malevolent beings or just misunderstood or confused rift-swept creatures who are not truly to blame for the situation. If possible, he and his team will try to reason

with such creatures and settle things without violence. Some of these creatures have even joined the company! **Note:** Vampires, alien intelligences and known demons are usually destroyed on sight!!

Tactics

DemonBusters' tactics follow simple guidelines: locate and identify the target and then try to subdue or destroy it with overwhelming force. Smith and his companions have extensive computer files on all supernatural creatures that have visited Rifts Earth, and several who have not yet appeared. Between Smith, Brother Lance, the Dreamer, and Delgado, the company has a vast amount of occult lore. Their database gives a user the equivalent of Demon/Monster Lore and Faerie Lore at 96% proficiency. Once the target has been tentatively identified, the company will select a handpicked team to deal with the abilities of the enemy. Exorcism, spell magic, magic items, psychic powers, energy weapons, special materials and equipment will vary depending on the foe and the situation.

Often, the creature (or all of its minions) and its resources cannot be positively or completely identified in time to prepare a specific set of tactics. In that case, the company tries to cover the most likely contingencies and typically use the dragon Delgado, robots and power armor to engage the enemy directly, while sharpshooters and sorcerers attack from a distance. Infiltrators and spies may be sent ahead.

DemonBusters' Colors and Banners

DemonBusters' symbol is a pentagram crossed out with two brushstrokes. More recently, Lightdancer has been pushing to use the symbol used in a 20th-century fictional film about a group that did the same job. Smith, who has seen that old movie more times than he cares to remember, has emphatically refused.

Uniforms and armor are grey with company symbol, rank, personalized detailing, and other highlights and trim in a variety of colors.

General Smith

Leader, Supernatural Investigator, Dimensional Traveler

Mr. Smith, also known simply as "The General," is a mystery to his own men. The first time anybody heard of him was ten years ago, in Ciudad Juarez, Mexico, where he single-handedly destroyed a vampire nest that hid in the city's slums. Hailed as a hero, he quickly became unpopular when he presented a bill to the city's authorities. When they refused to pay, he let them know that the nest he had destroyed was only one of several and if he wasn't paid, he'd let them run wild. After several days of looting and trouble from vampires, the government decided Mr. Smith's efforts were worth the money.

Over the next several years, the mercenary travelled across North America. His expertise on the supernatural is undeniable. Not only that, the man is obviously a disciplined and experienced soldier, although there are no records of him in any army of the known world. People have ignored the mysteries surrounding this character, because when it comes to combatting demonic infestations and supernatural monsters, nobody compares to The General.

Smith claims not to have much military knowledge. He calls himself "an armchair general" and "former war-gamer," but he obviously knows a great deal about weapons and tactics. Furthermore, his intelligence and imagination are often enough to make up for whatever lack of knowledge he may have.

Several members of DemonBusters believe that General Smith is a man from Earth's past. More than once, he has corrected mistaken beliefs about the Time Before the Rifts, and has shown remarkable skill in identifying and using objects found in ancient ruins. Smith



refuses to discuss his past, but many of his remarks and interests seem to confirm that his origin lays in the past. Once, when a group member praised the past, claiming it was a Golden Age, Smith exclaimed, "Wrong! It was a time of arrogance and greed. We thought that we knew all there was to know, or if we didn't, we'd figure it out one day. If we'd had some humility, the Coming of the Rifts would not have come to pass."

During his travels, he has met people who share his passion for fighting transdimensional threats. Many joined him and eventually Smith formed DemonBusters, a fairly large and profitable mercenary band.

DemonBusters is not designed to fight against conventional enemies, but the company can fight conventional troops, and has done so in the past. Smith always tries to avoid conflict with human nations, but his first concern is for his army and then for the lives of innocents. If an armed force or monsters threatens either, he will not hesitate to use his company to defend them. He has shown much interest (and support) in the nation of Lazlo and often wonders if the man whose name has been immortalized is still alive. Smith also has knowledge of the Palladium world, and speaks a few of the languages from that world.

Although the Coalition States have used his services on more than one occasion, he is not trusted by their government, especially since he associates with non-humans. He is careful to avoid major CS cities, but is often seen in the frontier areas and sometimes works with CS troopers where the military is less picky about whom they associate with. His company is always on the move, seemingly at random, but somehow they always arrive at places where DemonBusters' services are needed.

Full Name: Henry Smith

Alignment: Unprincipled

Attributes: I.Q. 17, M.A. 15, M.E. 19, P.S. 13, P.P. 17, P.E. 18, P.B. 10, Spd. 15

Hit Points: 43 S.D.C.: 26

Size: 6 feet, 2 inches (1.88 m) tall, 170 lbs (76.5 kg).

Age: Unknown; appears to be in his early 40's.

P.P.E.: 48

Disposition: Smith sometimes resembles an absent-minded college professor. He has an insatiable curiosity for the supernatural and always prefers studying things rather than destroying them. However, encounters with diabolic entities have taught him to restrain that urge and he has reluctantly accepted that there are things man is not meant to know.

As a military leader, Smith cares very much about the welfare of his people. He is not in the business just to make money, but to finance his study of the supernatural and his private war against the forces that threaten the world. He often makes contributions to Lazlo and New Lazlo, and has on occasion assisted both governments at reduced rates (and occasionally free of charge), paying for the group's expenses out of his own pocket. Despite this, he has become extremely wealthy. He has deliberately stayed out of the conflict between the CS and Tolkeen; he has mixed feelings about both factions in that strife.

Experience Level: 9th level Parapsychologist, 6th level Headhunter.

Magic Knowledge: Detailed knowledge of the occult, but knows no spells. However, he can operate TW equipment and read scrolls.

Psionic Powers (special): Presence sense only, but it costs no I.S.P. and can be used continually!

Combat Skills: Hand to Hand: Basic

Attacks per Melee: Three (3)

Bonuses: +2 to strike, +3 to parry and dodge, +2 to damage, +2 to roll with impact/punch, +2 to pull punch, +2 to save vs poison, +2 to save vs magic, +2 to save vs psionics, +4 to save vs horror factor, +2 to save vs possession.

Weapon Proficiencies: W.P. Energy Rifle, W.P. Energy Pistol, W.P. Revolver, W.P. Automatic Rifle.

Weapons of Note: TX-5 pump pistol, TW metal water pistol, TW water rifle, TX-16 pump rifle, plus access to any of the standard issue weapons, vehicles and equipment available to his company.

Armor: Explorer Composite Armor (M.D.C. 70) with the following techno-wizard (TW) modifications: Armor of Ithan, Chameleon and Impervious to Energy, all equal to a 6th level spell.

Skills of Note: Demon and Monster Lore, Ghost and Faerie Lore, Ley Line Lore and Religion Lore, all at 98%. Speaks English/American, Spanish, German, French and Latin, all at 98%. Speaks Dragonese, Gobbely and Eastern Human (Palladium) at 70%. Basic Radio 93%, Surveillance Systems 68%, Detect Ambush 73%, Detect Concealment 68%, Tracking 63%, Pilot Tank and APC 73%, Running, Swimming.

Description: A tall, lean, man in his early '40s, with a full head of grey hair, grey moustache, beard and green eyes. When not in body armor, he favors bulky overcoats and cloaks, with either a beret or a wide brimmed hat.

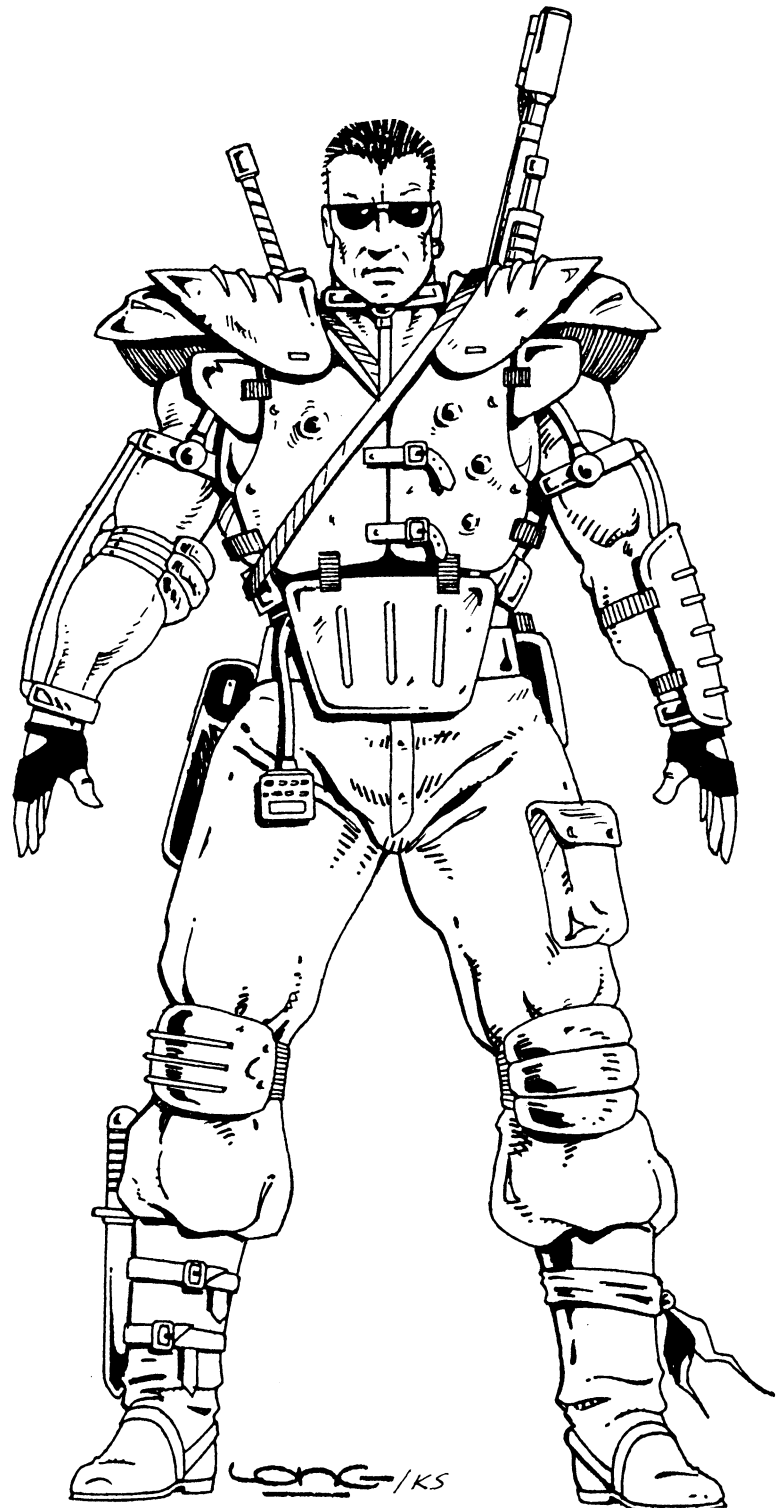

Cutter

Juicer & Enemy of the Supernatural

Barton Williams was a common laborer in a small village located in the Coalition States. He married his childhood sweetheart when the two were sixteen and had a child before their eighteenth year. He was happy, despite his poverty and hardships, and was content with his lot in life. One day, a giant monster rushed into the village. Nothing could stop the creature and it devoured two dozen people before slithering off into the wilderness. Among the dead were Barton's entire family.

That day marked the death of Barton Williams as well. He spent what little money he had making connections, offering his body and soul to become powerful enough to hunt down the creatures that slew

his loved ones. He submitted himself to juicer conversion, and then escaped his would-be employer to scour the countryside looking for monsters and evil D-Bees to slay. Even with his juicer abilities, Barton — who now calls himself Cutter — would not have survived more than a month. He was attacking supernatural monsters out of anger and ignorance. He knew little or nothing about them, making him dangerously vulnerable. Furthermore, he was being hunted by the people who had transformed him into a juicer. As luck would have it, DemonBusters was in the first town Cutter visited after becoming a juicer. General Smith convinced the desperate young man to join the outfit. In return, The General would pay off the body-chop-shop and employer who made the juicer conversion, and not only teach him about fighting the supernatural, but give him ample opportunities to destroy such beings. Cutter accepted and has become a dedicated and efficient hunter of the supernatural.

Cutter distrusts all non-humans, a legacy from his life in the Coalition States, and cares only for destroying monsters and demons. He is a driven, introverted man. He distrusts almost everyone in the company, with the exception of General Smith and Father Lance. Lightdancer, an elf, often makes fun of him, but Cutter has come to accept the jibes with good-natured humor. Although he'd hate to admit it, and despite his beliefs, he has come to like the elf (but only as an exception to his general rule, and he still doesn't trust him completely). Cutter respects The General and is glad to obey his orders.

Real Name: Barton Williams

Alignment: Aberrant

Attributes: I.Q. 10, M.A. 9, M.E. 11, P.S. 28, P.P. 21, P.E. 23, P.B. 8, Spd. 73.

Hit Points: 76, **S.D.C.:** 367 **Size:** 5 feet, 1 inch (1.55 m), 140 lbs (63 kg), **Age:** 23 (two years as a Juicer)

P.P.E.: 10

Disposition: Before a monster claimed his family, Barton was a nice, friendly and soft-spoken person. Ever since he became Cutter, however, he is cynical and insensitive to the needs of others. He has no sense of humor, and little patience with those who do (like Lightdancer who frequently gets on his nerves). Underneath this abrasive exterior, there is still a trace of the good-natured man he once was. He will never admit it, but he considers Lightdancer a friend and he doesn't really mind being the butt of jokes half as much as he pretends.

Experience Level: 7th level Juicer

Magic Knowledge: None

Psionic Powers: None

Combat Skills: Hand to Hand: Expert

Attacks per Melee: Six (6)

Bonuses: +2 on initiative, +5 to strike, +9 to parry and dodge, +13 to damage, +9 to roll with impact/punch, +2 to pull punch, +12 to save vs poison, +4 to save vs magic, +4 to save vs psionics, +6 to save vs psionic or chemical mind control.

Weapon Proficiencies: W.P. Energy Rifle, W.P. Knife, W.P. Energy Pistol, W.P. Heavy, W.P. Sword.

Weapons: JA-11 energy rifle, Wilk's 457 laser pulse rifle, WI-23 missile launcher, metal water rifle and water grenade launcher.

Armor: Juicer Assassin Plate Armor (45 M.D.C.)

Skills of Note: Wilderness Survival 70%, Land Navigation 69%, Piloting: Tank and APC 74%, Piloting: Jet Fighter 78%, Weapon Systems 80%, Detect Ambush 70%, Intelligence 65%, Athletics, Body Building, Boxing, Wrestling.

Description: A short, pale young man with close-cropped black hair, brown eyes and a serious expression.

Brother Lance

Priest of the Gods of Light

Rifts Earth has precious little spiritual comfort in this time of chaos. Many cults have sprung up in remote areas, but very few organized religions. Brother Lance hopes that one day he will change all that. He is a priest from another dimension, a follower of the Gods of Light; a multi-pantheon group that stands against demons and other dimensional threats. He worships Hyr, a god of war and justice that has never appeared on Earth before. Brother Lance is the member of a monastic order of fighting knights in the service of Hyr. His god sent him on a quest across the Megaverse, seeking worlds where a god of war and justice might be needed. When he arrived on Earth, Brother Lance decided that his quest was over. The war-torn planet desperately needs some force of stability. The warrior-priest decided to explore and try to discover what gods and dangerous powers exist in this world.

His first encounter with technology was almost deadly. He was attacked by bandits with energy weapons and only his priest spells saved

him from being killed. He is very concerned about the powers of technology which may be enough to injure or even kill a god, and which can replace magic and priestly powers. He suspects that technology is to blame for the lack of good deities in this dimension and wants to learn more.

For the next several months, he traveled the lands of North America, acting as a defender of innocents and an enemy of injustice. Most people assumed he was some sort of cyber-knight, one who preached about some strange god when his mission was done. He has made many enemies, mainly among the Coalition States, where he is regarded as an agent for an extra-dimensional invasion force.

Brother Lance and DemonBusters crossed paths when a rift-spawned demon threatened a whole city outside the protection of the CS. Brother Lance managed to banish the creature with the help of General Smith's troops, who managed to contain the creature while the removal ritual was being conducted. Afterwards, the priest offered his services to General Smith, who accepted him on a trial basis. Brother Lance is now a full member of the DemonBusters. General Smith is impressed by the enormous power the priest wields with such control and compassion, and is amused by his dedication and religious convictions. DemonBusters became an ideal ally for Brother Lance's research. Since the organization is dedicated to hunting supernatural manifestations, it provides an ideal opportunity for his search of other deities and supernatural forces, as well as allowing him to learn more about "technology."

General Smith, Brother Lance, Delgado and Lightdancer often spend quiet nights discussing theology and cosmology. They all agree to disagree in those discussions: The General has no use for organized religion. Lightdancer believes in a shapeless nature god and Delgado claims that all other "gods" are simply powerful entities who exploit the gullible. This hasn't stopped Brother Lance from trying to convert them. A few have been convinced. Hyr's religion is custom-made for warriors, teaching that courage and honor are the foremost qualities for a follower of Good. Brother Lance's proven bravery has served as an example for many company members. About a dozen soldiers now pray to Hyr and carry amulets in his name (Hyr's symbol is two crossed swords over a flaming background). Brother Lance is often accompanied by two other warriors who he has converted and trained as priests. Both are second level and serve under him as assistants and medics. One old ex-patriot became a priest of Hyr and has left the company to spread the word. Rumor has it this fellow has founded a small church somewhere near Tolkeen.

Brother Lance has discovered that there seem to be only a few god-like entities in the world (most deities left the Earth thousands of years ago and haven't come back yet). The only other "powers," as he calls them, which are known to him are predominantly evil supernatural beings dwelling in Canada, Mexico, South America, Atlantis, and Africa. The priest has heard rumors of deities appearing in Egypt and Germany, but he is reluctant to leave the DemonBusters (which operates exclusively in North America) to see if they're true. In a few years, he will communicate with his god Hyr and tell him about this world. This may cause many more priests to arrive and perhaps some demigods and other servants of Hyr.

Full Name: Brother Raymond Lance

Alignment: Scrupulous

Attributes: I.Q. 17, M.A. 16, M.E. 18, P.S. 14, P.P. 13, P.E. 13, P.B. 13, Spd. 14

Hit Points: 42, **S.D.C.:** 20

Size: 6 feet tall (1.8 m), 160 lbs (72 kg), **Age:** 43

P.P.E.: 96

Disposition: Brother Lance considers himself the spiritual leader of the mercenary company. As such, he always tries to set an example for the rest of the troops. He is always attentive, friendly and understanding towards both mercenaries and civilians. Spreading Hyr's word is important to him, but he tries not to be preachy or annoying,



realizing that pushing too hard will only drive people away. He prefers to let his deeds speak for him. Delgado and Lightdancer have become close friends of the priest and just about everybody respects him as a warrior.

Hyr's philosophy emphasizes honor, courage, and discipline. It is similar in many ways to the ideals of the Cyber-knights, and Brother Lance hopes one day to meet the legendary Sir Coake and convert that powerful group of champions.

Experience Level: 9th level Priest (see **Rifts Conversion Book Two**).

Magic Knowledge: He knows the following spells (gains spells in the same manner as a mystic): all level one spells, plus mystic alarm,

armor of Ithan, negate poisons/toxins, resist fire, energy field, fire bolt, magic net, cure minor disorders, heal wounds, horrific illusion, superhuman strength, call lightning, invulnerability, negate magic, and protection circle: simple.

Priest Abilities (see **Rifts Conversion Book Two: Pantheons of the Megaverse**): Exorcism 63%, healing touch (1D8 S.D.C./hit points or 1D4 M.D., as often as once every other melee), remove curse 63%, resurrection 32%, turn dead 60%, prayer of strength 84%, prayer of communion 84%, prayer of intervention 63%, miracles 61%.

Psionic Powers: None

Combat Skills: Hand to Hand: Expert

Attacks per Melee: Four hand to hand or two by magic.

Bonuses: +2 to strike, +3 to parry and dodge, +2 to roll with impact/punch, +2 to pull punch.

Weapon Proficiencies: W.P. Sword, W.P. Blunt, W.P. Archery and Targeting, W.P. Energy Pistol, W.P. Energy Rifle.

Weapons of Note: A Holy Sword that is an indestructible rune weapon that inflicts 4D6 + 6 M.D., and can perform healing touch (2D6 Hit Points or M.D.C.) six times every 24 hours; a gift from Hyr. He also uses a bow firing both conventional, high-tech and magic arrows, as well as having a fondness for Kittani plasma blades, vibroblades and techno-wizard (TW) weapons.

Armor: Enchanted chain mail with 120 M.D.C. and which is light-weight and regenerates five (5) M.D.C. points per hour; another gift from the Gods of Light.

Skills of Note: Radio: basic 58%, fishing 88%, detect ambush 88%, detect concealment 83%, tracking 78%, demon and monster lore 93%, religion lore 98%.

Description: An athletic man, with long grey hair and a goatee. Most of the time, he is dressed in his magical chain mail armor under a red cloak, or wears a simple but elegant blue tunic and pants.

Lightdancer

Elven Ley Line Walker

A few elven communities have appeared on Earth. Elric Lightdancer's people settled in a remote area of Europe one hundred and fifty years ago. He was among the first elves born on this planet. The elven community is dedicated to the study of magic, thus, as soon as it was determined he had the talent, Elric's family taught him the mystical arts. This academic life felt boring and stifling, however. One day, shortly after attaining adulthood, Lightdancer decided to leave his village and explore the world. He quickly discovered that Europe was strongly biased against non-human races, and those who welcomed such abilities were inhuman monsters with a distinct dislike for elves. At one point, he had to flee for his life to England, where he spent several years amidst the Druids and their awesome Millennium Trees (see **Rifts England**). He was honored by receiving several gifts from the great tree. Eventually, he was again consumed by wanderlust so he traveled to North America.

The Coalition States were another bastion of racism and bigotry. Annoyed, Lightdancer decided to have some fun at the Coalition's expense. His practical jokes angered and embarrassed the authorities and caused millions of credits' worth of damage. To this day, he is a wanted felon and several bounty hunters have tried to collect the reward for his head. DemonBusters helped Lightdancer when he inadvertently released a demonic creature trapped at a ley line nexus. After the battle was over, Lightdancer said, "Hey, that was fun. You guys do this for a living?" Lightdancer became a DemonBuster and he has been having fun ever since.

Full Name: Elric Lightdancer

Alignment: Anarchist.

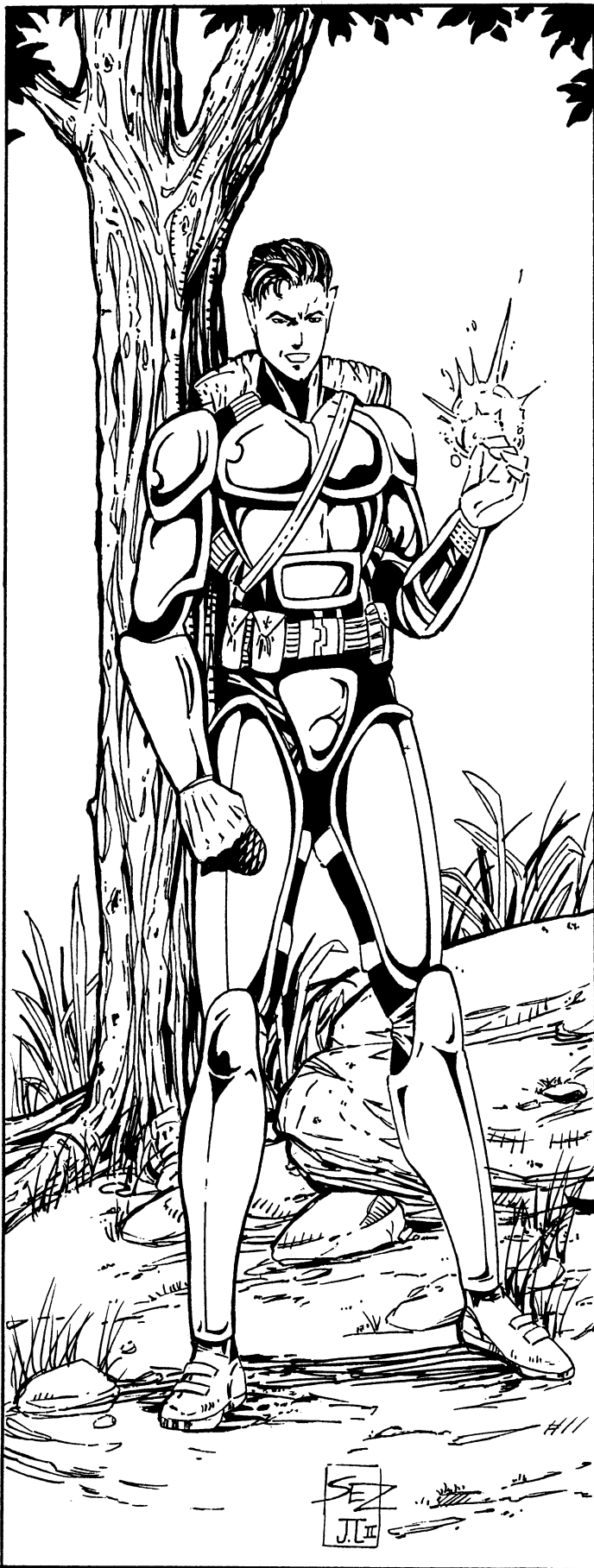

Size: Six feet, two inches (1.88 m), 180 lbs (81 kg).

Age: 80 years old, but looks 20.

P.P.E.: 186

Disposition: Lightdancer is the court jester of the company (he prefers to think of himself as the swashbuckler). He always tries to see the light side of every situation, no matter how deadly serious it might be ("A city of vampires? Dental care must be pretty good in there."). His practical jokes, puns and sense of humor are legendary. The practical jokes often involve magic and illusion, making them all the more impressive. Whenever he meets a new person, Light Dancer tries to see how far he can go before angering him or her. Unfortunately, self-control and knowing when to stop are not two of his virtues. Consequently, Lightdancer frequently pushes the limits of everyone around him and often goes too far. As a result, most people stop befriending him after a while, and stay clear to avoid his annoying antics. The only constant friends he has are Delgado (who is fairly thick-skinned, literally and figuratively) and Fireteam Alpha, who like the elf despite his annoying pranks (they always pay him back somehow). Cutter and Lightdancer have been described as friendly enemies, but both secretly respect and like each other more than either would dare to admit.

His saving graces are his quick mind, cleverness, imaginative resourcefulness and ability to keep a cool head even under the most frightening and deadly of circumstances. He is a brave warrior and a poker player with few peers.

Experience Level: 8th level ley line walker

Magic Knowledge: In addition to the usual ley line walker abilities, Lightdancer knows the following spells and rituals: Blinding flash, cloud of smoke, globe of daylight, see the invisible, sense magic, befuddle, chameleon, concealment, levitation, mystic alarm, turn dead, armor of Ithan, breathe without air, fingers of wind, ignite fire, impervious to fire, paralysis (lesser), astral projection, carpet of adhesion, blind, charismatic aura, magic net, shadow meld, horrific illusion, apparition, call lightning, fire ball, mask of deceit, invulnerability, and exorcism.

Psionic Powers: None

Combat Skills: Hand to Hand: Basic

Attacks per Melee: Three hand to hand attacks or two by magic.

Bonuses: +1 on initiative, +3 to strike, +4 to parry and dodge, +2 to damage, +2 to roll with impact/punch, +2 to pull punch, +3 to save vs magic, and +4 to save vs horror factor.

Weapon Proficiencies: W.P. Energy Pistol, W.P. Sword, W.P. Archery and Targeting.

Weapons of Note: Vibro-saber, TX-5 energy pump pistol, Coalition C-27 plasma cannon, TW water pistol, silver cross, silver dagger, and a long bow (he uses magic, high-tech and conventional arrows).

Armor: Crusader Body Armor (M.D.C. 55).

Skills of Note: Climbing 80%, land navigation 77%, wilderness survival 80%, pilot hover craft 98%, demon lore 80%, basic math 98%, Dragonese/Elven 98%, American 98%, Euro 98%, first aid 95%, intelligence 74%.

Description: A tall, handsome Elf, with black hair, twinkling eyes, and a mischievous smile.

Fireteam Alpha

A special team within DemonBusters

Some matches are made in Heaven. Most people who've become acquainted with Fireteam Alpha believe this particular match was made in a much warmer place. Lady Arson and her lover Zippo love fires. Perhaps because they can start them at will. This team of fire-manipulators recently joined DemonBusters, at the behest of General Smith. He decided their powers would be useful to the company and that the two young mutants were too dangerous to be left unsupervised. His

Attributes: I.Q. 19, M.A. 9, M.E. 14, P.S. 14, P.P. 18, P.E. 15, P.B. 19, Spd. 10

Hit Points: 38 S.D.C.: 21

instincts were right. Fireteam Alpha has become a valuable asset to the company while usually staying out of serious trouble.

The couple lives in a fire truck-red Iron Maiden APC refurbished into a Recreational Vehicle. Painted on the sides is the name "Firebase Alpha." They wear garish red and yellow costumes, courtesy of Zippo who comes from a world where super-powered heroes and villains are commonplace. The twosome's personalities are as wild and passionate as the force they control. People either love them or hate them at first sight. Lightdancer has become their friend and Delgado often hangs out with the couple. They are also popular among the more free-spirited members of the company.

The two fire shapers like attacking from the air, Zippo using his natural flying powers, and Lady Arson using a jet pack. Against foes that are unaffected by fire, they use their plasma rifles or incendiary grenades. Zippo is not comfortable around guns and prefers to rely on his powers.

Lady Arson Of Fireteam Alpha

Janice Melbourne was born on the wrong side of Chi-Town. She never knew her father, and mother tried to shelter her from the shadowy world of the slums that surround the magnificent fortress city. The little girl grew up on the streets where she learned several street skills, but thanks to her mother's efforts, was fortunate enough to avoid any serious trouble. She even got a little schooling, learning high-society manners and even the outlawed skill of literacy. At fourteen, her good looks and poise managed to get her into Chi-Town proper, working as a maid for the wife of an important merchant. Sadly, the job turned out to be a curse. Janice's employer was a cruel, abusive woman who enjoyed demeaning the help. Janice bore the taunts and cruelty with dignity, even when the woman purposely made messes for the maids to clean up, or berated them for no good reason. The abuse increased, and was especially harsh against the beautiful, young Janice, who had to control herself from doing something rash.

Three years went by. The insults, demeaning jobs, and verbal abuse continued, but Janice kept telling herself she needed the job too much. Then everything came crashing down. Frustrated by Janice's patience (and jealous of her beauty and poise), the woman went too far, and struck the girl when Janice dared to talk back to her. Something snapped inside Janice, and, as she lost her temper, a latent power inside her also came alive. The woman burst into flames. Janice and the other servants managed to save her life, but the woman was horribly burned nonetheless.

Janice knew what she had become. She had heard plenty of horror stories about *burst*ers and other psychic creatures from her mother and friends. The CS government would hunt her down and kill her as soon as the woman regained consciousness and revealed what had happened. She was sure of it! Janice briefly considered finishing her off, but she couldn't bring herself to do it. Instead, she stole all the money and easy to sell valuables she could find in the house, and left the city.

In the Burbs, she met up with a few of her childhood friends, who had grown up to become city rats and other members of the underworld. They accepted her without questioning her new powers. Grateful, Janice joined them in committing petty crimes. Her nickname, Lady Arson, soon became well known in the Burbs and among the CS security forces. It didn't take long before Chi-Town became too dangerous for her. Colonel Lyboc (see **Rifts Sourcebook One**) and his minions almost captured her on a couple of occasions. She and three companions left Chi-Town just ahead of a Dog Boy pack nipping at her heels.

Lady Arson was outside her element in the wilderness. A city girl, she and her companions were unused to the strange creatures and the

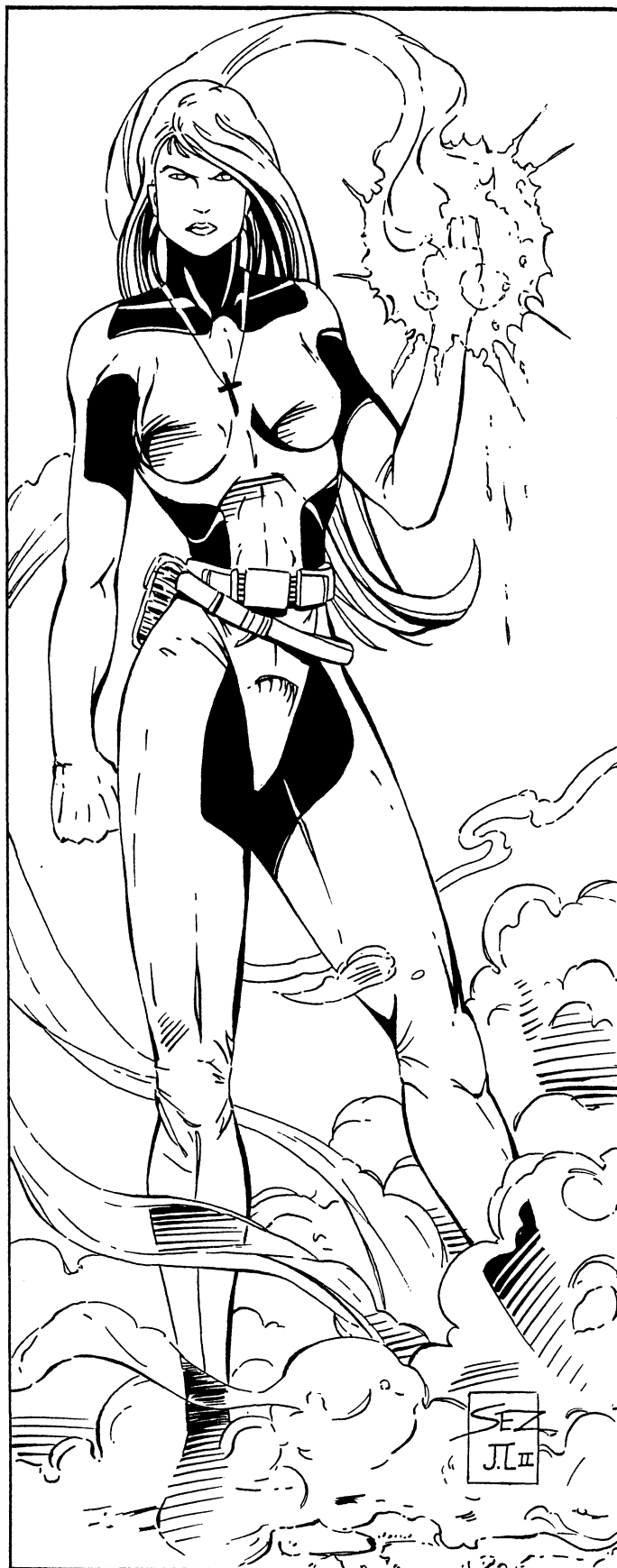

primitive cultures outside Chi-Town. The silence and open spaces scared her. Unable to return to the Burbs, she had no choice but to wander unhappily throughout the land. The next two years were dismal. One by one, the three friends who had accompanied her died in dangerous encounters.

The last fight occurred at an inn where she and her last childhood friend had been staying. It had been her birthday, and she had made the mistake of lighting the candles on her birthday cake with her burster powers. The superstitious town dwellers called the guards. They and a lynch mob surrounded the place and started shooting. Her friend died trying to protect her. Enraged, she burned down the inn, killing and injuring several people. Outnumbered, she would have been killed by the angry mob if a flying, flaming figure had not swept down from the sky and saved her. That figure was Zippo, a mutant from an alternate Earth who could turn his whole body into living flame. The rest is history.

Real Name: Janice Melbourne

Alignment: Anarchist.

Attributes: I.Q. 14, M.A. 11, M.E. 15, P.S. 9, P.P. 17, P.E. 17, P.B. 18, Spd. 8.

Size: Five feet, eight inches (1.73 m), 140 lbs (63 kg), **Age:** 20 years old.

Hit Points: 42, **S.D.C.:** 23

P.P.E.: 10

Disposition: The mistreatment Janice suffered during her childhood and early adolescence has left scars. Lady Arson finds it difficult to trust people and she is always unfriendly toward strangers and people from the Coalition States; usually receiving them with insulting comments. If people can get past the first bad impression and show Janice she can trust them, she will act like a different person. The nicer side of Janice is a surprisingly modest, shy young woman, who can be cheerful, fun and friendly.

Experience Level: 7th level burster.

Magic Knowledge: None.

Psionic Powers: All the usual Burster powers plus mind block, resist thirst and resist hunger. **I.S.P.:** 175

Combat Skills: Hand to Hand: Basic.

Attacks per Melee: Three hand to hand or psychic attacks.

Bonuses: +2 to strike, +3 to parry and dodge, +2 to damage, +2 to roll with impact/punch, +2 to pull punch.

Weapon Proficiencies: W.P. Energy Pistol, W.P. Energy Rifle, W.P. Sword, W.P. Automatic Rifle.

Weapons of Note: Wilk's 457 laser pulse rifle, a plasma rifle, AK-47 assault rifle loaded with silver bullets (for vampires and supernatural creatures), TX-5 pump pistol, vibro-sword, and a silver plated S.D.C. sword (1D6+2 damage).

Equipment of Note: Wilk's Jet Pack (M.D.C. 20).

Armor: Red and gold Bushman armor (M.D.C. 60).

Skills of Note: American 98%, Spanish 98%, piloting: tank and APC 66%, piloting: jet pack 80%, streetwise 58%, prowl 70%, concealment 58%, pick locks 75%, running.

Description: An attractive, blonde girl with hazel eyes, and an athletic, slender figure.

Zippo Of Fireteam Alpha

Michael Doherty was born in the world of **Heroes and Villains Unlimited**. A place where costumed super-heroes fought for justice, survival, or profit, depending on their ideals. He did not know he was a mutant until his sixteenth year, when he spontaneously burst into flames during a confrontation with muggers. Michael came to enjoy his new powers, adopted the nickname Zippo, and shortly afterwards, joined a group of heroes called the **New Guardians** (he never found out who the "old" Guardians were). The team was led by a wizard code-named Merlin, who claimed he was the ancient magician from Arthurian legend.

The New Guardians had many adventures, fighting everything from small-time crooks to world-threatening arch-villains. A recurring villain was another wizard who called himself **Doombringer**. His plots in-

involved the summoning of demons and other extra-dimensional creatures to the world. On their last battle, the New Guardians followed Doombringer through a dimensional portal and battled him in a world populated by monstrous creatures. This time, the heroes were in over their heads. Doombringer's minions were hundreds of powerful demons. One by one, the New Guardians perished. Zippo felt true fear for the first time. The portal that Merlin had created had remained open. When only he and Merlin stood to face the mounting hordes, he flew through the portal without thinking. He barely escaped the thronging demons. The last thing he saw was Merlin, staff twirling, fighting Doombringer and surrounded by monsters.

Zippo had thought the dimensional portal would take him back to Earth, where he might enlist help from other super beings. To his shock and amazement he was flung to a planet called Earth, but not the one he had left. This world was more advanced and more barbaric at the same time. On his world, he had been admired for his powers. On this one, he was called a "D-Bee" and hunted down like an animal. Fighting for Truth and Justice was a lot harder when you were branded a monster just for existing. Despondent, still hurting after the deaths of all his



friends, Zippo briefly turned to crime. Destiny brought him to a town where he found a lynch mob surrounding a fire-using human. Their similarity in powers and plights struck a deep chord within, sending him to her rescue. Thus he met Lady Arson.

The two found they had a lot more in common than their powers. Friendship quickly turned into love and the two became a couple; married in their hearts, if not officially. They adopted an "us against the world" attitude and were determined not to trust anybody else. Neither of them enjoyed committing crimes and hated pulling the most petty acts. Lady Arson had experienced too much cruelty to inflict it on others and Zippo was still infused with the heroic mentality of his

world. After a while, they gave up crime and became a two-person mercenary force. They became bodyguards, commandos, and defenders of small communities and large businesses, provided the price was right. Regrettably, they often caused a lot of collateral damage but didn't care as long as they got the job done. While no innocents suffered directly, the cost of damages were often greater than the pay they received. All of this would have eventually ruined their reputation. Fortunately, they met General Smith and his DemonBusters during a fight against a swarm of malignant (see **Rifts Conversion Book One**) who had created a monstrous anthill in the woods surrounding a town. The General liked Fireteam Alpha's style and sensed that they were too young and inexperienced to survive for long on their own. Michael was equally impressed by General Smith. Zippo quickly realized that the man was from 20th-Century Earth, but not "his" Earth.

Zippo has also learned from Lightdancer about the wizard Mrr'lyn of England. He thinks that this might be his old team leader, Merlin. He has told Janice that one of these days they should pay the wizard a visit. If he ever gets to see Mrr'lyn, he'll realize his mistake and may get into trouble.

Real Name: Michael Doherty

Alignment: Anarchist.

Attributes: I.Q. 11, M.A. 12, M.E. 15, P.S. 13, P.P. 9, P.E. 18, P.B. 11, Spd. 12.

Natural M.D.C.: 80 M.D.C. (or 220 M.D.C. when in fire form).

Size: 6 feet (1.83 m) tall, 170 lbs (76.5 kg). **Age:** 22

P.P.E.: 14

Disposition: Zippo still behaves like a costumed hero, addressing people in a loud, clear voice and saying things like "It's all right, I'll protect you," or "Did you really think you would get away with this?" Before coming to Rifts Earth, he'd only killed once, and that was by accident. Since his arrival to Rifts Earth, he has had to kill many evil beings, both supernatural and human. Those deaths have affected him to the point that he fears he may be becoming a villain. Only the fact that DemonBusters is engaged in defending innocent people from evil monsters, and Lady Arson's unwavering moral support, keep him from sinking into a depression.

Experience Level: 9th level Mutant from a different dimension.

Magic Knowledge: None

Psionic Powers: None

Super Abilities: Extraordinary physical endurance and alter physical structure: fire.

Combat Skills: Hand to Hand: Martial Arts.

Attacks per Melee: Four hand to hand attacks per melee

Bonuses: +3 to strike, +3 to parry and dodge, +2 to roll with impact/punch, +2 to pull punch, +2 to save vs poison, +2 to save vs magic.

Weapon Proficiencies: W.P. Energy Rifle, W.P. Energy Pistol.

Weapons of Note: Ceramic water rifle and a C-14 "Fire-Breather" Coalition laser rifle.

Armor: None. He wears a red and yellow costume that does not burn away when he is in flame form (a gift from his old super-buddies).

Skills of Note: Computer operation 90%, computer programming 80%, intelligence 73%, photography 85%, English/American 98%, and literacy in English 98%.

Description: Michael is lean and athletic, but not muscle bound. He has dark red hair and freckles, making him look a lot younger than he really is.



Delgado Hatchling Dragon

Delgado was born somewhere in the wilderness of the American Northwest, abandoned by his parents like most dragons. Weeks after his birth he met Joseph Delgado, an aging wilderness scout who had gotten tired of human society and decided to live by himself in the hostile forests of North America. Joseph was not afraid of the 20-foot long hatchling. Instead, he was friendly and curious in a detached sort of way. This tiny mortal human intrigued the young dragon, the two became friends, and a father-son relationship developed. Joseph's experience and common sense has deeply influenced the dragon who also learned many human skills from his tutor. This friendship lasted for twenty years, until the 73-year old Joseph died during a harsh winter. The dragon adopted his mentor's last name as a tribute.

Having grown accustomed to the companionship of humans, Delgado found himself missing it and set off toward human settlements. His old friend had warned him about the fear he would inspire in most humans, so he tried his best to conceal his nature, keeping a human form as long as he could. Every time he managed to befriend some humans, however, he was eventually forced to reveal himself, striking terror or suspicion in the hearts of most of his former companions.

Meeting General Smith changed all of that. They first crossed paths shortly before he founded DemonBusters. The General had been hired to rid a city of the dangerous and cunning dragon who often disguised himself as a human (for who knows what insidious purpose)! Of course, the dragon was Delgado. After finding the creature and talking with him, The General realized the young dragon meant no harm and forfeited his fee by allowing the dragon to escape. A few years later, Delgado heard of General Smith and his mercenaries and offered to join. He has been living happily among humans ever since. His fellow mercs



know he's a dragon and they consider him to be a trusted and valuable comrade-in-arms.

Alignment: Scrupulous

Species: Great Horned Dragon

Attributes: I.Q. 21, M.A. 14, M.E. 19, P.S. 26, P.P. 18, P.E. 27, P.B. 22, Spd. 18.

M.D.C.: 350

P.P.E.: 110

Natural Abilities: Fly 70 mph (112 km), nightvision 90 ft (27.4 m), see the invisible, fire and cold resistant (does half damage), and can bio-regenerate 1D4 × 10 M.D.C. every five minutes. Metamorphosis (lasts 12 hours), teleport 40%, and fire breath (2D6 M.D., 60 ft/18.3 m range).

Disposition: Delgado is an extremely likable person. He is free of the arrogance so common among dragons and is a friendly, kind and compassionate individual. The simple philosophy of his "father" has made him humble and reasonable. He wants very much to be liked by others and goes to great lengths to avoid scaring or intimidating others. Delgado is also very protective of humanoid children of any race and will go to great lengths to protect them.

At DemonBusters, the dragon gets along best with Lightdancer, with whom he can practice his native tongue, and Lady Arson and Zippo, who have sort of "adopted" him (of course, Delgado is actually wiser than either of them). During his career, he has met (and fought) several dragons and has not been impressed by their megalomania and sadism. He is developing profound contempt for his race, whom he considers self-centered monsters with no regard for those less fortunate than them. One day, Delgado hopes, he'll meet a dragon he'll like.

Experience Level: 6th level Dragon Hatchling

Magic Knowledge: Full understanding of magic and can use all types of techno-wizard equipment. He knows the following spells: Invulnerability, negate magic, heal wounds and magic net.

Psionic Powers: A major psionic with the following powers: Detect psionics, exorcism, healing touch, psychic surgery, astral projection, empathy, mind block, telekinesis, clairvoyance, see aura, sense evil, and sixth sense. **I.S.P.:** 100.

Combat Skills: Hand to Hand: Basic

Attacks per Melee: Four hand to hand or psychic attacks or two by magic.

Bonuses: +3 to strike, +4 to parry and dodge, +11 to damage, +2 to roll with impact/punch, +2 to pull punch, +6 to save vs poison, +6 to save vs magic, +2 to save vs psionics, +2 to save vs horror factor.

Weapon Proficiencies: W.P. Energy Rifle.

Weapons of Note: Northern Gun NG-E4 plasma ejector, TW water cannon, four storm flares and two globe of day light flares.

Armor: Never wears any, except for disguise.

Skills of Note: Dragonese/Elven and American, both at 98%, basic math 98%, wilderness survival 67%, land navigation 67%, detect ambush 67%.

Description: In dragon form he is an imposing horned dragon. His commonly used humanoid form is that of a rugged, unshaven man in his late 40's with a slightly receding hairline and white hair pulled into a ponytail — the living image of his old friend and mentor, Joseph Delgado.



The Dreamer

Psionic Immortal

The woman who calls herself The Dreamer is an enigma to the rest of the DemonBusters. Only General Smith seems to know and trust her. Two years ago, she appeared out of nowhere and joined the team. Her origins and her link to The General, remain unknown, but he has placed her in a position of importance in the group; something that

veterans like Cutter resent. Some people have started rumors that the woman is mind-controlling their leader, but Delgado and the other psionic members of the team claim this is not so. Others think that she also comes from the 20th century, Zippo among them.

The Dreamer was, in fact, born before the time of the rifts and is over two thousand years old! She is one of the last members of an ancient psychic race that appeared on Earth after the sinking of Atlantis. The name of the race has been forgotten — only some Atlantean scholars have heard of it, and they refer to its members as “The Lost Ones.” These supernatural beings have never numbered over a hundred. Most of their women never bear more than one child every two or three centuries and procreation with humans is not possible. Their immortality, incredible resistance to harm, and psionic powers resulted in their being worshipped as gods by primitive cultures. In later centuries, many Lost Ones were accused of being witches or demons and were persecuted.

The Dreamer has had hundreds of names during her lifetime. During the Roman Era, she was worshipped as a goddess by a secret cult, which was eventually hunted down by the Imperial authorities. In the Middle Ages and the Renaissance, she fled the Inquisition and married into half a dozen noble houses of Europe. She continued doing so until the turn of the 20th century.

General Smith met The Dreamer in 1990, while he was searching for an ancient vampire hiding in the Black Forest of Germany. She was a noblewoman who had kept her centuries-old title by using makeup to simulate aging and then passing on the title to her only “daughter.” Smith’s research revealed the woman to be an immortal. At first he thought she was a vampire, but during the ensuing confrontation, the true vampire was unmasked and destroyed. Soon after, Smith and the Dreamer became lovers. Eventually, Smith moved on, feeling too intimidated by the fact that she would never grow old while he would become feeble and eventually die. Not too long afterward, he disappeared into the Megaverse.

The Dreamer continues her ages-long existence. She is one of the few living witnesses to the Coming of the Rifts, an event she still refuses to discuss — it was one of the few events that has truly traumatized her. When she met Smith again, whom she believed long dead, the Lost One decided to join him. Smith was shocked by the reunion and realizes he is still very much in love with the enigmatic immortal.

Listed in parentheses are the attributes of The Lost Ones R.C.C., an optional player character.

Alignment: Unprincipled

Attributes: I.Q. 21 (3D6 + 6), M.A. 18 (3D6 + 6), M.E. 25 (4D6 + 5), P.S. 17 (3D6 + 4), P.P. 17 (4D6), P.E. 17 (4D6), P.B. 22 (3D6 + 6), Spd. 16 (4D6 + 4). Supernatural strength and endurance.

Hit Points: Supernatural mega-damage creature

Natural M.D.C.: 110 (3D6 × 10 M.D.C.)

Size: 6 feet, 3 inches tall (1.90 m); 140 lbs (63 kg).

Age: 2391 years old, give or take a few years, but looks to be 30.

P.P.E.: 17

Disposition: Dreamer has a remote, unearthly presence. Her beauty is breathtaking and she has enormous presence and charisma. This intimidates most people and makes them fear or even hate her on sight. She is extremely intelligent and wise, but also proud and arrogant. Over the centuries, she has lost patience with the mistakes humans make over and over, like their insane idea of stockpiling weapons that could lay waste to their planet, while hoping they would never have to use them. Her unique historical perspective has shown her that if you have a weapon, you’ll probably use it, for good or ill.

Brother Lance is one of the few people, besides The General, who seems to feel comfortable around her and the two often talk for hours. He suspects she is a supernatural creature, perhaps a

demi-god or godling. However, Dreamer remains secretive and will not reveal her origins or her true age to the priest. This frustrates him, but the two remain cordial and friendly toward each other.

Lightdancer respects her a lot she is one of the few people who can put the elf in a serious mood (and is rarely the butt of his jokes). Cutter is sure that she is some sort of witch or demonic creature and is itching for an excuse, any excuse, to destroy her. Dreamer knows this (it’s hard to hide such intense hatred from a psychic such as she), but she is not afraid of him and knows that in a couple of years the situation will correct itself (that’s how long Cutter has to live). Of course, it’s perfectly possible that the juicer will try to take Dreamer with him when he goes.

Experience Level: 9th level Lost One (equivalent to a 9th level Mind Melter).

Magic Knowledge: None.

Psionic Powers: Master Psionic. Knows the following powers: All healing and physical powers plus see aura, sixth sense, astral projection, clairvoyance, empathy, object read, presence sense, sense evil, sense magic, telepathy, total recall, bio-manipulation, bio-regeneration, electrokinesis, empathic transmission, group mind block, hypnotic suggestion, mind block auto-defense, mind bolt, P.P.E. shield, psi-shield and psi-sword (10D6 M.D.)! **I.S.P.:** 412 (1D4 × 100 plus 3D6 per level)

Combat Skills: Hand to Hand: Basic.

Attacks per Melee: Four hand to hand or psionic attacks.

Bonuses: +3 to strike, +4 to parry and dodge, +2 to damage, +2 to roll with impact/punch, +2 to pull punch, +3 to save vs magic, +1 to save vs poison, +5 to save vs psionics, +6 to save vs horror factor.

Weapon Proficiencies: W.P. Sword, W.P. Archery and Targeting, W.P. Energy Pistol, W.P. Energy Rifle.

Weapons: TW TK-Machinegun, TW flaming sword, vibro-saber.

Armor: TW-modified Bushman Armor (M.D.C. 60) with the following spells (all at 6th level): armor of Ithan, invisibility: superior (self) and superhuman strength.

Skills of Note: Speaks American, Dragonese/Elven, Euro and Atlantean, all at 98%, literacy Atlantean, American and Dragonese 98%, Demon Lore 88%, piloting: tank and APC 60%, wilderness survival 93%.

Description: A goddess-like, almost ethereal woman with flowing black hair and large, exotic greyish-green eyes. When not in battle armor, she wears a simple white robe and sandals.

Lieutenant Paul Konrad Glitter Boy Trooper

One recent DemonBusters operation involved destroying an adult Hydra whose rampage threatened an entire city. The encounter was very lethal and DemonBusters discovered that it did not have enough firepower to confront major supernatural entities of this magnitude. To prevent any future occurrences (and to replace the dozen or so troopers that died or were crippled in the encounter), General Smith started looking for an armored combat unit. His search was over when he met Paul Konrad and the Golden Squad.

Konrad was born in Free Quebec, where he was raised to distrust all non-humans. He displayed exceptional physical talents and was encouraged to enroll in the army. Unlike most CS members, Quebec maintains a large force of Glitter Boys and Konrad’s ability made him a natural as a Glitter Boy pilot. As expected, he excelled at training and soon became a platoon commander. His promising career came to a crashing halt as the result of a joint military maneuver conducted between Free Quebec and Chi-Town. Emperor Prosek wanted to see how well units from different States could work together. He had his doubts about the level of training and skill quality outside Chi-Town.

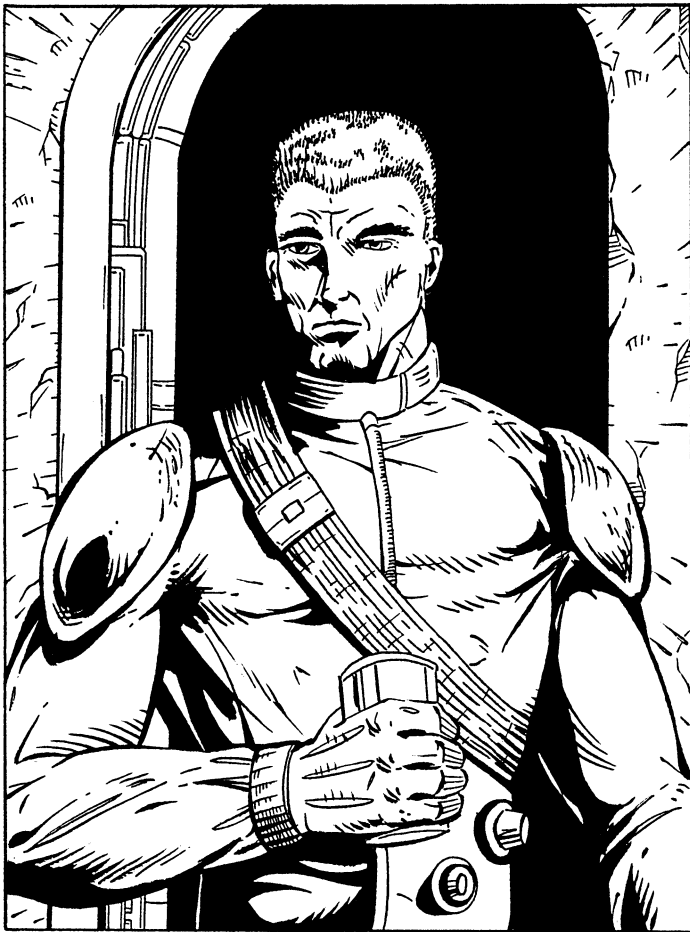

SEZ
JL II / SIEMIEDA

The maneuvers consisted of several cooperative battle drills. The Free Quebec military assigned several units of Glitter Boys to participate, which caused some tension to begin with — the Coalition does not approve of that armor type. Konrad, a skilled and promising officer, was a natural for the mission.

During maneuvers, a corrupt CS officer decided this was an opportunity to make some money. Selling CS standard equipment to the black market was extremely dangerous, since it could be traced back to the unit. On the other hand, if a dozen or so Glitter Boy units “deserted” during the maneuvers, the Quebec government would look bad and the Glitter Boys could be safely sold outside the Coalition. He and his corrupt armored company set up an ambush for Konrad’s platoon. The plan was to surround the Glitter Boys with overwhelming forces, make them surrender and step out of their suits.

Konrad detected the ambush and when the CS units started firing on them using live ammo, he ordered his platoon to return fire. In a matter of a few minutes, Konrad’s unit had decimated the ambushers. In desperation, the corrupt CS officer radioed for help, claiming that Konrad had gone rogue and was attacking without provocation. The commander-in-chief, who had little love for the arrogant Quebecois anyway, had no trouble believing the story and ordered all units to search and destroy the rogue platoon. Only six of the ten suits escaped from the scene. In an effort to make the remaining renegades surrender, Chi-Town authorities imprisoned the wives and closest relatives for the “crimes” of the platoon. In a daring move, Konrad and his squad managed to rescue the family members and escaped into the wilderness. The corrupt factions that instigated this travesty of justice have created such an unshakable story of apparent treason that even the most skeptical authorities at Free Quebec must recognize the soldiers as renegades and Enemies of the States. Konrad and his men (all of whom are extremely

loyal to him) had no choice but to leave their homeland in shame as outlaws.

The Glitter Boy platoon became a small mercenary unit. General Smith heard of them and, after checking their history, decided that Konrad and his men would be an excellent addition to DemonBusters. Konrad was easily convinced to join. He was uncomfortable with being an independent mercenary team. DemonBusters was attractive for two reasons, their goals were similar to the ideals he had come to cherish — the protection of humankind against the extra-dimensional threat, and the responsibility of running the operation and keeping food on the table was no longer his concern. Konrad and his troops accepted the offer and have been happy with the arrangement. However, they are still a bit uncomfortable working with what Konrad refers to as “undesirable elements” (non-humans), but have come to respect each and every member of the company, professionally if not personally.

Alignment: Aberrant

Attributes: I.Q. 12, M.A. 16, M.E. 15, P.S. 21, P.P. 23, P.E. 18, P.B. 10, Spd. 18

Hit Points: 47 S.D.C.: 66

Size: 6 feet (1.83 m) tall, 170 lbs (76.5 kg). **Age:** 29

P.P.E.: 4

Disposition: A brave and brilliant soldier, Konrad is an expert in small unit tactics. He is one of the most accomplished power armor pilots on the continent and is recognized and feared for it. Some people say the reason he joined DemonBusters was that no mortal human could match him on the battlefield and he sought more challenging foes. Konrad is very proud of his skill and the fame that follows it. An extremely honorable man, Konrad is also a fervent human supremacist and is overtly suspicious of non-humans. He is perfectly capable of committing atrocities against D-Bees. He only restrains himself because of General Smith’s authority and the fact that there are many targets that are more worthy than helpless civilians. His only close friend outside his own squad (all of whom consider him a father figure) is Cutter, who shares his prejudices.

Experience Level: 10th level Glitter Boy

Magic Knowledge: None

Psionic Powers: None

Combat Skills: Hand to hand: martial arts plus boxing and wrestling. Robot combat: elite and robot combat: basic.

Attacks per Melee: Five hand to hand attacks (does not include bonuses when operating power armor or bot vehicles).

Bonuses: +2 on initiative, +6 to strike, +9 to parry and dodge, +6 to damage, +5 to roll with impact/punch, +3 to pull punch, +2 to save vs poison, +2 to save vs magic.

Weapon Proficiencies: W.P. Energy Pistol, W.P. Energy Rifle, W.P. Knife, W.P. Automatic Rifle, W.P. Archery and Targeting.

Weapons of Note: 12 hand grenades, NE-4P plasma cartridge pistol, NE-10 plasma cartridge rifle, ceramic water rifle, AK-47 assault rifle (usually loaded with silver bullets). His Glitter Boy Armor’s Boom Gun can also fire a special wooden flechette round for anti-vampire purposes: inflicts 2D6 M.D., but 5D6 × 10 H.P. to vampires!. Range is only 2000 feet (610 m).

Armor: Glitter Boy personal armor (25 M.D.C.) or Gladiator armor (70 M.D.C.)

Skills of Note: Speaks American, French, Euro, all at 98%, land navigation 80%, basic electronics 90%, basic radio 98%, demolitions 98%, demolitions disposal 98%, read sensory equipment 90%, weapon systems 98%, navigation 95%, wilderness survival 80%, intelligence 72%, pilot robots & power armor (specifically Glitter Boy, SAMAS & Titan series).

Description: A ramrod-straight, tall man built like a pro football player with a crewcut, always clean-shaven.

Other Personnel

Other important characters include: Josh Brennan (7th level 'borg), Dr. Marcus (9th level Techno-Wizard), Shade (8th level Psi-Stalker), and Illyana Kovacks (6th level Summoner). The group also has the following combat effectives (not counting support personnel like mechanics, nurses, etc.).

- 3 Techno-Wizards, levels 2, 3 and 5.
- 4 Mystics, levels 2-4.
- 4-6 Psi-Stalkers, levels 2-4.
- 6-8 Dog Boys, levels 2-5.
- 5-8 Borgs, levels 2-5.
- 8-10 Juicers, levels 2-5.
- 5-10 Crazyes, levels 2-5.
- 6 Glitter Boy troopers, levels 4-6 (Konrad's squad).
- 18-25 Headhunters, levels 3-6, all trained in power armor or robot piloting.
- 7-15 Special Forces Soldiers, levels 1-7.
- 9-12 Wilderness Scouts, levels 1-5.
- 8-10 Freelance Spies, levels 1-5.
- 2-4 Super-Spies, levels 2-6
- 2-4 Assassins, levels 1-5.
- 1-2 Safecrackers, levels 3-7
- 5-10 additional soldiers (Vagabonds or Headhunters, levels 1-3), hired for short-term periods.
- 90-120 combat effectives total.

Non-Combatants: There are another 200 to 300 non-combatants, including family members (many of DemonBusters' soldiers take their families along — it's safer!), mechanics, medics, maintenance personnel, communication specialists, and merchants/suppliers. Adults belong to non-adventuring O.C.C.'s, levels 1-5; about 60% have some combat training (Hand to Hand: Basic, and 1D4 W.P.s) but are not paid to fight, although they will defend themselves if the camp is attacked.

Weapons and Equipment

Standard Issue Weapons

- Wilk's 457 Laser Pulse Rifle.
- MP-23A Caseless SMG with Ramjet and silver rounds.
- Conventional Water Pistol with Holy Water.
- Body Armor: Either Plastic Man or Crusader Body Armor; Explorer armor for elite combat units.
- Flashlight, compass, sleeping bag, short-range radio, foodstuffs, survival knife and other basic equipment.

Transport Vehicles

DemonBusters has no permanent headquarters, so they have a vehicle convoy able to transport over 300 people. The following vehicles are used for transport, and are never risked in combat (unless the convoy itself is attacked, of course).

- 6 Big Boss A.T.V.'s (Main Body: 80 M.D.C.; tires: 8 M.D.C.). Armed with machineguns.
- 8 Mountaineer A.T.V.'s (Main Body: 200 M.D.C.). Armed with NG-202 Rail Guns.
- 4 Converted Iron Maiden APCs (full weaponry kept, but modified to serve as living quarters).
- 10-12 S.D.C. Trucks and Buses. These carry the bulk of the non-combatants and material.

Combat Vehicles

- 4 Speedster Hover Cycles: Equipped with NG-P7 converted particle beam rifles.
- 6 Sky King aircraft
- 2 Iron Maiden APCs
- 4 Titan Combat Robots

- 4 Titan Light Combat Robots
- 4 Titan Reconnaissance Robots
- 6 Glitter Boy Suits (Konrad's squad)
- 2 Predator Power Armor
- 8 Samson Power Armor
- 4 Flying Titan Power Armor

Adventure Ideas

Described below are some brief adventure ideas for use with DemonBusters. The Player Characters can be members of the company, or they might be drawn into the adventure for other reasons. Any adventure group is likely to run into some of the DemonBusters at some point or another.

Trapped!

DemonBusters is summoned to a small town in the wilderness to destroy a group of monsters terrorizing the area. It turns out, however, that the whole town (or most of it) is made up of monsters! The creatures have captured several important members of DemonBusters and the rest of the company is away on another mission and may not even know their teammates are in trouble! The player characters can be hired to help, decide to help out of principles or might be trying to destroy the monsters for their own reasons. Alternately, the principles in this adventure can be flipped around; the player characters could be the victims of the town, trapped and hunted by monsters and some of the DemonBusters arrive and save the day.

Doctor Reid, I presume.

Vampire attacks are multiplying South of the Rio Grande. Several towns and cities pool their resources and hire DemonBusters for an extended tour against the vampires of Mexico. The company is given a lot of money and equipment, including enough cash to hire additional mercenary forces (the player characters could be part of one of these "subcontractor" groups). Some non-mercenary groups of would-be heroes and paladins are also joining the effort.

The problem is that the Mexican frontier already has a protector: Doc Reid and his Rangers (see **Rifts Vampire Kingdoms**). Reid is not happy that he wasn't offered the chance to lead this effort, but he is quick to offer the support of his people. At first, the multiple alliance seems to work well. General Smith listens to Doc Reid's advice and several vampire bands are exterminated. Soon, however, complications arise. Here's a few possibilities. Use one or all.

- Personality conflicts: Doc Reid is used to being in charge. When he and The General have disagreements and Smith goes ahead with his own plans, Doc Reid (or some of his misguided followers) start to sabotage the war efforts. Doc Reid isn't likely to do anything direct, but sometimes his troops don't show up in time to support the other mercenaries, or they show up just as the DemonBusters look to be in trouble, creating the illusion of saving the day (but they're the ones who put the mission in jeopardy by not showing up on time). Similarly, Reid's men aren't cooperative, grandstand, allow supplies to vanish, and troop commanders squabble or take a lot of time getting to where they are needed. These little "political games" could put the lives of the player characters (among others) in danger. Tension begins to mount between The General's forces and the Rangers. Some of the more heroic Rangers may side with DemonBusters which will only cause more confusion and bitterness. Could this dissension lead to actual fighting? The only winners of this would be the vampires.
- Dragon Troubles: One of Reid's Rangers (Carlotta the Wise) is actually a young dragon. Delgado discovers this and tries to talk to her about her life among humans. His efforts are rebuffed, and Carlotta's lover, a twisted Cyber-knight called Sir Raoul Lazarious, becomes angry and jealous of Delgado and tries to have him murdered or ambushed.

- **Cutthroat Competition:** As the problems between Doc Reid and Smith intensify, the two “allies” stop working together, or coordinating their attacks. This means, for example, that our heroes could spend several days planning an attack on a vampire lair, only to discover on the day of the attack that the Rangers got there first, and worse, they didn’t get half of the vampires, who now have hidden elsewhere. Or one of the groups could blunder into an ambush prepared by the other and accidentally fight. In the end, the competition will hurt both groups.
- **A touch of Madness:** Some of the player characters and/or DemonBusters realize that the legendary hero, Doc Reid, is off his nut and some of the Rangers are self-serving or downright evil. The Doctor’s tactics and inhuman experiments, even though they are performed on loathsome vampires, may shock and repulse some of the characters and mercs, creating a moral issue and more misunderstandings (our heroes may be accused of being wimps, “vampire lovers,” spies or worse).

Transdimensional Employment

DemonBusters is approached by a mysterious D-Bee that offers them triple the normal combat pay for a short-term job. The

catch is, the job is not on Earth, but in the alien dimension of **Wormwood!** The D-Bee that hired them is a Temporal Wizard from the independent dimensional city of Worldgate (see **Rifts Dimension Book One: Wormwood**). The company is hired to rescue a Temporal Raider, who has found himself and a few allies surrounded by a large force of the Unholy’s minions in the mountains. The besieged Raider cannot use his magic to teleport away, because the demons have a magical device that negates all temporal magic. The normal enemies of the Unholy, the humans who serve the Cathedral, won’t help the people of Worldgate whom they consider a decadent, unworthy bunch. DemonBusters mission: Break the mountain siege and capture or destroy the magical device that negates Temporal Magic. The company is assisted by a small band of freelancers and other enemies of the Unholy. The player characters could be members of either group — an ideal situation to bring together old characters from a Rifts campaign with new ones from Wormwood.

What happens after the mission? Does the company decide to stay on Wormwood for a while? Do they explore? Work for Worldgate? Clash with The Cathedral or other forces? Or do they come back, bringing with them new allies from this strange world? This will be up to the GM and the players. Of course, this same basic premise can be used to take Rifts Earth characters to any number of strange dimensions.

Crow’s Commandoes

- A. Sponsorship: Secret (Ishpeming Government) 0 Points
- B. Outfits: Gimmick Clothing. 30 Points
- C. Equipment: Electronic Supplies and Good Gear. 5 Points
Medical Clinic. 20 Points
- D. Vehicles: Combat Cars. 20 Points
- E. Weapons: Advanced Weaponry. 20 Points
- F. Communications: Full Range System. 15 Points
- G. Internal Security: Iron-Clad. 20 Points
- H. Permanent Bases: None. 0 Points
- I. Intelligence Resources: Infiltration. 50 Points
- J. Special Budget: Small Potatoes. 15 Points
- K. General alignment of personnel: Anarchist. 2 Points
- L. Criminal Activity: None. 0 Points
- M. Reputation/Credentials: Excellent Reputation. 25 Points
- N. Salary: Good Salary. 10 Points

Total Points Spent: 232 Points

Size & Orientation: Free Company

Like many mercenary companies, Crow’s Commandoes are specialists. He and his troops are experts in counter-terrorism, small-unit combat, hostage rescue and covert operations. His team relies on stealth and skill rather than overwhelming firepower. Like the ninja of old, Crow’s Commandoes often accomplish their missions before the enemy realizes it. They also are the terror of criminals and guerrillas, because they can find their targets almost anywhere, whether they are hiding in a jungle, a city’s slums, or fortified sanctuary.

The company is a comparatively small, extremely well organized, elite force. Crow’s Commandoes or some of Crow’s Special Forces are often subcontracted by larger mercenary companies and kingdoms to perform special missions during a larger campaign. *Larsen’s Brigade* has tried several times to absorb the group, but Crow likes his independence too much for that. Despite this, Larsen and Crow get along very well and are professional friends — not that they would hesitate to take up contracts on opposing sides of a war, which thankfully hasn’t happened yet.

Tactics

Crow’s Commandoes are designed to perform small, surgical strikes. Their missions are small, but very effective; blow up a bridge or an armory, kidnap or assassinate a military commander, or rescue the hostages of terrorists, guerrillas, or bandits. The element of surprise is very important for the company, so it usually spends a good deal of time carefully planning the mission before going in. The Commandoes don’t have the weapons or equipment necessary to fight a full-scale battle; they much prefer to operate in the shadows and attack by surprise.

Company Colors and Banners

Crow’s logo is a black bird, its wings extended over a white background. Both uniforms and armor are black, but less shiny than the black preferred by the troops of the Coalition States and have different styling. Even so, Crow’s soldiers are often confused for Coalition troopers with embarrassing and occasionally tragic results.

Lieutenant Damian Crow

Damian Crow is a product of the Ishpeming military machine. Ishpeming (better known as “Northern Gun”) is a major military production center with a highly trained army. Crow was a cadet who quickly rose through the ranks, until a scandal involving a superior officer’s wife cut his career short (as Crow sometimes says when he is reminiscing, “She was well worth the cost of a military career.”). Dishonorably discharged, Crow was snapped up by *Illych’s Immortals*, one of the many merc units operating out of Ishpeming. His training continued there, and he became an expert in special operations (missions that require highly trained soldiers and which use unconventional methods). He soon commanded a crack unit of “Special Ops” troops.

Illych’s Immortals did not live up to the name. The company hired out to the wrong side of a war between the Manistique Imperium and a feudal kingdom. The Imperium won, but Commander Illych was unfortunate enough to poke his head out of his command tank just as a flying power armor trooper was firing missiles at the tank. With the



commander/owner's death, the company disintegrated. Crow and his crack unit of scouts, infiltrators and special forces troops decided to strike out on their own. He needed funds, however, and he talked to some people in Ishpeming. His offer was to act as an unofficial spy and secret agent (along with the rest of the company) in return for a large no-interest loan. He had enough connections in Ishpeming to get the deal and kept his side of the bargain, repaying about half of the loan and feeding Ishpeming important information about their neighbors and other nations in North America.

He called the mercenary company Crow's Commandoes, although he is aware that the term "commando" is properly applied to a unit, not to an individual (so, in military terms, it should have been called Crow's Commando). Since then, Crow has hired several non-humans with useful abilities and has added some magical capabilities to the team, believing the team needs to match magical countermeasures. Crow holds command and tactical control of Alpha Squad, which is the most highly trained force in the company.

Alignment: Unprincipled.

Attributes: I.Q. 18, M.A. 20, M.E. 15, P.S. 17, P.P. 21, P.E. 15, P.B. 16, Spd. 27

Hit Points: 52 **S.D.C.:** 56

Size: 6 feet, 3 inches (1.90 m), 190 lbs. (85.5 kg),

Age: 38

P.P.E.: 9

Disposition: Crow is usually in a state of relaxed confidence. He rarely gets tense or angry and is always sure that he or his team can handle any situation they get themselves into. He has a good head for strategy and tactics and is a military expert in the field of small-unit tactics. He is also a very persuasive talker, who has often served as a hostage negotiator to convince terrorists to give up. His composure, air of confidence and smooth talking has also enabled him to bluff his way out of more trouble than one would believe possible.

His only weakness is for women, or at least it was until he met Leila, his bodyguard and current lover. Crow still has a wandering eye, however, and that might get him into some serious trouble (hell hath no fury like a werejaguar scorned).

Experience Level: 11th level Special Forces Soldier

Magic Knowledge: None

Psionic Powers: None

Combat Skills: Hand to Hand: Expert, Power Armor Elite (Triax Ultra-Max) and Basic, and Robot Combat (Basic), and boxing.

Attacks per Melee: Five hand to hand attacks.

Bonuses: +1 on initiative, +5 to strike, +8 to parry and dodge, +5 to damage, +3 to roll with impact/punch, +2 to pull punch.

Weapon Proficiencies: W.P. Energy Pistol, W.P. Energy Rifle, W.P. Knife, W.P. Heavy, W.P. Automatic Rifle, W.P. Automatic Pistol.

Weapons: Wilk's 320 Laser Pistol, WI-23 Missile Launcher, Vibro-Knife.

Armor: Explorer Armor (M.D.C. 70) with Jet Pack.

Cybernetics: Universal headjack and ear implant with radio receiver and transmitter, amplified hearing, sound filtration system and gyro-compass.

Skills of Note: Radio: basic 98%, literacy 98%, computer operation 98%, intelligence 95%, pilot: tank and APC 94%, weapon systems 98%, read sensory equipment 98%, running, detect ambush 98%, detect concealment 94%, tracking 90%, wilderness survival 98%, pilot: jet pack 90%, prowl 94% and streetwise 78%.

Description: A striking, black haired, black eyed man with pale skin and a strong build. He has a trimmed moustache and beard and usually wears dark glasses. Even when not in uniform, he favors black and dark colors.



Leila Martinez

Werejaguar

Sometimes, Crow is seen with a huge, spotted cat. Other times, his female bodyguard is at hand. But nobody has ever seen the cat and the woman together. Crow's personal bodyguard is a female werejaguar

from Central America. Only a handful of officers in the company know her true nature. Leila is an excellent bodyguard and spy, and she works for the Commandoes in both functions.

Leila is a rarity among the Jaguar People. She grew up in Ciudad Juarez, raised by a human family who taught her about her powers and kept her safe from human and supernatural enemies. Her adoptive parents told her that they found her as an infant outside their farming village and don't know where she came from. She has never met another of her kind and is afraid that other werejaguars would reject or even kill her if they should ever cross paths. Instead of searching for her past, she chooses to look to the future and walk among humans. Her limited invulnerability (see Natural Abilities, below) makes it easy for her to serve as a proficient thief and assassin. For several years, she has worked as a covert operative engaged in all types of illicit activities.

She met Crow during one such mission. It was a case of love at first sight. Since that time, she has been his loyal bodyguard and friend. The two have more than a professional relationship, but keep it very quiet; less people know about their love affair than about Leila's being a werebeast.

Alignment: Anarchist.

Attributes: I.Q. 14, M.A. 21, M.E. 16, P.S. 19, P.P. 20, P.E. 21, P.B. 23, Spd. 29.

Hit Points: 61, **S.D.C.:** None (see Natural Abilities).

Size: 6 feet (1.83 m) tall as a human woman, 7 feet (2.13 m) tall in humanoid werebeast form and 5 feet (1.52 m) long in jaguar-cat form, 160lbs (72 kg) all muscle. **Age:** 24 **P.P.E.:** 70

Natural Abilities: Can speak even when in animal shape, prowl 80%, swim 60%, climb 90%/80%, acrobatics 80%, track by smell 60%, nightvision 300 feet (91.5 m), and bio-regeneration: restores hit points at the rate of 2D6 H.P. an hour.

Special: Limited invulnerability. Invulnerable to most weapons, including mega-damage energy weapons, explosives, bullets, fire, wood, steel, poisons and toxins. Vulnerable to magic, psionic attack and weapons made of silver (double damage).

Shape-Changing power: She can shape-change at will, day or night. The metamorphosis takes effect in 15 seconds (one melee) and there is no limit to the number of times the creature can perform a metamorphosis or how long she can maintain that particular shape. Her true form is that of a half-woman, half-beast, but can also turn into a giant jaguar, black panther or a human at will.

Disposition: Leila is very cold and distant towards people she doesn't know. Her green eyes have a dispassionate, predatory expression that intimidates most humans. Towards people she likes, she is much friendlier. Typical of werebeasts, Leila is a night person and prefers to sleep during the day. Since most of Crow's operations take place under the cover of darkness, this is not a problem.

Experience Level: 7th level Jaguar People R.C.C.

Magic Knowledge: Knows the following spells at 6th level of ability: Tongues, chameleon, astral projection, repel animals, heal wounds, metamorphosis: animal, and metamorphosis: human.

Psionic Powers: Sixth sense, see the invisible, and mind block.

Combat Skills: Hand to Hand: Martial Arts.

Attacks per Melee: Five in natural monster or animal form; three in human form.

Damage: Claws — 1D6+4 S.D.C. (H.P. damage to vampires)

Bite — 2D6 S.D.C./H.P.

Punch (human shape) — 2D6+4 S.D.C./H.P.

Restrained claw — 4D6+4 S.D.C./H.P.

Power Claw — 1D6 M.D., counts as one attack.

Power Punch Claw — 3D6 M.D., counts as two attacks.

Power Bite — 1D4 M.D.

Bonuses: +1 to initiative, +7 to strike, +8 to parry and dodge, +4 to damage, +3 to roll with impact/punch, +3 to pull punch, +3 to save vs poison, +5 to save vs magic, +2 to save vs psionics, +6 to save vs horror factor.

Weapon Proficiencies: W.P. Knife, W.P. Energy Rifle.

Weapons of Note: Vibro-knife, L-20 pulse rifle.

Armor: Urban Warrior (M.D.C. 50); none in natural form.

Skills of Note: Speaks Spanish and American 98%, land navigation 90%.

Description: A beautiful woman with dark brown hair, green eyes, and tan skin. In natural form, she appears as a large jaguar-woman, still attractive in a furry way.



Sgt. 1st Class Wilhelm Kratz

Expert soldier

Wilhelm Kratz was born in the New German Republic, where he served in the elite branch of the Armed Forces. His skill with all types of weaponry and unarmed combat was unmatched, but his attitude was terrible. Kratz would not take orders from officers he did not respect and in every army there are always officers that aren't worthy of respect. Two of his lieutenants died "under mysterious circumstances" during battles with gargoyles (read, he fraged them). The third officer managed to escape with his life, and Kratz had to flee the NGR; he ended up in North America.

Illych's Immortals needed experienced soldiers. Kratz's experience landed him a sergeant's spot under Lieutenant Crow. Fortunately for both of them, Kratz quickly learned to respect Crow. This officer cared for his men and was not afraid to get down and dirty in the trenches with the rest of the troops. Crow's tactical abilities also impressed Kratz, who had no leadership ability or head for tactics. This has improved slightly with time, but Kratz is no military commander and he is glad that he has a competent superior to follow.

The sergeant is the team's weapon specialist. From a knife to a robot vehicle, Kratz can use any means of destruction with terrifying effi-

ciency. He is an expert in demolitions, infantry combat and piloting. Hand to hand combat is also a favorite of his and he used to be the company's unarmed combat instructor until Kinoshi replaced him. He is now in charge of Beta Squad, which specializes in assault missions.

Alignment: Aberrant

Attributes: I.Q. 13, M.A. 9, M.E. 17, P.S. 23, P.P. 22, P.E. 24, P.B. 7, Spd. 26

Hit Points: 59, **S.D.C.:** 74

Size: 6 feet, 6 inches (1.98 m); 210 lbs (90 kg) of pure muscle.

Age: 31 years old. **P.P.E.:** 6

Disposition: Kratz is a born warrior. He loves war and fighting for its own sake and is perhaps the most bloodthirsty member of Crow's team. Issues and politics don't matter to him. Whatever objectives he is given, he fulfills, and does not ask or think about the consequences. In his narrow world, there are three kinds of people: his fellow mercs whom he will protect with his life; the enemy, who has to be destroyed or neutralized by whatever means necessary; and civilians, who don't know anything, are beneath his contempt, and can become the enemy at a moment's notice.

When not on duty, Kratz is a drinker and a brawler; the terror of any tavern he happens to visit. He has enough control not to hurt anybody seriously during informal brawls (which are for fun, not business), but he does not care about property damages. He also fancies himself a ladies' man and he manages to seduce gullible young girls or adventurous married women with distressing frequency. On several occasions, this has caused problems with the locals (especially fathers and husbands of the women involved) and Crow has had to discipline Kratz regularly.

If he sat down and thought about it (which isn't likely), Kratz would consider himself a pro-human and anti-D-Bee kind of guy. Generally speaking, he distrusts most non-humans, however he really likes Mr. Green, the crocodile man, whom he considers the only person tougher than he is.

Experience Level: 8th level Special Forces Soldier.

Magic Knowledge: None.

Psionic Powers: None.

Combat Skills: Hand to Hand: Martial Arts, plus boxing and wrestling. Also, Power Armor Combat: Elite, Power Armor Combat: Basic, Robot Combat: Elite, and Robot Combat: Basic.

Attacks per Melee: Four hand to hand attacks.

Bonuses: +2 on initiative, +5 to strike, +9 to parry and dodge, +8 to damage, +8 to roll with impact/punch, +5 to pull punch, +5 to save vs poison, +5 to save vs magic, +1 to save vs psionics, and +1 to save vs horror factor.

Weapon Proficiencies: W.P. Energy Pistol, W.P. Energy Rifle, W.P. Sword, W.P. Blunt, W.P. Knife.

Weapons of Note: Wilk's 457 laser pulse rifle mated with a WI-GL4 grenade launcher (a big, heavy weapon), NG-57 ion blaster, WI-23 missile launcher, vibro-saber, vibro-knife, and always carries 6-12 grenades of assorted types.

Armor: Bushman armor (M.D.C. 60).

Skills of Note: Basic radio 90%, Speaks Euro and American 98% in both, literacy 80%, computer operation 85%, intelligence 79%, piloting: tank and APC 78%, weapon systems 95%, read sensory equipment 80%, fishing 80%, sniper, tracking 75%, wilderness survival 80%, detect ambush 80%, running, athletics, body building, boxing, wrestling.

Description: From a distance, his heavily muscled build makes Kratz look like a short, squat man, until somebody stands next to him and he is revealed as a near-giant. For all his size and bulk, the mercenary can move surprisingly fast, frequently to the painful surprise of people who thought they could outmaneuver the big guy. He is always chewing on an unlit cigar (he's trying to quit smoking), only lighting up when he's very tense or angry — a good signal to leave the room.



Mr. Green — Tauton Merc

The Tautons are a race of extra-dimensional crocodile-headed creatures who once served the evil god Set (see **Rifts Africa**). *Gr'yon Crick* was different from his fellow Tautons. Like the rest, he was raised in an arid, desert-covered dimension and trained in the arts of war and the philosophy of hatred, but *Gr'yon* did not accept the mindless sadism he was taught. Time and time again he was reprimanded, demoted, even tortured for his beliefs and humane conduct. His skills as a warrior were unsurpassed and, despite the black marks on his record, he rose through the ranks of the Tauton army.

The squad he led was eventually sent to the continent of Africa on Earth. His mission was to assist a number of demonic entities who would lay waste to the world. Once *Gr'yon* was away from his superiors, he saw his chance and took it. He turned against his squad and killed all nine of them. Then he fled. Africa was too dangerous for him (his wasn't the only Tauton squad sent to Rifts Earth), so he travelled westward, not stopping anywhere for long, until he reached America.

There, his frightening inhuman looks made him an outcast and hunted by the protectors of the Coalition States. However, he was accepted in one of the less "civilized" regions where his skills and superhuman powers made him someone to be respected, as well as feared. When he was offered a job with Crow's Commandoes, he accepted. During his short time with the company he has distinguished himself as a deadly and talented warrior. *Gr'yon* (who now calls himself "Green") likes and admires his fellow soldiers far more than he did his own people. Mr. Green commands Delta Squad, the Heavy Weapons segment of the company. His magic skills give the squad a tremendous edge over more conventional enemies.

Alignment: Unprincipled

Attributes: I.Q. 14, M.A. 11, M.E. 12, P.S. 32, P.P. 20, P.E. 23, P.B. 5, Spd. 28; supernatural strength and endurance.

Natural M.D.C.: 360

Size: 11 feet (3.35 m) tall, 900 lbs (405 kg), **Age:** 49 **P.P.E.:** 260

Natural Abilities: Horror factor of 11, nightvision 70 feet (21 m), see the invisible, resistant to heat, fire and cold (takes half damage), metamorphosis into a large poisonous snake, swim 98%, hold breath for 3D4 minutes, sees well even in murky water and heals twice as fast as humans.

Disposition: For a gigantic talking crocodile-man, Mr. Green has a very nice disposition. He enjoys good conversation, friendly contests and is kind, courteous and generous. In combat he exhibits both strength and mercy. He has become used to the fact that most people are going to react to him with fear, so he tries to break the tension with jokes and general good humor. Sometimes he pretends to be a cannibal, and throws out one-liners about having people over for lunch. He and Kratz like to hang out together — Mr. Green has often gotten the wild mercenary out of trouble and each would sacrifice their own life to save the other.

Experience Level: 6th level Tauton.

Magic Knowledge: All tautons are knowledgeable in the ways of ley line magic. Mr. Green knows the following spells: blinding flash, cloud of smoke, globe of daylight, see aura, chameleon, magic net, shadow meld, heal wounds, call lightning, fire ball, dispel magic barrier, negate magic barrier and metamorphosis: insect.

Psionic Powers: None

Combat Skills: Hand to Hand: Martial Arts, and boxing. Scorpion tail adds one melee attack per round and inflicts 1D6 M.D. plus injects a poison that causes 4D6 M.D. or 1D6 × 100 S.D.C. per round. Lasts 2D4 rounds. A save vs poison means the character suffers a mere 30% of the damage.

Attacks per Melee: Four hand to hand (plus tail strike) or two by magic.

Bonuses: +3 on initiative, +5 to strike, +8 to parry and dodge, +17 to damage, +4 to roll with impact/punch, +3 to pull punch, impervious to poison, +6 to save vs drugs, +5 to save vs magic, +1 to save vs psionics, +1 to save vs horror factor, and +1 on all saving throws.

Weapon Proficiencies: W.P. Sword, W.P. Knife, W.P. Blunt, W.P. Energy Rifle and W.P. Heavy.

Weapons of Note: TW flaming sword (4D6 M.D.), NE-200 plasma cartridge machinegun (rifle configuration), WI-GL20 automatic grenade launcher, and often carries a WI-40 super-heavy missile launcher.

Armor: Phoenix Empire body armor (M.D.C. 100) with attachments for Falcon 300 jet pack.

Skills of Note: Basic math 85%, speaks Dragonese/Elven 98%, Gobblely 98%, ancient Egyptian 98%, and American 60%, prowl 65%, tracking (humanoids) 75%, tracking (animals) 65%, intelligence 66%, wilderness survival 80%, detect ambush 65%, detect concealment 60%, computer operation 70%, literacy, 60% radio: basic 75%, surveillance systems 60%, pilot: jet pack 66%.

Description: Mr. Green has two shapes: a gigantic reptilian humanoid with a crocodile's head and a scorpion-like tail, and that of a 21 foot (6.4 m) long snake! Both are frightening visages.

Sonya "The Face" Schultz Changeling Infiltration Expert

Changelings are known and feared throughout the Megaverse. In the Palladium World, they are hunted mercilessly by most cultures. Sonya (she thinks of herself as a she) has known hatred and bigotry all her life on a dozen worlds. Since all Changelings are assumed to be spies and assassins, she felt she had no option but to become one — no other position was open to one of her kind. A magician and expert spy, she has traveled the Megaverse with a group of transdimensional mercenaries called *The Trashers*. Only among the misfits of myriad universes did she find herself at home. Unfortunately, the Trashers became greedy and overconfident. Lured by the wealth of Atlantis, they planned

a raid on the capital city of Splynn, right in the middle of a Dimensional Market.

Even then, Sonya was an infiltration expert. She arrived first, disguised as an Ogre warrior, and planted magical artifacts designed to weaken Splynn's dimensional defenses. Her fellow mercenaries were highly trained, experienced, and armed with the best technology, magic and techno-wizardry money could buy. But somehow, the Atlantean authorities learned of the raid, and the Trashers were met on arrival by a reinforced company of Kittani Serpent Warriors, several squads of Power Lords, and High Lords. The resulting battle killed hundreds of transdimensional tourists and destroyed a good chunk of the market, but the Trashers were soundly defeated. Stunned, Sonya saw most of her friends die in front of her eyes, then saw the surviving handful retreat through a dimensional gateway, leaving her stranded on Earth. Fortunately, she had not been an active participant in the fighting, so her involvement in the raid was not known. She was able to book passage out of Atlantis to Africa with the expense money she still had from her infiltration mission.

Sonya didn't like Africa. The Phoenix Empire disgusted her and the rest of the territory was too uncivilized for her taste, so she left the area. For several years, she stayed in the New German Republic (she likes big cities and high technology), working as a freelance spy. After several missions and a few solo adventures, she left the country a step ahead of the NGR's authorities. She eventually found her way to America, where her talents as a spy became famous. She became known as "the Face," a master of disguise (most people assume she uses magic, which is partially correct, to change her features so completely). Most of her work was very dangerous, top secret and done alone. Despite her success and fame, Sonya missed the companionship she enjoyed among mercenaries. After hearing several rousing stories about Crow's Commandoes, she sought them out and proved her worth by sneaking into Crow's headquarters in the middle of a military campaign and through tight security. The surprised Crow accepted her on a trial basis and has since found her talents indispensable.

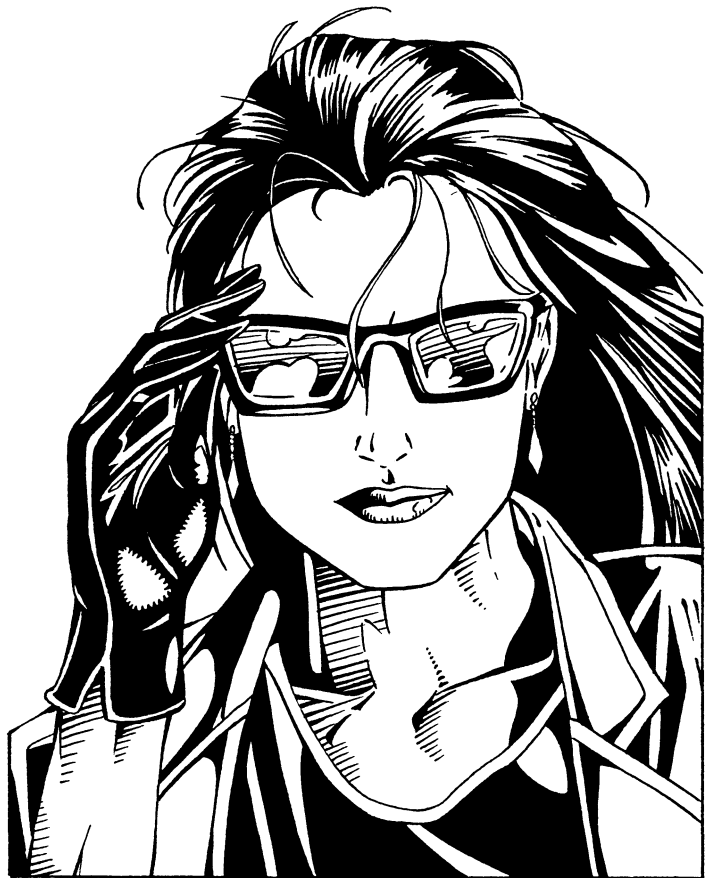

Sonya uses her shape-changing abilities as well as her magic primarily for information gathering purposes — not assassination. Sometimes, she assumes the appearance of an enemy soldier, officer, ambassador or government official. Other times she uses the simple guise of innocent refugee, peasant servant or youngster. One of her most successful disguises is that of an enticing maiden or better still, the current mistress, wife or lover of a military officer or government official. She is an excellent actress and can get into any character, from a member of the nobility to a street rat. Her natural abilities and long, bitter life still sets her apart from her fellow mercenaries, and she only has a couple of good friends among the Commandoes. Yet, all in all she feels much happier because she is not alone. She is a member of Ferret Squad, under the command of Kinoshi (see as follows).

Alignment: Unprincipled.

Attributes: I.Q. 16, M.A. 15, M.E. 23, P.S. 11, P.P. 14, P.E. 8, P.B. 10 (24 when in disguise), Spd. 6

Hit Points: 32 **S.D.C.:** 31 **Size:** Varies; her true height is 7 feet (2.1 m tall) and weighs 220 lbs. (99 kg). **Age:** 65 years old, but can look 13 or 300. **P.P.E.:** 111

Natural Abilities: Sonya can alter her shape and appearance to that of any humanoid form, ranging from 3 to 10 feet tall (0.9 to 3.0 m) (her body mass remains the same, however). “She” is not restricted to the female gender, although she is most comfortable with it, and can take the form of male or female, adult or teenager. She can instantly change her skin color, length of hair, features, grow fur, and so on. Changelings cannot grow extra limbs.

Disposition: Sonya has created a tough and wily femme-fatale facade to cover her insecurities. She acts like the stereotypical female spy of every bad movie ever made in the 20th century. Both her “regular” shape and her attitude are those of a seductress. This has made it difficult for her to get along with others. Most males only have one thing in their minds when they see her, and most females dislike her. Kinoshi is her best friend; the two are experts at the espionage game and each admires the other’s abilities. Sonya enjoys the intrigue, excitement and rush of being a spy. She is resourceful, cunning and thinks quick on her feet.

Experience Level: 9th level super-spy O.C.C. (magical).

Magic Knowledge: Has limited ley-line walker powers (only abilities 1-3), plus knows the following spells: Death trance, globe of daylight, see aura, befuddle, concealment, heavy breathing, armor of Ithan, invisibility: simple, paralysis: lesser, charismatic aura, shadow meld, multiple image, calling, superhuman strength, invulnerability, stone to flesh and wisps of confusion.

Psionic Powers: None

Combat Skills: Hand to Hand: Expert plus boxing.

Attacks per Melee: Five hand to hand or two by magic.

Bonuses: +2 to strike, +5 to parry and dodge, +3 to roll with impact/punch, +2 to pull punch, +4 to save vs psionics, +6 vs telepathic mind probes and mind control, +6 to save vs horror factor.

Weapon Proficiencies: W.P. Energy Pistol, W.P. Knife, W.P. Energy Rifle, W.P. Sub-Machinegun.

Weapons of Note: Splugorth Bio-Wizard Forearm Plasma Blaster (5D6 M.D.), Bio-Wizard Plasma Rifle, Plasma Sword, MP-23 Caseless SMG (loaded with ramjet rounds).

Armor: Explorer armor (M.D.C. 70).

Skills of Note: Radio: basic 90%, literacy 85%, intelligence 78%, pick locks 85%, disguise 80%, forgery 70%, prowl 80%, computer operation 90%, Dragonese/Elf 95%, Kittani 95%, Atlantean 95%, American 65%, Euro 70%, streetwise 61%, wilderness survival 75%.

Description: Her true form is like that of any Changeling, an unattractive, seven foot tall, hairless humanoid with pale yellow skin. In Germany, Sonya adopted the image of a black-haired, black-eyed, beautiful woman (P.B. 24) with exotic, Slavic looks and exaggerated anatomy. She has kept that “persona” ever since.

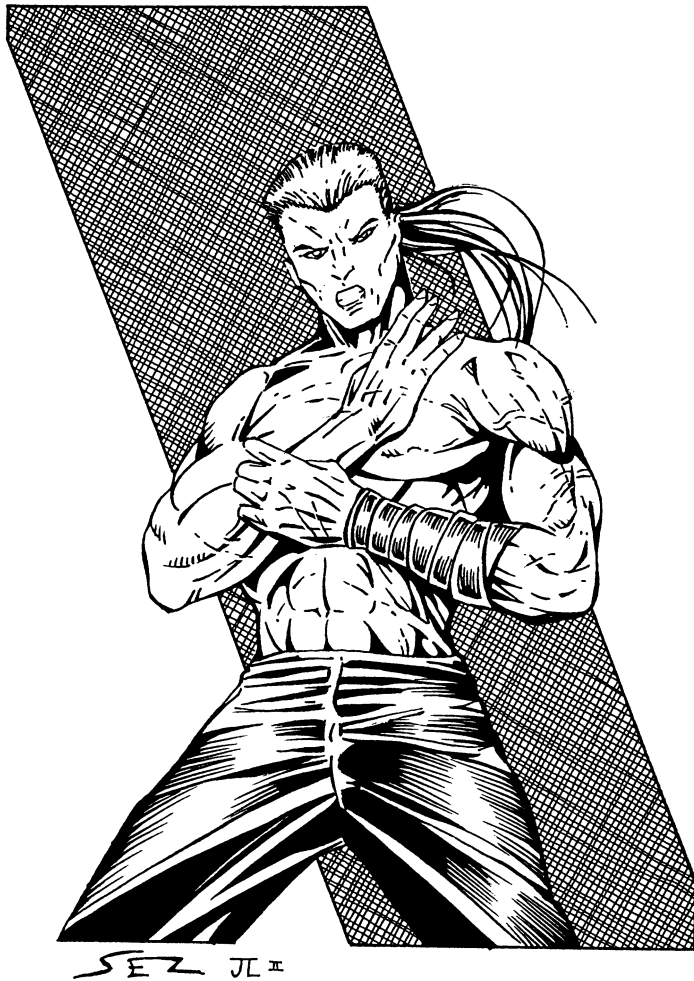

Kinoshi — Master of Martial Arts

This quiet Japanese man comes from another universe, the world of **Ninjas and Superspies**, but has adapted quite well to Rifts Earth. He is the Commandoes’ expert infiltration man and the top hand-to-hand instructor of the entire company. His skill would be legendary — if he ever advertised it. However, Kinoshi will never call attention to himself. Doing so would be breaking the traditions of the Ninja Clan that raised him. He even insists on maintaining a cover as the company’s supply officer (the equivalent of the Akido disguise of Merchant).

From his birth, Kinoshi was indoctrinated in the arts of Ninjutsu by a secretive clan hidden in Japan’s underworld. He proved to be an apt pupil and soon became a “Chunin” (veteran Ninja) and would have possibly risen to the rank of “Jonin” if it hadn’t been for the turn of events that took him to Rifts Earth.

Kinoshi was sent on a lone mission to prove his worth to the clan. His quest took him to a temple hidden in the jungles of Indonesia, where a great treasure was said to be hidden. He overcame the guardians of the temple and stepped through a set of golden doors that had remained closed for millennia. The doors transported him to a strange, new world where monsters wandered the Earth and magic was all too real.

Looking for a place to fit in, Kinoshi first became a bodyguard, then a mercenary. Lieutenant Crow realized that Kinoshi’s expertise would be a valuable asset to his mercenary company and quickly hired the man. Crow respects and is a little afraid of the small, quiet man who can move as silent as the wind and strike with the speed and deadliness of a cobra. For his part, Kinoshi is guardedly friendly toward this foreigner. After living in a sheltered clan for all his childhood and most

of his adult life, he has grown more relaxed in the less strict and friendlier environment of the mercenary company. He has even developed a quirky sense of humor and horseplay.

His training in the disciplines of the body and mind had made him a superhuman being in his home dimension. In the mystically supercharged world of Rifts, he is effectively a supernatural being, able to stand up to mega-damage weapons and survive. He commands Ferret Squad and specializes in stealth missions.

Full Name: Unknown

Alignment: Unprincipled.

Attributes: I.Q. 17, M.A. 19, M.E. 15, P.S. 21, P.P. 24, P.E. 20, P.B. 16, Spd. 18.

M.D.C.: 32

Size: 5 feet, 4 inches tall (1.63 m), 140 lbs (63 kg), **Age:** 41

Chi: 20, **P.P.E.:** 28

Disposition: A quiet man towards strangers. When he is among friends, he is a lot more laid back, with a quirky sense of humor (the teacher in *The Karate Kid* movies is a good model for this character). When he is on a mission, he is all business, however, and cannot understand the use of jokes to relieve tension — he prefers to deal with tension after the job is done, not before or during it.

He likes and admires both Leila and Sonya and bears no prejudice against their alienness. Kinoshi also gets along fine with Mr. Green. Kratz is a different matter altogether. The big man tried to bully Kinoshi when he first joined the team. The lessons Kratz learned at the hands of the ninja were both painful and humiliating and the two have remained cold and distant ever since. The two are professional enough to work together and even trust each other with their lives, but they never socialize.

Experience Level: 11th level Ninja/dedicated martial artist (see Palladium's *Ninjas and Superspies RPG*).

Magic Knowledge: None

Psionic Powers: None

Combat Skills: Ninjutsu

Special Martial Arts Powers:

1. Art of Disguise: Can alter one's appearance simply by changing one's posture, walking, and expression, or through the use of make-up; 82%.
2. Art of Vanishing: Can disappear in plain sight for about one melee action/4 seconds; 80% in the dark, -30% in good light, -20% on clear, flat featureless ground (penalties are cumulative).
3. Art of Mystic Invisibility: Uses Chi to cloud the mind of observers. Costs 1 Chi point per melee round if standing still, or 1 Chi per melee action if moving; 80%.
4. Stone Ox: Adds 25 M.D.C. points to his physical body.
5. Kick Practice: Power kick inflicts 2D6 M.D. but counts as two melee attacks/actions.

Attacks per Melee: Five hand to hand attacks.

Bonuses: +4 on initiative, +7 to strike, +7 to parry and dodge, +5 to roll with impact/punch, +2 to pull punch, +3 to save vs poison, +3 to save vs magic.

Weapon Proficiencies: W.P. Ninja Sword, W.P. Staff, W.P. Knife.

Weapons: Vibro-saber, vibro-knife. Doesn't like to use ranged weapons.

Armor: Crusader armor, painted black (M.D.C. 55).

Skills of Note: Japanese 98%, English/American 98%, Literacy 98%, Basic Math 98%, prowl 83%, wilderness survival 88%.

Description: A short, nondescript Japanese man. When in his "merchant" role, he wears colorful clothes, but most of the time he prefers black, dark brown or dark blue outfits.

Curtis "The Shadow-Man" Roberts

A Ley Line Walker Eccentric

Curtis Roberts was raised in the enlightened city of Lazlo where, unlike the majority of Earth's population, he was taught to read and write. As a child, Curtis got his hands on an ancient pre-Rifts book detailing the adventures of a pulp hero called *The Shadow*. A gun-wielding vigilante who dressed in black and could "cloud men's minds" to make himself seem invisible. This image made a deep impression on him, so when he discovered his magical talents, he tried to live up to that image and ideal. As a result, he specializes in spells dealing with detection, illusion and stealth. Curtis even started dressing the part, wearing a dark cloak, a wide-brimmed hat, and a long, maroon scarf that covered the lower part of his face.

His love for skulking around quickly made him unpopular in Lazlo, where such behavior suggested criminal tendencies. Curtis left his hometown with little regret and started looking for grander adventure. Crow's Commandoes, with their penchant for covert operations, was ideal for him. Crow needed the magical expertise Curtis brought in and did not mind the eccentric habits of the young wizard. The Shadow-Man was born.

The Shadow-Man's antics are amusing to the Commandoes, but he can be downright frightening towards people who are not familiar with him. This has often been useful for the team, but it has also been the subject of embarrassment and trouble on other occasions. Overall, however, the line walker is a very effective team member and his formidable array of spells makes up for his wackiness.

Shadow-Man is in command of Earnest Squad, which is made up of men of magic. He and his squad have the mission to disrupt enemy



forces, use magic to enhance the stealth capability of the company, and act as an attack force.

Alignment: Anarchist

Attributes: I.Q. 19, M.A. 6, M.E. 17, P.S. 11, P.P. 17, P.E. 13, P.B. 6, Spd. 15

Size: 5 feet 10 inches (1.78 m), 165 lbs (74 kg).

Hit Points: 37, **S.D.C.:** 21 **P.P.E.:** 170

Disposition: When he is "in character," which is 90% of the time, Curtis speaks in a hoarse whisper, interrupted by bursts of maniacal laughter. He likes to stare at people as if trying to read their minds and make them feel frightened or nervous. He has a genuine skill for making people feel intimidated.

Curtis can be a merciless foe and he will do whatever is necessary for the success of a mission. He really likes Kinoshi, and would like to learn to be a Ninja, but the Japanese martial artist thinks Curtis is insane and prefers to keep him at arm's length. Curtis does have an obsession with his Shadow-Man persona and skulking in shadows. Among other things, he will refuse to be scared, because the character of the books was fearless.

Experience Level: 8th level Ley Line Walker.

Magic Knowledge: Besides the usual ley line walker powers, Shadow-Man knows the following spells: blinding flash, cloud of smoke, see the invisible, sense evil, befuddle, chameleon, concealment, blind, magic net, shadow meld, domination, heal wounds, horrific illusion, sleep, armor of Ithan, invulnerability, agony, hallucination, wisps of confusion, call lightning.

Psionic Powers: None.

Combat Skills: Hand to Hand: Basic, and boxing.

Attacks per Melee: 3 hand to hand or 2 by magic.

Bonuses: +2 to strike, +3 to parry and dodge, +2 to damage, +2 to roll with impact/punch, +2 to pull punch, +2 to save vs magic, and +1 to save vs psionics.

Special bonus: The character's intense obsession with his Shadow-Man persona makes him +6 to resist Horror Factor, illusions and mind control, but it also means that he may fight against impossible or suicidal odds 30% of the time.

Weapon Proficiencies: W.P. Energy Rifle and W.P. Automatic Pistol.

Weapons of Note: Two Colt .45 pistols loaded with Ramjet rounds (1 M.D. point per round), L-20 pulse laser, and a pair of TW water pistols. Curtis also has two identical ruby rings that are actually talismans. One has the spell shadow meld and the other, escape! Each spell can be activated three times per day and is equal to an 8th level spell.

Magic Armor: TW-modified Urban Warrior armor (M.D.C. 50) with armor of Ithan, superhuman strength, and chameleon, all at 8th level.

Skills of Note: Climbing 64%, land navigation 77%, wilderness survival 80%, pilot: hover craft 98%, demon lore 80%, basic math 98%, pilot jet pack 84%, prowl 70%, computer operations 90%, literacy 80%, first aid 95%.

Description: A thin man whose most remarkable feature is his large beak of a nose, jutting over an almost lipless mouth and framed by black eyes with joined, thick eyebrows.

Other Personnel

Other notable characters include Sgt. Price (7th level Special Forces Soldier, second in command of Alpha Squad), Sgt. Mendoza (6th level headhunter, commander of Charlie Squad), and Sgt. Carmichael (6th level wilderness scout, leader of Gamma Squad); they are the other squad commanders. The Commandoes are broken into squads of 4-6 men. The squads are designated by letters, Alpha, Bravo, Charlie, Delta, Earnest, Ferret and Gamma, respectively. The squad breakdowns are as follows:

Alpha Squad: Commanded by Lt. Crow and Sgt. Price. All-purpose squad. Personnel: Five special forces soldiers, levels 4-6, two wilderness scouts and a psi-stalker, levels 6,7, and 9 respectively.

Beta Squad: Commanded by Sgt. Kratz. A power armor assault team. Personnel: Three headhunters, levels 4-6, three elite power armor/SAMAS pilots, levels 6 and 7, two wilderness scouts, levels 5 and 6. All have elite power armor training as their specialty. The last member is a 7th level techno-wizard in magic armor and flying wing board.

Charlie Squad: Commanded by Sgt. Mendoza. Assault squad (Infantry). Personnel: Five headhunters and four juicers, levels 4-5.

Delta Squad: Commanded by Mr. Green. Assault Squad: Heavy Weapons/Power Armor. Personnel: Four full conversion cyborgs, two headhunters, two military specialists, and a special forces soldiers, all level 5.

Earnest Squad: Commanded by Shadow-Man. A Magic Squad. Personnel: Two ley line walkers, both level 4, one 3rd level Shifter, one 5th level mystic, one 2nd level mystic, one 4th level techno-wizard, and two 6th level psi-stalkers.

Ferret Squad: Commanded by Kinoshi. Infiltration/Covert Operation Squad. Personnel: One changeling (Sonya), three spies, levels 3-5, one master assassin, level 4, two special forces soldiers, level 5 and one safecracker, 7th level.

Gamma Squad: Commanded by Sgt. Carmichael. Reconnaissance Squad. Personnel: Four wilderness scouts, three dog boys, levels 3-5, a 4th level professional thief, and a 6th level bounty hunter.

The company can outfit and supply an extra four squads of 6 to 10 troopers each, commanded by veterans from pre-existing squads. The temporary squads are designated Omega-1 to Omega-4. Total Personnel: 60-90 soldiers plus 60-70 support personnel.



Weapons, Equipment and Resources

Standard Issue Weapons

- L-20 Pulse Rifle or 1 NG-P7 Particle Beam Rifle
- 12 Grenades (6 frags, 6 plasma)
- One soldier per squad carries a WI-23 Missile Launcher.
- Black Explorer Armor (M.D.C. 50)
- NG-S2 Basic Survival Pack.

Additionally, Beta Squad is equipped with 3 Triax Ulti-Max armor suits and 3 Triax Predator armor suits. The headhunters in Delta Squad also have Ulti-Max armor suits; the cyborgs have Heavy Cyborg Armor and carry missile launchers. An additional 12 suits of Predator armor are kept in reserve; they can be used to equip any other two squads in case an armored assault is needed.

Vehicles

- 8 Mountaineer A.T.V.s with nuclear engines, 260 M.D.C., and armed with mini-missile launchers and rail guns.
- 12 Falcon 300 Jet Packs
- 8 Triax Ulti-Max Power Armor
- 15 X-10 Predator Power Armor
- 10 NG-EX10 Exo-Skeletons

Adventure Ideas

Scarecrows

The Commandoes have to kidnap the prince of an independent kingdom. The player characters are mercenaries charged with protecting "His Highness" in the Royal Castle (a supposedly impregnable M.D.C. structure). Are their security measures sufficient to deal with Kinoshi and his Ferret Squad? Possible complications:

Paranoia: The castle has been infiltrated by Crow's agent; maybe a maidservant is actually Sonya "the Face," or the cook is Kinoshi.

Triple-Cross: The player characters are working for Crow's Commandoes and are part of the kidnapping team sent by Crow to infiltrate the castle. While they are there, they discover that the whole thing is an elaborate trap set by the Prince himself and agents of the Coalition States (whom Crow has hurt in the past). When Ferret Team moves in, it will be ambushed by over a hundred soldiers with power armor and robot support. How do they save the squad and pay back their betrayers?

Prince of Hell: The adventurer group is protecting the Prince, but on the eve of the kidnapping he turns out to be possessed by a powerful supernatural entity (or is an evil supernatural being in disguise). Crow doesn't know this, nor do the people who contracted the kidnapping (they did want him out, because he was becoming a tyrant, but they didn't know an alien Intelligence or malevolent force was behind his rule). Bedlam erupts as supernatural minions and human dupes clash. Both the player characters and the Commandoes now have to fight for their lives. Enter DemonBusters?

King of the Mountain

A bandit gang has kidnapped the daughter of a wealthy Ishpeming citizen. Crow's Commandoes are hired to rescue her. This gang of humans and evil D-Bees has built an impressive fortress in an isolated mountain plateau. The place serves as a "trading town" for the underworld. A direct assault would be useless, so Crow orders one of his squads (Ferret team?) to infiltrate the hideout to prepare the rescue. Possible complications:

Too Many Heroes: The girl is a relative or loved one of one of the player characters. Or the player group has been hired by relatives to rescue the woman. They, Crow's Commandoes (hired by other friends) and maybe even some others are mounting their own rescue operation. Do the groups help or hinder each other? Do any of them have a chance

at saving the girl? What kind of lasting animosity will they earn from these bandits (or are they more than common brigands)?

The girl was NOT kidnapped: She left of her own free will with her new boyfriend, the bandit leader (or one of his main men). The father was lying and what he wants is the Commandoes to kidnap her and forcibly bring her back. If you've ever seen the old Western **The Professionals**, you get the idea.

Braddock's Bad Boys

- A. Sponsorship: None. 0 Points
 - B. Outfits: Specialty Clothing. 20 Points
 - C. Equipment: Electronic Supplies and good gear. 5 Points
Medical Clinic. 20 Points
 - D. Vehicles: Specialty vehicles. 30 Points
 - E. Weapons: Extensive Weaponry. 40 Points
 - F. Communications: Full Range System. 15 Points
 - G. Internal Security: Iron-Clad. 20 Points
 - H. Permanent Bases: Partial Headquarters. 2 Points
 - I. Intelligence Resources: Special Operatives. 10 Points
 - J. Special Budget: Large Loans. 25 Points
 - K. General alignment of personnel: Anarchist. 2 Points
 - L. Criminal Activity: Cyber-doc. 10 Points
Prostitutes. 5 Points
Psychic Enforcer. 15 Points
 - M. Reputation/Credentials: Known. 10 Points
 - N. Salary: Good Salary. 10 Points
- Total Points Spent: 239 Points
Size & Orientation: Large Company

Colonel Braddock

Once upon a time, Colonel Braddock was a promising young officer in the Army of the Coalition States. He seemed destined to become a general before he was forty. The son of an important Chi-Town city official, young Tiberius Braddock enrolled in the army when he was eighteen. He did so mainly because he didn't want to go into civil service like his father. Surprisingly, he discovered he loved the military life and showed great aptitude in strategy and tactics. From the beginning of his career, however, he discovered that he liked drinking a little too much. For some reason there had never been liquor at his house. He never thought to ask why. If he had, he might have learned that his father was a recovering alcoholic. For a long while, his drinking did not interfere with his career, but that would eventually change.

Shortly after attaining the rank of Captain, he married a wealthy socialite from Chi-Town and the couple had a beautiful daughter, Janet. His future seemed bright and untroubled. As the years went by, Braddock gained commendations and promotions, but his drinking grew steadily worse. His marriage suffered from both his drinking and his dedication to the military. He found himself unable to stop getting drunk, even on the eve of a major military operation. His judgment clouded by a hangover, he ordered a company of his troops on a suicide mission. He had forgotten a report regarding a huge Xiticix nest and sent his men into the jaws of death. They obeyed his orders without question and died like lambs led to the slaughter. Over a hundred men perished as a result of his negligence. Braddock's alcoholism was made public and he was dishonorably discharged. His wife left him shortly afterwards. Braddock drowned his pain and guilt in more booze.



The only person who stood by him was his fourteen year old daughter, Janet. He had always doted on her and she had inherited his love for the military life. Janet prevented Braddock from sinking completely into an alcoholic mire. She used his love for her and military discipline to eventually get him to quit drinking. It was one of the greatest battles he would ever fight. After many rough years, he overcame his problem.

His future with the Coalition army destroyed, Braddock went into business for himself. He scoured the 'burbs looking for promising criminals, disgruntled soldiers, veterans, and other "cannon fodder." When the authorities caught wind of his activity he was accused of subversive activities and had to leave Chi-Town, but by then he had a small army at his back. He shaped the motley band of cutthroats and undisciplined warriors into a wild but lethal unit. This is not the life he had hoped for, but it will do for now.

Full Name: Tiberius Braddock

Alignment: Unprincipled

Attributes: I.Q. 14, M.A. 13, M.E. 18, P.S. 19, P.P. 15, P.E. 14, P.B. 14, Spd. 18

Hit Points: 45, **S.D.C.:** 54

Size: 5 feet, 11 eleven inches (1.80 m); 210 lbs (94.5 kg); **Age:** 49.

Disposition: Braddock is a bitter man who feels betrayed by life. Although he knows that he is an alcoholic, he can't shake the feeling that the army and his so-called friends could have helped him, instead of ignoring the problem and then turning their backs on him when he needed them most. He hates the Coalition States, while at the same time longing to be welcomed there as a hero. Because of this, he is reluctant to take jobs that directly threaten the CS. He only really cares about his daughter and his troops. Like most people raised in the CS, Braddock distrusts non-humans and D-Bees, and will not hire or work for any group dominated by such beings. He dislikes magic, but realizes it is an important force in the battlefield

and has hired several mages into the company. Psionics also play an important part in his army.

Experience Level: 8th level Coalition Military Specialist

Magic Knowledge: None

Psionic Powers: None

Combat Skills: Hand to Hand: Expert, wrestling and boxing.

Attacks per Melee: Four hand to hand attacks

Bonuses: +2 to strike, +5 to parry and dodge, +5 to roll with impact/punch, +3 to pull punch and +2 to save vs psionic attack.

Weapon Proficiencies: W.P. Energy Pistol, W.P. Energy Rifle, W.P. Heavy, Robot Combat: Elite.

Weapons of Note: C-14 "Fire Breather" rifle, C-27 heavy plasma cannon, C-18 laser pistol, CR-1 rocket launcher; he's not above sticking his head out of the command tank and firing a few missile shots at the enemy.

Armor: Heavy Dead Boy armor (Officer Crest), painted in a green and brown camouflage pattern (M.D.C. 80).

Skills of Note: Basic radio 75%, literacy 80%, computer operation 85%, intelligence 74%, pilot hovercraft 98%, read sensory equipment 85%, weapon systems 90%, running, detect ambush 80%.

Description: Braddock is a slightly overweight middle-aged man with gray hair and a receding hairline. The alcoholism has aged him before his time, and he has a worn, haggard look to him. Although he's pushing 50 he looks more like 65. Despite his appearance he is in pretty good physical shape and can hold his own in battle.

Lieutenant Janet Braddock

Janet Braddock was the typical Army brat, raised on a military base and surrounded by soldiers and weapons. Her father taught her everything he knew about firearms, vehicles, and piloting, so that by age twelve she knew almost as much as a line soldier, and could probably outshoot him, too. She truly loves her father and has always stuck by him. She and her mother have little in common and the mother resents the closeness shared between father and daughter. When the mother left the family, Janet stayed behind with her father. The alcoholism of her father came as a shock. She knew her father had a drinking problem, but hadn't realized how bad things had gotten. Janet dedicated herself to saving her father, refusing to lose him to the bottle. For the next four years, they struggled, but in the end the Colonel stood victorious — clean and sober. After a year of travel as vagabonds, the Colonel decided to return to the only life he (or Janet) had ever known, soldiering. With his daughter at his side, he built a mercenary company that continues to build a reputation for itself.

The mercenary life has agreed with Janet. She has always enjoyed physical and mental contests, military regimen, and has a flare for strategy and tactics. She feels more comfortable in fatigues than a dress and gets along better in the company of soldiers than with civilians. Although her rank is only Lieutenant, Janet is Braddock's second in command. She refused a promotion, because she felt the men might feel "Daddy" was playing favorites, but most of the troops recognize her abilities, respect her command, and acknowledge her as an experienced combat veteran who likes being in the front line. Her father does not like seeing her exposed to danger, but knows better than to try to order her around. Lieutenant Braddock commands the power armor unit and is a demanding and strict officer. She shares all the risks she imposes on her troops.

Lieutenant Braddock has occasionally dated various officers, but most of them are intimidated by her self-confidence, strength, skills, and (she now realizes) her father, who thinks nobody is good enough for his little girl. Janet knows that when she finds someone she really likes, she is going to have to talk to Daddy Dearest and set things straight — the Colonel is the one who is in for a battle.

Alignment: Unprincipled

Attributes: I.Q. 17, M.A. 20, M.E. 18, P.S. 17, P.P. 19, P.E. 15, P.B. 19, Spd. 17

Hit Points: 43, S.D.C.: 30

Size: 5 feet, 6 inches (1.68 m), 125 lbs (56 kg); **Age:** 22
P.P.E.: 8

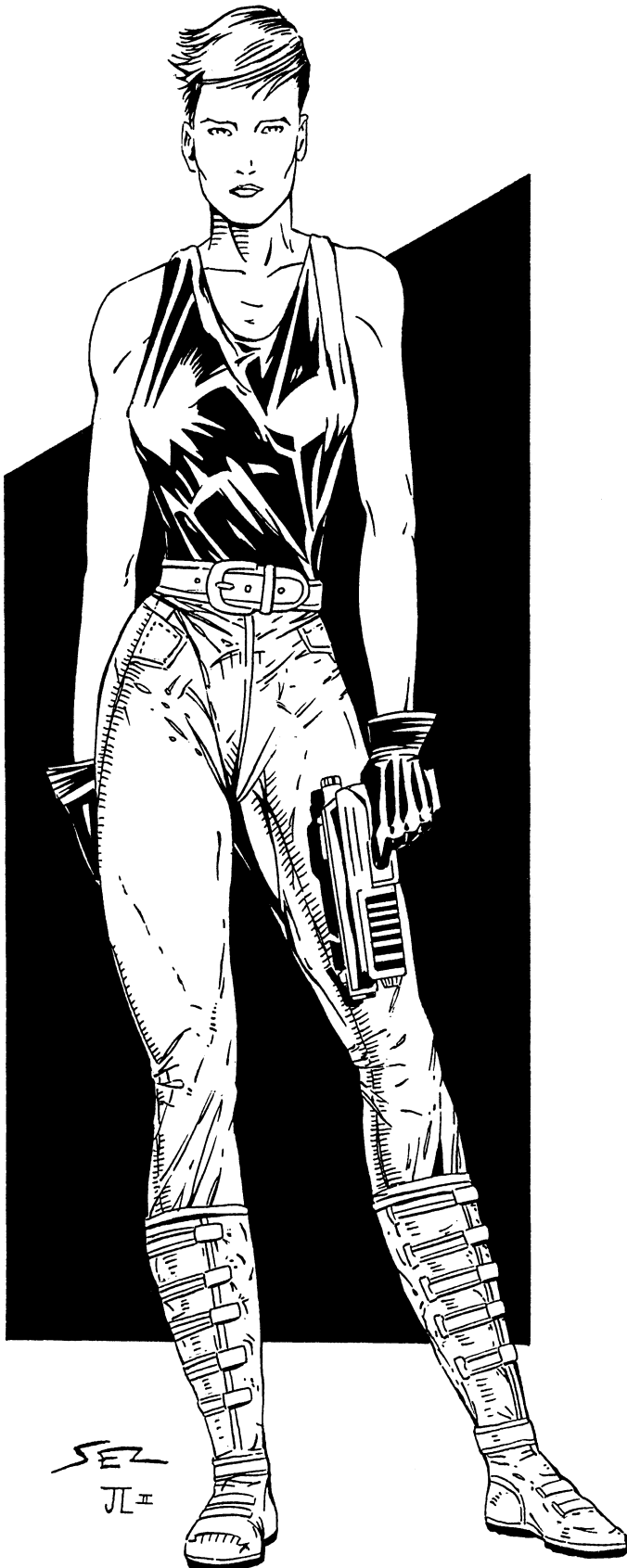

Disposition: Janet often acts like “one of the guys,” drinking and raising hell like her fellow mercenaries. She hates to be propositioned, especially while she’s in a rambunctious mood. More than one lecherous mercenary has learned the painful lesson of keeping his hands to himself. On duty, she’s a perfect officer, exhibiting impeccable judgement, discipline, and concern for her troops, while remaining slightly aloof and remote to maintain her authority. In combat, she’s a dangerous opponent, using her resources to their maximum effectiveness and employing both traditional and unconventional tactics. Lt. Braddock is bold, confident and capable. In many ways, she is a better, more capable soldier than her father.

Experience Level: 7th level Headhunter

Magic Knowledge: None, other than some knowledge of appropriate counter-magic tactics.

Psionic Powers: None

Combat Skills: Hand to Hand: Expert, Power Armor Combat: Elite and Power Armor Combat: Basic.

Attacks per Melee: Three hand to hand attacks.

Bonuses: +1 on initiative, +4 to strike, +5 to parry and dodge, +2 to roll with impact/punch, +2 to pull punch, +2 to S.D.C. damage, +2 to save vs psionics, +2 to save vs horror factor, and +3% on all skills due to her intelligence.

Weapon Proficiencies: W.P. Energy Rifle, W.P. Energy Pistol, W.P. Heavy, W.P. Automatic Rifle.

Weapons of Note: Her personal weapons are a captured Kittani K-4 laser pulse rifle, neuro-mace, vibro-dagger, and a KEP-Special energy pump pistol.

Armor: Bushman armor (M.D.C. 60) or Triax Ultra-Max power armor (M.D.C. 400)!

Skills of Note: Basic radio 95%, radio: scrambler 80%, detect ambush 75%, detect concealment 75%, tracking 70%, land navigation 74%, weapon systems 85%, read sensory equipment 75%, pilot jet pack 82%, pilot tanks and APCs 74%, demon lore 70%, American 95%, Euro 95%, Spanish 95%, paramedic 75%, sniping and prowling 60%.

Description: An attractive, athletic blonde woman with an intense, no nonsense look about her. She wears her hair short, so it doesn’t get into her eyes.

Lieutenant Lars Richardson

Lars Richardson carries a “Wanted” poster with his face on it. When he feels friendly, he shows it to people and explains why the Coalition States (CS) want him arrested. “I turned out to be a better killer than they trained me to be,” he says with a grin. That’s half of the story. True, the Coalition trained him to be an efficient soldier and Lars spent years of military service conducting search and destroy missions, but he wasn’t only good at killing, he enjoyed it immensely. There is something in the lieutenant that makes him feel like a god whenever he kills someone. The man is a psychopathic killer without a shred of humanity.

His last mission for the Coalition involved a search for a rogue psi-stalker. Lars and the SAMAS squad he commanded were certain that the fugitive was hiding at a small human village and started questioning the residents. Out of the corner of his eye, Lars thought he saw somebody pointing a gun at him. He whirled, firing his rail gun on full automatic. The M.D. rounds sliced through houses and people like a hot knife through butter. When the blazing gun finally struck the gunman, the lieutenant realized that he had shot a child playing with a stick. At that moment, something snapped in his mind and the lieutenant continued the massacre, gunning down anything that moved. His SAMAS companions tried to stop him, but he gunned them down as well. The rail gun was empty after 45 seconds, so he switched to his missiles. When those were gone, he used his bare hands. His strength



augmented by the power armor and his body sheathed in the mega-damage material of the armor made him a superhuman killing machine that could not be stopped. When the dust settled, he was the only one alive. The entire village of sixty-five people, and his three fellow soldiers, were all dead. Instead of remorse, Lars felt a rush like he had never known. He was a god. Able to kill with impunity. Laughing madly, he fled into the night, abandoning the military and the Coalition States.

The CS has posted a reward for his capture, but has not released the full details of his crimes, largely because investigators were unable to

determine exactly what had happened. They also hope to avoid negative publicity. The village was within CS territory and under the States' protection. The official story is that the Federation of Magic was responsible for the slaughter of the border village. The authorities would never want anybody to believe that any CS soldier was capable of such brutality.

Lieutenant Richardson eventually joined Braddock's Bad Boys. The mercenaries know that Lars is a bit unstable, but nobody, including the Braddocks, have any idea of just how crazy he is. Since he joined the team, Lars has acted surprisingly normal. The last two times the company camped near a civilized area, there were several unsolved murders and a tribe of about 40 D-bees were found slaughtered, but nothing was ever linked to Lars or anybody at the company. **G.M. Note:** Lars Richardson is a psychopathic, mass murderer. He is responsible for all the killings and will continue on his insane "exercises of power" whenever the opportunity arises. For the moment the madman has comparatively tight rein over himself and refrains from obvious acts of violence or insanity. However, he is ruthless in combat, does not show any mercy, always shoots to kill, and does seem to take great relish in bloodletting. Colonel Braddock has seen these hints of madness in others over the years and is beginning to wonder about this new recruit. For the moment he has nothing to support his fears other than a hunch, but he's decided to keep a closer eye on this brutal soldier.

Full Name: Lars Richardson

Alignment: Diabolic.

Attributes: I.Q. 20, M.A. 17, M.E. 19, P.S. 17, P.P. 18, P.E. 21, P.B. 14, Spd. 27

Hit Points: 56 **S.D.C.:** 97

Size: 5 feet, 10 inches tall (1.78 m); 185 lbs (83.2 kg); **Age:** 24 **P.P.E.:** 9

Disposition: Like many serial killers, Lars can seem quite normal, charming and outspoken. He is very adept at hiding his dark side from those around him. He is highly intelligent and has a good grasp of strategy and tactics. He is also the perfect gentleman and an officer around the Colonel and his daughter. However, some of the men have seen hints of his darker nature. He is a brutal interrogator, enjoys torturing others, and never takes prisoners (he kills everyone he faces, unless somebody intervenes).

When he decides to commit a murder, he plans it very carefully, leaving no clues pointing to him (if necessary, he'll try to find somebody to frame for the crime). During his time with the Bad Boys, he has murdered twelve innocent civilians and an entire tribe of D-bee nomads; not counting the scores of combatants he's killed in battle. Nobody yet suspects him of such heinous crimes. He even manages to fool psychics, because his emotions are so intense that he can use a mind block to hide his true nature and murderous thoughts. What a psionic might catch a glimmer of are his feelings of vast superiority, divinity, and megalomania, but again, this is not necessarily a bad (or uncommon) thing among mercenaries.

Experience Level: 9th level Coalition Elite RPA.

Magic Knowledge: None

Psionic Powers: Minor Psionic. Alter Aura, Mind Block. **I.S.P.:** 61

Combat Skills: Hand to Hand: Expert, Robot Combat: Elite, Power Armor Combat: Elite and Robot Combat: Basic

Attacks per Melee: Five hand to hand or psionic actions.

Bonuses: +1 on initiative, +4 to strike, +8 to parry and dodge, +1 to damage, +7 to roll with impact/punch, +2 to pull punch, +3 to save vs poison, +3 to save vs magic, +2 to save vs psionics, +2 to save vs horror factor.

Weapon Proficiencies: W.P. Energy Rifle, W.P. Energy Pistol, W.P. Knife, W.P. Heavy.

Weapons of Note: TX-16 pump rifle, vibro-knife, and is always picking up cheap knives, which he uses for his murders.

Armor: Dead Boy heavy armor (M.D.C. 80) or SAMAS (M.D.C. 250).

Skills of Note: Basic Radio 98%, pilot automobile 93%, pilot hovercraft 98%, pilot tank and APC 87%, read sensory equipment 90%, weapon systems 98%, running, prowl 70%, wilderness survival 75%, athletics, body building, boxing, gymnastics, wrestling and swimming 95%.

Description: The lieutenant is a large, powerfully built man who can be surprisingly soft-spoken, friendly, and who projects a good deal of charisma. However, his mood and demeanor can change in an instant to that of a maniacal and cheerful murderer.

G.M. Note: His latest scheme is to make Janet Braddock trust him. He is doing that by behaving as a perfect gentleman and by-the-letter soldier. He also pretends to have a sensitive side to his personality. He has recently been inspired to seduce and then murder her, but this is a long-term endeavor. In the meanwhile, he's content with the occasional random victim. Also note that at some point, Lars may go completely off the deep end and may ally himself with necromancers, vampires, entities or other demonic beings, especially if they accept him (or pretend to accept him) as their "god." Lars might find the Aztec gods and vampires especially appealing.

Dawud al-Jahiz

Dawud is a native of North Africa, from a community of D-Bees that appeared in Africa over a hundred years ago. He is an ogre, which are called lesser D'jin by some Muslim people. Like many D-Bees, his people willingly joined the Phoenix Empire (see **Rifts Africa**) only to discover the cruelty and atrocities of the demonic minions of Rama-Set after they became members of the dreaded kingdom. Dawud and his people reconsidered their alliance, but feared leaving the Empire would not be allowed. To criticize the Pharaoh means certain death. Those who are not happy at the Phoenix Empire frequently find themselves enslaved, tortured or executed as traitors.

The young ogre and several of his friends joined the Empire's Army where Dawud discovered he had a talent for warfare. Of the 24 volunteers from his village, only Dawud and eight others survived their gruelling tour of duty as cannon-fodder in futile campaigns and schemes of the mad Pharaoh. He and his friends were finally assigned to a mechanized squad led by a cruel dybbuk demon (see **Rifts Conversion Book One** for data regarding the dybbuk and many other creatures). One night, Dawud and his fellow ogres decided they'd had enough and their dybbuk officer found himself sharing a tent with an armed fusion block. A short but devastating explosion later, the mechanized squad escaped and tried to join the **Gathering of Heroes** fighting the *Four Horsemen of the Apocalypse*. They never made it to the Gathering. Instead, they stumbled into a dimensional rift — and found themselves thousands of miles away, in North America!

After several misadventures (none of the squad members spoke American), the group had the good fortune of running into Braddock's Company at a time when Braddock really needed help. The Bad Boys had picked the wrong side of a war and were pinned down by the enemy. Desperate for air support, they welcomed the firepower of four Phoenix sand skimmers (which can fly at speeds of over 600 mph) and four power armor troopers — ogre or not. The ogre team turned the tide and Dawud and his friends earned themselves a respected place among Braddock's Bad Boys. They have served happily among the mercenaries ever since. The ogres are extremely loyal to the company and are well liked by the other soldiers.

Full Name: Dawud al-Jahiz

Alignment: Unscrupulous

Attributes: I.Q. 13, M.A. 9, M.E. 18, P.S. 24, P.P. 16, P.E. 20, P.B. 8, Spd. 18

Hit Points: 48, S.D.C.: 101

Size: Seven feet tall (2.13 m), 280 lbs (126 kg), **Age:** 25 P.P.E.: 11

Disposition: Dawud is quiet and withdrawn, a devout Muslim who refuses to drink alcoholic beverages and disapproves of many of the practices of the mercenary company. His only true love is combat and facing worthy enemies. He enjoys defeating his foes through brains or brawn. Dawud is a good strategist and tactician as well as an excellent pilot.

Experience Level: 8th level Headhunter

Magic Knowledge: None

Psionic Powers: None

Combat Skills: Hand to Hand: Expert, Robot Combat: Elite, boxing and wrestling.

Attacks per Melee: Four hand to hand attacks.

Bonuses: +2 to strike, +5 to parry and dodge, +9 to damage, +4 to roll with impact/punch, +2 to pull punch, +3 to save vs poison, +3 to save vs magic, +2 to save vs psionics, +4 to save vs horror factor.

Weapon Proficiencies: W.P. Sword, W.P. Energy Rifle, W.P. Energy Pistol, W.P. Heavy Energy Weapons, W.P. Axe.

Weapons of Note: K-4 laser pulse rifle, KEP energy pump pistol, Kittani plasma axe, and a vibro-saber.

Armor: Phoenix Empire body armor (M.D.C. 100) or Phoenix Power Armor (M.D.C. 200).

Skills of Note: Basic radio 98%, detect ambush 80%, detect concealment 80%, tracking 75%, land navigation 78%, weapon systems 90%, read sensory equipment 80%, pilot jet pack 86%, pilot tanks and APCs 78%, pilot jet fighter 77%, pilot hover craft 95%, demon lore 75%, Gobblely 98%, Ogre 98%, Dragonese 98%, American/English 70%.

Description: Basically humanoid, but with brutish, Neanderthal features and coarse, hairy skin. His head is shaven but he has grown a long, black moustache.



SEZ JL II

Other Personnel

Officers: Lt. Diaz (7th level Coalition Technical Officer), Lt. Morrison (8th level RPA Elite), Lt. Harada (8th level Headhunter), Lt. Dancing Eagle (8th level Mystic) and Master Sgt. Perry (7th level Wilderness Scout).

Braddock's Personal Bodyguards/Enforcers: Arthur Leland (6th level Mind Melter), Freddy the Freak (9th level Crazy) and Matt Grisham (7th level Special Forces Soldier).

Line Troops:

- 40-60 Headhunters, levels 2-6; 40% have Robot or Power Armor Basic Training. An additional 30% have both Basic Training and one Elite Specialty.
- 30-50 Special Forces Soldiers, levels 3-6. All have Power Armor Elite training.
- 40-60 Coalition Grunts (deserters or veterans), levels 3-6.
- 40-60 Wilderness Scouts, levels 2-6.
- 20-30 Juicers (their numbers fluctuate as they die off from the drugs as well as combat), levels 1-6.
- 30-40 Crazies, levels 2-5.
- 40-50 Vagabonds, levels 3-6.
- 20-30 City Rats, levels 2-5.
- 30-40 Full Conversion Borgs, levels 2-6.
- 8-12 Special Operators, typically: 1D4 spies (2-6 level), 1D4 smugglers (3 to 7 level), two master assassins (4-8 level), a 5th level forger and a 9th level safecracker.
- 8 Ogre Headhunters (Dawud's squad), levels 4-7; all have the skills Power Armor Elite and Piloting: Land Skimmer.
- 6 Master Psychics (4 Mind Melters, 2 Bursters), levels 2-5.
- 9 Practitioners of Magic (2 Ley Line Walkers, 4 Mystics, and 3 Techno-Wizards), levels 3-6.

Total Personnel: 320-400 troops, and about 400-600 support personnel, family members and others. About 40% of the support personnel have some combat training (Hand to Hand: Basic and one or two W.P.s), and belong to non-adventuring O.C.C.s, levels 1-4.

Weapons, Equipment and Resources:

Standard Issue Weapons and Equipment

- NG-L5 Laser Rifle or NG-P7 Particle Beam Rifle (soldier's choice), both with extended E-Clips (double normal payload).
- 12 Grenades in Bandolier (6 Fragmentation, 6 Plasma).
- Half of the soldiers are issued either a WI-23 Missile Launcher or a WI-GL4 Grenade Launcher. The other half are given extra grenades (another 12 per soldier).
- Standard Body Armor: Bushman Environmental Armor (M.D.C. 60). Scout Units (20%) are equipped with Huntsman armor (M.D.C. 40); Heavy Assault Units (20%) are equipped with Gladiator armor.
- NG-S2 Basic Survival Pack.

Transport Vehicles

The Bad Boys have enough vehicles to transport almost 1,000 people from place to place. These vehicles are never used in combat (unless attacked while en route), but many have weapons and extra armor. The company can assemble an encampment in 1D4 hours; everybody, including non-combatants, have specific duties for building the camp.

- 30 Heavy-Duty Trucks, lightly armored (M.D.C. 40; tire M.D.C. 5), armed with machineguns.
- 30 Motor-Homes; lightly armored (M.D.C. 35; tire M.D.C. 5); armed with machineguns and mini-missile launchers. Each sleeps five.
- 4 Behemoth Explorer Robots: These vehicles restrict the speed at which the main convoy moves, but they are ideal travelling and sleeping vehicles (they carry veterans, officers, and their families; 40 people each, for a total of 160 inhabitants).

- 8 Iron Maiden APCs, modified into sleeping cars, but with all weaponry intact (they are the convoy's escorts, and are only used in combat in an emergency, which hasn't happened yet).
- About 20-50 assorted vehicles.

Combat Vehicles

- 8 NG-V7 Hunter Mobile Guns
- 10 UAR-1 Enforcer Robots
- 8 Triax X-500 Forager Battlebots
- 10 Triax X-10 Predator Power Armor
- 10 NG-X9 Samsom Power Armor
- 6 FT-005 Flying Titan Power Armor
- 8 Phoenix Power Armor (usable by Ogres only)
- 8 X-1000 Triax Ulti-Max Power Armor
- 4 Phoenix Sand Skimmers
- 12 Iron Maiden APCs
- 12 Iron Fist Medium Tanks
- 12 Iron Eagle Attack Helicopters

Adventure Ideas

Braddock's Last Stand

Braddock's Bad Boys have been hired to destroy a large band of Simvan monster riders threatening a number of independent kingdoms. The first few battles went well. The raiders were no match for air strikes and mechanized troops. The Simvan retreated with the company's mechanized infantry (robots and power armor) in pursuit. As the Bad Boys advance, they make a nasty discovery; the retreating Simvans have led them right into a huge Xiticix nest! As many as 5,000 insectoid warriors swarm against the threat to their homes. Now the Bad Boys have become trapped in a treacherous mountain area; their air support has been destroyed or damaged (all the helicopters are grounded, 3 of them permanently; all the land skimmers are also damaged). The mercenaries beat back multiple attacks from the insectoids. The main mountain path out of this trap is blocked by over a thousand xiticix warriors and supplies and ammunition are beginning to run low. The rest of the Bad Boys don't have enough firepower to break through the siege.

Possible ties to the player characters:

- Our heroes could be part of another mercenary company asked for assistance; Braddock is willing to pay a lot to save his troops (his daughter was in command).
- The characters know of a reclusive mountain man who may know of a hidden tunnel complex, big enough to permit even the giant robots to escape. All they have to do is find him, somewhere in a Simvan and Xiticix infested region. Travelling through the underground complex can be an adventure in and of itself. Is it a creation of pre-Rifts Earth? If so, is it an old military complex with valuable weapons and artifacts to be recovered? If so, are there also ancient dangers, traps and deadly secrets? There may be other scavengers/explorers not willing to share the treasure or secrets of the tunnels. And/or there may be other creatures (D-bee or supernatural) that control/haunt parts of the tunnels. Perhaps there's even a subterranean race or ley line or rift? Have fun.
- Alternately, the player characters may get caught in the turmoil caused by the conflict and become just as trapped and endangered as Braddock's company. The mercs will receive reinforcements sooner or later, but what about non-affiliated characters (especially those who don't want to get involved with mercs)? A small group such as our heroes might be able to slip through the simvan and xiticix and/or other hostile forces. In addition to the inhuman monsters, the player group might become the prey of a madman who thinks he's the god of death, Lieutenant Lars Richardson. Or they might find themselves temporarily allied with a small team of

mercs lead by Lieutenant Braddock. And/or encounter Coalition troops investigating the disturbance. If Lieutenant Richardson is with them, there can only be big trouble.

Note: Squads and members of Braddock's Bad Boys can be found almost anywhere in North America, under almost any circumstances. Remember that their activities and associations with "wanted criminals" and "drunken turncoats" like Lieutenant Richardson and Colonel Braddock has branded the Bad Boys as dangerous malcontents and a potentially dangerous enemy in the eyes of the Coalition States. There is no love lost between these two formidable forces. The player characters association (or perceived association) with Braddock's Bad Boys may be enough to give them grief with the Coalition for years to follow. Remember too, that most of the Bad Boys are not the most honest or reputable people around (the majority have an anarchist alignment and are in business for the money, glory and thrills).

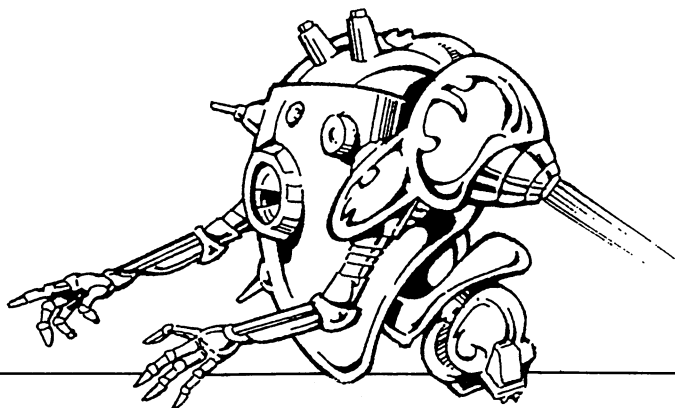

Robot Control

- A. Sponsorship: Naruni Enterprises; the equivalent to a small government. 0 Points
 - B. Outfits: Gimmick Clothing. 30 Points
 - C. Equipment: Unlimited Equipment. 50 Points
 - D. Vehicles: Combat Cars. 20 Points
 - E. Weapons: Extensive Weaponry. 40 Points
 - F. Communications: Deluxe Network. 25 Points
 - G. Internal Security: Tight. 10 Points
 - H. Permanent Bases: None. 0 Points
 - I. Intelligence Resources: Special Operatives. 10 Points
 - J. Special Budget: Large Loans. 25 Points
 - K. General Alignment: Anarchist and Unprincipled. 4 Points
 - L. Criminal Activity: Smugglers. 15 Points
 - M. Reputation/Credentials: Excellent Reputation. 25 Points
 - N. Salary: Excellent Salary. 20 Points
- Total Points Spent: 274 Points**
Size & Orientation: Large Company with a sponsor

A new arrival on the mercenary scene is **Robot Control**, who specializes in anti-robot and anti-armor/anti-tank strategies, tactics, combat and weapons. They use mostly infantry troops to stop, hinder and destroy huge (and expensive) war machines. The company often works alongside other "normal" companies, using its expertise to neutralize the enemy's robots, tanks and power armor while the other troops take the offensive. Robot Control also hires itself out to hunt down renegade robots, alien robots, Mechanoids, marauding cyborgs, magic war machines unleashed by Tolkeen, and giant monsters, including dragons, golems, giants and others with substantial amounts of mega-damage!

As an important sideline, the company also acts as a security advisor/trainer specializing in defense against robots and operating as an "official" seller of **Naruni Enterprises** weapons and vehicles. Robot Control's expertise and wonderful, high-tech weapons from another dimension can be invaluable to small kingdoms and wilderness people. These mercenaries (and Naruni weapon merchants) can train a kingdom's warriors in anti-robot tactics, general defense, and sell them the weapon systems they need.

Notes From Siembieda: Although Robot Control's association with Naruni Enterprises presently seems to be a windfall for the mercenaries, in the long run it may lead to their doom. Their growing presence as an arms dealer with ties to aliens from another dimension has given the Coalition States great cause for concern. The mercs' strong affiliations with the other-dimensional weapon manufacturer, Naruni Enterprises, has provoked the Coalition to consider launching a secret military campaign to eliminate Robot Control and their alien allies. The only thing that has stopped the CS from endorsing an all-out war is fear that Naruni Enterprises may retaliate by launching an invasion against all of North America. The always paranoid CS suspects that the long-term plans of Naruni is the invasion and conquest of North America and that their alliance with Robot Control is effectively a covert operation designed to provide reconnaissance, intelligence and lay the groundwork for such an invasion (which isn't far from the truth).

The Coalition's propaganda machines have publicly branded Robot Control as the "greedy dupes" of an "alien power whose only goal can be the subjugation of humankind!" and has made the purchase, sale and possession of Naruni products a serious crime.

In addition, Robot Control's sale of Naruni high-tech weapons has evoked the ire of other weapons manufactures such as Northern Gun/Ishpeming, Wilk's, Iron Heart and Triax, all of whom agree with the Coalition's speculation that Naruni Enterprises has designs on North America (perhaps the entire world). Or as an ambassador from the NGR put it, "It represents a genuine threat to international security." These manufacturers are so concerned that they have launched their own covert investigations into the activities of Robot Control. Their intention is to plant spies among the mercenary outfit and perhaps even among Naruni Enterprises in another dimension! Northern Gun and the CS are engaging in independent acts of infiltration and sabotage. There will be 1D4 spies among Robot Control working for Northern Gun, Wilk's, and Triax. The CS will have 2D4 spies among the mercenaries (including a Glitter Boy from Free Quebec, a dog boy from Chi-Town, and a forger from Iron Heart).

The Manistique Imperium, Arkansas/Fort El Dorado, and Whykin also see the Naruni presence as dangerous and have agreed not to support nor make purchase from Robot Control. This is the first time that anybody can remember, that all of the Coalition States (including Free Quebec) and the independent kingdoms of Ishpeming (the home of Northern Gun), Manistique Imperium and the NGR/Triax have agreed on anything! Ironically, the perceived threat of Naruni Enterprises may be the catalyst that makes the Coalition States even stronger than it already is, building closer ties with the powers of Upper Michigan and the NGR.

Of course, Lazlo, New Lazlo, Tolkeen, and other "D-bee lovers" or magic oriented kingdoms have not been approached by the CS in any way. They know how the CS and others feel but are left to draw their own conclusions.

A behind the scenes player is the Splugorth of Atlantis, who knows of Naruni Enterprises as an increasingly annoying competitor in the transdimensional marketplace. Lord Splynncryth may even dispatch his own special teams to observe and sabotage Naruni Enterprises' activities on Earth (as far as he's concerned the planet is not big enough for the two of them). A.R.C.H.I.E.-3 may also take an interest in these activities, because anti-robot fighters represent a serious threat to his existence and creations. Also see the section describing **Naruni Enterprises** and its weapon systems.

Tactics

Captain Lucia Chen, the leader of Robot Control, is an expert at anti-robot warfare. She and all the members of her team are extensively trained to combat and neutralize robots. Their favorite tactic is to ambush bots at close range. The machines frequently have the advantage of greater range, speed and heavy weaponry. Consequently, close combat will completely take out the advantage of range; the element of surprise and first strike gives the attackers the edge and compensates for the bot's greater mobility. However, close quarters may limit the use or effectiveness of certain heavy weapons. Attack squads are trained to target a specific area of an enemy robot, starting with the legs and sensor systems to cripple the enemy by impairing their mobility and senses. Once immobilized or impaired, the enemy can be more easily contained and destroyed. Mines, missiles, and explosives are used extensively, as are heavy hand-held weapons such as rail guns, particle beam guns and plasma weapons. Combat pods are the lethal vehicles used by the company and deployed with great skill.

The mercenaries always try to fight on terrain and a location of their choosing. To accomplish this, they rely on Naruni spy drones, humanoid spies, wilderness scouts and a psychic/magic team, and are usually well-informed about enemy movement and strength. Robot Control has some of the best reconnaissance capabilities in the mercenary community.

Company Colors and Banners

The symbol of Robot Control is a simple, cartoon-like drawing of a female figure in combat armor standing over a robot, its eyes crossed and springs and wires protruding from an open wound.

Captain Lucia Chen

Lucia Chen is a second-generation mercenary. Both of her parents were in the business and Lucia grew up among a ragtag band of Soldiers of Fortune. The company was originally equipped only with M.D.C. armor and hand weapons. However, one day they came across an enemy with giant robots. In the ensuing battle, Lucia's parents and most of the company's adults were killed. Lucia and the company's non-combatants watched the massacre from a nearby hill. They managed to escape in a few vehicles while the victors looted the main camp. She never forgot the size and power of the enemy's bots or the seeming ease with which they shrugged off laser beams while they slaughtered her family and friends.

The little girl was raised in Ishpeming with other mercenary relatives. She joined that nation's military and specialized in learning anti-armor weapons and tactics. When Lucia felt she had learned all she needed, she resigned her commission and used her savings to form a small, elite mercenary unit. All the members were infantry soldiers, which minimized equipment and expenses. More importantly, she made contact with **Naruni Enterprises**, who were just setting up shop in Ishpeming. The transdimensional traders were expelled from that nation shortly thereafter, due to influence from Northern Gun manufacturing. "Trader Joe" Ut-Naruni, the Naruni field representative had met Captain Chen and was impressed by her skills and leadership abilities. He decided to contact her and make an offer to help fund her operations, becoming, as he put it, "a silent partner" in the company, providing both money and Naruni equipment. In return, Robot Control would allow him and his field agents to travel with the mercenaries and arrange the sale of Naruni weapons and equipment to other interested parties. Of course, Robot Control could make additional purchases at cost. Trader Joe sees Captain Chen's mercenaries as a wonderful way to showcase Naruni wares.

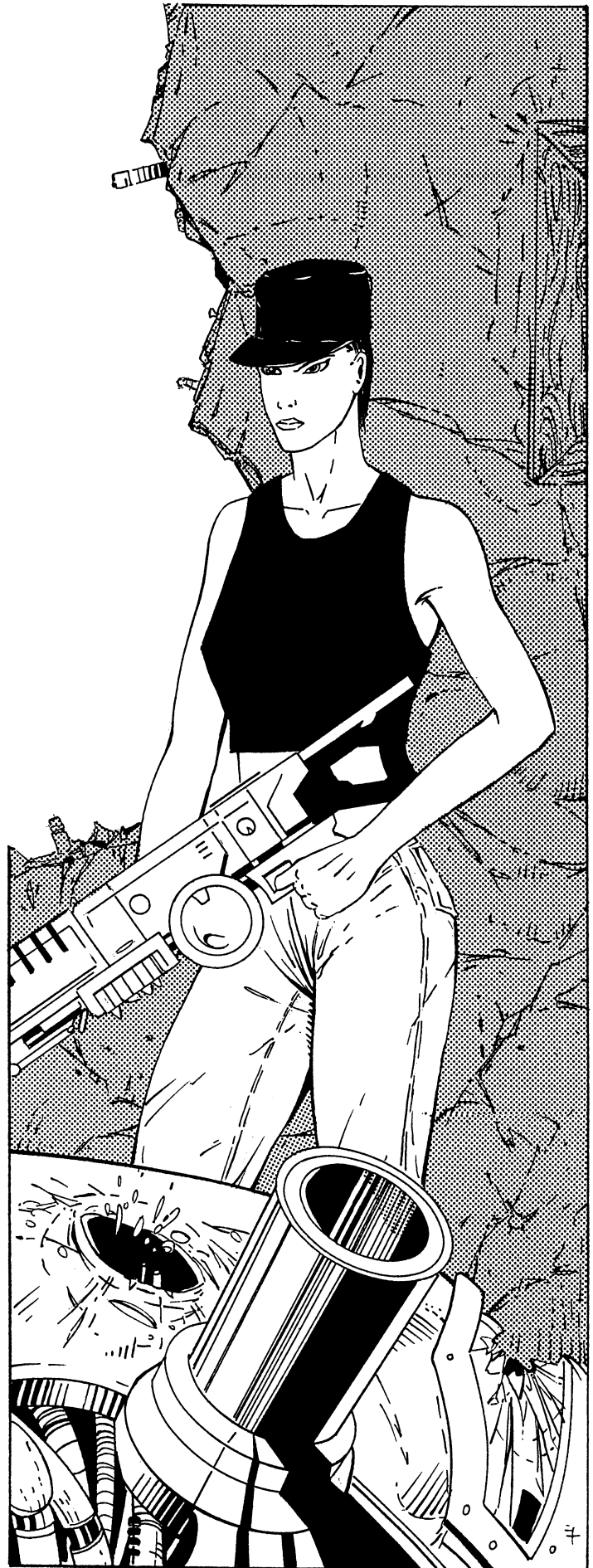

This partnership has proven to be highly successful. The company, combined with the aliens' ultra-technology and Captain Chen's expertise and leadership, and their history of notable battles against the Mechanoids has enabled them to build an amazing reputation in less than a year. The low cost of Naruni equipment to the company has allowed the Captain to charge less for their services than most other mercenaries equipped with more expensive (and somewhat less advanced) Earth equipment. Furthermore, the Coalition's rebuking of the company has given Robot Control a stamp of approval among wilderness communities, kingdoms and adventurers who feel persecuted or abandoned by the CS and often adopt the attitude of, "an enemy of the Coalition is a friend of mine." As a result, the mercenaries are never short on clients.

Notes from Siembieda: Meanwhile, Trader Joe is getting a firsthand look at the people, places and strengths of North America. Extremely valuable information in plotting his "market expansion" for Naruni Enterprises. Rifts Earth offers some very unique opportunities.

For a change, the CS is correct in calling Captain Chen and her mercenaries the "dupes" of a dangerous alien power. She and her troops are currently so caught up in the success and popularity of their company, that they are blind to any schemes Trader Joe may have in mind. Oh, of course, they realize that Joe and Naruni is profiting from their success through the sales of weapons, equipment and vehicles to wilderness communities, but that's to be expected. After all, this is a successful business partnership — both parties are in it for the money.

So far, Trader Joe has been a good guy with everybody, including those who purchase his products. However, Captain Chen is not aware of Naruni Enterprises' policy of encouraging clients to buy more than they can afford and then seizing land, resources and even enslaving people to pay the bill. Joe hasn't done this yet because he's sizing up the situation and lining up prospective clients/victims by showcasing Robot Control. If Naruni Enterprises starts engaging in such despicable activity (and they will), Captain Chen will dissolve their partnership, Naruni will slap her with a massive bill and breach of contract, and she will find herself at odds with a ruthless and powerful force. Most of her troops will remain loyal to her and will feel used by the alien corporation. If Trader Joe or other Naruni agents push Robot Control even an inch more than they already have, they will create a deadly and vengeful nemesis. Exactly what may transpire afterward, we leave to future books and the imagination of **Rifts** G.M.s and players.

Full Name: Lucia Chen

Alignment: Unprincipled (but basically good)

Attributes: I.Q. 17, M.A. 19, M.E. 15, P.S. 17, P.P. 20, P.E. 16, P.B. 15, Spd. 17.

Hit Points: 45 **S.D.C.:** 36

Size: 5 feet, 5 inches (1.65 m), 120 lbs (54 kg); **Age:** 34 **P.P.E.:** 11

Disposition: Captain Chen is a competent soldier, with a good grasp of strategy and tactics. She didn't really seek vengeance against the machines that killed her parents; it was more a quest to gain control over something she feared. Now she has no need to fear robots of any kind, giant, man-size or otherwise. Chen wants to have control of the situation under most circumstances. That makes her a good soldier, but a tough person to get along with. The only person she has a good personal relationship with is the cyborg Chrome, who shares a similar attitude. Towards the rest, she's the boss — a good boss, but never a friend. She is dedicated to getting the job done, whatever it may take.

Experience Level: 9th level Special Forces Soldier

Magic Knowledge: None

Psionic Powers: None

Combat Skills: Hand to Hand: Expert, boxing and Robot Combat: Elite.

Attacks per Melee: Five hand to hand attacks

Bonuses: +2 on initiative, +5 to strike, +8 to parry and dodge, +1 to damage, +3 to roll with impact/punch, +2 to pull punch.

Weapon Proficiencies: W.P. Energy Rifle, W.P. Energy Pistol, W.P. Heavy Energy Weapons, and W.P. Heavy.

Weapons: NE-10 Plasma Cartridge Rifle, NE-4P Plasma Cartridge Pistol, WI-GL4 Grenade Launcher and an assortment of grenades.

Armor: Camouflage Variable Armor with Medium Force Field (M.D.C. 80 plus 60 for the field).

Skills of Note: Radio: basic 98%, literacy 88%, computer operation 93%, intelligence 86%, pilot tank 85%, weapon system 98%, read sensory equipment 88%, running, pilot combat pod 75%, demolitions 90%, and demolitions disposal 90%.

Description: A short, athletic Asian-American woman whose strong personality more than compensates for her height. She can stand up to and intimidate mercenaries twice her size, and often has.

Arrak Chrome — D-bee Cyborg

Captain Chen's second-in-command is Arrak Khrum, a gigantic cyborg from another universe, who has been nicknamed "Chrome." It comes from an ancient civilization that has been at war with an army of relentless killing machines that call themselves **The Horde**. These creatures are very similar to the Mechanoids in that they wish to destroy human life — but Chrome contends that they go even beyond the Mechanoids in savagery. The Horde is made up of completely artificial life forms who seek the destruction of all *organic life!*

Arrak Khrum was born on that world, a member of a humanoid race who had warred against the Horde for centuries. At the age of 12, like everyone else in his planet, he joined the military. His aptitude tests indicated he was an ideal subject for cyborg conversion and was transformed into a silvery-plated walking weapon. The greatest irony of the war against the Horde was that the organic races had chosen to sacrifice their flesh and humanity to become like the machines they battled.

The young warrior spent ten years engaged in one savage battle after the next. Forced to a life of fighting the Horde's War-Machines, he became proficient only in the science of killing. He and an elite commando team were sent against a secret laboratory, where the Horde was conducting strange experiments on fourth-dimensional physics and space-time warps. After a brutal fight, Arrak and his team reached the main laboratory. A miscommunication among his people had also sent a spaceship to drop a nuclear device and blow up the complex. When the bomb struck, the explosion affected the space warp experiment in an unforeseen way, and launched Arrak (and his companions) through space and time. One moment he was fighting the Horde, the next he was spit forth from a dimensional rift on Earth!

He met the mercs of Robot Control when a squad was hired to investigate reports of an alien robot wandering the countryside. When given the opportunity to join them and fight new robot enemies, he jumped at it. Captain Chen has come to admire the cyborg so much that she has made him her second in command. Rifts Earth offers a warrior great opportunity and war is something that Arrak understands well.

Real Name: Arrak Khrum

Alignment: Aberrant

Attributes: I.Q. 13, M.A. 17, M.E. 19, P.S. 40 (bionic), P.P. 24 (bionic), P.E. 17, P.B. 6, Spd. 176 (120 mph/182 km).

M.D.C.: 450 main body, plus alien heavy infantry armor 550 M.D.C. (total 1000 M.D.C.)

Size: 12 feet tall (3.66 m), 6 tons in full armor. **Age:** 23

P.P.E.: 3

Disposition: Over the years, Chrome stopped caring about why he fought. Fighting was simply what he did. Fighting for pay is as good a reason as any. His only loyalty is to his fellow soldiers; nobody else matters.

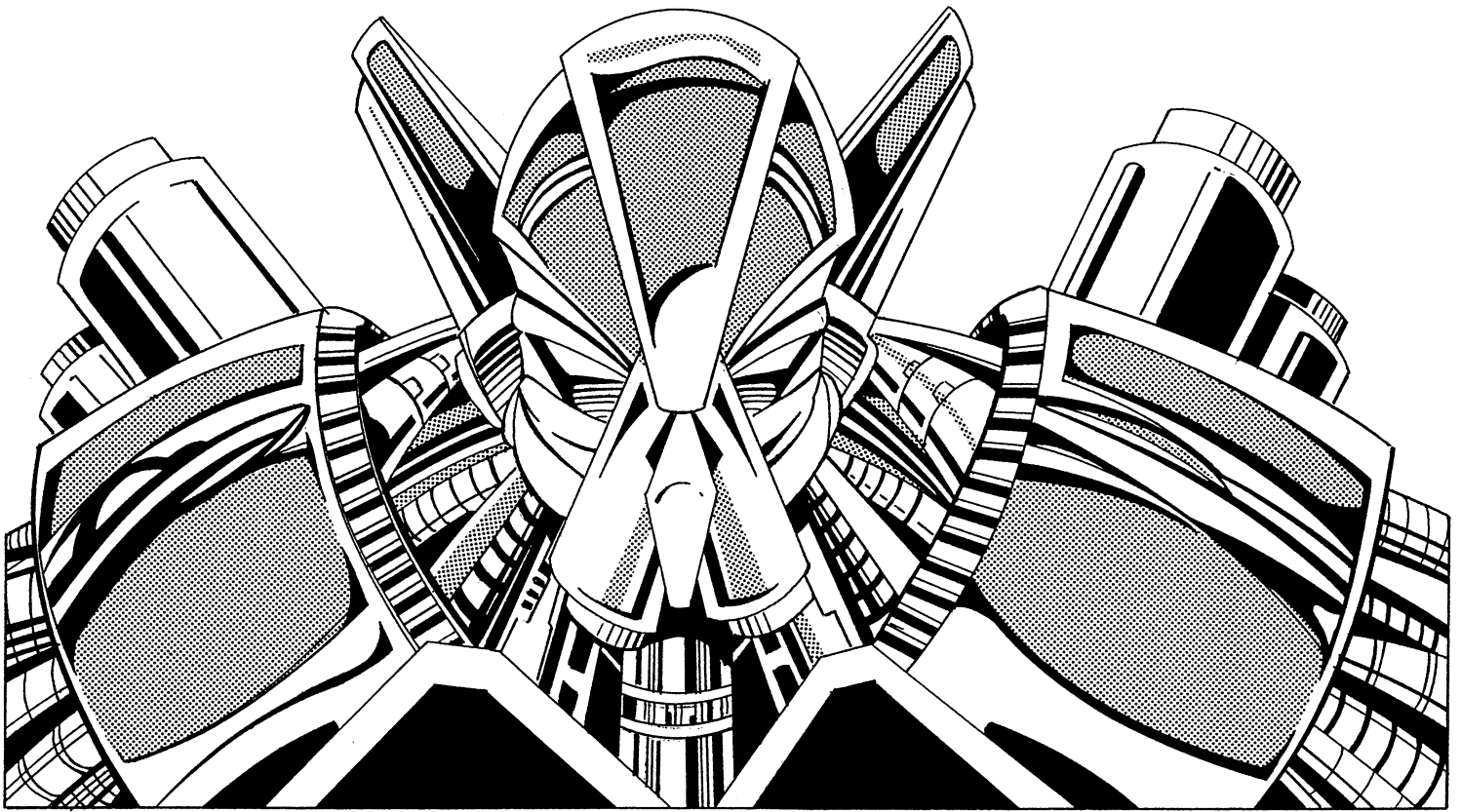

SEZ JL[™]

He respects and admires Captain Chen and the two consider each other friends, but the Captain's aloof manner makes it difficult to feel close to her. Chrome and Grunt, the other giant of the company, have developed a friendly rivalry, but the only close friend he's made is the mischievous faerie, Eowyna. He distrusts Trader Joe immensely. To the cyborg, the idea of somebody making a profit out of selling weapons is almost obscene. He tolerates the situation because he realizes this world is very alien to his own. These people, he reasons, do not have to fight for the survival of their species — they fight for pleasure and conquest (or so it seems to him).

Not too long ago, Robot Control ran into a band of Mechanoids (see *Rifts Sourcebook Two: The Mechanoids*, for more information on that alien threat). Arrak managed to capture and interrogate a Mechanoid Thinman robot (he interfaced with the robot's memory and "read" its artificial mind). The threat of the Mechanoids, so similar to the Horde, troubles him. Ever since the encounter, he spends a lot of time following up on rumors about Mechanoid activity.

Experience Level: 9th level 'Borg (alien).

Magic Knowledge: None.

Psionic Powers: Minor Psionic. Mind block, see the invisible, total recall and speed reading. **I.S.P.:** 67

Combat Skills: Hand to Hand: Expert and boxing.

Attacks per Melee: Six hand to hand attacks.

Bonuses: +3 on initiative, +7 to strike, +10 to parry and dodge, +9 to damage, +3 to roll with impact/punch, +4 to pull punch, immune to poisons, +4 to save vs magic, +2 to save vs psionics, +8 to save vs horror factor.

Combat Damage:

Restrained Punch — 1D4 M.D.

Full Strength Punch — 2D6 M.D.

Power Punch — 4D6 M.D.

Claws — Add 3D6 M.D. to punch damage.

Kick — 2D4 M.D.

Leap Kick — 3D6 + 4 M.D.

Cybernetics and Bionics: Chrome is 95% machine; only parts of his brain and spinal column remain. Even some of his brain has been replaced by ultra-sophisticated computers (enhancing his memory). He has the alien equivalent of these bionic/cybernetic systems: Bionic lung (lasts 18 hours — needs much less oxygen than even a full conversion borg), built-in self-programmable speech translator (can learn up to eight languages within eight hours of listening continually to them), multi-optic eye, universal headjack, motion detector, gyro-compass, radar detection, built-in radio.

The cybernetic organism is powered by a micro-fusion power plant decades ahead of anything produced on Earth, with a 60 year life (his was recently replaced, so he has about 50 years left).

The special alloys in the armor are served by millions of nano-machines (microscopic robots), which are able to transform less advanced materials into compatible alloys. This means that damage inflicted to the cyborg can be repaired using local M.D.C. materials. 20 M.D.C. can be restored per hour.

Any government, military or advanced bionics manufacturer would pay millions of credits to get their hands on Chrome and disassemble and study the alien cybernetics (the knowledge would put such an institution years ahead of anyone else in the field of cybernetics — but will also take a decade or two to develop). Even Naruni Enterprises would be interested, but Trader Joe has wisely not pressed the issue. Fortunately, for Chrome, few suspect he has such novel and advanced inner workings and dismiss him as just another borg merc.

Weapon Proficiencies: W.P. Energy Rifle, W.P. Energy Pistol, W.P. Heavy Energy Weapons, W.P. Sword, W.P. Blunt, and paired weapons.

Weapons of Note: Plasma Cannon: A heavy (800 lbs/360 kg) cannon recharged by his internal fusion power plant. The cannon inflicts 3D4 × 10 M.D., and has a payload of 20 shots and a range of 2000 feet; shots recharge at the rate of 1 per minute (4 melees). His cybernetic body also has metal claws (add 3D6 M.D. to hand to hand attacks) and a built-in laser (2D6 M.D., range 1000 ft/305 m,

payload unlimited). Often carries a WI-23 missile launcher as a secondary weapon.

Armor: Alien cyborg combat armor with 550 M.D.C. (can also be repaired by the nano-bots).

Skills of Note: Basic radio 98%, pilot hovercraft 98%, pilot tank and APC 77%, read sensory equipment 85%, weapon systems 90%, first aid 95%.

Description: At first sight, most people will confuse Chrome with a robot vehicle or oversized power armor suit. He is an imposing silvery-metal humanoid, with a baroque armor style reminiscent of the Kittani.

Sgt. Luigi “Va-Ba-Boom” Grimaldi

At a glance, Luigi Grimaldi is an unimpressive, short, skinny man with shiny black eyes. But Luigi’s hobby and profession makes up for any physical shortcomings. He likes to blow up things. From setting up mines to demolishing buildings and fortresses, he knows how to use explosives to get the most effect. His booby-traps are legendary. He has set up explosives in small packages such as an apple, articles of clothing, or in letters. His hand-crafted missiles and grenades are more potent than normal explosives. He can disguise mines so that nobody will suspect them until it’s too late.

Luigi’s hobby has not made him popular in more civilized areas. The fact that he is very eccentric (some would say outright crazy) does not help. He has been banned from Ishpeming and all cities in the Manistique Imperium, and is a wanted murderer in the Coalition States (after an army officer had an unpleasant — and deadly — experience in his office’s restroom). Not even the other members of Robot Control are completely comfortable with him. Luigi always has an explosive device on his person, either something visible like a pair of grenades, or disguised as an inoffensive article like a pen or large button. Many people half expect him to explode one of these days and nobody wants to be close by when that happens.

Full Name: Luigi Grimaldi

Alignment: Anarchist

Attributes: I.Q. 23, M.A. 10, M.E. 12, P.S. 9, P.P. 14, P.E. 13, P.B. 8, Spd. 9

Hit Points: 35, **S.D.C.:** 13

Size: 5 feet, 7 inches tall (1.70 m); 170 lbs (76.5 kg); **Age:** 29

P.P.E.: 12

Disposition: Sgt. Grimaldi can be a charming and funny guy, but his horror stories about explosives and accidents make people nervous. He also has an air of insanity about him that can be intimidating. The man has almost supernatural luck, has never had an accident and has never been hurt by one of his explosions. He doesn’t trust assistants, and does all his work himself. He produces a small number of “custom” explosives for use on special missions, and will make souped-up grenades and missiles for other members of the company.

Experience Level: 8th level safecracker/demolitions expert

Magic Knowledge: None

Psionic Powers: None

Combat Skills: Hand to Hand: Basic

Attacks per Melee: Three hand to hand attacks.

Bonuses: +1 to strike, +2 to parry and dodge, +2 to damage, +2 to roll with impact/punch, +2 to pull punch.

Weapon Proficiencies: W.P. Blunt, W.P. Energy Rifle, W.P. Heavy.

Weapons of Note: WI-GL4 grenade launcher, WI-23 missile launcher, an energy pistol, neural mace, survival knife, 2D4 souped-up plasma grenades, 1D4 souped-up fragmentation grenades, 1D4 types of fusion blocks (any type) and 1D4 other explosives of choice.



All the explosives he personally uses are typically customized to inflict 50% more damage. For example: A plasma grenade that normally does 5D6 M.D. is modified to inflict 7D6 M.D. and his plasma mini-missiles inflict 1D6 × 15 M.D. Sgt. Grimaldi can only manufacture a few dozen improved explosives a week, so there will never be more than 5D6 custom explosives on hand for use by other Robot Control members at any given time. Captain Chen determines which troopers need the extra firepower and issues them for special assignments.

Armor: Naruni super-heavy force-field; no body armor.

Skills of Note: Basic math 98%, advanced math 98%, electrical engineer 98%, mechanical engineer 94%, weapons engineer 88%, computer repair 83%, basic radio 98%, read sensory equipment 98%, pilot battle hover vehicle 96%, pilot jet pack 98%, pilot tank and APC 92%, chemistry 84, chemistry (analytical) 79%, demolitions 98%, demolitions disposal 98%, safecracking 98%, first aid 84%, weapon systems 89%, literacy 79%, photography 83%.

Description: A short, broad-shouldered and squat, black-haired man who never seems to appear clean-shaven (eternal 5 o’clock shadow even a few hours after shaving).

Grunt, The Giant

Grunt is a Jotan giant (see **Rifts Conversion Book One**) and a genius among his kind. He won’t tell where he comes from, but he has obviously had a great deal of experience with technology. There are many rumors about him, but the most prevalent ones suggest Grunt comes from Europe, where a secret Jotan community is helping the Gargoyle Empire against the New German Republic. Another popular rumor suggests he once worked with the nefarious Angel of Death. Grunt neither denies nor confirms the rumors. If asked, he says nothing and waits for the questioner to change the subject. If the person continues asking the same question, he gets annoyed, and most people know better than to annoy a 20 foot (6 m) warrior bristling with weapons.

The giant is equipped with a custom-made power armor suit that makes Grunt the match of any known robot. His specialty in the company is the use and placement of heavy ordnance (missiles and artillery)

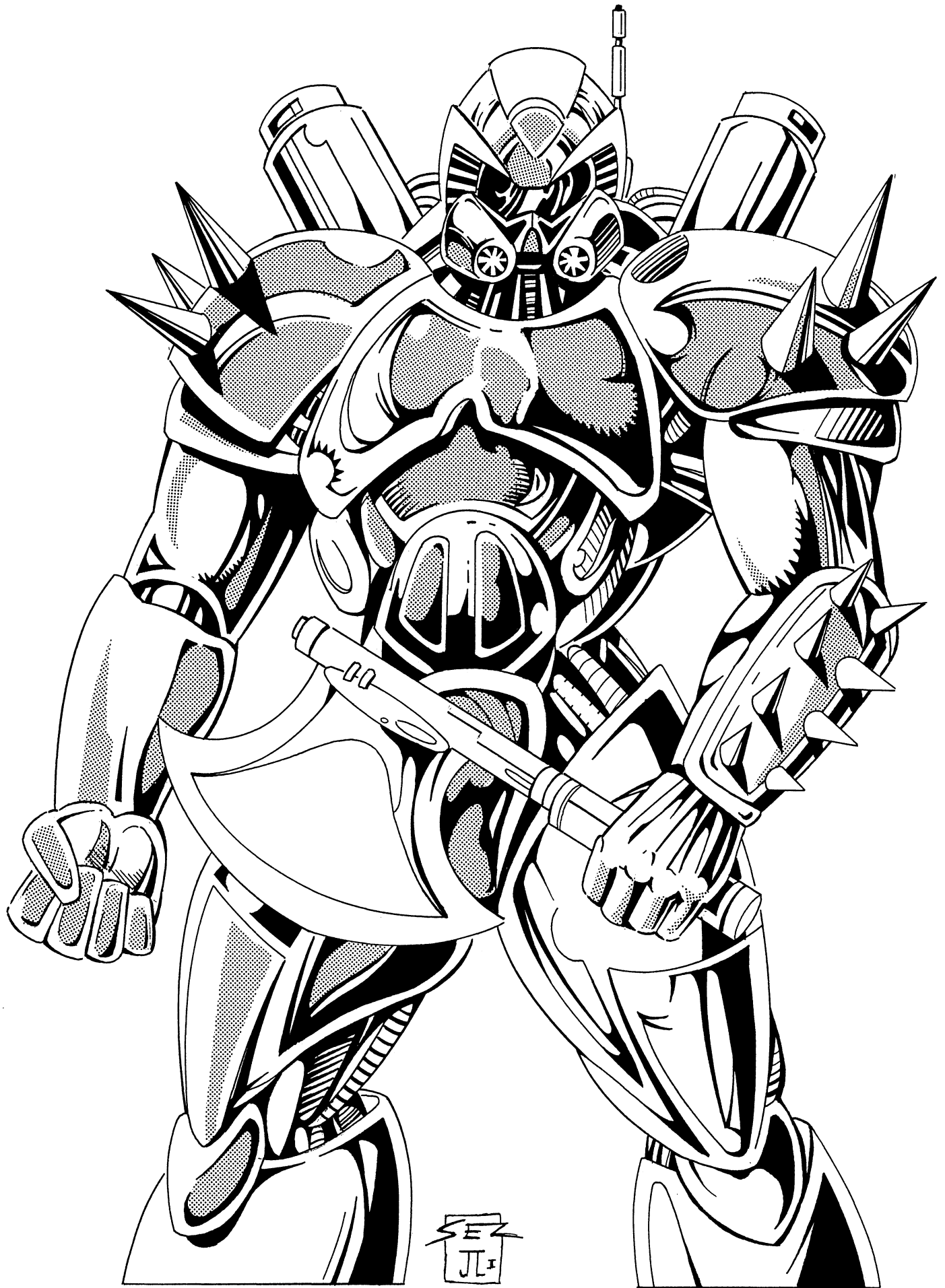

SEZ
JL I

against heavily armored targets. He has organized two squads of mis-sileers, all trained in ambush and anti-armor tactics. Although an expert in the use of missiles, whenever he gets the chance Grunt likes to engage in hand-to-hand combat, relying on his trusty power armor, strength and skills.

Alignment: Anarchist

Attributes: I.Q. 12, M.A. 6, M.E. 14, P.S. 30, P.P. 21, P.E. 25, P.B. 5, Spd. 17. Supernatural strength and endurance.

M.D.C.: 70

Size: 20 feet (6 m) tall, weighs 2000 lbs (900 kg) and the armor is another ton.

Age: 85 years old, looks to be about 40.

P.P.E.: 30

Natural Abilities: Nightvision 40 ft (12.2 m; can see in complete darkness), resistant to mega-damage heat/fire (takes half damage; immune to normal fire). Natural aptitude for mechanics.

Disposition: Grunt is surprisingly civilized, but he has a condescending attitude towards humans and other “small” humanoids. He never says so directly, but there is always an understanding that he can squash a human like a bug, so he doesn’t take the “little people” all that seriously. He respects Captain Chen’s expertise, but the only people in the company he treats as an equal are Arrak Chrome, the only one that Grunt couldn’t take in a straight fight, and Luigi Grimaldi, whose skill with explosives he admires.

Experience Level: 6th level headhunter

Magic Knowledge: None

Psionic Powers: None, however he seems mysteriously impervious to psionic mind probes and is +3 to save vs psionic attacks and possession. Unknown to all but Grunt, his resistance to psionics is the result of a tiny Mindwerks implant; further evidence that he is, or was, somehow involved with enemy forces in Europe. Unlike most recipients of such implants, Grunt seems free of side effects that lead to insanity.

Combat Skills: Hand to Hand: Expert and boxing

Attacks per Melee: Four hand to hand attacks

Bonuses (does not include power armor bonuses): +5 to strike, +8 to parry and dodge, +15 to damage, +5 to roll with impact/punch, +4 to pull punch, +5 to save vs poison, +5 to save vs magic, and +3 to save vs horror factor. Also see psionics above.

Weapon Proficiencies: W.P. Energy Rifle, W.P. Energy Pistol, W.P. Sword, W.P. Blunt, W.P. Heavy, W.P. Heavy Energy Weapons.

Weapons of Note: WI-GL20 Automatic Grenade Launcher.

Armor: Giant-sized plate armor — 150 M.D.C.; also see his power armor, below.

Skills of Note: Basic radio 90%, radio: scrambler 75%, detect ambush 70%, detect concealment 70%, tracking 65%, land navigation 70%, weapon systems 80%, read sensory equipment 70%, demon lore 65%, languages include: Troll/Giant 98%, Gobblely 98%, Euro 80%, American 75%.

Description: A bronze-skinned giant humanoid with dark brown hair and eyes and numerous scars, including signs of whippings and slavery; he never speaks about those.

Grunt’s Power Armor — The Pulverizer

Grunt’s suit of power armor came with him from Europe; it is a custom-made, one of a kind suit. This 26-foot (7.9 m) tall monster will be mistaken for a giant robot vehicle by anyone who doesn’t know about Grunt. The giant has decorated the suit with many spikes and sharp edges on the elbows, forearms, knees and feet. This makes it even more intimidating, and puts Grunt at an advantage in hand to hand combat.

The suit has two mini-missile launchers on the shoulders and two wrist-mounted plasma guns. The only other weapon he carries is a Kittani plasma axe (in his quarters, Grunt has mounted on a wall the head of the Serpent Armor suit of the previous axe owner).

Model Type: Pulverizer Mark I

Class: Giant Armored Infantry Assault Suit.

Crew: One.

M.D.C. by Location:

Mini-Missile Shoulder Launchers (2) — 150 each

Forearm Plasma Guns (2) — 80 each

Upper Arms (2) — 90 each

Legs (2) — 250 each

Plasma Axe — 100

Head — 140

Main Body — 450

Naruni Force Field — 260

Statistical Data:

Height: 26 feet (7.9 m)

Width: 13 feet (4 m)

Length: 8 feet (2.4 m)

Weight: 19 tons fully loaded

Physical Strength: Equal to a P.S. 50

Cargo: None

Power System: Nuclear, average energy life is 20 years.

Weapon Systems

1. Mini-Missile Shoulder Launchers (2): Mounted on the shoulders are two six-missile launch packs.

Primary Purpose: Anti-Personnel, Anti-Armor

Secondary Purpose: Defense

Mega-Damage: Varies with missile type. Grunt always uses plasma (1D6 × 10 M.D., or 1D6 × 15 M.D. if using Luigi’s specialty missiles).

Range: About one mile (1.6 m)

Rate of Fire: One at a time, or in volleys of two, four or six.

Payload: Twelve missiles total; six per launcher.

2. Plasma Guns (2): Wrist-mounted short-range beam weapons.

Primary Purpose: Anti-Armor

Secondary Purpose: Anti-Personnel

Mega-Damage: 1D4 × 10 M.D. per shot

Range: 1200 feet (365 m)

Rate of Fire: Standard

Payload: Effectively unlimited

3. Kittani Plasma Axe: A double-bladed energy weapon used for close combat. The giant weapon can be energized to cut through targets or fire a short-range burst of plasma twice per melee (each blast counts as one melee action).

Primary Purpose: Assault

Weight: 20 lbs (9 kg)

Mega-Damage: 1D4 × 10 M.D. per plasma energized strike, 1D4 × 10 M.D. from energy blast, or 1D4 M.D. as a blunt weapon.

Rate of Fire: Equal to number of combined hand to hand attacks.

Maximum Effective Range: Close combat or plasma blast 200 ft (61 m).

Payload: Effectively unlimited (taps into the power supply). An hour’s life from a standard E-Clip; the damage inflicted is half and it can only fire a total of six plasma blasts.

4. Hand to Hand Combat: Rather than use a weapon, the pilot can engage in mega-damage hand to hand combat. See Power Armor Combat Training.

Restrained Punch: 1D6 + 2 M.D.

Full Strength Punch: 3D6 + 6 M.D.

Power Punch: 1D6 × 10 + 10 M.D.

Kick: 4D6 M.D.

“Tinker Bell” Eowyna

One of Robot Control’s earliest missions took the company near a forest inhabited by faerie folk (see **Rifts Conversion Book One**). As one might expect, the company was beset by practical jokes and magic at the hands of the faeries. Captain Chen wisely ordered her troops not

to fire upon the faeries and to tolerate their pranks and harassment. She made an effort to communicate with the little creatures and managed to speak with their leaders. Chen had heard many tales about faerie folk, so she was careful not to eat any of their food, or make any of the mistakes which the Little People might want to punish. Through a combination of diplomacy, and a pocket full of chocolate candies, she negotiated a faerie truce and safe passage for the company. A silver bell faerie called Eowyna was assigned to be their liaison and guide.

Eowyna was friendly, but curious about humans and their machines. The silver butterfly winged woman appreciated that Captain Chen tried to answer all her questions as best she could and never tried to trick or harm her. Most surprising of all, the tiny creature struck a chord with Arrak Chrome. The cyborg had never seen any creature as happy and carefree as Eowyna and she was fascinated by the huge, shining metal-man. The two became fast friends. Consequently, it was not surprising that Eowyna told her people she would be accompanying the humans on their adventures beyond faerie territory.

At first Captain Chen and the others were worried about having a faerie join their ranks and the mayhem she might cause. However, Eowyna has shown great self-control, is a reliable teammate and proven herself to be a valuable asset to the company. She serves as a scout and counter-magic specialist. She knows the wilderness well and can travel silently and usually unnoticed, as well as squeeze into places much too small, narrow, high or dangerous for big folk. She also knows all about faerie lore (has connections with other faerie folk) and her faerie magic is a formidable deterrent against enemy magicians, dragons and supernatural forces. She lives in Chrome's tent and trusts only him and Captain Chen. All other "big folk" are viewed with suspicion.

For the faerie, the company's business is nothing more than a highly amusing game. This is only a short-term interest for Eowyna, but "short-term" for the immortal creature could be decades, or even centuries!

Full Name: Eowyna

Alignment: Anarchist

Attributes: I.Q. 14, M.A. 11, M.E. 8, P.S. 3, P.P. 17, P.E. 8, P.B. 24, Spd. 13 running and 150 flying.

M.D.C.: 30

Size: Six inches (0.15 m) tall and six ounces (0.17 kg).

Age: 73

P.P.E.: 300

Disposition: Like many faeries, Eowyna is cute and charming, but has an alien morality. She is not cruel or murderous towards humans, but cares very little for most of the "big folk." For her, combat is a fun game and the dozens or hundreds of men and women who die in the "game" mean nothing to her. She genuinely does care about Captain Chen and Arrak Chrome and will fight to the death to protect and help them; their deaths would sadden her as much as if one of her kind had died and she will almost certainly seek revenge against those responsible.

She is fairly good-natured and won't hurt people or property (mostly because she knows her two friends wouldn't approve), but she is a practical joker which does irritate many of the mercenaries. Of course those who complain and protest the loudest are her most frequent targets. Those who take her jokes in good humor are the least often victims and are considered by her with higher regard. She loves to play, dance, sing, tell bad jokes, eat sweets, and loves to listen to stories and watch comedy films (the Three Stooges are her absolute favorites).

Against enemy troops, Eowyna shows no mercy. She has been known to leave numerous "pranks" at enemy encampments, many of them quite lethal, and takes great delight in inflicting chaos, confusion and death. On several occasions, she has joined forces with Luigi Grimaldi (who she is getting to like) to prepare miniaturized explosives for sabotage and surprises for unsuspecting foes.

Experience Level: 3rd level Silver Bell Faerie

Magic Knowledge: Has innate magic powers, requiring a saving throw versus magic of 14 or higher and has a spell strength, duration and range equal to a 10th level wizard. Her spells include befuddle, charm, love charm, sense evil, wind rush, tongues and the faerie dance.

Psionic Powers: None

Combat Skills: Natural

Attacks per Melee: Three hand to hand attacks per melee or three using magic.

Bonuses: +3 to strike, +3 to parry and dodge, +5 to parry and dodge while flying, +2 to roll with impact/punch, +2 to pull punch, +2 to save vs poison, +2 to save vs magic, +2 to save vs psionics, +6 to save vs horror factor.

Weapon Proficiencies: W.P. Archery and targeting

Weapons of Note: Faerie short sword (inflicts one S.D.C. point of damage, plus can magically make victims sleep for 2D6 melees), Faerie bow (arrows do 1 S.D.C. damage, plus have a contact poison that inflicts 2D6 S.D.C. additional damage to humans and animals and 1D6 M.D. to mega-damage beings).

Armor: Like most Faeries, Eowyna doesn't wear armor; however, Trader Joe has fashioned a tiny force-field belt for her. It works like all Naruni force fields, but it only provides 30 M.D.C. worth of protection for four hours of constant use.

Skills of Note: Speaks Faerie and Gobblely 98%, American 75%, identify plants and fruits 60%, land navigation 82%, wilderness survival 90%, preserve food 90%, track animals 32%, faerie lore 90%, sing 98%, dance 94%, prowl 72%, climb 60%/50%.

Description: A tiny, beautiful, pale humanoid woman with golden hair and white wings. Her voice is excruciatingly beautiful, especially when she sings. More than one enemy sentinel has been lured away from his post when attracted by that voice.

"Trader Joe"

Naruni Sales Rep

Naruni Enterprises is a transdimensional arms merchant who sells its wares throughout the Megaverse (see the description in the equipment section). "Trader Joe" (his real name is Ut-Naruni) is one of many partners involved with Naruni Enterprises. He is a blue-skinned D-Bee skilled as a weapons dealer, making him a combination of soldier and salesman (some might say con-man). He is a weapons expert who knows how to use high-tech armaments of all kinds and handles himself well in combat. He is amazingly knowledgeable of the weapons he sells and is able to rattle off statistics like a computer. He is also well versed in Kittani and Splugorth weapon systems, and hints that he's been on the receiving end of both. From his inferences, he has seen his share of war, including encounters with the Minions of Splugorth (seeming to lend credibility to his being one of the good guys).

The mercenaries at Robot Control actually know very little about Joe, Naruni Enterprises, or his homeworld. In an unusual display of trust, Captain Chen has accepted Trader Joe at face value and cut a lucrative arms and financing deal with the alien. When Trader Joe met Captain Chen, he decided her company would make an excellent showcase for Naruni armaments. He spoke with his superiors and convinced them to fund the mercenaries by providing them with start-up capital and millions of dollars' worth of Naruni Enterprises weapons and vehicles. Furthermore, the mercenary company can purchase additional ammunition, weapons and equipment at cost.

Trader Joe was ordered to accompany Robot Control as a technical advisor and sales representative. Part of the deal with Robot Control was to allow Joe to sell Naruni wares to prospective customers. It stands to reason that those who hire mercenaries are also likely to need or want weapons themselves. Whenever the company arrives at a new



Note: Joe's race is called the Uteni; minor shape-shifters with some psionic abilities. Their average attributes are listed in parentheses and can be used as an optional R.C.C. It is inevitable that other Uteni will come to Earth — it's just too valuable for the dimensional merchants to ignore. See more details about Naruni Enterprises in the equipment section.

Alignment: Unprincipled

Attributes: I.Q. 17 (3D6+4), M.A. 19 (4D6+2), M.E. 14 (3D6+2), P.S. 16 (3D6), P.P. 16 (3D6+2), P.E. 15 (3D6+4), P.B. 18 (3D6), Spd. 14 (3D6).

Hit Points: 38, **S.D.C.:** 350 (1D4×100+20, in addition to O.C.C. and skill bonuses).

Size: Six feet (1.83 m) tall (in humanoid form), 210 lbs (94.5 kg).

Age: 120 (The life span of the average Uteni is 500 years).

P.P.E.: 30 (1D6×10)

Natural Abilities: Limited shape-changing. The Uteni's natural appearance is that of a hairless, light-blue biped, about eight feet (2.44 m) tall, with thin and spindly limbs, huge eyes and no mouth or nose (they breathe through their skins). They can, however, alter their size and features to those of any biped from four to nine feet tall (1.22 to 2.74 m) (their weight remains the same). They cannot simulate body hair, and their skin color always remains the same, blue. It is possible that they are distant cousins to the Palladium changeling, but this is not likely.

Disposition: When he is trying to sell something, whether it be an idea or a weapon, Trader Joe is extremely outgoing, talkative, and friendly. Among people who know him, he is a bit more private, speaking only when he has something useful to say. Joe is officially an "advisor," but he always joins combat operations whenever he can. He enjoys combat and loves weapons. Captain Chen allows him to take many risks, but she won't permit him to be in the front lines — he's too valuable to lose.

Experience Level: 7th level Alien Merchant/Soldier

Magic Knowledge: None. The Uteni know about magic, techno-wizardry and bio-wizardry but tend to avoid magic and magic items, relying instead on equally powerful technology.

Psionic Powers: 53 I.S.P., and knows object read, mind block and speed reading. All Uteni are minor psionics with 1D6×10 I.S.P. (plus 1D6 per level of experience) and can select three powers from one of the psionic categories of healing, sensitive or physical.

Combat Skills: Hand to Hand: Expert

Attacks per Melee: Three hand to hand attacks

Bonuses: +2 to strike, +3 to parry and dodge, +2 to roll with impact/punch, +2 to pull punch, +4 to save vs horror factor (all Uteni get a bonus of 1D6 to save vs HF).

Weapon Proficiencies: W.P. Energy Rifle, W.P. Energy Pistol, W.P. Heavy.

Weapons: Like a good company man, Joe only uses Naruni weapons, and uses them well. He has access to every item sold by his company.

Armor: Camouflage variable armor with built-in super-heavy force field (210 M.D.C. total; 80 from the armor plus 130 for the force field).

Note: The Uteni can be any of the following O.C.C.s: Bounty hunter, forger, freelance spy, master assassin, safecracker, smuggler, professional thief, special forces/military specialist, headhunter, or any scholar and adventurer class. They tend to avoid magic, chemical or mental augmentation, and full bionic conversion, but love cybernetic implants and partial reconstruction.

Other Personnel

In addition to the key characters described in detail, the following troops are members of Robot Control.

- 10 Headhunters, levels 4-6 (all have combat pod piloting and power armor basic).
- 16 Wilderness scouts, levels 3-6.

community, Joe pays a visit to the local government and prominent citizens to pitch his products. More often than not, he comes away with a sale — especially when Robot Control has won a battle using Naruni weapons. He has learned, however, never to let his business interfere with Robot Control's operations. So far, the relationship between Robot Control and Naruni Enterprises has been amicable and profitable for both sides. Whatever his full origins and intentions, Captain Chen and her mercenaries place their attention on the business of war and don't waste energy wondering if their D-bee ally has ulterior motives.

Trader Joe's primary purpose is to evaluate the resources of Earth and its potential for Naruni Enterprises' expansion. He is to collect intelligence information regarding the cultures, inhabitants, and tech-levels and identify potential enemies. He first approached the Coalition States, but was rebuked and barely escaped with his life. He then came across Robot Control and made arrangements with them.

Joe is fascinated by Rifts Earth. The fact that the planet is more or less connected to hundreds, maybe even thousands of other worlds makes him salivate at the possibilities for Earth to become a major transdimensional trade center. Trader Joe envisions a future Earth with luxurious, enormous cities where travelers from thousands of civilizations go for tourism and trade. He believes that the mixture of magic and technology will eventually result in something greater than the sum of its parts. Of course, he's sure that the first beneficiary of all this will be the weapon business; Naruni Enterprises, specifically. Of course, such a transition is likely to be violent and costly in lives and money, but it would be worth every sacrifice. **G.M. Note:** He speculates that no less than three or four "world wars" will erupt over the next century: Europe will most likely be the site of the first one, followed perhaps by a conflict between the Coalition States and any number of enemies, from vampires or Atlantis to some new threat from another dimension.

- 24 Special forces soldier, levels 5-6 (all have Power Armor Elite training).
- 10 Full conversion borgs, levels 4-6.
- 10 Safecrackers/Demolitions Experts, levels 3-7.
- 10 Vagabonds, levels 2-4 (light infantry).
- 4 Mind melters, levels 1, 2, 4 and 5.
- 4 Uteni Smugglers, levels 5-9.
- 2 Uteni Operators/Mechanics, levels 4 and 8.
- 2 Mystics, level 5 (a magical team, recent addition to the company).
- 2 Super spies, levels 3 and 7.

Total Personnel: 100-120 combat troops, plus another 120-200 non-combatants, including family members, medics, maintenance and others. About 30% have some combat training (Hand to Hand: Basic, and one or two W.P.s), level 1-3.

Weapons, Equipment and Resources:

Standard Issue Weapons and Equipment

- NE-10 Plasma Cartridge Rifle or a TX-30 Triax Ion Pulse Rifle.
- 12 Plasma Grenades.
- 1 out of every four men is also issued either a WI-23 Missile Launcher, or a WI-GL4 Grenade Launcher.
- Body Armor: Light Infantry Units are given Urban Warrior armor (M.D.C. 50) with built-in Light Force Field (M.D.C. 35). Elite units are issued Camouflage Variable Armor (M.D.C. 80) with built-in Light Force Field (M.D.C. 35).
- NG-S2 Basic Survival Pack.

Transport Vehicles

- 20 Mountaineer A.T.V.s with nuclear engines. The vehicles have NE-200 machineguns in swivel mounts.
- 5 Mountaineer A.T.V.s converted into passenger vehicles (cargo hold now has seats for an additional 15 people, for a total of 20 people per car).
- 10-12 assorted vehicles, from motorcycle-pulled wagons to civilian S.D.C. trucks; these vehicles carry many of the non-combatants and camp-followers.

Combat Vehicles of Note

- 10 Naruni OMAV Combat pods (60% chance that 1D6 of the combat pods don't have Destructo-Drones because they haven't been replaced yet).
- 12 NG-EX10 Combat Exo-Skeletons.
- 6 MK-PA12 Mecha-Knight Power Armor with N-20B Medium Force Fields (+60 M.D.C.).

Adventure Ideas

Robot Madness

A robot factory is taken over by a supernatural or alien force. The being takes control over 100+ robots at the factory and continues producing robots while its mechanical slaves spread terror through the neighboring areas. Robot Control is called to deal with the problem. Possible adventure hooks/complications:

A.R.C.H.I.E. 3 (see **Rifts Sourcebook One**) hears of this "robot revolution" and sends Hagan and a small robot army of its own to investigate. They may either join forces with or destroy the new robot leader. This may lead to a three-way conflict.

The player characters were in the factory (maybe they wanted to buy something) when the robots went berserk. Now they and a handful of survivors are trapped, surrounded by murderous machines. Robot Control makes contact with them (maybe through Eowyna) and tries to coordinate their efforts to stop the threat.

The alien force that takes over the factory is actually a Mechanoid Oracle and three Brains (see **Rifts Sourcebook Two**)! These Mechanoids are trying to retool the factory to start producing alien robots. Nearby may be a larger force of Mechanoids and/or their robots. They may be trying to secure the area or are headed for the factory as reinforcements. If the player characters and/or Robot Control does not take the factory quickly, they will have to fight on two fronts.

Spies, Spies Everywhere

Somebody has hired the player characters to pose as mercenaries looking for work in order to infiltrate Robot Control. Their mission can be simply to observe the group and send back periodic reports about the mercs and specifically the ones called Trader Joe, Arrak Chrome, and Captain Chen. Or the mission may include acts of sabotage and/or the capture and interrogation of Trader Joe or one of the other Uteni D-bees among the mercs.

The employer can be agents openly or secretly representing Northern Gun, Wilk's, Iron Heart, Triax, or the Coalition States. Possible adventure hooks/complications:

One or more other spies have the same idea and these forces clash. Perhaps the NPC spies steal the captive away and Robot Control still thinks the player characters are responsible. Our adventurers may find themselves trying to hunt down the NPC spies to recapture the Uteni while Robot Control is trying to hunt them down.

Another similar twist is that the NPC spies are really assassins and kill their captive. The player characters now have to find the killer(s) to prove their innocence or face the wrath of Robot Control!

Double-Cross Run-Around! Our heroes' employer has hired them to capture and bring Trader Joe or one of the other Uteni to them for questioning. They are assured that no harm will befall the Uteni and that when they are done with the captive, the group can return him to Robot Control/set him free. The player group is successful, but then things turn sour. Their employer ushers the Uteni away for questioning; they are not allowed to participate and may be distracted by an impromptu celebration of their success or the matter of their payment plus a bonus. Our heroes get paid, but after a while, an agent of their employer thanks them and tells them they can go — their job is done. When they ask about their captive they are told not to worry about him and leave. If they push the matter or perform a covert investigation, they'll find the character is gone (perhaps dead if a Uteni other than Trader Joe)!

They also discover that their employer was not a concerned citizen, government or friendly competitor, but really the Coalition States! This can lead to a multitude of conflicts and encounters with both Robot Control (who demands they get their man back or ELSE! They'll send one of their key members and a no-name merc or two to keep an eye on the group) and the Coalition! After several encounters with CS troops/spies/officers, it becomes clear that they don't know anything about it. After a dangerous wild goose chase, our heroes discover that they were played for bigger chumps than they originally realized. The CS isn't responsible! The Splugorth (or other deadly power of the G.M.'s choice) is the true culprit. The real villain implicated the Coalition to disguise their true nature and to instigate more animosity between the CS and Robot Control and the Uteni.

If the villain is the Splugorth (see **Rifts Atlantis**) the player characters and members of Robot Control will find themselves fighting a variety of different minions. Furthermore, they may find themselves following a trail east and fighting time to rescue the captive before Minions of Splugorth can take him to Atlantis! Depending on where this trail leads, the player group may find themselves facing confrontations with the Federation of Magic, bandits, B-bees, and even A.R.C.H.I.E. 3 or his minions. If the G.M. wants to get really wild, the Splugorth team may be ambushed and the Uteni captured by yet another party, like a Mechanoid in need of repair/help, a small, hostile kingdom who needs

an operator to repair their equipment, dragon, demon, or even the Coalition, who have seized the Uteni for questioning and termination! Did the Minions of Splugorth get destroyed? If not, or if a survivor is joined by reinforcements, they will also try to recapture the prisoner!

Hunted by Robot Control! Regardless of what transpires, the mercs at Robot Control are not going to let one of their own get kidnapped, hurt or killed without finding those responsible and make them pay or make restitution! Being hunted down by members of Robot Control can be frightening and dangerous. Eowyna may call upon other faeries to help (including the ugly and mean types) and lay traps. Other team members may seek revenge in blood. If the characters get caught and can't come to some understanding, they will be stripped of their weapons (armor too?) and interrogated. Depending on how things go, they may be set free after some humiliation or torture (weapons are not likely to be returned), beaten up and left for dead, or sent back to their employer with a message (and maybe a hidden bomb). It is also possible that Robot Control will convince the player characters that their employer is the real bad guy. This could lead to conflicts with their employer and get the characters to join Robot Control.

Armageddon Unlimited

- A. Sponsorship: Demonic (equal to a major world power) 0 Points
 - B. Outfits: Specialty Clothing 20 Points
 - C. Equipment: Magic Technologies 40 Points
 - D. Vehicles: Combat Cars 20 Points
 - E. Weapons: Advanced Weaponry 20 Points
 - F. Communications: Full Range System 15 Points
 - G. Internal Security: Paranoid 40 Points
 - H. Permanent Bases: None 0 Points
 - I. Intelligence Resources: Psionics and Magic 20 Points
 - J. Special Budget: Small Potatoes 15 Points
 - K. General Alignment is Evil: Miscreant or Diabolic 0 Points
 - L. Criminal Activity: Psychic Enforcer 15 Points
 - M. Reputation/Credentials: Known 10 Points
 - N. Salary: Excellent Salary 20 Points
- Total Points Spent: 235 Points
Size & Orientation: Free Company that's a "front" for a demonic power/sponsor.

Armageddon Unlimited is building a reputation as a mercenary company that gets the job done. What people don't hear much about is what happens to the majority of the clients who hire them. Just about every conflict that involves Armageddon Unlimited is the site of more destruction and bloodshed than anybody could have foreseen. The diabolic mercenaries commit one atrocity after the next, all the while insisting to their employer that fear, cruelty, savagery and destruction are necessary to accomplish the job. Many of the kings and government officials who have hired Armageddon Unlimited have gone insane, committed suicide, were run out of town, or become murderous tyrants. These tales are laughed off by the mercenaries as outrageous lies created by their competitors. Most potential employers dismiss the tales and focus on the fact that Armageddon Unlimited has an impressive record of wins and no losses. Sadly, the employers don't realize that while they may win the war, the cost in lives and morality may cause them to lose their very souls.

Armageddon Unlimited is not a large company, but its technological and supernatural firepower are the equal or superior to almost any army on the continent. As the company's reputation steadily grows, they attract more clients whom they can lead to ruin. Unknown to any, this outfit is the creation of the demonic Persian "god" Ahriman (see **Rifts**

Conversion Book Two: Pantheons of the Megaverse). The evil god delights in perverting the innocent, twisting good intentions and corrupting all around him. He has established many mercenary armies of destroyers and corruptors, this is just one of them.

These dimension travelling mercenaries wander the Megaverse, looking for conflict and spreading ruin as they go. In some dimensions, these beings have caused the collapse of civilizations that have existed for eons. Their arrival on Rifts Earth is no accident, but an intelligence probe for a possible transdimensional invasion. The demonic company continually reports to Ahriman, telling him about its findings. For the time being, they are operating mainly in the wilderness of southwest America, Mexico and western Canada. They try to avoid contact with the American midwest, which is dominated by the Coalition States and other powerful nations. The fear is that their true inhuman nature might be discovered and cause their undoing. However there has been some discussion of offering their services to Tolkeen, the independent fledgling nation beset by the Coalition. If Tolkeen should accept them, they will appeal to the people's hatred and fear to escalate the war. An all-out war will mean bloodshed unparalleled in CS or Tolkeen history! The demons hope that the war will weaken the Coalition who the mercs see as their only real competition (they underestimate Lazlo and others). Depending on the circumstances, desperate authorities might make a deal with these devils. Only time will tell.

Tactics

In battle, the company goes for speedy, overwhelming attacks. They use intimidation, lies/corruption, subterfuge, spies, and assassination to do as deadly a job as any weapon. Exercises in brutality, treachery, deception and magic are commonplace. For example, there have been many occasions when the demons have negotiated an enemy's surrender, only to massacre the soldiers after they laid down their weapons and slaughter defenseless civilians at the slightest provocation. They also like to engage in setting traps, ambushes, and spying.

Ursus and the minions of Armageddon Unlimited are clever, deceptive instigators, skilled at fanning the fires of hate and fear. It is not uncommon for a friendly, "impartial observer" from the company to whisper inflammatory words, observations and suggestions into the ear of angry warriors and kings. They suggest murder, blackmail, torture, and betrayal. They suggest strategies and tactics to assure one's power or welfare at the expense of others. Things like:

"You could ignore it, but I think they'll see your actions as a sign of weakness. I know I would ... if I didn't know better. Just the other day, I overheard some enemy soldiers laughing about how they showed you. How you're too stupid (or cowardly) to dare retaliate. They said you were washed up. A has-been whose power is slipping through his fingers, and too feeble to do anything about it. One even suggested that old age has made you soft. A coward. Oh well, you're probably right. It's best to ignore them."

Or something more direct like, "They despise you. They think you're weak! A coward! Destroy them! Show those worthless D-bee swine (or humans, or whoever) your strength. Show them your righteous anger (or justice). Make them grovel at your feet and beg for mercy. See if they mock you when you hold their lives in your hands. Violence is all these vermin know! They live like animals, spreading their filth and pestilence. Destroy them!! I'm with you! Say the word and my legion will ride down upon them tonight!! We'll teach them a lesson they'll never forget. Show them who holds the reigns of power! You must, or you'll never know peace and your people will suffer for it. My god, man, is there any other alternative? No! What do you say? Let me do this for you. It will be an honor." All too often such words lead to carnage.

Another one of Ursus' tactics is to send agents and monsters into peaceful regions, pretending to be members of an enemy force to stir up trouble. They may even destroy an entire village and slaughter all

its inhabitants, making it look like somebody else was responsible. These secret agents also perform crimes, acts of sabotage, and attack or murder key (ideally beloved) figures, again always careful to implicate other (innocent) parties. When emotions are at a breaking point and the people believe they are under siege by an enemy, or a genuine war erupts, Armageddon Unlimited “shows up” to offer its services. “A timely coincidence”.

If these monsters have any weaknesses, it's that they tend to underestimate human opponents, revel in deception (that sometimes tips their hand), engage in predictable acts of savagery, and rely too much on the use of magic, psionics, their supernatural abilities (which also reveals their identity as demonic fiends).

Company Colors and Banners

The company's symbol is a stylized flame, with an eye in the middle.

General Ursus

Major Demon, commander-in-chief, servant of Ahriman

Ursus is an ancient demon; he was a chief among Ahriman's hordes when the dark god rose up against the Gods of Light, eons ago. After an epic war, Ahriman, Ursus and his fellow monsters were defeated and imprisoned in a small dimension. For centuries, Ursus raged, consumed by hatred for all living things. Frustrated at being unable to strike out at anybody (besides other demons, of course), he teetered on the brink of insanity. Eventually, Ahriman was finally able to weaken the dimensional prison enough for some of his minions to escape, Ursus among them.

For hundreds of years they have run rampant throughout the Megaverse. Gathering new recruits and building demon legions to cause mayhem wherever they go. The legion of supernatural terrors under Ursus' command is Armageddon Unlimited. The outfit is composed of so-called demons and black-hearted humans and D-bees from across the cosmos. Although Ahriman remains trapped in his dimensional prison, he is able to communicate with his minions and it is he who has sent them to Earth. Their assignment is to work “undercover” (pretending to be D-bees and humans) to learn as much as they can about the political, social, military and magical climate of the planet. Their secondary purpose is to explore the secrets and potential of ley lines and dimensional rifts (stone magic and pyramids will be of great interest). Ahriman has reasoned that if any world offers him the means to escape his prison, it is Earth. As always, the demonic mercenaries are to act as a force of chaos and destruction, causing confusion, dissension, and help trigger wars among the planet's inhabitants.

In the five months that Armageddon Unlimited has been in operation, Ursus has learned a lot about the new planet. He knows about the Coalition States, their leaders, and their conflicts with Tolkeen, The Federation of Magic, and others. Emperor Prosek and his son will be ideal pawns for Ahriman, although their paranoia about magic and the supernatural actually protects them from any direct contact with the demons. Ursus also has learned about other forces on the planet, including the Splugorth, xiticix, gargoyles and vampires. The existence of the Vampire Kingdoms is especially intriguing, since Ahriman has frequently allied himself with the undead. Ursus has only sketchy details about England, Europe, Africa and other continents.

For the time being, Ursus knows he's only a minor player in the world's affairs, but that may change in a few years. Meanwhile he enjoys playing his diabolic games and inflicting unspeakable torment on those foolish enough to enlist his aid.



SEZ JL II

Full Name: Ursus Ahrahl

Race: Dysasha demon, an ancient, canine cousin to the raksasha, but nearly extinct. Most dysashas were slain during Ahriman's last great battle with the Gods of Light. Only a handful survived (less than a hundred?) and most of those are imprisoned with Ahriman.

Note: The number of dice to roll and create other NPC dysashas are listed in the parentheses. These characters are not generally suggested as player characters but make great villains. If a player character who is of a good alignment or who associates with good characters, he/she will be considered a traitor by other demons in general and hated and hunted by the minions of Ahriman.

Alignment: Diabolic (typically anarchist or evil)

Attributes: I.Q. 17 (3D6+2), M.A. 22 (3D6+9), M.E. 17 (4D6), P.S. 40 (6D6+10), P.P. 20 (3D6+9), P.E. 24 (3D6+9), P.B. 5 (2D6), Spd. 60 (2D4×10); supernatural strength and endurance.

M.D.C.: 3500 (1D6×1000+500)

Horror Factor: 14

P.P.E.: 400 (1D6×100)

Size: 7 feet (2.13 m) in human form, 13 feet (3.96 m) in his natural form.

Age: 6000 years (average life span 12,000 years)

Natural Abilities: Nightvision 200 ft (61 m), see the invisible, turn invisible at will, keen vision and hearing, swim 89%, climb 79%, bio-regeneration 1D6×10 M.D.C. every minute, resistant to heat and fire (does half damage), teleport self 62%, dimensional teleport 50% (only to Ahriman's dimensional prison from which he may not be able to escape again).

The creature can shape change at will into any human form (not humanoid D-bees). Even in human shape the monster has unusually large canine fangs, stands 7 feet tall, and the eyes turn blood red when angry or upset.

Disposition: A cool, calculating monster, very good at guessing what humans desire, or think they want or need. He always seems confident, strong and in control. He rarely yells or loses his temper, and almost always has a sadistic smirk on his face that suggests he knows a secret or is completely in control. Even under stressful situations he speaks in a quiet, moderate voice. His apparent strength and confidence only adds to his powers of persuasion. He is quick to offer anything he can to corrupt, confuse or trick others.

His minions are terrified of him, because he can commit atrocities without blinking and remain as calm and collected as always. Ursus is a fearsome warrior, but he prefers to let his underlings do most of the fighting; he feels he's paid his dues. The demon is not a great military strategist or tactician, but his cunning, ferocity and savagery has served him well.

Experience Level: Equal to a 6th level ley line walker (dysasha are typically 2D4 level ley line walkers or wizards).

Magic Knowledge: All ley line walker powers. Knows all spells from levels 1-3, plus astral projection, blind, fool's gold, magic net, domination, horrific illusion, compulsion, animate/control dead, and metamorphosis: human. Like their raksasha cousins, the dysasha lean toward magic of illusion and deception.

Psionic Powers: 150 I.S.P.; major psionic. All dysasha have all sensitive powers and 4D6×10 I.S.P.

Combat Skills: Supernatural/Natural

Attacks per Melee: Five hand to hand or psychic attacks, or two by magic.

Bonuses (does not include attribute bonuses): +3 on initiative, +3 to strike, +3 to parry and dodge, +3 to roll with impact/punch, +3 to pull punch, +6 to save vs magic, +3 to save vs psionics, +9 to save vs horror factor, +6 to save vs illusions.

Damage: Five hand to hand attacks:

Restrained Punch — 6D6+20 S.D.C.

Full Strength Punch — 5D6 M.D.

Power Punch — 1D6×10 M.D. (counts as two melee attacks)

Claws — Add 3D6 M.D. to punch damage whenever the monster assumes his natural form only.

Bite — 4D6 M.D. (half when in human form)

Kick — 5D6 M.D.

Leap Kick — 1D4×10+6 M.D. (counts as two melee attacks)

Bear Hug or Flip/Throw — 3D6 M.D. per hug or throw, plus the victim loses initiative and one melee action.

Weapon Proficiencies: W.P. Energy Pistol, W.P. Energy Rifle, W.P. Sword, W.P. Blunt.

Weapons of Note: TX-5 pump pistol, plasma ejector, and a laser pistol.

In combat, he prefers heavy weapons (loves Naruni and Kittani items), but his favorite weapon is a greatest rune weapon; a giant, dark crimson battle axe with the following powers.

- All the standard rune weapon abilities, indestructible, etc.
- I.Q. 14 with a diabolic alignment.
- Damage: 5D6 M.D.
- Dimension warping (same as a 10th level spell): Teleport lesser, teleport greater, mystic portal, time hole, and sanctum. Each can be cast three times per 24 hour period.
- Healing abilities: 2D6 hit points and S.D.C. or 2D6 M.D.C. six time per day, plus remove curse (56%), turn dead (55%), and animate and command 2D6 dead (64% chance of success), each four times per 24 hour period.

Armor: Dead Boy armor (M.D.C. 80) worn for show.

Skills of Note: Dragonese/Elf, Euro, American and over 20 other Earth languages (many of them extinct), all at 98%. Detect ambush 89%, detect concealment 84%, tracking 89%.

Character Creation Skill Notes: A dysasha can select a total of 12 skills from the following categories: espionage, technical, rogue, wilderness, weapon proficiencies, and science: basic math only, plus speaks six languages and can learn four new languages for every thousand years of existence.

Description: In humanoid form, Ursus is a large, heavily-muscled man with black hair, canine teeth, dark tanned skin and glowing red eyes. His true shape is that of a bear or canine humanoid with blood-red claws and large canine fangs. The creature is a distant relative of the tiger-headed raksasha.

Character Note: The dysasha tend to be more physically powerful, bloodthirsty, aggressive and war-like than the raksasha. Still, like their feline cousins, they are intelligent, calculating and manipulative.

Colonel N'iall — Raksasha

N'iall is Ursus' second-in-command, a raksasha demon (see **Rifts Conversion Book One**) in the service of Ahriman. This devious, power hungry monster resents being under Ursus' command (he feels the company should have been given to him) and he will try to discredit his commander at any opportunity. So far, time hasn't been right; Ursus is doing a commendable job spreading death and destruction and keeping Ahriman informed about Earth. But N'iall still hopes and plots. Ursus doesn't know about the raksasha's treachery, but he doesn't trust anybody as a matter of principle, so he is safe for now and won't be surprised if N'iall turns on him.

Unlike Ursus, N'iall is not happy with the assignment on Earth. He dislikes technology and humans, especially when they have weapons powerful enough to threaten even a being with his powers. He prefers to hunt on more primitive worlds where nothing can hurt him. But N'iall knows that the only way he can get ahead is to follow orders, no matter how disagreeable. He takes out his frustrations on the mercenaries of Armageddon Unlimited and helpless human and D-bee victims. In fact, he can be incredibly monstrous, biting off limbs, tearing people in half, burning down villages, torturing prisoners, etc. He sometimes even makes Ursus cringe in disgust.

One of the raksasha's primary missions is to scout ahead of the company, looking for (or causing) trouble. With his shape-shifting



SEZ JL^{III}

powers, the demon can easily cause misunderstandings, dissension, and treachery between leaders of different nations and organizations.

Full Name: Unknown; he's simply identified as N'iall.

Alignment: Miscreant

Attributes: I.Q. 17, M.A. 19, M.E. 13, P.S. 36, P.P. 17, P.E. 21, P.B. 15, Spd. 40

M.D.C.: 2500

Size: Six feet (1.83 m) tall in human form, 8 feet (2.44 m) and 700 lbs (315 kg) as a raksasha.

Age: 900 years old

Natural Abilities: Nightvision 120 ft (36.6 m; can see in total darkness), keen normal vision, see the invisible, turn into mist, track by smell 45%, dimensional teleport 51%, bio-regeneration 4D6 M.D. per minute, resistant to fire and cold (magic fire and cold, and M.D. plasma does half damage), teleport self and up to 300 additional pounds (135 kg) up to five miles (8 km) away at will, and magically knows all languages.

Shape-changing powers: can change, at will, into the shape of virtually any living creature no smaller than one foot (0.3 m) and no larger than 10 feet (3 m). The raksasha can also use this power to disguise himself to look exactly like a specific individual. Shape-changing disguise skill: 96% to 40%, depending on how much knowledge the demon has about the individual being imitated.

P.P.E.: 800

Disposition: A greedy and conniving bully who delights in tormenting those weaker than he. At heart, the monster is nothing but a snivelling coward (he will flee any enemy he perceives as more powerful or any fight he is losing). Underestimates humans and most mortal races, but is afraid of Ahriman, the Gods of Light, dragons, godlings, Splugorth High Lords and many other powerful supernatural creatures. Technology is something that bothers him a lot. He sees it as a potential equalizer between humans and superhumans, and would rather it was outlawed from the Megaverse.

Experience Level: Equal to a 3rd level wizard and 8th level mind melter.

Magic Knowledge: Knows all metamorphosis, protection and illusionary magic, plus create magic scroll, animate and control dead, turn dead, exorcism, remove curse, healing touch, see aura, mystic alarm, fear, fingers of wind, astral projection and blind.

Psionic Powers: Knows ALL psionic powers, at 8th level proficiency.
I.S.P.: 500

Combat Skills: Supernatural.

Attacks per Melee: Six physical or psionic attacks per melee or two by magic.

Bonuses: +3 to strike, +4 to parry and dodge, +21 to damage, +3 to roll with impact/punch, +2 to pull punch, +4 to save vs poison, to save vs magic, +4 to save vs psionics, +8 to save vs horror factor.

Weapon Proficiencies: W.P. Sword, W.P. Energy Rifle, W.P. Knife, W.P. Heavy.

Weapons: Uses standard issue equipment. While he's on a secret mission, he takes no weapons with him, relying on magic and his natural abilities. He is also fond of using magic potions, herbs, faerie food, drugs and poisons (must purchase them; he cannot make them).

Armor: None

Skills of Note: Basic and advanced math 98%, Dragonese/Elven, American, Euro, Gobblely, Spanish and French, all at 98%, forgery 75%, intelligence 85%, wilderness survival 60%, land navigation 60%, swim 60%, climb 80%/70%, streetwise 80%, demon lore 92%, faerie lore 92%, basic radio 98%, pilot tank and APC, pilot hover craft, and pilot jet pack, all at 70%.

Description: In humanoid shape, N'iall prefers to take the shape of a dark-skinned man with a short beard. His true form is that of an eight foot tall, tiger-headed humanoid.

Urlik Blackhand — Ogre Tattooed Man

Urlik is an ogre born in the Old Kingdom mountains on the Palladium world. When he was only a child, his tribe was attacked by Splugorth slavers, he was captured, and carried away to an alien world. Urlik was covered with magical tattoos and raised to be a slave-warrior on a Splugorth controlled world. Urlik's master was a sadistic High Lord who enjoyed mistreating slaves. The boy hated him.

The Splugorth ruler of the dimension had earned the enmity of Ahriman, because both were competing for control of the same resource rich dimension. When open warfare erupted, Urlik's master was ordered to join a large army of High Lords, Kydians, and Slavers assembled to destroy Ahriman's demonic minions. Of course, he took his slaves with him. A bloody battle raged for several days, but the Splugorth had miscalculated. Ahriman, through Ursus, had made several alliances with other dark gods. The Splugorth warriors were overwhelmed. Urlik's master was torn apart by three night owl demons. Urlik would have been next, but he did something unexpected. He denounced the Splugorth, offered his surrender and his services to the warrior about to cleave him in two. The warrior was Ursus. He had seen the tattooed ogre fight and respected his powers, fighting abilities and apparent experience. Ursus lowered his weapon and accepted the offer. Immediately Urlik turned and attacked the people who enslaved him. The ogre showed great courage and obedience, winning favor with Ursus. Unlike the Splugorth, Ursus treated Urlik well. The ogre responded to his new master with unwavering devotion.

Urlik has earned an honored and trusted place at the side of Ursus. As a reward, he has been made the company's combat leader. The warrior has a keen sense of strategy and tactics, is completely loyal to Ursus, and is afraid of nothing. He is particularly fierce when fighting Splugorth minions of any kind, especially High Lords. The ogre does not particularly like committing atrocities against humans, but he owes his full loyalty to Ursus and does as he is commanded to do without question or complaint. He despises N'iall and would love to gut him one day.

Full Name: Urlik Blackhand

Alignment: Aberrant

Attributes: I.Q. 9, M.A. 5, M.E. 13, P.S. 27, P.P. 16, P.E. 19, P.B. 4, Spd. 21

M.D.C.: 160 M.D.C. (the magic tattoos have made him a mega-damage creature).

Size: 7 feet tall (2.13 m), 300 lbs (135 kg), **Age:** 20 years old.



P.P.E.: 236

Disposition: An implacable, brave warrior, loyal to the death. Urlik actually feels pity for Earth's inhabitants and sees them as victims of forces beyond their comprehension. However, he won't let pity stay his hand. Urlik has an insane attraction for fighting, acquired during his slave training. He has no friends, only subordinates and superiors. Urlik suspects N'iall is out to hurt/betray his master, but since he has no proof, he has kept silent.

Experience Level: 8th level Tattooed Man O.C.C. (has 21 tattoos)

Magic Knowledge: None (but see Tattoos)

Psionic Powers: None

Combat Skills: Hand to Hand: Assassin and boxing

Attacks per Melee: Six hand to hand attacks per melee.

Bonuses: +2 to strike, +5 to parry and dodge, +12 to damage, +4 to roll with impact/punch, +3 to pull punch, +2 to save vs poison, +4 to save vs magic, and +6 to save vs horror factor.

Weapon Proficiencies: W.P. Sword, W.P. Blunt, W.P. Archery and Targeting, W.P. Energy Rifle.

Weapons of Note: One, a Splugorth Staff of All Seeing, given to him by Ursus (it originally belonged to his old High Lord master); otherwise he relies entirely on his natural powers.

Armor: None

Skills of Note: Swimming 90%, American 98%, Gobblely 98%, Ogre/Troll 98%, prowl 75%, land navigation 73%, hunting, wilderness survival 80%, intelligence 69%, detect ambush 75%, pilot tank and APC 73%, horsemanship 77%.

Description: Heavily-muscled, even for an Ogre, and even uglier than average. His body is covered with 21 tattoos, which are clearly visible (goes around bare-chested).

Magic Tattoos:

- 5 Simple Weapons: Sword, bow and arrows, S.D.C. shield, spear, staff. Cost 2 P.P.E. to activate, and last 4 hours.
- Two flaming swords crossed (counts as two tattoos): creates a magic Flamberge sword that inflicts 6D6 M.D. and is +1 to strike and +2 to parry. Costs 15 P.P.E. to activate and lasts 2 hours.

- 5 Animals: gorilla (30 P.P.E.), hawk (15 P.P.E.), horse (20 P.P.E.), tiger (30 P.P.E.) and large wolf (20 P.P.E.). Last 8 hours.
- 2 Monsters: Dragondactyl (100 P.P.E) and dragonsaurus (80 P.P.E.). Last 4 hours.
- Chain Encircling a Skull: Makes him impervious to mind control and +3 to save vs psionics. Costs 25 P.P.E. and lasts 8 minutes.
- Chain with a Broken Link: Increases P.S. to 33, and it becomes supernatural (4D6 M.D. punch). Costs 30 P.P.E. and lasts 40 minutes.
- Heart Encircled with Chains: Creates a glowing aura that provides 600 M.D.C. Costs 40 P.P.E. and lasts 1 hour and 20 minutes.
- Heart with Tiny Wings: Can run at a speed of 110 mph (176 km), gives a +2 bonus to dodge while running. Costs 10 P.P.E. and lasts 4 hours.
- Rose Dripping Blood: Can cast Heal Wounds like the spell, three times per minute. Costs 30 P.P.E. and lasts 8 minutes.
- Lightning Bolt: Fires a bolt of lightning inflicting 6D6 M.D. at up to 1000 ft/305 m. +3 to strike. Costs 30 P.P.E. and lasts 8 minutes.
- Skull Engulfed in Flames: Makes character immune to fire and heat, and surrounds the character with an aura that provides 60 M.D.C. and allows character to fire flame bolts that inflict 8D4 M.D. (range 800 ft/244 m, +2 to strike). Costs 45 P.P.E. and lasts 40 minutes.

Leon Pasquali — Witch, Major Pact

When Ahriman assigned Armageddon Unlimited to Earth, he decided to prepare a guide and local "friendly" to help the group adapt to the new world. To accomplish this, he made contact with a foolish mortal human willing to give up body and soul in the pursuit of power.

Leon Pasquali was a would-be summoner (1st level) who had neither the aptitude nor the dedication to become a powerful magician. Instead, he tried to take a shortcut by making contact with supernatural intelligences. He succeeded and got Ahriman. Leon hastily agreed to the promises of power, signed a pact, and received the Gift of Union (see *Rifts Conversion Book One*, page 56). Now the would-be sorcerer is nothing but Ahriman's puppet.

Leon thought he should be in command of Armageddon Unlimited, but Ursus quickly rid him of those notions. The persuasion process involved a long bout of physical punishment, during which Leon found his powers were gone. They were restored only when he begged for mercy and accepted Ursus as his leader. The witch has discovered that he cannot use his powers to hurt Ahriman's chosen henchman, Ursus; at least not with his witch abilities. Leon seethes with anger and he feels betrayed by Ahriman, but he has no choice but to accept his new life or die. There are benefits from his powers. He is one of the elite members of the company and most of the lesser demons and mercs fear him. He also enjoys an incredible feeling of power, direction and confidence. From time to time he suddenly finds himself filled with inspiration and ideas (from Ahriman) and occasionally he can even hear the voice of Ahriman giving him suggestions and complimenting his ingenuity. With time he will accept his fate and enjoy the evil power that comes with it, even if he is second to Ursus.

Full Name: Leon Pasquali

Alignment: Miscreant (even before melding with Ahriman).

Attributes: I.Q. 13, M.A. 21, M.E. 5, P.S. 12, P.P. 17, P.E. 10, P.B. 7, Spd. 12; supernatural strength and endurance.

M.D.C.: 640

Size: 5 feet, 9 inches tall (1.75 m); 170 lbs (76.5 kg). **Age:** 29

P.P.E.: 1172

Powers: The Gift of Union and Major Pact with Ahriman have changed Leon into a supernatural being. In addition to his supernatural strength and mega-damage body, Leon can regenerate 2D6 M.D.C. up to four times per day, is invulnerable to fire (no damage) and

has several magical and psionic abilities (see below). He also has a familiar in the shape of a giant snake (M.D.C. 60, I.S.P. 80, P.P.E. 200), which he can use to draw M.D.C., P.P.E. and I.S.P. from, and which has all sensitive and physical psionic powers and all the magical abilities Leon has.

Disposition: Leon is a lazy, greedy and brutal man who had given himself to a life of crime even before joining his body and spirit with the evil god Ahriman. He commands more raw power than he ever imagined and loves it. He has grudgingly accepted his fate and position as second banana, but still believes himself superior to Ursus and all others. He has begun referring to himself as the "Hand of Ahriman" and believes himself to be a demi-god.

Human lives mean less than nothing to him, but he can pretend to be a concerned friend and confidant when it suits his needs. When talking to a client, Ursus and Leon often play the parts of the "bad cop" and "good cop," respectively; Ursus being tough, intimidating and inflexible, and Leon acting in a friendly and conciliatory manner. Under different circumstances, the witch would have made a good con-man; he can smooth over any "irregularities" the company commits ("Yes, the incident at Harrisville was regrettable, Mr. Major, but there were armed guerrillas inside, and we had to — yes, I know they were only women and children, but they had weapons. We lost some good people there, and we didn't know who was inside until after the fires died down. The terrible fortunes of war."). When he's at a loss for words or ideas, Ahriman is usually available to provide them.

Leon also serves as the official High Priest of Ahriman, often conducting rituals to draw the power from the victims of war and sends them into a dimensional vortex, where they are absorbed by the demon-god Ahriman to weaken his dimensional prison.

Experience Level: 1st level Shifter (cannot increase) and a 4th level Witch.

Magic Knowledge: Leon has all 1st level Shifter powers and all the initial spells of his O.C.C. (see *Rifts*, p. 87), but all are limited to first level of proficiency and strength. The fragment of Ahriman inside of him knows ALL magic spells from levels 1-15, and ALL necromantic spells (see **Rifts Africa**). All spells are cast at 6th level strength. Leon can cast these spells only when his master lets him.

Psionic Powers: Was a minor psionic before his pact with the power of empathy, and has gained the powers: object read, and telekinesis.

I.S.P.: 132

Combat Skills: Hand to Hand: Basic.

Attacks per Melee: Three hand to hand or psionic attacks, or two by magic.

Bonuses: +2 on initiative, +1 to strike, +3 to parry and dodge, +3 to damage, +2 to roll with impact/punch, +2 to pull punch, +4 to save vs illusionary magic, +7 to save vs horror factor.

Weapon Proficiencies: W.P. Sword and W.P. Energy Rifle.

Weapons of Note: TW Lightning Rod and C-14 "Flame Breather" Rifle.

Armor: Dead Boy armor (M.D.C. 80) with officer crests, that has been TW-modified with armor of Ithan at 8th level strength.

Skills of Note: Demon and monster lore 65%, faerie lore 55%, pilot hover craft 75%, American 98%, Spanish 80%, Gobblely 80%.

Description: A scrawny, unattractive little man with weaselly features and dark, beady eyes. Despite his appearance, he can be convincing and charming; his voice is very well-modulated and expressive.

Sargon the Hunter

Sargon is a wild psi-stalker who enjoys killing and torturing. He is no better than the demons he works with. He feels a genuine kinship for supernatural creatures and as long as he is kept well-fed he is happy. Sargon joined the company after he witnessed the destruction of an entire village by Armageddon Unlimited. Some of the victims were minor psychics and their deaths stirred his hunger. He joined in, hunting down other psychics and murdering them. His abilities caught Ursus' eye and the demon lord decided that the Psi-Stalker would make a good addition to the company. Sargon now leads the scouting platoon of Armageddon Unlimited. The company often keeps a psychic, mage or creature of magic captive for several weeks, using him/her as Sargon's food supply!

The psi-stalker and his scout team, made up mostly of other psi-stalkers, renegade Dog Boys, and alu demons, call themselves the "Hell Hounds," and are a fearsome sight. They travel either on stolen Coalition Sky Cycles adorned with human skulls, or skulk around on foot. Sargon has collected a number of magical items, gifts from his commanding officers or loot seized after a battle, and he hopes to acquire more.

Full Name: Unknown, calls himself Sargon.

Alignment: Diabolic

Attributes: I.Q. 17, M.A. 9, M.E. 20, P.S. 17, P.P. 21, P.E. 23, P.B. 5, Spd. 22

Hit Points: 56, S.D.C.: 56

P.P.E.: 3

Disposition: A wild man, always howling, growling, snorting, or hooting to express his pleasure or anger (except when he is on the prowl, then he becomes almost unnaturally quiet). His savage disposition intimidates some of the human and D-bee members of the company, but actually endears him to the demons and supernatural monsters in the group. They have all but made him an honorary demon!

Experience Level: 10th level psi-stalker

Magic Knowledge: None. Can sense magic energy and collects magic items.

Psionic Powers: Considered a master psionic; he has all psi-stalker powers plus astral projection, clairvoyance, empathy, mind block, see aura, and telepathy. **I.S.P.:** 153



SEZ JL II



SEZ JI II

Combat Skills: Hand to Hand: Expert, boxing and wrestling.

Attacks per Melee: Five hand to hand or psionic attacks.

Bonuses: +1 on initiative, +5 to strike, +8 to parry and dodge, +4 to damage, +8 to roll with impact/punch, +2 to pull punch, +4 to save vs poison, +9 to save vs mind controlling/altering drugs, +7 to save vs magic, +4 to save vs psionics, +9 to save vs horror factor.

Weapon Proficiencies: W.P. Sword, W.P. Blunt, W.P. Archery and Targeting, W.P. Energy Pistol, W.P. Energy Rifle.

Weapons of Note: Vibro-saber, neural mace, bow with high-tech and magic arrows, and a NG-P7 particle beam rifle.

Magic Items of Note: Among Sargon's coveted magic items are a talisman with the spell mask of deceit (6th level, 3 × then exhausted), a talisman ring with the spell call lightning (6th level, 3x), a TW modified ion blaster that fires lightning bolts (5D6 M.D.; range 500 ft/152 m), a lesser rune dagger (11 I.Q., diabolic alignment, does 4D6 damage and has the usual properties), the tooth of a dragon, and three magic scrolls (not that he can read or use them).

Armor: Crusader Armor (M.D.C. 55).

Skills of Note: Wilderness survival 98%, track humanoids 88%, detect ambush 88%, escape artist 88%, prowl 88%, climbing 88%, American 73%, Spanish 73%.

Description: Sargon has ritually scarred his face with hot knives, giving him a horrible, monstrous appearance. His body is muscular, lean and wiry, like an acrobat's. He prefers a hunched down position as he walks, as if he was about to spring or jump into action. He shows a sense of humor by smiling without showing his teeth; grinning with his teeth showing is a sign of hostility, not humor. Sargon's companions have learned that when the psi-stalker bares his teeth, something bad is going to happen.

Other Personnel

Although many of the members of Armageddon Unlimited are demons, they are often mistaken for D-Bees. See **Rifts Conversion Book (one)** for complete data regarding demons and other monsters. The least human or D-bee looking creatures are turned invisible or kept hidden and operate behind the scenes. Many are shape shifters and illusionists who can be disguised to look human or humanoid. As for mutant animals, with Armageddon Unlimited one can never be sure it's a mutant, D-bee or demon until the beast is engaged in combat.

Ursus' Personal Bodyguard: 3 Baal-rog Demons (rarely show themselves in public).

Line Troops

- 12 Alu demons (scouts; look like dog boys)
- 12 Lasae demons (scouts; tiny, 8 inches tall)
- 12 Dar'ota (6 succubus & 6 incubus spies; shape changers)
- 12 Grave Ghouls (look like human corpses, but can hide underground)
- 6 Dimensional Ghouls (vaguely human/D-bee in appearance)
- 6 Gallu demons (can turn invisible at will)
- 4 Dybbuk demons (in human guise)
- 2 Werewolves (a mated pair)
- 1 Secondary Vampire (human female)
- 1 Demon locust demon (can turn invisible and fly)
- 10-15 Renegade Dog Boys, levels 4-7
- 10-20 Wild Psi-Stalkers, levels 3-6
- 15-20 Special Forces, human and D-bee
- 20-30 Human and D-bee headhunters, levels 3-5, all trained in Power Armor Elite.
- 10-20 Human and D-bee vagabonds, levels 2-5
- 6 City rats, levels 3-8
- 3 Human master assassins, levels 4, 7, 10
- 2 Human ley line walkers, levels 3 and 8 (both evil)

Total Personnel: 150 to 200 soldiers, and about 200 support personnel; mostly D-Bee cultists, levels 1-4, all with some degree of combat training (Hand to Hand: Basic and one W.P.).

Weapons, Equipment and Resources:

Standard Issue Weapons and Equipment

- L-20 Pulse Rifle
- Armor: Humanoids are given alien plate armor (M.D.C. 60). The Gallu bull and other large creatures are equipped with massive plate armor (M.D.C. 110).
- Vibro-Saber.

Transport Vehicles

- 15-20 lightly armored trucks/buses (M.D.C. 30).

Combat Vehicles

- 20 stolen Coalition Sky Cycles
- 30 Angrar Mark II Power Armor Suits
- 16 Angrar Assault Robots

Adventure Ideas

The types of confrontations and intrigue player characters might run into concerning Armageddon Unlimited is pretty obvious and covered in general under the company's tactics and specific character descriptions. Typically, these warriors are up to no good and can be found slaughtering and torturing enemy troops, slaughtering innocent civilians, looting and pillaging, conducting seek and destroy missions, sabotage, assassination, kidnapping, extortion, theft, espionage, dangerous or deadly magic rituals, and more.

The player characters might find themselves hired to protect an individual or community from Armageddon Unlimited, stand against them to protect innocent lives, avenge a murder, seek justice for crimes, stumble into one of their insidious plots, discover some of their secrets, be framed for crimes committed by them, be tricked into helping them do something bad, be targeted for robbery or trouble by them, or incur their wrath in some other way (being allied to any god of light is good enough for these demons). If the adventurers have any magic-using or psychic character among them, they will soon discover the horrible truth about the demon controlled company. Ahriman and the troops of Armageddon Unlimited can be incredibly cruel and vengeful. If they become an enemy, they are likely to be a recurring foe.

Larsen's Brigade

By C.J. Carella & Kevin Siembieda

- A. Sponsorship: None 0 Points
- B. Outfits: Specialty Clothing. 20 Points
- C. Equipment: Unlimited Equipment 50 Points
- D. Vehicles: Unlimited Vehicles 50 Points
- E. Weapons: Extensive Weaponry 40 Points
- F. Communications: Superior Communications 40 Points
- G. Internal Security: Iron-Clad 20 Points
- H. Permanent Bases: Headquarters. 10 Points
- I. Intelligence Resources: Psionics and Magic. 20 Points
- J. Special Budget: Large Loans. 25 Points
- K. General Alignment: Anarchist/Unprincipled. 4 Points
- L. Criminal Activity: Prostitutes (6) 10 Points
Smugglers and Sellers of Contraband 15 Points
- M. Reputation/Credentials: Excellent Reputation. 25 Points
- N. Salary: Excellent Salary 20 Points
- Total Points Spent: 349 Points**
- Size & Orientation: Mercenary Army**

Larsen's Brigade is one of the largest and best equipped mercenary armies on the planet. The Brigade is very well-trained and organized. Hiring an entire army can be incredibly expensive. Just paying for their basic expenses costs about 30 million credits per month and can be twice as much for hazardous combat duty. Of course, whenever the Brigade enters combat, the fighting is not expected to last more than a month or two. Larsen is also willing to hire out "Special Forces" squads and platoons to handle smaller and specialized "jobs." However, he will never risk weakening his army below 70% of its full strength.

Several officers deserting from the Coalition States started the Brigade, who recruited half a dozen smaller mercenary bands. Over the years, it has grown enormously and continues to make good profits, much of which have been reinvested into the company to maintain and purchase even better weapons and equipment. The Brigade's commander, Colonel Larsen, is a brilliant strategist and administrator. He has developed the company from a disorganized band into a highly disciplined and effective army.

Tactics

Colonel Larsen is a master of armored warfare, very possibly a match for Generals Cabot and Underhill, the Coalitions' best. He is an expert at combining all the armed forces and mixing up ground troops, artillery, air strikes, power armor, cyborgs, and lightning infantry assaults to shatter enemy formations.

Colors and Banners

The army's insignia is a black circle with a clenched silver fist, obviously cybernetic, in the center. A few units jokingly paint an up-raised finger in the middle of the fist, but only the toughest veterans can get away with it; several mercenaries have learned not to mess with that particular logo.

Uniform colors vary with the terrain: Camouflage, mottled green and brown for forest warfare, grayish for mountains, white for winter operations, and green for jungle settings.

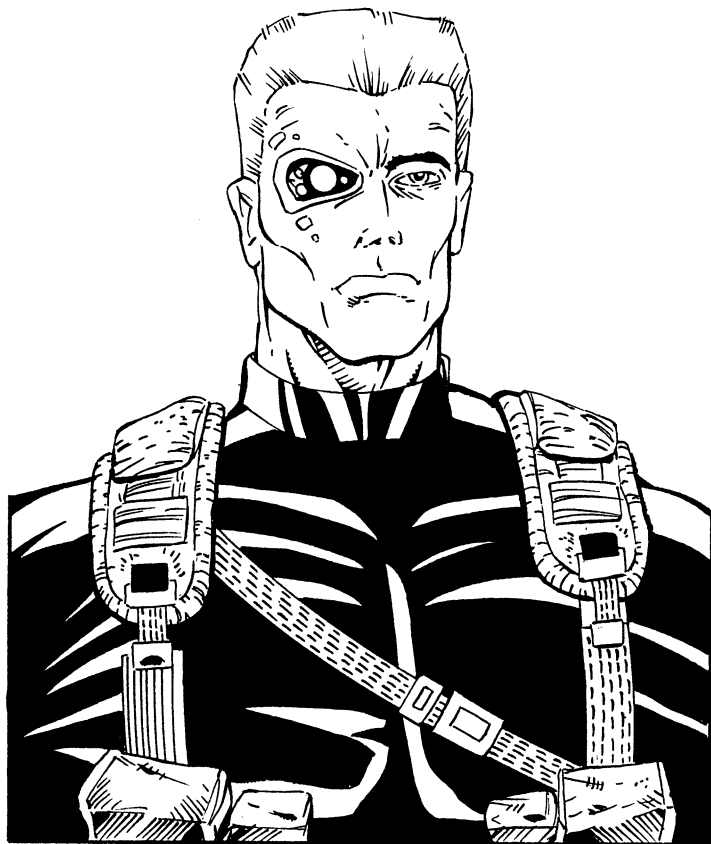

Colonel Marcus Larsen

Colonel Larsen served in the army of the Coalition States starting at age 16, when he lied about his age and enlisted for duty at Lone Star. From his first posting, a frontier station that was nearly overrun by vampire marauders, Larsen distinguished himself and received numerous decorations for bravery in the face of the enemy. He also earned several commendations and the equivalent of seven Purple Hearts for wounds received in combat. In a fight with bandits from the Pecos Empire, Larsen lost his left hand, seared away by laser fire. Soon the silver cybernetic replacement he received became his trademark, together with the intimidating camera-eye that replaced his own (he lost it in an explosion that consumed the cockpit of his Spider Walker).

At age 23, Larsen was promoted to Major and was put in command of the Odessa outpost. There he gained a reputation for being a fair commander who gained the respect of both his human and mutant animal troops. Around this time, he started speaking out for the rights of mutant animals and other non-humans. Mutants, he claimed, were as good and spirited soldiers as humans and should be treated with respect and dignity. At first his superiors ignored his outbursts, although he made no new friends among the military establishment. Despite his radical views (some whispered, treasonous), his talents as a military commander could not be obscured. During his second year of duty at Odessa, he and his 400 troops ambushed and soundly defeated a raiding

party from the Pecos Empire that numbered 2000 strong. Larsen masterfully used his troops to surprise the enemy and divide them into smaller units that were captured or eliminated piecemeal.

This victory made people forget his views about mutants and once again sent him on a route of rapid promotions. He became a Colonel at the unusual age of 26. However, his career in the CS soon came to an end. The final straw came when he was given command of an armored battalion involved in a major operation against a huge tribe of wild vampires and other monsters. Colonel Larsen led the attack against over 3,000 monsters. The fiends were destroyed and Larsen seemed destined to become a General and one of the greatest heroes in CS history. During the clean-up that followed the victory, however, army scouts discovered a small village of D-Bees. These gentle beings had nothing to do with the invasion force of monsters, but the fact that they were not human was enough for the General in charge to order their "extermination." This "honor" was given to Colonel Larsen's unit. Larsen refused the direct order. The General relieved him of duty and ordered his second-in-command to carry out the attack and arrest Larsen. The ambitious Major, seeing a promotion, cheerfully obeyed, sending hundreds of peace-loving aliens to their deaths.

That night, a group of Larsen's officers staged a daring midnight raid on the mobile army headquarters where Larsen was being held. During the ensuing shootout, the Major who had betrayed Larsen was killed and a dozen other soldiers were injured. The twelve deserters commandeered a Death's Head Transport and fled the burning campsite. Those seven men and five mutant animals (Dog Pack non-coms Larsen had promoted) formed the core of what would become Larsen's Brigade. Over the next week, 30 other CS soldiers and an entire platoon of mutant animals (160 troops; including experimental mutant animals created by Lone Star) also deserted and joined their beloved Colonel. Continuing his folly, the General in charge assigned a company from Larsen's former battalion to "track the traitor down and bring him to justice." Although these men were loyal to the Coalition, they also had loyalty to Larsen, thus they couldn't ever seem to find the renegade Colonel. After three months of fighting their conflicting loyalties and not giving their all in apprehending Larson, the company was recalled and its officers disciplined. By this time, the word was that Larsen had slipped into the vampire ridden wilderness of the Old Mexico Empire. Supposedly he had been joined by hundreds of other mutant animals who flocked to him like some messiah, as well as by mercenaries and D-bees. According to rumors, Larsen's renegades had swollen to over 500 strong!

The embarrassed General was about to personally lead an entire division after the Colonel and his fellow deserters, when Emperor Prosek interceded. His propaganda machine had made Colonel Larsen's group the people's heroes. It would do no good for the CS military to brand the man a traitor, hunt him down like an animal, and execute him. Prosek reasoned such an incident would only make Larsen a martyr and give his words even greater power. Furthermore, sending an entire CS division after a handful of CS officers and a rag-tag battalion of mutants and D-bees would be an embarrassment. Should they be defeated (and both the elder and younger Prosek feared they might be) it would deliver a terrible blow to the Coalition military who claimed to be the greatest army in the world. The Emperor considered many options from assassination to discrediting the Coalition's favorite son, but the final solution was a shocker.

Emperor Prosek gave Larsen (and secretly, the troops who followed him) a complete pardon and heralded him as one of the Coalition's greatest military heroes. The Emperor went on to announce that Colonel Larsen had "retired" and was considering starting his own, independent mercenary company. Prosek, speaking on behalf of all the people of the CS, wished him the best. End of story. There have been no acts of retribution whatsoever. However, the Emperor did send the veiled threat that Larsen could expect no trouble from the Coalition as long as he stayed out of CS business, including events transpiring at Tolkeen.

Larsen has set up base in the Manistique Imperium, but his army travels all over North America. He often takes contracts that protects D-bees and indirectly damages the interests of the Coalition States. He has provided limited services to Tolkeen in matters that did not involve the CS, but is considering offering his full military resources if they are invaded.

Full Name: Marcus Larsen

Alignment: Scrupulous

Attributes: I.Q. 23, M.A. 23, M.E. 20, P.S. 20, P.P. 18, P.E. 17, P.B. 15, Spd 15

Hit Points: 48, **S.D.C.:** 40

Size: 5 feet, 11 inches tall (1.80 m); 175 lbs (78.75 kg)

Age: 32 years old

P.P.E.: 9

Disposition: Larsen is a curt, no nonsense kind of guy with the aura of a genuine hero. He is usually brutally honest, especially when dealing with military strategy and evaluations. He is also friendly, sincere, confident and surprisingly capable at diplomacy. He has few regrets about his life and is becoming increasingly negative and outspoken about the Coalition States. Should Tolkeen, Lazlo, Kingsdale or any important nation be invaded by the CS, Larsen is likely to offer them his services at a reduced price. Truth be told, he is itching to try his battle-hardened veterans against the best the Coalition can throw at them. He is a charismatic leader loved by his troops, human and non-human alike.

Experience Level: 10th level CS Military Specialist

Magic Knowledge: Knows the basic principles of magic and its military applications.

Psionic Powers: None

Combat Skills: Hand to Hand: Expert, boxing, Robot Combat: Elite and Robot Combat: Basic.

Attacks per Melee: Five hand to hand attacks.

Bonuses: +1 on initiative, +4 to strike, +7 to parry and dodge, +5 to damage, +3 to roll with impact/punch, +2 to pull punch, +1 to save vs poison, +1 to save vs magic, +2 to save vs psionics, +2 to save vs horror factor.

Weapon Proficiencies: W.P. Energy Pistol, W.P. Energy Rifle, W.P. Heavy.

Weapons of Note: C-18 laser pistol, C-12 heavy assault laser rifle, four plasma grenades, two smoke grenades, and a vibro-saber.

Armor: Camouflage variable armor (M.D.C. 80) or SAMAS power armor.

Skills of Note: Basic radio 98%, literacy 98%, computer operation 94%, intelligence 91%, pilot hovercraft 98%, read sensory equipment 98%, weapon systems 98%, running, pilot tank and APC 85%, demolitions 98%, prowl 83%, paramedic 98%, American 98%, Spanish 83%.

Cybernetics: Multi-optic eye (1), silver-plated bionic hand (10 M.D.C.) with a laser finger blaster (1D4 M.D., 300 ft/91 m range) and fingerjack, clock calendar, gyro-compass, and oxygen storage cell.

Description: A grey-haired man with one serene blue eye, and one large cybernetic replacement. He has completely rejected the Coalition's dress code and wears camouflage fatigues when not in full body armor. However, he does use Coalition Dead Boy armor, painted in camouflage and a SAMAS power armor with which he is an expert pilot. His spies/friends at Lone Star have told him about secret field tests of a new, faster, more powerful power armor called the Super-SAMAS; he'd love to get his hands on one.

Antonio Giordano — Juicer

Antonio is Larsen's latest bodyguard, a quiet and withdrawn Juicer who is a living weapon at Larsen's beck and call. The Juicer has no qualms about murder or torture, as long as his boss thinks it's all right. He is a master of intimidation as well as an excellent commando. He often defuses quarrels among the troops with a snarl and it's claimed that he can frighten low level foes simply by staring at the enemy with his cold, unblinking eyes. Some people, have even claimed to have seen the image of their death in those eyes. The man has no fear. He once attacked a vampire assassin sent after Larsen with his bare hands and beat it into submission with a broken table leg before staking and beheading it.

Larsen likes and respects the juicer and Antonio knows it; that's one reason for his total devotion to the man. As long as he is alive, Colonel Larsen will be safe from danger.

Full Name: Antonio Giordano

Alignment: Aberrant

Attributes: I.Q. 14, M.A. 24, M.E. 17, P.S. 30, P.P. 26, P.E. 24, P.B. 16, Spd. 80

Hit Points: 89, **S.D.C.:** 456

Size: 6 feet tall (1.83 m), 190 lbs (85.5 kg). **Age:** 20

P.P.E.: 4

Disposition: Rarely speaks unless spoken to first. He always stares at people in an unnerving manner, as if he's sizing them up for a coffin or something equally unpleasant. He is totally dedicated to protecting Larsen, at the cost of his own life if need be. Antonio is a fairly good judge of character and has an uncanny sense of telling if someone means harm to the Colonel.

Experience Level: 8th level Juicer (3 years old).

Magic Knowledge: None

Psionic Powers: None

Combat Skills: Hand to Hand: Martial Arts, boxing and wrestling.

Attacks per Melee: Eight hand to hand attacks per melee.

Bonuses: +4 to initiative, +8 to strike, +11 to parry and dodge, +15 to damage, +8 to roll with impact/punch, +3 to pull punch, +8 to save vs poison, +4 to save vs magic, +5 to save vs psionics, +6 to save vs horror factor (special).

Weapon Proficiencies: W.P. Knife, W.P. Energy Rifle, W.P. Energy Pistol, W.P. Sword, W.P. Heavy Energy Weapons, W.P. Automatic Rifle, W.P. Heavy.

Weapons: NE-10 Plasma cartridge rifle, Wilk's 457 pulse laser rifle, C-14 laser pistol, vibro-knife, Kittani plasma sword (2D6 M.D. blade or 4D6 M.D. plasma blast), and a neural mace.

Armor: Dead Boy heavy armor (M.D.C. 80), with a white smile painted over the helmet's lower face. Painted on the chest and back are the words "Smile, you're dead!" and the company logo.

Skills of Note: Basic radio 95%, wilderness survival 75%, land navigation 73%, piloting: tanks and APCs 78%, piloting: jet pack 84%, weapon systems 85%, prowl 80%, swimming 98%, detect ambush 75%, detect concealment 70%, intelligence 69%, American 98%, Spanish 98% and Euro 98%.

Major Perrin — Dog Boy Officer

Perrin was a Dog Pack squad leader and one of the 12 who rescued Larsen from the CS General. In Larsen's army, talent, not race, is what determines who rises through the ranks. Perrin's skills have made him second-in-command. He is also the officer in charge of all the infantry and scouts. The mutant dog is uncommonly independent and less submissive to humans than most of his kind, probably because of the wolf genes used in his design.



SEZ II =

Major Perrin has also created a special squad of Dog Boys, Psi-Stalkers, and Ley Line Walkers which he uses for counter-supernatural security. Thanks to his efforts, many enemies who thought they could use sorcery to sabotage Larsen's Brigade have had the tables turned on them.

Alignment: Unprincipled

Attributes: I.Q. 17, M.A. 14, M.E. 16, P.S. 22, P.P. 17, P.E. 26, P.B. 16, Spd 31.

Hit Points: 52, **S.D.C.:** 82

Size: Seven feet, three inches tall (2.21 m), 400 lbs (180 kg).

P.P.E.: 12

Disposition: A good commanding officer who has gained the respect of his men and overcome the bigotry of many mercenaries. Major Perrin is compassionate and fair, but he does not tolerate insubordination from anybody and is a demanding leader. In this case, his bite is far worse than his bark. When he becomes violent, he is a terror to behold, combining the nastier side of a rabid dog with the calculating mind of an intelligent human.

Experience Level: 7th level Dog Pack R.C.C. (Wolf)

Magic Knowledge: None

Psionic Powers: All Dog Boy powers plus sense evil, sense magic, sixth sense, empathy and astral projection.

Combat Skills: Hand to Hand: Martial Arts and boxing.

Attacks per Melee: Four hand to hand or psionic attacks.

Bonuses: +3 to strike, +6 to parry and dodge, +4 to damage, +3 to roll with impact/punch, +3 to pull punch, +6 to save vs poison, +6 to save vs magic, +1 to save vs psionics.

Weapon Proficiencies: W.P. Energy Pistol, W.P. Energy Rifle, W.P. Knife.

Weapons of Note: NG-P7 particle beam rifle, C-14 laser pistol, four fragmentation grenades and a vibro-knife.

Armor: Dead Boy heavy armor (M.D.C. 80).

Skills of Note: Intelligence 66%, basic radio 90%, pilot hovercraft 98%, read sensory equipment 75%, weapon systems 85%, climbing 75%, running, land navigation 74%, wilderness survival 75%, prowl 65%, American 90%, Dragonese 90%, Spanish 80%.

Description: Many people who are familiar with the Wolfen think that Major Perrin is a member of that race because he's got almost the same features as those beings. Other than that, he's the typical Dog Pack soldier, aggressive yet loyal and trustworthy.

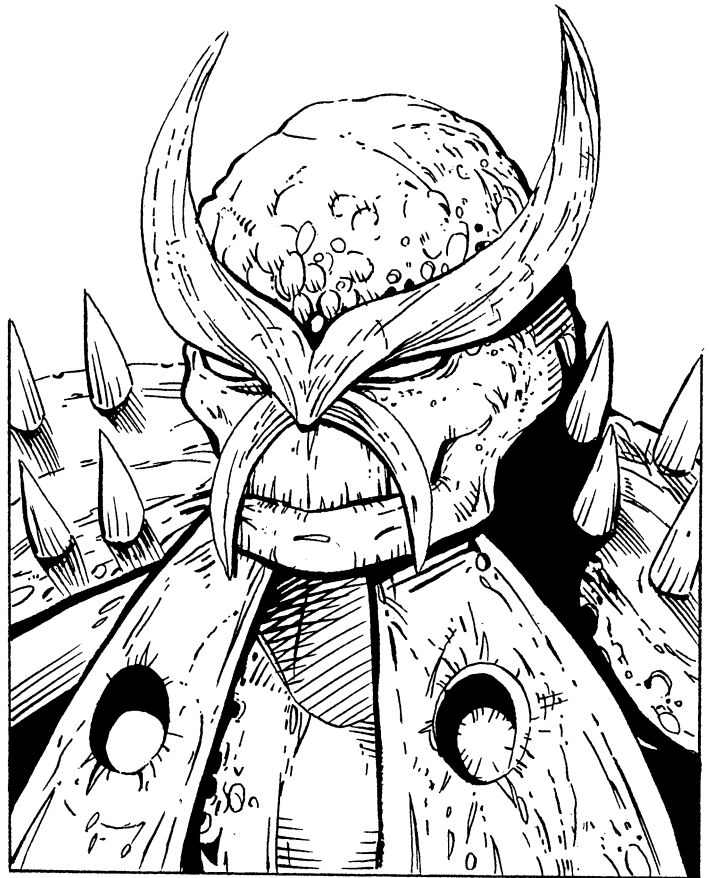

Ralph the Destroyer — Holy Terror

"Ralph" is a super-powerful D-Bee dedicated to battling evil entities. He arrived on Rifts Earth 55 years ago when he and the rest of a liberation army were travelling through a rift to aid the denizens of Wormwood (see **Rifts Dimension Book One**). Regrettably, the rift collapsed before the greater part of the liberation army had reached their destination (Wormwood's demonic overlords killed the shifter who was keeping the rift open). Even more regrettably, "Ralph" was right in between the two worlds when the rift slammed shut, spinning him into the Megaverse. Luckily a dimensional anomaly deposited him on Earth.

The Holy Terror soon discovered that this world could also use champions against the forces of evil. Cut off from his people and with no idea how to get back home, he joined a group of paladins commanded by a cyber-knight. For the next 50 years he travelled throughout the western parts of America and Canada, as far north as Alaska, fighting supernatural menaces and brigands. One by one, his companions died as enemies, accidents, disease and old age claimed them. Eventually, he was alone once again. He met Larsen's Brigade a couple of years later, when the mercs were fighting an evil necromancer and his army of demons and undead. Ralph joined them in the middle of a fight and has stayed with them ever since. Although he realizes these warriors are not dedicated to fighting evil, he has become friends with several of them and enjoys their company. As long as the army continues to choose worthy clients and regularly fights evil, he will stay.



Full Name: Ralph; that's it.

Alignment: Unprincipled

Attributes: I.Q. 15, M.A. 21, M.E. 20, P.S. 50 (supernatural), P.P. 19, P.E. not applicable, P.B. 11, Spd. 70

M.D.C.: 900

Size: 10 feet tall (3 m) but can grow to 20 feet (6 m) at will, and weighs 7 tons (21 tons in giant form), **Age:** Unknown

P.P.E.: 320

Natural Powers: See the invisible, nightvision 1000 feet (305 m), turn invisible at will, fire lightning bolt (1D6 × 10 M.D., range 2000 ft/610 m, +2 to strike), laser-like beams (5D6 M.D., range 4000 ft/1220 m, +3 to strike), silver spikes (2D6 M.D., 4D6 M.D. to supernatural monsters, 600 ft/183 m, +3 to strike), breathe toxic cloud (either cloud of sleep equal to the spell, 5th level; blinding mist; or toxic cloud that inflicts 6D6 M.D., or 1D6 × 10 M.D. to supernatural entities). Bio-regeneration 2D4 × 10 M.D.C. once per every other melee (30 seconds), and can regenerate lost limbs within 48 hours. Holy Terrors take double damage from rune weapons and fire.

Disposition: Ralph is a friendly and kind creature, interested in the details of other people's lives and problems. He is a good listener who often gives surprisingly sound advice. People who can look beyond his monstrous exterior soon realize he can be a very good friend. He loves combat and over the years has become less dedicated to fighting evil (demons in particular) and more on enjoying the company friends and enjoying life's simple pleasures. He can't stop himself from performing heroic feats and is inevitably drawn to righting injustice and protecting the innocent.

Experience Level: 6th level Holy Terror R.C.C.

Magic Knowledge: Can cast each of the following spells two times per 24 hours, equal to a 6th level wizard: call lightning, fire ball, magic net, energy disruption, turn dead, invisibility (superior/others), chameleon (self or others), heal wounds (others).

Psionic Powers: None

Combat Skills: Hand to hand: Expert and boxing.

Attacks per Melee: Four hand to hand or two by magic.

Bonuses: +2 to initiative, +4 to strike, +7 to parry and dodge, +35 to damage, +4 to roll with impact/punch, +5 to pull punch, +4 to save vs magic, +4 to save vs psionics, +5 to save vs horror factor.

Weapon Proficiencies: W.P. Sword, W.P. Blunt.

Weapons: None. Relies on his natural powers and magic.

Armor: None.

Skills of Note: American 80%, Demongogian 80%, Gobblely (60%), basic math 75%, land navigation 60%, climbing 60%, intelligence 66%.

Description: A walking, talking, giant suit of armor. Nobody knows if Ralph is some sort of cyborg, a magically-animated robot, or something else. He won't say and nobody can make Ralph do anything he doesn't want to. See **Wormwood: Rifts Dimension Book One** for more insight about Holy Terrors and other beings.

Other Personnel

Officers: Captain Martin (7th level Coalition Technical Officer), Captain VanBuren (7th level Coalition Elite RPA), Lt. Gillespie (6th level Dog Pack R.C.C.), Lt. Gonzales (7th level Borg), Zorlaak the Astonishing (8th level Ley Line Walker). Additionally, there are about 50 sergeant majors and 100 sergeants, drawn mostly out of the ranks of veteran (levels 5-7) soldiers.

Line Soldiers

- 40-60 Coalition Elite RPAs, levels 6-10 (CS deserters).
- 60-80 Special Forces Soldiers, levels 5-9 (recruited from Ishpeming or the Manistique Imperium)
- 80-100 Veteran Headhunters, levels 4-10, all with Robot Combat: Elite.

- 60-80 Coalition Grunts, levels 6-9 (CS deserters)
- 60-80 Veteran CS Dog Pack soldiers, levels 5-7 (more deserters)
- 40-60 Psi-Stalkers (wild and ex-CS), levels 5-8
- 80-100 Juicers, levels 2-7
- 60-80 Crazies, levels 2-7
- 60-80 Full conversion borgs, levels 2-8
- 60-80 Wilderness Scouts, levels 6-11
- 30-50 Ley Line Walkers, Mystics and Warlocks, levels 1-8
- 30-40 Bursters, levels 1-4
- 10-20 Mind Melters, levels 3-7
- 2 Hatchling Dragons, levels 2 and 5
- 100-140 Simvan Monster Riders, levels 3-10 (its members have sworn off cannibalism). These numbers only include warriors, not non-combatants (another 100-120 young and infirm members).
- 30-40 Dwarf Headhunters and Operators, levels 3-5 (Larsen has connections to some Dwarven communities in remote parts of North America).
- 46 Gargoyles, levels 2-4! This is the largest known group of Gargoyles in America not allied to the Splugorth. They are a group of transdimensional refugees (originally 63) whom Larsen accepted into his army. The 46 are all adult warriors; there are an additional 40 non-combatants (young, caretakers or the infirm).
- 400-600 Mutant animals; 65% are Dog Boys, the rest are animal experiments created at Lone Star. Average level is 2-7.
- 400-600 D-Bee warriors, no more than 20 beings of any one race; Orcs, Trolls, Goblins, Minotaurs, several giant races, Elves, Kittani, Splugorth slave races, and dozens of other D-Bees are part of the army. All equivalent to Headhunters, Wilderness Scouts, or Vagabonds, levels 2-6. Approximately 50 are extraordinary individuals with magical, psychic or super-powers.
- 200-250 Headhunters, levels 2-4
- 200-250 Wilderness Scouts, levels 2-4.
- 150-200 City Rats, levels 2-6.
- 200-250 Others (cyber-knights, glitter boys, smugglers, forgers, spies, D-bee warriors, adventurers, etc.), levels 2-6.

Total Personnel: 2800 to 4000 soldiers, and some 5,000 non-combatants (families, mechanics, medics, travelling merchants, convoy drivers, and other camp-followers). About 60% of these have minimal combat training (Hand to Hand: Basic, and one W.P.), levels 1-3.

Weapons, Equipment and Resources:

Standard Issue Weapons and Equipment

- NG-L5 particle beam rifle or Wilk's 457 laser pulse rifle (mercenary's choice)
- WI-GL20 grenade launcher or WI-23 missile launcher are issued to 1 out of every 4 infantry soldiers, or to strong D-Bees and 'Borgs.
- Crew-Served NG-E12 plasma ejectors are issued to 1 out of every 12 soldiers, or rifle version is assigned to light power armor troopers, cyborgs, or giant D-Bees.
- 12 grenades (Coalition or Northern Gun), mostly frags and plasma.
- Armor: Either explorer (to most line units) or camouflage variable armor (for elite units). Assault teams are 80% equipped with power armor or light exo-skeletons, while defending and rear-echelon units are not assigned any (dug-in infantry can hold off power armor troopers).
- NG-S2 Basic Survival Packs

Transport Vehicles

- 75 to 100 Mountaineer A.T.V. with NG-E12 tripod-mounted weapons (escort and cargo vehicles).
- 24 to 30 Iron Maiden APCs converted into personal vehicles (escort vehicles).
- 120 to 150 S.D.C. trucks for supplies and equipment.
- 60 buses (M.D.C. 30) for soldiers and families.
- 70-100 assorted vehicles which the rest of the camp-followers use to travel in.

Combat Vehicles

- 1 Death Head's Transport (now called "Larsen's Revenge"). Also used for transport purposes.
- 22 Coalition Sky Cycles
- 24 Grey Falcon Jet Fighters
- 8 Crescent Moon Delta-Wing Spaceplanes
- 12 Air Castle Bombers
- 16 Iron Eagle Attack Helicopters
- 36 Coalition Mark V APCs
- 48 Iron Maiden APCs
- 24 Iron Fist Medium Tanks
- 16 Iron Hammer Heavy Tanks
- 12 Iron Bolt Missile Vehicles
- 16 Carnivore Mark I Hover Tanks
- 8 Juggernaut Heavy Hover Tanks
- 40 SAMAS Power Armor
- 40 T-21 Terrain Hopper Armor
- 40 Flying Titan Power Armor
- 60 Triax X-10 Predator Power Armor
- 30 Triax X-100 Ulti-Max Power Armor
- 30 Ng-X9 Samsom Power Armor
- 40 MK-PA12 Mecha-Knight Power Armor
- 120 NG-EX10 Armored Infantry Light Exo-Skeletons
- 30 Nomad Scout Robots
- 20 Triax X-500 Forager Battlebots
- 20 NG-V7 Hunter Mobile Guns
- 18 DK-AR500 Death-Knight Robot Vehicles
- 16 UAR-1 Enforcer Robots
- 16 Spider Walker Robot Vehicles

The Shadow Warriors

- A. Sponsorship: Splugorth. 0 Points
 - B. Outfits: Unlimited Clothing. 50 Points
 - C. Equipment: Unlimited Equipment. 50 Points
 - D. Vehicles: Specialty Vehicles. 30 Points
 - E. Weapons: Extensive Weaponry. 40 Points
 - F. Communications: Full Range System. 15 Points
 - G. Internal Security: Iron-Clad. 20 Points
 - H. Permanent Bases: None. 0 Points
 - I. Intelligence Resources: Psionics and Magic. 20 Points
 - J. Special Budget: Big Bucks. 45 Points
 - K. General Alignment (Evil): Miscreant and Aberrant. 0 Points
 - L. Criminal Activity: Cyber-Doc (1) 10 Points
Smugglers 15 Points
 - M. Reputation/Credentials: Unknown. 5 Points
 - N. Salary: Good Salary 10 Points
- Total Points Spent:** 310 Points
Size & Orientation: Large Company

Lord Splynncryth assigned High Lord K'mar to a special mission to plant a team of spies on the North American continent. Spies who could blend into their surroundings and establish a base of operations. The High Lord designed a fake mercenary band led by a trustworthy human slave. The company is made up of a platoon of Kittani warriors, wolfen mercenaries and a handful of human slaves. He sent the mercs to Southern Texas, where the wolfen could pass as Dog Boys and where the Coalition State's hold seemed tenuous. At this location they could learn useful information about the Coalition and the Vampire Kingdoms; both a serious concern, the vampires especially so.

The exact plans for the creation of the mercenary company was left to the discretion of the human slave they called Commander Grey. Once on the continent, the company has grown and added local humans and D-Bees who made the mercs fit in more easily. The Splugorth investment has paid off generously. The Shadow Warriors have become such an influential force in the **Pecos Empire** that if Lord Splynncryth wished them to, they could probably unify the Empire of scoundrels under their control and lead thousands of bandits against the Coalition State of Lone Star or vampire forces. They have become known as vampire hunters and champions of D-bees. They have even met and befriended some of Reid's Rangers. For the time being, it is not in the best interests of Atlantis to move against the Vampire Kingdoms or the CS, so the Shadow Warriors remain content with increasing their numbers and reputation. Despite what one might think, the Splugorth's secret warriors do not commit unnecessary acts of violence or abuse their power. As a mercenary force, they are becoming known as an effective and reasonably trustworthy troop, especially among D-bee communities in the American southwestern territories and northern Mexico. So far the vampires have dismissed any danger they may represent. The Coalition finds their inhuman presences disturbing, but as long as they keep their operations to the southwest and Mexico, the CS will focus on more important matters in the midwest and north.

Tactics

The Shadow Warriors have trained under Kittani Drill Sergeants and know all there is to know about modern combat. Many are also proficient at combining magic and psionics with technology. This makes them, man for man, some of the best soldiers on the continent. Power armor attacks are the Kittani's specialty, using flying suits as air support while fast moving ground troops and strike teams work to outflank, surround and destroy enemy units. Scouts and advance soldiers are protected by wizards and psychics to gain the element of surprise. Against a superior force, the company utilizes ambushes and guerilla hit and run tactics to disorganize the enemy so it can be divided into smaller units and then destroyed one by one.

Company Colors and Banner

The Shadow Warriors' symbol is simple: two crossed, black axes over a white background.

Commander Grey

Transformed Human Splugorth Slave

William Grey was born into slavery. He has known no other life and believes that duty and obedience to the Splugorth and their minions is his purpose in life. He sincerely embraces the notion that the Splugorth are superior beings, wise and ancient creatures who deserve the devotion of all races. To Grey, the so-called "free" humans are misguided creatures, living out their pitiful existence without purpose. By contrast he is part of a noble civilization that has existed for eons and that is far greater than anything he or any human can ever hope to accomplish. In some ways, he resembles a religious zealot convinced that the Splugorth are god-like masters whose subjugation of mankind is a blessing.

His loyalty and dedication has not gone unrewarded. Grey's body and mind were augmented with bio-wizardry and he has become one of the Splugorth's top human agents, a deadly living weapon without any compassion for "lesser races" (including his fellow humans). He became the personal assistant of High Lord K'mar, who has earned his loyalty and trust. The High Lord decided that Grey would be the perfect "man" to lead the mercenary/spy organization he was developing.

"Commander" Grey now commands a small army, including some actual servants of the Splugorth. Some of these "servants" are 100% loyal to him and Atlantis, but some resent being lorded over by a mere

human and others would like to escape to live as free men. This does not bother Grey. He accepts it all as part of his duty. He is a very good strategist and tactician who knows how to best use his warriors under combat conditions. The Shadow Warriors have destroyed several armed bands in the Pecos Empire, some of them two or three times larger than themselves. This has led to a large number of new recruits who want to belong to the toughest bunch in the land. It has also bred resentment from a dozen of the most powerful and ambitious bandit leaders. Most of the gangs and outlaws that operate in the Pecos Empire see the Shadow Warriors as a rival gang muscling in on their territory. In the long run, the presence of the Shadow Warriors may serve to make these undisciplined brutes become more organized and even unite. At the very least, it may cause a temporary truce among these larger bands to take care of these new interlopers. Already, the Warriors have found they are becoming a more frequent target of raids and bushwhacking.

Full Name: William Grey

Alignment: Aberrant

Attributes: I.Q. 15, M.A. 19, M.E. 15, P.S. 40, P.P. 21, P.E. 21, P.B. 11, Spd. 44; supernatural strength and endurance.

M.D.C.: 200 (bio-wizard transformation) plus M.D.C. armor and Elom Force Field (60 M.D.C.).

Size: 6 feet, 7 inches tall (2.01 m), 200 lbs (90 kg).

Age: 29 years old.

P.P.E.: 10

Supernatural Powers: Grey's body has been recreated in the Splugorth transmutation chambers. See **Rifts Atlantis** for more details and information about other symbiotes.

1. His eyes have been replaced by the Eyes of Eylor. They give him a slightly goggle-eyed or owl-like appearance as they are larger and rounder than human eyes. They instill: perfect 20/20 vision,



nightvision 600 ft (183 m), telescopic vision (6000 ft/1830 m) and magnification to the 300th power!

The eyes also provide the following psionic and magic forms of vision without requiring I.S.P. or P.P.E.: see aura, see the invisible, sense magic, and see P.P.E. energy.

2. An Elom symbiotic organism has been implanted on the small of Grey's back. The creature creates a force field with 60 M.D.C. for up to 20 minutes, 12 times per 24 hours, and can release an electromagnetic discharge inflicting from 1 to 6D6 M.D. (range 2000 ft/610 m), or an area discharge inflicting from 1 to 4D6 M.D. (20 foot/6.1 m area).

3. Retractable knuckle blades: 3D6 S.D.C. damage

4. Although not a part of his physical transformation, the character uses bio-wizard microbes with temporary effects: Aerobes (+ 10 to save vs gases, +2 to save vs poison and drugs, lasts 24 hours), Aquarobes (breathe underwater, lasts 8 hours) and purirobes (imperious to poison and kills disease, lasts 4 hours).

Disposition: Despite his belief that humans (including himself) are an inferior race that should welcome, not resist, the Splugorth, Grey is noble, merciful, kind and generous. He always honors treaties and follows them to the letter, and extends mercy to enemies that surrender peacefully. When brutality will achieve his objectives, however, he has no compunctions to against using it. In the Pecos Empire, the Shadow Warriors beat and let go a band of marauders on the promise they wouldn't bother the company again. When the bandits once again ambushed the Shadow Warriors, Grey pursued them to the village they used as a base and exterminated every man, woman, and child present.

As a commander, he is always willing to listen to other people's opinions, but he always makes the final decision. He doesn't tolerate disobedience from anybody. Grey has personally executed two Kittani officers who thought they were too good to obey orders from a human. He doesn't resent the fact that some of his supernatural troops consider him a "filthy human;" they had just better respect his command and obey his orders. Insubordination is not tolerated. The human bandits who have joined the Shadow Warriors are in awe of Commander Grey, and some of his exploits against vampires have made some of these uneducated and superstitious people think he's a demi-god or a mythical hero.

Experience Level: 8th level Headhunter/Bio-borg

Magic Knowledge: None

Psionic Powers: None personally, but has a Splugorth "Enslaver."

Combat Skills: Hand to Hand: Expert and Power Armor Combat: Elite.

Attacks per Melee: Three hand to hand attacks plus two electromagnetic discharges.

Bonuses (includes all bonuses): +1 on initiative, +5 to strike, +6 to parry and dodge, +25 to damage, +2 to roll with impact/punch, +2 to pull punch, +3 to save vs poison, +4 to save vs magic, +4 to save vs horror factor.

Weapon Proficiencies: W.P. Energy Rifle, W.P. Energy Pistol, W.P. Sword, W.P. Blunt, W.P. Heavy Energy Weapons.

Weapons of Note: NG-E12 heavy plasma ejector (he uses it as a rifle), a forearm plasma blaster (5D6 M.D., 2000 ft/610 m range, same type as used by Splugorth slavers), KEP energy pump pistol, silver dagger, 1D6 TW storm flares, a plastic water pistol, and a rune Enslaver (see **Rifts Atlantis**). For use against the enemy he has a pair of mind slugs and four zombitrons.

Armor of Note: Explorer composite armor (M.D.C. 70), or Predator power armor.

Skills of Note: Radio: basic 98%, radio: scrambler 85%, detect ambush 80%, detect concealment 80%, tracking 75%, land navigation 78%, weapon systems 90%, read sensory equipment 80%, pilot jet pack 86%, pilot tank and APC 48%, pilot hover craft 95%, demon lore 75%, Dragonese/Elven 98%, Kittani 98%, Kydian 98%, American 85%, Euro 85% and Spanish 85%.

Description: An imposing man with large dark eyes, a powerful physique and intense expression. It is easy to believe he is an ancient hero of legend. He encourages that mistake, because in some ways he feels they are right, he does represent a power greater than humankind.

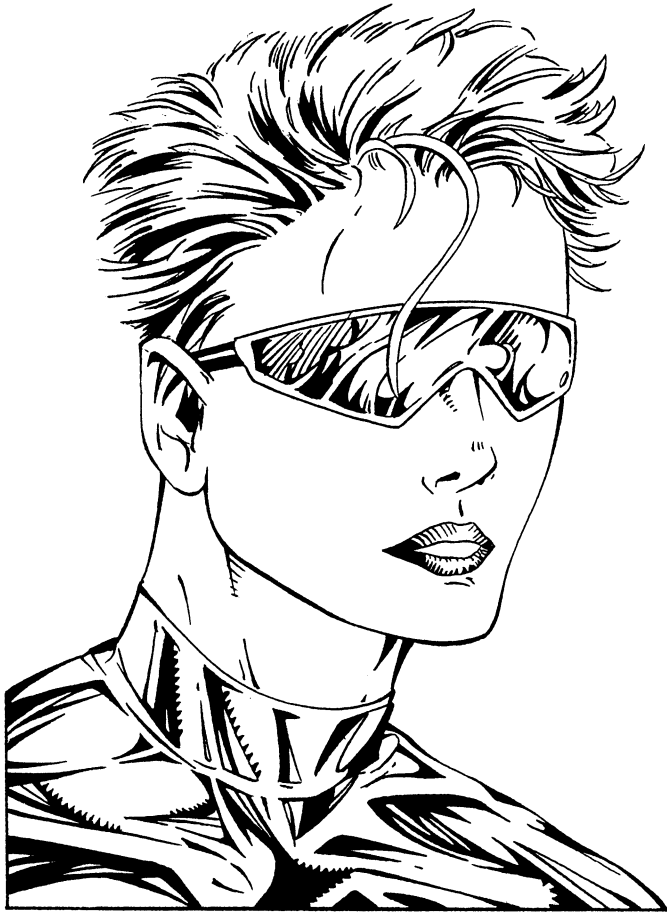

Captain Myriam

The Captain is an Altarian Warrior, one of the Splugorth's famous Blind Warrior Women. Her Slaver leader and all of her fellow warriors were killed fighting a small band of hatchling dragons who were raiding Splynn. She fought on and managed to defeat the remaining two dragons. Myriam has also acted as a secret agent and undercover operative, unearthing several plots in Lord Splynnryth's dimensional realms. This warrior has risen as high as her slave status allows. High Lord K'rmar thought she would be the ideal second-in-command for the Shadow Warriors.

The truth is, Myriam feels no real loyalty to Splynnryth, Atlantis or the Splugorth. Just the opposite, she wants to destroy Splynnryth and crumble his empire, but realizes a lone individual has no chance to do so. In the meanwhile, she will serve her foul masters as if she was a loyal servant. If the right opportunity arises she will take it.

This new mission gives Myriam the chance to study the world beyond Atlantis and enables her to take notes about the strengths and weaknesses of Splynnryth's possible enemies and look for potential allies. She is not above making a deal with evil beings, including vampires, if it means that the alliance will lead to Splynnryth's downfall. In her hatred for the Splugorth, she has become much like them.

Full Name: Myriam; it's the only name her masters have given her.

Alignment: Diabolic

Attributes: I.Q. 17, M.A. 19, M.E. 17, P.S. 25, P.P. 27, P.E. 24, P.B. 20, Spd. 30

Hit Points: 54, S.D.C.: 110

Size: 5 feet, 8 inches tall (1.73 m); 160 lbs (72 kg). **Age:** 26

P.P.E.: 4

Disposition: Captain Myriam is very cold and businesslike when acting as a military officer. She is a good actress, however, and can feign a number of emotions and attitudes. However, real love and compassion are alien to her; she can pretend to feel them, but she really never has. Her hatred is the only thing that is real to her and it has made her strong. Everybody around her is either an enemy or a pawn to be destroyed or used. She is merciless in combat and kills without the slightest hesitation.

The only people she cares anything for are her clone daughters. Ever since she started the mission, she has secretly "given birth" to three clones of herself (see *Rifts Atlantis*, page 51). Myriam is unusually fertile and she knows that if her clones are discovered, she will be destroyed or worse, studied in Atlantean laboratories. Her clones have been left to their own devices (and can be used as Altarian player characters or NPCs).

Experience Level: 8th level Blind Warrior Woman

Magic Knowledge: None

Psionic Powers: Sixth sense, presence sense, empathy, sense magic, sense evil, object read, clairvoyance and mind block. **I.S.P.:** 134

Combat Skills: Special

Attacks per Melee: Six hand to hand or psionic attacks.

Bonuses: +7 to strike, +8 to parry and dodge, +10 to damage, +4 to roll with impact/punch, +2 to pull punch, +5 to save vs poison, +6 to save vs magic, +4 to save vs psionics, +6 to save vs horror factor.

Weapon Proficiencies: W.P. Archery, W.P. Blunt, W.P. Knife, W.P. Sword, W.P. Energy Pistol and W.P. Energy Rifle.

Weapons of Note: NE-10 plasma cartridge rifle, TX-5 pump pistol, pair of laser wrist blasters (2D6 M.D., 1200 ft/366 m), Kittani plasma sword (2D6 M.D. or 4D6 M.D. blasts), a wooden dagger, a bow and arrows (high-tech, magic and wood) and 2D4 grenades.

Armor: Crusader body armor (M.D.C. 55).

Skills of Note: Running, climbing 80%, swimming 98%, prowl 65%, land navigation 73%, wilderness survival 80%, demon lore 70%, intelligence 74%, and paramedic 90%. She speaks Altara 98%, Dragonese/Elf 90%, Gobblely 90%, American 90% and Spanish 90%.

Description: A very attractive but cold and mostly expressionless woman with short black hair (implanted; naturally hairless). She always wears sunglasses or goggles to hide her sightlessness. See *Rifts Atlantis* for more complete details about the Altara warriors.

Soll-Thull

— Brodkil Warrior

Soll-Thull was a successful bandit leader in the Pecos Empire. He and his band of demonic marauders terrorized several communities, until their victims raised some money and hired the Shadow Warriors to deal with them. After a short campaign, Soll-Thull and his decimated band were captured and given the choice of joining the company and live or to be executed on the spot. The Brodkil are brutal and savage warriors, but they often willingly submit to someone they regard as more powerful than they. The Shadow Warriors were better fighters than Soll-Thull and he saw no dishonor accepting their offer and obeying the orders of his new leader.

The Brodkil and his warriors have been with the company for a while, and they have adapted to their new life. They've been forced to be less destructive and have learned to accept it. All in all, they are doing better than before. They have more money, more cybernetic toys to play with, and bigger guns. Soll-Thull considers Commander Grey and Captain Myriam to be worthy leaders and will follow them to Hell and back.



Full Name: Soll-Thull
Alignment: Miscreant
Attributes: I.Q. 10, M.A. 14, M.E. 20, P.S. 30, P.P. 20, P.E. 18, P.B. 6, Spd. 29; supernatural strength and endurance.
M.D.C.: 250
Size: 9 feet (2.74 m) tall, 350 lbs (158 kg), **Age:** 35
P.P.E.: 30
Natural Abilities: Impervious to normal fire and cold, turn invisible at will, bio-regenerate 2D6 M.D. per hour.
Disposition: He is loud and obnoxious. He never speaks if he can shout, he boasts constantly, and his growling, abrasive voice can drive most people to the edge. Soll-Thull is very greedy, and is always on the lookout for better bionic systems, magical weapons, and powerful guns. He used to love rail guns, but now he's in a missile-launcher phase.
Experience Level: 6th level Brodkil
Magic Knowledge: None
Psionic Powers: None
Combat Skills: Hand to Hand: Expert
Attacks per Melee: Five hand to hand attacks per melee.
Bonuses: +1 on initiative, +4 to strike, +6 to parry and dodge, +15 to damage, +2 to roll with impact/punch, +2 to pull punch, +2 to save vs poison, +6 to save vs magic, +4 to save vs psionics, +2 to save vs horror factor.
Weapon Proficiencies: W.P. Energy Rifle, W.P. Heavy Energy Weapons, W.P. Sword, W.P. Heavy, W.P. Blunt.
Weapons of Note: WI-23 Mini-missile launcher, NG-202 rail gun, Splugorth plasma rifle (6D6 M.D., 3000 ft/914 m range), large silver plated knife (1D6 S.D.C.), water cannon, and a magic amulet of turn the undead.
Armor: Modified plate armor (M.D.C. 100).
Bionics: The right arm is bionic with a P.S. of 20, a retractable vibro-blade (2D6 M.D.), and finger laser (1D4 M.D.). The bruiser also has a radar detector and gyro-compass.

Skills of Note: Tracking 55%, climbing 60%, prowl 60%, pilot hover craft 80%, intelligence 56%, radio: basic 75%, American 80%, Spanish 80%.

Description: A giant humanoid with coarse, hairless skin, oversized head, large carnivorous teeth and long clawed nails.

Anaconda — Kittani Warrior

Anaconda's true name is Grilian. She is the only member of the company who owns a Kittani Equestrian power armor suit. She is a veteran Kittani officer and spy, trained in the arts of deception. She finds the missions both exciting and challenging, a chance to fight tough enemies under primitive conditions.

Grilian is conducting a study of North America's military capabilities. She has identified the major military powers and their potential danger to Atlantis (almost none, in her opinion; no nation in North America has enough power to launch a successful invasion against Splynncryth).

True Name: Grilian Kzsmer, code name: Anaconda

Alignment: Aberrant

Attributes: I.Q. 22, M.A. 17, M.E. 20, P.S. 23, P.P. 18, P.E. 20, P.B. 11, Spd. 17.

Hit Points: 45, **S.D.C.:** 82

Size: 5 ft (1.52 m) tall, 170 lbs (76.5 kg). **Age:** 35

P.P.E.: 2

Disposition: A soldier first and foremost, and a stickler for military discipline who prefers to do things by the book. Sometimes, she has been a little inflexible when dealing with the unexpected, but most of the time her tactics work well. She has no problem working under Commander Grey. She approved of his executing the two rebellious soldiers and she would have done it herself if he had ordered it.



She is especially interested in learning more about Naruni Enterprises and the Mechanoids. The extra-dimensional arms merchant could upset the balance of power and she is going to recommend that special teams of assassins and saboteurs be sent against all Naruni trading centers. The Mechanoid threat scares her as much as every other Kittani. Although it seems that the insane cyborgs have been exterminated from Earth, she is always listening for rumors concerning their return.

Experience Level: 7th level Kittani Espionage Agent.

Magic Knowledge: None

Psionic Powers: Mind block, sixth sense, speed reading, total recall, object read and telemechanics. **I.S.P.:** 61

Combat Skills: Hand to Hand: Expert, boxing, wrestling, and Robot Combat: Elite and Basic.

Attacks per Melee: Four hand to hand or psionic attacks per melee.

Bonuses: +5 to strike, +8 to parry and dodge, +8 to damage, +4 to roll with impact/punch, +2 to pull punch, +3 to save vs poison, +3 to save vs magic, +3 to save vs psionics, +5 to save vs horror factor.

Weapon Proficiencies: W.P. Blunt, W.P. Sword, W.P. Energy Pistol, W.P. Energy Rifle, W.P. Heavy, W.P. Automatic Rifle, W.P. Axe.

Weapons of Note: Wilk's 457 laser pulse rifle, TX-16 pump rifle, TX-5 pump pistol, KEP-Special pump pistol, neural mace and Kittani plasma axe.

Armor: Bushman armor (M.D.C. 60) or Kittani Serpent Power Armor.

Skills of Note: Basic and advanced math 98%, radio: basic 98%, radio: scrambler 98%, surveillance systems 88%, basic electronics 83%, intelligence 78%, pick locks 83%, pilot tank and APC 72%, pilot hover craft 93%, Dragonese/Elf 98%, Gobblely 98%, American 83%, Spanish 78%, Euro 73%, climbing 83%, swimming 98%, prowl 68%, weapon systems 93%, read sensory systems 83%.

Description: An ape-like humanoid with an oversized cranium, flattened nose and covered with hair (except the top of her head).

Other Personnel

Officers: Camargo (7th level Juicer), Alfred Thonstone (8th level Headhunter), Thuarg the Mighty (9th level Wolfen warrior), Cassius (5th level Gargoylite), and Anana (7th level ley line walker).

- 20 Kittani warriors in Serpent power armor, levels 4-7.
- 30 Kittani warriors in Manling power armor, levels 3-6.
- 20 Wolfen (transdimensional mercs, hired by Atlantis), all warriors, levels 4-6.
- 20-30 Human headhunters, levels 2-4 (Pecos Empire recruits).
- 20-30 Juicers, levels 2-6.
- 10-20 Crazies, levels 2-6.
- 10-30 Full conversion borgs, levels 2-6.
- 10-30 Renegade Dog Boys and other mutant animals, levels 1-4.
- 10-20 Psi-Stalkers, levels 2-5.
- 50-100 Vagabonds and adventurers (mostly D-bees), levels 1-6.
- 10-30 Wilderness Scouts (mostly D-bees), levels 1-6.
- 23 Brodkil warriors, levels 3-5 (Soll-Thull's gang).
- 8-10 D-bee bounty hunters, 3-6 level.
- 6-12 Ley Line Walkers, levels 4-6 (Splugorth servants).
- 4-10 Mystics, levels 2-5.
- 5-10 Mind Melters or Burstlers, levels 3-5.

Total Personnel: 255-410 soldiers, and about 400 support personnel; of those, 50% have some useful combat skills, levels 1-3.

Weapons, Equipment and Resources:

Standard Issue Weapons and Equipment

Most of these weapons come from Triax Industries and Atlantis (Kittani items). If someone traced the serial numbers of the weapons, they would discover they were made and sold in Europe (or Atlantis) — they have come a long way to get to America.

Standard Issue Weapons

- K-4 (Kittani) laser pulse rifle or K-E4 plasma ejector.
- TX-30 Triax ion pulse rifle or TX-16 pump rifle.
- TX-5 pump pistol or plasma sword as a sidearm for officers.
- Bushman body armor (M.D.C. 60).
- NG-S2 Basic survival pack.
- Heavy Weapons: NG-202 rail gun (used as squad machinegun, 1 per 6-man squad), CR-1 rocket launcher (2 per squad), or K-500 rail gun.

Transport Vehicles

- Seven Insecton Land Rovers (Giant Robot Vehicle): Originally, there were nine such vehicles (they carried the original company members to America). Two have been destroyed by ambushers.
- 12 Kittani K-GTV hover land skimmers
- 24 Kittani KM-700 Uni-motorcycles
- 20-40 lightly armored trucks/buses (M.D.C. 30, wheel M.D.C. 5).

Combat Vehicles

- 20 Triax X-1000 Ulti-Max Power Armor
- 20 X-10 Predator Power Armor
- 20 T-21 Terrain Hopper Power Armor
- 10 Kittani K-ATV Hover Jets
- 10 NG-X9 Samson Power Armor
- 8 X-500 Forager Battlebots
- 10 TR-001 Titan Combat Robots
- 4 Coalition Mark V APCs

Adventure Ideas

The Pecos Empire By Kevin Siembieda

Members of the Pecos Empire are getting sick and tired of the Shadow Warriors and plan to do something about it.

Possible hooks and complications:

A band of dopey Pecos Raiders unleash a supernatural menace from a rift! The plan was to get this powerful "thing" to fight and kill the Shadow Warriors, but it (and its minions? Or perhaps it can control wild vampires or other monsters?) has run amok, killing Pecos Raiders and innocent people. The player characters try to stop the carnage. Ironically, the Shadow Warriors are nowhere to be found.

Pecos Raiders are in a bad mood and are chasing away any outsiders they encounter, including the adventurer group. They may even accuse the characters of being members of the Shadow Warriors or Coalition spies. The characters may also find themselves caught in rival gang wars or be hired by towns or villages to protect them from Pecos Raiders troubling their community.

Coalition Trouble: Pecos Raiders have been hitting more CS military installations in Lone Star, which has put the Coalition troops stationed in this territory in a bad mood. They are questioning, searching and molesting any strangers they encounter who look like they might be bandits or mercenaries. Groups composed of non-humans are given a closer (and meaner) investigation than others. These bitter and battle weary troops might even take justice into their own hands and execute "undesirables," D-bees, monsters and practitioners of magic, whether they are guilty of a crime or not.

Vampires vs Pecos Raiders: The player characters stumble upon a band of Pecos Raiders under attack by wild vampires (as many as a hundred or as few as 10 depending on the situation and strength of the player characters). They can't hold the monsters off much longer and will be slaughtered. Standing on top of a giant rock not far away is a master vampire and three secondary vampires orchestrating the attack.

Does the player group help? The Pecos Raiders are barbaric bandits, but do they deserve to be ripped apart by vampires?! If the group helps and are successful in defeating or repelling the vampires (killing the four leaders will send the wild vampires fleeing into the night), the Pecos Raiders will greet them as heroic brothers! The bandits will insist they come with them to the safety of their camp an hour away. They are very convincing (besides the vampires may come back in greater numbers).

If the characters go to the camp, they will be surprised to learn it is one of the major outlaw armies vying for power in the Empire. There are over a thousand men. The player group might even meet a couple of their leaders. Unless the characters are insulting or stupid they will be received as honored guests of a drunken festival to celebrate their heroics. If they keep their ears open they'll hear all kinds of things about the **Shadow Warriors** (only 50% are true), **Robot Control** (especially about the cool high-tech weapons one can purchase from Trader Joe), **vampires** (there are more than anybody suspects and some are "real smart"), and the **Coalition** (including rumors about strange, genetic experiments that create all types of mutant animals other than Dog Boys — a few are even members of this band, including a mutant bobcat and chimpanzee with psionic powers). If the player characters are liked by these brigands they will be offered membership to the group. Of course even being affiliated with these desperadoes can lead to all kinds of trouble and misunderstandings with local authorities, the CS, Shadow Warriors, Reid's Rangers, vampires and rival gangs. G.M.s, go with it and have fun.

Splugorth vs Splugorth

A number of Splugorth Slavers are coming in from the Gulf of Mexico and raiding the Texas and Louisiana area. The strange thing is, Commander Grey knows these raiders are NOT from Atlantis! This means that some other Splugorth must be sending minions to Earth. The Shadow Warriors volunteer to defend the area from the raiders. Commander Grey needs to get some prisoners and discover where the raiders are coming from.

Possible hooks and complications:

The player characters are also hired to deal with the Slavers. They track the Splugorth activity into vampire territory! It seems the Splugorth (they assume, Atlantis) has set up a base somewhere on the coast of Mexico, probably around the ruins of Ciudad Victoria. Following this lead can provide weeks of adventures fighting vampires, bandits, brigands from the Pecos Empire, the Minions of Splugorth, Coalition troops also investigating the problem, and the Shadow Warriors. Along the way, they may discover that the heroic Shadow Warriors are nothing more than Splugorth spies and pawns.

Ultimately, our heroes will learn that these Minions of Splugorth are not from Atlantis, but rogue operatives from another dimension. A fun twist might be to have the player characters get into a jam and be rescued (and subsequently captured?) by Minions from Atlantis or worse yet, vampires from the Vampire Kingdoms! Or they could be captured and taken to a different dimension dominated by the rogue Splugorth.

Vampire Trouble. This new Splugorth element operating in the area has caused the Vampire Kingdoms to investigate, sending three different teams of the intelligent secondary vampires. There are 4 to 10 secondary vampires per team, but each can command and control 12 wild vampires if they want to. Furthermore, they may enlist the aid of other evil beings. The player characters may run into these vampires as well as members of the Shadow Warriors.

A loved one has been kidnapped by Splugorth slavers. Then, the raiders are slain, and a few are captured by the Shadow Warriors. The adventurer group is trying to get the kidnap victim back, but the Shadow Warriors claim the raiders didn't have anybody. Are the mercenaries lying? If so, why are they torturing the slavers for information? Things

are worse than our heroes thought. According to the information extracted from the captured minions, a second, larger group of slavers raided a village and took another dozen women and children captive. Do the characters join forces with the Shadow Warriors? Or allow members of the Shadow Warriors to temporarily join the group to track down the real culprits?

On a Clear Day, You Can See Wormwood

Dimensional raiders from Wormwood (see **Rifts Dimension Book One**) run into the Shadow Warriors. The mercenaries learn from their captives about the strange new world. This is something that Lord Splynncryth would be most interested in. Commander Grey learns how to go to that dimension, and he and his company go on an exploratory mission. The player characters can get swept up in this in any number of ways (travelling with or having joined the Shadow Warriors, or following them, or getting captured by the invaders and later the Shadow Warriors offer the best odds of getting home, etc.).

Possible complications/adventure hooks:

In a Wormwood based campaign, they might hear news of a band of Earth mercenaries. If they have any connection with Lazarus Vesper (see **Rifts Dimension Book One**, page 79), he can ask for their aid. He knows of the Splugorth and is convinced the Shadow Warriors are Splugorth agents! If the company is not exterminated, they will report to Lord Splynncryth and doom the planet to an invasion by Splugorth minions.



New Equipment

"So whatdayasay? It's a beaut." Simon patted the armor's shiny surface affectionately. "You know the T-21 is the best light power suit around. And it's as good as new."

Greg squatted down and examined the left leg of the suit. "It's seen some action, that's for sure." He fingered a couple of patched holes on the armor's leg, where a serviceable but still noticeable patch had been applied. "Laser fire, I'd say."

Greg's companion said nothing. Simon continued his sales pitch. It was a cold November morning, but the black marketeer started sweating as he talked. The silent man's stare was making him nervous. "Sure it's seen action. But it's all fixed up, good as new. We even added an extra missile launcher for maximum firepower," he announced proudly.

"Yes, I can see that. The weld here looks kinda weak, though." Greg turned towards his silent partner. "Crunch?"

The huge, quiet man moved forward. He was bulky under the cloak and the wide-brimmed Mexican hat, but his movements were swift and direct. His gloved hands gripped the missile launcher, and pulled. With a tortured screech of torn metal, the launcher came off.

"Hey! What the hell are you doing?" Simon yelled. He made the hand signal that should have alerted the four bodyguards that stood behind him. Nothing happened. The huge man — cyborg, it had to be — continued to pull off the attached launcher. Simon risked a glance backwards. His men were there, all right. So was a refurbished UAR-1 Enforcer robot, all 30 feet of it. Somehow, the noise of his approach had been masked by the loud haggling and other market noises; many large vehicles came and went around the area.

The launcher came off. A logo was revealed beneath: A red heart with a spear runing through it. "There it is, Greg. I told you I had it magicked so no paint coat could cover it," Crunch said. Now that he had revealed his nature, his cybernetic alienness was apparent. Even the voice had an electronic, inhuman sound.

Greg nodded. "Two and a half months ago, Crunch was running patrol for Larsen's Brigade," he told Simon. "Somebody ambushed him, left him for dead, and stole his suit. There wasn't enough of him left to piece together as a human being. We had to rebuild him. And now, here is his old suit. Some coincidence, isn't it?"

Simon took a convulsive breath before stammering, "I ... I don't kn-n-n-now nothin' about no stolen suits!" Dammit! Red had promised him the suit would be unrecognizable. He promised!!

"Do I do him now, Greg?" Crunch asked.

"Nah. We'll take him to the Commander. The suit too. In fact, let's take all the suits here. No telling how many of 'em are stolen."

Disbelief temporarily displaced Simon's fear. "All the ... Wait, no, you ccccan't..." He checked himself when it finally sunk in that there was nothing he and his men could do to stop the mercenaries. The Market was not a military camp; it could not hope to keep out the UAR-1 robot, let alone the rest of Larsen's Brigade, only a couple of miles away. He was ruined. The fact became real. Ruined, that is, if he managed to escape with his life. Which wasn't all that likely.

Greg smiled. "Sorry, pal, but if you thought that you and your buddies could rip off Larsen's men and then try to sell them their own equipment, you deserve what's coming to you. And don't think your Black Market pals will try to protect you. They'll throw you to the wolves so fast your head'll spin before they make enemies with us mercs. We're their best clients, you see. You don't rip off Larsen's Brigade and expect to stay in business."

Simon's knees buckled. Crunch grabbed the merchant before he collapsed on the ground. Simon's heels left tracks on the earth as the cyborg dragged him towards whatever fate awaited him.

As the world slowly climbs its way up from barbarism, more manufacturing centers are being created. Some concentrate on producing farming and construction equipment, or in processing and packaging food products and other basic needs of life. The violence that pervades the world also creates a huge demand for weaponry, munitions, vehicles and combat equipment. There are currently about a dozen corporations happy to meet that demand, with only a handful of giants, like Wilk's, Northern Gun, Triax and the Coalition States. These four are facing growing competition from such companies as **Golden Age Weaponsmiths**, **Iron Heart Manufacturing**, **Wellington Industries**, and **Chipwell Armaments**. More recently, two transdimensional companies have started selling their wares on Earth, **Naruni Enterprises** and **Angrar Robotics**.

Game Master Note: The availability of any weapon, armor, bot, or vehicle is left completely to the G.M.'s discretion.

Golden Age Weaponsmiths

By Kevin Siembieda
Inspired by the name & ideas
conceived by C.J. Carella

Before the eruption of the ley lines and the coming of the rifts, 21st Century Earth was producing devastating mega-damage weapons and armor like the Glitter Boy. Still, most countries relied on 20th-century equivalent equipment. Even in North America, Federal and private armies still had stockpiles of conventional S.D.C. weapons and vehicles. Wars were comparatively uncommon during the Golden Age of science and advanced technologies, and much of the old war technology was put into mothballs. When the ley lines erupted and the rifts tore open, much of the new and old technology was lost or buried. It has only been in the last hundred years that the people of Rifts Earth have been actively unearthing the machines and secrets of the past.

At the Game Master's discretion, player characters can stumble across stockpiles of ancient weapons. Any of the weapons, explosives, and armored vehicles described in Palladium's **Compendium of Contemporary Weapons** can be found, as well as 21st Century items such as Glitter Boys and mega-damage tanks and aircraft (rare). It is also possible that military characters from the 20th Century could find themselves transported to Rifts Earth by accident. Imagine the shock a Desert Storm tank platoon would get if it was suddenly transported to a world of dragons and giant robots!

Against current mega-damage equipment, many of these weapons will have limited value. Most 20th Century missile launchers inflict between 1D4 and 2D6 M.D. and even a tank gun does a mere 3D4 M.D. — all about as powerful as an energy handgun or vibro-blade from Rifts Earth! By the same token, the armor of a 20th century tank typically offers around 10 to 20 M.D.C. (equal to light body armor) and needs fossil fuels to run.

Scavengers, independent operators, mercenaries and other organizations have realized that it is cheaper to simply modify the explosive mix of warheads and to weld a few plates of M.D. armor to an antiquated vehicle than to build such machines from scratch. The same is true of alien S.D.C. vehicles from other dimensions. The corporation that has become renowned for such “retrofitting” is **Golden Age Weaponsmiths, Inc. (a.k.a G.A. Weaponsmiths or GAW)**. This company has discovered, excavated and looted several National Guard depots and old military bases that held obsolete tanks, vehicles and weapons safely tucked away in storage.

Although G.A. Weaponsmiths has sent expeditions and agents to old military sites throughout the south, portions of the midwest and east coast in search of more relics, their main base of operations is headquartered at the **Redstone Arsenal**. Redstone was a major military installation of the old American Empire. It is located in northern Alabama between the Tennessee border and the Tennessee River near Huntsville, Alabama. There are several farms, cattle ranches, villages and three thriving cities growing around Golden Age Weaponsmiths’ home base. They are the rebuilt, pre-cataclysm cities of **Huntsville, Decatur, and Guntersville** along the Tennessee River. The latter two locations are right off the river and have rebuilt hydroelectric power plants. GAW operates a motorcycle factory and a gun and munitions factory (S.D.C. weapons) in Huntsville. It owns a refurbished automotive factory, several repair garages and an iron smelting plant in Decatur. The corporation also has interests in aluminum and iron mines in northwestern Alabama.

The location in Alabama is ideal because it’s outside the boundaries currently claimed by the Coalition States and puts them near several fledgling kingdoms and communities. They are also reasonably close to the gangs and tribes that make up the Pecos Empire which lays claim to most of Texas, as well as Whykin and Kingsdale in Missouri. Furthermore, the Tennessee river, which is wider and deeper than before the rifts, provides easy riverboat transportation across all of northern Alabama, and parts of Tennessee, Kentucky and the southwestern tip of Virginia.

Golden Age Weaponsmiths have made it their business to locate old military bases and scavenge every last bit of salvageable material. They’ve also found and excavated pre-rifts military equipment at Fort McCellan in Alabama, Fort Stewart in Georgia, and Fort Campbell, a helicopter training base straddling the borders of Tennessee and Kentucky. Fort Knox, Kentucky, an armor/tank training base, proved to be a virtual treasure trove of pre-rifts weapons, including a dozen Glitter Boys (GAW kept eight as part of their own defenses). They’ve built such a reputation over the last 25 years that they have mercs, adventurers and scavengers bringing items to them for swap, trade and cash. Not only that, but Golden Age Weaponsmiths have opened branch offices at El Paso, Kingsdale, the city of Wellington in the Manistique Imperium (in loose association with Wellington Industries), and are currently negotiating with Tolkeen. The corporation also has strong ties with the Black Market; mainly as a supplier.

Golden Age Weaponsmiths, Inc.

This thriving organization is NOT a mercenary company. Although it has a small force of defenders and squads of spies, scouts, scavengers, smugglers and field agents, it operates as a business that manufactures, repairs, rebuilds and sells military weapons and vehicles — it does not offer any of its people as soldiers for hire. GAW is basically a low-end arms dealer. We’ve used the mercenary company creation rules as a basic outline for their operations.

- A. Sponsorship: None 0 Points
- B. Outfits: Utility Outfits 5 Points
- C. Equipment: Electronic Supplies and good gear 5 Points
- D. Vehicles: Specialty Vehicles 30 Points
- E. Weapons: Extensive Weaponry 40 Points
- F. Communications: Full Range System 15 Points
- G. Internal Security: Tight 10 Points

H. Permanent Bases: Fortified Headquarters 20 Points

I. Intelligence Resources: Scout Detachment 5 Points

J. Special Budget: Large Loans 25 Points

K. General alignment of personnel: Anarchist 2 Points

L. Criminal Activity: Smugglers & Sells Contraband 15 Points

Forger (1; 10th level and several assistants) 30 Points

Con Man (2; 8th lvl head of sales & complaints) 10 Points

M. Reputation/Credentials: Known 10 Points

N. Salary: Good Salary 10 Points

Total Points Spent: 232 Points

Size & Orientation: Arms Dealer (equivalent to a Large Company)

Retrofitting Old Weapons

With a little work, ancient vehicles and some weapons can be refitted to operate in a mega-damage environment.

Most automatic and semi-automatic weapons cannot be transformed into mega-damage weapons except by *techno-wizards* and the use of these magic guns is limited to characters who are psychic or magical (needs I.S.P. or P.P.E. to fire mega-damage rounds).

S.D.C. weapons are still useful and common in the world of Rifts. Not every situation requires mega-damage power. Sometimes such devastating force is completely inappropriate. For example, mega-damage weapons are useless for hunting (unless one’s hunting dinosaurs). Even one M.D. point will vaporize a rabbit, bird, or other small animals. A single M.D. point will atomize half a deer or large animals, including humanoid. S.D.C. firearms are used for hunting, recreational target shooting, and to capture, wound or frighten away unarmored humans and D-bees. S.D.C. weapons are especially useful inside fortified cities where mega-damage weapons are not allowed.

Some S.D.C. weapons such as **rifles with grenade launchers** can fire modified mega-damage grenades (typically 1D6 or 2D6 M.D.) as well as S.D.C. damage grenades, tear gas and smoke grenades, but the gun still fires conventional S.D.C. bullets.

Most missile launchers/bazookas/LAWs, as well as mortars, and artillery cannons can use specially converted M.D. ammunition that does the equivalent of 1/20 its original S.D.C. damage in M.D. points. For example, a weapon that inflicted 1D4×100 S.D.C. now does 1D4×5 M.D.; range and targeting capabilities remain unchanged.

Retrofitting Pre-Rifts Vehicles

Armored vehicles can be easily transformed into M.D.C. vehicles, so that an equivalent of 1/10 to 1/2 their original S.D.C. is now in M.D.C. points. They can also be powered through nuclear or magic means, rather than liquid fuel, although this is probably too expensive and a waste on such a comparatively flimsy vehicle. The original weapon systems can be kept as is, loaded with modified mega-damage ammo or replaced with modern M.D. weapons such as rail guns, mini-missile launchers, and energy weapons.

Tanks, In General

There are very few tanks in service on Rifts Earth. The main reason for this is that tanks are obsolete when compared to giant robots or even the power armor. Tanks are not as fast, mobile or versatile. With the collapse of civilization, forests and wilderness have taken over the well-paved roads of the past and there are few places where tanks can operate free of obstruction (the west of the old American Empire is the most ideal for tanks). However, tanks tend to be cheaper to manufacture than robots and can run on fuel rather than nuclear energy. Most armies, especially mercenary and wilderness strongholds will have a few tanks, along with a robot, powered armor or cyborg infantry. Communities

with the least resources may have a platoon of tanks and only a few giant robots.

A few models of mega-damage tanks have appeared on Rifts Earth. Some are relics from the 21st Century, others are old S.D.C. tanks and armored vehicles rebuilt with M.D.C. armor. Some have been developed as inexpensive alternatives to robots, and others are vehicles brought to Earth by extra-dimensional visitors. See **Iron Heart** and **Triax**.

Golden Age Weaponsmiths has found a cache of armored vehicles that includes 40 ancient **M48A3 Main Battle Tanks** and 60 **Bradley Infantry Fighting Vehicles**, both of which were already old before the rifts came. See the **Compendium of Contemporary Weapons** for complete details about these tanks. Here are the improvements:

M.D.C. Modified M48A3 Main Battle Tank

- Speed: 30 mph (48.2 km); maximum fuel range: 288 miles (463 km).
- New armor plating provides 240 M.D.C. for the main body and 100 M.D.C. for the turret and cannon. The original S.D.C. of the main body was 1200 points (equal to 12 M.D.C.).
- The machinegun remains unchanged but can fire ramjet ammunition and the cannon fires 90mm HEAT rounds inflicting 5D6 M.D.
- One rail gun, mini-missile launcher, laser or other energy weapon can be mounted on the tank but costs extra.
- The G.A. Weaponsmiths are trying to peddle the retrofitted tanks for 110,000 credits each (a steal compared to new M.D.C. vehicles).

M.D.C. Modified Bradleys

- Speed: 41 mph (66 km); maximum fuel range: 300 miles (483 km).
- New armor plating provides 180 M.D.C. on the main body and 60 M.D.C. for the turret (the original main body had 950 S.D.C. or 10 M.D.C.).
- The cannon does 5D6 M.D., and the TOW Missiles inflict 1D6 × 10 M.D.
- One rail gun, mini-missile launcher, laser or other energy weapon can be mounted on the vehicle but costs extra.
- The Bradleys are being sold for 85,000 credits each. Some mercenary companies or small kingdoms may decide to purchase the vehicles due to their cheap price. G.A. Weaponsmiths are also pretending the vehicles are more effective than they really are; that and the appeal of pre-Rifts artifacts may attract customers.

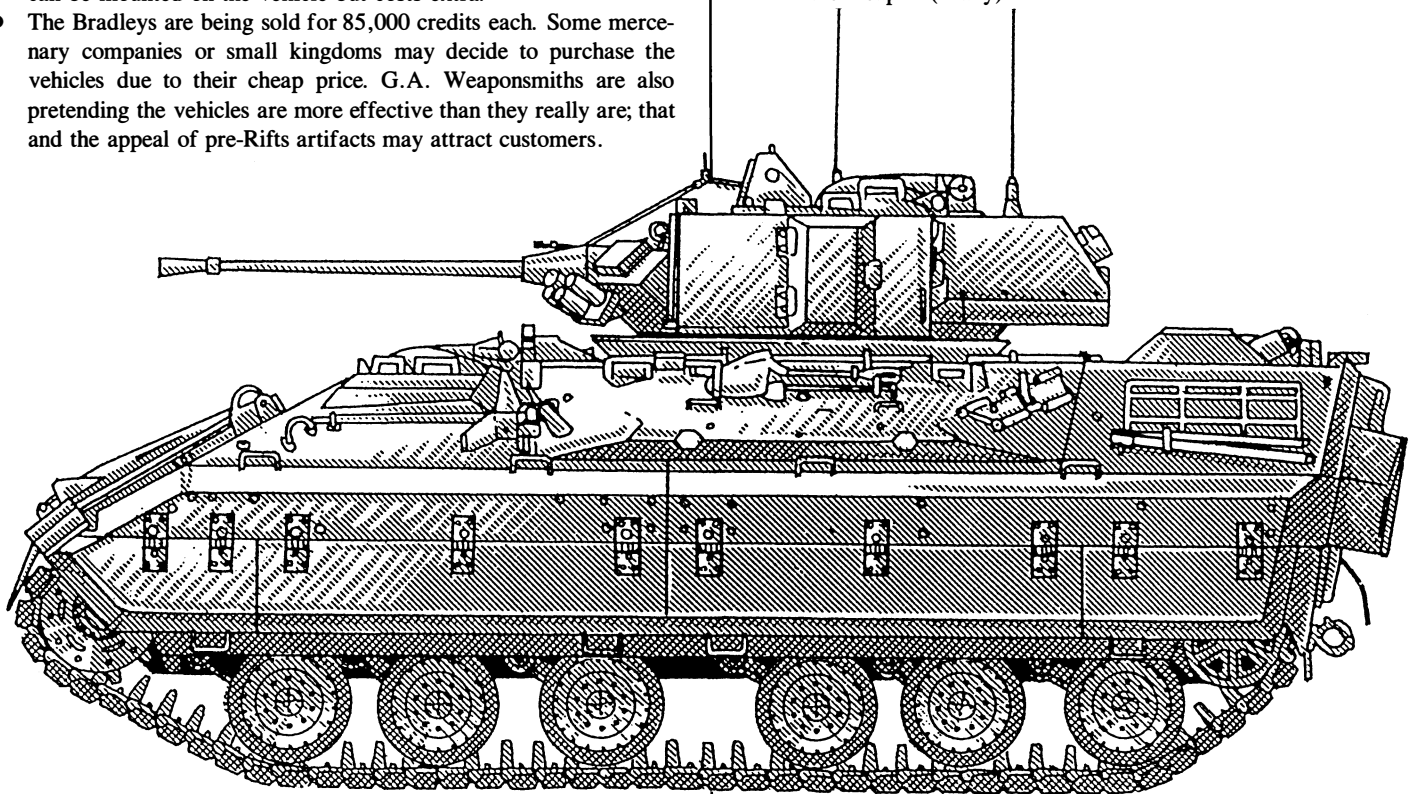

M.D.C. Modified Armored Cars & Light APCs

- Typical Speed: 60 mph (96.5 km); maximum fuel range: 250 miles (400 km).
- New armor plating provides 140 M.D.C. for the main body and 60 M.D.C. for the turret and cannon. The original S.D.C. of the main body is typically 500 to 600 points (equal to 5 or 6 M.D.C.).
- A rail gun, laser or other energy weapon is mounted on the turret or built into the vehicle or an existing S.D.C. machine-gun can remain unchanged, but fires ramjet ammunition or Naruni plasma rounds.
- Typical price for a retrofitted armored car is 60,000 credits.

M.D.C. Modified Large Trucks

- Typical Speed: 120 mph (192 km); maximum fuel range: 150 miles (240 km).
- New armor plating provides 60 to 80 M.D.C. for the main body of the cab and 90 to 120 M.D.C. for the trailer/cargo bay. S.D.C. tires are replaced with hard 3 M.D.C. wheels. The original S.D.C. of the main body is typically 400 to 600 points (equal to 4 to 6 M.D.C.).
- As many as four weapons can be mounted on the trailer section and one light weapon on the cab; each costs extra.
- Typical price for a retrofitted truck is 55,000 to 65,000 credits, plus the cost of the weapons (if any).

M.D.C. Modified Small & Medium Trucks

- Typical Speed: 90 mph (144 km); maximum fuel range: 200 miles (321 km). Souped up speed costs 5000 credits per each additional 10 mph (16 km) up to 80 extra mph (128 km) maximum.
- New armor plating provides 60 M.D.C. for the main body. S.D.C. tires are replaced with hard 3 M.D.C. wheels. The original S.D.C. of the main body is typically 200 to 400 points (equal to 2 or 4 M.D.C.).
- One light rail gun, laser or other rifle-sized energy weapon can be mounted on the hood, top or rear of the vehicle; costs extra.
- Typical price for a retrofitted truck is 24,000 credits, plus the cost of the weapon (if any).

M.D.C. Modified Automobiles & Jeeps

- Typical Speed: 110 mph (176 km); maximum fuel range: 300 miles (482 km). Souped up speed costs 5000 credits per each additional 10 mph (16 km) up to 80 extra mph (128 km) maximum.
- New armor plating provides 45 M.D.C. for the main body. S.D.C. tires can be replaced with hard 3 M.D.C. wheels. The original S.D.C. of the main body is typically 200 to 300 points (equal to 2 or 3 M.D.C.).
- One light rail gun, laser or other rifle-sized energy weapon can be mounted on hood, top or rear of the vehicle; costs extra.
- Typical price for a retrofitted car is 16,000 credits, plus the cost of the weapon (if any).

M.D.C. Modified Motorcycles

- Typical Speed: 140 mph (224 km); maximum fuel range: 300 miles (482 km). Souped speed costs 5000 credits per each additional 10 mph (16 km) up to 80 extra mph (128 km) maximum.
- New armor plating provides 25 M.D.C. for the main body (20 for a side-car, costs an extra 10,000 credits). S.D.C. tires can be replaced with hard 3 M.D.C. wheels. The original S.D.C. of the main body is typically 100 to 200 points (equal to 1 or 2 M.D.C.).
- One laser or other rifle-sized energy weapon can be mounted on the front of the bike; costs extra.
- Typical price for a retrofitted motorcycle is 11,000 credits, plus the cost of the weapon (if any).

M.D.C. Modified Aircraft

Pre-Rifts aircraft are more difficult to find in salvageable condition than cars, trucks and even tanks. However, from time to time, Golden Age Weaponsmiths does offer light aircraft, small jets, and helicopters.

- Typical Speed of Airplanes and Commercial Jets: 300 to 500 mph (480 to 800 km); maximum fuel range: 700 to 1000 miles (1120 to 1600 km).
- Typical Speed of average Combat Jets: 500 to 1340 mph/Mach 2 (800 to 2144 km); maximum fuel range: 700 to 1500 miles (1120 to 2400 km).
- Typical Speed of a Helicopter (including most combat types): 150 to 250 mph (240 to 400 km); maximum fuel range: 400 to 600 miles (640 to 960 km).
- New armor plating provides 100 to 140 M.D.C. for the main body. S.D.C. tires can be replaced with hard 3 M.D.C. wheels, propellers are 15 to 30 M.D.C. The original S.D.C. of the main body is typically 400 to 600 points (equal to 4 to 6 M.D.C.).
- Two or three weapon systems can be added, including light rail guns, laser or other rifle-sized energy weapon, or mini-missile launchers; each costs extra.
- Typical price for retrofitted aircraft: Small and medium airplanes: 60,000 to 90,000 credits, large airplanes 95,000 to 120,000 credits, jet aircraft 120,000 to 170,000 credits, and helicopters 90,000 to 120,000 credits, plus the cost of each weapon (if any).

Modifying M.D.C. Vehicles

The operators/mechanics at Golden Age Weaponsmiths boast that they can fix and customize anything. Although they specialize in cheap retrofitting of S.D.C. vehicles and repairs, they can repair and modify spanking new mega-damage vehicles as well. They can add weapons, upgrade weapon systems, combine weapons and parts from other manufacturers, add (limited amounts of) M.D.C. to vehicles, install sensory devices, do custom paint jobs (with striping and logos), and similar.

The purchaser pays for parts plus labor. In some cases, good working parts can be swapped at a fair to good rate of exchange (much better than a straight buy out). Simple jobs and minor modifications, easy

installations, and rudimentary repairs take a day or two (1D4+1 at their busiest). Paying 50% more will get the job done in four to six hours!

Big jobs, like refitting new and/or additional weapons, adding or repairing mega-damage armor, and extensive customizing can take two to four weeks depending on the complexity. Even paying double may only knock a week off the time; work can only be done so fast.

Labor for simple jobs: 20 credits an hour

Labor for jobs of medium difficulty (60%): 40 to 60 credits an hour.

Labor for difficult jobs: 100 to 200 credits an hour.

Labor for extremely difficult jobs: 200+ credits an hour and 25% to 50% of the total price added as a surcharge. It is wise to get an estimate on extremely difficult jobs because there may be unusual fees and extra charges.

Rush Jobs: 50% to 100% extra.

Illegal Customizing: 50% extra for modifying and removing serial numbers and obvious identifying marks from stolen goods; including ALL Coalition States armor, weapons and vehicles.

Recharging Standard Energy Clips: 1000 credits (most others charge 1500 credits)

Recharging "Long" Energy Clips (used by most rifles): 1500 credits (most others charge 2000 credits).

Recharging Coalition CE-Canister Clips and Triax E-clips: 1800 credits (most others charge 2300 credits).

Recharging NG Power Packs: 1/3 of the original cost (around 25,000 credits).

Weapons, Extra Features & Notes

Adding weapons and other extras like radar, radios, and sensors to retrofitted vehicles can be done, but the purchaser should be careful. In many cases, the weapons and extras can cost more than the vehicle and the overzealous character may find himself wasting expensive equipment on a flimsy piece of junk. For this reason, GAW operators will not even consider putting a nuclear engine or power supply in one of these retro-vehicles.

Other Extras Built into the Vehicle (also see the robot creation section in *Rifts Sourcebook One*):

Fuel Efficiency Modification (adds 20% to range): 1000 credits

Souped-Up Engine (adds 30% to maximum speed of vehicles): 10,000 credits; not available for humanoid robots.

Additional M.D.C. armor to mega-damage vehicles and giant robots: 20,000 credits per every 10 M.D.C. points; usually limited to 100 M.D.C. maximum.

Mini-Missile Launcher: 200,000 credits

Short-Range Missile Launcher: 300,000 credits for a three missile payload, 500,000 for a six missile payload, or 800,000 for a 12 missile payload.

Medium-Range Missile Launcher: One million credits with a three missile payload or 1.5 million for a six missile payload.

Long-Range Missile Launcher: Five million credits with a three missile payload or 8 million for a six missile payload.

Weapon Mounts: 1000 credits to mount a light weapon, 2500 credits to mount a heavy or large weapon, and 5000 credits for a weapon turret (rotates 360 degrees). The cost of the weapon is extra.

Ram Prow: A reinforced ram in the front of the vehicle used for ramming other vehicles and plowing through obstacles. The prow has 50 M.D.C. Small/automobile-size: 10,000 credits, medium: 15,000 credits and large/tank/semi-sized (+ 25 M.D.C.): 20,000 credits

Winch & Cable: Mounted on the front or rear of the vehicle is an electric winch; basically a motor connected to a cable and a hook. The cable is 100 feet (30.5 m) long and can pull up to two tons. 2000 credits

Secret compartment: 2000 credits small, 4000 credits medium and 8000 credits large.

Self-Destruct System: 1000 credits for an S.D.C. system, 40,000 for an M.D.C. vehicle, or 80,000 credits for a giant robot.

Environmental Pilot's Compartment: The cab/driver area has 40 M.D.C. and is airtight, with an independent oxygen supply, air-conditioning, and heating system, air purification and circulatory system (good for up to 24 hours). 50,000 credits or 5000 credits for a 100 S.D.C. compartment.

Flashing Lights (like the Police): 150 credits

Anti-Theft Alarm & Siren (makes a loud noise): 100 credits

Keypad Locks: 1000 credits per each lock.

Voice Activated Locks & Ignition: 12,000 credits

Mini-Radar system built into the dashboard: 3000 credits.

Laser Targeting System (+1 to strike): 50,000 credits

Targeting & Combat Computer: +1 to strike, can identify 32,000 targets, and can be linked to radar and sensors. 500,000 credits

Heads-Up Display System: 10,000 credits

Computer and Monitor built into the dashboard: 5000 credits

Computer Atlas Program: Displays city maps, roadways and trails.

The general atlas program shows the entire North American continent (USA and Canada), general geographic features (mountains, forests, rivers, etc.), the location of major nations, major cities, and major trouble spots such as the Calgary Rifts, The Devil's Gate, the Magic Zone, and so on. Specific discs are available for the roads and streets of major cities, including each Coalition State and city, Lazlo, Ishpeming, Tolkeen, Whykin, Kingsdale, and other major communities. Of course, the environment and communities are constantly changing so the information is only 75% accurate and updates are issued regularly. An atlas more than a year old will only be 50% accurate and places like the Burbs, shanty towns and mercenary operations change constantly so they are NOT included at all. Basic program costs 300 credits, specific places cost 100 credits each.

Water dispenser: A refrigerated container that holds and cools drinking water. 400 credits.

Mini-microwave oven (for larger vehicles): 300 credits.

Searchlight: 200 credits

Infrared Search Light: 500 credits

Loudspeaker: 200 credits

Short-Range Communicator (4 miles/6.4 km range): 200 credits

Long-Range Directional Radio (100 mile/160 km range): 1000 credits.

Video Camera (mounted inside or outside): 1200 credits (10 S.D.C.) or 8000 credits (5 M.D.C.)

Radar Detector: 200 credits

Radiation Detector/Dosimeter: 200 credits

Calendar and Clock: 100 credits

Some Things of Note: Golden Age Weaponsmiths also sells reconditioned S.D.C. vehicles (and parts) for half of the price listed for their mega-damage modified counterparts. GAW has frequent sales on S.D.C. motorcycles (they have a small factory that makes them) for only 3800 credits; the normal price is usually around 6000 credits. S.D.C. automobiles, jeeps, and pickup trucks (some manufactured by GAW, others reconditioned) typically cost 10,000 to 16,000 credits.

G.A. Weaponsmiths sells common weapons and parts for M.D.C. and S.D.C. vehicles, bots, and weapons. They repair and modify weapons and vehicles of all kinds, including M.D.C. giant robots, tanks, APCs and aircraft, as well as buy and trade parts, weapons, vehicles and equipment (purchase prices are comparable to the Black Market). This is particularly attractive to adventurers, mercenaries, and D-bees — GAW will trade, sell and deal with just about anybody. Cash deals are seldom questioned.

If the purchaser is known to be a wanted criminal on the run (especially if wanted by the CS), GAW may refuse to sell the person anything, but is likely to direct them to the local Black Market. Golden Age Weaponsmiths regularly works and trades with the Black Market, criminals, bandits, mercenaries, adventurers and people living in the wilder-

ness (human and D-bee). One of their biggest clients is the Pecos Empire and more recently, Tolkeen.

They are not on friendly terms with the Coalition States because of their indiscriminate sales practices (they often supply bandits and enemies of the CS). However, G.A. Weaponsmiths try to stay out of the Coalition's way.

Golden Age Weaponsmiths doesn't usually deal in magic weapons or techno-wizard modifications, but do occasionally offer such items (usually acquired in trade).

Workmanship is always good to very good and prices are usually fair.

Northern Gun Weapons

The weapon designers at Ishpeming continue to develop new weapons and features, including providing a greater availability of the "long" E-clip and a new, self-charging power pack that can regenerate a full payload six times before needing a factory recharge and overhaul. The recharging and overhauling of the unit takes one day, costs one-third the original price and can be over hauled four times before a replacement is needed. This item is the rage in the Mid-West.



NG-56 Northern Gun Light Ion Pistol

A slightly smaller, lighter version of the NG-57.

Weight: 3 lbs (1.4 kg)

Mega-Damage: 2D6 M.D.

Rate of Fire: Standard

Maximum Effective Range: 400 feet (122 m)

Payload: 6 shot standard clip, 12 shots long E-clip, or 42 shots with Power Pack (pack weighs 3 lbs/1.4kg and recharges 4 blasts per hour; cost 60,000 credits).

Black Market Cost: 5,000 credits

NG-E4 Plasma Ejector

A larger, rifle style weapon that comes standard with a telescopic sight.

Weight: 20 lbs (9 kg)

Mega-Damage: 6D6 M.D.

Rate of Fire: Standard

Maximum Effective Range: 1600 feet (488 m)

Payload: 10 shots standard clip, 20 shots long E-clip, or 70 shots with Power Pack (pack weighs 20 lbs/9 kg and regenerates 4 blasts per hour; costs 80,000 credits).

Black Market Cost: 30,000 credits

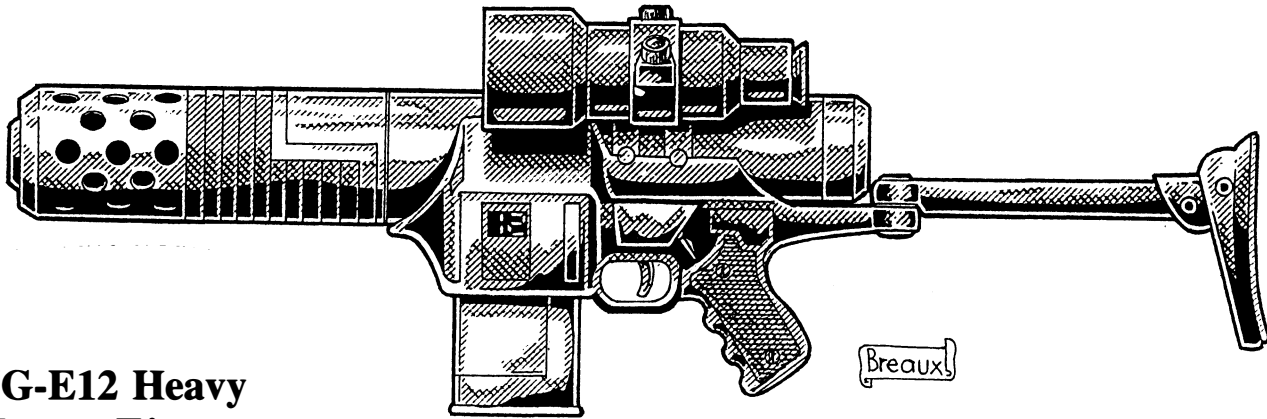

NG-E12 Heavy Plasma Ejector

This is a heavier version of the NG-E4 rifle designed as a tripod-mounted or light vehicle weapon. A secondary version, the NG-E4A, has a rifle configuration to be used by cyborgs and troops in powered armor. The weapon is too big and heavy to be used as a shoulder weapon by normal humans.

Weight: 30 lbs. using an E-Clip, 50 lbs. with a Power Pack.

Mega-Damage: 1D6 × 10 M.D.

Rate of Fire: Standard

Maximum Effective Range: 2000 feet (610 m)

Payload: 6 shots standard clip, 12 shots long E-clip, or 42 shots with Power Pack (pack weighs 20 lbs/9 kg and regenerates 4 blasts per hour; costs 80,000 credits).

Black Market Cost: 80,000 credits

NG Hand Grenades

Northern Gun produces its own line of grenades. They are cheaper, but slightly less powerful than the Coalition equivalents.

Fragmentation: 2D4 M.D. to a 20 foot (6 m) area.

High Explosive: 3D4 M.D. to a 6 foot (1.8 m) area.

Plasma: 4D6 M.D. to a 12 foot (3.6 m) area.

Smoke: No damage, but creates a smoke screen that covers a 40 foot (12 m) area.

Effective Range: When Throwing a Grenade: About 40 yards/meters.

Black Market Cost: 160 credits for fragmentation, 120 credits for high explosive, 275 credits for plasma, and 50 credits for smoke.

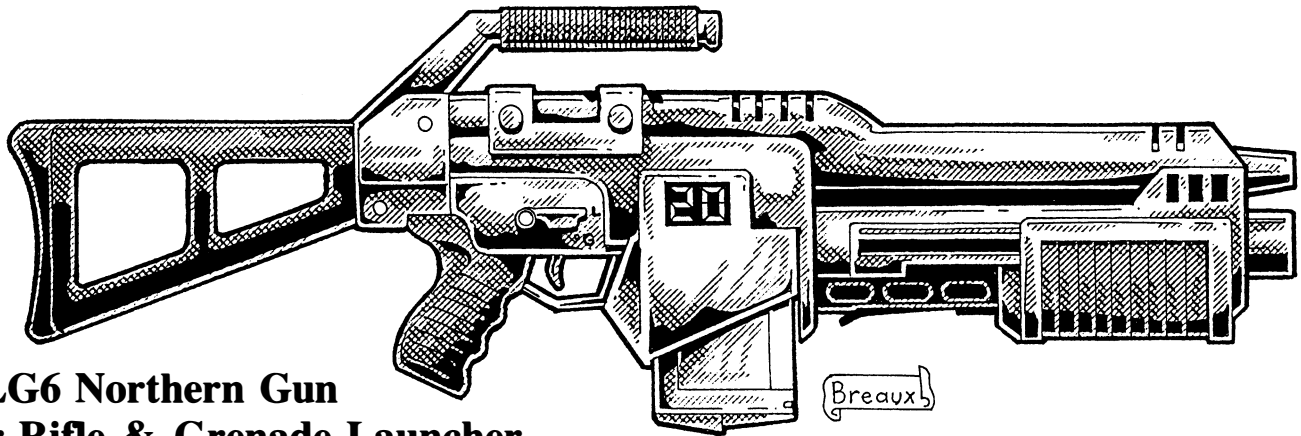

NG-LG6 Northern Gun Laser Rifle & Grenade Launcher

A grenade launching laser rifle.

Weight: 19 lbs (8.6 kg)

Mega-Damage: 3D6 M.D. per laser blast or 4D6 M.D per grenade.

Rate of Fire: Standard

Maximum Effective Range: Laser: 1600 feet (488 m). Grenade launcher 1100 feet (335 m) and a blast radius of about 12 feet (3.6 m).

Payload: Laser: 10 shots standard E-clip, or 20 shots long E-clip, or 70 shots with power pack (pack weighs 12 lbs/5.4 kg and regenerates 4 blasts per hour; costs 70,000 credits).

Grenade launcher: Four grenades (pump action). Can be reloaded in five seconds.

Black Market Cost: 20,000 credits; grenades cost 400 credits each.

Note: The introduction of the NG-LG6 rifle and increasing competition from Triax and Naruni Enterprises (among others) has caused a dramatic decrease in the price of the *NG-Super laser pistol and grenade launcher*; from 21,000 credits to 11,000 at most weapon shops.

Plastique Explosives & Others

Plastique is a wax or clay-like explosive that can be shaped like putty into a patty, block, rope or blob. It will not detonate if it is dropped, shaken, shot, blasted, or set on fire. It is detonated by an electric charge usually contained in a blasting cap. However, it can be detonated by lightning or electrokinesis. The explosion is usually contained mainly to the area where the plastique was placed, causing little shrapnel and putting the full force of the explosion on one concentrated area. Plastics are used for safecracking, sabotage and other precision explosions to blow out locks, open safes, cut girders, set off other explosives, etc. It comes in S.D.C. and M.D. types.

Commercial plastique: S.D.C. damage: 1D4 per ounce (28 grams or 1D6 × 10 per pound (0.45 kg); cost: 5 credits an ounce.

C4 (military HE) plastique: S.D.C. damage: 1D6 per ounce or 2D4 × 10 + 20 per pound (0.45 kg); cost: 8 credits an ounce.

S.D.C. Dynamite: 5D6 S.D.C. per stick; cost: 10 credits each.

M.D. Dynamite: 2D4 M.D.C. per stick; blast radius of 10 feet (3 m); cost: 130 credits each stick. Fair availability. A stick of dynamite is usually placed and detonated. It is not made for throwing. Maximum effective range throwing: 1D4 × 10 feet (1D4 × 3 m) (varies).

NG 2 M.D. plastique: M.D. damage: One point per ounce or 16 M.D. per pound (0.45 kg); cost: 20 credits an ounce or 320 credits a pound. Fair availability.

NG 4 M.D. plastique: M.D. damage: 1D4 points per ounce or 1D4 × 10 M.D. per pound (0.45 kg); cost: 40 credits an ounce or 640 credits a pound. Poor to fair availability.

NG 6 M.D. plastique: M.D. damage per ounce: 1D6 points per ounce or 2D4 × 10 + 20 M.D. per pound (0.5 kg); cost: 60 credits an ounce or 960 credits a pound. Poor to fair availability.

Blasting Cap: S.D.C. five credits or M.D.C. 40 credits

NG Mines

Northern Gun has started manufacturing some simple land mines for anti-vehicle and anti-personnel purposes.

Detecting Mines: Travelling on foot and looking for mines, the detect ambush or detect concealment skills at -10% can be used to spot land mines and booby-traps.

Vehicles can be outfitted with a basic mine detector for 50,000 credits. This unit has a 40% chance of locating mines before they are struck and detonated, but will also indicate harmless metal fragments as well (fragments must be the size of a soccer ball or bigger). The basic system can be “fine-tuned” and enhanced +10% for an additional 20,000 credits up to a maximum of 90% efficiency, but those are rare (most are at 70%). A pilot can try detect ambush or detect concealment skill rolls, but is -25% if travelling is at a crawl and -50% if traveling at over 30 mph (50 km).

NG Anti-Personnel Mines

These mines typically use fragmentary or incendiary charges designed to inflict damage to a large area, crippling troops with shrapnel or fire. Most are triggered by snapping a trip wire or responding to pressure/weight (100 lbs/45 kg or more).

Sensor Special: High-tech mines that come with special sensors that will detect a human-sized creature 6 feet (1.8 m) away, or a bot, cyborg, giant, or light vehicle up to 12 feet (3.6 m) away and detonate. The sensor types cost twice as much.

Damage: 4D6 M.D. to a 40 foot (12 m) area.

Black Market Cost: 600 credits for the standard mine, 1200 with sensor.

NG Anti-Vehicle Mines

Most have a rudimentary electronic sensor suite that can be programmed to detonate the explosives when a target of a pre-determined size comes close enough to be detected. The larger the size, the greater the detectable range. The weapons can also be triggered by a radio signal sent at a distance (ambushers can wait until the target is close enough, then detonate the explosive).

Type One: NG Light Anti-Vehicle Mines: Detects a vehicle of under 5 tons at 3 feet (one meter) away, a vehicle weighing 5-10 tons from 10 feet (3 m) away, and vehicles over 10 tons at 20 feet (6 m). People on foot only trigger it if they actually step over the mine, or if a remote controller detonates it by radio. Treat heavy creatures and humanoids weighing over 400 lbs (180 kg) as light vehicles.

Mega-Damage: Uses either a high explosive (HE), doing 5D6 M.D. to a 20 foot (6 m) area, or plasma, doing 1D4 × 10 to a 30 foot (9.1 m) area.

Black Market Cost: 1000 credits for HE, 2000 for plasma.

Type Two: Medium Anti-Vehicle Mine: As above, but does more damage.

Mega-Damage: HE explosion does 1D6 × 10 M.D. and the plasma inflicts 2D4 × 10 M.D. (area and detection range remain unchanged).

Black Market Cost: 3000 credits for HE, 4000 for Plasma.

Type Three: Heavy Anti-Vehicle Mine: As above, but even greater damage.

Mega-Damage: HE explosion inflicts 2D6 × 10 M.D. and the plasma does 3D6 × 10 M.D.; both with a blast area of 70 feet (21 m)

Black Market Cost 6000 credits for HE, 8000 for Plasma.

NG-S2 Basic Survival Pack

A very popular item among adventurers and other travelers, the NG-S2 survival pack contains all the basic things someone travelling through the wilderness could need. Cost: 3000 credits.

- Two-person tent: Folded, it's the size of a paperback book. Unfolded it can sleep two people comfortably. Offers protection against the cold and rain — insulates and keeps people inside relatively warm at temperatures up to -40 degrees Fahrenheit (-40 Centigrade). The tent has a water collection system to help the user(s) survive in desert climates as well. The tent collects all moisture that evaporates from the occupants, basically increasing any water supplies the user carries by 20% — with the tent, eight days of water will last ten days.
- A sleeping bag.
- Flashlight with a concealed pocket knife and 6 batteries (each battery has a life of 48 hours of continuous use).
- Compass/inertial mapper; lets you know how far you've travelled and in which direction(s): +10% to land navigation rolls. The compass has a mirror finish on one side and can use the sun to signal others or send Morse-code messages.
- Short-range radio: 5 mile (8 km) range.
- Mini-First-Aid Kit (1): A roll of gauze, 48 band-aids (different sizes), roll of medical tape, pair of small scissors, pocket knife, and a tube of protein healing salve.
- Hunting and fishing kit: Wires, fishing line and several hooks and pulleys, useful both for fishing and setting snares for small game.
- Saw-Wires (3): A serrated, ultra-hard wire with two ring handles, able to cut through wood, stone and even S.D.C. metals. Does most of the chores of an axe, but with less time and effort.
- Fire Starter (1): A pocket cigarette lighter and a flint sparker with 6 extra flints (good for starting hundreds of fires).
- Survival Knife, a small hatchet, and a wooden cross.
- Four signal flares.
- 30 feet of lightweight climbing cord, a pair of climbing gloves, four ceramic spikes and a small mallet.
- Bar of soap and a washcloth.
- Canteen and a food rations bag.

NG-EX10 Gladius Light Exo-Skeleton Battle Armor

This new Northern Gun suit tries to close the gap between common environmental body armor and power armor. The Gladius is cheap and reliable. Instead of a nuclear power pack (the most expensive part of any suit), it uses a rechargeable battery. The battery can be recharged by any vehicle or facility with a nuclear power plant or other generator (it takes 2 hours to recharge), and it lasts for 96 hours of continuous use (4-12 days, depending on how often the suit is used).

The Gladius cannot use any weapons that draw power from the suit (it would drain the battery in minutes), it cannot fly, and it cannot

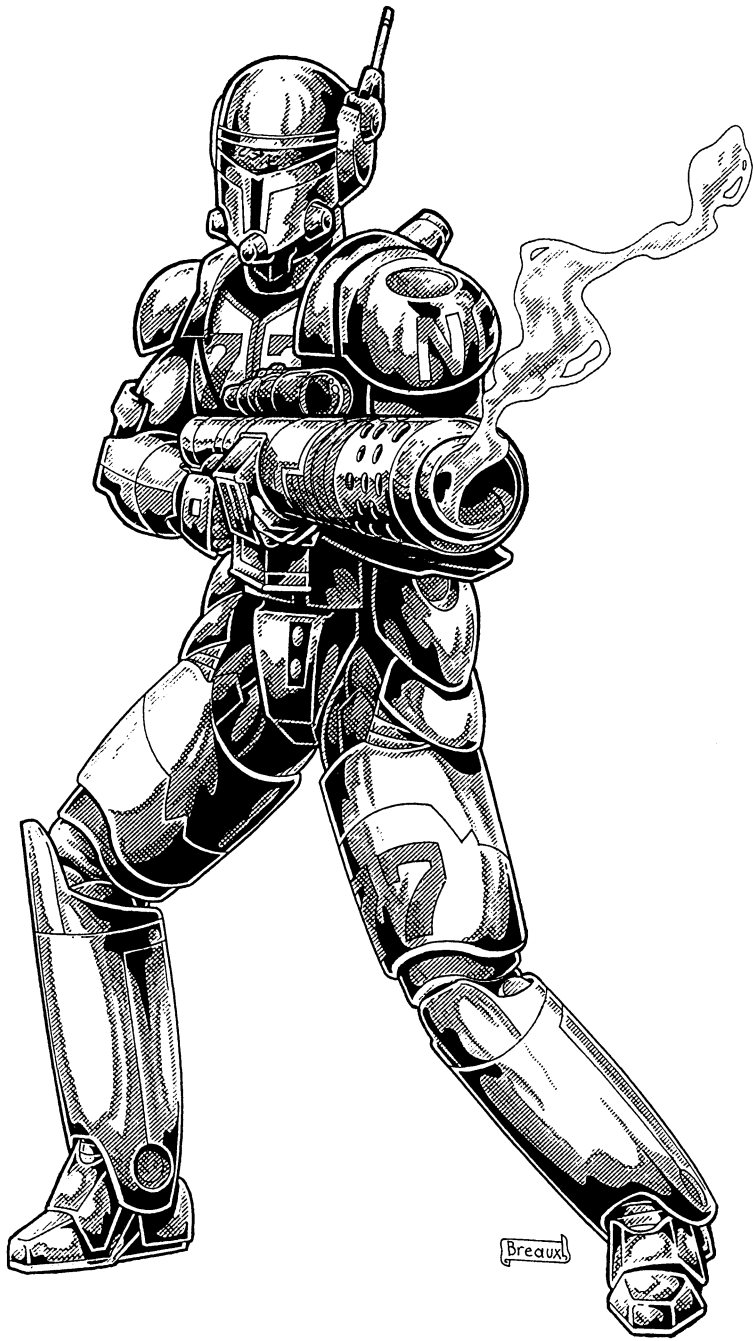

outrun most vehicles, but it provides much more protection and carrying capacity than a non-powered suit of conventional body armor.

The Gladius has just been offered for sale on the Black Market and in free cities. It is believed this model may have been produced to compete with the Chipwell armor line (see below), which is of very poor quality but has an unbeatable price.

Model Type: NG-EX10

Class: Armored Infantry Light Exo-Skeleton

M.D.C.: The suit offers 180 M.D.C. to the entire body (for damage purposes, treat it like a suit of non-power environmental armor).

Speed: Running: 40 mph (64 km) maximum. Note that the act of running does tire the user, but at 30% the usual fatigue rate, thanks to the exo-skeleton.

Statistical Data:

Height: +4 inches (0.10 m) taller than the wearer (adjustable to fit anybody between 5 feet, 6 inches/1.68 m and 6 feet, 10 inches/2.08 m.

Width: Variable

Length: Variable

Weight: 80 lbs (36 kg)

Physical Strength: Equal to a P.S. 20

Cargo: None

Power System: Electrical Battery (96 hours of continual use).

Black Market Cost: 150,000 credits

Weapon Systems: None. The wearer must use hand weapons, including most rifles and light rail guns suitable for use by cyborgs or power armor, as long as it has an independent power supply.

Hand to Hand Combat: Rather than use a weapon, the pilot can engage in mega-damage hand to hand combat.

Normal Punch: 1D4 M.D.

Power Punch: 2D4 M.D., but counts as two melee actions.

Kick: 1D6 M.D.

Leap Kick: 2D6 M.D., but counts as two melee actions.

Bonuses: +1 on initiative and +1 attack per melee.

Wellington Industries

Wellington Industries (W.I.) operates from the city of Wellington, a semi-independent manufacturing city-state in the Manistique Imperium. The company was founded when a group of archaeologists discovered a pre-rifts weapon manufacturing complex, complete with blueprints for several experimental weapon systems. Over the last two years, the city has enjoyed an economic boom, producing advanced weaponry sold both to the Imperium's army, Golden Age Weaponsmiths, mercenaries and several small kingdoms. Currently, a team of W.I. sales agents is engaged in talks with the Lazlo Congress of the Electorate. The company is offering to supply Lazlo's militia with Wellington's armaments.

W.I.'s move has angered Northern Gun who already supplies weapons to Lazlo and most non-Coalition nations. Ishpeming, which has always had a friendly relationship with the Manistique Imperium feels betrayed by their entering into arms manufacturing. Actually, Northern Gun, who has dominated the market for decades, is feeling incredible pressure by the sudden appearance of several new arms dealers in just the last five years. Their friendly neighbor becoming a friendly competitor has frustrated Northern Gun. Adding to their frustration was Wellington Industries' polite refusal to sell Northern Gun its new weapon secrets (although they have signed a trade agreement that gives each other favored status and wholesale rates). All and all, the competition between the weapons dealers is beginning to turn ugly.

Besides the weapons described below, W.I. manufactures normal vehicles, farm equipment and bulldozers. The company has also been dealing with Golden Age Weaponsmiths for several years now. W.I. does not have the resources to get into the robotics market and is likely to limit its manufacturing to weapons and weapon systems for vehicles. This has helped to placate Northern Gun.

Other weapons produced by the corporation include the WI-15 and WI-20, a laser rifle and pistol nearly identical to the NG-33 and NG-L5, respectively (use the same stats and price).

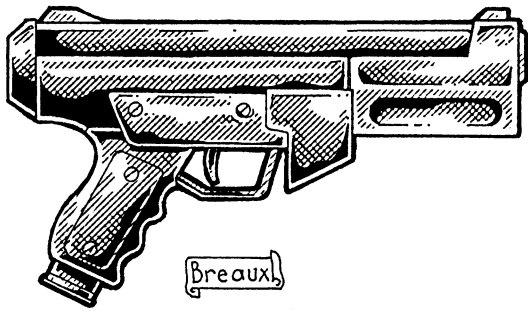

MP-10 Caseless Pistol (S.D.C.)

The "MP" line fires 10 mm caseless rounds. These bullets have no metal casing to hold the chemical propellants that fire them. Instead, the propellant is made up of a solid chemical that is completely consumed by combustion. This eliminates the need for an ejection port (which helps keep the gun clean) and allows for a greater number of bullets to be stored in a magazine. These bullets also do a little more damage than old-style rounds. The gun can be fired on semi-automatic or full auto settings.

Weight: 2 lbs (0.9 kg)

Cartridge: 10 mm caseless

Damage: Standard rounds: 3D6 S.D.C. for a single shot, 1D6 × 10 S.D.C. for a burst of 10 rounds. Depleted Uranium Armor Piercing Bullets: 4D6 S.D.C. for a single shot, 2D4 × 10 S.D.C. for a 10 round burst.

Effective Range: 1200 ft (365 m)

Payload: 20 or 30 round magazine

Cost: 2,500 for the pistol, 30 credits for a box of 50 standard cartridges (excellent availability) or 100 credits for a box of depleted uranium rounds.

WI-10 Ramjet Rounds

Ramjets are specially-designed cartridges with a hollow, ultra-hard casing filled with jet fuel. When it is fired, the air rushing into the speeding bullet burns with the jet fuel, propelling the round at supersonic speeds comparable to those of a rail gun round! The bullet is made of super-hard alloys, giving it enough penetration to damage M.D.C. armor. The rounds are outlawed in the Coalition States, banned as "cop-killing" bullets. Some mercenary outfits use them, because the bullets transform cheap S.D.C. weapons into mega-damage capable firearms.

Damage: Against mega-damage targets, ramjets inflict 1 M.D. point. "Soft" S.D.C. targets take 3D6 × 10 S.D.C. A burst from an automatic weapon (like an Ingram or an assault rifle) is 20 rounds and inflicts 2D4 M.D.

Limitations: Available only for .45, 9 mm, 10 mm, and 7.62 mm calibers.

Black Market Cost: 5 to 10 credits per round, depending on supply, demand and the seller. So a box of 100 will cost 500 to 1000 credits.

Ramjets are very scarce and expensive; only a half dozen places produce them.

MP-23A Caseless SMG

This is a sub-machinegun version of the MP-10, that fires the same caliber bullet but has a greater payload and rate of fire. The longer barrel gives the gun more damage and range. With depleted uranium armor-piercing rounds, it can inflict mega-damage!

Weight: 3 lbs (1.4 kg)

Cartridge: 10 mm caseless

Damage: Standard rounds: 4D6 S.D.C. for a single shot, 2D6 × 10 S.D.C. for a burst of 20 rounds. Depleted Uranium Armor Piercing Bullets: 5D6 + 5 S.D.C. for a single shot, or 3D6 × 10 S.D.C./1 M.D. point for a 20 round burst.

Effective Range: 1800 ft (548.6 m)

Payload: 100 round magazine

Cost: 4,500 for the sub-machinegun, 30 credits for a box of 50 standard cartridges (excellent availability) or 100 credits for a box of depleted uranium rounds.

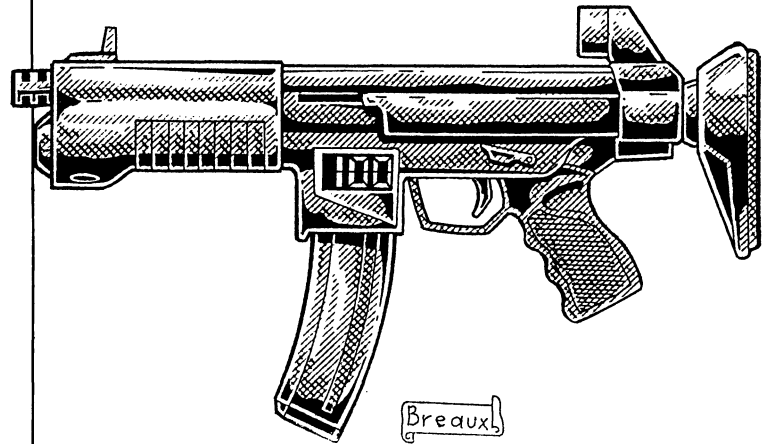

WI-2E Explosive Rounds

Explosive rounds are an attempt to increase the damage capabilities of normal slug-throwers. In a time when many animals and creatures are M.D.C. creatures, many designers are trying to come up with ways to "beef up" the destructive potential of normal S.D.C. guns. Explosive and ramjet bullets (see below) are two ways to achieve this. They use new explosives and materials to create more effective cartridges.

Damage: An explosive bullet inflicts triple normal damage, so a 9 mm explosive bullet does 6D6 S.D.C. and a 5.56 mm rifle bullet will inflict 2D4 × 10 S.D.C. This increased damage means automatic weapons can inflict mega-damage with bursts. A sub-machinegun will inflict 1D4 M.D., an assault rifle 1D6 M.D., and a heavy machinegun: 2D6 M.D. per burst of 20 rounds!

Black Market Cost: 2 credits per explosive pistol bullet, 4 credits for each rifle cartridge, and 6 for each heavy machine-gun round. Fair availability.

WI-20 Heavy Ramjet Rounds

Limitations: These cartridges are built for the 14.5 mm and .50 caliber machineguns.

Damage: 1D4 M.D. per single round. A burst is 40 rounds and inflicts 5D6 M.D.

Black Market Cost: 10 to 15 credits per round (to fill a belt of 200 rounds will cost 2,000 to 3000 credits).

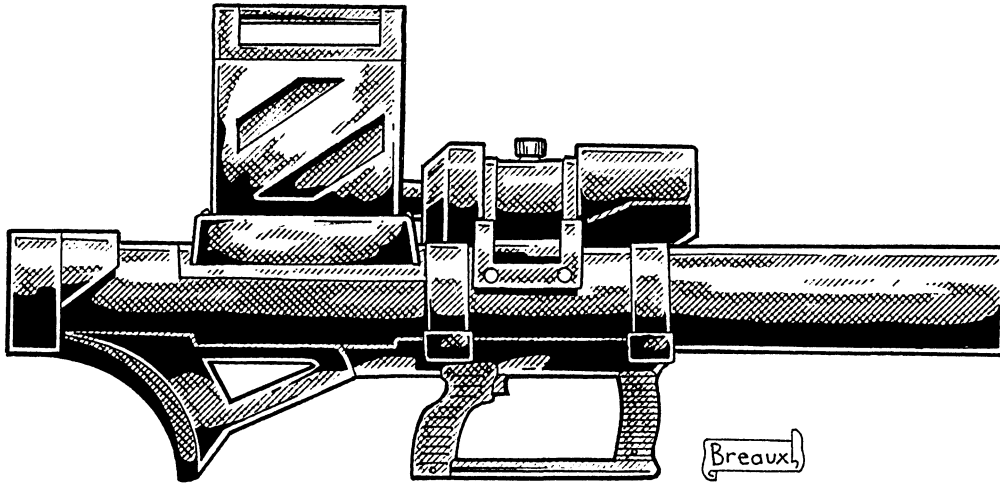

WI-23 Missile Launcher

This weapon is a clear improvement over the CR-1 Rocket Launcher and other similar anti-vehicle weapons. The WI-23 is an auto-loading launcher with a six-shot box magazine mounted on the right side of the tube. This allows the user to fire repeatedly without having to rely on a loader. The multi-optics scope is a copy of the CR-1 system, thinly disguised to avoid accusations of patent violations (which are fairly unimportant anyway, since there are few commercial treaties between the CS and other nations).

Weight: A fully loaded launcher weighs 26 lbs (11.7 kg), including its

payload of 6 missiles. Each box magazine weighs 12 lbs (5.4 kg) fully loaded.

Mega-Damage: Any type of mini-missile can be used, but the most common are armor piercing and plasma (1D4 × 10 or 1D6 × 10 M.D.).

Rate of Fire: Equal to the user's number of attacks per melee (maximum 6); reloading the magazine takes three melee actions if using a box magazine, or one full melee round if reloading loose missiles.

Effective Range: 1 mile (1.6 km)

Payload: Six missiles per magazine.

Black Market Cost: 30,000 for one launcher and one magazine, 4,000 for each additional magazine, not counting missile costs.

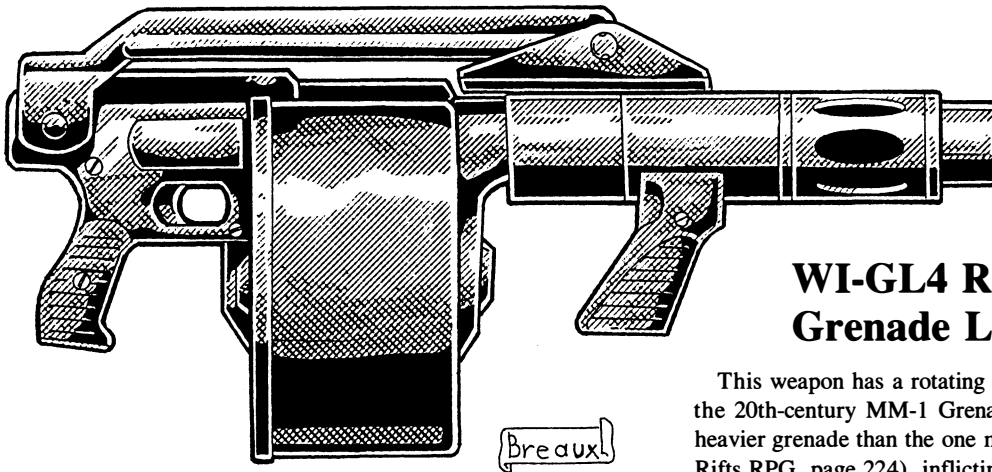

WI-GL4 Revolving Grenade Launcher

This weapon has a rotating drum that holds 24 grenades, similar to the 20th-century MM-1 Grenade Launcher! The GL4 uses a slightly heavier grenade than the one made for the NG-Super Laser Pistol (see Rifts RPG, page 224), inflicting more damage over a wider area. This is a heavy and bulky weapon (-1 to strike if P.S. is below 20), but it is also very intimidating, with a thick, wide barrel poking over the rotating drum of grenade tubes.

Weight: 20 lbs (9 kg)

Mega-Damage: Fragmentary: 4D6 M.D. to a blast area of 12 feet (3.6 m). Armor-Piercing: 1D4 × 10 M.D. to a blast area of 3 feet (0.9 m). Can also fire smoke, illumination and chemical rounds.

Rate of Fire: As many as hand to hand attacks per melee. Reloading the tubes takes two full melee rounds.

Maximum Effective Range: 1000 feet (305 m)

Payload: 24 rounds!

Black Market Cost: 50,000 credits; fair availability.

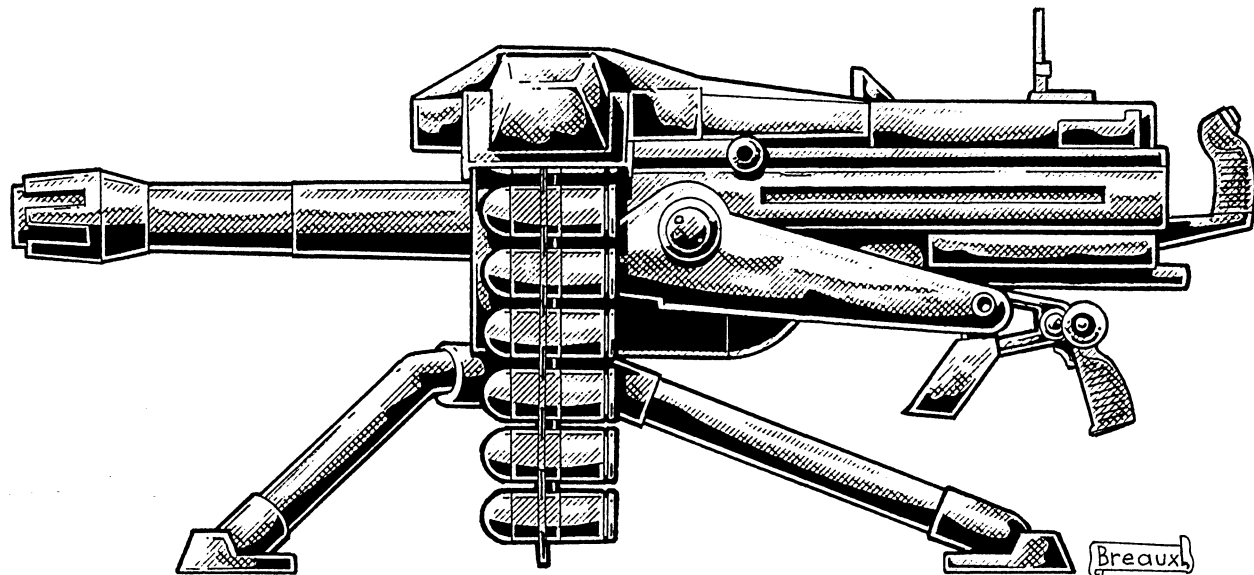

WI-GL20 Automatic Grenade Launcher

This weapon resembles a bulky machinegun that fires grenades from either a magazine or a disintegrating belt. It is designed as a tripod, crew-serviced infantry weapon, or as a vehicle or turret-mounted weapon.

Note: A "rifle" model, the WI-GL21, is made for use with power armor and cyborg soldiers and is fundamentally the same as the GL20, except that the user must have a P.S. 22 or higher, is -1 to strike and the rifle model cannot use the ammo-belt fed system.

Weight: 130 lbs/58 kg (150 lbs/68 kg with an ammo belt).

Mega-Damage: Fragmentary: 4D6 M.D. to a blast area of 12 feet (3.6 m). Armor-Piercing: 1D4 × 10 M.D. to a blast area of 3 feet (0.9 m).

A burst is 10 rounds! A burst of fragmentary grenades inflicts 2D6 × 10 M.D. with a blast area of 40 feet (12 m)! A burst of Armor-Piercing grenades does 3D6 × 10 M.D. with an 8 foot (2.4 m) blast radius.

Rate of Fire: Standard.

Maximum Effective Range: 3000 feet (914 m).

Payload: 40 round magazine or 200 round belt!

Black Market Cost: 150,000 credits; poor availability.

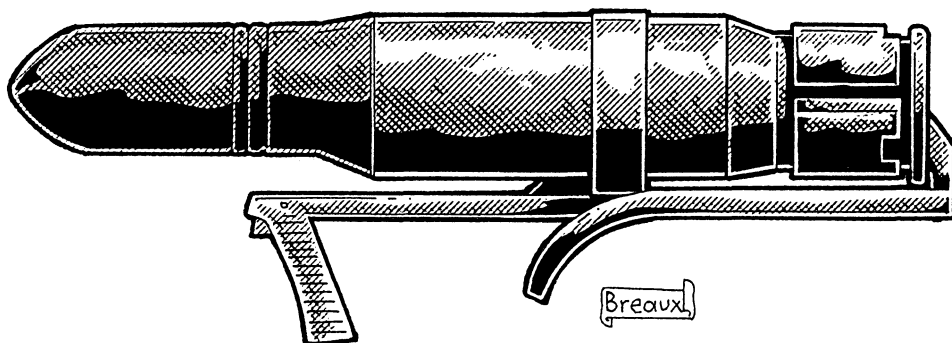

WI-40M Fire & Forget Super-Heavy Missile Launcher

The WI-40M provides the firepower of a tank (for one melee round) and is advertised as "the heaviest man-portable missile launcher in the world." That's partially true. It is man-portable for anyone who can lug its 120 lbs (54 kg) of missile and crude, disposable launch trigger. This means the operator must be a creature with a P.S. of 24 or greater, otherwise it will require two or three men to transport it.

The WI-40M is basically a medium-range missile with a plastic launching platform that has a handle and big trigger (big enough for the hand of most powered armor suits and giants). Once the missile is fired, the launching platform is ruined and discarded (the plastic has a

recycle value of 2D4 × 10 credits). The exhaust of the rocket also inflicts 1D6 × 10 S.D.C. to anything within 15 feet of the shooter; it won't affect characters in M.D.C. armor, but will ignite brush fires or explode any fuels and other volatile flammables nearby. Despite those shortcomings, it is a new favorite of power armor pilots and borgs.

Weight: The missile system weighs 120 lbs (54 kg) and is six feet (1.8 m) long.

Mega-Damage: Any medium-range missile can be used. It is usually Armor-Piercing (2D4 × 10 M.D.), Fragmentation (2D4 × 10 M.D.) or Plasma/Heat (2D6 × 10 M.D.).

Rate of Fire: One-shot weapon

Effective Range: 10 miles (16 km). The missile has less fuel than a vehicle-mounted medium-range missile.

Payload: One. A missile box containing four missiles and weighing 520 lbs (234 kg) is available. Taking a missile out of its box and aiming it usually counts as two melee actions/attacks.

Black Market Cost: The firing unit costs 25,000 credits. Missiles cost: 5,000 credits for a High Explosive (light), 8,000 for a High Explosive (medium), and 10,000 for a High Explosive (heavy). Fragmentation, Armor Piercing, and Plasma/Heat missiles cost 12,000 credits. Poor to fair availability.

Wellington Land Mines

Sensor Controlled Anti-Vehicle Weapon Systems (SAWS)

Wellington Industries has developed its own series of land mines. Their standard line is identical to Northern Gun's (described previously), but they've also released a more sophisticated, pre-Rifts, anti-vehicle mine. This so-called mine is a sensor suite (radar, laser, seismic, thermographic all patched into a targeting computer) mated with a missile launcher. The sensors detect and identify vehicles from as far away as a mile (1.6 km) or is an enemy fires at it, and responds with the missile launcher "popping up" from its concealed position. Alternately, the mines can be operated by a human and controlled via remote control radio. The gunner doesn't have to be near the weapon, so he can remain hidden and relatively safe as he designates targets for the missiles.

The targeting computer can be programmed to recognize friendly vehicles and fire only upon enemy targets. The recognition program of this "smart bomb" can be limited even further to fire only upon specific enemy targets. The spectrum of targets can be incredibly broad (any moving object larger than a motorcycle) or narrow (a CS UAR-1 only). The sensors can also be programmed to sweep a specific area and not pay attention to the rest of the sector.

The SAWS has a 87% accuracy rating, but if damaged, the unit's reliability drops to 43%. If multiple targets appear and there is only one SAWS, the device will pick one (usually the most dangerous — choosing from a priority list) and attack. Multiple SAWS can be radio linked so their computers can work in concert, each firing at a different target or one can fire while the others wait.

There are three types of SAWS: Light, Medium and Heavy. All are reusable; after it fires it can be moved to a new location (or leave it where it is), reload, reset, and leave.

Light SAWS (mini-missiles): This system consists of 3 mini-missiles in a two-tube launcher inside a square box, which also contains the sensors. The box is buried by the side of a road, in a clearing or other inconspicuous location. Laser and radar sensors can detect a vehicle as far away as one mile (1.6 km), but the effective range is often less than that due to terrain (the sensors cannot read through a hill, buildings, or dense forest, for example).

Note: The light SAWS has 20 M.D.C. and can be reused.

Combat Bonuses: The missiles are +3 to strike. Even when remotely controlled; do not add the operator's combat bonuses.

Mega-Damage: Varies with missile type. Usually armor piercing (1D4 × 10 M.D.) or plasma (1D6 × 10 M.D.).

Maximum Effective Range: 4000 feet/1200 m, (due to sensor limitations).

Rate of Fire: One at a time, or in volleys of two or four missiles.

Payload: Six total mini-missiles; three in each launcher.

Black Market Cost: 30,000 plus missile cost (about 3000 each).

Medium SAWS: Works like the light model, but it uses two medium-range missiles and has a longer range (6000 feet/1828 m). These SAWS are often placed on top of hills or mountains, where they have a good field of fire.

Note: The Medium SAWS has 35 M.D.C.

Combat Bonuses: The missiles are +5 to strike. Even when remotely controlled; do not add the operator's combat bonuses.

Mega-Damage: Any kind of medium-range missiles. Usually armor piercing (2D4 × 10 M.D.) or plasma (2D6 × 10 M.D.).

Maximum Effective Range: 6000 ft (1828 m) when set on automatic due to sensor limitations, or average 40 to 50 miles (64 to 80 km) when controlled by a human operator equipped with long-range radar.

Rate of Fire: Volley of two missiles

Payload: Two medium-range missiles

Black Market Cost: 50,000 plus missile cost (about 15,000 each).

Heavy SAWS: This system has the same sensor suite as the Medium SAWS, but it is large enough to accommodate two long-range missiles. The Heavy SAWS is well-armored (55 M.D.C.). The SAWS are often used to defend national borders by some wealthy kingdoms. The sensors will only attack large vehicles or animals (5 tons or greater, unless the sensors are reprogrammed).

Note: The Heavy SAWS has 55 M.D.C.

Combat Bonuses: The typical missile is +5 to strike, even when remotely controlled; do not add the operator's combat bonuses. Smart bombs are +7 to strike!

Damage: Any kind of long-range missile. Usually plasma/heat (3D6 × 10 M.D.) or proton torpedo (4D6 × 10 M.D.).

Maximum Effective Range: 6000 ft (1828 m) when sent on automatic due to sensor limitations, or 500 miles (804 km) when controlled by a human operator equipped with long-range radar.

Rate of Fire: Volley of two missiles.

Payload: Two long-range missiles.

Black Market Cost: 65,000 plus missile cost (about 25,000 each).

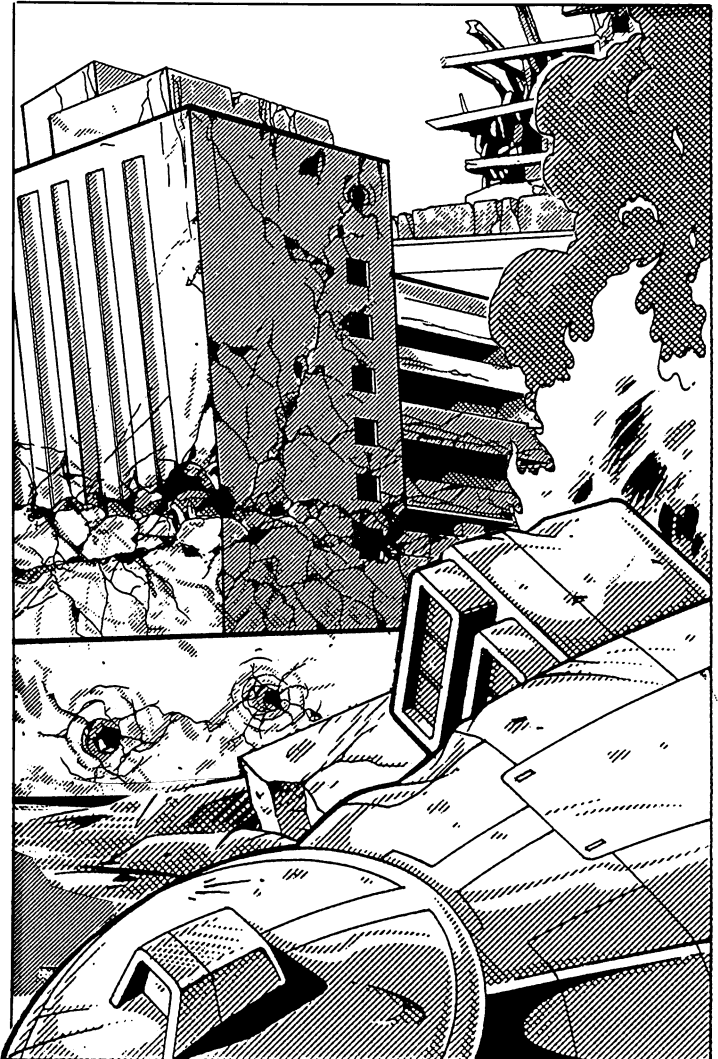

Iron Heart Armaments, Inc.

Iron Heart Armaments is a weapons producer specializing in non-robotic vehicles. The corporation was founded by a group of researchers from the Coalition State of Iron Heart. These researchers took a number of weapon designs unearthed from the ruins of Sudbury (see **Rifts RPG**, page 149) and left the Coalition to go into business on their own. Iron Heart Armaments is located outside the Coalition States at **New Kenora**, built on the ruins of the old city at the northeastern edge of the Lake of the Woods. About 80 miles (128 km) to the east are the ruins of **Dryden**. This city state had prospered after the Great Cataclysm, but fell first to D-bee invaders and more recently, to the xiticix (a small hive is located there).

Whether the owners use the name of their homeland as an insult or praise is not known. Although the Coalition has officially branded the owners of Iron Heart as "traitors," some of the States do business with the corporation. Iron Heart Armaments' initial problem was getting started. They held in their hands the blueprints for pre-Rifts mega-damage tanks and weapons, but had no means of producing them. That's where New Kenora, a city of 32,000 people (70% human) with a good industrial foundation came in. The small community had dreams of becoming a major force in North America, but had three major problems. They were far removed from most other civilized places, there is the threat of the xiticix encroaching on their territory, and they have a low tech-level only roughly equal to 20th Century Earth, circa 1965. These factors kept the community from growing at its full potential. Desperate to make a mark for themselves and build a better defense against the xiticix and other D-bee threats, the city counsel quickly agreed to a manufacturing partnership with the folks from Iron Heart Armaments. Within seven months, several factories had been retooled to produce the new mega-damage weapons. Four months later the first tank rolled off the production line. The vehicles have proven to be everything they hoped for and were an instant hit!

Iron Heart Armaments' greatest weakness continues to be its lack of sophisticated computer and manufacturing facilities. Their factories cannot produce the advanced micro-circuitry, nano-technology and nuclear power supplies needed for robots and powered armor. That's why the corporation has focused on building tanks, aircraft and ships which can be manufactured with comparatively low technology and resources.

The tanks and armored vehicles created by Iron Heart Armaments fill a niche in the market that few other manufacturers have shown an interest in. It would seem that niche market is bigger than anybody thought and Iron Heart Armaments is reaping the reward. Sales representatives are currently in Tolkeen, negotiating the sale of several hundred Iron Fist and Iron Hammer tanks. Larsen's Army and other mercenaries have also shown great interest in these products. This has made New Kenora a boom town overnight. The population has grown from 32,000 to nearly 50,000 in less than a year and two new (more advanced) factories are under construction.

A note about Xiticix: Although xiticix scouts and scavengers have occasionally been spotted in the old province of southwestern Ontario and a tiny hive has been built at Dryden, the creatures are not common to the area. Paranoia about the monsters invading and destroying New Kenora abounds among the human population, but is greatly overexaggerated. The xiticix build their hive communities in dry areas such as forests, scrublands and plains; the wetlands of southwestern Ontario are extremely unappealing. The Dryden hive, although built in a dry, wooded area, is an oddity because it is surrounded by wetlands and hundreds of lakes and ponds. In fact, it is very likely that this is a hive of renegades who specifically sought a place away from their brothers.

Iron Hammer Main Battle Tank

This is the heaviest armored vehicle in the Iron Heart fleet. A powerful, rugged, tracked tank, the Iron Hammer can slug it out with a heavy robot or dragon, although it cannot match them in speed and maneuverability. On the other hand, for the price of one giant robot, one can purchase a half dozen Iron Hammers with gasoline engines.

Model Type: IH-1B

Class: Main Battle Tank

Crew: Four: One driver, two gunners, one commander. No room for passengers, although one human could probably be squeezed in.

M.D.C. by Location:

Cupola on Turret — 100

Rail gun on Cupola — 75

Main Turret — 300

200mm Auto-Cannon — 170

Side Mini-Missile Launchers (2) — 40 each

Front Rail gun — 50

Front Vulcan Laser Turret — 75

** Main Body — 650

*Track Treads (2) — 120 each

** Depleting the M.D.C. from the main body will shut the tank down completely, rendering it useless.

* Depleting the M.D.C. of a tread will immobilize the tank until it is replaced. Replacing a tread will take 1D6 × 10 minutes by a trained crew (2 replacements are carried on board) or three times as long by the inexperienced. Changing the tread is only possible when the vehicle is not under attack.

Speed: 60 mph (96 km) on land. Buttoned up, it can travel under water at 20 mph (32 km).

Maximum Effective Range: 600 miles (960 km) with a full tank of gasoline or via electric motor, before needing refueling; unlimited if nuclear (10 year life).

Statistical Data:

Height: 20 feet (6 m)

Width: 12 feet (3.6 m)

Length: 35 feet (10.7 m)

Weight: 65 tons fully loaded

Cargo: Minimal storage space; about four feet (1.2 m) for extra clothing, weapons, and personal items. Four Wilk's 447 laser rifles and three WI-23 Missile launchers with 5 loads each are stored in a compartment behind the driver's seat.

Power System: Gasoline, electric or nuclear.

Black Market Cost: 4 million with gasoline engine, 6 million for an electric motor, 35 million with a nuclear engine (lifetime of 10 years). Missiles cost extra (about 15,000 credits each for medium range).

Weapon Systems

- 200mm IH-B Auto-cannon (1):** This is the Iron Hammer's main gun. The cannon has a variety of loads, including high explosive (HE), high explosive anti-tank (HEAT), armor-piercing explosive (AP), and armor piercing, sabot-discarding solids (APSD). The APSD round consists of a metal dart that flies at enormous speeds towards the target: it is not as fast as a rail gun, but makes up for it with the greater mass of the slug.

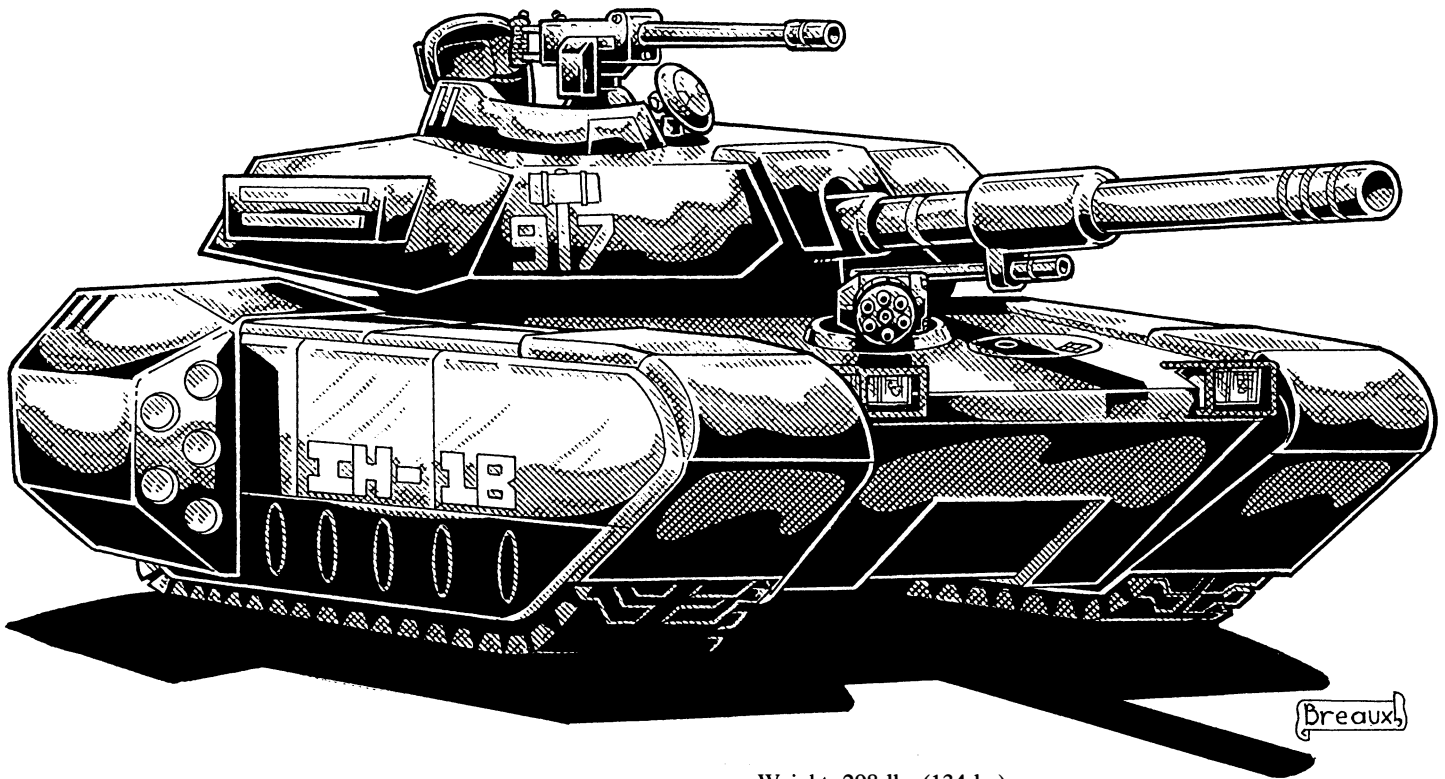

Since the cannon is built into a turret, it can rotate 360-degrees and can aim upwards 60 degrees — allowing it to engage low-flying aircraft/creatures. The cannon is controlled by a gunner inside the turret compartment.

Primary Purpose: Assault; anti-tank, anti-robot, and anti-dragon.

Secondary Purpose: Defense and anti-aircraft

Weight: 3 tons

Mega-Damage: High-Explosive (HE): 2D6 × 10 M.D. with a blast radius of 30 ft (9 m), High-Explosive Anti-Tank (HEAT): 3D6 × 10 M.D. with a blast radius of 12 ft (3.6 m). Armor Piercing (AP): 1D6 × 10 M.D. and APSD: 2D6 × 10 M.D.; neither have a blast radius.

Rate of Fire: 2 per melee round.

Effective Range: 6000 feet (1824 m) for all rounds.

Payload: The tank can carry up to 80 rounds. The standard distribution is 20 rounds of each type, but that can be altered to suit the mission.

2. IH-100 Rail Gun (1): This gun is a copy of Northern Gun's NG-202, modified for a higher rate of fire. It is located in the cupola (mini-turret) over the main turret, and has a 360-degree rotation of fire and can elevate 90 degrees to engage aerial targets. The tank commander, the gunner, or the driver can access and use the rail gun.

Primary Purpose: Anti-aircraft and anti-vehicle.

Secondary Purpose: Defense: anti-personnel.

Weight: 300 lbs (135 kg)

Mega-Damage: A burst is 60 rounds and inflicts 1D6 × 10 M.D. One round does 1D4 M.D.

Rate of Fire: Equal to number of combined hand to hand attacks (usually 4-6) of the gunner.

Effective Range: 4000 feet (1200 m)

Payload: 12,000 round drum, that's 200 bursts! Up to five drums can be carried by the tank. Reloading the drum takes 15 minutes if done by hand, 5 minutes if done with robots and special equipment.

3. IH-105 Rail Gun (1): This light rail gun is another copy of the NG-202, with a normal rate of fire. The gun is right under the tank's main gun and shoots at the same target. It is intended to shoot infantrymen not worth spending a cannon round to kill.

Primary Purpose: Anti-personnel and anti-vehicle.

Secondary Purpose: Defense

Weight: 298 lbs (134 kg)

Mega-Damage: A Burst is 40 rounds and inflicts 1D4 × 10 M.D.; one round does 1D4 M.D.

Rate of Fire: Equal to number of combined hand to hand attacks (usually 4-6) of the gunner.

Effective Range: 4000 ft (1200 m)

Payload: 8,000 round box in the turret; that's 200 bursts!

4. IH-44L Vulcan Laser (1): This weapon is a secondary turret mounted on the bow of the tank and is operated by the driver or the tank commander. The weapon consists of six rotating laser cannons, cycling through bursts of six blasts per second! In vehicles without nuclear engines, the laser is powered through a battery.

Primary Purpose: Anti-Vehicle, Anti-Robot, and Anti-Dragon/monster

Secondary Purpose: Defense

Weight: 1200 lbs (540 kg)

Mega-Damage: 3D4 × 10 M.D. per instantaneous burst (counts as one blast/attack).

Rate of Fire: Can shoot up to six times per melee!

Effective Range: 4000 feet (1200 m)

Payload: Battery is good for 500 bursts. Unlimited if vehicle has a nuclear engine.

5. Medium-Range Missile Launchers (2): Two side-mounted missile launchers complete the Iron Hammer's armaments. Both launchers are usually controlled by a gunner, but can be fired by the driver or tank commander if the gunner is injured. They are usually outfitted with High-Explosive, Fragmentary or Plasma missiles. The launchers can rotate up or down 180 degrees, allowing them to engage air and ground targets. Field experience has shown that enthusiastic tank crews usually fire all 10 missiles within minutes of entering combat; a new model with a missile magazine and auto-loading capabilities is being developed.

Primary Purpose: Anti-Aircraft and Anti-Vehicle.

Secondary Purpose: Defense

Mega-Damage: Medium-range missiles of any type.

Rate of Fire: One at a time, or in volleys of two or four.

Effective Range: About 40 miles (64 km).

Payload: Ten missiles, five in each launcher. Reloading each launcher

takes five to ten minutes for an experienced crew, or as much as half an hour otherwise.

Note: All Iron Heart Armaments' tanks have a short-range radar (5 miles/8 km), laser targeting (+1 to strike), combat computer (+1 to strike), long-range and short-range radio, loudspeaker, radiation detector, light radiation shielding, and an environmental crew compartment with air-conditioning, heating, oxygen supply and an air purging, purification and circulation system.

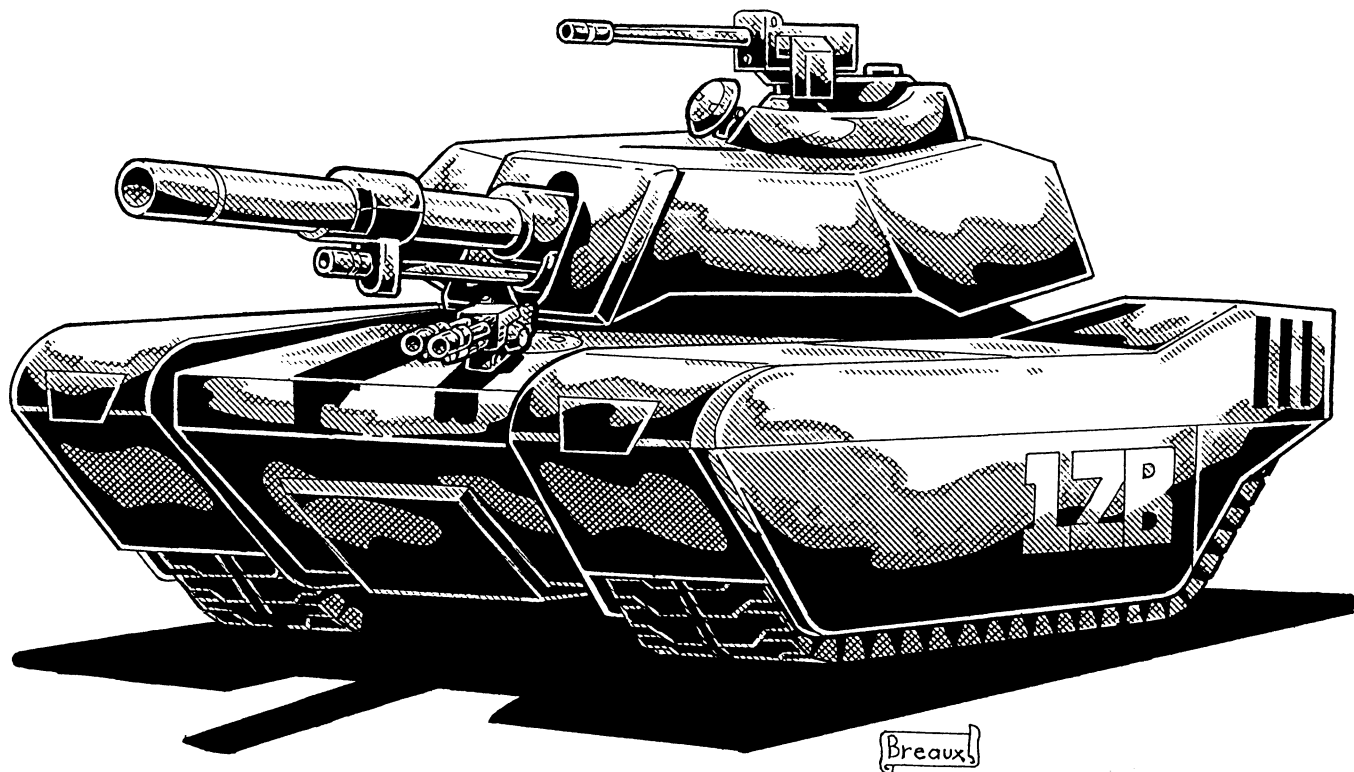

Iron Fist Medium Tank

The Iron Fist medium tank is slower than most robot vehicles, but wields decent firepower and is well protected. Its main weakness lies in its tread — they can be destroyed relatively easily, immobilizing the tank. 80% of all Iron Fist tanks use gasoline or electric motors. A few have been outfitted with nuclear engines, for sale to mercenary companies that want the vehicles with unlimited range.

Model Type: IH-12B

Class: Assault Tank

Crew: Three: one driver, a gunner, and a commander. Can accommodate two passengers in a snug area behind the crew.

M.D.C. by Location:

Cupola on Turret — 75

Rail Gun on Cupola — 60

Turret — 200

Reinforced Crew Compartment in the Turret — 50

120mm Auto-Cannon — 120

Co-Axial Rail Gun — 25

Forward-mounted Laser — 25

Smoke/Gas Dispensers (2) — 15 each

** Main Body — 450

Reinforced Crew Compartment (main body) — 100

*Track Treads (2) — 90 each

** Depleting the M.D.C. from the main body will shut the tank down completely, rendering it useless.

*Depleting the M.D.C. of a tread will immobilize the tank until it is replaced. Replacing a tread will take 1D6 × 10 minutes by a trained crew (2 replacements are carried on board) or three times as long by the inexperienced. Changing the tread is only possible when the vehicle is not under attack.

Speed: 65 mph (104 km) on land. Buttoned up, it can travel under water at 30 mph (48 km)!

Maximum Effective Range: 600 miles (960 km) with a full tank of gasoline or via electric motor, before needing refueling; unlimited if nuclear (10 year life).

Statistical Data:

Height: 18 feet (5.5 m)

Width: 10 feet (3 m)

Length: 32 feet (9.7 m)

Weight: 35 tons fully loaded

Cargo: Minimal storage space; about four feet (1.2 m) for extra clothing, weapons, and personal items. Three Wilk's 447 laser rifles and two WI-23 missile launchers with five loads each are stored in a compartment behind the driver's seat.

Power System: Gasoline, electric or nuclear.

Black Market Cost: 2.5 million with gasoline engine, 3 million for one with an electric motor, 23 million with nuclear engine (life-time of 10 years).

Weapon Systems

1. 120mm IH-B Auto-Cannon Turret (1): This is the Iron Fist's main gun. The cannon has a variety of loads, including high-explosive (HE), high-explosive anti-tank (HEAT), armor-piercing explosive (AP), and armor-piercing sabot-discarding solids (APSD). The APSD round consists of a metal dart that flies at enormous speeds towards the target: it is not as fast as a rail gun, but makes up for it with the greater mass of the slug.

Since the gun is situated in the turret, it can rotate 360 degrees and can aim upwards up to 60 degrees — allowing it to engage low-flying aircraft/creatures. The gun is controlled by a gunner inside the turret compartment.

Primary Purpose: Assault; anti-tank, anti-robot, and anti-dragon.

Secondary Purpose: Defense; anti-aircraft.

Weight: 2 tons

Mega-Damage: High-Explosive (HE): 1D6 × 10 M.D. with a blast radius of 20 ft (6.1 m). High-Explosive Anti-Tank (HEAT): 2D6 × 10 M.D. with a blast radius of 10 ft (3 m). AP: 1D4 × 10 M.D. and APSD: 2D4 × 10 M.D.; both have no blast radius (they punch through the armor).

Rate of Fire: A maximum of three attacks per melee round regardless of the gunner's hand to hand combat numbers.

Effective Range: 6000 feet (1828 m) for all rounds.

Payload: The tank can carry up to 80 rounds. The standard distribution is 20 rounds of each type, but that can be altered to suit the mission. For example if the tank is going to be fighting infantry, the usual load would be 50 HE, 20 HEAT, and 10 APSD rounds).

2. IH-100 Rail Gun (1): This gun is a copy of Northern Gun's NG-202, modified for a higher rate of fire. It is located in the cupola (mini-turret) over the main turret, and has a 360 degree rotation of fire and can elevate 90 degrees to engage aerial targets. The tank commander, the gunner, or the driver can access and use the rail gun.

Primary Purpose: Anti-aircraft and anti-vehicle.

Secondary Purpose: Defense: anti-personnel.

Weight: 300 lbs (135 kg)

Mega-Damage: A burst is 60 rounds and inflicts 1D6 × 10 M.D. One round does 1D4 M.D.

Rate of Fire: Equal to number of combined hand to hand attacks (usually 4-6) of the gunner.

Effective Range: 4000 feet (1200 m)

Payload: 12,000 round drum, that's 200 bursts! Up to five drums can be carried by the tank. Reloading the drum takes 15 minutes if done by hand, 5 minutes if done with robots and special equipment.

3. IH-105 Rail Gun (1): This light rail gun is another copy of the NG-202, with a normal rate of fire. The gun is right under the tank's main gun and shoots at the same target. It is intended to shoot infantrymen not worth spending a cannon round to kill.

Primary Purpose: Anti-personnel and anti-vehicle.

Secondary Purpose: Defense

Weight: 298 lbs (134 kg)

Mega-Damage: A Burst is 40 rounds and inflicts 1D4 × 10 M.D.; one round does 1D4 M.D.

Rate of Fire: Equal to number of combined hand to hand attacks (usually 4-6) of the gunner.

Effective Range: 4000 ft (1200 m)

Payload: 8,000 round box in the turret; that's 200 bursts!

4. IH-34L Laser Turret (1): This weapon is mounted on the bow of the tank and can be fired by the driver or the tank commander as a secondary weapon. The weapon consists of two laser cannons firing simultaneously at the same target. In vehicles without nuclear engines, the laser is powered by a rechargeable battery.

Primary Purpose: Anti-Personnel

Secondary Purpose: Defense

Weight: 600 lbs (279 kg)

Mega-Damage: 6D6 M.D. per dual blast.

Rate of Fire: Can shoot up to six times per melee.

Effective Range: 4000 feet (1200 m)

Payload: 1000 dual blasts. Unlimited if vehicle has a nuclear engine.

5. Smoke/Gas Dispensers (2): A smoke/gas dispensing unit is attached to each side of the APC. The dispenser releases a dense cloud of smoke that covers a 40 foot (12.2 m) area in front of the vehicle. It can also release tear gas.

Payload: 20 total; 10 charges each; typically all smoke.

Note: All Iron Heart Armaments tanks have a short-range radar (5 miles/8 km), laser targeting (+1 to strike), combat computer (+1 to strike), long-range and short-range radio, loudspeaker, radiation detector, light radiation shielding, and an environmental crew compartment with air-conditioning, heating, oxygen supply and an air purging, purification and circulation system.

Iron Bolt Missile Vehicle

The Iron Bolt is built on the Iron Fist chassis, but the turret has been replaced with an MLRS-120 Multiple Launcher Rocket System (MLRS) with an internal auto-loading magazine that holds up to 120 mini-missiles! Plus laser turret and a missile launcher turret that contains 12 long-range missiles!

A battery of six Iron Bolt vehicles can gut an armored formation in a matter of seconds. The problem is the vehicle has limited mobility and is comparatively slow. The Iron Bolt is usually stationed about a mile away from the front lines and has their targets indicated by forward observers, scouts and advancing soldiers who pinpoint the location of the enemy and radio their coordinates. The vehicle is almost helpless against point-blank range attackers (within 100 yards/meters or less).

Model Type: Missile Vehicle

Class: Mobile Artillery

Crew: Three: driver, gunner, and commander

M.D.C. by Location:

***Multiple Launcher Rocket System — 150

** Main Body — 450

Reinforced Crew Compartment (main body) — 100

*Track Treads (2) — 90 each

*** Depleting the MLRS will cause the vehicle to explode, doing the damage of one missile times the number of remaining missiles in the box in a 600 foot radius (so, if the box had 12 Nuclear Multi-Warhead missiles, the explosion will do 4D6 × 120 M.D. in the blast area.

** Depleting the M.D.C. from the main body will shut the tank down completely, rendering it useless.

*Depleting the M.D.C. of a tread will immobilize the tank until it is replaced: replacing a tread will take 1D6 × 10 minutes by a trained crew (2 replacements are carried aboard) — this is only possible are the vehicle is not under attack at the time.

Speed: 55 mph (88 km); land only.

Maximum Effective Range: 400 miles (640 km) with a full tank of gasoline or via electric motor before needing refueling; unlimited if nuclear (10 year life).

Statistical Data:

Height: 20 feet (6 m)

Width: 10 feet (3 m)

Length: 32 feet (9.7 m)

Weight: 40 tons fully loaded

Cargo: Minimal storage space; for extra clothing, weapons, and personal items. Two Wilk's 447 laser rifles and two DRU-10 Missile launchers with three loads each are stored in the compartment behind the driver's seat.

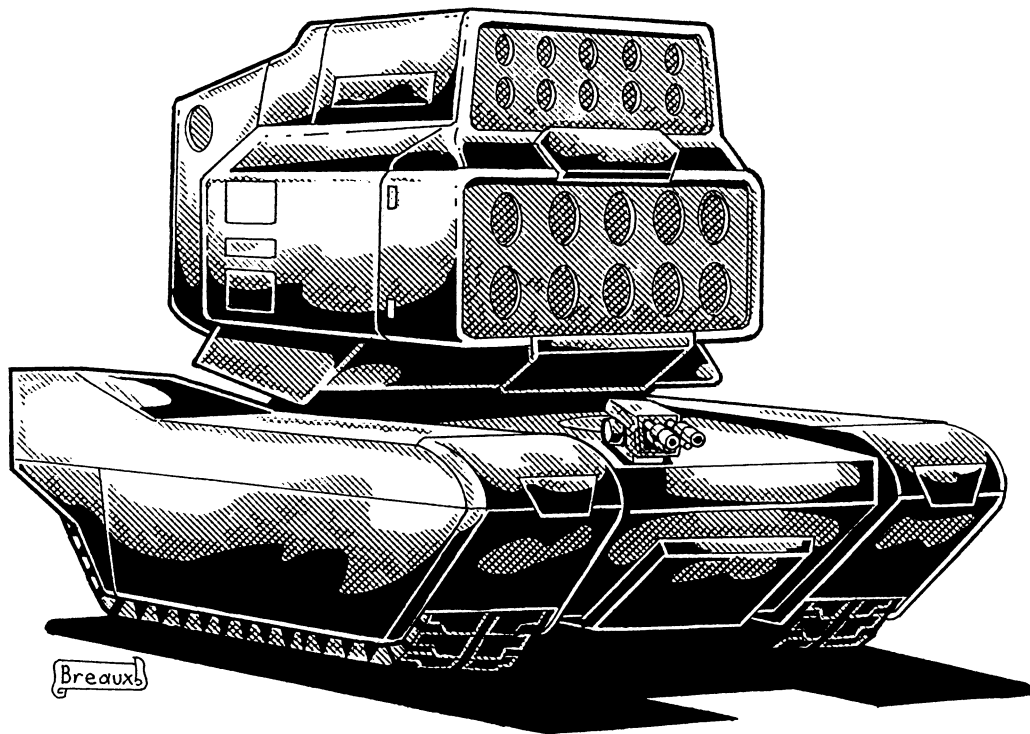

Power System: Gasoline, electric or nuclear.

Black Market Cost: 4 million with gasoline engine, 5 million for one with an electric motor, 23 million with nuclear engine (lifetime of 10 years). Missiles cost extra (3000 for each mini-missile and about 25,000 for each long range missile; nuclear warheads cost 5 × more and are rare).

Weapon Systems

1. ML-12-Long Range Missile System (1): This box launcher holds two rows of six missiles, which can be fired in any order the gunner chooses. The launcher can rotate 360 degrees and can be raised up to 60 degrees.

Primary Purpose: Artillery

Secondary Purpose: Anti-vehicle and anti-dragon.

Weight: 12 tons

Mega-Damage: Varies with missile type. Typically

Rate of Fire: One at a time or in volleys of 2, 4, or 6 missiles. Launcher is reloaded from the magazine in 1 melee round.

Effective Range: 500 to 1000 miles (800 to 1600 km), depending on missile type.

Payload: 12 long-range missiles. A cargo truck can hold additional missiles and a giant robot can reload the main launcher within six minutes (30 seconds per missile); twice as long if not familiar with the loading procedure.

2. MLRS-120 Multiple Launcher Rocket System (1): The MLRS-120 has an internal auto-loading magazine that holds 120 mini-missiles! The launcher can rotate 360 degrees and can be raised up to 60 degrees.

Primary Purpose: Short range artillery; anti-vehicle and anti-troops.

Secondary Purpose: Defense

Weight: 8 tons

Mega-Damage: Varies with missile type. Typically armor piercing and plasma.

Rate of Fire: One at a time or in volleys of 2, 4, 6 or 10 mini-missiles per melee round. The Launcher is reloaded from the magazine automatically and has a full payload ready for the next melee round.

Effective Range: One mile (1.6 km)

Payload: 120 mini-missiles.

3. IH-34L Laser Turret (1): The weapon consists of two laser cannons firing simultaneously at the same target. In vehicles without nuclear engines, the laser is powered by a rechargeable battery.

Primary Purpose: Anti-Personnel

Secondary Purpose: Defense

Weight: 600 lbs (279 kg)

Mega-Damage: 6D6 M.D. per dual blast.

Rate of Fire: Can shoot up to six times per melee.

Effective Range: 4000 feet (1200 m)

Payload: 1000 dual blasts. Unlimited if vehicle has a nuclear engine.

Note: The Iron Bolt Missile Vehicle has a short- and long-range radar, laser targeting (+ 1 to strike), combat computer (+ 1 to strike), long-range and short-range radio, loudspeaker, searchlight and an environmental crew compartment with air-conditioning, heating, oxygen supply and an air purging, purification and circulation system.

Iron Maiden APC-10

This is a light Armored Personnel Carrier that can accommodate a 10 man infantry squad in battle armor or man-sized power armor, plus a two man crew. It is patterned after the old Bradleys of the 20th century and resembles a tank to those not familiar with military vehicles. The Iron Maiden is also a favorite vehicle for convoys. It can haul a semi-trailer or other vehicles, or be converted into a travelling vehicle for two people with a built-in cargo bay (10 × 10 ft with a 7 foot/3 × 3 × 2.1 m ceiling, and can still haul an additional trailer). Overall, the Iron Maiden is not as large as the Coalition Mark V and it carries less troops, but has comparable firepower and armor.

Model Type: APC

Class: Infantry Assault and Transport Vehicle

Crew: Two: pilot and gunner

Troop Transport Capabilities: 10 troops

M.D.C. by Location:

Weapon Turret — 150

30mm Auto-cannon in Turret — 60

MLRS-24 Mini-Missile Launchers (2) — 40 each

Smoke/Gas Dispenser (2) — 15 each

Laser Turret (1) — 60

****Main Body — 320**

Reinforced Crew Compartment — 100

Treads (2) — 60 each

Speed: 70 mph (112.6 km) on land; it cannot travel on or under water.

Statistical Data:

Height: 11 feet (3.3 m)

Width: 10 feet (3 m)

Length: 25 feet (7.6 m)

Weight: 20 tons fully loaded

Cargo: Storage space for extra clothing, weapons, and personal items; 10 rifles of any type, 4 rocket launchers (either CR-1 or WI-23) and 24 mini-missiles stored in locked overhead compartments.

Power System: Combustion or electric engine or nuclear.

Black Market Cost: One million credits for the basic gasoline driven vehicle or 1.3 million for electric engine with no infantry weapons included; add another 2 million for the weapon systems. 14 million for nuclear with 15 year life and full armaments.

Weapon Systems

1. IH-10RJ 30mm Ramjet Auto Cannon: This is a giant machinegun that fires cannon-size, ramjet armor penetrators. The IH-10RJ can chew through the front armor of a tank or a giant robot in a matter of minutes. When it fires, the ramjet rounds leave a white plume behind that resembles an energy beam.

Primary Purpose: Anti-Vehicle, Anti-Personnel.

Secondary Purpose: Defense.

Weight: 2 tons

Mega-Damage: A burst is 20 rounds and inflicts 2D6 × 10 M.D. A single round does 3D6 M.D.

Rate of Fire: Equal to the gunner's hand to hand attacks; each burst counts as one melee action.

Effective Range: 3000 feet (914 m)

Payload: 2000 round drum magazine; that's 100 bursts! The cargo area has up to four additional drums. Reloading is done inside the vehicle and takes two melee rounds (30 seconds) for two crewmen or passengers and six melees (90 seconds) if only one person is involved or the people aren't trained in the reload procedure.

2. MLRS-24 Multiple Launcher Rocket System (2): An MLRS-24 is built into each side of the vehicle. Each holds 24 mini-missiles and can rotate 360 degrees and can be raised 60 degrees.

Primary Purpose: Short-range artillery; anti-vehicle and anti-troops.

Secondary Purpose: Defense

Weight: 200 lbs (90 kg)

Mega-Damage: Varies with missile type. Typically armor piercing and plasma.

Rate of Fire: One at a time or in volleys of 2, 4, or 6 mini-missiles.

Effective Range: One mile (1.6 km)

Payload: 48 total, 24 mini-missiles in each launcher.

3. IH-34L Laser Turret (1): This weapon is mounted on the bow of the tank and can be fired by the driver or the tank commander as a secondary weapon. The weapon consists of two laser cannons firing simultaneously at the same target. In vehicles without nuclear engines, the laser is powered by a rechargeable battery.

Primary Purpose: Anti-Personnel

Secondary Purpose: Defense

Weight: 600 lbs (279 kg)

Mega-Damage: 6D6 M.D. per dual blast.

Rate of Fire: Can shoot up to six times per melee.

Effective Range: 4000 feet (1200 m)

Payload: 1000 dual blasts. Unlimited if vehicle has a nuclear engine.

4. Smoke/Gas Dispenser (2): A smoke/gas dispensing unit is attached to each side of the APC. The dispenser releases a dense cloud of smoke that covers a 40 foot (12.2 m) area in front of the vehicle. It can also release tear gas.

Payload: 20 total; 10 charges each; typically all smoke.

Note: Standard features include a short-range radar (5 miles/8 km), laser targeting (+1 to strike), combat computer (+1 to strike), long-range and short-range radio, loudspeaker, radiation detector, light radi-

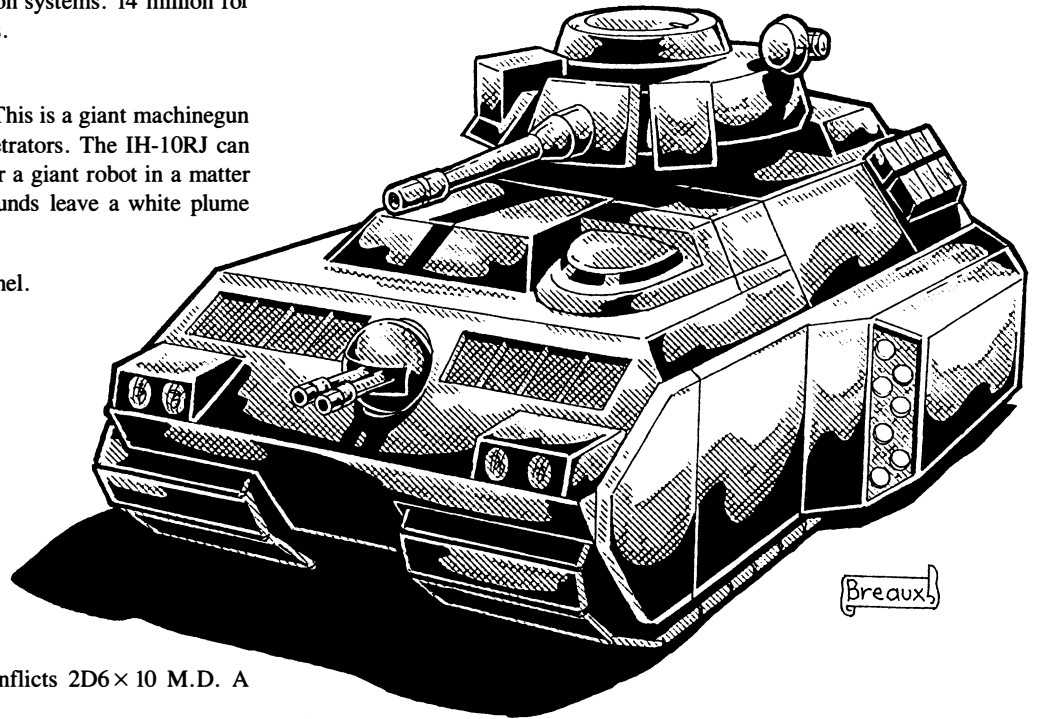

ation shielding, and an environmental crew compartment with air-conditioning, heating, oxygen supply and an air purging, purification and circulation system.

Iron Heart Aircraft

Iron Heart Armaments also has a line of military aircraft. Some mercenary companies have realized that air superiority can be an important factor in combat. The pre-Rifts designs of the American Empire intended the aircraft to be used in a wide variety of battle conditions including irregular terrain, consequently all have VTOL (Vertical Take-Off and Landing) capabilities. This is ideal for mercenaries and adventurers since most cities don't even have airfields.

Sensor Systems: Unless otherwise noted, all aircraft have all the standard robot sensors and systems, as well as the following:

1. Enhanced Radar: Can identify and simultaneously track up to 96 different targets. Range: 500 miles (800 km).

2. Sonar: Can detect underwater targets. Range: 500 miles (800 km).

Note: The nuclear engines are not manufactured Iron Heart Armaments, although they are competent at repairing and installing them.

Grey Falcon Attack Jet

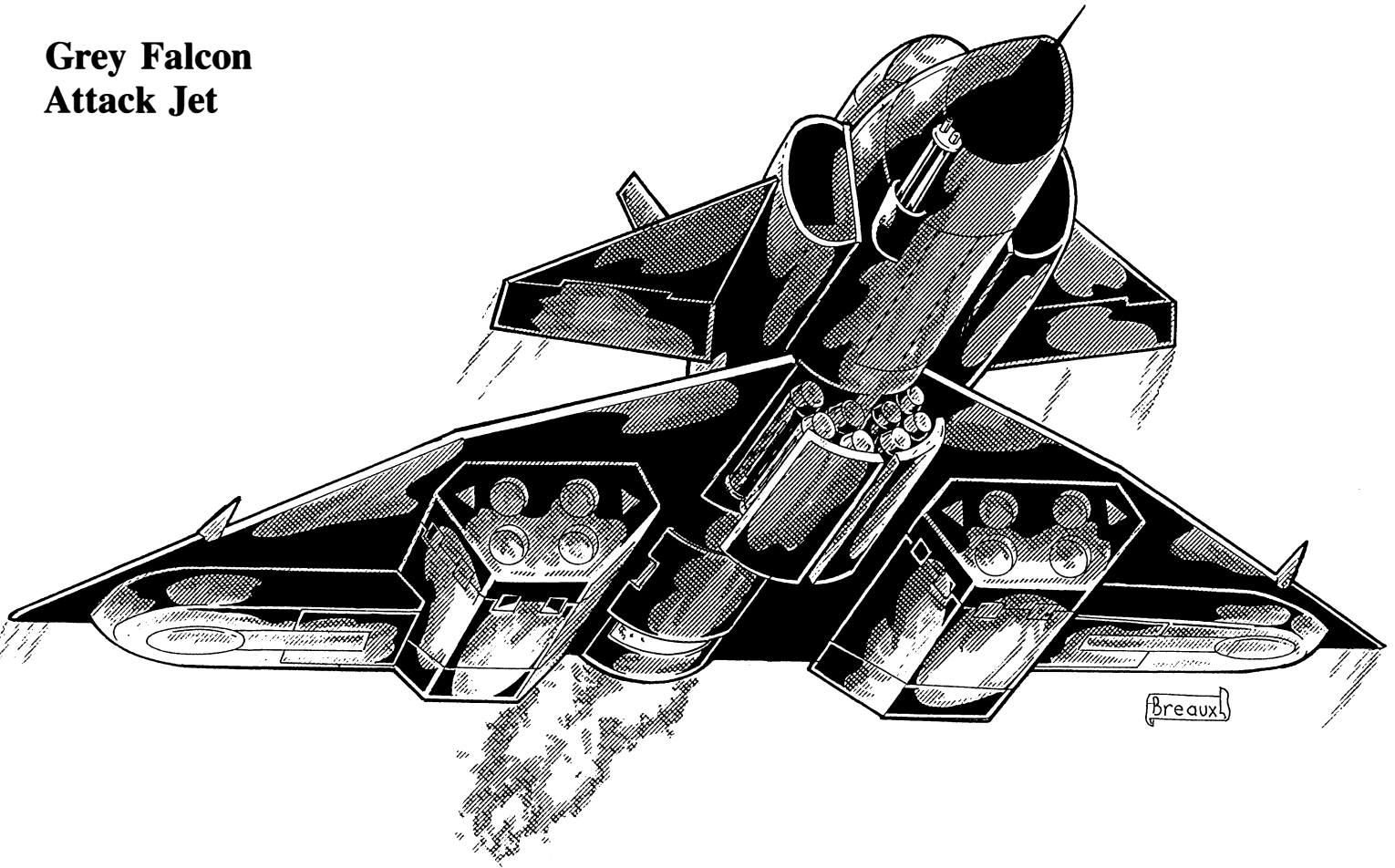

The Grey Falcon is becoming popular among the air forces of non-CS nations. This powerful ultrasonic jet is excellent in combat against all kinds of aerial opponents, as well as bombing and strafing ground troops. The Grey Falcon is designed to use smart bombs to strike targets at great distances, but can fire almost any type of aerial missile. The vehicle can take-off and land on any flat surface more than 40 feet (12.2 m) in diameter, but it cannot hover and fly at low speeds which is perhaps its greatest shortcoming. One of its most unique features is its modular construction that allows crews to disassemble the jet in a matter of minutes for easy storage and transport! It can be reassembled in less than 10 minutes!! Many merc companies carry a wing or two of Grey Falcon jets, transported from place to place on trucks and deployed as needed.

Model Type: GF-1A

Class: Attack Plane

Crew: One

M.D.C. by Location:

Forward Mounted Rail Gun — 50

** Wings (2) — 100 each

Wing Mounted Long-Range Missile Launchers (2) — 60 each

Side Mounted Medium-Range Missile Launchers (4) — 50 each

Belly Mounted Mini-Missile Launcher (1) — 60

*Main Body — 170

Reinforced Pilot's Compartment — 100

*Depleting the M.D.C. of the main body causes the craft to crash.

** Destroying a wing causes the craft to crash.

Speed:

Driving on the ground: Not possible

Flying: The jet propulsion system enables the Grey Falcon to reach a maximum speed of Mach 2 (1,350 mp/2,173 km) and climb to an altitude of 40,000 feet (12,190 m). The jet has a minimum glide-speed

of 60 mph (96 km); if it goes any slower, it may stall completely and crash, unless engaged in VTOL. Cruising speed tends to be between 200 and 500 mph (320 to 800 km). Attack speed can range from 200 to 670 mph (320 to 1072 km) against ground targets and up to maximum speed against aerial advisories. Some attacks involve launching missiles from 5+ miles away, others are direct strafing runs or close aerial combat using the rail guns and mini-missile launcher.

Range: Nuclear power gives it continual energy, but the jets overheat after 10 hours of continual use above 200 mph, or 4 hours if going above 600 mph (960 km). Going at 200 mph (320 km) with occasional rest stops will allow the aircraft to travel for 40 hours.

Statistical Data:

Height: 12 feet (3.8 m) with landing pads out, 9 feet (2.7 m) airborne.

Width: Wingspan is 40 feet (12.2 m)

Length: 70 feet (21.3 m) long

Weight: 18 tons fully loaded

Cargo: Minimum storage space of three feet (0.9 m) behind pilot's seat for extra clothing, weapons, and personal items.

Power System: Nuclear.

Note: Equipped with an exploding canopy and ejecting, parachute seat for emergency evacuation.

Black Market Cost: 20 million for a new, undamaged, fully powered and equipped GF-1A (radar, long-range radio, ejection seat, etc.).

Weapon Systems

1. Wing Mounted Long-range Missile Launchers (2): This is the main weapon of the Gray Falcon. The aircraft carries up to 8 long-range missiles.

Primary Purpose: Anti-Armor/Vehicle and Anti-Structure

Secondary Purpose: Anti-Personnel

Mega-Damage: Varies with missile type. Missiles used will vary with the aircraft's mission.

Rate of Fire: One at a time or volleys of two missiles.
Effective Range: 500 to 1,000 miles (800 to 1600 km).
Payload: 8 total; four missiles per launcher.

2. Side-Mounted Medium-Range Missile Launchers (4): These secondary launchers are built into the fuselage of the plane, one above and one below each wing. This weapon is mostly used against enemy aircraft.

Primary Purpose: Anti-Aircraft and Anti-Dragon.

Secondary Purpose: Anti-Armor and Anti-Personnel.

Mega-Damage: Varies with missile type. Usually Armor-Piercing or Plasma.

Rate of Fire: One at a time or in volleys of two or four missiles.

Effective Range: Between 40 and 80 miles (64 to 128.7 km).

Payload: 4 missiles per launcher, totalling 16 missiles.

3. Forward Mounted Rail Gun: This nose gun is the last line of defense against enemy planes, although some pilots use it for strafing runs against ground targets.

Primary Purpose: Anti-Aircraft

Secondary Purpose: Anti-Personnel and Defense.

Mega-Damage: A burst is 40 rounds and inflicts $1D4 \times 10$ M.D.; can only fire bursts.

Rate of Fire: Standard

Effective Range: 4000 feet (1200 m)

Payload: 8,000 round internal magazine; that's 200 bursts.

4. Belly Mounted Mini-Missile Launcher: This is an auto-loading missile launcher that allows for rapid firing (but not volleying) of mini-missiles. Between the rail gun and the mini-missiles, a Grey Falcon strafing run can clear an area of enemies with one pass. This weapon system is also used in dog fights against other enemy aircraft/flying creatures.

Primary Purpose: Anti-Personnel, Anti-Vehicle, and Anti-Aircraft

Secondary Purpose: Defense

Weight: 1 ton

Mega-Damage: Varies per mini-missile type.

Rate of Fire: Equal to the total number of hand to hand attacks per melee. The missiles are fired one at a time; cannot fire volleys.

Effective Range: About one mile(1.6 km).

Payload: 50 mini-missiles in 5 magazines carrying 10 each, allowing for as many as 5 types of missiles to be used; the pilot can select between the 5 magazines with a flick of a switch.

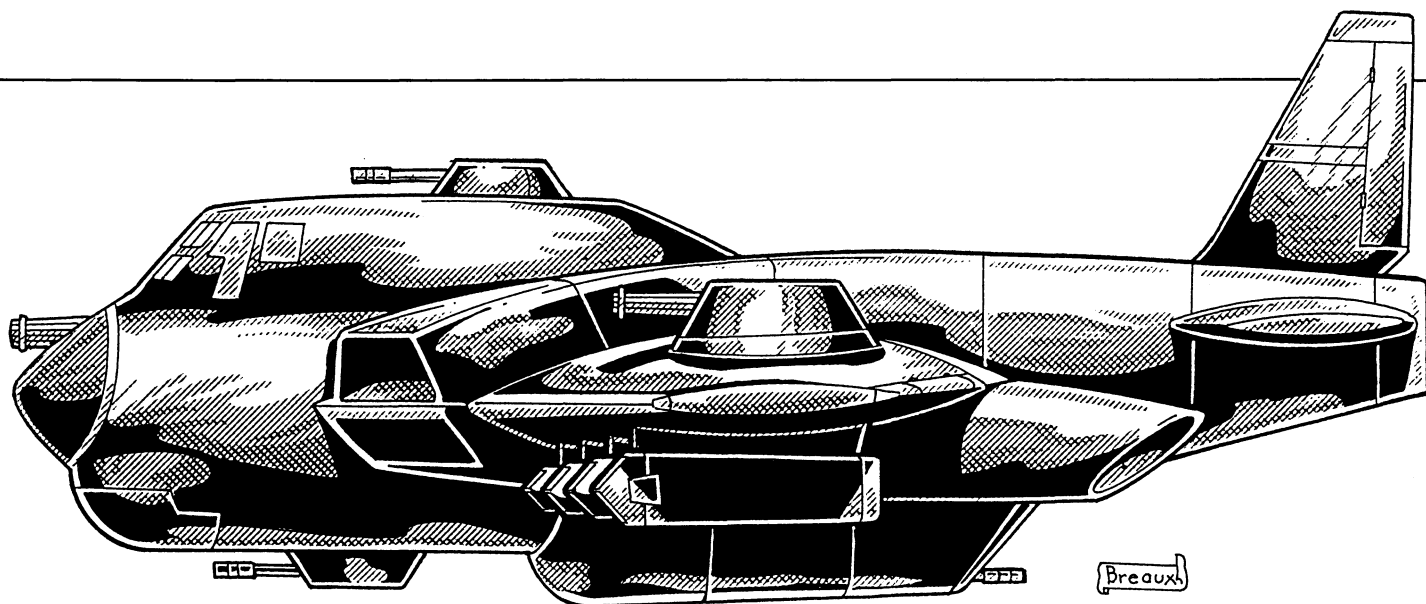

AC-29 Air Castle Bomber

The AC-29 is a huge jet airplane nearly as large as the Coalition's Death Head Transport. Unlike the transport, its cargo is pure destruction. Each Air Castle carries an enormous payload of bombs and missiles, enough to level a city. Besides its explosives, the Air Castle has a number of combat towers, each with the firepower of a small tank, to protect it from enemy aircraft and ground defenses. This plane is reminiscent of the 20th Century B-52 bomber, but much bigger.

Less than one hundred Air Castles have been built. Ishpeming and the Manistique Imperium have added a few squadrons of the bomber to their arsenals. **Larsen's Brigade** has two wings of AC-29s, twelve bombers that make the company more deadly than many armies.

Important CS Note: The Coalition States are terrified about the potential danger of this 21st Century bomber and its use of heavy smart bombs and long-range missiles. They have increased their air capabilities accordingly and have warned Iron Heart Armaments to stop manufacturing the AC-29 bomber, long-range missiles and smart bombs. The CS has issued a public warning that any Air Castles entering CS air

space shall be considered hostile and blown out of the sky without any communications or negotiations! Five AC-29s have already met with this fate and three were 100 miles (160 km) outside of CS airspace!

If Iron Heart Armaments refuses to comply, the Coalition States have a secret plan for a tactical strike against the factories (with hopes of seizing the plans of these combat vehicles for their own use) and permanently eliminating the threat by eradicating Iron Heart Armaments and New Kenora from the face of the Earth! The plan suggests that less than 3% of the population will survive! If the CS moves against Tolkeen, they will almost certainly strike New Kenora first or perhaps simultaneously.

Model Type: AC-29

Class: Heavy Bomber

Crew: Fourteen: Pilot, co-pilot, two communications engineers, six gunners and four flight engineers. Can accommodate five additional passengers.

M.D.C. by Location:

Nose Vulcan Laser Turret — 150
** Wings (2) — 400 each
Wing Mounted Vulcan Laser Turrets (2) — 150
Wing Mounted Medium-Range Missile Launchers (8) — 30 each
Top Auto-Cannon Turret — 160
Belly Mounted Forward Auto-Cannon Turret — 160
Belly Mounted Back Auto-Cannon Turret — 160
Bomb Bay — 300
Long-Range Missile Launchers (12) — 100 each
*Main Body — 800
Reinforced Crew Compartment — 200

*Depleting the M.D.C. of the main body causes the craft to crash.

**Destroying a wing causes the craft to crash.

Speed: Driving on the ground: Not possible.

Flying: The jet propulsion system enables the Air Castle to reach a maximum speed of 800 mph (1,280 km), and climb to an altitude of 50,000 feet (15,240 m). The jet has a minimum speed of 160 mph (256 km); if it goes any slower, it stalls and may crash, unless engaged in VTOL. Cruising and attack speed vary, but tend to be between 160 and 500 mph (256 to 800 km), depending on the target and the mission. Some attacks involve launching missiles from 5+ miles (8 km) away, others are direct bombing runs. The jet engines can be reoriented and pointed downwards, allowing the plane to take-off and land without a runway (still needs a flat area about 500 feet (152.4 m) in diameter, much larger than a football field.

Range: The nuclear engine gives it continual power, but the jets overheat after 10 hours of continual use above 200 mph, or 4 hours if going above 500 mph. Going at below 200 mph (320 km) with occasional rest stops will allow the plane to travel for 40 hours. A liquid fuel engine has a range of 900 miles (1440 km) — roughly 12% of the bombers use liquid fuel.

Statistical Data:

Height: 30 feet (9 m)

Width: 230 feet wingspan (70 m)

Length: 210 feet (64 m)

Weight: 200 tons

Cargo: Standard storage compartments are usually equipped with parachutes, a dozen first-aid kits (complete with RMK Robot Medical Kits), food and water for 20 people for two weeks, 12 Wilk's 447 laser rifles, 48 E-clips, 12 signal flares, and a field radio.

Power System: Liquid fuel or nuclear.

Black Market Cost: 100 million credits for nuclear or 80 million for gasoline type. Both are rare/poor availability.

Weapon Systems

1. Vulcan Laser Turrets (3): This heavy, multi-barreled laser is used for missile defense and anti-aircraft roles. Each is controlled by an independent gunner. One is mounted on the nose of the aircraft and the other two are on top of its wings. The wing turrets can rotate 360 degrees and fire on a 180 degree arc, sweeping the air above the aircraft.

Primary Purpose: Anti-Aircraft and Anti-Missile.

Secondary Purpose: Defense

Mega-Damage: 2D4 × 10 M.D. per blast.

Rate of Fire: Each turret can shoot up to six times per melee round.

Effective Range: 6000 feet (1828 m)

Payload: Effectively Unlimited

2. Auto-cannon Turrets (3): Two 30mm auto-cannons are mounted on belly turrets and a third in the middle of the plane, on top of the fuselage. The belly guns can engage any target below the bomber. They use special ramjet rounds, powerful enough to rupture the heaviest armor. The turrets can rotate 360 degrees and fire in a 180 degree arc.

Primary Purpose: Anti-Vehicle and Anti-Personnel

Secondary Purpose: Defense

Weight: 2 tons

Mega-Damage: A burst is 20 rounds and inflicts 2D6 × 10 M.D. A single round does 3D6 M.D.

Rate of Fire: Normal

Effective Range: 4000 feet (1200 m)

Payload: 4000-round drum magazine per cannon; that's 200 bursts.

3. Wing Mounted Medium-Range Missile Launchers (8): These launchers are placed in a row of four on each wing. They are part of the defense systems of the bomber, enabling it to knock enemies out of the sky at a distance. The launchers have a payload of six missiles each, for a total payload of 48 missiles.

Primary Purpose: Anti-Aircraft, Anti-Missile.

Secondary Purpose: Anti-Vehicle.

Mega-Damage: Varies with missile type. Common types include Heavy High Explosive, Armor-Piercing, and Plasma.

Rate of Fire: One at a time, or in volleys of two, four or eight missiles.

Effective Range: About 50 miles (80 km)

Payload: Six missiles per launcher (8), for a total of 48 missiles.

4. Bomb Bay: Most of the cargo of the AC-29 is made up of bombs, although vehicles and supplies could be substituted in a pinch. The aircraft is a bomber and carries tons of explosives; enough to level the toughest building or a blow a convoy of vehicles to Kingdom Come. The impact of these bombs is roughly the same of a long-range missile. Conventional explosive charges can be literally "dropped" from the plane and detonate upon hitting the target on the ground. However, smart, self-guided, missile-like bombs with steering fins and a small rocket motor are the unique bombs specially developed for this aircraft (more American ingenuity). This makes the deadly cargo all the more dangerous because of the level of accuracy. The smart bombs are dropped and fall to the earth, as they approach their intended preprogrammed target, rockets engage and adjust trajectory. They can even pursue a moving target, but are limited to a range of half a mile (0.8 km) maximum!

The AC-29 can also do carpet-bombing sweeps, where all the bombs are instructed to hit a specific area and saturate it with explosions. Similarly, they can be directed to strike one specific building/large target or anti-vehicle sweeps where bombs attack individual vehicles (usually tanks and robots).

Primary Purpose: Anti-Structure and Anti-Vehicle

Secondary Purpose: Anti-Personnel

Mega-Damage: Varies with bomb type; same types and damage as the long-range missiles, but triple the blast radius.

Rate of Fire: A volley of 10, 20 or 30 bombs can be dropped once per melee round (every 15 seconds).

Effective Range: About half a mile (0.8 km) from the drop site.

Payload: 200 heavy bombs (same types and damage as long-range missiles).

Note: Hitting a large stationary target like a building or bridge or blanketing a specific area is automatic! To hit a moving target, roll to strike (+ 6 per bomb). The entire bomb volley can strike one target or each can veer away to hit a different target (such as a tank or bot).

5. Long-Range Missile Launchers (12): The front, bottom area of the AC-29 opens up to reveal two menacing rows of missiles. The missiles are dropped and then self-ignite and fly towards their targets 5 seconds later. Unlike bombs, the missiles can fly and engage targets hundreds of miles away — the AC-29 can launch a missile attack while flying hundreds of miles away! The missile launchers hold 5 long-range missiles each, for a total payload of 60 missiles.

Primary Purpose: Anti-Vehicle.

Secondary Purpose: Anti-Structure and Anti-Aircraft

Mega-Damage: Varies with missile type

Rate of Fire: Up to twelve missiles can be fired per melee round.

Effective Range: Between 500 and 1200 miles (800 to 1920 km).

Payload: 60 missiles. The plane can be reconfigured to carry a cargo of missiles instead of bombs. In that case, the payload can be increased to 120 missiles (but no bombs will be available). The reconfiguration of the plane into a missile ship costs an extra 100,000 credits.

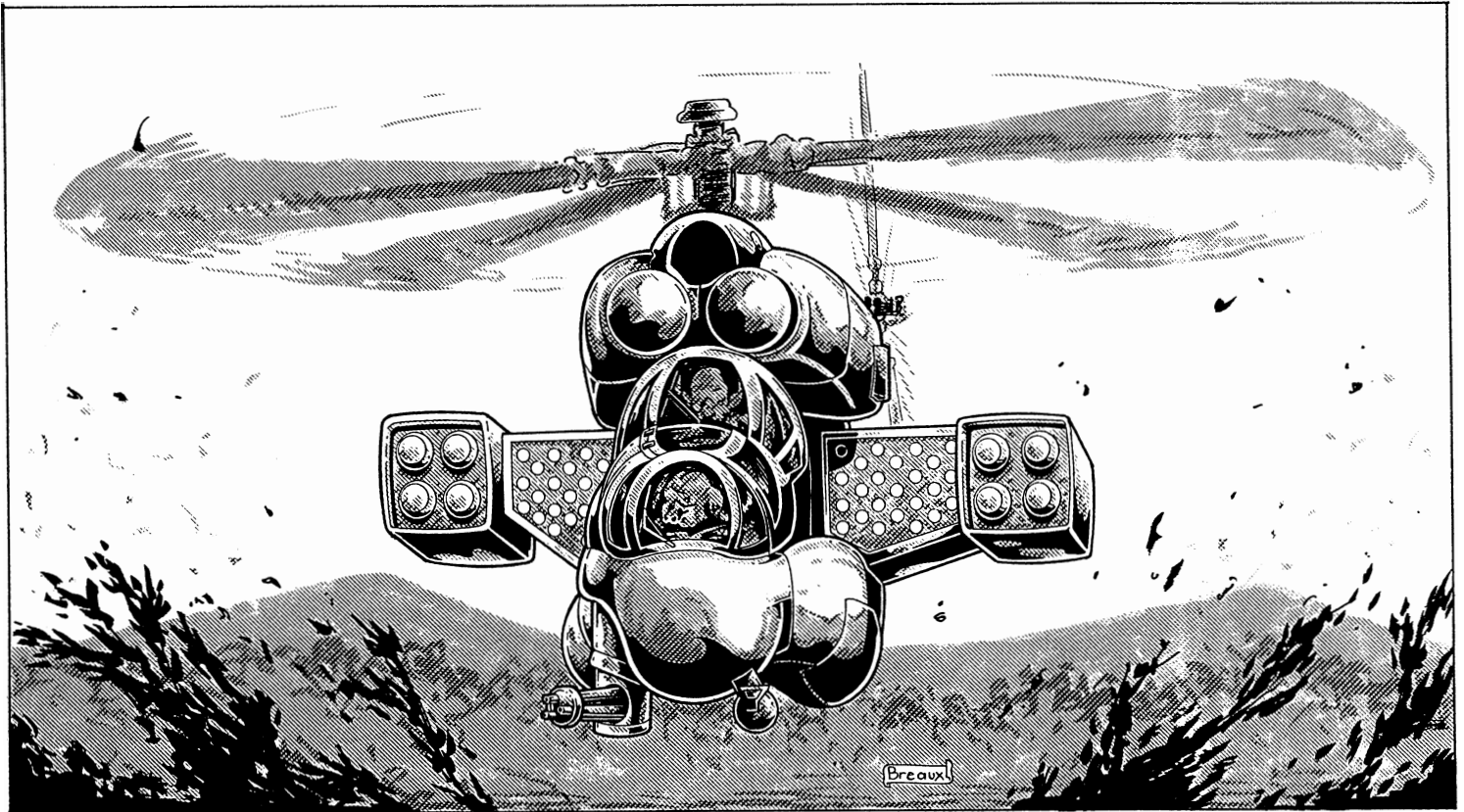

Iron Eagle Attack Helicopter

Iron Heart Armaments has revived the old 20th Century aircraft in a fairly effective, heavily armored model patterned after the ancient Cobra and Apache helicopter gunships used by the American Empire. The Iron Eagle has impressive firepower and maneuverability. A squadron of five gunships can inflict a lot of damage on a ground force and bots. The Sky King is faster and more maneuverable, but cannot match the Iron Eagle in armor and firepower.

A nautical helicopter version of the Iron Eagle is also available. It is called the Iron Trident. The stats are unchanged, except a sonar system and pontoon runners are added so it can land on water, and the medium-range air missile launchers are replaced by torpedo launchers (used to hunt submarines, bots and sea serpents).

Model Type: IE-15AH (nautical model is designated as IE-ITAH).

Class: Helicopter Gunship.

Crew: Four: Pilot, co-pilot/gunner, communications technician and a secondary gunner. Two human-sized passengers can be squeezed in too.

M.D.C. by Location:

** Four-Blade Top Rotors — 80 (20 each blade)

*** Rear Rotor — 60

Mini-Missile Launchers (2) — 100 each

Medium-Range Missile Launchers (2) — 100 each

Nose Auto-Cannon — 100

*Main Body — 300

Reinforced Pilots' Compartment — 150

*Destroying the main body knocks the helicopter out of the sky and renders it completely useless.

/ Destroying the rear rotor or one of the main blades will cause the helicopter to fly at half speed, wobble and is -6 to parry, -3 to strike, and -50% on piloting skill/maneuvers. Smart pilots will land as soon as possible. Destroying the main top rotor (80 M.D.C.) will knock the bird out of the sky! Roll under piloting skill -40% for a successful crash landing (chopper is wrecked but crew and passengers are uninjured).

Speed:

Driving on the ground: Not possible.

Flying: The Iron Eagle can hover in a stationary position up to 3000 feet (915 m) high and can achieve a maximum flight speed of 300 mph (480 km), and climb to an altitude of 3000 feet (915 m). Cruising and attack speeds vary, but tend to be between 100 and 200 mph (160 to 329 km) and it has excellent VTOL capabilities.

Range: The nuclear energy source gives the Iron Eagle continual power, but the jets overheat after 10 hours of continual use above 100 mph, or 4 hours if going above 200 mph (329 km). Going at 100 mph or below with occasional rest stops will allow the helicopter to travel for 40 hours. A liquid fuel version is also available with a range of approximately 400 miles (643 km).

Statistical Data:

Height: 15 feet (4.6 m)

Width: 10 feet (3 m) wide; rotors have a diameter of 50 feet (15.2 m).

Length: 55 feet (16.8 m)

Weight: 10 tons fully loaded

Cargo: Limited; enough room to add two passengers or equivalent cargo.

Power System: Nuclear or liquid fuel.

Black Market Cost: 24 million credits for nuclear, 1.5 million for liquid fuel, both with full weapon systems. Approximately half the assault helicopters sold use liquid fuel, and a quarter are designed for nautical use.

Weapon Systems

1. Mini-Missile Launchers (2): These are multi-missile launchers, each able to release a volley of 24 missiles! They can be controlled by the pilot or the secondary gunner.

Primary Purpose: Anti-Vehicle and Anti-Personnel

Secondary Purpose: Defense

Mega-Damage: Varies with missile type.

Rate of Fire: One at a time, or volleys of two, three, five, ten or twenty-four.

Effective Range: About one mile (1.6 km)

Payload: 48 total; 24 mini-missiles per launcher.

2. Medium-Range Missile Launchers (2): These heavier missiles

are used against tanks, robots, and other large, well-protected targets.

Usable by the co-pilot/gunner or secondary gunner.

Primary Purpose: Anti-Armor and Anti-Aircraft

Secondary Purpose: Defense

Mega-Damage: Varies with missile type.

Rate of Fire: One at a time, or in volleys of two or four.

Effective Range: About 50 miles (80 km).

Payload: 8 total; four per launcher.

3. 30mm Auto-Cannon: This nose-mounted cannon is controlled by the co-pilot/gunner. It is used to “hose” enemy areas and to engage vehicles and infantry.

Primary Purpose: Anti-Vehicle and Anti-Personnel

Secondary Purpose: Defense

Weight: 2 tons

Mega-Damage: A burst is 20 rounds and inflicts 2D6 × 10 M.D.; a single round does 3D6 M.D.

Rate of Fire: Normal

Effective Range: 3000 feet (914 m)

Payload: 4000-round drum magazine; that’s 200 bursts!

Iron Heart Watercraft

Iron Heart has recently purchased some shipyards on the coast of Lake Superior at the rebuilt city of Duluth, Minnesota. Since the Great Lakes and other coastal areas are so dangerous, the company is trying to sell its patrol and attack boats to coastal communities, mercenaries and adventurers. Even the CS of Quebec has made a few purchases. Unfortunately, would-be pirates who roam the lakes and seas are becoming Iron Heart Armaments’ best customers (cash sales only).

Sensor Systems: Unless otherwise noted, all watercraft have all standard robot sensors and systems, as well as the following:

1. Enhanced Radar: Can identify and simultaneously track up to 96 different targets. Range: 500 miles (800 km).
2. Sonar: Can detect underwater targets. Range: 500 miles (800 km).

Iron Heart Torpedoes

Iron Heart has created high explosive and plasma torpedoes that are fundamentally missiles designed for propulsion through water rather than air. High explosive (HE) torpedoes do more damage underwater because water is a better conductor of concussion waves than air. Torpedoes are slower than missiles (about 300 mph/482 km) and can usually be “seen” with the naked eye at about 500 feet (153 m) away from its target and detected by sonar miles away. The further away the torpedo is launched, the greater the chances it can be destroyed or evaded before reaching its intended target.

Torpedo Statistical Data:

Penalties: Torpedoes are –2 to strike at any range longer than a mile (1.6 km). At 1000 feet (305 m), the torpedo’s tracking system will follow and hit all but the nimblest targets and is +3 to strike. The problem is that at 1000 feet the missile will be in range of almost every known weapon system, allowing the enemy one attempt of blowing it up with weapons of their own.

Speed: All torpedoes travel at approximately the same speed of 300 mph (482 km)

M.D.C. of Torpedoes: Mini-torpedo: 10 M.D.C., light: 15 M.D.C., medium: 30 M.D.C., heavy: 50 M.D.C., and depth charges have five M.D.C. points. Depleting the M.D.C. will cause the torpedo to detonate the instant it hits zero points. Thus, they can be prevented from reaching their intended target. As a result, torpedoes are often

launched in pairs or volleys. Detonating one only has a 33% chance of causing the others to explode as well.

Cost & M.D.C. Damage Inflicted by Torpedoes & Depth Charges:

Mini-torpedo: 1D6 × 10 M.D. (HE or Plasma). Range: One mile (1.6 km). Cost: 3500 credits each.

Light Torpedo: 2D4 × 10 M.D. (HE) or 1D6 × 10 M.D. (Plasma). Range: 5 miles (8 km). Cost: 8000 credits each missile.

Medium Torpedo: 3D4 × 10 M.D. (HE) or 2D6 × 10 M.D. (Plasma). Range: 10 miles (16 km). Cost: 10,000 credits each.

Heavy Torpedo: 4D6 × 10 M.D. (HE or Plasma). Range: 20 miles (32 km). Cost: 20,000 credits each.

Depth Charges: Basically a bomb that is dropped into the water, sinks and detonates when it reaches a particular depth or hits an object. Maximum range/depth: 2000 feet (610 m) deep — automatically explodes at 2000 feet (or any depth between 200 and 2000 feet/61-610 m); damage: 2D4 × 10 M.D. (HE); cost: 4500 credits each.

Black Eel Torpedo Boat

This is a small, hydrofoil assault craft, designed to destroy larger ships and combat sea monsters. The small boat is built around a single launch tube (its main armament) and is very light and maneuverable. It has become a favorite among adventurers, escort services and pirates.

Model Type: IH-TB12

Class: Torpedo Boat.

Crew: Four: Pilot, navigator/sensors operator, gunner and mechanic.

M.D.C. by Location:

Dual Machinegun — 20

Reinforced Crew Compartment — 70

Depth Charge Launcher (1) — 40

*Torpedo Bay — 100

** Main Body — 125

*If the Torpedo Bay is destroyed, any damage affects the torpedoes inside. If one is destroyed, it explodes and causes a chain reaction, inflicting the combined M.D.C. damage of all the torpedoes left in the bay (so, if there were 5 Heavy Plasma Torpedoes, the explosion will inflict 4D6 × 50 M.D. to the ship and its occupants — don’t bring flowers to the funeral).

**Depleting the M.D.C. of the main body will cause the boat to sink.

Speed: 70 mph (112.5 km)

Maximum Range: 800 miles (1280 km); a fuel driven vessel.

Statistical Data:

Height: 18 feet (5.5 m)

Width: 18 feet (5.5 m)

Length: 25 feet (7.6 m)

Weight: 4 tons

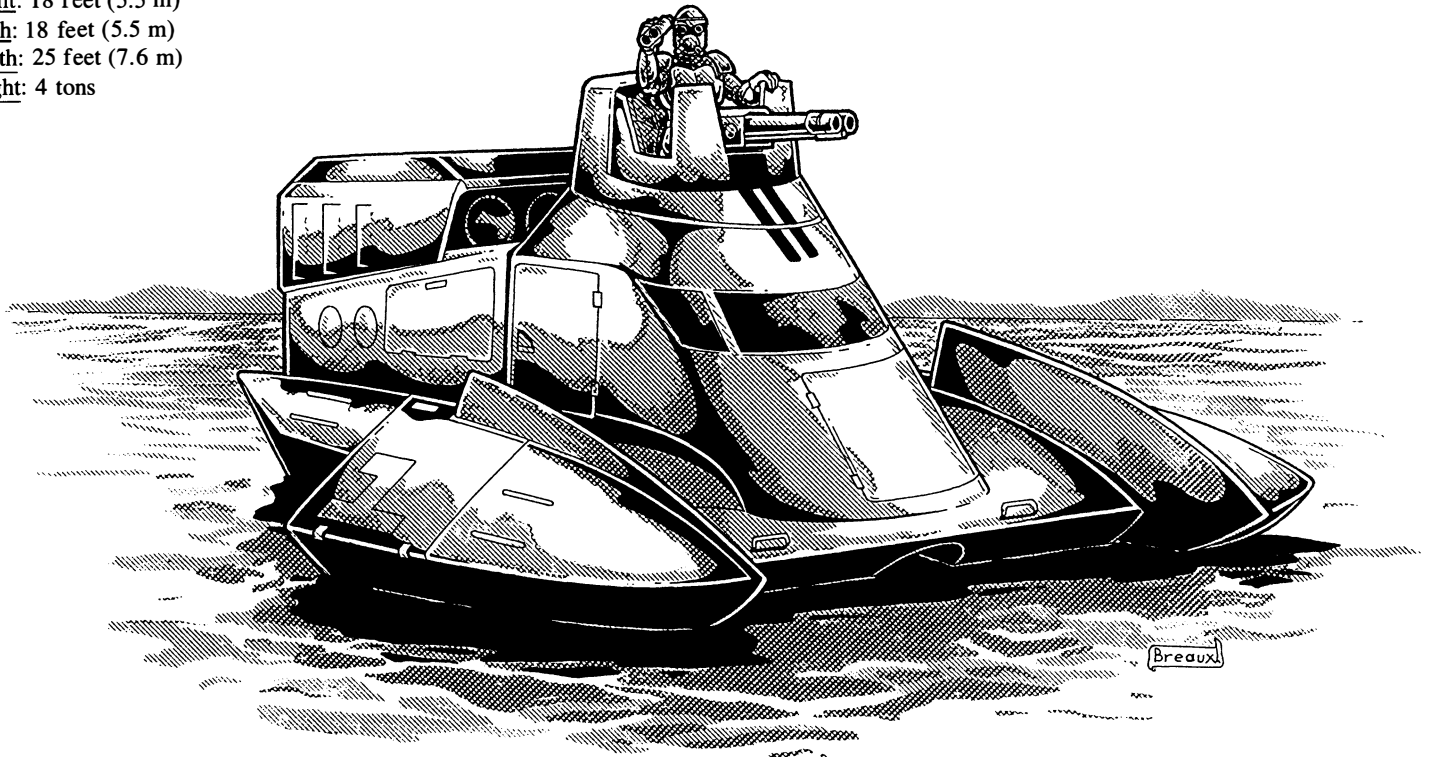

Cargo: A small 3×3 foot (0.9×0.9 m) area.

Power System: Liquid fuel; back-up sail optional (25,000 credits).

Black Market Cost: 100,000 credits not counting the torpedo and depth charge payloads.

Weapon Systems

1. 14mm Machinegun: A heavy, dual machinegun loaded with explosive bullets. The main section of the gun is protected by a small metal shield. The gun is used mostly to fight off other small watercraft and to defend against aircraft. It can also be used to detonate enemy torpedoes.

Primary Purpose: Anti-Vehicle and Anti-Personnel

Secondary Purpose: Defense

Mega-Damage: A burst is 40 rounds and does 1D4×10 M.D. Only fires bursts.

Rate of Fire: Standard

Effective Range: 2000 feet (610 m)

Payload: 2000 rounds (that's 50 bursts).

2. Heavy Torpedo Tube (1): This is the main weapon of the Black Eel. The heavy torpedo can severely damage or sink most small ships.

Primary Purpose: Anti-Ship

Secondary Purpose: Anti-Sea Monster

Mega-Damage: Varies with missile type.

Rate of Fire: Only one torpedo can be launched per melee round.

Effective Range: 20 miles (32 km)

Payload: 6 torpedoes

3. Depth Charge Launcher (1): This weapon is used against vessels and monsters submerged under the waves.

Primary Purpose: Anti-Ship

Secondary Purpose: Anti-Sea Monster

Mega-Damage: 2D4×10 M.D. — explosive canisters.

Rate of Fire: One at a time or volleys of two. One or two can be launched three times per melee round.

Effective Range: 2000 foot (610 m) depth.

Payload: 10

Triton Patrol Boat

The Triton is a small, fast combat boat that uses a hydrooil propulsion system for great speed. It is ideal as a Coast Guard ship or defender to deter pirates, monsters and smugglers. The boat is also well-armed with a complement of missiles, medium-range torpedoes and two heavy rail guns. Additionally, its standard complement of four flying power armor troops gives the Triton limited air reconnaissance and defense capabilities. The flying troopers are often deployed to destroy incoming torpedoes and to pursue escaping vessels. The CS of Free Quebec has bought six Tritons for its shore defense forces. Some coastal kingdoms, smugglers and even a few pirates from South America have made discreet purchases.

Model Type: IH-PB12

Class: Patrol Boat

Crew: 6 to 17: The captain, one navigator, one communications tech, two gunners and a sailor/assistant are the minimum requirements to safely and efficiently operate this boat.

A standard military complement (17 personnel) includes: Captain, second officer, two navigators, three communication technicians, three gunners, two engineers, one doctor, and four seamen.

In an emergency, the ship can be run with as few as three crew members, but only a maximum of three weapon systems can be operated and the short-handed crew is – 1 to strike and – 2 to dodge.

Troop Capacity: Besides the crew, the Triton can accommodate up to twelve power armor marines (usually SAMAS, Flying Titans or Predators, depending on the buyer), regular infantry soldiers or passengers. The ship has a total of 16 double cabins (two bunk beds per cabin), and six personal cabins for officers and important passengers. Additionally, there is a brig with three cells.

M.D.C. by Location:

Bridge — 225

Missile Launcher — 150

Torpedo Tubes (2) — 100 each

Depth Charge Launchers (2) — 55 each

Rail Gun Turrets (2) — 200 each

*Sensor/Communication Array (4) — 100 each

** Main Body — 650

*Destroying all four arrays will blind the ship's sensors and knock-out the communications system (missiles are fired at -2 to strike, relying on their own homing sensors; range for all weapon systems drops to line of sight). Each array is a relatively small target, requiring a called shot at -1 to strike.

** Depleting the M.D.C. of the main body will cause the ship to sink in 1D4 minutes. Inflatable rafts (enough for twice the maximum crew) are stored in special compartments in the ship.

Speed: 50 mph (86 km); cruising speed is about half.

Statistical Data:

Height: 30 feet (9 m)

Width: 9 feet (2.7 m)

Length: 130 feet (39.6 m)

Weight: 250 tons

Cargo: The hold can store up to 10 tons of cargo, in addition to ship basics. Each bunk cabin has a small storage space (about 3 feet/0.9 m) for personal items. A weapons locker holds 24 energy pistols, 12 energy rifles, 6 heavy energy rifles, and 6 missile launchers (for the crew). Weapons issued to the marine force are stored in a different compartment.

Power System: Nuclear; average energy life is 15 years.

Black Market Cost: 200 million credits for a new, undamaged ship with all weapons and accessories. Does not include the marine force or the ammunition, either of which can cost more than the whole ship.

Weapon Systems

1. Mini-Missile Launcher: The missile launcher is located in the stern of the ship. This is an auto-loading missile turret, able to put its entire payload in the air in a few minutes. The missiles' range and the ship's sensors allow the Triton to conduct battles without ever seeing the enemy directly.

Primary Purpose: Anti-Ship

Secondary Purpose: Anti-Aircraft and Defense

Mega-Damage: Varies with missile type.

Rate of Fire: One at a time or volleys of two, four or sixteen missiles! Once the magazine is empty, it must be reloaded from the cargo hold, which requires two trained crewmen and takes 30 minutes.

Effective Range: About one mile (1.6 km)

Payload: The launcher has an auto-loading magazine that holds 160 mini-missiles. The cargo hold has another 320 missiles in storage!

2. Torpedo Tubes (2): The Triton also has a torpedo bay and two tubes. A common tactic against a single foe consists of launching a combined torpedo and missile attack to overwhelm the target's defenses through saturation.

Primary Purpose: Anti-Ship

Secondary Purpose: Anti-Sea Monster

Mega-Damage: 3D4 × 10 M.D. (HE) or 2D6 × 10 M.D. (Plasma).

Rate of Fire: Two attacks per melee round, firing one at a time or two pairs of torpedoes.

Effective Range: About 10 miles (16 km)

Payload: 100 torpedoes (50 per tube)

3. Rail Gun Turrets (2): One turret is located over the bridge; the other is amidships. The rail guns are heavy artillery pieces designed to knock down missiles or enemy aircraft and able to engage enemies who get close enough.

Primary Purpose: Anti-Aircraft and Defense

Secondary Purpose: Anti-Ship

Mega-Damage: A burst is 40 rounds and inflicts 3D4 × 10 M.D.; can only fire bursts.

Rate of Fire: Standard

Effective Range: 11,000 feet (about two miles/3.2 km).

Payload: 8000 rounds in each turret; that's 200 bursts.

4. Depth Charge Launchers (2): This weapon is used against underwater submarines and monsters.

Primary Purpose: Anti-Ship

Secondary Purpose: Anti-Sea Monster

Mega-Damage: 2D4 × 10 M.D. — explosive canisters.

Rate of Fire: One at a time or volleys of two. A single depth charge or a pair can be launched three times per melee round.

Effective Range: 2000 foot (610 m) depth.

Payload: 100 total; 50 depth charges for each launcher.

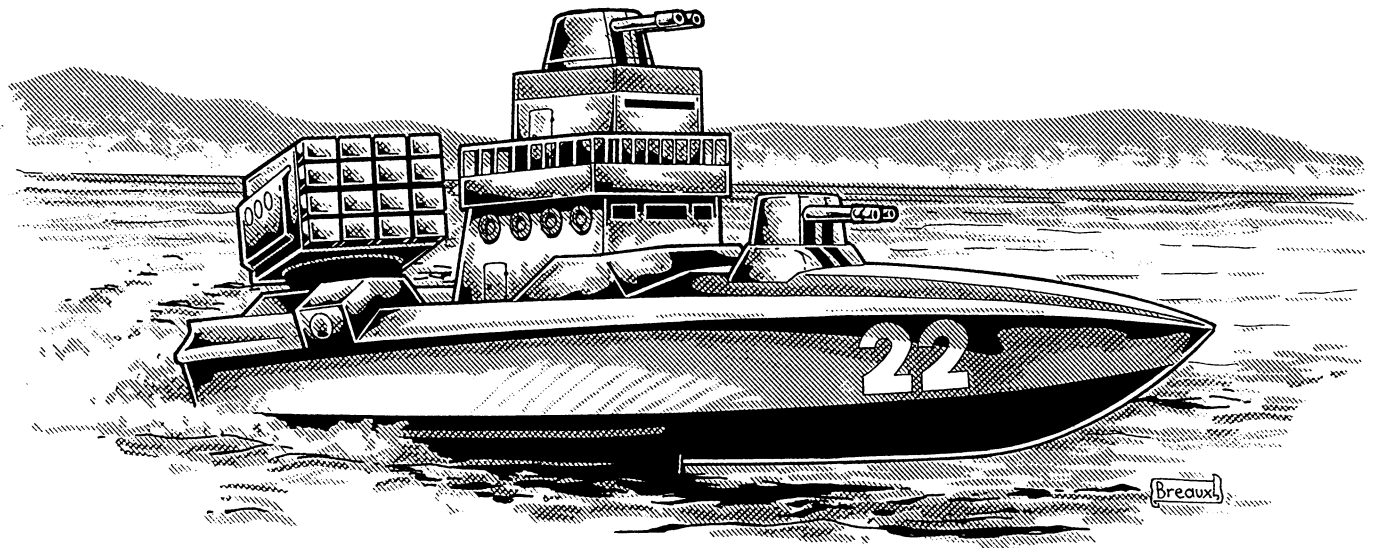

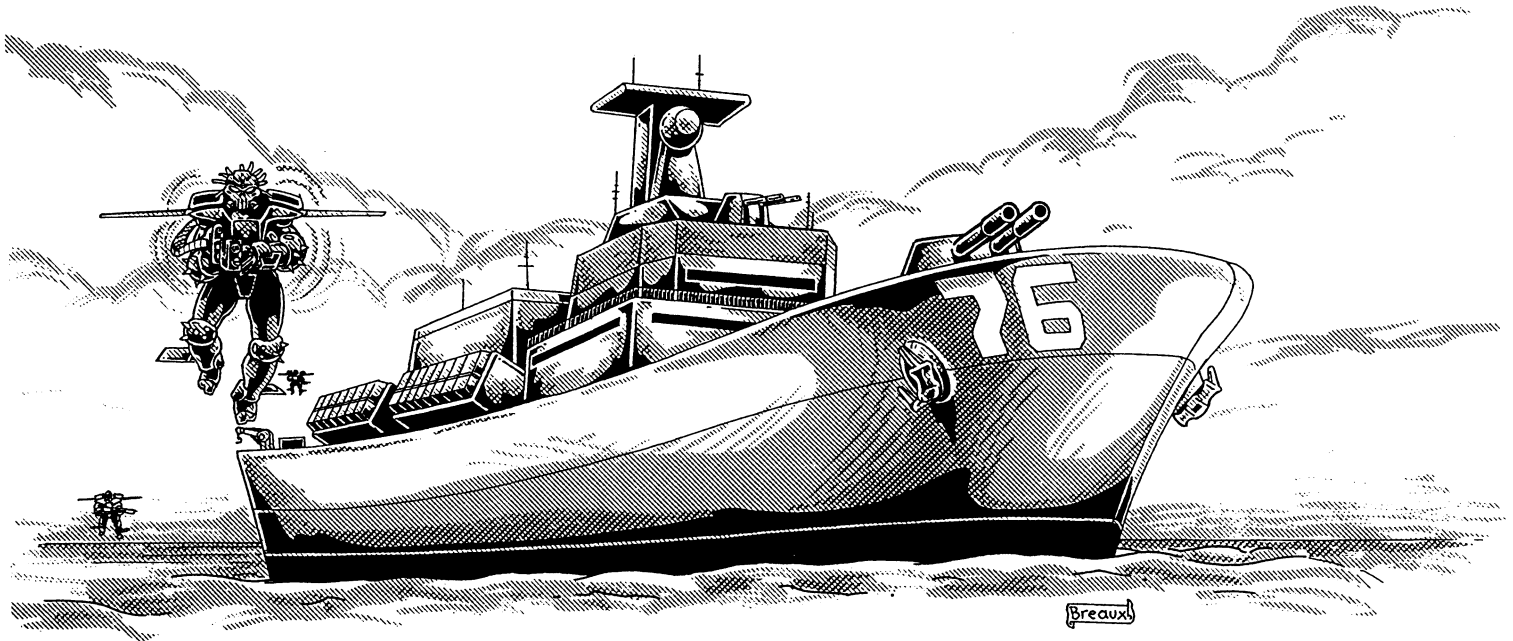

Sea King Missile Cruiser

This is the heaviest ship manufactured by Iron Heart Armaments and only a dozen or so have been produced so far. Free Quebec has purchased four (much to the chagrin of Chi-Town). The others are in the hands of diverse kingdoms and nations or still up for sale.

This 10,000 ton ship seems enormous to most people of Rifts Earth, but is actually based on a design for an American escort ship before the Great Cataclysm. 21st Century flagships were aircraft carriers weighing 90,000+ tons! Still, the Sea King has a lot of firepower, with several missile launchers, six torpedo tubes, high-capacity rail gun cannon, and laser batteries. It carries four modified helicopters and has a complement of 40 Marines in powered armor with flight capabilities (either Triax Predators or Coalition SAMAS, depending on the client). A Quebec owned Sea King managed to destroy a huge, seemingly indestructible monster (actually, a Metzla from Atlantis). After that, Free Quebec created a tiny "fleet" of two Sea Kings and six Tritons navigating the mouth of the Quebec inlet.

Note: The sale of such ships to *private individuals* who operate within the Coalition's territories is illegal. Like the AC-29 Air Castle Bomber, this vessel has been outlawed by the Coalition and, excluding the four Free Quebec vessels, will be destroyed without warning whenever it is encountered.

Model Type: IH-MC1A

Class: Missile Cruiser

Crew: Typically 40-50: Captain, First Officer, four Chief Officers (in charge of navigation, sensors, engineering and weapon systems respectively), two medical officers, three communication technicians, three sensor operators, two navigation technicians, four engineers/mechanics, four nurses, a cook and four assistant cooks, and fifteen seamen all trained in gunnery and other areas of ship operation.

The ship can be piloted by a skeleton crew of eight, but at half efficiency and manning only one weapons system at a time.

Troop Capacity: Typically has a marine force of up to 40 power armor troopers (usually SAMAS or Predators) or 50 infantry soldiers and two to four Iron Trident Helicopters, each with a special sonar array for detecting submarines and sea monsters. The ship has 42 double cabins for the crew and marines, and 12 single cabins for officers and important passengers. The brig can house up to 12 people.

M.D.C. by Location:

Bridge — 500

Missile Launchers (4) — 150 each

Torpedo Tubes (6) — 100 each

*Sensor/Communication Array (4) — 100 each.

Rail Gun Turrets (2) — 150 each

Cannon Turret (1) — 350

Depth Charge Launchers (2) — 55 each

** Main Body — 2600

*Destroying all four arrays will knockout the ship's sensor and communication systems (missiles are fired at -2 to strike, relying on their own homing sensors; range for all weapon systems drops to line of sight). Each array is a relatively small target requiring a called shot at -1 to strike.

** Depleting the M.D.C. of the main body will cause the ship to sink in 1D4 minutes. Inflatable rafts (enough for twice the maximum crew) are stored in special compartments on the ship.

Speed: 40 mph (64 km)

Statistical Data:

Height: 55 feet (16.7 m)

Width: 32 feet (9.75 m)

Length: 565 feet (173 m)

Weight: 10,000 tons

Cargo: Can store 1,000 tons of nonessential equipment and supplies.

Power System: Nuclear, with an average life of 20 years.

Black Market Cost: About 600 million credits.

Weapon Systems

1. Missile Launchers (4): The missile launchers are located to the stern of the ship in two rows. They are the main weapon systems of the Sea King. These auto-loading missile turrets can fire off their entire payload in a couple of minutes. The missiles' range and the ship's sensors allow the Sea King to conduct battles without ever seeing the enemy directly. Launchers are controlled from the bridge, sometimes by a single gunner/operator.

Primary Purpose: Anti-Ship and Anti-Aircraft.

Secondary Purpose: Defense

Mega-Damage: Varies with missile type. Medium and Long-Range missiles can be used.

Rate of Fire: One at a time or volleys of two, four or sixteen missiles! Once the magazine is empty, it must be reloaded from the cargo hold,

which requires two trained crewmen and takes 30 minutes.

Effective Range: 50 to 500 miles (80-800 km) depending on type.

Payload: Each launcher has an auto-loading magazine that holds 160 missiles. The cargo hold has another 560 missiles in storage.

2. Torpedo Tubes (6): The Sea King also has a torpedo bay and six tubes which fire "heavy" torpedoes. Four crew members must be at the torpedo bay to prepare the weapon.

Primary Purpose: Anti-Ship

Secondary Purpose: Anti-Sea Monster

Mega-Damage: 4D6 × 10 M.D.; same damage for heavy HE and plasma torpedoes.

Rate of Fire: Up to 6 per melee round.

Effective Range: About 20 miles (32 km)

Payload: 600 torpedoes (100 per tube)

3. Long-Range Rail Gun Turrets (2): One turret is located over the bridge. The other is amidships, over the larger Cannon Turret. The rail guns are heavy artillery pieces designed to knock down missiles and enemy aircraft, as well as to engage other seagoing vessels at a distance. Each turret is manned by one crewman or can be controlled from the bridge.

Primary Purpose: Anti-Aircraft and Anti-Ship

Secondary Purpose: Defense

Mega-Damage: A burst is 40 rounds and inflicts 3D4 × 10 M.D.; can only fire bursts.

Rate of Fire: Standard

Effective Range: 11,000 feet (about two miles/3.2 km).

Payload: 8000 rounds in each turret (200 bursts).

4. Eight-inch Naval Guns (2): These massive cannons are mounted on a heavy turret at the bow of the ship. They were not part of the original design, but the weapon engineers at Iron Heart Armaments believed that the artillery would make the ship more intimidating. Besides, they had found the cannon in the remains of another pre-rifts ship and copied the design. Whatever the reasons, these two cannons add to the firepower of the ship. The cannon's rounds use special propellants that give them great range and damage capabilities.

Primary Purpose: Anti-Ship

Secondary Purpose: Anti-Shore Installations.

Mega-Damage: 4D6 × 10 M.D. to a blast radius of 50 feet (15.2 m).

Rate of Fire: Up to four shots per melee (two per cannon).

Maximum Effective Range: 20 miles (32 km)

Payload: 60 total; 30 rounds per each gun. Reloading from the hold of the ship requires two crew members and takes 10 minutes.

5. Depth Charge Launchers (2): one unobtrusive depth charge launcher is located at opposite ends of the ship.

Primary Purpose: Anti-Ship

Secondary Purpose: Anti-Sea Monster

Mega-Damage: 2D4 × 10 M.D. — explosive canisters.

Rate of Fire: One at a time or volleys of two. A single depth charge or a pair can be launched three times per melee round.

Effective Range: Up to 2000 feet (610 m)

Payload: 50 depth charges in each launcher; plus another 200 in storage.

6. Iron Trident Helicopters: These choppers have the same stats as the Iron Eagle (see above), but fire torpedoes and have pontoons for landing on calm waters. The Iron Tridents are also used to support the power armor marines in boarding enemy vessels and amphibious assaults.

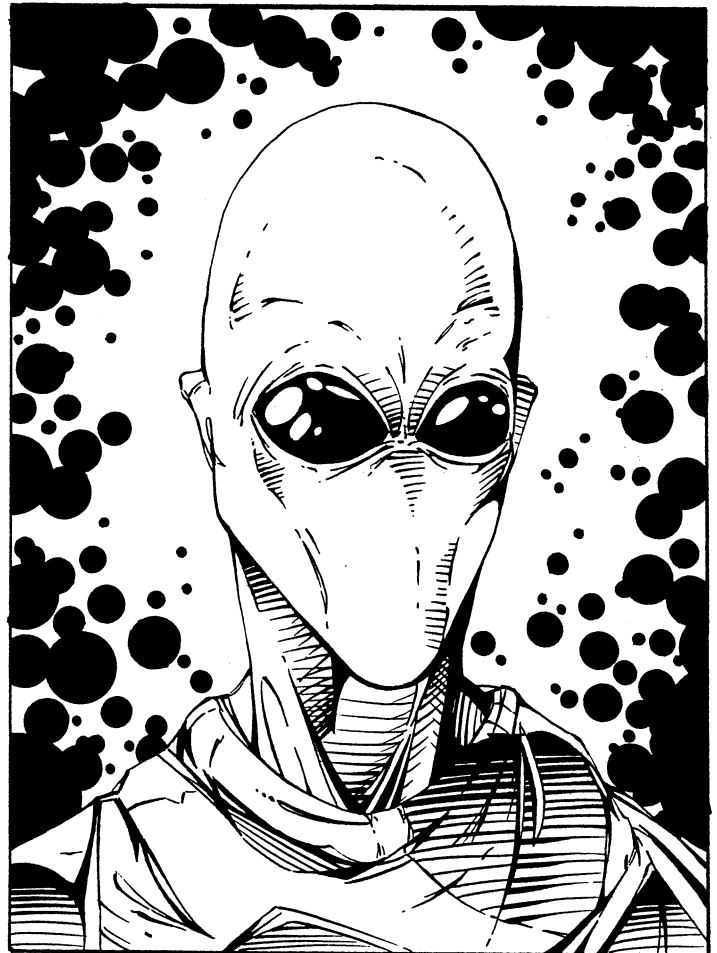

Naruni Enterprises

All that Earth's inhabitants know about **Naruni Enterprises** is that it is a mysterious corporation that operates in the wilderness and among some independent kingdoms throughout North America. The Coalition States want nothing to do with the organization and have outlawed the possession of Naruni weapons in any of the Coalition States. The CS has branded the corporation as a dangerous subversive organization dedicated to undermining the human race. As proof, they point to the facts that the organization is obviously controlled by D-Bees and deliberately sells to the enemies of humankind. Many have interpreted this to mean Naruni Enterprises refuses to sell exclusively to the CS and sells to anybody with cash in hand, including D-bees, the folks at Tolkeen, and other non-allied and non-human factions.

The Coalition States are not the only ones concerned with the presence of Naruni Enterprises. Other weapon manufacturers, including Northern Gun, Wilk's and all of those featured in this section, suspect that the presence of Naruni Enterprises means trouble. The Splugorth of Atlantis and their minions know the Naruni to be dangerous transdimensional competitors and are not happy to learn that they have discovered Rifts Earth. **Note:** See the section on the mercenary company known as **Robot Control** for complete details about how Northern Gun, the CS, Splugorth and others feel about Naruni Enterprises and their plots to undermine the newcomers.

Interdimensional Arms Dealers

The Naruni are alien arms dealers from another dimension. Like the Splugorth, they sell and trade throughout of the Megaverse. Presently, they are about half as well known, powerful, and hated as the Splugorth.

No one race runs the transdimensional corporation. Rather, its employees are chosen from all over the Megaverse, with a preference toward those from high-tech worlds. However, most of Naruni Enterprises' top management and owners are members of the Naruni race (see *Trader Joe* in the section describing **Robot Control** for the alien's stats as an optional R.C.C.). Naruni factories are located in other dimensions, where hundreds of thousands of vehicles, weapons and munitions are produced every day for sale on hundreds of worlds.

Naruni Enterprises and the Splugorth are ruthless competitors so the Naruni try to avoid dealing with them or Splugorth controlled worlds. The Splugorth have no liking for the corporation, whom they see as a group of meddlers and an increasingly annoying rival in transdimensional commerce currently dominated by the Splugorth. The fact that Naruni Enterprises seems to frequently arm the enemies of the Splugorth hasn't helped relations between the two either. The weapons and vehicles sold by Naruni Enterprises are among the best in the Megaverse. Only the Kittani and similar high-tech civilizations can match them. However, Naruni items are very expensive.

To make a sale, the salespeople at N.E. allow governments and large businesses to buy on credit. The weapon merchants are friendly, cheerful and helpful in consummating the sale, but when it is time to collect the debt, the corporation is ruthless! If the purchaser cannot pay in cash, the corporation will consider trading goods or services, but is more inclined to acquire (seize) mining and land rights as payment. On several worlds, this credit and collection policy has enabled Naruni Enterprises to seize entire planets! Naruni Enterprises will get its money any way it can. In some instances they have taken the entire population of a indebted kingdom or planet to sell into slavery. In other cases, it has forced the population to build and operate high-tech factories and into a life of hard labor. Beautiful land, sometimes entire planets are transformed into giant, smoke-belching factory worlds. Few dare to fight Naruni Enterprises because they have resources across the Megaverse and access to troops, allies and weapons that dwarf any one planet or even most collectives of planets. The corporation can be heartless and in this regard they aren't much better than the Splugorth (although they don't make a practice of slave trading nor do they engage in the horrible science of bio-wizardry).

Rifts Earth is seen as an incredible land of opportunity for the weapons dealers. The many conflicts and uneven range of technology provides a multitude of clients. More importantly, Earth has become a dimensional gateway to a thousand different worlds, many of which have not yet been exposed to the charm and opportunities Naruni Enterprises has to offer them. The corporation is aware of the Splugorth's strong presence in Atlantis and has decided to infiltrate North America. For now, it is content with opening a few "trading posts" on that continent, but is planning expansion and economic domination within the next 30 years. Naruni Enterprises had considered setting up its base of operations in Europe, but the Splugorth influence (through the Gargoyle Kingdom) is too strong and the general environment too unstable. China isn't much better, and most of the rest of the world has its own share of problems.

They see the Coalition States as their only serious obstacle in North America. They and other human supremacist groups will try to prevent humans from making deals with extra-dimensional manufacturers such as they. Naruni Enterprises tries to avoid direct conflicts with the Coalition States, but made the potentially fatal mistake of approaching them first and alerting them to their presence. After being rebuffed by the CS (the three Naruni Enterprises sales representatives barely escaped

with their lives), the corporation has focused the majority of its attention on several independent kingdoms and cities in the Americas. In the future, they hope to set them against the Coalition to clear the way for easy exploitation of the Americas. However, the corporation's strategists have been so blinded by the incredible potential Earth has to offer and are so cocky, that they have failed to include other powerful forces in their equation for economic conquest. The most notable include Northern Gun, Manistique Imperium, Wilk's, Triax and other weapon manufacturers. They also fail to realize that there are dedicated enemies of the CS, like the nation of Lazlo and many powerful heroes, who will fight alongside the Coalition to keep their planet free from alien tyrants and con-men like those employed by Naruni Enterprises. In this case, the Coalition would be seen as the lesser of two evils. Then there are the Splugorth who should never be underestimated.

The secretive A.R.C.H.I.E. 3 has also caught wind of these interdimensional traders and is cautiously investigating them himself. Whether the strange machine intelligence will ally himself with the aliens, humans or stay neutral is yet to be seen. However, since the Mechanoid crisis, he and Hagan are incredibly leery of aliens.

For the present, Naruni Enterprises is blissfully operating as if they are in complete control. A representative for the corporation has allied himself to **Robot Control**, an elite force of mercenaries who find Naruni products very attractive. Other reps are actively dealing with Kingsdale and factions within the Pecos Empire, while others are attempting to solicit sales at Tolkeen and the Federation of Magic, among many other lesser known kingdoms.

Naruni Enterprises brings vehicles, weapons and equipment to Earth by opening a dimensional rift. However, there are no permanently opened rifts connecting any of their alien manufacturing or storage facilities to Earth.

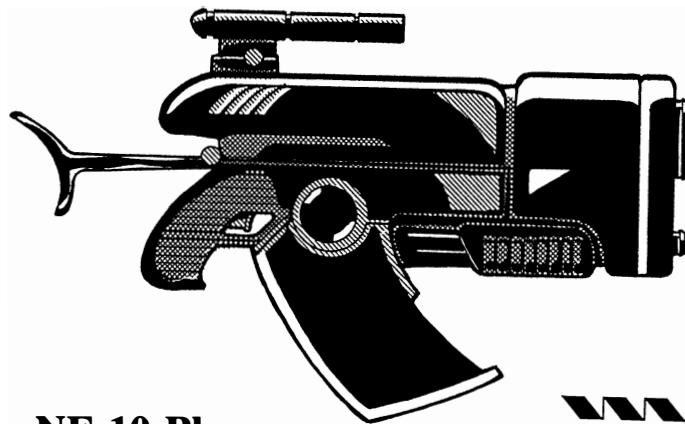

NE-10 Plasma Cartridge Rifle

This weapon is an energy rifle that does not require an E-Clip. Instead, it uses thick cartridges that have a small impact primer. When the primer is hit by the mechanical weapon, the cartridge is converted into energy, causing a plasma discharge. The blast inflicts a lot of damage, but the weapon has a very limited range. Furthermore, it has the drawback that the ammunition cannot be duplicated with Earth technology and **MUST** be purchased from Naruni Enterprises. The gun's bore is almost two inches wide — having it pointed your way is very intimidating.

Weight: 20 lbs (9 kg)

Mega-Damage: 1D4 × 10 per single shot.

Rate of Fire: Standard

Maximum Effective Range: 1200 feet (365 m).

Payload: 20 shot Magazine

Black Market Cost: 40,000 credits for the gun. Each round costs 40 credits, so a full magazine costs 800 credits.

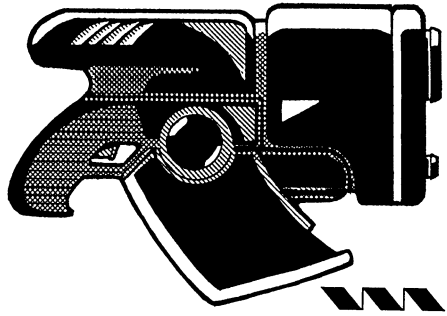

NE-4 Plasma Cartridge Pistol

The pistol version of the same weapon; it fires the same cartridges and inflicts the same damage, but has reduced range. It is very heavy and cumbersome for a pistol, but firepower fans love it. Characters with a P.S. of 17 or less are -2 to strike even on an aimed shot.

Weight: 6 lbs (2.7 kg)

Mega-Damage: 1D4 × 10 M.D.

Rate of Fire: Standard

Maximum Effective Range: 500 ft (152 m)

Payload: 10 shot magazine

Black Market Cost: 25,000 credits for the gun. Each round costs 40 credits, so a full magazine costs 400 credits.

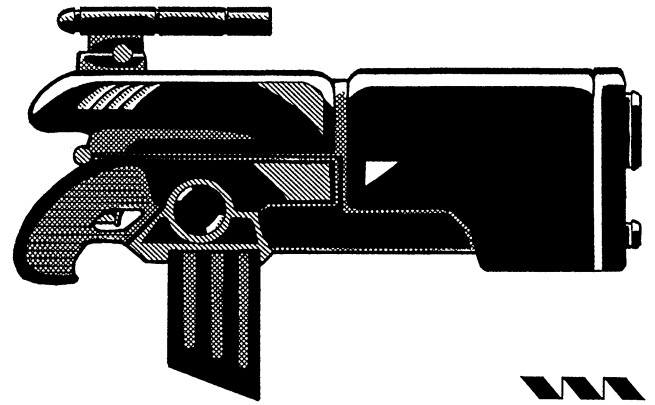

NE-50 Particle Beam Rifle

A heavy energy rifle that has been "modified" to operate on Earth type "E-clips."

Weight: 13 lbs (5.9 kg)

Mega-Damage: 1D4 × 10 M.D. per blast

Rate of Fire: Standard

Maximum Effective Range: 1200 feet (365 m).

Payload: 8 shots from a standard "short" E-clip or 16 from a long E-clip.

Black Market Cost: 45,000 credits.

Note: The NE-50 (unmodified) particle beam rifle sold in other dimensions has a range of 1600 feet (488 m) and an NE energy clip can fire 24 shots; same damage. This weapon has not been offered to the Earth market yet, but may be used by some of the sales reps.

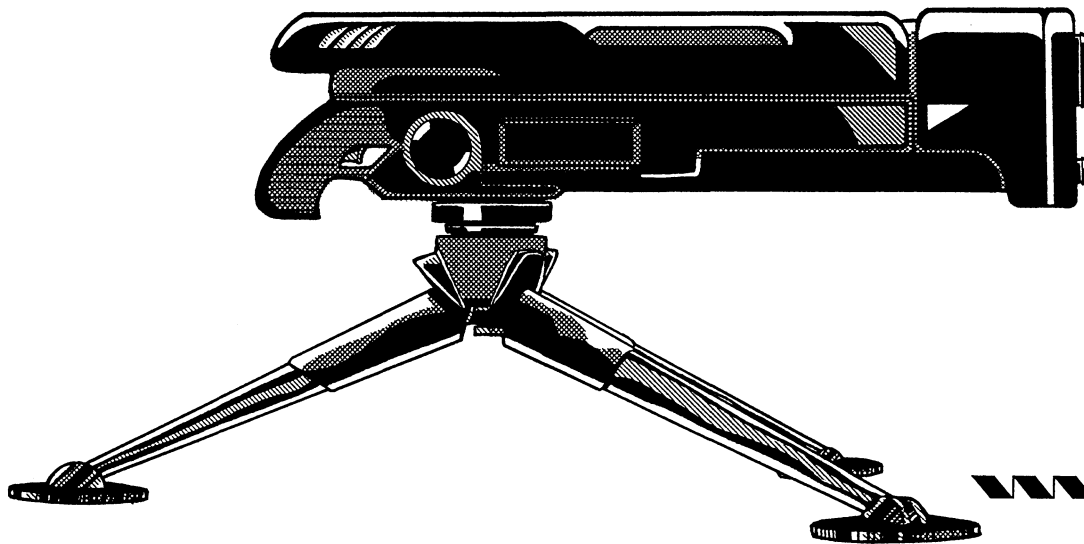

NE-200 Plasma Cartridge Machinegun

This is a belt-fed, heavier version of the NE-10 rifle, used as a tripod or vehicle mounted weapon. There is also an oversized rifle version suitable for use by power armor troops, cyborgs and bots (that model has a 40-shot magazine). The user must have a P.S. 24 or greater.

Weight: 70 lbs (31.7 kg) with magazine. The belt weighs another 15 lbs (6.8 kg).

Mega-Damage: 1D4 × 10 M.D. per single shot, or 2D6 × 10 M.D. for a burst of 10 shots.

Rate of Fire: Standard

Maximum Effective Range: 2000 feet (610 m)

Payload: 200 shot belt or 40 shot magazine.

Black Market Cost: 95,000 credits. Each round costs 40 credits, so a full magazine costs 1600 credits and a belt, 8000 credits.

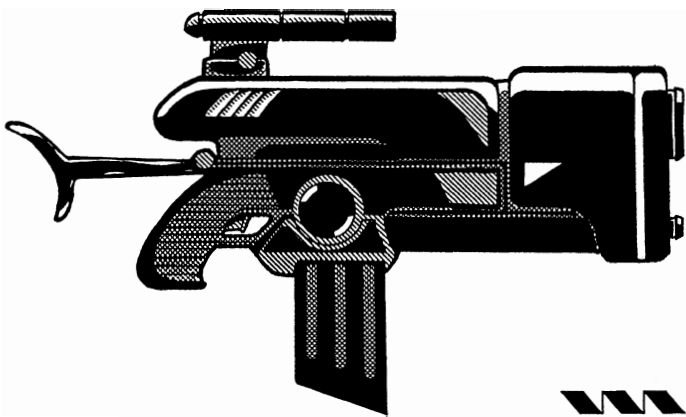

NE-1000 "Modified" Plasma Ejector Rifle

A heavy energy rifle that looks a lot like the cartridge rifle but works on energy clips. The "modified" version has been adjusted to operate on Earth type "E-clips."

Weight: 22 lbs (10 kg)

Mega-Damage: 6D6 M.D. per blast

Rate of Fire: Standard

Maximum Effective Range: 2000 feet (610 m).

Payload: 8 shots from a standard E-clip or 16 from a long E-clip.

Black Market Cost: 36,000 credits.

Note: The NE-1000 (unmodified) plasma rifle sold in other dimensions has a range of 3000 feet (914 m) and an NE energy clip can fire 30 shots and does 1D4 × 10 M.D. per blast. This weapon has not been offered to the Earth market yet, but may be used by some of the sales reps.

NE-C20 Camouflage Variable Armor

This is a light and durable suit of combat armor with a fiber-optic material that can change colors to match the general environment. The color change takes 1D4 melees (15 to 60 seconds), in which the suit becomes the exact same color as the predominant one in the area. In the woods, the suit will also create stripes and blotches of lighter and

darker color like a camouflage pattern. In all cases, the wearer is difficult to spot: -20% for others to detect ambush and detect concealment, +5% to the wearer's prowl skill, and even characters without prowl have a 40% chance of not being seen if they stay under cover and don't move).



The suit also masks infrared and thermal emissions, making the wearer's heat invisible to infrared and thermal optics! There's only a 21% chance of showing up on thermal systems and even then the reading/image will seem unusual. This feature has made the armor extremely popular.

- M.D.C.: 80
- Weight: 13 lbs (5.8 kg).
- Fair Mobility, -5% to prowl.
- Black Market Cost: 75,000 to 100,000 credits depending on the seller and availability. Excellent availability from Trader Joe with Robot Control, terrible availability most everywhere else.

Camouflage Sheets

These sheets are made of special fiber-optics designed to completely blend with the surrounding terrain. Enough of these sheets can make a tank or a giant robot look like part of a hill or a forest. As long as the men and vehicles under the sheets remain motionless, the sophisticated chameleon fibers of the sheet will imitate the area's colors and take the appearance of an inanimate object. The sheets also offer some protection (about 10 M.D.C.), but as soon as they take damage, the chameleon effect is dissipated. The sheet also has micro-sensors that allow vehicles or armor helmets to see through them, provided they are properly connected.

Black Market Cost: 15,000 per 10 square foot (1 square meter) section.

Personal Force Fields

Naruni Enterprises offers force fields, the latest development in personal defense technology. Unlike suits of armor, force fields are light and noncumbersome (no penalty to prowl rolls). The force fields that Naruni Enterprises sells work by reacting to energy beams, fire and fast-moving objects (like bullets and punches); the field absorbs and disperses the incoming energies.

It is possible for an enemy attacker to move very slowly and press a weapon against the skin of the wearer and strike (shoot, cut, etc.) without triggering the force field, but this is much easier said than done. Such attacks are made at -6 to strike, unless the target is unable to move away and even then any sudden movement will activate the field of protective force. Unlike environmental armor, the force field offers no protection against magic, psionics, disease, gases, water, heat, cold, radiation or other hostile environments. This means the user of the force field can drown if submerged under water, bake in the sun, burn from the heat of a fire, choke on a toxic gas cloud, and so on.

If the M.D.C. of the field is depleted, it overloads and cannot be reactivated for 12 hours. As long as the M.D.C. has not been overloaded, it regenerates lost M.D.C. at the rate of one point per melee round (that's four M.D.C. per minute).

The force fields of Naruni Enterprises need a source of energy and have been modified to use normal E-clips from energy weapons. One E-clip will keep force fields active for a period between 6-12 hours, depending on the power of the field (see below). Naturally, this means that force fields cannot be left "on" all the time, but only when battle is imminent.

It is NOT possible to wear armor under a force field, unless the field generator is built into a conventional environmental suit or power armor; a fairly simple modification that costs 30,000 to 40,000 credits and takes 1D4 days to install. When connected to a nuclear power generator like those used in power armor, the field can run indefinitely, but is still subject to overload if all the M.D.C. is depleted.

Payload/Duration: 6-12 hours per E-clip depending on the type of force field. A new E-clip can be installed just like with a gun, pop out the old cartridge and put in a new one — which takes about four seconds.

Using one of Northern Gun's new power packs can keep a light or medium force field running for 36 hours and the heavy types for 24 hours before needing a fresh power pack or energy clip.

Activation: Activating the field after putting in a new E-clip and turning it on takes half a melee round (about 7 seconds). It will protect the wearer immediately after full activation cycling is completed.

Note: There are also equivalents of all force field classes for use in robots and cyborgs. They offer double the mega-damage protection, but they cost 20 times as much!

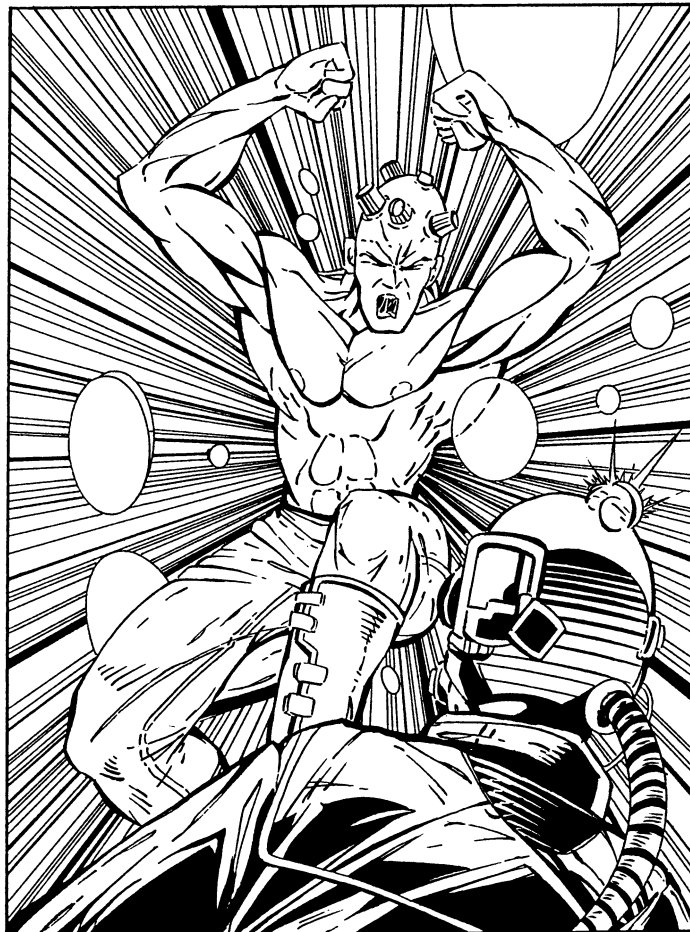

N-F10A Light Force Field

This is the lightest model available and is worn as two crossed belts over the person's torso (at no charge, those belts can be converted into bandoliers for holding grenades or E-clips; each bandolier strap can hold 6 grenades or 4 E-Clips).

- M.D.C. 45
- Weight: 8 lbs (3.6 kg)
- No movement penalties.
- 12 hour duration per E-clip.

Black Market Cost: 40,000 credits

N-F20A Medium Force Field

Virtually identical to the N-10A. An E-Clip will power the force field for 10 hours.

- M.D.C. 75
- Weight: 10 lbs (4.5 kg)
- No movement penalties.
- 10 hour duration per E-clip.

Black Market Cost: 60,000 credits

N-F40A Heavy Force Field

This force field requires a harness system, and is slightly heavier than the medium force field.

- M.D.C. 110
- Weight: 15 lbs (6.8 kg)
- No movement penalties.
- 8 hour duration per E-clip.

Black Market Cost: 120,000 credits

N-F50A Superheavy Force Field

This is the most powerful force field available. It looks and weighs the same as the N-F40A field, but is much more intense.

- M.D.C. 160
- Weight: 15 lbs (6.8 kg)
- No movement penalties.
- 6 hour duration per E-clip.

Black Market Cost: 200,000 credits

Naruni Vehicles

Naruni Enterprises produces a number of tanks, aircraft and other vehicles. The company also manufactures robot combat drones that can act on their own or be remote controlled. Drones have no capacity for passengers.

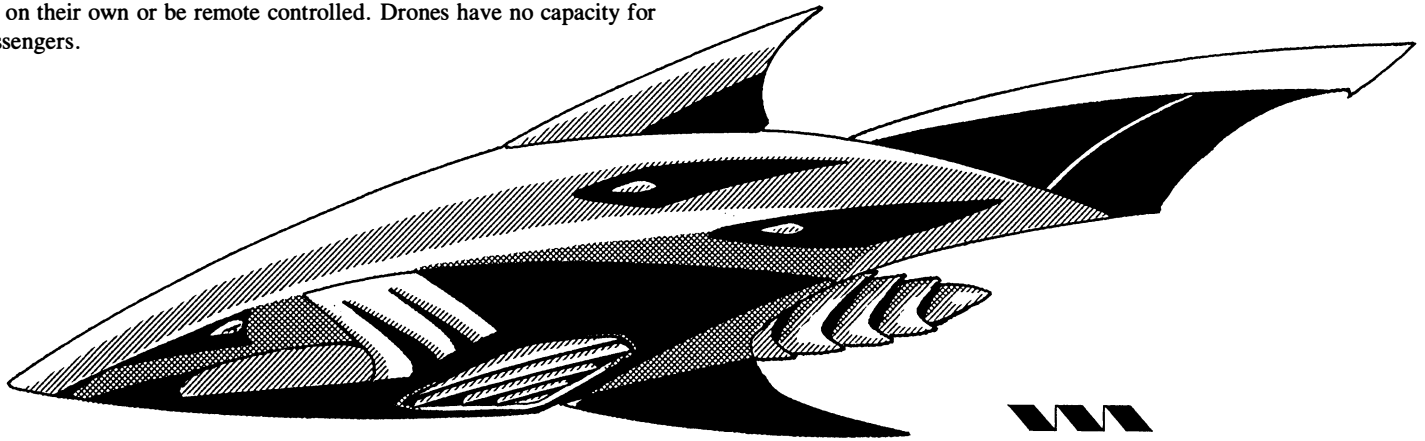

NE-010 Destructo-Drone

This is a flying robot drone that is little more than an intelligent missile! The drone is fish-shaped, using its tail like a rudder for quick moves in the air. It has a rudimentary computer and navigation system, and basic sensor capabilities. It attacks by flying full-speed at the target and detonating its payload. It has a light laser, mostly for anti-missile/self-defense purposes, but it will shoot the laser at the intended target (or secondary targets or nearby defenders) while in pursuit on its suicide run. The Destructo-Drone can be programmed to accept launch orders from an operator, a Combat Drone, or a Combat Pod. By itself, it can be easily fooled; it is best used as a secondary weapon.

Unlike a normal missile, the drone's slower speed allows it to correct its course, avoid obstacles, dodge enemy attacks, and turn around if it misses its target on the first pass. Likewise, it can follow targets that take evasive action. If it loses its target, the smart bomb can stop, land, and wait until "the target" reappears, or another programmed target comes on the scene!

The explosive charge in the drone is as potent as most long-range missiles'. The Destructo-Drones don't have nuclear engines. Instead, they have a limited power supply that can carry them about 2400 miles (3840 km). They do have a power cord that allows the drones to recharge their batteries off any nuclear engine!

These incredible smart bombs are often dispatched with a Spy or Combat Drone and can recharge off them, if necessary. Otherwise, once activated, the drone's power will run out in about 24 hours of continual flight (72 hours if it stops and remains dormant most of the time) or until it finds its target and explodes, whichever comes first. One great tactic is to leave a half dozen or more Destructo-Drones behind retreating troops or as an ambush, so that the missiles can attack advancing enemy bots, armored vehicles or low flying aircraft and power armor. The drone is most effective against armored ground vehicles, bots and power armor.

Model Type: NE-010 Smart Bomb

Class: Naruni Infantry Drone Missile

Crew: None

Speed: Hover stationary, cruising speed 200 mph (320 km) or up to 400 mph (643.6 km) at full missile speed. Maximum hover height is 5000 feet (1524 m).

Effective Range: 2400 miles (3840 km) without recharging; battery life is 24 to 72 hours depending on activity of the missile.

Size: 2 feet (0.6 m) in diameter, 7 feet (2.1 m) long.

Weight: 500 lbs (225 kg)

M.D.C. by Location:

Small Assault Laser (1) — 15

Lower Hover Jets (3) — 10 each

Main Rear Rocket Jet (1) — 30

Main Body — 70

Mega-Damage: Small Light Laser: 2D6 M.D. Explosive Charge: 3D6 × 10 M.D. to a 15 feet (4.6 m) area.

Rate of Fire: Four laser blasts per melee.

Effective Range: Laser: 2000 feet (610 m).

Payload: 100 laser blasts.

Robot Defense System: Combat programs enable it to recognize, locate and identify targets 89%, hide and prowl at 48%, land navigation 89%, detect ambush 50%, detect concealment 48%, and can recognize 1000 different targets.

Bonuses: +2 on initiative, +6 to strike, +8 to dodge, four attacks per melee (laser; one impact attack destroying the drone).

Sensors & Optics: Infrared, passive nightsight and laser targeting. Motion detector and radar (can track 24 different targets, one mile/1.6 km range). Full radio transmission and reception, plus radio scrambler.

Black Market Price: 250,000 credits. This may seem expensive for a device that can only be used once, but these drones can be incredibly effective!

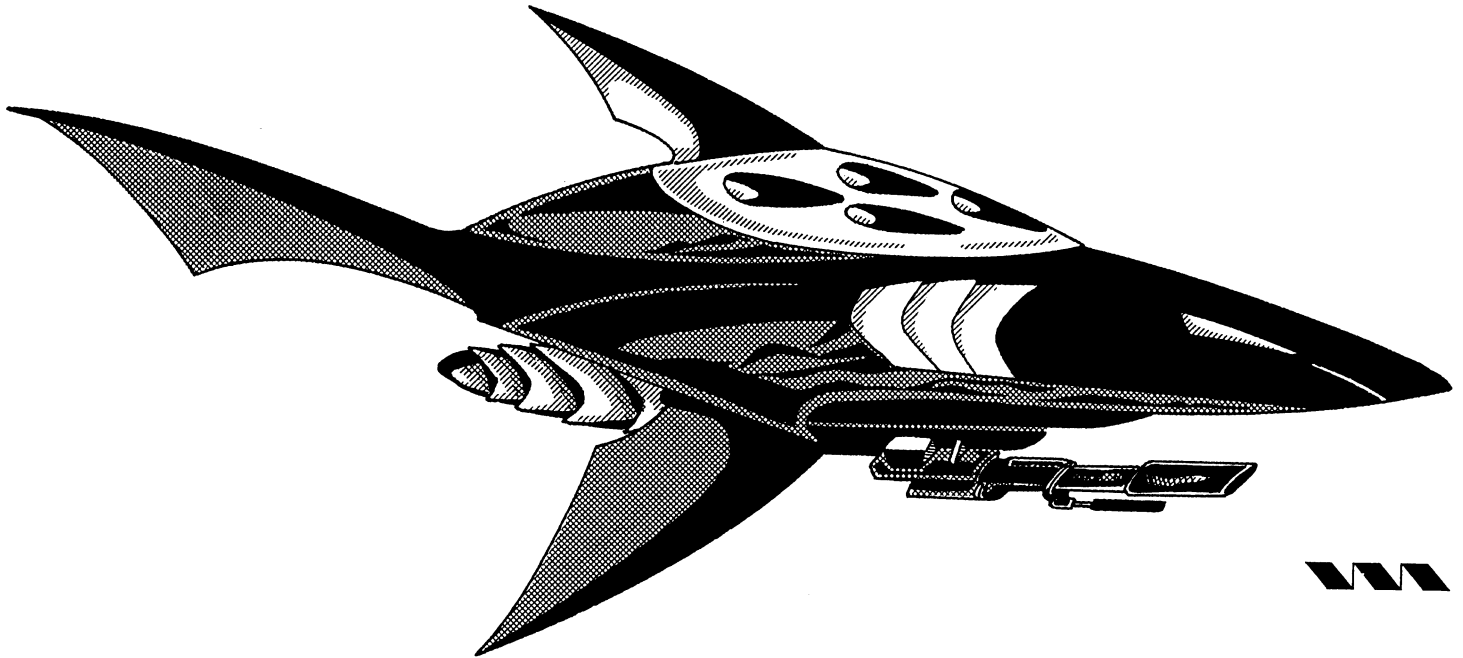

NE-020 Combat Drone

A combat drone is a heavy laser cannon and a mini-missile launcher with hover jet propulsion and robot response system. The robot “brain” simulates the abilities of a human gunner, while the hover system and small size allows the bot drone to maneuver better than an infantryman or biped robot. Like most robots, the drones lack imagination and initiative. They blindly follow orders which can sometimes be as much a curse as a blessing. Combat drones are especially useful for groups that have limited manpower and for hazardous missions.

Combat drones can also be directed through a remote control computer. The computer screen shows the drone’s controller whatever the drone is sensing/experiencing so that he can react accordingly — the sensation is similar to playing a video game. A more advanced Virtual Reality System can also be used, giving the wearer the illusion that he is actually the drone! The VR system costs half a million credits — the remote control and simple robot brain are part of the standard package.

Model Type: NE-020 Combat Platform

Class: Naruni Infantry Drone Robot

Crew: None

Speed: Hover in a stationary position or up to 60 mph (96 km). Maximum hover height 600 feet (182 m).

Size: The main body is one foot (0.3 m) thick, 3 feet (0.9) wide and 6 feet, 6 inches (2.0 m) long.

Weight: 650 lbs (292.5 kg)

Power System: Nuclear

M.D.C. by Location:

Sensor Antenna (3) — 20 each

Mini-Missile Launcher — 35

Laser Cannon — 120

Lower Hover Jets — 40

Main Body — 100

Mega-Damage: Laser Cannon: 5D6 M.D. per blast.

Mini-Missiles: Damage varies with missile type.

Rate of Fire: Six attacks per melee round; any weapon combination.

Effective Range: Laser Cannon: 4000 feet (1200 m); mini-missiles vary with type, about one mile (1.6 km).

Payload: Effectively Unlimited for the laser. Mini-missiles: Eight; any type.

Robot Defense System: Combat programs enable it to relocate to a better position, hide and take evasive action, perform rudimentary strategy and tactics: detect ambush 80%, detect concealment 68%, land navigation 80%, intelligence 80%, prowl 60%, and can recognize 1000 different targets.

Bonuses: +1 on initiative, +2 to strike and parry, +4 to dodge; impervious to gas, poison, mind control, magic illusions and horror factor (unless controlled by a human operator).

Sensors & Optics: Full range optics equal to a multi-optics helmet, including thermo-imager, infrared, ultraviolet, passive nightsight, telescopic, and laser targeting. Motion detector, heat sensor, radiation sensor, radar detector, radar (can track 48 different targets, one mile range), enhanced hearing, full radio transmission and reception, radio scrambler.

Black Market Price: Four million credits for a standard drone.

NE-030 Spy Drone

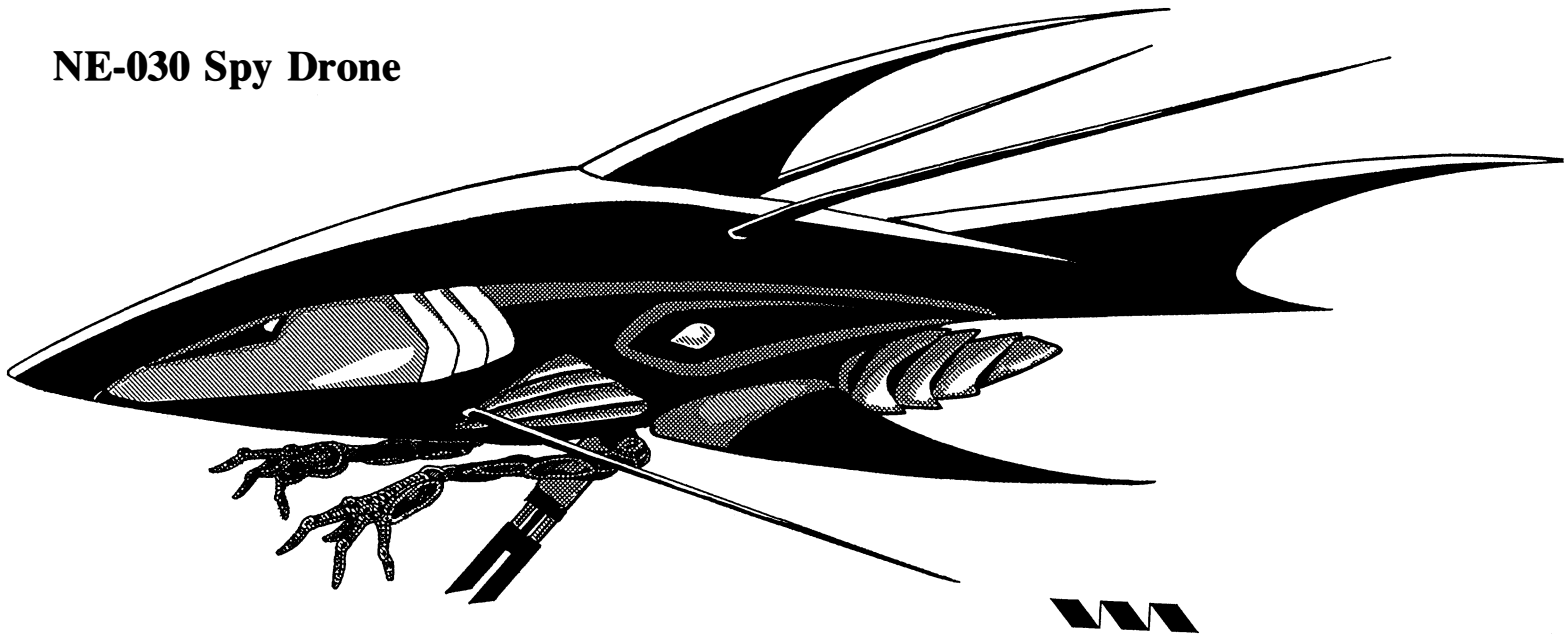

A drone used for reconnaissance and covert operations. It is equipped with an advanced stealth configuration and has a camouflage fiber-optic exterior similar to the variable armor. It also has a sophisticated sensor system and a good deal of information processing capabilities. Its hover system has special sound-suppressors that make it effectively noiseless (prowl 89%). The Spy Drone can be linked with up to four other drones, such as the Combat Drone or Destructo-Drone, which it can control. In a combat situation, the spy drone will try to remain hidden while it directs the attacks of the others.

Model Type: NE-030 Reconnaissance Drone

Class: Naruni Infantry Scout Drone

Crew: None

Speed: Hover in a stationary position or up to 150 mph (240 km).

Maximum hover height is 1000 feet (305 m).

Size: 3 feet (0.9 m) tall, 3 feet (0.9 m) wide and 7 feet (2.1 m) long.

Weight: 800 lbs (363 kg)

Power System: Nuclear

M.D.C. by Location:

Sensor Array (1) — 50

Communications Array (1) — 50

Laser Turret (1) — 50

Retractable Arms (2) — 25 each

Lower Hover Jets (3) — 30 each

Main Body — 125

Mega-Damage: Laser Turret: A light double laser: 4D6 per double blast; can rotate 360 degrees.

Rate of Fire: Seven per melee round.

Effective Range: 2000 feet (610 m).

Payload: Effectively unlimited.

Special Features: 1) A pair of small, thin, retractable arms that enables the drone to pick up, retrieve and carry objects. P.S. 18, they are not designed for combat but can inflict 1D4 M.D. from punches or fire handguns.

2) Camouflage fiber-optic exterior similar to the variable armor.

3) Sound suppressed hover jets.

Robot Defense System: Combat and spy programs enable it to relocate to a better position, hide, set ambushes, and take evasive action. It can also perform simple strategy and tactics, detect ambush 92%, detect concealment 89%, land navigation 80%, intelligence 89%, prowl 89%, and can recognize 10,000 different targets.

Bonuses: +2 on initiative, +3 to strike and parry, +5 to dodge, impervious to gas, poison, mind control, magic illusions and horror factor (unless controlled by a human operator).

Sensors & Optics: Full range optics equal to a multi-optics helmet, including thermo-imager, infrared, ultraviolet, passive nightsight, telescopic, and laser targeting. Motion detector, heat sensor, radiation sensor, radar detector, radar (can track 48 different targets, one mile range), enhanced hearing, full radio transmission and reception, radio scrambler.

Black Market Price: Eight million credits.

NE-300 OMAV Combat Pod

OMAV stands for One-Man Army Vehicle. The robot hover pod holds one humanoid pilot who controls the pod and several other linked drones. The OMAV is a heavily armored hover pod equipped with extensive combat armaments. More importantly, it has an advanced computer, virtual reality system and sensor array that links the OMAV pilot to a standard complement of three NE-020 Combat Drones, one NE-030 Spy Drone, and one to five NE-010 Destructo-Drones! The pilot inside the OMAV can display the actions of the drones on nine different view screens. He can direct the drones like robot troops via voice or radio command or take complete control of one or two via remote control or a virtual reality system. The range of control is limited to 50 miles/80 km without fear of losing contact with any of the drones. If an NE-010 Destructo-Drone flies out of range, the OMAV pilot loses contact with that unit. The other drones will not go beyond the 50 mile range unless ordered to do so.

Through a remote control system, the pilot can see and hear everything the drones experience by monitoring their optical and sensor transmissions on a split display screen. Through the virtual reality system, the operator experiences everything the drone experiences and has one extra attack/action per melee round. The pilot can focus on any one or two of the drones at a time by limiting the input to just those particular units. The pilot can then direct the bots' actions via voice command or direct remote control (and monitor the action on the screens, HUD or VR system). Under these conditions, it is the OMAV pilot who directly accesses and controls the drones' weaponry and actions. A

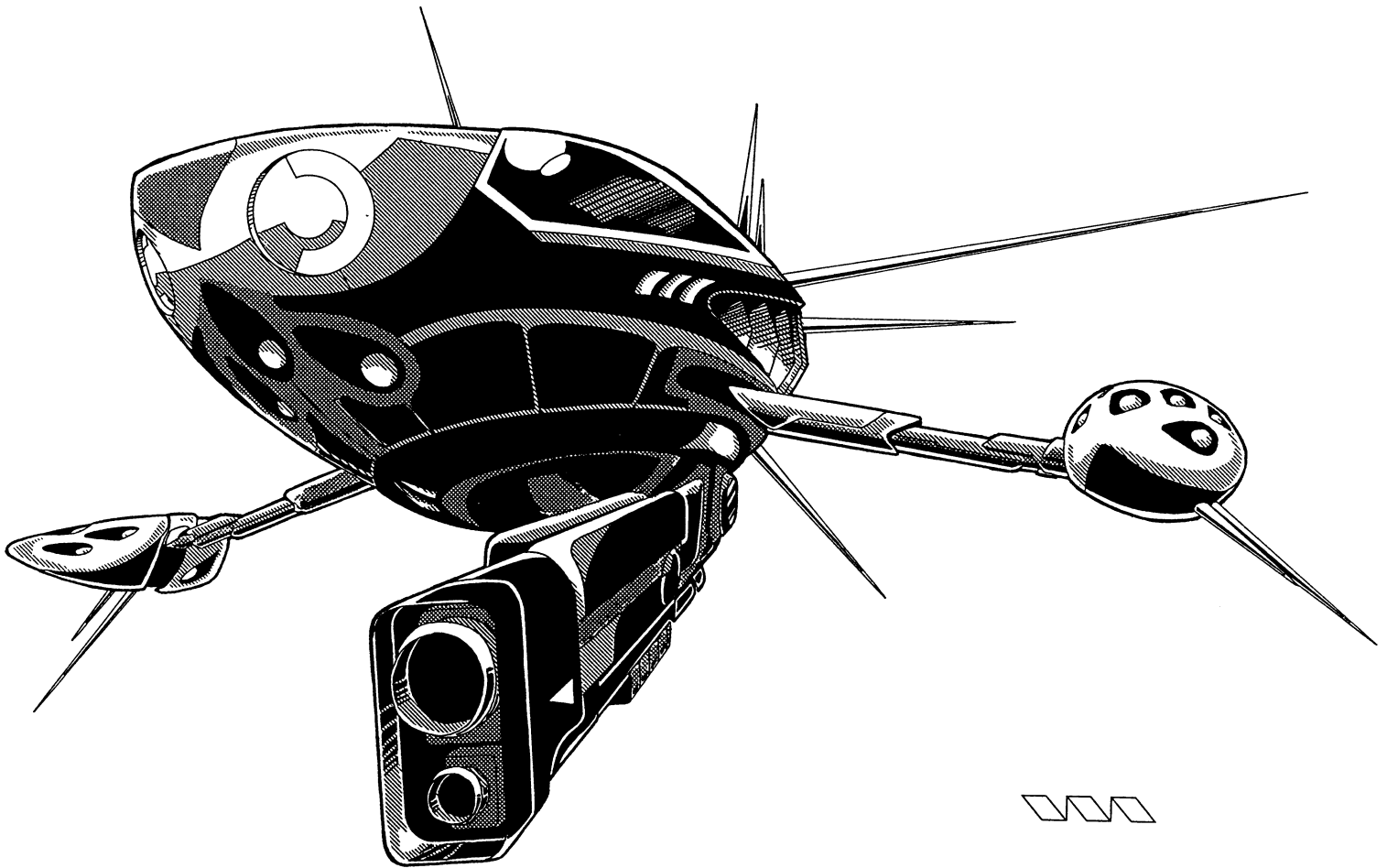

single OMAV pod and a standard complement of drones as described above can make the pod pilot the commander of a unit of robot “troops!”

In combat, the pilot can fight using the OMAV Combat Pod or any one or two of the drones, as well as command the others into action. Since the drones can fight independent of the OMAV Combat Pod, the operator can set them on a course of action and focus his or her attention on one or two specific units under his/her direct control. For example, he can order one of the combat drones to attack a target head on, send two destructo-drones around the target for a flank or rear attack or dispatch them with specific orders and forget about them. The pilot can switch his control from one specific drone to another as easily as changing channels on a television set with a remote control.

Note: Piloting an OMAV Combat Pod requires training and a new skill: Combat Pod Piloting, described in the O.C.C. section.

Although combat pods are very efficient weapons, they haven’t found widespread acceptance on Rifts Earth and are extremely rare. Only Robot Control makes widespread use of these advanced weapons. Their stiff price of 50+ million credits also contributes to their scarcity.

Model Type: NE-300 One-Man Army Vehicle

Class: Drone Command Combat Pod — Infantry

Crew: One pilot who controls as many as nine robot drones.

M.D.C. by Location:

*Sensor Array (1) — 60

*Communications Cluster (1) — 100

Particle Beam Turret (1) — 80

Mini-Missile Launchers (2) — 40 each

Reinforced Pilot’s Compartment — 100

** Main Body — 300

*The Sensor and Communications cluster are small targets, requiring a called shot at -3 to strike.

** Destroying the main body causes the pod to crash-land, but it can continue controlling its drones until the pilot is neutralized or the communications cluster is destroyed.

Speed: Hover in a stationary position or fly at speeds up to 300 mph (480 km). Minimum hover height is two feet (0.6 m) with a maximum height of 100 feet (30.5 m).

Statistical Data: Pod is roughly egg-shaped — resembles a giant mechanical egg laying on its side with weapons and antennas sticking out of it.

Height: 5 feet (1.5 m)

Width: 5 feet (1.5 m)

Length: 8 feet (2.4 m)

Weight: One ton

Cargo: A small 1 × 1 foot (0.3 × 0.3 m) area typically containing an energy rifle, handgun, 1D4 + 1 grenades, one signal flare, canteen, and a first aid kit.

Power System: Nuclear; average energy life is 8 years.

Black Market Cost: 50 million credits for an OMAV Combat Pod with only a remote control system. 55 million for a virtual reality system with remote control back-up system. May cost 10% to 25% more depending on availability (and Naruni discretion).

Weapon Systems of the OMAV Combat Pod

1. Particle Beam Gun Turret: The main weapon of the OMAV pod is a small but powerful particle beam gun mounted on the lower pod area. Can rotate 360 degrees and has a 180 degree arc of fire.

Primary Purpose: Anti-Vehicle, Anti-Personnel.

Secondary Purpose: Defense.

Weight: 500 lbs (225 kg)

Mega-Damage: 1D6 × 10 per blast.

Rate of Fire: Standard

Effective Range: 1200 feet (365 m).

Payload: Effectively unlimited

2. Mini-Missile Launchers (2): A pair of mini-missile launchers are mounted on the sides of the OMAV pod.

Primary Purpose: Anti-Vehicle and Anti-Personnel

Secondary Purpose: Defense

Mega-Damage: Varies with mini-missile type.

Rate of Fire: One at a time or in volleys of two, three or four.

Effective Range: About one mile (1.6 km).

Payload: 12 missiles; 6 per launcher.

Sensors of Note: Full range optics equal to a multi-optics helmet, including thermo-imager, infrared, ultraviolet, passive nightsight, telescopic, and laser targeting. Motion detector, heat sensor, radiation sensor, radar detector, radar (can track 96 different targets, ten mile range), enhanced hearing, full radio transmission and reception, radio scrambler. OMAV Combat Pod computer can interpret and display the sensor readings of all nine drones.

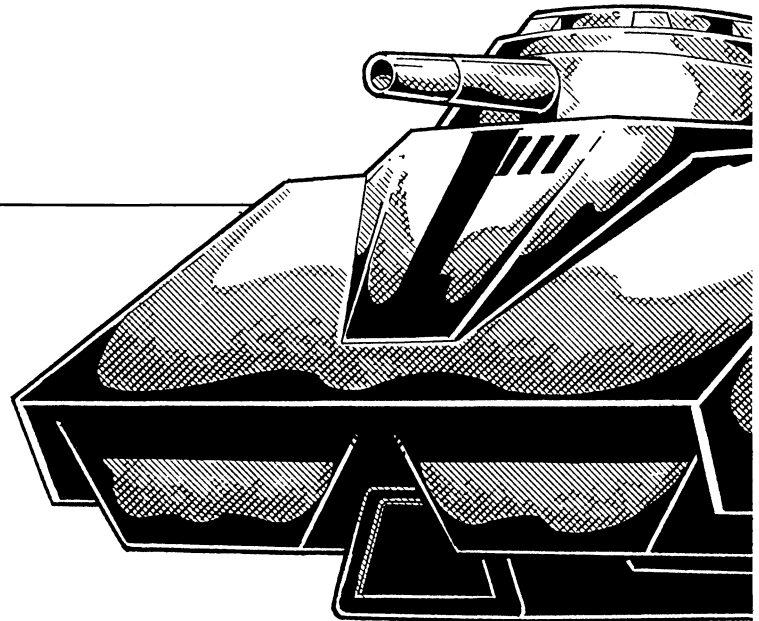
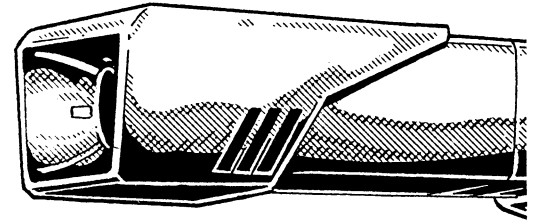

Carnivore Mark I — Light Hover Tank

This medium assault vehicle is a very fast scout and combat vehicle with good armor and weaponry. It can keep up with slow moving aircraft and power armor. The hovercraft system allows it to travel over obstacles and broken terrain where even all-terrain wheeled vehicles would be hopelessly stalled. Its particle beam cannon is among the most powerful beam weapons found on the planet and its rate of fire and unlimited power makes it the leader on the battlefield.

Model Type: N-120B

Class: Assault Vehicle.

Crew: Two: one driver, one gunner. Can accommodate two passengers.

M.D.C. by Location:

Particle Beam Cannon (1; main turret) — 90

Mini-Missile Launcher (1; main turret) — 30

** Main Turret (1) — 200

Laser Turret (front; shielded) — 100

* Main Body — 400

Reinforced Pilot and Crew Compartment — 120

* Depleting the M.D.C. of the main body will shut the tank down completely, rendering it useless.

** Knocking out the main turret prevents the use of all its weapon systems.

Speed: 180 mph (288 km) maximum speed. Can travel over ground and water, but cannot lift itself above 20 feet (6.1 m) off the surface.

Statistical Data:

Height: 14 feet (4.3 m)

Width: 9 feet (2.7 m)

Length: 25 feet (7.6 m)

Weight: 22 tons fully loaded.

Cargo: 6 x 6 foot (1.8 x 1.8 m) compartment, plus a small weapons locker that holds three rifles, pistols and signal flares.

Power System: Nuclear; average energy life is 15 years.

Black Market Cost: 40 million credits if purchased new from a Naruni outlet — there are only a few such places in North America, and none, so far, in Europe.

Weapon Systems

1. **Particle Beam Cannon:** This is a very powerful artillery piece built into the main turret. It requires so much energy that its payload is limited, drawing energy from a capacitor that must be recharged after a number of shots. The main turret can rotate 360 degrees and the P-beam cannon can be raised and lowered in a 90 degree arc of fire. The cannon is typically operated by the gunner.

Primary Purpose: Anti-Armor/Robot and Anti-Dragon

Secondary Purpose: Defense

Weight: 1.2 tons.

Mega-Damage: 1D6 x 10 M.D. per single blast, or 3D6 x 10 M.D. per multiple pulse burst (three simultaneous shots).

Rate of Fire: Standard.

Effective Range: 4000 feet (1220 m).

Payload: 30 shots; then the capacitor must be recharged. The power plant recharges the gun at the rate of one shot per melee round (the

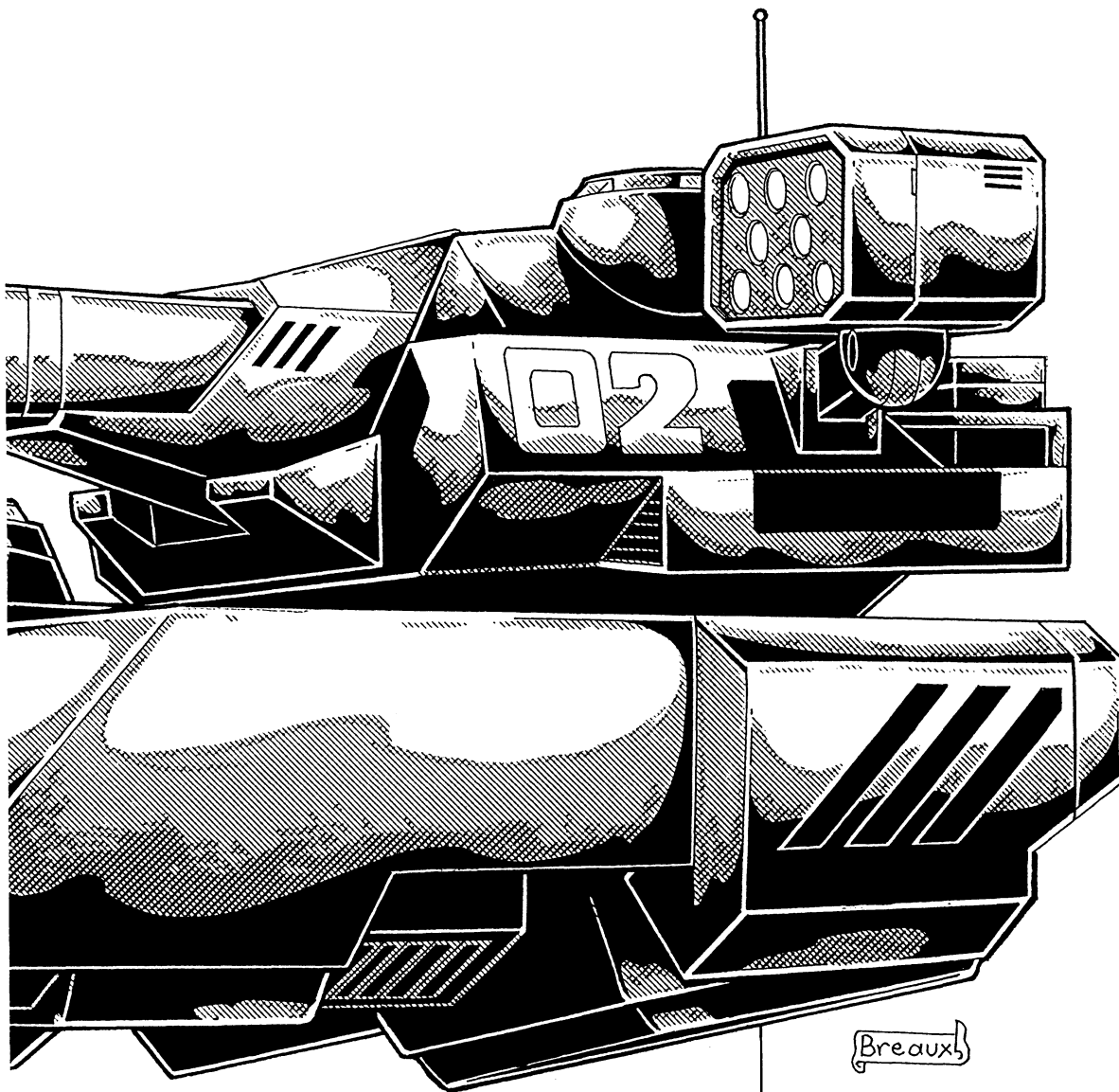

Breaux

weapon cannot be used that round). This means if locked in combat, once the 30 shots are fired, the tank can only fire the particle beam cannon once every other melee round.

2. Mini-Missile Launcher: A multi-tube missile launcher is also built into the main turret. The launcher is typically operated by the gunner.

Primary Purpose: Anti-Vehicle and Anti-Personnel

Secondary Purpose: Defense

Mega-Damage: Varies with missile type.

Rate of Fire: One at a time or volleys of 2, 4 or 8 missiles.

Effective Range: About 1 mile (1.6 km).

Payload: 24 missiles

3. Laser Turret: This is a secondary turret that is built into the front of the main body and is not part of the main turret. The turret can rotate 360 degrees and the laser gun can be raised and lowered in a 90 degree arc of fire. It is typically controlled by the driver.

Primary Purpose: Anti-Personnel

Secondary Purpose: Defense

Mega-Damage: 4D6 M.D. for a single blast, 1D6 × 10 + 10 M.D. per multiple pulse burst (three simultaneous shots).

Rate of Fire: Standard.

Effective Range: 4000 feet (1220 m)

Payload: Effectively unlimited.

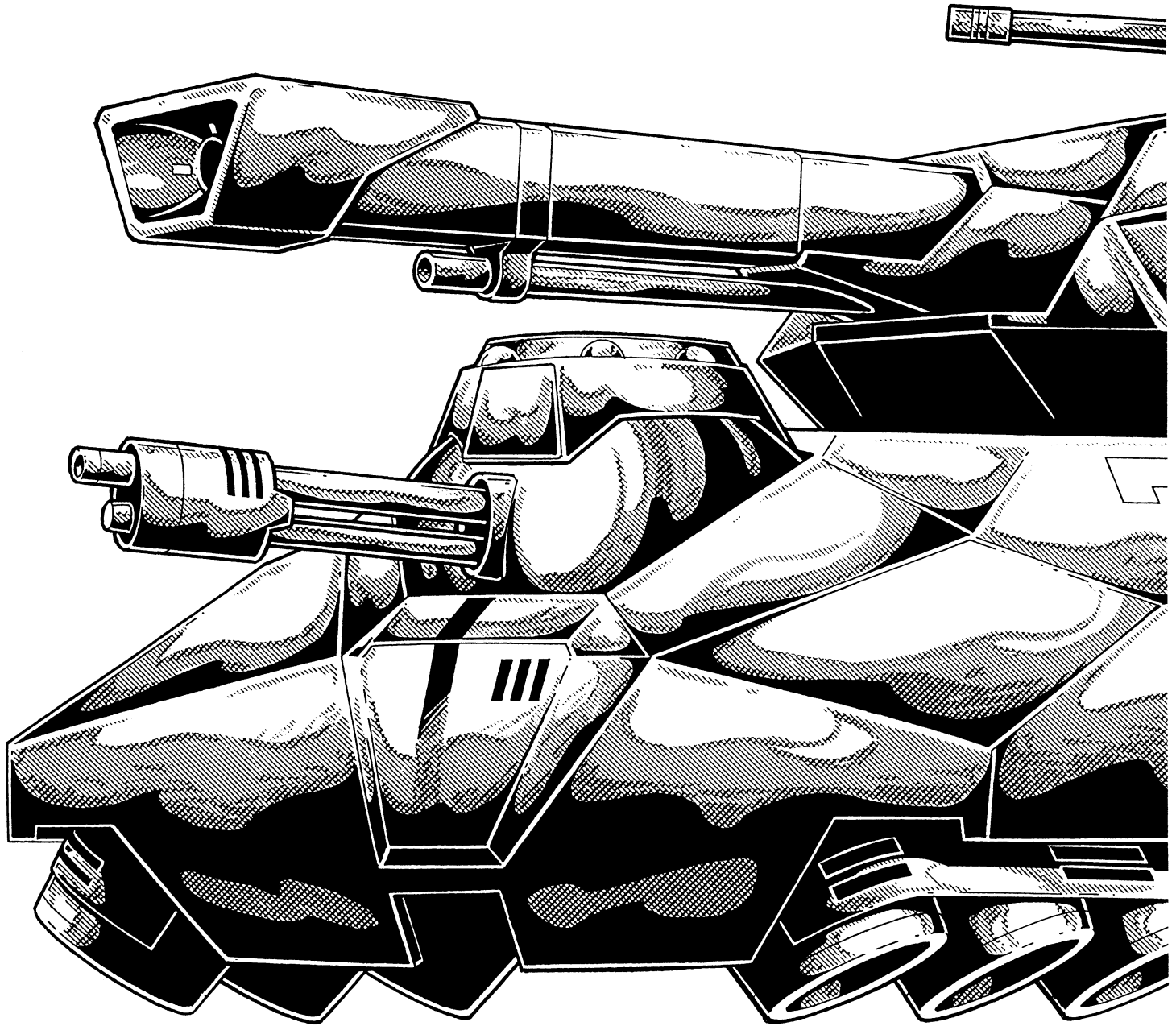

Juggernaut — Heavy Hover Tank

This is a larger version of the Carnivore; a huge, 200 ton war machine with more firepower than a platoon of normal tanks or the average giant robot. The tank's main gun is a huge particle beam generator that inflicts massive damage. The energy requirements of the cannon are so enormous, however, that it must draw from a capacitor that recharges slowly, thereby reducing its rate of fire. However, even the Juggernaut's secondary, support weapons are superior to the main gun of most tanks and robots! The tank's hover system is more advanced than anything found in the Coalition States, giving it more speed than any other known land tank on Earth. Its only disadvantage is that it lacks the maneuverability compared to that of most giant robots.

The Juggernaut is incredibly rare because it is hideously expensive. So far, the only quantity purchases have been made by Larsen's Brigade. A couple of the largest independent kingdoms have also bought a few. Some mercenary companies will invest several years' profits to buy even one of these tanks.

Model Type: J-2

Class: Heavy Assault Vehicle.

Crew: Four: one pilot, two gunners and a commander; can accommodate one passenger.

M.D.C. by Location:

Main Turret — 600

Particle Beam Cannon in Turret — 250

Coaxial Rail Gun in Turret — 100

Mini-missile Launchers in Turret (8) — 50 each

Laser Battery on Cupola — 100

Side-mounted Medium Range Missile Launchers (8) — 75 each

Bow-mounted Rail Gun Cannon — 150

* Fan Skirts — 350

** Main Body — 900

Reinforced Crew Compartment — 200

Force Field — 400

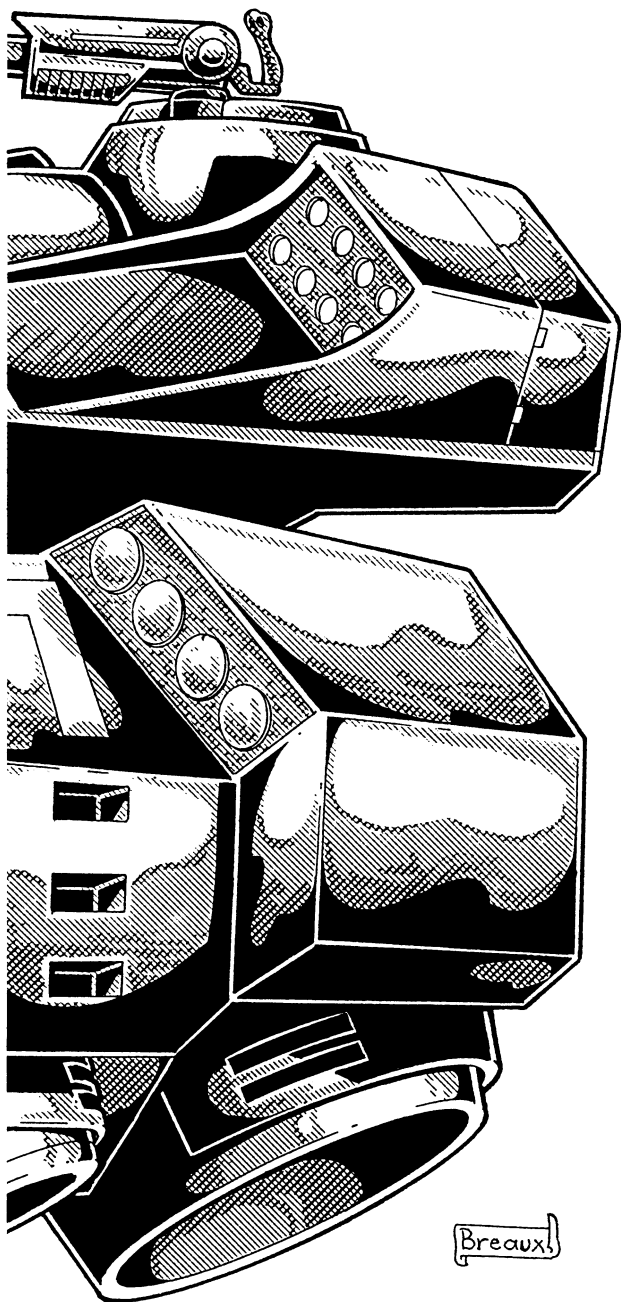

* Destroying the Fan Skirts will destroy the hovercraft system, grounding the vehicle and rendering it immobile. Field repairs will take at least 1D6 hours (and there is a 01-50% that the tank will need major repairs). Hitting the fan skirts requires a called shot (no penalty).

** Depleting the M.D.C. of the main body destroys the vehicle.

Speed: Driving over ground: Technically, the Juggernaut hovers over the ground, but it cannot lift more than five feet (1.5 m) off any surface. Maximum speed is an impressive 200 mph (320 km) on land. The Juggernaut can travel over swamps and mud normally, but is too heavy to go over water (it will sink like a stone).

Statistical Data:

Height: 20 feet (6.1 m)

Width: 26 feet (7.9 m)

Length: 35 feet (10.7 m)

Weight: 200 tons

Cargo: Minimal storage space: about four feet (1.2 m) for extra clothing, weapons and personal items. Four NE-10 rifles and four NE-50 particle beam rifle, with 10 magazines/E-clips each, are stored in locked overhead compartments.

Power System: Nuclear; average energy life is 15 years.

Black Market Cost: 60 million credits, 80 with force field option.

Weapon Systems

1. **Naruni Particle Beam Cannon:** This cannon requires a special capacitor that is charged by the nuclear engine at a slow rate. The weapon is controlled by a gunner on the turret, although the commander or the secondary gunner can also take over in an emergency.

Primary Purpose: Anti-Vehicle.

Secondary Purpose: Defense.

Mega-Damage: 5D6 x 10 M.D. per blast.

Rate of Fire: Equal to number of combined hand to hand attacks of the gunner.

Effective Range: 11,000 feet (about two miles/3.2 km).

Payload: Effectively unlimited but restricted. Fully charged, the cannon has 60 blasts. The cannon recharges at the rate of one energy blast per minute; that's once every four melee rounds. To compensate for the possible lapse in particle beam firing power, a coaxial Rail gun, several mini-missile launchers and a laser battery on a cupola have been fitted as secondary guns for the turret gunner.

2. **Coaxial Rail gun:** This medium Rail gun cannon is mounted just below the particle beam cannon, and has the same aiming point. The rail gun is engaged only when the particle beam cannon has been turned off for recharging purposes; trying to fire both guns at the same time is possible, but risks overloading the power circuits (01-60% chance of an overload burning out both guns, which renders them useless).

Primary Purpose: Anti-vehicle

Secondary Purpose: Defense

Mega-Damage: A Burst is 80 rounds and inflicts 2D4 x 10 M.D., one round does 2D4 M.D.

Rate of Fire: Equal to number of combined hand to hand attacks (usually 4-6).

Effective Range: 6000 feet (1830 m), a little over a mile.

Payload: 20,000 rounds, that's 250 bursts. Reloading the gun requires special equipment and takes about an hour.

3. **Mini-missile Launchers in Turret (8):** These launchers come four on each side of the turret, and are controlled by the turret gunner. Usually, the gunner fires one volley of 8 as one of his melee actions, and then uses the particle beam cannon or the rail gun. 15 seconds' worth (one melee round) of missile and cannon fire will crumple most vehicles.

Primary Purpose: Anti-Vehicle

Secondary Purpose: Defense

Mega-Damage: Varies with missile type. Standard issue is plasma (1D6 x 10 M.D.).

Rate of Fire: One at a time, or in volleys of two, four, or eight.

Effective Range: About one mile (1.6 km).

Payload: 48, six missiles per launcher.

4. **Laser Battery on Cupola:** This completes the array of weaponry controlled from the turret. This secondary gun is used against lightly armored targets.

Primary Purpose: Anti-Personnel

Secondary Purpose: Defense

Mega-Damage: 5D6 M.D. per blast.

Rate of Fire: Standard

Effective Range: 4000 feet (1220 m)

Payload: Effectively unlimited.

5. **Side-mounted Medium Range Missile Launchers (8):** Four missile tubes are mounted on each side of the tank's main body. They can be fired by either the secondary gunner or the driver.

Primary Purpose: Anti-Vehicle and Anti-Aircraft

Secondary Purpose: Defense

Mega-Damage: Varies with missile type.

Rate of Fire: One at a time, or in volleys of two, four, or eight missiles.

Effective Range: 40 to 80 miles (64 to 128 km)

Payload: 48 missiles (six missiles per tube).

6. Bow-Mounted Rail Gun Cannon: This secondary gun is a powerful Rail gun that fires flechette rounds similar to the Glitter Boy's "Boom Gun Rounds." It is controlled by the secondary gunner or the driver. The gun has a limited arc of fire (30 degrees side to side), but the tank's hover system lets it rotate at will, so it is almost as effective as a turret-mounted cannon.

Primary Purpose: Anti-Vehicle.

Secondary Purpose: Defense.

Mega-Damage: One flechette round holds 200 slugs that inflict 3D4 x 10 M.D.

Rate of Fire: Equal to number of combined hand to hand attacks of the gunner.

Effective Range: 11,000 feet (about two miles/3.2 km).

Payload: 200 rounds.

7. Rechargeable force field: A mega-damage capacity force field generator can be added to the tank, at extra cost. The force field can be engaged at any time, usually at the beginning of heavy combat, thus letting the rechargeable field take the brunt of the initial combat damage. The two drawbacks of the field are that the cupola laser cannot be fired, and the particle beam cannon will not recharge as long as the field is operating (the PB cannon can fire its current payload, however, and the Rail guns and missiles are unaffected). Depleting the 400 M.D.C. of the force field will automatically shut the field generating system down and all subsequent damage is subtracted from the body of the J-2. A depleted force field requires a full 24 hours to regenerate to full capacity. Even minor damage (100 M.D.C. or less) will require eight (8) hours to restore to full power.

* Destroying the head/helmet has a 01-70% chance of knocking the pilot unconscious. If conscious, the pilot has two problems; one, no power armor combat bonuses to strike, parry, and dodge, and two, the human head is now vulnerable to attack. **Note:** The head is a small and difficult target to hit. Thus, it can only be hit when a character makes a called shot and even then the attacker is -3 to strike.

** Depleting the M.D.C. of the main body will shut the armor down completely, and the pilot will be vulnerable to attack.

Speed: Running: 44 mph (70 km) maximum. Note that the act of running does tire out its operator, but at 10% the usual fatigue rate, thanks to the robot exo-skeleton. Leaping: The powerful robot legs can leap up to 15 feet (4.6 m) high or across unassisted by the thrusters. A jet thrust assisted leap can propel the armor up to 100 feet (30.5 m) high and 200 feet (61.0 m) across without actually attaining flight. Flying: The rocket propulsion system enables the Mecha-Knight to hover in stationary position up to 500 feet (152 m) or fly. Maximum flying speed is 300 mph (480 km).

Statistical Data:

Height: 10 feet (3.0 m) from head to toe, or 11 feet (3.4 m) with the wings extended.

Width: Wings down, 5 feet (1.5 m). Wings extended, 16 feet (4.9 m).

Length: 5 feet (1.5 m)

Weight: 1 ton

Physical Strength: Equal to a P.S. 40

Cargo: None

Power System: Nuclear; average energy life is 15 years.

Black Market Cost: 25 million credits for a complete suit. A force field can be added (see Naruni Personal Force Fields, above) at extra cost.

Weapon Systems

1. Particle Beam Rifle: This is a giant particle beam rifle, very powerful and long-ranged. It connects directly to the armor's power supply, giving it an unlimited payload. The rifle has an attachment clamp on the right side of the suit, where it can be put away when the sword is used (trying to use both the rifle and the sword gives a -2 penalty to both).

Primary Purpose: Assault

Secondary Purpose: Defense

Weight: 800 lbs (360 kg)

Mega-Damage: 2D4 x 10 M.D.

Rate of Fire: Standard.

Effective Range: 4000 feet (1220 m)

Payload: Effectively unlimited.

2. Energy Sword: An energy weapon used for close combat. The huge sword can be used as a bludgeon or energized to slice through mega-damage structures. The sword has an attachment on the left side of the armor, allowing it to be put away while the rifle is being used. Trying to use both the sword and the rifle at the same time gives a -2 penalty to both.

Primary Purpose: Assault.

Weight: 40 lbs (18 kg)

Mega-Damage: 1D6 x 10 per energized strike, or 1D6 as a blunt weapon.

Rate of Fire: Equal to number of combined hand to hand attacks.

Effective Range: Close combat.

Payload: Effectively unlimited.

3. Laser (Right Shoulder): A medium laser is mounted on the shoulder, where it can be used at all times as a secondary weapon.

Primary Purpose: Defense.

Secondary Purpose: Assault.

Weight: 100 lbs (45 kg)

Mega-Damage: 3D6 M.D.

Rate of Fire: Standard.

Effective Range: 2000 feet (610 m).

Payload: Effectively unlimited.

Naruni Robots & Powered Armor

Mecha-Knight Medium Powered Armor

The Mecha-Knight is both flashy and effective. Its medieval outlines and its energy sword makes the suit a favorite of cyber-knights and would-be warriors, and its heavy protection (second only to the Glitter Boy) is attractive to experienced soldiers as well. The energy sword makes the suit unsurpassed in hand to hand combat, and for long-range work, its arm-mounted particle beam cannon makes it a good rival for most artillery on the planet. Its flying capabilities are superior to the Coalition SAMAS, and it is more heavily armored. The power armor can also have a Naruni Personal Force Field installed (see above).

Model Type: MK-PA12

Class: Medium Strategic Environmental Exo-Skeleton.

Crew: One.

M.D.C. by Location:

Shoulder Wings (2) — 70 each

Medium Laser (right shoulder) — 30

Main Rear Jets () — 90 each

Lower Maneuvering Jets () — 50 each

Arms (2) — 100 each

Energy Sword — 90

Rifle-Shaped Particle Beam Cannon — 120

Legs (2) — 150 each

* Head — 130

** Main Body — 400

4. Hand to Hand Combat: Rather than use a weapon, the pilot can engage in mega-damage hand to hand combat.

Restrained Punch: 1D4 M.D.

Full Strength Punch: 2D4 M.D.

Power Punch: 3D6 M.D. (counts as two attacks).

Kick: 2D6 M.D.

Leap Kick: 4D6 M.D. (counts as two attacks).

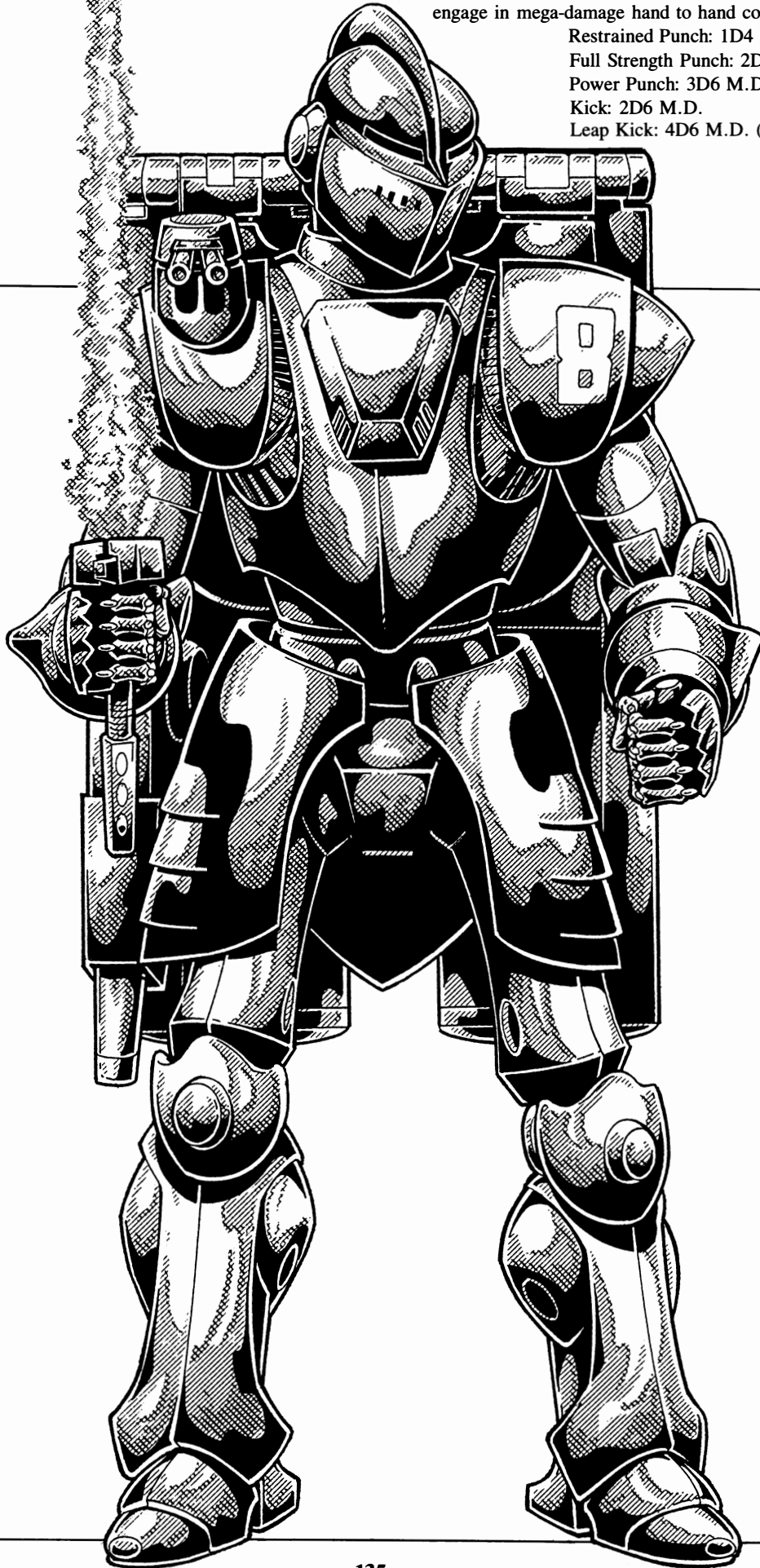

Death-Knight Assault Robot

This is a large combat robot, also built with a fantasy motif (the Naruni Marketing executives decided that these lines were ideal for a world where both magic and technology exist). In fact, both the Death-Knight and the Mecha-Knight are becoming favorites of Techno-Wizards, who put enchantments into them to enhance their effectiveness. This robot is a combat model, designed to strike fear in the enemy; its helmeted skeleton head design sometimes causes people to mistake it as a Coalition robot.

Like all Naruni vehicles, the Death-Knight has better-than-average firepower, ranging from a particle beam cannon to four short-range missile launchers. Mercenaries and small kingdoms are trying to buy as many of these expensive robots as possible.

Model Type: DK-AR500

Class: Infantry Assault Robot Vehicle.

Crew: Three: One pilot, one co-pilot and one gunner. Can carry up to four passengers. The controls are designed so that the pilot can handle all functions if necessary.

M.D.C. by Location:

- Hands (2) — 60 each
- Forearms (2) — 100 each
- Forearm Particle Beam Cannon (left arm) — 120
- Energy Axe — 160
- Upper Arms (2) — 120 each
- Legs (2) — 240 each
- Missile Launchers (four on chest) — 80 each
- Laser (Left Shoulder) — 120
- Belly Rail Gun — 100
- * Sensors (2 in head, 1 on right shoulder) — 10 each
- ** Main Access Hatch (1; top) — 80
- Emergency Hatch (1; top rear) — 80
- *** Main Body — 600

Reinforced Crew Compartment — 200

* Destroying all 3 sensor arrays will destroy the main radar and targeting system (no bonuses to strike, parry or dodge). The pilot must rely on his own human vision and less accurate computer and sensory systems. **Note:** The sensor arrays are small and difficult items to hit, especially on a moving target. Thus, they can only be hit when a character makes a called shot, and even then the attacker is -3 to strike.

** Depleting the M.D.C. of the entry hatch makes the robot vulnerable to entry by the enemy from the top. The inner hatch has only 50 M.D.C.

*** Depleting the M.D.C. of the main body will effectively destroy the bot, shutting it down completely, rendering it useless.

Speed: Running: 70 mph (112 km) maximum. Note that the act of running does NOT tire the robot and speed can be maintained indefinitely. Leaping: Not recommended because of the weight and disproportionately heavy upper body. Leaps are possible only from a running start and limited to approximately 20 feet (6.1 m) lengthwise; height is only five or six feet (1.5 to 1.8 m). The chance of falling is high; roll percentile for every jump/leap, 01-60% likelihood of falling over. A fall causes the Death-Knight to lose all its attacks for one melee round while the crew struggles to stand the bot back up.

Statistical Data:

Height: 30 feet (9.1 m).

Width: 16 feet (4.9 m)

Length: 14 feet (4.3 m).

Weight: 40 tons fully loaded.

Physical Strength: Equal to a P.S. 60.

Cargo: Minimal storage space; about 4 feet (1.2 m).

Power System: Nuclear, average energy life is 18 years.

Black Market Cost: 90 million credits for a new, undamaged, fully powered unit, complete with fully functioning weapon systems.

Weapon Systems

1. Particle Beam Cannon: This cannon requires a special capacitor that is charged by the nuclear engine at a slow rate.

Primary Purpose: Anti-Armor

Secondary Purpose: Defense

Weight: 1.4 tons

Mega-Damage: 1D6 x 10 + 10 M.D.

Rate of Fire: Standard

Effective Range: 6000 feet (1830 m).

Payload: Effectively unlimited but restricted. Fully charged, the cannon has 60 blasts. The cannon recharges at the rate of one energy blast per minute; that's equal to four melee rounds.

2. Energy Axe: A huge energy axe used for close combat. The giant weapon can be used as a bludgeon or energized to slice through mega-damage structures like a hot knife through butter.

Primary Purpose: Assault

Weight: 800 lbs (360 kg)

Mega-Damage: 2D6 x 10 M.D. per plasma energized strike, or 2D6 M.D. as a blunt weapon.

Rate of Fire: Equal to the combined hand to hand attacks.

Effective Range: Close combat only.

Payload: Effectively unlimited.

3. Missile Launchers (4): Fire short-range missiles.

Primary Purpose: Assault

Secondary Purpose: Defense

Mega-Damage: Varies with missile type.

Rate of Fire: One at a time or volleys of 2, 3, 4, 6 or 8 per melee.

Effective Range: About 50 miles (80 km).

Payload: 32 total, eight per launcher.

4. Laser Gun: Shoulder mounted laser. Can rotate 180 degrees upward; used mostly against enemy fliers.

Primary Purpose: Anti-Aircraft

Secondary Purpose: Defense

Mega-Damage: 3D6 + 2 M.D. for a single blast, 1D6 x 10 M.D. per multiple pulse burst (three simultaneous shots).

Rate of Fire: Standard.

Effective Range: 4000 feet (1220 m).

Payload: Effectively unlimited

5. Belly Rail gun: Designed to scatter ground troops.

Primary Purpose: Anti-Personnel

Secondary Purpose: Defense

Mega-Damage: A burst is 40 rounds and inflicts 1D6 x 10 M.D. Can only fire bursts.

Rate of Fire: Standard.

Effective Range: 4000 feet (1220 m).

Payload: 40,000-round drum; that's 1000 bursts. Reloading a drum takes about five minutes.

6. Hand to Hand Combat: Rather than use a weapon, the robot can engage in mega-damage hand to hand combat. Combat abilities are identical to the UAR-1 Enforcer, with the following exceptions.

Restrained Punch: 1D6 M.D.

Full Strength Punch: 3D6 + 2 M.D.

Power Punch: 6D6 M.D.

Body Block: 2D6 M.D.

Stomp: 2D6 M.D.

Kick: 2D4 M.D.

Leap Kick is NOT possible.

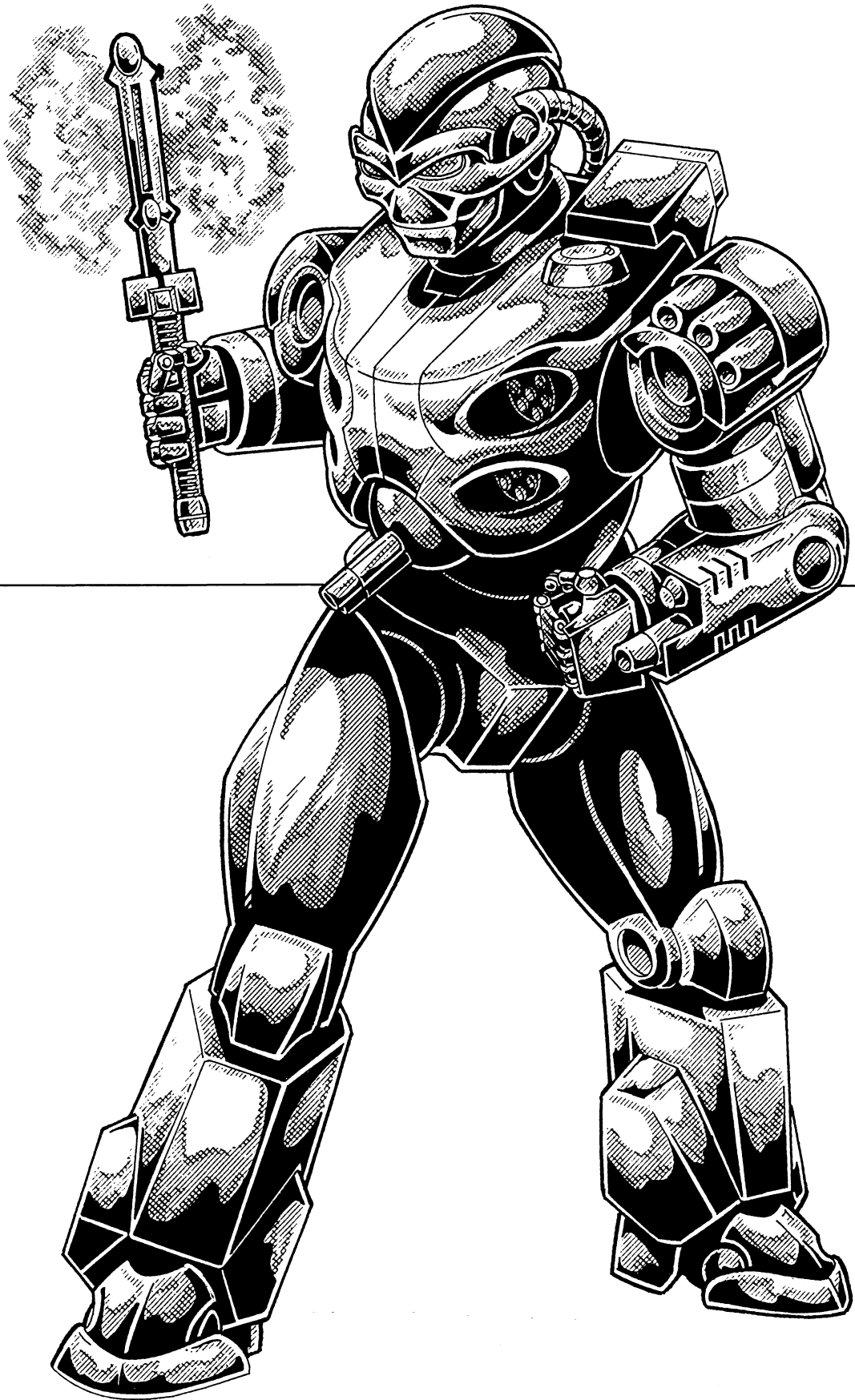

Breaux!

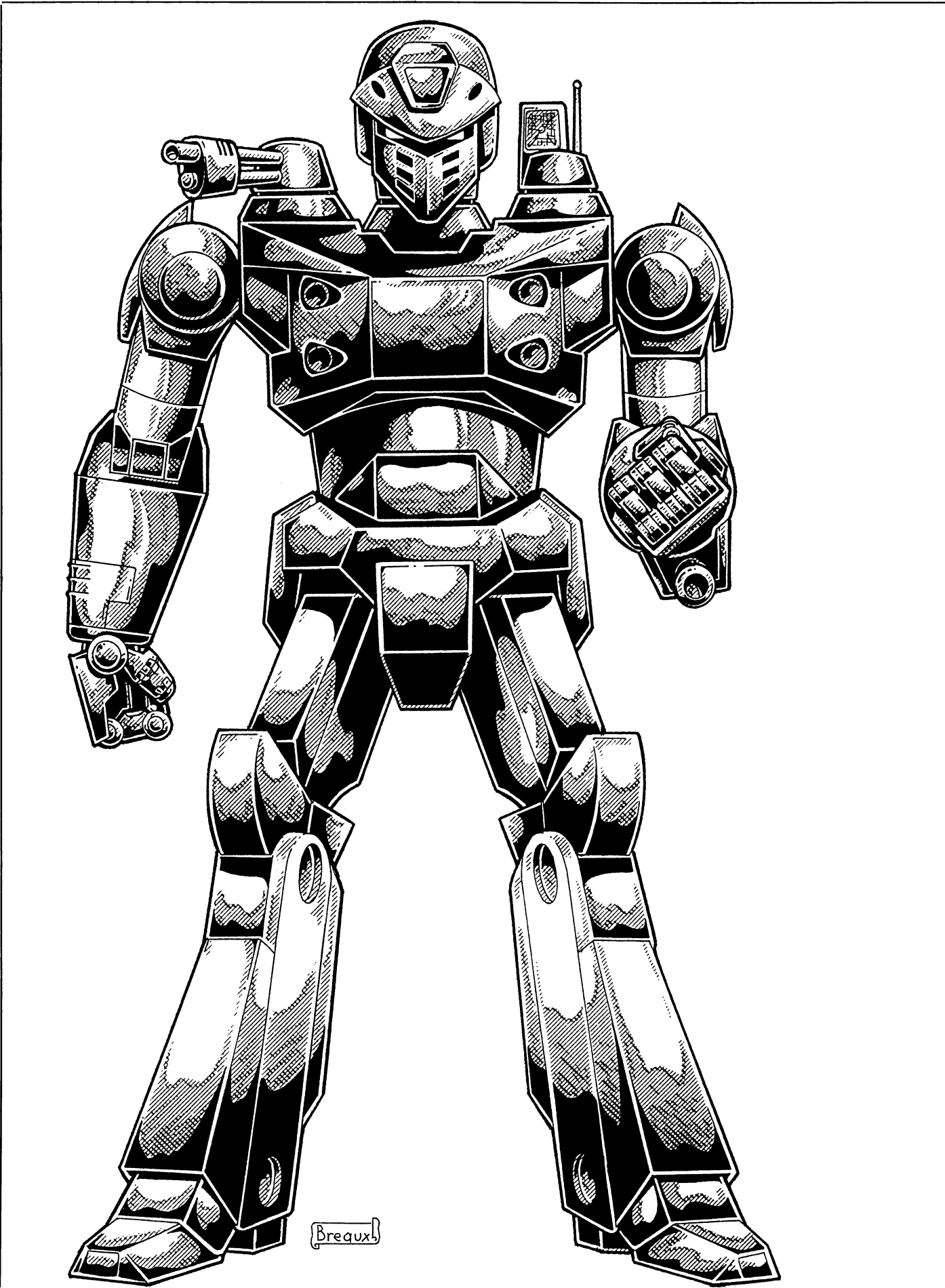

Nomad Scout Robot

This small robot (almost bordering on being a powered armor suit) has a highly sophisticated stealth system, including a chameleon light-distortion field that allows the Nomad to blend in with the surrounding terrain. These features have made the robot very popular among wilderness scouts and mercenaries in general. The Nomad is not as heavily armed as other Naruni vehicles, but it is still a military vehicle of great efficacy.

Model Type: N-SR20

Class: Infantry Reconnaissance Robot.

Crew: One pilot. Can accommodate two passengers.

M.D.C. by Location:

Upper Arms/Shoulders — 130

Rail Gun (Right Shoulder) — 100

Searchlight (Left Shoulder) — 5

* Sensor Array (2; left shoulder and head) — 20 each.

Missile Launcher in Upper Torso — 30

Head — 120

Hands (2) — 60 each

Arms (2) — 120 each

Laser on Left Arm — 40

Legs (2) — 200 each

** Main Body — 470

* Destroying the sensor arrays will destroy the main radar and targeting system (no bonuses to strike, parry or dodge). The pilot must rely on his own human vision and less accurate computer and sensory systems. **Note:** The sensor arrays are small and difficult items to hit, especially on a moving target. Thus, it can only be hit when a character makes a called shot, and even then the attacker is -3 to strike.

** Depleting the M.D.C. of the main body will effectively destroy the bot, shutting it down completely, rendering it useless.

Speed: Running: 150 mph (240 km) maximum. Leaping: The powerful robot legs can leap up to 15 feet (4.6 m) high or across. Add 10 feet (3.0 m) with a running start.

Statistical Data:

Height: 16 feet (4.9 m)

Width: 7 feet (2.1 m)

Length: 5 feet (1.5 m)

Weight: 12 tons fully loaded.

Physical Strength: Equal to a P.S. 40

Cargo: Minimal storage space; about four feet (1.2 m) for extra clothing, weapons, and personal items.

Power System: Nuclear; average energy life is 20 years.

Black Market Cost: 20 million credits for a new, undamaged, fully powered Nomad with all weapons and equipment and the Variable Camouflage System.

Weapon Systems

1. Rail Gun Turret: A Rail gun is mounted on the robot's right shoulder. The weapon can rotate up 180 degrees, allowing it to track airborne targets.

Primary Purpose: Anti-Aircraft

Secondary Purpose: Anti-Armor and Defense

Weight: 1 ton

Mega-Damage: A burst is 40 rounds and inflicts 1D6 x 10 M.D. Can only fire bursts.

Rate of Fire: Standard

Effective Range: 4000 feet (1220 m)

Payload: 1200-round drum; that's 30 bursts.

2. Missile Launcher: A rapid-fire mini-missile launcher is mounted on the chest; used primarily as an anti-personnel (fragmentation missiles) or anti-vehicle (plasma missiles) weapon.

Primary Purpose: Anti-Armor and Anti-Personnel

Secondary Purpose: Defense

Mega-Damage: Varies with missile type.

Rate of Fire: One at a time or volleys of two, three or four missiles.

Effective Range: About one mile (1.6 km).

Payload: 16 mini-missiles.

3. Laser Gun: A high-intensity pulse laser is mounted on the left arm.

Primary Purpose: Anti-Armor

Secondary Purpose: Defense

Mega-Damage: 3D6 + 2 M.D. for a single blast, or 1D6 x 10 M.D. per multiple pulse burst (three simultaneous shots).

Rate of Fire: Standard

Effective Range: 2000 feet (610 m)

Payload: Effectively unlimited.

4. Hand to Hand Combat: Rather than use a weapon, the robot can engage in mega-damage hand to hand combat. Combat abilities are identical to the UAR-1 Enforcer.

5. Camouflage System: The robot's exterior can change colors to match the surrounding terrain. The color change takes 1D4 melees, and the robot becomes the same color as the predominant color(s) in the area. This makes the bot very difficult to spot (-20% to Detect Ambush and Detect Concealment rolls). The system also masks infrared and thermal emissions, making heat sensors useless.

Crescent Moon Delta-Wing Spaceplane

These hypersonic vehicles can actually fly and fight in space, and they might be able to breach the defenses that encircle the planet (so far, nobody has bothered to try). Even in an atmosphere, the Crescent

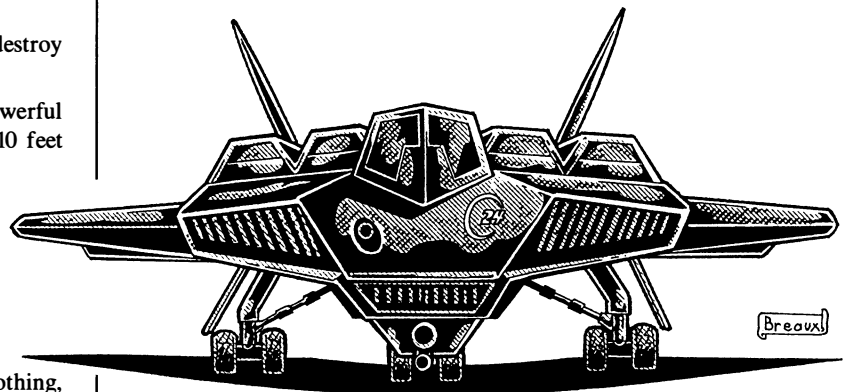

Moons are incredibly fast and maneuverable, due to the use of contragravity generators (which haven't been developed on Rifts Earth). These systems also allow the ship to hover in the air and land on any flat surface (doesn't need runways) and let it fly despite its weight (it is heavily armored). The planes also have a very weak radar signature, and have several "stealth" systems that make them hard to detect (-25% penalty for all sensory equipment rolls directed against the aircraft).

The Crescent Moon is the highest-performance aircraft on the planet at this time.

Model Type: CM-DW1000

Class: Fighter/Attack Aircraft.

Crew: Two: pilot and co-pilot/gunner. Can accommodate two passengers.

M.D.C. by Location:

Main Jet Thrusters (4) — 90 each

Weapons Pod (Underbelly) — 200

Missile Launchers (4; 2 on each wing) — 60 each.

Pilot's Compartment — 150

Main Body — 600

Speed: Hover stationary or fly at speeds up to Mach 5.5 (about 3700 mph/5920 km) and capable of breaking away from Earth's gravity. Cruising speed ranges from 100 to 600 mph (160 to 960 km).

Statistical Data:

Height: 12 feet (3.7 m)

Width: Wingspan is 60 feet (18.3 m).

Length: 40 feet (12.2 m).

Weight: 30 tons.

Cargo: A small 3 x 3 foot (0.9 x 0.9 m) area.

Power System: Nuclear; average energy life is 10 years.

Black Market Cost: 50 million credits.

Weapon Systems

1. Weapons Pod: A rotating turret with a high-intensity plasma projector and a pulse laser (the pulse laser's thinner barrel is mounted below the plasma projector).

Primary Purpose: Anti-Aircraft and Anti-Armor

Secondary Purpose: Defense

Weight: 4 tons

Mega-Damage: Plasma Projector: 2D6 x 10 M.D. per blast. Pulse Laser: 1D6 x 10 + 6 M.D. Simultaneous blast: 4D4 x 10 M.D. (counts as two attacks).

Rate of Fire: Standard.

Effective Range: 6000 feet (1830 m).

Payload: Effectively unlimited.

2. Missile Launchers (4): Medium-Range Missile Launchers.

Primary Purpose: Anti-Armor and Anti-Aircraft

Secondary Purpose: Defense

Mega-Damage: Varies with missile type.

Rate of Fire: One at a time or in volleys of two, three, four, six or eight missiles.

Effective Range: Varies with missile type.

Payload: 20 missiles (5 per launcher).

3. Nose Laser: A second Pulse Laser is mounted in the aircraft's nose.

Primary Purpose: Anti-Aircraft

Secondary Purpose: Defense

Mega-Damage: 1D4 x 10 + 6 M.D.

Rate of Fire: Standard

Effective Range: 6000 feet (1830 m)

Payload: Effectively unlimited.

Boomerang Attack Aerodyne

This aircraft also has a v-shape, but its propulsion system is located on its bottom, making it work like a helicopter in reverse (pushing, rather than pulling, the vehicle). The aerodyne is as maneuverable as a helicopter, but its systems are less vulnerable to attack. A favorite maneuver of the Boomerang pilot is a fast attack sweep, then a very tight turn to come back to the target for a second sweep — the "boomerang effect."

Model Type: B-AA14

Class: Attack Aerodyne.

Crew: Two: Pilot and gunner.

M.D.C. by Location:

* Propulsion System — 120

Mini-Missile Launchers (4) — 20 each

Rail Gun Cannon, front — 100

Pilots' Compartment — 100

Main Body — 320

* Destroying the propulsion system will incapacitate the craft, but it can glide down to a safe landing. **Note:** The propulsion system is well shielded and difficult to hit, especially on a moving target. Thus, it can only be hit when a character makes a called shot, and even then the attacker is - 3 to strike.

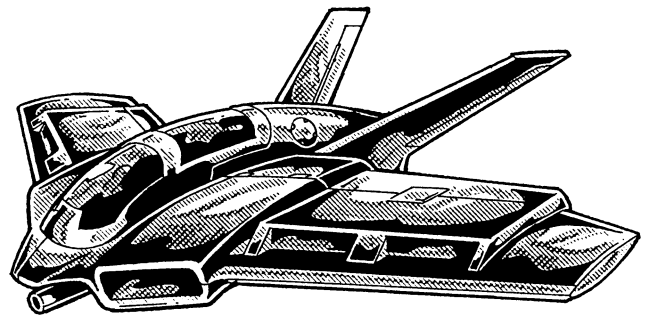

Speed: Hover in a stationary position up to 2500 feet (762 m) or fly at up to 300 mph (480 km).

Statistical Data:

Height: 12 feet (3.7 m)

Width: 30 feet (9.1 m)

Length: 30 feet (9.1 m)

Weight: 10 tons.

Cargo: A small 3 x 3 foot (0.9 x 0.9 m) area.

Power System: Nuclear, average life is 10 years.

Black Market Cost: 8 million credits.

Weapon Systems

1. Rail Gun Cannon: A heavy rail gun firing high-density heavy rounds. Firing the cannon makes the Boomerang tremble in mid-air.

Primary Purpose: Anti-Armor, Anti-Aircraft.

Secondary Purpose: Defense.

Weight: 1.5 tons.

Mega-Damage: A burst is 80 rounds and inflicts 2D4 x 10 M.D. Only fires bursts.

Rate of Fire: Standard.

Effective Range: 6000 feet (1830 m).

Payload: 20,000 rounds; that's 250 bursts.

2. Mini-Missile Launchers (4): Side-mounted missile launchers.

Primary Purpose: Anti-Personnel and Anti-Aircraft

Secondary Purpose: Defense

Mega-Damage: Varies with missile type.

Rate of Fire: One at a time or volleys of 2, 4, 6 or 8 missiles.

Effective Range: About 1 mile (1.6 km).

Payload: 40; 10 missiles per launcher.

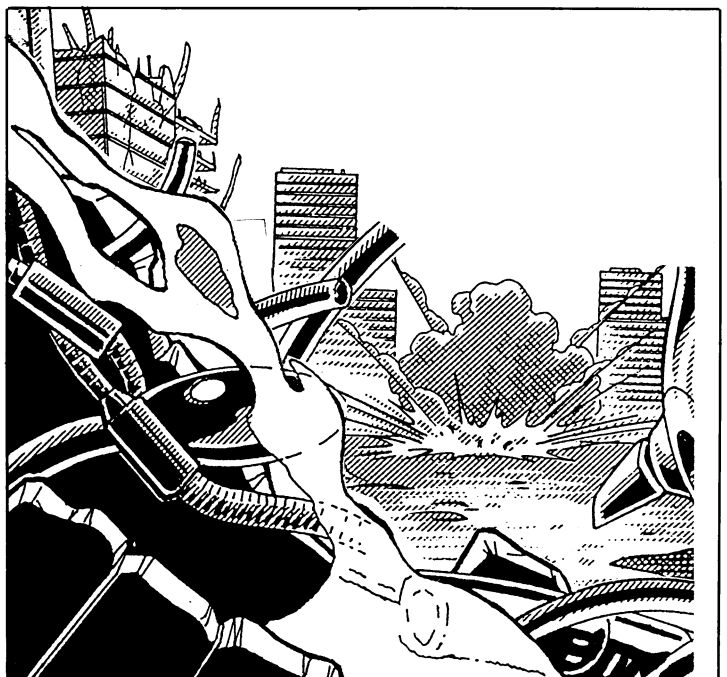

Angrar Robotics

This brand name of powered armor and robot vehicles just made its appearance on Rifts Earth. Everyone who has seen them agrees that the suits are very powerful and versatile; they have become highly coveted in some mercenary circles. Practitioners of magic and psychics are wary of the suits, feeling a sense of wrongness emanating from them. Techno-wizards are baffled by them; the few who have tried to study Angrar suits have died under mysterious circumstances.

The terrible truth is that the suits are the brainchild of the demonic entity known as Ahriman (see **Rifts Conversion Book 2: Pantheons of the Megaverse**), a godlike being intent upon spreading death through the Megaverse.

Angrar Mark II Power Armor

The demonic-looking suit is more powerful than most comparable equipment. Unknown to most, however, the suits are actually altered demonic entities, reshaped into the form of a suit of armor. The demon is the actual “sensor” system and power source! Psychic sensitives will sense the demonic presence and its evil, but may believe it comes from the wearer of the suit. This suit of armor regenerates damage (the sellers call it “living metal”) and is ridiculously cheap for its capabilities — it is “better” than almost any suit of armor in existence. This is exactly what Ahriman’s agents intend, because the true price of the armor will only become apparent with time.

The horrible truth about these suits is that those who are fooled into using them will be unknowingly serving a demonic force and will soon be consumed by it. These demons are P.P.E. vampires, absorbing some of the life force of any being the wearer kills with the suit. This P.P.E. is then siphoned by Ahriman’s demons and given to the god, who uses it to increase his power. Also, Ahriman or his underlings can at any time see through the demon’s eyes, giving the evil god an immensely wide spy network. As yet another side effect, after a few months of ownership, the owner starts to become an insane, malevolent monster. Eventually, the creature will become one with the demon, eternally fused to the suit of armor, and will be transported to Ahriman’s dimension as yet another shock trooper!

Effects of the armor: A character who uses the armor will start becoming more bloodthirsty in combat. He will also begin to depend more and more on the suit, preferring it to other vehicles he might own. Each time the character kills another while inside the armor, he should roll a save vs magic (12 or higher). On a failed save, he gains a slight demonic feature (slightly sharpened teeth, more facial hair than normal, skin roughness, or any other effect the GM might see fit). In addition, the character should roll a save vs magic once a month. After six failed monthly rolls (not killing rolls), the character becomes a demon, fully integrated into the armor.

Exorcism will work against the suit of armor and may free a trapped character (roll again on a successful exorcism; 01-40% results in the suit abandoning the human wearer). Banishment will also work. Control/enslave entity can also be attempted, but it may trap the wearer inside an enslaved demon armor who will obey the spell caster! Any attempts at analyzing or studying the armor will result in its coming alive and attacking the researchers! The demon is not an experienced warrior (this is the reason Ahriman sends them over to “recruit” true soldiers), and fights like a first level character with no attribute bonuses. If captured or controlled for more than 48 hours, the armor will dissolve and disappear.

Suits of Angrar Power Armor are sold in selected places throughout the Megaverse. Some may be found in the hands of transdimensional warriors. The first dealerships have just made an appearance on Earth! Evil summoners like to equip human retainers with these suits and then control the resulting demon-human hybrids.

Model Type: AM-II

Class: Strategic Armor Military Assault Suit.

Crew: One.

M.D.C. by Location:

Plasma Gun (right shoulder) — 90

Arms (2) — 120 each

Shoulders (2) — 200 each

Legs (2) — 250 each

Head — 120

* Main Body — 700

* Depleting the M.D.C. of the main body will shut the armor down completely and kill the demon; until then the “sensors” will continue to work.

Note: The armor regenerates at the rate of 1D4 x 10 M.D.C. per hour. Vulnerabilities: Silver weapons do mega-damage to the suit; rune weapons, holy weapons, and Millennium Tree weapons do double damage (higher if the weapon does more damage to demonic or supernatural entities).

Speed: Running: 44 mph (70 km) maximum. **Leaping:** The powerful robot legs can leap up to 15 feet (4.6 m) high or across. Add 10 feet (3.0 m) with a running start.

Statistical Data:

Height: 9 feet (2.7 m).

Width: 6 feet (1.8 m)

Length: 5 feet (1.5 m).

Physical Strength: Equal to a P.S. 40 (supernatural!)

Cargo: None

Power System: Demonic; unknown (the suits have been sold in the Megaverse for a mere five years).

Black Market Cost: Ahriman’s agents are selling the suits for a measly 8 million credits. Profiteers who try to buy the suits cheap and resell them for more (the suit could go for as much as 40 million in the open market) will be found and killed (remember, the armor suits are partially sentient).

Weapon Systems

1. Angrar Rail Gun (1): This is basically a copy of the Triax VX-180 Maxi-Rail Gun, with a shorter range. It is actually powered by P.P.E. produced by the demon suit.

Primary Purpose: Assault

Secondary Purpose: Defense.

Weight: Gun: 350 lbs (157.5 kg). One A-30 Ammo-Drum: 200 lbs (90 kg); two ammo drums are standard. The gun is totally compatible with any other ammo drum produced in the Megaverse (the demon will alter the gun’s shape to accommodate them!).

Mega-Damage: A Burst is 40 rounds and inflicts 1D6 x 10 M.D. Can only fire bursts.

Rate of Fire: Equal to number of combined hand to hand attacks.

Effective Range: 4000 feet (1220 m).

Payload: 4000-round drum; that’s 100 bursts. The second drum feeds automatically after the first drum is exhausted. May use other sizes of ammo drum — the gun is universally adaptable.

Special Features: The demon telepathically senses the wearer’s intentions and helps lock onto the target. The wearer gets the eerie feeling that the gun starts aiming at the target before he starts moving! Bonuses: +2 to strike.

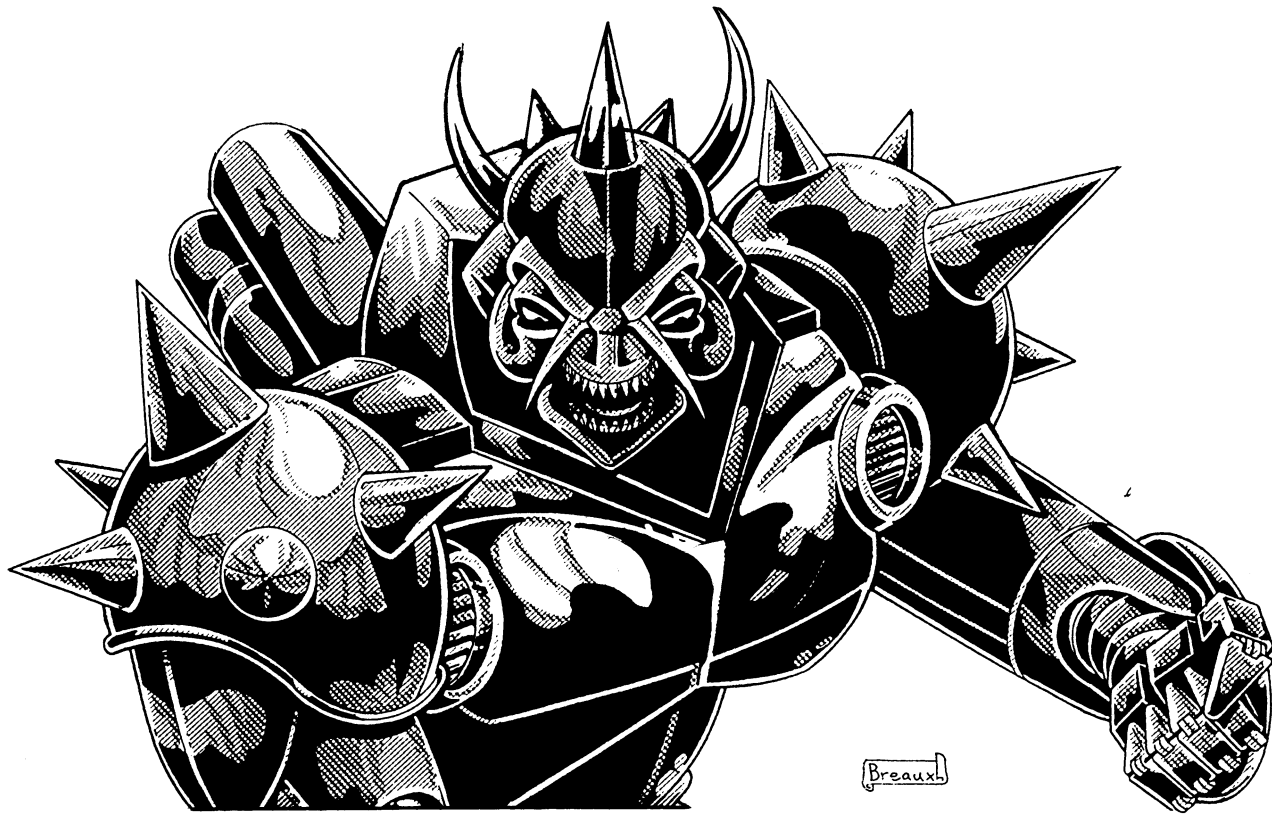

- 2. AR-90 Plasma Gun:** This is a shoulder mounted TW-Plasma Gun. Again, since the demon is the one actually using the weapon, the wearer does not have to be psychic or magically oriented to use it! In fact, the sellers prefer characters without powers as clients, as they are less likely to notice the terrible transformation until it's too late.

Primary Purpose: Assault

Secondary Purpose: Defense

Weight: 120 lbs (54 kg)

Mega-Damage: 1D4 x 10 M.D.

Range: 4000 feet (1220 m)

Rate of Fire: Equal to number of combined hand to hand attacks.

Payload: Effectively unlimited

- 3. Hand to Hand Combat:** Rather than use a weapon, the pilot can engage in mega-damage hand to hand combat. The Angrar suit is unparalleled in close combat, able to rip apart larger robots with its supernatural strength. Most wearers prefer to close in the range and attack characters in this manner. See Basic and Elite Power Armor Combat Training. All abilities are the same except as follows:
Restrained Punch: 5D6 + 25 S.D.C.
Punch: 3D6 M.D.
Power Punch: 6D6 M.D.
Kick: 3D6 M.D.
Leap Kick: 5D6 M.D.

Angrar Assault Robot

This is a giant robot vehicle of immense destructive power, and made up of several powerful demons shaped into robotic parts. The vehicle has a crew of four, and the demons can corrupt all the crew members at the same time. After a while, the crew tends to stay together, whether they were friends or not before using the robot. The members tend to shun the company of normal people, and start following an impulse to participate in strange rituals every full moon.

Each member of the robot crew must make a save vs magic (12 or higher) once a month. After all crew members fail at least one roll, they develop a strange kinship with each other. They never talk about it, but they feel more comfortable with each other than with other

people. All the crew members become obsessively protective of the robot; they won't allow others to inspect or try to pilot it, and will go berserk if someone tries to deny them access to "their" robot. Every successive failed roll makes the obsession stronger. When all crew members have failed four rolls, they become demonic parts of the creature, eternally fused into the robot, which becomes a single, gigantic entity.

Model Type: AM-XX

Class: Assault Robot.

Crew: Three: One pilot, one-copilot/gunner, one gunner.

M.D.C. by Location:

Hands (2) — 80 each

Arms (2) — 400 each

Legs (2) — 600 each

Hellfire Projector — 400

Mini-Missile Launchers (2 in torso) — 30 each.

Head — 500

* Main Body — 900

* Destroying the main body causes the armor to fall apart — and become a group of demons! Each body part retains its M.D.C. (minus any damage taken) and becomes a demonic creature that is +1 to strike, +2 to parry and dodge, claw attack does 2D6 M.D., three attacks per melee.

Note: The demonic armor regenerates damage at the rate of 1D4 x 10 M.D.C. per body part per hour. Silver weapons do mega-damage to the suit. Rune weapons, holy weapons, and Millennium Tree weapons do double damage (higher if the weapon does more damage to demonic or supernatural entities).

Speed: Running: 70 mph (112 km) maximum. Note that the act of running does not tire the demons and speed can be maintained indefinitely. Leaping: The robot can leap 20 feet (6.1 m) lengthwise or high.

Statistical Data:

Height: 26 feet (7.9 m)

Width: 20 feet (6.1 m)

Length: 20 feet (6.1 m)

Weight: 35 tons

Physical Strength: Equal to a P.S. 50 (supernatural).

Cargo: Minimal storage space. A small area for the crew's personal items, as well as a weapon bin that has room for 4 rifles, 4 pistols, 4 suits of body armor, and other supplies.

Power System: Demonic; unknown (the suits have been sold in the Megaverse for a mere five years).

Black Market Cost: 25 million credits. Profiteers who try to buy the robots cheap and resell them for more (the robot could go for as much as 90 million in the open market) will be found and killed (remember, the robots are partially sentient).

Weapon Systems

1. Hellfire Cannon: This is a Techno-Wizard item activated by the suit's demon (so the pilots don't have to be men of magic or psychics to use it). The cannon spews forth magical flames that do enormous damage.

Primary Purpose: Anti-Armor

Secondary Purpose: Defense

Weight: 1 ton

Mega-Damage: 3D4 x 10 M.D., doubled to dragons and supernatural entities; vampires take full damage.

Rate of Fire: Standard.

Effective Range: 4000 feet (1220 m).

Payload: Effectively Unlimited.

2. Mini-Missile Launchers (2). The only non-demonic (wholly artificial) weapon in the robot.

Primary Purpose: Anti-Personnel, Anti-Aircraft.

Secondary Purpose: Defense.

Mega-Damage: Varies with missile type (usually plasma).

Rate of Fire: One at a time or volleys of 2, 4, 6 or 8 missiles.

Effective Range: About 1 mile (1.6 km).

Payload: 20; 10 missiles per launcher.

3. Energy Claws: The robot suit can make its hands glow with demonic energy. These energy claws do extra damage or can fire short-range energy blasts.

Primary Purpose: Assault.

Mega-Damage: Add 2D6 M.D. to hand to hand attacks, or fire an energy bolt inflicting 4D6 M.D.

Rate of Fire: As many as combined hand to hand attacks.

Effective Range: Blasts: 1600 feet (488 m).

Payload: Effectively unlimited.

4. Hand to Hand Combat: Rather than use a weapon, the pilot can engage in mega-damage hand to hand combat. All abilities are the same as the UAR-1 enforcer except the damage, which is much higher than any normal robot suit's.

Restrained Punch: 1D6 M.D.

Full Strength Punch: 1D6 x 10 M.D.

Power Punch: 2D6 x 10 M.D.

Powered Claw Attack: Add 2D6 to punch damage.

Chipwell Armaments, Inc.

Chipwell Armaments is the latest entrant to the weapons market. It was founded by former Coalition Army Engineer Boris Chipwell, who decided to offer something the competition didn't — affordable powered armor suits and robots. Chipwell's robot vehicles are sold at a fraction of the cost of a Triax, Northern Gun, Titan series or Coalition-produced armor. Since the introduction of Chipwell products to the market, townships that might have afforded to buy one or two suits of powered armor now can outfit a dozen or two warriors with M.D.C. suits!

The downside, however, is that people get what they pay for. Within a month of the company's first sales, the product line became popularly known as "Cheapo Armaments." Most experienced adventurers wouldn't be caught dead wearing any equipment with the Chipwell logo — according to conventional wisdom, dead is what you'll be if you trust your life to these suits. Chipwell cut prices down by using substandard parts and equipment and replacing as much of the model's chassis and armor with common steel, rather than standard M.D.C. alloys. The company also uses substandard electronic systems, which result in slow, sluggish responses in the robots, compared to the superhuman reflexes found in quality suits. Contrary to popular opinion, Chipwell suits are not more prone to breakdowns — they are just inferior in protection, maneuverability, and overall quality. Other Chipwell suits are only slightly inferior, but literally run on batteries, and can only work and fight for a few hours. Thus they are only useful for defensive purposes.

Despite these shortcomings, Chipwell Industries has sold thousands of models during its first few months of operation — even after word got out about their problems. Why? Simple economics. With robot vehicles costing only 1-6 million credits instead of 10-60 million, and powered armor costing 50,000-200,000 credits instead of the usual 400,000+, governments and armies can afford to outfit a lot more soldiers with powered armor or robots. The fact that many of these

suits are little better than deathtraps is not important to many army leaders; as long as the soldiers inside can fight and hurt the enemy before being destroyed, they have fulfilled their mission. There are also many villages and small towns whose inhabitants might be able to scratch together a few million credits for a defense force, and who feel safer with a dozen "well-equipped" soldiers than with one or two lone champions (this also reduces the chance that a single armored warrior might decide to take over the community).

Newly founded mercenary outfits on a budget sometimes take advantage of Chipwell's low prices. In the final analysis, even a Chipwell powered armor suit is more than a match for an infantryman in M.D.C. body armor, and ten Chipwell suits can overpower a good quality normal suit — although less than half of the attackers would survive. It is expected that many town guard units, bandits, outlaws and other groups will be equipped with Chipwell armor in the near future. The Coalition is conducting a feasibility study about equipping a whole division of non-Citizen troops (mercenaries and desperate people offered citizenship if they fight in a war) with low-cost Chipwell suits, and using them for cannon fodder in one of the CS's upcoming campaigns.

Chipwell Series Power Armor

Unlike most suits of power armor, Chipwell suits do NOT have all the features described in Rifts, p. 211. This elimination of important features is part of what has reduced the cost of the suits. Among other things, the range of both radar and targeting computers is usually lower than average, ranging from 1 to 5 miles (1.6 to 8 km), instead of the customary 10 mile (16 km) range. A few models are not even fully

sealed, environmental armor, which means that the wearers will suffer if exposed to fire, even normal S.D.C. fire! Each suit description will list which features it possesses, and what changes have been made to them.

CAI-50 Challenger Light Combat Armor

This is a relatively high-quality armor suit (by Chipwell standards), whose major shortcoming is that instead of a nuclear power plant, it runs on batteries good for 24 hours of continued use (it can even be jury rigged to run on E-Clips!). The suits are often bought by city garrisons, who can always count on being resupplied with batteries within a day. The suits are much less useful for adventurers travelling in the wilderness, unless they are planning to carry tons of batteries with them!

Model Type: CAI-50

Class: Light Infantry Armor Military Exo-Skeleton.

Crew: One.

M.D.C. by Location:

Arms (2) — 20 each

Legs (2) — 50 each

* Head — 50

** Main Body — 120

* Destroying the head/helmet has a 01-70% chance of knocking the pilot unconscious. If conscious, the pilot has two problems; one, no power armor combat bonuses to strike, parry, and dodge, and two, the human head is now vulnerable to attack. **Note:** The head is a small and difficult target to hit. Thus, it can only be hit when a character makes a called shot and even then the attacker is -3 to strike.

** Depleting the M.D.C. of the main body will shut the armor down completely, and the pilot will be vulnerable to attack.

Speed: Running: 40 mph (64 km) maximum. Note that the act of running does tire out its operator, but at a fatigue rate 20% less than normal, thanks to the robot exo-skeleton. **Leaping:** The robot can leap 15 feet (4.6 m) straight up or across. **Range:** The robot's batteries provide power for 24 hours of use only; giving it a useful range of less than 500 miles (800 km).

Statistical Data:

Height: 7 feet (2.1 m).

Width: 3 feet (0.9 m).

Length: 3 feet (0.9 m).

Weight: 130 lbs (58.5 kg)

Physical Strength: Equal to P.S. 20

Cargo: None.

Power System: Electrical batteries; 24 hours of continual use.

Black Market Cost: 90,000 credits for a new, undamaged, fully powered suit.

Weapon Systems

- 1. No Integrated Weapon Systems.** The wearer must use a hand-held weapon.
- 2. Hand to Hand Combat:** Rather than use a weapon, the pilot can engage in mega-damage hand to hand combat. All abilities are the same as the Power Armor Basic Training, with the following changes:
Punch: 1D4 M.D.
Leap Kick: 1D6 M.D.
- 3. Sensors and Optics:** The helmet is equipped with laser targeting, telescopic, passive nightvision and polarization, as well as a short-range radio. No other features.

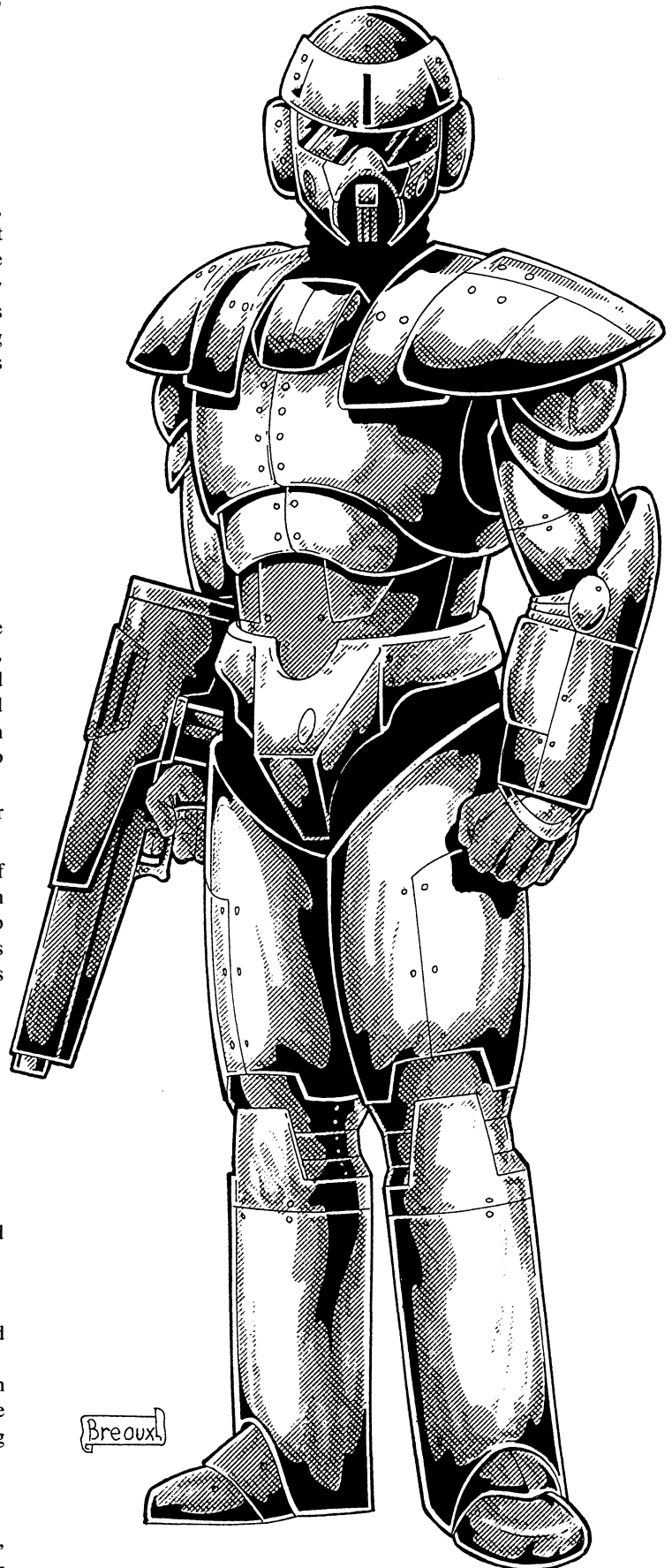

Chipwell Assault Suit

This is a big, heavy suit that looks powerful and intimidating, but which, in reality, is less powerful and resistant to damage than all but the lightest standard suits. This is because many of its components use normal S.D.C. parts instead of expensive M.D.C. alloys. The suit has a nuclear power plant, but it's smaller and less durable (effective life of 5 years). Integral weapon systems includes a laser (actually a modified, built-in laser rifle), and it carries a heavy machinegun modified into a rifle configuration.

Model Type: CAS-30

Class: Armored Infantry Assault Suit.

Crew: One.

M.D.C. by Location:

Arms (2) — 20 each

Legs (2) — 30 each

Built-in Laser (Right Arm) — 12

Machinegun — 8

* Head — 55

** Main Body — 150

* Destroying the head/helmet has a 01-70% chance of knocking the pilot unconscious. If conscious, the pilot has two problems; one, no power armor combat bonuses to strike, parry, and dodge, and two, the human head is now vulnerable to attack. **Note:** The head is a small and difficult target to hit. Thus, it can only be hit when a character makes a called shot and even then the attacker is -3 to strike.

** Depleting the M.D.C. of the main body will shut the armor down completely, and the pilot will be vulnerable to attack.

Speed: Running: 40 mph (65 km) maximum. Note that the act of running does tire out its operator, but at a fatigue rate 20% less than normal, thanks to the robot exo-skeleton. **Leaping:** The robot can leap 15 feet (4.6 m) straight up or across.

Statistical Data:

Height: 11 feet (3.4 m).

Width: 5 feet (1.5 m)

Length: 4 feet, 6 inches (1.4 m).

Weight: 500 lbs (225 kg)

Physical Strength: Equal to a P.S. 24

Cargo: None.

Power System: Nuclear; average life is 5 years.

Black Market Cost: 250,000 credits for a new, undamaged, fully powered suit.

Weapon Systems

1. Machinegun: This is a 14.5 mm machinegun reconfigured as a rifle and firing explosive bullets. It's a poor substitute for a rail gun, but much cheaper.

Primary Purpose: Assault.

Weight: 30 lbs (13.5 kg).

Mega-Damage: A burst is 40 rounds and inflicts 5D6 M.D. A single round does 1D4 M.D.

Rate of Fire: Standard.

Effective Range: 2000 feet (610 m).

Payload: Drum magazine with 800 rounds; that's 20 bursts. Changing drums takes one melee round.

2. Integral Laser: This is nothing more than a Wilk's 457 Pulse rifle, assembled into the arm. The weapon is connected to the power plant.

Primary Purpose: Assault.

Secondary Purpose: Defense.

Weight: 4 lbs (1.8 kg).

Mega-Damage: 3D6 + 2 M.D. per single shot, 1D6 x 10 M.D. per multiple pulse burst (three simultaneous shots).

Rate of Fire: Standard.

Effective Range: 2000 feet (610 m).

Payload: Effectively unlimited.

3. Hand to Hand Combat: Rather than use a weapon, the pilot can engage in mega-damage hand to hand combat. All abilities are the same as the Power Armor Basic Training.

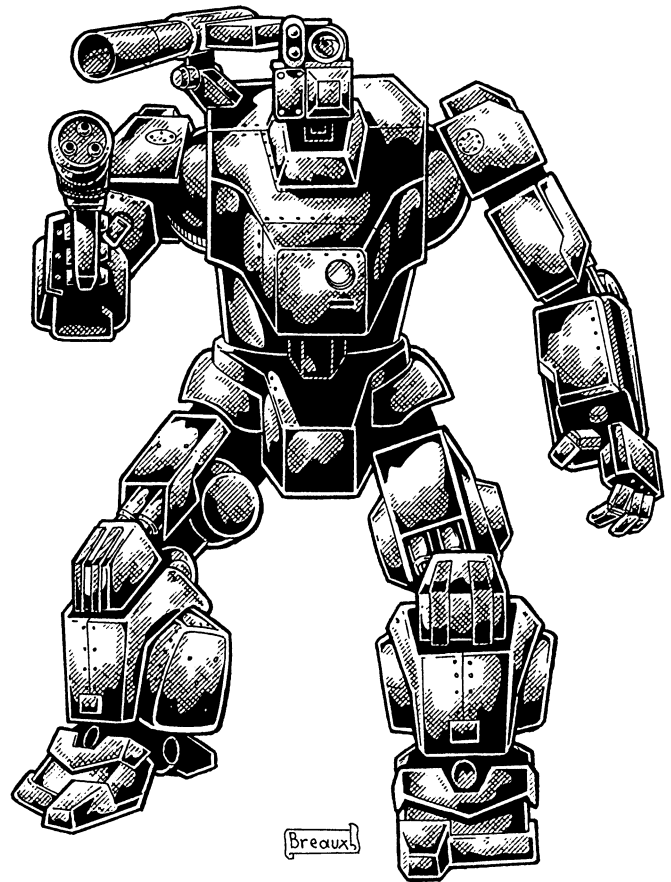

CAI-100 Warmonger Combat Suit

Easily the worst of the worst, this cumbersome suit is made up of steel, aluminum and S.D.C. alloys. As a result, the armor can be damaged or destroyed by S.D.C. weapons! The suit's only redeemable feature is its rock-bottom price, barely more expensive than a suit of non-powered armor. It lacks all but the simplest sensor and communication systems, and offers only partial environmental protection. It is equipped with a modified WI-23 Multi-Missile Launcher (the launcher is the only thing made out of M.D.C. alloys, and it's an optional feature!). The battery is good for seven days of continuous operation, but most people with any knowledge of the suit doubt that it could survive seven days of fighting. In its two years of service, the Warmonger has become universally regarded as a deathtrap. Still, some princelings prefer to have 10 soldiers in Warmonger suits and one or two wearing real powered armor — it looks better to have a lot of soldiers, and a polished Warmonger suit looks just as nice as any other.

Model Type: WC-300

Class: Armored Infantry Assault Suit.

Crew: One.

M.D.C. by Location: **Note:** This suit is made up of S.D.C. alloys, so even S.D.C. weapons can damage it.

Arms (2) — 5 each (500 S.D.C.)

Legs (2) — 8 each (800 S.D.C.)

Shoulder-Mounted Missile Launcher — 10 (this is an M.D.C. piece).

* Head — 10 (1000 S.D.C.)

** Main Body — 40 (4000 S.D.C.)

* Destroying the head/helmet has a 01-70% chance of knocking the pilot unconscious. If conscious, the pilot has two problems; one, no power armor combat bonuses to strike, parry, and dodge, and two, the human head is now vulnerable to attack. **Note:** The head is a small and difficult target to hit. Thus, it can only be hit when a character makes a called shot and even then the attacker is -3 to strike.

** Depleting the M.D.C. of the main body will shut the armor down completely, and the pilot will be vulnerable to attack.

Speed: Running: 40 mph (65 km) maximum. Note that the act of running does tire out its operator. **Leaping:** The robot can only leap 15 feet (4.6 m) with a running start.

Statistical Data:

Height: 11 feet (3.4 m).

Width: 5 feet (1.5 m)

Length: 5 feet (1.5 m)

Weight: 500 lbs (225 kg)

Physical Strength: Equal to a P.S. 20

Cargo: None.

Power System: Batteries (seven days of continual use).

Black Market Cost: 80,000 credits without a missile launcher, 100,000 credits with launcher.

Weapon Systems

1. Modified WI-23 Missile Launcher: This repeating missile launcher is the only integral system in the suit. It is mounted on the shoulder, and has a rudimentary but ineffective targeting system (-1 to strike).

Primary Purpose: Assault.

Secondary Purpose: Defense.

Weight: 30 lbs (13.5 kg).

Mega-Damage: Varies with missile type.

Rate of Fire: Equal to the user's number of attacks per melee (maximum 6); reloading the magazine takes 3 melee actions if using a box magazine, or 2 melee rounds if using loose missiles.

Effective Range: 1 mile (1.6 km).

Payload: Six missiles.

2. Other weapon systems: The wearer is usually assigned another hand weapon, usually an energy rifle or a grenade launcher.

3. Hand to Hand Combat: Rather than use a weapon, the pilot can engage in mega-damage hand to hand combat. All abilities are the same as the Power Armor Basic Training, with the following changes:

Punch: 1D4 M.D.

Leap Kick: 1D6 M.D.

4. Sensors and Communication: The suit's helmet has a limited targeting system and passive night vision, as well as a short-range radio. No other systems are available.

5. Environmental System: The Warmonger offers partial protection against hostile environments (gas, toxins, etc.), but the sealed systems often malfunction. If in a hostile environment (a smoke-filled room, tear gas cloud, or a vampire in mist form that is trying to get in), make a save (8 or higher); a failed save means that the suit's system has been breached. Reduce the save to 12 or higher if the suit's main body has taken any damage.

New Coalition Vehicles

The CS is continually fieldtesting new vehicles and vehicle classes. Its robot forces are now being supplemented by tanks and aircraft. Emperor Prosek wants to become the master of the German-style Blitzkrieg ("lightning strike"), a swift attack using air and ground forces that overwhelm enemy defenses and create openings that the rest of the army can exploit.

Coalition Air Defense Systems

Some characters may think that owning a few jet planes may allow them to strike at Coalition facilities and go unpunished. They are wrong. The CS has air defense radar stations in all military outposts. These radar systems are much more powerful than those found in robots and vehicles, and will quickly pick up any high-altitude flying object within thousands of miles. Once the intruder is detected, a battery of long-range missiles will be launched to deal with him. The only way to avoid detection is to travel in uninhabited areas, flying low to the ground (which requires travelling at a slower pace).

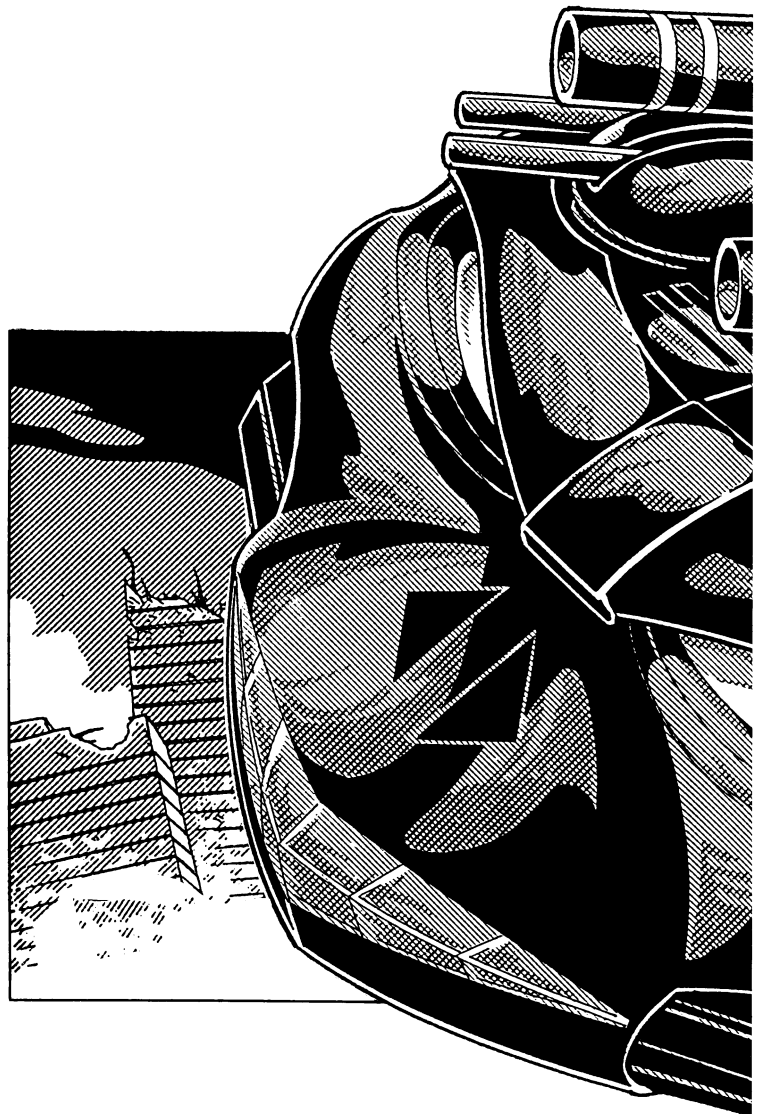

CS Grinning Skull Main Battle Tank

The Grinning Skull is a powerful battle tank designed to lead the Mark V Armored Personnel Carrier into combat. Built along the same lines of the Mark V, but much bigger, and with a large turret on top. Even more distinctive is the grinning skull that is mounted on the front. Some people who have faced the Grinning Skull are even more scared by the maniacal grin than by the usually solemn Coalition death-head motifs.

Its speed is the same as the Mark V, and the tank can be carried by a Death Head Transport (a Grinning Skull can replace a Spider-Skull Walker or two UAR-1 Enforcers). The main turret mounts two C-144 autocannons (also mounted on the IAR-2 robot), and a laser mini-turret on top for added firepower. Two side turrets and side-mounted mini-missile launchers follow the Coalition multiple-gun doctrine, which requires a larger crew than most equivalent battle tanks (i.e., more than one gunner).

Besides its firepower, the tank can also double as an APC; it has room for a six-man squad or two SAMAS. SAMAS are the preferred complement for the tank, because they can provide some degree of air support.

Model Type: Coalition Grinning Skull

Class: Main Battle Tank.

Crew: Six: Pilot, copilot, communications and three gunners.

M.D.C. by Location:

Main Turret on Top — 250

C-144 Cannons (2, on main turret) — 100 each

Laser (1, on main turret) — 50

Mini-Missile Launchers (2, on back sides) — 40 each

Side Laser Turrets (2) — 20 each

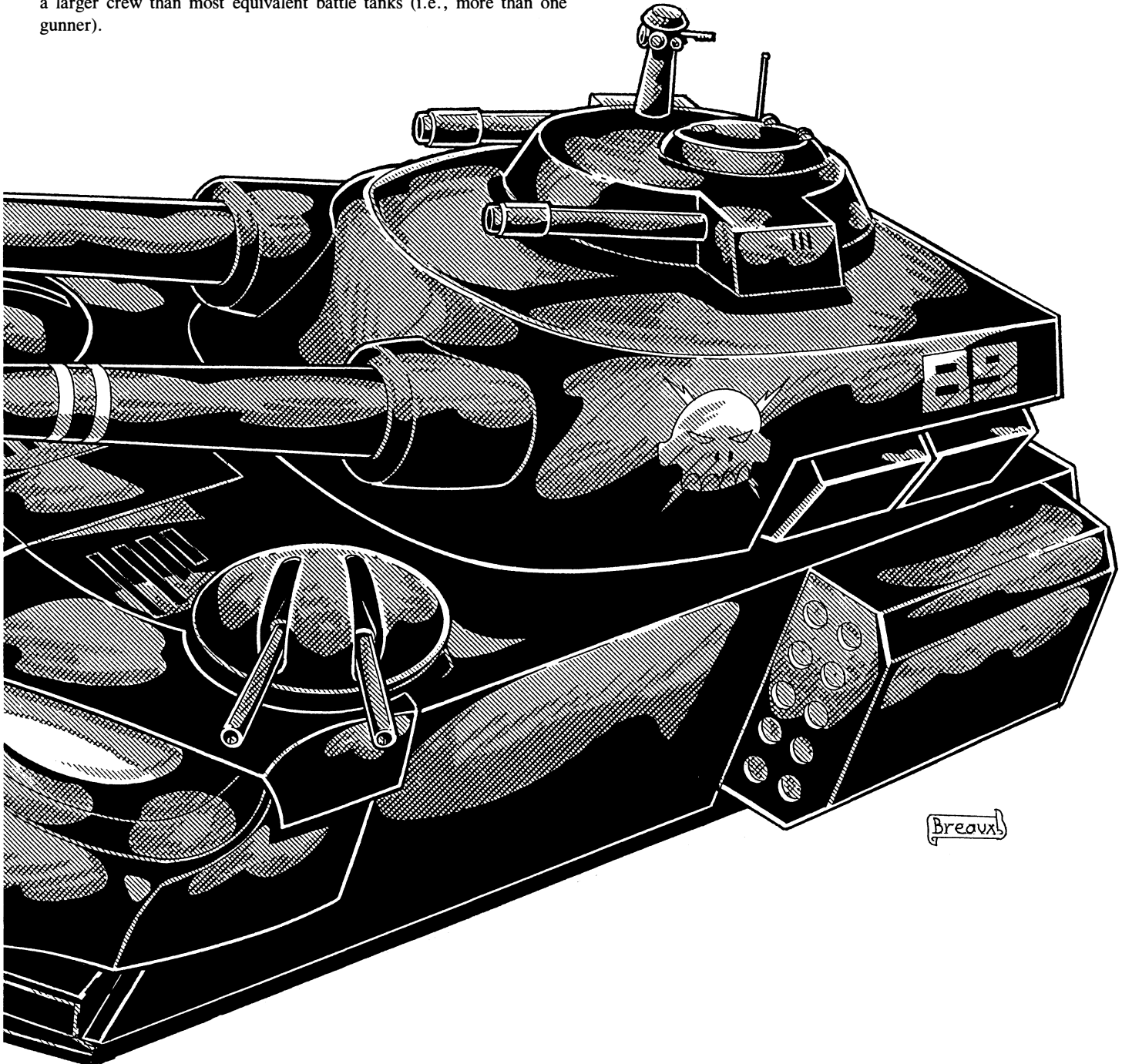

Forward Headlights (2; in Eyes) — 10 each
Ram Plate (Skull Face) — 100
* Main Body — 500
Wheels (8) — 60 each
* Depleting the M.D.C. of the main body will shut the tank down completely, rendering it useless.

Speed: 90 mph (144 km) maximum on land. In water, speed is about 30 mph (48 km).

Statistical Data:

Height: 20 feet (6.1 m).

Width: 13 feet (4.0 m).

Length: 33 feet, 6 inches (10.2 m).

Weight: 45 tons fully loaded.

Cargo: Minimal storage space; about four feet (1.2 m) for extra clothing, weapons and personal items. 4 C-14 Fire-Breather Assault Rifles, 2 C-27 Plasma Rifles, two rocket launchers and 12 fragmentation mini-missiles are stored in locked overhead compartments.

Power System: Nuclear; average energy life is 15 years.

Black Market Cost: No Grinning Skull has appeared on the Black Market; brand new model, just recently put into use.

Weapon Systems

1. C-144 Cannons (2): The Grinning Skull's main weapon is a pair of automatic, self-loading cannons. These cannons are operated by the turret gunner, but in an emergency can be used by another gunner, the pilot, or the copilot. The turret can rotate 360 degrees and has a 70 degree angle of fire (up and down).

Primary Purpose: Assault; anti-armor.

Secondary Purpose: Defense.

Weight: 4 tons.

Mega-Damage: 2D4 x 10 M.D. per single blast or 4D4 x 10 M.D. per double blast.

Rate of Fire: Can fire 4 single blasts or 2 double blasts per melee round.

Effective Range: 6000 feet (1830 m).

Payload: 60 shells; both cannons are fed from one magazine.

2. CR-4T Laser Turret: The turret has a cupola (mini-turret) with a laser battery. This is the same gun used in the Coalition Mark V, but used here as a secondary weapon. The gun can be fired by any of the three gunners. The gun has the same rotation and arc of fire as the main gun.

Primary Purpose: Anti-Personnel, Anti-Aircraft.

Secondary Purpose: Defense.

Mega-Damage: 6D6 M.D. per dual blast.

Rate of Fire: Can shoot up to six times per melee.

Effective Range: 4000 feet (1220 m).

Payload: Effectively unlimited.

3. C-2T Dual Turrets (2): There is one light laser turret on each side of the tank. They are the same turrets mounted on the Mark V, but only two have been installed. There is usually one gunner per side, using both the turret and the mini-missile launcher (see below). The laser turrets have a 360 degree rotation and a 90 degree arc of fire.

Primary Purpose: Anti-Personnel.

Secondary Purpose: Defense.

Mega-Damage: 4D6 M.D.

Rate of Fire: Can shoot up to six times per melee.

Effective Range: 4000 feet (1220 m).

Payload: Effectively unlimited.

4. CR-10S Side-Mounted Missile Launchers (2): Two multi-tube missile launchers are mounted on either side of the tank's main body. The missiles are fired by the side gunners or the co-pilot.

Primary Purpose: Anti-Personnel, Anti-Armor.

Secondary Purpose: Defense.

Mega-Damage: Varies with missile type; the tank's standard load is an even mix of fragmentary (5D6 M.D.) and plasma (1D6 x 10 M.D.).

Rate of Fire: One at a time or in volleys of two, three, five or ten missiles.

Effective Range: About one mile (1.6 km).

Payload: 40, twenty per each launcher.

Coalition Mark IX Missile Launcher Vehicle

This vehicle is still in its testing stage. Basically, it consists of a Mark V chassis with a long-range multi-missile launching system on top. The CS Army would like to use these Mark IX vehicles as long-range artillery to support assaults. They would be ideal to weaken cities and fortifications (the first possible targets for these missile launchers would be Xiticix nests) before they were stormed by ground and airborne troops. Like most Coalition vehicles, the Mark IX has several weapon systems designed to protect the vehicle from enemy rockets and aircraft.

A variant of the Mark IX is also being tested as an anti-aircraft vehicle, given a powerful radar system to detect airplanes and missiles and shoot them down before they reach their targets. The radar system can track up to 96 targets simultaneously, range 500 miles (800 km), for aircraft flying above 300 feet (91 m). Some long-range planners are calling for more advanced air defenses in preparation for the day that invaders like Atlantis or an expanded NGR might threaten the skies of North America.

A few 4-vehicle platoons have been stationed near Minnesota in anticipation of the invasion of Tolkeen and the Xiticix territories.

Model Type: Coalition Mark IX MLRS

Class: Multiple-launch rocket system vehicle.

Crew: Six: Pilot, commander/gunner, sensors operator, communications operator, two gunners.

M.D.C. by Location:

* Multiple Missile Launcher — 250

Side Laser Turrets (4) — 20 each

Forward Mini-Missile Launchers (2) — 40 each

Smoke/Gas Dispensers (2) — 15 each

Forward Auto-Cannons (2) — 10 each

Forward Headlights (2) — 2 each

** Main Body — 350

Reinforced Crew Compartment — 100

Wheels (8) — 50 each

* Depleting the M.D.C. of the Multiple Missile Launcher will cause the vehicle to explode, doing the damage of one missile times the number of remaining missiles in the vehicle in a 600 foot (183 m) radius (so, if the MLRS had 40 Nuclear Multi-Warhead missiles, the explosion will do 4D6 x 400 M.D. to the whole area!). Another danger: if an enemy attack destroys a missile while it is being launched, the missile will detonate, doing damage to the launcher, and could start a chain reaction with the same results. Striking a missile while it is being launched is very difficult, requiring a called shot at a -4 penalty.

** Depleting the M.D.C. of the main body will shut the Mark IX down completely, rendering it useless.

Speed: 90 mph (144 km) maximum on land. Unlike the Mark V, it cannot travel underwater.

Statistical Data:

Height: 20 feet (6.1 m)

Width: 9 feet (2.7 m)

Length: 33 feet, 6 inches (10.2 m).

Weight: 25 tons fully loaded.

Cargo: Minimal storage space; about four feet (1.2 m) for extra clothing, weapons and personal items. The rest of the cargo space (and troop transport rooms) have been modified to hold over a hundred long-range missiles.

Power System: Nuclear; average energy life 15 years.

Black Market Cost: The Mark IX has never been available on the black market.

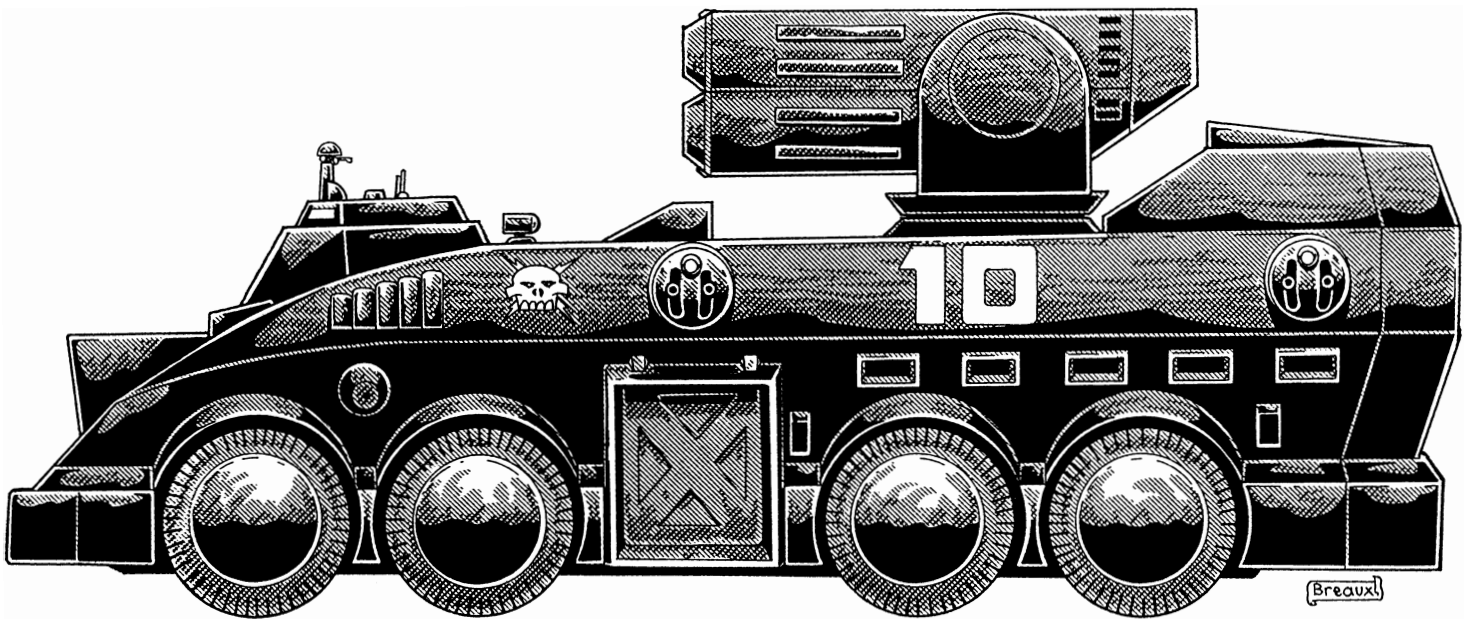

Weapon Systems

1. MLRS: The Multiple-Launch Rocket System has 8 launch tubes that can be reloaded from the magazine below them every 5 seconds (allowing for 3 full volleys per melee). These vehicles are supposed to attack in platoons of four Mark IX's, which means the platoon can fire 96 missiles every melee! Using Proton or Nuclear Multi-Warhead missiles, these vehicles can reduce a city to rubble in a few minutes.

Primary Purpose: Artillery.

Secondary Purpose: Anti-Aircraft.

Weight: 10 tons.

Mega-Damage: Varies with missile type.

Rate of Fire: One at a time or volleys of two, three, four, six or eight. Can fire up to 3 volleys per melee.

Effective Range: About 500 miles (800 km).

Payload: The Mark IX carries 160 missiles (20 full volleys). Supply trucks that carry 160 missiles can transfer them to the Mark IX in 10 minutes.

2. C2-T Dual Laser Turrets (4): These follow the same configuration as the Mark V. Basically, it was decided to keep all the secondary armaments of the APC to better protect the MLRS vehicle.

Primary Purpose: Anti-Personnel.

Secondary Purpose: Defense.

Mega-Damage: 4D6 M.D. per dual blast.

Rate of Fire: Can shoot up to six times per melee.

Effective Range: 4000 feet (1220 m)

Payload: Effectively unlimited.

3. CR-10 Forward Mini-Missile Launchers (2): Located in the very front of the Mark IX are rapid-fire mini-missile launchers. They are used for anti-personnel, anti-aircraft, and counter-missile fire. Against nearby targets (within 1 mile/1.6 km), these missiles can be added to the heavy rockets to make the bombardment even more devastating.

Primary Purpose: Anti-Aircraft, Anti-Personnel.

Secondary Purpose: Defense.

Mega-Damage: Varies with missile type, but mostly uses plasma missiles.

Rate of Fire: One at a time, or in volleys of two, three, five, ten, or twenty!

Effective Range: About 1 mile (1.6 km).

Payload: 40; twenty per each launcher.

4. Forward Auto-Cannons (2): Mounted on both sides of the mini-missile launchers are auto-cannons, usually operated by the pilot. Each auto-cannon can be rotated 180 degrees.

Primary Purpose: Anti-Aircraft.

Secondary Purpose: Defense.

Mega-Damage: 3D6 M.D. per fragmentation round; area affected is 20 feet (6.1 m).

Rate of Fire: Standard.

Effective Range: 2000 feet (610 m)

Payload: 60 total; 30 per each cannon.

Coalition Nightwing Attack Aircraft

The Nightwing is a V-shaped aircraft reminiscent of the 20th-century Stealth Bomber. Unlike that vehicle, the Nightwing's main purpose is not stealth but indiscriminate destruction. This fast and tough combat plane is designed to destroy enemy aircraft and ground targets. The Nightwing has movable thrusters that allow it to hover in midair, unlike most other jet planes, as well as land on any flat surface the width of its wingspan.

This vehicle is being slowly incorporated into the Coalition's army. The CS has tended to rely on their SAMAS and sky cycles for air support, but the recent threat of fast attack jets like the Grey Falcon have required that a true Air Force be developed. The Nightwing has two main missions. First, it is designed to act as an escort for the Death Head Transport, which despite its size and firepower, is relatively vulnerable to attacks by jet planes. Its other mission is to attack ground targets on its own. The first massive use of these aircraft will probably take place during the invasion of Minnesota.

The new Coalition blitzkrieg will consist of 1-20 Death Head Transports protected by a wing of five Nightwings per transport. When the air carriers are nearing their target, the Nightwings will provide air support, attacking enemy ground forces and "softening" them for the troops that will disembark from the Death Heads. Only a highly organized army would survive such an attack, and there aren't that many on the continent.

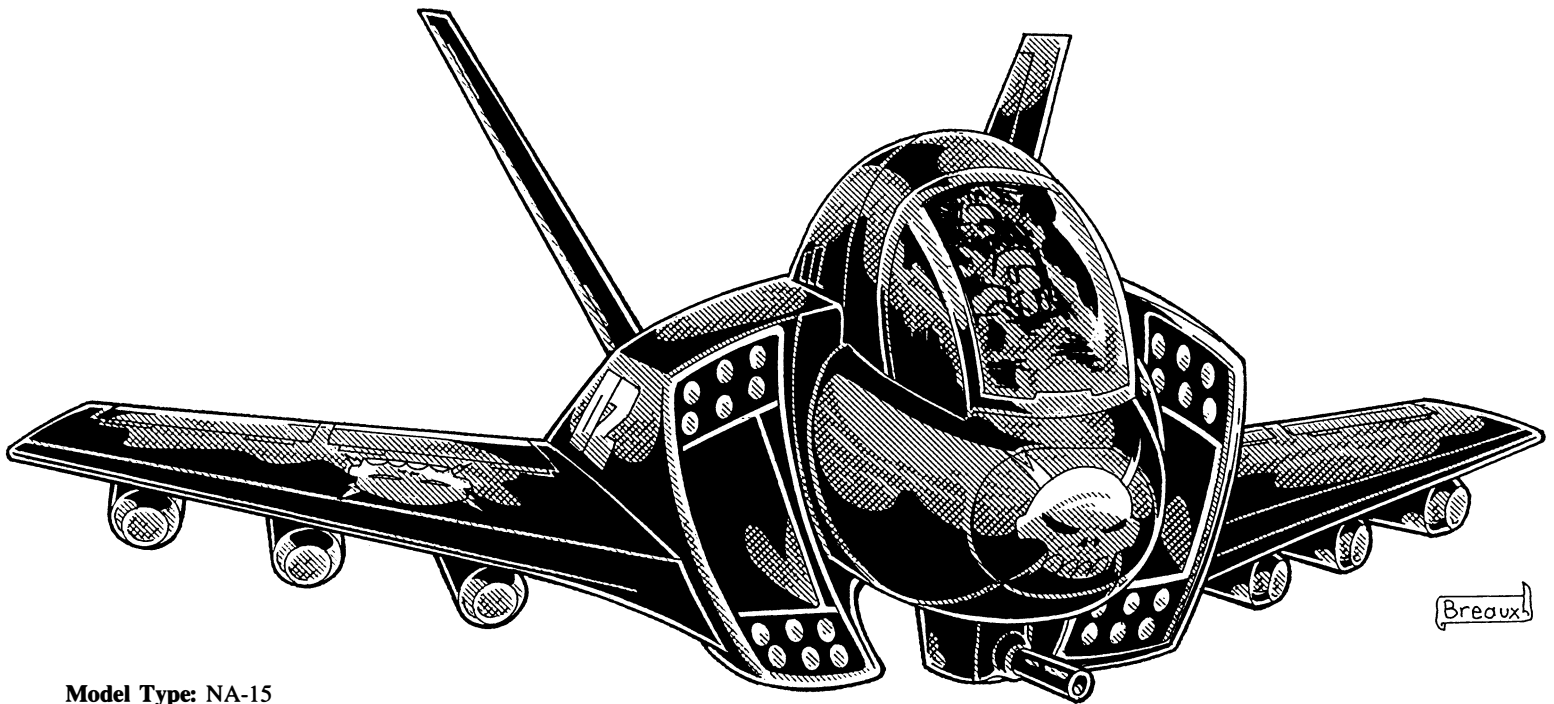

Model Type: NA-15

Class: Attack Jet Plane.

Crew: Two: one pilot, and one copilot/gunner.

M.D.C. by Location:

** Wings (2) — 300 each.

Wing Mounted Medium-Range Missile Launchers (4) — 50 each.

* Pylon Mounted Long-Range Missile Launchers (6) — 20 each.

Belly Mounted Laser Turret — 100.

*** Main Body — 450

Reinforced Pilots' Compartment — 150

* The missiles under the wings are difficult targets to hit; they require a called shot and are at -2 to strike.

/ Destroying one of the wings or depleting the M.D.C. of the main body will knock the bird out of the sky! Roll under piloting skill -40% for a successful crash landing (plane is wrecked, but crew is uninjured).

Speed: Driving on the ground: Not possible. Flying: The jet propulsion system enables the Nightwing to hover stationary up to 10,000 feet (3,050 m) or fly. Maximum flying speed is Mach 2.05 — 1,350 mph (2,160 km). Cruising and attack speeds vary, but tend to be between 100 and 500 mph (160 to 800 km), depending on the target and the mission. Some attacks involve launching missiles from 5+ miles (8+ km) away, others are direct strafing runs using the rail guns and mini-missile launcher. **Note:** A similar jet able to reach Mach 3 is still under development. Range: The nuclear power plant gives it continual power, but the jets overheat in 10 hours of continual use above 200 mph (320 km), or 4 hours if going above 600 mph (960 km). Going at below 200 mph (320 km) with occasional rest stops will allow the plane to travel indefinitely.

Statistical Data:

Height: 10 feet (3.0 m).

Width: 8 feet (2.4 m) body; wingspan 60 feet (18.3 m).

Length: 60 feet (18.3 m).

Weight: 14 tons.

Cargo: Minimal storage space (about 1 foot/0.3 m) for weapons and extra clothing.

Power System: Nuclear.

Black Market Cost: At least 50 million credits. It has never been available on the market.

Weapon Systems

1. High Intensity Laser Turret: This is one of the latest CS developments, a high-powered laser with greater penetration than previous models.

Primary Purpose: Anti-Aircraft.

Secondary Purpose: Anti-Vehicle.

Mega-Damage: Each blast inflicts 2D4 x 10 M.D.

Rate of Fire: Equal to number of combined hand to hand attacks per melee.

Effective Range: 6000 feet (1830 m).

Payload: Effectively unlimited.

2. Wing Mounted Medium-Range Missile Launchers (4): This is the secondary anti-aircraft weapon of the jet planes. They are meant to be used against enemy aircraft and missiles.

Primary Purpose: Anti-Aircraft.

Secondary Purpose: Defense.

Mega-Damage: Varies with missile type.

Rate of Fire: One by one or volleys of two or four.

Effective Range: About 40 miles (64 km).

Payload: 6 missiles per launcher for a total of 24 missiles.

3. Pylon Mounted Long-Range Missiles (6): These missile launchers are used mostly on attack missions (although they are often used in an anti-aircraft mode as well). Each plane only carries six long-range missiles, three mounted under each wing, so pilots are instructed to "save" them for important targets only. In practice, pilots often fire the missiles at the first opportunity.

Primary Purpose: Anti-Vehicle.

Secondary Purpose: Anti-Aircraft.

Mega-Damage: Varies with missile type.

Rate of Fire: One by one or volleys of two, four or six missiles. Commonly used types are Plasma/Heat (3D6 x 10 M.D.) and Proton Torpedo (4D6 x 10 M.D.).

Effective Range: Between 400 and 1,800 miles (640 to 2880 km).

Payload: Six missiles.

Casualties of Peace

Scenario Outline

The old man watched the plain, squinting against the morning sun. The lands east of Hope City were part of the fields that fed the population. The crops had been harvested before their time to make room for the huge makeshift camps that now surrounded the town. If he didn't know better, the elder would have thought that the city was under siege. He shook his head slowly.

War was near. Soon the mercenary armies gathered on the fields would join Hope City's militia and City Guards and march against Benford. Hundreds, perhaps thousands, would die. At least, those were the estimates discussed at the council. He knew better. If this war was allowed to ignite, death would be the least of anyone's problems. Despite the sun shining down on him, the old man shivered. He had been unable to convince the Council, but he would not give up. His children and his children's children deserved better.

He was the only one who knew why the war must be stopped. Nobody inside Hope City's walls believed him. Looking at the mercenary companies below the walls, the man prayed that someone there would help.

Asking mercenaries to help to stop a war seemed bitterly ironic. He hoped someone would have the sense to realize that starting this war would mean death on a scale unimaginable to either side.

Getting Started

Casualties of Peace is an adventure for a group of mercenary player characters. At least one psychic (minor, major or master psionic) player character or non-player character (NPC) should be involved. The Game Master can adjust the difficulty of encounters and obstacles depending on the power and experience levels of the characters.

This adventure takes place on the eve of a war between two cities — **Benford Town** and **Hope City**. A dispute over a rich mining area situated between the two communities is threatening to explode into war. Mercenaries are being recruited by both sides. The faraway Coalition States have taken an interest and are involved indirectly in some of the transpiring events. The player characters can be adventurers caught in the middle or another group of the many other mercenaries being solicited by both sides. In either case, they have just arrived.

However, things are not as they seem. The player characters stumble onto evidence of a plot to incite both sides to a senseless war. The consequences of the conflict are revealed to be far more serious than anybody would guess, and the adventurers are placed in the uncomfortable (and unprofitable) position of having to try and stop the war before it erupts.

Hope City

Hope City is a new, modern settlement, built away from any dangerous ruins. The city was founded by survivors of a city from the Mid-West, a city that was destroyed by marauding monsters from a Rift. The settlers managed to rebuild their industries (they literally dismantled and carried whole factories with them), and Hope City has grown to become a fairly wealthy and well-developed community.

Compared to Chi-Town and other Coalition cities, Hope City is relatively small, but far larger than most settlements on Rifts Earth. It has a permanent population of about 100,000, with an additional 5,000 to 20,000 itinerant visitors (traders, travelers and farmers selling their produce in the city). The city is surrounded by a dozen small farming villages (100 to 500 people on each), and a large section of fields

worked on by city residents (including work gangs of convicted criminals). The population is 86% human, 6% Elf (it has one of the largest Elven communities on Earth), 2% Wolfen, and 6% assorted D-Bees; no other group has more than a thousand. A surprising 60% of the population is at least partially literate, the result of a generous public school program. The Town is very tolerant of D-Bees, but is very paranoid about monsters, demons and malevolent entities. Consequently, any creature that could conceivably be a supernatural threat (including changelings, brodkil, and giants, and as well as the more obviously demonic) are not allowed within the city and many are actually hunted down and destroyed unless trustworthy companions can vouch for the being in question.

Government

The City Government is made up of the City Mayor, the Guilds' Council and the Citizens' Assembly. **The Guilds' Council** is made up of all the prominent merchants — there are no "true" guilds, only wealthy individuals. The prerequisite to qualify for a position on the Guilds' Council is to contribute one million credits to the City Fund; money talks in Hope City. **The Citizens' Assembly** is elected by free elections, open to all citizens. The twenty people who get the most votes get to sit on the council and serve for two years. It is possible to be a member of both the Council and the Assembly, if one has the money to buy enough votes.

The City Mayor is picked from among the Citizens' Assembly by the Guild Council. The selection is subject to a veto from the Assembly. He (currently, she) is in charge of most administrative duties, public works, and internal security. The mayor also acts as the Supreme Judge and decides on important cases that have been appealed. The incumbent's name is **Celia Brunel**; she is a wealthy landowner (much of the farmland surrounding the city belongs to her) who has become popular in the city due to many acts of charity, including the endowment of an excellent medical facility (a hospital with 100 beds and a permanent staff of 30 doctors and nurses). Brunel has done a good job managing the city, but all her time is now dedicated to the goal of destroying Benford Town.

Overall, the Council and the Assembly do a decent job of checking and balancing each other, although the wealthy have a lot more political power (but, as many Hope City people will tell you, isn't that true everywhere?). Both bodies can propose and pass laws, but if either side disagrees with a new law, the two assemblies vote together on it. It is carried or defeated by the total number of votes. There are 15 people sitting at the Guilds' Council, six of whom also hold seats at the Citizens' Assembly.

Military Forces

The Hope City Guard is made up of a local militia numbering 2,000. The Guard is mostly used as a police force and has little military training and equipment. Additionally, there is a Defense Force of 300 men which includes a highly disciplined Wolfen troop of 120 well-trained warriors (mercenaries from the Palladium World). Ninety percent of the City Guard are first or second level vagabonds (unskilled) or the equivalent of CS Grunts, equipped with plastic-man armor and a light energy pistol, or even S.D.C. weapons!

The Defense Force is made up of second to fourth level Headhunters or Wilderness Scouts, equipped with medium M.D.C. armor and energy rifles and pistols. They also have 12 Samsom Power Armor Suits, eight

NG-M56 Multi-bots (the last major defense expenditure the city made), and 10 converted NG-W10 Heavy Labor Bots with two rail guns and a mini-missile launcher outfitted on each. Other vehicles include six Big Boss ATVs with rail guns and eight Mountaineer ATVs used for patrol and to transport troops.

Besides official troops, many of the wealthy citizens have small troops of bodyguards consisting of 4D6 mercenaries. This gives the city another 2,000 or so fighting men, mostly Headhunters, Wilderness Scouts and the occasional borg, juicer and crazy; levels 1D4+1 (the wolfen are 1D4+3 level).

The City Government has realized that these forces are not enough to carry out their military operations, so they have started recruiting more mercenaries.

Benford Town

Benford Town is in economic trouble. It is a mining city that has nearly exhausted all of its resources and is desperately looking for new alternatives. The city has been very wealthy and, for the moment, still is, but the Governor knows that in a few years at best, there will be no more mining and Benford's prosperity will pop like a soap bubble.

The city started out as a small mining town on the side of a mountain. The mountain turned out to be a treasure trove with rich veins of a dozen different minerals, from iron to gold. Many geologists claim these mineral deposits are not natural and are the result of either the wars that caused the Rifts (some say that maybe a whole city was melted into slag and that the mountain is the result of the slag hardening) or by a supernatural event (maybe the whole mountain was Rifted to Earth). The original miners have now become the infamous "Five Families," the powers that control the city.

Benford's population totals 60,000; 90% are human, the rest are mutant dogs. Only 20% of the population is fully literate; the rest are mostly miners with an ingrained distrust for "book learnin'." A trading post on the outskirts of the city holds another 5,000 non-residents, of which 80% are human and the rest, diverse D-Bees or mutants. The town is not actively racist, but dislikes anybody who doesn't "fit in." D-Bees, practitioners of magic, rogue scientists and scholars usually fit that criteria and are generally distrusted and/or blamed for any crime that occurs while they are around.

There are a few farming villages around the area, but strip-mining has rendered most of the land around the city sterile, so most foodstuffs have to be imported from either the Coalition States or other outlying communities (even Hope City). There are a few factories that produce mining-related equipment and weapons (Chipwell Armaments has a factory here, taking advantage of the raw ores extracted at the mining sites), but the economy revolves around mining. When the mines have nothing more to give, the city is doomed.

Government

The city is ruled by a Governor who holds all the legislative, law-enforcement and administrative powers and is advised by the Five Families. The Governor is almost always a member of the Five Families and is selected by them. The current Governor is Giles Jackson III, of the Jackson Clan. The government concentrates only on things like law-enforcement and external security. There are no government controlled public works (including utilities, schools and other services); most of the population is made up of independent miners who don't want the government nosing around in their business.

The Five Families are envied but not hated. Every miner "knows" in his heart that one day he'll be just as wealthy. Since all miners are well paid and draw a share of the town's entire income, most (about 70%) of the citizens have a decent standard of living.

The poor are usually people who cannot or will not work in the mining industry or in any of the service industries that take care of the miners' needs. The rest of the population considers them "bums" and have little respect for them. Vagrancy laws are one of the things the police strongly enforce: Anybody who cannot prove he has a job or will find one in the next 48 hours will be run out of town either by the police or an angry mob.



Military Forces

The **Benford Peacekeepers** are a combination police/army unit. Its main concern is patrolling the outskirts of the city to prevent marauders or vagrants from entering or living too close to the city. The police force's primary concern is dealing with trouble from "outsiders". Consequently, the place can be quite lawless when local politics are concerned (especially when members of the five families are involved) — police turn a blind eye to "local" justice, so the lynching of criminals and mob justice is fairly common here. The whole town's philosophy is similar to the views of the ancient American Old West's. People take care of their own affairs, and if somebody harms the community, the community will deal with the perpetrator.

The mountains to the West are the home of some D-Bee tribes (mostly Goblins and Ogres), and the Peacekeepers often launch raids against those settlements to "keep their heads down," as they say. More than one small non-human village has been totally exterminated by the Peacekeepers, who treat outsiders much like the U.S. Cavalry treated Indian tribes during the 19th century. The Peacekeeper have about 500 soldiers, mostly Headhunters and Wilderness Scouts, with a few elite squads of Juicers and Cyborgs. They are heavily armed, equipped with 20 Challenger Powered Armor suits, 4 Titan Combat Robots and 6 Titan Light Combat Robots. The rest of the force is equipped with medium M.D. armor, energy rifles and rocket launchers. Other vehicles include a dozen Iron Maiden APCs for quick troop transport. The Peacekeepers even have an Air Force consisting of 5 Sky Kings and 5 Grey Falcons.

The city also has a Militia, manned by volunteers. Any able-bodied citizen of either sex can serve in the militia, and most of the tough miners welcome the chance to play with military weapons. If the whole militia was mobilized, it would total some 8,000 people, but usually less than 1,000 are on active duty at any one time. Besides, mass mobilization would paralyze the mining industry. At this point, 3,000 militiamen are ready to march off to war. The Militia is mostly made up of Vagabond-equivalent characters (i.e., miners who have picked up some weapon and piloting skills on their own), levels 1-5. Many miners have had experience defending themselves from D-Bees and other undesirables, who sometimes raid excavation sites and other outposts, and are competent (although slightly disorganized) fighters.

Militiamen supply their own equipment. **Chipwell Industries** has done a good job pushing their wares on the miners, who love the idea of having a nice, shiny powered armor suit taking up a corner of the living room. As a result, there are 700 Warmonger Combat Suits in the city, of which 300 or so have been readied for combat duty. The Peacekeeper Commander (who is also in charge of the Militia) is hoping he won't have to commit them to battle or at least not have against enemies in robots or powered armor — he knows such combat would mean tremendous losses among the militia.

In all respects, Benford is better prepared for a war. They have hired a handful of small mercenary companies, and one big one — Larsen's Brigade, which by itself, could be enough to completely tip the balance of any conflict.



SEZ
JLII

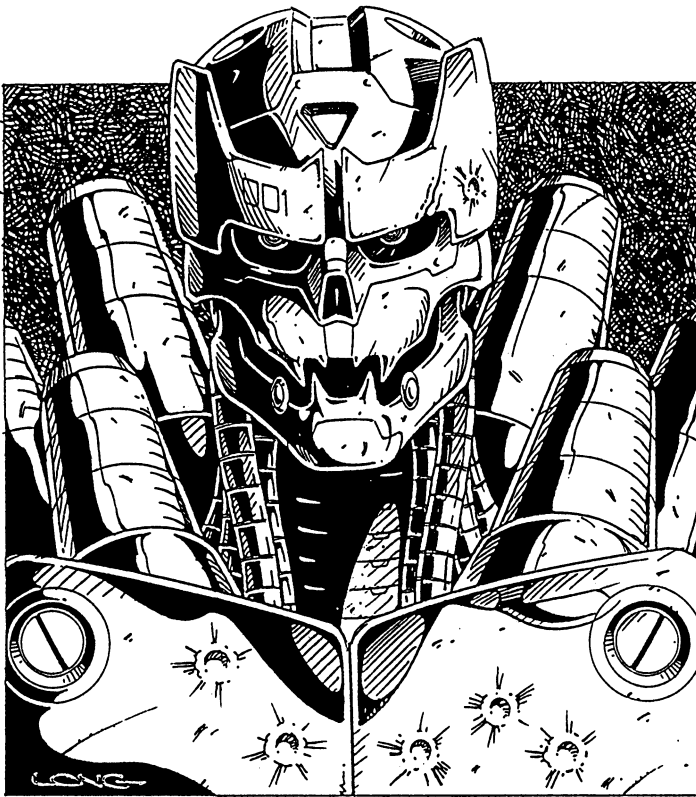

The Conflict

Six months ago, a former citizen of Benford Town, now a Hope City resident, decided to go prospecting in a hilly area somewhere between the two city-states. He struck gold and several other minerals! It was, the man claimed, as big a find as the one that had provided all of Benford Town's wealth in its early years. The land was unclaimed, and the miner had no liking for his former compatriots, so he sold the location to Hope City (actually, to the Guilds' Council) for several million credits. A small army of prospectors descended over the site and confirmed that it was an incredible find.

Mining operations were funded by the Guilds' Council, who turned it into a city project to avoid taxes. Hope City had no mining equipment, so it sent a mission to buy some from Benford Town. It was impossible to hide what the equipment was for, and nobody in Hope City thought of trying to deceive the neighboring settlement in the first place. Nobody had any reason to expect trouble. A couple of weeks later, a delegation from Benford was sent to address the Hope City Government. They claimed that the location of the mines belonged to Benford Town and that the man who had sold the location had no rights to those lands. The delegation had very little evidence to support their claims, other than a handful of sketchy land survey reports made several years ago in that area (surveys, by the way, that had found no mineral deposits).

The Guilds' Council (backed by the Citizens' Assembly) had no intention of giving up the wealth of those mines. On the other hand, they did not want to antagonize their neighbors, so they tried to negotiate a settlement where the mines would be exploited in partnership by the two cities. Under their proposal, both cities would share the profits and the expenses equally. Such a partnership seemed both fair and ideal since Benford Town knew a lot more about mining and would be able to make the most out of the mineral situation.

For a month, the talks continued. Just as an arrangement seemed to have been reached, a strange chain of events destroyed the good will between the two parties. First, one of the Benford delegates became insulting and aggressive. Out of nowhere, he demanded that all non-humans in the Hope City Assemblies be barred from further negotiations

(there were three elves and one wolfen in the Citizens' Assembly, and one elf on the Guilds' Council). The delegate insisted, "We at Benford don't do business with no D-Bees." Negotiations hit an impasse and when Hope City refused to eject the "non-humans" from the negotiations, the Benford Town delegates broke off all communication. Hope City demanded an apology both from the delegation and Benford Town itself and petitioned to reestablish negotiations.

A week later, a group of Hope City prospectors were ambushed and murdered by unknown attackers. Several members of the Assemblies accused Benford Town of the crimes and demanded action to protect their citizens in the mining outpost. The government stationed a mixed force of 100 City Guards and 150 Defense Force soldiers in the area. The Benford Town delegates protested this action, claiming that Hope City was seizing the lands in dispute by force. The next evening, all the Benford Town delegates died under mysterious circumstances when a fire ravaged the inn where they were staying! The blaze claimed seventeen people, including the six delegates. Somehow, Governor Jackson became convinced that Hope City had deliberately murdered the delegates.

The talks ceased completely without any hope for entering into meaningful discussion. A month later, a force of 200 Benford Town Peacekeepers with robot support made camp a short distance away from the Hope City mining outpost. The Peacekeepers' commander demanded that the outpost be evacuated and turned over to Benford Town. The Hope citizens dug in and called for reinforcements. A skirmish ensued between the two armies, resulting in property damage and two dead and six wounded Hope citizens, and one dead and twelve wounded among the Peacekeepers. Hope City sent an additional 100 Defense Force soldiers and 300 City Guards, who started fortifying the area just before winter. Neither side wanted to fight during the winter months, so the two armies dug in, dispatched reinforcements, and waited. Around this time, both also started hiring mercenaries.

Help Wanted

The player characters can join the conflict in a number of ways. First, over the winter, agents from both cities will travel all around the area, looking for mercenaries and equipment. The two cities are very wealthy and are spending billions of credits in the belief that the mine's profits will make up for the expense. The players could be part of Crow's Commandoes, Braddock's Bad Boys, or Larsen's Brigade, all of which are hired into the war. Or they could have their own mercenary company or be an independent band of adventurers looking for an opportunity to make some money, nab some glory or find excitement. They may be approached by either or both sides and if their reputation is good enough they may find their services caught in a bidding war (within reason). Both cities are hiring anybody who is good with a gun.

Once they are hired, the player characters have to get to their employer's city. It's up to the GM whether this is an uneventful trip or an adventure by itself. Once they arrive, they will be assigned a campsite near the city, while they wait for a mission. Small groups may be assigned to a larger military company and are expected to be cooperative and show some measure of military discipline.

A week passes before the first operations are carried out (a last-ditch round of negotiations has started, but it is doomed to fail). By the time the player characters get involved, the division of forces is as follows: Hope City has hired Braddock's Bad Boys, Crow's Commandoes, 8 other small to medium-sized companies (150-200 soldiers each), and about a dozen small groups (10-50 men). Benford Town has hired Larsen's Brigade and about six small groups, as well as a handful of bounty hunters and special forces operatives.

Bad Omens

From the first night in the city, any player character (or friendly NPC) with psychic abilities will be plagued by strange nightmares. They see a battlefield with thousands of men and vehicles destroying each other. Suddenly, the ground cracks open beneath the soldiers' feet and a huge tentacle reaches up into the sky. The dreamers sense that something huge and horrible is breaking free — and then they wake up! The dream repeats itself every night.

Three days after their arrival, the characters are approached by a mysterious old man. This encounter can take place in a number of places. They might find the man in the camp one night or they might run into him when they are leaving a bar, sightseeing on the streets, or while on guard duty.

The man seems to be in his eighties or nineties and is an albino, with pinkish-white skin, white hair, and colorless eyes. He is wearing a faded brown cloak over black robes. Psionic and magic senses will both be triggered by the man; he may be a mystic, or some sort of D-Bee. When the player characters approach, he speaks to them. "You! Maybe you will listen to me! Please. The city is in danger! This war... this war must not continue. Please, you must listen to me!"

If the adventure group dismisses the man, he shrugs and says, "We will talk later, then, when you have seen more," and he leaves. If they attack or try to capture the man, he disappears into thin air!

If the characters report either the dreams or their encounter with the old man, their superiors will dismiss them both — "I think I've told you before, no drinking while on guard duty!" Even if the characters are important or trustworthy enough to make themselves heard, dreams and a strange old man are not enough to convince anyone that something is wrong. Many psychics experience bad dreams before a war, as a precognitive side effect of the death and destruction caused by a battle. Another explanation may be that the enemy is using some kind of psionic attack or magic to damage morale. In either case, the matter is dismissed and forgotten.

The rest of the week passes without any serious incidents as the characters get acquainted with the other mercenaries hired by their employer. If they are working for Hope City, the two largest companies involved are Braddock's Bad Boys and Crow's Commandoes. Braddock himself has been given command over all the forces in the area, subject to approval by the City Government.

Benford Town has hired Larsen's Brigade and Colonel Larsen is in charge of all the armed forces — he answers to no one. The two enemy commanders are both the products of the Coalition's army training and some people are placing bets about who is the better man. In Benford Town, there has been tension between the Brigade's mutant and D-Bee soldiers and the locals, many of whom are prejudiced. If any player character is a mutant animal or D-Bee, he might be harassed by drunks and bullies on the street. At worst, this may end up in a brawl, but as long as nobody pulls a weapon, it won't go beyond a few bruises and black eyes. If a non-human puts up a good fight, the harassment will cease; the character will have "proven himself."

Begins The War

Hostilities have already broken out at other locations, so trouble is expected. The night before, Larsen's air force launched an air strike against the disputed area. Reported casualties were light for both sides.

After a week, the player character's unit is assigned a patrol position near the disputed mining area (a front-line post). They'll have no more than 20 soldiers and no less than 10 (add NPCs if there aren't enough members in the players' unit). If a player character is an officer or an adventurer of renown, he/she will be given command over the entire unit. Their mission is to watch for enemy scouts, spies and evidence of offensive actions. Once they reach their destination, the party will

be stationed on top of a hill, where they will set up camp, send out reconnaissance patrols four times a day and await further orders. Psychic characters will continue having those disturbing dreams.

The characters set out in the morning, either in their own vehicles/robots or in two Iron Maiden APCs and up to four Mountaineer A. T. V. s. Travel to the disputed zone will take two days by ground vehicle; there isn't much in the way of roads, so travel is slow — especially if one is on the lookout for enemy troops and ambushes. During those two days, they may run into some danger from the wilderness, bandits or an enemy unit. Roll on the table below:



Random Encounter Table

Note: Roll once or twice per day (or as desired) during the group's trip and once each time they are sent on any sort of reconnaissance mission.

01-10 A pair of Fury Beetles or Rhino-buffalo run into the party.

They might leave the party alone, or mistake the vehicles for a dangerous animal and attack! (50-50 chance).

11-20 Air Strike! Enemy aircraft finds the unit and attacks. This will be either two or three Iron Eagle Attack Helicopters (if the characters are working for Benford Town) or Grey Falcon jet planes (if the characters are working for Hope City). The aircraft will make two passes, launching missiles and firing their guns, then leave. If the defenders take down an aircraft, they will receive a bonus of $1D4 \times 1000$ credits or $2D6 \times 1000$ if they destroy them all.

21-25 Simvan Monster Riders (see Rifts Sourcebook One or substitute some other D-bee race). $2D6 + 4$ Riders on Ostrosaurus mounts, armed with NG-P7 Particle Beam Rifles and light M.D.C. armor, ambush the convoy; they fire from a distance and under cover. The simvan retreat after two of them are killed or four are seriously wounded. Captured riders will say that the enemy gave them guns and other valuables to get them to harry the enemy forces.

26-30 Enemy patrol! $1D6 + 3$ Wilderness Scouts with one or two juicers or headhunters among them ($1D6$ level). The scouts are

armed with L-20 Pulse Rifles and clad in Plastic-Man armor (they belong to a small merc company). One has a WI-4GL grenade launcher and another has an NG-P7 particle beam rifle.

31-37 2D4 Unscrupulous freebooters (of any kind: Juicers, crazies, borgs, psi-stalkers, line walkers, D-bees or a combination) attack. These brigands (all anarchist or evil alignments) aren't affiliated with either side. They figure they can grab some quick, easy booty during all of the confusion. They won't fight to the death or to destroy their opponents. They want to make a profit by capturing equipment, weapons, armor, vehicles and gold. They may join one side or the other at a later time, especially if pickings are slim. They may also be encountered later looting the dead bodies on the field of battle.

38-41 Supernatural creature. The patrol encounters a manticore, sphinx or waternix (G.M.'s choice). The creature is not necessarily hostile and if it is not attacked, it will try to talk to the group. It is curious about all the commotion. Among other things, it'll tell them that something strange is going on in a cave area somewhere to the east of the camp. It has seen several men with guns there. If the patrol decides to investigate, go to the **Into the Caves section**.

42-51 Nothing happens. No sign of trouble or the enemy.

52-58 Heavy Air Strike! The group is attacked by 3D4 medium range missiles, launched from several miles away by an enemy aircraft. The characters have to knock out as many missiles as possible or face oblivion! A second volley will occur 2 minutes (8 melees) later. The player characters never see or find the aircraft.

59-69 Power Armor Assault! 1D4 + 2 power armor troopers (G.M.'s choice regarding types) swoop down from the trees. They will not fight to the death. Instead they strike to disable the character's squad to soften them up rather than to kill. Of course the G.M. can opt to send in a power armor squad with more lethal intentions.

70-75 The camp is attacked by 1D4 vampires or other supernatural menace. The fiends will carry off one or two sentries and leave the rest of the party alone.

76-81 1D4 Enemy Grunts and a sorcerer. All have 1D4 + 1 levels of experience. The sorcerer can be any of the magic O.C.C.s.

82-88 Enemy pickets. The group runs into a scouting unit. The enemy consists of either A) four Wolfen (3rd level Wilderness Scouts) with energy rifles and M.D.C. armor and one Samsom Power Armor (Hope City), or B) 4 Headhunters (3rd level) in Challenger Exoskeletons with heavy energy rifles. The scouts will retreat in good order, firing as they withdraw. The G.M. can substitute mercenary attackers if he or she desires.

89-94 1D6 + 1 Dog boys (2D4 level) in light body armor (not CS style) attack with CS and Northern Gun weapons. They can be affiliated with either side, function as bandits or freebooters or be looking for work. They are really Coalition spies.

95-00 A Tri-Fang snake or other predatory monster (perhaps more than one) ambushes any straggler or advance scout(s); the snake will attack up to three people at once.

News and Occurrences

After the player characters are stationed in the boonies for two days, a major skirmish between power armor and aircraft units takes place some 30 miles (48 km) away from their position. This encounter is bloodier than the last few, with a total of 12 dead, three wounded and lots of equipment damage (you don't get many wounded when mega-damage weapons are used).

They later learn that Braddock (actually, Crow) won the skirmish, which started when a Brigade armored column was ambushed by a platoon of Wolfen warriors supported by two of Crow's elite squads. The ambushers struck, damaging several vehicles and retreated as several Sky Cycles and Iron Eagle Helicopters scrambled to deal with them. The air reinforcements were in turn attacked by Braddock's Sand Skimmers from the Phoenix Empire and a short air battle followed.

The characters will hear and see some of the air action from their positions. At least 1D4 times during the battle, an enemy aircraft comes within one mile of them. If they have any missiles, they can fire on them. No aircraft from either side are destroyed, unless the player group manages to down one themselves (that will earn the shooter a 1D4 × 1000 credit bonus, and 1D4 × 100 credits for every member of the unit). Other than that, nothing else happens and they are ordered to hold their post and not join the fray.

The Battle

On the third day, the characters become involved in their first pitched battle of the war. This is still not a full-scale conflict, just more of a test of each side's strength.

It starts when Larsen bombs enemy positions around the disputed area and then sends an assault force of power armor soldiers with sky cycle support. Braddock responds with his own artillery and counterattacks with all his robots and aircraft. The player characters are given attack orders at 1 a.m. (if they are working for Benford Town). If they are employed by Hope City, they will be put on a general alert at 3 a.m. The role the player characters will play in the battle will be very different depending on who they're working for.

Benford Town: The player character's unit is given the following orders at 1 a.m.: Leave the vehicles behind, under watch, and advance to attack a Hope City position 20 miles (32 km) to their East. They are to move on the ground, not fly, as hundreds of missiles are going to be fired and airborne soldiers could be hit by mistake. As they advance, they can see missiles flying overhead, and the occasional helicopter and jet plane. Nothing bothers them through the 20 mile run, which takes roughly 45 minutes. The position they find is a semicircle of trenches and machinegun nests at the top of a hill. The area around the position has been defoliated for 300 yards/meters all around the hill. The encampment has been severely bombed, and only a few survivors are left to put up any resistance. They include the following (the G.M. should modify these forces to present a challenging scenario for his group):

- Two 3rd level Headhunters with Samsom Power Armor. One suit took a direct hit from a medium-range missile (main body M.D.C. reduced to 170). Both suits are out of missiles (spent them all trying to shoot down the incoming rockets). Attributes are average, they both have Hand to Hand: Expert and Power Armor Combat: Elite.
- Eight 2nd level Vagabonds in Bushman armor, armed with L-20 laser pulse rifles and 6 fragmentation grenades. They will fire from cover and throw grenades as soon as the enemy is within 40 yards. Hitting them requires a called shot, or the attackers can try to shoot through the cover: the sand sacks and stone only provide 1200 S.D.C./12 M.D.C. of protection.
- 2 Giant Robots. One of them has lost its left leg and taken additional damage (main body reduced to 230 M.D.C.), the other is intact, with about a third of its missiles (if any).

If the player characters cannot take the hill, they can try calling up an air strike. **Note:** 60% chance of getting it eight melees later — a Grey Falcon will make a missile pass, launching eight medium-range missiles against the enemy position. One of them hits an infantry soldier, killing him messily; the others will target the robots and power armor. The enemy will try to hold the position until either one of the robots and/or power armor suits are destroyed. This will demoralize the survivors: 1D6 of the vagabonds will try to run. The rest of the soldiers will throw down their arms and surrender.

Hope City: Explosions and flashes of light at around 1:05 a.m. will wake up the player characters. They will be alerted by radio a few minutes later that the enemy is launching an offensive and that their unit is charged with trying to intercept enemy ground forces. They are ordered to use all their vehicles and weapons to try to stop the enemy



advancement. The characters will run into the following enemy elements (again, the G.M. should modify this to fit his particular playing group):

- 4 Triax Ulti-Max power armor soldiers (worn by 4th level Headhunters with Hand to Hand: Expert, and Power Armor: Elite).
- 8 NG-EX10 Exoskeletons (worn by 3rd level Headhunters with Hand to Hand: Expert, and Power Armor: Basic).
- * 2 UAR-1 Enforcer Robots (supposedly captured from the CS).

If the player characters need help, they can try asking for an air strike (40% chance of getting one; try once every four melees until one air strike is executed). Two Iron Eagle Attack helicopters will make a missile attack (for a total of 8 medium-range missiles and 40 mini-missiles fired at the enemy). The enemy will retreat if they lose more than 2 Exoskeletons or 1 Ulti-Max or UAR-1 robot. The player characters should retreat if they lose more than 20% of their forces.

Since the enemy's advance will make a lot of noise, the player group will have a chance to set up an ambush. This will give the player characters the advantage of firing from behind cover (enemy needs to make a called shot to hit, or can try to shoot through the rock and stone; provides 1200 S.D.C./12 M.D.C. of extra protection). The enemy has a 50% chance of spotting the ambush.

These encounters should be challenging, but not impossible to win. If they need more help, bring in an air strike or other, more heavily powered reinforcements during the course of the fight. That extra firepower should even the odds enough for the characters to achieve their objective without it being handed to them on a silver platter.

The outcome of the battle doesn't change: Over one hundred dead on both sides and three dozen vehicles destroyed beyond repair. In addition, hundreds are wounded and tons of vehicles, bots and equipment are damaged. At the end of the battle, one thing becomes clear: Benford Town has the edge both in numbers and firepower. Larsen's Brigade dominates the skies, has more tanks, robots, and elite troops.

After Effects

As the player characters finish up the battle, every psychic character suddenly sees a monstrous, gigantic face hovering over the battlefield. The face has a Horror Factor of 16 (18 for more sensitive characters like Dog Pack warriors or Psi-Stalkers). It laughs -- an inhuman sound, and then vanishes. Those without psychic powers (unless he uses the spells sense evil or astral projection) won't see a thing and will wonder why the psychics are staring into the skies with their mouths open.

The Cave

A day passes after the battle, with only minor skirmishes. Many Dog Boys and psychics have seen this giant face and some of them want an investigation before continuing the fight. Of the two leaders, Larsen is more open to the suggestion than Braddock. The two cities' governments refuse to even consider an armistice. They want to continue the war, period.

As the player characters are conducting a patrol on the second day after the battle, they make a strange discovery. As they climb a hill, they see a figure clad in M.D.C. armor lying at the bottom of a ravine. It is a man, alive but barely moving. Removing the helmet reveals a human face, but obviously in some state of shock; his eyes are not focusing right and he's drooling. Questions only get a dazed look. Telepathy and Empathy will only show overpowering, insane fear. The man has a TX-5 Pump Pistol as a sidearm and is wearing undamaged Bushman armor, but has nothing else on him. A quick search of the area soon reveals a cave on the side of the hill, partially hidden by some bushes.

If the characters radio headquarters about their discovery, they will be ordered to make a short reconnaissance of the place and to report back in an hour. As the characters enter the cave, psychics will sense a wrongness within. Dog pack and psi-stalkers will sense a ley line nearby, which will reduce their psychic senses, but even so, they feel negative vibes inside. The caves mouth and the cave itself are only 10 feet (3 m) tall and wide; robot vehicles taller than 8 feet (2.4 m) will barely be able to move (-2 to strike, -3 to parry and dodge). Vehicles over 10 feet (3 m) tall will have to advance crouched or on all four (half melee attacks, -4 on all actions).

As soon the party has advanced more than 50 feet (15.2 m) into the tunnel, psychics with either presence sense, sense evil, or any sense that extends over 100 feet, will detect a being approaching them at great speed. Whatever the thing is, it will reach the party in one melee round (15 seconds). The group can make their stand right there or try to retreat and fight outside. In any case, the cave dweller will follow them and fight to the death!

The entity is a vaguely humanoid form walking on two long legs. Instead of a head or arms, the upper torso holds six concentric, clawed tentacles. It has no eyes or mouth. Its skin is covered with coarse scales. The grotesque being makes no noise; it simply attacks — there is no reasoning with it.

Guardian of the Caves (Supernatural Minion)

Alignment: Miscreant

Horror Factor: 15

M.D.C.: 500

Natural Abilities: Bio-regeneration 1D6 M.D.C. per melee, takes half damage from fire and heat attacks (no damage from normal fire), supernatural senses allow it "see" 360-degrees to a distance of 2000 feet/610 m. Tentacles stretch out for up to 60 feet (20 m).

Number of Attacks: Six hand to hand attacks per melee.

Bonuses: +2 to strike, +3 to parry and dodge, +1 to roll with punch/blow, +1 to pull punch, +3 to resist magic and psionics, immune to Horror Factor.

Damage: Restrained claw 1D4 M.D., full strength claw 5D6 M.D., power claw 1D6 × 10 (counts as two attacks). Every time the tentacles strike, the character must make a save vs psionics or lose 1D4 M.E. (temporal loss, regained at the rate of one point per 10 minutes); if M.E. is reduced to 0, the character temporarily becomes a mindless zombie until at least 1 point of M.E. is regained.

If, after dealing with the guardian creature, the characters continue exploring the cave, they find seven other men, dressed like the one they found before, but all dead, ripped out of their armor and torn apart. The sense of something being wrong is even stronger than outside. Furthermore, powerful supernatural evil can be sensed within the caves.

When they inform their superiors of this, they will be referred to the high command; either Larsen or Braddock himself will take the call and ask them to tell their story again. Their superiors' reaction will be the same: They are interested in finding the source of the psychic problems that have been plaguing them since the beginning of the campaign. They cannot afford to send large numbers of troops into the area without starting another round of battles. The order is simple: Go in and try to find out more. Destroy the enemy if encountered.

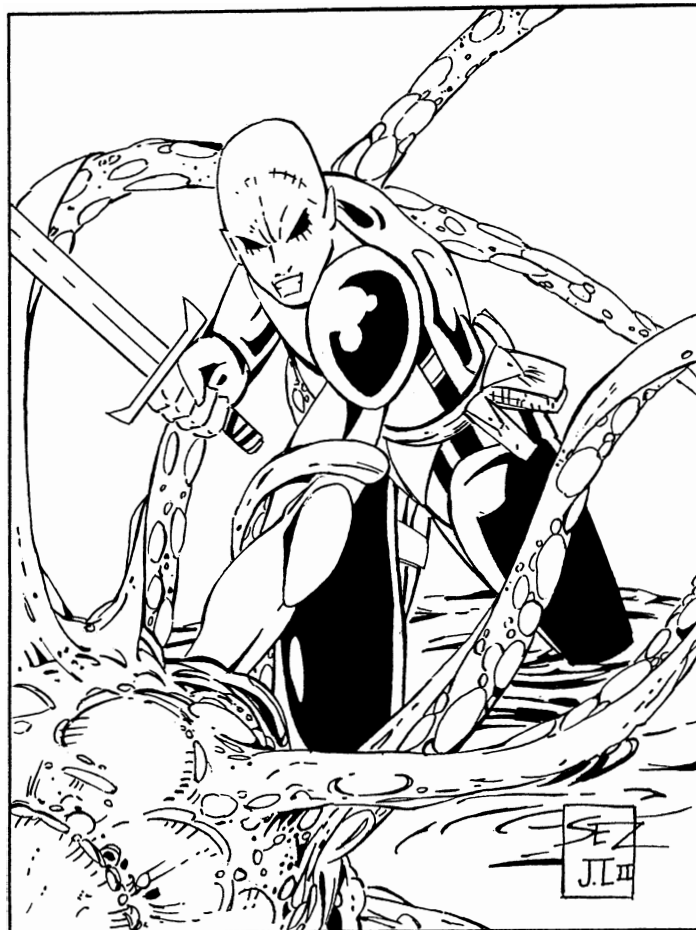

The Thing at the End of the Tunnel

As the party goes deeper into the tunnel, they notice a number of things. First of all, the tunnel walls are unnaturally smooth and curved. Not as if it was man-made, but as if something long and worm-like had melted the rock. Also, the walls shine with a bluish glow 100 yards/meters into the tunnel; so bright that flashlights are no longer necessary. Also along the way, the party finds the scattered remains of a team of miners who came down the tunnel. From the looks of it, the miners killed each other. The skeletal hands of one is wrapped around the throat of another, who in turn shot his slayer. The other two stabbed each other to death. There is no valuable equipment among the corpses, just some tools, S.D.C. knives and a rusty .45 pistol.

300 yards/meters further, the cave opens into a large, open 50 × 50 × 10 yard/meter area. Floating in the middle of it is a monstrous creature. A thing made out of a single eye with multiple clawed tentacles protruding around it. The creature is translucent, insubstantial. Any physical weapons used against it will go right through the creature. So will magic. Only a mind bolt, psi-sword or other psionic attacks will do any damage to it (see below):

The entity's astral projection does not attack. Instead, it addresses them in perfect American. "You have been very entertaining, mortals. In a few hours, I will pay you my respects — personally. The energies released in the upcoming battle will be enough to release me into your world. Soon to be mine." It laughs, and all the psychics in the room recognize it as the inhuman sound they heard over the previous battle.

If the mercenaries try to get out of the room, the creature will say, "Leaving so soon?" and will try to possess up to three of them. Its astral form is very weak, however, and possession can be successfully resisted by a saving throw vs psionics of only 10 or higher; minor

psionics save on an 8 or higher, and master psionics only need a 6 or higher, not counting bonuses. Possessed characters will attack their companions and fight to the death, but at -1 to strike, parry and dodge and half their number of attacks per melee.

If that doesn't work, the creature will use a debilitating power similar to the Mind Bleeder's (see Rifts Africa), but which affects P.P.E. and I.S.P.; the targets (it can attack up to 6 times per melee) have to make a standard save vs psionics. A failed roll means they lose all remaining attacks per melee and suffer a temporary depletion of 1D4 points of P.P.E. or I.S.P. (whichever is higher). After both P.P.E. and I.S.P. are reduced to 0, P.E. points are absorbed; when that is reduced to 0, the character falls into a coma (not deadly; character will recover in 2D6 hours).

The player characters can try to deal with the creature in several ways. Its astral form only has 300 S.D.C.; a Psi-Sword or a Mind Bolt will do their normal damage (but each point of damage rolled will count as one S.D.C. point, even for M.D.C. attacks). Characters who can astrally project can attack the creature directly through hand to hand combat, but the creature can fight them back. If they disrupt the astral form by depleting its S.D.C., the projection will disappear for 2D4 minutes, at which time it'll come back at full S.D.C.! Banishing or transdimensional spells will not work in the cave or against the creature.

When (if) the player group gets out of the room, they will be safe from the creature's psionic attacks. When they leave the cave and get in touch with their headquarters, they learn that a large-scale battle is about to start.

The Last Battle

Larsen has decided to stop pussyfooting around. He is convinced he will be able to seize the disputed zone, and if Hope City tries anything else he'll attack the city directly. A massive air and ground assault is about to be launched. Braddock has anticipated this and plans to send forth all his armored troops in an attempt to shatter the assault. Whoever wins, hundreds will be killed — enough deaths and P.P.E. to empower the alien intelligence manifesting in the cave.

The player characters have to stop the battle! They receive some unexpected help from the old man they met at the city several days earlier. This man is a former government official who has had a psychic premonition about the monster's plans and is determined to prevent the killing. He can confirm the monster's power and intentions and will do whatever he can to stop the battle. If the player group is too slow to act or uncooperative, the old man drives a jeep to the middle of the disputed zone and starts broadcasting on an open channel, begging the two sides to stop. This alone won't prevent either side from entering the battle. Only the player characters can do this.

The ingenuity and role-playing skills of the players will be critical at this point. The characters can broadcast on an open channel, revealing the monster's plot. They can attempt to convince their commanding officer(s), or somehow plead, trick, convince or intimidate the two armies from escalating the war. If they are convincing enough, Larsen and Braddock will call for a truce and investigate.

The Price of Failure

If our heroes cannot or will not prevent the battle from taking place, a number of nasty events follow. The battle is waged: Larsen's assault slams into Braddock's defense. For about an hour, the two sides are stalemated, until Larsen's Air Castle planes break through the enemy air defenses (losing three aircraft in the process) and carpet-bomb all of the defensive positions in the area. Over two hundred soldiers are killed and dozens of vehicles destroyed. Braddock's defenses are shattered. Larsen's Brigade and the Benford Town militia triumphantly ride over the remains of the enemy line... but not for long.



Suddenly, there is a loud earth tremor. Cracks open in the ground, some wide enough to swallow a tank or a robot whole. The hill where the cave was found bursts open in a flash of light, and the monstrous creature, all 300 feet of it, appears over the battlefield. With it are 1D4 × 1000 + 1000 of the guardian beings, all exactly like the one that attacked the player group earlier. The monsters and their master fall upon Larsen's disorganized troops. The Brigade might have been able to stand up to this monster, if they had been fresh and prepared for supernatural combat, but not after fighting a four hour engagement. The second battle lasts somewhat longer than the first, because it is a battle to the death! The only survivors are those who manage to flee or hide from the enemy; everyone else is killed, their energies invigorating the monster.

After the battle is over, the monster and its army will destroy both cities and slaughter most of their inhabitants. Then it will rule over the ruins of Benford Town, slowly increasing its power over the area. Every 24 hours the monster will Rift in another 1D6 × 100 of its creatures, until it brings an army of 50,000 servants. Sooner or later, the Coalition and/or other human nations will become involved in a war for survival with uncertain results.

The Conqueror Alien Intelligence

This entity may have some relationship to Palladium's Old Ones, or to one of the other monstrous entities that occasionally threaten the Megaverse. This ancient being has become attracted to Rifts Earth's magical energies, but unlike other entities, it cannot make use of normal rifts to enter a dimension. Instead, it requires a massive involuntary release of P.P.E., like what occurs at the moment of death. A battle, or large-scale human sacrifice, would be enough to allow it to break through the dimension.

To arrange for the battle, the creature first possessed and then brainwashed the poor miner who claimed there was wealth in the hills, and then did the same to all the other people who came to verify the account. The truth is, there are some small mineral deposits in the area, but nowhere near what both cities think is there. Using possessed agents, the Conqueror managed to worsen the situation and manipulate the two cities into war.

Alignment: Diabolic

Species: Supernatural Intelligence

Attributes: I.Q. 29, M.A. 20, M.E. 23, P.S. 52, P.P. 18, P.E. 24, P.B. 2, Spd. 60 floating.

M.D.C.: 100,000

P.P.E.: 20,000

Natural Abilities: Nightvision 2000 ft (610 m), see the invisible, bio-regenerate 4D6 × 10 M.D. per melee. All non-magical attacks do half damage. Rune weapons and silver weapons do double damage, Millennium Tree weapons quadruple damage.



The creature can create an astral projection (S.D.C. 300) without a silver cord, and send it to other dimensions at P.P.E. rich locations (limited by other factors too). It can enter Earth at only three locations, here, India and Iceland. It can also be reached via the Tree of Darkness in the Black Forest of Germany, but must be summoned by a practitioner of magic.

In its astral form, the Conqueror can summon only one Guardian to protect it, but can summon thousands when it inhabits the physical plane.

It can also fire a psychic bolt of energy that inflicts $2D4 \times 10$ M.D., range 4000 feet/1200 m., +3 to strike, each blast counts as one melee attack.

Experience Level: Equal to an 8th level mind melter or mind bleeder and a 7th level wizard.

Magic Knowledge: Knows all magic spells, levels 1-10.

Psionic Powers: Major psionic. Has all sensitive, physical and super powers. I.S.P.: 3,000.

Combat Skills: Supernatural.

Attacks per Melee: Six hand to hand or psychic attacks or three by magic.

Bonuses: +6 to strike, +8 to parry, +1 dodge, +1 to roll with impact/punch, +2 to pull punch, +10 to save vs poison, +10 to save vs magic, +10 to save vs psionics, +10 to save vs horror factor. Reduce bonuses by half for the astral form.

Damage: The tentacles have a reach of 150 feet (50 m).

Restrained Tentacle Claw — $2D6$ M.D. (1D6 S.D.C. in Astral Form)

Full Strength Tentacle Claw — $2D6 \times 10$ M.D./5D6 S.D.C.

Power Claw — $4D6 \times 10$ M.D./1D6 $\times 10$ S.D.C. (counts as two melee attacks)

Note: Once the creature is firmly implanted in the physical realm, it can be destroyed but such a feat will require a herculean effort.

The Rewards of Victory

If the player characters manage to stop the battle and help to conduct the investigation the two commanders will confirm the situation. Larsen and Braddock will hold an uneasy meeting face to face, with the player group as witnesses. If the characters do a good job describing the situation, they might make a friend in either or even in both commanders. The two soldiers agree to investigate the matter further. They'll also learn that the mines are not as rich as everyone thought. The two will enforce the cease-fire and suggest peace negotiations.

Stopping the bloodshed and cooling tempers for more than six months, will break the Conqueror's connection to Rifts Earth and it will simply fade away. It was only a combination of consequences that enabled it to get even a foothold on Earth. The monster has a tenuous link to Earth at only three locations — this was one such place. The right events and loss of life are necessary for it to enter into our world.

War and destruction is averted, but both cities are stuck with huge mercenary expenses — Benford Town goes nearly bankrupt, and Hope City's economy is severely shaken up. Many mercenaries are not as thankful to the player characters as they should be, because they have lost a lucrative war contract and they don't believe the threat from the

monster was anything they couldn't handle. This may gain the characters a few enemies. **Note:** No matter what, the Conqueror will remember the characters. One day, it will try to extract revenge.

Continuing Sub-Plots

The Coalition States also had a secrethand in this affair. They allowed a number of UAR-1s to fall into Benford Town's hands. A number of the dog boys and cyborgs are really CS spies and instigators.

The CS encouraged the war in order to damage or destroy the D-bee lovers at Hope City. The CS also hoped that a major conflict involving Larsen and Braddock might cripple Larsen's Brigade, who has recently shown an interest in events transpiring at Tolkeen. Without the threat of Larsen's involvement in the northern conflict, the Coalition States would be more tempted to move against that northern nation. If one or both mercenary commanders should perish, the CS could take pleasure in their demise (both are considered to be Coalition traitors). If things went extremely well, the CS had an armored Brigade (1920 troops) waiting in the wings to sweep down under the guise of a peacekeeping force to seize control of the area and its mineral resources. Benford Town would have been placed in power and cultivated a CS ally. With the end of the war, the CS forces will quietly slip away to engage in other, more profitable endeavors. They will actually see a peaceful settlement as a success, considering the discovery of the alien intelligence and its plans for conquest. However, because of this, the CS will keep a close eye on future developments in this area and Benford Town may still be recruited by the CS in the future.

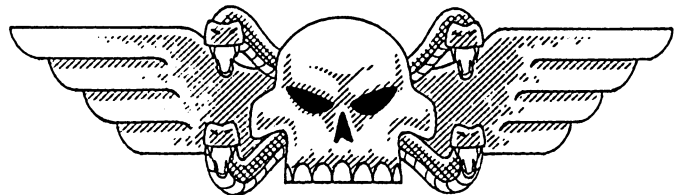



RIFTS®

- Imagine Earth transformed into an alien landscape.
- Humans exist – barely. And we are not alone.
- Aliens and monsters emerge from the Rifts – holes torn in the fabric of space and time, connected to countless worlds and realities.
- Ancient gods, demons and magic have returned.
- Magic and technology clash.
- Hundreds of character classes, many inhuman.
- *Rifts® Ultimate Edition* is the core RPG rule book.
- Expansive world setting with 90+ sourcebooks to draw upon.
- Rifts®, your portal to endless adventure.
- Limited only by your imagination.

www.palladiumbooks.com

© 2014 Palladium Books. Rifts®, Megaverse®, Nightbane® and other titles, slogans and likenesses are trademarks of Palladium Books, Inc. Palladium Books - 39074 Webb Court, Westland, MI 48185 USA - 734-271-2903 order line.

Other RPG Worlds from Palladium Books®:

- *Rifts®* – the ultimate role-playing experience.
- *Rifts® Chaos Earth®* – Play the apocalypse as it happens.
- *Splicers®* – Weird science. Bio-tech battles insane robot legions.
- *Robotech® RPG* – All eras of the TV show brought to life.
- *Dead Reign™ RPG* – Can you survive the Zombie Apocalypse?
- *Palladium Fantasy RPG®* – Unique world, monsters as player characters, magic and more.
- *Heroes Unlimited™ RPG* – Play any hero; mutants, aliens, cyborgs, superhumans, mages, immortals and more.
- *Nightbane® RPG* – Conspiracy, magic, horror and monsters.
- *Beyond the Supernatural™ RPG* – Modern horror and suspense.
- *Ninjas and Superspies™*, and more.

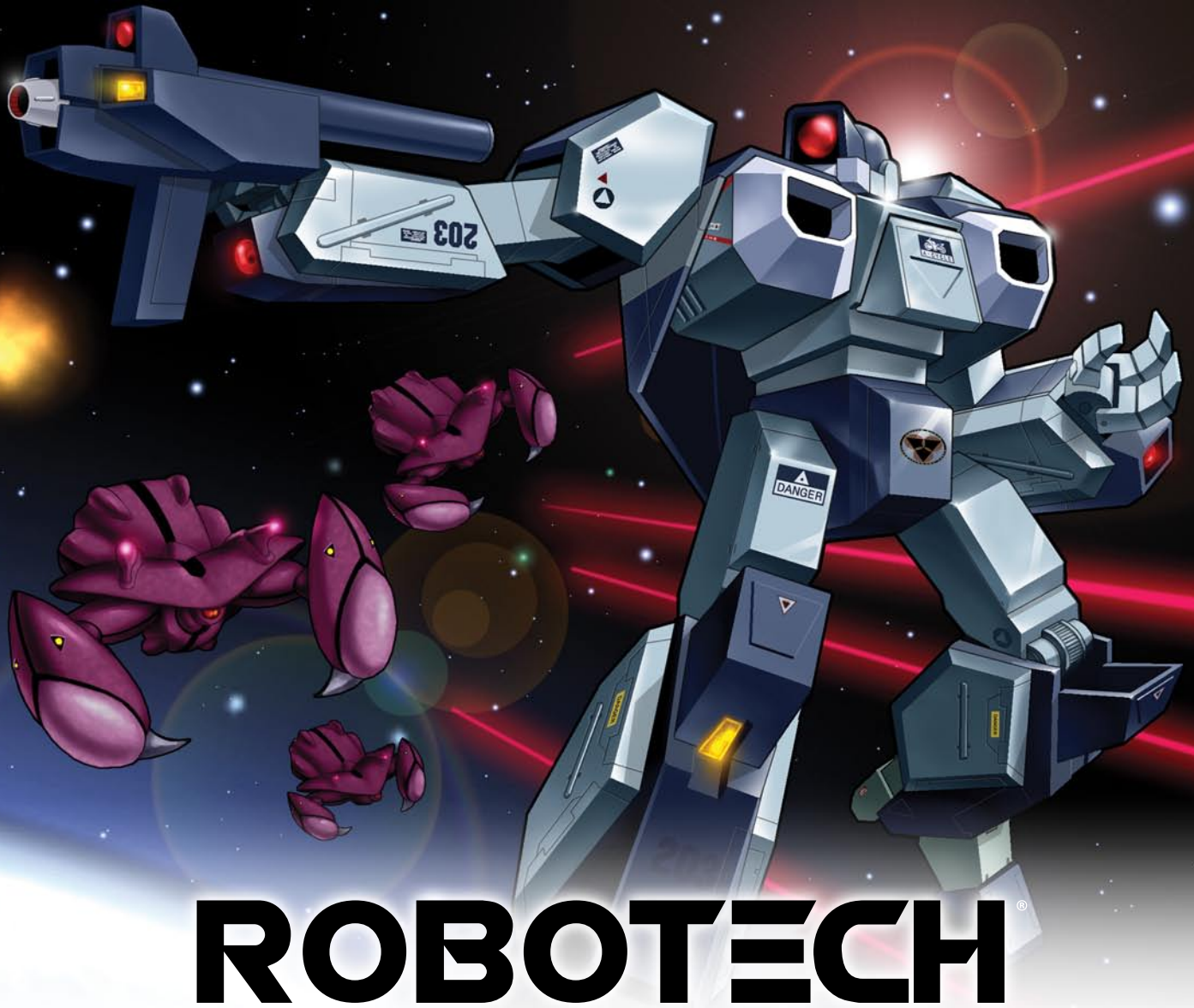

ROBOTECH®

Role-Playing Game and Sourcebooks

- **Four generations of heroes and mecha** • **Giant transformable robots** • **Alien invaders** • **Battle for control of the Earth** • **Combat takes to the stars** • **All presented in a core rule book and dynamic set of epic sourcebooks** • **Easy to learn** • **Fun to play** • **Quick character generation** • **Fast combat** • **Captures the action and adventure of the anime TV series** • **Isn't it time you joined the adventure?**

Robotech® "Core Rules" – Shadow Chronicles® RPG Hardcover

All the rules and information a player needs to start a Robotech® role-playing campaign with Admiral Rick Hunter and the United Earth Expeditionary Force trekking across the galaxy.

- Human mecha: Alphas, Betas, Cyclones & much more.
- Five character classes. 25 different Military Specialties.
- Invid mecha, Haydonites, and alien enemies.
- Quick roll character tables. Make a character in 15 minutes.
- A complete, stand-alone RPG.
- 224 pages. Cat. No. 550HC. 8½ x 11 size, hardcover.

Robotech®: The Macross® Saga Sourcebook – Cat. No. 551

A treasure chest packed with the iconic mecha, vehicles, weapons and characters that made Robotech® famous. Valkyries, Destroyers, ground vehicles, aircraft, spacecraft, weapons, Zentraedi soldiers, Zentraedi mecha, alien invaders, heroes, villains, and more.

- All the iconic Macross mecha, vehicles, weapons & characters.

www.palladiumbooks.com

Robotech®: The Masters Saga™ Sourcebook – Cat. No. 552

Tons of never before seen stats and descriptions for the many weapons, armor, mecha and robots of the Army of the Southern Cross.

- The Army of the Southern Cross™ – all 15 branches and their mecha!

Robotech®: New Generation™ Sourcebook – Cat. No. 554

The battle for the liberation of Earth starts here.

- Kit-bashed mecha combining parts from different mecha.
- Invid Hives, world overview, key characters and adventure ideas.

Robotech®: Genesis Pits™ Sourcebook – Cat. No. 555

The Invid Genesis Pits, their purpose, function.

- Inorganics and other war machines of the Invid Regent.
- Genesis Pit mutations and monsters.

Robotech®: Expeditionary Marines Sourcebook – Cat. No. 553

Join the UEEF (United Earth Expeditionary Force) led by Admiral Rick Hunter as they travel across the galaxy liberating planets from the bondage of the Invid Regent, the Robotech Masters and other tyrants.

- New mecha, weapons, and character classes of the UEEF Marines.
- New alien species and allies. Planet hopping and more.



ROBOTECH

RPG TACTICS™

Main Boxed Game – Cat. No. 55100 – Available Now!

A fast-paced, strategy battle game that captures the speed and action of Robotech®. Play Earth defenders or Zentraedi invaders.

- Scalable from small squad skirmishes to mass battles.
- Turn-based system of play and uses D6. Two or more players.
- 34 highly detailed game pieces. 6mm scale.
- 112 page color rule book with paint guide and index.
- 53 laminated, color game cards.
- 24 custom dice, two decal sheets and more.
- Assembly and painting required. Glue not included.
- \$99.95 retail – Cat. No. 55100 – shipping now!
- Available in North and South America, the EU, Australia & New Zealand.

Note: Each product contains plastic game pieces requiring assembly and painting. Glue not included. This is not a toy. Small parts, not suitable for children under the age of 13. Adult supervision advised. Images shown here are not to scale.



UEDF Valkyrie Wing™ – Cat. No. 55201

Build your fleet of Earth defenders with the Valkyrie Veritech Fighter; six game pieces total. **\$36.95 retail.**

- 2 Valkyries in Fighter mode.
- 2 Valkyries in Guardian mode.
- 2 Valkyries in Battloid mode.
- Multiple heads for making the VF-1A, VF-1J, VF-1R & VF-1S.



UEDF Tomahawk/Defender Destroids™ – Cat. No. 55202

Expand your Destroid squad with these formidable walking tanks; four game pieces total. **\$32.95 retail.**

- 2 Tomahawk Destroids – the main battle tank of Destroids, brimming with powerful particle beam cannons for arms, and wielding a battery of missiles and an array of other weapons.
- 2 Defender Destroids – a long-range, anti-aircraft juggernaut capable of shooting down incoming Zentraedi Battlepods and Gnerl Fighters.



UEDF Spartan/Phalanx Destroids™ – Cat. No. 55203

Add some long-range power and up-close punch to your army with these valuable Destroids; four game pieces total. **\$32.95 retail.**

- 2 Spartan Destroids – civil defense, riot control and deadly in hand to hand combat.
- 2 Phalanx Destroids – a walking, long-range missile artillery unit.



Zentraedi Regult Battlepods™ – Cat. No. 55401

Expand your Zentraedi forces with their main infantry battle mecha; six game pieces total. **\$36.95 retail.**

- 6 Regult Tactical Battlepods – the lightning quick Regults, armed with a pair of particle cannons and auto-cannons, attack in wave after wave.



Zentraedi Artillery Battlepods™ – Cat. No. 55402

Give your Zentraedi legion greater firepower with these artillery and support Battlepods; four game pieces total. **\$36.95 retail.**

- 4 Zentraedi Support Battlepods, each of which can be made into:
 - Gluhaug-Regult – Light Artillery Battlepod
 - Serauhaug-Regult – Heavy Artillery Battlepod
 - Telnesta-Regult – Experimental Particle Beam Battlepod
- Four game pieces total.**



Zentraedi Glaug Command™ – Cat. No. 55403

This diverse pack provides your Zentraedi forces with greater tactical capabilities; three game pieces total. **\$36.95 retail.**

- 1 Glaug Officer's Battlepod – the fast and deadly mecha of Zentraedi field leaders.
- 1 Quel-Regult Scout Battlepod – the stealthy eyes and ears of your Zentraedi battle force; electronic warfare capabilities.
- 1 Quel-Gulnau Recovery Pod – enhances the Glaug's ability to bring in Battlepod reinforcements. **Note:** This figure has NEVER before been offered by any company.

Can YOU survive the Zombie Apocalypse?



Dead Reign™ RPG

It is the aftermath of the *zombie apocalypse*. Civilization is gone, the dead reign, and the living fight to survive against impossible odds. Tales of zombies, human survival and horror as a fast-paced, easy to learn game and sourcebooks.

- **Zombie combat rules, vehicles and equipment.**
- **Six iconic Apocalyptic Character Classes and Ordinary People with 40+ occupations to choose from.**
- **Seven types of zombies plus the Half-Living.**
- **Secrets of the Dead and tips on fighting zombies.**
- **Death Cults, their Priests, power over zombies and goals.**
- **101 Random Scenarios, Encounters and Settings.**
- **100 Random Corpse Searches and other tables.**
- **Quick Roll Character Creation tables (10 minutes).**
- **A complete role-playing game by Siembieda and others.**
- **\$22.95 retail – 224 pages – Cat. No. 230. Available now.**

Civilization Gone™

Dead Reign™ Sourcebook One

It has been months since the dead rose to attack the living. Civilization has crumbled. There is no army, no government, no help coming. You are on your own and things are only getting worse.

- **Madmen and Psychopaths including the *Zombie Master, Ghost Walker, Backstabber, Messianic Leader, Zombie Lover, Deathbringer* and others.**
- **Bandits and Raiders who prey upon other survivors.**
- **Street Gang Protectors and their mission to save lives.**
- **Phobia and Obsession tables. Many adventure ideas.**
- **House and home resource and encounter tables.**
- **Random encounter and survivor camp creation tables.**
- **Additional world information and survival advice.**
- **\$12.92 retail – 64 pages – Cat. No. 231. Available now.**

Dark Places™

Dead Reign™ Sourcebook Two

Secrets of survival, including using railroad tracks and the urban underground to travel unseen and undetected by zombies.

- **Worm Meat, Bug Boy, Sewer Crawler and Impersonator Zombies.**
- **“Live Bait” zombie lures with human beings as bait.**
- **Traveling the rails and boxcar encounter tables.**
- **Traveling sewer tunnels, steam tunnels & other dark places.**
- **The pitfalls and dangers of the urban underground.**
- **Diseases, infection and additional world information.**
- **Random encounter tables, boxcar content tables, and more.**
- **\$12.92 retail – 64 pages – Cat. No. 232. Available now.**

Endless Dead™

Dead Reign™ Sourcebook Three

The zombie hordes grow in number and strangeness. Can humankind survive? Where is the military?

- **New types of zombies like Fused Zombies and Walking Mass Grave.**
- **New O.C.C.s including Wheelman and Zombie Hunter.**
- **Info & tables for weaponizing vehicles and vehicle combat rules.**
- **Random encounter tables for military bases, police stations, gun stores, buildings, suburbs, industrial parks, small towns, farmland and wilderness.**
- **Tables to make Survivor caravans, hideouts, Safe Havens & more.**
- **Timetable for setting zombie campaigns & many adventure ideas.**
- **\$16.95 retail – 96 pages – Cat. No. 233. Available now.**



Other horror titles from Palladium Books®

Fear the Reaper™

Graveyard Earth™

Beyond the Supernatural™ RPG

Nightbane® RPG series

© Copyright 2012 Palladium Books Inc. All rights reserved. Rifts®, Palladium Books®, Megaverse®, Nightbane®, Heroes Unlimited, Dead Reign and other published book titles, names, slogans and likenesses are trademarks of Palladium Books Inc.

www.palladiumbooks.com

Palladium Books® Check List & Order Form

Dept. P-16, 39074 Webb Court, Westland, MI 48185

Name: _____ Address: _____

City: _____ State: _____ Zip/Postal Code: _____ Country: _____

Credit Card Number: _____ Expiration Date: _____ Visa MasterCard

Telephone Number: _____ Signature: _____ AMEX Other

The Rifter® Series

- ___ 170 The Rifter® #70 – \$13.95
- ___ 171-172 The Rifter® #71 & 72 – \$24.95
- ___ 173 The Rifter® #73 – \$13.95
- ___ 174 The Rifter® #74 – \$13.95
- ___ 175 The Rifter® #75 – \$13.95
- ___ 176 The Rifter® #76 – \$13.95 (Fall)

Splicers®

- ___ 200 Splicers® RPG – \$23.95
- Note: Sourcebooks coming soon.

Dead Reign®

- ___ 230 Dead Reign® RPG – \$22.95
- ___ 231 SB 1: Civilization Gone™ – \$12.95
- ___ 232 SB 2: Dark Places™ – \$12.95
- ___ 233 SB 3: Endless Dead™ – \$16.95
- ___ 234 SB 4: Fear the Reaper™ – \$12.95
- ___ 235 SB 5: Graveyard Earth™ – \$12.95
- ___ 236 SB 6: Hell Followed™ – \$20.95 (coming)

Rifts® Novels

- ___ 301 Sonic Boom™ – \$9.95
- ___ 302 Deception's Web™ – \$9.95
- ___ 303 Treacherous Awakenings™ – \$9.95
- ___ 304 Tales of the Chi-Town 'Burbs™ – \$12.95
- ___ 305 Rifts® Path of the Storm™ – Screen-play & Sourcebook – \$12.95

Weapons Books

- ___ 401 Weapons and Armor™ – \$8.95
- ___ 402 Weapons and Castles™ – \$8.95
- ___ 403 Weapons and Assassins™ – \$8.95
- ___ 404 Weapons & Castles of the Orient™ – \$8.95

Palladium Fantasy RPG®

- ___ 450 The Palladium Fantasy RPG® – \$26.95
- ___ 4500HC Palladium Fantasy RPG® 30th Anniversary Hardcover – \$50.00
- ___ 451 Dragons & Gods™ – \$24.95
- ___ 453 Old Ones™ 2nd Ed. – \$24.95
- ___ 454 Monsters & Animals™ 2nd Ed. – \$24.95
- ___ 455 Adventures on the High Seas™ – \$24.95
- ___ 458 Island at the Edge of the World™ – \$20.95
- ___ 459 Yin-Sloth Jungles™ – \$20.95
- ___ 462 Western Empire™ – \$24.95
- ___ 463 Baalgor Wastelands™ – \$24.95
- ___ 464 Mount Nimro™ – \$20.95
- ___ 465 Eastern Territory™ – \$24.95
- ___ 466 Library of Bletherad™ – \$20.95
- ___ 467 Northern Hinterlands™ – \$24.95
- ___ 468 Land/Damned 1: Chaos Lands™ – \$24.95
- ___ 469 LoD 2: Eternal Torment™ – \$24.95
- ___ 470 LoD 3: The Citadel – \$24.95 (coming)
- ___ 471 Wolfen Empire™ – \$20.95
- ___ 472 Mysteries of Magic™ One: Heart of Magic – \$16.95
- ___ 474 Bizantium/Northern Islands™ – \$20.95
- ___ 475 Garden of the Gods™ – \$12.95 (coming)

Heroes Unlimited™ / After the Bomb®

- ___ 500-2 Heroes Unlimited™, 2nd Ed. – \$26.95
- ___ 5000HC Heroes Unlimited™ 30th Anniversary Hardcover – \$50.00
- ___ 501 Villains Unlimited™ Revised – \$24.95
- ___ 503 After the Bomb® RPG – \$24.95
- ___ 505 Road Hogs™ (After the Bomb® II) – \$9.95
- ___ 507 Mutants Down Under™ (AB III) – \$9.95
- ___ 511 Mutants of the Yucatan™ (AB IV) – \$9.95
- ___ 513 Mutants in Avalon™ (AB V) – \$16.95
- ___ 514 Mutants in Orbit™ (AB VI) – \$16.95
- ___ 515 Aliens Unlimited™ – \$24.95
- ___ 516 Heroes Unlimited™ G.M.'s Guide – \$24.95
- ___ 517 Century Station™ – \$24.95
- ___ 518 Gramercy Island™ – \$24.95
- ___ 519 Aliens Unlimited Galaxy Guide™ – \$24.95
- ___ 520 Mutant Underground™ – \$16.95
- ___ 521 Powers Unlimited® One – \$16.95
- ___ 522 Powers Unlimited® Two – \$16.95
- ___ 523 Powers Unlimited® Three – \$16.95
- ___ 525 Revised Ninjas & Superspies™ – \$20.95
- ___ 526 Mystic China™ – \$24.95
- ___ 527 Armageddon Unlimited™ – \$20.95

Robotech® RPG

- ___ 550 Robotech® The Shadow Chronicles® RPG (manga size) – \$16.95
- ___ 550HC Robotech® The Shadow Chronicles® Deluxe Hardcover RPG – \$30.95
- ___ 5500HC Robotech® The Shadow Chronicles® Gold Ed. Hardcover RPG – \$70.00
- ___ 551 Robotech® Macross® Saga Sourcebook – \$16.95
- ___ 552 Robotech® The Masters Saga™ Sourcebook (NEW in 8½ x 11) – \$20.95
- ___ 553 Robotech®: Expeditionary Force Marines Sourcebook – \$20.95
- ___ 554 Robotech® The New Generation™ Sourcebook – \$16.95
- ___ 555 Robotech® Genesis Pits Sourcebook – \$16.95

Robotech® RPG Tactics™ (New!)

- ___ 55100 Robotech® RPG Tactics™ – \$99.95
- ___ 55105 Robotech® RPG Tactics™ Rulebook – \$20.00
- ___ 55101 UEDF Dice Pack – \$12.00
- ___ 55102 Zentraedi Dice Pack – \$12.00
- ___ 55201 UEDF Valkyrie Wing – \$36.95
- ___ 55202 UEDF Destroid Pack – \$32.95
- ___ 55203 UEDF Spartan Pack – \$32.95
- ___ 55401 Zentraedi Regult Battlepods – \$36.95
- ___ 55402 Zentraedi Artillery Battlepods – \$36.95
- ___ 55403 Zentraedi Glaug Command – \$36.95

Rifts® Chaos Earth®

- ___ 660 Rifts® Chaos Earth® RPG – \$20.95
- ___ 661 Rifts® CE Creatures of Chaos™ – \$12.95
- ___ 662 Rifts® CE The Rise of Magic™ – \$12.95
- ___ 665 Rifts® Chaos Earth® First Responders™ – \$16.95 (coming)
- ___ 666 Rifts® Chaos Earth® Resurrection™ – \$20.95

Beyond the Supernatural™

- ___ 700 Beyond the Supernatural™, 2nd Ed. – \$24.95
- ___ 702 Tome Grotesque™ – \$20.95 (coming)
- ___ 703 Beyond Arcanum™ – \$24.95 (coming)

Nightbane®

- ___ 730 Nightbane® RPG – \$24.95
- ___ 731 Nightbane®: Between the Shadows™ – \$20.95
- ___ 732 Nightbane®: Nighlands™ – \$20.95
- ___ 733 Nightbane®: Through the Glass Darkly™ – \$20.95
- ___ 735 Nightbane® Survival Guide™ – \$20.95

Rifts®

- ___ 800HC Rifts® RPG Ultimate Edition – \$39.95
- ___ 801 Rifts® Sourcebook One Revised – \$20.95
- ___ 802-E Rifts® World Book 1: Vampire Kingdoms™, Revised – \$24.95
- ___ 803 Rifts® Conversion Book One™ – \$24.95
- ___ 804 Rifts® WB 2: Atlantis™ – \$20.95
- ___ 805 Rifts® Sourcebook 2: Mechanoids™ – \$16.95
- ___ 807 Rifts® WB 3: England™ – \$20.95
- ___ 808 Rifts® WB 4: Africa™ – \$20.95
- ___ 809 Rifts® Dimension Book 1: Wormwood™ – \$20.95
- ___ 810 Rifts® WB 5: Triax™ – \$24.95
- ___ 811 Rifts® Pantheons of the Megaverse® – \$24.95
- ___ 812 Rifts® Sourcebook 3: Mindwerks™ – \$16.95
- ___ 813 Rifts® Mercenaries™ – \$20.95
- ___ 814 Rifts® WB 6: South America™ – \$20.95
- ___ 815 Rifts® WB 7: Underseas™ – \$24.95
- ___ 816 Rifts® DB 2: Phase World® – \$24.95
- ___ 817 Rifts® DB 3: Phase World® Sourcebook – \$16.95
- ___ 818 Rifts® WB 8: Rifts® Japan™ – \$24.95
- ___ 819 Rifts® WB 9: South America Two™ – \$24.95
- ___ 820 Rifts® WB 10: Juicer Uprising™ – \$20.95
- ___ 821 Rifts® WB 11: Coalition War Campaign™ – \$24.95

- ___ 822 Rifts® WB 12: Psyscape™ – \$20.95
 ___ 825 Rifts® WB 13: Lone Star™ – \$20.95
 ___ 826 Rifts® WB 14: New West™ – \$24.95
 ___ 827 Rifts® WB 15: Spirit West™ – \$24.95
 ___ 828 Rifts® Sourcebook 4: Coalition Navy™ – \$16.95
 ___ 829 Rifts® WB 16: Federation of Magic™ – \$20.95
 ___ 830 Rifts® DB 4: Skraypers™ – \$20.95
 ___ 831 Rifts® Index Volume Two™ – \$16.95
 ___ 832 Rifts® WB 17: Warlords of Russia™ – \$24.95
 ___ 833 Rifts® WB 18: Mystic Russia™ – \$20.95
 ___ 834 Rifts® WB 19: Australia 1 – \$24.95
 ___ 835 Rifts® WB 20: Canada™ – \$24.95
 ___ 836 Rifts® WB 21: Splynn Dimensional Market™ – \$24.95
 ___ 837 Rifts® WB 22: Free Quebec™ – \$24.95
 ___ 838 Rifts® WB 23: Xiticix Invasion™ – \$20.95
 ___ 839 Rifts® Coalition Wars®: Sedition™ – \$20.95
 ___ 840 Rifts® Coalition Wars®: Coalition Overkill™ – \$16.95
 ___ 841 Rifts® Coalition Wars®: Sorcerers' Revenge™ – \$16.95
 ___ 842 Rifts® Coalition Wars®: Cyber-Knights™ – \$16.95
 ___ 843 Rifts® Coalition Wars®: Shadows of Evil™ – \$16.95
 ___ 844 Rifts® Coalition Wars®: Final Siege™ – \$24.95
 ___ 845 Rifts® Game Master Guide™ – \$26.95
 ___ 846 Rifts® Aftermath™ – \$24.95
 ___ 847 Rifts® DB5: Anvil Galaxy™ – \$20.95
 ___ 848 Rifts® Book of Magic™ – \$26.95
 ___ 849 Rifts® Adventure Guide™ – \$24.95
 ___ 850 Rifts® Bionics Sourcebook™ – \$16.95
 ___ 851 Rifts® DB 6: Three Galaxies™ – \$20.95
 ___ 852 Rifts® Dark Conversions™ – \$24.95
 ___ 853 Rifts® Chi-Town 'Burbs™ – \$9.95
 ___ 854 Rifts® The Tolkien Crisis™ – \$12.95
 ___ 855 Rifts® The Black Vault™ – \$9.95
 ___ 856 Rifts® The Vanguard™ – \$9.95
 ___ 857 Rifts® WB 24: China One™ – \$20.95
 ___ 858 Rifts® WB 25: China Two™ – \$20.95
 ___ 859 Rifts® DB 7: Megaverse Builder™ – \$16.95
 ___ 860 Rifts® DB 8: Naruni Wave Two™ – \$16.95
 ___ 862 Rifts® WB 26: Dinosaur Swamp™ – \$20.95
 ___ 863 Rifts® MercTown™ – \$20.95
 ___ 865 Rifts® Merc Ops™ – \$20.95
 ___ 866 Rifts® WB 27: Adventures in Dinosaur Swamp™ – \$20.95
 ___ 867 Rifts® Mercenary Adventure Sourcebook – \$12.95
 ___ 868 Rifts® WB 28: Arzno™ – \$20.95
 ___ 869 Rifts® WB 29: Madhaven™ – \$16.95
 ___ 870 Rifts® John Zeleznik Coloring Book – \$5.95
 ___ 871 Rifts® Machinations of Doom™ – \$18.95
 ___ 872 Rifts® DB 10: Hades™ – \$24.95
 ___ 873 Rifts® DB 11: Dyval™ – \$24.95
 ___ 874 Rifts® WB 30: D-Bees of North America™ – \$24.95
 ___ 875 Rifts® DB12: Dimensional Outbreak – \$24.95
 ___ 876 Rifts® Megaverse® in Flames™ – \$24.95
 ___ 876HC Rifts® Megaverse® in Flames™ Gold Hardcover Edition – \$50.00
 ___ 877 Rifts® Heroes of the Megaverse® – \$16.95
 ___ 878 Rifts® Sourcebook: Shemarrian Nation™ – \$16.95
 ___ 880 Phase World®: Fleets of the Three Galaxies™ – \$16.95
 ___ 881 Rifts® WB 31: Triax™ Two – \$24.95
 ___ 883 Rifts® DB 14: Thundercloud Galaxy™ – \$20.95
 ___ 884 Rifts® Vampires Sourcebook™ – \$20.95
 ___ 885 Rifts® WB 32: Lemuria™ – \$24.95
 ___ 886 Rifts® Black Market™ – \$24.95
 ___ 886HC Rifts® Black Market™ Hardcover Gold Edition – \$60.00
 ___ 887 Rifts® WB 33: Northern Gun™ One – \$24.95
 ___ 888 Rifts® WB 34: Northern Gun™ Two – \$26.95
 ___ 889 Rifts® Sourcebook: Coalition States, Heroes of Humanity™ – \$20.95
 ___ 890 Rifts® World Book: Secrets of the Atlanteans™ – \$24.95 (coming)
 ___ 891 Rifts® World Book: Sovietski™ – \$24.95 (coming)
 ___ 892 Rifts® Sourcebook: The Disavowed™ – \$16.95 (coming)
 ___ 893 Rifts® CS: Heroes of Humanity™ Arsenal Sourcebook – \$16.95 (coming)
 ___ 894 Rifts® Haunted Tech™ – \$16.95 (coming)
 ___ 2510 Rifts® & The Megaverse® Art Book – \$22.95
 ___ 2510-HC Rifts® & The Megaverse® Art Book, Hardcover – \$50.00
 ___ 2510-CML Rifts® & The Megaverse® Art Book, Collector's Masterwork Edition – \$125.00
- Miscellaneous Products**
 ___ 600 Deluxe Revised RECON® RPG – \$22.95
 ___ 2537 Gamer Coffee Mug – \$10.00
 ___ 2539 Rifts® Dice Bag – Black – \$8.00
 ___ 2545 Dead Reign™ Coffee Mug – \$10.00
 ___ 2554 Palladium Bookmarks, Set One – \$5.00
 ___ 2555 Palladium Bookmarks, Set Two – \$5.00
 ___ 2561 Property of Chi-Town Library Pencil – \$0.50 each
 ___ 2562 Future Visions™ – The Artistry of Charles Walton II – \$13.95
 ___ 2566 Glitter Boy Mouse Pad – \$9.95
 ___ 2567 Old Ones Mouse Pad – \$9.95
 ___ 2568 Zombie Graveyard Mouse Pad – \$9.95
- Note:** T-shirts and other products can be found online: www.palladiumbooks.com
- Rifts® Miniatures**
 ___ MI8002 Xiticix Pack – \$18.00
 ___ MI8004 Coalition Dog Pack – \$18.00
 ___ MI8005 Men of Magic Pack #1 – \$18.00
 ___ MI8006 Cyborgs Pack #1 – \$18.00
 ___ MI8007 Simvan & Ostrosaurus Pack – \$18.00
 ___ MI8008 Coalition Skelebots Pack #1 – \$18.00
 ___ MI8009 Coalition SAMAS Pack #1 – \$22.00
 ___ MI8010 Coalition Sky Cycle Pack – \$22.00
 ___ MI8011 Coalition Dog Pack #2 – \$18.00
 ___ MI8015 Damaged Skelebots Pack #1 – \$12.00
 ___ MI8016 Cyber-Adventurers Pack – \$18.00
 ___ MI8017 Rogues & Scout Pack #1 – \$18.00
 ___ MI8018 Brodkil & Witchling Pack – \$18.00
 ___ MI8019 Damaged Skelebots Pack #2 – \$18.00
 ___ MI8020 Psi-Stalkers & Scouts Pack #1 – \$18.00
 ___ MI8021 Shadow Beast – \$12.00
 ___ MI8022 Mystic Knight – \$6.00
 ___ MI8023 Lord Magus – \$6.00
 ___ MI8024 High Magus – \$6.00
 ___ MI8025 Coalition Psi-Stalker – \$6.00
 ___ MI8026 Coalition Dog Boy in DPM-D1 Armor – \$6.00
 ___ MI8027 Coalition Dog Boy #2 – \$6.00
 ___ MI8028 Coalition Dog Boy #3 – \$6.00
 ___ MI8029 Coalition Dog Boy #4 – \$6.00
 ___ MI8030 Coalition Dog Boy #5 – \$6.00
 ___ MI8031 Glitter Boy – \$20.00
 ___ MI8032 Glitter Boy Pilot – \$6.00
 ___ MI8033 Kydian Overlord – \$20.00
 ___ MI8034 Dragonsaurus – \$10.00
 ___ MI8035 Slaver and Slave (Atlantis) Set – \$10.00
 ___ MI8036 Crazy – \$6.00
 ___ MI8037 Juicer #1 – \$6.00
 ___ MI8038 Juicer #2 – \$6.00
 ___ MI8039 Cyborg #1 – \$12.00
 ___ MI8040 Cyborg #2 – \$12.00
 ___ MI8041 Cyborg #3 – \$6.00
 ___ MI8042 Coalition Officer – \$6.00
 ___ MI8043 Coalition Grunt #1 – \$6.00
 ___ MI8044 Coalition Grunt #2 – \$6.00
 ___ MI8045 Coalition Grunt #3 – \$6.00
- When placing an order by mail, please add money for shipping and handling.** Add \$5.00 for orders totaling \$1-\$50, \$10.00 for orders totaling \$51-\$95, and for orders totaling \$96-\$200 please add \$15.00 US. Double the amount for Canada, and *quadruple* it for overseas orders. For more shipping options, order online at www.palladiumbooks.com. Allow 2-4 weeks for delivery. Make checks and money orders payable to: *Palladium Books*
- Check release dates for new products.** If the book you order has not been released yet, your order will be held as a backorder until the product is available. Please note that prices are subject to change without notice.
- Orders can also be placed by phone,** at (734) 721-2903 (order line only). Please have your credit card information when you call.
- www.palladiumbooks.com**

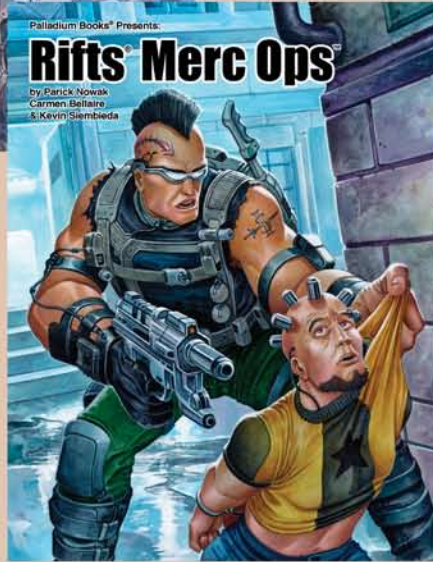

Also from Palladium Books®

Rifts® MercTown™

- 204 key locations – each an adventure idea.
- Street gangs, the Black Market, thieves' guild & more.
- Magic district and magic items.
- Adventure ideas by the hundreds, and more.
- 160 pages. Written by Nowak & Bellaire.

Rifts® Merc Ops™

- More weapons and ammo.
- New power armor and vehicles.
- New Techno-Wizard weapons and devices.
- Bounties and Job Brokers.
- Merc Ops' Ten Most Wanted and adventures.
- 160 pages – by Siembieda, Nowak & Bellaire.

Rifts® Mercenary Adventures™

- Seven new mercenary O.C.C.s.
- Combat Mage O.C.C. and Combat Magic.
- Mercenary Boot Camp! Training, bonuses and adventure.
- Hook, Line and Sinker adventures in and around MercTown.
- 64 pages – by Siembieda, Nowak & Bellaire.

Naruni™ Wave 2

- Not even the Coalition could keep them away.
- New Naruni weapons, vehicles and equipment.
- New, wild Naruni power armor and drones.
- Molock Enforcers and background on the Naruni.
- 96 pages. Written by Nowak & Bellaire.

Palladium Books® Presents:

Rifts® Mercenaries

A giant sourcebook for the Rifts® Role-Playing Game.

- **9 new Occupational Character Classes including the Bounty Hunter, Master Assassin, Smuggler, spies and more.**
- **Rules for creating a mercenary company.**
- **Six NPC mercenary companies are described, complete with key characters, villains, history and adventure idea. Some are good, some evil, others more than they seem.**
- **Transdimensional mercs and arms dealers.**
- **More weapons and equipment from Northern Gun.**
- **Scores of new weapons, bots and vehicles.**
- **Additional hints and data about the Coalition states, Tolkeen, the Pecos Empire and visitors from other dimensions.**
- **Tons of adventure ideas, characters and more!**
- **160 pages.**

\$20.95

Cat. No. 813

ISBN-10: 0-916211-70-3

ISBN-13: 978-0-916211-70-7

**Palladium
Books Inc.®**

www.palladiumbooks.com