

Palladium Books® Presents:

# Rifts® Merc Ops™

by Patrick Nowak  
Carmen Bellaire  
& Kevin Siembieda





# Warning!

## Violence, War, Magic & the Supernatural

The fictional worlds of *Rifts*® and *Phase World*® are violent, deadly and filled with aliens, war and supernatural monsters. Other-dimensional beings often referred to as “demons,” torment, stalk and prey on humans. Alien life forms, monsters, gods and demigods, as well as magic, insanity, and combat are all elements in this book.

Some parents may find the violence, magic and supernatural elements of the game inappropriate for young readers/players. We suggest parental discretion.

Please note that none of us at Palladium Books® condone or encourage the occult, the practice of magic, the use of drugs, or violence.



An epic sourcebook for the *Rifts*® series.

Compatible with the entire Palladium Books® Megaverse®

## Dedication

Dedicated to the soldiers of 31B - and all our troops and allies fighting the good fight overseas and at home. We salute you.

– Nowak, Siembieda, & Bellaire – 2005

The cover, by *John Zeleznik*, depicts a Juicer Merc snagging himself a bounty on a Crazy desperado somewhere in MercTown.

## PDF Edition – November 2016

First Printing – May 2005

No part of this publication may be scanned, OCR'd or reproduced in any way for electronic publication on the web/internet or any other medium.

Copyright 2005 Palladium Books Inc. & Kevin Siembieda

All rights reserved, worldwide, under the Universal Copyright Convention. No part of this book may be reproduced in part or whole, in any form or by any means, without permission from the publisher, except for brief quotes for use in reviews. All incidents, situations, institutions, governments and people are fictional and any similarity, without satiric intent, of characters or persons living or dead, is strictly coincidental.

Rifts®, The Rifter®, Phase World®, Megaverse®, The Mechanoids®, The Mechanoid Invasion®, After the Bomb®, Coalition Wars® and Palladium Books® are registered trademarks owned and licensed by Palladium Books Inc. and Kevin Siembieda.

Merc Ops, MercTown, Rifts® Merc Ops, Chaos Earth, Heroes Unlimited, Aliens Unlimited, Rifts® Game Master Guide, Rifts® Book of Magic, Rifts® Mercenaries, Splynn Dimensional Market, Dinosaur Swamp, Rifts Earth, Wilk's, Wellington, Northern Gun, Golden Age Weaponsmiths, Naruni, Naruni Enterprises, MageFire, Manistique Imperium, Coalition States, CS, Free Quebec, Tolkeen, Federation of Magic, Stormspire, Lazlo, New Lazlo, Iron Heart, the 'Burb, Chi-Town, Pecos Empire, Bandito Arms, Lone Star, Cyber-Knights, Repo-Bots, Juicer, Crazy, Shifter, Biomancer, Bio-Wizardry, Ley Line Walker, Mind Melter, Tattooed Man, Maxi-Man, Undead Slayer, Shifter, Techno-Wizard, Temporal Raider, 'Burb, 'Borg, Bio-Borg, 'Bot, Cyber-Doc, Body Fixer, Cyber-Doc, Full Conversion Cyborg, Headhunter, Archie-3, E-Clip, Mega-Damage, M.D.C., S.D.C., I.S.P., P.P.E., Splugorth, Splugorth Slaver, Splugorth High Lord, Splynncryth, Splynn, Kittani, Powerlord, Sunaj, and other names, titles, characters, character likenesses and slogans are trademarks owned by Kevin Siembieda and Palladium Books Inc.

Palladium Online: [www.palladiumbooks.com](http://www.palladiumbooks.com)

Rifts® Merc Ops™ is published by Palladium Books Inc., 39074 Webb Court, Westland, MI 48185. Printed in the USA.

**Palladium Books® Presents:**

# **Rifts® Merc Ops™**

**A *Rifts*® sourcebook**

Written by: **Patrick Nowak, Carmen Bellaire & Kevin Siembieda**

Editors: **Alex Marciniszyn**

**Wayne Smith**

**Kevin Siembieda**

Proofreader: **Julius Rosenstein**

Cover Painting: **John Zeleznik**

Interior Artists:

**Kent Burles**

**Michael Dubisch**

**Drunken Style Studio (DSS)**

**Brandon C. Clark (DSS)**

**Mark Dudley (DSS)**

**Ka Xiong (DSS)**

**Apollo Okamura**

**Freddie E. Williams II**

Art Direction & Keylining: **Kevin Siembieda**

Typography: **Wayne Smith**

Based on the RPG rules, text, characters,  
concepts and Megaverse® created by **Kevin Siembieda**.

**Special Thanks to** Pat Nowak, whose work and ideas have inspired four books, Wayne and Alex for their suggestions and input, Carmen for his zany enthusiasm and writing, John Zeleznik for another great cover, to *all* the artists who worked on this book and to the hardworking crew at Palladium Books, Julius, Hank, Kathy, and the rest.



# Contents

<b>Merc Ops</b> . . . . .	7
Private or Exclusive Bounties . . . . .	7
Public Bounties . . . . .	8
Merc Ops Broker Fees . . . . .	8
Commonly Available Bounties . . . . .	8
Proof of Service . . . . .	9
Common Bounties, Crimes & Punishment . . . . .	9
<b>Mercenary Operations</b> . . . . .	11
Mercenaries & the Business of War . . . . .	11
Mercenary Missions . . . . .	12
Police Operations . . . . .	12
Muscle/Hired Gun . . . . .	13
Military Ops & Special Ops . . . . .	13
Search & Rescue . . . . .	16
Tolkeen Operations . . . . .	16
Working for the Coalition . . . . .	16
Working for the Tolkeen Resistance . . . . .	17
A final note on mercs . . . . .	18
<b>Merc Ops Top Ten Most Wanted</b> . . . . .	19
Gunther Black . . . . .	19
True Stats . . . . .	21
Carl Dansinger . . . . .	24
True Stats . . . . .	27
Frederic Hollingsworth . . . . .	30
True Stats . . . . .	32
Doctor Daniel Simmons . . . . .	34
True Stats . . . . .	36
Martin Cotswoller . . . . .	38
True Stats . . . . .	41
Kindra & Catrina Maxwell . . . . .	42
True Stats . . . . .	44 & 45
Auto-G R.C.C. . . . .	48
Quinn ‘Qualja’ . . . . .	50
True Stats . . . . .	52
Quick Draw Jeremiah . . . . .	54
True Stats . . . . .	56
Krane T’zaka . . . . .	57
True Stats . . . . .	59
The Blue Dragoons . . . . .	60
Old Glory, The Tank . . . . .	61
Sgt. Chris Schultz . . . . .	63
<b>Power Armor &amp; Vehicles</b> . . . . .	70
<b>Chipwell Armaments, Inc.</b> . . . . .	70
Vampire Combat Armor Mark II . . . . .	70
Sky Power Armor . . . . .	72

Chipwell Body Armor . . . . .	73
<b>Northern Gun Power Armor</b> . . . . .	73
NG-11F Red Hawk Flying Power Armor . . . . .	73
NG-NX12 Beach-Stormer Marine Power Armor . . . . .	76
NG-X13 Samson Missleman Infantry Power Armor . . . . .	78
NG-Dragonfly Combat Hover-Chopper . . . . .	79
NG-Skybunker Hover Carrier (APC) . . . . .	81
<b>Titan Robots &amp; Power Armor</b> . . . . .	82
TR-004 Titan Heavy Combat Robot . . . . .	82
Titan Footman Power Armor . . . . .	85
<b>Tech Weapons &amp; Gear</b> . . . . .	87
<b>Northern Gun</b> . . . . .	87
M.D.C. Body Armor . . . . .	87
<b>Northern Gun Weapons</b> . . . . .	90
NG Blue-Green Laser Underwater Conversion Kit . . . . .	90
NG-LP25 Laser Pulse Submachine-Gun . . . . .	90
NG-MC1 Mega-Crossbow . . . . .	91
NG-T6 Taser Neural Distruptor . . . . .	91
NG-303 Infantry Mini-Rail Gun . . . . .	93
NG-404 Heavy Rail Gun . . . . .	94
NG-101ARG Automated Rail Gun . . . . .	95
NG-Military Grade Explosives & Mines . . . . .	96
<b>Wellington Industries</b> . . . . .	98
WI-LP24 Laser Pistol . . . . .	98
WI-AL18 Assault Laser Rifle . . . . .	99
WI-GL8 Automatic Shotgun/Grenade Launcher . . . . .	100
WI-23A1 SAWS Remote Missile Launcher . . . . .	101
<b>Wilk’s Laser Industries, Inc.</b> . . . . .	102
Wilk’s 300 Hideaway Laser Pistol . . . . .	102
Wilk’s 577 Double-Threat Laser Rifle . . . . .	103
Notable Wilk’s Optic Systems . . . . .	104
Notable Wilk’s Communications & Sensor Systems . . . . .	105
<b>Miscellaneous Equipment</b> . . . . .	107
Weapons . . . . .	107
Neural Dusters . . . . .	108
Olterak Mace Spray . . . . .	108
Clothing, Specialized . . . . .	109
Communications Equipment . . . . .	110
Communications & Surveillance Equipment . . . . .	111
Chemicals/Performance Enhancing Drugs . . . . .	111
Construction Equipment . . . . .	112
Explosives & Detonators . . . . .	113
EOD Equipment . . . . .	114
Diving Equipment . . . . .	115
Field Equipment . . . . .	116
Fortification Materials . . . . .	118

Megacrete	118
Optic Gear	119
<b>Golden Age Weaponsmiths Inc.</b>	<b>119</b>
Body Armor	120
<b>GAW Old Style Firearms</b>	<b>120</b>
Common Weapons	120
Golden Age Ammunition	121
Firearm Accessories	122
Incendiary Weapons	123
Modern S.D.C. Knives	124
Miscellaneous Modern Weapons	124
<b>Light Mega-Damage Weapons</b>	<b>124</b>
Golden Age Howitzers	125
GAW Mortars	126
<b>New (GAWS) Combat Vehicles</b>	<b>127</b>
GAW-M1A3 Improved Abrams Battle Tank	127
GAW-M113 Improved APC	128
GAW-998 Improved Hummer	129
Special Ops Dune Buggy	130
GAW-A-10 Improved Thunderbolt II Fighter	131
GAW-130 Improved Hercules Airplane	133
GAW-64 Improved Apache Helicopter	134
GAW-47 Improved Chinook	137
<b>Techno-Wizard Devices</b>	<b>138</b>
<b>Armstrong TW Armaments Co.</b>	<b>138</b>
Bug Zapper TW Rifle	139
Thunderbolt TW Shotgun	139
Bolter TW Sniper Rifle	140
D-Pocket Pistol (TW Derringer)	141
Para-Stunner Pistol	141
Windscream TW Cannon	142
Swarm Bow TW Crossbow	142
TW Lightning Dagger	143
Demonbane Halberd	143
Medusa Goggles	144
Mind Shatter Helmet	144
<b>MageFire Weaponry, Inc.</b>	<b>145</b>
MP-1 TW Laser Pistol	145
MP-3 MageFire Bolt Pistol	146
MPR-4 E-Mag Splinter Pistol	146
MP-6 Firebolt Pistol	146
MR-10 Magefire Bolt Rifle	146
MR-12 E-Mag Splinter Rifle	147
MR-15 TW Particle Beam Rifle	147
MSR-1 "Vampire" Sniper Rifle	147
ML-20 TK Grenade Launcher	148
TW EMP Cannon	148

<b>MageFire TW Grenades</b>	<b>149</b>
Beehive Grenade	150
Nexus Grenade	151
Void Grenade	151
MageFire Specialty Equipment & Weapons	152
Skorblades	152
Mystic Assault Glove	152
Death Ray Blaster	153
<b>MageFire Mystic Power Armor</b>	<b>153</b>
MA-2 TW Combat Mage Armor	153
MA-W1 TW Wraith Suit	154
MA-75 Shining Swordsman TW Armor	154
Atlas Enhanced Strength Power Armor	155
Flying Dragon Power Armor	156
Missile Chart	158
<b>Rifts® Ultimate Edition</b>	<b>159</b>

## Quick Find

Assassin NPC Villain (see Maxwell Twins)	42
Auto-G NPC Villains (see Maxwell Twins)	42
Auto-G R.C.C.	48
Bounties, Dealing with CS	7
Bounties, Suspect Wanted for Questioning	10
Bounties, Types Listed	9
Bounties, Wilderness	11
Cyber-Doc NPC Villain (see Simmons)	34
Devilman NPC Villain (see 'Qualja)	50
Dragon, Nightstalker NPC Villain (see Gunther Black)	19
Dragon Juicer NPC Villain (see Hollingsworth)	30
Field Equipment 1	16
Innocent NPC (see Cotswoller)	38
Merc Broker (see Merc Ops)	7 & 8
Merc Operations: Missions	12
Merc Operations: Special Ops	13
Merc Ops, the Organization	7
Merc Ops Most Wanted	19
Merc Squad NPC Villains (see Blue Dragoons)	60
Quick-Flex Alien NPC Villain (see Jeremaih)	54
S.D.C. Ammunition	122
S.D.C. Explosives	113
S.D.C. Guns	120
S.D.C. Knives	124
Super-Soldier NPC Villain (see Dansinger)	24
Techno-Wizard Grenades	149
Techno-Wizard Items	138
Techno-Wizard Item Theft (see T'zaka)	57
Titan Robot Killer (see TR-004)	82





# Merc Ops

By Carmen Bellaire and Kevin Siembieda

**Merc Ops** is the name of an organization that brokers jobs to mercenaries, freelancers and opportunists. Although supposedly an independent organization, some people believe Merc Ops is a covert arm of the North American Black Market. Such individuals are quick to point out that there seems to be a Merc Ops office found wherever the Black Market has more than a foothold.

All bounties brokered by Merc Ops are secured by bond to ensure that any mercenary taking one of these bounties will be paid promptly, minus Merc Ops' usual 15% broker fee. These bounties come from all over North America and may even include bounties from the *Coalition States*, *Free Quebec*, *the Federation of Magic* and *Atlantis*. As long as the bounty is secured by bond, the organization may accept it. So far, the only exception has been Coalition State bounties placed on the heads of Tolkeen refugees. A lot, an estimated 40%, of its mercenary clients have fought in the Tolkeen-Coalition War or done work for Tolkeen in the last ten years, and an estimated 83% knew someone who fought or died on the side of Tolkeen, making such bounties a delicate subject for mercs. The fact that so many of Merc Ops' clients are D-Bees or practitioners of magic also makes bounties on Tolkeen citizens, sorcerers, freedom fighters and political figures a touchy subject.

Merc Ops always reserves the right to reject or accept a bounty without having to explain itself to the sponsor, as well as which bounties it decides to endorse and publicize. Consequently, it has chosen *not* to broker Tolkeen bounties that involve clients and friends from the past who are wanted by the Coalition States (at least at this time). That includes lucrative bounties like the 10 million credits on the head of former Tolkeen King, *Robert Creed*, and other members of the Tolkeen ruling body and military.

Don't get all misty-eyed and start thinking that the folks who run Merc Ops are noble, humanitarians or anti-Coalition. This is a business decision, and right now there is more money and opportunity in offering quiet support to the hundreds – perhaps thousands – of Tolkeen Retribution Squads, Freedom Fighting organizations, revolutionaries and thousands of refugees from the fallen kingdom than a short term windfall collecting on a few CS bounties. It is simply politically beneficial to exhibit sympathy and support for the survivors, people and memory of Tolkeen, as well as to the multitude of people who still fight (or seek revenge) in the kingdom's name. And that includes a huge percentage of warriors in the mercenary community to which Merc Ops caters.

Of course, the CS has made such bounties known to the public and throughout adventurer and mercenary circles. Mercs with no history or loyalty to Tolkeen are certainly free to take their chances in dealing with the Coalition States directly. D-Bee mercs would be wise to remember who they are dealing with, however, and be extremely careful with any involvement in Coalition affairs. They would not be the first to get double-crossed, set-up or gunned down by agents of the Coalition States. The CS has no honor when dealing with *nonhumans* or *practitioners of magic*, and most Coalition representatives see any D-Bee,

practitioner of magic or other “official” enemy of the States as pawns and villains to be used and betrayed for the Coalition's own gain. Thus, such *brigands* in the eyes of the CS are fair game and there is no shame in tricking, cheating or terminating D-Bees or sorcerers, especially mages after the massacre of the *Sorcerers' Revenge* in the last year of the Siege on Tolkeen.

Mercs who *associate* with or *work for* the **Coalition States** should also be aware that they may be looked upon with suspicion and disdain by their fellow mercenaries and adventurers, many of whom have survived their own clashes with the CS (which is the majority) or lost friends or loved ones in the war (which is about half of them). “Coalition lackeys and lap dogs,” as they are called, are not to be trusted and may find themselves at the business end of an energy rifle or a hand grenade if they push their luck. There is an unspoken sense of fraternity among mercenaries that makes them all kindred spirits. That means when push comes to shove, most mercs usually side with, and try to help, their merc brethren. Most will *not* rat out one of their own even if they don't personally know the mercenaries in question or they suspect the mercs of wrongdoing. That also creates a general consensus that the CS is trouble and that one is best to avoid Coalition entanglement if they want to live to a ripe old age. **Game Master Note:** For a list of Coalition Bounties, see **Rifts® Coalition Wars® Two: Coalition Overkill**, pages 48-50, and/or **Rifts® Aftermath**, pages 16-17. Both list CS bounties and how to collect on them.

When Merc Ops does offer jobs on behalf of the **Coalition States**, the company uses tact and finesse, and charges a larger broker fee (25%) to act as *the middleman*. This is actually good, because as middleman, Merc Ops conceals the mercenaries' identity, delivers the fugitive or suspect to the Coalition States, collects the bounty and pays the balance (minus its cut) to the mercs who made the bounty. The CS never knows who actually did the job, and the mercs involved safely keep their anonymity to avoid treachery at the hands of the CS or retribution by friends of the person or people on whom the bounty was collected.

Long time associates of Merc Ops will notice that the broker has added a new *bounty sponsor* they believe to be reliable, the newly independent nation of **Free Quebec**. For mercs who can overlook Free Quebec's long history as human supremacists and having once been a card-carrying member of the Coalition States, this new bounty sponsor offers a variety of unique and profitable opportunities, and on a no questions-asked basis. Free Quebec has agreed to let Merc Ops serve as their *middleman*, so even D-Bees and sorcerers can take work from Quebec without ever having direct contact with the nation, there is no risk and their anonymity is preserved. According to Merc Ops, Free Quebec's liaisons insist they only care about the *results* and have no interest in the details of where, how, or *who* got the job done. Of course, Merc Ops charges a premium for this service (20%), but the Free Quebec offerings are still well worth a merc's while.

**Private or Exclusive Bounties:** These are bounties quietly offered through a middleman or broker such as *Merc Ops*, rather than a public frenzy. An exclusive bounty can *only* be collected by going through the offering agent/broker – the client's identity may also be kept a secret. These are the best, because the bounty is typically offered to only one or two different man-hunters at a time, not dozens or thousands. The notion that some competition

is good and will motivate both teams to win the bounty first is why a private or exclusive bounty is often (though not always) assigned to two rival groups or individuals. Such bounty offers usually have a performance clause and a timetable. The former is typically a bonus of 5-30% if the job is done quickly or by a specific date and/or certain provisions are carried out; i.e., the police are not involved, the job is done without publicity, the item stolen is also recovered, the subject of the bounty is returned unharmed, or killed slowly and painfully, or quickly and mercifully, or the target's partner or innocent bystanders are not harmed, there are no witnesses, and so on.

The timetable for delivering on a bounty is typically a "fair play" provision in which the two rival merc outfits or bounty hunters put on the job are told that if they have not succeeded within "X" amount of time (two days, a week, several weeks, a month, or a specific date), another couple of crews will be given the assignment. The first teams may still collect on the bounty after the timetable expires, but they will not get a bonus and they know that the competition has increased and that additional man-hunters are on the job looking for their quarry as time goes on. Still, the competition is much less than widely publicized bounties.

**Public Bounties:** These are the classic Wanted Posters plastered all over the walls of communities. The poster indicates the price, basic terms (alive, dead, etc.), who is offering the bounty and contact information. Public offerings usually reflect a certain level of desperateness on the part of the organization or person offering the bounty, or a high level of animosity (hate) for the target, because it is offered to *anyone* and *everyone*. The problem with a Public Bounty is that it often becomes a free-for-all in which two to twenty, to thousands of Bounty Hunters, mercenary outfits, adventurers and even ordinary people are all out looking to make a "kill" or "capture" to collect on the bounty. That means a great deal of competition and the very real likelihood of being attacked, tricked, sabotaged, or killed by a rival individual or team. It is common for a team to capture the target of a public bounty only to find their prisoner kidnaped when they weren't looking, or taken after a firefight with unknown assailants. The most ruthless and evil bounty hunters have no qualms about lying to, stealing from, and killing fellow mercs or innocent people to collect on a bounty for themselves. The bigger the bounty, the greater the number of predators on the prowl, and the more extreme measures they are willing to take.

**Merc Ops Broker Fees:** 15% is the typical fee to broker any bounty or job offered by Merc Ops. The fee comes out of the reward paid to the representative making a bona fide, verifiable claim. An additional fee of 10% is charged for a Merc Ops representative to act on an individual's or mercenary team's behalf to collect a bounty from the Coalition States and similar troublesome or difficult bounty sponsors.

The advantage of using Merc Ops as the *official rep* or go-between is that the mercenaries' identities are kept completely secret, Merc Ops cashes any credit vouchers, and pays out the balance of the bounty to the proper claimant in untraceable Universal Credits, cash or in trade for Black Market goods (further evidence of a connection to the Black Market).

The disadvantage of using Merc Ops as one's rep/go-between is that they take an additional 10% of the bounty as their service

fee. However, an estimated 77% of all professional Bounty Hunters and 59% of all mercenaries use this service to protect their identities from the client and the public – including the victim's friends, family, business partners and associates who might seek revenge.

**Note:** Involving Merc Ops as one's agent/go-between always costs an extra 10% of the bounty, the 15% comes off the top from *any* bounty offered by Merc Ops whether the mercs collect the bounty in person or through Merc Ops.

**Other Jobs.** Merc Ops seems to have connections everywhere outside of the Coalition States. Being so well "connected" means they know who is looking for a "crew" of mercenaries, adventurers or specialists for military, police, guard, man-hunting, monster stomping and espionage work. As usual, the company takes a 15% commission out of the mercs' pay as a finder's and placement fee. The 15% is usually deducted from the employee's pay by the employer and sent directly to Merc Ops, so the hired gun never even sees that money.

## Commonly Available Bounties

Many public and private bounties are available without actually being bonded with a broker like Merc Ops, but these are often smaller bounties for regional criminals wanted by a particular kingdom, city, town, organization or individual person. The bounty is also small, ranging from 1,000 to 40,000 credits. Merc Ops does offer a listing of these region specific and smalltime bounties, but only a bounty bonded with Merc Ops *guarantees* payment and may be handled directly by Merc Ops upon *fulfillment* of the bounty.

The real trick for mercs and bounty hunters is collecting on the reward offered by the sponsor. Many times the individual, group or government offering the bounty doesn't really have all the money and can't pay up, at least not in Universal Credits. In these cases, 30% to 60% of the bounty is paid in Universal Credits, with the balance being paid in "trade" of goods and/or services; sometimes even land, homes, an interest in a business, slaves or livestock. Not necessarily a bad deal, but definitely inconvenient and sometimes problematic. What's a mercenary outfit going to do with a hundred heads of cattle or sheep, or interest in a dairy farm, if they don't have a buyer for them or an immediate use for them, or somebody to watch out for their interest? As for an interest in a business, 90% of all businesses fail within the first three years (and that's true of our own modern era, let alone the dangerous period of Rifts Earth). This is why **Merc Ops** and other brokers try to specialize in bonded bounties and merc operations – the broker may take his 15% to 25% cut, but the money is guaranteed at the end of the job. Each bounty accepted by Merc Ops is only listed after the bounty has been paid out in full and the money put into an escrow account until it can be collected or the bounty is withdrawn. **Note:** Most large bounties range from 500,000 credits to a few million. While these get the most publicity, they are the least common. Medium bounties range from 100,000 to 450,000 credits. Small bounties are the most common and numerous and range from 1,000 to 90,000 credits, with 1,000-40,000 being the largest range. Merc Ops never offers a bounty for less than 1,000 credits, and specializes in medium and large, premium, bounties. Anything smaller is not worth the organization's involvement.

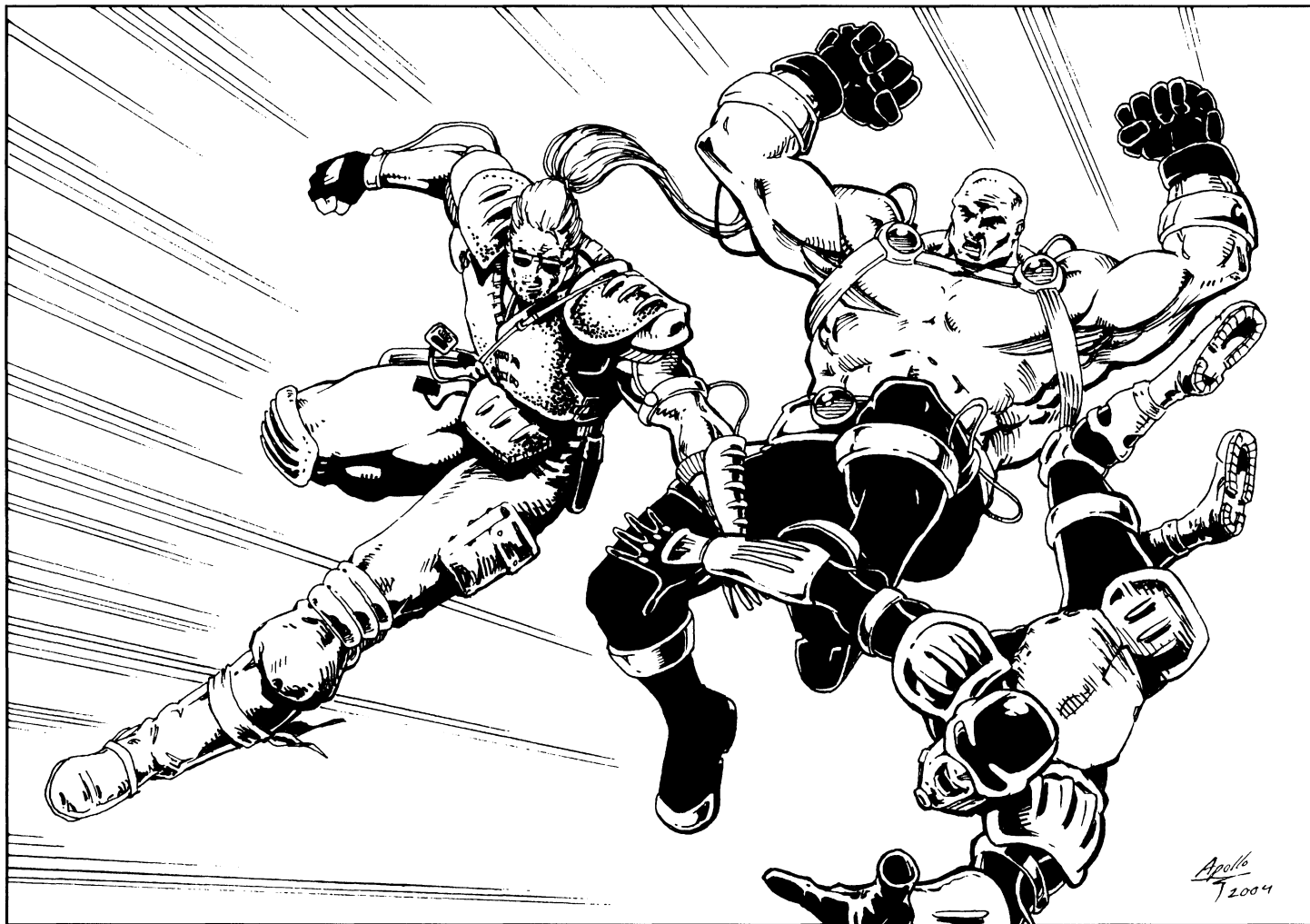

However, local or visiting mercs, adventurers and City Rats (and those just starting off in the merc or bounty hunting business) may find small, local jobs like 500 credits to recover a stolen item or to identify a gang of vandals, or to capture a crook burglarizing local homes or businesses to be easy work, and a means to put a little extra spending money in their pockets or to pay bills when times are tough and work is sparse.

**Proof of Service.** The other problem with collecting on bounties is *proving/validating* the success of the claim, especially when involving a “kill.” The best is to have the physical body, dead or alive. Oftentimes just the head(!) will do, particularly if it involves a common enemy or monster. Killing a public figure or infamous criminal can usually be verified from news reports, the authorities and spies, however, sometimes other bounty hunters or mercenary groups will make a false claim to the reward unless the outfit that is truly responsible can offer *proof*. If there are two or more claimants without supporting evidence, the bounty may be withheld indefinitely or withdrawn without payment made to anybody (the broker still getting *half* his usual percentage from the sponsor for brokering the deal and managing the dispute regardless of the outcome). Only after one of the claimants presents undisputable evidence of their claim, confirmed and warranted by Merc Ops, will the funds (minus the broker fee) be released in the form of Universal Credits. Payment may be transferred to the account of the bounty hunter or directly to a local bank.

## Common Bounties, Crimes and Punishment

The following are some of the crimes, the typical range of the bounty, and the typical punishment for the crime(s) committed. The amount offered in the bounty is limited by the resources of the organization or individual placing the bounty. All amounts noted are the common range offered as bounties, there are always exceptions. Also remember, what is a crime in one community may be completely legal in another. For example, buying and selling (even using) magic or distributing historical artifacts and contraband books is a serious crime punishable by death in the Coalition States, while perfectly legal and open in most other independent kingdoms and nations.

The Crime - Average Bounty - Typical Sentence:

**Treason** - 100,000 to 2 million credits (dead or alive) - court martial if military treason and execution or life imprisonment.

**Genocide** - 250,000 to 20 million credits (dead or alive) - execution. **Note:** Genocide usually involves the systematic extermination of a particular people based on race, occupation, religion or beliefs and involves the murder or attempted murder of hundreds, thousands or millions of people.

**Mass Murder** - 250,000 to 5 million credits (dead or alive) - execution. **Note:** Typically involves the murder or attempted



murder of dozens to hundreds, sometimes thousands of people, and may include terrorists and cultists.

**Serial Murder** – 10,000 to 250,000 credits (dead or alive) – execution or life imprisonment. **Note:** A serial killer is someone who regularly targets specific individuals, usually one at a time, for murder over a period of time.

**Murder, First Degree** - 25,000 to 500,000 credits (dead or alive) - execution or 25 years to life. **Note:** Includes assassinations and hits for hire.

**Murder, Second Degree** - 10,000 to 150,000 credits (dead or alive) - 15 years to life.

**Attempted Murder** - 5,000 to 75,000 credits (dead or alive) - 5 to 15 years. **Note:** Includes attempted assassinations and criminal hit attempts.

**Terrorism Using Summoned or Controlled Monsters/Demons/Animated Dead (namely Shifting/Summoning or Necromancy)** – 10,000 to 250,000 credits (dead or alive) - 10 to 30 years imprisonment (death in the CS). **Note:** Includes raids on villages, supply depots, and transport vehicles using monsters.

**Using Monsters or Animated Dead in the Commission of a Crime** – 5,000 to 150,000 credits (dead or alive) - 5 to 20 years imprisonment (death in the CS). **Note:** Includes raids on towns, supply depots, and transport vehicles and, in effect, using monsters to intimidate or rob – fundamentally the same as an armed robbery.

**Cyber-Snatching** – 5,000 to 50,000 credits (dead or alive) – 3 to 12 years imprisonment for robbery without killing. 15 years to life or execution for committing murder in the process of Cyber-Snatching. **Note:** The sentence depends on the severity of the crime and the number of victims. Cyber-Snatching typically involves mutilation and murder. Sadly, this is a crime that is often overlooked on the mean streets of high-tech cities, despite the level of violence. In other cases, the perpetrator is charged with multiple counts of first degree murder. Cyber-Snatchers are often dealt with outside the law (i.e. a bounty for “dead”) with bounties sponsored by private individuals, family members and vigilante groups.

**Cybernetic Body-Chop-Shop Operations** – 2,000 to 75,000 credits (alive) – One to 8 years imprisonment for running or participating in the operation of an illegal cybernetics ring that buys, sells and installs stolen and/or defective used bionics and cybernetics. Another crime that is frequently ignored by the law.

**Cyber-Smuggling (Black Market Contraband)** – 1,000 to 25,000 credits (alive) – One to 6 years imprisonment for buying, selling, trading, smuggling and installing illegal, Black Market cybernetics. Another crime that is frequently ignored by the law.

**Manslaughter** - 20,000 to 30,000 credits (alive) - 2-8 years of imprisonment; reduced or suspended sentence is possible due to extenuating circumstances.

**Negligent Homicide (Accidental Death)** - 5,000 to 50,000 credits (alive) - 1-4 years; reduced or suspended sentence is possible due to extenuating circumstances.

**Kidnaping** – 5,000 to 250,000 credits (alive) - 10-20 years imprisonment; reduced or suspended sentence is possible due to extenuating circumstances.

**Assault: Armed (Use of a Deadly Weapon)** - 1,000 to 25,000 credits (dead or alive) - 1-8 years imprisonment.

**Assault: Felonious (With Intent to Kill)** - 5,000 to 50,000 credits (dead or alive) - 5-15 years imprisonment. May involve the use of magic or psionics.

**Assault: Unarmed** - 2,000 to 10,000 credits (alive) - 6 months to 2 years of imprisonment.

**Arson or Sabotage (Deliberate, Massive Damage to Property)** – 2,000-250,000 credits (dead or alive) – 8-20 years imprisonment, life or execution if people died as a direct result of said criminal act.

**Vandalism** – (typically on a large scale or serial basis) – 1,000 to 10,000 credits (alive) – 4 months to two years imprisonment, plus fines and restitution; a reduced or suspended sentence is possible for first-time and youthful offenders, or due to mitigating circumstances.

**Racketeering (Most Organized Crime Operations)** – 10,000 to 250,000 credits (alive) – 10 to 20 years imprisonment. **Note:** Includes protection rackets, numbers running, money laundering, and most criminal operations that have a network of agents and operatives or involve a criminal organization that extorts and handles money.

**Resisting Arrest** - 500 to 5,000 credits (alive) - 1 to 2 years imprisonment, plus fines. A reduced or suspended sentence is possible for first-time and youthful offenders, or due to mitigating circumstances. *Also see Suspect.*

**Robbery, Armed** - 5,000 to 25,000 credits (dead or alive) - 5 to 20 years imprisonment.

**Robbery, Bank** - 10,000 to 50,000 credits (dead or alive) - 20 years imprisonment.

**Robbery, Horse/Cattle Rustling** - 5,000 to 30,000 credits (dead or alive) - 2-12 years imprisonment.

**Robbery, Unarmed** - 1,000 to 5,000 credits (alive) - six months to 4 years imprisonment.

**Sex Crimes** - 25,000 to 150,000 credits (dead or alive) - 1 to 25 years depending on the type of crime.

**Slaving** – 10,000 to 75,000 credits (dead or alive) - 10-20 years imprisonment, death in some communities. **Note:** The practice of capturing sentient life forms (humans, D-Bees and others) for resale against their will as slaves.

**Suspect Wanted for Questioning** – 1,000 to 100,000 credits (alive) – wanted for questioning or further investigation; criminal charges may be made at a later date.

**Smuggling** – 10,000-100,000 credits (alive) depending on what is being smuggled and who is placing the bounty.

**Contraband: Alien Technology (dangerous or illegal)** - 10,000 to 100,000 credits (dead or alive) - 2 to 10 years imprisonment (death in the CS).

**Contraband: Books & Historical Documents** – 1,000 to 50,000 credits (alive) – 1-5 years imprisonment (death in CS).

**Contraband: Drug Production & Smuggling** - 20,000 to 100,000 credits (dead or alive) - 5-10 years imprisonment.

**Contraband: Demons/Dangerous Animals** - 20,000 to 200,000 credits (dead or alive) - 6-30 years imprisonment (death in the CS).

**Contraband: Magic** - 50,000 to 100,000 credits (dead or alive) - 5 to 15 years (death in the CS).

**Contraband: Pre-Rifts Artifacts (or forgeries of artifacts)** 1,000 to 50,000 credits (alive) – 1-8 years imprisonment (death in CS).

**Contraband: Slaves** - 5,000 to 50,000 credits (dead or alive) - 10-20 years to life.

**Contraband: Weapons** - 10,000 to 100,000 credits (dead or alive) - 5-15 years to life (death in the CS if weapons are alien technology or magic based).

**Contraband: Weapons of Mass Destruction** - 50,000 to 1 million credits (dead or alive) - execution or life imprisonment (death in the CS).

**Extortion/Blackmail** - 25,000 to 250,000 credits (dead or alive) - 10 to 20 years imprisonment.

**Espionage, State (Stealing Government Secrets)** – 500,000 to 5 million credits (dead or alive) - execution or life imprisonment.

**Espionage, Industrial (Stealing Proprietary Information)** – 25,000-5 million credits (dead or alive, but usually alive) – 5-15 years imprisonment or Mind Wipe, plus possible civil action for restitution.

**Forgery, Currency/Credits** - 5,000 to 50,000 credits (alive) - 10 to 25 years imprisonment.

**Forged Documents** - 500 to 10,000 credits (alive) - 1 to 4 years imprisonment.

**Forgery, Identity Documents** – 5,000 to 50,000 credits (dead or alive) – 3-12 years imprisonment (death in CS if the papers/IDs were to get into a fortified city like Chi-Town).

**Forgery, Pre-Rifts Artifacts** - 1,000 to 50,000 credits - 1-8 years (a beating and destruction of property to death in the CS).

**Illegal Augmentation/Genetic Manipulation** – 10,000 to 200,000 credits (dead or alive) – 15-30 years, possibly execution (death in CS). **Note:** Double the bounty and the punishment if it involves kidnaping and experimentation against the subject's will.

**Impersonation** – 5,000 to 100,000 credits (dead or alive; typically alive) – 5-10 years imprisonment, possibly life or execution for impersonating a high ranking military or political leader (death in the CS).

**Man-Eater, Feeding on Human Flesh or Blood** - 10,000 to 100,000 credits (dead or alive) - 10 to 20 years imprisonment (death in CS).

**Mind Control, Psionics (Misuse of Psionics)** – 15,000 to 200,000 credits (dead or alive) – 2-12 years (double in the CS, loss of citizenship and expulsion out of the fortified cities). **Note:** Includes using psionic abilities in a crime that involves altering or eliminating a person's memories, mind control and mental manipulation, harassment (bad dreams and illusions) and similar acts of mind control or mental torture.

**Mind Control, Magic** – 20,000 to 200,000 credits (dead or alive) – 2-8 years (death in the CS). **Note:** Using magic to charm, dominate, enslave, mind control, or torment one's victim, includes the use of illusions.

### **Notable Bounties Wanted Dead Only**

– applicable only to *select* wilderness communities

50 credits per head of a Xiticix.

100 credits per head of a Brodkil, Simvan or Gargoyle.

200 credits per head of a Mega-Damage monster.

500 credits per head of a Black Faerie or Witchling.

2,000 credits per head of a Daemonix (CS).

1,000 credits per head of a demon or Dyvalian.

2,000 credits per head of a supernatural monster.

3,000 credits per head of a were-creature.

100-300 credits per Wild Vampire (southwest).

300-1000 credits per Secondary Vampire (southwest).

10,000 credits per head of a Naruni/Uteni Alien or Molock (CS).

# Mercenary Operations

By Kevin Siembieda

## Mercenary Code of Conduct

It's easy to say that mercenaries are hired guns, and they are, but mercs engage in all manner of military, paramilitary, police, and detective operations, from security and defense to initiating or coordinating acts of aggression.

The difference between a *soldier* and a *mercenary* is that a soldier typically serves a nation and fights for a cause he believes in. Mercenaries are in it for the money.

*Adventurers* may be mercenaries or borderline mercenaries in it for the money, but more often than not, they are heroes who fight for a cause, even if it is personal revenge or personal gain.

Mercenaries may consider themselves heroes and even be regarded as such by the public, especially if they carefully choose and pick their assignments, but many "jobs" may be seen as criminal or heartless, even evil by their victims or one side or another.

## Mercenaries and the Business of War

For a merc, war is business and the character must approach his work with an eye toward logistics, overhead, cost effectiveness, profits and loss. If a job is not worth taking or the risk of loss is too great (loss in equipment as well as manpower), the merc will turn the job down.

As a rule, most mercs make a deliberate effort *not* to become emotionally involved or attached to a client, country or cause. They live by the *three G's* – get in, get the job done, and get out. It's better that way for everyone. Emotional involvement can get in the way of good business and get messy. If the employer suddenly can't pay, the mercs have to be ready and willing to walk away regardless of the consequence to their employer or the innocent people their actions might impact. The same holds true when accepting a job – innocent civilians are likely to get hurt, and the mercenaries are likely to be the ones putting on the hurt. That's the ugly side of war. People suffer and die. Consequently, most mercenaries try to stay aloof and focused on business. That means avoiding fraternization with the locals, avoiding, even denigrating or vilifying, the indigenous people (if you don't like or respect your employer or his people, it's easy to walk away or do whatever becomes necessary), and focus on the work at hand. Likewise, mercs try not to identify with

or understand the *enemy's* side or position. For a merc, the enemy of his employer is his enemy, plain and simple.

**Trust.** A mercenary's cold heart and indifferent attitude (for those who can do it) enables the warrior to work for one side this year and, perhaps the rival side the next. That having been said, mercenaries are usually very fastidious about *fulfilling their contract*, and living by the letter of that agreement. When the obligations of that contract are ended, then, and only then, will the mercenary outfit consider taking a new one. That means a reputable mercenary company will *NOT* switch sides in the middle of a conflict because the other side seems to have the upper hand, or offers them more money to abandon their current employer and walk away or join the rival.

Living up to one's contractual obligations is sound business, and should not be construed as a sense of duty or loyalty. To do otherwise is to get a reputation for being unreliable or worse, untrustworthy. A mercenary with a reputation that they can be bought by the highest bidder will quickly find nobody is willing to hire them. There has to be some kind of code of ethics and some measure of assurance between the employer and his hired guns, or there can be no trust. Without trust, there is anarchy and treachery. Thus, unless a mercenary outfit is cheated, tricked or betrayed by their employer first, they will stick out the worst tour of duty until the bitter end. Ah, but that *end* is conditional.

Most mercs (unless they've gone and done the unthinkable and become personally involved) will not fight to the death for their employer. When the outcome of a conflict seems obvious, most mercs will surrender on the condition that they are allowed to walk away with only their own gear, and let the vanquishing army ride in to claim their spoils. Again, the merc outfit's *word of honor* is paramount, and once the mercenary company agrees to walk away, they must live up to the bargain and keep on walking without serious altercations. If the mercenary outfit reneges and attacks the vanquishing force from a better position because they were allowed to leave under a surrender agreement, the mercs will be shown no quarter in combat and executed to the last man if their treachery fails. A merc company that earns a reputation for being untrustworthy may not be allowed to surrender in the future and certainly will never be trusted by an opponent.

## Mercenary Missions

The following are descriptions of common mercenary missions, assignments and tours of duty. Their exact wages (usually paid every other week or monthly) will vary depending on the wealth of the employer and the level of need.

### Police Operations

In communities and situations where there is no formal police department or law enforcement, or even a volunteer militia, mercenaries *may* be hired as police and peacekeepers. This could be a single squad acting as sheriff and deputies, or an entire company or brigade serving as a larger police force.

The duties of these hired policemen would be exactly what you'd think they'd be, and will include keeping the peace, enforcing the law, enforcing curfews, handling domestic disputes, investigating crimes, locking horns with criminals, tracking

down and putting an end to dangerous fugitives (capture or kill), and generally defending the public (and in some cases, their specific employer) from danger in whatever form it may take. The mercs' combat training and experience makes them prone to take a more direct and violent hand in dealing with "bad guys," and they are not afraid to engage in gunfights or tackle forces that outnumber them, especially if the mercenaries determine their opponents to be inexperienced, afraid or desperate.

**Note:** Mercs are seldom as lenient or forgiving as true police officers, and tend to use strong-arm tactics and lethal force at the slightest provocation. Likewise, some of the more aggressive merc outfits may not be concerned about civilian endangerment and casualties. As soldiers, they expect collateral damage, and the most aggressive may engage in gunfights where numerous civilians are injured or killed.

**Adventure Ideas:** If the player group is being hired to serve as the local lawmen/sheriffs/police officers, they may find themselves embroiled in all kinds of adventures against criminal masterminds, street gangs, organized crime, roving gangs of bandits or raiders from outside the community they protect, magic-based threats (say a Shifter and his legion of monstrous misfits engaging in criminal pursuits), random violence, terrorist/hostage situations, hostile (criminal or foreign government) takeover attempts, smuggling, cultists, vampires (and other demons or monsters), spies from the Coalition or other powerful nations or organizations, to conspiracies involving powerful local business people, politicians, or criminal masterminds.

The police/lawman angle can make for a few nights of fun or a mini-campaign where the characters take the police work as a

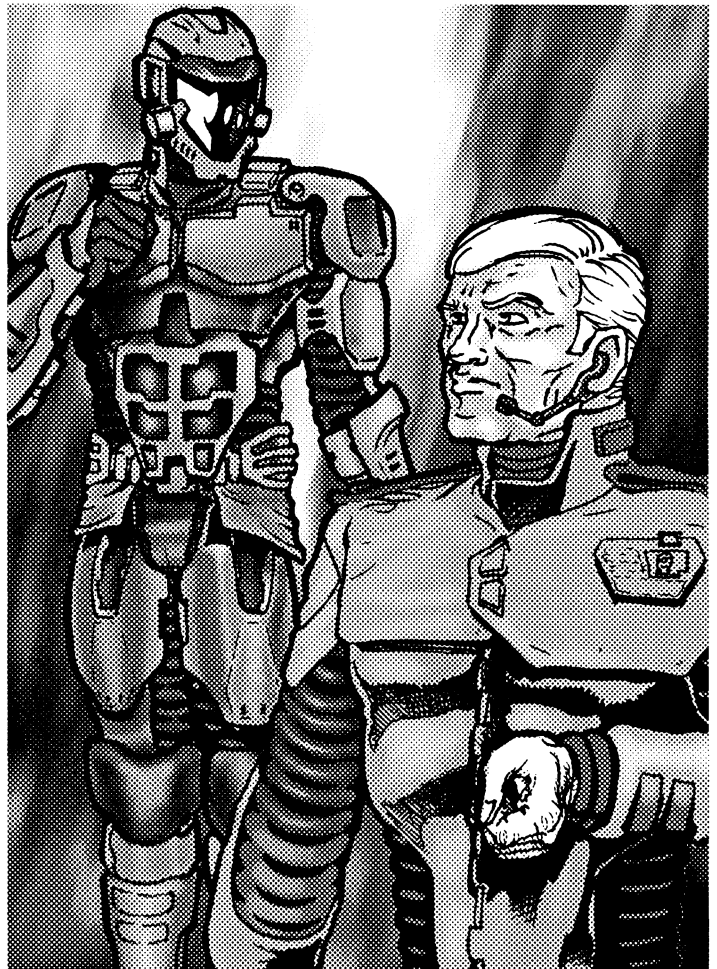



temporary job to make money, or to build their reputation, before moving on to bigger and better things, to a full-fledged campaign that could run for months or years! Give it some thought.

## Muscle/Hired Gun

**Assassin/Hit Man.** The merc or merc squad is hired to kill a particular person, group or members of an organization. Their job is to find the target(s) and liquidate them. An assassin typically arranges an ambush, hides in wait, and strikes from a distance or with the element of surprise, and leaves. His only concern is the specified target. No one else. Hit man is the criminal vernacular for an assassin, somebody who is sent out to eliminate people causing a problem for his boss. Ultimately, any assassin or hit man job involves killing a specified target.

**Enforcer.** Work as an enforcer may involve assassinations or hits, but ultimately the goal is to *enforce* the will of their employer or to arrange for the employer's desired outcome by any means necessary. While that may include murder, it is more likely to involve threats, blackmail, bribes, coercion, leg breaking and other means and methods to *intimidate* people into compliance with their employer's desires. The same tactics are used to enforce the rules, edicts and operations of a crime boss or local leader. In every case, a designated crew (or crews) functions as the boss' enforcer team to make it all happen according to plan. Enforcers may also punish those who fail to comply via more strong-arm tactics. A hit man/assassin may be called in for the final word.

**Guard: Convoys and Merchant Caravans.** Rifts Earth is a wild and wooly place with an ever-changing landscape. Opportunists, crooks, raiders, mercs, monsters, enemies and rivals may all have a reason to attack cargo transports, even if it's as simple and basic as to steal the goods or hurt a rival. Mercenaries are frequently hired to ride shotgun and protect convoys and caravans transporting valuable goods (sometimes people) and keep them safe from harm.

**Guard: Personal Bodyguards.** The most likely scenario is being hired by someone with power, money and influence for protection or to protect his wife, a family member, or a vital person or persons in his organization. Bodyguards may also be hired to protect a group of individuals or organization and its officers or its people/workers/followers.

Adventure Ideas: Most guard assignments of this sort probably involve one of the following themes complicated by political intrigue, lies, betrayal, dirty dealings, and manipulative people in power.

1) The employer is either a scumbag who has rattled the cage of the wrong people and they are out to kill him, or he is a political or military leader whose enemies would like to see the character "neutralized." That could mean killed, blackmailed into compliance or framed to destroy his career and undermine his power and level of influence. It is the mercenaries' job to prevent any of this from happening.

2) The nasty side of politics where political intrigue and maneuvering may obscure who the good guys are and who the real bad guys are. Or it may draw the characters into a political hotbed that could lead to scandal, a secret war, or outright war between two rival nations or political powers. In this case, the

mercs are hired to protect one faction's leader from the other's henchmen, hit men or dirty tricks – even if he is just as bad or worse.

3) The person the mercs are to protect is a political leader (good, selfish or evil) who has been targeted by rivals who don't like his political agenda. The mercs' job, to keep their employer alive and safe.

4) The person(s) the mercs have been hired to protect is a good guy or social leader who has dared to oppose a nasty bad guy or evil organization, and he (and his family, partners, etc.) has been marked for death. Their job, to keep him alive at all costs.

5) The person the mercs are hired to protect is an innocent who has seen something he or she shouldn't have, and is threatened by the person or people that information would hurt.

**Note:** The above is the *passive assignment*, where the hired guns *react* to attacks and defend their charge. The aggressive alternative is being hired to identify and neutralize the source of these threats or attacks. "Neutralize" could be anything from outright assassination or murder, to finding evidence that can be used against the evildoer(s) to get him arrested and locked away by the authorities, or to leverage him (blackmail or threats) to get him to relent, and similar operations. This can include the classic detective search and confront adventure to the "time is running out" adventure where the heroes have to find and stop the assassin before he can strike again, or before the big political rally on Sunday, and so on.

**Note:** Adventures with a political backdrop should be filled with intrigue, backstabbing, surprise twists, red herrings and subplots.

**Political Intrigue.** This could include aspects outlined under Personal Bodyguard, as well as extend into areas of espionage and sabotage. The mercs may have been hired to find dirt on somebody, create a scandal, or frame, threaten, blackmail, kidnap or kill someone as instructed by their employer, all for political reasons. **Note:** Depending on the characters' alignments, they may need a good reason, a noble cause or to be working for the good guys to hurt the bad, or they may not care about anything but the money and be willing to work for any side willing to hire them.

## Military Ops & Special Ops

**Assault on a Fortified Position.** The employer needs to neutralize an entrenched enemy force. The enemy may be a criminal base, guerilla encampment, hideout, stronghold, monster's lair, etc., requiring a commando style surgical strike designed to penetrate and destroy the strategic position or to rout and chase away or destroy the enemy within.

**Combat Operations.** Stand up combat missions of every kind. This involves missions to take a strategic position or enemy resource, rout an enemy stronghold, and other engagements that are fundamental infantry combat situations.

**Commando Raid.** Typically a surgical strike that utilizes the element of surprise and confusion to effect a jailbreak, rescue, capture of enemy personnel, targeted sabotage, assassination or neutralizing attack (knock out a bridge, supply depot, enemy squad or outpost, etc.).

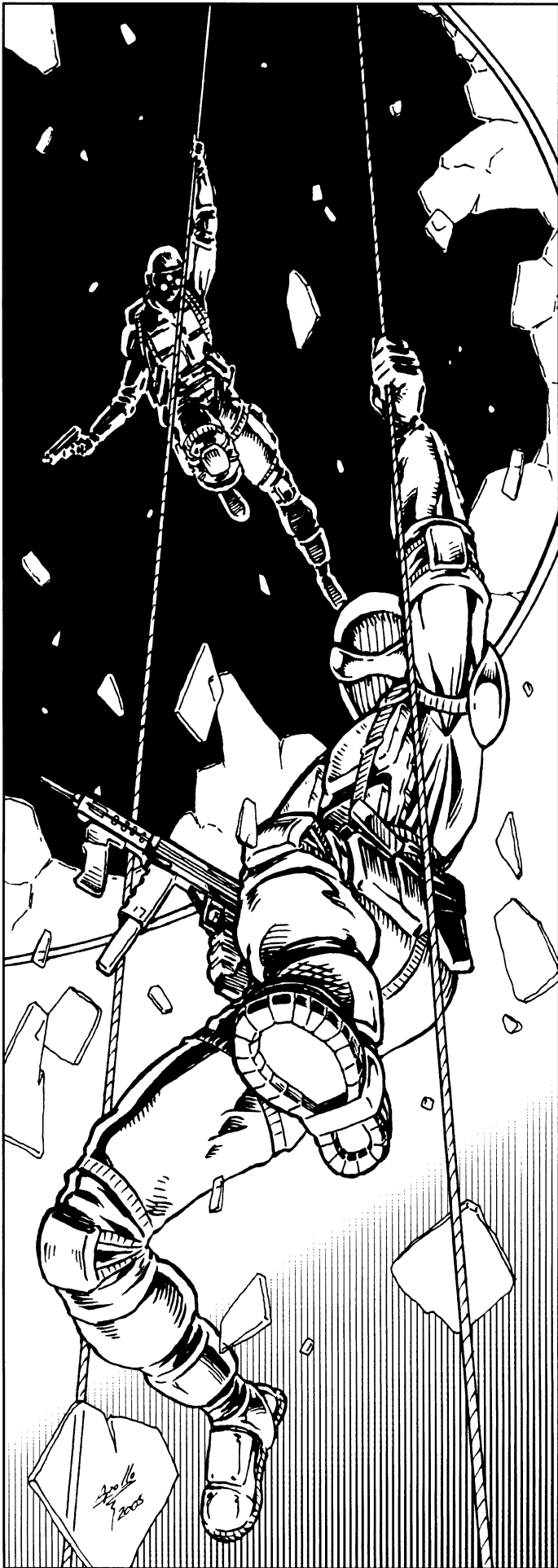

**Counter-Terrorism.** Another type of surgical strike or commando raid in which the mercenary team, unseen, penetrates a position held by terrorists (barricaded gunmen, hostage situation, sniper's nest, etc.), gets into optimal strike positions and then launches a quick siege attack designed to kill each terrorist with as little collateral damage and loss of civilian life as possible. May involve Demolitions Disposal.

**Defend This Town (or Strategic Position).** In the violent world of Rifts Earth, cities, towns, and communities need defenders to protect them from raiders, bandits, slavers, monsters, conquering armies and madmen. When they are given advanced warning of such a threat (or fear it as a result of events happening to their neighbors), they hire Mercs as a deterrent and champions to fight on their behalf. When a community has fallen to a tyrant, evildoers, or monster, a representative may sneak out to find a mercenary outfit or adventurers to remove the villain and his henchmen (*see Liberation*).

Similarly, the merc team may be called upon to defend a position or resource of military significance (stronghold, factory, artifact, a battlefield vantage point, etc.). The goal, to rebuff and kill all takers.

**Dragon/Monster Slayers.** All manner of alien invaders, demons, and monsters threaten the people of Rifts Earth. Some are long-time adversaries or predators of humans, others are strange new arrivals recently emerged from a Rift. Whatever they are, wherever they're from, a person, community or business may need specialists to help protect them from the creature(s), chase it away, and/or to hunt it down and destroy it.

**Extraction and Insertion.** The mercenary squad is responsible for the inserting/dropping off and picking up/extraction of reconnaissance teams, Special Ops and other units at pre-designated zones, and bringing them back to base safely. Requires the appropriate vehicle (ground, air or water vessel), pilots and defenders who are willing to die protecting and retrieving the team.

**Find and Neutralize Enemy Positions.** This can include locating and seizing, sabotaging or destroying enemy supply depots, bunkers, hideouts, safe houses, drop zones, sniper nests, strategic observation points, and so on.

**Find and Neutralize Enemy Mines and Traps.** The dangerous job of locating hidden mines, booby traps and explosives. Includes clearing mine fields (or finding a safe trail through a mine field), deactivating bombs (EOD), springing traps and similar work.

**Guard & Escort.** A military escort to defend and protect military supply convoys, designated teams or individuals, resources and strategic position, etc.

**Guerilla Warfare.** Hit and run tactics, ambushes, traps, and relentless harassment of the enemy to create confusion, fear, diminish their combat capabilities and/or resources and ultimately capture or destroy the enemy.

**Harassment.** Rather than open warfare, the mercs engage in acts of harassment using hit and run tactics. Most attacks are designed to unnerve, confuse, prevent sleep, keep the enemy unnerved and hurt him in small ways (cause damage, jam radio transmissions, steal or damage supplies, block supply lines, ruin food or water supply, interfere with rest or sleep, create an aura of fear or suspicion, etc.).

**Kidnaping/Abduction.** At first glance, this may sound more like a criminal act, but there are a lot of military reasons why one might kidnap an individual or enemy. The target could be a spy, a double-agent, a head of state, high ranking military personnel, or individuals with specialized knowledge (including scientists, experts, practitioners of magic, psychics, etc.) for interrogation and intelligence. Abduction of an enemy's friend, loved one, business partner, associate or other individual whose captivity can be used to leverage, threaten, intimidate, distract, misdirect, harass or provoke the enemy is another motive for kidnap operations, as is blackmail.

**Kill My Enemy.** This operation has a lot of different names, but the bottom line is that mercenaries have been hired to find and kill one particular person, a group or combat force for whatever reason. It could have military and strategic significance or be motivated by hate, greed, rivalry or revenge.

**Liberation.** This could be something as simple as "go slay the dragon," or the tyrant king, or evil gang, sorcerer, merc, etc. (and his henchmen) who have taken over a community or resource. **Note:** On a larger scale, the merc team could lead a coup attempt to topple an entire government or seize control of an army and leverage the government out (i.e., a bloodless coup).

**Magic Neutralization.** Magic (and psionics) are commonplace on Rifts Earth. Those with the knowledge and the power have an upper hand and can become a problem. Mercs, particularly those wielding or versed in anti-magic combat strategies and tactics, may be called in to dispatch a problem involving sorcery, magic items, demons and creatures of magic.

**Merc vs Merc.** This can be any of the missions outlined in this section in which the opponent or opposing force is another mercenary outfit. Hopefully, not one known and liked by the group. Typically involves small squad tactics and combat.

**Military: Advisors.** On the surface, military advisors are hired as expert counsel to offer information, insight, observations, strategies, tactics, and suggestions for the best course of action under the circumstance. However, most military "advisors" play a much more active and direct hand. Thus, they may engage in direct dialogues and negotiations (and threats), lead military teams and operations, and be members of an elite mercenary/combat team that personally engage in Special Forces operations, surgical strikes, and acts of sabotage and/or assassination. Such are the benefits of expert "military advisors" who enjoy getting their hands dirty.

**Adventure Hooks:** This type of "work" can involve every type of espionage and black ops scenario one might imagine. However, the "advisors" might find themselves hamstrung and compromised at times by behind the scenes political intrigue, and must be careful not to be exploited and hung out to dry (left on their own and/or used as scapegoats) by the powers that be; perhaps by the very person(s) who hired them. Wartime politics can be trickier and more deadly for soldiers than any battlefield firefight. Mercs, most of whom tend to be straightforward and live by some type of military or honorable code of conduct, may find themselves ill-prepared for the treachery of politics behind every war.

**Military Deterrent.** The mercs' very presence is meant as a deterrent to keep trouble away. This typically includes raiders, bandits, slavers and powerful beings. The best case scenario is that the bad guys will stay away or go away because they won't

want to tangle with the hired guns. However, if that doesn't work and the bad guys do attack, it is the mercenaries' job to make them regret it, while protecting their employer (which may be the entire town and all of its citizens). Putting mercs in the role of champions and defenders is very common on Rifts Earth.

**Military: Training of Others in Combat Basics.** Mercs are frequently hired to train the armies, militias, police and defenders of a community or fighting force.

**Patrols.** May be a foot, water or air patrol along a border, perimeter line, secured facility, strategic position, etc. to make sure it is free from enemy incursion.

**Reconnaissance.** This may sound boring, but in all wars, knowing where the enemy is and what he is doing is essential. The challenge comes from the mercs being inserted into an area where unknown numbers of the enemy are deployed. They must survive and get the information back to their employer. Radios may not be an option for getting information out depending on the expertise of the enemy (someone might pick up the transmission). Mercs are valuable for reconnaissance because they offer plausible deniability; i.e., they could be on their own, passing through, or working for anybody (including the enemy, so beware). They do not wear the insignia of any army or nation, and they are often hired by middlemen (trusted middlemen). Furthermore, mercs are usually kept out of the loop, so even if captured, all they can reveal is the identity of their employer (or his middleman) and be unable to provide any info on any other part of the employer's operation. Merc reconnaissance teams appear like ghosts and vanish.

**Special Ops: Recovery.** Stealing or getting back items of value or strategic importance in the possession of the enemy, or to acquire the item to prevent the enemy from obtaining it. May include weapons, documents, plans, schematics, layouts, and, on occasion, even an important individual (scientist, spy, head of state, prisoner, etc.). **Special Ops: Sabotage.** Typically a small squad operation to infiltrate enemy lines and undermine the enemy's position or resources by eliminating strategic targets; i.e., knocking out a communications tower, destroying a bridge, destroying a supply depot, water supply, ammunition dump, destroying a bunker, pillbox or other fortified position, sabotaging vehicles or artillery, etc., to weaken the enemy's defenses or offensive combat capabilities.

**Special Ops: Search and Destroy.** Typically a small squad operation charged with locating an enemy force, stronghold, base camp, operation or resource and destroying it.

**Special Ops: Surgical Strike.** Typically a commando style hit and run assault designed to take out one particular aspect of the enemy's capabilities. The target may be inanimate (weapon, bridge, bunker, communications, piece of equipment, magic artifact, etc.) or live (a key officer, informant, scientist, etc.). Also see *Special Ops Sabotage and Commando Raid*.

**Special Ops: Sniper.** The difference between a sniper and an assassin or hit man, is that the sniper only engages military targets, and provides support for his own troops (i.e., picks off advancing enemy troops, officers, other snipers, etc.). In this case, there is no *one* specific person or target, but a wide range of strategic military targets.

**Special Ops: Sniper Elimination.** The dangerous mission of locating (via observation, trajectory of attacks, and fighting

knowledge) the position of an enemy sniper and moving in and behind him without being seen and becoming one of his targets. The goal is to get into a position where the enemy sniper can be neutralized.

**Special Ops: Starting a War/Conflict.** The mercenaries are hired to provoke an armed conflict – incite war. This may be accomplished by planting incriminating evidence, planting false evidence to frame a highly placed leader or officer, assassinating or kidnaping a top military or political leader (and, perhaps, planting evidence to incriminate one side or another), acts of terrorism, sabotage or destruction, issuing a public challenge or creating a public embarrassment or a demand for revenge, blackmail and so forth.

On a purely military level, this may include acts of escalating aggression and threats, worrisome military exercises, land claims and strategic positioning (like a chess game) that forces the rival/enemy force to respond or fall into a compromised or weakened defensive position. There are a lot of ways to instigate war.

**Theft.** An item that was either wrongfully acquired by the target and wanted back by the mercs' employer, or something of strategic or political importance that the employer wants for himself (perhaps to rally his forces or to demoralize the enemy's forces) or to give his forces the upper hand in raw power, courage, righteousness, etc.

## Search and Rescue Operations

This could be a military operation that carries the mercs into hostile enemy territory, or a civilian operation that takes them into hostile wilderness or the urban jungle (i.e., anti-terrorism, kidnaping, riot control, missing persons who may be victims or party to criminal and or military action, etc.).

**Disaster Relief.** Finding, freeing, treating and rescuing people from toppled buildings and debris, the wreckage of a hurricane, earthquake or other natural disaster, providing evacuation and/or medical services, as well as defending survivors and/or property or a strategic location or resource from looters, raiders, bandits, slavers, predatory monsters, and so on.

**Evacuation & Group Rescue.** Locate and escort troop personnel, injured or designated people out of a danger zone and harm's way. These could be POWs, combat troops or civilians. The setting may be wilderness, urban or combat zone. May involve transport vehicles and aircraft.

**Hostage Rescue.** A combat style raid in which the hostage is rescued and the perpetrators are neutralized.

**Jailbreak.** A targeted operation to hit a jail house, sheriff's office (with jail cells) or police station (the prisoner is in one of the holding cells). To avoid an all-out gunfight with (innocent) authorities, the mercs are likely to create a distraction or commotion while part of their team (Special Ops) sneak into the facility or outside the jail cell and break out their comrade, friend, or a designated prisoner. Level of difficulty is moderate. Explosives, heavy weapons, power armor, or magic may be required.

**Prison Break.** A prison is, in effect, a fortified compound with an outer perimeter fence or wall, observation towers, guards and defense force. Level of difficulty is high. The liberators will have to learn exactly where the target is located, deter-

mine the most effective way in, the best way out (least resistance and/or fastest exit) and how to impair or prevent pursuit.

**Prison Transportation Break.** Hitting a prisoner transport vehicle even with armed guards or heavy-duty escorts is easier than breaking into a prison, and perfect for an ambush and hit and run tactics. Level of difficulty is moderate to high depending on the level of security (magic, supernatural, power armor, robots, etc.) and how quickly reinforcements (police, military, mages, etc.) can respond once the transport is disabled. Sometimes difficulty is low, especially in backwater towns without technology or magic.

**Medical Relief.** Getting medical personnel to those who need medical assistance, protecting the medical team and the injured, and escorting the team and the injured to safe ground, base camp or a full medical facility.

**Military Rescue.** A downed airman, lost pilot or ground patrol has gone missing and may be injured, pinned down in enemy territory, or taken prisoner. It is the squad's mission to track the missing personnel, rescue and bring him (or them) home alive. Could turn into a surgical attack or a jailbreak depending on the circumstances. Wilderness and tracking skills usually a must.

**VIP Rescue.** A Very Important Person has gone missing or is known to have fallen into enemy hands. This person could be a diplomat, spy, a celebrity, a wealthy person, head of a large or influential company, a political prisoner, a military operative, undercover cop, and so forth. May require some detective or tracking work, espionage and possibly a jail break or surgical strike.

**Wilderness Search & Rescue.** An individual or group of people (child, civilians, escaped prisoner) has gone missing, last seen in a wilderness area and is presumed to be lost in the wilderness. The missing persons may be simply lost or injured, or captured by hostile forces. Wilderness and tracking skills usually a must; medical skills may be required.

## Tolkeen Merc Operations

### Working for the Coalition

In the aftermath of war, there is plenty of work for skilled mercenaries hired by the victorious.

Why would any self-respecting merc hire out to the CS? There are plenty of reasons:

1) Sometimes there isn't other work available and a merc will take undesirable jobs or garbage work to make ends meet.

2) Others either don't care and/or don't see the CS as "evil" and believe what they do is *good* or at least fair game. This attitude would certainly apply to fellow human supremacists and merc outfits who have a hate on for demons, dragons, monsters, D-Bees, Daemonix, Necromancers or other practitioners of magic, as well as scum-sucking opportunists who hope to come upon treasure, magical loot or valuables they can acquire and sell behind the Coalition's back while "officially" serving the CS. There are always carpetbaggers and vultures looking to profit or feast from every war. It can't be avoided.

3) Coalition loyalists and sympathizers would see this as both an honor and an opportunity to be recognized by the CS to help ensure they can get future work.

## Types of Coalition Missions in Tolkeen

The CS hires mercs to do some of their dirty work and to handle assignments that are deemed hazardous to CS personnel. (Why risk the life of a CS soldier when you can get a no-name merc to do it or die trying.) If captured or questioned by the enemy, the mercenaries are to deny any involvement with the Coalition Army.

**Anti-Insurgency Personnel.** Rooting out bands of insurgents, resistance cells, freedom fighters and Retribution Squads. This probably means going up against forces whose members include practitioners of magic, psychics, and inhuman creatures (dragons, demons, Witchlings, Brodkil, etc.).

**Anti-Insurgency Operations.** Tracking down and locating rebel lairs, meeting places, safe houses, supply depots, lines of communication and similar places, people and resources that keep rebel insurgency active in the region.

**Assassination.** Eliminating key rebel leaders, Tolkeen patriots and other CS designated targets without implicating the CS.

**Covert Ops.** The CS likes to hire mercenaries for missions where the CS does not want to be implicated – a mysterious disappearance, a tragic accident, assassination, theft or destruction of a rare magic item, plans, etc., and especially the capture or termination of wanted Tolkeen war criminals and fugitives in the protective custody of other nations, kingdoms, and organizations (like the Cyber-Knights, Tundra Rangers, the Black Market, and mercenary companies).

**Guarding and patrolling supply routes** and dispatching rebels and suspicious characters.

**Infiltration Operations.** The merc team is to infiltrate resistance cells posing as mercenaries for hire or Tolkeen sympathizers. The purpose of the infiltration may be to supply the CS with intelligence, to identify and locate rebel leaders, strongholds and secret base camps, or to undermine rebel operations, and/or (at some point) capture or terminate the rebel cell.

**Locating and Eliminating Enemy Strongholds.** May include infiltration, sabotage or military siege operation.

**Reconnaissance into Enemy Held Territories.** Scouting and intelligence missions in and around Tolkeen to locate rebel operations, strongholds and operatives. Combat is to be avoided, engaging in gunplay only when attacked first and only in sufficient amount to make good an escape. If captured, the merc team is to deny any involvement with the Coalition Army.

**Search and Destroy Monster Squads.** Tracking and destroying Monster Squads, dragons, and bands of demons and monsters still operating in the occupied Tolkeen region.

**Search and Destroy Practitioners of Magic.** The merc squad is charged with hunting down and terminating *all* practitioners of magic (including creatures of magic) in the vanquished territory; may pursue targets into surrounding regions at the unit's discretion.

**Surgical Strikes.** Special Ops missions to eliminate powerful leaders, rebel squads, base camps, strongholds, TW factories, magic weapons, weapon depots and other strategic targets.

**Xiticix Duty.** Patrols along the border of Xiticix territory where the merc squad observes the insectoids' activities and exterminates those who are active beyond the current Xiticix border and/or threaten CS troops or holdings. Is likely to include

border incursions and Xiticix extermination raids conducted in such a way as to not literally “stir up a hornets nest.” Likewise, the team on Xiticix duty is to make sure insurgents are not up to anything that might bring down a Xiticix swarm on CS forces.



## Tolkeen Jobs

### Working for the Tolkeen Resistance

Pushing the Coalition Army out of the Kingdom of Tolkeen and reestablishing the Tolkeen government is a pipedream. All resistance is a losing battle, however there are still vital ongoing operations sponsored by the Tolkeen government, Tolkeen Resistance Forces and outside humanitarian groups like Lazlo, the Cyber-Knights, Kingsdale and various independent kingdoms.

Then there is the not-so-humanitarian agenda of the Federation of Magic, other Coalition haters, Retribution Squads and opportunists.

### Types of Missions in Tolkeen

Here are some common assignments available at Tolkeen, among others.

**Defend Strategic Position/Holding.** Defend and protect a secret rebel base camp, supply depot, safe house, factory, escape route (tunnel, ley line, Rifts/dimensional portal, etc.), precious resource (magic item, energy source, etc.) or other holding.

**Defend Refugee Camp.** A civilian community, town or band of refugees (entirely human or mixed group) still living in Tolkeen and probably waiting for an escort to a safe territory. If entirely human, the mercs will keep a low profile and observe, attacking only when the refugees are threatened by the CS, mercs, bandits, slavers or other danger.

**Defend, Guard & Escort Strategic Figure.** A political or military figure who is currently active in the fight against the Coalition occupation force or reestablishing the Tolkeen government. May be a positive, well intentioned rebel leader or a hate-filled Retributionist or terrorist (human, D-Bee or monster) whose only goal is to hurt CS military operations in Tolkeen and kill as many Coalition soldiers as possible before they get him and his team.

**Defend, Guard & Escort Strategic Figure.** A political, military or civilian leader, inventor, scientist or mage who once served the toppled kingdom of Tolkeen and is marked for death by the CS whether the individual fought against the Coalition Army or not. The individual remains in Tolkeen territory to con-



tinue to help the refugees and perform other humanitarian services (medical treatment, guidance, etc.).

**Recovery.** May include works of art, historical documents, books of all kinds (especially pre-Rifts books and books of magic), magic weapons, magic components, magic vehicles, secret documents, military documents, plans for Techno-Wizard devices, relics, and so on.

**Rescue/Escort Refugees** out of Minnesota and into free lands where they can make their own way. Requires scouting and wilderness skills and may involve armed conflict against Coalition troops, mercenaries working for the CS, bandits, slavers and other hostile forces out to kill or prey upon the refugees. Typically a squad of 4-10 mercs will escort a band of 20-100 refugees.

**Rescue Refugees Trapped in Enemy Held Territory.** These are specifically D-Bees, dragons, other creatures of magic and practitioners of magic trapped in CS occupied territories. They are currently in hiding, but need help (a diversion, an escort, protection) to escape from the Coalition occupied and dominated town, city or bombed out ruin. The CS has standing orders to terminate all such individuals whether they fought against the CS or not.

**Rescue Tolkeen Prisoners of War.** All prisoners taken by Coalition Forces (including mercs and adventurers in their employ) are ultimately executed by the CS. This includes all D-Bees and non-humans, all practitioners of magic, and all known Tolkeen soldiers/defenders and leaders. Fewer than 25% of all humans taken in for questioning for suspicion of collusion with Tolkeen insurgents are ever released, the rest are interrogated for 1D4 days and executed as war criminals. Rescue teams must act quickly, ideally while the prisoner(s) is en route to a CS base camp or holding facility.

**Rescue: Prison Break.** Breaking one or more (dozens?) prisoners out of a Coalition holding facility. The rescue team has only 4D6+18 hours before the typical prisoner brought to such a facility is questioned, found guilty and executed; half that time if a D-Bee.

**Revenge Operations Against the CS.** Harassment, combat, sabotage and killing of Coalition Forces entirely out of revenge. Merc teams who take this assignment should share a blood-thirsty hate for the CS, otherwise they will find themselves in a compromising position.

**Revenge Operations Against Tolkeen Faction.** The merc team or their employer has it out for some person, group or organization within Tolkeen (the government, the military, a business rival, college of magic, an occupation like Necromancers, a race like Daemonix or Larmac, etc.) and is using the cover of war and CS occupation to extract his revenge against them. Revenge may involve theft, sabotage, scandal, murder or military-style conflict.

**Search and Rescue V.I.P.** Going into hostile, enemy-held territory to locate a missing person of strategic, political or humanitarian significance (the latter can be a doctor/healer, great teacher or theologian, scientist, etc.) believed to be alive and reported in the target area. The team's mission, locate, rescue and bring him to back alive.

**Theft/Looting Tolkeen's Treasures.** Outright robbery. Steal valuables (treasure, gold, gems, jewelry, works of art, artifacts, etc.) and/or magic items, weapons or secrets for resale to third

party forces before the CS gets them. May include stealing from the Coalition forces, Tolkeen freedom fighters, other mercs, innocent civilians, churches, schools, and just about anyone. Whether violence, murder or combat is involved will depend on who has the coveted item(s) and how bad the merc team or their employer wants it.

**Theft/Raiding Coalition Forces.** If working for the Tolkeen Resistance, raiding CS convoys and supply depots may have the twin result of supplying the Resistance or helping fugitives, and undermining CS operations.

If opportunists, these mercs or adventurers can raid, loot and rob the Coalition forces and have bandits or the Tolkeen Resistance fighters blamed. Stolen goods can then be sold or traded to the Resistance or third parties like other mercs and adventurers, the Black Market, the Pecos Empire, other kingdoms, or at open markets like the one in MercTown.



## A final note on mercs

Unlike soldiers in the regular military of any country, including Special Operations, mercenaries have much greater latitude. They can work outside the law or military ethics, and do whatever they must to get the job done. They are often the invisible arm, spies, defenders and agents of nations and groups who can't afford to become directly involved, making mercs *shadow warriors* working for forces (good, selfish and evil) behind the scenes.

Although soldiers for hire, money is seldom the true motivating factor and most mercenaries never get rich on the job. Many are ex-military who live for the thrill of combat, believe they are born warriors, or who believe they provide a necessary and even noble and heroic service. This sentiment is especially true in the sprawling wilderness and unstable political empires of Rifts Earth. Danger lurks everywhere, the law and even military protection is sparse to non-existent in 80% of the world, making mercenaries with good intentions and heroic souls wandering *ronin* – masterless samurai warriors – willing and able to fight for a just cause provided they get a little cash and respect for their troubles. Others are motivated by a sense of adventure or wanderlust, and still others just don't have any other trade and resign themselves to do what they know best whether they enjoy it or not. The worst of the lot are one step away from being raiders, brigands and killers who enjoy violence and feel powerful as warriors.

Hero or villain, mercs come in every size, shape, color and area of expertise, from psychics and spell casters, to mutants, monsters and ordinary soldiers.

# Merc Ops Top Ten Most Wanted

By Carmen Bellaire & Kevin Siembieda

Merc Ops and other information brokers routinely list and post bounties. The following are the current **Ten Most Wanted** bounties in North America (excluding Tolkeen fugitives wanted by the CS). The bounty may be limited to one individual or an entire group of desperados.

## Gunther Black

### Wanted Dead or Alive

#### Merc Ops Number One Most Wanted

#### Bounty Commissioned by New Lazlo

**5,000,000** Credits payable upon receipt of the fugitive.

**2,000,000** Credits payable upon receipt of the corpse.

Positive identification is a must in either case.

#### Known Statistics

**Full Name:** Gunther Black.

**Known Aliases:** Paul Murphy, Alex Wind-Runner.

**Race:** Human.

**Sex:** Male.

**Age:** 42.

**Height:** 5 feet, 8 inches (1.68 m).

**Weight:** 192 lbs (86 kg).

**Build:** Athletic, toned and muscular.

**Eye Color:** Green.

**Hair Color:** Black.

**Skin Color:** Caucasian.

**Distinguishing Features:** None.

**Threat Level:** Medium to high; presumed armed and dangerous.

**Known Capabilities:** Spell caster believed to be a mid to high-level Ley Line Walker. Possesses spell casting abilities and has a number of stolen Techno-Wizard items.

**Previous Known Accomplices:** None. May be associated with factions in the Federation of Magic.

**Last Known Location:** The outskirts of New Lazlo. The fugitive was seen fleeing New Lazlo south in the direction of the Magic Zone and the Federation of Magic. Most authorities believe that the fugitive will be heading for the *City of Brass* or *Stormspire*.

**Arrest Warrant For:** Six counts of murder, four counts of aggravated assault, one count of attempted assassination of a government official, six counts of grand theft.

**Criminal Record:** No previous arrest record in New Lazlo, but may be wanted in other jurisdictions.

**History:** On the morning of September 3, 108 P.A., a single, white male known as Gunther Black, an advisor to the Mayor of New Lazlo, teleported into the office of Mayor Damien Patrovick, and began an unchecked murder spree and attempt on



the Mayor's life. The suspect incinerated the Mayor's secretarial assistant, one Patricia Bradshaw, with some type of devastating magic fire spell. The spell may have been Elemental in nature, there are no eyewitness accounts and study of security tapes were inconclusive. Two paid bodyguards of Mayor Patrovick responded to the woman's screams and commotion in the reception lobby. Both guards were quickly slain by electrical discharge, probably another magic spell. Reception clerk, Mike Lang, rushed to the scene just in time to make a positive identification of the perpetrator and ran to get help when he saw Mr. Black smash through light (15 M.D.C.) reinforced doors into the Mayor's office.

As the suspect, Gunther Black, was ripping through the doors to Mayor Patrovick's inner office, New Lazlo Police Mages, Corporal Jack Collen and Sergeant Hurby Smith, arrived on the scene. A spell exchange between the officers and the suspect resulted in serious property damage and the death of one innocent bystander inside the Mayor's office, identified as ombudsman Mary Jenkins.

During the battle, suspect Black managed to strike Mayor Patrovick in the chest with a bolt of fire. The Mayor survived, but sustained burns on 31% of his body. Officers Collen and Smith were not so lucky. Both were slain by the suspect, torn limb from limb by a supernatural force unleashed by the murderous sorcerer. It is believed that Mayor Patrovick was the true

target of the assault and that it was the suspect's intention to assassinate the Mayor for political reasons.

When additional officers arrived on the location, the suspect teleported away, leaving no trail to follow. Several video cameras in the Mayor's office caught much of the attack and murders on video-disk. No fingerprints or DNA evidence, however, were recovered at the crime scene.

The bounty has been issued by the Mayor of New Lazlo, personally, and is held on retainer by **Merc Ops** until the apprehension of the fugitive and confirmation of receipt of the prisoner (or his corpse) by the authorities at New Lazlo.

## The Fugitive's Story

When Gunther Black is finally tracked down, his side of the story will be rather different from that of the police back in New Lazlo.

Gunther will claim that he is the victim of an elaborate frame up, insisting that Mayor Patrovick was using him, and taking advantage of his unfamiliarity with this world, as well as the laws and customs of New Lazlo, and that the battle was self-defense.

Gunther will weave his tale with a practiced indignation, apparent sincerity and flare. His story is that of a lonely traveler lost in a strange land. Shortly after his arrival, he was taken in by the Mayor of New Lazlo. The man seemed kind and caring, but Gunther would later realize that the Mayor had recognized his unique powers and ignorance and "tricked" him into using his abilities to rig the Mayor's re-election. The Mayor had Gunther eliminate his rivals by planting false evidence against them, then using blackmail and threats of reputation-destroying disclosure, or threats of violence and other nefarious means to get them to withdraw from the race. The Mayor justified these foul deeds, Gunther claims, by telling him these were all wicked men who would misuse the Mayoral office to the detriment of the people and the fine city-state of New Lazlo. Gunther claims he believed the Mayor, falling into his web of lies, ruining or threatening one good man after another. It took him many months to figure out that it was the Mayor who was "evil" (he's actually Anarchist) and that he had been tricked into doing very bad things. Recognizing his folly, Gunther went to confront the Mayor, but was threatened by members of the Mayor's staff and attacked by "corrupt police officers on his payroll." The people he killed were all *villains* out to "kill him." The battle was all "self-defense."

Gunther claims once the battle began, he knew he had to fight for his life, or be slain on the spot while Patrovick looked on grinning with satisfaction. The fight was terrible and Gunther was forced to kill many of the Mayor's evil henchmen before he was able to flee the building. To his deepest sorrow, he regrets having killed anyone, but it was a panic situation and he truly believed it was him or them. Gunther has seen cuts of the "video tape" and the crime scene from media reports, but he claims the film has been tampered with to make the Mayor look like more of a victim via computer generated images. Gunther says he can't go to the authorities because they are all in the Mayor's pocket, and he can't go to someone else because who would believe him? Besides, the Mayor of New Lazlo has a long reach.

Gunther knows that he has committed other crimes during his run from New Lazlo, but did so, he insists, only in his bid for

survival. He knows that if the "police" catch him, he will be killed for sure, either gunned down "resisting arrest" or "die mysteriously" sometime during his incarceration and transport back to New Lazlo, "maybe they'll make it look like suicide."

"Please, won't you let me go?" The desperate fugitive will plead. Adding, "If you want to stop an evildoer, you need to investigate the Mayor of New Lazlo before he hurts more people."

As for why Gunther ran away? "What else could I do?" he says. "If I stayed, I knew I was a dead man, so I fled. And look, because I know so much and he's afraid I'll tell someone the truth, he's put a bounty on my head. And . . . well, here you are. Just another set of pawns to do this scum's dirty work. Don't let him use you like he did me."

Then with a growl and a bit of a threatening tone, he says, "I know you're just pawns in this power-mad politician's schemes, and I don't want to hurt you, but I will not surrender. If you attack me, I will fight as if my life depends on it, because it does. Better to die free out here than like a beaten dog in a cage back at New Lazlo."

If the bounty hunters do let Gunther go, he will give them the 200,000+ credits and a couple of the TW weapons he stole from Armstrong Armaments. Gunther insists he just wants to put the whole incident behind him and get as far away from New Lazlo as possible, find a quiet place to settle down and build a new life.

## Game Master Notes:

### The True Story

The following is the real story behind this attack and additional background on the wanted fugitive. Only some serious investigation and/or coming across the right person will reveal any of this information to the player characters; Game Master discretion.

The above story is nothing but lies. "Gunther" will *lie* through his teeth to get away from the player characters, and do so convincingly. However, examination of the tapes will show they have not been tampered with, the Mayor was not smiling, the attack appears unprovoked, and other inconsistencies. Likewise, while the Mayor has a bit of a questionable past and is known for pulling dirty tricks and using smear campaigns, he is not an evil man nor has he ever resorted to violence. Furthermore, the police are not in his pocket.

**Gungraal (a.k.a. Gunther Black)** was a sullen and pathetic excuse for a *dragon* even before coming to Rifts Earth. The creature has always been more interested in his own pleasure and selfish needs than anything else. The Night Stalker dragon had matured on a primitive world, among a tribe of savage Lizard Men whom he forced into worshiping him as a living god. Cruel and spiteful, Gungraal abused his subjects, using most as his personal slaves and playthings. Those he disliked or who dared to speak against him were eaten alive!

The dragon grew fat and lazy living among the tribe, indulging all his dark delights, and would never have voluntarily left this private little paradise, but fate would deal Gungraal a just hand and set the Lizard people he had subjugated free.

Gungraal is a dragon who enjoys flirting with all manner of dark passions and magic. Cold-hearted and evil, the monster en-

joyed using ritual sacrifice to supplement his own magical powers (P.P.E.) and for the simple pleasure of torturing and killing his hapless sacrificial victims. During one of Gungraal's midnight incursions into the hidden secrets of magic, under the light of a full moon during an eclipse, a terrible mistake was made. Gungraal had meant this to be a triumph of his control over the forces of magic. Instead, the mystic energy spiraled out of his control, creating a Rift through time and space. An unstable dimensional anomaly that grew, swallowed the dragon whole. The dimensional forces tore the beast from his home dimension and flung him to Rifts Earth. Before Gungraal could react, the Rift closed and vanished.

Gungraal found himself in a strange world of humanoids, cut off from the realm he dominated and the reptilian slaves he once commanded. This new world was a strange and wondrous place, and the dragon could feel the magic in the air, but it lacked the comforts to which he had grown accustomed. In vain, Gungraal tried for many years to find his way back to his own place and time, but even his own natural dimension hopping abilities could not return him to his paradise. Finding no means to return home, the evil dragon resolved to create a new paradise for himself, and to build a new kingdom where he'd be worshiped, feared and adored. That agenda brought Gungraal to New Lazlo in the summer of 106 P.A. There, the dragon met Damien Patrovick, the Mayor of the city. The two quickly struck a working relationship. The Mayor agreed to provide the dragon with the splendor and servants he was accustomed to if the dragon would eliminate the Mayor's many political enemies. This was an arrangement that Gungraal could enjoy, and soon the Mayor's most ardent political rivals began to have accidents, suddenly withdrew from running or were smeared by something terrible (and untrue) leaked to the media and the public. In return, Patrovick set the dragon up in one of his most splendid apartments, and paid for a butler, cook and maid for his *human advisor*, Gunther Black. Black was the human identity of Gungraal, and served as Damien Patrovick's secret, personal "political advisor." In addition, the dragon was given a figurehead position within the city, and a very generous wage at the people's expense.

Life was fine for the Mayor and Gungraal for the first couple of years of their relationship. However, it was impossible for Gungraal to repress his dark nature and the beast began to be a problem. The dragon began to demand more money and special privileges, but then began to indulge his murderous ways. Money was one thing, but harming innocent constituents was another thing entirely. Somehow, Gungraal had imagined himself as the true power behind the figurehead of the Mayor, but Patrovick was no figurehead nor a weakling. He confronted the dragon and quickly put the monster in his place. He told the evil creature that he had done a little investigating of his own and knew the dragon had begun to indulge in his old hobbies of torture, mutilation and feasting on the tender flesh of young humanoids. When young women and men of New Lazlo began to disappear at a rate of one or two a month, it did not take the Mayor too long to figure out that Gungraal was behind it. The Mayor was unscrupulous and ruthless, but not a murderer or a madman, so he demanded the dragon stop his depravity in "his" city-state, or else.

The Mayor had intended the beast no harm, but to a dragon who had once been worshiped as a god, being treated like a sub-

servient by a mere mortal was more than the creature could bear. Over the next few days the creature's rage boiled inside of him until the dragon snapped. The Mayor was a maggot! How dare he belittle any dragon, let alone one as great as he, Gungraal the Dark!? Before Mayor Patrovick knew what was happening, Gungraal had bashed his way into his office, killing anyone who got in his way.

The creature still smolders with hate and anger, and the Mayor knows he has made an enemy for life. He also knows a dragon's revenge is often lingering and terrible, and that the people of New Lazlo could end up paying for his indiscretions. Not knowing what else to do, the Mayor put up most of his own, personal fortune to have the fiend brought in for trial and just punishment, or (and this is the Mayor's secretly hope) killed before he can do any more harm and before anyone realizes he had employed the beast to strong-arm his competition in the last election. Afraid that his political skullduggery might come out if people knew Gunther Black was a dragon, he has left that part out, instead claiming that he doesn't know why Mr. Black would want to harm him, and suggesting "the man" is a rogue Ley Line Walker of considerable power *apparently* hired to kill him for reasons unknown. "You make your fair share of enemies in politics," the Mayor is fond of saying. "There's always someone you've angered or dissatisfied who wants to get back at you."

## True Stats for Gunther Black

**Race:** An *adult* Night Stalker dragon, named Gungraal. His most common disguise is as the human male, Gunther Black. The cunning dragon can assume any guise through metamorphosis, but will not hide from humans and D-Bees, so he continues to use the Gunther Black appearance as a gesture of defiance and a display of his power.

**Alignment:** Diabolic.

**Attributes:** I.Q. 22, M.E. 24, M.A. 16, P.S. 30 (Supernatural Strength), P.P. 14, P.E. 26, P.B. 12, Spd. 50 running (33 mph/52 km) and 70 flying (75 mph/120 km).

**M.D.C.:** 3200.

**Height:** 10 feet (3 m) tall, 40 feet (12 m) long, and a 60 foot (18.3 m) wingspan, **Weight:** 2.8 tons.

**Age:** Unknown, presumably he is over 4,000 years old (he has actually lost track of his age), **Sex:** Male.

**P.P.E.:** 882, **I.S.P.:** 114.

**Experience Level:** 12th level adult dragon.

**Insanities:** Sadistic, obsessed with power and being worshiped by lesser beings, and a sociopath who cares only about himself.

**Disposition:** Gungraal is truly a creature of darkness. Among his better virtues are sloth, envy, selfishness, ruthlessness, cruelty, and a sadistic pleasure in hurting and enslaving lesser beings like humans and D-Bees. He cares only about himself and his wants, needs, and image. The dragon enjoys tricking, ruining and hurting others, which is why he initially enjoyed helping Patrovick. Inflicting suffering upon others makes Gungraal feel important and powerful, especially when they fall on their knees in fear or agony, begging him for mercy which never comes. When Patrovick treated him like an underling, it was the ultimate insult to this power-crazed beast,

and when the Mayor did not quake in fear and let the dragon dominate him, it sent Gungraal into a slow burning rage. Now, Gungraal plans on destroying New Lazlo one constituent at a time to make the Mayor suffer slowly.

The dragon has also developed a taste for human and humanoid flesh and blood, and believes the meat of his victims tastes best when the person realizes he is about to be slain and eaten, to the point that the foul beast starts to eat his victims *alive*. **Note:** The Mayor was not aware of this horrendous proclivity when he first engaged the monster's service, but came to learn of it over time. As ruthless as the Mayor can be, he is not a murderer and could not indulge Gungraal's murderous acts. While the Mayor hopes to come out of this without serious damage to his reputation, he puts the well-being of New Lazlo before his own and will do whatever it takes to save lives and stop the dragon before others die.

**Horror Factor:** 14.

**Skills of Note:** Advanced and Basic Math (98%), Cardsharp (72%), Computer Operation (75%), Computer Programming (65%), Demon & Monster Lore (98%), Detect Concealment (90%), Faerie Lore (98%), Forgery (90%), Gambling (90%), Holistic Medicine (98%), Identify Plants & Fruits (98%), Interrogation (75%), Navigation (98%), Pick Locks (95%), Pick Pockets (90%), Pilot: Hovercraft (Ground) (85%), Prowl (90%), Radio: Basic (98%), Radio: Scramblers (98%), Read & Speak American, Dragonese, Faerie and Techno-Can (98%), Seduction (60%), Streetwise (84%), Surveillance Systems (95%), Tracking (98%), W.P. Blunt, W.P. Energy Pistol, W.P. Energy Rifle, W.P. Heavy Energy Weapons, W.P. Heavy Weapons, W.P. Knife and W.P. Sword.

**Magical Knowledge:** Gungraal has a good range of mystical knowledge. He knows all Invocations levels one through eight, as well as these spells: Remove Curse (140), Create Mummy (160), Create Zombie (250), Summon Lesser Being (425), Summon Shadow Beast (140), Resurrection (650), Restoration (750), Ensorcel (400), Soultwist (170), Impenetrable Wall of Force (600), Close Rift (200+), Reality Flux (75) and Create Magic Scroll (100). Spell descriptions are found in the **Rifts® Book of Magic**.

**Psionics:** Considered a Major Psychic, and has *all* Sensitive psi-powers (see the **Rifts® RPG** or **Rifts® Game Master Guide** for descriptions).

**Natural Abilities:** Nightvision: 600 feet (183 m; can see in total darkness), poor day vision (about half of a human's and extremely bright light blinds him), see the invisible, track by smell (84%), bio-regeneration 1D4x10 M.D.C. per minute, resistance to fire and cold (does half damage, including M.D. magic fire and plasma energy), metamorphosis at will (up to 48 hours at a time), teleport self (90%), dimensional teleport (72%) and all other dimensional powers common to all *true* dragons.

**Combat Training:** Natural combat ability.

**Attacks Per Melee:** Six attacks per melee round, or four fire breath and two physical, or two by magic. Favorite weapons are heavy weapons (grenade launchers and missiles mostly), his natural breath weapon and the use of spell magic.

**Combat Bonuses:** +4 to initiative, +6 to strike, +7 to parry and dodge, +4 to pull punch, +4 to roll with impact, +7 to save vs

magic and poison, +6 to save vs psionics and insanity, +20% to save vs coma/death, and +4 on all other saving throws.

**Other Combat Info:** Restrained punch: 5D6+15 S.D.C. damage, full strength punch: 3D6 M.D., power punch: 6D6 M.D. (counts as two attacks), kick or slashing tail attack: 2D6 M.D., bite: 2D6 M.D., or by Black Flames Breath.

**Black Flames Breath (Special):** Like all adult Night Stalkers, Gungraal can breathe forth a magical black flame that stings more than it burns. **Range:** 100 feet (30.5 m), six feet wide (1.8 m) and inflicts 2D6 S.D.C. damage to mortal beings (or 4D6 M.D. if the mortal is wearing M.D.C. armor, or is an M.D.C. mortal being), or 4D6 M.D. to demons and other supernatural creatures. It can be used as often as four times per melee round and the width of the blast enables the dragon to strike several opponents (2-6) simultaneously if they are huddled closely together.

Mortal characters who fail to make a saving throw vs magic (14 or higher) have candle-size licks of black flames flickering around their head and shoulders, plus their eyes turn completely black. These victims are temporarily consumed by dark emotions and fears that *may* compel them to perform selfish, foul, vindictive and hateful things contrary to their alignment (lie, cheat, steal, abandon a friend in need, torture, kill, etc.).

Every dark thought and emotion comes flooding uncontrollably into their mind. To fight these ideas and desires is a huge emotional and mental strain. It can be done, but the victim suffers the following penalties: No initiative, and melee attacks/actions, combat bonuses and skill performance are all reduced by half unless it is to do something bad. Duration of **Enchantment:** 1D6+1 melee rounds (reduce by half if the victim's M.E. is 20 or higher). **Note:** The Black Flames only affect humans and other *mortal* beings (even mortal M.D.C. beings), including those in environmental body armor, but not those inside power armor, robots or vehicles. Supernatural beings, demons, gods, and creatures of magic are impervious to this dark magic.

**Favorite Weapons:** In his human disguise, the dragon likes to use heavy weapons, claiming that the strength necessary to use them comes from one of his many spells. Unfortunately for him, the only heavy weapon he was able to get away with was a Wellington grenade launcher rifle and eight grenades, but he has recently stolen a half dozen Techno-Wizard weapons from Armstrong TW Armaments Co.

**Body Armor:** He does not wear armor in dragon form, but wears light body armor (30-50 M.D.C.) as a disguise when he is playing the role of Gunther Black, along with all the usual trappings of a Ley Line Walker.

**Personal Vehicle:** None, Gungraal typically walks, flies or teleports wherever he needs to go.

**Other Equipment:** Only what he has managed to gather while on the run from the authorities, including 235,000 in Universal Credits, 45,000 credits in jewelry and raw gems, and the six Techno-Wizard items stolen from Armstrong TW Armaments Co. (G.M.'s discretion as to their worth and exactly what they are), plus a few personal items that Gungraal could not bear to part with when he fled from New Lazlo.



# Hook, Line & Sinker Adventures

## Sighting in Blackberry

**Hook:** Gunther Black was spotted in a small rural town known as Blackberry, near the old Ohio/Kentucky border. Blackberry is a modest town of about 300 humans and D-Bees dedicated to agriculture and woodworking. Gunther blew through town about two days ago and was recognized from some wanted posters handed out in town a while back. The townsfolk are scared that a dangerous and wanted killer could be hiding nearby. Many of the town's residents ask the player characters if they are mercenaries/bounty hunters tracking down Gunther. If any of the characters answer yes, the town's mayor will be called to speak with them. If they answer no, the townspeople will still invite strangers, especially those who look like they might be adventurers or practitioners of magic, to hunt the fugitive down and collect the reward – they'll show the heroes the wanted posters. If the group said yes or seem likely candidates to take the job, the mayor will speak to them and offer the player group a free place to stay in the town and a hot meal, along with the recharging of any E-Clips (on the town's old generator) if they will make sure that Gunther does not return to Blackberry. The mayor feels that the presence of some armed mercenaries will deter the fugitive's return. Everyone in town is sincerely afraid of falling victim to this rogue sorcerer.

**Line:** While scouting the local area and asking the townsfolk what they saw of Gunther, a middle-aged woman approaches the group. She explains that her two small children went missing yesterday. One of the neighbors is certain she saw them talking to the man in the wanted poster! A few other townspeople think they saw the man in the same general area the day before, watching the children play. The local men have been unable to find their trail, even using hounds, and the desperate woman begs them to find and save her children. It is an impassioned plea that no character of a good alignment will be able to turn down, and even Unprincipled and Aberrant characters will be touched by her words. She also offers them her prize cow, six chickens and a hot meal – it is all she can afford to pay. The fact that this maniac has the children makes finding him all the more time sensitive. The fiend is not likely to keep them alive for more than 72 hours. Mr. Black may have kidnaped them to be slaves, or to torture and kill, or to be eaten alive. Or he might be planning to sacrifice them in a magic ritual.

**Sinker:** Should the group accept the job of looking for the children or working as man-hunters trying to capture (or kill) Gunther Black, they stumble across a small wooden shack deep in the surrounding forest. The sounds of weeping and crying can be heard coming from inside the building, along with the growling of something "unnatural." When the players investigate, they will discover the two children locked in a steel cage. Standing guard over them, outside the cage, are a pair of *Serpent Hounds* (see **Rifts® World Book 18: Mystic Russia**, page 40. The G.M. may add a hound or may substitute Serpent Hounds with some other appropriate monster or lesser demon, but whatever it is, they should be deadly). The guardian monsters attack the first intruder they see and will fight to the death, eating anyone who falls prey to them.

The monsters and the children have been left behind as a ploy to throw any do-gooders following Gunther off his trail, or

at least slow them down (at this point, he should already have a one or two day head start and could be anywhere). The monsters have been told they can kill and eat anyone who tries to rescue the children, wait four days and then eat the kids! Truth is, the beasts have had to use great restraint to keep from eating the youngsters already, and welcome the chance to kill and eat any heroes or fools who come their way. If our heroes defeat the monsters and free the children (and they should), the oldest child will remember something the "bad man" said – a valuable clue (or outright location) that will enable them to continue their pursuit.

**Alternate Sinker:** In the alternative, this could be a fun subplot and side adventure that turns out to have been a *false lead*. In this scenario, our heroes track the kids down, only to discover that Gunther Black is not the kidnapper, but some *other villain* or group is responsible. Slavers, Psi-Goblins, cultists, etc., might have snatched the children. The situation is no less dire, but it has nothing to do with Gunther Black; keep looking. Then again, the kidnappers *may* have a clue or some information about Black's whereabouts or plans (saw him at such and such, heard about a guy who . . . and so on). However, they may try to barter the information for their freedom or leniency.

## Following the Trail

**Hook:** On the fugitive's trail south from Blackberry, the man-hunters encounter a large group of destroyed S.D.C. trucks, cars and buses (an Operator O.C.C. will find enough working parts to rebuild one of the trucks, if given enough time; at least 1D4+1 hours). Littered, here and there, around the destroyed vehicles are the scattered remains of 10 to 14 humans and a few D-Bees. It is impossible to know for sure how many victims there were as it appears a few were dismembered and possibly eaten. **Note:** Searching the gory remains will uncover 3D6x100 in Universal Credits. As the characters poke around the ruined vehicles, one of them spots a discarded sheet of paper. It looks as if it had been used to wipe the blood from someone's hands. Closer inspection reveals that the paper bears the governmental seal of New Lazlo from the Mayor's office. A wanted poster for Gunther Black is also nearby, stuck to a bit of shrubbery.

**Line:** While the blood soaked paper is unreadable, if a psychic *Object Reads* the paper, it will reveal that the paper's owner is an evil, angry, medium level Ley Line Walker. The psychic will also get an image of three or four old-style SAMAS, repainted in mercenary colors, blasting away at a group of civilians in trucks. A black haired man stands in the middle of the carnage, several people already dead at his feet. It is this man who is wiping blood from his hands with the paper. The psychic reading ends with the man's and the SAMAS going down the southern trail, but just before the vision stops, the psychic sees the man's face. It is definitely *Gunther Black*. Our heroes stand at that very trail. Gunther Black and the SAMAS can't have more than a six hour lead on them. (In the alternative, any type of Wilderness Scout/Woodsman should be able to tell that those responsible went down the southern trail.)

**Sinker:** Traveling south, down the trail, the player group runs across the four repainted SAMAS just as the brigands are preparing to take flight. However, the man is not with them, there is only the four 3rd level power armor pilots clad in rebuilt, old style SAMAS (each suit only has 2D6x10+50 M.D.C.

remaining, but all weapon systems are functioning fine). These weasels make a living raiding and robbing, killing is just a fun perk for them. They hooked up with Gunther a few days ago and have been working together ever since – they like his style. Somehow Gunther knew bounty hunters were on his tail, so he gave each of the raiders a couple thousand credits in gems, and told them to hang back, ambush any pursuers and that he'd pay 10,000 credits for every head they brought back to him. Thus, they attack as soon as they see the player group. The above information is provided by any of the power armor pilots who survive the battle. Likewise, in exchange for his freedom, one of them can show our heroes Gunther's secret hideout just north of Stormspire, in the Federation of Magic.

**Alternative Sinker:** The four SAMAS clad raiders don't know Gunther at all, but they are also on his trail, hoping to collect the bounty on his head. They notice the player group, figure they are after Gunther too, and attack the player characters to eliminate the competition.

## A Dragon by the Tail

**Hook:** The group's most recent lead has brought them to the hideout of Gunther Black. To their surprise, it is nothing more than a large cave in the side of one of the many mountains in the area. Approaching the cave entrance reveals that it is guarded by four *Serpent Hounds* (or lesser demons or other type of monster suitable for the task like a couple of Brodkil or Black Faeries or Witchlings). The vicious guards are patrolling the mouth of the cave and attack at the sight of fresh meat. If the player group manages to defeat the guards quickly, they can enter the cave without further trouble.

**Line:** Searching the cave reveals no furniture, just a large pile of pillows to one side of the cave, surrounded by books, files and other papers, many of which bear the seal of New Lazlo. Several of the papers and files detail the illegal activities of Mayor Patrovick and the part Gunther played in them. The papers reveal that the good Mayor ran a dirty campaign, although one has to wonder how much he actually knew about Gunther/Gungraal's tactics. It's not so much that the Mayor of New Lazlo told Gunther what to do, but rather that he focused on results, no questions asked. How his henchman accomplished that end was better left alone, giving the Mayor a convenient out. Closer inspection of the books may (01-50% chance) uncover the personal diary of Gunther, a.k.a. Gungraal the Night Stalker dragon. The diary talks about his history, situation and the fact that he is trapped on Rifts Earth; somehow his natural ability to dimensional teleport ceased functioning on his violent trip to Earth. The diary talks about how the dragon has given up his struggle to find a way back to his own dimension, dreams of building an empire on Rifts Earth, and his bloody plans for revenge upon Mayor Patrovick and the people of New Lazlo. There are also gory accounts of his killings and other despicable acts, almost as if he is proud of his despicable acts.

**Sinker:** Shortly after the player invades the hideout and finds bits of evidence (and possibly the diary), Gunther returns home. Even if the group has hidden the bodies of the slain guards, the dragon will smell their spilled blood and the scent of humans. Seeing that the bounty hunters have trailed him to his sanctum, he tries to speak to the party from the mouth of the cave. Hoping they haven't yet figured out he's a dragon, Gunther tells his *fu-*

*gitive's story of lies* and pleads for the characters to leave him in peace. If he believes the heroes have honestly fallen for his yarn, Gunther *may* even suggest that they go back to New Lazlo together, wipe out the Mayor's henchmen (i.e., the Mage Police), publicly execute the Mayor, and liberate the city-state from that administration's tyranny. Of course, Gunther plans to take the seat of government for himself, kill anyone who gets in his way (read: the player group) and begin to build his new kingdom. However, Gungraal/Gunther is no fool, and if he senses the slightest bit of trickery and insincerity, the dragon will know the heroes are just leading him on, and he'll play along only long enough to lure them into the open where he can destroy them. Likewise, if one or more of the player characters challenge the facts or suggest he's lying, the dragon is quick to anger and will launch his own attack. Gunther/Gungraal will also attack if he sees that his diary is in their possession or missing. If he is attacked first, Gunther will assume his true dragon form, and the Night Stalker will attack them without remorse. Gungraal will not be locked in a jail cell and will fight to the death to avoid such an ignoble fate. If defeated, all the valuables that the dragon had are hidden here in the cave, under the pillows in a small depression dug in the ground.

# Carl Dansinger

## Wanted Dead or Alive

### Merc Ops Number Two Most Wanted

### Bounty Commissioned by Free Quebec

7,000,000 Credits payable upon receipt of the fugitive.

4,000,000 Credits payable upon receipt of the corpse.

### Known Statistics

**Full Name:** Carl Edward Dansinger, formerly held the rank of Corporal.

**Known Aliases:** No known aliases.

**Race:** Human.

**Sex:** Male.

**Age:** 33.

**Height:** 6 feet (1.83 m).

**Weight:** 202 lbs (91 kg).

**Build:** Muscular and well built.

**Eye Color:** Brown.

**Hair Color:** Grey.

**Skin Color:** Well-tanned Caucasian; possibly of mixed racial heritage.

**Distinguishing Features:** Large scar across the eye and left side of the face, three M.O.M. style implants protruding from the top of his head and a tattoo on his right shoulder of a Coalition Death's Head emblem with three bullet holes in the forehead.

**Known Capabilities:** Believed to be a Burster or a Zapper or a mutant hybrid of both. He is a Master level psychic with a variety of physical psionic powers, including Electrokinesis, Pyrokinesis and Telekinesis. The full range of his abilities is unknown, and they make the fugitive armed and dangerous even when he is without any obvious weapon.



**Accomplices:** Although he often works alone, he sometimes leads bands of pirates and bandits to raid military targets and commercial cargo vehicles. He is disenfranchised from his former *Free Quebec* military unit.

**Last Known Location:** Old Bones in the Trade Center District of town, just outside the Riverside Hydroelectric Power Plant.

**Arrest Warrant For:** Military arrest warrant for one count of striking a superior officer and thirteen counts of murder.

**Criminal Record:** None, but he is suspected of terrorism and as many as 36 different murders in the nation of Free Quebec alone.

**History:** Most Recent Incident: At 5:35 PM, March 8, 109 P.A., the suspect entered door J2, level one of the mega-city of Free Quebec. The subject was stopped and inspected by customs, where the individual passed the customary examinations and questioning.

A single soldier returning from the Chi-Town front recognized the suspect, and screamed out to Customs Officials that the person in question was a murderer and deserter. At that time, the subject released his psionic masking, allowing our psi-sensors to detect him, and launched into an attack. The suspect released a bolt of electricity that killed the soldier who identified him and then turned his attention on Customs Officers, killing them and nine civilians with bolts of fire and electricity before fleeing through the same door he had entered. The entire melee lasted 96 seconds and was captured by surveillance cameras.

Outside of the mega-city, he stole a Free Quebec armed forces Cougar Hover Jeep and some weapons.

The suspect was later positively identified as the deserter Corporal Carl Edward Dansinger, by le Surete du Quebec (civil secret intelligence). The Civil Secret Service also has released information that Dansinger has stolen a case of 12 heavy fusion blocks and that he is severely mentally unstable and may be plotting a terrorist strike on Free Quebec or the surrounding communities. Dansinger is believed to be a *Psychic Zapper* with a range of *Burster* pyrokinetic abilities, making him extremely dangerous even when he appears to be unarmed. Deadly force has been authorized in the apprehension of this disturbed felon.

**Corroborating Data:** Additional military reports released to civilian authorities indicate that Carl Dansinger was a volunteer in a Mind Over Matter (M.O.M.) implantation experiment by a rogue cell within the military designed to create a superman. Corp. Dansinger seemed to be a success in the illegal experiment, but subsequently exhibited increasing paranoid delusions and violent behavior. It is believed that his delusions now control his mind and emotions, and that the once decorated soldier now believes Free Quebec, the Coalition States and most authority figures to be his enemy and the enemy of the people. Tragically, Dansinger's acts of murder and attempts to unleash mass destruction are his misguided attempts to save lives and liberate Free Quebec from an invading force. He harbors the delusion that the Quebec government surrendered to Emperor Prosek, and that the Coalition Army has seized control of Free Quebec and rules over the nation with an iron fist. Anyone in a uniform is perceived to be an evil Coalition Soldier.

## G.M.'s Notes: The True Story

The following is the real background on this character. Only some serious investigation and/or coming across the right people will reveal any of this information. Game Masters, use your discretion.

**Carl Dansinger** was an upstanding soldier twice decorated for heroics in the field of combat and scheduled for a promotion. He was part of an elite Special Ops unit where he was noticed by the unit's superiors. They had a secret program that needed volunteers like Dansinger, and true to form, when approached, he accepted. The program was radical, a revolutionary way to instill superhuman abilities into ordinary soldiers. The process involved using brain implants similar to those used in M.O.M. conversions to create *Crazies*. The main difference was that the implants were not supposed to unleash psychic abilities (the people of Free Quebec don't trust psychics), but bring out other superhuman abilities such as energy expulsion. When told about a program designed to create super-soldiers to fight in Free Quebec's struggle for true independence, the Corporal volunteered without hesitation. This occurred just a few months after Free Quebec split from the Coalition States and Coalition forces were gathering on the borders of Quebec.

What Dansinger didn't know was that his unit was controlled by a rogue cell within the Quebec military. A covert group of super-patriots who skirted the line when it came to the government's long-standing position on *psychic abilities* – for what else could these brain implants be doing, but finding a way to tap into the *psychic potential* of the subject? The ability to channel electrical energy like a *Zapper* and/or pyrokinesis like a *Burster* was the goal of the program, and both were psychics. This rogue outfit, however, had convinced itself that if their ef-

forts were a success, their superiors would thank them and endorse further human augmentation. After all, technically this was NOT psionic augmentation, because the test subject was not a psychic, but an *artificial* means of inducing abilities to control electricity and fire without being psychic. At least that was the rationale.

Dansinger underwent brain surgery and was given with three brain amplifying implants that the rogue scientists were certain could tap into the part of the mind that could influence and control energy fields outside the body. The surgery went well and Dansinger came out of it in good spirits. At first he exhibited no special powers. His only peculiarity, a fear and distrust of the doctors and nurses that were helping him recover from the surgery. By his third week of recovery, however, Corp. Dansinger was manifesting a number of abilities. For one, he was almost completely healed. For another, he could control fire and expel bolts of electrical energy from his hands. Moreover, the soldier wanted to get back to the field of combat where he could test his newfound powers and help defend his beloved country from the Coalition forces.

Unknown to his doctors and handlers, Dansinger was also beginning to hear *voices* and a constant *machine noise* in his head. When the Corporal finally confessed about the constant machine noise and “confusion” (not voices), the rogue team leaders decided to ignore the problem as a minor complication of the implants. They had the doctors give him some medication to help quiet the noise in his head and enable him to concentrate better, and other medication to help him sleep. Then they posted him back with his old Special Ops unit with an observer attached to watch his progress. Things seemed to go well for the first few months. Dansinger showed a wide range of abilities involving electricity and fire, and phenomenal control over both. He possessed nearly the full range of *Zapper* and *Burster* abilities, and if that was not enough, Dansinger seemed to exhibit an intuitive understanding of how best to use them.

Despite this wonderful news, his handler reported increasingly erratic behavior by Dansinger, and suggested removing the Corporal from active service for a psychological evaluation under controlled conditions. Chief among the handler’s concerns was that he suspected Dansinger was developing other *psychic abilities*, which was bad, that he was lying about them, and worse, that he was regularly taking wild risks that put himself and the rest of his unit in severe danger. However, the leaders of this rogue unit decided to keep Dansinger in the field and sent him and his squad on several dangerous covert operations against the Coalition invasion force where a superman would come in handy. Corporal Dansinger performed beyond expectations, so they ignored the fact that the Corporal’s displays of Pyrokinetics and Electrokinetic powers injured and scarred several members of his own squad. In short, the rogue leaders only heard what they wanted to hear, and they didn’t want to hear that a) their hard work was a failure or b) they may have ruined the life of a soldier who was a genuine hero.

By the time the unit’s leaders recognized that Dansinger had become a liability, it was too late. The Corporal was living in his own fantasy world and trusting only *the voices* in his head. Voices that told him the Military High Command was out to get him and his squad, and that the government leaders of Free Quebec planned to sell out the people of Quebec, surrender, and let the Coalition Army place the nation under its military control.

When High Command arrested Dansinger’s Spec Ops leaders for engaging in illegal psychic experimentation and sent a squad to *remove* him from duty, it proved what the voices were saying was true. That the CS had gotten to his commanders and the government leaders. A true patriot, Dansinger decided to defy his orders to stand down and continued to fight the CS occupation force *and* the traitors who sold out their own people. The collection team – members of his own squad – sent for Dansinger were the first to feel his righteous wrath. They tried to reason with him, but the voices said, “Look, son of Free Quebec, look how deep the treachery reaches. Even your brothers turn against you and their heritage. You are alone now. Only you can liberate the motherland. Only you can defy the Coalition, destroy the traitors and inspire the people to rise up and demand their independence.”

Dansinger didn’t want to believe the voices. He screamed and pleaded with his teammates to stop fighting him. To stand at his side and to defy the leaders who betrayed them all. To fight the Coalition tyrants with their last dying breath so that the people of Quebec could live free. He didn’t stop his pleas until his teammates laid at his feet dead or defeated.

Ironically, Free Quebec’s independence came one month after Dansinger’s break with reality. The Coalition Army pulled its troops out of the country long ago, and Emperor Prosek has signed a treaty acknowledging Free Quebec’s sovereignty.

For Corporal Dansinger, however, the war continues. Every person he sees in a uniform is either a Coalition Soldier or traitor in the Quebec Army. A diehard patriot, Dansinger strikes out at Quebec’s defensive fortifications, military patrols, ammunition depots, Quebec Glitter Boys, communication towers, soldiers, police officers and other authority figures in an ongoing campaign to “harass the enemy,” for he does *not* see his own people, but occupying Coalition Soldiers. He’s also come to trust the voices completely, for they never lie, and kills only when they tell him to (which is with increasing frequency), or when he fears for his life or capture by the enemy. Dansinger also surfaces to make impassioned pleas to the people of the Quebec ‘Burbs and outlying communities beyond the fortress city of Quebec. When someone chastises him, tries to reason with him or calls him crazy, Dansinger sees only Coalition spies or traitors. When the authorities arrive on the scene, or anyone tries to apprehend him (i.e., the player characters, mercs, bounty hunters and well intentioned heroes), the mentally ill super-soldier sees Coalition troops coming to *kill him!* The voices concur and encourage him to fight back, unleashing fire and lightning with deadly force and ruthless savagery.

Lately, Dansinger’s assaults have become even more diverse, with him attacking commercial trucks, ships and vehicles he believes are enemy convoys of tanks, giant robots or supply trains. And now he has issued a threat to the Quebec government: Throw out the Coalition invasion force and compel the people to fight for their freedom, or be destroyed. There is evidence (the fusion blocks for one) that he plans to destroy the heads of parliament in acts of terrorism to wake up the citizens of Quebec and incite them to rise up against the (imaginary) CS tyrants and traitorous leaders who subvert their freedom and happiness.

Perhaps unnecessary to say, Dansinger is terrorizing and killing the very people of Free Quebec he believes he is fighting to liberate. He has already destroyed private and public property to

the tune of millions of credits, has set hundreds of fires, injured thousands, and killed several dozen civilians (his rap sheet does NOT include the two scores of military people he has killed or the hundreds of soldiers he has injured attempting to bring him in). Many more will suffer from Dansinger's increasingly violent and expanding military operations against the imaginary enemy. In his tortured mind, bringing down the government is a logical strategy, and anyone who stands in his way will be fried.

The Quebec military and police have their own plans and operations in mind to stop this lunatic – one way or the other – but so far, he has managed to elude all such attempts. Dansinger is using hit and run guerilla tactics against Free Quebec and its military, while holing up outside the city proper. In recent months, he has enlisted rogue mercenaries, pirates, raiders and other criminals and madmen in his schemes. All of them go along with the insane warrior because he leads them on raids to rob and loot Free Quebec's military depots, bases, convoys and Navy ships, and now commercial cargo haulers. Loot which the bandits divide up and sell on the Black Market and to other brigands. Of course, Corporal Dansinger thinks they are all  *courageous freedom fighters* whom he has come to trust. This has led the government of Free Quebec to post a bounty on Dansinger's head in the hopes that one of these greedy brigands will kill him for the money, or some other merc outfit will intervene and bring him to justice. So far, that hasn't happened. The problem is that the leaders of the bandits, pirates, and raiders are protecting him. They are realizing higher profits than they have ever seen, thanks to this lunatic and his "military raids." He's their "golden goose," and they aren't going to let anything happen to him if they can prevent it. Consequently, they hate it when Dansinger sneaks off on one of his imaginary  *solo missions*.

Dansinger's recent attempt at using his psionic powers to mask his true identity is only his first attempt to slip into the mega-city undetected, with Fusion Blocks in hand. His plan, to blow up parliament! This time he was recognized, but what about next time? And although he was discovered and was forced to flee, ten more innocent people died in Dansinger's attempt. Unless he is stopped, disaster awaits.

## The Fugitive's Story

Dansinger is a true, blue patriot fighting for his people, plain and simple. He is completely lost in his delusions and permanently insane. At this stage, removing the brain implants will have no positive effect on his mental state.

If Dansinger is ever captured he will do everything in his power to escape. If he can't escape, he'll fight to the death, taking as many of the enemy as he can with him. However, the one thing Dansinger is not, is suicidal. The madman is brilliant, well trained in Special Ops, and extremely resourceful. He will play possum or seem to cooperate while he secretly waits for the right opportunity to escape or wreak mayhem upon the enemy.

A career soldier and special operative of Quebec's elite Commando Division, he has been trained to resist torture, drugs and other forms of coercion, and will be reluctant to tell his side of events even under the most gruesome torture or most pleasant and hospitable conditions. Any sort of incarceration, even a hospital, will be seen as an interrogation camp, and  *everyone* working there an enemy.

Dansinger is not proud of the things he has been forced to do by circumstance, but as any good soldier knows, war is hell and one must do what needs to be done. Dansinger may seem evil, but in his mind he is a hero fighting for a noble cause. A cause for which he is willing to die. He doesn't realize the war is over or that he has killed innocent civilians. Even if it can be proven to him, there is always collateral damage in war; innocent people die, it's the high price of war and can't be avoided.

Dansinger's only purpose is to force the Coalition Army to vacate Free Quebec and recognize its independence as a sovereign nation. Nothing can convince him that this has  *already* transpired and he is fighting a phantom war. Any "evidence" that is produced will be deemed by him as fakes and forgeries to confuse and trick him. The voices will reinforce that notion. As for his old Special Ops unit and other commandos, he sees them  *all* as traitors and relishes the idea of revenge against his old teammates and superiors.

Dansinger will never acknowledge that he is insane or that the voices in his head are pushing him further into insanity. He will insist that any suggestion of insanity is a conspiracy to frame him and discredit his patriotic actions in the eyes of the public.

It is believed by most experts that removing the brain implants will eliminate Dansinger's super abilities and leave him a vegetable. A tiny handful fear that removing the implants at this point will have no effect, except to make him angrier and set off a berserker rage, or allow him to feign incapacitation long enough to make good an escape. An escape that can only lead to a new campaign of murder and terror, thus, they advocate the only way to be safe is to kill the poor soul.

The real tragedy in all this is that Corporal Dansinger is a good man and a loyal soldier. It's not his fault he's doing these terrible things, he was a pawn in a bigger game that went wrong, and he is truly delusional. If there is any alternative to removing the implants and rendering him catatonic, or killing him, it is a solution that will have to be found and implemented by an outside source (i.e., the player characters). However, it certainly appears that the only viable solution is to put Dansinger down like a mad dog.

## True Stats for Carl Dansinger

**Race:** Human.

**Alignment:** Scrupulous, but his delusions have him acting more like Diabolic or Aberrant evil.

**Attributes:** I.Q. 13, M.E. 28, M.A. 14, P.S. 15, P.P. 17, P.E. 25, P.B. 14, Spd. 20.

**Hit Points:** 56. **S.D.C.:** 43.

**Height:** 6 feet (1.8 m). **Weight:** 202 lbs (91 kg) of muscle.

**Age:** 33, **Sex:** Male.

**P.P.E.:** 4.

**I.S.P.:** 287.

**Experience Level:** Equal to a 9th level Commando and 5th level Zapper and Burster.

**Insanities:** Dansinger is a classic paranoid schizophrenic who hears imaginary machine noise and voices in his head. He is also afraid of flying, extremely aggressive, ruthless, and obsessed with his delusions – namely driving Coalition occupa-



tion forces from his homeland, making traitors pay for their treachery and seeing Free Quebec become a free, independent nation. He has no remorse or hesitation at killing the enemy (i.e., those he believes are Coalition soldiers, traitors, spies, assassins or anyone out to get him), and shows no mercy in dealing with them. He reacts with mindless aggression and a homicidal fight response when cornered. He also has a phobia about doctors and anyone in the medical profession (including Psychic Healers; part of his extreme paranoia), and a god complex in which he believes only he can get the people of Quebec to rise up and throw off the CS shackles of subjugation, and that the voices are angels guiding him. Otherwise, his day to day routine is an unrelenting motivation to harass, kill and repel the enemy.

**Disposition:** Carl Dansinger was once a nice guy, but has been driven insane as a result of the brain implants that gave him his incredible psionic abilities. He is so completely lost in his delusions that nothing can shake his beliefs, making him all the more dangerous.

**Horror Factor:** 10 to soldiers, 15 to the public/civilians.

**Skills of Note:** Basic Math (90%), Basic Electronics (98%), Basic Mechanics (70%), Body Building, Boxing, Demolitions (89%), Literate in American and French (75%), Climbing (85/75%), Navigation (85%), Pilot: Hovercraft (Ground) (98%), Prowl (65%), Read Sensory Equipment (80%), Radio: Basic (98%), Running, Speak American and French (95%), Streetwise (56%), Trap Construction (59%), Wilderness Survival (70%), Wrestling, W.P. Energy Pistol, W.P. Energy Rifle and W.P. Knife.

**Magical Knowledge:** None.

**Psionics:** All the standard abilities of the *Zapper* at 5th level and all O.C.C. abilities and psionic powers of the *Burster* also at 5th level, plus the following: Alter Aura (2), Bio-Regenerate (self; 6), Brain Scan (10), Deadened Senses (4), Impervious to Electricity (no I.S.P.; half damage from all energy attacks), Sense Electricity (2), Electrical Aura & Radiate Electricity (5; electrified body protection: 38 M.D.C.), Electrical Absorption (4), Electrokinetic (varies; double normal range), Mask I.S.P. & Psionics (7), Mind Block (4), Nightvision (4), Presence Sense (4), See Aura (6), See the Invisible (4), Speed Reading (2), Summon Inner Strength (4), Telekinesis (super; 10+), Telekinetic Force Field (30, 225 M.D.C.), Telekinetic Acceleration Attack (10/20), Telekinetic Leap (8), Telekinetic Lift (6), Telekinetic Punch (6), Telekinetic Push (4), and Telepathy (4).

**Most Notable Fire Powers:** Impervious to Fire and Heat (no I.S.P. cost), Extinguish Fires (4 I.S.P.; 95 feet/29 m), Fire Bolt (2 I.S.P. and does 7D6 S.D.C. damage, or 4 I.S.P. to inflict 3D6 M.D.; 190 feet/58 m), Fire Eruption (10/20; damage varies +1D6; 140 feet/42 m) and Pyrokinesis (varies; does 1D6 additional M.D.), plus all the other *Burster* psionic abilities. Dansinger just grows more and more powerful with every passing week, although most experts believe he has “peaked” and will not develop any additional powers from this point on.

**Psi-Implants:** Psionic Actuator implant, Psionic Booster implant, and Psionic Eruptor implant.

**Combat Training:** Hand to Hand: Expert.

**Attacks Per Melee:** Seven.

**Combat Bonuses:** +2 to initiative, +4 to strike, +6 to parry and dodge, +2 to disarm, +6 to pull punch, +5 to roll with punch, fall or impact, +4 to save vs Horror Factor, +7 to save vs psionics and insanity (Master psychic; needs a 10 to save vs psionics), +20% to save vs coma/death, +5 to save vs magic, poisons, toxins, and disease.

**Other Combat Info:** Kick does 1D6 S.D.C. damage, Critical Strike on an unmodified roll of 18, 19 or 20, W.P. Paired Weapons, and Judo-style body throw/flip; does 1D6 S.D.C. damage, and the victim loses initiative and one melee attack/action.

**Favorite Weapons:** Although Dansinger tends to rely on his psionic abilities, he still uses a few military weapons; carries 14 Micro-fusion grenades, 6 standard E-Clips and 4 long E-Clips. Dansinger tends to pick up new grenades or E-Clips off the bodies of his victims as he needs them.

**Q1-02 “Stopper” Ion Pistol:** Mega-Damage: 4D6+4 M.D. per single blast. The pistol cannot fire bursts. Rate of Fire: Semi-automatic, each shot counts as one melee action. Range: 200 feet (61 m). Payload: 12 shots per standard E-Clip or 24 per long E-Clip.

**CP-50 Dragonfire:** Mega-Damage: 2D6 M.D. per single blast or 6D6 M.D. per triple-blast. Micro-fusion grenades, fired from the underbarrel grenade launcher, do 6D6 M.D. to a 12 foot (3.6 m) diameter blast area. Rate of Fire: Laser fires single shots or triple-bursts. Grenade launcher fires single shots or bursts of four rounds. Range: 2000 feet (610 m). Payload: 30 laser blasts per long E-Clip and 12 grenades in the grenade launcher.

**Body Armor:** Free Quebec QEBA-10 body armor, currently has 63 M.D.C. remaining.

**Personal Vehicle:** A stolen Cougar Hover Jeep from Free Quebec; the vehicle still has 220 M.D.C., but all of its weapons have been stripped. It was in for repairs and refit when Dansinger stole the vehicle.

**Other Equipment:** The madman has stolen no less than 12 heavy fusion blocks (4D6x10 M.D.C. each)! He intends on using them to blow up the parliamentary offices in Free Quebec and other government buildings and personnel. Personal items are limited, most are basic military gear.

**Money:** Spends money he acquires on explosives, equipment and efforts that support his delusional quest. Currently has 200,000 credits on various credit sticks stolen from his victims.

## Hook, Line & Sinker Adventures

### No Bones About It

**Hook:** The player group is sitting around in a pub in Old Bones, looking through the Merc Ops list of new bounties. Many of them appear to be out of the characters’ league, or are just small fries not worth their time. At that moment, as fate would have it, one of the characters recognizes a man entering the bar. It is none other than Carl Dansinger, the second most wanted fugitive on the Merc Ops bounty list. A big score! Dansinger moves quickly through the crowd and out the back door of the pub.

**Line:** If the characters rush out the back door they see the fugitive setting up a pair of heavy fusion blocks outside of the bar. The bar is packed with off-duty Free Quebec soldiers having a good time, but to the delusional Dansinger, they are Coalition soldiers and CS sympathizers laughing about how they push around the people of Free Quebec. The blast will certainly kill 1D4x10+12 soldiers and injure 2D6x10 other patrons when the fusion blocks explode. After setting the bombs, Dansinger jumps into his Cougar Hover Jeep and flees the scene.

The characters have time to stop the simple timer, or they can chase after the madman, not both, unless they split up.

Those who chase after him will be led out of town, until they eventually lose sight of him in a small market bazaar just outside of town.

Disarming the bombs or grabbing them and running them out someplace where there are no or few people, will save dozens of lives and earn the heroes the gratitude of the locals (particularly the bar owner and the soldiers inside). This could help the group with problems in the future and/or getting clues and information to help them track down Dansinger.

**Sinker:** Dansinger's jeep is found hidden under an old tent at the old bazaar, but he is nowhere to be seen. When the group fans out to look for him, they come up empty-handed. Unfortunately for them, Dansinger has paid a gang, giving them 10,000 credits, to "get rid of anybody who follows him." (The eight gang members are 4th to 6th level City Rats and Cyber-Snatchers, armed with laser pistols that do 2D4 M.D., Vibro-Blades that do 1D6 M.D., and wearing body armor with 30-45 M.D.C.) He also gave them two hand grenades (4D6 M.D.) just in case. The boys in the gang are quite happy to get rid of the player characters, steal their valuables and chop 'em up for cybernetic parts. They are also satisfied with simply running them off. The gang is large enough where they will try to surround the interlopers and jump them. Police don't come to this part of town, so the player characters could find themselves in a protracted battle. There is also a 01-50% chance that the battle will be joined by 1D6+1 additional thugs or Cyber-Snatchers if it lasts for more than two or three minutes.

## Your Bomb or Mine

**Hook:** Dansinger flees south after the player characters encountered him in Old Bones. The lunatic has connections with the Pirates of Montreal as well as other pirates and brigands up and down the St. Lawrence and active in the Great Lakes. Not to mention other brigands and mercs he believes to be freedom fighters, so he could be headed almost anywhere. Surprisingly, his trail has been relatively easy to follow, as he has been blowing up Free Quebec and real Coalition base camps, outposts and patrols all the way to Iron Heart! While following the trail, somewhere in the old Canadian province of Ontario, near the town of New Hope, the player group catches a glimpse of the fugitive. When they see him, he is in the midst of planting another fusion block, outside of another bar, this time with some off-duty CS troops partying it up inside. No one else seems to see Dansinger at work and his bomb looks nearly complete.

**Line:** While our heroes may have had time to stop his last attack, this time Dansinger has set a fusion block for a very short delay – just 10 seconds – and he is already running for his hover

jeep when the characters catch up to him. If they stop to try and prevent the bomb from going off, they are likely to be caught in its blast radius (full damage to those within five feet/1.5 meters, with the rest taking half damage, 2D4x10 M.D.!). As the counter is too far along to stop, without some kind of magical or psychic powers, their best bet is probably to dive for cover. If the group goes after Dansinger instead of the bomb, he leaps into his idling hover jeep and speeds through town. If they give pursuit, he will throw armed hand grenades (he has 24 at this point) out of the jeep to stop them. He is only concerned with getting away, not fighting, but still, innocent people are likely to get hurt.

**Sinker:** At some point in the chase our heroes will find a nasty surprise. Dansinger realized some time ago that the player group was better at tracking him than he was at running away, so he booby trapped his Cougar Hover Jeep with one of his stolen fusion blocks. Once he is out of sight of his trackers, he parks and gets out of his vehicle, waiting nearby with a radio controlled detonator. Once a few of the characters begin to snoop around his jeep, Dansinger will blow it to high heaven, doing a combined damage of 4D6x10 M.D. to a blast radius of 20 feet (6.1 m)! He hopes to kill or damage them enough to get them off his tail. **Note:** He realizes they are bounty hunters, but has never liked warriors willing to hunt down other men for money rather than a noble cause. To him, they are just hired guns working for his enemies.

## One Final Blast

**Hook:** A new lead has taken our heroes (who hopefully survived the previous explosive encounter with Dansinger) to a wooded area. The fugitive's trail is easy for any type of tracker to follow through the northern Ontario countryside. While Dansinger's trail is easy to follow, our heroes will have to follow him on foot due to the nature of tracking and the thick natural terrain. Faster methods of travel make it impossible to follow the trail.

**Line:** Following the fugitive's trail is not as easy as it first appears. Dansinger has set six different explosive traps (2D4x10 M.D. each) along the trail to blow up anyone stupid enough to follow him. The explosions will also alert him that he's being pursued and help indicate the location of his pursuers. (G.M.s, have some fun with the traps as listed in the **Rifts® Game Master's Guide**, page 63-64, don't make it too easy for the characters to find and avoid them all). Dansinger has grown tired of this constant pursuit and figures the only way he can rid himself of them is to maim or kill all of them. Watch your step!

**Sinker:** Dansinger knows the bounty hunters are coming long before they can get to the little hunting shack (400 S.D.C.) where he is hiding. Tipped off by the noise of explosions and his Psychic Sensitive powers, Dansinger will be ready for a final confrontation. He's tired of running, and if his enemy gets this far, he plans to stand his ground and fight. Inside are all his weapons set out for easy access, like in some Old West movie. Dansinger will shield himself with his psi-powers and blast away at the characters until he runs out of grenades and ammunition. Then he will light up his Zapper, Burster and other offensive psychic powers to lay waste to them once and for all. The super-soldier is tired of being hounded, angry, and ready for a showdown, so he will not pull any punches. Unless the player

characters are able to disable and/or restrain Dansinger, he will fight to the death rather than be captured. His psionic powers will make it highly unlikely that the characters will be able to catch him by surprise, and their best chance for success is teamwork, coordinated attack and a bit of luck. Actually, setting their own trap and laying in wait in ambush is better yet. Although a well placed sniper's shot is not a hero's preferred way, it may be the group's best course of action. Magic and psionics may also help even the odds in a standup battle. This war story is not likely to have a happy ending. **Note:** If the group should turn back in retreat, Dansinger will *not* pursue them, satisfied with running them off for what he assumes will be the last time. If they should cross paths after this, he will kill every last one of them without hesitation.

## Frederic Hollingsworth

### Wanted *Alive* Only

#### Merc Ops Number Three Most Wanted

#### Bounty Commissioned by Stormspire

6,000,000 Credits payable upon receipt of the fugitive.

There is **no** bounty payable upon receipt of a corpse. The fugitive must be delivered *alive*.

#### Known Statistics

**Full Name:** Frederic Allen Hollingsworth.

**Known Aliases:** Dragon Freddy.

**Race:** Human.

**Sex:** Male.

**Age:** 23, but 3rd month as a Juicer.

**Height:** 6 feet, 2 inches (1.88 m).

**Weight:** 200 lbs (90 kg), all muscle.

**Build:** Typical Juicer's overly muscular build.

**Eye Color:** Blue.

**Hair Color:** Blonde.

**Skin Color:** Caucasian with very pale skin.

**Distinguishing Features:** Both forearms are covered in large tattoos; a tattoo of a knight in full armor on his left forearm and a tattoo of a beautiful dancing girl on his right forearm.

**Known Capabilities:** Dragon Freddy is a fully enhanced *Dragon Juicer*, he is presumed armed and dangerous. (See **Rifts® World Book 10: Juicer Uprising** for complete details on different types of Juicers.)

**Previous Accomplices:** It is believed that Frederic has ties to Lord Dunscon and the Federation of Magic.

**Last Known Location:** Headed for Dweomer, exact location unknown.

**Arrest Warrant For:** Multiple counts of kidnaping, rape and murder, the actual number (30+) of counts is still unknown.

**Criminal Record:** None. Hollingsworth was a fine, upstanding member of Stormspire until he underwent the Juicer process.

**History:** Jane May was found murdered on the morning of August 6, 109 P.A., she had been sexually assaulted, slain and her body horribly mutilated. She was the first of an estimated thirty

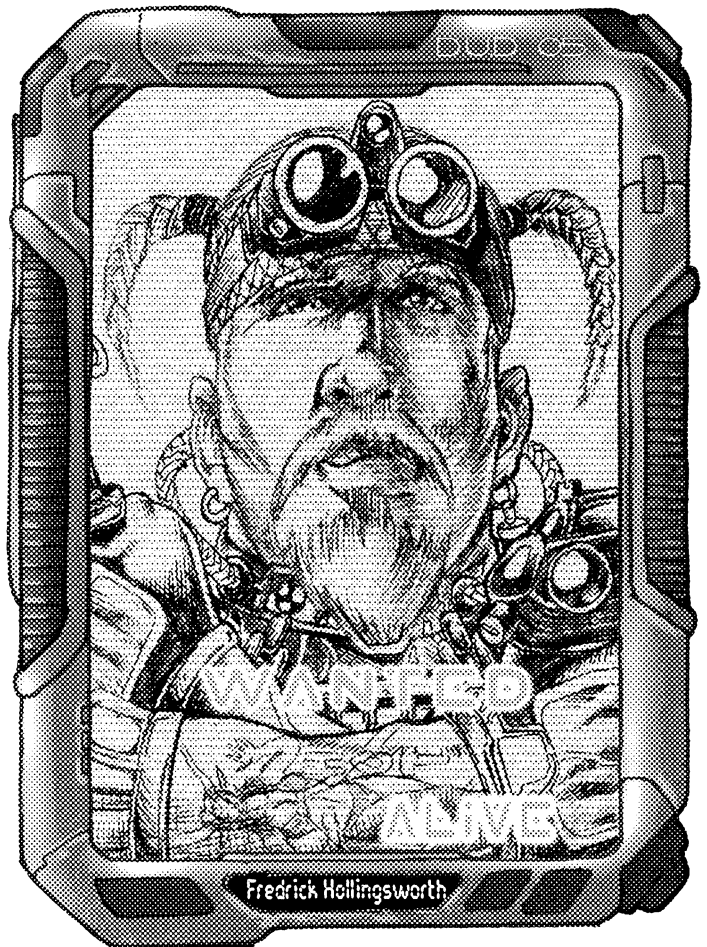

such victims found in just under one month. Psychic and magical examinations of the bodies and crime scenes point to Frederic Allen Hollingsworth as the most probable suspect. Suspect Hollingsworth was the recent recipient of *Dragon Juicer augmentation*, and according to the technicians, he was unstable and may have turned psychotic after being *juiced*.

It is believed that the suspect is unable to contain his urges to kill, has become a serial killer, and is likely to leave a trail of bodies wherever he goes. Hollingsworth is important to Stormspire for political reasons, so the bounty is for a *live capture* only. It is possible that he has already fled the city of Stormspire and is headed to another location in the Magic Zone, with Dweomer or the City of Brass being the most likely destination. However, Lazlo, New Lazlo or similar magic communities may also be a destination, as might MercTown or Kingsdale, both common destinations for Juicers. His capture is of paramount importance because this disturbed young man cannot stop killing. Unless he is apprehended, many more innocent young women will perish.

### The Fugitive's Story

According to all the experts, including the technicians who performed the *Dragon Juicer* augmentation, the experience has driven Frederic Hollingsworth insane. Most subjects suffer some form of mental illness as a result, but seldom this extreme. Dragon Freddy, however, insists he is **NOT** criminally insane.

Anyone who finally captures this fellow will quickly realize that Freddy truly believes he *is* a dragon. Freddy denies being

crazy and is indignant that mere “mortals” were able to capture him, a dragon. However, instead of trying to fight his abductors any further, he seems resigned to his fate and lets them take him wherever it is they plan to go – Stormspire or wherever. On the way, Frederic will accurately recount how he was recruited by Lord Dunscon to become a Dragon Juicer and what an honor and privilege it was to be chosen by such a great leader. It’s after the treatment that his tale falls into the realm of fantasy.

According to Freddy, he really is a *dragon*. He doesn’t know how, but his enemies have worked some dark magic upon him to wipe away his memory and make him forget his true self. The Great Lord Dunscon must have known this and that’s why he had him undergo the Dragon Juicer process . . . because Dunscon must have known it would awaken his true dragon self. Unfortunately, laments Freddy, the process was only a partial success, and though he now remembers being dragon, he is still locked in human form and has very few memories of his life as a dragon. Freddy suspects his dragon self is exerting itself, however, and may take control of him and do dragon things, which is why he experiences blackouts and doesn’t remember anything while the dragon is in control. If he has actually killed any women, and Freddy denies it, he can only assume it was the dragon inside of him. At least that’s what Freddy claims. Supposedly, he can’t remember what he has done during these blacked out periods. If he thinks those listening to his tale are sympathetic, he adds that he was afraid he might have had something to do with the murders, and that is why he fled Stormspire – in the hope that if he got away from the source of the Juicer conversion that the blackouts might stop and then, maybe, nobody else would have to die.

If the player characters insist that he be taken back to Stormspire (for the bounty, trial or psychotherapy) Freddy begs them to let him go. He says fears he can’t control his dragon-self and that if he’s around lesser beings (i.e., humans and D-Bees) the dragon will emerge and kill again. He *seems* very sincere and passionate about this. If he can’t convince his captors to let him go, he suggests it would be best if they took him to the *City of Brass* where Lord Dunscon or one of his esteemed advisors should know how to contain the dragon inside of him. In truth, Freddy hopes they will be able to unleash him from his mortal form so that he may become a dragon again. Freddy wants to be a dragon more than anything, and once that happens, he’ll make those who have hounded and hurt him pay for their callous insolence! Until then, or until he finds a genuine chance to escape, he pretends to be contrite and docile.

It is beneath him (a dragon) to subject himself to the will of others, especially mere humans, so if his captors do not buy the innocent playacting, Freddy denies that he had anything to do with the murders and insists that such things are not worth a real dragon’s time. Dragon Freddy doesn’t care about the bounty, who wants him or why, he just wants to be free and find a way to resume his real dragon form. He will not allow himself to be *caged* and will fight like, um, a dragon if threatened with being put behind bars of any kind.

## Game Master Notes – The True Story

The following is the real background on this character. Only some serious investigation or happening across the right people will reveal any of this information. Game Master discretion.

**Frederic Hollingsworth.** With the fall of Tolkeen and Lord Dunscon calling for a War of Retribution against the Coalition States, Stormspire is being forced to provide Juicer augmentation to the Federation of Magic at cost, including the dangerous and unstable process for creating *Dragon Juicers*. The candidates being chosen by Lord Dunscon are often emotionally and/or mentally unstable, homicidal maniacs and bloodthirsty thugs who should never receive Juicer augmentation. K’zaa, Lord of Stormspire, has no choice in the matter, unless he wants to defy Lord Dunscon, so he ends up “juicing” people like Frederic Hollingsworth. Ironically, Frederic appeared to be one of the better candidates. He was a nice kid from the City of Brass and an admirer of Lord Dunscon. He was chosen for his loyalty to Lord Dunscon and his disdain for the Coalition States. Lord Dunscon has been hand-picking zealots to serve in his new, elite corps of Dragon Juicer Commandoes. Frederic was an obvious choice and sent to K’zaa along with the appropriate amount of dragon’s blood. The doctors and technicians at Stormspire performed the enhancement, and the procedure went off without any problems.

Shortly after his augmentation, Frederic awoke from his anesthesia calling himself *Dragon Freddy*. Within a matter of minutes, the doctors realized Frederic saw himself not as a Dragon Juicer, but as an actual *dragon*. This meant Dragon Freddy saw all other humans and D-Bees as inferior beings to serve his every whim and to be used and abused as he chose. At first the abuse was verbal, but quickly escalated to physical violence, beating those who were unfortunate enough to get in his way or invoke his ire. Regrettably, these were only the first signs of his growing instability and vile change of nature.

Two weeks later, the hospital discovered a murdered nurse laying next to Hollingsworth’s empty bed. The first kidnaping occurred the very next day, 17 year old Jessica Adams. Her body was found in an alley three days later. Like all the women who would follow, she was found beaten, abused and savagely murdered. Her corpse, beyond recognition, was identified through psychic means. Nice ol’ Frederic had been transformed into a homicidal maniac with the brute strength and endurance of a demigod. A brutal, sadistic, serial killer without any sort of emotional restraint, Dragon Freddie has a compulsion to kill, and he enjoys all acts of violence. Even in a world as violent as Rifts Earth, the murders of Dragon Freddy are extreme, frightening and excessively violent.

When Lord Dunscon tried to have his new pet Juicer returned to the City of Brass, Freddy just slipped away from Dunscon’s men and continued on with his killing spree. Even with the help of Stormspire’s guards, they have not been able to rein in Hollingsworth, leaving four dead men in the wake of their attempt. The whole affair is very embarrassing to Lord Dunscon and the fact that the town guards cannot catch the maniac is an even greater embarrassment. The posting of the bounty has sent everyone scrambling to get Dragon Freddy, but the demented young man has turned it all into a game of cat and mouse, and he’s the predator.

Lord K’zaa’s sees the sad fate of Freddy Hollingsworth and his victims as an opportunity. If his agents can capture the Juicer, K’zaa can turn “Dragon Freddy” into the poster child to expose Lord Dunscon’s at-any-cost hatred of the Coalition States and that the cost of Dunscon’s War of Retribution against

the CS is too great. He hopes to show that Lord Dunscon doesn't really care about the citizens of Stormspire, and that Stormspire needs to break its allegiance with the Federation and align itself with Dweomer against Dunscon's mad dreams before he brings ruination to them all. The advantage of Lord K'zaa getting the young man is that he'll actually try to get Freddy help, not just execute him or throw him on the front-line to kill as many of the enemy as he can before he dies in the name of glory for the Federation of Magic.

Meanwhile Lord Dunscon wants Hollingsworth to hide the truth and prevent Lord K'zaa or other enemies from using this "unfortunate incident" against him (and resolve the problem by sending Hollingsworth to his doom on a suicide mission). He needs to keep Stormspire a member of the Federation of Magic and to keep the people of Stormspire rallied for war. All of this has turned Frederic into a political hot potato with numerous factions looking to capture him for their own agenda.

The bounty has sent Dragon Freddy into hiding and on the run, but it has not stopped him from killing, though it has slowed the body count to about one every three days. The Juicer plans on fleeing to Dweomer or maybe New Lazlo, at least for the time being. He's recently heard about the Pecos Empire and likes the idea of joining one of the Pecos gangs, because it would give him the opportunity to raid and kill Coalition troops. No plans are etched in stone and Dragon Freddy will probably end up wherever the wind happens to blow. How many women will die along the way will depend on how fast somebody (and who) captures the lad.

## True Stats for Hollingsworth

**Race:** Human.

**Alignment:** Diabolic.

**Attributes:** I.Q. 9, M.E. 8, M.A. 12, P.S. 32 (Supernatural Strength), P.P. 24, P.E. 25, P.B. 8, Spd. 65.

**M.D.C.:** 245.

**Weight:** 200 lbs (90 kg), **Height:** 6 feet, one inch (1.85 m).

**Age:** 23, but 1st year as a Juicer, **Sex:** Male.

**P.P.E.:** 62, **I.S.P.:** None.

**Experience Level:** 1st level Dragon Juicer.

**Insanities:** Frederic believes he is a real dragon, and as such, he has the right to prey upon those lesser beings around him.

**Disposition:** Although Frederic was once friendly and outgoing, but a bit unstable, now he is a brutal, sadistic murderer. Dragon Freddy, as he is known, lost his humanity when he underwent the Juicer process. Shortly after his conversion, Hollingsworth's personality changed and he became a cruel, cold-hearted killer who enjoys inflicting pain and suffering.

**Horror Factor:** Dragon Freddy is a serial killer notorious throughout the Magic Zone. This reputation has earned him a Horror Factor of 12, 15 for women.

**Skills of Note:** Athletics (Aerobics & General), Basic Math (70%), Boxing, Demon & Monster Lore (35%), Find Contraband (30%), General Maintenance & Repair (35%), Land Navigation (36%), Pilot: Hovercycle (68%), Prowl (30%), Radio: Basic (50%), Read American (50%), Speak American and Dragonese (50%), Streetwise (32%), Wilderness Survival (35%), Wrestling, W.P. Energy Pistol, W.P. Energy Rifle, W.P. Heavy Energy Weapons.

**Magical Knowledge:** None.

**Psionics:** None.

**Natural Abilities:** Supernatural Strength and Endurance, leap 20 feet (6.1 m) by 40 feet (12.2 m) with a short run; automatic parry or dodge on all attacks, Nightvision 100 feet (30.5 m), see the invisible, hawk-like vision, keen sense of smell, impervious to disease, normal heat and cold, and bioregenerates 4D6 M.D.C. every minute.

**Combat Training:** Hand to Hand: Assassin.

**Attacks Per Melee:** Six.

**Combat Bonuses:** +4 to initiative, +5 to strike, +6 to parry and dodge, +23 to damage, +1 to disarm, +4 to pull punch, +6 to roll with punch, fall or impact, +5 to save vs Horror Factor, +2 to save vs psionics, +4 to save vs mind control, +40% to save vs coma/death, +5 to save vs magic, +10 to save vs poisons, toxins, gases and other drugs.

**Other Combat Info:** Knockout or pin/incapacitate on an unmodified roll of 18, 19 or 20, W.P. Paired Weapons, and can inflict Mega-Damage with his bare hands: Punch: 4D6 M.D., Power Punch 1D4x10 M.D. (counts as 2 attacks), or Kick 5D6 M.D.

**Favorite Weapons:** Dragon Freddy uses a pair of NG Ion pistols most of the time: Mega-Damage: 3D6 M.D. per shot. Rate of Fire: Single shots only. Range: 500 feet (152 m). Payload: 10 shots per standard E-Clip or 20 shots from a long E-Clip. Freddy generally carries six standard E-Clips and four long E-Clips.

A pair of large Vibro-Swords: Mega-Damage: 2D6 M.D. each and may be used as Paired Weapons and in simultaneous attacks (4D6 M.D., but Freddy cannot dodge or parry immediately after delivering a simultaneous attack).

TW Fire Dagger: Mega-Damage: 2D6 M.D. (double damage to beings vulnerable to flame) plus the fiery dagger returns when thrown. P.P.E. Cost to Activate: 6 P.P.E. (or 12 I.S.P.) to activate the dagger for 20 minutes.

**Body Armor:** Owns a suit of dragon skin armor (140 M.D.C.) and a light suit of NG Range Rider armor (30 M.D.C.).

**Personal Vehicle:** A.T.V. Speedster Hover Cycle: 220 mph (352 km), 75 M.D.C. with a single laser (1D6 M.D., 1200 feet/366 m, unlimited payload) and mini-missile launchers; each launcher fires two mini-missiles (armed with plasma 1D6x10 M.D.C.).

**Other Equipment:** Techno-Wizard bio-comp, bio-data and bio-feedback implants, drug harness and dragon blood supply, an IRMSS kit, utility belt, backpack, passive nightsight binoculars, sunglasses, two canteens, pair of handcuffs, 30 feet (9.1 m) of rope, and some personal items.

**Money:** 27,000 credits in cash.

## Hook, Line & Sinker Adventures

### Freddy the Ripper

**Hook:** In one of the many one horse towns on the way to Dweomer, the bodies of three prostitutes are found gruesomely butchered. All were rather young and attractive. The attacks only started about a week ago and the local authorities have no idea who the culprit may be. The townspeople, however, are



abuzz with talk about the killings and fingers point at every stranger in town. The authorities do not have psychics or even a mage who could assist in finding the killer, so when the player group comes to town, the local lawmen ask if they wouldn't mind lending them a hand. The player characters are approached for two reasons, 1) they look like hero (or capable mercenary) types and 2) they weren't in town when the murders happened, so they can be ruled out as suspects. Although the lawmen cannot pay much for their services, they can offer to recharge any E-Clips, give our heroes room and board, a hot supper, and their eternal gratitude.

**Line:** The locals suspect every stranger, but the local authorities have three suspects, a gang of five bawdy roughnecks who like smacking women around (2 third level Headhunters, 2 Wilderness Scouts and a Second level Necromancer; all Anarchist), a pair of oddballs named Merk and Smirk (a 4th level Bounty Hunter and a 6th level Professional Thief; both Miscreant) and a quiet, brooding loner whom they think is named Freddy. The last guy usually keeps to himself, but there was one incident where he got drunk and became boisterous and violent, starting a fight in the local pub, taking on and besting six visiting mercs, and then trying to pick up the barmaid who rebuffed his advances. The bruiser named Freddy didn't like being rejected by the barmaid, smashed a table in a temper tantrum and made the comment, "I've had a hundred witches like you, and left better ones laying dead in alleys." However, except for this scary outburst, the young Juicer has kept to himself and (seems to have) stayed out of trouble. Personally, the locals suspect the gang of five. The lawmen offer the information for the player group's consideration, nothing more, and lets the characters make their own decisions on who to investigate and in what order. All three groups of suspects have been in town for about a week or so. As for the townsfolk, they suspect everyone and even talk about the possibility of a demon or monster walking the streets. Indeed, Freddy the Juicer, whom the local authorities have on their suspect list, has claimed that he knows a dragon walks among them, disguised as a man. Hearing this claim, the gang of five threw a party, buying everyone drinks in the bar that night, stripped themselves half-naked and crawled around on all fours pretending to be dragons and harassing the female patrons and barmaids until the barkeeper finally pulled out his trusty ol' particle beam rifle (he's a retired, 6th level merc himself), and insisted the party was over and it was time for the boys to call it a night. The Necromancer in the group (the only one not drunk or acting like a dragon) growled that the barkeep would be sorry for this insult. The next morning, the third victim was found dead behind the bar. Written in blood on the wall, the words, "Dragon be here."

**Sinker:** If the group was already on Freddy's trail, they know he is the killer and have no trouble locating where he's staying. They will have plenty of time to plot and set a trap or ambush.

If the player group doesn't know about the bounty and haven't heard about the serial killer in Stormspire, then they might investigate one or both of the other suspects first. The gang does indeed sound suspicious, especially considering their threat to the barkeeper the night of the third murder. If the investigation takes more than a day and a half, a fourth woman will be slain. Or the heroes, if patrolling the streets at night, hear a scream of

terror and arrive just in time to see the Dragon Juicer holding a woman with one hand and big knife in the other. She's still alive, but won't be in the next 30 seconds unless somebody intervenes.

Sooner or later, the evidence should point to Freddy the Juicer and a fight will ensue. The Juicer will fight until he is physically subdued or killed. Or, consider the following alternative.

## Catching the Killer

**Hook:** The basic setup is the same as the previous Hook, Line and Sinker, in which our heroes are approached by the town leaders or local authorities and agree to lend a helping hand.

**Sinker:** The townspeople seem uncooperative and nervous around our heroes, giving them the eye, pointing and whispering among themselves. When they are approached, the townspeople scurry away like rats, or refuse to talk. Eventually, word on the street gets back to the player group that the reason the townspeople are acting so odd is that they suspect *them* as the killers and are afraid to trust them. Apparently, someone (Freddy) has started a rumor that the group has been camped out in the woods for the last week and could have easily slipped into town to rob and kill. Further investigation of this rumor eventually points to Freddy the Juicer as its author.

**Line:** The Juicer isn't at his apartment and can't be located. Finally, one of the townspeople (perhaps the bartender who likes the group) says he saw him go out back with Sally about a half hour ago. Checking out that location, our heroes find poor Sally dead in a pool of her own blood. Before they can react they hear a voice shout, "There, see! I told you they were the killers!" Freddy and the gang of five (and/or the two other suspects) have just stepped out from around the corner. They look both angry and happy to have cornered the killers responsible for the recent carnage.

Freddy takes a step back, smiles and urges them to attack, saying, "What other proof do you need? Get 'em before they make a run for it." The gang is convinced and charges. They are reckless yahoos who have a nasty habit of shooting first and asking questions later. If our heroes look like they are on the verge of escaping or defeating the gang of five, Freddy will join the battle, otherwise he stays out of it. If he joins the fight, it is for fun as much as to kill the heroes and frame them for his crimes. If the local lawmen intervene or the group prevails in the battle, the Juicer will slip away, grab his gear and head out of town toward the Pecos Empire, but first stop, *MercTown*.

## Can it be true?

**Hook:** After a ferocious confrontation, Dragon Freddy drops to his knees, raises his hands and surrenders.

**Line:** While in the custody of our heroes, Freddy exhibits a variety of abilities common to dragons and above and beyond the normal capabilities of a Dragon Juicer. These include bio-regeneration at a rate of 1D4x10 per melee round (completely healed in a matter of minutes, not a scratch on him), he can breathe fire (1D6 M.D.) when angry, a See Aura or Sense Magic shows Freddy is magical (as in creature of magic) although it

doesn't look or feel right for a dragon, he understands Dragonese/Elven at 98%, and other little things.

**Hook:** At some point Freddy tries to escape or is provoked or attacked by a third party. He flies into a rage, snaps any restraints and suddenly transforms into a Great Horned dragon! He is thrilled by this transformation into his true self and feels vindicated. All the natural abilities of the dragon are known to him, he can breathe fire (2D6 M.D. per attack) and he can cast a dozen first and second level magic spells plus Escape, Invisibility: Simple, Fireblast and Firebolt.

If any member of the player group apologizes, Freddy feels vindicated and, if they do NOT attack or threaten him, the dragon does not harm them. In fact, he thanks them for helping him find himself, but does so in a condescending tone. Then he mutters something about needing to figure out who did this to him, and that his memories are still incomplete, with many large holes, but first he's going to get revenge on those who mocked him, hounded him, or threatened him in any way, including lawmen who desired to bring him to justice. With that, he flaps his wings, rises into the air, tells the player characters he hopes never to cross their paths again, adds that he likes to kill women and nobody's going to stop him, and flies away. Whoever or whatever he is, Freddy is Diabolic evil through and through. He is a natural born killer, despicable and vindictive. Fortunately, he is only a 5th level Hatchling without the full range of his mystic knowledge.

The player group is faced with a decision. Move on and hope they never cross Freddy's path again, or hunt him down a second time and put an end to his evil once and for all. Dragons are known to carry grudges to ridiculous levels, and Freddy is just the type of cretin to go back and destroy every person, establishment and lawman that ever stood up to him, starting with the town that asked our heroes for help. Furthermore, it's clear that he intends to keep on killing women. If the characters choose the latter, at least they know what they're dealing with.

## Dr. Daniel Simmons

### Wanted Dead or Alive

#### Merc Ops Number Four Most Wanted

#### Bounty Commissioned by George Edward Wallis of Kingsdale

3,500,000 Credits payable upon receipt of the fugitive.

5,000,000 Credits payable upon receipt of the corpse; conditional (read on).

#### Known Statistics

**Full Name:** Dr. Daniel Simmons.

**Known Aliases:** None.

**Race:** Human.

**Sex:** Male.

**Age:** 42.

**Height:** 5 feet, 6 inches (1.68 m).

**Weight:** 189 lbs (85 kg).

**Build:** Short, stocky, brick of a man.

**Eye Color:** Brown.

**Hair Color:** Greying, brown, curly hair.

**Skin Color:** African American; medium complexion.

**Distinguishing Features:** His left eye is cybernetic, a large, surgical macro-eye.

**Known Capabilities:** Doctor Simmons is a skilled surgeon, with some psychic healing abilities.

**Previous Accomplices:** None. Simmons hires his nurses and medical assistants as needed.

**Last Known Location:** Kingsmen Medical Center in Kingsdale, where he was last seen packing for a getaway before he could be captured. Authorities believe that he was headed northwest for either New Lazlo or Chi-Town.

**Arrest Warrant For:** Four counts of criminal surgical malpractice and organ trafficking, and suspicion of illegal black market Body-Chop-Shop operations. Private bounty.

**Criminal Record:** Doctor Simmons has been previously arrested twice for illegal organ trafficking, although he has since been pardoned of those and related charges.

**History:** George Edward Wallis was suffering from acute chest pain when he checked himself into the Kingsmen Medical Center in Kingsdale. He had been suffering pain for several days and was afraid that he was having a heart attack. Once admitted to the Medical Center, George was told that he needed a quadruple bypass immediately. They rushed him into a surgical suite. He woke up two days later still suffering with chest pain, but also stomach pain and shortness of breath. Upon being discharged, Mr. Wallis thanked the good doctor and proceeded straight to another clinic for a second opinion.



The second clinic performed a complete medical exam, including blood work, physical exam, MRI scan and gastroscopie and concluded Mr. Wallis was suffering from acute gastric reflux disease, not a heart attack. More amazing was that one of Mr. Wallis's kidneys, one lung, a long length of intestine and half his liver were missing. Shocked, he went to the local authorities to report the crime and get Doctor Simmons arrested. The local police took the report, but no action was taken on the case. Mr. Wallis would have sued, but Kingsdale's civil courts are notoriously slow and corrupt. With no other recourse, Mr. Wallis decided to launch a public campaign to warn others of Dr. Simmons' criminal activities.

Doctor Simmons had his share of civil officials and law enforcement in his pocket, but Mr. Wallis' campaign was proving to be extremely effective, had attracted local media, and three other "victims" had stepped forward. The Doctor knew his time in Kingsdale was finished when several of his paid officials refused to return his calls. Fearing that his nefarious medical practices were about to be completely uncovered, Dr. Simmons took basic medical equipment, a number of bio-systems and cybernetics, and two or three million credits from the clinic (although it is believed he was cooking the books and may have skimmed off several times that amount), and fled to parts unknown. There is reason to believe that the suspect has relocated to *MercTown* or the *Chi-Town 'Burbs*.

Mr. George Wallis, on behalf of himself and several other victims, has turned to Merc Ops to find satisfaction. He'd like Dr. Simmons captured and brought back to Kingsdale where the doctor will be charged for criminal misconduct. If possible, Mr. Wallis would like his missing organs returned or replaced with life-like bio-systems by Dr. Simmons under the scrutiny of trustworthy representatives with a medical background (this could be the player characters, or at least those of them with medical knowledge) at no cost, and 12 million credits in restitution from the good Doctor to be divided nine ways to the other, unspecified claimants. Mr. Wallis is a (10th level) Techno-Wizard with means, and Merc Ops, serving as the broker of this job, is holding the full sum of the bounty in escrow, waiting to be collected.

If the acquisition team for this bounty determines that Doctor Simmons can *NOT* make the aforementioned restitution, the client is willing to pay an uncharacteristic higher bounty for proof of Doctor Simmons' untimely demise. A corpse and medical confirmation of the deceased's identity is a must to collect payment.

## The Fugitive's Story

Dr. Simmons is no fighter, although he will fight when cornered. If pressed to tell his side of the story, he will admit to what he did to Mr. Wallis, but insists he is not a bad man. He simply made a mistake, a huge medical error. He got *Mr. Wallis* confused with *Mr. Walls*, another patient, who was making a multiple organ donation. The similarity between the two names was the cause of the whole situation, leading to the disastrous mistake. Regrettably, he . . . um, the clinic, made a few other *mistakes* and when it all went public, well, he panicked and fled instead of facing the music like he should have. He took only what belonged to him, a little money in his bank account, and hopes to get a clean start at a more reputable clinic or hospital

where these kinds of disturbing mistakes can't happen. Really, the staff should have caught it. A brilliant surgeon like himself shouldn't have to deal with clerical matters, after all, but he'll take responsibility. Simmons would fix the situation if he could, but now it has all spiraled out of control, making him the victim of a witch-hunt. In fact, the doctor explains, the irony of it all is that the organs were used in free transplants for those who cannot afford bio-systems/cybernetic/bionic implants. He'd be glad to tell them who those three people were, but he lost the records when he was attacked by bandits a few weeks ago. The ruffians took half of everything he owned, including some valuable cybernetic components, medical equipment and a briefcase with the medical records – they must have thought it contained drugs or other valuables. "My just deserts," he says with his head hung low, "for my cowardice back at Kingsdale, but it's taught me a lesson. The thieves got away with half my money too, but here . . ." To make restitution he offers any Bounty Hunters who find him 1.2 million to give to Mr. Wallis . . . or . . . to keep for their troubles. He wishes it were more, but that leaves him with only a few thousand to rebuild his life. Won't they please have mercy on him and take the money? It won't happen again, he promises. Please?

Simmons pleads with the characters not to condemn him to death for an "honest mistake" that really wasn't even his fault (someone else's clerical mistake, remember). He vows to make amends if they let him, by starting a free clinic in his spare time to help the poor and needy. He also vows that this type of horrible mistake will never happen again! Not on his watch! If pressed for more cash he grudgingly ups the ante to two million credits, but insists that's all he has other than 20,000 credits for himself, and if he must, he can cough that up too, leaving him penniless but free. He will also offer his services as a *doctor*, for any character who may need medical treatment.

If the bounty hunters take the money, Doctor Simmons goes on his way to set up shop, using an alias, someplace new. If questioned about the purpose of the multiple organ transplants, Simmons claims that the organ donations are voluntary and most of the donations come from those who have been saved at the clinic at some time in the past. The doctor ensures them that the entire system is above board and it is the only hope for many of the people that came to his old clinic. He only was striving to help the poor and now he will be condemned to die for it.

The coward will offer just about anything to avoid being taken in. Doctor Simmons is sure that the authorities at Kingsdale must have been bought off by now and that they will execute him if he returns there. He's sure of it. The fact that the bounty on his head is higher for a corpse would seem to confirm his fears, and characters of a good alignment might take that into consideration.

## Game Master Notes – The True Story

The following is the real background on this fugitive. Only some serious investigation and/or coming across the right people (through research or purely by accident) will provide any of this information; Game Master discretion.

**Dr. Daniel Simmons** is, indeed, a brilliant and talented surgeon. He comes from a wealthy family from an Old Town 'Burb outside of Chi-Town and his skills almost won him citizenship in the fortress city of Chi-Town itself. At least until the authori-

ties discovered he put himself through school working in illegal Black Market Body-Chop-Shops. In fact, the good doctor has a long history of working for the Black Market and unethical practices. Chi-Town screens out criminals and undesirables, so Daniel Simmons was kicked off the coveted CS Citizen's Candidate List. This also resulted in the removal of all family members from the list, which has made him a pariah among the Simmons clan in the 'Burbs.

Feeling the heat in Chi-Town, young Doctor Simmons found some work in the 'Burbs at Iron Heart until a scandal prompted him to move his practice to Old Bones. There he prospered until he was caught skimming money from the Black Market organization for whom he was working. Over the next ten years he bounced from one southern Canadian town to another until landing in Kingsdale where he set up a "legitimate" clinic with his own funds. He thought he had finally found the place to plant some roots until that loudmouth Wallis blew the whistle and those other crybabies joined Wallis' public crusade against him. It's not like he killed anybody for God's sake. Wallis will recover completely and never miss those organs. That's how skilled Doctor Simmons is at his job (and how impressive advanced medicine can be on Rifts Earth for those who can afford it). Doctor Simmons is also a Major Psychic with natural healing abilities which he uses during each surgery, reducing the recovery time for his patients by half, and the amount of time he has to spend in surgery by one third, so he can enjoy the finer things in life.

His clinic in Kingsdale was the best operation he had going yet, until Wallis ruined it all for him. At first it was an honest clinic that catered to wealthy residents and mercenaries in need of a superior surgeon. However, the good doctor became disenchanted with being a simple healer and it wasn't long before he had made connections with the Black Market to "harvest" human organs. Technology was advanced enough to allow said harvesting from "living donors" with modest danger for the donor. Simmons' natural surgical skill and psionic healing powers reduced the risk to virtually zero. That meant he could harvest organs from "donors" without even asking permission because they wouldn't even notice until years later, if ever. Callous and self-centered, the doctor never stopped to consider what the consequences of such harvesting might mean to the people from whom he stole organs. There were bionics and artificial Bio-Systems they could purchase if need be – assuming they could afford them. It wasn't his problem if they couldn't.

To help cover his trail, Doctor Simmons opened a branch of the clinic to indigents and poor people, "to give back to the community," he said. In reality, he was harvesting their organs, replacing them with cheap, secondhand bionic and Bio-Systems he acquired from Cyber-Snatchers or mercs who died on the operating table, claiming their organs and bionics as "fair payment" for his efforts; few friends argued about it. Meanwhile, the poor he "treated" had no idea that they were being mutilated and robbed of their body parts. The arrogant Doctor Simmons became so arrogant that he even began to harvest hearts and other "one of a kind" organs, replacing them with substandard cybernetic counterparts.

All the *genuine* organs being harvested went to a growing underground customer base within the Black Market who preferred *real human* organs rather than the artificially grown

(good as real) Bio-Systems or mechanical alternatives offered through cybernetics. Customers who could afford to pay tens of thousands to hundreds of thousands of credits for the organs they desired. Best of all, since Doctor Simmons had stolen the organs, this operation was almost entirely pure profit, because the organs were "free." Simmons also offered Black Market clients, criminals and fugitives "new face" cosmetic procedures out of the backdoor, as well as the installation of Black Market cybernetics.

As usual, Doctor Simmons' downfall was his greed and arrogance, pushing the limits of his illegal practice without ever considering the consequences for his patients or himself. Like most crooks, he never thought he'd get caught. And if he did, he'd weasel his way out of trouble and skip town to set up his shingle someplace new like he always did. And that's exactly what he's trying to do now.

The monkey wrench in his plan is that he messed with the wrong person. George Edward Wallis is not a man without resources. He is angry beyond words to discover his body violated in such a callous manner. His own investigation found a half-dozen other victims (and since going public, 23 others in Kingsdale have been uncovered, with undoubtedly scores of others). He wants justice and is willing to pay for it.

If the player characters should fall for *The Fugitive's Story*, Doctor Simmons will set up shop in the Warrens of MercTown where he'll start "harvesting organs" from the poor who live there and the many transients who pass through MercTown. In fact, he doesn't know why he didn't think of MercTown sooner. It's perfect! He is still in good standing with the Black Market (that little indiscretion of his youth taken care of and long forgotten) and will also open up his own Body-Chop-Shop dealing in Black Market cybernetic goods and services.

### True Stats for Simmons

**Alias:** The bounty on his head has forced Daniel Simmons to assume an alias for the first time in his life. As a private joke he has taken the name *Wallis E. George*, after the man who put the bounty on his head, George Edward Wallis.

**Race:** Human.

**Alignment:** Miscreant.

**Attributes:** I.Q. 24, M.E. 11, M.A. 15, P.S. 7, P.P. 17, P.E. 8, P.B. 9, Spd. 12.

**Hit Points:** 43, S.D.C.: 31.

**Height:** 5 feet, 10 inches (1.66 m). **Weight:** 189 lbs (85 kg).

**Age:** 42, **Sex:** Male.

**P.P.E.:** 2, **I.S.P.:** 82.

**Experience Level:** 9th level Cyber-Doc.

**Insanities:** None, although he is conceited, selfish and callous to the point of feeling no remorse about stealing organs of innocent victims or any of his crimes. He can't help it if he's smarter and better than others.

**Disposition:** Doctor Simmons seems like a kind and caring home-town doctor and surgeon that oozes the kind of confidence one wants in a surgeon. This helps him to lie without blinking an eye. In reality, Simmons is a conniving, greedy, self-serving low life who desires the best things in life and takes them at the expense of others. He uses his wonderful gifts of healing to abuse and mutilate his victims for his own

profit. Everything the doctor does is motivated by greed and self-preservation. Doctor Simmons is a highly educated, soft spoken, and easy-going person who seems calm even under duress. He wears his superior intellect and ability like a badge, and is always rather aloof and condescending even to people of high station. While he is getting older, Daniel still considers himself a ladies-man and regularly hangs out in pubs, bars and discos.

**Horror Factor:** None. In fact, Doctor Simmons inspires confidence even as he puts one under with anaesthesia to steal a kidney or a lung.

**Skills of Note:** Anthropology (75%), Archaeology (75%), Athletics (General), Basic Electronics (85%), Basic and Advanced Math (98%), Basic Radio (98%), Biology (98%), Body Building, Botany (80%), Boxing, Chemistry (85%), Chemistry: Analytical (80%), Cooking (85%), Criminal Science & Forensics (98%), Field Surgery (73%), Holistic Medicine (85%), Horsemanship: General (70/50%), Juicer Technology (78%), Medical Doctor (98/98%), M.D. in Cybernetics (88/98%), Pathology (98%), Pilot Automobile (81%), Read American (98%), Speak American and Spanish (98%), Swimming (75%), Sewing (90%), W.P. Energy Pistol and W.P. Knife.

**Magical Knowledge:** None.

**Psionics:** Major psychic: Bio-Regenerate (self; 6), Deaden Pain (4), Healing Touch (6), Induce Sleep (4), Psychic Diagnosis (4), Psychic Purification (8), Psychic Surgery (14) and Suppress Fear (8).

**Natural Abilities:** See Psionics and Attributes.

**Combat Training:** Hand to Hand: Basic.

**Attacks Per Melee:** Seven.

**Combat Bonuses:** +1 to strike, +5 to parry and dodge, +2 to damage, +4 to pull punch, +4 to roll with punch, fall or impact.

**Other Combat Info:** Kick does 1D6 S.D.C. damage, Critical Strike on an unmodified roll of 19 or 20, Knockout on a Natural 20, and Judo-style body throw/flip; does 1D6 S.D.C. damage, and the victim loses initiative and one melee attack/action.

**Favorite Weapons:**

**Wilk's Pocket Laser.** Damage: 4D6+2 S.D.C. or 1D4 M.D. Rate of Fire: Standard. Range: 150 feet (45.7 m). Payload: 10 S.D.C. shots or four M.D.; has two rechargeable batteries for it.

**Wilk's 300 "Hideaway" Laser Pistol.** Damage: 1D8 M.D. Rate of Fire: Standard. Range: 600 feet (183 m). Payload: 20 blasts per standard E-Clip. Bonus: +1 to strike on an aimed shot. Has three extra clips for it.

**Wilk's Laser Scalpel.** Damage: 1D6 S.D.C. Range: Hand to hand combat. **Note:** Skilled with the use of any type of knife or scalpel, including Vibro-Knives.

**Body Armor:** Plain clothes armor (14 M.D.C.).

**Personal Vehicle:** A rebuilt, pre-Rifts sedan style automobile (250 S.D.C.).

**Other Equipment:** The facilities of a medical clinic and Cybernetics Body-Chop-Shop. Portable gear includes surgical gowns, box of 100 surgical gloves, surgical kit (includes

scalpels, clamps, suture, needles, etc.), medical kit (first-aid kit, bandages, antiseptics, protein healing salve, aspirin, pain-killer, antibiotics, pen flashlight, hypodermic gun, stethoscope), IRMSS and RMK, handheld computer, handheld blood pressure machine (computerized), thermometer, several unbreakable vials, computerized drug dispenser, portable laboratory, four Wilk's Laser Scalpels and similar.

**Money:** Has three million credits on him at all times. An additional 9 million is on deposit at the *NGMI Bank* (#23 MercTown), two million credits are held in a private account at the *Palace Hotel & Casino* (#20 MercTown) and another 23 million is hidden safely away somewhere in one of the Chi-Town 'Burbs. And that's after investing 38 million credits in his new clinic in the Warrens District of MercTown, the *New Start Clinic* (across from #164 Robyn's Rib Rack on *Cyber Street*).

## Hook, Line & Sinker Adventures

### Is There a Doctor in the House?

**Hook:** One of the player characters (or an NPC member of the group) comes down with an illness, or suffers an injury or combat wound and needs to get to a clinic for help. The Doctor at the New Start Clinic is supposed to be amazing and charges mercs and adventurers half the usual rate for surgery! What a godsend.

**Line:** No surprise here, it's Doctor Simmons under the alias of Wallis E. George, and he's up to his old tricks again. The clinic is fairly modern and clean, the doctor is busy treating patients when the characters arrive. The wounded/ill player character is rushed into one of the doctor's treatment rooms. The others are told that their friend will be okay and that they should go find themselves a room for a few days while their friend recovers.

**Sinker:** Indeed, Doctor George is a miracle worker. The character has never felt better and the bill is more than reasonable. (And he's only missing one kidney!) While a patient, the character has seen the doctor and his crew perform numerous acts of kindness and charity. Consequently, the recovering character and any of his buddies present to take him home/to camp are quick to protect the Doctor when he is threatened by a crazed Headhunter (4th level). The man is out of his head and keeps shouting about how he (the doctor) "stole my insides!" And keeps repeating it, without ever offering any details. Whether the Headhunter is alone or accompanied by a couple of pals is up to the G.M. In either case, unless this trouble can be put to a quick end, innocent people (patients and staff) are going to get hurt.

**The Real Sinker:** Later, perhaps a few days or weeks later, the members of the player group are kicking back in a bar having a few drinks and relaxing before they begin their next adventure or mission. One of the characters gets access to the Merc Ops boards and is flipping through the wanted posters. He comes across the poster of *Doctor Daniel Simmons*. There is a 01-50% chance anyone looking at the screen will recognize that he is Doctor George! The hair is now a mustard blond color and the skin is lighter, but Doctor Simmons sure looks a great deal like . . . the doctor who just treated him (or his friend) a short time ago! Could it be? What next? An investigation? Blackmail

the Doctor to keep his secret? Collect on the bounty? Go get a CAT scan!?!

## A Case of Mistaken Identity

**The Hook:** The Doctor hires the player characters as bodyguards, telling them that it seems he rather resembles an unscrupulous character named Simmons something-or-other. Someone has placed a bounty on this Simmons person and, from time to time, a bounty hunter or merc team mistakes him for this cad.

**Line:** A friend (a Black Market connection) has warned him that there is a band of mercs at the Gold Nugget Hotel. Rumor has it they plan on bringing him in "dead." He'd like the player group to, **a)** provide around the clock protection (paying 500 credits per day, per each character), **b)** try to reason with them (i.e., vouch for his good character and convince them they are mistaken), and failing that, **c)** arrange to dispatch them (beat up and boot them out of town, leaving them too scared to come back, or *kill* them). There is a 20,000 credit bonus or 60,000 in a non-cash line of credit toward cybernetic augmentation in it for the group if it comes down to the latter, plus the Doctor's clinic will take care of any injuries sustained in the line of duty free of charge.

**Hook:** Investigating or roughing up these guys will reveal they are murderous raiders working for the Coalition Army, including two undercover CS spies! They are in town trying to find fugitives from Tolkeen.

This is a setup, a favor for his Black Market buddies who don't want Coalition blood on their hands, but need to see these goons eliminated. Our heroes will find themselves in a situation where they will have no choice but to kill or be killed by this covert group. Fortunately, the Doctor (and his Black Market connections) will help the player characters get off without criminal charges. Which might strengthen their friendship with Doctor George and line them up for future work from him (mainly as dupes doing the Black Market's dirty work).

# Martin Cotswoller

## Wanted Dead or Alive

### Merc Ops Number Five Most Wanted

#### Bounty Commissioned by Northern Gun, Ishpeming

4,000,000 Credits payable upon receipt of the fugitive.

3,000,000 Credits payable upon receipt of the corpse.

6,000,000 Credit bonus payable upon the return of stolen documents.

### Known Statistics

**Full Name:** Martin Louis Cotswoller.

**Known Aliases:** Mark Louis, Luke Merrick, Carlos Swan.

**Race:** Human.

**Sex:** Male.

**Age:** 65.

**Height:** 6 feet, 3 inches (1.9 m).

**Weight:** 160 lbs (72 kg).



**Build:** Very thin, tall and lanky man.

**Eye Color:** Green.

**Hair Color:** Salt and pepper hair, with white moustache and beard.

**Skin Color:** Caucasian.

**Distinguishing Features:** Large, deep scar through his chin.

**Known Capabilities:** Martin is a brilliant scientist, he is believed to be armed and dangerous.

**Previous Accomplishes:** Unknown, he may have had assistance in accomplishing his jailbreak.

**Last Known Location:** Ishpeming, the Northern Gun research complex.

**Arrest Warrant For:** Four counts of murder and 12 counts of industrial espionage and theft of intellectual properties.

**Criminal Record:** None, he has worked as a company scientist for the last 40 years.

**History:** Martin Cotswoller was arrested and charged for the murder of his daughter and her husband, leaving three orphaned children, as well as multiple counts of industrial espionage and theft of intellectual properties uncovered by Northern Gun. He was being held in the Ishpeming prison when a Hunter Mobile Gun giant robot tore out the wall to the prison cell and escaped with Cotswoller. Authorities surmise that Cotswoller may have been piloting the robot by remote control to make his getaway.

Cotswoller is presumed to be armed with a 34 ton robot at his disposal. Current whereabouts are unknown, but the Hunter disabled three police NG Samsons on its way out of Ishpeming.



Police assume that the escaped prisoner is headed for a kingdom that does not have extradition laws with the CS or its allies.

Northern Gun executives have revealed that Cotswoller stole many of their new research plans and had yet to reveal where they were hidden before he broke out of jail. Cotswoller was at odds with Northern Gun executives and went berserk when told they were forcing him out of the company and replacing him with a younger designer.

It is believed that Cotswoller intends to sell the stolen designs to one or more of Northern Gun's competitors on condition that they take him on as a lead robot/weapons engineer. Such a sale will compromise the future of Northern Gun and the national security of Ishpeming as an independent state. This could also violate Ishpeming's treaty with the Coalition States.

It should be noted that the bounty contract is only to be paid out upon receipt of a corpse that can be positively I.D.ed as the fugitive, or alive and in condition for questioning. Recovery of the stolen documents (design schematics) before they can be sold or distributed earns the recovery team a six million credit bonus.

Martin Cotswoller could be headed anywhere in North America, but he is most likely to be seeking someone in the robotics business, perhaps the *Titan Robotics* headquarters in the town of New Cedarville. It is believed Cotswoller may have ties with the weapon designers and executives at that company. The fugitive could also be headed for *Chipwell Armaments*, *Wellington Industries*, *Golden Age Weaponsmiths* or elsewhere; the stolen designs could put any robotics or weapon programs several years ahead of their current level.

## The Fugitive's Story

Martin Cotswoller is happy to tell his side of the story.

When questioned about stolen plans and designs, he has no idea what the bounty hunters are talking about. He never took any plans and he would never compromise Northern Gun. The company has been his life for almost fifty years and he expected to put in 21 more before he retired. Sure he was having trouble with the manager of his current project, but hurt the company? Never.

He claims he doesn't have the robot or access to one, although he certainly was busted out of jail by someone in a Hunter 'bot. It might have been one of his old assistants or some other friend from Northern Gun – he has a lot of them – he didn't stop to ask, he just ran. The robot dumped him in the wilderness, with few a thousand credits, a week's worth of water and food rations, and an ion pistol.

He figured he'd get a job as an Operator and lose himself in some two garage town until he could figure out what to do next to prove his innocence. In the meanwhile, he's been working in a garage as an Operator who specializes in combat vehicles and robot repairs for mercenaries.

Martin's eyes fill with tears when he talks about his daughter and her husband. He insists he had nothing to do with their deaths. He had never hurt a hair on her head his entire life. He loves his grandchildren and fears for what will become of them.

He doesn't know who killed them, but he has his suspicions. When pressed, he says his bet is on *Alvin Johnson*, the executive in charge of his department. Alvin Johnson is a ruthless

go-getter bucking for a promotion. He wants to be the youngest executive to control his own research wing and oversee the most prestigious NG projects. Although Alvin is a skilled technician, he is a rotten manager, with no people skills and no loyalty or regard for the people working under him. No loyalty to the company either, Martin would wager. Alvin is an unimaginative little worm with delusions of grandeur and aspirations for power. He's best at tackling straightforward problems and getting under the skin of the people who are doing all the real work. He and Martin went at it head to head constantly, with Cotswoller interceding on behalf of his design team whenever Alvin would press them for unreasonable deadlines or encourage them to take shortcuts that would endanger the integrity and safety of the project. "You can't take shortcuts on weapon designs without taking lives," growls Cotswoller, "and I wasn't going to endanger the lives of the men and women under me for that little sy-phant."

Cotswoller goes on to explain that Alvin Johnson had tried to get him transferred or fired on several occasions, but he has 49 years at the company, an exemplary work record and plenty of connections, so neither were going to happen. In fact, Alvin got reprimanded for not working with his top engineer and was told to resolve his problems with Cotswoller and learn to work together. Things only got worse after that.

To make a long story short, Cotswoller explains he discovered the "Little Worm" had gone behind his back to intercept test results that showed errors that resulted in dangerous stress fractures making their project unstable. (Even now, the old man is careful NOT to reveal any company secrets to people who don't need to know what "project" he and his department were working on.) "To go back and fix the problem now," says Cotswoller, "would put us back nine months, at least. Somebody's head was going to roll for this and it wasn't mine or anyone on my team. It turns out Alvin was falsifying our tests all along. I found some other underhanded stuff about the Little Worm and was going to blow the lid off the whole shebang, only Alvin found out and beat me to the punch. Things went to hell after that. My guess is that . . . that son of a . . ." Cotswoller's voice chokes out and his clenched fists tremble. "He did this to save his can. Killed my sweetheart and her husband – he was a good man too, Johnny was – and left three girls orphans. I can see going after me, I guess, but not sweet Crystal and . . ."

Cotswoller has to stop for a minute to collect himself. "The Little Worm is responsible for this. I know it. Trouble is he's framed me good. And I bet you boys aren't buying any of this. 'I'm innocent,' that's what all the guilty people say, isn't it? The greater tragedy is that I'm sure he'll make it look like I was hiding the test results, then he'll make a few quick, half-cocked patches over the problem, push the project through and more people are going to die because of it. A lot more people, damn him!"

Cotswoller knows it is going to take a great deal of money to buy the lawyers he'll need to "prove" his innocence and doesn't know if that's even possible. The Little Worm has had plenty of time to forge documents and pile the evidence up against the old man. "I bet those stress tests and other documents will turn up any day now showing me as a rat. I wouldn't be surprised if it's Alvin who uncovers the plot. It'd be just like him to want the

spotlight as the hero when he's really the murdering scum behind all of this."

If the characters buy Cotswoller's story they have a few choices to make. The simplest is letting him go and walking away from the bounty, and letting things fall where they may.

The more complicated choice is trying to help Martin Cotswoller clear his name and get evidence on Alvin Johnson as the culprit behind all this. If Cotswoller is telling the truth, more people may die, and there isn't any family to take the three little girls. They have already lost their mom and dad, it would be nice to put them with their granddad, especially if he is innocent. The old man is right about one thing, the evidence is stacked against him. This won't be easy. And if they are wrong, they could be helping a wily industrial spy or turncoat. It wouldn't be the first time a trusted employee turned against the company he works for, especially to make millions and retire to live in the lap of luxury. But killing his daughter and a lot of other things just don't seem to add up.

Worst of all, they'd be walking away from a lucrative bounty and taking on a charity case that could be more grief than it's worth. That's why it's said the best bounty hunters and mercs don't ask questions and don't get involved, they just do the job and take their money. Problem is, that's easier said than done, especially if the mercs have a heart or fancy themselves as heroes. On the other hand, Northern Gun would probably pay them a nice gratuity – at least a cool million credits – for righting this injustice, revealing the true villain, returning a valued employee, and saving them from millions in liability lawsuits when the "project" hurts more people. Maybe they can be talked up to paying out two million. Certainly Cotswoller will support their position.

Decision time.

## Game Master Notes – The True Story

The following is the real background on this character. It will only be uncovered if the player characters do a little investigating or it just happens to fall in their laps from the right person at the right time; Game Master discretion.

**Martin Cotswoller** is a true mechanical genius. He has been the mind behind many of Northern Gun's most successful designs and has helped develop and produce many others. Some of his accomplishments include: the Red Hawk Flying Power Armor, Missileman Power Armor, NG-V7 Hunter Mobile Gun, NG-M56 Multi-Bot and all of NG's labor bot designs, along with other less well known creations, including heavy construction machines and factory robots. Martin has also worked with several of the weapon design teams, and his experience with NG weapons, robots, vehicles and technology is unsurpassed. Although much of his work has been in the area of robots and weapons, he always considered it his life's work to help *protect* humanity, not making weapons that kill people. It is his weapons and robot designs that have helped to keep Ishpeming and other communities safe all these years.

Martin's current problems began when a young hotshot executive, Alvin Johnson, was assigned as the new department head of his current project. Alvin, or the "Little Worm" as Cotswoller and the rest of the department members are fond of calling him, is a petty tyrant who pushes people unreasonably, likes to take

shortcuts and wants results when he wants them. He felt it was time for an old-timer like Martin Cotswoller to step down and allow the younger designers to take over. After coming out on the losing end of several critical design decisions, deadlines and personnel issues, Alvin began to look at Cotswoller not only as a career obstacle but as a monster who was ruining his career aspirations and making him look bad while doing it. When his superiors took Cotswoller's side and told the Little Worm to play nice with others and try to learn from a man like Martin Cotswoller, it stuck in his craw. Cotswoller thought the whole thing blew over after that night, but Alvin made it his mission to give Cotswoller more grief than ever.

It was eight days later when the Little Worm heard from one of his bootlicking stooges that Cotswoller had discovered incriminating evidences of Alvin's misconduct and was gathering it for presentation to the Board of Directors. The evidence was so damning that there could be no doubt of Alvin Johnson's criminal misconduct – falsifying documents, concealing vital machine failure, stress fractures and other life-threatening design flaws, as well as gross incompetence and ignoring warnings and questions from none other than Martin Cotswoller. Cotswoller, always *Martin Cotswoller*.

Alvin's hatred made it an easy thing for him to kill. He wanted to take away the things the old man loved most in the world, just like Cotswoller was doing to him. That meant taking away the job, his reputation, and most importantly, the man's daughter and grandchildren who he talked about with such contemptible fondness. Alvin surprised himself. He didn't feel a thing when he vaporized the woman's head with a single blast from the ion pistol. No, that's not true, he felt excited. When the husband came around the corner shouting, it made him frightened. He hated being scared. It reminded him of Cotswoller and when his father used to yell at him, so he felt good when the upper half of the husband vanished in a red mist. Killing him made Alvin feel powerful. In control. The children weren't home. He found out later that the kids were off at a friend's house so the husband and wife could have a romantic evening alone. Another disappointment, but their deaths would do. An anonymous caller tipped the police that Martin Cotswoller had an argument with his daughter and son-in-law about moving away to another city. The husband didn't want to work at Northern Gun even if it meant better pay and the two men had a strong argument about it. That's what Cotswoller gets for talking about his family all the time. It gave the Little Worm a motive to hang on the old man. A crime of passion, dear, dear.

Cotswoller was arrested the next day when Alvin's stooge found the murder weapon with the old man's prints tossed into a trash bin scheduled for atomization along with some hazardous materials. Sure enough, the gun was a souvenir of one of Cotswoller's original award winning designs. The micro-splatters of blood on the barrel proved it was used in the double homicide. The Northern Gun R&D design studio is a top secret facility, so there are no security cameras inside the lab to prove Martin Cotswoller was actually in the studio at the time of the crime. The police theorize that he was actually killing the family when he was supposedly in his lab. Martin had easy access to the facility and knew all its secrets, including ways to slip in and out unseen. Robots, power armor and weapons were all accessible to his level of security. By the end of the day, Cotswoller was charged with two counts of first degree murder, booked and

held in the Ishpeming jail awaiting further investigation and an appearance before the grand jury to set bail.

Alvin the Little Worm was proud of himself. His plan was all going so well. However, it wouldn't do for an actual trial, the slippery old goat would probably be proven innocent, and more importantly, he'd still have time to report Alvin. No, that wouldn't do. So the Little Worm hired a merc to steal a 32 foot (9.7 m) tall Hunter Mobile Gun from the police compound (Alvin had all guard schedules and security override commands) to rip through the outside wall of his cell and whisk the man away in its steel arms. Until the robot punched through the wall, everyone thought it was a police 'bot on patrol. The Little Worm then stole the project documents, including the files that incriminated him, and blamed Cotswoller. He also suggested the bounty, "dead or alive."

Running from Ishpeming was a painful affair for Martin Cotswoller. He was leaving behind his entire life and the three people he loved most in the world, but he was afraid that the frame job on him was too tight. He figured he could work a few months or a year, save up his money and hire a private investigator. A psychic, if possible. This left him a fugitive on the run with nothing but a credit stick and a light ion pistol thrown on the ground near him. Martin still doesn't know that the pistol is the same one that killed his family. The other gun was at the scene, but it's not the weapon that did the actual shooting. Just one more bit of revenge for Alvin Johnson.

**Breaking news on the Martin Cotswoller story:** "It has just been disclosed that computer files were uncovered showing that Martin Cotswoller had been concealing vital documents and falsifying reports to cover up his own criminal negligence. A spokesperson for Northern Gun made this brief statement: "The consequences of this misconduct could have had tragic consequences. We applaud *Alvin Johnson* for his diligence in uncovering this evidence and the courage for coming forward with it to his superiors. Mr. Johnson displays the integrity that has made Northern Gun a trusted industry leader."

## True Stats for Martin Cotswoller

**Race:** Human.

**Alignment:** Scrupulous.

**Attributes:** I.Q. 29, M.E. 24, M.A. 19, P.S. 9, P.P. 7, P.E. 13, P.B. 17, Spd. 11.

**Hit Points:** 67. **S.D.C.:** 23.

**Height:** 6 foot, 3 inches (1.9 m).

**Weight:** 160 lbs (72 kg).

**Age:** 69, looks more like 59 (remember the longer life span of most people living in the high-tech cities of Rifts Earth).

**Sex:** Male.

**P.P.E.:** 4.

**I.S.P.:** None.

**Experience Level:** 13th level Operator/Engineer and Developmental Scientist specializing in robotics and weapons.

**Insanities:** None.

**Disposition:** Martin is an old softy, a gentle soul with a good heart. He loves engineering work, especially research and development, and sees his work in robotics and weapons development as helping people, not killing. He has even spoken

openly about greater tolerance of D-Bees, many of whom he sees as misunderstood victims of cruel fate. He would never hurt a fly, loves children and adored his daughter and her family which is why he didn't want them to move far away. He has countless friends and acquaintances who would do anything for him. He is also 100% loyal to Northern Gun.

**Horror Factor:** None.

**Skills of Note:** Advanced and Basic Math (98%), Aircraft Mechanics (85%), Anthropology (98%), Archaeology (98%), Artificial Intelligence (98%), Automotive Mechanics (85%), Chemistry (98%), Chemistry: Analytical (98%), Computer Hacking (90%), Computer Operation (98%), Computer Programming (98%), Computer Repair (98%), Electrical Engineer (98%), Field Armorer (98%), Land Navigation (98%), Locksmith (70%), Mechanical Engineer (98%), Pilot: Automobile (98%), Pilot: Robots & Power Armor (98%), Radio: Basic (98%), Read American (98%), Read Sensory Equipment (98%), Robot Electronics (98%), Robot Mechanics (98%), Speak American (98%), Submersible Vehicle Mechanics (70%), Vehicle Armorer (98%), Weapons Engineer (98%), W.P. Energy Pistol, W.P. Energy Rifle, and W.P. Heavy Energy Weapons.

**Magical Knowledge:** None.

**Psionics:** None.

**Natural Abilities:** Trust/Intimidate of 55% and Charm/Impress of 35%.

**Combat Training:** Hand to Hand: Basic.

**Attacks Per Melee:** Six.

**Combat Bonuses:** +2 to strike, +5 to parry and dodge, +2 to damage, +6 to pull punch, +5 to roll with punch, fall or impact.

**Other Combat Info:** Kick does 1D6 S.D.C. damage, Critical Strike on an unmodified roll of 19 or 20, Critical Strike or Knockout from behind, Knockout on an unmodified roll of 20, and Judo-style body throw/flip; does 1D6 S.D.C. damage, and the victim loses initiative and one melee attack/action.

**Favorite Weapons:**

**NG-56 Light Ion Pistol:** Mega-Damage: 2D6 M.D. per shot. Rate of Fire: Standard. Range: 400 feet (122 m). Payload: 6 shots per standard E-Clip or 12 shots long E-Clip. Only has one standard E-Clip, which is in the weapon.

**Body Armor:** None, Martin fled Ishpeming with just the clothes on his back.

**Personal Vehicle:** None, he has not had enough money to buy or lease a vehicle while on the run.

**Other Equipment:** A basic tool kit, canteen, ion pistol, and basic personal items.

**Money:** He's only earned a few hundred credits. All his other assets have been frozen by the law pending a full investigation.

## Hook, Line & Sinker Adventures

### A Slip of the Tongue

**Hook:** The group's equipment has been on the fritz for days with battle damaged and armor, bots and power armor in serious need of repair. They have heard through contacts that there is a

whiz of an Operator in a nearby town that can fix just about anything and at reasonable rates too! The group makes it to the town and checks out the garage where the guy works. The place is a hole in the wall, set up in an old industrial warehouse. Several vehicles, a pair of giant robots and some suits of power armor, as well as two farm tractors and several other vehicles, are located throughout the facility. When they ask for “the Wizard,” they’re told by the owner of the business that, “This guy is the best I’ve ever seen, boys. He’s tripled my business in just a few weeks. I’m telling you, if you didn’t know better, you’d believe he’s the guy who invented the damn things.”

The Wizard, is an aging, muscular man with white hair and a wrinkled face that only seems to add to his character. He’s repairing an ancient S.D.C. motorcycle with the shabbiest, rusty old tools the characters have ever seen. Recognizing the look on their faces, he says, “Don’t let these relics fool you, gentlemen. They’re like me and still have plenty of good years in them if you know how to use them. Now, how can I help you?” The engine of the motorcycle is purring like a kitten in the background.

**Line:** The characters bring in their equipment and the Operator looks it over and, if asked his name, introduces himself as Art Young (otherwise he goes by the Wizard). He seems a bit melancholy, sticks to business and doesn’t engage in friendly banter. A young mechanic butts in to say that Art don’t like to talk about personal things like family, before being shooed away. “Art” breaks out some whiskey while they discuss how much it will cost and how long it will take to fix everything. When someone comments on his lack of tools, Art agrees, but he says this isn’t quite the career he had in mind at this age, and then changes the subject back to their gear. After one too many drinks with the characters, the old man lets it slip that his family was killed and that he’s, “a gol’ darn fugeeative from juftice, kin yooos belif it? Me a foogatiff? Justif. There’s no juftif for me.”

**Sinker:** A simple check on the Merc Ops data base will pull up the file for Martin Cotswoller, a fugitive matching the old man’s description. The characters cannot believe their good fortune, the old man is worth 4 million credits, and an easy catch. Like taking candy from a baby! Only characters with a heart will wonder how this guy they drank with, and who the whole town seems to have fallen in love with in just a few weeks, could be a killer. Confronting Cotswoller and asking him for his story (See *The Fugitive’s Story*) only raises more doubt and is likely to take them to Northern Gun to prove the man’s innocence. Whether Cotswoller comes back to NG (he’d want to) or not depends on the group and the Game Master.

## The Other Guys

**Hook:** Cotswoller is gone.

**Line:** If he doesn’t come with them to prove his innocence (our heroes might think it too dangerous and insist he stay behind, for now), the townspeople tell the returning heroes that he was confronted by some soldiers and he went away with them.

If Cotswoller was to join the group to head back to Northern Gun, he doesn’t show up at the designated meeting place. Going to the shack at the back of the garage where he’s been living, our heroes find signs of a struggle and Martin gone. A photograph is found of him playing with three young girls, and a woman (his daughter) looking on the scene with dismay. The photo has the heel imprint of a military boot.

**Sinker:** Word of “the Wizard” has spread throughout the network of small towns in the area, so when a transport vehicle broke down, the soldiers escorting the transport went to get the Wizard.

**Problem Number One:** The soldiers, for they are *Coalition soldiers* assigned as the convoy’s protectors.

**Problem Number Two:** The convoy is transporting military supplies (trade goods) to Free Quebec *from* Northern Gun where the “Cotswoller Story” has been big news and everybody has seen Martin’s face.

**Problem Number Three:** Even if our heroes have proven the man’s innocence, word of it is only being aired in Ishpeming and it most definitely hasn’t reached these people, and *can’t* out here in the boondocks. In their minds, Martin Cotswoller is a murderer and a traitor.

**Problem Number Four:** Northern Gun’s Coalition States *allies* are certain to arrest Cotswoller and they aren’t likely to have any sympathy for a man alleged to have killed his own daughter! Moreover, they might conspire to shoot the man and have one of the *civilian drivers* claim the bounty reward and secretly split it between them. Of course, good soldiers wouldn’t do that, but the Coalition’s reputation is such that there is no telling whether these are good Coalition soldiers or corrupt troops. And even if they’re good guys, are they going to believe a group of characters like the player group (any mages or D-Bees present will destroy their credibility)?

Or does the hired Wilderness Scout recognize Cotswoller, abandons his position with the CS convoy, and circle back with some merc or bandit buddies to get the old man? Again, they aren’t going to believe he’s been found innocent (the Merc Ops data file won’t be updated for another week!), and it’s not uncommon for unscrupulous mercs and bandits to steal another independent team’s bounty, especially when he’s worth as much as Cotswoller.

What to do? Wait to see how things unfold and hope nobody notices? Launch a mock attack and whisk Martin away in the confusion? What?

Game Masters, have fun.

# Kindra & Catrina Maxwell a.k.a. the Gemini Twins

## Wanted Dead or Alive

### Merc Ops Number Six Most Wanted

#### Bounty Commissioned by the Black Market

6,000,000 Credits payable upon receipt of *each* of the fugitives.

2,000,000 Credits payable upon receipt of each of their corpses.

#### Known Statistics

**Full Names:** Kindra and Catrina Maxwell.

**Known Aliases:** Kindra and Catrina Black, Gemini One and Two, and The Twins.

**Race:** Human, although there has been some conjecture as to whether or not they wield magic or psionic abilities that can mask or disguise their appearance.

**Sex:** Both are female.

**Age:** 23 year old twins.

**Height:** Both are 5 feet, 6 inches (1.7 m) tall.

**Weight:** Kindra is 120 lbs (54 kg), Catrina is a little heavier at 130 lbs (58.5 kg).

**Build:** Both are slight and small; Kindra is thin and Catrina is a little more buxom.

**Eye Color:** Brown.

**Hair Color:** Kindra's hair is black, but Catrina's is blonde (dyed).

**Skin Color:** Caucasian.

**Distinguishing Features:** None, only their hair color and their builds are slightly different.

**Known Capabilities:** Skilled assassins, spies and thieves.

**Previous Accomplices:** The sisters are each other's only known ally.

**Last Known Location:** The Gemini Twins were last seen in the Chi-Town 'Burb known as *Firetown*.

**Arrest Warrant For:** Theft of secrets from the Black Market and the assassination of Black Market operatives.

**Criminal Record:** The Gemini Twins are known assassins wanted in multiple jurisdictions for murder, blackmail, extortion, robbery, information thefts, identification fraud, forgery and a list of other crimes as long as one's arm. Among their victims, the Black Market.

**DISCLAIMER:** Merc Ops tries to keep its operations free of Black Market entanglement and is an independent organization with no ties to the Black Market network. We are serving only



as the *broker* in this bounty arrangement, as we always do, and trust our clients don't mind that our client is the Black Market. The bounty has already been taken in bond by Merc Ops to ensure that any mercenary taking these bounties will be paid promptly. Our normal brokerage fee applies. The fugitives may be turned in to any Black Market operatives in North America. Upon confirmation of receipt of goods, Merc Ops will make the payment in person or wire the funds to a designated location with our banking partners.

**History:** The Chi-Town Black Market has suffered a series of information thefts, with valuable data stolen concerning some of its most important operations. There has also been some data corruption and sabotage.

The break-ins are known to be the work of the notorious *Gemini Twins*, masters in the arts of theft, assassination and espionage. The client has reported they found one of their locations compromised, the database purged (and presumably the files stolen as per the Twins' M.O.). Among the data stolen were the schematics and plans for Bandito Arms Sidewinder and Wild Weasel SAMAS with the full design specifications for building and reproducing these deadly power armors. The two also killed several personnel, including guards, scientists and technicians in their escape from the facility.

The Black Market representatives believe that Kindra and Catrina are planning to turn the location of the, now abandoned, base camp and the SAMAS designs over to the Coalition States for a huge reward. The CS has been out to stop the Black Market and Bandito Arms for some time and the Gemini Twins could have given them all they need to cripple Black Market operations in the region. This is why the Black Market is willing to place such a high bounty on the twins. The executives of the Black Market hope to learn how two mere women could have made it into the center of their operations, even if they were assisted by magic or psionics. The base camp's security should have been impregnable. Security camera film is being examined.

## The Fugitives' Story

Yes, we're naughty girls. What are you going to do about it?

## Game Master Notes – The True Story

The following is the real background on these characters. Only some serious investigation or luck will reveal any of this information; Game Master discretion.

**The Gemini Twins.** As toddlers, the twins were found in the most rundown section of the Chi-Town 'Burbs. They have no memories of their parents, nor do they know where they originate. Their earliest memories are of growing up in Camp Fire-place, an orphanage, dodging the adults and running wild in the streets. No one had to show them how to use their shape-shifting abilities, they seemed to know. The same was true of their psionic powers.

The twins, who quickly became known as the Gemini Twins because they looked so much alike, would use their powers to impersonate others, even as children. They would use this "gift" to steal toys, food, money, blankets, clothes, and anything else they needed or wanted. However, they kept their shape-shifting abilities a secret, so no one could ever figure out how they could

get away with the things they did without being seen. Their early years passed quickly, but the twins did a good job of learning the ropes of life on the street as thieves and con artists.

As teens, the twins were taken under the wing of a notorious mercenary group known as Crow's Commandoes, and by one woman in particular, Sonya "The Face" Schultz. Under her guidance, the two girls learned to become competent spies and saboteurs. Sonya helped the twins to mold and refine their natural shape-shifting abilities, which were similar to her own. She also taught them basic combat skills. However, the girls proved to be incorrigible and of loose morals. Sonja didn't care for how the Twins seemed to view *everyone* as outsiders, marks, chumps and victims and after a year and a half, cut them loose as untrustworthy and dangerous to the rest of the Commandoes. Indeed, both girls learned to use their feminine wiles to use men and gain entry into anywhere they wanted. Most men only have one thing on their minds when dealing with attractive women, especially gorgeous twins, making them easy to manipulate – and kill.

The twins found other teachers and training over time. Kindra, the darker of the two, chose the path of the assassin, in direct violation of everything Sonya of Crow's Commandoes had tried to teach her. Meanwhile Catrina focused on being a Professional Spy and Thief, even though she had a better knack for tricking men than her sister. It was also Catrina who set down the rules that the twins live by:

- 1) Never let anyone know that they are Auto-Gs (Only Sonya of Crow's Commandoes and Crow, himself, know that they are shape-shifters).
- 2) Never trust anyone.
- 3) Never betray each other, no matter what, especially for a man.
- 4) Teamwork can overcome anything.
- 5) Live life to the fullest, to Hell with the rules, and die rich and beautiful.

The Gemini Twins quickly became known on the mercenary circuit as one of the best espionage and assassin teams available. They have been contracted for some of the best jobs available, snatching work from many of the established spies and assassins, as well as earning themselves enormous wages. This has brought them both their share of credits and enemies.

## Kindra Maxwell

Even as a child, Kindra was the sadistic one of the pair. She would torture puppies and skin kittens. For her this was all just good fun. Kindra was also the most aggressive, daring and violent. Her first kill came at the tender age of eleven, when one of the boys who lived near Camp Fireplace insulted her sister. Kindra followed him to his family's shack and strangled the boy with his own yo-yo string. He would be the first of many. Anytime someone dares to attack or insult Kindra or her sister Catrina, they might as well sign their own death certificate. However, Kindra also enjoys cat and mouse games and psychological torture, so she has developed a game where she only defeats male opponents, leaving them unconscious or at the brink of death the first time she encounters them. She leaves them a little worse off the second time (may be scarred, maimed, etc.) and kills them outright the third time – what she likes to call her "three strikes, you're dead rule."

Kindra is the muscle of the team. She is the one who usually brings the firepower to the missions, and she is the one who generally kills when it comes time to eliminate a mark. She doesn't take any crap from anyone, and the fool who gets between her and her sister, or threatens or endangers one of them, is dealt with harshly, and is one of the exceptions to her *three strikes, you're dead rule*.

**Race:** Auto-G (a human mutant who can take on other forms).

**Alignment:** Diabolic.

**Attributes:** I.Q. 14, M.E. 18, M.A. 12, P.S. 25, P.P. 17, P.E. 20, P.B. 20, Spd. 16 (has no cybernetics/bionics).

**Hit Points:** 42, **S.D.C.:** 108.

**Weight:** 120 lbs (54 kg).

**Height:** 5 feet, 6 inches (1.7 m).

**Age:** 21, **Sex:** Female.

**P.P.E.:** 80, **I.S.P.:** 72.

**Experience Level:** 6th level Assassin.

**Insanities:** Plenty. Sadistic sociopath who hates men, enjoys violence, enjoys killing, enjoys intimidating others, and doesn't trust anyone other than her sister. Will kill anybody who threatens or harms her sister.

**Disposition:** Kindra is the ice queen of the Gemini Twins, she is cool, collected and calculating in the same way as a predator. A true cold-blooded, brutal killer, she enjoys stalking and killing, and enjoys intimidating and hurting men. Even when she is just relaxing, Kindra is withdrawn and focused. She has a hard time letting her guard down and relaxing. Instead, she's constantly sizing up those around her and plotting in her mind how to take them down if the need should arise. She never drinks alcohol or takes drugs and only really feels fulfilled when she is taking a life. She adores her sister and considers her the pretty one.

**Horror Factor:** 10, if it is realized she is an Auto-G.

**Skills of Note:** Athletics (Aerobics & General), Basic Math (90%), Boxing, Detect Ambush (65%), Detect Concealment (60%), Escape Artist (65%), Find Contraband (66%), General Repair and Maintenance (60%), Intelligence (62%), Interrogation (65%), Pilot: Automotive (80%), Pilot: Motorcycle (90%), Prowl (55%), Radio: Basic (80%), Radio: Surveillance Systems (70%), Read American (75%), Recognize Weapon Quality (60%), Speak American (98%), Speak Dragonese (95%), Seduction (36%), Streetwise (50%), Sniper, Tracking: Humanoids (70%), Trap/Mine Detection (60%), W.P. Blunt, W.P. Energy Pistol, W.P. Energy Rifle, W.P. Knife, W.P. Paired Weapons, and W.P. Sword.

**Magical Knowledge:** She cannot perform magic of any kind, nor can her P.P.E. be siphoned away by sorcerers or P.P.E. vampires. Additionally, her P.P.E. drops by 70% for 24 hours after a transformation into a nonhuman life form.

**Psionics:** Alter Aura (2), Death Trance (1), Mask I.S.P. & Psionics (7), Mask P.P.E. (4), Mind Block (4), Nightvision (4) and Summon Inner Strength (4).

**Natural Abilities:** To assume the identity of another race, be it Dog Boy, D-Bee or alien, the Auto-G must actually have something with that being's genetic signature. This requires the shape-shifter to chew and swallow a bit of the subject targeted for replication, such as a bit of hair, fingernail, dry



skin, or a tiny drop of blood. Other than this ability to change their physical bodies and DNA, they are effectively mutant humans with the same fundamental abilities and characteristics. When replicating an inhuman race, the character has all the natural abilities of that race, other than spell casting or psionics.

**Combat Training:** Hand to Hand: Martial Arts.

**Attacks Per Melee:** Seven.

**Combat Bonuses:** +4 to initiative, +5 to strike, +7 to parry and dodge, +12 to damage, +3 to disarm, +1 to entangle, +10 to pull punch, +6 to roll with punch, fall or impact. +5 to save vs magic and magical illusions, +8 to save vs possession, +7 to save vs Horror Factor, +15% to save vs coma/death, +3 to save vs poisons, toxins and disease, +2 to save vs psionics, insanity and mind control, she is considered a major psychic, and needs a 12 or higher to save vs psionics. Charm/Impress of 80%.

**Other Combat Info:** Karate Kick does 2D4 S.D.C. damage, Jump Kick (Critical Strike), Critical Strike on an unmodified roll of 18, 19 or 20, Knockout or a Pin/Incapacitate on an unmodified roll of 20.

**Favorite Weapons:** Kindra's favorite weapons are a pair of **Wilk's 247 "Hero" Dual Pistols:** Mega-Damage: Medium Laser: 2D6 M.D.; Heavy Laser 3D6 M.D. Rate of Fire: Standard. Range: Medium Laser: 1000 feet (305 m). Heavy Laser: 500 feet (152 m). Payload: Medium Laser: 20 shots. Heavy Laser: 32 shots with a long E-Clip (16 with a standard "short" clip). Bonus to Strike: +2 bonus to strike on an aimed shot when used with two hands; no bonus if fired with one hand or wild.

**TX-30 Triax Ion Pulse Rifle:** Mega-Damage: 2D6 M.D. single shot, or 6D6 multiple pulse burst (three simultaneous shots). Rate of Fire: Standard. Range: 1,600 feet (488 m). Payload: 40 shots for a short E-Clip or 50 shots for a long E-Clip.

She has 8 short E-Clips and 4 long E-Clips.

**Q4-40 "Mule" Assault Rifle:** Mega-Damage: One explosive round does 2D6 M.D., a rapid-fire triple burst fired at the same target does 6D6 M.D. Rate of Fire: Equal to the number of combined hand to hand attacks; each shot or triple burst counts as one melee attack. Range: 800 feet (244 m). Payload: 12 total; six held in the weapon, six in the standard clip. The clip can be replaced with a 24 round drum, for a total payload of 30 rounds. She carries two drums, four clips and 60 rounds.

**T.W. Battle Fury Blade:** Mega-Damage: 6D6 M.D., M.D.C. of the Fury Blade: 200, regenerates 20 M.D.C. per day. Powers: By channeling 40 P.P.E. (or 80 I.S.P.) into the weapon, the wielder can invoke the Battle Fury. While this fearsome ability is active, the weapon inflicts a whopping 1D6x10 M.D. with every hit, and the wielder gets an extra, second attacks with each successful strike. This second, almost instantaneous second strike comes with such blistering speed that opponents are -5 to parry the unexpected super-quick attack. Finally, for the duration of the enchantment, the sword wielder is encased in a suit of magical force with 100 M.D.C. (Subtract damage from it first). Duration: Battle Fury lasts for 12 melee rounds/3 minutes.

**Body Armor:** Kindra wears matte black explorer body armor (70 M.D.C.), with no reflective surfaces. Dark armor enables her to better hide in shadows and contributes to her intimidation factor. She has a stylized death's head faceplate. She also has a Naruni, personal force field (150 M.D.C.).

**Personal Vehicle:** NE-DD6 "Rover" SUV: 220 mph (352 km), 220 M.D.C., and it's an open topped vehicle.

**Other Equipment:** A pair of Vibro-Blades (1D6 M.D.), 4 small silver, plated knives (1D6 S.D.C. damage), a gold cross necklace, six fragmentation hand grenades (2D6 M.D. to a 10 foot/3 m blast radius), gas mask and air filter, high-impact sunglasses, knapsack, traveling clothes, bedroll, tent, backpack, RMK and IRMSS kits, some personal items and 2 million credits in cash. Kindra is the one with the plans for the Bandito Arms Sidewinder and Wild Weasel SAMAS and the location of the Black Market Area 51 base.

**Money:** Always has at least 100,000 credits on her, with another half million credits within easy access. Has approximately 12 million stashed in various accounts and hiding places throughout the Midwest.

## Catrina Maxwell

Catrina is the thinker and planner of the two, she is the one who picks the contracts they will undertake, and the one who is responsible for everything going off as planned. She ensures that the two of them have the gear, documents, weapons, and other items they need to pull off the mission at hand, as well as a method of escape and a patsy to take the fall for their operation. She can't believe that things went as bad as they did concerning the Black Market, and that they could have ended up with a bounty on their heads. Catrina is hoping that if they can get the plans and location to the CS, the Coalition will cripple the Black Market before they are able to capture them. Of course, she also wants to make a big score by selling that information to the CS. In the alternative, she wonders if they might not be able to sell the information *back* to the Black Market for even more money. Her first objective is to see what the CS will pay, then give the Black Market a crack at it, and hopefully start a bidding war that will make them 200 million credits or more.

**Race:** Auto-G.

**Alignment:** Miscreant.

**Attributes:** I.Q. 19, M.E. 17, M.A. 21, P.S. 19, P.P. 24, P.E. 20, P.B. 21, Spd. 14.

**Hit Points:** 42. **S.D.C.:** 76.

**Height:** 5 feet, 6 inches (1.68 m).

**Weight:** 130 lbs (58 kg).

**Age:** 21, **Sex:** Female.

**P.P.E.:** 60, **I.S.P.:** 132.

**Experience Level:** 6th level Super-Spy.

**Insanities:** None.

**Disposition:** Catrina is a lot more laid back than her sister, and while she is a professional on the job, she does know how to relax. Catrina likes to kick back in a bar, letting the locals fall all over each other to buy her a beer. She knows how beautiful the two of them really are and likes to flaunt it. While she does not use her beauty for seduction in the manner her sister does, she does love to out charm the local women and seduce

the local men. She can never have too many men on her down time. She adores her sister, and considers her the strong one.

**Horror Factor:** 10, if it is realized she is an Auto-G.

**Skills of Note:** Basic Math (95%), Basic Electronics (60%), Computer Hacking (51%), Computer Operation (75%), Computer Programming (60%), Cryptography (65%), Disguise (65%), Forgery (55%), Intelligence (72%), Imitate Voices & Impersonation (66/46%), Palming (70%), Pick Locks (65%), Pick Pockets (50%), Prowl (65%), Radio: Basic (85%), Radio: Scramblers (75%), Read American (90%), Speak American and Dragonese (98%), Seduction (40%), W.P. Knife, and W.P. Energy Pistol.

**Magical Knowledge:** She cannot perform magic of any kind, nor can her P.P.E. be siphoned away by sorcerers or P.P.E. vampires. Additionally, her P.P.E. drops by 70% for 24 hours after transformation into a nonhuman life form.

**Psionics:** Alter Aura (2), Death Trance (1), Mask I.S.P. & Psionics (7), Mask P.P.E. (4), Mind Block (4), Nightvision (4), Bio-Regenerate (self; 6), Suppress Fear (8), Detect Psionics (6), Telekinesis (varies), Deadened Senses (4), Levitation (varies), Machine Ghost (12), Psychic Body Field (30), Psionic Invisibility (10) and Hypnotic Suggestion (6).

**Natural Abilities:** To assume the identity of another race, be it Elf, Dog Boy, D-Bee or alien, the Auto-G must actually have something with that being's genetic signature. This requires the shape-shifter to chew and swallow a bit of the subject targeted for replication, such as a bit of hair, fingernail, dry skin, or a tiny drop of blood. Other than this ability to change their physical bodies and DNA, they are effectively human with the same fundamental abilities and characteristics. When replicating an inhuman race, the character has all the natural abilities of that race, other than spell casting or psionics.

**Combat Training:** Hand to Hand: Martial Arts.

**Attacks Per Melee:** Six.

**Combat Bonuses:** +1 to initiative, +7 to strike, +10 to parry and dodge, +4 to damage, +1 to entangle, +3 to pull punch, +5 to roll with punch, fall or impact. +5 to save vs magic and magical illusions, +10% to save vs coma/death, +6 to save vs possession, +3 to save vs Horror Factor, +3 to save vs poisons, toxins and disease, +1 to save vs psionics and insanity, she is considered a master psychic, and needs a 10 or higher to save vs psionics. Trust/Intimidate of 65% and Charm/Impress of 80%.

**Other Combat Info:** Karate Kick does 2D4 S.D.C. damage, Jump Kick (Critical Strike), Critical Strike on an unmodified roll of 18, 19 or 20, Knockout or a Pin/Incapacitate on an unmodified roll of 20.

**Favorite Weapons:** Catrina always carries a pistol in her boot.

**Wilk's 320 Laser Pistol:** Mega-Damage: 1D6 M.D. Rate of Fire: Standard: aimed, burst or wild. Range: 1000 feet (305 m). Payload: 20 shots with a standard short E-Clip, 40 shots with a long E-Clip. Bonus to Strike: +2 bonus to strike on an aimed shot. She has three standard E-Clips for the pistol.

**CP-50 "Dragonfire" Pulse Laser Rifle & Grenade Launcher:** Mega-Damage: 2D6 M.D. per single laser blast or 6D6 M.D. per rapid-fire triple pulse. Standard Grenade

does 2D6 M.D. to a blast area of 12 feet (3.6 m). Rate of Fire: Each single or triple laser blast or fired grenade counts as one melee attack. Range: Laser is 2000 feet (610 m); grenade is 1200 feet (365 m). Payload: 21 M.D. single shots or 7 triple pulse shots from a standard E-Clip or 30 single shots (10 triple pulses) from a long E-Clip. Grenade launcher holds 12 grenades. Laser Targeting Bonus: Add +1 to strike on an aimed shot. Catrina has 4 long E-clips for the laser, 2 standard E-Clips and 12 grenades in the launcher, with another 24 spare grenades.

**T.W. Flaming Dagger:** Mega-Damage: 2D6 M.D. Range: Hand to hand. P.P.E. Cost to Activate: Seven points.

**Body Armor:** Catrina wears the same matte black explorer body armor (70 M.D.C.) as her sister Kindra, and also has a personal force field (150 M.D.C.) purchased from Naruni Enterprises.

**Personal Vehicle:** Catrina rides with Kindra in her NE-DD6 Rover.

**Other Equipment:** Black fatigues for espionage, traveling clothes, portable DVD player and headphones, language translator, hand-held computer and micro-printer, multi-function digital camera with telescopic lenses, micro-film camera, pen flashlight, gas mask and air filter, high-impact sunglasses, knapsack, bedroll, tent, backpack, and some personal items.

**Money:** Always has at least 50,000 credits on her, plus another 30,000 credits worth of jewelry. Has approximately 9 million stashed in various accounts and hiding places throughout the Midwest. Catrina spends her money more freely and carelessly than her sister.

## Hook, Line & Sinker Adventures

### Let's Make Deal

**Hook:** The heroes find the Gemini Twins and have them cornered. Catrina does the talking for the both of them while Kindra stands silent and ready for action like a viper.

**Line:** Catrina admits that they have stolen some data from the Black Market, but she's sure there are those among them who have done worse and others who have no love for the Black Market. So this makes the contract entirely business. She smiles slyly and invites them to "talk business." She points out that the bounties on their heads are high ones, six million credits each, if they are brought back *alive*, but that's not going to happen. Even if, by some miracle, the group did manage to capture them (and she giggles at the mere suggestion, while Kindra only sneers), somebody, probably several somebodies, is going to get hurt, or oops, killed, and nobody wants that now, do they?

If the bounty hunters should manage to kill them both, the bounty for the corpses is only two million each and they have that much cash on them right now. Catrina giggles again, winks and points out that she wouldn't be much of a business woman to just hand over the cash. After all, the bounty hunters have to remember that every business deal is a compromise, and they will be walking away with their lives, uninjured if they accept 250,000 credits for the each of them. A half million credits for walking away. Deal?

**Sinker:** If the bounty hunters complain or make a counter offer, Kindra growls, Catrina giggles and makes a new suggestion. Her deal is this: If the bounty hunters will escort them to the Coalition State of Chi-Town, they will pay each man who survives the trip, *FIVE MILLION* credits. That's five million for each person in the merc group, not a measly 4 or 12 million to be divide how many ways. Deal?

If the bounty hunters are willing to work with the Gemini Twins, instead of trying to take them in (and someone is likely to get killed in the attempt), all of them can make some *real money*. Good characters might think of themselves as Robin Hoods stealing from the big, bad criminal underground that is the Black Market and giving to the . . . um, themselves or the poor or whomever they please. Besides the CS is, arguably, the rightful owners of the SAMAS designs.

Anarchist and evil characters should salivate over such an opportunity. If anything, their downfall will be fighting their own greed and the idea of stealing the data from the women and selling it themselves.

Sissies who fear retribution from the Black Market should also be afraid of tangling with these two, and accept the original bribe, take the money and run.

Can the Maxwell Twins be trusted?

Now its Kindra's turn to smile as she tosses the group's apparent leader a Universal Credit debit card and says, "Consider this a down payment, handsome." A quick scan shows there's 100,000 credits on the card! Besides, the Twins have a reputation for being honest in their business deals, one has to be when your business is that of an assassin and thief, otherwise you'd never get any clients.

On a more personal note, the twins will try to turn on the charm with any human or attractive D-Bee males in the group. After all, there could be other benefits to a working relationship between the bounty hunters and the women. If one of the characters looks particularly vulnerable to this type of persuasion one of the twins will try to work on that character and get him to trust her if not fall head over heels in love. Of course, any romantic entanglement with Kindra is like a romance with a black widow spider (the female spider kills and eats the male after procreation), and Catrina is *not* the flighty little sweetheart she pretends to be! Good luck, you'll need it.

**Adventure Conflict Notes:** This is not the sweetheart deal it may first appear to be. There are a lot of fortune hunters looking for the Twins, so our heroes (and we use the term loosely in this case) *should face several* (that's 4-8) attacks from different factions on their journey to Chi-Town.

#### **Likely Adversaries (listed in no particular order):**

1) One or more *mercenary or adventurer groups* (3-6 characters per group).

2) *A lone thief* or bounty hunter figuring one man may succeed where a group might fail.

3) *A large gang* of 1D6+8 low level (first and second) bandits hoping they can succeed where one man or a small group might fail. The hope to win by sheer weight of numbers (the bandits will run off as soon as things get ugly and half their number are killed or severely wounded). These losers are poorly equipped and no match for the Twins let alone the player characters.

4) One or more run-ins with *a band of thugs from the Black Market* looking to recover the data without having to shell out a few million credits to an independent contractor. This appeals to soldiers and agents in the Black Market because it will advance their station in the organization as well as get them a 100,000 credit bonus.

5) *A squad of (6-10) Coalition soldiers* hoping to secure the data without their government having to shell out money to criminals or D-Bees. Of course, their actions are not known to or sanctioned by the Coalition government who already has a tentative verbal deal with the Twins. Only the transfer of goods, the final sum, and the means of payment are yet to be finalized.

6) Adventurers, psychics and practitioners of magic and anybody willing to risk their neck for a few million credits might take a shot at the characters, including nice ol' Farmer Brown and his family.

Ah, and then there are the women's dangerous proclivities. Who knows what the women might do along the way that might incite trouble and conflict. Kindra is a murdering hot head who settles insults and rudeness with her fists, a Vibro-Blade or a gun. Catrina is a manipulative, scheming little witch who likes to mess with people for the fun of it.

## **Bounty Hunters Out of Necessity**

**Hook:** The player characters are visiting some Black Market contacts to get some new equipment or information. While things seem to have been going okay, one of the characters says something suspicious to the black-marketeers and a gunfight erupts. When the dust clears a large amount of Black Market goods are damaged and the characters are subdued. The Black Market operators are uncharacteristically understanding about it all and offer a "solution" to the trouble

**Line:** The "solution" is to catch the Gemini Twins or recover the stolen computer data. The Black Market has a problem with a pair of espionage agents that broke into their establishment and stole some important data. The black-marketeers want the characters to track them down, retrieve the data and either kill the spies or bring them back for the Black Market to deal with. They give our heroes their most recent lead and a warning. Fail, and never come back to this part of the country. Succeed and all is forgiven.

**Sinker:** There is one catch (beyond the fact that the characters may not be bounty hunters or equipped to deal with the Twins), there is an open bounty of six million credits each, but the Black Market expects the group NOT to collect on the bounty. Black Market operators say that the whole amount will go to cover the damages the characters caused, so the characters will not see a penny of the bounty.

Actually, there's another problem. Every merc and broke adventurer within a thousand miles (1600 km) is looking for the Gemini Twins and there are a lot of very nasty mercs after those bounties.

---

## Auto-G R.C.C.

---

### Reprinted from Coalition Wars® 3: Sorcerers' Revenge™

Auto-Gs are presumed to be extremely rare. Whether they are mutants, aliens or the product of some genetic experiment gone awry (CS perhaps) is unknown. They consider themselves to be Earthlings, if not entirely human. To that end they claim their natural shape and appearance is “human,” however, an Auto-G can take on the appearance and nature of most mortal humanoids. The Coalition, Splugorth and other groups consider these strange beings to be the ultimate shape-changer without actually being a supernatural being or true creature of magic. Unlike other shape-shifters, the Auto-G can completely transform into whatever particular race it chooses, right down to the natural abilities. This means if the race they are copying has wings and flies, or can teleport, or turn invisible, etc., so can the Auto-G while in that form. If killed while in its unnatural form, that's the way the body remains. It does not revert to its true (allegedly) human appearance.

The transformation can go far beyond imitating a specific race, the Auto-G can study and duplicate a specific individual to every detail, right down to his or her unique genetic structure! The Auto-G's transformation is so complete that the imposter has identical fingerprints and can fool retinal scans, blood tests, voice pattern identification, DNA examination and similar tests! Even a spouse or the character's own mother can not tell the original from the genetic duplicate. This places Auto-Gs among the very best and most dangerous of spies, assassins, kidnapers, thieves, blackmailers, and masters of “the frame” in the world.

Of course, the Auto-G does not possess or copy the skills, memories, or personality of the character (or race) they are mimicking, which can give them away to those who know them best. Nor can they generate bionic implants or artificial appendages, only the actual, physical form. This means questioning *can* sometimes be used to ferret out an Auto-G impersonator, however, one is more likely to simply believe their cohort, friend or loved one is angry, confused or ill rather than jump to the conclusion that he has been replaced by a shape-changer.

Psionic powers can also help uncover an Auto-G, however, these beings pass casual inspection by Dog Boys, Psi-Stalkers and psychics with ease. Since they *are* whatever race they are impersonating they do NOT register as being supernatural or creatures of magic. Thus, the keen psychic senses of these races are useless against Auto-Gs, for they can even disguise their P.P.E. and alter their auras. Telepathic scans *may* be able to pluck out surface thoughts, but only an interrogation and pointed questions are likely to stimulate thoughts that might betray the impostor – a casual scan of surface thoughts will rarely reveal anything suspicious or incriminating. A psychic *Mind Bond* will always reveal the truth but most psychics avoid using this invasive and distasteful power. Meanwhile, using a *See Aura* is likely to display a very normal looking aura for that race. Unless the psychic has studied the character's aura before being impersonated, he will not know if it looks different. However, if the psychic is very familiar with the *real McCoy's* aura (typically a friend, loved one or somebody important) he is likely to notice some subtle and disturbing differences or aberrations

– one of which is an unusually high amount of P.P.E., but whether these small differences from what he remembers are enough to make him suspicious is another matter entirely. **Note:** Auto-Gs are so incredibly rare that most people do not believe they are real. In fact, most ordinary people (95%) have never even heard of Auto-Gs, and even many (60%) of the learned scholars, adventurers and practitioners of magic who have heard of them, believe they are mythical creatures that never really existed. A fictional boogie-man from the paranoid time of the Dark Ages.

### Auto-G R.C.C. Special Abilities, Transformation, & Bonuses

**1. True form.** The Auto-G can only assume one of two forms, the current person or race he is *copying*, and the creature's (supposedly) natural *human form*. Most Auto-Gs' natural appearance is that of a very attractive human with a P.B. of 12 or higher. Most Auto-Gs have a healthy, youthful appearance and even those in their nineties look to be in their forties.

An Auto-G has a definite male or female gender, but they can assume the “appearance” of the opposite sex when they transform into a different race. Assuming the opposite sex and acting the part can prove difficult, as the shape-changer may be a male in a female body and vice versa, with all his normal male attitudes and instincts. Acting the part of a female (and vice versa) *may* be harder than one thinks.

When abandoning the false identity, the Auto-G can only revert back to his human-looking natural form. To change into another race, he must consume some DNA from that life form.

**2. DNA sample required to change.** To assume the identity of another race, be it Elf, Dog Boy, D-Bee or alien, the Auto-G must actually have something with that being's genetic signature. This requires the shape-shifter to chew and swallow a bit of the subject targeted for replication, such as a bit of hair, fingernail, dry skin, or a tiny drop of blood. One minute (four melee rounds) after consumption, the Auto-G is able to replicate the exact genetic structure of that race and transform himself into a convincing copy! This only enables the Auto-G to turn into a member of that race, not an exact copy of a specific individual. **Note:** As long as the creature copied is mortal, whether it is an S.D.C. or M.D.C. being, the Auto-G can replicate it right down to additional limbs, natural abilities and its genetic code. An Auto-G can NOT replicate a supernatural being, creature of magic or a being who is extremely alien (i.e. an intelligent blob, talking cockroach or tree-person is out of the question).

**3. To replicate a specific individual,** the Auto-G must be able to thoroughly examine the subject (dead or alive) for at least 15 minutes (20-30 is better), consume a large DNA sample (one ounce minimum) and be within 12 feet (3.6 m) of said individual when the change takes place. After the appropriate amount of time, concentration and meditation, the Auto-G will turn into an identical-looking twin down to the smallest detail and genetic composition. Fingerprints, voice, eye color, hair growth, hair style, and natural moles, as well as scars and blemishes caused by injury or birth defect, are all replicated 99.7 percent. Bionic implants, tattoos and piercings can not be replicated and if the impostor is to com-

plete the charade, the character must be physically altered (i.e. get an identical tattoo, implant, etc.). Strangely, while the Auto-G can not make a tattoo appear when he changes his form, the tattoo will *disappear* when he reverts back to his natural, human form. Likewise, any cybernetic implants or bionic limbs will be harmlessly dispelled and the Auto-G will regenerate any missing limbs or organs. In fact, if a bionic arm or leg is required for the disguise (typically only necessary when replicating a specific individual), the Auto-G will appear without that limb when he transforms (awaiting a bionic supplement to be attached to complete the transformation). **Note:** Full bionic conversion is not possible for Auto-Gs and will kill them if attempted. In fact, the beings will die if more than 40% of their body is replaced with machine parts. Consequently, most try to avoid cybernetics at all costs, even if it's only temporary.

When assuming the exact identity of a specific individual, there is no necessity to kill the genuine article. Auto-Gs who respect life will usually imprison and hide the person until they no longer have any need for the charade, and release him or extort valuables for his location or safe return. On the other hand, evil and ruthless Auto-Gs (many of whom are professional assassins and spies) kill those they impersonate and destroy the body (or at least dispose of it) to prevent accidental escape or discovery.

4. **Unusually high level of P.P.E.** Auto-Gs have 2D4x10 +P.E. attribute number in P.P.E., roughly 10-30 times more than the average human adult. Yet despite this, Auto-Gs can NOT perform magic of any kind nor can their P.P.E. be syphoned away by sorcerers or P.P.E. vampires. Additionally, the individual's P.P.E. drops by 70% for 24 hours after a transformation into a nonhuman life form. Presumably, the expenditure of P.P.E. at the moment of transformation is necessary for the Auto-G to change his genetic structure and appearance. This may mean these enigmatic beings are actually minor creatures of magic of some kind.
5. **Instant adaptation to alien form.** The Auto-G instantly and intuitively understands the new body, even if it is completely alien and has additional appendages and inhuman powers (psionics, instincts, wings and flight, aquatic capabilities, M.D.C. body, superhuman P.S., and so forth). They are immediately comfortable with their new bodies and whatever power and abilities that may come with them. For example, if an Auto-G turns into a *Simvan*, he has the power to control and command animals. If he turns into a *Psi-Stalker* or *Dog Boy*, the Auto-G possesses and understands the abilities of that race (including instincts, heightened senses and natural needs to sustain that body), and so on.
6. **R.C.C. Bonuses:** +2 to save vs magic, including magic illusions, +3 to save vs Horror Factor, and +2 to save vs possession at levels 2, 4, 6, 8, 11 and 15. Needs a 12 or higher to save vs psionic attacks. Also see attributes, psionics, and other stats.
7. **Restrictions:** Can not replicate the genetic structure or appearance of nonliving materials, animals, lower life forms, creatures of magic, supernatural beings, or truly alien creatures (i.e. a pile of tentacles, an intelligent plant, etc.), only other mortal humanoids. Can not cast spells or draw upon magic. Can not have its P.P.E. drained by outside forces, including allied mages.

## Auto-G R.C.C.

**Note:** "Auto-G" is slang for "auto-genetic" a term coined to describe their ability to duplicate the genetic structure and physical appearance of other races.

**Alignment:** Any, but professional assassins and spies lean toward Anarchist, Aberrant, Miscreant and Diabolic.

**Player Character Attributes:** The number of dice to roll are as follows: I.Q.: 2D6+8, M.E.: 2D6+8 (roll another 1D6 if the initial generated number is 17 or higher), M.A.: 3D6, P.S.: 3D6, P.P.: 3D6, P.E. 2D6+8, P.B.: 3D6+6, Spd. 3D6

**Hit Points:** P.E. number is the base, plus 1D6 per level of experience.

**S.D.C.:** 24 +P.E. attribute number and any additional S.D.C. points acquired through skills or O.C.C.; tend to be a bit tougher than normal humans.

**Mega-Damage:** Auto-Gs can become M.D.C. beings whenever they alter their genetic structure to replicate a *mortal* Mega-Damage creature. However, more likely than not, they must wear M.D.C. armor to protect themselves.

**Horror Factor:** 10

**Size:** Same as a human, 5-7 feet (1.5 to 2.1 m); **Weight:** 120 to 240 lbs (54 to 108 kg).

**Life Span:** Unknown, but seems to be a bit better than an ordinary human, with a typical life expectancy of 140 to 200 years.

**P.P.E.:** 2D4x10 +P.E. attribute number.

**Natural Abilities:** Other than the ability to alter their physical structure on a genetic level and change their physical bodies, they are effectively human with the same fundamental abilities and characteristics. When replicating an inhuman race, the character has all the natural abilities of that race, other than spell casting.

**Available O.C.C.s:** Auto-Gs tend toward the following: Master Assassin, Super-Spy, Thief/Bandit, Highway Man, Smuggler, Con Artist, Soldier, Bounty Hunter, City Rat, Wilderness Scout, Drifter, Vagabond and most any of the Scholar & Adventurer O.C.C.s. **Note:** Can not select any O.C.C. that artificially augments the body, including Cyborg, Cyber-Knight, Crazy, Juicer, Headhunter, nor any Practitioner of Magic O.C.C. or Psychic R.C.C.

**Attacks per Melee:** As per O.C.C. and current race.

**Bonuses** See Special R.C.C. Abilities earlier.

**Damage:** Varies with race or weapon.

**Magic Powers:** None, and can not practice magic of any kind.

**Psionics:** Mind Block, Mask P.P.E., Mask I.S.P. & Psionics, Alter Aura, Death Trance, Nightvision and Summon Inner Strength. Considered a Major psychic and needs a 12 or higher to save vs psionic attack. **I.S.P.:** M.E. attribute number plus a roll of 4D6. Add an additional 1D6+1 per level of experience.

**Bionics:** Avoid it whenever possible. Never make more than 40% of their body cybernetic (any more will kill them).

**Weapons:** None per se; varies with personal preference and O.C.C.

**Allies:** Nobody in particular. Those who pursue criminal professions tend to associate with like-minded evildoers and power-brokers. A number of Auto-Gs are rumored to be members of and/or work with the *Federation of Magic*.

**Enemies:** Most people fear and distrust them and many will slay Auto-Gs whenever they are discovered, just to be on the safe side. The CS has an ongoing campaign of genocide to eradicate the Auto-Gs (be they human mutants or weird aliens) from the face of the planet. The CS also has the knowledge and means to identify these beings. Otherwise, enemies are anybody who gets in their way or threatens their existence.

**Habitat:** Basically the same as any human or whatever race they are impersonating. Auto-Gs are believed to originate from North America. Long ago they primarily inhabited the Midwest, but since they are so feared and hunted, they hide their true natures. Theoretically, anybody, human or D-Bee, could be an Auto-G. Since most people believe them to be nothing more than myth or legend, nobody other than the Coalition States has any tests in place to identify them.

**Note:** It is believed there are fewer than six hundred Auto-Gs in all of North America and most people don't believe they ever really existed. The CS suspects there are half that number, but even that is too many. Of course, no one knows how many exist and since they could be almost anybody, there could be thousands living among the many human and D-Bee communities undetected.



## Quinn 'Qualja

### Wanted Dead or Alive

## Merc Ops Number Seven Most Wanted

### Bounty Commissioned by the Three Lords of Dweomer

**2,500,000 Credits** payable upon receipt of the fugitive.

**500,000 Credits** payable upon receipt of the corpse.

### Known Statistics

**Full Name:** Quinn Xoja 'Qualja.

**Known Aliases:** None.

**Race:** D'norr Devilman.

**Sex:** Male.

**Age:** 44.

**Height:** 5 feet (1.5 m).

**Weight:** 180 lbs (81 kg).

**Build:** Short and portly.

**Eye Color:** Dark blue.

**Hair Color:** Red; dark red on the back and top portion of the head, with tiny red spines where the hair would be on a human.

**Skin Color:** Light reddish-tan.

**Distinguishing Features:** Large, dark purple-black horns.

**Known Capabilities:** He is a Lord Magus, a spell caster of incredible skill.

**Previous Accomplices:** He was once a part of the Dweomer Defense Forces.

**Last Known Location:** Quinn was seen trying to slip out of the Magic Zone, headed for either New Lazlo or Lazlo.

**Arrest Warrant For:** Quinn 'Qualja is wanted for the mass murders of 63 Tolkeen refugees on their way to the city of Dweomer.

**Criminal Record:** None, until this rampage.

**History:** Once a dedicated soldier and scholar, the suspect seems to have snapped. Since the collapse of Tolkeen, refugees have been flooding over the Mississippi River to make it to the safety of the Magic Zone. Many are fleeing to Dweomer to find sanctuary and rebuild their lives. The three Lords of Magic have dedicated their forces to that effort, so it came as a huge surprise at Dweomer when one of their own Lord Magi turned on the refugees in a bloody display on the banks of the Mississippi River.

The slaughter left 63 bodies spread over a 40 foot (12.2 m) area. Most of the carnage was completed before the Dweomer Defense Forces arrived. The only survivor was a young woman the accused tried to incinerated with a gout of Mega-Damage fire. One of the members of the Defense Force blocked the flames in the nick of time while the rest tried to apprehend the man responsible. Unfortunately, he was too quick, first Shadow Melding and then fleeing off into the night. The Dweomer Forces were able to bring the young woman back to the city of Dweomer, where the victim was healed of her minor injuries, counseled and able to identify the person responsible, Quinn 'Qualja. According to her testimony, the attacker was a practitioner of magic who fled with them *from* Tolkeen.

By running her description through the Dweomer criminal and military records along with records salvaged from Tolkeen, the authorities came up with the name of Quinn 'Qualja, one of



the Lord Magi and formally a member of the Dweomer Defense Forces. Quinn was one of the Magi who went to fight on Tolkeen's behalf in the war. Thus, it is hard to believe that he would slaughter six dozen of the very people he has been fighting to protect. The Lords of Magic suspect he *may* have been under the control of a demon or monstrous influence released by the Tolkeen defenders in their last bid for survival. For this reason, they want him back alive, but will accept a corpse if it is absolutely necessary.

## The Fugitive's Story

Quinn will first use every last point of P.P.E. to try and kill those looking to capture and imprison him. After expending all of his spells, P.P.E., ammunition and weapons, he will try to fight the bounty hunters tooth and claw. It turns out that Quinn truly believes he is a *Deevil*, a lesser supernatural being from the Hellish plane known as Dyval. Only once he has been beaten and restrained will anyone be able to talk to him at all. Binding his hands and feet will be necessary to stop him from running away or trying to attack them again. Once suitably restrained, he'll talk, but only when spoken to and only if prodded. When asked about the Mississippi River slaughter, he will say he was *possessed*. That it was not his fault, he was not in control of his own body, and that he can only speak now because they have beaten the beast within him into submission – for the moment.

The Devilman tells them to leave him before his strength returns and the possessing force is able to strike back at them and kill them. They should flee immediately, while they still can, their lives are not worth the money they will be paid for capturing him. They should just leave him and run.

If roughed up, or if the group has a *Shifter* to pressure him, Quinn will say that he is a *Deevil* summoned here from a hellish dimension to kill Coalition soldiers. But those who summoned him are dead, and he is free to kill as he pleases. He will not bow to the will of a new mortal master either, the group can kiss his . . . (you get the drift). If the group has a *Shifter* (or just someone who can pretend to be one well enough), Quinn can be tricked into a "Battle of Wills" in which he will stare at the "Shifter" and if the *Shifter* can go longer than him without blinking, he will bow to the ground before the *Shifter* (or pretender), saying, "Oh I am not worthy master! I shall do as you command. Please forgive my outburst. Do not punish me!" Quinn appears to be truly *insane* and believes that he is under the *Shifter's* "control" and will do whatever that man asks of him, but with a devilish twist whenever possible, just like a real *Deevil* might.

## Game Master Notes – The True Story

The following is the real background on this character. Only some serious investigation or stumbling across the right person will reveal any of it; Game Master discretion.

**Quinn 'Qualja** was born to parents who had been torn from their native world and flung to Rifts Earth by a cosmic upheaval on their planet. Without any way to return home, the Devilman's parents made the best life they could for themselves. A short time later, a child was born. Quinn was actually one of the lucky ones, his parents were Rifted to Earth together;

many people saw their families torn apart by the dimensional warping of space and time as the ripples of what was happening on Rifts Earth were felt throughout the space-time continuum. Quinn was also lucky that he had two loving parents who adored their little boy, giving him a loving childhood. As he approached puberty, Quinn was hand-picked for training in the arts of magic and soon made the choice to become a *Lord Magus* (see **Rifts® Federation of Magic** for complete details on this O.C.C.). His early training was flawless and he graduated into the Dweomer Defense Force. Quinn moved through the ranks quickly to become one of the youngest Captains among the defense force, and his future seemed bright.

When the war at Tolkeen erupted, however, Quinn was one of Dweomer's Lord Magi who chose to go to fight on Tolkeen's behalf, rather than obey the Lords of Magic and their decision that all citizens and warrior-mages of Dweomer should stay out of the war. Quinn understood their position, but he just couldn't do it. He felt a duty to help Tolkeen and went to join the battle against the CS invaders. He fought and distinguished himself in many battles, and was on the Northern border of Tolkeen when General Holmes' Army swept down from the Xitixiv Hivelands, cutting a swath of destruction right into the heart of the Kingdom. It was a move that would bring Tolkeen to her knees.

The street to street fighting was intense, the atrocities committed by both sides of the conflict were terrible. Quinn had escaped participation in the *Sorcerers' Revenge*, but this was just as bad, maybe worse, for the toppling of Tolkeen was more than the loss of a great magic nation, it was the death of an ideal.

Ultimately, it was more than Quinn's generous soul could endure. To his fragmenting mind, the atrocities seemed more like something he could imagine a *demon* doing, but not humans or Devilmen, or any mortal beings. It was beyond reason and terrible – the noise, the screaming, the tears, the destruction, the brutality – it was all more than he could bear to watch. Through it all, he kept telling himself it was worth the sacrifice and horror to save Tolkeen, to save everything the kingdom represented.

Quinn, like all the others, was stunned when Tolkeen's defenses collapsed and seemingly endless, black waves of Coalition soldiers and robots swept over them like hungry locusts or an angry sea. Overhead, through the billows of smoke and flashes from aerial combat, Quinn could see the Dragon Kings take wing. Not to fight, but to flee. He remembers thinking, "If the Dragon Kings fled before the might of the Coalition, what chance do us mere mortals have?" They are the last thoughts he remembers clearly. After that, Tolkeen's fighters and citizens fled in all directions as the Coalition swarmed through the streets, killing all in their path. The defenders staggered back to a holding position and kept fighting, but their task seemed impossible. The end was near. As Quinn counted the minutes of life he still had left, he saw a pair of Shifters open a dimensional portal and unleash a horde of *Deevils* summoned up straight from the plane of Dyval. They leapt into combat without hesitation and fought the Coalition Dead Boys with tooth, claw and spell, but they too were overwhelmed. It was then that Quinn decided to step into the nearby ley line and phase out of the city and the war.

The next thing he remembers, is being en route to Dweomer amongst a group of shell-shocked refugees. What happened in Tolkeen, how he got here, was all a blur. A dim, shattered recol-

lection of fighting Coalition soldiers like a demon among the Deevils. It was a battle no mortal could have survived. And that's when it struck him, he wasn't a D-Bee, he was a *Deevil*. Somehow, he had become one of them. Perhaps he had always been one. That would explain why magic came so easy for him and why, when the call to arms came, he felt compelled to answer it. He was a Deevil. A true being of supernatural power. No longer were the problems of others his concern. No longer did he have to worry about who lived or who died. No longer did the edicts of the Lords of Magic concern him. He was above such things. Quinn was free from all the moralities of those around him.

Even now, he doesn't remember exactly what transpired at the river. He remembers walking like a zombie, lost in his revelation and newfound immortality as a supernatural being, when a child said, "Look, mommy. A devil." "Hush," the mother said, "that's no devil. That's a man." Quinn remembers saying something like, "No I'm not. The child is correct, I am a demon . . . a Deevil from the sulfur pits of Dyval." Then, he remembers faces laughing. A sea of fingers pointing and faces laughing. Only the child seemed frightened. He knew in her innocence, she saw him for what he really was, and so he made a point of killing her quickly, before she even knew what happened. The rest – he doesn't really remember the rest. The screaming and shouting, it all gets confused with the streets of Tolkeen and him fighting with his Deevil brethren. And when the swirl of emotions, sound and memories subsided, he found himself surrounded by the bodies of those who had been laughing. All of them silent in death and turning the banks of the mighty Mississippi red with blood. Over sixty lay dead at his feet and Quinn drunk deep in the silence born from the chaos of only a moment ago. Only one was left standing, so he struck out at her only to have his blast intercepted by a Dweomer Defender, another Magus like him . . . er, like he had once been. Then he simply ran off, leaving behind one survivor and a squad of horrified defenders who had come to the river's edge in search of refugees to escort back to Dweomer.

Now it was Quinn who was the hunted. Of course, he thought to himself. Mortals fear and hate the supernatural, as well they should, for they are nothing to beings such as he. Nothing but cattle and playthings to do with as he pleases.

## True Stats

**Race:** D'norr Devil Man.

**Alignment:** He claims he is evil incarnate (Miscreant?) and acts like a ruffian. His alignment was Scrupulous until his mental breakdown.

**Attributes:** I.Q. 14, M.E. 13, M.A. 24, P.S. 10, P.P. 13, P.E. 22, P.B. 6, Spd. 22.

**Hit Points:** 64. **S.D.C.:** 41.

**Height:** 5 feet (1.5 m).

**Weight:** 180 lbs (81 kg).

**Age:** 44, **Sex:** Male.

**P.P.E.:** 312, **I.S.P.:** None.

**Experience Level:** 7th level Lord Magus.

**Insanities:** Quinn is one of countless victims in the Coalition-Tolkeen War. His own appearance contributed to his malady and convinced him he is a "real" supernatural Deevil.

Imagining he is a demonic creature has helped him cope with the terrible things he witnessed and the killing he, himself, had to do. He feels removed and estranged from ordinary people and ordinary life. He is also subject to blackouts and unable to remember what he may have done during them. Whether drugs and/or therapy might soothes his fevered mind and break him out of his delusions is unknown at this time.

**Disposition:** Quinn is no longer the carefree, devilish charmer he once was, but a confused wanderer who believes himself to be a demonic monster. So he tends to be cool, indifferent and uncaring about ordinary people and their troubles. At the same time, he cannot abide acts of wanton cruelty, torture or injustice and strikes out against them. He also has a short temper when it comes to authority figures, soldiers, police, and slavers, especially if they are roughing people up or are corrupt, and lashes out at them in a fury. While he can still turn on the charm to get his way, Quinn is more inclined to use intimidation, threats and violence nowadays. He is a Deevil, after all, and tries to behave as he imagines a Deevil would.

Half the time he seems in a daze without purpose or direction, and only reacting to situations as they come at him. When attacked, however, he automatically uses deadly force and fights like an angry tiger and with amazing skill.

**Horror Factor:** 12, at least until one gets to know him.

**Skills of Note:** Advanced and Basic Math (95%), all Lore Skills (at base+45%), Anthropology (60%), Art (75%), Athletics (Aerobics & General), Computer Operation (80%), Computer Programming (70%), Disguise (65%), Find Contraband (55%), Forgery (60%), Intelligence (66%), Interrogation (70%), Land Navigation (66%), Law (General; 65%), Military Etiquette (70%), Mythology (70%), Pick Locks (70%), Pick Pockets (65%), Read American and Dragonese (80%), Research (80%), Running, Speak American, Demongogian and Dragonese (98%), W.P. Energy Pistol, W.P. Energy Rifle and W.P. Sword.

**Magical Knowledge:** Knows *all* Level One and Two spell invocations, and has a vast knowledge of spell magic, including the following:

Level Three: Armor of Ithan (10), Magic Shield (6), Orb of Cold (6), Telekinesis (6).

Level Four: Astral Projection (10), Electric Arc (8), Fireblast (8), Fist of Fury (10 or 50), Magic Net (7), Reflection (7), Ricochet Strike (12), Shadow Meld (10), Watchguard (10), Weight of Duty (10).

Level Five: Circle of Flame (10), Horrific Illusion (10), Lifeblast (15), Mental Blast (15).

Level Six: Barrage (15), Call Lightning (15), Illusion Booster (15), Illusory Wall (15 or 30), Magic Pigeon (20), Targeted Deflection (15), Teleport: Lesser (15), Time Slip (20).

Level Seven: Ballistic Fire (25), Fire Gout (20), Fly as the Eagle (25), Heal Self (20), Invulnerability (25), Life Drain (25), Negate Mechanics (20), Sonic Blast (25), Spinning Blades (20), Sub-Particle Acceleration (20).

Level Eight: Forcebonds (25), Hallucination (30), Shock-wave (35), Sorcerous Fury (70).

Level Nine: Illusion Manipulation (25-60).

Level Ten: Illusory Forest (45-90), Mystic Portal (60).

Level Eleven: Illusory Terrain (55-120).

**Psionics:** None.

**Natural Abilities:** Fatigues at half the normal rate, can hold his breath for three minutes. Spells, psionic attacks, drugs and disease that cause confusion, dizziness or dull the senses are half as effective (reduce penalties by half). Become invisible at will, regenerate 2D6 Hit Points/S.D.C. per minute, has double normal spell range, impervious to possession, ages one year for every five, magic heat and fire do half damage. Sense ley lines, ley line phasing, and ley line rejuvenation, all as a Ley Line Walker. Recovers P.P.E. at a rate of 6 P.P.E. per hour of rest or sleep; 12 P.P.E. per hour through meditation.

**Combat Training:** Hand to Hand: Martial Arts.

**Attacks Per Melee:** Six (more when using the Fury Blade).

**Combat Bonuses:** +3 to initiative, +4 to strike, +6 to parry, +4 to dodge, +2 to kick damage, +3 to disarm, +1 to entangle, +7 to pull punch, +5 to roll with punch, fall or impact. -1 (minus) to save vs insanity, +4 to save vs mind control, +3 to save vs possession and illusions, +2 to save vs Horror Factor, +6 to save vs magic, +4 to save vs poison, toxins and diseases, +19% to save vs coma/death. +2 Spell Strength. Trust/Intimidate of 80%.

**Other Combat Info:** Karate Kick does 2D4 S.D.C. damage, Jump Kick (Critical Strike), Critical Strike on an unmodified roll of 18, 19 or 20. W.P. Paired Weapons. Head butt with horns does 2D4 S.D.C. damage + P.S. bonus.

**Favorite Weapons:** One of the few weapons he escaped with was a **Dragonfire Flamethrower:** Mega-Damage: 1D6x10 M.D. to everything in its 100 foot (30.5 m) length of fire. Rate of Fire: Single shots only. However, the flame can be whipped back and forth, striking multiple targets in both directions. Moving it back and forth will hit everything in a corridor 10 feet (3 m) wide and 100 feet (30.5 m) long, but uses three melee attacks/actions. Range: 100 feet (30.5 m). Payload: 5 blasts per P.P.E. clip.

**TW Battle Fury Blade:** Mega-Damage: 6D6 M.D. M.D.C. of the Fury Blade: 200, regenerates 20 M.D.C. per day. Powers: By channeling 40 P.P.E. (or 80 I.S.P.) into the weapon, the wielder can invoke the Battle Fury. While this fearsome ability is active, the weapon inflicts a whopping 1D6x10 M.D. with every hit, and the wielder gets an extra, second attack with each successful strike. This second, almost instantaneous strike comes with such blistering speed that opponents are -5 to parry the unexpected super-quick attack. Finally, for the duration of the enchantment, the sword wielder is encased in a suit of magical force with 100 M.D.C. (Subtract damage from it first.) Duration: Battle Fury lasts for 12 melee rounds/3 minutes.

**Body Armor:** Heavy Lord Magus body armor (90 M.D.C.) and helmet (45 M.D.C.). The helmet, modified for his horns, has a crustacean appearance with insect-like eyes, open pincer-like mouth area, and a long, segmented hood that extends beyond the head, down the back. The fingers are tipped with ceramic spike-like claws (adds 1D6 S.D.C. damage to hand to hand damage).

**Personal Vehicle:** None. He wanders everywhere.

**Other Equipment:** A canteen, backpack and only the most basic gear, in addition to the weapons and armor noted above.

**Money:** Only 500 Universal Credits.

## Hook, Line & Sinker Adventures

### Making a Deal with the Devil

**Hook:** While the characters are in some small town (a stop-over between adventures), they meet a strange looking D-Bee that resembles a Deevil (he is a D'norr Devilman, if they have encountered that race before). The Devilman asks if the characters are looking for work. You see, some D-Bee haters have been hunting him down for the last few days and he is looking for some able-bodied men to tie them up for a while, so that he can make his escape. The strange little fellow has a way with words, even if he sounds a little cold and confused. He does not want the characters to kill anyone or to put themselves at any real risk. Just foul up his pursuers' vehicle, get them drunk, have a friendly bar fight, or something similar, to slow them down a bit, or better yet, send them on a wild goose chase in the wrong direction. He will give them 500 credits in cash now and if he makes it away, he will meet them at the next town (they plan which one) for the remainder of the payment, another 9,500 credits. He shows the group the credits first so they know he is up front about everything. He would give them more up front, but if they can't slow down the guys chasing him, he may need that money to buy himself out later.

**Line:** The little D-Bee Devilman does, indeed, head off and in the direction they discussed. Not too soon after, a party of mean looking characters arrives in town. While they don't look too tough (low level), there are eight of them, more than that little fellow could possibly handle. The player group can work to slow them up and/or point them in the wrong direction any way they can.

**Sinker:** The roughnecks after the Devilman are all rude, crude bounty hunters of Anarchist or evil alignment. Depending on how things unfold, our heroes *may* find out that the little guy they just helped is wanted for murdering 60+ refugees and has a price on his head. They can, however, make things right, by capturing him themselves (and getting a nice bounty to boot).

On the other hand, they may not realize anything, do their job and meet up with the Devilman in the next town to get paid. As it turns out, he doesn't have the money and never did, it was all a fake (only the 500 credits was real). With a new confidence he tells them to buzz off before he gets angry and hurts one of them. When asked what he thinks he's doing (or a similar opening) he'll say, "What do you expect from a Deevil? Now, buzz off. If they persist, he'll hit the most threatening one with Call Lightning and continue to boast about being a great and powerful Deevil. He threatens to kill them all if they don't leave him alone. Now what?"

### The Face of Evil

**Hook:** Whatever the player group's previous experience with Quinn, they finally confront him in a small town and manage to subdue and capture him. (**Note:** He'll pass out or surrender when 70% of his P.P.E. is used up or he's clearly outnumbered and realizes he can't win.)

**Line:** At the end of the battle, confused townspeople come over to talk. They explain that just a few hours (or a day) before, Quinn rescued the townspeople from a gang of slavers who were pushing people around, killed their two defenders and had collected a couple dozen young women and children to haul away to the slave market. It was an impressive fight and the Devilman fought valiantly. When the slavers fled, the hero turned down money and livestock as a reward, saying a Deevil had no need for such things. He then went on to conduct himself like a gentleman. Not exactly the behavior of a Deevil or a killer.

**Sinker:** If the group has a psychic/mind reader or healer among them, that character can assess Quinn as a shell-shocked lunatic living a delusion, but he doesn't seem to be the cold-blooded killer he (and some others) believes himself to be. Furthermore, an attempt to read his mind gives the psychic fragmented visions of a beautiful young girl killing refugees along a riverbank. The addled Quinn could do nothing but watch in horror. When the slaughter ended a few short minutes later, the girl turned to him, her eyes glowing red, her gown covered in blood. Other thought fragments show Quinn speculating that she must be a fellow demon, yet at the same time he was thinking how terrible this is and he should do something . . . kill her . . . stop her before she kills more innocent people . . . but wait . . . isn't this what demons and Deevils do? Finally, he shot a fiery blast at her, but Dweomer Defenders appeared on the scene while he was distracted and intervened. Confused and not wanting to fight old allies, Quinn ran away and pushed the entire affair from his mind. If asked about it, he takes responsibility for the slaughter, pontificating about how that's what Deevils do. Only it's not true. The real monster has been taken to the city of Dweomer! God only knows the kind of damage she . . . it, might do there.

If the player group doesn't have such a character in their team or he/she doesn't probe Quinn's mind, this information will be presented by a psychic in town who had the opportunity to read his mind after his battle with the slavers. She told the group because they seem to be heroes and, well somebody should know the truth and warn the authorities at Dweomer.

**G.M. Note:** Exactly what the girl is, we leave to your imagination, but she is wicked and powerful, and up to no good. True heroes would never let Quinn take the blame for a heinous crime he didn't commit, nor leave the unsuspecting people of Dweomer to a questionable fate at the hands of some terrible creature. Heck, for all they know, she could be some kind of shape-changing demon or dark god or powerful sorcerer out to kill the Three Lords of Magic or who knows what. Unleash your imaginations and have fun.

Also note that despite his aberrant behavior and claims of being an evil Deevil, Quinn will want to accompany them and he will fight to destroy the demonic teenager, and could die in battle saving one of the player characters or saving the day. He'd rather be dead than be forced to live with all the suffering and horror he has seen, and dying a hero would make him happy.



## “Quick Draw” Jeremiah

a.k.a. Butch Cassidy

Wanted Dead or Alive

**Merc Ops Number Eight Most Wanted**

**Bounty Commissioned by Sundance of the Pecos Empire**

2,000,000 Credits payable upon receipt of the fugitive.

2,000,000 Credits payable upon receipt of the corpse.

### Known Statistics

**Full Name:** Quick Draw Jeremiah.

**Known Aliases:** Butch Cassidy.

**Race:** Quick-Flex Alien.

**Sex:** Male.

**Age:** 26.

**Height:** 5 feet, 6 inches (1.65 m).

**Weight:** 150 lbs (67.5 kg).

**Build:** Light, thin frame which is typical of his race.

**Eye Color:** Emerald green.

**Hair Color:** Jet black.

**Skin Color:** Pale white.

**Distinguishing Features:** His arms and chest are adorned with tattoos of skulls and roses.

**Known Capabilities:** He has been implanted with Danger Response M.O.M. implants that enhance his already quick reflexes.

**Previous Accomplices:** He was a member of *Warlord Don Marco's gang* in the Pecos Empire, at least until he flipped and started to think of himself as a new Butch Cassidy.

**Last Known Location:** The Pecos Empire, he was headed out into the New West when last seen.

**Arrest Warrant For:** Personal bounty placed on Jeremiah for impersonating the “true Butch Cassidy” of Rifts Earth (obviously another character who has taken the name of the Old West outlaw for himself, but his partner, Sundance, doesn't appreciate others riding on *his* old pal's reputation).

**Criminal Record:** Butch/Jeremiah has been arrested now and again for minor crimes, but they have nothing to do with this warrant.

**History:** According to Sundance, it's simple: “Jeremiah says he is Butch Cassidy, I says he ain't. He don't want to quit claiming he is my old saddle buddy, so I want his ass dead! Bring me him or just his head and I'll give ya 2 million credits! It's as simple as that.”

## The Fugitive's Story

“Butch” is easy going and fairly laid back, so he is easy to get talking, but if anyone even flinches as if he's pulling a weapon, his guns will be out and ready to shoot before anyone knows what's happening. The affable Butch Cassidy (Jeremiah) likes to gab, and once he gets going, he is pleased to talk about his exploits and positively raves about all of his and Sundance's old pre-Rifts adventures (the ones in the pre-Rifts movies). Furthermore, he can't understand why *Sundance* would call him an imposter and put a bounty on his head. He's half convinced this bounty is from a “pretender” out to trick him. Either that, or this is some kinda trick on the part of Sundance or somebody in the Wild Bunch.

While Butch would like to work things out with Sundance, he is not going to let anyone bring him in for a reward. Butch (Jeremiah) knows that if he meets Sundance without his guns, in the middle of the Wild Bunch, he is as good as dead. So he might as well just shoot it out with the bounty hunters instead of letting them tie him up like some calf. On the other hand, if the bounty hunters are willing to join his gang (they being the only gang members), they could go see Sundance together and try to straighten everything out. This Butch Cassidy (Jeremiah) actually believes that Sundance will recognize him as Butch Cassidy if they met eye to eye. A clever group could use this ploy to lead Butch Cassidy to Sundance without gun play, at least until the two meet. But if the characters insist that Jeremiah is not Butch Cassidy, or that he is not even human, Jeremiah will laugh, and call *them* crazy. If he feels threatened or that he's being set up for a trap, Butch whips out his guns and starts shooting at anyone involved in taking him in. Likewise, anyone who threatens to question his version of reality is likely to be called a liar and a yellow coward, and challenged to a showdown in the street. The slightest inappropriate movement will get the individual(s) shot where he stands – Butch don't take unnecessary chances, friend. Extreme caution is recommended.

## Game Master Notes – The True Story

The following is the real background behind this fugitive. Only a serious investigation or plain dumb luck will reveal any of this information; Game Master discretion.

“Quick Draw” Jeremiah (*claiming to be Butch Cassidy*) grew up in the badlands of the Pecos Empire, running from one little town to another, avoiding the gangs, the gunslingers, and the vampires. His natural reflexes helped him a lot with the quick draw and gun handling, but even so, he was never quite fast enough. That all changed when he signed up with *Warlord Don Marco* and the *Silver Daggers gang*. The Silver Daggers were looking to get some faster guns so that they could do some real damage to the other gangs. Warlord Don Marco saw that the kid was fast and told him they could make him faster. Within a few hours of the lad agreeing, they had him inside a Black Market Body-Chop-Shop for enhancement to become a Wired Gunslinger.

The “enhancement” was the Danger Response M.O.M. implants. This odd little variation on M.O.M. technology does not have all the powers or side effects of the normal augmentation, but it does enhance the reflexes and reaction times incredibly. When combined with Jeremiah's natural reflexes as a Quick-Flex Alien, he became faster than most professional Gunslingers. At first, everything was great with the new implants and the lad quickly developed a reputation as *Quick Draw Jeremiah*, one of the fastest guns in the New West.

Don Marco wasted no time in putting him to work and was impressed with Jeremiah's success rate. Finally, he sent him to whack Warlord Sabre Lasar's hired guns one at a time. This made Jeremiah's face well known throughout the Pecos Empire as he went from place to place calling out gunmen for showdowns in the street. He also took on all comers, and seemed to live a charmed life by coming out of each confrontation, ambush and trap alive. In between his gun-slinging, Jeremiah also collected a huge number of pre-Rifts movies and earned a lot of credits collecting on bounties and doing jobs that required some-one good with a gun.

The problem with any kind of augmentation that affects the brain is that mental illness is a likely side effect. Before long, Quick Draw Jeremiah was acting more like a Hollywood movie cowboy than a real gunslinger. Worse, he started to “become” movie characters, assuming their name, habits, disposition and personality quirks. He'd typically assume an identity and hold on to the persona for a few weeks to several months before changing into somebody new. Six months ago, somebody gave Quick Draw Jeremiah the pre-Rifts movie, *Butch Cassidy and the Sundance Kid*, starring Paul Newman and Robert Redford. Jeremiah loved it, and it wasn't long before he began running around the Pecos Empire calling himself Butch Cassidy. Problem is, either Butch is his favorite persona and he won't give it up, or he's locked into this identity. Whatever the case may be, he's been Butch Cassidy for six months with no sign of snapping out of it. He has gunned down a bunch of lawmen under the name of Butch Cassidy and robbed a few Techno-Wizard trains, both of which have caught the attention of Sundance and his Wild Bunch. Sundance believes that if he survived the journey to Rifts Earth, then so did Butch Cassidy, and he is not going to let anyone take Butch's name, especially a *D-Bee loser*.

Sundance (see **Rifts® Lone Star** for details on who Sundance is, his past, and the new Wild Bunch) has an open offer of two million credits to anyone who can bring him the imposter. This has put “Butch” on the run from his own “best friend” (he has never met Sundance, except in his own imagination), and he can’t figure out why. Maybe it is time he and Sundance had a little talk.

## True Stats for Quick Draw Jeremiah

**Race:** Quick-Flex Alien.

**Alignment:** Anarchist.

**Attributes:** I.Q. 7, M.E. 13, M.A. 22, P.S. 17, P.P. 26, P.E. 20, P.B. 7, Spd. 86.

**Hit Points:** 48. **S.D.C.:** 144.

**Height:** 5 feet, 6 inches (1.65 m).

**Weight:** 150 lbs (67.5 kg).

**Age:** 26.

**Sex:** Male.

**P.P.E.:** 6, **I.S.P.:** None.

**Experience Level:** 5th level Wired Gunslinger.

**Insanities: Assuming False Identities:** Along with the more typical insanities for a Wired Gunslinger, Jeremiah is obsessed with pre-Rifts cowboy movies, to the point that he believes he is one of the characters from the movies. For a while he was the Harmonica Man (Charles Bronson from *Once Upon a Time in the West*), then the Man with No Name (Clint Eastwood *Spaghetti Western*), then Jeremiah Johnson (Robert Redford), Wyatt Earp (not only the Kurt Russell and Kevin Costner versions, but Burt Lancaster as well), then Josey Wales (Clint Eastwood), then the Duke (actually, several versions of John Wayne’s cowboys), High Noon Sheriff (Gary Cooper), Shane (Alan Ladd), and then Chris (Yul Brenner from the *Magnificent Seven*; that one lasted three months), the Unforgiven (Clint again), Roy Rogers the singing cowboy (thankfully, Roy only lasted for a week and a half, and he has never seen any Hopalong Cassidy flicks), and now, *Butch Cassidy*. He really believes he is Butch Cassidy, as he does every character’s identity he assumes. Butch, however, is his longest and most intense obsession yet, and after six months he still clings to that identity as his own.

**Obsessive Disdain for the Law and Lawmen:** Quick Draw Jeremiah ignores all laws (unless he’s assumed the role of a lawman) and openly belittles, defies and challenges lawmen – he especially loves it when they draw on him or challenge him to a showdown.

**Obsessed with Being the Fastest:** And welcomes showdowns, quick draw contests, sharpshooting and taking on gunslingers and others who claim to be good with a gun. Most such “contests” are to the death.

**Phobia:** Crazies and clowns, he tries to avoid them, backs down from them, avoids shows including them, and even accepts their mocking him. Fights them only when backed into a corner.

**Disposition:** Jeremiah is a nice guy; friendly, courteous and hospitable even now. He loves to talk, share stories, drink and have a good time. Saloons and taverns are among his favorite places, along with dance halls and gambling casinos.

When combat starts, however, he becomes a wild man, bold, cocky and overconfident, quick to kill and fast as lightning. Insanely gung-ho in a battle, he takes unnecessary risks and loves to be flamboyant. Jeremiah sees himself as a dashing and daring anti-hero, the loveable rogue. To him, fighting the good fight and defying laws that limit one’s freedoms is what it is all about. This is probably why he’s so attracted to the Butch Cassidy movie persona.

**Horror Factor:** +11 reputation (+2 against ordinary folks).

**Skills of Note:** Athletics (Aerobics & General), Basic Math (60%), Boxing, D-Bee Lore (45%), Detect Ambush (45%), Detect Concealment (40%), Find Contraband (36%), Horsemanship (General; 46/26%), Interrogation (45%), Land Navigation (52%), Palming (40%), Prowl (50%), Recognize Weapon Quality (50%), Running, Speak American, Dragonese, French and Spanish (95%), Streetwise (36%), Wrestling, W.P. Automatic Pistol, W.P. Energy Pistol, W.P. Energy Rifle, W.P. Heavy Energy Weapon, W.P. Knife, W.P. Revolver (includes Derringers) and W.P. Sharpshooting (Revolvers and Pistols).

**Magical Knowledge:** None.

**Psionics:** None.

**Natural Abilities:** Basically the same as a human except for hyperactivity, enhanced reflexes, great running speed and can leap 8 feet (2.4 m) high or lengthwise from a standing still position! Add an additional 4 feet (1.2 m) from a running start.

**Combat Training:** Hand to Hand: Martial Arts.

**Attacks Per Melee:** Eight, +2 melee attacks when using Revolvers and Pistols (any type).

**Combat Bonuses:** +13 (+3 more when using Revolvers and Pistols) on initiative, +2 to strike using modern weapons/guns, bow and arrow and thrown weapons, +8 to strike otherwise, +13 to parry, +14 to dodge (automatic dodge on all attacks), +4 to damage, +1 to disarm, +1 to entangle, +8 to pull punch, +8 to roll with punch, fall or impact, +4 to save vs Horror Factor, +3 to save vs psionics and insanity, +3 to save vs magic, poison, toxins and diseases, +10% to save vs coma/death.

**Other Combat Info:** Danger Response (special), Karate Kick does 2D4 S.D.C. damage, Jump Kick (Critical Strike), W.P. Paired Weapons (including paired Revolvers & Pistols, ambidextrous), Knockout or a Pin/Incapacitate on an unmodified roll of 20.

**Favorite Weapons:** Butch always has several loaded revolvers on his person.

Two **BigBore Revolvers:** **Mega-Damage:** 1D6 M.D. per round, plus human-sized targets must roll a 20-sided die to maintain their footing. This balance roll must equal or surpass the attacker’s roll to strike. A failed roll means the victim is knocked off his feet, falls back onto the ground (fall back 1D4 feet), loses initiative (if he had it) and loses one melee attack/action! Even those in M.D.C. body armor will be knocked down. **Rate of Fire:** Single shots only! **Range:** 200 feet (61 m). **Payload:** Six shot revolver. He has a box of 144 rounds.

A pair of **NE-6 “Magnum” Plasma Cartridge Revolvers:** **Mega-Damage:** 1D4x10 M.D. per each plasma



round. Rate of Fire: Single shots only! Range: 500 feet (152 m). Payload: 6 shot cylinder. Reloading the weapon takes one melee action per cartridge, or one melee action to load all six if a speed loader is used. He has two speed loaders and 60 plasma rounds.

A pair of **NG-45LP “Long Pistols”**: Mega-Damage: 5D6 M.D. per shot. Rate of Fire: Single shots only. Range: 1200 feet (365 m). Payload: 8 shots per standard E-Clip or 13 shots long E-Clip.

A pair of **Wilk’s 330 Sniper Laser Pistols**: Mega-Damage: 2D6 M.D. Rate of Fire: Standard. Range: 1,000 feet (305 m). Payload: 12 shots with a standard E-Clip, 24 shots with a long E-Clip. Bonus to Strike: +3 bonus to strike on an aimed shots. Butch has a dozen standard E-Clips and four long E-Clips for his energy pistols.

**Body Armor**: NG “Maverick” Riding Armor (36 M.D.C.) and a Branaghan armored overcoat (28 M.D.C.).

**Personal Vehicle**: Appaloosa robot horse, with 200 M.D.C., 75 mph (120 km), leap 10 feet (3 m) high and 20 feet (6.1 m) long.

**Other Equipment**: A quality cowboy hat, set of riding clothes, fancy suit for town (and when an acting sheriff), flashlight, binoculars, laser distancer, pocket language translator, gun cleaning kit, cigarette lighter, pair of handcuffs, two Vibro-Knives (1D6 M.D.), gun belt with holsters, utility belt, saddlebags, saddle, tack and harness, two canteens, and some common personal items.

**Cybernetics/Bionics**: Clock Calendar, Multi-Optic Eyes, Amplified Hearing, Sound Filtration System and Ultra-Ears.

**Money**: 25,322 in Universal Credits.

## Hook, Line & Sinker Adventure

### The Quick & the Drunk

**Hook**: While stopped over in a small town (in the New West, MercTown, or anywhere in the west) the player characters are having a few drinks. One of them accidentally bumps into a gunslinger drinking at the bar next to them. No time is wasted in the gunfighter calling the player character out for a showdown.

**Line**: If the player character sincerely apologizes, the gunslinger offers to buy him a drink and introduces himself as Butch Cassidy.

If the pair step out of the bar for the gunfight, the Gunslinger introduces himself as Butch Cassidy and tells the player character that it is unfortunate that he must die. Butch doesn’t really want to kill him, but if he doesn’t others might think he is getting soft. He tells the character not to worry about it, he’ll just bounce a BB or two off his armor to save face and if he drops his gun or staggers and falls to the ground, Butch is the winner and he’ll buy him a drink. If they really shoot it out . . . well, let’s hope that doesn’t happen.

**Sinker**: After the “gunfight,” Butch goes back to the bar with the group for a few drinks. If the group knows there’s a bounty on his head, they’ll have to figure out what they do next. If they don’t they’ll notice a wanted poster on the outside wall of the bar, and a mustache drawn on it with magic marker. “I dun that,” coos a cheerful Butch Cassidy, “I think it makes me look more distinguished, don’t you?”

Will the group try to apprehend Butch for the bounty or let him go? Or will they hang for awhile? Butch can be a good guy, and if the group is in a jam, he’s always glad to help a drinking buddy, ‘specially if there’s a gunfight involved.

In the alternative, our heroes might find themselves helping out ol’ Butch.

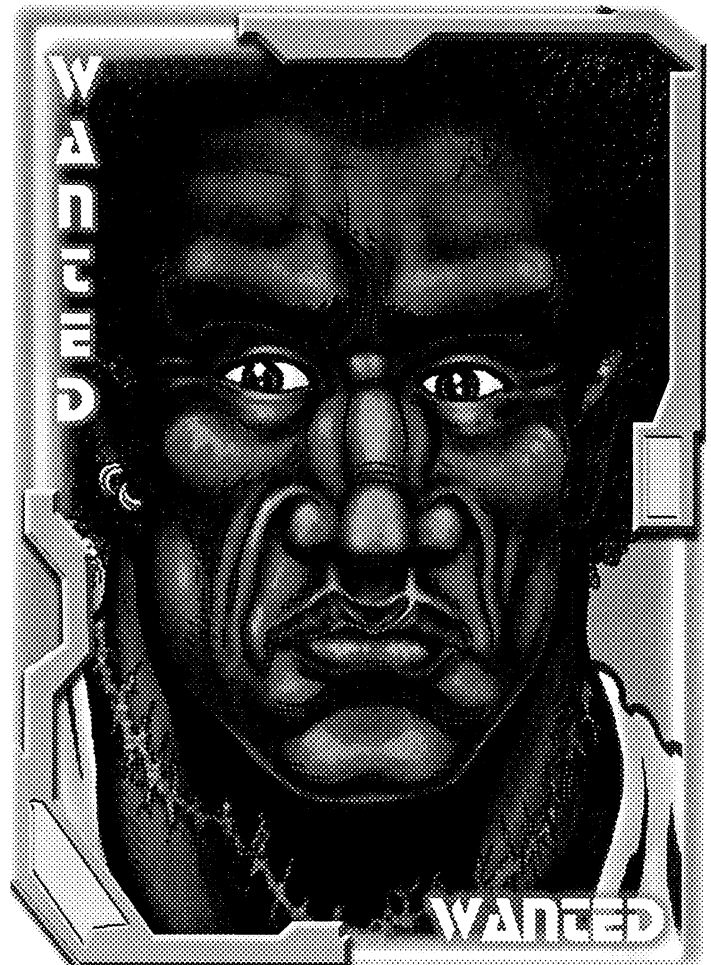

## Krane T’zaka

### Wanted *Alive Only*

#### Merc Ops Number Nine Most Wanted

#### Bounty Commissioned by Colorado Baronies

1,000,000 Credits payable upon receipt of the fugitive.

There is *no* bounty payable for a corpse.

#### Known Statistics

**Full Name**: Krane T’zaka.

**Known Aliases**: Bob.

**Race**: Human.

**Sex**: Male.

**Age**: 33.

**Height**: 6 feet, 2 inches (1.9 m).

**Weight**: 240 lbs (108 kg).

**Build**: Large, muscular and athletic.

**Eye Color**: Green.

**Hair Color:** Black, curly hair.

**Skin Color:** African American, dark brown.

**Distinguishing Features:** He has one large scar that runs around his throat, as if someone tried to cut off his head.

**Known Capabilities:** Krane is suspected to be some type of practitioner of magic, although no one knows for sure.

**Previous Accomplices:** He is always accompanied by his two pet coyotes, both are scraggly and scrawny.

**Last Known Location:** Silvereno in the Colorado Baronies, but he may be headed further west or south into the heart of the Pecos Empire.

**Arrest Warrant For:** The highjacking of a shipment of Techno-Wizard weapons bound for the Tolkeen defenders.

**Criminal Record:** None, while Krane has been suspected of other crimes, he has never been convicted.

**History:** Near the end of the Tolkeen-Coalition War, a large shipment of Techno-Wizard weapons was en route from the Colorado Baronies to the besieged Kingdom of Tolkeen. The order was collected from all around the Baronies and loaded onto a single, large hover cargo truck for transport to Tolkeen. The driver for the truck was to be one Krane T'zaka, a young adventurer with some magical talents. While he was somewhat new to the area, the leaders of the community trusted him. Six guards were assigned to escort and protect the cargo, and a Wilderness Scout to get them to Tolkeen safely.

The six guards and the scout were found four days later, all dead. There was no sign of the hover cargo trucks, the load or the driver. It is suspected that the entire shipment was stolen by the driver, or that he was the "inside man" for the heist. Whether or not he pulled the trigger, he's still responsible for these men's murders. He is wanted by the Colorado Baronies *alive*, because they want more information, what became of the shipped goods, where are they, who were his accomplices, was he working for the Coalition States, and so on.

## The Fugitive's Story

If captured, Krane T'zaka will admit to selling the weapons shipment, but he claims he really didn't steal them, and denies killing the guards and the scout.

The way he tells it, everything was going as planned when a CS mechanized scout force found them. The seven of them decided to hold off the Coalition while he escaped with the hover truck. The guards pulled out some of the heaviest Techno-Wizard weapons he had ever seen, and laid down some cover fire as he took the hover truck over a ridge. From his vantage point, Krane could see the battle down below, the seven of them in a deep ditch trying to hold off two Hellfires and a Spider-Skull Walker. They didn't have a chance. It only took 90 seconds for the CS 'bots to eliminate them, but not before the defenders were able to immobilize the three robots vehicles and completely knockout the Spider-Skull Walker! While the seven of them died, the remaining Coalition troops were stranded and unable to follow Krane as he fled with the arms shipment. The only problem was that he did not know any direct route to Tolkeen, and now he was scared. It seemed obvious to him, that somebody had sold him and the escorts out. Why else would the CS troops have been laying in ambush? There's seldom Coalition troops this far west – somebody had to have given them in-

side information – and if that were true, then more could be waiting ahead.

He felt like a sitting duck out there in a vehicle full of very expensive Techno-Wizard weapons and with nowhere to take them, so he decided to take a back road he knew about, and head for the nearest town where there would at least be other people. When he got there, he bumped into a mercenary company complaining about getting cheated out of their pay, having the CS on their tail, and being low on weapons and ammo. They had come from Tolkeen, where they said the kingdom's days were numbered and that they were lucky to get out when they did. Among the group were numerous Line Walkers and other practitioners of magic who could use TW weapons, so Krane approached one of the lieutenants and offered him the shipment, at bargain prices. Truth was, he didn't know what was in the truck or what it might be worth. The mercs did, because they were acting like children on Christmas morning. They offered him 55,000 in Universal Credits, another 50,000 in trade items, and let him keep the truck (worth 60,000 credits all by itself). He just wanted to get the stuff off his hands, and escape CS scrutiny. Let these mercs worry about it. Besides, if Tolkeen's days were numbered then they didn't really need the cargo and wouldn't have been able to pay for it. Either way the Baronies were going to lose out. This way, at least, the magic items wouldn't fall into the Coalition's hands, and people who could use them, maybe to fight the CS, would get them. Meanwhile, he'd score a nice nest egg and get a truck that he could use to make cargo and supply runs. A good deal for everyone.

He knew he couldn't return to the Baronies, so he headed south and has been working making cargo runs to various places in Arizona and the Pecos Empire (Texas). He swears that's the truth and pleads for his captors to let him go free. If a bribe is required, he can pay 25,000 credits – it's all he has left.

## Game Master Notes – The True Story

The following is the real background on this character. Only serious investigation and/or dumb luck will reveal any of this information; Game Master discretion.

A lot of what **Krane T'zaka** claims as his story is true. He had no plan to steal the magic items, he did not kill anybody, the CS really did jump them from an ambush position (a traitor in the Colorado Baronies?), the CS did kill everybody, and he really was scared spitless. However, Krane is not as dumb as he pretends. Although he is not a spell caster, he knew darn well that his cargo was worth millions, especially east of the Mississippi in the Magic Zone. There was no point in getting himself killed trying to make the delivery to Tolkeen, besides, according to a merc outfit from Tolkeen, the kingdom's days really were over, so Krane decided *somebody* should profit from this sad turn of events, and that somebody was him. He'd go east and sell it for millions of credits!

The problem was the cargo was too hot and the CS had the Mississippi sealed off. He'd have to wait. Krane has hidden away 90% of the cargo in an abandoned mine and sold off 5% at the bargain price of 580,000 credits to make his wait more comfortable. That sale was more than he's ever seen in his life and will keep him happy for another six months until the CS lets up and he can get to the Magic Zone. He figures the cargo is worth at least 20 Million (try 5 times that amount) and all he has to do is sit back and enjoy the good life.

If he should need anything, he'll just sell off a few items piecemeal or he could head south, except he's afraid of vampires. He's also considered trying to sell them at MercTown or Arzno, but is afraid that someone will get wise and cause him grief.

This is his windfall, the money that will enable him to retire in the lap of luxury, and no amount of threats or coercion or even physical torture will force him to reveal the location of his treasure. He'd rather die than let someone else find it.

**Note:** Krane has no love for the CS. The jagged scar around his neck, ear to ear, is from a sadistic CS officer who threatened to cut his head off if he didn't tell him where a group of D-Bee outlaws were hiding. Krane knew they were innocent and he liked them, so he took the torture and almost died. One of the D-Bees he protected with his silence healed him.

## True Stats for Krane T'zaka

**Race:** Human.

**Alignment:** Anarchist.

**Attributes:** I.Q. 12, M.E. 14, M.A. 10, P.S. 17, P.P. 12, P.E. 13, P.B. 10, Spd. 9.

**Hit Points:** 62, **S.D.C.:** 92.

**Height:** 6 feet, 4 inches (1.92 m).

**Weight:** 220 lbs (99 kg).

**Age:** 23.

**Sex:** Male.

**P.P.E.:** 3. **I.S.P.:** 39.

**Experience Level:** 5th level Vagabond/Trucker/Laborer.

**Insanities:** None.

**Horror Factor:** None.

**Skills of Note:** Athletics (Aerobics & General), Astronomy (85%), Basic Math (89%), Brewing (45/50%), Cook (65%), Demon & Monster Lore (45%), Dowsing (50%), Find Contraband (38%), Land Navigation (66%), First Aid (75%), Pick Pockets (55%), Prowl (45%), Pilot: Hovercraft (Ground; 90%), Pilot: Hovercycle (82%), Pilot: Truck (70%), Running, Speak American (98%), Swimming (75%), Track: Animals (40%), Wilderness Survival (50%), W.P. Energy Rifle and W.P. Energy Pistol.

**Magical Knowledge:** None.

**Psionics:** Minor psychic with Mind Block (4) and Object Read (4).

**Natural Abilities:** Not applicable.

**Combat Training:** Hand to Hand: Basic.

**Attacks Per Melee:** Five.

**Combat Bonuses:** +1 to initiative, +1 to strike, +2 to parry, +3 to dodge, +3 to damage, +1 to disarm, +2 to pull punch, +2 to roll with punch, fall or impact.

**Favorite Weapons:** Wilk's 227 Pulse Pistol: Mega-Damage: 2D6 M.D. per single blast and 4D6 per double blast. Rate of Fire: Each single blast or pulse counts as one melee attack. Range: 900 feet (274 m). Payload: 12 double pulse shots. Note: Has four extra E-Clips.

A TK-Rifle: Mega-Damage: 3D6 M.D. Rate of Fire: Standard/each shot counts as one melee attack. Range: 1600 feet (488 m). Payload: 12 shots. I.S.P. Cost to Activate: 30 (half that in P.P.E.).

A Fire Ball Pistol: Mega-Damage: 2D6 M.D. Rate of Fire: Standard/each shot counts as one melee attack. Range: 200 feet (61 m). Payload: Three shots. I.S.P. Cost to Activate: 10 (half that in P.P.E.) per every three fire balls.

**Body Armor:** NG Range Rider Armor (30 M.D.C. main body +28 when wearing an M.D.C. duster over it), plus has an *amulet of Armor of Ithan* (100 M.D.C., three times per 24 hours).

**Personal Vehicle:** The hover truck, hidden away, and a Bronco Scooter (110 M.D.C. main body, 190 mph/304 km max speed, 60 foot/18.3 m maximum altitude).

**Other Equipment:** Basic wilderness gear, tent, sleeping bag, canteen, air filter, gas mask, goggles, sunglasses, traveling clothes, and personal items, plus a TW Field Generator, TW Magic Optic system, and the entire shipment of TW weapons and equipment still in the truck hidden away in a mine shaft; the hover-truck too.

**Pets:** Krane always has a pair of tame coyotes at his side (Billy has 34 S.D.C. and Fang has 31 S.D.C.; their bites do 2D4 S.D.C. damage and they can run 30 mph/48 km when they have to). Both are friends and companions for long hauls and wilderness travel.

**Money:** He still has 147,000 credits left and the remaining TW weapons are worth 96 million on the open market at low end retail prices! Krane should be able to get at least 4D6+3 million for it as a lot, more if he sells it himself piece by piece, but that's more dangerous and time consuming. He plans on retiring someplace nice, the Chi-Town 'Burbs perhaps, or Kingsdale, or even Lazlo.

## Hook, Line & Sinker Adventure

### Stand-Off in the Desert

**Hook:** The player group has run afoul of a Coalition Long-Range Reconnaissance team looking for fugitives and war criminals from Tolkeen. For whatever reason, the team has targeted the group for termination or mistaken them for the ones the soldiers are looking for.

**Line:** They are pinned down when a man on a flying horse appears in the distance behind them and motions them to come his way. If they do, he has a secret hiding place (another abandoned mine) that the CS should not be able to find.

**Sinker:** Their rescuer is a wanted man. How bad do they need money, or do they try to figure out his story and see if they can find the missing magic weaponry for themselves? Krane will join the group (as a Non-Player Character, of course) because he feels up to a little adventure. This could lead to them becoming friends, their protecting him from bounty hunters or angry Tolkeen refugees, and so on. Whether he ever tells them about his treasure, or shares any of it with the group, will depend on how things work out over several months of role-playing. They'd have to become damn good friends for Krane to share his fortune.

**The Tolkeen Equation:** Unfortunately for Krane T'zaka, the bounty has made his face known to thousands of mercs, bounty hunters, adventurers and Tolkeen refugees, all of whom think he's a murderous sleeze bag who betrayed Tolkeen and hurt its chances for survival out of greed. Many Tolkeen survivors and

freedom fighters take that an unrealistic step farther, and claim that if T'zaka had made his delivery, Tolkeen might have successfully won the siege against them. This makes Krane a loathsome figure who should be hunted down and executed for commending the great kingdom to its doom. It's not true, but that's how many Tolkeenites see it. This makes Krane T'zaka a target of Retribution Squads and other Tolkeen extremists, possibly some dragons, Monster Squads and other Tolkeen loyalists. This could lead to a lot of conflicts, problems and adventure if he's an NPC member of the player group. Think about it.

## The “Blue Dragons” – Mercenary Squad

### Wanted *Alive* Only

#### Merc Ops Number Ten Most Wanted

**Bounty Commissioned by the Coalition States of El Dorado and Lone Star; also wanted in other jurisdictions, but the CS has the best bounty.**

**500,000 Credits** payable upon receipt of *each* of the fugitives. There are *no* bounties payable upon receipt of their corpses.

#### Known Statistics

**Full Names:** Christopher Schultz, Christoff Wosik, Kevin Thibert, Oskar Horyd, Stanley Burk and Steve Turner.

**Known Aliases:** Blue Dragons.

**Race:** It is believed that all the members of the Blue Dragons are humans.

**Sex:** All the Blue Dragons are male.

**Age:** Varies from their early twenties, to the late fifties.

**Height:** Varies, although they all are of roughly average heights.

**Weight:** Varies, although they all appear to be well fit.

**Build:** Average.

**Eye Color:** Unknown.

**Hair Color:** Unknown.

**Skin Color:** All the members appear to be Caucasian.

**Distinguishing Features:** Unknown, nobody has gotten a good look at the fugitives and those who know aren't talking.

**Known Capabilities:** They are a mercenary squad with no known psionic or magical capabilities, but possess limited cybernetics/bionics and heavy military weapons and equipment, including a modified, heavy combat hover tank. Only the six-man tank team is ever identified (the tank crew), but there may be other members of the Blue Dragons outfit as well as mercs or bandits hired on an as-needed basis.

**Previous Accomplices:** Known to have connections and buyers with numerous factions within the Pecos Empire, and are suspected of having ties (at least as a purchasing agent for their stolen weapons and goods) with Bandito Arms and the Black Market in general. May have connections to the MercTown Black Market or Thieves' Guild as well. Suspected of working with and selling booty to pirates operating in the Great Lakes and the Gulf of Mexico.

**Last Known Location:** Leaving the Coalition State of Missouri after hitting a Tolkeen Freedom Fighter supply convoy and a platoon of Coalition troops. Heading south towards the Pecos Empire or the Coalition State of Lone Star.

**Arrest Warrant For:** The mercenary unit is responsible for numerous raids on communities in Coalition held territories as well as raids on CS military outposts, supply convoys and troops.

**Criminal Record:** Raiders and bandits operating throughout the American Midwest and Southwest.

**History:** The Blue Dragons have been raiding military outfits, base camps, and towns throughout the Midwest and Southwest for three years now. What their exact origins may be remains a mystery.

Do NOT be fooled! Although the current bounty has been posted by the Coalition States in the south, the Blue Dragons have attacked countless communities and merc companies with no affiliation with the CS, including the city-state of Arzno and a few Kingsdale border towns. These men are raiders and opportunists who will attack whenever the opportunity presents itself. EVERYONE is a potential target. The fact that they tend to direct the majority (80%) of their attacks against military targets, including the Coalition, mercenary and adventurer groups, and nomads does not make them friendly toward independent communities or small bands.

### The Fugitives' Story

“Ain't nobody's business why we do what we do. Maybe it's because we can, and there ain't nobody to stop us. Now hand over your gear, real slow and gentle like, if you want to stay in one piece.”

### Game Master Notes – The True Story

The following is the real background on this group of characters. Only serious investigation and/or coming across the right person will reveal any of this information; Game Master discretion.

## The Blue Dragons

The simple story is the Blue Dragons are bad to the bone. Each member of the squad has his own origin story, but all share a common mean streak and love the thrill of combat, killing and looting. All of them have served in somebody's army or worked as mercs for years before hooking up together. The squad has quickly become one of the most notorious group of raiders in North America and just doesn't care about anybody but themselves. Ultimately, they expect to get rich and have fun doing it, but the Blue Dragons spend most of their money as fast as they make it.

The crew has all kinds of connections with the bandits of the Pecos Empire who, collectively, are the mercs' biggest customer for military hardware, especially CS gear. They also have strong ties with pirates in the Great Lakes and in the Gulf. When things get too hot, they lay low in the Pecos Empire or along the Mexican border, or *in Mexico* where the CS never goes and most mercs avoid.

The Dragoons enjoy their infamy and are thrilled to be famous. For most of them, power and fame is half the thrill.

Anyone who opposes them are killed. Anyone who hunts them are killed or lured to their doom in the Southwest via bandits, dinosaurs, monsters or vampires.

The team has no loyalty for other mercs or adventurers, distrusts magic, and don't like vampires, although they have made a few friends and contacts with the undead in Ciudad Juarez and a couple of Mexican border towns. Recently, the Blue Dragoons have aided Tolkeen military forces and Splugorth Slavers and recovery teams (trying to recover magic items and Tolkeen's TW secrets). The Blue Dragoons don't trust magic, but that doesn't preclude them from stealing it and selling it.

Although the Blue Dragoons tend to avoid working with others (they don't trust anybody) they do sometimes accept bounties and sometimes hook up with other small mercenary units, Pecos Bandits and pirates, but only for a short while and only if the money sounds good. Then again, the Blue Dragoons also act on whim, and the breeze catches them just right, who knows what they might get involved in.

Sarge came up with the name for the group during a weekend of binge drinking with an ice dragon. He doesn't remember

where he got the idea from, but the rest of the crew likes it, they think it sounds snappy and they've decided to keep it.

## Old Glory – The Tank

Old Glory is a modified *NE-J2 Juggernaut Heavy Hover Tank*, with the optional force field generator and the following additional changes, additions and souped-up features. This type of vehicle is rare in North America. The CS systematically hunts them down and destroys them so relentlessly that few merc companies or kingdoms buy them anymore. The vehicle is also out of the price range of most mercenary companies.

**Model Type:** NE-J2

**Crew:** Four: one pilot, two gunners and a commander; can accommodate one passenger.

**M.D.C. by Location:**

Main Turret – 700 (souped up)

Particle Beam Cannon in Turret – 250

Mini-Missile Launchers in Turret (8) – 50 each

RG-14 Rail Gun on Cupola – 100

Side-mounted Medium Range Missile Launchers (8) – 75 each

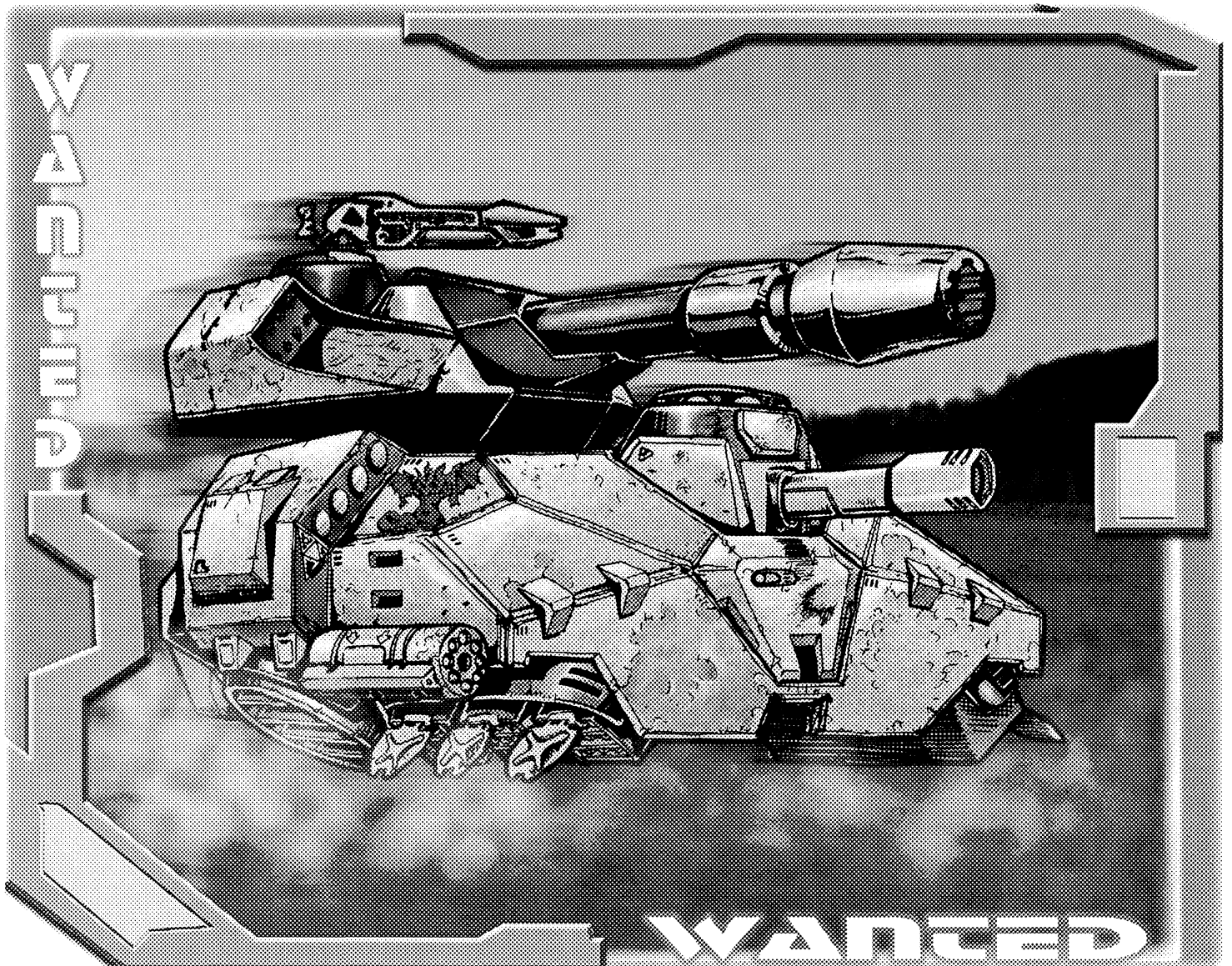

Front Mounted Artillery Turret (1) – 150  
Short-Range Missile Launchers (2) – 35 each  
Mobile Mine Deployment System (1; rear) – 55  
\* Fan Skirts – 350  
Reinforced Crew Compartment – 200  
\*\*Main Body – 1100 (souped up)  
Force Field – 400

\* Destroying the Fan Skirts will destroy the hovercraft system, grounding the vehicle and rendering it immobile. Field repairs will take at least 1D6 hours (and there is a 50% chance that the tank will need major repairs). Hitting the fan skirts requires a Called Shot (no penalty).

\*\* Depleting the M.D.C. of the main body destroys the vehicle.

**Speed:** Driving over ground: Technically, the Juggernaut hovers over the ground, but it cannot lift itself more than five feet (1.5 m) off any surface.

Maximum speed is an impressive 170 mph (272 km) on land (slower than the standard 200 mph/320 km due to the extra armor modifications). The Juggernaut can travel over swamps and mud normally, but it is too heavy to go over water (it will sink like a stone).

#### **Statistical Data:**

Height: 20 feet (6.1 m).

Width: 26 feet (7.9 m).

Length: 35 feet (10.6 m).

Weight: 200 tons.

Cargo: Minimal storage space: about four feet (1.2 m) for extra clothing, weapons and personal items. Four NE-15 rifles and four NE-60 rocket rifles with 10 magazines/E-Clips each are stored in locked overhead compartments.

Power System: Nuclear; average energy life is 15 years.

Cost: 80 million credits with the force field.

#### **Weapon Systems:**

**1. Improved Armor:** The armor on the main body of the tank has been improved from 900 M.D.C. to 1100 M.D.C. and the armor on the main turret has been improved from 600 M.D.C. to 700 M.D.C., but this has reduced the tank's speed by 15%. All are noted in the stats.

**2. Naruni Particle Beam Cannon (main gun):** This cannon requires a special capacitor that is charged by the nuclear engine at a slow rate. The weapon is controlled by a gunner in the turret, although the commander or the secondary gunner can also take over in an emergency. Turret can rotate 360 degrees and has a 45 degree arc of fire.

Primary Purpose: Anti-Vehicle.

Secondary Purpose: Defense.

Mega-Damage: 5D6x10 M.D. per blast.

Rate of Fire: Each blast counts as one of the gunner's melee attacks.

Effective Range: 11,000 feet (about two miles/3.2 km).

Payload: Effectively unlimited but restricted. Fully charged, the cannon has 60 blasts. The cannon recharges at the rate of one energy blast per minute. To compensate for the possible lapse in particle beam firing power, several mini-missile launchers and

an RG-14 Rail Gun on a cupola have been fitted as secondary weapons for the turret gunner.

**3. Forward Artillery Cannon Turret (1):** This weapon replaces the standard bow-mounted rail gun cannon (damaged in combat and unable to be replaced). The weapon is controlled by a gunner inside the tank although the commander or the secondary gunner can also take over in an emergency. Turret can rotate 45 degrees side to side and has a 45 degree arc of fire.

Primary Purpose: Anti-Vehicle.

Secondary Purpose: Defense.

Mega-Damage: 1D6x10 M.D. per plasma round blast.

Rate of Fire: Each blast counts as one of the gunner's melee attacks.

Effective Range: 8,000 feet (2438.4 m).

Payload: 40 rounds.

**4. RG-14 Rapid Acceleration Electromagnetic Rail Gun (1; on top of the main gun):** This "Boom Gun" replaces the original cupola mounted laser battery on the tank, the massive recoil handled by the enormous weight of the tank and adjustments to the hover system. The Boom Gun is fired by the tank commander, either by using the gun's trigger or by an electronic control rigged up inside the tank.

Primary Purpose: Anti-Armor/Assault.

Secondary Purpose: Anti-Aircraft/Defense.

Mega-Damage: One Boom Gun Flechette round holds 200 slugs that inflict 3D6x10 M.D.

Effects of the Sonic Boom: The tank is insulated from the shock waves of the Boom Gun, however, everybody within 200 feet (61 m) will be temporarily deafened. Characters without any type of head/ear protection will be temporarily deafened for 2D4 minutes and are -8 on initiative and -3 to parry and dodge. Characters who are in protective body or power armor will have some protection, but are still temporarily deafened for 1D4 minutes; same penalties apply. Each sonic boom adds to the duration of the deafness. The sonic boom will also affect the physical surroundings by shaking buildings and shattering S.D.C. windows within 300 feet (91.4 m) of the sonic boom.

Rate of Fire: Each blast counts as one of the gunner's melee attacks. Bursts and sprays are not possible!

Effective Range: 11,000 feet (about two miles/3.2 km).

Payload: 40 rounds, the rounds are held in a GB ammo carrying drum (it has 30 M.D.C.) attached to the side of the cupola, but the Boom Gun must be reloaded by hand, one round at a time. It will take about 15 minutes to load approximately 40 rounds.

**5. Short-Range Missile Launchers (2):** Bracketing the front of the tank, along the hover skirts, is a pair of short-range missile launchers. These are tube style auxiliary launchers, similar to those mounted on some helicopters, with 35 M.D.C. each.

Primary Purpose: Anti-Aircraft.

Secondary Purpose: Anti-Armor.

Mega-Damage: Varies with missile type.

Missile Type: Any short-range missile can be used, but they have it armed with plasma (2D6x10 M.D.).

Rate of Fire: One at a time or volleys of 2, 4, 6, or 8.

Effective Range: 5 miles (8 km).



Payload: 24 total missiles; 12 short-range missiles in each of the launchers.

**6. Mobile Mine Deployment System (1):** Mounted on the rear of the vehicle is a salvaged minelaying system. This voice-activated weapon tracks pursuing vehicles (including robots and power armor in excess of 7 feet/2.1 m tall), then releases one of three grades of NG anti-vehicle plasma mines designated by the pilot: light, medium, or heavy. The system then detonates the mine by radio command. A built-in safety prevents a mine from being detonated within range of the tank. Pursuers may alter course to avoid the mines, but in so doing, lose considerable ground. The mines can also be dropped and set to be activated when a target comes into range (30-70 feet/9.1 to 21.3 m). The mine deployment system has 50 M.D.C.

Mega-Damage: Varies by mine type (carries all three types); ideal for blowing out tires and damaging the feet of robots.

Rate of Fire: One per melee round (15 seconds).

Effective Range: The radio transmitter has a roughly 3000 foot (914 m) range.

Payload: 12 total; various types

**7. Rechargeable Force Field:** A Mega-Damage capacity force field generator can be added to the tank, at extra cost. The force field can be engaged at any time, usually at the beginning of heavy combat, thus letting the rechargeable field take the brunt of the initial combat damage.

*The two drawbacks of the field* are that the cupola Boom Gun cannot be fired and the Particle Beam Cannon will not recharge as long as the field is operating. The Particle Beam Cannon can fire its current payload, however, and the cannon and missiles are unaffected. Depleting the 400 M.D.C. of the force field will automatically shut the field generating system down and all subsequent damage is subtracted from the body of the tank. A depleted force field requires a full 24 hours to regenerate to full capacity. Even minor damage (100 M.D.C. or less) will require eight hours to restore to full power.

**8. Mini-missile Launchers in Turret (8):** These launchers come four on each side of the turret, and are controlled by the turret gunner.

Primary Purpose: Anti-Armor.

Mega-Damage: Varies with missile type. High Explosive (1D4x10 M.D.) is standard for Old Glory.

Rate of Fire: One at a time, or in volleys of two, four, or eight.

Effective Range: About one mile (1.6 km).

Payload: 48, six missiles per launcher.

**9. Side-mounted Medium Range Missile Launchers (8):** Four missile tubes are mounted on each side of the tank's main body. They can be fired by either the secondary gunner or the driver.

Primary Purpose: Anti-Vehicle and Anti-Aircraft.

Mega-Damage: Varies with missile type.

Rate of Fire: One at a time, or volleys of 2, 4, or 8.

Effective Range: 40 miles (64 km).

Payload: 48 missiles (six missiles per tube).

## Sgt. Chris Schultz (a.k.a. Sarge)

Schultz was your typical army brat who would never have made it through basic training if it weren't for his daddy, a CS Army colonel. Chris spent more time in the stockade during his basic training than he did in the field. He was caught pushing drugs, pimping prostitutes, running illegal gambling, and a variety of other schemes that would turn him a quick buck. The final straw was when Schultz was arrested for loan sharking. His father finally had enough and refused to bail Schultz out. Chris did three years in the stockade and was forced to repeat his basic training. Upon completion of his second boot camp, it was noticed that he had a natural aptitude for the water, so he was reassigned to the fledgling CS Naval Infantry.

At the Naval Infantry Institute, he found a place where he could excel, even if he didn't feel like he was really a sailor and hated the military's rigid rules and code of ethics more with every passing day. His own aptitudes leaned more toward anarchy and crime. Still, he was doing well in the Navy, and it only took another year for Schultz to be promoted to a Reconnaissance Landing Team as a Commando. This also earned him a promotion to Corporal and some additional training that few infantrymen receive. Schultz liked being an RLT Commando and it didn't take long for him to be promoted to the rank of Sergeant. Even though he was put second in charge of their RLT, he still wanted out of the service. He liked the work, but not the restrictions of rank and the responsibilities of duty.

After a few years at sea, the Revenge class destroyer he was assigned to was sunk by a Splugorth Slaver ship. Rather than staying to fight a hopeless battle, he took this opportunity to desert. (The CS had him listed MIA for a long time.) He joined a band of pirates and did a three year stint with them. He enjoyed piracy and raid operations, but eventually decided to go off on his own.

He and his crew don't hate the CS, it's just that he knows them so well that they are easy and lucrative targets. After all, he's in this business as a raider for the money and glory. For Sgt. Chris Shultz, money isn't everything . . . it's the only thing.

**Race**: Human.

**Alignment**: Anarchist.

**Attributes**: I.Q. 12, M.E. 10, M.A. 21, P.S. 18, P.P. 23, P.E. 19, P.B. 10, Spd. 17.

**Hit Points**: 32. **S.D.C.**: 91.

**Height**: 6 feet, 2 inches (1.9 m).

**Weight**: 195 lbs (87.75 kg).

**Age**: 29.

**Sex**: Male.

**P.P.E.**: 7. **I.S.P.**: None.

**Experience Level**: 6th level CS Naval Commando turned Mercenary.

**Description**: A well-built, tall Caucasian male with short, dark brown hair and green eyes. He has a CS Naval Infantry tattoo on his left forearm and a tattoo of a falcon on his right upper arm. Chris also has a deep scar across his right wrist.

**Insanities**: None.

**Disposition**: Schultz is rather cocky and arrogant of his abilities, not because he is a big-mouth, but because he is a highly trained specialist and his attitude reflects this. Sarge's atti-

tude still gets him into more trouble than his teammates sometimes think he is worth. Schultz doesn't realize it, but the only thing that's kept him in place as Sergeant and team leader is his knowledge of CS operations, procedures and troop movements, as well as his ties to pirates and his Special Ops skills. Furthermore, he excels in times of crisis and thinks fast on his feet. Unfortunately, his daily lifestyle of "writing checks his body can't cash" is going to catch up to him someday.

**Horror Factor:** None.

**Skills of Note:** Athletics (Aerobics & General), Body Building, Boxing, Climbing (75/65%), Demolitions (89%), Demolitions Disposal (89%), Demolitions: Underwater (82%), First Aid (70%), Land Navigation (73%), Parachuting (80%), Pilot: Tanks & APCs (68%), Prowl (65%), Radio: Basic (80%), Read Sensory Equipment (60%), Running, S.C.U.B.A. (85%), Sniper, Speak American (98%), Swimming (95%), Weapon Systems (75%), Wilderness Survival (65%), Wrestling, W.P. Energy Pistol, W.P. Energy Rifle, W.P. Heavy Energy Weapon and W.P. Knife.

**Magical Knowledge:** None.

**Psionics:** None.

**Natural Abilities:** Trust/Intimidate of 65%.

**Combat Training:** Hand to Hand: Commando.

**Attacks Per Melee:** Seven.

**Combat Bonuses:** +3 to initiative, +6 to strike, +10 to parry and dodge, +5 to damage, +1 to disarm, +7 to pull punch, +6 to roll with punch, fall or impact, +3 to save vs Horror Factor, +8% to save vs coma/death, +2 to save vs magic, +3 to save vs poison, toxins, and diseases.

**Other Combat Info:** Karate Kick does 2D4 S.D.C. damage, Knockout or a Pin/Incapacitate on an unmodified roll of 20.

**Favorite Weapons:** Schultz still has several of his old CS weapons, he has 4 standard E-Clips and 6 long E-Clips.

He has a pair of **C-18 Laser Pistols:** Mega-Damage: 2D4 M.D. Rate of Fire: Standard. Range: 800 feet (244 m). Payload: 10 shots. Chris has had the opportunity to replace them with better pistols, but has a fondness for these old ones.

**CP-40 Pulse Laser Rifle:** Mega-Damage: Setting One: 2D6 M.D. or Setting Two: 6D6 M.D. S.D.C. Damage: Setting Three: 3D6 S.D.C. or Setting Four: 1D6x10 S.D.C. Rate of Fire: Each blast, whether S.D.C. or M.D.C., single shot or triple pulse counts as one melee action. Range: 2,000 feet (610 m). Payload: 21 M.D. single shots or 7 triple pulse shots from a standard E-Clip, or 30 single shots (10 triple pulses) from a long E-Clip. Note that six S.D.C. shots equal one Mega-Damage blast. Laser Targeting: Add +1 to strike on an aimed shot only.

**CSN-T30 Torpedo-Grenade Launcher:** Mega-Damage: 4D6 M.D. to a blast area of 15 feet (4.6 m) per regular torpedo-grenade, or 1D4x10 M.D. to a blast area of 60 feet (18.3 m) with a new micro-fusion grenade. Rate of Fire: One at a time, or up to six torpedo-grenades fired in rapid succession (burst if all at the same target, wild if sprayed into an area). Range: 400 feet (122 m) underwater. Torpedo-grenades can be fired on the surface, but have a minuscule range of 30 feet (9 m), have a blast radius of 10 feet (3 m) and do less damage (3D6 M.D.; micro-fusion 6D6 M.D. to a 40

foot/12.2 m blast area). Payload: 10 shots per detachable circular drum magazine. Schultz currently has 40 torpedo-grenades and 12 micro-fusion grenades.

**Body Armor:** Repainted (red) Shark Naval Infantry Armor (100 M.D.C.), but with a customized demon-faced helmet.

**Personal Vehicle:** He rides in "Old Glory" with the rest of the Blue Dragoons, normally acting as the Tank Commander and Squad Leader.

**Other Equipment:** A creature of habit, Schultz always carries at least three fragmentation and two plasma grenades, two signal flares, two Vibro-Knives (1D6 M.D.), survival knife, utility belt, first aid kit, air filter and gas mask, fatigues, dress uniform, combat boots, backpack, a canteen, a 3D camouflage suit that fits over his body armor (+10% to Prowl and Camouflage skills), black jumpsuit for night operations, two fusion blocks, swim fins, heavy-duty rucksack, tinted goggles, distancing binoculars, IRMSS & RMK, water purification kit, a week of freeze-dried rations, and some personal effects.

**Money:** 12,000 credits on him at any given time and 48,600 credits salted away in a bank at MercTown, but that's a pittance compared to what he's made over the last few years.

## Christoff Wosik (a.k.a. Wrench)

Even in his childhood Chris, called "Wrench" by his friends, was known for tearing apart and rebuilding anything he could get his hands on. It seems he was a natural born Operator. He loved electronics, robots, vehicles, and machines of all kinds. Tinkering and repairing things was the way he spent his days, even though he was born in Lazlo and his parents wanted him to learn magic, like a good boy. Techno-Wizardry, perhaps, since he liked machines so much. But Wrench would hear none of it, he wanted to apprentice with a mechanic and learn to design and build vehicles, robots and other machines for his living.

Although there were plenty of Operators to learn from in Lazlo, Wrench found the person he wanted to apprentice under in a mercenary company that was traveling through the area. The merc group may have been a little small, but they specialized in armored combat. The unit had two NE Juggernaut Heavy Hover Tanks, four Glitter Boys, six Iron Hammer MBTs, and four NG Hunter Mobile Gun robots, along with a collection of secondary and maintenance vehicles. Once Wrench was taken on as an apprentice he had the opportunity to work on a wide variety of combat vehicles, more than he would have been exposed to at Lazlo. He quickly took to working on these heavy combat vehicles and became one of the best combat mechanics in the company. Wrench was assigned the role of driver for one of the Juggernauts and because that squad's dedicated Operator.

Things went great for Wrench for a long time. He enjoyed piloting the huge tank and combat was a thrill, although he tried not to think of the poor bastards on the receiving end of their main gun. The mercs fought many battles and Wrench remained with them for over six years. It was not until a battle at Tolkeen that the merc company's luck ran out. They went up against an armored robot company of the Coalition Army and had their butts handed to them. The battle was fierce, their unit had never went up against a force equal to them before, and the CS forces hammered them. When the retreat was called, only Wrench's

tank and a lone Glitter Boy made it out. His tank had been badly damaged and the Glitter Boy pilot died shortly thereafter, his left arm had been blown off during the battle. Likewise, his own tank crew was badly chewed up, two died, two others deserted, leaving him in sole possession of the tank. That was about two years before the fall of Tolkeen.

After a short time being solo and working on tank repairs, he ran into Sarge. The two hit it off instantly and Sarge plunked down 420,000 credits from a huge score he'd just made into the repairs of the tank. Wrench fixed up his tank and the pair began their career as heavyweight raiders, picking up the rest of the crew and making connections along the way. A year ago, Wrench made the final additions to the armor and weapons on Old Glory, an NE-J2 Juggernaut Heavy Hover Tank, making the vehicle more deadly than ever.

**Race:** Human.

**Alignment:** Anarchist.

**Attributes:** I.Q. 24, M.E. 9, M.A. 10, P.S. 12, P.P. 12, P.E. 21, P.B. 11, Spd. 31.

**Hit Points:** 54. **S.D.C.:** 52.

**Height:** 5 feet, 6 inches (1.68 m).

**Weight:** 176 lbs (79.2 kg).

**Age:** 23.

**Sex:** Male.

**P.P.E.:** 4, **I.S.P.:** 58.

**Experience Level:** 7th level Operator and tank driver.

**Description:** Wrench is an average looking guy with wild, bright red hair and pale skin and ample freckles, so without a helmet he stands out in a crowd.

**Insanities:** None.

**Disposition:** Wrench is very friendly and outgoing, and can be a real ladies' man on the prowl after a few drinks. While a professional at his craft, he tries not to let that get in his way when he is having fun working on some new toy, or adding a new weapon system to his hover tank "Old Glory." Old Glory is his true pride and joy, and while he will let the other Blue Dragoons command the tank and fire its guns, only "he" is permitted to drive the vehicle and make improvements and modifications. If the team ever breaks up, the tank goes with him.

**Horror Factor:** None.

**Skills of Note:** Advanced and Basic Math (98%), Aircraft Mechanics (75%), Athletics (Aerobics & General), Automotive Mechanics (75%), Body Building, Boxing, Computer Operation (90%), Computer Programming (80%), Computer Repair (75%), Electrical Engineer (90%), Mechanical Engineer (85%), Photography (85%), Pilot: Hover Craft (Ground; 98%), Pilot: Motorcycle (98%), Pilot: Tanks & APCs (85%), Radio: Basic (90%), Radio: Scramblers (80%), Read American and Techno-Can (80%), Read Sensory Equipment (90%), Robot Electronics (80%), Robot Mechanics (70%), Speak American and Techno-Can (98%), Vehicle Armorer (80%), Weapons Engineer (80%), Weapon Systems (90%), W.P. Blunt and W.P. Energy Pistol.

**Magical Knowledge:** None.

**Psionics:** Major psychic but only has three powers: Mind Block, Object Read and the super-psionic power of Telemechanics.

**Natural Abilities:** None.

**Combat Training:** Hand to Hand: Martial Arts.

**Attacks Per Melee:** Six.

**Combat Bonuses:** +1 to strike, +5 to parry and dodge, +4 to damage, +1 to disarm, +5 to pull punch, +5 to roll with punch, fall or impact, +14% to save vs coma/death, +4 to save vs magic, poison, toxins, and diseases.

**Other Combat Info:** Kick does 1D6 S.D.C. damage, Critical Strike on an unmodified roll of 19 or 20, and Knockout on an unmodified roll of 20.

**Favorite Weapons:** His tank.

**Body Armor:** T-13 Field Mechanic body armor (80 M.D.C.), this is his brand new armor and it's never even been scratched yet.

**Personal Vehicle:** He owns the "Old Glory" and is the tank's driver (he won't let anyone else drive it).

**Other Equipment:** Portable tool kit with an electric screwdriver and additional interchangeable heads, wrenches, etc., large tool kit, soldering iron, laser torch (for welding), lots of duct & electrical tape, pen flashlight, large flashlight, a dozen flares, portable language translator, protective goggles, work gloves, diagnostic equipment & computer, multi-optics headband, air filter and gas mask, binoculars, stethoscope, flexible telescopic mini-periscope and some personal items.

**Money:** 20,000 credits on him at any given time and 168,000 credits salted away at various banks and locations in the Midwest. Wrench is a saver.

## Kevin Thibert

As the oldest member of the Blue Dragoons, Kevin does not like to reflect on his past. He began as a simple bounty hunter out in the New West. He earned a good reputation as a capable bounty hunter and brought many a Gunslinger and bandit to justice, although it was usually the justice of the grave. He became known for taking out deadly Gunfighters by sniping them from long-range, killing the bounty from a range that no Gunfighter or Gunslinger could match. While some called him a coward, a yellow bellied snake, for using such low-down tactics as long-range sniper attacks, ambushes and surprise, he didn't care. And if the person got too outspoken or threatening, Kevin would shut him up with the butt of a rifle or a deadly energy blast. He wasn't a coward, he just always felt that it wasn't worth risking his neck just to bring in a fugitive alive, not when the bounty was also paid for a corpse.

When Kevin headed east, he found his old skills as a sniper and bounty hunter were in demand among many of the mercenary units. He plied his trade with several different units and is well known as a top notch sniper. He even worked for a few of the larger units, like Larsen's Brigade and Braddock's Bad Boys for a while, but realized that his skills were best suited to smaller operations. That led Kevin in and out of many small merc units. Although he simply packed up and left a number of units, others weren't left so much as survived. As a unit's sniper, he is often hidden away in a secluded sniper's nest, while the squad he is covering is engaged in more conventional face to face combat. This has led him to be rather grumpy and detached from his comrades, so that he doesn't get to close too them, just in case he ends up watching them all die, again.

He is one of the newest members of the Blue Dragoons, joining them after his last unit was double-crossed and eliminated by Armageddon Unlimited about a year ago. Many would expect Kevin to want to get revenge on Armageddon Unlimited, but he realizes that they were just looking to maximize their profits by disposing of the hired help. Since Kevin realizes this is just the way the merc game is played, he is not taking it personally, but if he does get a chance to “pop” a few of their men, he is likely to do so. Kevin is just in the business to save up enough credits for a long overdue retirement.

**Race:** Human.

**Alignment:** Diabolic.

**Attributes:** I.Q. 10, M.E. 9, M.A. 6, P.S. 19, P.P. 20, P.E. 20, P.B. 9, Spd. 26.

**Hit Points:** 53. **S.D.C.:** 78.

**Height:** 5 feet, 5 inches (1.6 m).

**Weight:** 165 lbs (74.25 kg).

**Age:** 52.

**Sex:** Male.

**P.P.E.:** 2, **I.S.P.:** None.

**Experience Level:** 9th level Bounty Hunter (as found in **Rifts® New West**).

**Description:** Kevin is a grey bearded, old war dog, with white hair and old blue eyes that have seen too many battles. He is covered in old battle scars, and is starting to get a pot-belly, but his short frame bears his age well.

**Insanities:** None.

**Disposition:** Kevin is mean, ornery, gruff, grumpy and surly, and these are just his good points. He has been jaded to the world from years of bounty hunting, both in the New West and in eastern North America. He has seen too many fights, battles and wars to be inclined to go on any more great adventures. No, he would like to just pack it all in, but cannot afford to. He is a free spender and has never gotten around to saving any credits for his old age, so he is forced to work as a mercenary sniper. But he would prefer to just find a nice plot of land out west and set himself up a little ranch and learn how to ride a horse.

**Horror Factor:** None.

**Skills of Note:** Athletics (Aerobics & General), Basic Math (98%), Body Building, Boxing, Climbing (80/70%), Detect Ambush (80%), Detect Concealment (70%), Escape Artist (75%), Find Contraband (68%), Intelligence (79%), Interrogation (80%), Land Navigation (83%), Pilot: Hovercycle (98%), Pilot: Motorcycle (98%), Prowl (65%), Radio: Basic (98%), Sniper, Speak American and Spanish (98%), Surveillance Systems (80%), Streetwise (50%), Swimming (98%), Track: Humanoids (80%), Trap/Mine Detection (70%), Wilderness Survival (85%), Wrestling, W.P. Energy Pistol, W.P. Energy Rifle and W.P. Sharpshooting.

**Magical Knowledge:** None.

**Psionics:** None.

**Natural Abilities:** None.

**Combat Training:** Hand to Hand: Commando.

**Attacks Per Melee:** Seven.

**Combat Bonuses:** +6 to initiative, +5 to strike, +9 to parry and dodge, +3 to automatic dodge, +8 to damage, +2 to disarm,

+3 to automatic body flip/throw, +11 to pull punch, +8 to roll with punch, fall or impact, +6 to save vs Horror Factor, +10% to save vs coma/death, +3 to save vs magic, poison, toxins, and diseases.

**Other Combat Info:** Karate Kick does 2D6 S.D.C. damage, Jump Kick (Critical Strike), W.P. Paired Weapons, Knockout or Pin/Incapacitate on an unmodified roll of 20, Critical Body Flip/Throw (double damage), Backward Sweep Kick: Used only against opponents coming up behind the character.

Does no damage; it is purely a knockdown attack (same penalties as body flip) but cannot be parried (an opponent can try to dodge it but is -2 to do so). Death Blow on a Natural 18-20!

**Favorite Weapons:** Kevin’s “working” weapon an **NE-75H Shoulder Cannon**: Mega-Damage: 2D4x10+20 M.D. per shot from a heavy plasma cartridge. Rate of Fire: Each shot counts as one melee attack. Range: 6,000 feet (1,829 m). Payload: 8 cartridges in magazine. He has four magazines for the weapon and a total of 64 heavy plasma cartridges.

For simple self-defense he uses an **NG-IP7 Ion Pulse Rifle**: Mega-Damage: Single shot for 3D6 M.D., or triple pulse burst for 1D4x10 M.D. Rate of Fire: Standard. Range: 1,600 feet (488 m). Payload: 18 with a standard E-Clip, 30 shots with a long clip. Kevin always has two standard E-Clips and six long E-Clips on him for the pulse rifle.

Tucked in his boot is a **TX-5 Triax Pump Pistol**: Mega-Damage: 4D6 M.D. Rate of Fire: Standard. Range: 800 feet (244 m). Payload: 5 rounds, loaded manually, one round per melee action. He has 30 rounds for his pump pistol.

**Body Armor:** Kevin has suit of NE-BA-50 “Raider” Heavy Battle Armor (140 M.D.C., which takes half damage from M.D. fire, heat, plasma and kinetic attacks, like explosions, rail guns, bullets, missiles, grenades, etc., and masks infrared emissions).

**Personal Vehicle:** Kevin’s hovercycle was destroyed some time ago, so he has been riding shotgun in Steve’s Pathfinder.

**Other Equipment:** An extra suit of light armor (50 M.D.C.), several sets of clothing, camouflage fatigues, a gas mask and air filter, tinted goggles or sunglasses, infrared distancing binoculars, portable language translator, a dozen tracer bugs, a pocket scrambler, 4 sets of handcuffs, utility belt, backpack, a pair of Vibro-Bowie knives (2D4 M.D.), Neural-Mace, a dozen tear gas grenades, passive nightvision goggles, and some personal items.

**Money:** 8,000 credits, with 90,000 credits in a bank and a home in Kingsdale.

## Oskar Horyd

Oskar was born into poverty and was orphaned by the time he was six. Struggling to survive, he eventually lost his left hand as a punishment for stealing from the receiving plate of a religious cult. As a teenager, his opinion of the world grew particularly grim. However, fortune smiled on him when a locksmith took him on as an apprentice. The old locksmith took Horyd off the streets and taught him a worthy trade, eventually helping him to earn enough credits to replace his lost hand.

One fateful evening a safe with a faulty lock was delivered to the shop to be opened. That night, as Oskar was keeping an eye

on the safe, a thief broke in and he told the kid to open it, *or else*. Of course, Oskar did as he was told and was surprised to hear the thief offer him a share of the loot for doing so. Completely on impulse, Oskar took his share and asked the thief if he could join him. He was looking for a new mentor to teach him new things. He was tired of the tedious work around the shop and wanted a life of adventure and fortune. The thief agreed and the two ran out into the night.

The relationship with his new mentor lasted until Oskar decided to break into the same church that lopped off his hand. The thief wouldn't cross that line, so the two went their separate ways. Shortly thereafter, Oskar broke into that church and stole every credit in the coffers as well as all the financial records that could prove the church's connections to criminal operatives in the town. He anonymously handed the data over to the local authorities, so they could shut down the crime ring and bring justice to the corrupt church. Mission accomplished, Oskar felt good about himself and was able to finally close the book on that painful chapter of his life. It didn't take him too long to meet up with the boys in Blue Dragoons, a fine crew that was in need of a thief with his special talents for opening things.

**Race:** Human.

**Alignment:** Miscreant.

**Attributes:** I.Q. 13, M.E. 14, M.A. 12, P.S. 10, P.P. 14, P.E. 10, P.B. 24, Spd. 11.

**Hit Points:** 38. **S.D.C.:** 24.

**Height:** 5 feet, 10 inches (1.7 m).

**Weight:** 180 lbs (81 kg).

**Age:** 26.

**Sex:** Male.

**P.P.E.:** 4. **I.S.P.:** None.

**Experience Level:** 5th level Safecracker/Thief.

**Description:** Average height, fair skin, an average build. He is always clean shaven, has brown eyes and short-cropped brown hair.

**Insanities:** None.

**Disposition:** Outwardly, Oskar is an outgoing person who generally puts others before himself. Most of the members of the Blue Dragoons enjoy having him around as he always has something insightful to add to the conversation. However, when forced to interrogate a prisoner, his cruel streak comes out and it has earned him the nickname "Mr. Horrid." **Horror Factor:** 10, but only when he is torturing a prisoner.

**Skills of Note:** Basic Electronics (65%), Basic Math (85%), Climbing (60/50%), Computer Hacking (39%), Computer Operation (70%), Computer Programming (50%), Computer Repair (45%), Cooking (55%), Cryptography (45%), Demolitions (87%), Demolitions Disposal (87%), First Aid (55%), Gemology (50%), Intelligence (53%), Locksmith (65%), Mechanical Engineer (55%), Pick Locks (65%), Pilot: Hovercraft (Ground) (80%), Prowl (45%), Read American (65%), Read Sensory Equipment (50%), Research (60%), Speak American (98%), Streetwise (40%), Surveillance Systems (55%) and W.P. Energy Pistol.

**Magical Knowledge:** None.

**Psionics:** None.

**Natural Abilities:** Charm/Impress of 70%.

**Combat Training:** Hand to Hand: Basic.

**Attacks Per Melee:** Five.

**Combat Bonuses:** +3 to initiative, +1 to strike, +5 to parry and dodge, +2 to pull punch, +2 to roll with punch, fall or impact.

**Other Combat Info:** Kick does 1D6 S.D.C. damage.

**Favorite Weapons:** Oskar carries few weapons but does have a **Wilk's 320 Laser Pistol:** Mega-Damage: 1D6 M.D. Rate of Fire: Standard, aimed, burst, wild. Range: 1000 feet (305 m). Payload: 20 shots with a standard short E-Clip, 40 shots with a long E-Clip. Bonus to Strike: +2 bonus to strike on an aimed shot because of the light weight and superior balance.

**Wilk's 447 Traditional Laser Rifle:** Mega-Damage: 3D6 M.D. Rate of Fire: Standard. Range: 2,000 feet (610 m). Payload: 20 shots standard E-Clip, can not use a long E-Clip. Bonus to Strike: +1 to strike on an aimed shot. Oskar carries six standard E-Clips that he uses for both the laser rifle and the laser pistol.

**Body Armor:** Urban Warrior body armor (50 M.D.C.) with a custom brushed black finish.

**Personal Vehicle:** He rides in "Old Glory" with the rest of the Blue Dragoons, normally acting as the radio/missile operator.

**Other Equipment:** Several sets of clothing, a set of black fatigues, fine leather gloves, ski-mask to hide his face, stethoscope, tinted goggles, PC-3000 handheld computer, PDD, audio recorder, laser distancer, flashlight, portable tool kit, automatic lock pick gun, lock picking kit, first-aid kit, IRMSS & RMK, 12 explosive hand grenades, 6 smoke grenades, 8 flares, 20 shaped charges, five pounds (2.25 kg) of plastique, 4 standard fusion blocks, and an entire case of dynamite sticks.

**Cybernetics/Bionics:** Amplified Hearing, Sound Filtration System, Ultra-Ears and a Sensor Hand for his left arm.

**Money:** 24,000 credits.

## Stanley Burk

Born into the mercenary life, Burk is the son of two mercs who operated in the Canadian North and around demon-plagued Calgary. His earliest memories are of cleaning energy weapons, recharging E-Clips and handling explosives. Death and killing is as natural to Burk, as breathing is to most other people, so it was only natural that Burk would become a mercenary himself. While he stayed in his parents mercenary company for some time, eventually he decided to strike out on his own and he headed east, where the guns-for-hire work was flowing. However, upon his arrival in Ontario, Burk found that much of the work had dried up, thanks to the Coalition States and Free Quebec coming to a mutual understanding. While there was mercenary work to be had, it was grunt work for chump change.

Like most professional warriors, Burk has seen his share of ups and downs. In one engagement he simultaneously lost an arm, eye and lung, all along his right side. He was caught in the blast radius of a missile that took out the tank he was using for cover. While he lived, he needed massive bionic reconstruction, which he got by agreeing to serve a six year stint with the merc company that had originally hired him for special operations. Burk didn't mind much. The state of bionics had improved dramatically since the "early days," and he had seen plenty of

bionic limbs among mercs so it seemed a natural progression, maybe even a badge of honor to get his own bionics.

Burk is a real Techno-Hound, but he tends to prefer gadgets that he can carry as opposed to those which are implanted in one's body.

He got out of his service agreement when the company he worked for was devastated in a brutal ambush. It was pure luck that Burk and one other had been sent to check on a lead in the opposite direction. On his own again, Burk worked solo as a mercenary until he ran into a band of mercs in Upper Michigan – the Blue Dragoons. The group had need of a reliable extra man, and the tank crew hit it off with Burk right from the start. They made him feel like he fit in, so he joined the team. He liked the idea of being a part of a small unit that specialized in smash and grab operations, supplementing their income with a little smuggling, a little bounty hunting and a little piracy. Burk was tired of putting his butt on the line every day in large scale war, and liked these small scale operations. He also liked having the heavily modified NE-J2 Juggernaut hover tank as their main vehicle and source of power. Burk has never regretted his decision to sign on with the Blue Dragoons, and has a copy of the current bounty notice tucked away in a scrapbook for Ma and Pop.

**Race:** Human.

**Alignment:** Anarchist with leanings toward Miscreant.

**Attributes:** I.Q. 13, M.E. 19, M.A. 13, P.S. 21 (bionic; right arm), P.P. 13, P.E. 23, P.B. 12, Spd. 19.

**Hit Points:** 19. **S.D.C.:** 97.

**Height:** 6 feet (1.83 m).

**Weight:** 202 lbs (91.5 kg).

**Age:** 38.

**Sex:** Male.

**P.P.E.:** 3. **I.S.P.:** None.

**Experience Level:** 6th level Techno-Hound Headhunter.

**Description:** Burk is a battle-hardened warrior, covered in scars and old war wounds. His right arm has been replaced with a bionic one for quite some time. His right eye and lung are also bionic. Burk's salt and pepper hair is always kept crew-cut length and his face clean shaven, except for a well kept moustache. With startling green eyes, an impressive build and stature, Burk can often intimidate rivals just by his imposing presence and stern demeanor.

**Insanities:** None.

**Disposition:** Burk is a rough, tough, serious warrior who rarely smiles and never allows anyone to call him "Stan" only "Burk." He does have his friendly and jocular side, which comes out in the bar among friends. In battle, Burk is the no-nonsense soldier who only takes the risks necessary to complete the mission at hand and to ensure the enemy is killed.

**Horror Factor:** None.

**Skills of Note:** Athletics (Aerobics & General), Body Building, Boxing, Camouflage (60%), Computer Operation (75%), D-Bee Lore (60%), Demon & Monster Lore (60%), Detect Ambush (65%), Detect Concealment (65%), Faerie Lore (60%), Find Contraband (68%), Land Navigation (66%), Parachuting (80%), Pilot: Automotive (80%), Pilot: Hovercraft (Ground) (85%), Pilot: Motorcycle (90%), Pilot: Tanks

& APCs (66%), Radio: Basic (85%), Radio: Scramblers (70%), Read Sensory Equipment (65%), Recognize Weapon Quality (65%), Running, Speak American and French (98%), Swimming (60%), Tracking (60%), Trap Construction (55%), Trap/Mine Detection (60%), Weapon Systems (75%), Wilderness Survival (65%), Wrestling, W.P. Blunt, W.P. Energy Pistol, W.P. Energy Rifle, W.P. Heavy Energy Weapons, W.P. Paired Firearms, W.P. Sharpshooting (Energy Pistol and Energy Rifle) and W.P. Sword.

**Magical Knowledge:** None.

**Psionics:** None.

**Natural Abilities:** None.

**Combat Training:** Hand to Hand: Expert.

**Attacks Per Melee:** Six.

**Combat Bonuses:** +2 to initiative, +3 to strike, +6 to parry and dodge, +8 to damage, +2 to disarm, +8 to pull punch, +5 to roll with punch, fall or impact, +3 to save vs Horror Factor, +2 to save vs psionics and insanity, +26% to save vs coma/death, +4 to save vs magic, +4 to save vs poison, toxins, and diseases.

**Other Combat Info:** Kick does 1D6 S.D.C. damage, Critical Strike on an unmodified roll of 18, 19 or 20, and Knockout or a Pin/Incapacitate on an unmodified roll of 20.

**Favorite Weapons:** Always ready for action, Burk always carries 12 standard E-Clips and eight long E-Clips.

Has a pair of **Wilk's 227 Pulse Pistols:** Mega-Damage: 2D6 M.D. per single blast, or 4D6 per double blast. Rate of Fire: Standard. Range: 900 feet (274.3 m). Payload: 12 double pulse shots with a standard short E-Clip, 24 shots with a long E-Clip. Bonus to Strike: +2 bonus to strike on an aimed shot because of the light weight and superior balance.

A pair of **NG-57 Northern Gun Heavy-Duty Ion Blasters:** Mega-Damage: Two settings, 2D4 or 3D6 M.D. Rate of Fire: Standard. Range: 500 feet (152 m). Payload: 10 shots per standard E-Clip, or 18 with a long E-Clip.

His favorite weapon for heavy combat is an **NG-E12 Heavy Plasma Ejector:** Mega-Damage: 1D6x10 M.D. Rate of Fire: Standard. Range: 2000 feet (610 m). Payload: 4 shots standard E-Clip, or 8 shots long E-Clip.

**WI-23 Missile Launcher:** Mega-Damage: Any type of mini-missile can be used, but he normally uses plasma mini-missiles (1D6x10 M.D.). Rate of Fire: Equal to the user's number of attacks per melee (maximum 6); reloading the magazine takes three melee actions if using a box magazine, or one full melee round if reloading loose missiles. Range: One mile (1.6 km). Payload: Six missiles per magazine. Has two sets of replacement plasma mini-missiles.

**WI-GL4 Revolving Grenade Launcher:** Mega-Damage: Fragmentary: 4D6 M.D. to a blast area of 12 feet (3.6 m). Armor-Piercing: 1D4x10 M.D. to a blast area of 3 feet (0.9 m). Can also fire smoke, illumination and chemical rounds. Rate of Fire: As many as hand to hand attacks per melee. Reloading the tubes takes two full melee rounds. Range: 1,000 feet (305 m). Payload: 24 rounds. Burk has 48 extra grenades stored on the outside of the hover tank.

**Body Armor:** He wears a suit of customized Coalition CA-6EX Heavy Armor (200 M.D.C.), with the skull motif removed.



**Personal Vehicle:** He rides on “Old Glory” with the rest of the Blue Dragoons, normally acting as the tank’s gunner.

**Other Equipment:** Several sets of street clothes, one set of dress clothes, camouflage outfit for covert operations, combat boots, a Neural-Mace, six Vibro-Knives (1D6 M.D.), two fragmentation grenades, gas mask and air filter, bedroll, high-impact sunglasses, a hatchet for cutting wood, knapsack, tent and backpack, canteen, and some personal items.

**Cybernetics/Bionics:** Right arm is bionic with retractable Vibro-Blades (2D6 M.D.) and concealed Arm Laser (1D6 M.D., range: 800 feet/244 m). Bionic Lung with Oxygen Storage Cell, Multi-Optic Eye, Cyber-Armor (50 M.D.C.) and Universal Headjack.

**Money:** 35,000 credits is carried on him, he has “sent home” more than 200,000 credits and he has another 200,000 tucked away for bionic repairs and upgrades as needed.

## Steve Turner

Steve began life as a child of prestige and privilege living in the upper levels of the famed Chi-Town fortress city. He attended the best of schools reserved for the Coalition’s elite and had everything money and power could buy. Everything but his parents’ time and affection. He was a bit of a loner and troublemaker in school, but his parents money always got him through any difficulties he may have created. Steve’s life of luxury fell apart when it was revealed that his father, a producer of parts for Coalition vehicles, had been overcharging the CS Armed Forces by almost 30% on every part his company produced. Steve’s family was disgraced, dishonored and discredited. The courts forced his father to surrender the family business as punishment and restitution, and the family was forced to move out of their privileged upper-level home to the squalor and artificial light of the lower levels. Without the money and the business, the family was cast into impoverished shame. It didn’t take long before his parents couldn’t stand the life of the poor and destitute. Late one evening, Steve heard two gunshots, ran into his parents tiny bedroom and found his mother and father both dead. His mother had shot his dad through the head, then turned the gun on herself. He was 17 and he had lost everything.

He declined an offer to join the CS military (he blames them for his parents’ deaths and all his problems), cashed out everything that his family had left, which wasn’t much, and moved out of the great city of Chi-Town permanently. It didn’t take long to find someone who would buy his identity and citizenship documents from him. In the ‘Burbs there are thousands of people striving to get into the great fortified city and very few trying to leave it permanently. This meant that he was able to get 50,000 credits for his old life and put that money into building a new one. (**Note:** Being a pampered city kid, Steve had no idea his identity was easily worth 500,000 to a million credits. He was happy to get 50,000.)

Steven knew what commodities the rich and corrupt people of Chi-Town wanted, and what they would pay for them. After all, as the son of a rich man he had seen his father and his cronies buy a large number of illegal books and films from Black Market runners who visited the upper levels. Books and films his father had paid huge sums of credits to obtain (and the last nail in his family’s coffin when investigated for fraud, con-

demning them to the bowels of the city). So he decided to become a smuggler, bringing products who people wanted to those that could afford them.

While smuggling solo went well for many, many years, eventually Steve decided to hook up with a mercenary group and try to break into the more lucrative business of running guns and energy weapons. He rolled over his profits to get a vehicle that could handle the new line of work and began his hunt for a merc crew with which to partner. As luck would have it, he found the Blue Dragoons and established a good working relationship with them. He finds it’s a matter of providence that he and the boys regularly target the Coalition Army for their raids, and he takes great pleasure in inflicting with disgrace and loss. Whenever a CS target is available, Steve is quick to support tackling it.

**Race:** Human.

**Alignment:** Aberrant.

**Attributes:** I.Q. 11, M.E. 10, M.A. 15, P.S. 15, P.P. 19, P.E. 11, P.B. 13, Spd. 10.

**Hit Points:** 28. **S.D.C.:** 34.

**Height:** 6 feet, 3 inches (1.9 m).

**Weight:** 190 lbs (85.5 kg).

**Age:** 35.

**Sex:** Male.

**P.P.E.:** 5. **I.S.P.:** 28.

**Experience Level:** 3rd level Smuggler.

**Description:** A tall, good looking white male with light blond hair and sparkling blue eyes.

**Insanities:** Deep, seated resentment for the Coalition Army and a borderline obsession to bring them hurt and disgrace.

**Disposition:** Steve is a quiet man with a tendency to be a loner. He is not the outgoing, fast-talking scoundrel one often pictures when they imagine how a smuggler should be. While he is friendly enough on a personal level, he is also reserved and calculating, always looking for his “edge” in any negotiations, as well as traps and trouble that might be coming his way.

**Horror Factor:** None.

**Skills of Note:** Art (55%), Basic Math (85%), Basic Mechanics (40%), Body Building, Computer Operation (65%), Concealment (38%), Cryptography (45%), Detect Ambush (55%), Detect Concealment (45%), Disguise (45%), Electronic Countermeasures (50%), Find Contraband (35%), Forgery (45%), General Repair & Maintenance (55%), Navigation (55%), Palming (40%), Pilot: Automobile (69%), Pilot: Hovercraft (Ground; 65%), Pilot: Truck (53%), Read American (65%), Radio: Basic (70%), Radio: Scramblers (55%), Recognize Weapon Quality (35%), Speak American (98%), Speak Euro and Spanish (80%), Streetwise (45%), W.P. Energy Pistol, W.P. Energy Rifle and W.P. Knife.

**Magical Knowledge:** None.

**Psionics:** Minor psychic with Mind Block (4) and Sixth Sense (2).

**Natural Abilities:** None.

**Combat Training:** Hand to Hand: Basic.

**Attacks Per Melee:** Four.

**Combat Bonuses:** +1 to initiative, +2 to strike, +4 to parry and dodge, +2 to pull punch, +2 to roll with punch, fall or impact.

**Other Combat Info:** Kick does 1D6 S.D.C. damage.

**Favorite Weapons:** L-20 Pulse Rifle: Mega-Damage: 2D6 M.D. single shot, or 6D6 triple-pulse burst. Rate of Fire: Standard. Range: 1600 feet (488 m). Payload: 40 shots per standard E-Clip or 50 shots long E-Clip. Only has two standard E-Clips.

**Body Armor:** He has Explorer body armor (70 M.D.C.), but he rarely has to use it, as he is not one of the squad's fighters.

**Personal Vehicle:** He owns an NE Pathfinder ATVR3 (360 M.D.C., 200 mph/320 km) that he practically lives in, but

which is used to store the group's equipment and whatever he is trying to smuggle at the time. It can hold 18 tons of cargo in a 30 foot (9.1 m) storage area.

**Other Equipment:** He has a huge wardrobe, with casual, dress, travel and work clothes, a PC-3000 hand-held computer, a full-sized computer in the ATVR, language translator, PDD, pocket flashlight, gas mask and air filter, tinted goggles and more personal items than the rest of Blue Dragons put together.

**Money:** 15,000 in Universal Credits and 300,000 credits worth of Black Market trading items.

---

# Power Armor & Vehicles

---

## Chipwell Armaments, Inc.

Chipwell Armaments is an arms dealer who specializes in low-end robotics, and business has never been better.

The Coalition's war on Tolkeen has created an aura of fear and concern that has encouraged kingdoms large and small, as well as mercenary companies and, especially, D-Bee groups, to upgrade, improve and expand their defenses and weaponry. Chipwell's best customers are small towns and kingdoms without a lot of money to throw around, but who have an immediate need for power armor protection. Small-time mercenary companies and adventurer groups also use Chipwell suits frequently. Professional soldiers and the best supplied mercs scoff at these inexpensive suits and robots, and would die of embarrassment if they were forced to use one. However, such elitism and snobbery vanishes on the field of combat, and if forced to choose between Chipwell armor and weapons versus no suits or gear at all, every single merc would welcome Chipwell gear and probably find it surprisingly adequate.

Despite Chipwell's reputation for simple, bargain basement weapons, armor, and robotics, the manufacturer has a large customer base and manages to find and fill niches left open by other companies. The following are a handful of new (at least to the Midwest and East), inexpensive power armor suits.

## Vampire Combat Armor Mark II

By Kevin Siembieda and Mark Sumimoto

(Inspired by material that first appeared in *The Rifter*® #4)

The Mark II is fundamentally an improved version of the discontinued Mark I. It is a simple suit of power armor made of heavy body armor, standard environmental systems and augmented by a light exoskeleton which makes it a light, basic suit of power armor. Designed to fight *vampires*, the suit is extremely popular in the *Southwest* where vampires have been an ongoing and escalating problem. For people living in what was once the old American and Canadian Empires, vampires are the stuff of legend and scary stories, but to the people of the Ameri-

can Southwest and Mexico, the undead are a nightmare and very, very real and dangerous. This suit is perfect for those living in *vampire territory* like Texas, Arizona, New Mexico and the wastelands of California, because it is comparatively inexpensive but fits most people's basic needs. "People" meaning regional wealthy cattlemen and landowners, lawmen, mercs, adventurers, explorers and vampire hunters on a budget.

On one hand, the Undead are superhuman beings invulnerable to most conventional weapons, even Mega-Damage ones. On the other, vampires are tragically flawed and susceptible to certain *ordinary* things, many of which have been incorporated into the Chipwell Vampire Combat Armor. Ordinary wood, silver, running water, and holy symbols are all capable of inflicting serious damage to vampires, and from Chipwell's point of view, this is wonderful, because all these materials are inexpensive, especially compared to M.D.C. armor and M.D. energy weapons. Thus, *Vampire Combat Armor* incorporates silver-plated claws, small searchlights, and a water-spraying gun to become an effective vampire killing machine. It also works as a simple deterrent, because the undead see people clad in Vampire Armor as someone prepared for them and probably best to avoid (there are plenty of human cattle for them to feed upon). Of course, against other supernatural creatures and mortal threats, the Chipwell Vampire suit is greatly inferior, but in the vampire-ridden American Southwest and Mexico, these armored suits are being scooped up like crazy, leaving better armed troops to deal with other threats and monsters.

**Model Type:** CAI-V50 Mark II

**Class:** Light Anti-Vampire Combat Armor.

**Crew:** One.

**M.D.C. by Location:**

Water Cannon (back, slung on the back) - 22

Water Drum - 18

Wooden Claws (2, retractable; left arm) - 30 S.D.C. each

Silver Forearm Claws (2, retractable; right arm) - 10 each

Arms (2) - 26 each

Legs (2) - 55 each

\*Head - 50

High-Powered Water Gun – 5

\*\*Main Body - 130

\* Destroying the helmet/head covering will eliminate all optics and sensor systems and has a 01-70% chance of knocking the pilot unconscious. If still conscious, the pilot must rely on his own vision and senses. No power armor combat bonuses to strike, parry, and dodge. **Note:** The head is a small and difficult target to hit, especially on a moving target. Therefore, the attacker suffers a penalty of -3 to strike even on a Called Shot.

\*\* Depleting the M.D.C. of the main body will shut down the armor, rendering it useless.

#### **Speed:**

Running: 40 mph (64 km) maximum; the act of running tires the pilot, but at 20% of the usual fatigue rate thanks to the robot exoskeleton.

Leaping: The robot can leap up to 15 feet (4.6 m) straight up or across.

Flying: Possible only with a jet pack (sold separately).

Underwater Capabilities: Not designed with underwater operations in mind, the suit has very poor mobility underwater. The best it can do is walk along the bottom at 10 mph (16 km). Losing even half of its M.D.C. will allow water to leak into the suit and fill it in a matter of minutes, drowning the pilot.

Maximum Ocean Depth: 400 feet (122 m).

Range: The suit operates on batteries that have a life of 24 hours before requiring a recharge. This gives it a practical range of only 500 miles (800 km). The suit's primary function requires that it operate at night, extending the charge of the batteries, and providing a lot of time to recharge and replace the batteries the next day. May be substituted with a standard fusion power supply, but adds one million credits to the cost and is just *not* worth it.

#### **Statistical Data:**

Height: 6-7 feet (1.8 to 2.1 m); human-sized.

Width: 3 feet (.9 m).

Length: 3 feet (.9 m).

Weight: 150 lbs (67.5 kg) without the water gun and drum.

Physical Strength: Equal to a Cyborg/Augmented Human P.S. of 21.

Cargo: None.

Power System: Electrical batteries, providing a life of 24 hours before requiring recharging.

Cost: 89,500 credits for a new, undamaged, fully powered suit with full weapon systems. Very popular in human cities in Mexico and Southwestern United States.

#### **Weapon Systems:**

**1. CAI-V Water Cannon:** This is just a conventional, portable water cannon with the tank and rifle-like gun mounted on the back of the suit.

Primary Purpose: Anti-Vampire.

Secondary Purpose: Fire-Fighting.

Weight: 11 lbs (5 kg), plus 35 lbs (15.8 kg) with a full tank.

Damage: 1D6x10 Hit Point damage to vampires and other creatures vulnerable to water with every "super-soaker" strike.

Rate of Fire: Each water blast counts as one melee attack.

Effective Range: 100 feet (30.5 m).

Payload: 60 water blasts.

**2. CAI-V Cross Spotlight (1):** This is just a conventional spotlight with a crucifix pattern on it. The spotlight may come as a should mounted mechanism that slides behind the shoulder when not in use, or as a handheld "light gun" – many mercs and vampire hunters feel more comfortable using a gun-like device. This incredibly simple projection mechanism (basically a durable, high-impact flashlight shaped as a gun) is very effective against vampires, particularly Wild and young (under 50 years old as an undead) Secondary Vampires.

Primary Purpose: Anti-Vampire.

Secondary Purpose: Flashlight/Illumination.

Damage: None to ordinary people, 2D6 Hit Point damage to *Wild Vampires*, 1D6 H.P. damage to *Secondary Vampires* and only 1D4 points of S.D.C. damage to *Master Vampires*. The damage results from the shadow of the cross, but the shadow cross must be clearly defined, whole and recognizable; most effective at ranges under 120 feet (36.6 m), beyond that the image begins to distort and becomes unrecognizable. Shining the image of the cross in front of a lesser vampire may also stop the fiend from stepping into its shadow and may hold the creature at bay.

Rate of Fire: Works like a flashlight, with each display of the image counting as one of the operator's attacks/actions.

Effective Range: 120 feet (36.6 m).

Payload: Hours, as long as the suit's or gun's batteries are charged.

**3. CAI-V Anti-Vampire Silver Claws (2):** These are extendible and retractable silver-plated claws typically mounted on the right forearm of the suit.

Primary Purpose: Anti-Vampire.

Damage: 3D6 S.D.C. damage plus P.S. damage bonus, double damage to vampires.

**4 CAI-V Anti-Vampire Wooden Blades or Shooter (2):** These are extendible and retractable hard wood claws typically mounted on the left forearm of the suit. A *wooden stake shooter* may be substituted.

Primary Purpose: Anti-Vampire.

Damage: 2D6 S.D.C. damage, plus P.S. damage bonus; double damage to vampires.

A Wooden Stake Shooter does 2D6 S.D.C. damage per stake launched.

Range: Hand to hand for the blades, or 100 feet (30.5 m) for the forearm stake shooter.

Payload: Two retractable blades or a launcher that can hold and fire two wooden stakes (one at a time or simultaneously). Takes three melee actions to reload two new stakes into the shooter. Extra stakes can be carried in a shoulder satchel, backpack or sack.

**5. Handheld Weapons:** Other weapons are often added to the suit's arsenal to make it somewhat effective against other opponents, but are not a part of the suit's standard equipment.

**6. Hand to Hand Combat:** Rather than use a vampire weapon, the power armor pilot can engage in Mega-Damage hand to hand combat or use any type of weapon, which is highly suggested against foes that are not vampires.

**Power Armor Punch:** 1D4 M.D. or 2D8 for a Power Punch (counts as two melee attacks/actions).

**Leap Kick:** 2D4 M.D.

### 7. Special Features:

A) A basic visual enhancement package: Laser targeting, telescopic, passive nightvision, and polarized lenses.

B) It also has a built-in short-range radio system.

C) Silver neck studs. Silver-plated bolts rim the neck and center of the chest, and will supposedly burn the hand of any vampire who tries to grab the armored warrior around the neck or remove his helmet. (**Note:** It's a good thought, but doesn't actually work like that. Still, it gives many buyers a false sense of security.)

D) White, yellow or red cross painted on the chest. Intended to hold vampires at bay and prevent them from grappling with the armored warrior. However, this simple approach only has any effect on *Wild Vampires* who are distracted by the holy symbol and suffer the following penalties when fighting someone in CAI-V50 Vampire Combat armor: -2 on initiative, -1 to parry and strike. It has no negative impact on Secondary and Master Vampires.

E) Has connectors for any style of conventional jet pack.

**Note:** Also see other vampire-fighter equipment in this book and in *Rifts® World Book One: Vampire Kingdoms*.

## Sky Power Armor

By Kevin Siembieda (inspired by ideas from Mark Sumimoto that appeared in *The Rifter®* #4)

It is said that only a Crazy or a Juicer would consider using Sky Power Armor in an all out battle, because is it a light armored unit that is comparatively slow, lacks maneuverability and has no anti-aircraft capabilities. Sky Power Armor is a far cry from the fast, heavily armored suits being produced by the Coalition States, Northern Gun, Triax and others, but the light-weight flying armor makes a decent air reconnaissance unit, scout or escort where no, little or light combat is anticipated. The Sky Power Armor has a pair of folding wings reminiscent to the SAMAS, but made of a durable, flexible M.D.C. plastic that gives them a fragile dragonfly appearance; they actually flutter, like a sail, in the wind. The overall flight system is about half as loud as a SAMAS and other flying power armors, and the Sky is capable of *silent gliding*. Flight capabilities are provided by an electric jet pack that is a light, built-in version of the more powerful portable jet packs.

Against a SAMAS or even Flying Titan power armor, the wearer of this suit doesn't have much of a prayer. However, against land-bound civilians or light troops without anything heavier than standard energy rifles, the Sky is an adequate war machine. It is popular among high-tech Wilderness Scouts, explorers, Operators, mail couriers, some Headhunters, bandits, espionage operatives and adventurers. The armor offers better than average protection compared to most suits of *body armor* (not power armor) and provides low cost and efficient aerial transportation. The Sky Power Armor's affordability has made it nearly as popular as the Triax Terrain Hopper among many wilderness communities, scouts and adventurers.

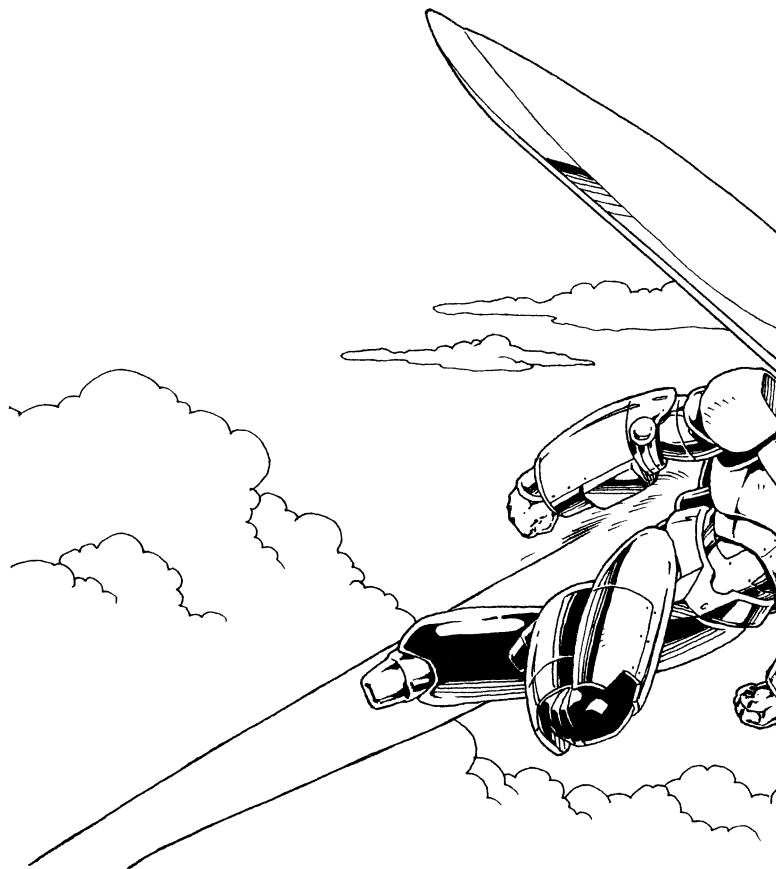

**Model Type:** CAI-77 SPA

**Also Known as:** The Little Dragonfly, a common nickname.

**Class:** Light Reconnaissance Flight Armor (usually advertised as light power armor).

**Crew:** One.

**M.D.C. by Location:**

Wings (2) - 28 each

Jet Pack (1; back) - 32

Arms (2) - 26 each

Legs (2) - 50 each

Built-in Jet Pack (1; rear) - 23

\*Head - 40

\*\*Main Body - 142

\* Destroying the head eliminates all optics and sensor systems and has a 01-70% chance of knocking the pilot unconscious. If still conscious, the pilot must rely on his own vision and senses. No power armor combat bonuses to strike, parry, and dodge. **Note:** The head is a small and difficult target to hit, especially on a moving target. Therefore, it can only be hit on a Called Shot at a penalty of -4 to strike, the same goes for the jet pack and wings.

\*\* Depleting the M.D.C. of the main body will shut down the armor, rendering it useless.

**Speed:**

**Running:** 40 mph (64 km) maximum. Note that the act of running tires the pilot, but at 20% of the usual fatigue rate thanks to the robot exoskeleton.

**Leaping:** 15 feet (4.6 m) straight up or up to 60 feet (18.3 m)

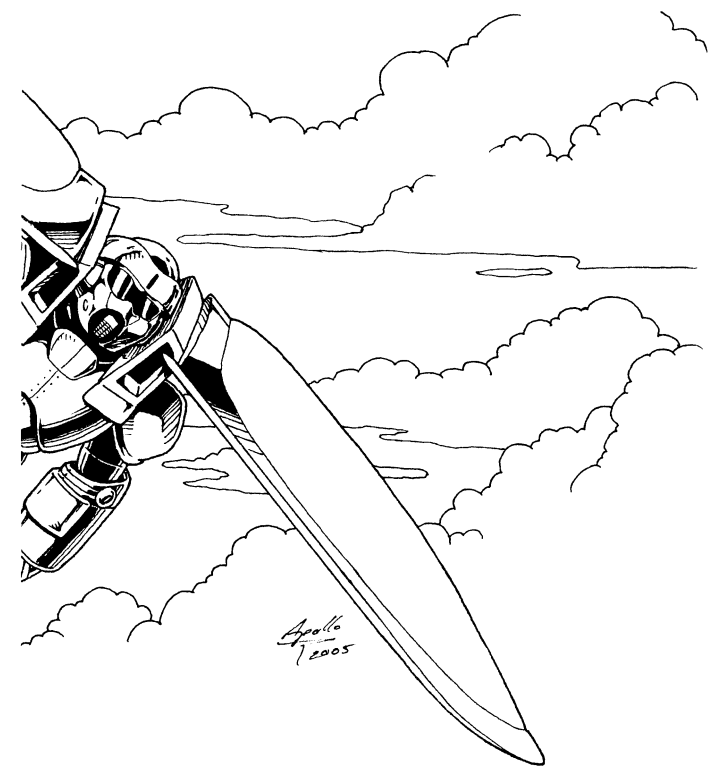

across when unfurling the wings to glide; double that range when gliding down from a high position to begin with (at least six stories or higher).

**Flying:** Maximum speed is 130 mph (208 km), but cruising speed and gliding speed are 40-60 mph (64-96 km). Maximum altitude is only 3000 feet (914 m), but that's still beyond the range of most handheld weapons.

**Flying Range:** The flight system runs on electrical batteries that have a range of about 600 miles (960 km) or about 9-10 hours of continuous flight, otherwise good for 48 hours of use with intermittent flying under ten hours total. Takes two hours to recharge the batters, six minutes to swap out spent batteries for fresh ones.

**Underwater Capabilities:** None and sinks like a rock.

**Colors:** Standard colors are Silver, white, grey, or black with optional red, blue or gold trim and highlights, and camouflage.

**Statistical Data:**

**Height:** 7 feet (2.1 m).

**Width:** 3 feet (.9 m) from shoulder to shoulder, 14 feet (4.2 m) with wings fully extended.

**Length:** 3 feet (.9 m).

**Weight:** 200 lbs (90 kg).

**Physical Strength:** Equal to a Cyborg/Augmented Human P.S. of 25.

**Cargo:** Straps and clamps allow the suit to carry a maximum of 200 additional pounds (90 kg).

**Power System:** Electrical batteries, providing a life of 24 hours before requiring recharging, plus the flight system has a separate power supply that gives it an average of 10 hours of use. In an

emergency, the suit's power can be routed to the jet pack to increase the range by 80 miles (128 km) per every hour of charge.

**Cost:** 164,000 credits for a new, undamaged, fully powered suit.

**Weapon Systems:** None per se. Weapons are limited to whatever the user carries with him (i.e., pistols, rifles, etc.), although forearm Vibro-Blades, and forearm and shoulder weapon systems like those used by cyborgs can be mounted on the Sky at additional cost (same as bionic equivalents).

**Features and Sensor Systems:**

A) The helmet is only equipped with basic optic systems: Laser targeting, telescopic, passive nightvision, and polarized lenses.

B) Short-range radio, 20 miles (32 km). Long-range radio system (400 miles/640 km) is optional but requires an antenna and costs an extra 10,000 credits.

C) Built-in compass and altitude reader displayed via Head's Up system in the helmet.

D) Simple radar that can track up to 32 different aerial targets; 80 mile (128 km) range.

## Chipwell Body Armor

Chipwell sells its own versions of all common body armor, including the Crusader (55 M.D.C.), Gladiator (70), Huntsman (40), Juicer Armor (45; basic), Plastic Man (35), Urban Warrior (50), and Bushman (60) at the standard list rates, as well as the *Land Roamer Power Armor* (the Sky Power Armor *without* the wings and jet pack; 135 M.D.C. main body, no weapons; costs 102,000 credits).

## Northern Gun

### NG-11F "Red Hawk" Flying Power Armor

For decades Northern Gun has produced the Samson as their primary power armor suit for export and sale. While an excellent robotic augmentation in its own right, the Samson lacks full flight capability and is showing the signs of age. People want new designs, and Northern Gun has its R&D teams working overtime on several new suits of power armor. The Red Hawk is one of NG's new designs, a SAMAS equivalent flying power armor.

Anyone with an eye for design or engineering will recognize the propulsion system and wing elements to be a clear knock-off of the Coalition's original SAMAS. (Northern Gun designers prefer the term "inspired.") Surprisingly, the Coalition States have not protested about Northern Gun's SAMAS "inspired" armor, which has led some to speculate that the Ishpeming government has either licensed the design from the CS or is being allowed to use the design as part of a secret deal – an arrangement some have speculated includes the manufacturing of old (and/or new) style SAMAS for the government of the Coalition States. If this speculation proves to be true, then it would be the first time that the CS has ever allowed an outside manufacturer

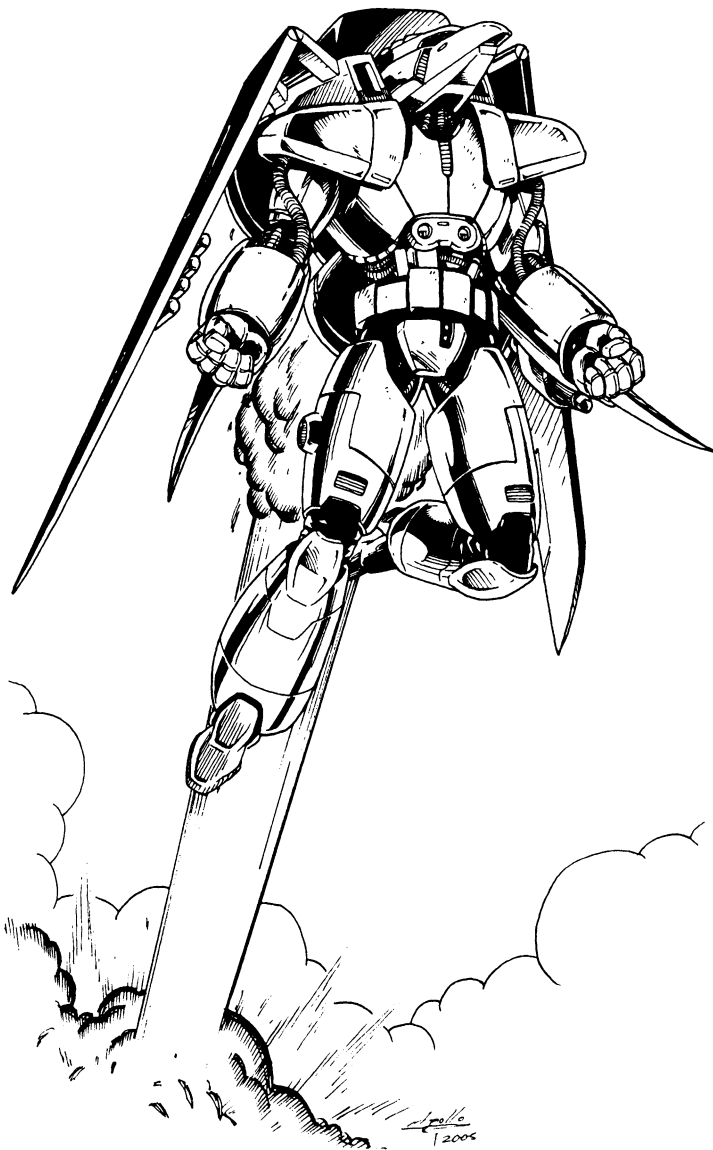

to make war machines for them, suggesting that the alliance between the Coalition States and Ishpeming/Northern Gun (and the Manistique Imperium) goes deeper than many people originally imagined. **Note:** The Ishpeming armed forces also use a variation of the Red Hawk.

Red Hawk power armor is an advanced, heavily armed and agile system that is, arguably, superior to the original CS SAMAS suit. In most aspects it is roughly on par to the original SAMAS, but has a special, heavy jet thruster that can be engaged in short spurts to give the Red Hawk bursts of rocket speed to attain a higher altitude or to zoom in and out of combat at great speed. The rest of the power armor looks nothing like the Coalition's SAMAS. The reinforced helmet has a very hawk/bird of prey appearance and is protected from behind by part of the jet thruster housing. Another cosmetic variation is a pair of scythe-like Vibro-Blades that extend from the forearm. A mini-missile or short-range laser can also be mounted on one or both arms. The Red Hawk is not nearly as capable as many of the newer Coalition SAMAS variants in the CS arsenal, as recently debuted during the *Siege on Tolkeen*, but it can hold its own with the old style Sams and most styles of flying power armor offered in North America. The Red Hawk has only recently

been introduced into the marketplace and is gaining popularity with mercenary companies, independent military forces and the armed forces of numerous kingdoms.

**Model Type:** NG-11F Red Hawk PA

**Class:** Armored Flying Infantry Assault Suit.

**Crew:** One.

**M.D.C. by Location:**

Shoulder Wings (2) - 45 each

Main Rear Jets (2) - 50 each

Rocket Jet (1; lower) - 60

\* Lower Maneuvering Jets (3) - 20 each

\* Hands (2) - 15 each

Arms (2) - 50 each

Legs (2) - 90 each

NG-202 Rail Gun - 50

Ammo Drum (rear) - 30

\*Forearm Blades (2) - 25 each

\*Forearm Mini-Missile Launcher or Laser (1 or 2) - 15 each

\*Wing Mounted Mini-Missiles (12) - 10 each

\*\* Head - 65

\*\*\* Main Body - 192

\* All areas that are marked with a single asterisk are small and difficult targets to hit. They can only be hit when an attacker makes a called shot, and even then he is -4 to strike (includes the head).

\*\* Destroying the head/helmet has a 01-70% chance of knocking the pilot unconscious. If conscious, the pilot has two problems: 1) No power armor combat bonuses to strike, parry, and dodge, and 2) the human head is now vulnerable to attack. The head is a small and difficult target to hit. Thus, it can only be hit when a character makes a Called Shot with a penalty of -5 to strike.

\*\*\* Depleting the M.D.C. of the main body will shut the armor down completely, and the pilot will be vulnerable to attack. Destroying one of the wings makes flight impossible, but the suit can still make jet assisted leaps.

**Speed:**

Running: 60 mph (96 km) maximum. The act of running does tire out its operator, but at 10% of the usual fatigue rate thanks to the robot exoskeleton.

Leaping: The powerful robot legs can leap up to 15 feet (4.6 m) high or across unassisted by the jet boosters. A jet booster assisted leap can propel the unit up to 100 feet (30.5 m) high and 200 feet (61 m) across without attaining flight.

Flying: The rocket propulsion system enables the Red Hawk to hover stationary up to 400 feet (122 m) or fly. Maximum flying speed is 290 mph (464 km), but cruising speed is considered to be 150 mph (240 km). **Note:** When the *super-thruster* is engaged, the Red Hawk rockets at a speed of 490 mph (784 km) but only for 90 seconds and all combat bonuses are reduced by half due to the high velocity and shaky movement. Great for surprise dive attacks, quick getaways and hot pursuits. **Note:** The Super-Thruster can be engaged six times per hour. An internal automatic shut-off switch won't allow more uses than that to prevent overheating and thruster burnout.



Maximum Altitude: Limited to 2000 feet (610 m); up to 4000 feet (1219 m) when the super-thruster is engaged, but the Red Hawk slowly descends to its normal 2000 foot (610 m) altitude.

Flying Range: The nuclear power system gives the Red Hawk 15 years of life, but the jet rockets get hot and need to cool after a maximum of eight hours of flight; can fly indefinitely with rest stops.

Underwater Capabilities: The Red Hawk is not designed for underwater combat, but is capable of functioning underwater. It cannot fly underwater, but can swim underwater at about four mph (6.4 km) or walk or run on the floor of rivers, oceans and lakes at about 25% of its normal running speed (15 mph/24 km).

Maximum Ocean Depth: 1000 feet (305 m).

#### **Statistical Data:**

Height: Approximately 8 feet (2.4 m) from head to toe, 9 feet (2.7 m) to the top of the propulsion system.

Width: 4 feet (1.2 m) with wings folded, and 13 feet (3.9 m) with wings extended.

Length: 4 feet, 8 inches (1.45 m).

Weight: 550 lbs (247.5 kg).

Physical Strength: Equal to a Cyborg/Augmented Human P.S. of 28.

Cargo: None.

Power System: Nuclear, average life is 12 years.

Cost: 2 million credits for a new, undamaged, fully powered suit complete with rail gun, ammunition and missiles. Poor to fair availability at most Northern Gun outlets, but good availability at Kingsdale and Arzno, and excellent availability at Ishpeming/Upper Michigan and MercTown.

#### **Weapon Systems:**

**1. NG-202 Rail Gun:** A standard NG-202 rail gun is the primary weapon system for the Red Hawk. The weapon draws power from the nuclear power plant and ammunition is fed from a drum magazine mounted on the back of the power armor.

Primary Purpose: Assault.

Secondary Purpose: Defense.

Mega-Damage: 1D4 M.D. for a single round, or 3D6 M.D. for a burst of 20 rounds or 1D4x10 M.D. for a burst of 40 rounds.

Rate of Fire: Each burst counts as one melee attack.

Effective Range: 4000 feet (1219 m).

Payload: 2800 round drum for 140 medium (3D6 M.D.) bursts or 70 heavy (1D4x10 M.D.) bursts. Reloading a drum takes about 5 minutes for those not trained, but only about 90 seconds by somebody trained in the use of power armor.

**2. Wing Mounted Mini-Missile Launchers:** As many as six mini-missiles can be attached to each of the Red Hawk's wings. These are mainly used in air-to-air combat against enemy aircraft or air to surface attack.

Primary Purpose: Anti-Aircraft.

Secondary Purpose: Air to ground assault.

Mega-Damage: Varies with missile type.

Missile Type: Any mini-missile can be used, but standard issue is armor piercing (1D4x10 M.D.) or plasma (1D6x10 M.D.).

Rate of Fire: One at a time or volleys of 2, 4 or 6.

Effective Range: One mile (1.6 km).

Payload: 12 total, six per wing.

**3. Forearm Ranged Weapon: Mini-Missile Launcher and/or Laser (1 per arm):** A mini-missile launcher or a short-range laser can be mounted on one or both of the forearms of the armor suit. The two-shot forearm mini-missile launcher is identical to the one used on the *NG Samson* power armor.

Primary Purpose: Anti-Armor.

Secondary Purpose: Assault.

Mega-Damage: Laser: 2D6+1 M.D.

Mini-Missile (varies with missile type): Any mini-missile can be used, but standard issue is armor piercing (1D4x10 M.D.) or plasma (1D6x10 M.D.).

Rate of Fire: Laser: One at a time or two simultaneous blasts; each single or double blast counts as one melee attack.

Mini-Missiles: One at a time or a volley of two.

Effective Range: Laser: 1000 feet (305 m). Mini-Missile: One mile (1.6 km).

Payload: Laser: Effectively unlimited (taps into the suit's power supply). Mini-Missile Launcher: Two per launcher (two launchers maximum).

**4. Scythe-Forearm Vibro-Blades (2):** A scythe-like Vibro-Blade can be extended and retracted from each of the Red-Hawk's forearms. These blades can be used in hand to hand combat and speed slashing runs. The pilot must be careful, however, especially in high speed dives and runs, for if he misses his intended target it is possible that he might hit an ally or collide into his opponent, or someone or something else (aircraft, wall, tree, the ground, etc.) and takes 1D10 M.D. for every 100 mph (160 km) of speed he is traveling. A failed roll to strike means the pilot must roll under his piloting skill with a -30% penalty. A failed piloting skill means the Red Hawk collides with its target or something nearby. High speed attacks and dive attacks always have a piloting penalty of -30%.

Primary Purpose: Anti-Power Armor.

Secondary Purpose: Defense.

Mega-Damage: 2D4 M.D. per strike in hand to hand combat at cruising speeds or slower. 4D4 M.D. at speeds of 61-150 mph (97.6 to 240 km), and 5D6 M.D. for attacks at speeds greater than that. Dive attacks count as two melee attacks/actions.

**5. Hand to Hand Combat:** Rather than use a weapon, the pilot can engage in Mega-Damage hand to hand combat (punches and kicks).

Restrained Punch: 1D4 M.D.

Full Strength Punch: 1D6 M.D.

Power Punch: 2D6 M.D., but counts as two melee attacks.

Power Dive Punch: 3D6 M.D., but counts as two melee attacks and all combat bonuses except to strike are reduced by half, including roll with impact.

Kick: 1D6 M.D.

Leap Kick: 2D6 M.D., but counts as two melee attacks.

May also use other handheld weapons (guns, clubs, etc.).

# NG-NX12 “Beach-Stormer” Marine Power Armor

A recent addition to the Northern Gun family of naval weapons systems is the NG-NX12 “Beach-Stormer” power armor. Just like its land-based counterparts, this marine power armor suit was developed to fill the gap between robot vehicles and regular body armor. Northern Gun executives recognized that marine infantry forms an essential element of naval combat forces, and that no North American arms manufacturers offered any marine armor suits besides simple body armor. Even the folks at Iron Heart Armaments supplied only regular flying power armor with their ships, not aquatic suits capable of combat diving and prolonged underwater maneuvers. The Beach-Stormer is Northern Gun’s first marine power armor suit, and it has been instantly accepted by naval forces, mercenaries, pirates and mariners of all kinds.

The NG-NX12 is somewhat of a “mongrel” creation that combines features of existing Northern Gun power armor with an underwater propulsion system. It has the durability and strength of the NG-X9 Samson, the NG-EX10 Gladius’ inexpensive construction and quickness, as well as a reliable hydro-jet propulsion pack that enables the power armor to travel at speeds of up to 35 mph (56 km) on the surface of water and 20 mph (32 km) under the water. The suit also has an impressive array of standard-issue underwater and surface weapons, making it a formidable water to surface combat machine. The NG-NX12 is excellent for all aspects of amphibious warfare operations, including scouting, underwater demolition, sabotage, search and rescue, exploration, beach reconnaissance, and of course, amphibious landings and assaults.

**Model Type:** NG-NX12

**Class:** Amphibious Infantry Assault Suit

**Crew:** One.

**M.D.C. by Location:**

Hydro-Jet Propulsion Pack - 30

Hands (2) – 8 each

Arms (2) - 45 each

Legs (2) - 65 each

Feet/Flippers (2) – 11 each

\* NG-P67 - 15

\* NG-M100 Underwater Rifle - 30

\* Head - 50

\*\* Main Body - 170

\* All of the targets marked with an asterisk are small and difficult to hit. Thus, they can only be struck when a character makes a Called Shot, and even then the attacker is -3 to strike. Destroying the head of the power armor will eliminate all forms of optical enhancement and sensory systems. The pilot must rely on his own human vision and senses; no bonuses to strike, parry or dodge from power armor combat – and will suffer from exposure to deep sea pressure at depths greater than 220 feet (67 m; takes 2D6 S.D.C./Hit Point damage per melee round and all bonuses are reduced by half!

\*\* Depleting the M.D.C. of the main body will shut the armor down completely, making it useless.

**Speed:**

Running: 40 mph (64 km) maximum. Removing the detachable hydro-jet propulsion pack adds +10 mph (16 km) to the top speed. The act of running tires out the operator, but at 10% of the usual fatigue rate thanks to the robot exoskeleton.

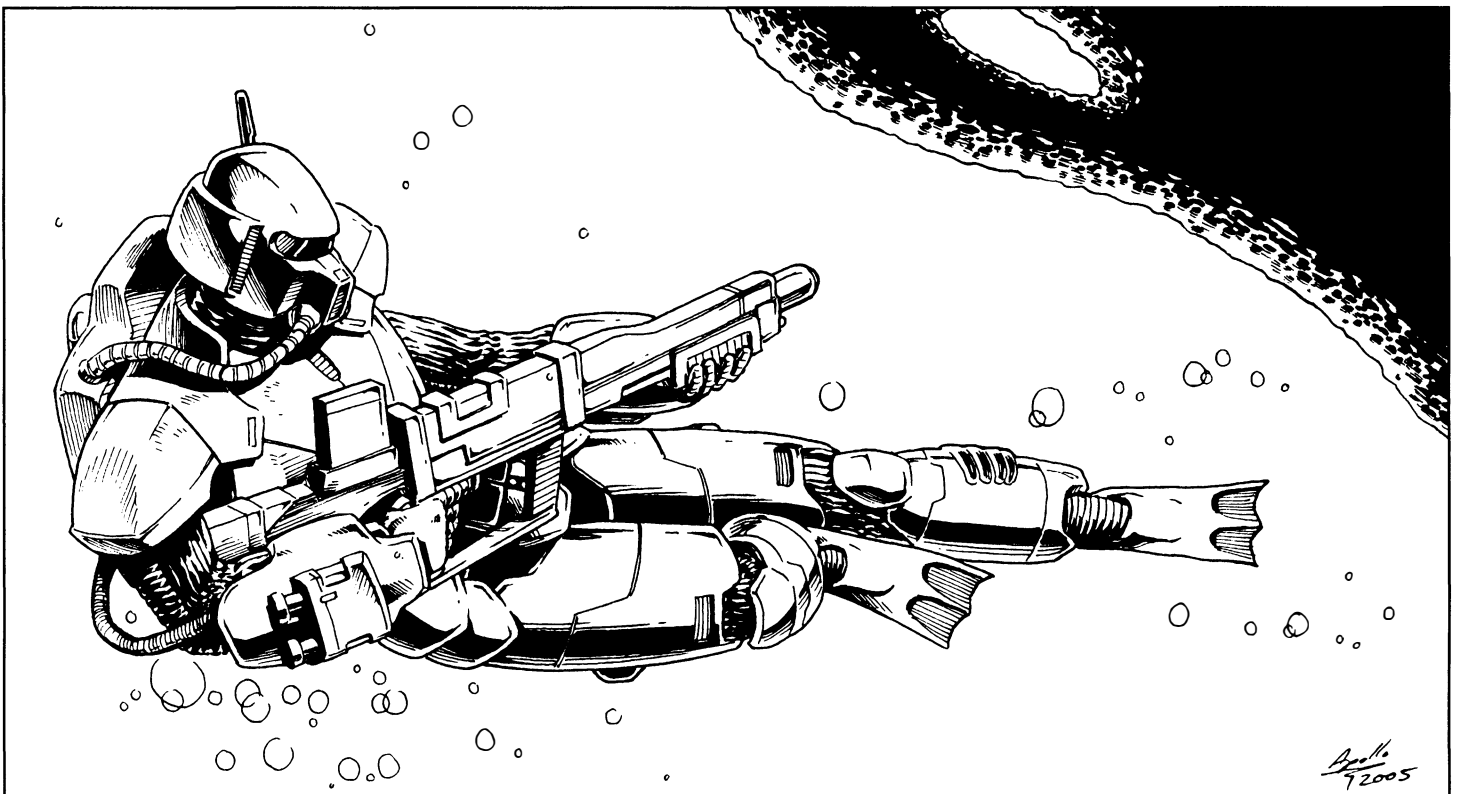

Leaping: The powerful robot legs can leap up to 15 feet (4.5 m) high or 25 feet (7.6 m) across.

Flying: Flight is no possible.

Underwater Capabilities: The hydro-jet propulsion pack enables the power armor to travel at 35 mph (56 km) on the surface of the water or when submerged.

Maximum Range: Restricted to 8 hours by the needs of the pilot and the lack of an air recycling system.

Maximum Depth: 3,000 feet (915 m).

#### **Statistical Data:**

Height: 7.2 feet (2.2 m).

Width: 4 feet (1.2 m).

Length: 5 feet (1.5 m) with hydro-jet pack; 3 feet, 4 inches (1 m) without.

Weight: 326 lbs (146.7 kg) total; 280 lbs (126 kg) without weapons.

Physical Strength: Equal to a Cyborg/Augmented Human P.S. of 24.

Cargo: None.

Power System: A rechargeable battery that holds enough power for 96 hours of continuous use. It can be recharged by any vehicle or facility with a nuclear power plant or other generator (takes about 2 hours to recharge). A fusion battery pack can be substituted but adds 1.2 million credits to the cost; 15 year life.

Cost: 340,000 credits for a brand new, fully charged suit complete with the P-Beam Short-Gun, Multi-Rifle, 10 E-Clips, and a payload of grenades or torpedoes.

#### **Weapon Systems:**

**1. NG-P67 Particle Beam Short-Gun:** This is an underwater version of the NG-P7 particle beam rifle. It is a large, heavy-duty weapon and, although somewhat smaller than the rifle, the gun is still awkward to fire by those without robotic or Supernatural Strength (-2 penalty to strike for a human P.S. under 26). There is a serious drawback to the NG-P67 Short-Gun, that being a limited payload: a regular E-Clip provides just 10 shots. To offset this limitation, a power cable extending from the NG-NX12's forearm connects the gun to the suit's battery. This is a stopgap solution to the payload problem at best, because for every 30 shots fired from the gun one hour (or 2 minutes per shot fired) is drained from the battery (not applicable to fusion power supplies).

Primary Purpose: Assault.

Secondary Purpose: Antipersonnel.

Weight: 16 lbs (7.2 kg).

Mega-Damage: 6D6 M.D. per shot.

Rate of Fire: Each blast counts as one melee attack.

Effective Range: 1000 feet (305 m) in an atmosphere/air, 700 feet (213.3 m) underwater.

Payload: 10 from a standard E-Clip or the weapon can draw on the suit's power supply, but every 30 shots drains one hour's operation time from the battery.

Cost: It is possible to buy the NG-P67 Short-Gun separately from the Beach-Stormer at a cost of 25,600 credits. **Note:** A normal Particle Beam weapon has half its normal range and half its normal damage underwater.

**2. NG-M100 Multi-Weapon Underwater Rifle:** The NG-M100 is the standard-issue underwater weapon of the Beach-Stormer power armor, and is also one of Northern Gun's most exotic creations. It is not a built-in weapon system, but rather a rifle that comes standard with the suit. The NG-M100 is an over-under combination weapon that consists of a stubby ion blaster mounted atop a smooth-bore semi-automatic missile launcher. The ion blaster is unremarkable except that it is capable of firing above and underwater.

A great deal more can be said of the launcher which is based on the WI-23 of Wellington Industries. Like the WI-23, the launcher portion of this rifle is an auto-loading weapon fed by a top-mounted detachable box magazine. But, unlike the WI-23, this launcher is capable of firing both grenades and micro-torpedoes with no more adjustment needed than simply changing magazines! There is no rear opening on the launcher, because grenades and torpedoes are launched 'cold' by compressed air; the motors don't ignite until the torpedo has traveled five feet (1.5 m) from the launcher.

Primary Purpose: Anti-Sea Monster/Anti-Ship.

Secondary Purpose: Defense.

Weight: 20 lbs (9 kg); grenade and micro-torpedo magazines weigh 12 lbs (5.4 kg) each.

Mega-Damage: The ion blaster inflicts 4D6 M.D.

Grenades do 4D6 M.D. each.

Micro-torpedoes do 5D6 M.D. each; both grenades and torpedoes are considered armor piercing and have a 3 foot (0.9 m) blast radius.

Rate of Fire: Each blast counts as one melee attack/action.

Effective Range: Ion Blaster: 800 feet (244 m). Grenades or Micro-Torpedoes: 1400 feet (426.7 m).

Payload: Ion Blaster: 10 shots from a standard E-Clip. Grenades or Micro-Torpedoes have 20 rounds per magazine.

Cost: The NG-M100 can be purchased separately from the Beach-Stormer power armor at a cost of 34,000 credits for a rifle and one grenade or torpedo magazine. Additional magazines cost 5,000 credits, which includes the cost of the explosive ammunition.

**3. Hand to Hand Combat:** Rather than use a weapon, the pilot can engage in Mega-Damage hand to hand combat. Combat abilities are identical to *Basic Power Armor Training*.

**4. Systems of Note:** The suit has all the sensors and systems common to power armor, except for the nuclear power plant. Instead, the suit runs off a rechargeable battery that holds enough power for 96 hours of continuous use (good for 4-12 days depending on how often it's used. The battery can be recharged from any nuclear power plant. Takes about 2 hours to recharge), making it much more affordable than most types of power armor.

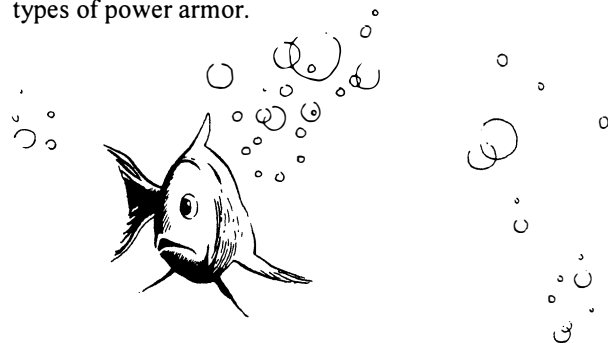

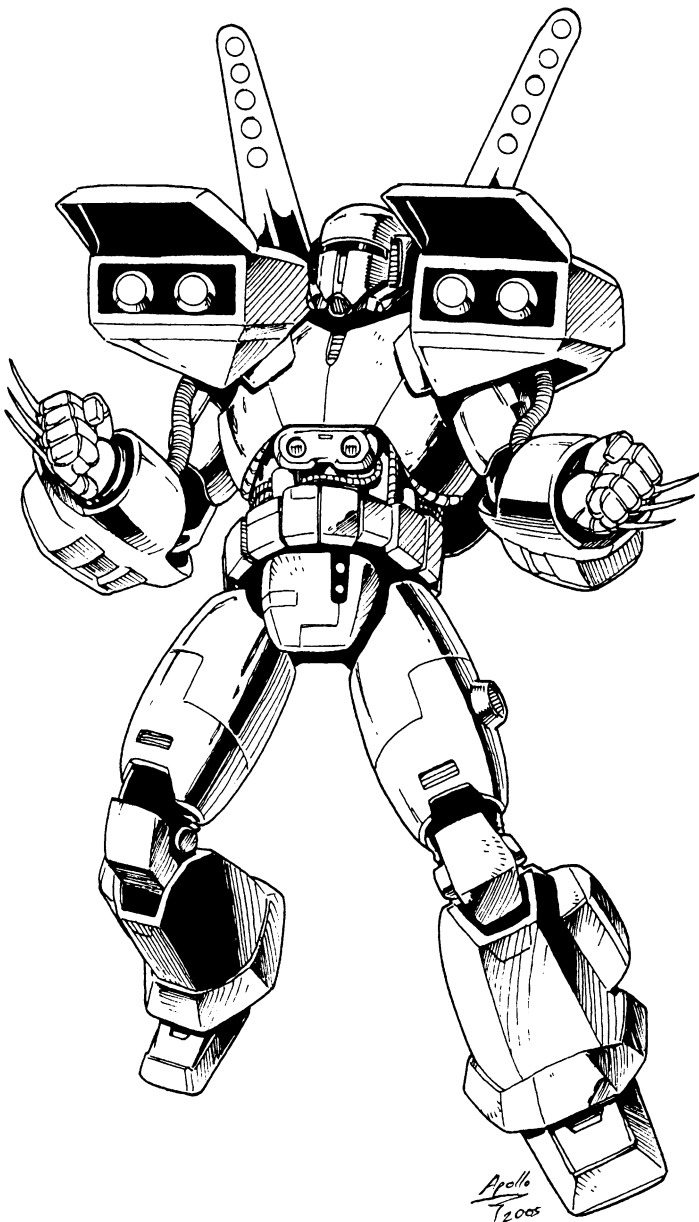

## NG-X13 “Samson Missileman” Heavy Infantry Power Armor

The growing number of heavy armored vehicles such as tanks, robots and IFVs in North America has left the infantry soldier vulnerable on the modern battlefield. Man portable missile launchers and power armor suits are versatile and critical equalizers, but even they are not always up to the task of engaging tanks and giant robots. To give the infantry soldier a fighting chance, the designers at Northern Gun have created a suit of heavy infantry power armor designed specifically to fight Main Battle Tanks, giant robots, supernatural menaces and similarly heavily armored enemy targets. In short, the NG-X13 Samson Missileman is equipped with an arsenal of missiles, making the operator a walking pillbox able to take on and destroy tanks and similar vehicles.

Missileman armor is built upon the basic chassis of the *NG Samson*, with heavier armor plating and missile launchers mounted on the back, shoulders and forearms. The additional weapons ground the power armor (cannot fly or leap), and for the unit to survive on the modern battlefield, it really should be

flanked by ground troops or escorted by lighter, faster power armor or flyers. It is especially popular among mercenary groups that engage in heavy combat and assault fortified positions, and anti-robot specialists.

**Model Type:** NG-X13 Missileman

**Class:** Armored Infantry Assault Suit.

**Crew:** One.

**M.D.C. by Location:**

Scissor Short-Range Missile Launchers (2; back) - 70 each

NG-S202 Rail Gun – 50

Ammo Drum (rear) – 30

\*Hands (2) – 20 each

Arms (2) - 65 each

\*Forearm Mini-Missile Launchers (2) – 15

Legs (2) - 95 each

\*Mini-Missile Launchers (2; shoulders) - 50 each

\*\* Head - 90

\*\*\* Main Body - 285

\* All areas that are marked with a single asterisk are small and difficult targets to hit. They can only be hit when a character makes a called shot, and even then the attacker is -4 to strike.

\*\* Destroying the head/helmet has a 01-70% chance of knocking the pilot unconscious. If conscious, the pilot has two problems: 1) no power armor combat bonuses to strike, parry, and dodge, and 2) the human head is now vulnerable to attack. The head is a small and difficult target to hit. Thus, it can only be hit when a character makes a called shot and even then the attacker is -4 to strike.

\*\*\* Depleting the M.D.C. of the main body will shut the armor down completely, and the pilot will be vulnerable to attack.

**Speed:**

Running: 80 mph (128 km) maximum. The act of running does tire out its operator, but at 10% of the usual fatigue rate thanks to the robot exoskeleton.

Leaping: The powerful robot legs can leap up to 5 feet (1.5 m) high or 10 feet (3 m) across even with the awkward addition of the missile racks. No feet or rear jet boosters.

Flying: Flight is not possible.

Underwater Capabilities: The Samson Missileman is not designed for underwater combat, but is capable of functioning underwater. It cannot swim underwater, but can walk or run on the floor of rivers, oceans and lakes at a maximum speed of 20 mph (32 km).

Maximum Ocean Depth: 2000 feet (610 m).

**Statistical Data:**

Height: 11 feet (3.3 m) – 16 feet (4.9 m) with the short-range missile launchers engaged.

Width: 5 feet, 6 inches (1.7 m).

Length: 5 feet, 6 inches (1.7 m).

Weight: 900 lbs (405 kg), fully loaded.

Physical Strength: Equal to a *Robotic* P.S. of 28.

Cargo: None.

Power System: Nuclear, average life is 15 years.

Cost: 1.2 million credits for a new, undamaged, fully powered

suit complete with rail gun, one ammo-drum and full missile complement. Fair availability.

## Weapon Systems:

**1. NG-S202 Super Rail Gun:** An NG-S202 Super Rail Gun is the standard issue infantry weapon for the Samson Missileman. The weapon draws power from the nuclear power plant and ammunition is fed from a drum magazine mounted on the back of the power armor.

Primary Purpose: Assault.

Secondary Purpose: Defense.

Mega-Damage: 1D6 M.D. for a single round, or 1D6x10 M.D. for a burst of 60 rounds.

Rate of Fire: Each burst counts as one melee attack.

Effective Range: 4000 feet (1219 m).

Payload: 6000 round drum for 100 bursts. Reloading a drum takes about 5 minutes for those not trained, but a mere one minute by somebody trained in the use of power armor.

**2. Scissor Short-Range Missile Launchers (2):** A scissor-style missile launcher similar to that of the NG-M56 Multi-Bot is attached to the back of the bot. When the system is readied for combat the twin, five-shot missile arms snap up and lock into a V shape for firing. This system is included for anti-armor and anti-dragon combat.

Primary Purpose: Anti-Armor/Anti-Dragon.

Secondary Purpose: Assault.

Mega-Damage: Varies with missile type.

Missile Type: Any short range missile can be used, but standard issue is armor piercing (2D6x10 M.D. to a 5 ft/1.5 m radius) or plasma (2D6x10 M.D. to a 15 ft/4.6 m blast radius).

Rate of Fire: One at a time or volleys of 2, 4, 6, or 8.

Effective Range: Five miles (8 km).

Payload: 10 total, five missiles per scissor arm.

**3. Mini-Missile Launchers (2):** Attached to the shoulders of the Samson Missileman are eight-shot mini-missile launchers. The forearms have the standard two-shot model.

Primary Purpose: Anti-Aircraft.

Secondary Purpose: Assault/Defense.

Mega-Damage: Varies with missile type.

Missile Type: Any mini-missile can be used, but standard issue is armor piercing (1D4x10 M.D.) or plasma (1D6x10 M.D.).

Rate of Fire: One at a time or volleys of 2, 4, 6, 8 or twelve.

Effective Range: One mile (1.6 km).

Payload: 20 total, eight missiles per shoulder launcher and two in each forearm launcher.

**4. Knuckle Blades:** Three vicious looking blades extend from the knuckles of the hand for use in hand to hand combat. Add 1D6+2 M.D. to punch attacks.

**5. Hand to Hand Combat:** Rather than use a weapon, the pilot can engage in Mega-Damage hand to hand combat.

Restrained Punch: 1D4 M.D.

Normal Punch: 1D6 M.D.

Power Punch: 2D6 M.D., but counts as two melee attacks.

Kick: 1D6 M.D.

Leap Kick: 2D6 M.D., but counts as two melee attacks.

**6. Sensor System Note:** The Samson Missileman has all of the standard features and systems of power armor suits, plus a complete optics package, including laser targeting, telescopic (up to 10x magnification, range is 2 miles/3.2 km), passive nightvision (2000 foot/610 m range), thermal-imaging (1000 foot/305 m range).

Robot Combat & Sensor Bonuses: +1 to strike.

## NG Dragonfly Combat Hover-Chopper

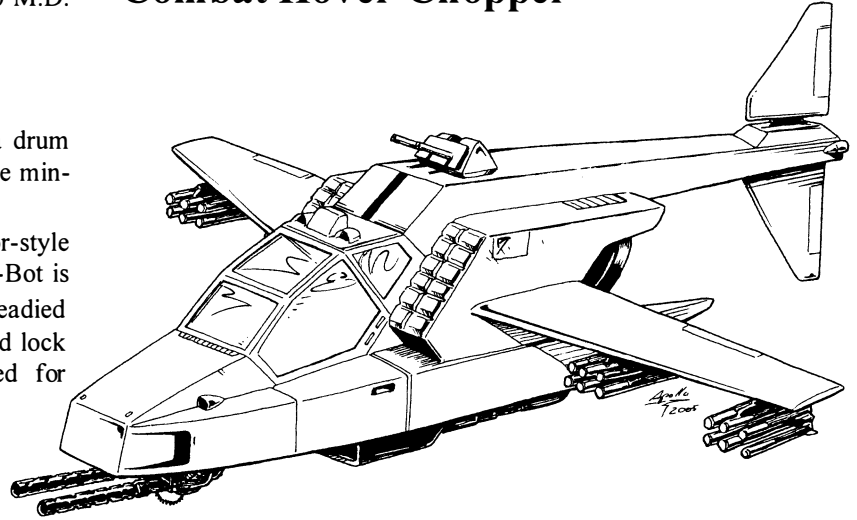

Northern Gun's alternative to the modern combat helicopter, the Dragonfly is a hybrid combination of Sky Cycle or Sky King and olden day helicopter gunship. The vehicle utilizes a hover propulsion system which provides flight capabilities similar to a helicopter – VTOL (Vertical Takeoffs & Landings), hover and low altitude flying and low to moderate speed flight, high maneuverability in an urban or wilderness setting, and so forth. Have no doubt however, this is no reconnaissance or medical evacuation vehicle, but an all-out combat vehicle designed as a tank and giant robot (or dragon) killer. In the armies of Ishpeming, the Dragonfly enjoys widespread use as a tank and robot buster as well as heavy troop support. Several naval forces also use the Dragonfly for coastal patrols, anti-submarine warfare, and blasting pirates and sea serpents out of the water. Some of the largest warships have a wing of Dragonflies stowed on deck.

In an urban setting and field conditions with a good deal of ground cover, and wherever low altitude flying and surgical strikes are desired (coming over a rise, or from around a building, to strike enemy tanks and robots is one of its specialties), the Dragonfly performs admirably with capabilities that rival the Coalition's *Black Lightning combat helicopter*. However, in an open field of combat, the slow moving and somewhat awkwardly balanced Dragonfly is a sitting duck for smaller, fast moving power armor, larger and faster aircraft, and even entrenched ground positions. That having been said, it is one of the best combat vehicles of its kind on the market, and is especially popular in the north and northeast, around the Great Lakes and Saint Lawrence Seaway. Even the Tundra Rangers and Free Quebec have purchased some for their combat forces.

**Model Type:** NG-HC1000 Dragonfly

**Class:** Hover Combat Gunship.

**Crew:** Two; a pilot and a gunner. A third, human-sized passenger (or equipment) can be squeezed into the cockpit, but the fit is tight, there is no seat for the third person and the cramped conditions inflict a -10% penalty to the piloting skill.

**M.D.C. by Location:**

Main Jet Thrusters (2; rear) - 90 each

\* Hover Jets (3; undercarriage) – 15 each

\* Ion Pulse Turret (1; top turret) - 20

\* Dual Rail Cannon Gun Pod (1; nose) - 50

\* Min-Missile Launchers (2; side) - 50 each

\* Wing Launch Racks (4; holds short- & medium-range missiles) - 10 each

\*\* Wings (2) - 70 each

Reinforced Pilot's Compartment - 65

\*\*\* Main Body - 185

\* All areas that are marked with a single asterisk are small and difficult targets to hit, requiring an attacker to make a Called Shot, and even then he is -4 to strike.

\*\* Destroying one or both of the wings reduces the flight performance of the vehicle, however as long as the hover system is functional the Dragonfly can continue to hover and fly. Reduce speed by 30% and impose a -20% penalty to the piloting skill when one wing is lost. Reduce speed by an additional 30% (60% total) and impose an additional -20% penalty to the piloting skill when both wings (or the tail and a wing) are lost. Note that if either of the wings are destroyed any missiles still mounted to the wing are likely to detonate (01-80% likelihood, causing 1D4x100 M.D. to the main body of the aircraft).

\*\*\* Depleting the M.D.C. of the main body will knock the bird out of the sky! Roll under piloting skill -40% for the pilot to manage a crash-landing from which he, the gunner and any passenger don't take damage (the aircraft is scrap metal, but they survive inside a shattered reinforced pilot's compartment).

**Speed:**

Driving on the ground: Not possible.

Flying: The hover jet propulsion system of the Dragonfly allows the vehicle to hover stationary, VTOL, and fly at a maximum speed of 200 mph (320 km).

Maximum Altitude: A max ceiling altitude of 10,000 feet (3048 m) and a combat altitude (the height in which air to ground attacks are possible) is limited to 4000 feet (1219 m); greater when using missiles.

Flying Range: Its nuclear power supply gives the Dragonfly years of life, however the hover jets require cooling after 12 hours of continuous use.

**Statistical Data:**

Height: 9 feet (2.7 m); low profile.

Width: 28 foot (8.5 m) wingspan.

Length: 36 feet (11 m).

Weight: 6 tons, seven when fully loaded with full missile complement and rail gun ammo.

Cargo: A small weapons storage locker is located in the pilot's compartment that holds up to two rifles, three pistols, a portable radio, food rations for a week, two gallons (7.6 liters) of water, and an NG-S2 survival kit.

Power System: Nuclear, average energy life is 15 years.

Cost: 2.8 million credits. Excellent availability in Ishpeming and MercTown, only fair availability elsewhere. Northern Gun is considering offering a liquid fuel version for around one million credits, but fossil fuels are rare and expensive outside the Coalition States which is likely to limit the interest in that model. If NG moves forward, it plans to debut the liquid fuel model at MercTown.

**Weapon Systems:**

**1. Dual NG-404 Rail Gun Pod:** Mounted under the nose of the Dragonfly gunship is a double-barreled NG-404 heavy rail gun turret. These weapons are large bore barrels that are capable of turning side to side at a 90 degree angle and can tilt up and down 40 degrees without having to angle the nose and tilt the entire aircraft.

Primary Purpose: Assault and Strafing Runs/Anti-Personnel.

Secondary Purpose: Defense.

Mega-Damage: 1D4x10 M.D. for a single burst or 2D4x10 for a simultaneous double burst from both barrels. A single burst is 30 rounds, a dual burst is 60 rounds.

Rate of Fire: Each single or double burst counts as one of the gunner's melee attacks.

Effective Range: 4000 feet (1219 m).

Payload: 3600 round internal drum fed magazine for 120 single bursts or 60 double barrel bursts (60 rounds). Reloading the drum is a complicated process that requires special equipment, a trained ground crew and 15-20 minutes time.

**2. Mini-Missile Launchers (2; side):** Mounted on the body of the gunship, just behind the pilot's cockpit, are a pair of mini-missile launchers capable of rapid-fire and large volleys of missiles.

Primary Purpose: Anti-Missile and Anti-Aircraft.

Secondary Purpose: Anti-Fortification, Assault and Defense.

Mega-Damage: Varies with missile type.

Missile Type: Any mini-missile can be used, but standard issue is armor piercing (1D4x10 M.D.) or plasma (1D6x10 M.D.).

Rate of Fire: One at a time or volleys of 2, 4, 6, 8, 12 or 24! Each volley, regardless of the number of missiles fired, counts as one melee attack.

Effective Range: One mile (1.6 km).

Payload: 48 total missiles (24 in each launcher).

**2. Wing Missiles (4 racks):** A missile rack hooks onto the wing and can hold a cluster of six short-range missiles or two medium-range missiles per rack (that's 12 short- and four medium-range missiles or 24 short-range missiles if only that missile type is used).

**Missile Payload Penalty:** The weight and bulkiness of the missiles cause air drag and some imbalance to the aircraft. Reduce speed by 20% and impose a -20% piloting penalty for dogfighting, evasive and trick maneuvers as long as even one weapon rack remains fully loaded. Increase the speed and eliminate the piloting penalty when ALL missiles are fired and the wings are *empty*.

Short-Range Missiles

Primary Purpose: Anti-Armor & Assault.

Secondary Purpose: Assault and Defense.



Mega-Damage: Varies with missile type.

Missile Type: Any short-range missile can be used, but standard issue is armor piercing (2D6x10 M.D.) or plasma (2D6x10 M.D.).

Rate of Fire: One at a time or volleys of 2, 4, 6, or 12.

Effective Range: 5 miles (8 km).

Payload: 12 total missiles; six per wing, usually those toward the wing tip.

#### Medium-Range Missiles

Primary Purpose: Anti-Armor and Anti-Fortification.

Secondary Purpose: Anti-Aircraft, missiles and troops.

Mega-Damage: Varies with missile type.

Missile Type: Any medium-range missile can be used, but standard issue is armor piercing (3D6x10 M.D. to a 20 foot/6.1 m blast radius) or high explosive (medium: 2D6x10 M.D. to a 30 foot/9.1 m blast radius).

Rate of Fire: One at a time or volleys of 2, 4 or 6 missiles.

Effective Range: 40 miles (64 km).

Payload: Four medium-range missiles total; two per wing, usually those on the inside of the wing, toward the body of the aircraft. The larger, heavier medium-range missiles may be substituted with six short-range missiles per wing (for a total of 24) as depicted in the illustration.

**3. Double-Barrel Ion Turret:** A small, dual beam, ion pulse turret is mounted on the top of the aircraft just behind and above the cockpit and may be controlled by the gunner or the pilot. This is a defensive weapon system usually operated to engage enemy aircraft, power armor and other flyers attempting to dog tail the Dragonfly or drop down from above. The ion pulse turret is capable of 200 degree rotation and has a 90 degree arc of fire up and down.

Primary Purpose: Defense.

Secondary Purpose: Anti-Aircraft/flyers.

Mega-Damage: 4D6+2 M.D. per dual pulse blast.

Rate of Fire: Standard.

Effective Range: 1400 feet (426.7 m).

Payload: Effectively unlimited.

**4. Fuselage Weapon Hard Points (4):** Four hard points are located on the undercarriage of the vehicle for mounting bombs, torpedoes, or depth charges. The only problem is that the Dragonfly is not really designed to carry the extra weight and air drag beneath its fuselage, which reduces the maximum speed by 30% and the pilot suffers a -2 penalty to all combat rolls, but his piloting skill, however, is not affected.

Primary Purpose: Assault/Anti-Ship.

Secondary Purpose: Anti-Armor/Antipersonnel.

Mega-Damage: Varies with weapon type; typically 1D6x10 or 2D4x10 M.D.

Weapon Type: Any bomb, depth charge, or torpedo can be used depending on the vehicle's mission. For example, a Dragonfly tasked for anti-submarine warfare is likely to be equipped with a mix of depth charges and heavy torpedoes.

Rate of Fire: Can drop Standard.

Effective Range: Except for torpedoes that travel underwater on their own power after hitting the water, bombs and depth

charges are "dropped" and explode on impact or at a set depth.

Payload: Four.

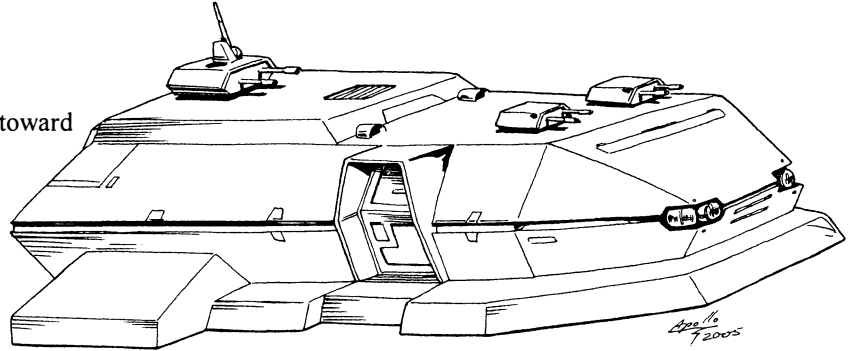

## NG Skybunker Hover Carrier

The Northern Gun Skybunker is a flying armored personnel carrier (APC) that is inspired by the Coalition's *Death Bringer* and *Sky Lifter APCs*. Like the Coalition's flying APCs, the Skybunker is far more agile, maneuverable and mobile than conventional ground vehicle Infantry Field Vehicle designs. The hover carrier is capable of flying over the most rugged terrain features, including forests, hills, water features and even man-made obstacles. In many ways the design is a mating of the best features of both a helicopter and Infantry Field Vehicle (IFV). It has the heavy armor plating of a tank coupled with the mobility of a helicopter. Northern Gun's Skybunker uses a large, powerful hover propulsion system that provides good lift and speed.

Although it has been a part of the Ishpeming military for several years, the Skybunker is being offered to the mass market for the first time to high demand. Numerous kingdoms and large mercenary companies are snatching them up. The vehicle is ideal for troop transport, vehicle transport, deployment of rapid reaction forces and even to drop paratroopers.

**Model Type:** NG-HC2000 Skybunker

**Class:** Armored Hover Personnel Carrier.

**Crew:** Four; pilot, co-pilot, communications/sensor operator, and gunner.

**Troop Transport:** The troop compartment can hold 30 fully equipped human-sized troops dressed in regular M.D.C. body armor, plus 18 paratroopers or nine troops in light power armor like the Red Hawk, Samson, Flying Titan, Sky Power Armor, T-21 Terrain Hopper, or SAMAS. In the alternative, the Skybunker can transport supplies or building materials, or 12-18 troops plus 4-8 vehicles depending on their size, such as hover cycles, rocket bikes, jeeps, and so on.

**M.D.C. by Location:**

Main Jet Thrusters (4; rear) - 90 each

\* Hover Jets (10; undercarriage) - 15 each

\* Laser Turrets (3) - 65 each

Main Cargo Door (1; rear) - 110

Extendable Cargo Ramp (1; rear) - 80

Side Cabin Door (1) - 80

\* Searchlight (1; mounted on top; optional) - 30

- \* Headlights (4) – 10 each
  - \* Other Lights (4; top and bottom) – 5 each
  - \* Window Slit (1; forward) – 22
- Reinforced Crew Compartment - 120
- \*\* Main Body - 410

\* All items marked with a single asterisk are small and difficult targets to hit, and even a character making a Called Shot is -4 to strike.

\*\* Depleting the M.D.C. of the main body will knock the bird out of the sky! Roll under piloting skill -45% for the pilot to manage a crash-landing from which he and the crew don't take any damage (the aircraft is scrap, but they survive inside the shattered reinforced crew's compartment). Likewise, a successful crash-landing means troops or cargo inside suffer only 1D4x10 M.D. each (otherwise they each take 3D4x10+30 M.D. from a crash).

#### Speed:

Driving on the Ground: Not possible, but can hug the ground at up to maximum flying speed.

Flying: Hover stationary, VTOL or fly at a maximum speed of 280 mph (448 km). Cruising speed is considered to be 50-80 mph (80 to 128 km).

Maximum Altitude: Limited to about 4000 feet (1219 m).

Flying Range: Its nuclear power supply gives the Skybunker more than a decade of life, however the hover jets require cooling after 6-8 hours of continuous use.

#### Statistical Data:

Height: 17 feet (5.2 m).

Width: 23 feet (7 m) wingspan.

Length: 44 feet (13.4 m).

Weight: 34 tons.

Cargo: Up to 10 tons. Designed as a troop transport, cargo is usually soldiers; troops and their basic gear: pack, weapons and equipment, or crates of supplies. Additional cargo may be strapped to the outside of the APC and troops may also ride on top of it, but maximum speed is 40 mph (64 km). Going any faster will knock soldiers off the roof and has a 01-30% chance of tearing away cargo strapped to the vehicle (roll for every 15 minutes).

Power System: Nuclear, average energy life is 13 years.

Cost: 28.5 million credits. Fair availability at Ishpeming and MercTown, poor everywhere else. The high demand for this product has caught Northern Gun by surprise and it cannot keep up with demand.

#### Weapon Systems:

**1. Laser Turrets (3):** Three double-barreled laser turrets are mounted on the top of the vehicle. There are two in the forward section, behind the cockpit, and one at the rear. These are defensive weapon systems, operated by the gunner and/or co-pilot (or, in a pinch, a passenger) to engage enemy aircraft. Each turret is capable of rotating 360 degrees and has a 45 degree arc of fire up and down.

Primary Purpose: Defense.

Secondary Purpose: Anti-Aircraft/Flyers.

Mega-Damage: 4D6 M.D. per simultaneous dual blast.

Rate of Fire: Each blast counts as one of the gunner's melee attacks.

Effective Range: 2000 feet (610 m).

Payload: Effectively unlimited.

**2. Door Gunner:** There is a strap and harness at the two side doors (one on each side of the vessel) and three at the rear cargo door in which a soldier in M.D.C. body armor or power armor can "strap-in," open the door and fire at enemy targets in the air or on the ground using any type of handheld weapon (laser rifle, rail gun, grenade launcher, etc.).

**3. Troops:** As a troop transport, one of the vehicle's potential, optional weapons is the very troops it carries. Infantry troops can be "dropped" at a landing zone while those on rocket bikes, hovercycles, or clad in flying power armor can be disembarked in midair while the vehicle is in full flight.

## TR-004 Titan Heavy Combat Robot A.k.a. Titan Robot Killer

The Titan Combat Robot has proven to be a tough, dependable war machine for a little more than a decade. While a reasonable match for the UAR-1 Enforcer and other giant combat robots, and large monsters, the robot falls short compared to the latest Coalition combat robots. To maintain the Titan robots' popularity and battlefield effectiveness, Titan Robotics has released an upgraded and improved model, the Titan Heavy Combat Robot better known as the "Robot Killer." Another secret creation of the enigmatic ARCHIE Three, inspired by concepts from his human partner, Hagan Lonovich, the TR-004 Robot Killer arguably represents the most powerful robot released by Titan Robotics.

The TR-004 retains the basic styling of the early editions, but abandons the bulky, brushed metal hide for a sleeker body with improved speed and mobility while retaining much of the same M.D.C. as the earlier, bulkier Combat Titan (still available on the market). Designed for combat, one arm is a powerful, long-range cannon, the other the classic Titan two-fingered, clawed hand. A belly gun, reminiscent to the Coalition's *IAR-1*, is designed to keep enemy infantry troops at bay, and an array of mini-missiles gives the 'bot additional heavy hitting power. The Robot Killer has also caught the attention of the Coalition Army. The CS has been suspicious of Titan for years, and this recent release utilizing the weapon styling of the CS (belly gun, sensor tower, chest mini-missiles, and leg rockets) and the alien Shemarrians (e.g. the cannon-arm resembles the Shemarrian's rail gun) has piqued the Coalition's interest in this rogue weapons manufacturer. The TR-1000 has only been made available in the last six months, and already the Coalition Army has had four clashes with one or more of them. This Heavy Combat Titan appears to have struck the fancy of numerous CS enemies, mercenary companies and independent operatives. The entire Titan line of robots are sold only in the Manistique Imperium and Kingsdale, but recent rumors suggest a Titan Robotics dealership may soon be opening in MercTown. Until production in-

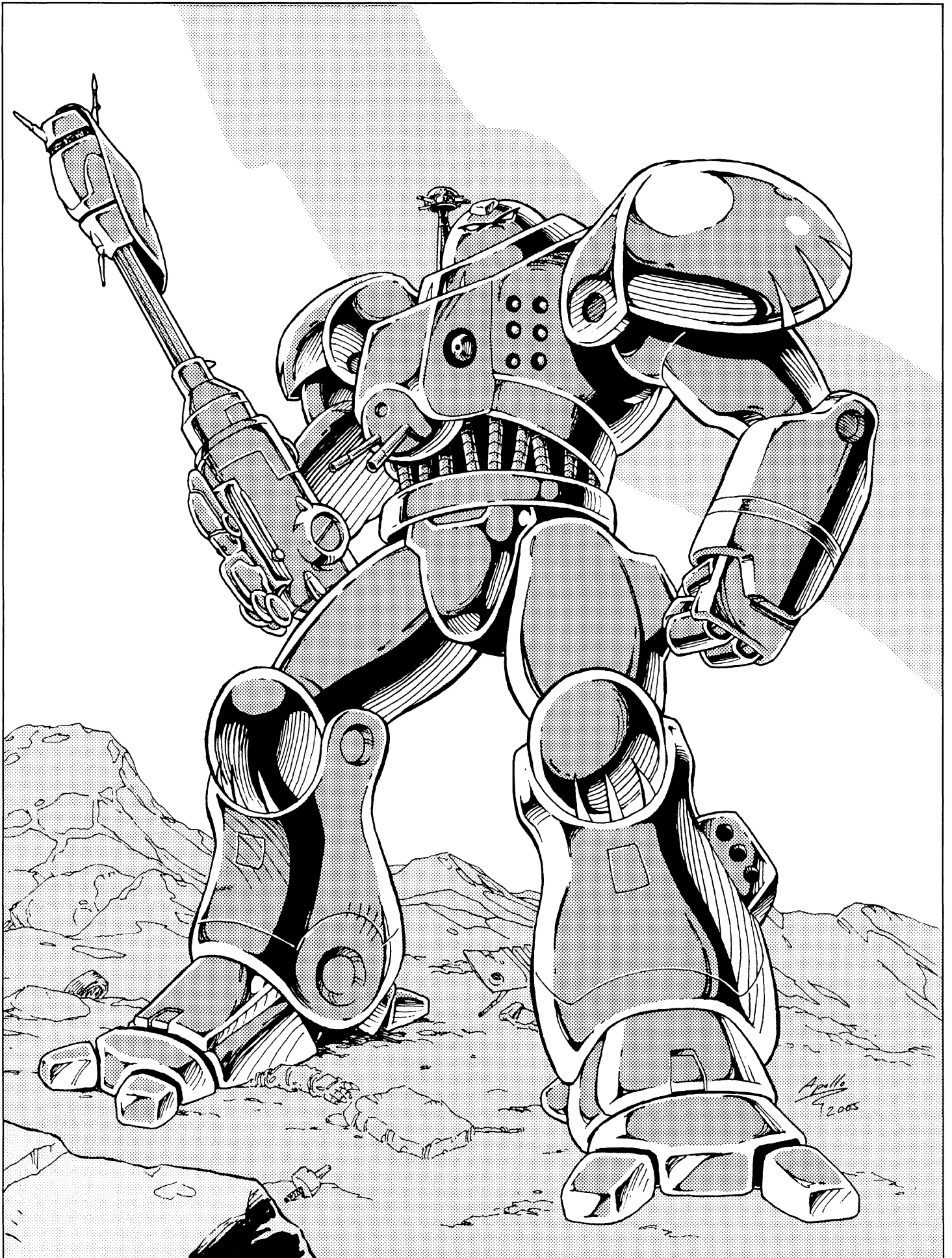

creases to match demand, however, the Heavy Titan is not likely to be found elsewhere. Titan Robotics has a nasty habit of low production runs and underselling their products, despite high demand. A habit that frustrates mercs from coast to coast.

**Model Type:** TR-004

**Class:** Anti-Robot Infantry Assault Robot.

**Crew:** One pilot, a co-pilot/communications officer, and can accommodate one passenger, two under cramped conditions.

**M.D.C. by Location:**

Rail Gun Arm (1; right arm) - 200

\* Chest Mini-Missile Launchers (2) - 60 each

\* Chest Lasers (2; low profile) - 20 each

Belly Ion Turret - 40

\* Vibro-Blade (1 giant-size; left arm) - 90

Lower Leg Multi-Grenade Launchers (2) - 25 each

\* Hand (1) - 50

Arms (2) - 170 each

Shoulder Plates (2) - 150 each (protects head, chest & arms)

Legs (2) - 200 each

Head - 100

\*\* Sensor Tower (1; right shoulder) - 20

\*\*\* Main Body - 350

Reinforced Pilot's Compartment - 100

\* All items marked with a single asterisk are small and difficult targets to hit, and even a character making a Called Shot is -3 to strike.

\*\* Destroying the sensor turret on the right shoulder of the Heavy Combat Titan will destroy the radar and targeting system. The pilot must now rely on his own human vision and other optical enhancements of the robot. The turret is a small and difficult target to hit, requiring an attacker to make a Called Shot and even then, the attacker is -2 to strike.

\*\*\* Depleting the M.D.C. of the main body will shut the robot down completely, rendering it useless.

**Speed:**

Running: 100 mph (160 km) maximum, which is faster than most robots in its size-class.

Leaping: The powerful robot legs can leap up to 20 feet (6.1 m) high or across. Add 10 feet (3 m) with a running start.

Flying: Flight is not possible.

Underwater Capabilities: The TR-004 Heavy Combat Robot is not designed for underwater combat, but is capable of functioning underwater. It cannot swim or fly underwater, however the robot can walk or run on the floor of rivers, oceans and lakes at a maximum speed of 30 mph (48 km).

Maximum Ocean Depth: 1000 feet (305 m).

**Statistical Data:**

Height: 24 feet (7.3 m).

Width: 13 feet, 6 inches (4.1 m).

Length: 9 feet, 4 inches (2.8 m).

Weight: 19 tons fully loaded.

Physical Strength: Equal to *Robotic* P.S. 38.

Cargo: Minimal storage space; about four feet (1.2 m) for extra clothing, weapons, and personal items.

Power System: Nuclear; average energy life is 15 years.

Cost: 30 million credits for a new, undamaged Heavy Combat Titan complete with rail gun ammunition and missiles. Poor availability outside of major trading centers.

**Weapon Systems:**

**1. Rail Gun Arm (1):** The right arm of the Heavy Combat Titan ends in a large bore rail gun rather than a hand. This weapon is no standard rail gun, but a canister-launching, rail cannon similar to the infamous Boom Gun. In actual fact, this system is a slightly modified copy of the Shemarrian Rail Gun issued by A.R.C.H.I.E. Three to his female robot warriors. Like the Shemarrian's weapon, this rail gun uses an electromagnetic mass driver to launch single cartridges which break open during flight, releasing hundreds of flechette shards. The Heavy Combat Titan's rail gun arm is equipped with a suppressor system to reduce recoil and muffle the rail cannon's sonic boom. It does prevent a sonic boom, but the shot is still extremely loud, like a shotgun blast or small explosion. This weapon alone gives the TR-004 its robot killer power, providing the 'bot with a weapon of superior range and destructive power compared to most robots on the continent.

**Note:** At present, the CS believes Titan Robotics has managed to copy the rail gun of the alien warrior women known as *Shemarrians*, but this could be a tactical error on the part of ARCHIE Three. It could lead to the Coalition States realizing that the Shemarrians are not cybernetic aliens, but the robot creations of *Titan Robotics!* This will send the Coalition Army to raid and shut down Titan Robotics and place it on the CS Enemies list. Under the CS alliance pact with Ishpeming and Manistique, both nations agree they will not knowingly harbor an alien or dangerous threat to the security of the Coalition States – and ARCHIE *is* just that. Consequently, neither nation will challenge or interfere with the Coalition's attack on Titan Robotics (which also eliminates a serious competitor). Such a turn of events seems only a matter of time, and will also cause the Coalition to launch an intense and extensive investigation into the Shemarrian tribes of the east. Such an investigation could, in turn, lead to the discovery of ARCHIE Three's factory compound and lair in Maryland (and possibly the discovery of the Republicans as well).

Primary Purpose: Assault.

Secondary Purpose: Anti-Aircraft/Anti-Armor/Anti-Robot.

Mega-Damage: 2D6x10 M.D. per round.

Rate of Fire: Single shot flechette round only. Each shot counts as one melee attack.

Effective Range: 6000 feet (1828 m).

Payload: 220 rounds in an internal drum magazine. Reloading the internal drum requires a trained mechanic or Operator, special tools and about 30 minutes.

**2. Chest Lasers (2):** A pair of small, single-shot ball lasers are built into the center of the chest above the Ion Belly Turret. These weapons can be fired independently or simultaneously at the same target. Each laser turret is capable of rotating 180 degrees in all directions.

Primary Purpose: Defense and Anti-Personnel.

Secondary Purpose: Assault.

Mega-Damage: 2D6 M.D. per single blast or 4D6 M.D. per double simultaneous blast. These weapons are typically controlled by the pilot.

Rate of Fire: Standard.

Effective Range: 1200 feet (366 m).

Payload: Effectively unlimited.

**3. “Belly Gun” – Double-Barreled Ion Ball Turret:** A heavy ion cannon is mounted in the belly of the robot to deal with attacking ground troops and close-range targets. The turret can rotate 180 degrees in all directions.

Primary Purpose: Assault and Anti-Personnel.

Secondary Purpose: Anti-Aircraft and Defense.

Mega-Damage: 4D6 M.D. for a single blast or 1D4x10 M.D. per dual simultaneous blast.

Rate of Fire: Each blast counts as one melee attack. This weapon is typically controlled by the gunner or co-pilot.

Effective Range: 1200 feet (366 m).

Payload: Effectively unlimited.

**4. Chest Mini-Missile Launchers (2):** Rapid-fire, multiple shot mini-missile launchers are built into each side of the Robot Killer’s chest.

Primary Purpose: Antipersonnel and Anti-Missile.

Secondary Purpose: Assault and Defense.

Mega-Damage: Varies with missile type.

Missile Type: Any mini-missile can be used, but standard issue is fragmentation (5D6 M.D.), armor piercing (1D4x10) or plasma (1D6x10 M.D.).

Rate of Fire: One at a time or in volleys of 2, 3, 4, or 6.

Effective Range: One mile (1.6 km).

Payload: 24 total, 12 mini-missiles per each side of the chest.

**5. Lower Leg Multi-Grenade Launchers (2):** Mounted on the calf of each leg is a multi-grenade launcher. These weapons are typically used to release smoke screens or to engage infantry, monsters or animals attacking the feet of the vehicle.

Primary Purpose: Antipersonnel and Assault.

Secondary Purpose: Defense.

Mega-Damage: Any grenade can be used, but standard issue is high explosive (4D6 M.D.), fragmentation (2D6 M.D.) and smoke (each smoke grenade covers a 40 foot/12.2 m area).

Rate of Fire: One at a time or in volleys of 2, 3, 4 or 6.

Effective Range: 2000 feet (610 m).

Payload: 48 total, 24 grenades per leg launcher.

**6. Retractable Vibro-Blade:** A giant-sized Vibro weapon slides out of a housing on the left forearm.

Primary Purpose: Hand to hand combat.

Mega-Damage: 3D6 M.D.

Effective Range: Hand to hand combat.

**7. Hand to Hand Combat:** Rather than use a weapon, the robot pilot can engage in Mega-Damage hand to hand combat.

Attacks per Melee Round: Those of the pilot +1 at levels 1, 3, 5, 8, 11 and 14. Applicable only if the pilot has *Elite Robot Combat* in this style of robot, otherwise he gets the first level bonus only, no other.

Long-Range Bonuses: Rail Gun: +1 to strike at levels 1, 4, 8, and 12 on an Aimed or Called Shot.

Laser, Ion Cannon, Mini-Missiles and Grenades: +1 to strike at levels 1, 5, and 10 (plus the gunner’s bonuses from the Heavy Weapons skill, if any).

Hand to Hand Combat Bonuses: Applicable only if the pilot has Elite Robot Combat in this style of robot, otherwise he gets the first level bonus only, no other.

+1 on initiative at levels 2, 6 and 12.

+1 to strike at levels 1, 4, 8, and 12.

+1 to parry, disarm, and dodge at levels 1, 3, 6, 9, and 12.

+1 to roll with impact at levels 1, 5, 10 and 15.

Hand to Hand Mega-Damage: As per Robotic P.S. and notable special features.

Restrained Punch – 1D4 M.D.

Full Strength Punch – 2D6 M.D.

Power Punch – 4D6 M.D., but counts as two melee attacks.

Claw Strike – 2D6+4 M.D.; not available as a power punch.

Kick – 3D8 M.D.

Leap Kick – 5D8 M.D., but counts as two melee attacks.

Stomp Attack – 1D6 M.D.; effective only against targets smaller than 10 feet (3 m) tall.

Body Block/Tackle/Ram – 3D6 M.D. plus there is a 01-50% chance of knocking a comparable sized opponent off his feet (01-80% if the target is smaller than 18 feet/5.5 m). Victims of a knockdown ram/tackle lose initiative and two melee attacks. Triple the damage if performed at or near full running speed, but counts as four melee attacks.

**8. Sensor Systems of Note:** Standard robot vehicle sensor system includes full optical system, infrared, ultraviolet, telescopic, thermal-imaging, polarization, radar, and laser targeting. Advanced radar targeting and combat computer adds to the robot’s quick assault capabilities. **Note:** Unknown to the purchaser, there is a hidden recording device similar to the black box of an aircraft, known to and accessible by Titan Robotics and ARCHIE Three whenever the giant robot is brought into a Titan repair or maintenance facility (or comes within close proximity of another ARCHIE Three robot).

## Titan Footman Power Armor

The Titan Footman is a suit of heavy infantry power armor designed for front-line combat, and is a departure for Titan Robotics which has never offered power armor before. This suit is bulky and squat, with large, heavily armored shoulders that protect the head and arms. Ultimately, the man-sized suit looks like a miniature version of one of the giant Titan robot vehicles. Its main features are good robot strength, fair speed and impressive armor for a man-sized unit. This means the suit enables the wearer to use most heavy weapons, rail guns and otherwise two-man weapons with relative ease as a one- or two-hand held weapon. There are few other power armor suits that can match the Titan Footman in M.D.C. protection, making for an excellent front-line infantry ground unit. The standard Titan Footman is not capable of flight unless it sacrifices its back-mounted mini-missile launcher unit for a jet pack. However, it can make

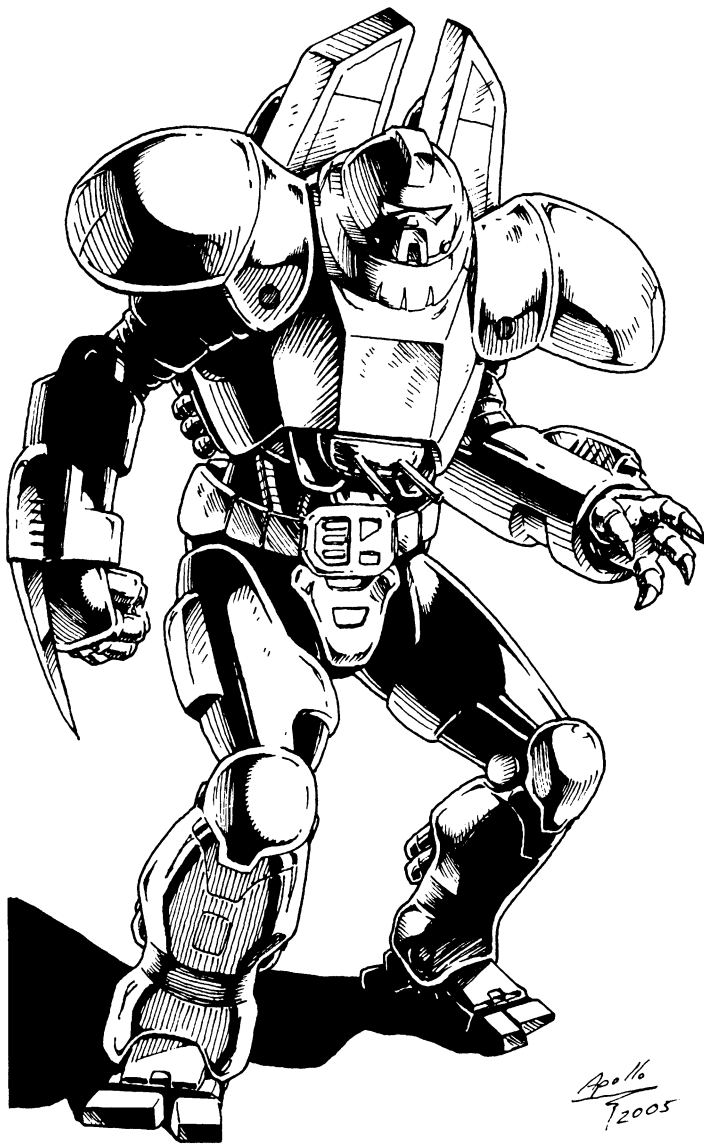

jet-assisted leaps and leap into enemy troops wearing conventional body armor and cut them to pieces.

As typical of Titan Robotics, production has been kept to relatively low numbers and the armor is available only at the Manistique Imperium and MercTown in fair to good supply. Rare to impossible to get at most other locales (and usually costs double the price when a few do become available).

**Model Type:** TPA-101

**Class:** Heavy Infantry Assault Power Armor.

**Crew:** One.

**M.D.C. by Location:**

Backpack Mini-Missile Launchers (2 launch towers) - 60

Belly Laser Turret (1) - 20

Forearm Vibro-Swords (2) - 30 each

Leap Jets (2, back) - 20 each

Hands (2) - 20 each

Arms (2) - 60 each

Shoulder Plates (2) - 80 each

Legs (2) - 100 each

\* Head - 90 (shielded from the back by missile launcher)

\*\* Main Body - 240

\* Destroying the head/helmet has a 01-70% chance of knocking the pilot unconscious. If conscious, the pilot has two problems: 1) there is no radar or targeting systems, so the pilot has no power armor combat bonuses to strike, parry, and dodge, and 2) the human head is now vulnerable to attack. The head is a small and difficult target to hit and protected by the shoulder plates and missile launcher, so attackers must make a Called Shot and even then are -5 to strike.

\*\* Depleting the M.D.C. of the main body will shut the power armor down completely, rendering it useless.

### Speed

**Running:** 50 mph (80 km) maximum, the act of running tires the user at 10% the usual fatigue rate.

**Leaping:** The powerful robot legs can leap up to 12 feet (3.6 m) high or across unassisted by jet thrusters. Jump jets built into the back of the armor can propel the unit up to 100 feet (30.5 m) high and 200 feet (61 m) across without actually attaining flight.

**Flying:** Flight is not possible unless the mini-missile launcher mounted on the back is replaced by a jet pack. Any standard jet pack works, but reduce speed by 20% due to the weight of the Titan Footman power armor.

**Underwater Capabilities:** The Titan Footman is not designed for underwater combat, but is capable of functioning underwater and the jet leap system can propel the armor in short bursts at a speed of 30 mph (48 km). The heavy power armor cannot swim or fly underwater, but it can walk or run on the floor of rivers, oceans and lakes, at a maximum speed of 20 mph (32 km).

**Maximum Ocean Depth:** 600 feet (183 m).

### Statistical Data:

**Height:** 7 feet (2.1 m) from head to toe, 8 feet, 6 inches (2.6 m) including the detachable mini-missile backpack (may be substituted with a standard jet pack).

**Width:** 5 feet, 6 inches (1.7 m).

**Length:** 4 feet (1.2 m).

**Weight:** 650 lbs (293 kg).

**Physical Strength:** Equal to a *robotic* P.S. 24.

**Cargo:** None.

**Power System:** Nuclear; average energy life is 15 years.

**Cost:** 1.4 million credits for a brand new, fully equipped suit.

### Weapon Systems:

**1. Mini-Missile Backpack Launcher:** A large, Mini-Missile unit with twin launch towers is standard issue for the Titan Footman. A hatch opens at the top of each tower from which one or a pair of mini-missiles can be simultaneously launched (one from each launch tower). A new missile is automatically moved up and into launch position every time a mini-missile is fired for rapid assault.

**Primary Purpose:** Anti-Armor/Assault.

**Secondary Purpose:** Anti-Aircraft and Anti-Missile.

**Mega-Damage:** Varies with missile type.

**Missile Type:** Any mini-missile can be used, but standard issue is fragmentation (5D6 M.D. to a 20 foot/6.1 m blast radius) or armor piercing (1D4x10 M.D. to a 3 foot/0.9 m blast radius).

**Rate of Fire:** One at a time or in volleys of two.

**Effective Range:** One mile (1.6 km).

**Payload:** 20 total, 10 missiles in each launch tower.



---

# Tech Weapons & Gear

---

## Northern Gun

The Northern Gun manufacturing corporation of Ishpeming Michigan is the dominant arms maker in North America. With the exception of the Coalition States Army, there is no other weapons manufacturer on the continent that can match Northern Gun in volume, overall quality or price. Its products are found from coast to coast and everywhere in between. The corporation boasts sales numbering into the billions of credits, with customers ranging from the Free State of Lazlo to the bandits of the Pecos Empire, to one horse kingdoms and towns across the continent. Northern Gun (along with the Manistique Imperium and the Black Market) is also the primary supplier for mercenaries and adventurers.

In the last two decades, Northern Gun has seen its market share decrease due to growing competition from its neighbor, the Manistique Imperium/Wellington Industries, long-time rival Wilk's and upstart companies like Chipwell, Bandito Arms, Titan Industries, Golden Age Weaponsmiths, various Techno-Wizard companies, and even foreign competition from the likes of Triax, Atlantis and Naruni Enterprises. The upper ranks of the corporation are becoming very concerned that their monopoly is crumbling despite the fact that Northern Gun still controls roughly 57% of the weapons market in North America (it was 69% only 25 years ago). To stave off the competition, the company has released dozens of new products over the last five years, and its designers continue to develop new technologies as well as cosmetic improvements to classic favorites in its product line. While these measures have stopped or slowed Northern Gun's sliding market share, they have failed to produce any mega-hits . . . yet.

A few of the more paranoid corporate bosses have formed a secret council to take more active measures to ensure that Northern Gun stays at the top of their game. Rather than try to win over prospective customers, the council intends to simply remove the competition through whatever means necessary, including industrial espionage, hostile takeovers, blackmail, sabotage, and disinformation. Top on their list is *Naruni Enterprises* followed by *Titan Industries*, *Chipwell*, and *Bandito Arms*. Members of the council are using their personal, political influence to steer Ishpeming's government into conflict with its neighbor Wellington Industries/Manistique adding military force to their list of acceptable tactics.

## M.D.C. Body Armor

### NG Stalker Suit

The Stalker Suit is a new creation from Northern Gun designed for infiltration, sabotage and other covert operations.

- 2. Belly Gun (1):** A small laser turret is built into the stomach area of the Titan Footman and can be fired via a verbal command or a concealed button on each of the shoulder plates. This weapon is often overlooked by opponents who aren't used to seeing such a weapon on man-sized suit and tend to be distracted by the missile launcher, assault rifle, or Vibro-Swords. The turret can rotate up and down in a 45 degree arc of fire and side to side in 180 degrees. One or both barrels can fire.

Primary Purpose: Assault and Anti-Personnel.

Secondary Purpose: Defense.

Mega-Damage: 2D4 M.D. for a single shot or 4D4 M.D. for a simultaneous twin blast.

Rate of Fire: Each blast counts as one of the character's melee attacks, but the Belly Gun gives the user one extra attack per melee round.

Effective Range: 1000 feet (305 m).

Payload: Effectively unlimited.

- 3. Retractable Vibro-Blades:** A Vibro-Short Sword can be extended from a housing in each of the forearms for close combat.

Primary Purpose: Hand to hand combat.

Mega-Damage: 2D4 M.D.

Effective Range: Close combat.

- 4. Handheld Weapons:** The Titan Footman can use most types of weapons from pistols to rifles and heavy weapons like rail guns.

- 5. Hand to Hand Combat:** Rather than use a weapon, the pilot can engage in Mega-Damage hand to hand combat. The suit's Robotic P.S. of 24 means the pilot can inflict Mega-Damage with his punches and kicks.

Restrained Punch – 6D6 S.D.C.

Full Strength Punch – 1D4 M.D.

Power Punch – 2D4 M.D.

Claw Strike – 1D6+2 M.D.; cannot be used as a power punch.

Vibro-Blades – 1D6 M.D. per blade.

- 6. Sensor Systems:** Standard power armor sensor system includes full optical system, infrared, ultraviolet, telescopic, thermal-imaging, polarization, radar, laser targeting, and targeting and combat computer. Sensor Bonuses: +1 to initiative and +1 to strike using long-range weapons, both are in addition to Robot Combat: Basic or Elite training.

**Note:** Unknown to the purchaser, there is a hidden recording device similar to the black box of an aircraft, known to and accessible by Titan Robotics and ARCHIE Three whenever the giant robot is brought into a Titan repair or maintenance facility (or comes within close proximity of an ARCHIE Three robot).



Stalker Suit

NG-A10 Body Armor

Scout

NG-A12 Anti-Ballistic

State of the art, Mega-Damage polymer woven fabrics and thermal disruption technology are used in the production of this skin-tight, black body suit. It provides the wearer with limited protection against Mega-Damage weapons, but doesn't restrict movement in any way (no penalties to swim, climb, prowl, etc.). Stalker body suits, being skin-tight, can be worn underneath regular clothing or body armor. The suit is ideal for spies, assassins, thieves and undercover operatives and is very popular in these circles.

**Class:** NG Stalker Suit

**Size:** Human equivalent.

**Weight:** 3 lbs (1.35 kg).

**Mobility:** Incredible; no penalties to Climb, Prowl, Swim or perform any other physical activities.

**M.D.C. Protection:** 12 (main body), covers entire body, except for the head; a separate helmet is suggested.

**Special Feature:**

**Thermal Reduction:** The fabric and strategic padding of the Stalker Suit is specially designed to dissipate the wearer's IR heat signature, making him more difficult to detect with thermal imagers and similar heat detection equipment. All attempts to detect the Stalker Suit with thermal systems suffer a penalty of -20% to the *Read Sensory Equipment* skill.

**Cost:** 11,100 credits.

## NG-A8 Scout Armor

Based on the popular Huntsman design of light body armor, Northern Gun's NG-A8 Scout Armor is a lightweight armor suit that provides improved protection. This additional protection comes without sacrificing mobility, making it an ideal choice for Wilderness Scouts, Psi-Stalkers, Juicers, Assassins, Thieves and operatives in urban settings. Sales of the Scout Armor have been high and its popularity has eclipsed similar suits, such as the Plastic Man and Huntsman.

**Class:** NG-A8 body armor.

**Size:** Human equivalent.

**Weight:** 12 lbs (5.4 kg).

**Mobility:** Excellent mobility; -5% to Climb, Prowl, Swim, perform Acrobatics and similar physical skills/performance.

**M.D.C. by Location:**

Head/Helmet - 35

Arms - 25 each

Legs - 40 each

Main Body - 50

**Cost:** 28,000 credits.

## NG-A10 Body Armor

A plain, non-environmental, but nonetheless robust suit of body armor manufactured for issue to Ishpeming military forces as well as for export. The lightweight suit consists of composite armor plates strapped over a flexible, padded body suit that closely resembles Bushman armor. NG-A10 armor comes in olive drab color, with no markings and is fairly popular for its combination of mobility and protection.

In addition to the standard human-sized model, Northern Gun manufactures the NG-A10 armor in a giant size that is big enough to fit large humanoid like Grackle Tooth, Brodkil, Ogres, Trolls and others. The larger suit has increased protection (with a main body of 110 M.D.C., increase all other M.D.C. locations by +20), but somewhat reduced mobility (additional -5% penalty to Climb, Prowl and physical skills).

**Class:** NG-A10 body armor.

**Size:** Human equivalent to giant size.

**Weight:** 18 lbs (8 kg), 44 lbs (20 kg) for giant-size.

**Mobility:** Good mobility; -10% to Climb, Prowl, Swim, perform Acrobatics and similar physical skills/performance.

**M.D.C. by Location:**

Head/Helmet - 50

Arms - 35 each

Legs - 45 each

Main Body - 72

**Cost:** 36,000 credits. Giant-size suits cost 50,000-75,000 credits depending on the actual size.

## NG-A12 Anti-Ballistic Armor

The recently introduced NG-A12 represents a departure from the regular “no-nonsense” design of Northern Gun products, and is an innovative advance in body armor technology that could be the company’s next blockbuster product. The NG-A12 was developed independently by a Northern Gun engineer named Burt Turner. This armor is a normal environmental suit except that it provides tremendous protection from kinetic energy attacks. When a punch, bullet or explosive blast strikes the suit, a loose outer mantle dissipates the force over the entire body armor. This diminishes the attack’s penetrating power of the impact or explosion and thereby reduces damage to the suit; damage from all kinetic attacks is reduced by *half*.

There is a further safeguard incorporated into the suit to protect pilots from crashes and falls: The air inside the suit is highly pressurized to form a protective cushion or layer around the wearer. This air cushion absorbs the majority of the impact from *falls* and *crashes* – the character inside takes only one tenth the regular amount of damage! An additional benefit of the pressurized air is that it prevents gasses, toxins and germs from entering the armor even when it has been breached. This body armor comes in olive green, tan, white, grey and camouflage with no additional markings. Different colors, logos, and insignias cost extra (anywhere from a couple thousand credits to as much as 12,000 for really elaborate custom jobs).

**Class:** NG-A12 Anti-Ballistic environmental body armor.

**Size:** Human equivalent.

**Weight:** 25 pounds (11.25 kg).

**Mobility:** Fair mobility; -10% to climb and -15% to prowl, perform acrobatics and similar physical skills/performance.

**M.D.C. by Location:**

Head/Helmet - 40

Arms - 35 each

Legs - 45 each

Main Body - 80

**Special Features: Impact Absorbing Systems:** Armor takes half damage from all kinetic attacks, including punches, kicks, falls, impact damage, and explosions. If the character also manages to roll with impact/fall, damage is reduced by half again. Also, the character wearing the armor suffers only 25% of the usual damage from falls and crashes.

**Cost:** 68,000 credits, but prices are expected to fall by 10% over the next few months as production increased to meet demand.

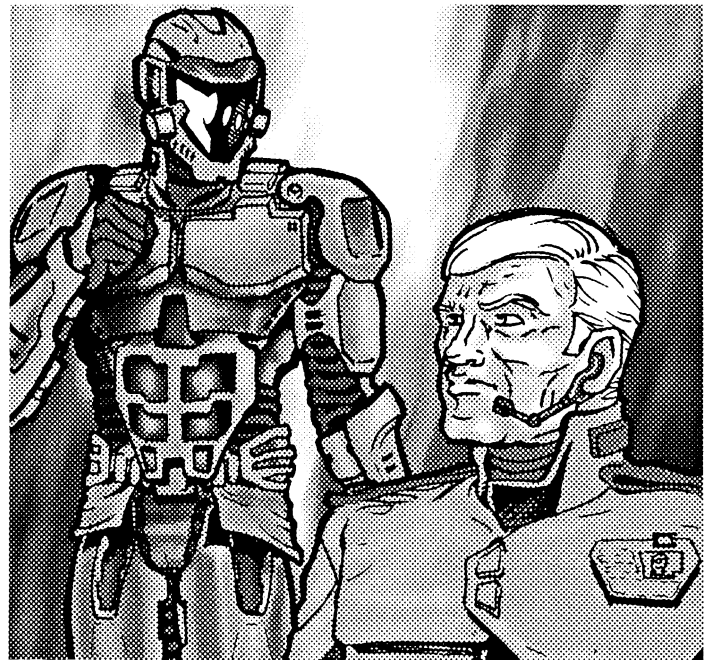

## NG-A15 Peacekeeper Body Armor

The Peacekeeper is a modular design that can be quickly altered to best accommodate the situation. The armor is targeted at law enforcement personnel and military police, but can be used by anybody. Here’s how it works. For routine calls and patrols, a law man needs only a basic, light Mega-Damage suit which offers good mobility and reasonable protection against all S.D.C. weapons and light Mega-Damage attacks. However, when an intense tactical situation arises, additional armor plating can be rapidly attached to the basic structure, augmenting the armor in a matter of seconds. It takes 1D4 melee actions to effectively double the suit’s Mega-Damage capacity. The Peacekeeper Armor also features a built-in bio-computer monitoring system that not only alerts the lawman to his physical condition, but is also capable of transmitting the officer’s vital signs to a mobile or regional command center/police station. This device continually monitors the life signs of the person wearing the armor and, if anything goes wrong, it is linked to the internal radio and automatically sends a request for backup and homing beacon in case the officer is rendered unconscious or vitals indicate

severe bodily injury or removal of the armor. The overall high quality and special monitoring features have made Peacekeeper armor very popular with lawmen and police departments throughout North America, but also among Rogue Scientists and explorers out in the field.

**Class:** NG-A15 Peacekeeper Body Armor.

**Size:** Human equivalent.

**Weight:** 16 pounds (7.2 kg), the additional tactical armor plating adds a further 11 lbs (5 kg) to the overall weight.

**Mobility:** Excellent mobility; -5% to Climb, Prowl, perform Acrobatics and similar physical skills/performance. The tactical armor increases the penalties to -15%.

**M.D.C. by Location:** Note that the number in parentheses is the total M.D.C. when the tactical add-on armor is attached.

Head/Helmet - 50

Arms - 25 basic (increases to 50) each.

Legs - 30 basic (increases to 55) each.

Main Body - 40 basic (increases to 85).

**Special Features:** 1. Built-In Radio: Range is about 12 miles (19 km) in city environments and 30 miles (48 km) in the wilderness; a signal booster can increase that range by 50% at a cost of 5,000 credits.

2. Vital Signs Monitor: An integral, miniature life signs monitor built into the suit that monitors the wearer's heart rate, blood pressure, respiration, body temperature and other vital signs. It is tuned to the specific life signs of the armor's owner, so that if these drop below registered norms, the system automatically sends a request for backup using the internal radio to other officers or a mobile command center, the police department, army garrison, etc.; all calls are routed to a designated location or monitoring unit.

**Cost:** 40,000 credits including one monitoring unit built into a briefcase-sized portable carrying case.

## NG Blue-Green Laser Underwater Conversion Kit

For nautical operations and navy combat, Northern Gun offers a basic underwater conversion kit that modifies any standard NG laser weapon to fire blue-green frequency laser beams. The kit is simple to use and any character with the *Basic Mechanics* or *Field Armorer* skill can make the necessary modifications in about 10 minutes with a successful skill roll. A weapon can be converted back to firing its normal laser beam frequency using the same basic kit. It is also possible to use this same kit to modify other brands of laser weapons, but all such attempts incur a -5% penalty. Northern Gun markets the conversion kit as an alternative to producing a separate line of blue-green laser weapons, which they see as an unnecessary and expensive proposition for a limited niche market.

**Conversion Kit Statistics/Adjustments:** The kit itself weighs about 6 ounces (170 grams), the Mega-Damage inflicted by the converted weapon and its payload remains the same, but *reduces* the weapon's range by one quarter underwater, and by two-thirds on land.

**Cost:** 4,500 credits.

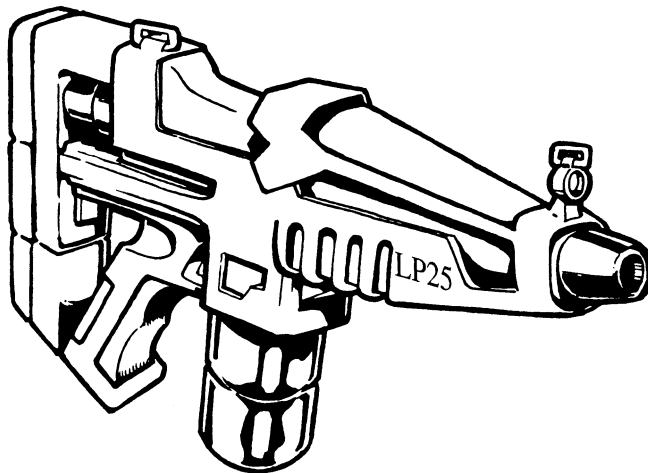

## NG-LP25 Laser Pulse Submachine-Gun

Northern Gun's LP25 is a compact, lightweight laser pulse weapon that resembles the MP5K submachine-gun of ancient times. This weapon is dependable, reasonably accurate and due to its compact design, is excellent for VIP protection, urban warfare, sweeping streets, hostage rescue and special operations missions. It packs the same punch as a standard laser rifle, but is small enough that with a short E-Clip it can be worn in a concealed shoulder holster. The LP25 enjoys widespread use with law enforcement, tactical units, special forces, bodyguards, raiders, spies, assassins and street gangs. Thousands have been sold to customers all across the continent; it is also standard issue for the Ishpeming SWAT team.

**Weight:** 4 lbs (1.8 kg).

**Mega-Damage:** 2D6+1 M.D. per single shot, or 5D6 M.D. per rapid-fire, triple shot pulse.

**Rate of Fire:** Each blast or triple pulse counts as one melee attack.

**Effective Range:** 1000 feet (305 m).

**Payload:** 21 shots or 7 pulse volleys per standard (short) E-Clip, or 36 shots for a long E-Clip.

**Cost:** 19,000 credits.

## NG-SSL20 Super-Sniper Laser Rifle

**Inspired by Mark Sumimoto (from The Rifter® #4)**

This is arguably, the most deadly, high-powered laser sniper rifle on the North American continent. It has state-of-the-art laser targeting and uses computerized weight distribution for better balance and a steady shot. It has a powerful energy delivery system and good range, but limited payload due to the powerful blasts it delivers. The laser requires careful calibration with every shot fired, so it is not an effective assault rifle and uses two melee attacks/actions to make an aimed shot.

**Weight:** 10 lbs (4.5 kg).

**Mega-Damage:** 6D6+6 M.D. for the laser; single shot only.

**Rate of Fire:** Each shot counts as *two melee attacks*.

**Effective Range:** 2000 feet (610 m).

**Payload:** 6 laser blasts per short E-Clip or 12 laser blasts per long E-Clip.

**Bonus to Strike:** +1 to strike on aimed attacks in addition to the character's usual bonuses.

Penalty to Strike: -1 to strike when used for anything other than an aimed shot.

Cost: 60,000 credits.

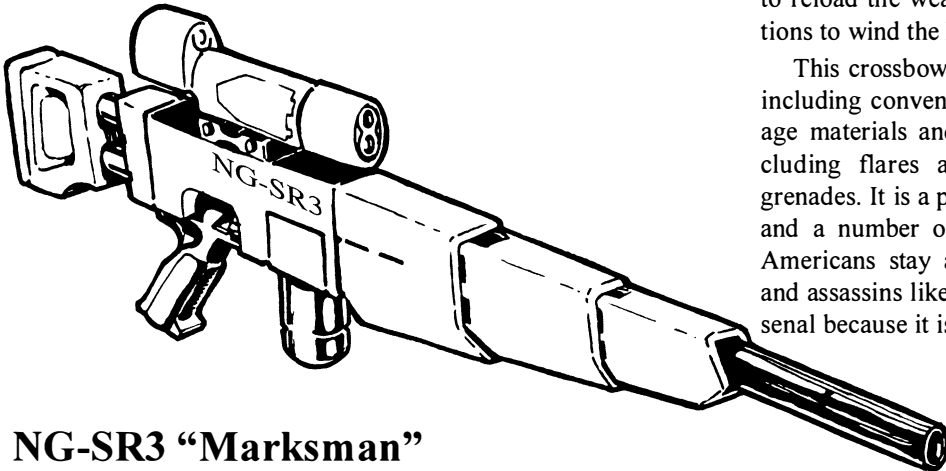

## NG-SR3 “Marksman” Collapsible Sniper Laser Rifle

The Marksman is a precision laser rifle built for long-range fire and sniping. It features several laser settings, including a high intensity beam of the type normally fired by vehicle mounted laser turrets. Another advantage of the weapon is that it can be quickly disassembled and collapsed into five components, including the barrel, trigger assembly, stock, telescopic sight and E-Clip, to fit into a briefcase or backpack. The process of stripping and assembling the weapon takes just one melee round (15 seconds), making the rifle a favorite for snipers, assassins and covert operatives.

Weight: 8 lbs (3.6 kg).

S.D.C. Damage: The weapon has an S.D.C. setting that inflicts 1D6x10 S.D.C. per shot.

Mega-Damage: 3D6 M.D. on the medium setting or 4D6 M.D. for the high intensity laser setting.

Rate of Fire: Each blast counts as one melee attack.

Effective Range: 2400 feet (731.5 m).

Payload: Varies. A standard E-Clip provides enough energy for 5 high intensity or 10 medium M.D. shots; S.D.C. firing drains far less energy, it takes five S.D.C. blasts to drain the same power as a single medium M.D. blast. Long E-Clips double the payload.

Bonus to Strike: +2 to strike on an aimed shot.

Note: Comes standard with a basic telescopic sight and passive nightvision scope (both 2000 feet/610 m range).

Cost: 32,000 credits.

## NG-MC1 Mega-Crossbow

Inspired by the NA-SW4 compound bow design of the New West, Northern Gun has developed an M.D.C. crossbow. It looks like a regular, modern crossbow with a synthetic stock, pulleys and multiple strings, but is constructed of Mega-Damage materials designed to fire M.D.C. arrows. Once loaded and cocked, anyone, regardless of their physical strength attribute, can pull the trigger to fire the weapon, however, cocking the weapon is another story entirely. The string pull is about 1,000 lbs (450 kg), so it requires a Supernatural or Robot P.S. of 17, or

a bionic P.S. of 20, or a human P.S. of 26 to cock the MC1 Mega-Crossbow. Northern Gun does offer a special pulley system to assist in cocking the weapon, allowing a regular human to reload the weapon, but it burns up 1D4+1 melee attacks/actions to wind the hand cranks and cock the crossbow.

This crossbow can be used to fire any kind of crossbow bolt, including conventional S.D.C. bolts, ones made of Mega-Damage materials and any type of specialized crossbow bolts, including flares and those tipped with smoke or explosive grenades. It is a popular weapon among woodsmen, Psi-Stalkers and a number of D-Bees. Interestingly enough, most Native Americans stay away from crossbow weapons. Some snipers and assassins like having the Mega-Crossbow as part of their arsenal because it is a silent weapon and just as deadly in the right

hands as a laser rifle. The CS has already outlawed the weapon within its territory.

Weight: 14 lbs (6.3 kg) for the crossbow; Mega-Damage bolts weigh eight ounces (0.22 kg) to 1.5 lbs (0.7 kg) each.

Mega-Damage: Ordinary S.D.C. bolts do 2D6+2 S.D.C. and may shatter on impact. Crossbow bolts made of M.D.C. material (about three times thicker than normal arrows) inflict 1D6 M.D. each. High-tech speciality bolts with explosive heads typically do 2D6 M.D. or 3D6 M.D.; smoke grenade arrows (no damage, but fills a 40 foot/12.2 m diameter), flares (3D6 S.D.C. damage; intended for signaling), and flame grenade types (3D6 M.D.) are also available.

Rate of Fire: Special. It takes about one melee attack/action to cock the weapon by individuals with a Supernatural, Robotic or Bionic P.S., or a human P.S. of 26 or higher. Those of lesser P.S. need a special pulley system to cock the weapon, and it uses up 1D4+1 melee actions/attacks of the character.

Effective Range: 1,500 feet (457 m).

Payload: Up to six bolts can clip onto the crossbow itself. Quivers and carrying cases typically hold 12, 24 or 32 crossbow bolts.

Bonus to Strike: +1 to strike on an aimed shot when a telescopic sight is attached to the crossbow.

Cost: 18,000 credits for the bow. Basic M.D.C. bolts/quarrels cost 100 credits each, and modern specialty explosive arrows cost 400 (2D6 M.D.), 800 (3D6 M.D.), and 120 credits for flare/tracer and smoke bolts.

## NG-T6 Taser Neural Disruptor

The NG-T6 is a non-lethal stun weapon that is the Northern Gun alternative to the Neural Mace and other stun guns. This weapon employs the same neural disruption technology as the mace, but can be used to disable targets from a safe distance. It resembles a typical handgun and when the trigger is pulled, the taser fires tiny metal darts attached to thin, highly conductive, Mega-Damage wires that remain attached to the gun. A pulse of neural disruptive energy is channeled through the wires to short-circuit the victim's nervous system. The victim is knocked unconscious, unless a save vs neural disruption of 16 or higher is

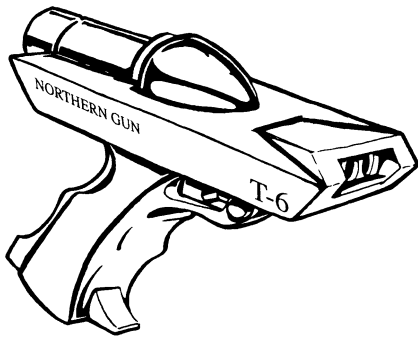

made. Even if the saving throw is successful, the victim still suffers penalties of -4 to strike, parry and dodge for 1D8 melee rounds.

A burst of compressed air propels the darts to their target, with a standard E-Clip as the power source for the neural disruption pulse. The NG-T6 is capable of firing eight times before both the E-Clip and compressed air cartridge need to be replaced, and the wires need to be rewound. Northern Gun makes a larger, rifle version called the NG-T8 that fires M.D.C. darts propelled by a heavy rifle cartridge that is capable of penetrating the skin of Mega-Damage and supernatural creatures. These weapons are standard issue for the Ishpeming police and are sold to dozens of law enforcement agencies across the continent.

Weight: 4 lbs (1.8 kg).

S.D.C. Damage: The impact of the darts inflicts 1D4 S.D.C. Plus the victim is rendered unconscious unless a save vs neural stun (16 or higher) is made. Even those who save suffer penalties of -4 to strike, parry and dodge for 1D8 melee rounds from the disruptive attack. **Note:** The pistol is not effective against even minor Mega-Damage beings or characters in full environmental body armor that has more than 40 M.D.C.

Rate of Fire: Single shot; each counts as one melee attack.

Effective Range: 100 feet (30.5 m).

Payload: Eight.

Cost: 12,000 credits for the basic pistol model, the larger taser rifle costs 18,000 credits.

**Note:** An NG-T8 Rifle is also available. It weighs 9 lbs (4 kg), the darts inflict 1D6 S.D.C., has a range of 300 feet (91.5 m), and has a 12 shot payload.

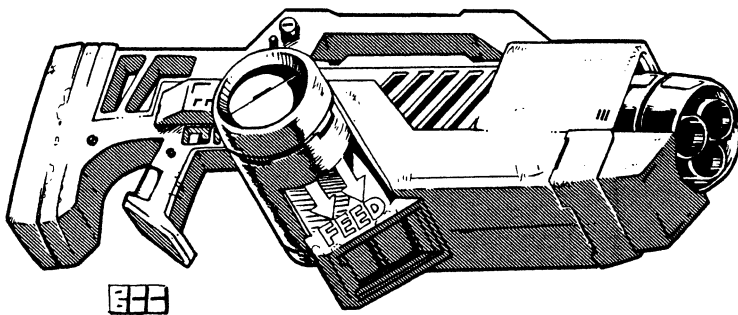

## NG-E15 Pulse Plasma Ejector

Inspired by Mark Sumimoto (from *The Rifter*® #4)

A wet dream for fan of heavy firepower, this heavy energy weapon is capable of rapid-firing plasma bursts! The rapid-fire system is not as efficient as the NG-E12 and has a violent kick that reduces accuracy, but offers tremendous firepower ideal for

use against supernatural beings, creatures of magic like dragons, armored combat vehicles, power armor, robots and military fortifications. A heavy barrel and air cooling system allows this weapon to fire the multiple blasts without fear of overheating. Its weight prevents most humans from using it as anything except a tripod or vehicle mounted cannon, but full conversion cyborgs, Crazies, and Juicers love it as a heavy assault rifle. Headhunters and D-Bees with great strength are also starting to use the NG-E15 more often. Characters with an ordinary human P.S. of 24 or less are -7 to strike with this weapon even when aimed. Even those with a P.S. of 25 or greater, or superhuman P.S., fire with a penalty of -2 to strike. Standard issue is the NG Power Pack, but a standard E-Clip can be substituted in an emergency.

Weight: 50 lbs (22.5 kg) plus an additional 20 lbs (9 kg) for the Power Pack which can be carried in a hip-pack or backpack.

Mega-Damage: 5D6 per single shot or 2D4x10 per triple pulse burst.

Rate of Fire: Each single blast or triple pulse counts as one melee attack/action.

Effective Range: 1600 feet (488 m).

Payload: The Power Pack, provides enough power for 48 single shots or 16 triple pulse blasts. A long E-Clip has enough power for 12 single shots or four pulse shots and a standard E-Clip has enough for 6 single shots or two pulse blasts.

Penalty to Strike: -2 for anyone, even those with Supernatural, Robot or Bionic P.S. or a human P.S. of 25 or greater. -7 to strike for characters with less strength, and -1 even when mounted on a tripod or vehicle.

Cost: 62,000 credits for the weapon. The Power Pack costs 30,000 credits and can be recharged at a cost of 10,000 credits up to 20 times before needing to be replaced.

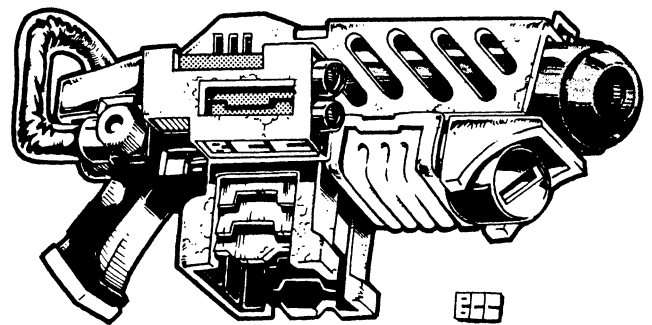

## NG-GL10 Grenade Launcher

Inspired by Mark Sumimoto (from *The Rifter*® #4)

Not to be outdone by Wellington Industries and Triax, Northern Gun has released its own grenade launcher. It is a versatile weapon capable of using fragmentation grenades for anti-personnel purposes, armor-piercing for anti-armor/monster, as well as stun, smoke, and tear gas for urban assaults and riot control. This makes it a favorite of characters looking for heavy firepower and versatility. A Physical Strength of 20 or higher is required to fire the grenades to avoid a penalty of -2 to strike.

Weight: 25 lbs (11.3 kg), plus the grenades (about one pound/0.45 kg per four grenades).

Mega-Damage: 3D6 M.D. to a 12 foot (3.7 m) radius for *frag-*



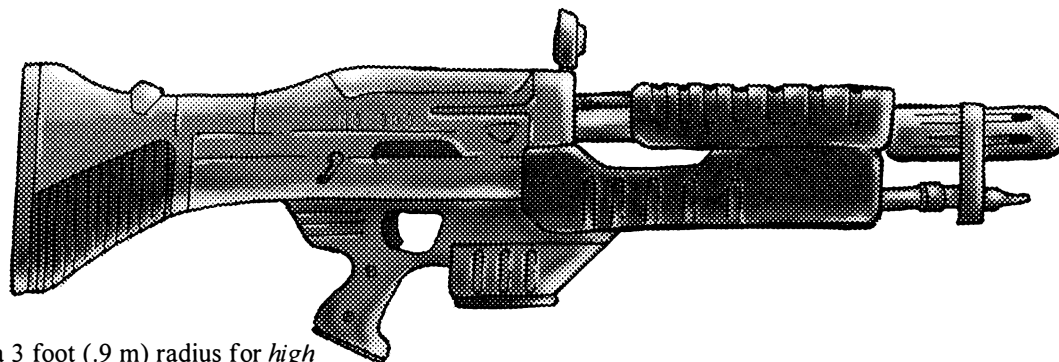

## NG-303 Infantry Mini-Rail Gun

The popularity of light rail guns like the Triax TX-500 and Bandito 5000 series prompted Northern Gun to manufacture its own version for heavy infantry soldiers. Rather than simply copying existing light rail guns, the manufacturer decided to improve on the available designs to produce a model capable of delivering the same firepower as conventional vehicle mounted rail guns, like the NG-101 or C-40R. The NG-303 is the result of that development, a lightweight, man-portable, high-powered rail gun that has the same high quality and dependability as other Northern Gun products. As with most heavy weapons, the NG-303 requires a strong individual to operate without penalties; requires a minimum P.S. of 21. If the operator's P.S. is less than 21, he suffers a penalty of -3 to strike and -3 on initiative.

Weight: 27 lbs (12.2 kg), which includes the weight of a full ammunition drum.

Mega-Damage: 1D4 M.D. for a single round, a burst is 10 rounds and inflicts 5D6 M.D.

Rate of Fire: Each ten round burst counts as one melee attack.

Effective Range: 2000 feet (610 m).

Payload: A standard plastic, detachable drum holds 200 rounds or 20 bursts. The NG-303 uses a long E-Clip, which provides enough power to fire 40 rounds. Backpack mounted ammo-drum, typically used by cyborgs and others with bionic or better P.S., holds 600 rounds and can fire 60 bursts.

Cost: 58,000 credits for the gun, standard drum magazine costs an additional 1000 credits, the backpack 2800 credits.

mentation grenades, 4D6 M.D. to a 3 foot (.9 m) radius for high explosive/armor piercing grenades, 6D6 M.D. to a five foot (1.5 m) radius for plasma grenades, while a smoke grenade covers a 40 foot (12.2 m) radius in a dense cloud of smoke obscuring vision and creating cover, a tear gas grenade covers a 25 foot (7.6 m radius) and makes the eyes and nose of victims not protected by gas masks or environmental armor burn and tear, as well as gag and choke them (-10 to strike, parry, dodge, -3 on initiative and lose one melee attack as long as they are in the gas cloud and for 1D6+1 melee rounds after exiting it; protected individuals suffer no penalties), and stun or flash grenades unleash a bright flash, sparklets and white smoke that make victims -10 to strike, parry, and dodge, -1 on initiative, and lose one melee attack for 1D4 melee rounds.

Rate of Fire: Single shot only, each blast counting as one melee attack/action.

Effective Range: 1000 feet (305 m).

Payload: A six grenade clip, or 24 round drum or a backpack ammo-drum that carries up to 60 rounds.

Cost: 50,000 credits, plus the grenades. 500 credits each for plasma grenades, 350 for high explosive/armor piercing grenades, 200 credits each for fragmentation grenades, 250 for tear gas, 200 for stun grenades and 50 credits for smoke grenades.

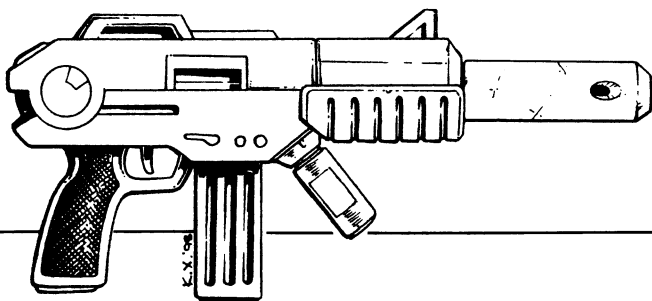

## NG-R50 Mini-Rail Gun

By Mark Sumimoto (from *The Rifter*® #4)

This is the smallest rail gun on the market. It fires only single shots, but uses a heavier round to inflict decent damage. It also uses an E-Clip to power its electromagnetic drive. The drawbacks include a limited payload and short range for a rail gun, and it requires a P.S. of 20 or higher to handle properly. A P.S. less than 20 imposes a penalty of -3 to strike on the shooter. This item has become popular among Crazies, Juicers, Headhunters and raiders as well as large, strong D-Bees.

Weight: 25 lbs (11.3 kg).

Mega-Damage: 4D6 M.D.

Rate of Fire: Each shot counts as one melee attack/action.

Effective Range: 1500 feet (457.2 m).

Payload: 14 round capacity from a short ammo clip powered by a standard E-Clip or 24 rounds from a banana ammo clip powered by a long E-Clip. A small, portable Power Pack can be used as an alternative to provide enough energy to fire 192 rounds, but weighs 20 lbs (9 kg) and costs 30,000 credits all by itself.

Cost: 30,000 credits for the mini-rail gun, two credits per ammo round and extra for E-Clips (standard short E-Clip costs 6,000 credits, a long E-Clip costs 11,000 credits and typical E-Clip recharge costs 1500 and 2000 respectively).

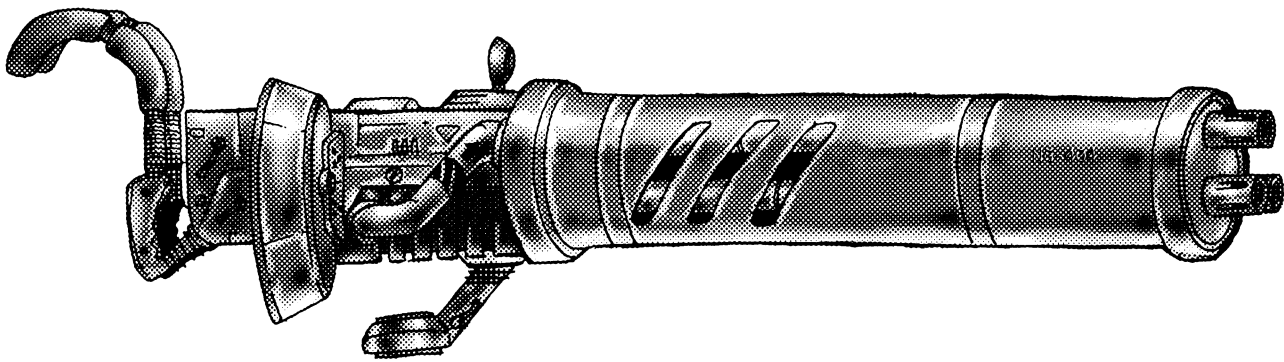

## NG-404 Heavy Rail Gun

### A vehicle mounted weapon

Northern Gun's NG-404 is a heavy rail gun pod designed to be mounted on combat vehicles or used by heavy power armor and robot vehicles. This three-barreled, Gatling style cannon is a complete weapon system that includes an internal drum magazine, nuclear power supply and laser targeting. It is far too heavy to be carried by an individual, even full conversion cyborgs, mutants, D-Bees and creatures of magic with a Supernatural strength up to a P.S. of 30 are incapable of using the weapon with any measure of accuracy (-10 to strike if it can be pointed at all) – it must be mounted on a vehicle or a heavy tripod anchored to the ground or a fortified position. The NG-404 is ideal for tanks, aircraft, giant robots, and other heavily armored combat vehicles. Mercenary companies and armies purchase the weapon to replace inferior systems on their vehicles and entrenched defensive fortifications like reinforced guard towers and bunkers.

Weight: 460 lbs (207 kg).

Mega-Damage: 1D6 M.D. for a single round, or a burst of 20 rounds that inflicts 1D6x10+6 M.D.

Rate of Fire: Each burst counts as one melee attack.

Effective Range: 6000 feet (1828 m).

Payload: 600 rounds (30 bursts) in a disintegrating link belt, ammunition belts come pre-packaged in metal ammo cans. It takes two melee rounds (30 seconds) for a two-man team to reload. Energy is provided by a portable power generator which can fire 1200 bursts before needing to be recharged, or can be linked to a vehicle's nuclear power supply for unlimited firing capacity.

Cost: 120,000 credits for the gun, ammo canisters cost an additional 2000 credits each.

## NG-ML6 Mini-Missile Cannon

The NG-ML6 cannon is a large, oversized gun chambered to fire mini-missiles. Rather than creating a conventional, tube-style launcher, the weapon designers at Northern Gun decided to stick with what they know best, and developed a multiple shot missile gun. This weapon is aimed and fired just like a typical assault rifle when used by a cyborg or power armor unit, but otherwise requires a two-man team (one to shoulder the weapon and one to aim and fire). When the weapon is fired, the missiles are launched "cold" from the barrel by a small charge that propels the missile out of the tube. This protects the shooter from any back blast. The main rockets of the mini-missile kick in approximately 50 feet (15.2 m) after leaving the weapon to speed the warhead to its target.

For greater accuracy, the weapon is equipped with a multi-optics targeting sight which provides passive nightvision (3000 feet/914 m range), thermal imaging (1200 feet/366 m range) and laser targeting (3000 feet/914 m range; provides a bonus of +1 to strike). Despite the size and weight of the cannon, it can be operated by almost anyone, including normal humans - although individuals with a P.S. attribute of 18 or less suffer a penalty of -2 to strike unless the gun is used by a two-man team as noted earlier. Northern Gun's so-called "Rocket Gun" is a popular weapon among mercenaries, raiders, cyborgs, Headhunters, Juicers, Crazy's, Power Armor pilots and anti-robot specialists.

Weight: 16 lbs (7.3 kg) plus the weight of each mini-missile.

Mega-Damage: Varies with mini-missile type, the cannon can fire any standard mini-missile type but standard issue is armor piercing (1D4x10 M.D.) or plasma (1D6x10 M.D.).

Rate of Fire: One at a time, with each mini-missile fired counting as one melee attack.

Effective Range: One mile (1.6 km).

Payload: 6 mini-missiles packaged in a disposable box magazine. Reloading the magazine is a simple task that takes just two melee attacks/actions.

Cost: 72,000 credits for the weapon, additional missiles are 2000 credits for armor piercing and 3000 for plasma.

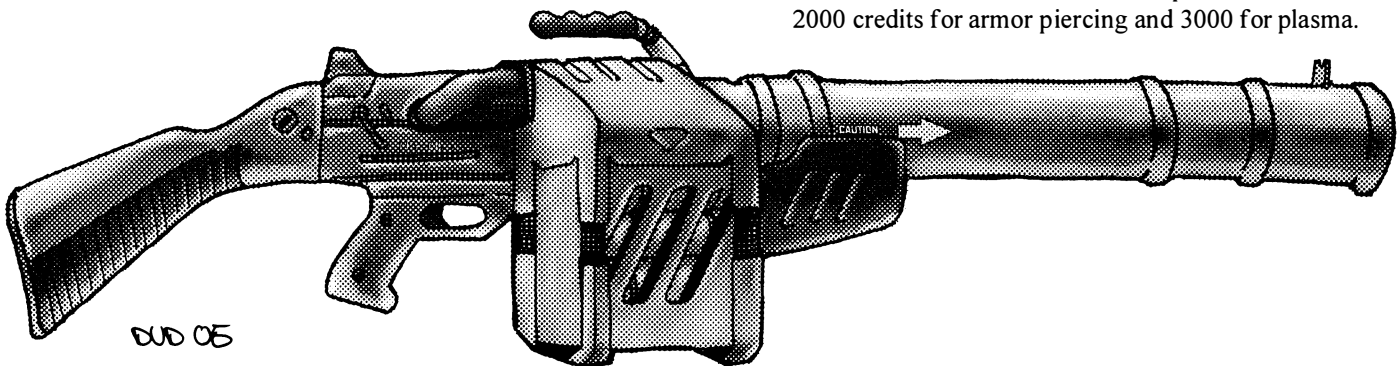

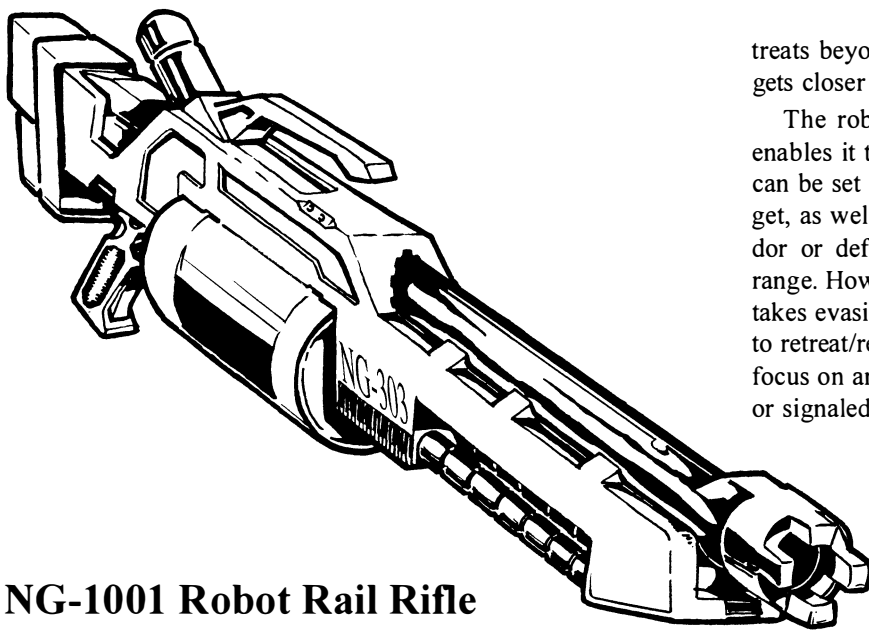

## NG-1001 Robot Rail Rifle

The NG-1001 is a giant, hand-held electromagnetic rifle that is designed for use by giant robots. It is a rapid-fire rail gun that can be used by any humanoid style giant robot vehicle with hands. The weapon is roughly 8 feet (2.4 m) long and weighs 350 pounds (158.5 kg); it is too large to be used by humanoids or even power armor suits, but can be operated by big, supernatural beings and giant D-Bees (20 feet/6.1 m and larger). Ammunition is packaged in 920 round detachable drum magazines that hook directly to the giant rifle. A separate energy canister can be used to power the weapon, but it is typically cabled to the robot's power supply. A robot can be equipped with energy ports housed in the right or left forearm or shoulder at a cost of 30,000 credits, or the back for 25,000 credits, hooking the NG-1001 to the robot's own internal nuclear power plant.

Weight: 350 lbs (158.5 kg).

Mega-Damage: A burst is 20 rounds and inflicts 1D6x10 M.D.

Rate of Fire: Each burst counts as one melee attack/action.

Effective Range: 4000 feet (1219 m).

Payload: 920 rounds or 46 bursts per detachable drum magazine.

Cost: 95,000 credits for the rail gun, 2000 credits per ammo-drum magazine.

## NG-101ARG Automated Rail Gun

The NG-101ARG Automated Rail Gun, more commonly known as the "Argonaut," is a heavy rail gun mounted on a simple robot. Mercenary companies have gone wild for this weapon and it seems destined to become Northern Gun's mega-hit seller. Simple but effective, the Argonaut is an NG-101 rail gun mated to a walking, robot chassis and a very simple computer and sensor array. The sensor package is a compact, computerized module that includes short-range radar, motion sensors, heat detector and camera eye. When placed on automatic, the sensor module detects the presence of human-size or larger targets and fires – the internal computer and targeting system picks the target (typically the nearest or largest) and plots the line of fire to engage the target. Once it has locked onto a target, the automated gun continues to fire until the target stops moving, re-

treats beyond its range, or a new target passes the original and gets closer (at which point the gun trains on it and fires).

The robotic nature and programming of the automatic gun enables it to *reposition* itself (move) to get the best shot, and it can be set or signaled to advance upon or pursue an enemy target, as well as to patrol a particular area, ideally a tunnel, corridor or defensive line, and attack anything that comes within range. However, the auto-rail gun is not very fast nor intelligent, takes evasive action only when programmed to do so or radioed to retreat/return to base, and cannot make arbitrary selections or focus on any one, specific target (unless it is the nearest, largest or signaled to do so by a human operator a safe distance away).

**Note:** The robot can be preprogrammed or controlled remotely via radio (observed from a distance via binoculars or remote cameras).

The majority of customers who purchase the NG-101ARG Automated Rail Gun employ this weapon system as a remote sentry device or robot defense force positioned along a set perimeter. Only the most successful and affluent merc companies and communities can afford them, and the Argonauts are not recommended for civilian defense as the robot cannot distinguish between friend and foe, and attacks anyone who enters its proximity of attack.

Weight: 285 lbs (128.2 kg).

Mega-Damage: 6D6 M.D. per 30 round burst.

Computer Targeting System: The computerized sensor suite and targeting module has a detection range of one mile (1.6 km) with an equivalent *Read Sensory Equipment* skill of 74%. Its targeting computer provides the equivalent of +3 to strike on a burst and has three attacks per melee round.

Payload: An ammunition drum that holds 1200 rounds (40 bursts) is standard and provides full mobility. However, the Argonaut can be hooked to an ammo-block with 4800 rounds (160 bursts) but the auto-gun is fixed to that position like a pit bull chained to a fence post. It can maneuver and change its di-

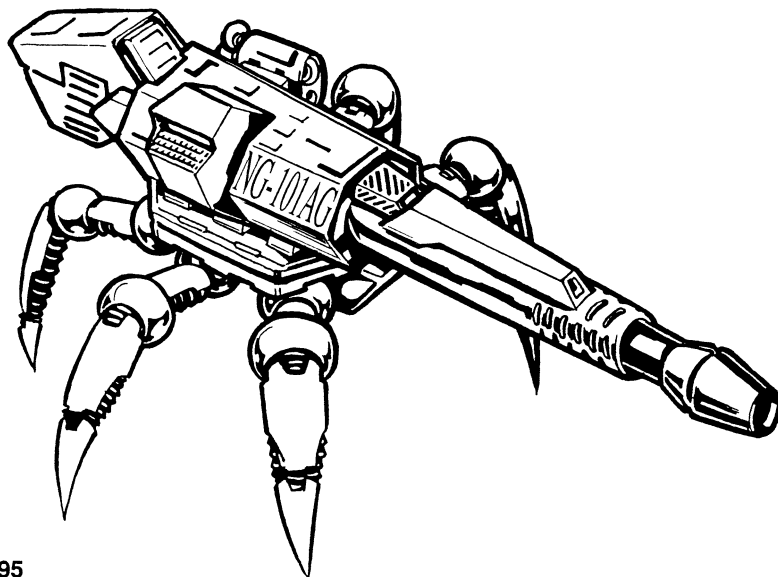

rection, but can't go more than six feet (1.8 m) from the ammo block without disconnecting itself from it. In any case, once this ammo is exhausted the system is rendered harmless, although it can be manually reloaded (operators and loaders carry a sensor that tells the gun that they are "friends") or the unit can be programmed to return to base, a mobile command center or check point for more ammo or collection.

**Notable Features:** In addition to the computer, sensors and combat capabilities already noted, the rail gun can turn 180 degrees on its robot legs and point up and down in a 30 degree arc of fire without having to use its legs to reposition. The legs can squat and position to provide a greater arc of fire, up to a 45 degree angle.

**Maximum Running Speed:** 20 mph (32 km) and can navigate rugged terrain, crawl over and under debris, and manage inclines up to a 50 degree angle.

**M.D.C. by Location:**

Control Pad (1) – 6 (attackers are -9 to strike it)

Legs (6) – 15 each (attackers are -4 to strike)

Rail Gun (main body) – 100

**Cost:** 225,000 credits for the entire robot unit (gun and legs), 5000 per ammo drum (1200 rounds) and 18,000 credits per ammo-block (the casing has 50 M.D.C. and holds 4800 rounds).

## NG Military Grade Explosives & Mines

In the realm of modern military operations, mines and explosives are inexpensive, highly effective and readily available. The vast majority of military forces and mercenary groups in North America make regular use of such explosive devices in their operations. Northern Gun has come up with a variety of specialty mines and explosives to increase its overall market share.

### NG NM-3 Firefly Plasma Mine

One of the most popular models in Northern Gun's series of land mines is the Firefly anti-personnel plasma mine. When triggered, a grenade-like plasma charge ignites from the mine casing to a height of 3 feet (1 m) before exploding and showering the area with super-heated plasma. The mine uses two activating mechanisms, a pressure detonator that is activated by a weight of 50 lbs (22.5 kg) or more, or a trip wire that triggers the device when pulled.

**Weight:** 6 lbs (2.7 kg).

**Mega-Damage:** A direct hit by the fiery geyser is 5D6 M.D., otherwise everyone in the blast radius takes 1D6 M.D.

**Blast Radius:** 40 foot (12.2 m) diameter.

**Cost:** 1000 credits.

### NG NM-4 Claymore

Based on the US Army M18A1 of antiquity, this is a modern claymore design that incorporates Mega-Damage explosives and very dense (i.e. M.D.C.) ball bearings similar to ammunition used for the NG-101 rail gun. The claymore is a directional blast mine that operates in a fashion similar to a shotgun shell. When

the explosive charge detonates, it hurls nearly two hundred ball bearings in a 120 degree arc to a distance of 100 feet (30.5 m). This type of mine is normally command detonated, meaning that it is connected by "detcord" to a detonator held by a person who must trigger the mine manually. However, the claymore can be fitted with a sensor package capable of detecting motion and a human-sized target(s) or larger up to six feet (1.8 m) away and detonating.

**Weight:** 3 lbs (1.4 kg).

**Mega-Damage:** 4D6 M.D. to everything within six feet (1.8 m) of the initial blast and 1D4 to everything else within the blast radius.

**Blast Radius:** This mine creates a directional, cone shaped blast that is 100 feet (30.5 m) long in a 120 degree arc.

**Cost:** 750 credits. Add 1500 credits to the cost if fitted with a high-tech sensor.

### NG NM-9 Plasmore Mine

Northern Gun also has developed a modern, high-tech version of the ancient US Army M18A1 claymore. Unlike the original, this version fires a stream of super-heated plasma in a directional blast, rather than hundreds of ball bearings. When the Plasmore detonates it sends gobs of plasma in a 120 degree arc to a distance of 100 feet (30.5 m). This mine is highly effective, capable of disintegrating lightly armored troops and minor supernatural beings. The plasmore is usually command detonated, meaning that it is connected to a handheld detonator and is triggered manually. However, the claymore can be fitted with a sensor capable of detecting a human-sized target or larger up to 12 feet (3.6 m) away and detonating.

**Weight:** 4 lbs (1.8 kg).

**Mega-Damage:** 1D4x10 M.D. to those caught directly in its blast (within 12 feet/3.6 m) and 1D6 M.D. to everyone else in its blast radius.

**Blast Radius:** Special. This mine creates a directional, cone shaped blast that is 100 feet (30.5 m) long in a 120 degree arc.

**Cost:** 1000 credits. Add 1500 credits to the cost if fitted with a high-tech sensor.

### NG NMBS-11 Bio-Sensor Mine

The NMBS-11 is an anti-monster mine developed by NG for its CS allies. It is a simple anti-personnel style explosive that produces a large blast with fragmentation. What makes the NMBS-11 unique is its high-tech bio-sensor triggering system - a sensor that recognizes the thermal signature, heart rate and other vital signs of humans (and most mortal humanoids) versus supernatural creatures, dragons, and monsters. The bio-sensor is programmed to ignore human and human-like signatures and will not detonate in their presence, however if the system detects the presence of any large (man-sized and larger), inhuman creatures, it will automatically explode.

Thanks to this safety feature, the NMBS-11 is harmless to human beings and many (not all) D-Bees, but at the same time is highly effective against monsters. The CS army first deployed these mines in the last two years of the Tolkeen War without fear of producing any friendly casualties. Around that same time the NMBS-11 was also released widely in North America where

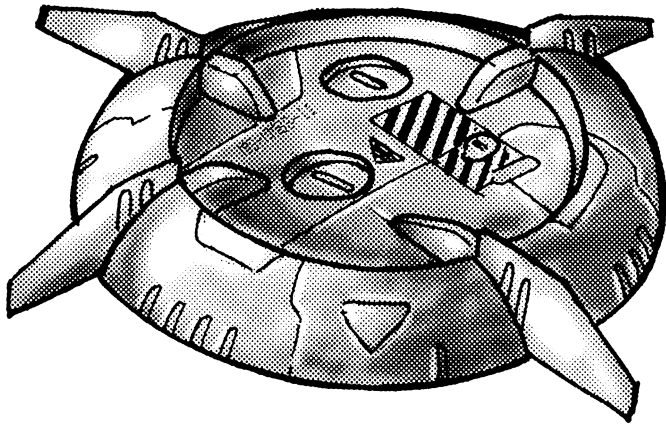

it has been purchased by predominantly human communities like Whykin, El Dorado and GAW towns, as well as mercs and other outfits.

Weight: 3 lbs (1.4 kg).

Mega-Damage: 1D4x10 M.D. at point-blank range (within six feet/1.8 m) and 2D6 M.D. to everything else in the blast radius.

Blast Radius: 15 feet (4.6 m), kept deliberately small to avoid human casualties.

Bio-Sensor: The sophisticated bio-monitoring sensor attached to the NMBS-11 is capable of detecting the vital signs of life forms within the mine's blast radius. Moreover, the sensor is able to differentiate between the vital signatures of human beings and monstrous creatures, detonating only when nonhumans are present (Gargoyles, Brodkil, demons, dragons, etc.). The mine will *not* explode if a human is within the blast radius! Can scan as many as 12 different signatures at a time.

Cost: 2800 credits. Fair availability in North America.

### NG NM-12C "Smart" Scatter Mines

Northern Gun produces the Scatter Mine by the hundreds of thousands. The NM-12C is a cluster-style scatter device used by Northern Gun itself, the Coalition States, and several other CS allies like Whykin and El Dorado. Each individual NM-12C is a small device about the same size and shape as a hockey puck, with a micro-fusion charge and high-tech sensor. The sensor will detect a human-sized creature at a distance of 10 feet (3 m), or a cyborg, giant or robot up to 30 feet (9.1 m) away.

What makes the NM-12C unique is that 20 individual mines are packaged in a single canister. The canister is designed to be delivered by aircraft, artillery or missile launcher. In the air, the canister breaks apart, scattering the twenty mines within a 100 by 100 foot (30.5 x 30.5 m) area, creating an instant mine field. According to rumor, NG sells special transponders that are instantly recognized and ignored by the NM-12C mine's high-tech sensor. This means that while these mines are lethal to all other forces, those with a transponder can walk right through a mine-field of NM-12Cs without setting off a single one!

Weight: 1 lb (0.45 kg) each.

Mega-Damage: 3D6 M.D. per each of the 20 scatter mines to everything in its narrow blast area.

Blast Radius: 5 feet (1.5 m).

Cost: 4800 credits for a NM-12C canister containing 20 individual land mines. **Note:** Limited to the Coalition States and its au-

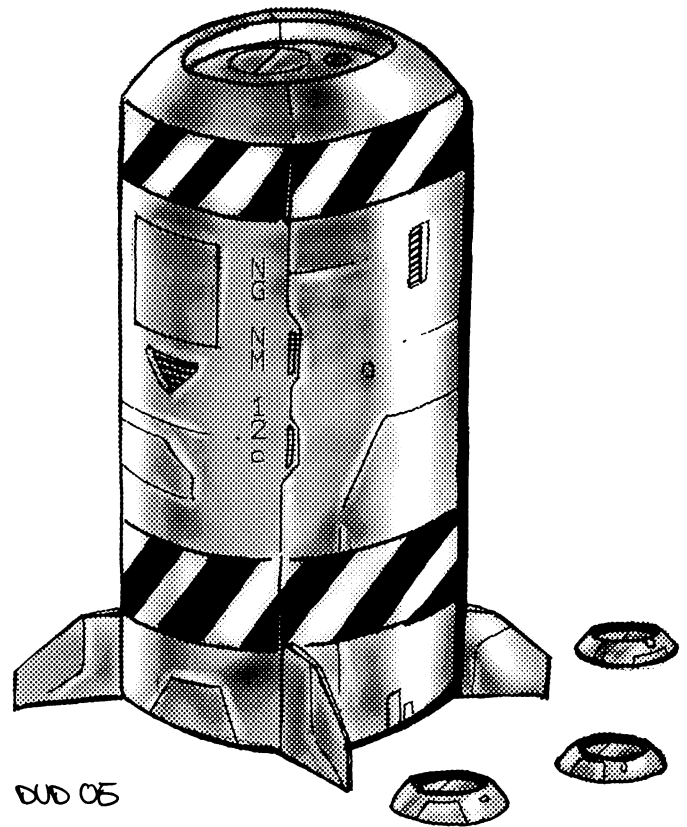

thorized allies. Neither the NM-12C mines or the transponder (1200 credits) are sold to the general public. However, they are sometimes "captured" and retooled by rogue Operators and the Black Market so they can be used by people other than the CS. When available (rare), a ready to go canister costs 12,000 credits – transponders, 2000 credits each.

### NG NMX-18 Stinger Anti-Flyer Mine

The Northern Gun Stinger Mine is a high-tech, computerized munition similar to the Wellington SAWS, and is designed to engage flying targets. Originally conceived as an automated weapon defense system to engage dragons, demons, gargoyles and similar low flying supernatural creatures, the Stinger is also effective against low altitude, slow moving aircraft and vehicles such as Wing Boards, soldiers with jet packs, helicopters, hovercycles, flying power armor, flying sorcerers, and similar aerial opponents. Thus, the NMX-18 may be programmed to target *any* flyer or to recognize and attack specific targets, up to 3200 of them.

When the mine is placed, it may be programmed to engage a limited, specific number of targets (such as SAMAS power armor, Iron Eagle choppers, Juicer Icarus Flight System, Gargoyle, etc.) or a broad range (hundreds or thousands) and will ignore any others, or set to attack any and all flyers. When such a target passes within the system's detection range (2 miles/3.2 km), the mine is triggered, it releases one or more Stingers and the enemy is engaged. The Stinger is a unique drone warhead equipped with a hover propulsion engine and targeting system. The drone has limited maneuvering and its maximum speed is only 300 mph (480 km), but that's sufficient to catch most slow moving targets as well as to intercept fast moving ones coming in its general direction (but at -2 to strike). Furthermore, most civilians, low tech people, adventurers and even a third of all

# Wellington Industries

For decades the industrialized Manistique Imperium had focused on producing all-purpose vehicles, parts and adventuring gear, along with weapon knock-offs sold mainly to the Black Market. Around 78 P.A., however, **Wellington Industries**, the primary weapons manufacturer in the Manistique Imperium, started to produce its own, original weapon designs. In recent years, it has further expanded its operations by reinvesting its profits and attempting to compete toe to toe with its neighbor, Northern Gun. The once second-rate gun maker is now considered to be one of the major players in the industry, alongside other corporations like *Wilk's Laser Industries* and *Northern Gun*. Its position has become even more secure with the tripartite alliance in 105 P.A. with the *Coalition States*, and more importantly, with Wellington's main competitor, *Northern Gun*. Wellington Industries has also closed a big deal with the armed forces of the Manistique Imperium, signing an exclusive contract to outfit its ground forces. The company has made inroads into communities in and around Free Quebec, Lazlo, New Lazlo, and MercTown, as well as supplying about one fifth of the small arms sold by the Black Market to adventurers.

Wellington Industries remains the cheap alternative to those who cannot afford high end products, but still offers durable and reliable weaponry. Since the signing of the three-way alliance with the Coalition States and Northern Gun and the Manistique Imperium, Wellington operations have increased across the board by 22%, and sales of Wellington armaments have increased 43%. Wellington has branched out to produce personal body armor and expanded its line of combat vehicles and field weapons. Wellington Industries still lacks the ability to manufacture high-tech robotics, and thus the emphasis of its production continues to focus on weapons and vehicles. Since its alliance with the CS, sales of WI weapons have grown to give it 19% of the North American market (up from 12% five years earlier), while Northern Gun has struggled to hold steady (but hangs on to a whopping 57% of the market).

Some of Wellington's latest releases include the following.

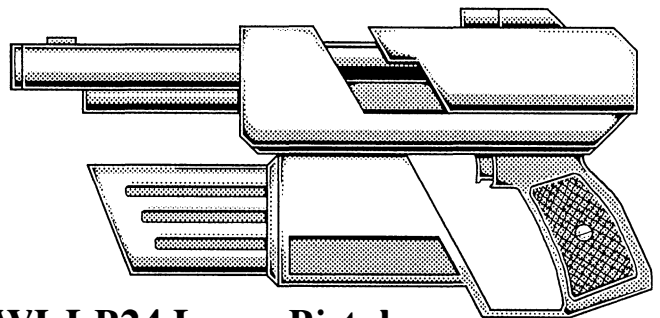

## WI-LP24 Laser Pistol

A laser pistol that features the Forward Sliding E-Clip, an innovation that does not seem to be catching on.

Weight: 2 lbs (0.9 kg).

Mega-Damage: 2D6 M.D.

Rate of Fire: Single shot only. Each blast counts as one melee attack.

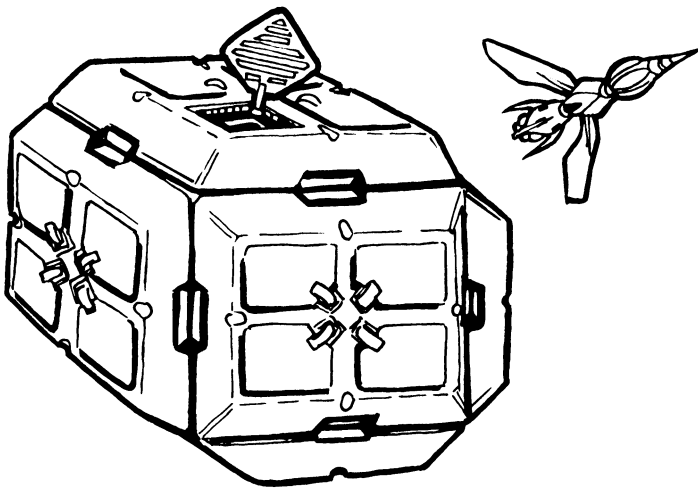

mercenaries have never seen or heard of this mine and misidentify the incoming warheads as birds, insects or something unknown, causing them to hesitate too long before taking evasive action (-3 on initiative and -1 to dodge).

Note: Sometimes called the "poor man's mini-missile."

Weight of Launch Cube: 45 lbs (20.3 kg). Stingers are one pound (0.45 kg) each.

Mega-Damage: 5D6 M.D. plasma warheads plus 1D4 M.D. to everything in the blast radius from flying shrapnel and plasma.

Blast Radius: 30 feet (9.1 m).

Effective Range: 3600 feet (1097 m).

Rate of Fire: One at a time or in volleys of 2 or 4. The launch cube has three attacks/launches (single Stinger or volley) per melee round.

Computer Targeting System: The NMX-18 is equipped with a radar suite with a 2 mile/3.2 km range, an effective *Read Sensory Equipment* skill of 88%, and computer recognition package equal to the Wilk's PC-2020 field identifier with an accuracy of 94%. All target data is uploaded to the drones prior to firing, making the drone system the equivalent of a smart missile with bonuses of +3 to strike, +1 to dodge incoming attacks and three attacks/actions per melee round until it finds its target, hits and detonates on impact.

Payload: 12 Stinger drone warheads. The launch unit can be physically picked up and relocated without disturbing the cube, however, trying to pry open any of the hatches or deliberately damaging the cube (it has 31 M.D.C.), will cause the cube to "retaliate," typically by launching one or two of its drones at the cause of the disturbance. Reloading takes about 5 minutes.

Note: The maximum speed of the drone is 300 mph (400 km) which means that it cannot effectively engage fast moving air targets; the system will not even fire at targets traveling faster than 300 mph (480 km) unless it has a chance of intercepting it should it come within 2000 feet (610 m) of the launch cube.

Cost: 140,000 credits for the launch cube, plus the cost of the individual Stingers, 2500 credits each. Fair availability in North America wherever Northern Gun products are sold; good to excellent availability at MercTown.



Effective Range: 800 feet (244 m).

Payload: 21 shots per Forward Sliding E-Clip.

Cost: 15,000 credits.

## WI-SL13 Gunfighter Laser Rifle

A solid, reliable heavy laser rifle that utilizes state of the art laser targeting, and a forward sliding E-Clip. Fancied by mercs, bounty hunters, and Wilderness Scouts looking for heavy firepower and good range.

Weight: 5 lbs (2.3 kg).

Mega-Damage: 3D6 M.D.

Rate of Fire: Single shots only, each counts as one attack.

Effective Range: 1800 feet (548.6 m).

Payload: 24 with per Forward Sliding E-Clip.

Cost: 22,000 credits.

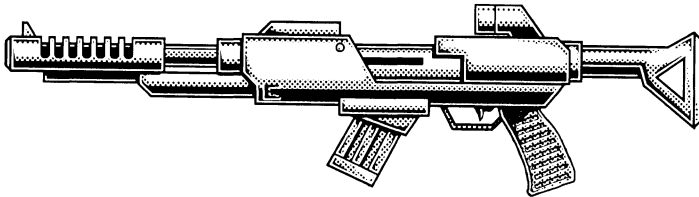

## WI-AL18 Assault Laser Rifle

Like some of Wellington's other recent releases, this new weapon was "inspired" by the weapons of Triax and is basically a knock-off of their technology. These new, powerful weapons are helping to carve out a greater piece of the arms market in North America for Wellington Industries, and are easily some of the best weapons available for the price.

Weight: 7 lbs (3.1 kg).

Mega-Damage: 2D6+2 M.D. per single shot, or 6D6+3 per simultaneous triple pulse.

Rate of Fire: Each single or triple pulse blast counts as one melee attack.

Effective Range: 1600 feet (488 m).

Payload: 21 single shots per standard E-Clip, 7 triple pulse blasts; double the payload with a long E-Clip.

Bonus: +1 to strike.

Cost: 38,000 credits.

## WI-R12 Multi-Purpose Submachine-Gun

The WI-R12 assault rifle is a large submachine-gun that fires a powerful 13mm round that is similar in performance to the old .50 caliber (12.7 mm) machine-gun cartridge. This rifle features a bulpup action and an advanced muzzle-brake recoil compensation system which allows even a normal human to fire it from the shoulder despite its heavy caliber and overall weight. Provisions have also been made to allow easy modification of the rifle by the attachment of an optical sight and a WI-GL8 or other grenade launcher. Additionally, the rifle is capable of firing the

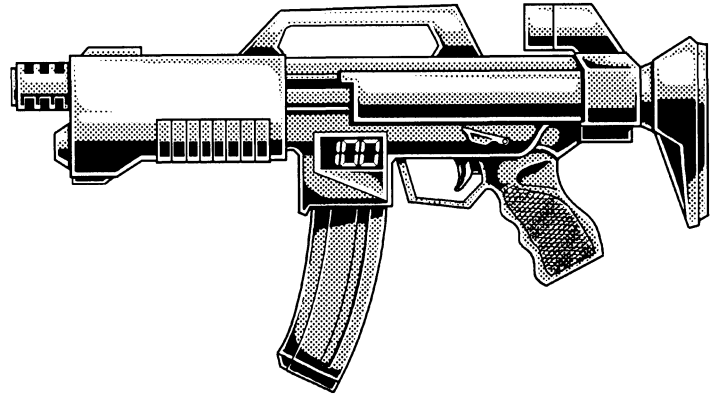

various Wellington Industries rifle grenades with no modifications required.

Due to its heavy caliber cartridge, the WI-R12 rifle can also fire *ramjet* rounds. The weapon is inexpensive, can take a beating in the field and its capability of handling several different types of ammunition gives it a versatility seldom seen in projectile weapons. Sales have been very good, and the WI-R12 is gaining a large following with mercenaries, vampire hunters (silver bullets), farmers, hunters, bandits, raiders and Wilderness Scouts.

Weight: 12 lbs (5.4 kg).

Damage: Standard 13mm rounds: 6D6 S.D.C. for a single shot, or 1D6x10+3 S.D.C. for a burst of three rounds.

WI-D12 Depleted Uranium Armor Piercing Bullets: 1D6x10 S.D.C. for a single shot or 3D4x10 S.D.C./one M.D. for a three round burst.

Light Ramjet Rounds: One M.D. single shot or 1D4 M.D. for a three round burst.

Heavy Ramjet Rounds: 1D4 M.D. for a single shot or 2D4 M.D. for a three round burst, or 4D4 M.D. for a sustained six round burst (counts as two melee attacks).

May also use WI-2E explosive rounds (see **Rifts® Mercenaries**, page 103).

Rate of Fire: Each single shot or burst counts as one melee attack.

Effective Range: 300 feet (91.5 m).

Payload: 100 round banana clip magazine using 13mm rounds, or 50 rounds in the same magazine using DU-rounds or Ramjet ammo.

Cost: 8,500 credits for the submachine-gun, 45 credits for a box of 50 standard 13mm cartridges, 200 credits for 50 silver 13mm rounds (double damage to vampires), 200-600 credits for a box of 50 depleted uranium rounds (rare in North America), 250-500 credits for Light Ramjet rounds, or 500-1500 credits for a box of 50 Heavy Ramjet rounds (uneven availability; always available at places like Manistique and MercTown, but scarce and higher priced elsewhere, and may not be available at all in small towns and low-tech or magic communities).

## WI-SR15 15mm Sniper Rifle

A heavy duty, automatic assault rifle that can turn into a single shot sniper rifle with the flip of switch. It fires the same 15mm ammunition as the Viper WI-MG15 machine-gun. The rifle is equipped with a bipod and a basic telescopic sight with passive nightvision capability (3000 foot/914 m range). Due to

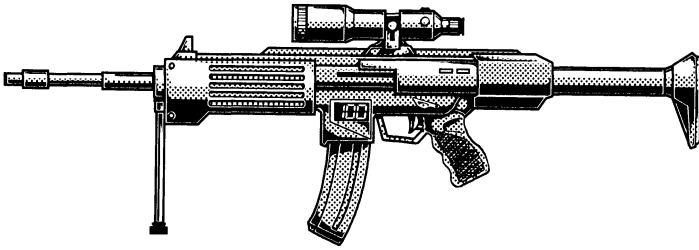

its weight, the SR-15 rifle can only be fired from a prone position or supported on its bipod, or by a character with a P.S. of 20 or higher. The rifle has good accuracy and a longer range than most energy rifles, but it is too underpowered for major military applications (it inflicts only 1-8 M.D. when using Ramjet rounds). However, it can be devastating against S.D.C. opponents as well as the undead when silver S.D.C. rounds are used. It has failed to gain widespread popularity except among big game hunters, dinosaur hunters, vampire hunters, and adventurers in Xiticix territory who like to take pot-shots at the insectoids from a safe distance for sport or revenge.

Weight: 21 lbs (9.5 kg).

S.D.C. Damage: A single standard round inflicts 1D8x10 S.D.C., a three round burst does one M.D. and 10 round burst does 1D4 M.D. (or 1D4x100 S.D.C.).

Mega-Damage: One WI-10 Light Ramjet round: One M.D.; short five round burst 1D4 M.D. or 2D4 M.D. for a 10 round burst.

WI-20 Heavy Ramjets: 1D4 M.D. per single round, 4D4 M.D. per five shot burst or 1D4x10 M.D. per 10 round burst.

Rate of Fire: Single shots and 5-10 round bursts count as one melee attack.

Effective Range: 2600 feet (792.5 m).

Payload: 50 round banana clip standard.

Cost: 11,500 credits for the rifle, 200 credits for a box of 100, 15mm S.D.C. rounds, triple for silver rounds (double damage to vampires), 500-1000 credits per 100 Light Ramjet rounds or 1000-1500 credits per 100 Heavy Ramjet rounds. Purchases of 600 or more rounds usually get a 5-10% discount.

## WI-MG15 “Viper” 15mm Anti-Infantry Machine-Gun

The Viper is a 15mm heavy machine-gun commonly mounted on combat vehicles, especially by Golden Age Weaponsmiths. It is essentially an air-cooled, general purpose machine-gun with a long, heavy barrel. It fires belted ammunition, has excellent range and good damage capacity, at least when Ramjets are used. Vipers are heavy, bulky weapons that are designed to be used with a bipod and a two-man firing crew,

or mounted to a fixed position or combat vehicle. Only individuals with a P.S. of 26 or higher may use it as a *two-handed machine-gun* – and even then the individual suffers a penalty of -2 to strike. Characters with bionic, robotic or Supernatural P.S. (20 or higher) can use the heavy weapon without penalty. For sustained, accurate fire, the Viper should be mounted, braced or otherwise propped against a sturdy support (wall, iron beam, etc.). The WI-MG15 Viper is Wellington’s answer to the rail gun, but both the weapon and its ammo are more expensive than most medium and heavy rail guns.

Weight: 60 lbs (27 kg), plus ammo (30 lbs/13.5 kg per 200 rounds); typically belt fed from an ammo drum.

S.D.C. Damage: A single S.D.C. round inflicts 1D8x10 S.D.C. points of damage, a 10 round burst inflicts 1D8x100 S.D.C. or the equivalent of 1D8 M.D. and a 20 round burst does 2D8 M.D. (or 4D4 M.D.).

Mega-Damage: *WI-10 Light Ramjets:* 1D10 M.D. per 10 round burst or 3D6 M.D. per 20 round burst.

*WI-20 Heavy Ramjets:* 1D4x10 M.D. per 10 shot burst or 2D4x10 M.D. per 20 round burst.

Rate of Fire: Burst fire only, single shots are not possible. Each (10 or 20 round) burst counts as one melee attack.

Effective Range: 4000 feet (1219 m).

Payload: 200 round (10-20 bursts) disintegrating link belt is standard when used as a handheld heavy weapon by power armor troops, cyborgs or other strong characters, but additional belts can be linked together and WI-MG Vipers mounted to a combat vehicle or fortified bunker may be hooked to a 4000 round ammo drum (400 to 200 bursts depending on the size of each burst). Remember, the weapon can fire 15mm S.D.C. rounds or Light or Heavy Ramjet rounds.

Cost: 110,000 credits for the gun, 1000-2000 credits per 200 Light Ramjet round belt or 2000-3000 credits per 200 round belt of Heavy Ramjets. Purchases of 600 or more rounds usually get a 5-10% discount.

Note: Juicers and Crazies *NEVER* use this large, clumsy weapon, but Headhunters, full conversion cyborgs, raiders and power armor pilots love it.

## WI-GL8 Automatic Shotgun/Grenade Launcher

This weapon is essentially a smaller, lighter, short-barreled version of the *WI-GL4 Grenade Launcher* that is also capable of firing large-bore conventional shotgun cartridges. It fires the same standard Wellington grenades as the WI-GL4, but also shoots a special large-bore shotgun cartridge, standard rifle grenades, and even Triax TX-5 and TX-16 ammunition. Ammunition comes pre-packaged in ten grenade rounds or 60 shotgun

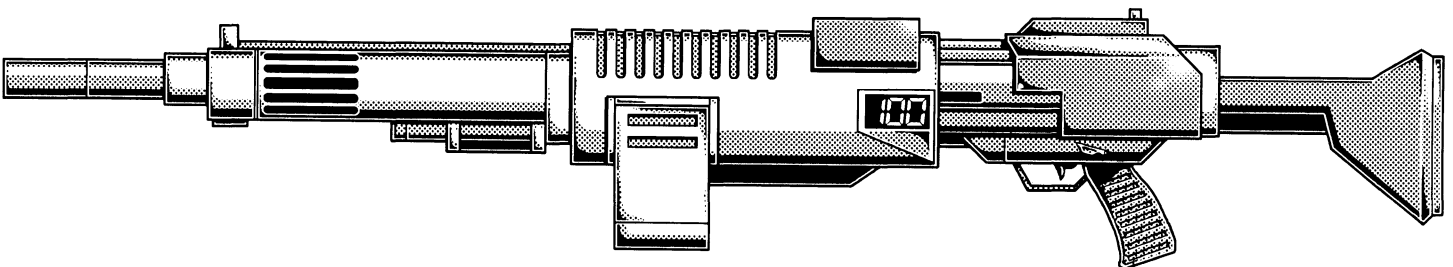

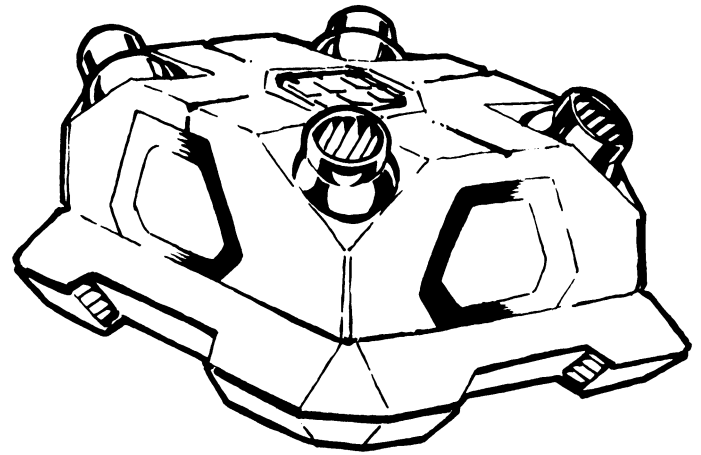
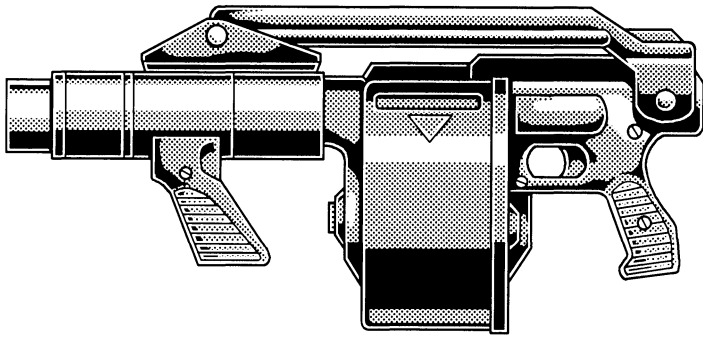

rounds, in disposable plastic cylinders which can be reloaded quickly (takes three melee actions/attacks); far more quickly than the WI-GL4, which requires reloading by hand and takes about 5 seconds for every 4 grenades (that's 30 seconds/two full melee rounds to reload completely)!

Weight: 7 lbs (3.2 kg).

S.D.C. Damage: Large-bore shotgun rounds inflict 6D6 S.D.C.

Mega-Damage: Fragmentary: 4D6 M.D. to a blast area of 12 feet (3.6 m). Armor Piercing: 1D4x10 M.D. to a blast area of 3 feet (0.9 m). Can also fire smoke, illumination and chemical rounds.

Rate of Fire: Each shot counts as one melee attack/action.

Effective Range: 800 feet (244 m).

Payload: 10 grenades or 60 shotgun rounds.

Cost: 30,000 credits for the gun, grenades are an additional cost, and a drum of 60 shotgun rounds costs 32 credits.

## WI-GL80 "Predator" Super-Grenade Launcher

A long barreled, single-shot grenade launcher that can fire rifle grenades a good distance, much farther than a traditional rifle launcher. It is typically used as a two-man rifle team, in a similar way as a bazooka team, with one propping the weapon on his shoulder and helping to balance and aim it, and the other aiming and pulling the trigger. May also be used as a two-handed weapon by full conversion cyborgs and power armor units.

Weight: 45 lbs (20.2 kg) plus the grenades.

Length: Seven feet (2.1 m) long.

Mega-Damage: *HEAT/Armor Piercing Grenade:* 1D4x10 to a radius of 3 feet (0.9 m) around the target. *Fragmentation Grenade:* 4D6 M.D. to everything in a 12 foot (3.6 m) blast radius. *Other:* Smoke, tear gas or other types of grenades may be substituted.

Rate of Fire: Single shot, each counting as one melee attack.

Effective Range: 2100 feet (640 m)!

Payload: Six, hand loaded.

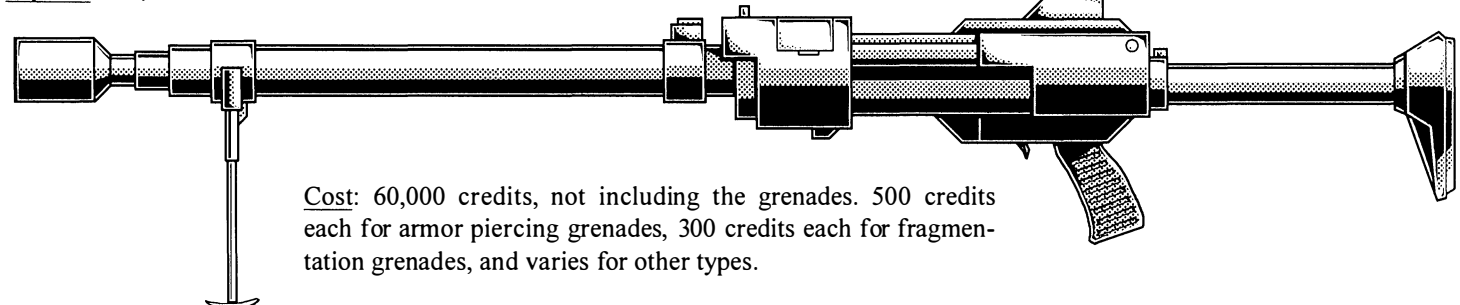

Cost: 60,000 credits, not including the grenades. 500 credits each for armor piercing grenades, 300 credits each for fragmentation grenades, and varies for other types.

## WI-23A1 SAWS Remote Missile Launcher

This is not a new weapon system, but a modification of the WI-23 missile launcher adapted to fire independently. It can be shoulder-fired the same as the old system, or set up to fire automatically like the Wellington series of SAWS mines. For independent fire, the weapon is placed in the target area and secured to a solid object (tripod mount, tree trunk, tree stump, large rock, etc.) by means of a special clamp. The system features a sophisticated computer module that with the flick of a switch will automatically target and fire on enemy vehicles. The computer module is mounted on the side of the launcher, next to the optics. It has a basic I/O interface port that connects to a Wilk's PC-2020 Field Identifier/Laser Holographic Portable Computer. Using the Wilk's PC-2020, the system can be programmed to recognize, target and fire on up to ten specific vehicle models (i.e. SAMAS, Grey Falcon, NE Carnivore tank, etc.). When a vehicle of that specific type comes within range (the sensor has a 3000 foot/914 m range), the weapon automatically locks on target and fires. The launcher shoots only one missile at a time, but has a six round payload, meaning it can fire up to six times before reloading is necessary.

The WI-23A1 SAWS is a practical and effective weapon for special forces operations, is lighter and easier to transport than standard Wellington SAWS mines, and can be set up in a matter of seconds. The real advantage of the system is that it can be infiltrated into enemy held territory and camps, and placed at strategic locations to target vehicles or robots traveling along roads or located at airstrips, and vehicle assembly points, as well as made to target standing structures like supply depots, radio towers, sentry posts, bunkers and fortifications. Once it has been

fired, the device is difficult to locate without the enemy combing the area with a large number of personnel. Often the seekers are unable to find the remote launcher because they are likely to be looking for troops and not an automatic weapon system. When used in this fashion the WI-23A1 SAWS can have a dramatic disruptive effect, forcing the enemy to move its vehicles or to ground aircraft, and to believe there are more enemy troops than there really are.

Weight: 40 lbs (18 kg).

Mega-Damage: Typically Armor Piercing: 1D4x10 M.D. or HEAT/Plasma Mini-Missiles: 1D6x10 M.D.

Rate of Fire: Single shot, each counting as one melee attack, but the device has six attacks per melee round and can fire all six mini-missiles unless programmed to do otherwise (i.e. once, twice, four times or all six per 15 second melee round). The tactical advantage of fewer shots is to make the enemy believe there are troops firing from a distance at a concealed location.

Effective Range: 3000 feet (914 m) in automatic fire mode, due to the limitations of the optical sensor.

Payload: Six. The launcher can be hand-loaded, one mini-missile at a time, which takes one minute for characters with the Weapon Systems skill and 1D4+1 minutes for anyone else.

Cost: 50,000 credits, not including the cost of the mini-missiles.

# Wilk's Laser Industries, Inc.

Laser technology is the hallmark of the Wilk's company, arguably the best manufacturer of laser weapons and equipment in the world. Wilk's Laser Industries is one of the oldest weapons makers in North America and has been producing high quality laser weapons for more than a century. However, while Wilk's may be one of the industry giants, it is not, strictly speaking, an arms manufacturer. The corporation does make some of the finest energy weapons in the world, but its focus is more broad-based than Wellington Industries, Northern Gun and others. In fact, Wilk's earns more profit from sales of its other product lines than it does from weapons.

In addition to laser weapons, Wilk's also produces top quality communications systems, laser tools, electronics, sensor systems (radar/sonar), cybernetic implants (especially optical implants), laser range-finders, computers, computer programs, translator devices, holographic imaging systems, PDD player/recorders, and various optical systems, including thermal-imagers, binoculars, nightvision goggles, multi-optic systems, and gun sights. Numerous other companies like Northern Gun and Golden Age Weaponsmiths, to name but a few, *buy* these Wilk's products as components for their own weapons, armor, robots, power armor and vehicles. In fact, 66% of such items are made by Wilk's, the quiet industrial giant.

Sales of Wilk's laser weapons have dragged in recent years, dropping about 11%, spurring the company to place a greater emphasis on developing new laser weapons and military systems. The corporation has released a number of new weapons to

spur renewed interest and increase overall sales of its weapons line. These systems feature the same standard Wilk's trademarks of sleek, lightweight, black plastic and ceramic construction, precision accuracy, long firing range and reliability under the most demanding field conditions.

## Wilk's 101 Pocket Laser

The Wilk's Pocket Laser more resembles a cell phone that fits in the palm of the hand. It has a thin, stubby barrel barely one inch long that protrudes from the larger/wider end of the tiny weapon; point and shoot. The Pocket Laser is super easy to palm and conceal (+10% to the skills *Palming* and *Concealment*) and is virtually undetectable by most security systems. It is constructed entirely of non-metallic parts, and uses tiny, conductive fiber optic cables instead of normal metal wiring. Instead of the traditional E-Clip, the Pocket Laser uses a new, rechargeable battery that is the size and thickness of a pre-Rifts silver dollar. It is immensely popular among City Rats, Smugglers, Spies, Assassins, Rogue Scholars, women and ordinary folk looking for a little personal protection.

Weight: Eight ounces (half a pound/0.23 kg).

Damage: Two settings: 4D6+2 S.D.C. and 1D4 M.D.

Rate of Fire: Each blast counts as one melee attack/action.

Effective Range: 150 feet (45.7 m); better than some full-sized pistols.

Payload: 10 M.D. shots or 40 S.D.C. blasts (four S.D.C. blasts equal one M.D. beam).

Cost: 12,000 credits and in high demand; can't keep the item in stock.

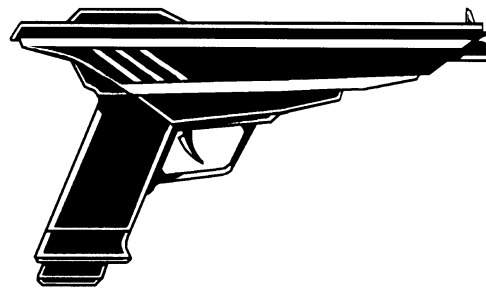

## Wilk's 300 "Hideaway" Laser Pistol

A high-powered, short-barrel version of the classic 320 pistol that is roughly the size of a human hand. The pistol is easy to conceal (+5% to the *Concealment* and *Palming* skills) and is virtually undetectable by most security systems. It is constructed entirely of non-metallic parts, and uses tiny conductive fiber optic cables instead of normal metal wiring. The only component of the pistol that can be detected by sensors is the ceramic E-Clip, and it can be detected only by the most sophisticated weapons scanners. The 300 Hideaway sacrifices range for increased power, but the weapon remains perfect for close combat and urban settings.

Since its release, the Wilk's 300 Hideaway laser has become extremely popular with City Rats, Spies, Bounty Hunters, lawmen, criminals and civilians looking for a concealed laser weapon with some oomph; nobody else comes close to this little gem.

Weight: 1.5 lbs (0.7 kg).

Mega-Damage: 1D8 M.D.

Rate of Fire: Each blast counts as one melee attack/action.

Effective Range: 600 feet (183 m).

Payload: 20 shots with a standard E-Clip.

Bonus: +1 to strike on an aimed shot.

Cost: 11,000 credits.



### Wilk's 325 "Mariner" Pulse Laser Pistol

The Wilk's 325 "Mariner" is a heavy-duty pulse laser pistol nearly identical to the 227 pistol, except that it also has a blue-green laser setting to fire underwater. It is the standard issue energy pistol of the Lazlo Defense Flotilla/Navy, and is also popular with Marine Commandos, privateers and pirates throughout the Great Lakes region and Mississippi River.

Weight: 3 lbs (1.4 kg).

Mega-Damage: 2D8 M.D. per single shot, or 4D8 M.D. per double shot pulse.

Rate of Fire: Each single or dual blast counts as one melee attack.

Effective Range: 900 feet (274.3 m).

Payload: 12 double pulse shots with a standard E-Clip, 24 dual shots with a long E-Clip.

Bonus: +2 to strike on an aimed shot.

Cost: 20,000 credits.

## Wilk's 459 "Marine" Rifle

### Laser Pulse Rifle & Torpedo-Grenade Launcher

This laser rifle is a modified Wilk's 547 Double Dealer, with a laser rifle that fires a blue-green frequency laser from the top barrel and a second barrel (with a separate E-Clip) located underneath that fires a mini-torpedo, similar to a combination laser and grenade launcher. The weapon is popular with pirates, privateers and other maritime forces throughout the country.

Weight: 13 lbs (6 kg).

Mega-Damage: 3D6 M.D. per single shot and 4D6 M.D. per mini-torpedo (blast radius 10 feet/3 m).

Rate of Fire: Each laser blast or torpedo counts as one melee attack.

Effective Range: Laser: 1100 feet (335 m) underwater, 600 feet (183 m) on land/in the air.

Mini-Torpedo launcher: 1000 feet (305 m) underwater, 200 feet (61 m) when fired in the air (blast area of 10 feet/3 m).

Payload: Laser: 20 shots from a standard E-Clip or 40 from a long E-Clip. Mini-Torpedo: Eight. Can be reloaded in one melee round.

Bonus: +1 to strike on an aimed shot with the laser.

Cost: 36,000 credits for the gun, mini-torpedoes cost 30 credits each.

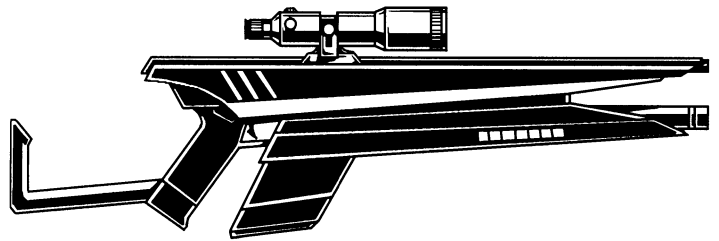

### Wilk's 577 "Double-Threat" Laser Rifle

In a surprise move, the Wilk's 577 combines its traditional laser (the top barrel) with a particle beam gun (the second, lower barrel). This marks the first time that Wilk's has combined two different energy weapon features into a single weapon. This innovation has draw high praise from the likes of Juicers, Crazies, Headhunters and other warriors who like the versatility and combined firepower. The only drawback of the Wilk's 577 is that the energy weapons can only fire one at a time, not simultaneously. Still it is a weapon that has just hit the market and is gaining popularity with every passing day. Some weapon experts believe it is the deadliest man-sized rifle on the continent.

Weight: 9 lbs (4 kg).

Mega-Damage: Laser: 3D6 – Particle Beam: 5D6+8 M.D.

Rate of Fire: Single blast from one or the other; each shot counting as one melee attack.

Effective Range: Laser 2000 feet (610 m). Particle Beam: 1200 feet (365 m).

Payload: Laser: 20 shots from a standard, short E-Clip. Particle Beam: 8 blasts from a standard E-Clip or 16 from a long E-Clip.

Note that the Wilk's 577 holds two E-Clips, one in the handle for the laser and a second in the clip port for the particle beam barrel.

Bonus: +2 to strike on an aimed shot for the laser.

Cost: 55,000 credits.

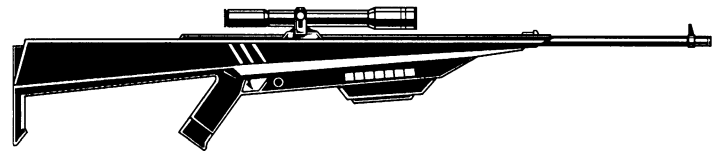

### Wilk's 587 Sniper Heavy Laser Rifle

The Wilk's 587 is a high-powered, laser sniper rifle designed for accurate long distance shooting. The enhanced scope has a range of 4000 feet (1219 m), the laser has superior range and it fires a heavy laser beam that can hit targets at ranges approaching one kilometer (about 3000 feet/914 m). And it does so without sacrificing accuracy, weight or style. The rifle has become an instant favorite of snipers, assassins, dinosaur and big game hunters, and espionage agents throughout North America.

Weight: 9 lbs (4 kg).

Mega-Damage: 4D6+2 M.D.

Rate of Fire: Single shots only.

Effective Range: 3000 feet (914 m).

Payload: 10 shots with a standard E-Clip, or 18 from a long E-Clip.

Bonus: +2 to strike on an aimed shot.

Cost: 60,000 credits.

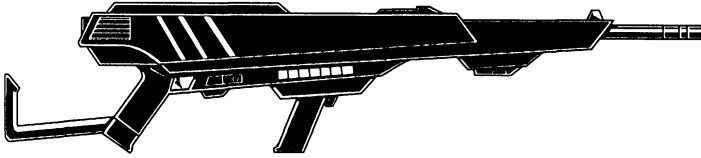

## Wilk's 1000 Pulse Laser Cannon

The Wilk's 1000 Pulse Laser Cannon is designed to be a manned, mounted gun for combat vehicles and fixed fortified positions (bunkers, sentry towers, etc.), as well as used by power armor, full conversion cyborgs and giant robots under 20 feet (6.1 m) tall. Just like a rail gun, it can be mounted on a tripod or gun turret to fire from a static position or gun emplacement. Energy for the cannon is supplied by a power generator that weighs 30 lbs (13.5 kg) or cabled into the power supply of the armor, robot or vehicle. The Wilk's 1000 is a popular alternative to rail guns and machine-guns.

Weight: The cannon itself weighs 40 lbs (18 kg) and a portable power generator weighs 30 lbs (13.5 kg), for a total combined weight of 70 pounds (31.5 kg).

Mega-Damage: 5D6+3 M.D. for single shots, or 3D4x10 M.D. for a three pulse blast.

Rate of Fire: Each blast or pulse counts as one melee attack.

Effective Range: 3000 feet (914 m).

Payload: 240 single shots or 80 triple pulse blasts are possible from a portable generator. The generator recharges at a rate of 8 blasts per hour, but can be recharged completely using a nuclear power supply in one hour's time. The weapon can also be directly tied to a vehicle or robot's power supply, effectively providing it with an unlimited payload.

Cost: 150,000 credits.



## Wilk's Laser Sword

This weapon is essentially a more powerful and larger version of the Wilk's laser knife. When activated, a three foot (0.9 m) long, visible laser blade projects from the handle. The laser sword is more powerful than a Vibro-Sword and inflicts about twice as much damage. However, the blade drains a considerable amount of energy and doesn't have anywhere near the operating time as a Vibro-Blade weapon. A rechargeable battery built into the handle provides enough power for 15+5D6 minutes of continuous operation, with an unpredictable duration. For many potential buyers this is a frightening prospect, as the sword can run out of energy right in the middle of a fight, leaving its owner weaponless. The Wilk's Laser Sword comes with

an adapter cable so that its battery can be recharged with a standard E-Clip, a process that takes about 10 minutes. Sales of the Laser Sword have been disappointing, and Wilk's is considering stopping production altogether.

Weight: 1.5 lbs (0.7 kg).

Mega-Damage: 5D6 M.D. per strike.

Rate of Fire: As per hand to hand attacks; W.P. Sword bonuses apply.

Effective Range: Handheld like any sword; cannot be thrown (automatic "deadman switch" shut-off feature).

Payload: The built-in battery provides only enough power for 15+5D6 minutes of continuous operation, creating a limited and unpredictable duration. It can be recharged with an adapter using a standard E-clip, which takes about 10 minutes.

Note: The laser blade cannot be used to parry any type of attack; it cuts everything it touches.

Cost: 24,000 credits, reduced from 32,000. Poor availability and may be discontinued.

## Notable Wilk's Optics Systems

Wilk's is a world leader in optical enhancement systems. Its products are the state-of-the-art in known human technological design. Only Triax comes close, and without question, Wilk's designs are the most technologically advanced optical systems in North America.

### Wilk's Integrated Optics Gun-Sight

A universal weapon sight designed for quick and easy attachment to any rifle. The module features cross-hairs, telescopic magnification (3000 foot/914 m range), passive night vision (3000 foot/914 m range) and FLIR thermal-imaging (1600 foot/488 m range), as well as a laser range-finder (one mile/1.6 km) and aiming system. The gun-sight is very reliable, waterproof, and durable under field conditions, which means it can survive a considerable amount of punishment without a systems failure. There is only a 01-06% likelihood of the laser targeting module crashing under stressful and damaging circumstances (impacts, falls, etc.). However, if the sight, itself, directly sustains 5 M.D.C. or more damage it is rendered useless. **Weight:** 2 lbs (0.9 kg). **Range:** As above. **Targeting Bonus:** +2 to strike on aimed shots. **Cost:** 4,000 credits.

### Wilk's "Aimer" Gun-Sight

A small laser sight module that fits beneath the barrel of most standard pistols or atop of most standard revolvers. The sight is calibrated so that the weapon will hit whatever the bright red "aiming dot" illuminates. **Weight:** 6 ounces (170 grams). **Range:** 1200 feet (366 m). **Targeting Bonuses:** +1 on initiative and +1 to strike on aimed shots. **Cost:** 1,000 credits.

### Wilk's Infrared Binoculars

Basic, first generation, IR Distancing Binoculars. A high-powered optical enhancement device with an active infrared



system, cross-hair lines, and digital readout of the approximate distance (within six inches/15 cm) and estimated rate of travel if the target is moving (70% accuracy). If there is a problem, it is that the thin, infrared (IR) light beam fired by the binoculars (and similar gun-sights) is visible to other IR optics, drawing a thin red line right back to the exact location of the binocular's user. This can be an obvious liability in stealth and combat situations. Nonetheless, the IR Distancing Binoculars remain extremely popular among civilians, hunters, Psi-Stalkers, Wilderness Scouts and start-up groups of adventurers, and are highly reliable and relatively inexpensive. **Weight:** One pound (0.45 kg). **M.D.C.:** One. **Range:** 2 miles (3.2 km). **Cost:** Lists for 1,200 credits, but many retail outlets sell the item new for 900 credits and used for 600 credits.

## Wilk's FLIR

### Distancing & Recording Binoculars

This is a second generation FLIR (Forward Looking Infrared) optics system that is an improvement over the old style IR distancing binoculars. It is a *passive*, thermal-imaging system that uses ambient infrared radiation which means that, unlike with traditional IR binocs, these binoculars do *not* emit any infrared light that can be tracked back to the user. The binoculars also feature a laser distancing module with digital display that provides an accurate digital readout of the distance, within two centimeters, and the estimated rate of the target's travel (96% accurate) if it is moving. Moreover, this device has an integrated recording module that can be used to record visual images on a standard one inch disc. Each disc can record up to four hours of images.

Wilk's FLIR Distancing & Recording binoculars are extremely popular, especially among Wilderness Scouts, Rangers, espionage agents, special forces, mercenaries, explorers and adventurers all across the continent.

**Weight:** 2 lbs (0.9 kg). **M.D.C.:** One. **Range:** 2.5 miles (4 km). **Cost:** 2,500 credits. Recordable discs cost 50 credits each. **Note:** Also available as goggles without the recording feature and with half the range for around 2,000 credits.

## Wilk's LRD-10

### Laser Rangefinder, Designator & Recorder

The LRD-10 is an upgraded, more sophisticated version of a simple Wilk's laser designator. Compared to the generic model, the LRD-10 is smaller, lighter, and has a greater range. It incorporates the added features of a laser rangefinder/distancer and digital recorder available as binoculars (LRD-10A) and multi-optics helmet (LRD-10B) package and looks very similar to each of these standard items, only 50% larger.

How the LRD-10 works is that it projects an invisible laser beam to target objects for precision, laser-guided targeting. To employ this feature the operator simply has to look through the optical device, place the reticle squarely on the target, then press and hold the "designate" button. Laser-seeking guided missiles and bombs will then hone in on the reflected beam, impacting on the *specified/laser tagged* target. LRD-10s are used to *guide missiles* fired from any launch platform, including ground

launch systems (mines and guns), armored vehicles, helicopters and aircraft. All that has to be done is to program the LRD-10 with the laser frequency matching that of the missile, accomplished using most any handheld, portable computer.

Moreover, it has a rangefinder feature that works the same as that of the Wilk's FLIR binoculars (gives digital readout of distance, bearing and speed; 96% accuracy) and an integrated recording system that will record images on standard one inch discs (great for confirming strikes and bomb damage assessment). Each disc can record up to four hours of images. **Weight:** 4 lbs (1.8 kg). **M.D.C.:** Two. **Range:** 6 miles (9.6 km). **Bonuses:** Laser-guided rockets and missiles are +3 to strike their designated targets. **Cost:** 12,500 credits. Recordable discs cost about 50 credits each.

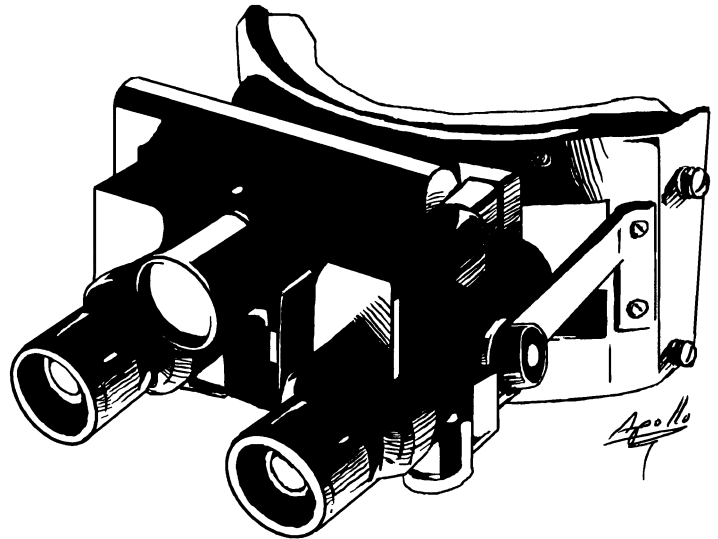

## Wilk's Portable Thermal-Imager

Wilk's Portable Thermal-Imager is a second generation FLIR optical system that converts the infrared radiation of warm objects into a visible image. It allows the operator to see in complete darkness, shadows and through smoke. The device is powered by a standard E-Clip and is electrically cooled. This system is a rather large and bulky telescopic-style optic system. It can be used as a handheld device like binoculars or attached to an assault rifle, but is designed for attachment to a tripod mount. If the thermal-imager is mounted on a rifle the extra weight (4 lbs/1.8 kg) will throw off the weapon's balance and make shooting more difficult, incurring a penalty of -1 to strike on an aimed shot and -2 to strike on a burst or spray. **Weight:** 4 lbs (1.8 kg). **M.D.C.:** 3. **Range:** 2,000 feet (610 m). **Battery/E-Clip Life:** A standard E-Clip provides 96 hours of continuous operation. **Cost:** 3,000 credits. **Note:** Also available as an attachment to a helmet for an extra 600 credits.

## Notable Wilk's Communications & Sensor Systems

Wilk's communications systems are on the cutting edge of current human technology. Radios manufactured by the company are light, durable, long-ranged and very reliable, although prices are steeper than the competition's. Wilk's radios are ex-

tremely popular with top security forces, spies and intelligence operatives, mercenary groups, special forces and the armed forces of numerous kingdoms.

## Wilk's PRC-5 Secure Walkie-Talkie

An enhanced walkie-talkie personal radio communications (PRC) system with a special cryptographic package. The unit provides 15 channels, all of which have a secure capability as well as normal scrambling and unscrambled features. For secure communications, a special cryptographic program is loaded into the radio using a standard Wilk's 3000 (or other handheld) computer. Once this program is loaded into the radio, only other radios with the same program are capable of receiving its transmissions.

For another 200 credits the system comes with a microphone and comfortable earpiece headgear for *hands-free* communications. Other versions of the PRC-5 system include a wristband-style radio and a system designed for installation into standard environmental body armor and helmets.

**Weight:** 1 lb (0.45 kg). **M.D.C.:** 2. **Range:** 10 miles (16 km). **Battery Life:** A rechargeable battery provides 96 hours of continuous operation before needing to be recharged. **Security Note:** Due to the sophisticated scrambler program, the *Cryptography* skill has a penalty of -25% to crack the system's secure communications feature. **Cost:** 3,000 credits per single unit. Additional batteries cost 1,000 credits, and can be recharged using a portable generator, nuclear power plant or even standard E-Clips.

## Wilk's PRC-60 Secure Field Radio

The PRC-60 is a man-portable, backpack style field radio with expanded capabilities. Its advantages over the small handheld radios include a much longer range, 90 channels and a greater frequency range. This radio uses the same special cryptographic package as the PRC-5 walkie-talkie, meaning that only other radios and walkie-talkies loaded with the same cryptographic program are capable of receiving its transmissions. As with the PRC-5, the program must be loaded into the PRC-60 using a handheld computer. The radio is also capable of normal, unencrypted radio communications.

**Weight:** 11 lbs (5 kg). **M.D.C.:** 6. **Range:** 60 miles (96 km) in the city and in the mountains, 120 miles (192 km) in the open/wild. **Battery Life:** A single standard E-Clip provides enough power for 48 hours of continuous operation. **Security Note:** Due to the sophisticated scrambler program, all *Cryptography* skill checks have a -25% penalty to crack the system's secure communications feature. **Cost:** 7,500 credits.

## Wilk's LASCOM PLC-150 Field Radio

The Wilk's PLC-150 is a man-portable, backpack style laser communications (LASCOM) system that uses a directional laser beam to transmit information. This system is packaged in an impact resistant case (15 M.D.C.) with backpack straps and numerous exterior pouches. It is a sophisticated, computerized system that is capable of transmitting and receiving voice, digital text,

video and/or computer data downloads. All transmissions are processed and encoded by the internal computer and then translated into a communications laser beam (and vice versa, translates laser transmissions into voice, data or text). The computer aligns the laser transmitter which sends information at an incredibly high speed. Even long messages of 15-20 pages of text, maps, artwork/pictures or five minutes of video/film take only 1D4 melee rounds (15-60 seconds) to transmit! It takes a trained operator 5-8 minutes (1D4+4 minutes) to assemble the LASCOM for transmission. A communications *Laser* skill check is required to assemble the system properly.

Like the PRC-60 Field Radio this is a secure system. Only a computer loaded with the proper decryption codes can successfully decode messages sent by the LASCOM unit. Attempts to crack this code are extremely difficult, imposing a -30% penalty on the *Cryptography* skill.

**Weight:** 20 lbs (9 kg). **M.D.C.:** 15. **Range:** 150 miles (240 km). **Battery Life:** The radio and computer module are powered by two standard E-Clips which provide enough power for 6 hours of continuous operation. The laser transmitter is powered independently by a standard E-Clip which provides enough power for 30 minutes of continuous operation. **Cost:** 35,000 credits.

## Wilk's LASCOM PPLC-500 Field Radio

The PPLC-500 is a large, sophisticated laser communications (LASCOM) suite that is designed for command and control functions. It consists of a 15 foot (4.5 m) tall and 10 foot (3 m) wide pulse laser dish transmitter and receiver. The system has the same security features as the smaller, portable PLC-150 with the added capability of pulse transmission. Before sending a transmission the internal computer (which can incidentally also be used to download cryptographic programs) compresses information so that even the longest messages (numbering thousands of pages of text) can be sent in a laser pulse that takes only 1D4 melee attacks/actions. It is nearly impossible to intercept the laser, let alone decrypt its message, due to the small window of time it takes the pulse to transmit information. Furthermore, the tight beam escapes normal radio scans from picking up its signal or intercepting even scrambled messages.

**Weight:** 60 lbs (27 kg). **M.D.C.:** 20. **Range:** 500 miles (800 km) and may be bounced from relay stations to increase the range up to 500 miles (800 km) per station. **Battery Life:** A portable nuclear battery provides power for the system with 5 years of continuous power (typically good for 10-12 years under normal use). Alternatively the LASCOM system can be connected to the power supply of a vehicle, robot or generator. **Cost:** 300,000 credits.

## Wilk's Portable Ultra-Mini-Radar

A backpack radar unit with tripod and monitor that can be set up in about 5 minutes. A trained operator (using the *Read Sensory Equipment* skill) can positively identify objects, pinpoint their location and estimate rate of travel and direction with a 90% accuracy. This system is state-of-the-art and has an increased range over older models.

**Weight:** 23 lbs (10.4 kg). **M.D.C.:** 12. **Range:** 20 miles (32 km) and can track up to 72 separate targets. **Battery Life:** The unit is powered by two standard E-Clips which provide enough energy for 144 hours of continuous operation. **Cost:** 5,500 credits.

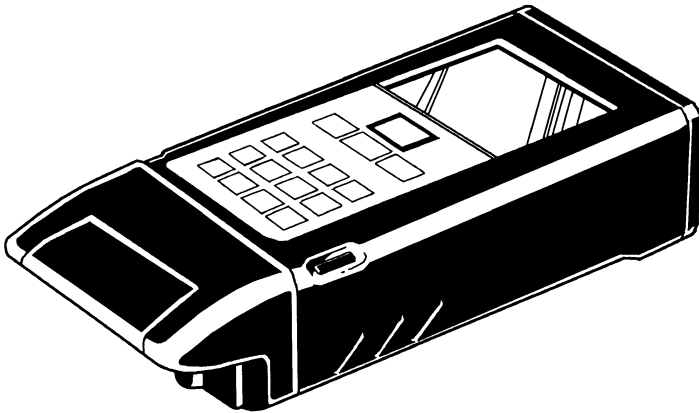

## Wilk's Ultra-Pocket Laser Distancer

A small device, roughly the size of a cigarette lighter, that is used to measure distances. The unit has an LED display with a built-in calendar, clock and alarm clock capability.

**Weight:** 4 ounces (113 grams). **M.D.C.:** One. **Range:** 6000 feet (1829 m). **Battery Life:** A built-in battery provides enough power for 800 hours of operation (which usually translates into 5-10 years of normal use). It can be recharged with an adapter using a standard E-Clip, which takes about 10 minutes. **Cost:** 1,800 credits.

## Wilk's Laser Flashlight

Wilk's produces a series of high-powered laser flashlights that provide greater illumination and range than a normal flashlight. The flashlights have both a visible light and an infrared setting, the latter can only be seen by individuals who naturally see in the infrared spectrum of light or are using an IR optics system or thermal-imager. Wilk's also sells mounting brackets so that a laser flashlight can be easily attached to most military grade rifles.

**Weight:** 1.5 lbs (0.7 kg). **M.D.C.:** One. **Range:** 1000 feet (305 m). **Battery Life:** A built-in battery provides enough power for 800 hours of operation (which usually translates into 1-3 years of normal use). It can be recharged with an adapter using a standard E-Clip, which takes about 10 minutes. **Cost:** 2,000 credits.

## Wilk's High-Powered Laser Floodlight

A large floodlight designed for mounting on a vehicle, tower or wheeled mounting that can be pulled by a vehicle or troops. It has two settings, both visible light and infrared, the latter of which can only be seen by those with IR or thermal-imaging optics and individuals who see in the infrared spectrum of light.

**Weight:** 25 lbs (11.25 kg). **M.D.C.:** 6. **Range:** 1400 feet (426.7 m), and illuminates a 10 foot (3 m) diameter area. **Battery Life:** A built-in battery provides enough power for 800

hours of operation (translating into about 6-9 months worth of frequent use). The spotlight can also be connected to a power pack or generator quadrupling its life. **Cost:** 8,500 credits. 60,000 credits for a power pack or generator.

## Wilk's Holographic Mini-Camera

This device is about the same size as a small pair of binoculars and records three-dimensional images in the same manner as an old VHS hand-held camera. Sound and images are recorded on three inch computer discs which can be played on the Wilk's PC-2020 Field Identifier/Laser Holographic Portable Computer. The discs have enough space to record up to six hours of images.

**Weight:** 4 lbs (1.8 kg). **Range:** 1000 feet (305 m). **Battery Life:** The mini-camera is powered by a standard E-Clip which provides enough energy for 72 hours of continuous operation. **Cost:** 10,000 credits. Discs cost about 50 credits each.

## Wilk's LRF-3 Laser Designator

The LRF-3 Laser Designator is a man-portable device that projects an invisible laser beam to designate or "paint" targets for laser-guided missiles and bombs. The beam reflected from the "painted" target is a beacon for the laser-seeker guidance module in precision CS missiles. This designator is similar to standard rangefinder binoculars in operation and basic design. The operator views a target through the eyepiece, centers the cross-hairs on it and presses the button. Unlike with the rangefinder, the laser beam must be left on the target to designate until the munitions arrive. The LRF-3 can be used to direct missiles from the Mark IX to strike identified targets.

**Weight:** 8 lbs (3.6 kg). **Range:** 6 miles (10 km). **Bonuses:** Laser-guided munitions are +3 to strike. **Cost:** 8,000 credits. The LRF-3 on its own is useless. To be effective it must be used in conjunction with the Mark IX or another MLV.

# Miscellaneous Equipment

## Weapons

**Ballistic Knives.** A ballistic knife is a combat knife that can, in addition to normal hand to hand use, propel its blade with lethal force. When the trigger is pressed the blade shoots out from the handle, propelled by means of a powerful coiled spring, and strikes with several times the force of a normal stab. The ballistic knife is totally silent, can penetrate light S.D.C. body armor and is effective to a range of 9 m (30 feet). Ballistic knives are fairly unusual and rare weapons typically used by City Rats, thieves, bandits, and other criminal elements.

**Weight:** One pound (0.45 kg).

**S.D.C. Damage:** 1D6 S.D.C. from a stab or slash, or 2D6 S.D.C. when fired as a projectile.

Rate of Fire: One.

Effective Range: 30 feet (9.1 m).

Payload: One.

Cost: 600 credits.

**Ballistic Vibro-Knife.** A new twist on an old idea, the ballistic Vibro-Knife is essentially identical in concept to a standard ballistic knife except that it fires a Vibro-Blade capable of inflicting Mega-Damage. This weapon is also uncommon, but somewhat popular in underworld circles and among Head-hunters.

Weight: 2 lbs (0.9 kg).

Mega-Damage: 1D6 M.D. from a stab or slash, or it inflicts 2D6 M.D. when fired as a projectile.

Rate of Fire: One.

Effective Range: 30 feet (9.1 m).

Payload: One.

Cost: 8,000 credits.

**Garrotte.** The garrotte is an ancient strangling weapon that has been used by assassins for centuries. It is a simple weapon, basically just a length of thin, sharp wire often with wooden handles at both ends. To use the garrotte a would-be assassin approaches his victim from behind, places the wire around the victim's neck, crosses the handles and pulls. If the assassin makes a successful *Prowl* skill roll, the victim is caught unawares and damage from the attack is inflicted direct to Hit Points. Should the intended victim detect the attacker's approach, i.e. a failed *Prowl* roll, he has the chance to defend himself and the damage is subtracted from S.D.C.

Weight: 2 ounces (56.7 grams).

S.D.C. Damage: Inflicts 4D6 S.D.C., plus P.S. damage, every melee round.

Cost: 30 credits.

**Vibro-Garrotte.** This is a modernized version of the ancient garrotte that channels a Vibro-Energy cutting field along the wire. As a result, this garrotte is capable of inflicting Mega-Damage, making it a highly lethal weapon (especially to S.D.C. creatures). Power for the Vibro-Garrotte is provided by cylindrical E-Clips housed in the handles at both ends of the wire. In combat, the Vibro-Garrotte is employed in the exact same way as the conventional S.D.C. version described above (see garrotte description for details). The cylindrical E-Clips provide enough energy for one hour of continuous use.

Weight: 4 ounces (113 grams).

Mega-Damage: Inflicts 4D4 M.D. per melee round.

Cost: 850 credits for the garrotte, E-Clip cylinders cost 200 credits each.

**Neural Dusters.** Styled after brass knuckles, the Neural Duster is a compact, easily concealed variation on the Neural Mace. The weapon fits over the fist and when it strikes, releases a neural disruptive pulse that temporarily incapacitates the victim. If the victim fails to save vs Neural Stun, a 16 or higher, he is rendered unconscious. Even if the victim saves and remains conscious, he will suffer penalties of -8 to strike, parry and dodge, loses two melee attacks, and Spd is halved for 2D4 melee rounds.

Weight: One pound (0.45 kg).



Damage: 2D4 S.D.C., plus P.S. damage bonus (if any), as well as the penalties listed above. Once the stun capabilities are momentarily used up, the device can be used like brass knuckles, adding 1D4 S.D.C. damage to normal punches.

Payload: Two neural stun attacks. May be recharged four times by a standard E-Clip.

Cost: 9,000 credits.

**Olterak Mace Spray.** Olterak mace is a debilitating chemical spray that comes in a small aerosol canister. This is a non-lethal, personal defense weapon similar to mace or pepper spray. The difference is that the spray in this canister uses a synthesized chemical taken from the musk of a skunk-like creature from another dimension. It is far more effective than earth variants and works even against supernatural and magic creatures. When the victim is sprayed he suffers penalties of no initiative, -5 to strike, parry and dodge, reduce attacks per melee by half and reduce Speed attribute by one third. If a successful save vs non-lethal poison is made, all penalties are reduced by half.

Weight: 1 lb (0.45 kg).

Damage: 1D4 S.D.C. plus penalties listed above.

Duration: 1D6 melee rounds for the penalties, but the stink lingers for 1D6 hours and sprayed victims are +20% to track by Dog Boys and other beings who can track by smell.

Rate of Fire: Each blast counts as one melee attack/action.

Effective Range: 10 feet (3 m).

Payload: Six uses.

Cost: 1000 credits.



## Clothing: Specialized

**Armor: Light Tactical Armor.** This is a light Mega-Damage body suit made from a polymer weave fabric with semi-rigid M.D.C. plastic plates that provides the wearer with 6 M.D.C. It is lightweight, has excellent mobility (no penalty to Prowl) and is completely invulnerable to S.D.C. weaponry. Light tactical armor is mainly used by police and security personnel in urban areas where Mega-Damage weaponry is illegal and not easily available. **Weight:** 6 lbs (2.7 kg). **M.D.C.:** 6; protective helmet additional. **Cost:** 5,000 credits.

**Armor: M.D.C. Flight Suit.** Based on the design of the Glitter Boy pilot suit, this is a non-restrictive, lightweight body suit that nonetheless provides its wearer with Mega-Damage protection. The flight suit is made of multiple layers of a polymer weave fabric reinforced in vital areas by semi-rigid M.D.C. plastic plates. It is not meant as a front-line armor suit, but designed for aviators, vehicle crews and power armor pilots as a last resort protection measure if their vehicle is destroyed, shot down, crashes, or is breached. **Weight:** 11 lbs (5 kg). **Mobility:** Unrestricted (no penalties). **M.D.C.:** 22 (main body). **Cost:** 20,000 credits.

**Armor: TacVest.** The tactical vest is a popular alternative to standard webbing or utility gear, often used by special forces, hostage rescue teams and urban tactical forces. Compared to

typical web gear the tacvest is lighter, more compact, less cumbersome and makes it easier to get at equipment - especially magazines for weapons. Normally the vest is covered in pockets, pouches and straps for the attachment of essential equipment like portable walkie-talkie radios, ammo clips, grenades, Vibro-Knives, handcuffs, Neural Mace or nightstick, etc. On most models the ammo pouches are removable, meaning that the user can attach pouches of the appropriate size for his personal weapon. Some tacvests have internal compartments for Kevlar-style bulletproof materials, effectively making it a frag vest, useful for S.D.C. settings. **Weight:** 2 lbs (0.9 kg). **A.R.:** 16 (covers the torso only, so the M.D.C. TacVest has an A.R. similar to Cyber-Armor). **Cost:** 500 credits for an unarmored TacVest, 2,400 credits for a standard S.D.C. model (120 S.D.C./1 M.D.C.), or 25,000 credits for one with 25 M.D.C. armor plating.

**Camouflage: Black Covert Jumpsuit.** This is a one piece, black body-suit and hood made of a durable, non-flammable S.D.C. fabric. Its design is similar to regular combat fatigues with a multitude of pockets. These suits are typically used by professional thieves, assassins and spies for missions of infiltration, sabotage and espionage. **Cost:** 100 credits. **Bonus:** +5% to Prowl at night.

**Camouflage: Ghillie Suit.** The ghillie suit is a three dimensional camouflage covering that fits over body armor and is designed to help conceal its wearer from observation (+5% bonus to Prowl and +10% to Blend). Ghillie suits are made from strips of camouflaged burlap cloth that effectively break up the silhouette of its wearer and make it easy to hide in natural vegetation. Typically these suits are used by snipers, reconnaissance troops and game hunters to stalk up on targets unobserved, and are incredibly effective even in grassy fields and scrub land. **Cost:** 500 credits.

**Camouflage: Stealth Ghillie Suit.** This is basically an advanced version of the basic ghillie suit listed above. The suit is designed to slip over the top of standard body armor, held in place by a harness and tie-downs for the arms and legs. Its exterior is a many-layered, three dimensional covering made from strips of camouflage cloth to provide visual concealment (+10% bonus to Prowl and Blend skills). What makes the suit more advanced is the interior layer which is electronically cooled by means of a standard E-Clip (48 hours of use) to suppress the wearer's thermal pattern. Due to this cooling system, the stealth suit cannot be detected by thermal-imagers at ranges greater than 200 feet (61 m), and even within close range, attempts to detect the heat signature of the person inside the suit suffer a penalty of -30% to the operator's *Read Sensory Equipment* skill. The CS, Northern Gun and Wellington all produce versions of this suit. **Cost:** 3,500 credits.

**Camouflage Netting:** Not clothing, but camouflage netting made from cloth with a special, computer generated pattern attached to a large cargo netting. These nets are used to conceal cases of supplies, cargo, parked vehicles, tents, buildings and defensive positions. Anyone attempting to detect an item or object covered by one of these nets suffers a penalty of -15% to the *Detect Concealment* skill. A typical net is large enough to cover a 10 by 10 foot (3 x 3 m) area, but may be combined with other nets to cover larger surfaces. **Cost:** 250 credits.

**Pilot's Survival Kit:** Being shot down behind enemy lines or in a hostile wilderness is a real concern for pilots. To give them a better chance for survival and eventual recovery, most militaries issue them a stripped-down, lightweight basic survival kit. The standard design is a pouch-covered, web-vest assembly worn over the flight suit at all times. The vest is olive drab, somewhat bulky and doubles as a personal flotation device (+25% to Swimming skill) in addition to containing basic survival gear. Includes a shoulder holster for standard-size handguns (pistols or revolvers; including M.D. varieties), two additional magazines/E-Clips, multi-tool/knife, heliograph (signaling mirror), map, compass, minimal first-aid kit, strobe light & tracking beacon, long-range walkie-talkie (10 mile/16 km range with 72 continuous hours of battery life), emergency "space" blanket (folds to the size of an envelope), a half-liter squeeze bottle of water, water purification tablets, and an emergency food ration (holds a handful of condensed, energy- and protein-packed meal replacement bars good for three days). **Weight:** 15 lbs (6.7 kg). **Cost:** 500 credits plus the cost of the sidearm. **Note:** The kit is not meant to support a prolonged survival effort, instead it is for a short-distance, limited duration escape and evasion. It is adequate for a period of 24-72 hours, during which, in most cases, the pilot will be rescued. After that time, the individual must rely on his own abilities to forage and survive in the wilderness.



## Communications Equipment

**Field Telephone:** A military version of a standard phone system with a fiber optic land line connecting individual field

telephone terminals. It functions in the same way as an intercom and once set up, is a non-portable, stationary communications system. The big advantage to the phone system is that unless the fiber optic cable is severed or broken, there is no way for the enemy to eavesdrop, interfere or jam transmissions between the phone terminals. **Cost:** 800 credits per 100 feet (30.5 m) of fiber optic cable, and 200 credits per phone terminal.

**Cellular Phone:** These compact, lightweight and portable hand-held telephones are still available on Rifts Earth, but only at technologically advanced urban centers. Places in North America that offer cellular service include all cities in the Coalition States, Old Town 'Burbs (and some New Town 'Burbs), Old Bones, MercTown, Northern Gun, Manistique Imperium, Lazlo, New Lazlo, Free Quebec and Kingsdale, among a small handful of others (and the fallen kingdom of Tolkeen, as well as the New German Republic and the tech cities of Japan). Calls are only possible within city limits and, due to the lack of satellites and phone lines, long-distance calls between cities are impossible. The biggest problem is that cellular phones are an "unsecured" means of communication, they use commercial airwaves and are very easy to trace, track, tap into, monitor and record. **Range:** Effectively limited to within city limits. **Weight:** As small as a beeper and as light as 5 ounces (141.8 grams). **Cost:** 150 credits for the phone, 30 credits per month for basic service, plus the cost of air time (probably 50-100 credits per month for light to average use).

**Secure Cellular Phone:** Secure cellular phones are identical to regular civilian models except for the addition of a scrambler chip. This chip uses a computer-generated algorithm to encrypt its transmissions, making it difficult for outsiders to tap and eavesdrop unless the matching phone has a chip loaded with the identical encryption code or other tapping system is used. Attempts to decrypt the transmission suffer a penalty of -20%. Popular among City Rats, Rogue Scholars, Rogue Scientists, undercover agents/spies and members of the criminal underworld. **Range:** Effectively limited to within city limits. **Weight:** As small as a beeper and as light as 5 ounces (141.8 grams). **Cost:** 5,000 credits, typically only available from the Black Market, intelligence agencies and elite military personnel.

**Ear Mic Radio Receiver and Transmitter:** A tough, reliable radio accessory device that plugs into the ear. With the help of a transducer connected to a receiver/transmitter device, and manually activated for speaking or listening modes, the user can both listen and speak through the earphone. This is possible because the ear canal captures outgoing sound (voice), as well as incoming sounds. It is so effective that the user can transmit softly spoken words just above that of a whisper. Compatible with any portable, two-way radio equipped with an external speaker/microphone or bionic radio systems. **Range:** One mile (1.6 km). **Weight:** 6 ounces (170 grams), **Cost:** 2,200 credits.

**Field Expedient Antenna:** It is possible to boost the range of a tactical radio set by rigging a field expedient antenna. There are various methods of accomplishing this, but most involve stringing a specific length of wire, either vertically or horizontally, above the ground or arranged on the ground in a complex "radiation pattern." To put up or make a field expedient antenna, all that's needed is the skill *Basic Electronics* or *Radio: Basic*, the latter at a -10% penalty. **Range:** Doubles the range of the radio set. **Weight:** 10-15 lbs (4.5 to 6.8 kg) depending on the materials used. **Cost:** 100 credits for the materials to make one, or



300 credits for a minimal construction necessary, pre-built unit. **Note:** A laser communications relay station is twice the size and weight, requires a ready to build kit and costs 10,000 credits.

## Communications & Surveillance Equipment

**Note:** All surveillance devices are illegal or restricted to police and government agencies in the Coalition States and most high-tech communities. All are available from Wilk's Laser Industries and the Black Market.

**Amplified Sound Detector:** A device designed for security and espionage purposes to extend the range of normal hearing. It is a two-piece unit, consisting of headphones and sound detector, which at first glance, resembles a very large flashlight. The detector utilizes a built-in, 3.5 inch (9 cm) parabolic dish for sound mirror effect. Amplifies normal sound by several thousand times so that a whisper can be heard at 300 feet (91.5 m). **Weight:** 2 lbs (0.9 kg). **Cost:** 2,400 credits.

**Cellular Telephone Transmission Interceptor:** A device about the size of a handheld computer with an extendable antenna and earphones designed to pick up nearby cell phone signals/transmissions, focus on a specific transmission and listen and record it. Can also trace the transmission from its sender to the receiver, but only so long as the connection (conversation) is ongoing. **Weight:** 2 lbs (0.9 kg). **Range:** 1200 feet (366 m). **Cost:** 8,000 credits.

**Laser Eavesdropping Device:** A high-tech eavesdropping electronic device that uses a focused laser beam. The invisible beam is projected at the window of the room that the operator wishes to spy on. When the occupants of the room speak, the sound waves produce vibrations in the window glass, which is then translated by the laser beam into an audio recording at the receiving end of the device. **Weight:** 15 lbs (6.8 kg). **Range:** 4000 feet (1219 m). **Cost:** 6,500 credits.

**Weapon Scanner:** This handheld device is used to detect concealed and cybernetic/bionic weapons. It works by detecting the presence of metal compounds and energy sources, both of which are common components of modern weaponry. The weapon scanner has a relatively short range, but is powerful enough to detect even cybernetic and bionic weapons implanted inside an organic host with an accuracy of 87%. **Weight:** 5 lbs (2.3 kg). **Range:** 100 feet (30.5 m). **Cost:** 10,500 credits.

**White Noise Generator:** A small electronic device the size of a cigarette package that generates white noise, which is used to muffle conversations and distort bugging systems by 40% to defeat eavesdropping. **Weight:** 2 lbs (0.9 kg). **Cost:** 2,000 credits.

## Chemicals/Performance Enhancing Drugs

Performance enhancing drugs, or PEDs, are narcotics designed to increase physical performance in the areas of agility, strength and endurance. These chemicals do *not* produce a "high" in the same manner as recreational narcotics, but can dramatically boost physical attributes for short durations which, in turn, provides an adrenaline buzz and/or emotional high for the

user. Mercenaries, warriors and athletes use PEDs to get an edge in competitions and combat situations. The downside to these chemicals is that some are potentially addictive, they are illegal substances in numerous kingdoms, including the Coalition States (with stiff penalties simply for possession), and regular use for as little as a year or two can have a lasting impact on the user's body – typically reducing one's life expectancy by 2D6 years, causing joint and muscle stiffness, aches and pain (similar to arthritis or gout) by age 40, and often (62% of the time) lead to substance abuse (drugs and/or alcohol).

**Dragon Hormone, a.k.a. "DH":** This type of PED is a steroid synthesized from the hormones of giants, dragons and other supernaturally strong beings. Unlike most other PEDs on the market, these do not have an immediately noticeable effect but must be taken over a period of several weeks to produce results.

**Duration of Benefits & Bonuses:** Permanent, so long as the character maintains a strict physical training regimen, including weight lifting, and takes DH on a daily basis. **Bonuses:** +1D6x10 lbs in weight/muscle mass, +1D6+4 to P.S., +1D4 to P.E., +3D6+3 to S.D.C. and raise ordinary human P.S. to the equal of *Bionic/Augmented Human P.S.* **Level of Addictiveness:** Medium to high. **Cost Per Dose:** 125 credits per daily dose, that's 875 credits for a week's dosage. **Penalties:** Serious side effects are likely from these hormones, which are not always compatible with human/mortal biology. Roll on the following side effects table.

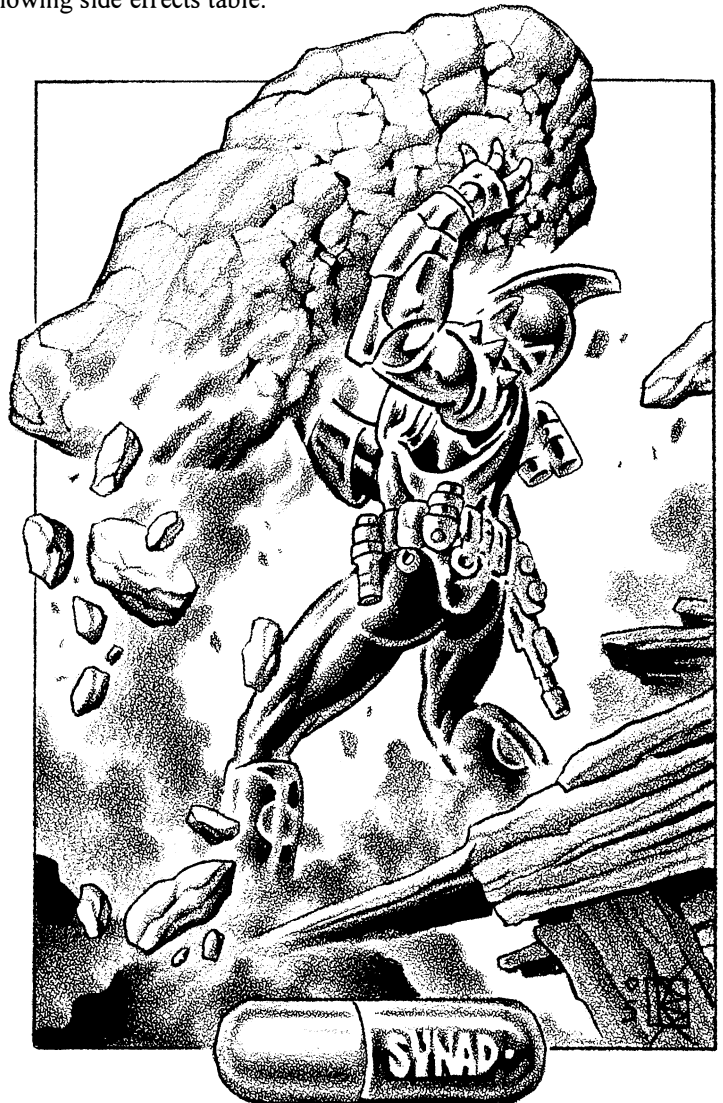



01-20% *Lucked out, no side effects – yet.* Roll again in six months.

21-40% *Skin becomes noticeably hard and rough*, which is usually a romantic turn off; also reduce P.B. by 10%, and skills requiring a fine or delicate sense of touch, like Palming, Pick Pockets, Safe-cracking and surgery or mechanics skills are -5%.

41-60% *Muscle stiffness in the joints.* Reduce speed attribute by 10% and -2 on initiative. 01-50% chance pain and penalties are permanent even after the character stops taking DH.

61-70% *Severe muscle stiffness.* Reduce speed attribute by 20% and attacks per melee round by one. Permanent, even after the character stops taking DH.

71-80% *Paralyzing muscle cramping* when the user is dehydrated or exhausted. 01-50% arm cramp and pain renders the limb *useless* for 1D6+3 minutes. 51-00% leg cramp and pain locks the leg, making it impossible to move; limps at half Spd for 1D6+3 minutes. The problem persists as long as the drug is taken and there is a 01-30% chance it is permanent and persists even after one stops using DH.

81-90% *Skin discoloration, itching and flaking.* The skin turns a sickly grey, green or pale tone, and scratching itchy skin leaves marks and creates flakes (body dandruff). Reduce P.B. by 30% and M.A. by 20%, there can be no denying one uses DH (as this is a known symptom), the character is -1 on initiative and maybe considered diseased or unsanitary. Problem remains for as long as the drug is used, and may become permanent (01-60% chance) if DH is taken for more than eight years.

91-00% *Sexually impotent*, no sex drive; applicable to males and females. Drive returns 1D4 weeks after going off DH, but the problem remains as long as the drug is used.

**Synthetic Adrenaline a.k.a. “Rush”:** A substance identical to the adrenaline in the human body, but synthesized from chemical compounds. When injected the character gets a chemically induced rush or surge of added energy, strength and speed. This super adrenaline is similar to some of the chemicals used in the Juicer bio-comp system. **Duration:** 1D10+10 minutes. **Bonuses:** +1D4+2 to P.S. and +1D6+6 to Spd attributes, +2 to save vs poison, drugs or disease, +1 on initiative, +1 to strike, +2 to parry and dodge and +1 attack per melee round! **Penalties:** Once the effects wear off the character feels exhausted, clumsy and lethargic. Reduce speed by 30%, -2 attacks per melee round, -2 on initiative and -1 to strike, parry, dodge and other combat moves for one hour. **Level of Addictiveness:** Medium. **Cost Per Dose:** 500 credits.

**Qwik-Heal a.k.a. “Q”:** Qwik-Heal is a combination of coagulant, painkiller, and stimulant with a tissue regenerative compound synthesized from D-Bees with natural bio-regenerative abilities. It is possible to take Qwik-Heal as a preventative measure prior to engaging in combat (causing wounds acquired after taking Qwik-Heal to mend before one’s eyes), or after getting an injury. **Duration:** 4D4x10 minutes. **Bonuses:** No blood loss, pain and exhaustion penalties are halved, and bio-regenerates 2D6 S.D.C. or Hit Points every 10 minutes. **Penalties:** When the drug wears off the character feels exhausted and his body aches for 1D4 hours; reduce Spd and all combat bonuses by half, skill performance is -10% for the duration. **Level of Addictiveness:** Medium. *Addicts* believe they *need* Q to fight at their top level or to survive serious combat. A hit of Q has the usual effect for the usual duration, but the addict can fight for an

additional 1D4 hours at his normal level before the penalties kick in. Without Q, however, the addict fights poorly, as if all combat bonuses and skills are half, and he is -1 melee attack. Furthermore, the Q-junkie is paranoid in combat without the drug and fears he will die in combat. This takes away all bonuses to dodge and the warrior is -3 to save vs Horror Factor and illusions. **Cost Per Dose:** 6000 credits, sometimes double.

**No Doze Stimulant, a.k.a. “Sleep Away”:** Chewable tablets containing a moderate strength stimulant that fights the symptoms of fatigue and keeps away sleep. By taking these tablets it is possible to go without sleep for periods of several days without any negative effects. **Duration:** 12 hours per dose. **Bonuses:** For the duration of the effect the character does not require any sleep and remains alert. **Penalties:** Once the character stops taking Sleep Away he immediately feels the effects of prolonged fatigue, finds it near impossible to stay awake and is -10% to perform skills (increase the skill penalty -10% for every 24 hours without sleep). An exhausted character is -5 on initiative, -4 on all combat rolls, Spd is -40%, and reduce attacks per melee by half! **Level of Addictiveness:** Medium. Junkies are fidgety, hyper, seldom sleep more than 3-4 hours a day, and often go 3-6 days at a time without sleep. **Cost Per Dose:** 100 credits.

**Block-Out:** A rare chemical imported from an alien dimension that provides increased resistance to psychic abilities. Useful for mercs who know they have to confront powerful psychics such as the Mind Melter or Mind Bleeder and others. **Duration:** 1D6x10 minutes. **Bonuses:** +3 to save vs psionic attacks, +4 to save vs mind control and illusions. **Penalties:** The user tends to be a little irritable and gets a dull headache that lasts 1D4 hours per dose of Block-Out. Taking more than three doses in one day may also interfere with one’s ability to sleep. **Level of Addictiveness:** Low. **Cost Per Dose:** 1,200 credits.

**Note:** Also see Medical Equipment.

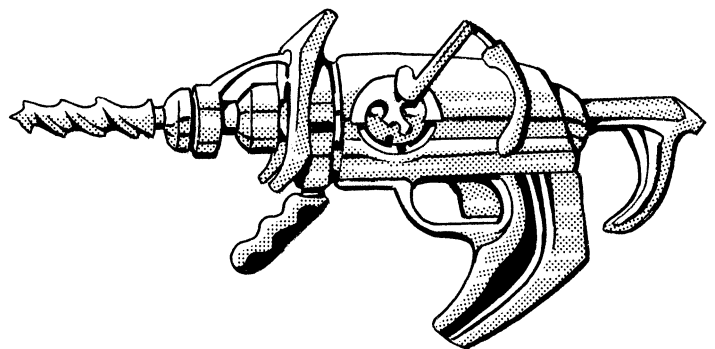

## Construction Equipment

**Diamondback Chainsaw:** Similar to a conventional chainsaw except that the Diamondback is converted to use an electric engine powered by standard E-Clips or a heavy electrical outlet, and the saw blades are made of diamond. The Diamondback is capable of cutting through Mega-Damage materials, including M.D.C. body armor, although it is designed to be used as a tool, not a weapon. **Weight:** 8 lbs (3.6 kg). **Damage:** Inflicts 2D6 M.D. per melee round. **Payload:** An E-Clip provides enough power for one hour of continuous use. **Cost:** 5,500 credits, and replacement diamond chainsaw blades cost 1,500 credits each.

**Handheld M.D. Power Drill:** This is an extremely powerful, handheld power tool that can be fitted with drill bits, sockets

and screwdriver heads. It generates enough torque to tighten or remove bolts on tanks or robot vehicles. Powered by special, rechargeable, cylindrical energy cells. **Weight:** 4 lbs (1.8 kg). **Damage:** Inflicts 1D4 M.D. per melee when fitted with diamond drill bits. **Payload:** The rechargeable E-Cells provide enough power for thirty minutes of continuous use; an E-Clip adapter unit gives it three hours. **Cost:** 1,200 credits.

**Vibro-Cutters:** These are high-tech bolt cutters that use a Vibro-Energy field to cut through Mega-Damage materials. Vibro-Cutters are used to cut through thick tree branches, wire, metal bolts, conduit, locks and similar S.D.C. and M.D.C. structures. **Weight:** 2 lbs (0.9 kg). **Mega-Damage:** 1D4 M.D. **Payload:** An energy cell provides enough power for 30 minutes of continuous use; an E-Clip adapter unit gives it five hours. **Cost:** 2,400 credits.

**Plasma Torch:** A welding and cutting torch that projects a short stream of superheated plasma. The plasma torch inflicts Mega-Damage and is designed to burn through heavy armor plating like that on an M.D.C. main battle tank. Requires a hip or back mounted plasma canister. **Weight:** 5 lbs (2.2 kg). **Mega-Damage:** Three settings: 1D6, 2D6 and 3D6 M.D. **Range:** 2 feet (0.6 m). **Payload:** The canister holds enough super heated plasma for 20 cutting blasts at maximum power. **Cost:** 10,000 credits.

**Electromagnetic Nail Gun:** A device similar to a conventional nail gun except that this is a tool designed to drive nails and bolts into Mega-Damage structures and materials. Power is provided by an E-Clip (two hours of constant use) or a backpack or hip power pack (six hours of continuous use). This device is not designed to be used as a weapon but can be employed as one in an emergency situation. **Weight:** 6 lbs (2.7 kg). **Mega-Damage:** 1 M.D. per shot/nail. **Range:** Touch or up to 50 feet (15.2 m). **Payload:** Nails are loaded in clips of 200. **Cost:** 8,000 credits.

**Miniature Fusion Power Plant:** A portable, nuclear power generator approximately the size of a large suitcase or small trunk. It provides power output equal to a big robot vehicle engine. The miniature fusion plant can be used for any number of tasks from providing power for a camp, building or hamlet, recharging electric engines or E-Clips, powering heavy equipment or even as a replacement for a vehicle's nuclear power plant. **Weight:** 48 lbs (21.6 kg). **Payload:** The miniature plant has an energy life of 10 years. **Cost:** 2 million credits.

**Vehicle Diagnostic Computer:** This is a handheld style computer sensor that when connected to a vehicle, robot or power armor suit, detects mechanical, electrical and computer problems. Not only will the Diagnostic Computer locate the source of the problem, it provides the user with a holographic schematic of the malfunctioning mechanism along with specifications of the parts that need to be repaired or replaced and the common, recommended procedure to effect the repair. The Vehicle Diagnostic Computer is a valuable tool that quickly identifies problems and greatly speeds up repair time. **Weight:** 3 lbs (1.3 kg). **Accuracy:** 92% for common Rifts Earth manufactured vehicles; however, accuracy drops to a mere 30% when dealing with alien or extra-dimensional vehicles. **Bonus:** +10% to appropriate Mechanics skills. Even someone with *Basic Mechanics* can attempt to make the repair, but without the aforementioned bonus. **Cost:** 80,000 credits.

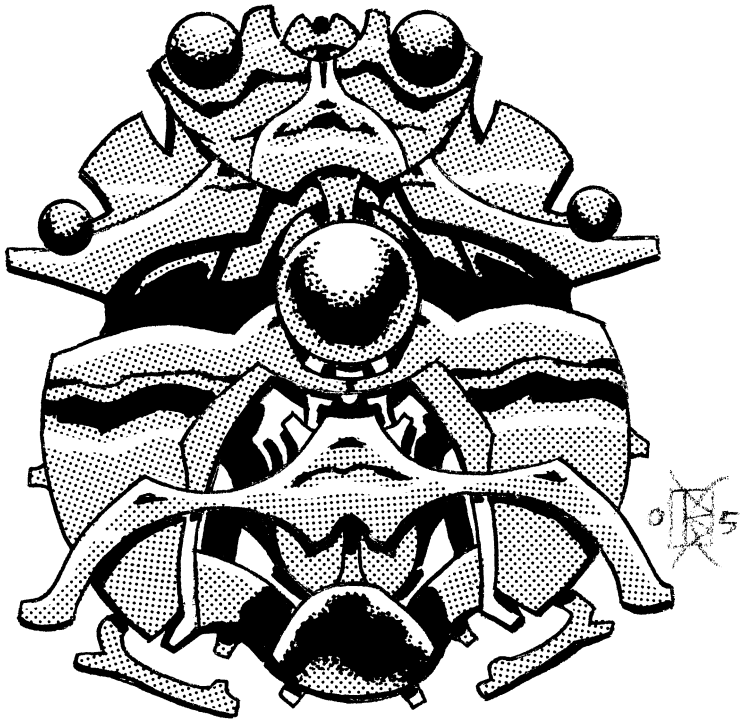

## Explosives & Detonators (S.D.C.)

There are a large number of explosive devices available on the open and Black Markets of Rifts Earth. Not all are military grade, Mega-Damage explosives, in fact many of the explosives sold in North America are S.D.C. charges intended for use in construction, mining and industry. Generally speaking, explosives are a restricted substance that cannot be purchased except by legitimate companies and/or military or defense organizations.

**Dynamite:** A nitroglycerin based S.D.C. explosive widely used in mining, demolition and road construction. Dynamite can be detonated with blasting caps and time delay devices, as well as other detonators. **Damage:** 1D4x10 S.D.C. **Blast Radius:** 10 feet (3 m). **Cost:** 30 credits per stick.

**Liquid Nitroglycerin:** An extremely dangerous, unstable S.D.C. explosive concentrate used in the creation of dynamite. A sudden or severe jerk, bump or jar can cause the liquid nitroglycerin to detonate (there is a 01-20% likelihood, increase that to 01-35% in heat greater than 82 degrees Fahrenheit). Mainly due to its unstable nature, this explosive is not commonly available to anyone but the most skilled and bonafide user. **Damage:** 4D4x10 S.D.C. (equivalent to one M.D.). **Blast Radius:** 20 feet (6.1 m). **Cost:** 200 credits per ounce/charge.

**Cutting Charges:** Similar to detcord, this type of explosive is a linear shaped charge that produces a directional blast capable of cutting through poles, pipes, cables, doors, windows and walls. The charge looks like a length of triangular shaped wire with an adhesive strip along one side for easy attachment to the target. It is extremely useful for urban combat as it produces only localized damage, meaning that it can be employed safely without resulting in collateral damage. Cutting charges are often used by special forces and counter-terrorist forces as breaching charges to gain entry into target buildings and/or vehicles by literally blowing open a doorway. **Weight:** 9 lbs (4 kg) per 6 foot (1.8 m) length. **Damage:** Available as S.D.C. and M.D. explo-

sives. **S.D.C. Cutting Charge:** 2D4x10 damage. **Mega-Damage Cutting Charge:** 4D6 M.D., in both cases, the damage is done only along the line of the surface on which it is placed. **Cost:** S.D.C.: 200 credits per 6 foot (1.8 m) length, 1,200 for an M.D. equivalent.

**Blasting Cap:** A blasting cap is a small primer charge similar to that used in a conventional bullet. When the cap is struck or ignited it detonates, in turn igniting an explosive charge. These are small, inexpensive and relatively commonplace. A simple blasting cap is capable of setting off most explosive devices. **Weight:** 4 ounces (113 grams) for a package of 20. **Damage:** 1D4 S.D.C. but is normally used to set off larger explosive charges, plastique, etc. **Cost:** 100 credits for a package of 20.

**Electric Blasting Cap:** Similar to a regular blasting cap but this style of detonator releases an electric blast to ignite the main charge rather than exploding. **Weight:** 4 ounces (113 grams) for a package of 6. **Damage:** 1D4 S.D.C. but is normally used to set off larger explosive charges. **Cost:** 200 credits for a package of 6.

**Detcord:** This is used in conjunction with firing devices to detonate explosive charges. Detcord is a black cable or cord filled with a small amount of explosives that burns at a high rate and ignites other demolition devices or explosives. On its own, detcord is not especially useful and cannot produce an explosion. However, detcord can burn through S.D.C. materials such as thin branches and wood, the cord is first wrapped around the object and then ignited; this is a useful trick for quickly clearing trees for landing zones, defensive positions, etc. **Weight:** 5 lbs (2.3 kg) per 100 feet (30.5 m). **Damage:** 1D6+4 S.D.C. when wrapped around a branch, wooden or plastic handle, etc. **Cost:** Five credits per foot (0.3 m) or 500 credits for 100 feet (30.5 m).

**Time Pencils:** A type of simple time delay fuse that consists of a spring-loaded firing pin inside of a copper tube. Also inside the tube is a glass ampule of corrosive liquid and a steel wire that holds the firing pin cocked. The corrosive liquid eats away at the steel wire, releasing the firing pin which strikes a blasting cap after a specific time period. **Weight:** 7 ounces (198 grams) for a package of six. **Damage:** 1D4 S.D.C.; is used to set off larger explosive charges. **Time Delay:** Depending on the type of acid used in the pencil the delay can be anywhere from 10 minutes to 15 hours. **Cost:** 300 credits for a package of six.

**Pressure Fuse:** This firing device is a small metal or plastic box that is activated when 40 lbs (18 kg) of pressure is applied, in a fashion similar to a land mine. The box contains a blasting cap that is triggered when pressure is applied, thereby setting off a larger explosive charge. This style of fuse or firing device is commonly used for sabotage purposes, traps and mines. **Weight:** 2 ounces (56.7 grams). **Cost:** 80 credits each.

**Pressure Release Fuse:** A spring loaded firing device that is already under pressure from a weight placed on top of the fuse. When the pressure is released the fuse detonates a blasting cap and ignites a larger explosive charge. This style of fuse or firing device is commonly used for sabotage purposes, traps and mines. **Weight:** 2 ounces (56.7 grams). **Cost:** 100 credits each.

**Pull Firing Device:** Similar to a pressure release fuse, this firing device is attached to a trip wire. If the attached wire is pulled or cut the device triggers its blasting cap, thereby igniting an explosive charge. This style of fuse or firing device is commonly used for sabotage purposes, traps and mines. **Weight:** 1 ounce (28.4 grams). **Cost:** 75 credits.

**Electronic Time Delay:** An electronic fuse that is set like an alarm clock for a specific time delay of up to 24 hours. At the end of the countdown the device releases an electric blast which in turn ignites an explosive charge. **Weight:** 4 ounces (113 grams). **Cost:** 250 credits.

**Mini-Motion Detector Detonators:** Specialty detonators equipped with miniature motion sensors similar to the ones used in the cybernetic implant. These sensors can be set to detonate when the target is within a pre-set interval, anywhere from 10 feet (3 m) to 200 feet (61 m). **Weight:** 2 ounces (56.7 grams). **Cost:** 400 credits.

**Molecular Decaying Detonator:** An organic alien fuse that is virtually undetectable by modern sensor devices. The detonator contains an organic compound that has an incredibly short half life and degrades at a rapid rate. When the molecules of the compound completely break down they release an electric charge that can set off other explosive charges. **Weight:** 4 ounces (113 grams). **Cost:** 800 credits, poor and spotty availability.

**Plunger Detonator:** A manually operated detonator that is attached to explosives by means of detcord. When the plunger is turned it releases an electric spark that ignites the detcord which in turn causes an explosive charge to detonate. **Weight:** 2 lbs (0.9 kg). **Cost:** 300 credits. **Note:** This device is reusable and can be attached to multiple explosive charges at one time.

**Improvised Detonator:** An individual with training in demolitions can make improvised detonators from common materials. An improvised detonator can be any type, including pressure, pressure release, pull or even time delay depending on the materials used and the amount of time put into its creation. **Weight:** Varies. **Cost to Make:** Anywhere from 15 to 100 credits for materials. **Time:** 1-10 hours depending on the complexity of the device. **Success Ratio:** Equal to the character's Demolitions skill.

## EOD Equipment

**Anti-Mine Mortar:** This is a special mortar round in a disposable launcher that is used to detonate land mines from a safe distance. When fired, the mortar round arcs through the air, into the minefield, setting off a seismic shock wave within the earth on impact. This shock wave has a 01-66% chance of detonating (doing their normal damage) each land mine in the target radius. **Weight:** 6 lbs (2.7 kg). **Damage:** Only from the mines set off. **Effective Range:** 150 feet (45 m). **Radius of Effect:** 60 feet (18.3 m). **Cost:** 5,000 credits.

**Demolitions Multi-Tool:** This is a pocket multi-tool specifically designed for demolitions and used for preparing or disarming explosives. The multi-tool is made of a non-sparking, non-magnetic metal alloy and includes numerous tools, including wire snips, pliers, knife blade, file, thin pick, tiny screwdriver, etc. **Weight:** 4 ounces (113 grams). **Cost:** 120 credits.

**Dual Purpose Bomb Detector:** This handheld sensor combines the capabilities of a metal detector and chemical sensor which, in concert, can detect the presence of land mines and explosives. Despite its limited range, a mere 60 feet (18.3 m), this sensor is an excellent tool for the military, police and security forces, and construction crews. The unit detects explosives with a 01-65% level of accuracy, +15% when the detector is within

one foot (0.3 m) of the explosive (i.e. scanning a box, bag or person). **Weight:** 3 lbs (1.4 kg). **Effective Range:** 60 feet (18.3 m). **Cost:** 10,500 credits.

**EOD Helmet:** A heavy reinforced helmet that can be worn in conjunction with most body armor suits, with built-in macro-lens optics with 10-100x magnification for close-in work. **Weight:** 4 lbs (1.8 kg). **M.D.C.:** 65. **Cost:** 16,000 credits.

**EOD Armor:** A suit of very heavily reinforced armor designed for EOD work, and while the suit has good mobility for the hands and arms, it is not intended for combat. The EOD armor is restrictive and cumbersome, but is designed not to interfere with EOD work. **Weight:** 30 pounds (13.5 kg). **Cost:** 26,000 credits. **Mobility:** Very poor mobility, intended for EOD work, not combat; -35% to Climb, Swim, Prowl, perform Acrobatics and similar physical skills/performance. In addition, reduce the wearer's speed attribute by half and he is -2 on all combat actions. **M.D.C. by Location:** Head/Helmet - 65; Arms - 80 each (designed for delicate work, no skill penalties to *Demolitions Disposal*, *Basic Electronics* or similar work); Legs - 110 each; Main Body - 120.

**Mine Detector:** A basic, handheld mine detector that has a 01-60% chance of locating mines before they are struck and detonated. It is essentially a metal detector, which means that it will also indicate harmless metal fragments as well (fragments must be the size of a bowling ball or bigger). **Weight:** 7 lbs (3.2 kg). **Effective Range:** 15 feet (4.5 m). **Cost:** 2,000 credits.

**Protective Tinted Goggles:** These are a pair of wraparound, tinted M.D.C. goggles designed to give the wearer at least minimal protection when dealing with explosive devices. The goggles only protect the eyes. **Weight:** Six ounces (0.2 kg). **M.D.C.:** 9. **Cost:** 3,650 credits.

## Diving Equipment

**Snorkel Kit:** Consists of a mask, snorkel and fin package for shallow diving. All components are designed to fit over standard body armor. Swim fins add 20% to swimming speed. **Cost:** 100 credits.

**S.C.U.B.A. Package:** Includes an 80K cylinder (air tank) with boot, datacom double console (PSI depth), regulator, wet suit, pack power supply and air tank with an oxygen capacity of 90 minutes. Designed to fit over conventional body armor. **Cost:** 820 credits.

**Self-Contained Rebreather:** An underwater respirator lung that uses a special chemical process to recycle breathable air. Every time the wearer exhales, the carbon dioxide passes through a chemical filter that recycles it into breathable oxygen molecules. The advantage of the rebreather is that it is a self-contained system, meaning that unlike S.C.U.B.A. gear it does not release any bubbles to give away the swimmer's position. Unfortunately, the diver cannot swim deeper than 130 feet (39.6 m) or the pressure will interfere with the chemical filter and the rebreather ceases to recycle oxygen. The rebreather filter provides up to four hours of oxygen before needing to be replaced. **Weight:** 4 lbs (1.8 kg). **Depth Tolerance:** 130 feet (39.6 m). **Oxygen Supply:** 4 hours; designed to fit over the faceplate of standard body armor. **Cost:** 2,500 credits.

**Diver's Watch:** A multipurpose digital and analog (hands) display, with an alarm, two time zones, timer, rotating bezel,



sweep second hand, depth gauge and depth warning alarm (vibrates and flashes). Waterproof to a depth of 3,000 feet (914 m). **Cost:** 900 credits.

**Dive Beacon:** A waterproof beacon and rescue marker that can be used on the surface or to a depth of 1,000 feet (305 m). Operates on a standard E-Clip power source and displays either a visible or infrared strobe light. **Cost:** 300 credits.

**Waterproof Bag:** A rubberized, waterproof bag with shoulder strap that is large enough to hold a standard energy rifle, four extra ammo clips, a walkie-talkie, canteen, flashlight and a few similar, small items. Waterproof to a depth of 1000 feet (305 m). **Cost:** 150 credits.

## Field Rations

Field rations, or "rats," are a necessity for extended field operations. Weapons, ammo and machines may seem more important but food is a necessity to keep troops fighting fit. History has proven an army can survive without resupply of war material for several days but the same force would collapse without a steady supply of food. An average soldier needs 2000-3000 calories per day of fighting. Augmented humans - Juicers, Crazies and D-Bees with high metabolisms - need to eat as much as 10,000 to 20,000 calories per day! Unless troops can afford to waste time foraging in the wild, fresh food is not an option, and soldiers need to rely on prepared rations.

**Basic MRE:** An MRE, Meal Ready to Eat, is a full meal that only requires the soldier to add water, and comes in sealed packages to prevent spoiling. These rations include a main entree, fruit or dessert, drink mix and crackers or candy bar, and can be

eaten either cold or heated by a small, portable field stove. MREs normally hold 2,000 to 3,000 calories, are fortified with vitamins and supplements, and are fairly tasty. **Cost:** 50 credits each.

**Freeze-Dried Ration:** Originally designed in the 20th century for the astronaut program, these rations are freeze-dried to preserve them over extended periods. While these rations stay good for months or even years, they typically are fairly dry tasting, and are often compared to cardboard by the troops. Moreover, a freeze-dried ration is not particularly nourishing compared to MREs or fresh food. **Cost:** 25 credits each.

**Instant Heat MRE:** Basically a standard MRE with the addition of a non-toxic, edible compound that produces a chemical reaction when exposed to air. Within a few seconds of opening the main entree package its contents are heated just as if they'd been boiled on a cook stove. **Cost:** 70 credits each.

**Meal Bars:** Designed as a meal replacement, these granola-style bars are fortified with nutrients. While not particularly filling, the meal bar provides enough vitamins and nutrients to keep a soldier going for a couple of days. Plus they require no cooking, are easy to carry and can be eaten quickly. **Cost:** 5 credits each.

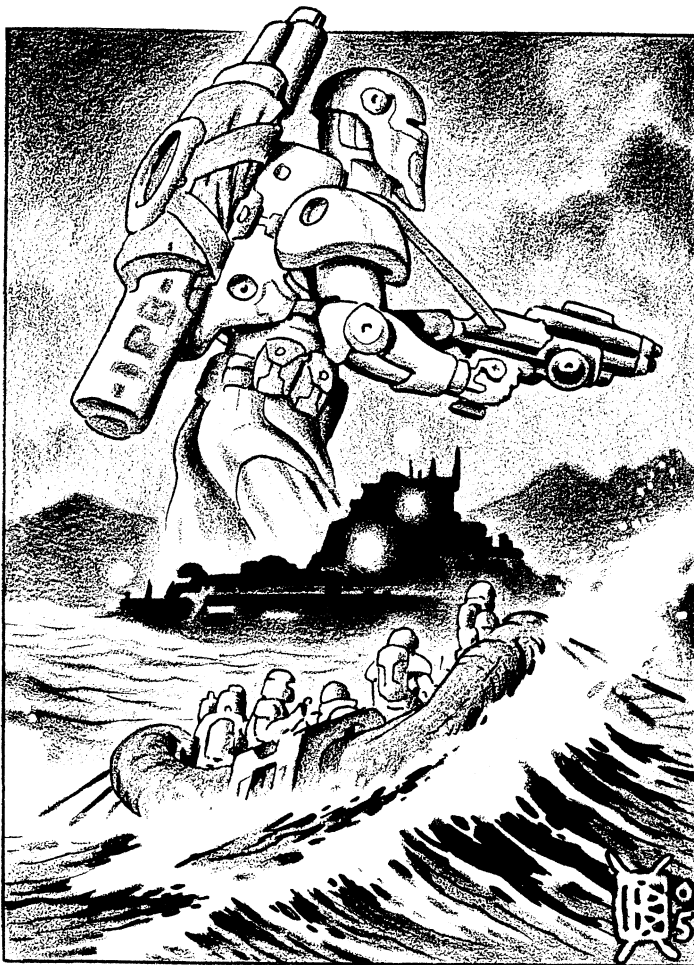

## Field Equipment

**Black Ball Spray Paint:** Black Ball is a special black matte paint that reflects radar pulses. It can be sprayed on any object to give that piece of equipment a rudimentary stealth capability. Attempts to detect any object coated with Black Ball paint using

radar suffer a penalty of -10% to the *Read Sensory Equipment* skill. Each can holds enough paint to coat two suits of man-sized environmental body armor. **Cost:** 1,200 credits per can.

**Compass:** The most basic and most important navigational aid an explorer or an adventurer can have. When in proper working order and away from metal, magnets or electricity (which interfere with its operation), the compass can accurately determine direction. So long as the user knows what direction he's supposed to be heading, the compass will point the way and keep him from straying off course or traveling in circles. A compass is a simple, rugged device unlikely to fail or break down in the field. **Weight:** 2 ounces (56.7 grams), **Accuracy:** within 1.0 degrees, **Cost:** 20 credits. **Skill Bonus:** A compass provides a +10% bonus to the *Land Navigation* skill.

**Electric Heater/Stove:** Powered by a regular E-Clip, this device is both a cook stove and a space heater. It provides a tremendous amount of heat, considering its small size, enough to keep an enclosed 10 by 10 foot (3x3 m) shelter at room temperature even in arctic conditions (at least 58 degrees Fahrenheit; typically 70 degrees in less extreme environments). Each standard rifle E-Clip supplies enough power for 6-10 hours of continuous operation (the colder it is, the sooner the energy is used up). **Weight:** 5 lbs (2.3 kg). **Cost:** 250 credits.

**Flare Gun:** A plastic handgun that fires signal flares to illuminate an area. The flares light up a 300 foot (91.5 m) area for about five melee rounds (75 seconds). It is not intended to be used as a weapon, thus it is not balanced for aiming and W.P. Handgun skill bonuses do NOT apply. **Weight:** 2 lbs (0.9 kg). **Range:** 500 feet (152 m) **Damage:** 2D6 S.D.C. per melee round and burns for 1D4 rounds. **Rate of Fire & Payload:** Two. **Cost:** 140 credits for the gun, flares cost 10 credits each.

**Hard Dome Shelter:** An easily collapsible dome-style tent made from a revolutionary, new, waterproof, Mega-Damage miracle fabric that provides light M.D.C. protection. The dome shelter has 10 M.D.C. and its fabric reacts to the exterior temperature, reflecting heat in the summer and containing heat in winter. These shelters come in three sizes; two-man, four-man and eight-man. **Weight:** 40, 90 and 200 lbs respectively (18, 40.5 and 90 kg). **M.D.C.:** 10. **Cost:** 3,500 credits for two-man, 7,000 credits for four-man and 14,500 credits for the eight-man version. Poor availability.

**IDF Commando Wristwatch:** This wristwatch is a hallmark of the Ishpeming Special Forces. Until about five years ago it was issued only to these commando units, but since then has been released on the open market by a subsidiary of Northern Gun. The wristwatch is very durable, impact resistant (A.R. 14, 60 S.D.C.) and waterproof to a depth of 3000 feet (914 m). As a chronometer it is nearly as accurate as an atomic clock, displaying the exact time and date. The watch has an alarm feature, one that vibrates when it goes off (instead of emitting a beep that can be heard by any nearby enemy). It also functions as an altimeter for parachuting and is designed for use as a detonator for explosives - either as a plunger when attached to detcord or as a time delay detonator if the watch is attached to an explosive charge. **Cost:** 1,300 credits.

**Inflatable Patrol Boat:** This is an eight-man patrol boat constructed from a rubbery material and is packed in an oversized rucksack. It is attached to a cylinder of compressed air that inflates the craft in under a minute, once it has been unpacked.

The entire package, including the rucksack, patrol boat and four paddles, weighs 70 lbs (32 kg). The paddles collapse to the size of a folded entrenching tool, four are carried in pouches on the rucksack exterior. Additional paddles must be carried separately by the members of the patrol. **Weight:** 70 lbs (32 kg). **S.D.C.:** 200 (equal to 2 M.D.C.). **Cost:** 3,200 credits. **Note:** A silent, E-Clip powered *portable electric motor* is designed for this vessel. The motor weighs 15 lbs (6.8 kg), runs for up to six hours on a standard E-Clip and provides a top speed of 5 mph (8 km). **S.D.C.:** 100/1 M.D.C. **Cost:** 1,500 credits.

**Laser Gyro Navigating (LGN) Aid:** A hand-held electronic device made of hard impact plastic about the size of a paperback novel. The LGN is essentially a computerized map and compass that uses an internal laser gyroscope to provide precision navigation. Loaded into the LGN computer's memory banks are topographical maps of North America. Once a fixed point has been entered into the device, either manually or from a remote navigation relay (found in settled regions of high-tech countries like the Coalition States, Ishpeming, the Manistique Imperium and Lazlo), the device enables its operator to navigate with amazing accuracy. It can be used to take a bearing, generate a grid reference or position, or by programming a series of way points to navigate from one position to another; indicating direction with a simple pointer arrow similar to a compass needle.

The LGN display gives an exact position in latitude and longitude, precise time, altitude and rate of travel (average speed). It is fairly accurate, giving grid references within 82 feet (25 meters) in most areas of North America; accuracy level is roughly 88% in Middle America and Southern Canada, but drops to 62% west of the Rocky Mountains and in other remote, unsettled areas like the east coast, Mexico, Central America, and the Pacific Northwest. **Weight:** 2 lbs (0.9 kg), **Power Supply:** Standard E-Clip. **Battery Life:** 96 hours of continuous use. **Skill Bonus:** An LGN Aid provides a bonus of +20% to the *Land Navigation* skill if the operator is reasonably familiar with the device. **Cost:** 3,500 credits.

**Maps:** Topographical maps are the best aids for navigation, especially when used in conjunction with a compass. These maps show the locations of major terrain features (ridges, hills, rivers, streams, roads, trails, etc.) which can then be recognized and used to judge an individual's position relative to the features. When such a map is combined with a compass, the individual is capable of navigating with reasonable precision from point A to point B. There are numerous map makers in North America, including the CS Army Mapping Agency who offer topographical maps of most areas in North America. Each individual map sheet is produced in standard 1:50,000 military scale and marked with the military grid system to locate a specific point on the map with accuracy to within 100 meters (328 feet). This is the grid scale that is used to generate 6- or 8-digit coordinates or grids that can be used to mark targets for artillery bombardment. **Cost:** 100 credits per map sheet, **Accuracy:** From within 100 m (328 feet) to within 10 m (32.8 feet) depending on the user's skill. **Skill Bonus:** +5% bonus to the *Land Navigation* skill for a topographical map on its own, +15% when the map is combined with a compass or LGN.

**Mega-Rope:** Made from the Mega-Damage fibers of a hemp-like alien plant grown in arid regions of North America, this is a super strong and durable rope. The rope can support up to 4000 lbs (1800 kg) of weight and has 200 S.D.C./2 M.D.C.

per foot or two of length (difficult to cut). **Cost:** 50 credits per yard/meter of length; uncommon, poor availability.

**Metal-Spray:** The latest in armor repair equipment from an alien dimension, this spray allows for limited field repairs on body armor, robots and vehicles. The spray is a super-epoxy and metal alloy that seals gaps in armor by becoming a rapid-hardening M.D.C. foam. One treatment on a suit of power armor, robot or vehicle will repair 4D6 M.D.C. to large structures like vehicles, or 2D6 M.D.C. to small items like body armor, a helmet, gun handle, etc. The spray will only work if the component/structure/armor has not been completely destroyed (its remaining M.D.C. must be two or greater). Only a maximum of 24 M.D.C. can be restored as a sort of Mega-Damage Bondo material, even with multiple applications. Each spray can has enough juice for three applications. The spray comes in three colors: black, grey and green, and is exclusively available from, you guessed it, Naruni Enterprises. **Cost:** 18,000 credits per can; very poor availability even at MercTown.

**Moisture Condenser:** This is a high-tech dehumidifier that collects moisture from the atmosphere, condenses and then filters it to produce *drinkable* water. It resembles a regular plastic, 5 gallon (19 liter) jerry can with a rectangular electronic portion attached to the top. The evaporator works quickly, and even in the driest conditions can fill the jerry can attachment in about eight hours (time is dramatically reduced in more humid environments). **Cost:** 1,350 credits.

**Parachute Flare:** A signal flare that is fired from a handheld, disposable launch tube and deploys a parachute equipped flare. No visible rocket trail is left behind in its launch path to give away the shooter's position. **Weight:** 2 lbs (0.9 kg). **Maximum Height:** 1000 feet (305 m). **Duration:** Illuminates for 60 seconds (4 melee rounds). **Cost:** 80 credits per gun and flare each.

**Pencil Flare Rocket:** A lightweight, miniature flare the size of an unsharpened pencil that fires tiny flares designed for special forces use. Fired from a single-handed, lightweight, pencil-type launcher. **Weight:** 2 ounces (57 grams). **Maximum Height:** 320 feet (98 m). **Duration:** Illuminates for 10 seconds, designed as a signaling device. **Cost:** 250 credits for the launcher and 5 flares. Additional flares cost 5 credits each.

**Basic Parachute:** This is a basic military static line parachute that is strapped to the back of a paratrooper by a harness. It comes complete with a reserve parachute and V-ring attachments for a backpack or rucksack. The static line attaches to a cable in an airplane or helicopter, and pulls out the canopy which inflates approximately 4 seconds after the paratrooper exits the aircraft. Static line parachutes are essentially foolproof when packed correctly (which requires special training). **Weight:** 40 lbs (18 kg), and supports up to 400 lbs (180 kg). **Cost:** 1,500 credits. **Note:** The parachute is reusable but requires specialized training to pack correctly.

**Free Fall Parachute:** A rectangular, steerable parachute that enables the paratrooper to glide through the air and land with little or no impact. The free fall parachute is used for HALO and HAHO drops and can be used to glide up to 100 miles (160 km) when deployed at heights of 30,000 feet (9144 m). Unlike a static line chute, this style of parachute requires the operator to manually open it by pulling a rip cord. Comes complete with a reserve parachute in case the main canopy malfunctions.



**Weight:** 20 lbs (9 kg), and supports up to 400 lbs (180 kg). **Cost:** 2,900 credits. **Note:** The parachute is reusable and can be packed correctly by anyone with the HAHO or HALO *Parachute* skill.

**Universal E-Clip Recharger:** A nuclear powered, portable generator approximately the size of a suitcase that weighs 15 lbs (6.8 kg). There are eight ports in the unit, each of which can recharge a standard E-Clip in about one hour. It also comes with adapters to enable the device to recharge unusual and alien E-Clips such as those used by *Naruni Enterprises* and the *Kittani*. Considering the number of high-tech devices that use E-Clips as a power source, everything from jet packs and Naruni force fields to stealth suits and energy weapons, this is a tremendously valuable piece of equipment. The Universal E-Clip Recharger has an energy life of 12 years and has a power output roughly equal to most suits of power armor. **Cost:** 790,000 credits is the list price, but the price is often jacked up to two and three times that in places where supply fails to meet demand. Fair availability except at places like Ishpeming, Manistique, MercTown, and Arzno.

**Weapon Cleaning Kit:** A complete cleaning kit with special optical lens cleanser, lens paper, cleaning rods and brushes, swabs and gun oil. Contained in its own pouch. **Cost:** 80 credits.

**Weapon Repair Kit:** This is a portable weapon repair kit with a complete set of precision tools, spare parts, screws, springs and cleaning rods. It is contained in a carrying case designed to be easily attached to a harness or utility belt, slung over the shoulder by its carrying strap or stuffed into a backpack. **Cost:** 500 credits.

## Fortification Materials

**Barbed Wire:** Basic cattle wire with sharp barbs spaced along its length, this material is used to make fences and obstacles. The wire will not hurt Mega-Damage body armor but it still hooks and entangles the feet, snags fabric and impairs movement – victims see their speed reduced by 20% until the wire is removed, which could take 1D6 minutes. Comes in 500 foot (152 m) spools. **Weight:** 30 lbs (13.6 kg) per spool. **Damage:** One S.D.C. from contact with barbs. **Cost:** 250 credits.

**Concertina Wire:** Cyclone-style coils of razor sharp wire that stand roughly 3 feet (1 m) high and are 50 feet (15.2 m) long. Concertina wire is quick to set up, light and can be collapsed for ease of transportation, plus the coils can be stacked atop each other to make a larger barrier. Like barbed wire, concertina does not harm Mega-Damage body armor but hooks and entangles the feet, snags fabric and impairs movement – victims see their speed reduced by 30% until the wire is removed, which could take 2D4 minutes. When concertina is stacked together to make a cat wire fence it is very nearly impassable without blasting through it. **Weight:** 15 lbs (6.8 kg). **Damage:** 1D4 S.D.C. from contact with razor wire. **Cost:** 350 credits per coil.

**Vibro-Wire:** Vibro-Wire looks like ordinary concertina or barbed wire but is made from a super-conductive material capable of channeling a Vibro-Energy field. For it to function, the Vibro Wire needs to be hooked up to a power source like a fusion generator or engine, otherwise it is just regular barbed wire. The main advantage of Vibro-Wire is its ability to hurt Mega-Damage structures and armor. **Mega-Damage:** 1D4 M.D. per contact. **Cost:** 3,500 credits per 50 feet (15.2 m) of length.

**Megacrete:** This material is a heavy duty concrete that hardens into a Mega-Damage structure. Like regular concrete, Megacrete is sold in bags of powder that are mixed with water then poured into forms. **Weight:** A bag of powder weighs 50 lbs (22.5 kg). **M.D.C.:** 12 per 6 foot (1.8 m) area once hardened. **Cost:** 8,000 credits per bag.

**M.D. Armor Plating:** For use in construction of trenches, bunkers, pillboxes and similar fortifications, sheets of plating made from the same material as many body armors are available. These plates look like sheets of galvanized steel and are malleable enough that they can be bent or fitted into place. **Weight:** 10 lbs (4.5 kg) per 3 x 5 foot (0.9x1.5 m) sheet. **M.D.C.:** 20 per sheet. **Cost:** 16,000 credits per sheet.

## Medical Equipment

**Field Medic Kit:** A compact yet extensive medical kit with all of the necessary supplies for routine as well as emergency medical treatment. It contains all of the items typically found in a first-aid kit: sterile bandages, gauze, medical tape, etc.) plus a miniature diagnostic computer with a holographic display that is capable of monitoring all of a patient's vital signs, a complete set of medical and dental implements/tools, basic medicines and painkillers, a quick hardening chemical cast (consists of two chemicals that react to form a hard resin), a fast acting burn salve (heals 1D6 S.D.C. or 2 Hit Points per application), protein salve, plus a mini-oxygen supply. **Weight:** 30 lbs (13.5 kg). **Cost:** 2,500 credits. Robot kits are extra.

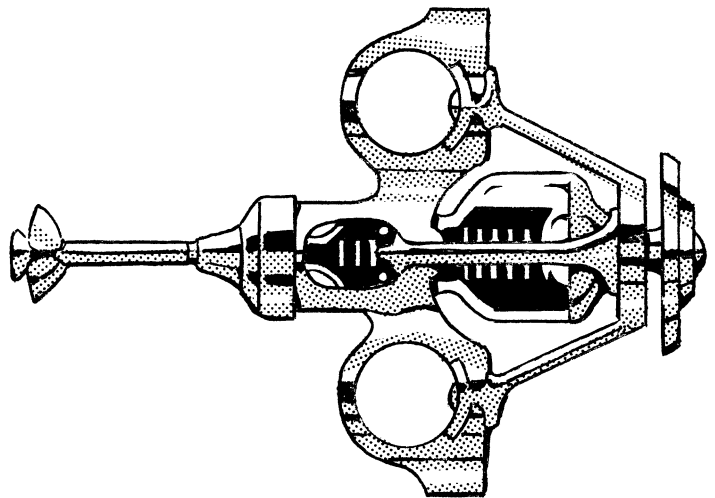

**Hypo-Spray Injector:** The Hypo-Spray is a high-tech alternative to a syringe that uses compressed air to inject sedatives, medicines or even narcotics. Its main advantage is that no training is required to use the hypo-spray, unlike a syringe, and all that one needs do is place the nozzle against exposed skin and push the button. **Weight:** 2 ounces (57 grams). **Cost:** 120 credits.

**Mystic Bandages:** A magical strip of cloth that looks like an ordinary roll of bandages. However, when it is unrolled and placed on a wound it releases a magical salve, healing injuries and causing the wound to clot, stopping blood flow, and it kick-starts tissue regeneration. Heals 4D6 Hit Points or S.D.C. (or 1D6 M.D. for Mega-Damage creatures) in 24 hours. **Cost:** 20,000 credits per foot (0.3 m) of two inches (5 cm) wide bandage roll, or for a six inch (0.15 m) diameter patch. Rare.



**Protein Healing Salve:** A special high protein chemical solution that comes in a tube like toothpaste. The salve can be applied to burns, cuts and rashes to increase the rate of healing; double. **Cost:** 100 credits per eight ounce (225 gram) tube.

**Qwik-Clot:** Comes as a powder or chemical spray that if applied over an open wound cause it to instantly clot and stop bleeding. This is a life saving chemical agent that is standard issue in the armies of most kingdoms and mercenary groups. **Duration:** Ten minutes, long enough to apply a permanent bandage or sutures to close the wound and prevent further injury and complications. **Cost:** Five credits per typical dose, 100 credits for a 20 dose aerosol spray can or re-sealable plastic bag.

**Universal Anti-Toxin (UAT):** Imported from an alien dimension and sold exclusively by Naruni Enterprises, this is a wide-spectrum antidote that works against 100,000 known poisons, venoms, toxins, chemical and biological agents. Its components are mutable chemicals that will shift at the molecular level to neutralize harmful toxic elements. This gives the patient a *bonus of +10* to save against poisons and toxins. The UAT will not heal damage already done by the poison, only stop/negate the poison in a person's system before it does more harm. **Cost:** 4,500 credits per two dose vial.

**Note:** And don't forget about the internal and external nanobot medical systems, Compu-Drug Dispenser, and portable lab.

## Optics Gear

**Optic Glasses:** An optical enhancement system that appears to be nothing more than regular sunglasses or tinted goggles, but is, in reality, a set of state of the art, miniaturized optical enhancement devices. They are especially popular with security specialists, spies, master thieves, assassins, Rogue Scientists and City Rats. Various models of these glasses are available. **Types of Enhancement:** Passive nightvision, infrared, ultraviolet, thermal-imaging and telescopic magnification – all come with light adjusting tinting. **Range:** 300 feet (91.5 m) for all models. **Cost:** 4,300 credits.

**Basic Telescopic Sight:** A simple, telescopic weapon sight that is made from rugged, durable materials. It can be fitted on any rifle, including high-tech energy models, and provides a bonus of +1 to strike on an aimed shot. The range of the sight is 3000 feet (914 m). **Cost:** 1000 credits.

**Laser Aimer Sight:** A small device that attaches to any small arms like a regular telescopic weapon sight and operates on the same principle. This device projects a laser beam that appears as a small, bright red dot on the target. If the weapon is sighted properly, bullets or blasts fired from it will strike where the laser dot appears. This type of sight allows for rapid target acquisition and accurate firing, even from the hip. Military versions of the sight project infrared beams that are invisible unless the character is looking through night vision, infrared or thermal-imaging optic systems. **Range:** 300 feet (91.5 m), double for military models. **Bonuses:** +1 to strike and initiative. **Cost:** 3,500 credits.

**Laser Designator:** A laser designator is a handheld, man-portable device that projects an invisible laser beam to designate ("paint") targets for laser-guided missiles and bombs. The beam reflected from the "painted" target is a beacon for the la-

ser-seeker guidance module in precision munitions. In general operation and design the designator works like a set of range-finder binoculars. All the operator needs to do is view the target through the eyepiece, center the reticle on it, and press the laser button. Unlike a rangefinder the laser beam must be left continuously on the target until the guided munition impacts. The laser designator can be used to direct guided missiles from any launch platform. However, it must be programmed via a computer terminal to project the correct laser frequency sought by the missile's guidance module. **Weight:** 8 lbs (3.6 kg). **Range:** 2 miles (3.2 km). **Bonuses:** Laser-guided munitions are +3 to strike. **Cost:** 8,000 credits.

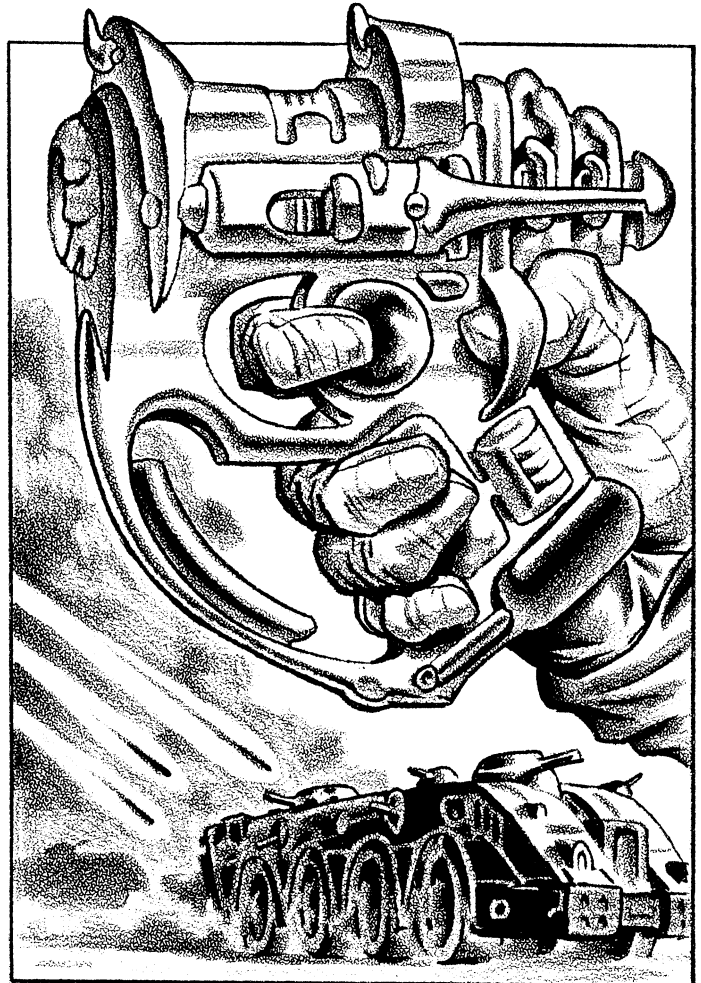

## Golden Age Weaponsmiths Inc.

Golden Age Weaponsmiths (GAW) is known for refitting military equipment salvaged from pre-Rifts arsenals and selling it at discount prices. The company has a reputation for products of reasonable quality that, although somewhat inferior to modern equipment, retail at a fraction of the cost. Still, most buyers view Golden Age Weaponsmiths in the same light as Chipwell Armaments, a second-rate armaments manufacturer for nickel and dime shoppers who can't afford better. GAW's customers consist mainly of small mercenary outfits, start-up companies, poor kingdoms, wilderness people and bandits.

Things are starting to change for Golden Age Weaponsmiths. In a giant stroke of luck, GAW was in the process of recovering pre-Rifts US Navy warships from the submerged Norfolk arsenal at the same time the Coalition started building a navy of its own. The CS negotiated a treaty to acquire all the warships that Golden Age Weaponsmiths recovered (see **Rifts® Sourcebook Four: Coalition Navy**, pages 16-17, for details), and in return the Coalition provided the manufacturer and the kingdom that has grown up around it with technical assistance, official recognition of its sovereignty, and gigantic refitting contracts that earned them billions in profit. Profits that were funneled back into Golden Age Weaponsmiths' ongoing retrieval and retrofitting operations.

This money is being used to fund an extensive recovery operation, uncovering as many pre-Rifts military bases as possible. Golden Age Weaponsmiths has also gone beyond refitting pre-Rifts designs, like the F-16 Fighters, M3A2 Bradley Fighting Vehicle, or M48A3 Main Battle Tank, to refitting and reproducing pre-Rifts small arms, mortars and howitzers. All of these products represent a qualitative leap over earlier GAW products, but are still slightly capable compared to the ultra-modern equipment produced by the likes of the Coalition States, Northern Gun, Wilk's, Triax, Iron Heart Armaments, and others.

Golden Age Weaponsmiths' main thrust continues to be refitting pre-Rifts systems and producing S.D.C. weapons and vehicles as well as turning S.D.C. structures into light M.D.C. combat vehicles. The available features, construction times and costs remain unchanged (see **Rifts® Mercenaries**, pages 95-99, for details). With GAW's recent find of a U.S. Army joint strike base, they have an all new line up of retrofitted small arms, ground attack aircraft, helicopters, howitzers, and light strike vehicles.

## GAW Mark I Flight Suit Armor

The Mark I Flight Suit Armor is made of "soft" armored materials (S.D.C.), but the flight suit has all the standard features of environmental body armor as listed in the **Rifts® RPG**. The hard chest and back plates contain a small, removable flotation device built into the upper back, neck, and shoulders that automatically engages upon contact with water. This keeps the pilot's head face-up and shoulders above the water, even if unconscious. A built-in oxygen supply is good for up to 1.5 hours in hostile environments and high altitude ejection.

**Class:** GAW Mark I Flight Suit Armor

**Size:** Human equivalent.

**Weight:** 9 lbs (4.1 kg).

**Mobility:** Fair; -10% to Climb, Prowl, perform Acrobatics and similar physical skills/performance, but +15% to the Swimming skill with the built-in flotation device active.

**M.D.C. by Location:**

Head/Helmet - 10 M.D.C.

Arms - 5 M.D.C. each

Legs - 10 M.D.C. each

Main Body - 16 M.D.C.

**Black Market Price:** 7,500 credits, good availability.

## GAW Mark II Battlefield Armor

Mark II Battlefield Armor is a Golden Age Weaponsmiths copy of the US Army's standard issue armor for the mid-21st century. Before the Coming of the Rifts, this body armor was already considered obsolete and was issued only to National Guard units, but the battlefield armor does have *all* the standard features of environmental body armor as listed in the **Rifts® RPG**. Golden Age found thousands of these suits, along with the Mark I Flight Suits, and has continued production as a cost effective (*read:* cheap) alternative to many of the other body armor suits on the market.

**Class:** GAW Mark II Battlefield Armor

**Size:** Human equivalent.

**Weight:** 18 lbs (8.1 kg)

**Mobility:** Poor mobility, -15% to Climb, Prowl, Swim, perform Acrobatics and similar physical skills/performance.

**M.D.C. by Location:**

Helmet/Head - 25 M.D.C.

Arms - 10 M.D.C. each

Legs - 25 M.D.C. each

Main Body - 38 M.D.C.

**Black Market Price:** 18,000 credits, excellent availability.

## GAW Old Style Firearms

Believe it or not, there is a tremendous demand in North America for conventional **S.D.C. weapons**. Hunters, farmers, police and soldiers all have a need for a good, old-fashioned pistol or rifle from time to time. Few arms manufacturers offer brand new S.D.C. firearms, which forces people to rely on ancient pre-Rifts models that, in many cases, are barely functional. Golden Age exploited this opportunity and is one of the leading independent manufacturers of conventional firearms on the continent, and has been for years. Only Wellington Industries produces more.

Golden Age makes a wide number of pre-Rifts model firearms for both sporting and military purposes. The company has modified the designs of these weapons to increase performance. Lightweight Mega-Damage polymers have been used wherever possible, and laser targeting systems or telescopic sights have been integrated into nearly all models.

## Common Weapons

Some of the firearm models that GAW produces include the following. Note that machine-guns and mini-guns inflict the equivalent of Mega-Damage to M.D.C. opponents.

Cost:

Pistols & Revolvers: 300-600 credits.

Submachine-guns: 700-900 credits.

Rifles (Hunting and Sniping): 900-1400 credits.

Assault Rifles: 1200-1800 credits.

Light & Medium Machine-Guns: 3000-5000 credits

Heavy Machine-Guns: 8,000-10,000 credits.

Mini-Guns and Gatling Style Machine-Guns: 12,000-15,000 credits.

Physical S.D.C. of Armaments: The S.D.C. the weapon itself can sustain ranges from 30-50 for small arms, to 100 for rifles and shotguns, and 300 S.D.C./3 M.D.C. for machine-guns and mini-guns. The weapon takes damage only when it is specifically targeted for destruction.

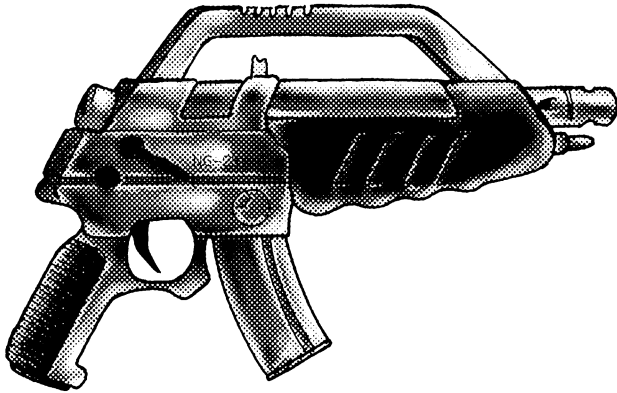

**M9 Beretta or Colt Style 9mm Pistol:** Damage: 3D6 S.D.C. Effective Range: 150 feet (45.7 m). Payload: 15 shot clip.

**.45 caliber Pistol:** Damage: 4D6 S.D.C. Effective Range: 150 feet (45.7 m). Payload: 7 or 13 shot ammo clip.

**10mm Colt Delta Elite:** Damage: 4D6 S.D.C. Effective Range: 150 feet (45.7 m). Payload: 9 or 15 shot clip.

**.357 Magnum Revolver or Pistol:** Damage: 4D6+2 S.D.C. Effective Range: 150 feet (45.7 m). Payload: 6 or 13 shot clip.

**.41 Magnum Revolver:** Damage: 5D6 S.D.C. Effective Range: 180 feet (54.8 m). Payload: 6 round cylinder.

**.44 Magnum Revolver:** Damage: 6D6 S.D.C. Effective Range: 180 feet (54.8 m). Payload: 6 round cylinder.

**.38 Smith & Wesson and Colt Revolver:** Damage: 2D6+2 S.D.C. Effective Range: 120 feet (36.5 m). Payload: 6 round cylinder.

**9mm Submachine-gun:** Damage: 3D6 S.D.C. per single shot or 6D6 per three round short burst. Effective Range: 650 feet (198 m). Payload: 30 round magazine.

**9mm Ingram Submachine-gun:** Damage: 4D6 S.D.C. per single shot, 1D4x10 per three round short burst. Effective Range: 650 feet (198 m). Payload: 30 or 50 round magazine.

**9mm Uzi Submachine-gun:** Damage: 3D6 S.D.C. per single shot or 6D6 per three round short burst. Effective Range: 600 feet (183 m). Payload: 30 or 50 round magazine.

**9mm Mini-Uzi Submachine-gun:** Damage: 2D6 S.D.C. per single shot or 4D6 per three round short burst. Effective Range: 500 feet (152 m). Payload: 15 or 30 round magazine.

**5.6mm Bolt-Action Sniping Rifle:** Damage: 5D6 S.D.C. per single shot. Effective Range: 2000-2400 feet (610 to 731.5 m). Payload: 8-16 round magazine. **Note:** Stats vary slightly with specific weapon models and manufacturers.

**7.6mm Sniping Rifle:** Damage: 6D6 S.D.C. per single shot. Effective Range: 2200-2800 feet (670.56 to 853.4 m). Payload: 8-16 round magazine. **Note:** Stats vary slightly with specific weapon models and manufacturers.

**5.56mm Assault Rifle:** Damage: 3D6 S.D.C. per single shot or 6D6 per three round short burst. Effective Range: 1200 feet (366 m). Payload: 20 to 50 round magazine.

**5.56mm M16A2 Assault Rifle:** Damage: 3D6 S.D.C. per single shot or 6D6 per three round short burst. Effective Range: 1900 feet (579 m). Payload: 20, 30 or 50 round magazine.

**7.56mm Assault Rifle:** Damage: 5D6 S.D.C. per single shot or 1D6x10 per three round short burst. Effective Range: 1600 feet (488 m). Payload: 30 to 50 round magazine.

**7.56mm AK-47 Assault Rifle:** Damage: 5D6 S.D.C. per single shot or 1D6x10 per three round short burst. Effective Range: 1000 feet (305 m). Payload: 30 round magazine or 60 round drum.

**.30 Caliber Light Machine-Gun:** Damage: 5D6 S.D.C. per single shot or 3D6x10 S.D.C. (equal to 1 M.D.) per 10 round burst. Effective Range: 3000 feet (914 m). Payload: 200, 300 or 600 round disintegrating belt or belt fed drum.

**7.62mm Medium Machine-Gun:** Damage: 6D6 S.D.C. per single shot or 4D6x10 S.D.C. (equal to 1D4 M.D.) per 10 round burst. Effective Range: 3000 feet (914 m). Payload: 200, 300 or 600 round disintegrating belt or belt fed drum.

**.50 Caliber Heavy Machine-Gun:** Damage: 1D6x10 S.D.C. per single shot or 1D6x100 S.D.C. (equal to 1D6 M.D.) per 10 round burst. Effective Range: 6000 feet (1828 m). Payload: 300, 600 or 1200 round disintegrating belt or belt fed drum.

**.50 Caliber GECAL Six Barrel Machine-Gun or a Mini-Gun:** Damage: 2D6x10 S.D.C. per single shot or 2D6x100 S.D.C. (equal to 2D6+3 M.D.) per 10 round burst. Effective Range: 8000 feet (2438 m). Payload: 300, 600 or 1200 round disintegrating belt or belt fed drum.

**40 mm Grenade Launcher (attaches to assault rifle):** Damage: 2D4x10 S.D.C. Effective Range: 1200 feet (366 m). Payload: Single shot.

**40mm Multiple Grenade Launcher/Rifle:** Damage: 2D4x10 S.D.C. Effective Range: 1200 feet (366 m). Payload: Single shot.

**Shotguns:** The effective range for all shotguns is 150 feet (45.7 m). Buckshot and similar fragmentation rounds will spray a 3 foot (0.9 meter) area. A sawed-off shotgun has a dramatically reduced barrel size which increases the width of the buckshot "spray" (covers a 1.5 m/5 foot area), but reduces the effective range to 60 feet (18 m). Semi-automatic/self-loading shotguns can fire a three-round burst that acts as a short burst, but it is -1 to strike.

Typical Damage: 4D6 for Buckshot (scatters to cover a 3 ft/0.9 m area at 30 feet/9.1 m and a 10 feet/3 m area at 60 feet/18.3 m); 5D6 for solid slug.

**NOTE:** For a variety of *specific* S.D.C. weapons of the 20th and 21st Century, see the **Compendium of Contemporary Weapons** sourcebook with 700 weapons listed, started out and illustrated, plus body armor, grenades, EOD, mortars, and select armored vehicles.

## Golden Age Ammunition

Golden Age operates four munitions plants that produce every conceivable type of ammunition, from S.D.C. types to Mega-Damage rounds and explosives. Two of these recently opened in Huntsville as part of the new marketing strategy. The oldest two are located in Guntersville where for decades the largest factory has been making old S.D.C. pistol, rifle, shotgun and machine-gun cartridges in most standard calibers.

At the two newer ammunition plants the only ammunition types made are the heavy-duty, Mega-Damage rounds, depth charges, torpedoes and missiles of the unguided or “dumb” variety which are built at one, and Mega-Damage, high-caliber explosive, plasma and ramjet shells for auto-cannons and other heavy weapons, tank guns, howitzers and cannons and warship cannons are made at the other. **Note:** GAW does not produce long-range or nuclear missiles.

**Cost:** Golden Age Weaponsmiths’ ammunition prices are 10-20% lower than their competitors.

Conventional S.D.C. ammunition on average costs 30-60 credits per box of 100 rounds.

**Conventional Guns & Ammo:** Revolvers, automatic pistols and submachine-guns take approximately the same type and caliber of ammunition.

Prices are per box of 100 rounds, but prices will vary greatly from place to place based on the level of technology and availability. Weapons and ammo that are especially hard to come by, like heavy weapons, may cost 2-5 times more.

.22 caliber, 15 credits – 2D4 S.D.C. damage.

.32 A.C.P. caliber, 20 credits – 2D6 damage.

.32 Long, 30 credits – 3D6 damage.

.38 caliber, 30 credits – 3D6 damage.

.38 Power caliber, 40 credits – 4D6 damage.

.45 A.C.P., 42 credits – 4D6 damage.

.41 Magnum, 50 credits – 5D6 damage.

.44 Magnum, 60 credits – 6D6 damage.

.357 Magnum, 45 credits – 4D6+2 damage.

9mm & 7.65mm (pistol), 32 credits – 3D6 damage.

10mm (pistol), 40 credits – 4D6 damage.

5.56mm (rifle), 50 credits – 5D6 damage.

7.5mm (rifle), 55 credits – 5D6 damage.

7.62mm (rifle), 45 credits – 4D6 damage.

.30 caliber (rifle), 42 credits – 4D6 damage.

.50 caliber (rifle), 55 credits – 6D6 damage.

7.62 Medium Machine-gun, 200 credits – 6D6 S.D.C. damage per single round.

.30 Caliber Machine-gun, 150 credits – 5D6 S.D.C. damage per single round.

.50 Caliber Machine-gun, 300 credits – 1D6x10 S.D.C. Damage per single round.

Dum Dum (handmade, black market, any caliber), add 150 credits to the cost of the box and +1D4 to S.D.C. damage per round.

Full Metal Jacketed, add 30 credits to cost of the box and +1 to damage per round.

Hollow Point, add 40 credits – +1 damage per round/bullet.

Teflon (armor piercing, not available to the public), add 100 credits to the cost of the box and +2 damage per round/bullet.

Exploding S.D.C. Shell (not available to the public), add 300 credits to the cost of the box and +2D6 to S.D.C. damage per round.

Tracer Cartridge, 45 credits – no damage.

40mm Grenade Cartridge, 900 credits (per 100).

Ramjet rounds for small caliber weapons are priced at 4-8

credits each, the cost rises to 8 credits per round for large-size cannon ammo; double when supplies are short and demand is high.

Depth charges are 2,000-6,000 credits each and *torpedoes* range in price from 6,000-18,000 credits depending on their size.

Explosive shells for tank guns, howitzers, and naval guns are packed in crates of ten which cost 8,000 to 26,000 credits each; double for plasma rounds.

Replacement missiles vary greatly in price depending on warhead type and range; mini-missiles cost 800 to 2000 credits, short-range missiles cost 2000-4000 credits, and medium-range missiles cost 6,000 to 10,000 credits (high-explosive, armor piercing and plasma are the most expensive, fragmentary and smoke missiles are cheapest).

## Firearm Accessories

**Battle Harness:** Combination of suspenders and belt designed for distributing the weight of ammo pouches and accessories. In choice of camouflage, black, grey, brown, cream or khaki. 150 credits.

**Battle Pack:** Lightweight frame, heavy-duty, water resistant canvas. Multiple interior and exterior compartments. Fasteners for exterior pouches/grenades. Choice of camouflage, green or khaki colors. 350 credits.

**Field Gun Cleaning Kit:** A complete cleaning kit contained in its own pouch. 50 credits.

**Flash Suppressor:** An attachment that fits over a gun barrel to mask the muzzle flash during firing. Characters within 100 feet (30.5 m) of a suppressed shot have only a 25% chance of seeing it. Outside of that, suppressed shots are not visible. **Cost:** 400 for pistol or submachine-gun or 900 for a rifle. **Note:** Combined silencers and flash suppressors cost 1,000 credits for pistol or submachine-gun or 2,000 credits for a rifle, but reduce the weapon’s range by 25%.

**Gun Repair Kit:** This is a 4 pound (1.8 kg) gun repair kit. Each tool is fitted into a separate loop and there’s plenty of room for spare bolts, screws, springs and cleaning rods. Contained in a 12 inch by 8 inch by 2 inch (30x20x5 cm) case. Can be attached to a harness or worn over the shoulder with strap, which is included. 250 credits.

**Holster, Ankle:** Padded for comfort, with velcro closure. Fits a snub-nosed revolver or any *small* frame automatic. Can be concealed under pant leg. 40 credits.

**Holster, Inside Trousers Holster:** Clips on belt or waistband of pants. 20 credits.

**Holster, Side Holster (fits onto belt):** 50 credits.

**Holster, Belt Slide Holster:** 50 credits.

**Holster, Belt Thumbbreak Holster:** 60 credits.

**Holster, Patrolman, Police-Style Belt and Holster, 24 bullet loops:** 100 credits.

**Holster, Police-style Shoulder Type:** 110 credits.

**Holster, Military-style Shoulder Type:** 90 credits.

**Holster, Horizontal Shoulder Type:** 100 credits.

**Holster, Scoped Shoulder Holster:** 120 credits.

**Holster, Concealed Wallet Holster:** For *small* automatic weapons; fits easily into back trouser pocket. 60 credits.

**Holster & Web Belt:** Holster, ammo pouches (2-4) and accessory attachment clips (4); 100 credits.

**Magazine Ammo Bags:** 50 credits.

**Magazine Clips:** Any weapon, any size, from 7-round pistol to 30-round rifle. 4 credits each.

**Magazine Clip Pouch:** Each of these specially designed ammo pouches is designed for 2 (slimline) or 4 (heavy-duty) ammo clips. Choice of camouflage, green, khaki or black colors.

Automatic Pistol: 2 clips, 10 credits or 4 clips, 30 credits.

Submachine-gun: 2 magazines is 20 credits, 4 magazines is 40.

5.56mm Assault Rifle, 20-round: 2 clips is 20 credits; 4 clips 40 credits.

5.56mm Assault Rifle, 30-rnd: 2 clips is 30 credits; 4 clips 55 credits.

7.62mm Assault Rifle, 20-rnd: 2 clips is 35 credits; 4 clips is 70 credits.

**Metal Ammunition Boxes:** These waterproof ammo boxes are designed for easy storage and carrying. .50 caliber size: 25 credits, .30 caliber size: 18 credits.

**Multi-Purpose Pouch:** All around, useful utility pouch designed for attachment to web belt or battle harness. 10 credits.

**Nylon Cord:** A variety of heavy-duty, all-purpose, nylon rope or cord is available. Average tension strength is 600 pounds (2670 Newtons). Average length is 300 feet (91 m). **Cost:** 100 credits; good availability.

**Protective Shooting Glasses:** Change color and density in response to changes in light and weather. Also reduces glare and improves visibility. **Cost:** 100 credits.

**Protective Goggles (simple):** 10-50 credits depending on the quality.

**Recoil Diminishers:** A small tube filled with mercury and ball bearings and mounted along the length of the firearm to counter recoil during firing. The system is custom built for each class and type of firearm. Adds +1 to strike when burst firing. Not suitable with machine-guns and other heavy weapons. **Cost:** 1,600 credits.

**Rifle Case, Assault:** 90 credits.

**Rifle Case, Hunting/Bolt-Action:** 110 credits.

**Silencer:** An attachment which fits over the barrel of a gun to muffle the sound of the report. Perception rolls require a 10 to detect silenced shots from 20 feet (6.1 m) away; outside of that, silenced shots are inaudible. Silencers reduce a weapon's range by 10%. **Cost:** 500 credits for a pistol or submachine-gun, 1,200 for a rifle. Cannot be used on machine-guns. Reduce the weapon's range by 10%.

**Shotgun Bandoleer:** Bandoleers are made of brown leather, with a heavy-duty, brass belt buckle. Shotgun versions will hold 56 rounds. 40mm grenade version holds 18 rounds. 40 credits.

**Submachine-Gun Case:** 90 credits.

**Wrist Cartridge Bandoleer:** Perfect for concealing 3 extra cartridges. 20 credits each.

**Web Belt:** Classic military belt complete with buckle and pouch fasteners. Choice of camouflage, green or khaki. 40 credits.

## Incendiary Weapons

**Distress Signal Kit:** Consists of a tube launcher and six red flares. **Maximum Height:** 900 feet (274 m). **Duration of Illumination:** 30 seconds. **Power:** 10,000 candela. **Cost:** 140 credits.

**Handheld Flares:** The hand-held flare is generally used to mark an area or for signaling. They are similar to those used by present day truck drivers. **Range:** Hand Held. **Damage:** One point. **Attacks Per Melee:** Equal to hand to hand attacks. **Weight:** 6 ounces (170 grams). **Cost:** 5 credits each; wide availability.

**Incendiary Hand Grenade:** This is a very dangerous weapon and not just for the enemy. It is difficult or impossible to throw it far enough to avoid getting hit with fragments. **Damage:** up to 12 feet (3.6 m) from impact – 2D4x10+20 S.D.C. (or 1 M.D.C.); 12-24 feet (3.6 to 7.3 m) away 1D6x10; 25-36 feet (7.6-11 m) away – 5D6; 37-120 feet (11.3-36.6 m) away – 2D6. Burns for 10 melee rounds. **Weight:** 24 ounces (0.7 kg). **Time Delay Fuse:** 4-5 seconds. **Cost:** 300 credits.

**Mini-Signal Cartridges:** A lightweight signal cartridge designed for the military special forces. Fired from a single-handed, lightweight, pen-type launcher. **Maximum Height:** 320 feet (97.5 m). **Duration of Illumination:** 10 seconds. **Power:** 150,000 candela. **Colors Available:** Green, red or white. **Cost:** 250 credits.

**Molotov Cocktail:** A classic incendiary weapon, since it is so easy to make from commonly available materials. **Range Thrown:** 30 feet (9.1 m). **Damage:** 3D6 damage – up to a 12 foot (3.6 m) area. Burns for 4 melee rounds. **Cost:** Negligible to make or can be purchased ready made at many GAW outlets for 15 credits.

**Portable Flamethrower:** With a solid stream of fire, a soldier could clear out an entire enemy machine-gun nest. In confined spaces (inside a bunker, foxhole or building), everyone in the target area is affected equally. **Damage:** 5D10 S.D.C. plus ignition of all combustible material. **Weight:** 42.5 pounds (19 kg). **Feed:** Manual. **Effective Range:** 70 feet (21.3 m), unthickened; 150 feet (45.7 m), thickened. **Cost:** 100 credits.

**Rocket Flare:** This hand-held flare has a disposable, one time, launch mechanism which fires the flare gun. Commonly used for expeditions in the wild. A -3 to strike penalty applies if used as a weapon. **Range:** 300 feet (91.4 m) straight up. **Damage:** 2D6. **Attacks Per Melee:** One. **Capacity:** One. **Weight:** 5 ounces (140 grams). **Cost:** 15 credits each; wide availability.

**Rocket Parachute Flare:** A signal flare that is fired from a single hand launch tube or flare gun and deploys a parachute-support star. No visible rocket trail is left behind in its launch wake to give away the shooter's position. **Maximum Height:** 1000 feet (305 m). **Duration of Illumination:** 30 seconds. **Power:** 200,000 candela. **Cost:** 15 credits per flare, plus 300 credits for the flare gun. **Available colors:** White, red, green, and yellow.

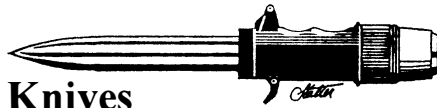

## Modern S.D.C. Knives

**Combat Bush Knife:** Heavy-duty, all-purpose survival knife. The best carbon steel 7 inch (17.7 cm) blade. **Cost:** 200 credits. **Damage:** 1D8.

**Slimpack Throwing Knife:** With a flat, lambskin sheath, this knife is perfect for concealment. Also a perfectly balanced 6 inch blade (0.15 m). **Cost:** 50 credits. **Damage:** 1D6.

**Belt Throwing Knife Set:** 4 ultra thin throwing knives in a single belt sheath designed for an easy, fast draw. **Cost:** 200 credits. **Damage:** 1D6.

**Polycarbonate Knife:** This 7 inch (17.7 cm) knife (with silk sheath) is guaranteed not to show up on metal detectors. Balanced for throwing, yet with a keen edge for slicing. **Cost:** 500 credits. **Damage:** 1D6.

**Small Boot Knife:** For easy concealment. **Cost:** 20 credits. **Damage:** 1D4.

**Bayonet:** Attaches to combat rifles. **Cost:** 140 credits. **Damage:** 1D6+1.

**Grappling Hook & Line:** This is your typical grappling hook and line for scaling surfaces. **Range:** 100 feet (30.5 m). **Damage:** 1D4. **Attacks Per Melee:** Each strike counts as one melee attack. **Weight:** 2 pounds (0.9 kg). **Cost:** 150 credits for the hook and 300 feet (91.5 m) of good line/climbing cord.

## Miscellaneous Modern Weapons

**Black Jack:** A small hand-held club, usually handmade, 10 inches (25 cm) long, weighing 2 to 4 pounds (0.9 to 1.8 kg). **Cost:** 30 credits. **Damage:** 1D6.

**Brass Knuckles:** **Cost:** 20 credits. **Damage:** 1D6 plus the character's usual punch damage and applicable damage bonuses (P.S., skill, etc.).

**Cattle Prod:** An electric rod, operated on "C" cell batteries, that emits a 4500 volt shock when it is touched to the skin. 12 or 22 inch (30 or 56 cm) lengths. **Cost:** 45 credits. **Damage:** 1D4.

**Itching Powder:** Range varies with applications; can be used as a powder, launched in a grenade, housed in a pellet that ruptures on impact, and similar devices. Victims are very uncomfortable, distracted and are -3 on initiative. **Duration:** 1D4 hours or until washed off. Affects only bare skin. **Costs:** Only 5 credits per ounce (28 g).

**Sap Glove:** Six ounces (0.2 kg) of powdered lead is built into each glove just above the knuckles, padding the wearer and adding weight and strength to the force of one's blow. +2 to *S.D.C. damage*. **Cost:** 30-50 credits.

**Fiberglass Nightstick:** **Cost:** 15 credits. **Damage:** 1D4.

**Steel Rod Encased Nightstick:** **Cost:** 30 credits. **Damage:** 1D6.

**S.W.A.T. Entry Tool** a.k.a. Hooligan Tool: A long, one inch (2.5 cm) thick, stress-proof bar, heat treated for durability and strength. On one end is a large chisel, spike-like, pry bar. On the opposite end is a claw/chisel-point (crowbar-like). Used to pry open security doors and grilles. **Cost:** 350 credits. **Damage:** 1D8 S.D.C. (either end). Pops normal, S.D.C. door locks on a roll to strike of 8-20; pops heavy locks and security door locks on a roll to strike of 12-20.

## Light Mega-Damage Weapons

### GAW-21 Laser Assault Rifle

Among the hundreds of M16 series rifles GAW scouts have found in the ruins of the many military bases, the also had uncovered was a handful of M-21 laser assault rifles. The M-21L was selected by the US Army as its standard-issue rifle in the middle 21st century. When the Great Cataclysm occurred it was just beginning to replace the M-16 in National Guard units. It is an over/under weapon that features a conventional S.D.C. assault rifle mounted above an anti-armor laser. GAW recently began producing its own version of the rifle called the GAW-21 Laser Assault Rifle in an attempt to break into the laser small arms market. Their version is built of a light Mega-Damage plastic polymer and has a single magazine that holds rifle cartridges and an additional E-Clip for the laser. The GAW-21 LAR has failed to make a significant dent in a marketplace dominated by Northern Gun and Wilk's laser weapons even at its low price. However, the GAW-21 seems destined to find its place in the market because of its versatility. The weapon can be used for hunting, S.D.C. combat and Mega-Damage skirmishes as well as sniping.

Weight: 10 lbs (4.5 kg).

S.D.C. Damage: Assault rifle: 4D6 S.D.C. per single round or 1D6x10 S.D.C. for a controlled three round burst.

Mega-Damage: The under-barrel laser: 2D6 M.D. per shot. It can only fire single shots.

Rate of Fire: Each firing of a bullet, burst or laser blast counts as one of the shooter's attacks per melee round.

Effective Range: S.D.C. rifle cartridges: 1600 feet (488 m).

Laser: 1800 feet (548.6 m).

Payload: Rifle magazine: 60 (20 bursts) or 96 (32 bursts) round clip. Laser: 20 laser blasts for a standard E-Clip.

Cost: 14,000 credits.

### GAW-AT6 LAW Missile Launcher

Golden Age Weaponsmiths produces an improved version of the ancient model M72 Light Anti-tank Weapon (LAW). This weapon is a single-shot, shoulder-fired, disposable launcher consisting of two concentric tubes. The outer tube carries the trigger and safety mechanisms as well as the sighting assembly. The inner aluminum tube extends telescopically rearward.

Weight: 3 lbs (1.4 kg).

Mega-Damage: Varies with missile type.

Missile Type: Can fire any standard mini-missile type, but GAW offers the weapon with High Explosive (5D6 M.D. to a 5 foot/1.5 m blast radius) and Fragmentation (5D6 M.D. to a 20 foot/6.1 m blast radius).

Rate of Fire: Single shot only.

Effective Range: 3200 feet (975.3 m); reduced range for the HE mini-missile due to the launch mechanism.

Payload: One shot

Cost: Disposable Launcher: 200 credits. High Explosive mini-missile (5D6 M.D.): 900 credits. Fragmentation mini-missile (5D6 M.D.): 800 credits. Armor-piercing (1D4x10 M.D. to a 3

foot/0.9 m blast radius): 1400 credits, and 2000 credits for a plasma mini-missile (1D6x10 M.D. to a 20 foot/6.1 m blast radius).

## GAW RPG-70

An old standby of guerrilla and third world forces across the planet, the RPG-7 is another ancient weapon reproduced by Golden Age Weaponsmiths. It is a simplistic, unsophisticated weapon that consists of a launcher and trigger assembly, and a range-finding optical sight with passive nightvision sight (2000 foot/610 m range) for nighttime use. When fired, large knife-like fins spring out from the rocket-propelled grenade (RPG) round to stabilize it in flight. The system is reasonably accurate when there are no crosswinds, but because the RPGs are “dumb,” or unguided, they are erratic in windy conditions (-2 to strike).

Golden Age decided to reproduce this weapon because it is durable, reliable and effective against S.D.C. fortifications and does light Mega-Damage. The weapon can withstand the extreme cold of arctic conditions, the humidity of the jungle and also the hot, dusty conditions of a desert environment. Moreover, the GAW RPG-70 weapon is simple to operate, any right-handed individual can be taught to use it in less than an hour (note that gas generated from rocket launch is vented through a hole on the left side of the launcher, which inflicts 3D6x10 S.D.C./1 M.D. to the head of anyone attempting left-handed firing) and is inexpensive to make.

Weight: 17 lbs (7.7 kg).

Damage: 2D4x10 S.D.C. for fragmentation to a 20 foot (6.1 m) blast radius, 2D6x10+12 S.D.C. (equal to 1D4 M.D.) for Armor-Piercing/HEAT, and 4D6 M.D. for a High Explosive Mega-Damage rocket-grenade.

Rate of Fire: One shot per melee round; reloadable.

Effective Range: 3000 feet (914 m).

Payload: One. A trained operator can reload the weapon in just under one melee round, meaning that the RPG-7 can be reloaded and fired once every melee round. A two-man team with one designated person to reload can fire the weapon twice per melee round, the act of reloading taking two melee actions plus one action to aim and fire.

Cost: 20,000 credits for the launcher. S.D.C. Fragmentation RPG: 100 credits., High Explosive (1D4 M.D.): 180 credits, or M.D. Plasma RPG (4D6 M.D.): 350 credits.

## Golden Age Howitzers

In the past, artillery has been a vital component for victory on the battlefield. However, since the Great Cataclysm and the advent of Mega-Damage power armor, bionics and energy weapons that turn ordinary soldiers into walking or flying tanks/artillery units themselves, big cannons and artillery units have become antiquated and much less effective. It is difficult to target and hit fast moving augmented warriors who are, in effect, miniaturized artillery units themselves. After all, a squad of 10 Glitter Boys or other power armor (or a couple squads of full conversion cyborgs) are the equivalent of an entire pre-Rifts tank company and a squad of SAMAS the equivalent of 40 helicopter gunships, only the SAMAS are even smaller and more difficult to hit, more maneuverable and just as deadly.

Furthermore, the big howitzers slow down the small, fast combat units of today’s armies, and they require heavy vehicles for transportation and an entrenched artillery position. Entrenched positions can become a liability in this new age of magic, psionics and Mega-Damage individuals, especially if the position is captured and the artillery turned on its own troops, base camp or fortifications. Beside, with large cities beginning to appear in only the last century, traditional artillery is more trouble than it’s worth when a company of Mega-Damage capable soldiers can take most villages, towns and even cities without heavy backup. Lasers, energy weapons, M.D. mini-missiles, power armor and magic are the new “heavy weapons” and mobile artillery of the post-Cataclysm world. That having been said, Golden Age Weaponsmiths is trying to give antiquated artillery a comeback.

**Note:** Any artillery units brought and the troops responsible for bringing them onto *Coalition* controlled territory are targeted for immediate destruction. No questions asked. *Free Quebec* has a similar policy, and places like *Kingsdale* and *MercTown* insist artillery be kept a minimum of 30 miles (48 km) beyond their borders.

## GAW-102 105mm Howitzer

The smallest and oldest of the howitzers. These are rebuilt M102s recovered from Army, Marine and National Guard bases. Golden Age Weaponsmiths recovered a total of 243 serviceable M102s, but there are probably another hundred or more scattered across the continent.

Length: 17 feet (5.2 m).

Width: 6 feet, 6 inches (2 m).

Height: 5 feet, 3 inches (1.6 m).

Weight: 3324 pounds (1496 kg).

Mega-Damage: Varies with ammunition type.

Ammunition Types: *Plasma:* 1D6x10 M.D. to 25 foot (7.6 m) blast radius.

*High Explosive (HE):* 1D4x10 M.D. to 10 foot (3 m) blast radius.

*Dual-Purpose (DP) Fragmentary:* 6D6 M.D. to 20 foot (6.1 m) blast radius.

*Anti-Personnel (AP) Fragmentary:* 5D6 M.D. to 40 foot (12.2 m) blast radius.

*Smoke:* Covers 20 foot (6.1 m) blast radius.

**Note:** May be substituted with S.D.C. munitions.

*High Explosive (HE):* 5D6x10 S.D.C. to 10 foot (3 m) blast radius.

*Dual-Purpose (DP) Fragmentary:* 4D6x10 S.D.C. to 20 foot (6.1 m) blast radius.

*Anti-Personnel (AP) Fragmentary:* 3D6x10 S.D.C. to 40 foot (12.2 m) blast radius.

*Smoke:* Covers 20 foot (6.1 m) blast radius.

Effective Range: 7.2 miles (11.5 km).

Rate of Fire: 10 rounds per minute.

Crew: 8 total.

M.D.C. of the Weapon: 20.

Cost: 150,000 credits. Poor availability, little demand.



## GAW-198 155mm Howitzer

In the time before the Rifts the M198 was the main towed howitzer of US forces. GAW has recovered 176 of these heavy-duty weapons. As with the M102, there are probably more of these weapons scattered across the continent.

Length: 36 feet (11 m).

Width: 27 feet, 10 inches (8.5 m).

Height: 6 feet (1.8 m).

Weight: 8 tons (7200 kg).

Mega-Damage: Varies with ammunition type.

Ammunition Types:

*Plasma:* 3D4x10 M.D. to 30 foot (9.1 m) blast radius.

*High Explosive:* 2D4x10 M.D. to 15 foot (4.6 m) blast radius.

*DP Fragmentary:* 1D6x10 M.D. to 30 foot (9.1 m) blast radius.

*AP Fragmentary:* 1D4x10 M.D. to 50 foot (15.2 m) blast radius.

*Smoke:* Covers 40 foot (12.2 m) blast radius.

Effective Range: 11.3 miles (18.1 km).

Rate of Fire: 4 rounds per minute.

Crew: 11 total.

M.D.C. of the Weapon: 20.

Cost: 350,000 credits. Poor availability, minimal demand.

## GAW-155 Electromagnetic Howitzers

This is the only howitzer designed and manufactured by Golden Age Weaponsmiths. The GAW-155 is a 155mm howitzer built along the same lines as the GAW-198, and looks almost the same upon casual inspection. Unlike the venerable GAW-198 howitzer that it resembles, this weapon is built entirely of lightweight Mega-Damage materials. It also has a series of electromagnetic coils lining the interior of the barrel to propel the projectile at high speeds and greater distances. The GAW-155 rail howitzer fires shells at nearly twice the range of the old M198. It can also be used as a direct-fire cannon, like the Boom Gun, to destroy point targets like tanks, APCs and giant robots.

Length: 36 feet (11 m).

Width: 27 feet, 10 inches (8.5 m).

Height: 6 feet (1.8 m).

Weight: 9 tons (8100 kg).

Power System: Nuclear, with energy life of 2 years.

Mega-Damage: Varies with ammunition type.

Ammunition Types:

*Plasma:* 3D4x10 M.D. to 30 foot (9.1 m) blast radius.

*High Explosive:* 2D4x10 M.D. to 15 foot (4.6 m) blast radius.

*DP Fragmentary:* 1D6x10 M.D. to 30 foot (9.1 m) blast radius.

*AP Fragmentary:* 1D4x10 M.D. to 50 foot (15.2 m) blast radius.

*Smoke:* Covers 40 foot (12.2 m) blast radius.

Effective Range: 20 miles (32 km).

Rate of Fire: 4 rounds per minute.

Crew: 11 total.

M.D.C. of the Weapon: 90.

Cost: One million credits. Poor availability, minimal demand.

## GAW Mortars

A mortar is essentially a man-portable, miniature artillery weapon. It is a lightweight, crew-served indirect fire weapon once used to provide support for front-line units. The weapon can be carried by a small crew of foot soldiers and can be set up virtually anywhere (unlike heavy artillery). Mortars were the basic infantry support weapon and in pre-Rifts times were issued to heavy weapons formations at the battalion, company and even platoon level to attack enemy infantry units, defensive positions and light-skinned vehicles (APCs, IFVs, armored cars and supply trucks). *However*, with the advent of Mega-Damage mini-missiles, rifle grenades, and long-range, precision energy weapons, mortars, like artillery, became obsolete.

Still, Golden Age Weaponsmiths offers a couple varieties at low prices. Most effective against entrenched positions and low tech, S.D.C. opponents.

If the mortar is firing at a stationary or fixed target, like a bunker or building, once the coordinates for the target have been determined, every round will hit the target; i.e., in game terms, once the mortar has made one successful strike roll, every round thereafter will automatically hit the "fixed" target (no roll to strike is necessary as long as the attacker does not change his position). The rate of fire is equal to the attacker's usual number of hand to hand attacks per melee round. It takes 1D4+1 melee attacks to make the initial hit/strike, using up one additional melee attack/action for each adjustment, after each mortar round that misses. There is one huge drawback to the weapon, because the mortar is an indirect fire weapon, it has virtually no chance of directly hitting small or moving targets (like cyborgs, power armor, robots, tanks, and even foot soldiers, monsters, etc.). It is also ineffective against small bands of troops who are not clustered close together. If a mortar gunner wishes to hit such small, moving targets a *Called Shot* is required and he must roll an *unmodified (Natural) 18, 19 or 20* to hit! Remember though, even if the mortar gunner fails to score a direct hit, the target *may* get caught in the blast radius, thus taking *half damage* from the mortar round.

## GAW Commando 60mm Handheld Mortar

The Commando mortar is an extremely lightweight, 60mm weapon that has no bipod, sights or base plate. It is designed to be fired by a single infantryman who literally holds the tube upright (grasping an insulated hand-grip that protects the shooter from the heat). There is no sight assembly, meaning that the operator has to align the tube to the target and judge the elevation on his own. Commando mortars are so light they can be carried in a backpack or slung over the shoulder like a rifle. Then when it is needed the weapon can be unslung and used to lob shells at enemy troops, fortifications and vehicles.

Weight: 8 lbs (3.6 kg).

Mega-Damage: Varies with ammunition type.

Ammunition Types: Uses the equivalent of grenades to inflict Mega-Damage.

*Plasma:* 6D6 M.D. to a blast radius of 12 feet (3.6 m).

*High Explosive/HE:* 4D6 M.D. to a blast radius of 6 feet (1.8 m).

*Fragmentation:* 2D6 M.D. to a blast radius of 20 feet (6.1 m).

*Smoke:* Covers an area of 20 feet (6 m) in colored smoke (black, white and red). *Parachute Flares:* Glides down and burns to illuminate the target area for 1D6 minutes.

Rate of Fire: 1-2 shots per melee round (characters with 5 or more attacks/actions per round can fire twice); each shot may include a minor adjustment and counts as three melee attacks.

Effective Range: 4000 feet (1219 m), the weapon has a minimum range of 130 feet (40 m).

Payload: Single shot, each round manually loaded/fired.

Note: Commando mortars have no sighting device meaning that the operator must aim the weapon by a process of guesswork, and thus, typically these mortars are not accurate weapons. For any hope of hitting the target the operator of a Commando mortar must have the *W.P. Mortar* skill and even then, he is at -3 to strike.

Cost: 2000 credits for the mortar, bombs cost the same as CS hand grenades: 250 credits for fragmentation, 275 for High Explosive, 350 for plasma, 180 credits for smoke and flares.

## GAW Sledgehammer 81mm Medium Mortar

The Sledgehammer is a larger mortar that fires rounds at greater ranges. Before the Rifts these weapons were issued to heavy weapons platoons at the battalion level. When broken down into component parts these mortars can be transported on foot by their crew of five troops. This mortar fires standard HE rounds against infantry and soft-skinned vehicles, but with the development of “smart” HEAT mortar rounds they are also effective against IFVs and tanks!

Weight: 89 lbs (40 kg).

Mega-Damage: Varies with ammunition type.

Ammunition Types: Uses the equivalent of grenades to inflict Mega-Damage.

*Plasma:* 6D6 M.D. to a blast radius of 12 feet (3.6 m).

*High Explosive/HE:* 4D6 M.D. to a blast radius of 6 feet (1.8 m).

*Fragmentation:* 2D6 M.D. to a blast area of 20 feet (6.1 m).

*Smoke:* Covers an area of 20 feet (6 m) in colored smoke (black, white, and red). *Parachute Flares:* Glides down and burns to illuminate the target area for 1D6 minutes.

Rate of Fire: 1-2 shots per melee round (characters with 5 or more attacks/actions per round can fire twice); each shot may include a minor adjustment and counts as three melee attacks.

Effective Range: About 3 miles (4.8 km), the weapon has a minimum range of 130 feet (40 m).

Payload: Single shot, must be reloaded by hand.

Cost: 4,500 credits for the mortar, bombs cost the same as CS hand grenades: 250 credits for fragmentation, 275 for High Explosive, 350 for plasma, 180 credits for smoke and flares.

# New Combat Vehicles

Military vehicle production is the primary focus of Golden Age Weaponsmiths’ retrofitting operations. All of these vehicles are refitted with armor capable of sustaining Mega-Damage and are equipped with the best high-tech computer and electrical components that are available to them. However, none of these vehicles are new designs, rather they are recovered combat vehicles salvaged by Golden Age Weaponsmiths from ruined bases and armories and “souped up” with additional M.D.C. plating, weapons and modern features. GAW tries to select what it feels are the most capable, durable and combat-worthy vehicles – old, reliable workhorses – and has upgraded them for survival on the modern battlefields of Rifts Earth. In spite of the age of these designs, the vehicles are still highly effective and have fair to good levels of overall performance. However, they are “rebuilt” of actual old vehicles or M.D.C. redesigns with minimal M.D.C. and basic weapons to keep the cost cheap. The Golden Age Weaponsmiths’ vehicles are very affordable, less expensive than most other vehicles on the market, but are generally ranked as second-rate when it comes to heavy combat. Still, sales of these vehicles are good, especially among adventurers, small mercenary outfits and independent kingdoms.

## GAW-M1A3 Improved Abrams Main Battle Tank

The Abrams MBT was once a mainstay of the old U.S. Empire’s mechanized armored force; quick, tough and well armed, improving upon the tank was a relatively straightforward project for the engineers of Golden Age Weaponsmiths. The new Abrams is a fair match for Iron Heart’s medium tank, and weaker than their Iron Hammer MBT, but still, for the cost, the GAW’s Improved Abrams cannot be beat.

**Model Type:** GAW-M1A3 Improved Abrams Main Battle Tank  
**Class:** Main Battle Tank.

**Crew:** Four crewmen, a Tank Commander/pilot/driver, gunner, loader/Operator/mechanic and communications officer.

**M.D.C. by Location:**

Cupola on Turret – 50

Main Turret – 120

Improved 120 mm Auto-Cannon – 50

\* Modified .50 cal Coaxial Machine-Gun – 8

\* Modified 7.62 mm Cupola Machine-Gun – 5

\* Box Style Missile Launchers (2) – 15 each

\*\* Track Treads (2) – 20 each

\*\*\* Main Body - 266

Reinforced Crew Compartment 25

\* The items marked by a single asterisk are small and difficult to hit (or shielded) and require a Called Shot to strike with the shooter suffering a penalty of -2 to strike.

\*\* Depleting the M.D.C. of a tread requires a Called Shot (and -2 to strike), but destroying one set of treads immobilizes the tank until it can be replaced. Replacing a tread will take 1D6x10+10 minutes by a trained crew (2 replacements are car-

ried on board) or three times as long by an inexperienced crew. Changing the tread is only possible when the vehicle is not under attack.

\*\*\* Depleting the M.D.C. of the main body completely destroys the vehicle.

#### **Speed:**

Maximum Speed: 60 mph (96 km) maximum, speed cross-country is typically 40 mph (64 km).

Range: 500 miles (800 km) before requiring refueling.

#### **Statistical Data:**

Height: 18 feet (5.5 m).

Width: 12 feet (3.6 m).

Length: 36 feet (10.9 m).

Weight: 40 tons fully loaded.

Cargo: Minimal storage space, just enough room for extra clothing, weapons and some personal items.

Power System: Conventional diesel engine.

Cost: 200,000 credits.

#### **Weapon Systems:**

**1. 120 mm Auto-Cannon:** The Abrams main gun fires explosive shells at visible targets (line up in the targeting sights and fire; but is only +1 to strike if the target is "painted" with a laser designator). The tank may also operate like an artillery unit, firing at a set of coordinates without actually seeing the target (-2 to strike). The auto-cannon is built into the turret, and the turret can rotate 360 degrees and can aim up and down in a 60 degree angle, allowing the tank to engage low-flying aircraft and other types of slow flyers (however, it is -3 to hit flying targets moving faster than 80 mph/128 km). The gun is controlled by a gunner inside the turret compartment.

Primary Purpose: Anti-Tank/Anti-Robot/Anti-dragon.

Secondary Purpose: Self-Defense.

Mega-Damage: 6D6 M.D. per High-Explosive (HE) round to a 10 foot (3 m) radius or 1D4x10 per Armor Piercing round to a 3 foot (0.9 m) radius, both rounds are designed to take down other tanks, armored vehicles, giant robots and fortifications.

Rate of Fire: A maximum of three attacks per melee round regardless of the gunner's hand to hand combat numbers.

Effective Range: 6000 feet (1828 m) for all rounds.

Payload: The tank can carry up to 80 rounds; typically a mix of half and half, plus six smoke shells (covers a 40 foot/12.2 m radius), but may be all of one kind (plus smoke) or the other.

**2. .50 cal Coaxial Machine-gun:** This machine-gun is mounted under the main cannon, forcing the entire main turret to turn in order to engage new targets. The weapon may fire conventional ammunition or Wellington Industries M.D. ramjet rounds (much more expensive).

Primary Purpose: Assault and Defense.

Secondary Purpose: Anti-Infantry/Soft Targets.

Mega-Damage: *Conventional .50 Caliber Rounds:* 1D6x100 S.D.C. or 1D6 M.D. per burst of 10 rounds.

*Light Ramjet Rounds:* One M.D. per round, doing 1D8+2 M.D. per ten round burst. (Cost is 4 credits per Light Ramjet round from GAW when purchased in batches of 100 or more. Smaller quantities cost 5-6 credits each from GAW; fair to good availability.)

*Heavy Ramjet Rounds:* 1D4 M.D. per round, doing 1D4x10 M.D. per ten round burst. (Cost is 8 credits per Heavy Ramjet round from GAW when purchased in batches of 100 or more. Smaller quantities cost 10-12 credits each from GAW; fair to good availability.)

Rate of Fire: Each burst counts as one of the tank gunner's hand to hand attacks per melee.

Effective Range: 6000 feet (1828 m).

Payload: 3000 rounds, equal to 300 bursts!

**3. Box Style Mini-Missile Launchers (2):** These two box-mounted launchers have been added to the sides of the GAW Abrams for use against lightly armored targets and infantry.

Primary Purpose: Anti-Vehicle and Fortifications.

Secondary Purpose: Anti-Aircraft/Missiles and Anti-Personnel.

Mega-Damage: Varies with type of missile.

Missile Type: Can fire any standard mini-missile type, but GAW sells the tank with six High Explosive (5D6 M.D. to a 5 foot/1.5 m blast radius) and six Fragmentation (5D6 M.D. to a 20 foot/6.1 m blast radius) mini-missiles.

Rate of Fire: Volleys of 1, 2, 4, or 6. Fired by the gunner.

Effective Range: One mile (1.6 km).

Payload: 12 total. Each missile launcher holds six mini-missiles.

**4. 7.62 mm Cupola Machine-gun:** A 7.62 mm machine-gun manned by a gunner protected by the cupola (shielding). May be loaded with Wellington Industries' WI-2E explosive rounds, that allow the weapon to inflict greater Mega-Damage. The machine-gun is mounted in the cupola and can be pointed in any direction by the gunner for a 360 degree rotation and a 120 degree arc of fire up and down.

Primary Purpose: Anti-Infantry/Soft Targets.

Secondary Purpose: Self-Defense.

Mega-Damage: 4D6x10 S.D.C. or 1D4 M.D. per 10 round burst, 2D4 M.D. for a 20 round burst. Using WI-2E explosive rounds doubles the damage noted above (2D4 M.D. per 10 round burst and 4D4 M.D. per 20 round burst).

Rate of Fire: Each 10 round burst counts as one of the gunner's attacks per melee. A 20 round burst counts as two.

Effective Range: 3000 feet (914 m).

Payload: 1600 rounds, equal to 160 ten round bursts.

**5. Systems of Note:** Vehicular radio with 50 mile (80 km) range, and passive nightvision with 2000 foot (610 m) range.

## **GAW-M113 Improved (APC) Armored Personnel Carrier**

The M113 is a simple all-purpose APC with superior speed and better armor and weapons. The vehicle can deliver combat infantry and supplies to the battlefield in relative safety. Although the refitted M113 are no match for modern APCs, one cannot beat the rock bottom price offered by GAW – they're practically giving the M113s away.

**Model Type:** GAW-M113s Improved Armored Personnel Carrier.

**Class:** Armored Personnel Carrier.

**Crew:** Three crewmen: a driver/APC commander, cupola gunner, and a communications officer.

**Troop Transport:** Comfortably seats either 24 heavy infantry soldiers or 14 power armor suits.

**M.D.C. by Location:**

Turret - 80

\* Cupola Rail Gun - 50

\* Box Style Mini-Missile Launcher - 10

\*\* Track Treads (2) - 14 each

\*\*\* Main Body - 168 M.D.C. (the main body is reinforced with modern M.D.C. materials).

\* The items marked by a single asterisk are small and difficult to hit (or shielded) and require a Called Shot to strike with the shooter suffering a penalty of -2 to strike.

\*\* Depleting the M.D.C. of a tread requires a Called Shot (and -2 to strike), but destroying one set of treads immobilizes the vehicle until it can be replaced. Replacing a tread will take 1D6x10+10 minutes by a trained crew (2 replacements are carried on board) or three times as long by an inexperienced crew. Changing the tread is only possible when the vehicle is not under attack.

\*\*\* Depleting the M.D.C. of the main body completely destroys the vehicle.

**Speed:**

Maximum Speed: 80 mph (128 km) maximum, speed cross-country is typically 45 mph (72 km).

Range: 500 miles (800 km) before requiring refueling.

**Statistical Data:**

Height: 9 feet, 9 inches (2.97 m).

Width: 8 feet, 4 inches (2.54 m).

Length: 21 feet, 2 inches (6.45 m).

Weight: 14 tons.

Cargo: Can hold 5,000 lbs (2,250 kg) worth of equipment.

Power System: Conventional diesel engine.

Cost: 80,000 credits.

**Weapon Systems:**

**1. Cupola Rail Gun:** This gun is a copy of Northern Gun's NG-202, located in the cupola (mini-turret). The turret must be manned by a gunner, can rotate 360 degrees and has a 90 degree arc of fire up and down.

Primary Purpose: Anti-Aircraft and Anti-Vehicle.

Secondary Purpose: Defense and Anti-Personnel.

Mega-Damage: 1D4x10 per 40 rounds burst; one round does 1D4 M.D.

Rate of Fire: Each burst counts as one of the gunner's attacks per melee round.

Effective Range: 4000 feet (1219 m).

Payload: 3,200 round drum, for 80 bursts. Reloading the drum takes 15 minutes if done by hand, 5 minutes if done with robots and special equipment. One extra drum can be carried inside the APC.

**2. Box Style Mini-Missile Launcher:** A single box style mini-missile launcher has been added to the top of the APC to provide aerial protection for the vehicle and its mechanized infantry, the launcher is fired by the driver.

Primary Purpose: Anti-Aircraft.

Secondary Purpose: Anti-Vehicle.

Mega-Damage: Varies with mini-missile type.

Missile Type: Can fire any standard mini-missile type, but GAW sells the tank with six High Explosive (5D6 M.D. to a 5 foot/1.5 m blast radius) and six Fragmentation (5D6 M.D. to a 20 foot/6.1 m blast radius) mini-missiles.

Rate of Fire: One at a time or volleys of 2, 4, or 6.

Effective Range: About 1 mile (1.6 km).

Payload: Six mini-missiles.

**3. Systems of Note:** Vehicular radio with 50 mile (80 km) range and passive nightvision with 2000 foot (610 m) range.

## GAW-998 Improved Hummer Combat Utility Vehicle

The GAW-998 Hummer is an extremely popular light combat and utility vehicle. As with most vehicles manufactured by Golden Age Weaponsmiths, the GAW Hummer is a Mega-Damage retrofit of a pre-Rifts American military vehicle. In the age before the Coming of the Rifts, the M-998 series HMMWV, or High Mobility Multi-purpose Wheeled Vehicle, was one of the most widely used vehicles in the modern American military. Its design stands out for two main reasons, utility and mobility. The retrofitted GAW-998 can be used for dozens of different applications, including troop transport, resupply, staff car, reconnaissance, field ambulance, towing artillery pieces, and when armed with a TOW launcher, as a mobile weapons platform for anti-tank combat. Without much exaggeration, it can be said that the Hummer can go anywhere. It can go wherever tanks can, ford rivers (up to 2.5 feet/0.76 m deep), climb virtually any hill, scale logs, steps and other obstacles up to two feet (0.6 m) tall, and drive across sand, snow and ice with equal ease. Hummers are incredibly rugged and continue driving at normal speeds even when all four tires are flat (they all come with the run-flat tire system). The vehicle can carry a payload of up to 2500 lbs (1125 kg) of cargo or up to 10 seated troops in full gear and tow a maximum payload of 3,400 lbs (1530 kg); as much as a 105mm howitzer. Even the vehicle itself is easy to move; the Hummer can be carried by a GAW-60 Blackhawk helicopter, and two Hummers can be carried by the GAW-47 Chinook.

Another winning feature of the vehicle's design is that with little effort, all Hummers can be outfitted for combat use. Every Hummer, even ambulance models, come equipped with a weapon mount on the roof on which numerous weapons can be attached when needed. All GAW Hummers also have a basic radio with a 5 mile (8 km) range.

**Model Type:** GAW-998 Improved Hummer

**Class:** High Mobility Multi-purpose Wheeled Vehicle.

**Crew:** One pilot/driver is all that's critical, but it can accommodate a four person crew (co-pilot, gunner, and 1 communications officer, in addition to the pilot, or pilot and three passengers) in addition to six seated troops or additional passengers (8 under cramped conditions). As an ambulance, it easily accommodates 4 stretchers and 2-4 seated patients or 10-12 seated passengers, the "crew" being the driver, a doctor and two paramedics/field medics.

### **M.D.C. by Location:**

- Weapon Turret (optional) – 40
- Ballistic Windows (3; forward) – 12 each
- \* Headlights (6) – 3 each
- \* Hardened Tires (4) - 6 each
- Reinforced Pilot's Compartment – 25
- \*\* Main Body - 122

\* The items marked by a single asterisk are small and difficult to hit and require a Called Shot to strike with the shooter suffering a penalty of -3 to strike.

\*\* Depleting the M.D.C. of the main body completely destroys the vehicle.

### **Speed:**

Maximum Speed: 90 mph (144 km) maximum, speed cross-country is typically 15-35 mph (24-56 km).

Range: 800 miles (1280 km) before requiring refueling.

### **Statistical Data:**

Height: 6 feet (1.83 m).

Width: 9 feet, 1 inch (2.75 m).

Length: 16 feet (4.72 m).

Weight: 5,060 lbs (2277 kg).

Cargo: Can hold 2,500 lbs (1,125 kg) worth of equipment, plus tow a load of 3,400 lbs (1,530 kg).

Power System: Conventional gas engine.

Cost: 95,000 credits.

**Weapon Systems:** Every GAW Hummer has a weapon mount on the roof of the vehicle. This mount can support numerous weapons, including most machine-guns, rail guns, Wellington Industries auto-cannons, the WI-GL20 grenade launcher, TOW launcher, mini-missile launcher or any type of rifle style energy weapon. When the Hummer is armed the weapon is accessed through a hatch from the back seat of the vehicle and must be manned by a gunner. Two mini-missile box launchers can also be attached to the exterior (back or sides) of the vehicle (six mini-missiles per launcher).

## **GAW Fast-Attack Vehicle Special Ops Dune Buggy**

The GAW Fast Attack Vehicle (FAV) is a high speed, heavily armed, rugged off-road dune buggy-like vehicle designed for special operations applications. Its basic function is to augment the firepower and mobility of elite troops without sacrificing their ability to hide and maneuver covertly. And in so doing, the FAV has expanded the capabilities of Special Ops personnel.

FAVs are three-man, all-terrain vehicles that have a top road speed of 90 mph (144 km). The FAV Dune Buggy is rugged and can negotiate virtually any ground terrain. It drives over steep inclines, through roadblocks, over tank traps, sand, mud, ditches and trenches as well as other rough terrain and obstacles (up to 4 feet/1.2 m tall) that are impassable for most other military vehicles. A fully-loaded FAV travels cross-country at speeds varying from 25-60 mph (40 to 96 km), which on average is 50% greater than the off-road speed of the GAW-H998 Hummer.

Armament for the FAV, aside from the driver's personal weapons, consists of a roof-mounted WI-GL80 "Predator" (or Super-Grenade Launcher), and a pair of mini-missile launchers. This impressive array of weaponry gives the three-man FAV crew the firepower of a heavy power armor suit or light combat robot, and enough firepower to engage much larger infantry units, enemy installations, soft-skinned vehicles and even light armored vehicles (such as an Iron Maiden APC-10, Bradley IFV or Coalition APC). The FAV is also easy to transport; one can be carried by a GAW-60 Blackhawk, or two by the GAW-47 Chinook, and the FAV can even be rigged to parachute from transport aircraft.

Since it was first offered by Golden Age Weaponsmiths, the FAV has been purchased for special operations units in many armies, including the Manistique Imperium, Ishpeming, Lazlo and Tolkeen, as well as by numerous mercenary and bandit groups. These forces use the FAV in many roles, including reconnaissance, patrolling, security, light strike, infantry support, covert surveillance, covert infiltration, forward air control (using laser designators) and for standby combat search and rescue.

**Model Type:** GAW Fast Attack Vehicle (FAV)

**Class:** Fast Attack Vehicle Special Ops Dune Buggy.

**Crew:** Two, driver and gunner, plus 2-4 passengers.

### **M.D.C. by Location:**

- \* Headlights (4) – 3 each
- \* Hardened Tires (4) - 4 each
- \* Roof Gun (typically a WI-GL80 Predator) - 50
- \* Box Style Missile Launcher (1) - 10 each
- \* Exposed Rear Mounted Engine - 12
- \*\* Main Body - 82

\* The items marked by a single asterisk are small and difficult to hit and require a Called Shot to strike with the shooter suffering a penalty of -3 to strike.

\*\* Depleting the M.D.C. of the main body completely destroys the vehicle.

**Note:** This is not an environmental enclosure, the crew sits exposed to the elements, but does have the benefits of partial cover and concealment. Shots directed at the crew suffer a penalty of -2 to strike.

### **Speed:**

Maximum Speed: 120 mph (192 mph), off-road speed is reduced. A fully-loaded FAV travels cross country at speeds varying from 25-60 mph (40 to 96 km) depending on the difficulty of the terrain.

Range: 1500 miles (2400 km), due to its electric engine.

### **Statistical Data:**

Height: 6 feet, 3 inches (1.9 m).

Width: 6 feet, 11 inches (2.11 m).

Length: 13 feet, 11 inches (4.25 m).

Weight: 2,750 lbs (1,237.5 kg).

Cargo: None.

Power System: Electrical engine.

Cost: 270,000 credits.

### **Weapon Systems:**

**1. Roof Gun:** May be the WI-GL80 "Predator" Super-Gre-

**nade Launcher** or a **.50 Caliber Heavy Machine-Gun**. This weapon is mounted on a reinforced roll-bar and requires a gunner (typically one of the passengers standing up on his seat and strapped into the gunner's harness). The weapon can rotate 360 degree and has a 90 degree arc of fire up and down.

Primary Purpose: Assault and Defense.

Secondary Purpose: Anti-Personnel.

Mega-Damage: Predator Grenade launcher: *HEAT/Armor Piercing Grenade:* 1D4x10 to a radius of 3 feet (0.9 m) around the target. *Fragmentation Grenade:* 4D6 M.D. to everything in a 12 foot (3.6 m) radius. *Other:* Smoke, tear gas or other types of grenades may be substituted.

.50 Caliber Machine-gun: 1D6 M.D. per 10 round burst.

Rate of Fire: Each grenade or machine-gun burst fired counts as one of the gunner's attacks per melee.

Effective Range: Grenade Launcher: 2100 feet (640 m). Machine-gun: 6000 feet (1828 m).

Payload: Grenades: 60 grenade belt feed or 800 machine-gun rounds (80 bursts).

**Note:** This weapon may be replaced with a mounted laser or other rifle style energy weapons, but requires E-Clips or a separate power pack or generator for power.

**2. Box Style Mini-Missile Launchers (2):** These two box-mounted launchers on the sides of the FAV are used against lightly armored targets and infantry, both of these launchers are fired by the gunner.

Primary Purpose: Anti-Aircraft.

Secondary Purpose: Anti-Vehicle.

Mega-Damage: Varies with mini-missile type.

Missile Type: Can fire any standard mini-missile type, but GAW sells the FAV with six High Explosive (5D6 M.D. to a 5 foot/1.5 m blast radius) and six Fragmentation (5D6 M.D. to a 20 foot/6.1 m blast radius) mini-missiles.

Rate of Fire: One at a time or volleys of 2, 4, or 6.

Effective Range: About 1 mile (1.6 km).

Payload: 12, six mini-missiles per launcher.

**3. Systems of Note:** Basic radio with 5 mile (8 km) range, passive nightvision with 2000 foot (610 m) range, and souped up for fast turns and evasive maneuvers (half the usual piloting penalties for trick and evasive moves).

## GAW-A-10 Improved Thunderbolt II Fighter Aircraft

Inspired by Owen Johnson

Adapting this Thunderbolt to the Rifts environment was a major undertaking for GAW. Newly rebuilt, it now has modern medium-range missiles, as well as enhanced sensors. Fully armored throughout, its strong frame is capable of carrying much heavier armor, living up to its other nickname as the "flying tank." The redesigned seven-barrel GU-A/8 Avenger cannon is still the centerpiece of the Thunderbolt.

Top speed of the aircraft has been increased to 450 mph (720 km). It has a low stall speed and is extremely maneuverable. A factor the designers kept in mind, because these low speeds al-

low the pilot to perform stunts that are difficult in other aircraft. It's so well built that the major systems are armored, shielded from EMP effects and feature triple redundancy. GAW even installed an ejection seat system based on the original "zero-zero" design. This means that the ejection system works in flight or on the ground at "zero altitude and zero speed."

**Model Type:** GAW-A-10 Improved Thunderbolt II, a.k.a. the "Warthog"

**Class:** Close-support ground attack aircraft.

**Crew:** One, pilot.

**M.D.C. by Location:**

Dual-Rudder Tail - 45

\* Landing Gear/Tires (3) - 5 each

\* Jet Engines (2) - 55 each

\* Avenger Cannon - 20

\* Missile Pylons (9) - 5 each

\*\* Wings (2) - 60 each

\*\* Main Body/Fuselage - 140

Reinforced Pilot's Compartment - 60

\* Items marked by a single asterisk are small and/or difficult targets to hit and require a Called Shot to strike with a -5 penalty to strike when the aircraft is moving faster than 100 mph (160 km; -2 to strike moving slower than that). Destroying the landing gear will result in an emergency landing (same as crash landing but with 01-77% chance of success). The loss of one engine reduces maximum air speed by half and impose a -15% penalty to the piloting skill and trick maneuvers. There are three weapon pylons per wing and three under the fuselage. Destroying a pylon prevents missiles or bombs from being mounted to the aircraft. Destroying a missile attached to a pylon will detonate it and inflict damage to the aircraft.

\*\* Destroying one of the wings or depleting the M.D.C. of the main body will knock the bird out of the sky! Roll under piloting skill -30% for a successful crash landing (plane is wrecked, but the pilot comes out alive).

**Speed:**

Driving on the Ground: Not possible, taxi speed is 5 mph (8 km) on paved surfaces, 2 mph (3.2 km) on rough terrain.

Flying: The twin turbojets enable the Thunderbolt aircraft to reach a maximum speed of 450 mph (720 km) in level flight. Cruising speed is considered 325 mph (520 km). Stall speed is an impressive 50 mph (80 km) fully loaded. The landing system is reinforced, making landings possible on rough, level terrain (-10% to -30% modifier, any higher results in a controlled crash attempt) and allows it to be positioned near the battlefield. At maximum weight, takeoff distance is only 70 feet (21.3 m)!

Maximum Altitude: The maximum altitude of the Warthog is 45,000 feet (13,716 m).

Range: 1000 miles (1600 km) before requiring refueling.

**Statistical Data:**

Height: 11 feet (3.3 m).

Width: 60 foot (18.2 m) wingspan.

Length: 64 feet (19.5 m).

Weight: 13 tons empty, 19 tons fully loaded.

Cargo: Minimal storage space for extra clothes, weapons and personal items.

Power System: Conventional twin turbojet engines.

Cost: 38 million credits for a single undamaged and fully armed Thunderbolt.

## Weapon Systems:

**1. GU-A/8 Mk. II Avenger Cannon (1; experimental):** This is the centerpiece of the Thunderbolt. It is 21 feet (6.4 m) long without the ammo drum (32 feet/9.8 m with it). It fires specially, shaped armor piercing Mega-Damage projectiles using a high-yield propellant. It is highly accurate, able to concentrate its firepower inside a two foot (0.6 m) area. The cannon's high rate of fire requires 77 horsepower just to rotate the barrels. The only exposed part of the gun is the armored 2 foot (0.6 m) section under the nose. The rest of it is inside the main body of the aircraft.

Primary Purpose: Assault/Anti-Armor.

Secondary Purpose: Anti-Dragon/Anti-Aircraft.

Mega-Damage: 2D6x10 M.D. to a two foot (0.6 m) area per 100 round burst. Ricochets are common against "hard targets" and do 2D6 M.D. to everything in a 15 foot (4.6 m) radius of the main target.

Rate of Fire: 100 round bursts only.

Effective Range: 5800 feet (1768 m).

Payload: The ammo drum holds 2000 rounds for 20 bursts, but it's usually enough to get the job done. The ammo drum can be hand-loaded inside the aircraft, but that usually takes 2 hours. Normally a belt driven loader, common to all heavy projectile weapon systems, is used (with reloading only taking 10 minutes). Instead of reloading the drum it can be replaced with another one. Requires heavy equipment and/or a robotic P.S. of 25 or more.

**2. Wing Mounted Short-Range Missiles Pylons (6):** Three short-range missile are mounted on each wing. These missiles represent the majority of the aircraft's firepower and are used against conventional targets.

Primary Purpose: Anti-Structures/Anti-Vehicle and Anti-Robot.

Secondary Purpose: Anti-Aircraft/Anti-Infantry and Anti-Dragon.

Mega-Damage: Varies with type of missile.

Missile Type: Any short-range missile can be used, but standard issue is Armor Piercing (2D6x10 M.D. to a 5 foot/1.5 m blast radius) or light High Explosive (2D4x10 M.D.).

Rate of Fire: One at a time or volleys of 2, 4, or 6.

Effective Range: Five miles (8 km).

Payload: Six short-range missiles.

**3. Fuselage Mounted Missile Pylons (3):** These pylons can mount one medium-range missile (3D6x10 M.D. with a 40 mile/64 km range) or three additional short-range missiles (typically the latter). Used for air to air interception missions against other aircraft.

Primary Purpose: Anti-Aircraft/Anti-Dragon.

Secondary Purpose: Self-Defense.

Mega-Damage: Varies with type of missile.

Missile Type: Any medium-range missile or short-range missiles can be used.

Rate of Fire: One or a volley of 2 or 3.

Effective Range: Five miles (8 km) for short-range missiles, 40 miles (64 km) for medium-range missile.

Payload: One medium or three short-range missiles.

**4. Systems of Note:** The Thunderbolt has all the standard features of robot vehicles as listed in the **Rifts® RPG**. In addition to the following special features applicable to characters with the Jet Fighter skill; no bonuses for those untrained in combat aircraft.

Special Bonuses: One additional melee attack/action per melee round against ground-based opponents, +1 on initiative, +2 to dodge when flying at slow speeds or at low altitude, +4 to dodge when flying over 325 mph (520 km).

Special Enhanced Radar: Can identify and simultaneously track up to 96 different targets. Range: 300 miles (480 km). The radar is in the nose and faces forward. Only targets in the forward 60 degree arc of the jet can be targeted. Special ground attack mode identifies and tracks ground targets only.

Laser Designator/Targeting System: Mounted on the right side of the nose, the laser targeting is used with Avenger Cannon shots. The aiming reticle appears on the HUD for cannon shots. Bonuses: +1 to strike with the cannon. Range: 2 miles (3.2 km).

Radar Detectors: Hidden in the wingtips and tail section, these sensors will display, on a receiver screen, the direction and source(s) of radar energy hitting the aircraft. The radar detector system software and sensitivity is so great that it can identify the radar source, direction and type of signal with an accuracy rating of 80%.

## GAW-F16C Improved Falcon

Of all the newly retrofitted model equipment produced by Golden Age, the GAW-F16C Falcon comes closest in overall performance to the competition. Much of the reason for this is that the single-seat multi-role fighter was so capable even before the modifications were made. Still changes were necessary, including more durable armor plating, improved radar and sensors, and a turbofan engine for increased range. The GAW-F16C does have several *limitations* in comparison to its competitors, like the lack of a VTOL system – meaning it needs to operate from a full-sized runway – and it has fewer weapons. To make up for these handicaps the Improved Falcon is marketed at a very low price, at least half the cost of other aircraft.

**Model Type:** GAW-F16C Improved Falcon

**Class:** Multi-role fighter aircraft.

**Crew:** One.

**M.D.C. by Location:**

\* Landing Gear/Tires (3) - 5 each

\* Nose Gun (1) - 10

\* Wing Pylon Mounted Missiles (6) - 2 each

\*\* Wings (2) - 43 each

Reinforced Pilot's Compartment - 30

\*\* Main Body/Fuselage - 100

\* Targets marked by a single asterisk are small and/or difficult to hit and require a Called Shot to strike with a -3 modifier. Destroyed landing gear will result in emergency landing rules. Destroying a pylon-mounted missile or bomb will detonate it and inflict damage to aircraft.



\*\* Destroying one of the wings or depleting the M.D.C. of the main body will knock the bird out of the sky! Roll under piloting skill -40% for a successful crash landing (plane is wrecked, but pilot survives with a few scrapes and bruises).

#### **Speed:**

Driving on the Ground: Not possible, taxi speed is 5 mph (8 km) on paved surfaces, 2 mph (3.2 km) on rough terrain.

Flying: The turbofan engine of the Falcon jet fighter enables the aircraft to reach maximum flying speeds of Mach 2 (approximately 1,320 mph/2,112 km). Cruising speeds vary according to the situation but tend to be sub-sonic, usually between 300 and 500 mph (480 and 800 km). At maximum weight, takeoff distance is approximately 600 feet (183 m).

Maximum Altitude: The maximum altitude for the Falcon is 50,000 feet (15,240 m).

Range: 2000 miles (3200 km) before requiring refueling.

#### **Statistical Data:**

Height: 16 feet, 8 inches (5 m).

Width: 32 feet, 10 inches (10 m) wingspan.

Length: 49 feet, 4 inches (15 m).

Weight: 18 tons empty, 22 tons fully loaded.

Cargo: Minimal storage space for extra clothes, weapons and personal items.

Power System: Conventional turbofan, fuel-base engine.

Cost: 36 million credits for a single undamaged and fully armed GAW Improved Falcon.

#### **Weapon Systems:**

**1. M61 20mm Gatling Cannon:** This is the same pre-Rifts gatling cannon originally installed on the F-14 and F-16 series fighters. The cannon is armed with Mega-Damage, armor piercing ramjet ammunition.

Primary Purpose: Anti-Robot/Anti-Vehicle.

Secondary Purpose: Assault.

Mega-Damage: 2D6+3 for a short 10 round burst, 6D6+6 for a medium 30 round burst.

Rate of Fire: Each burst (short or medium) counts as one of the pilot's melee attacks/actions.

Effective Range: 6000 feet (1829).

Payload: 2400 rounds, equal to 240 short bursts or 80 medium bursts.

**2. Air-to-Ground Missiles (4):** Two medium-range missiles are mounted on each wing. They are used for air to ground attacks, typically to target entrenched fortifications, bunkers, bridges, artillery, communication towers and other fixed positions, but also to take down or soften up giant robots, tanks and monsters, and to punch holes into infantry lines.

Primary Purpose: Anti-Robot and Anti-Vehicle.

Secondary Purpose: Anti-Structures and Anti-Dragon.

Mega-Damage: Varies with missile type.

Missile Type: Can use any short- or medium-range missiles, but High Explosive (Heavy): 3D6x10 M.D. or Plasma: 4D6x10 M.D., do the most damage.

Rate of Fire: One at a time or in volleys of up to nine.

Effective Range: 40 miles (64 km).

Payload: Four medium-range missiles.

**3. Wing Mounted Mini-Missiles (16):** Eight mini-missiles are mounted on each of the wings. They are used for air to air interception missions against other aircraft and missile volleys.

Primary Purpose: Anti-Aircraft and Other Flyers.

Secondary Purpose: Defense and Assault.

Mega-Damage: Varies with type of missile.

Missile Type: Any mini-missile can be used, but standard issues are Armor Piercing and Fragmentation.

Rate of Fire: Volleys of 2, 4 or 6; each volley counting as one melee attack.

Effective Range: One mile (1.6 km).

Payload: 16; eight per wing.

**4. Systems of Note:** The Falcon has all the features common to robot vehicles as listed in the **Rifts® RPG**. These include standard radio communications, ejector seats, a fully environmental cockpit and a laser targeting system. Additionally, the plane has the following:

Enhanced Radar: Can identify and simultaneously track up to 96 targets. Range: 250 miles (400 km).

Pilot and Sensor Systems: H.U.D. helmet, optics include thermal imager (6000 feet/1828 m), passive nightvision (4000 foot/1219 m range), laser targeting system (+2 to strike with M61 20mm Gatling Cannon), and special fly-by-wire flight controls. These features significantly improve the reaction time of the pilot for firing weapons (missiles & cannon), providing a bonus of +1 on initiative, +1 to strike, and +8% skill bonus for pilots with the *Jet Fighter* skill.

## **GAW-130 Improved Hercules Airplane**

A retrofitted C-130 Lockheed Hercules, which is arguably the finest military transport plane ever made. Golden Age Weaponsmiths has retrofitted and sold hundreds of these vehicles to a variety of users, including merchants, independent kingdoms, shipping companies, mercenary groups and major corporations like Wellington Industries and Wilk's. The transport can carry 92 fully equipped troops, 64 paratroopers, or cargo loads of up to 21 tons!

**Model Type:** GAW-130 Improved Hercules

**Class:** Heavy lift transport aircraft.

**Crew:** Three, plus up to 92 fully equipped soldiers or 64 paratroopers.

**M.D.C. by Location:**

\* Landing Gear/Tires (3) – 15 each

\* Engines (4) - 45 each

\*\* Wings (2) - 80 each

\*\* Main Body/Fuselage - 180

Reinforced Pilot's Compartment - 60

\* Items marked by a single asterisk are small and/or difficult to hit, requiring an attacker to make a Called Shot to hit with a penalty of -2 strike.

Destroyed landing gear will result in emergency landing rules.

The loss of a single engine will reduce maximum air speed by 25% and impose a -15% penalty to all piloting rolls (penalties are accumulative with each engine lost). Losing all four engines will cause the plane to crash.

\*\* Destroying one of the wings or depleting the M.D.C. of the main body will knock the aircraft out of the sky! Roll under piloting skill -50% for a successful crash landing.

#### **Speed:**

Driving on the Ground: Not possible, taxi speed is 2 mph (3.2 km) on paved surfaces.

Flying: The powerful engines of the GAW's Hercules enable the plane to reach maximum flying speeds of 374 mph (598 km), even with a maximum load. Cruising speeds vary according to the situation but tend to be slow, usually between 110 and 240 mph (176 and 384 km). At maximum weight, takeoff distance is approximately 900 feet (274 m).

Maximum Altitude: The maximum altitude for the Hercules is 33,000 feet (10,058 m).

Range: 3000 miles (4800 km), due to its newly designed engines.

#### **Statistical Data:**

Height: 38 feet, 1 inch (11.6 m).

Width: 132 feet, 7 inches (40.4 m) wingspan.

Length: 97 feet, 9 inches (29.7 m).

Weight: 78 tons.

Cargo: Internal cargo stowage of up to 21 tons or 92 troops.

Power System: Conventional jet engines.

Cost: 12 million credits for a single undamaged Hercules.

Weapon Systems: None, exclusively transport.

## **GAW-60 Improved Black Hawk Assault Helicopter**

The Black Hawk is an all-purpose utility helicopter that is used to move combat troops and military supplies, for airmobile assaults and to transport casualties to medical facilities.

**Model Type:** GAW-60 Improved Black Hawk

**Class:** All-purpose utility helicopter.

**Crew:** Two; pilot and gunner, plus up to 12 passengers.

#### **M.D.C. by Location:**

\* Landing Gear – 12

\* Main Rotors (4) - 10 each

\* Tail Rotor Section - 20

\* 7.62 mm Machine-Gun - 5

Reinforced Pilot's Compartment - 30

\*\* Main Body/Fuselage - 85

\* Items marked by a single asterisk are small and/or difficult to hit, requiring an attacker to make a Called Shot to hit with a penalty of -3 strike (-5 to strike if the chopper is going 100 mph/160 km or faster).

Destroyed landing gear will result in emergency landing rules.

The loss of a single main rotor blade will reduce maximum air speed by 10% and impose a -25% penalty to all piloting rolls

(penalties are accumulative with each blade lost). Losing three or all of the rotor blades will cause the helicopter to crash. Roll under piloting skill -40% for a successful crash landing.

#### **Speed:**

Driving on the ground: Not possible.

Flying: 175 mph (280 km), being a helicopter it is capable of hovering and VTOL (Vertical Take-Off & Landing) operations as well as low altitude attacks and maneuvering through city streets and around buildings.

Maximum Altitude: The maximum altitude for the helicopter is 19,150 feet (5837 m).

Range: 1500 miles (2400 km), due to its electric engine.

#### **Statistical Data:**

Height: 16 feet, 10 inches (5.13 m).

Width: 53 feet, 8 inches (16.3 m) rotor blades.

Length: 50 feet, 1 inch (15.26 m).

Weight: 6 tons.

Cargo: Can carry 6,000 lbs (2700 kg) suspended from the helicopter, in addition to passengers.

Power System: Electric engine.

Cost: 850,000 credits.

#### **Weapon Systems:**

**1. Modified M-23 7.62 mm Machine-Gun:** The machine-gun is mounted in the nose of the Black Hawk as a "chin gun," allowing it a 270 degree arc of fire.

Primary Purpose: Anti-Infantry/Soft Targets.

Secondary Purpose: Self-Defense.

Mega-Damage: 1D4 M.D. per 10 round burst, 2D4 M.D. per 20 round burst, or 4D4 M.D. for a 40 round burst.

Rate of Fire: Each burst counts as one melee attack.

Effective Range: 3000 feet (914 m).

Payload: 4000 rounds, for 400 short bursts, 200 medium bursts or 100 long bursts (4D4 M.D.).

**Note:** May be substituted with an M.D. rail gun or energy weapon but at considerably more cost (60,000-120,000 credits).

**2. Systems of Note:** The Black Hawk has all the standard features common to most robot vehicles, plus a radio with a range of 500 miles (800 km), optics systems include passive nightvision (3000 feet/914 m), thermal imager (1400 feet/426.7 m), laser designator (+1 to strike but targeting uses up one of the gunner's melee attacks) and enhanced radar: tracks 72 targets, with 100 mile (160 km) range.

## **GAW-64 Improved Apache Helicopter**

A retrofitted version of the old US Army attack helicopter, the AH-64 Apache combat assault helicopter was upgraded using modern M.D.C. materials. A very capable aircraft that excels at missions of close air support and tank-busting.

**Model Type:** GAW-64 Improved Apache

**Class:** Ground attack helicopter.

**Crew:** Two; one pilot and one gunner.

### M.D.C. by Location:

- \* Main Rotors (4 blades) – 15 each
- \* Tail Rotor Section - 20
- \* G-109 Enhanced Rail Gun (1) - 12
- \* Short-Range Missile Rails (2) - 3 each
- \* Mini-Missile Pods (2) - 15 each
- Reinforced Pilot's Compartment - 30
- \*\* Main Body/Fuselage - 112

\* Items marked with a single asterisk are small, moving and/or difficult targets to hit and require a Called Shot to strike, but even then the attacker is -4 to strike (-6 if the helicopter is flying faster than 100 mph/160 km).

Destroying one of the missile pods or an attached missile will detonate the ordnance and inflict damage to the helicopter.

The loss of a single main rotor blade will reduce maximum air speed 25% and impose a -25% to all piloting skill rolls (penalties are accumulative with each main rotor lost). Losing three or four main rotors or losing the tail rotors completely will cause the helicopter to crash.

\*\* Depleting the M.D.C. of the main body will knock the helicopter out of the sky! Roll under piloting skill -50% for a successful crash landing by auto-rotating.

### Speed:

Driving on the Ground: Not possible.

Flying: 184 mph (294.5 km), being a helicopter the GAW-64 is capable of hovering and VTOL (Vertical Take-Off & Landing) operations as well as low altitude attacks and maneuvering through city streets and around buildings.

Maximum Altitude: The maximum altitude for the Apache is 20,000 feet (6096 m).

Range: 1200 miles (1920 km) before requiring refueling.

### Statistical Data:

Height: 16 feet, 3 inches (4.95 m).

Width: 48 feet (14.6 m) rotor blades.

Length: 50 feet, 9 inches (15.47 m).

Weight: 8 tons.

Cargo: None.

Power System: Conventional combustion engine.

Cost: 1.4 million credits.

### Weapon Systems:

**1. G-109 Rail Gun:** A modern rail gun was installed in the nose of the GAW-64 Apache, instead of its old mini-gun. The G-109 enhanced rail gun is mounted in the nose, as a "chin gun," allowing it a 270 degree arc of fire.

Primary Purpose: Anti-Robot, Vehicle and Personnel.

Secondary Purpose: Anti-Aircraft and Anti-Dragon.

Mega-Damage: Rail Gun: 1D4x10 M.D. per 20 round burst. If the old style Mini-Gun is kept, it does 2D6+3 M.D. per 10 round burst or 4D6+4 M.D. per 20 round burst.

Rate of Fire: Each burst counts as one of the pilot's melee attacks.

Effective Range: 4000 feet (1219 m).

Payload: 4000 rounds for 200 bursts.

**2. Short-Range Missile Rails (2):** Originally used to carry the

Hellfire anti-tank missiles, the rails have been adapted to carry standard short-range missiles, for use against heavily armored targets, like robot vehicles and main battle tanks.

Primary Purpose: Anti-Structures, Robots and Vehicles.

Secondary Purpose: Anti-Aircraft.

Mega-Damage: Varies with type of missile.

Missile Type: Any short-range missile can be used.

Rate of Fire: Volleys of 1, 2, or 4.

Effective Range: Five miles (8 km).

Payload: Four total. Each rail can mount two short-range missiles.

**3. Mini-Missile Pods (2):** A mini-missile pod is located on both sides of the AH-64 Apache.

Primary Purpose: Anti-Infantry and Soft Targets.

Secondary Purpose: Assault and Defense.

Mega-Damage: Varies with mini-missiles type.

Missile Type: Any mini-missiles can be used, but standard issue is High Explosive (5D6 M.D.) or Armor-Piercing (1D4x10 M.D.). Fragmentation (5D6 M.D. to a 20 foot/6.1 m radius) will be used for anti-personnel operations.

Rate of Fire: One at a time or volleys of 2, 4, or 6.

Effective Range: One mile (1.6 km).

Payload: 36; 18 missiles per launcher.

**4. Systems of Note:** The Apache has all the standard features of robot vehicles as listed in the **Rifts® RPG**, plus a radio with range of 500 miles (800 km), optics systems include passive nightvision (3000 foot/914 m range), laser designator (+1 to strike) and enhanced radar: tracks 48 targets within a 120 mile (192 km) range.

## GAW-1W Improved Super-Cobra Gunship

Older than the AH-64 Apache, but still very effective the Super Cobra is a popular attack chopper. The engines of the Super Cobras have been replaced with high-output electric engines to increase their loiter times and increase their flight ranges. The vehicle is smaller and faster than the Apache, but it doesn't pack the same payload of weapons. It makes an excellent light assault helicopter, scout and reconnaissance vehicle. At the same time it is capable of performing missions of close air support and tank-busting. Super-Cobras are often used as escort aircraft for air ambulances and downed pilot rescue missions.

**Model Type:** GAW-1W Improved Super Cobra

**Class:** Ground attack helicopter.

**Crew:** Two; one pilot and one gunner.

### M.D.C. by Location:

- \* Main Rotors (4) - 12 each
- \* Tail Rotor Section - 18
- \* XM-134 7.62 mm Mini-Gun - 6
- \* XM-3 2.7 inch Rocket Launchers (2) - 8 each
- \* Short-Range Missile Rails (2) - 4 each
- Reinforced Pilot's Compartment - 30
- \*\* Main Body/Fuselage - 90

\* Items marked with a single asterisk are small, moving and/or difficult targets to hit and require a Called Shot to strike, and even then the attacker is -4 to strike (-6 if the helicopter is flying faster than 100 mph/160 km).

Destroying one of the attached missiles will detonate the ordnance and inflict damage to the helicopter.

The loss of a single main rotor blade will reduce maximum air speed 25% and impose a -25% to all piloting skill rolls (penalties are accumulative with each blade lost). Losing three or all blades or losing the tail rotor completely will cause the helicopter to crash.

\*\* Depleting the M.D.C. of the main body will knock the helicopter out of the sky! Roll under piloting skill -50% for a successful crash landing by auto-rotating.

#### **Speed:**

Driving on the Ground: Not possible.

Flying: 196 mph (314 km), being a helicopter it is capable of hovering and VTOL (Vertical Take-Off & Landing) operations as well as low altitude attacks and maneuvering through city streets and around buildings.

Maximum Altitude: The maximum altitude for the helicopter is 14,750 feet (4496 m).

Range: 2000 miles (3200 km), due to its electric engine.

#### **Statistical Data:**

Height: 14 feet, 2 inches (4.31 m).

Width: 48 feet (14.63m) rotor blades.

Length: 58 feet (17.68 m).

Weight: 7 tons.

Cargo: None.

Power System: Electric high-output engine.

Cost: 1.2 million credits.

#### **Weapon Systems:**

**1. XM-134 7.62 mm Mini-Gun:** This six-barreled, 7.62 mm gatling gun is driven by an independent electric motor that rotates the gun barrels as they fire, allowing it to achieve incredibly high rates of fire without overheating. The mini-gun is mounted in the nose of the Super Cobra as a "chin gun," allowing it a 270 degree arc of fire.

Primary Purpose: Anti-Robot/Anti-Vehicle.

Secondary Purpose: Anti-Infantry/Soft Targets.

Mega-Damage: 2D6+3 M.D. per 10 round burst or 4D6+4 M.D. per 20 round burst.

Rate of Fire: Each burst, short or medium, counts as one of the gunner's attacks per melee round.

Effective Range: 4000 feet (1219 m).

Payload: 2400 rounds for 240 short bursts or 120 medium bursts.

**2. Modified XM-3 2.7 inch Rocket Launchers (2):** These rocket launchers are honeycombed tubes mounted under the stubby wings of the Super Cobra. The ancient XM-3 2.7 inch rockets have been refitted with a modern fragmentation warhead by the technicians at Golden Age Weaponsmiths, for anti-infantry missions in a Mega-Damage environment.

Primary Purpose: Anti-Infantry/Anti-Power Armor.

Secondary Purpose: Area Saturation.

Mega-Damage: 5D6 M.D. per rocket, to a 20 foot (6.1 m) blast radius.

Rate of Fire: One at a time, or in volleys of 2, 4 or 6 rockets.

Effective Range: 5000 feet (1524 m).

Payload: 48 total, 24 unguided rockets per launcher.

**3. Short-Range Missile Rails (2):** Original used to carry anti-tank missiles, the rails have been adapted to carry two standard short-ranged missiles for use against heavily armored targets, like robot vehicles and main battle tanks.

Primary Purpose: Anti-Structures and Anti-Armored Vehicle.

Secondary Purpose: Anti-Aircraft.

Mega-Damage: Varies with type of missile.

Missile Type: Any short-range missile can be used, but standard issue is armor piercing (2D6x10 M.D.) or high explosive (2D4x10 M.D.).

Rate of Fire: Volleys of 1, 2, 3, or 4.

Effective Range: Five miles (8 km).

Payload: Four total, two per each rail.

**4. Systems of Note:** The Super Cobra has all the standard features of robot vehicles as listed in the **Rifts® RPG**, plus a radio with a range of 500 miles (800 km), optics systems include passive nightvision (3000 foot/914 m range), laser designator (+2 to strike rolls) and enhanced radar: tracks 72 targets within a 120 mile (192 km) range.

## **GAW-58D Improved Kiowa Warrior Helicopter**

In the American military the Kiowa Warrior was employed as a scout helicopter working in conjunction with the AH-64 Apache. It is a small target, difficult to detect, and agile, allowing the helicopter to scout for enemy positions and then feed the targeting data to nearby combat choppers, which can attack from a distance without risking damage to the Apache. The bird remains popular on Rifts Earth with mercenary companies and armed forces as a workhorse reconnaissance and transport helicopter with light combat capabilities. Due to the fact that it can transport up to 6 passengers it is also used to insert and extract special forces squads into enemy territory.

**Model Type:** GAW-58D Improved Kiowa Warrior

**Class:** Scout helicopter.

**Crew:** Two, pilot and communications officer, plus up to 6 passengers.

#### **M.D.C. by Location:**

\* Main Rotors (4) - 8 each

\* Tail Rotor Section - 12

\* .50 cal Machine-Gun - 5

Reinforced Pilot's Compartment - 15

\*\* Main Body/Fuselage - 75

\* Items marked with a single asterisk are small, moving and/or difficult targets to hit and require a Called Shot to strike, but even then the attacker is -4 to strike (-7 if the helicopter is flying faster than 100 mph/160 km).

The loss of a single main rotor blade will reduce maximum air speed 25% and impose a -25% to all piloting skill rolls (pen-

alties are accumulative with each blade lost). Losing three or all main rotors, or losing the tail rotors completely, will cause the helicopter to crash.

\*\* Depleting the M.D.C. of the main body will knock the helicopter out of the sky! Roll under piloting skill -40% for a successful crash landing by auto-rotating.

**Speed:**

Driving on the Ground: Not possible.

Flying: 147 mph (235 km), being a helicopter it is capable of hovering and VTOL (Vertical Take-Off & Landing) operations as well as low altitude attacks and maneuvering through city streets and around buildings.

Maximum Altitude: The maximum altitude for the helicopter is 15,000 feet (4572 m).

Range: 1400 miles (2240 km), due to its electric engine.

**Statistical Data:**

Height: 12 feet, 11 inches (3.94 m).

Width: (rotors) 35 feet (10.67 m).

Length: 42 feet, 2 inches (12.85 m).

Weight: 3 tons.

Cargo: Minimal, can carry about 100 pounds (45 kg) in gear, in addition to pilot and passengers.

Power System: Electric engine.

Cost: 725,000 credits.

**Weapon Systems:**

**1. .50 Caliber Machine-Gun:** This machine-gun is mounted under the nose of the Kiowa in a fixed forward position, forcing the Kiowa to turn in order to engage new targets.

Primary Purpose: Defense and Assault.

Secondary Purpose: Anti-Infantry and Soft Targets.

Mega-Damage: 1D6 M.D. per 10 round burst or 2D6 M.D. for a 20 round burst. The weapon *may* substitute Wellington Industries M.D. ramjet ammunition for greater damage, but also at much greater expense.

Rate of Fire: Each burst counts as one of the pilot's melee attacks.

Effective Range: 6000 feet (1828 m).

Payload: 1000 rounds for 100 ten round bursts (1D6 M.D.) or 50 twenty round bursts (2D6 M.D.).

**2. Tube Mini-Missile Launcher (1):** Mini-missiles can be fired from the side of the helicopter.

Primary Purpose: Anti-Infantry and Anti-Power Armor.

Secondary Purpose: Assault and Defense.

Mega-Damage: Varies with missile type.

Missile Type: Can fire any type of mini-missile, but typically has fragmentation (5D6 M.D.) or high explosive (5D6 M.D.).

Rate of Fire: One at a time, or in volleys 2, 4 or 6.

Effective Range: One mile (1.6 m).

Payload: 12 total mini-missiles in the launch tube.

**3. Systems of Note:** The Kiowa has all the standard features of robot vehicles as listed in the **Rifts® RPG**, plus a radio with a range of 500 miles (800 km), optics systems include passive nightvision (6000 foot/1828 m range), laser designator (+1 to strike) and radar: tracks 96 targets within a 100 mile (160 km) range.

## GAW-47 Improved Chinook

Larger than the Black Hawk, the GAW-47 Chinook is a heavy transport chopper used to move troops, supplies and casualties. It can also be used to drop paratroops or power armor troops, as well as transport supplies and light vehicles like the G998 Hummer, Fast Attack Vehicle, hovercycles and similar cargo. The Chinook has two contra-rotating and intermeshing, three-bladed rotors which operate in tandem to keep the helicopter flying and moving at high speeds. The Chinook only has a basic radio (500 miles/800 km range).

**Model Type:** GAW-47 Improved Chinook

**Class:** Heavy lift, transport helicopter.

**Crew:** Three, plus 56 fully equipped passengers or 42 paratroopers or 32 power armor troops.

**M.D.C. by Location:**

\* Landing Gear – 10

\* Rotor Blades (6; 3 front and 3 rear) - 12 each

Reinforced Pilot's Compartment - 30

\*\* Main Body/Fuselage - 125

\* Items marked with a single asterisk are small, moving and/or difficult targets to hit and require a Called Shot to strike, but even then the attacker is -3 to strike (-5 if the helicopter is flying faster than 100 mph/160 km).

The loss of a single main rotor blade will reduce maximum air speed 25% and impose a -25% to all piloting skill rolls (penalties are accumulative with each main rotor blade lost). Losing three of the main rotor blade will cause the helicopter to crash.

\*\* Depleting the M.D.C. of the main body will knock the helicopter out of the sky! Roll under piloting skill -40% for a successful crash landing by auto-rotating.

**Speed:**

Driving on the Ground: Not possible.

Flying: 167 mph (267 km), being a helicopter it is capable of hovering and VTOL (Vertical Take-Off & Landing) operations as well as low altitude flying.

Maximum Altitude: The maximum altitude for the Chinook is just 8,450 feet (2575 m).

Range: 1300 miles (2080 km) before requiring refueling.

**Statistical Data:**

Height: 16 feet, 10 inches (5.13 m).

Width: (rotors) 60 feet (18.29 m).

Length: 52 feet (15.8 m).

Weight: 25 tons.

Cargo: Can carry 12,000 lbs (5400 kg) suspended from the helicopter, in addition to passengers.

Power System: Conventional combustion engine.

Cost: 1.3 million credits.

**Weapon Systems:** None.

# Techno-Wizard Devices

## Armstrong TW Armaments Co.

### A Techno-Wizard Armaments Manufacturer

By Carmen Bellaire & Kevin Siembieda

In North America there are several dozen, small, Techno-Wizard manufacturers located in the various magic practicing communities, such as *Lazlo*, *New Lazlo*, *Kingsdale* and the *Magic Zone*. Most of these companies are small-time outfits compared to the arms-making giants like Northern Gun, Wellington Industries and Wilk's, and employ a minimal staff with 10-100 technicians, Operators and Techno-Wizards. One reason for this is that not everyone can use Techno-Wizard weapons and equipment; only characters with significant amounts of P.P.E. (10 or more P.P.E. or double that in I.S.P.) can use TW items. As a result, they are really only viable for practitioners of magic, psychics, D-Bees and supernatural beings who possess large reservoirs of P.P.E. (or I.S.P.). Despite this limited market, most successful Techno-Wizard manufacturers can pull down 10-40 million credits per year.

Based in *New Lazlo* (built on the site of what was once Ann Arbor, Michigan, about 45 miles/72 km west of the demon haunted ruins of Old Detroit), **Armstrong TW Armaments Company** is a relative newcomer to the Techno-Wizard small arms manufacturing business who is shaking up the industry. The manufacturer has already earned a good reputation for producing durable, high quality and stylish Techno-Wizard weapons at competitive prices – competitive even with the largest Techno-Wizard manufacturers like *Stormspire* and the now defunct *Kingdom of Tolkeen*. If the quality and level of production can be maintained as the company grows, Armstrong TW Armaments could become one of the top leaders in the Techno-Wizard weapons industry within a year or two. (A fact that has not gone unnoticed by the Coalition States.) Armstrong TW Armaments is already the second largest manufacturer of Techno-Wizard devices in *New Lazlo*, and number one when it comes to weaponry. The company has an extensive distribution network that extends north to *Lazlo*, *Old Bones* and other communities in Ontario, to scattered kingdoms and tribes in the east, and to *Kingsdale*, *MercTown*, Tolkeen resistance fighters, mercs and adventurers in the west.

One of Armstrong TW Armaments' advantages over the competition, and a big selling point, is the company's willingness and ability to make *custom weapons* and *specialty items* at reasonable costs. Most other Techno-Wizard weapon-makers produce mass market items that all look identical, just like traditional weapon manufacturers. However, Armstrong TW Armaments has recognized a sizeable niche market that seeks unique designs for distinctive looking weapons and items tailored to the needs of the buyer. TW weaponry customized, tweaked and modified to a specific group's particular needs and desires has attracted a large number of mercenary squads and companies, as

well as bands of adventurers and small businesses, who want a particular "look" or "style" that will distinguish their group from other mercenary outfits. Likewise, small squad to company-sized outfits are often looking for weapons and gear that step out of the box and address the specific needs of their operations, personal tastes or unique image or trademark. For example, the **Hellfire Company** (predominantly composed of Bursters, Mystics, Psi-Stalkers and other psychics) dress in red body armor, have a flaming, demon-horned, laughing skull as their emblem, and desire weapons that, a) are red in color, b) have a demonic appearance, and c) shoot plasma and fire bolts as opposed to other types of energy blasts. The Armstrong TW Armaments Company was glad to accommodate them, and the Hellfire Company was equally pleased to pay a 20% premium on fire and heat based weaponry made in red and designed to their personal tastes and company image. Armstrong TW Armaments' willingness to cater to the individual and small groups has made them hugely popular among bands of adventurers and mercenary groups looking for something other than "cookie-cutter" TW weaponry and designs.

The Armstrong TW Armaments Company is a family business. The founder and company's executive officer is *Martha "Martie" Armstrong*, a former weapons designer from the TW manufacturing capital of North America, *Stormspire*, located in the Magic Zone. Other family members who work for the company include her brother Edward, sister Lilly, three cousins, a nephew, two nieces and four of Martie's own children. The entire family left Stormspire in 104 P.A., moving to New Lazlo, and started a new life with their own approach to custom Techno-Wizard weaponry. It was Martie who encouraged leaving the Magic Zone over growing disillusionment with life in Stormspire. She disliked the unimaginative and ruthless business model of its leadership as well as the instability within the Magic Zone (high crime rates, general lawlessness, the dark influence of the Federation of Magic, etc.). The final straw came when a demon, intent on slaughtering a family of defenseless D-Bees, killed Martie's husband. The Armstrongs packed their belongings and moved without ever looking back.

In New Lazlo the Armstrongs' custom Techno-Wizard weaponsmith business has boomed, in part, due to their willingness to customize, and in part, due to their inventiveness, which has given birth to several magical weapon designs that have become instant smash hits. Based on the sales of those models, the company has expanded and is trying to compete with the "big boys." Armstrong TW Armaments is a minor player in the arms industry when compared to giant corporations like Northern Gun, Manistique Imperium and Wilk's, but is steadily gaining a

reputation for high quality Techno-Wizard weapons and equipment. As sales increase, so does the company's profile. One day, Martie Armstrong hopes to expand her operation enough to challenge Stormspire's virtual monopoly on the Techno-Wizard arms trade in eastern and central North America. It is a dream that may happen sooner, rather than later.

The technicians and Techno-Wizards at the Armstrong factory are capable of modifying most high-tech weapons and vehicles with any of the traditional features listed under the *Techno-Wizard O.C.C.* described in the *Rifts® RPG*. Physical designs can be given a hard, technological appearance or something wildly fanciful or alien. Custom orders normally require 3D4 days to complete, and cost the list price plus a 10% to 20% premium to cover the increased amount of labor, artistic craftsmanship and customized magic required for the speciality weapon. (Most other TW companies charge 50% to double, if they are willing to take a custom job at all, and usually require 2D4 weeks to get it done.) When the company is working on a major order, custom work may take longer to complete, as much as 3D6+6 days, but is well worth the wait.



## Bug Zapper TW Rifle

A Techno-Wizard rifle that fires bluish-purple lightning arcs reminiscent of those seen erupting from Ley Line Storms. It's an odd-looking weapon that more resembles a submachine-gun with a barrel made from a short fluorescent light tube wrapped in coils of copper wire, with a simple handle. The Bug Zapper is

not a great infantry assault rifle because it has a short range and small payload. However, it is ideal in close quarters, tunnels, sewers, city streets, buildings, and the hive tunnels of the Xiticix. In fact, the Bug Zapper was designed with Xiticix combat in mind, and the rifle inflicts *double damage* to the Xiticix and an extra 2D6 M.D. to most other M.D.C. insectoid aliens. This property of the rifle has obvious appeal for people living, adventuring or involved in military operations in the expanding Xiticix territories of Canada and the Middle American north. Lazlo has placed orders for a few thousand of these rifles to be used in their planned campaign against the hives of Manitoba, Minnesota and the Dakotas.

Weight: 6 pounds (2.7 kg).

Mega-Damage: 5D6 M.D. per shot, double damage (5D6x2 or 10D6 or 1D6x10) to Xiticix – or 7D6 to all other Mega-Damage insects and insect-like aliens.

Stun Effect: Xiticix and other insects must also roll a 14 or higher to save vs electrical stun attack. A failed roll means the creature is stunned for 2D4 melee actions (8-30 seconds). Being stunned reduces the insectoid's attacks per melee round to two, initiative is lost (the bug is the last to attack), skill performance is -70%, and all combat actions are -6 while stunned. Supernatural beings who are immune to electricity will take only 1D6 M.D. and are immune to being stunned, but those vulnerable to electricity suffer double damage, though they have no fear of being stunned.

Note: The Bug Zapper also affects characters inside body armor, exoskeletons and most types of light power armor with under 100 M.D.C. – suffering 1D6 S.D.C./Hit Point damage to their own body per blast. Vehicles and robots with a reinforced pilot's compartment, as well as heavy power armor, heavy body armor, and medium to heavy cyborg armor, will protect the wearer or pilot and crew completely; damage is done only to the vehicle/robot, not the people inside.

Rate of Fire: Each blast counts as one melee action/attack.

Effective Range: 600 feet (183 m).

Payload: 10 shots. Requires 25 P.P.E. or 50 I.S.P. to fully charge the rifle (3 P.P.E. or 6 I.S.P. to recharge a single blast).

Cost: 55,000 credits.

## Thunderbolt TW Shotgun

Big, rugged and intimidating, the Thunderbolt is a pump-action combat shotgun. It is devastating in close combat operations and is designed for urban assault, riot control, street-fighting and police SWAT style missions. The weapon fires ball lightning roughly the size of a basketball, similar to those from the Air Warlock spell. When the ball lightning strikes a target it also produces a loud boom, a magical Thunder Clap with a Horror Factor of 10. The boom is startling and provides the shooter with a +2 bonus on initiative for his next attack against those lost to fear or panic. A booming barrage of lightning and thunder is likely (01-70% chance) to frighten superstitious people, primitive warriors, and civilians (as well as most animals and green recruits), causing them to flee and/or take shelter. However, the barrage will have no negative impact on trained military personal or seasoned adventurers (3rd level or higher) after the initial volley (even vets may be startled by the first shot or two).



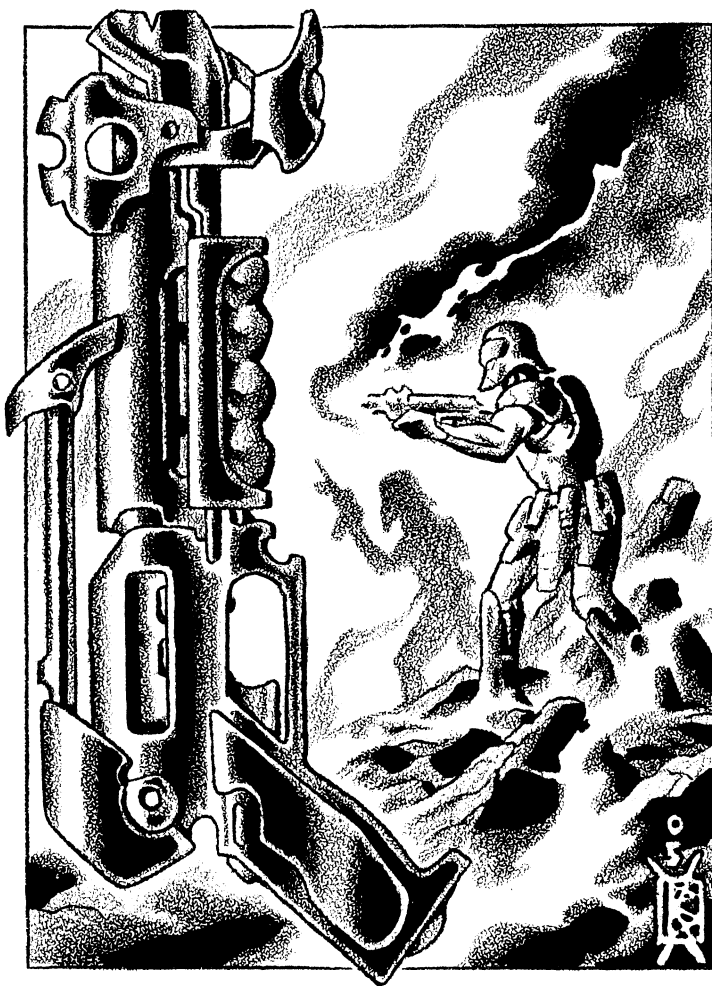

Thunderbolt shotguns are one of Armstrong's most popular weapon designs with sales numbering in the thousands. The Thunderbolt is New Lazlo's standard issue weapon for police tactical units, as well as for their militia.

Weight: 5 lbs (2.25 kg).

Mega-Damage: 4D6+2 M.D. per single shot, plus Horror Factor of 10, and 01-70% likelihood of panicking/scaring untrained combatants.

Rate of Fire: Each blast counts as one melee attack.

Effective Range: 400 feet (122 m).

Payload: Eight. 24 P.P.E. or 48 I.S.P. is required to fully recharge the weapon (or 3 P.P.E./6 I.S.P. for a single blast).

Cost: 50,000 credits.

## Armstrong "Bolter" TW Sniper Rifle

The Bolter or "Bolt Gun" is a high quality Techno-Wizard rifle designed for accurate long-range shooting. Its light weight and zero kick makes it easy to use and accurate to fire. The weapon is also quiet, emitting a soft "zeewump" sound that can't be heard more than 1000 feet (305 m) away. Designed as both a military grade sniper and big game hunting rifle, this weapon fires a magic Power Bolt. Unlike the Power Bolt spell - which never misses - the shooter of the Bolter rifle must take time and care to *aim* at his target. However, the rifle is so well crafted and lightweight that even a moderately skilled shooter or talented amateur can center-punch a basketball-size target at a

range of up to five hundred yards/meters! Thus it is no surprise that the Bolter was an instant hit among Psi-Stalkers, Druids, Native American Indians and other wilderness people who possess at least modest psychic or mystical energy (i.e., have I.S.P. or P.P.E.), as well as mercenaries, master assassins, bounty hunters and snipers who have connections with psychics or practitioners of magic (or have P.P.E./I.S.P. themselves) to recharge the weapon for them before going into the field. Magic-wielding special forces units throughout North America are taking a hard look at this exquisite weapon.

Weight: 5 lbs (2.25 kg).

Mega-Damage: 3D6+2 M.D. per single shot; designed for accuracy, not heavy firepower.

Rate of Fire: Each shot counts as one melee attack/action.

Effective Range: 2200 feet (670.6 m).

Payload: Two shots. To recharge a single Power Bolt requires 10 P.P.E. or 20 I.S.P. Remember, this weapon is designed for long-range precision shooting, it is not an assault rifle.

Bonus: +3 to strike on an aimed shot, in addition to any W.P. bonuses the character might possess! Moreover, when using this rifle, the shooter does not suffer from range penalties of any sort.

Cost: 120,000 credits. These rifles are exceedingly hard to come by, and, at present, supplies are limited, with most models being sold either at MercTown or directly to the defenders of New Lazlo.



**Note:** *Stormspire* offers a knock-off version of the Bolter they call the “Sure-Shot Sniper Rifle.” It has twice the payload (4 blasts) at half the price, but it also has half the range (1100 feet/335 m), does 2D8 M.D. and is only +1 to strike; fair availability.



## D-Pocket Pistol (TW Derringer)

The ultimate “concealed weapon” and a revolutionary breakthrough in Techno-Wizard technology, the tiny, derringer-style D-Pocket Laser Pistol was an instant hit among Psi-Stalkers and psychic and magic wielding assassins, bounty hunters, card-sharps, spies, thieves and criminal types. By expending 15 P.P.E. or 30 I.S.P., the handgun can actually be transported to a *Pocket Dimension*, but can be summoned by its owner, at will, appearing in his hand or a pocket in his clothing. Characters without sufficient P.P.E. themselves can pay a practitioner of magic (typically for 500-1500 credits) to spend the necessary mystic energy to make the weapon disappear into the *Pocket Dimension* for them, but in this case, the weapon will appear in a *predesignated pocket* in their clothing when it is summoned. When the pistol is in the *Dimensional Pocket* it is absolutely *impossible to detect* by physical search or any conventional or mechanical means of detection, because it does not exist in our dimension! Only a character who can see or sense dimensional anomalies (i.e., Shifters, Temporal Raiders and similar O.C.C.s that specialize in dimensional magic and energies) can see a dimensional disturbance on the person of the individual, signaling that he or she is connected to a tiny *Dimensional Pocket*.

**Weight:** Half a pound (0.23 kg).

**Mega-Damage:** 1D6 M.D. per single shot.

**Rate of Fire:** Each blast counts as one melee attack/action.

**Effective Range:** 100 feet (30.5 m).

**Payload:** 2 shots, uses a special Wellington Industries “mini-battery” from the WI-LP3 Pepperbox Laser (described in **Rifts®: Juicer Uprising™** page 72, and also found on page 172 of the **Rifts® G.M. Guide**, packed with weapons, armor and vehicles from the first 23 World Books).

**Cost:** 50,000 credits; each battery costs 100 credits, but takes two melee rounds (30 seconds) to remove the battery and replace it with a fresh one.

**Note:** So far, only the tiny laser derringer can be teleported into a *Pocket Dimension* via this secret TW design. Armstrong Armaments are looking into applying the technique to large and other types of weapons, but so far, without success (it may be impossible).

## Para-Stunner Pistol

The Para-Stunner is not in actuality a magical weapon, this pistol is really little more than a powerful air gun that fires magic darts. These darts are made of a crystal compound that dissolves immediately upon making contact with organic matter, releasing a magical effect that paralyzes its victim. Humans and other (S.D.C.) mortals struck by the darts must save vs magic (13 or higher) or find their limbs to suddenly becoming heavy and numb. The Para-Stunner is a popular self-defense weapon in New Lazlo and Kingsdale, where it is issued to security guards, police and similar law enforcement groups.

**Weight:** 2 lbs (0.9 kg).

**S.D.C. Damage:** 1D6 S.D.C. from the impact of the dart, plus penalties from paralysis effect listed below.

**Penalties & Effects:** -6 on initiative, no combat bonuses (unmodified die rolls only), skill performance requiring hands or feet -70%, and reduce Spd and attacks per melee by half for a duration of 1D4+1 minutes. **Note:** Three or more shots by the Para-Stunner in which the victim fails to save, will reduce the number of attacks to one, inflict a -6 penalty on all combat moves and reduce Spd to a crawl.

**Rate of Fire:** Each blast counts as one melee attack/action.

**Effective Range:** 120 feet (36.6 m).

**Payload:** Five.

**Cost:** 3,000 credits for the gun, 6,000 credits per each magical stun dart.

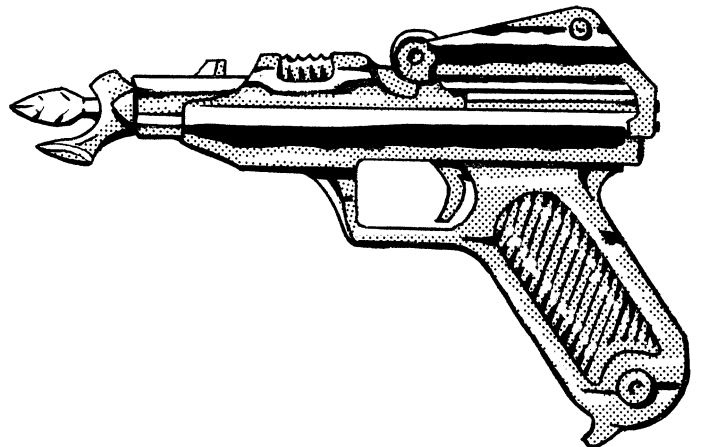

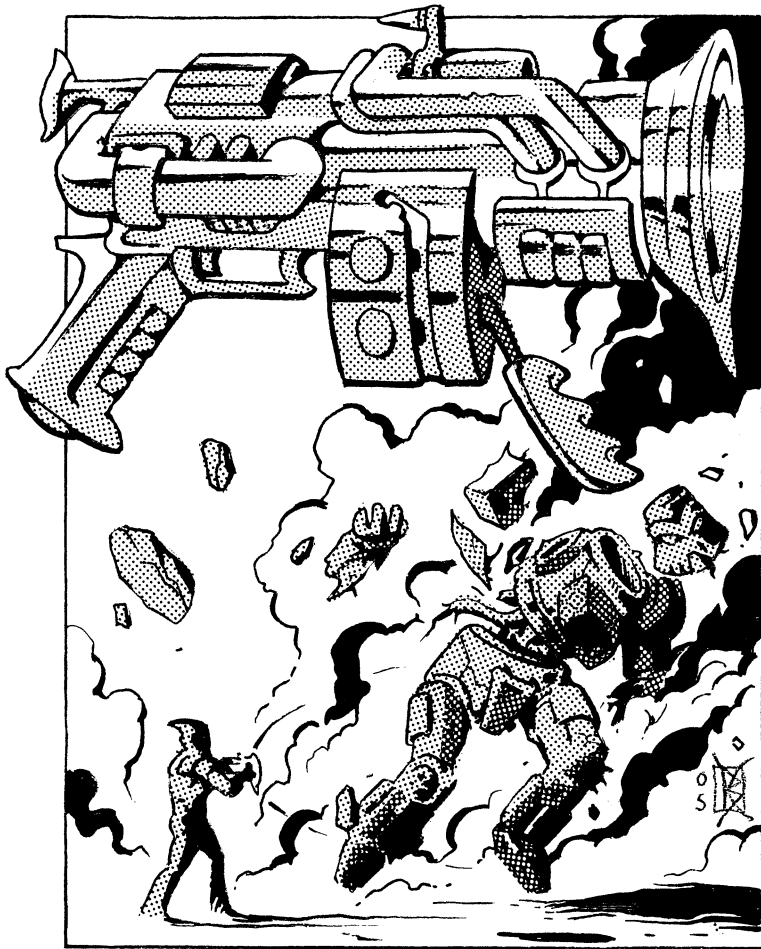

## Windscream TW Cannon

A heavy-duty support weapon that can be handled by a single soldier. The Windscream cannon is a powerful weapon that uses Elemental Air magic to unleash a hurricane-force blast of wind. Each time the cannon is fired, it releases a screeching, violent rush of air with the combined effects of the Air Elemental spells Wind Blast and Howling Wind. Aside from the destruction caused by the gale force blast, the Windscream cannon produces a shrill, eerie howl that has an effective Horror Factor of 14; anyone who fails to save vs Horror Factor suffers the usual penalties, plus there is a 01-40% chance that those overcome by fear will flee the immediate area (applicable to untrained military personnel).

Weight: 12 lbs (5.4 kg).

Mega-Damage: 1D6x10 M.D. per jackhammer-like blast or the target can be hit with the equivalent of an enhanced Wind Rush spell.

The enhanced Wind Rush blast inflicts 6D6 S.D.C. damage, and the short, powerful wind blast knocks human-sized targets weighing less than 500 pounds (225 kg) off their feet and flying backward 1D6x10 yards/meters (30-180 feet (9.1 to 54.8 m) backwards. The victim must roll an 18, 19, or 20 to hold on to anything in his hands (P.P. attribute bonuses may be applied) and he loses 1D6 melee attacks/actions for that round. Targets weighing 501-2000 pounds (226-900 kg) take half damage, lose 1D4 melee attacks, have the same trouble holding on to their possessions, and are hurled a shorter distance (6D6 feet/1.8 to 11 m). Opponents weighing more than a ton take only 2D6

S.D.C. damage, are -1 on initiative, but are not uprooted or hurled backward.

Rate of Fire: Each blast counts as one melee attack/action.

Effective Range: 1000 feet (305 m).

Payload: Four, regardless of which type of wind blast is used. Requires 20 P.P.E. or 40 I.S.P. per *each* blast.

Bonus: +2 to strike on an aimed shot.

Cost: 80,000 credits.

## Swarm Bow TW Crossbow

There is a huge market in the magic practicing communities of North America for magical bow weapons. Many of the D-Bee groups who have migrated to Rifts Earth come from primitive or medieval style cultures, and don't feel comfortable with modern weapons. In an attempt to satisfy these customers, Armstrong TW Armaments has created the Swarm Bow, a TW crossbow built along the same lines as modern high-tech crossbows, like Northern Gun's NG-MCI Mega-Crossbow.

What separates Armstrong's Swarm Bow from conventional models of crossbows are the enchantments to extend its range and magically increase its accuracy. The Swarm Bow is as accurate as many precision sniper rifles on the market, and its effective range is equal to many energy assault rifles. More important to the average user is that the string pull is minimal, almost negligible, allowing it to be easily operated by even puny, untrained shooters.



Like other Mega-Damage bows on the market, the Swarm Bow can fire any kind of crossbow bolt, including regular S.D.C. bolts, ones made of Mega-Damage materials and also any type of specialized ammunition. The most impressive and lethal ammunition for this TW weapon are the magic **Swarm Bolts** produced only by Armstrong TW Armaments. It is these which give this crossbow its name. Swarm Bolts are enchanted crossbow bolts made from M.D.C. materials that, when fired, magically multiply into a volley of six bolts that all swarm towards the same target. Thus, each Swarm Bolt becomes a *volley* of six after being fired and strikes a target with the impact of a rail gun.

The Swarm Bow is a popular weapon that has been purchased by countless adventurers, mercs, assassins, hunters, Psi-Stalker tribesmen and special forces units due to the weapon's range, accuracy, quietness and lethality. Another added bonus is that unlike most Techno-Wizard weapons, the Swarm Bow does not require any P.P.E. expenditure to use, meaning that it can be operated by anyone firing non-magical crossbow bolts, and not just by practitioners of magic or psychics.

Weight: 6 lbs (2.7 kg) for the crossbow; bolts weigh about one pound (0.45 kg) each.

Mega-Damage: Ordinary crossbow bolts inflict 2D6 S.D.C. and may shatter on impact. Bolts made of M.D.C. material (about three times thicker than S.D.C. ones) inflict 1D6 M.D., specialty high-tech bolts with explosive heads typically do 2D6 M.D. or 3D6 M.D.; smoke grenade arrows (no damage, but fills a 40 foot/12.2 m diameter); flares (3D6 S.D.C. damage, intended for signaling), and flame grenade bolts (3D6 M.D.) are also available.

A single magical *Swarm Bolt* inflicts 6D6+6 M.D. for the *total volley* of six bolts (not for each bolt in the volley).

Rate of Fire: Each shot counts as one of the shooter's attacks per melee round; archery skills and related rate of fire are applicable. A volley of six swarm arrows is initially fired as one, and counts as one melee attack.

Effective Range: 1500 feet (457.2 m).

Payload: One on at a time, easy to hand-load.

Bonus: +2 to strike due to its light weight and mystical properties.

Cost: 35,000 credits. Basic M.D.C. bolts/quarrels cost 100 credits each, and modern specialty explosive arrows cost 400 (2D6 M.D.), 800 (3D6 M.D.), and 120 credits for flare/tracer and smoke bolts. Swarm Bolts cost 2,000 credits each and require 3 P.P.E. (or 6 I.S.P.) to activate and get to multiply into a volley of six.

## TW Lightning Dagger

This weapon is a gold-plated dagger with a jagged-eight inch (20.3 cm) blade that resembles a miniature bolt of lightning. It is a versatile weapon that can be used either as a melee weapon or, when charged with 10 P.P.E. (or 20 I.S.P.), thrown like a lightning bolt, which then returns to the wielder after it hits its target. The TW Lightning Dagger is a unique weapon that is similar to the lightning rod and also the infamous creations forged by the mythical Cyclops. Its method of creation is a secret, known only to the Armstrong family, as well as to a handful of other TW



manufacturers in the Free States of Lazlo and New Lazlo. It has only recently been introduced to the open market.

Weight: One pound (0.45 kg).

Mega-Damage: Inflicts 1D6 M.D. as a hand-held weapon, or 4D4 M.D. when thrown. **Note:** In the alternative, a charged Lightning Dagger can protect its user from electrical discharge by absorbing and magically dispersing up to 50 M.D. from an electrical attack. This defense, however, uses up one of its thrown lightning strike attacks.

Rate of Fire: One.

Effective Range: 300 feet (91.5 m), thrown.

Payload: Special. No P.P.E. cost to use as a melee weapon (1D6 M.D.), but requires an expenditure of 8 P.P.E. or 16 I.S.P. every time the dagger is thrown for a lightning strike or to absorb a lightning attack leveled at the knife's owner.

Cost: 50,000 credits.

## Demonbane Halberd

A large, wicked looking pole arm with a dark red axe blade and a black shaft, forged specifically to fight evil *supernatural* beings. As a Demonbane weapon, this halberd inflicts double damage to all demons and similar creatures of supernatural evil like the Lipoca, Vyarnect, Oni of Japan, Russian demons and dark gods. It is also enchanted with a number of spells that can be activated when the owner expends P.P.E., including *Armor of Ithan* (appears around the pole arm's user), *Fire Ball* and *Exorcism*. Furthermore, the halberd is enchanted with a protective aura identical to the Protection Circle: Simple, which when acti-



vated makes it impossible for *lesser* demons to make physical contact with the halberd's wielder.

The Demonbane Halberd is one of Armstrong's more unusual and spectacular creations. It is an expensive weapon and is only produced in small numbers. Nonetheless the Demonbane Halberd is gaining popularity among Demon Hunters, Psi-Stalkers, Cyber-Knights and similar characters devoted to fighting supernatural evil.

Weight: 10 lbs (4.5 kg).

Mega-Damage: Blade: 3D6 M.D., double damage to supernatural evil, plus the M.D. punch damage for wielders with supernatural, bionic or robotic strength is added to the overall damage delivered. Fire Ball Blast: 4D6 M.D.

Rate of Fire: Each blast counts as one melee attack/action.

Effective Range: Hand to hand combat or 90 feet (27.4 m) for the fireball blast.

Payload: Varies, see special features.

Special TW Features & P.P.E. Cost (double for I.S.P.): The number in parentheses indicates the P.P.E. necessary to activate (double that amount when I.S.P. is used). Enchanted with the spells Armor of Ithan (10; lasts for 10 minutes), Exorcism (30), Fire Ball (10) and Protection Circle: Simple (30); equal to 5th level strength when not otherwise indicated. The magic and Mega-Damage capabilities of the blade itself are always on and do not require activation.

Cost: 550,000 credits.

## Medusa Goggles

Intended for personal defense, Medusa Goggles are used to protect the wearer from the petrifying gaze of a Medusa/Gorgon, and Earth Elemental magic that can turn its victim to stone, or encase its victim in stone. In fact, the wearer is +3 to save against all types of magical transformations as long as the glasses are worn over the eyes. This Techno-Wizard device resembles a pair of aviator goggles with green tinted lenses. They are simple to operate, requiring only that the wearer spend 10 P.P.E. or 20 I.S.P. to activate them.

Weight: 8 ounces (0.22 kg).

Mega-Damage: None.

Effective Range: Self; defense.



Payload: Requires 10 P.P.E. for three hours of protection.

Duration: Three hours per 10 P.P.E. or 20 I.S.P.

Cost: 170,000 credits.

## Mind Shatter Helmet

Something of a misnomer, the Mind Shatter Helmet prevents its wearer from suffering the effects of mind shattering attacks from sorcerers, powerful psychics and supernatural beings with mind powers. It is a regular M.D.C. body armor helmet with a special lens that goes over one eye, a large crystal affixed to the forehead portion and several smaller crystals positioned in various locations across its surface. These serve as the focus for a





# MageFire Weaponry, Inc.

## A Techno-Wizard Armaments Company

MageFire Weaponry, Inc. is a newcomer to the arms market in North America. Like the infamous Naruni Enterprises, MageFire is a trans-dimensional arms dealer based in another dimension and has no permanent manufacturing facilities on Rifts Earth. Its products first appeared in the besieged nation of Tolkeen in mid-104 P.A. with the opening of a small retail outlet. The company has been very busy in the years since its arrival, expanding its retail outlet in Tolkeen and opening similar outlets in select locations in North America, including Lazlo, New Lazlo, Kingsdale, and MercTown. It has been run out of the Magic Zone by the Federation of Magic and rival TW manufacturers (and quite possibly, Naruni Enterprises). Its products are some of the most diverse and unique TW weapons on the continent.

The weapons makers at MageFire Inc. place a definite emphasis on making their products look sleek and alien. Wherever possible, the company avoids using unorthodox or ancient style patterns, as do many other TW manufacturers. This is done to increase customer acceptance and easy for brand identification. Virtually all of the equipment produced by MageFire Inc. are built to resemble firearms, with a few staves, wands, amulets, and melee weapons.

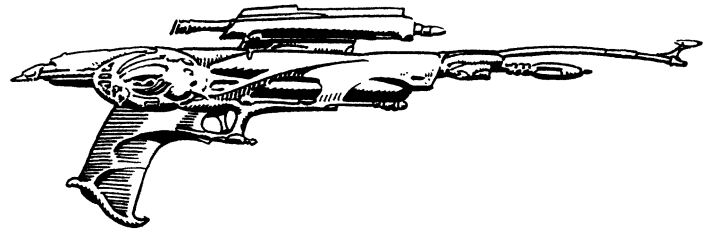

### MP-1 TW Laser Pistol

The MP-1 is a basic, TW converted laser pistol that uses magic or psychic energy as a power source rather than a normal energy clip magazine. It is the least powerful handgun produced by the company, but enjoys relative popularity among Wilderness Scouts, gamblers and adventurers.

Weight: 2 lbs (0.9 kg).

Mega-Damage: 3D4 M.D. per shot.

Rate of Fire: Each blast counts as one melee attack/action.

Effective Range: 1000 feet (305 m).

Payload: 12 shots. Requires either 12 P.P.E. or 24 I.S.P. to fully recharge the weapon.

Cost: 21,000 credits.

number of mind affecting magical spells that allow the wearer to keep his mind and function normally even when under mental assault. Thus, the wearer is impervious to mind altering magic such as Wisps of Confusion, Mental Blast, Mental Shock, Domination, Disharmonize, Charm and Befuddle, as well as Hallucination and magic illusions; +6 to save vs possession and the World Bizarre spells.

Against true *psionic attacks*, the wearer is +6 to save vs all Mind Bleeder attacks and +3 to save vs other types of mind control psionics and psychic illusions.

Weight: 5 lbs (2.25 kg).

M.D.C. of the Helmet: 45

Protection: As noted above.

Effective Range: Protects the wearer only.

Payload: Requires 12 P.P.E. (or 24 I.S.P.) per hour of protection, but that energy may come from the wearer or an ally willing to give up some of his P.P.E. to protect a buddy.

Cost: 180,000 credits.

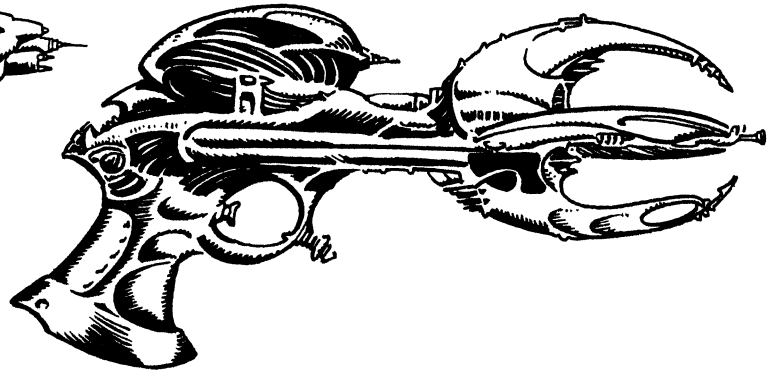
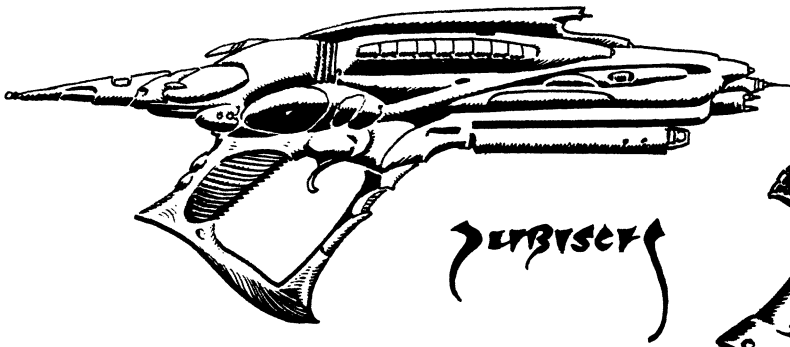

## MP-3 MageFire Bolt Pistol

A robust, heavy-duty pistol for front-line combat. The weapon fires bolts of pure *MageFire*, an intense bluish-purple fire that burns nearly as hot as plasma, but only when it makes contact with an object. This magical flame is one of the many mystical secrets of the manufacturer. It appeals to bandits and mercenaries with sufficient P.P.E. or I.S.P. who are looking for heavy firepower in a small package.

Weight: 4 lbs (1.8 kg).

Mega-Damage: 3D6+3 M.D.

Rate of Fire: Each blast counts as one melee attack/action.

Effective Range: 500 feet (152.4 m).

Payload: 8 shots. Requires either 12 P.P.E. or 24 I.S.P. to fully charge the weapon.

Cost: 24,000 credits.

with the punch of a rail gun round, and upon impact, the Telekinetic Force Field immediately dissipates, releasing the mini-fireball contained within. Superior range for a pistol, nearly equal to a laser.

Weight: 4 lbs (1.8 kg).

Mega-Damage: 1D6 M.D. from the TK impact, +2D6 M.D. from the fireball (unless the target is impervious to fire).

Rate of Fire: Each single shot counts as one melee attack/action.

Effective Range: 800 feet (244 m).

Payload: 10 shots. Requires either 15 P.P.E. or 30 I.S.P. to fully charge the weapon.

Bonus to Strike: +1 to strike on aimed shots.

Cost: 46,000 credits.

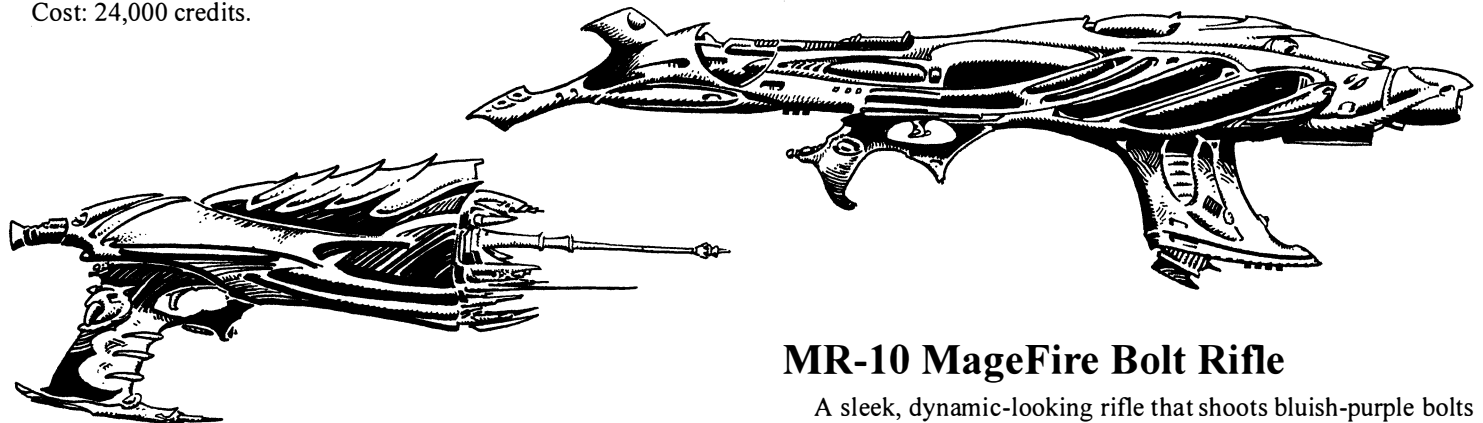

## MPR-4 E-Mag Splinter Pistol

The E-Mag – short for “Electric Magnum,” figuring the name would attract plenty of human buyers – fires powerful electric bolts. The weapon inflicts superior damage but has a short range.

Weight: 5 lbs (2.25 kg).

Mega-Damage: 5D6+5 M.D. per blast.

Rate of Fire: Each blast counts as one melee attack/action.

Effective Range: 200 feet (61 m).

Payload: 5 blasts. Requires either 20 P.P.E. or 40 I.S.P. to fully recharge the weapon.

Cost: 57,000 credits.

## MR-10 MageFire Bolt Rifle

A sleek, dynamic-looking rifle that shoots bluish-purple bolts of MageFire. Compared to the pistol, this rifle has an extended range, greater accuracy and a pulse feature allowing it to fire multiple-shot bursts. Sales on Rifts Earth have been excellent, especially among Techno-Wizards, Psi-Stalkers, psychics, creatures of magic and the forces of fallen Tolkeen.

Weight: 7 lbs (3.2 kg).

Mega-Damage: 5D6+3 M.D. per single shot, or 1D6x10+6 M.D. for a three shot pulse.

Rate of Fire: Each single blast or three bolt pulse counts as one melee attack/action.

Effective Range: 1600 feet (488 m).

Payload: 18 total blasts for six pulse shots or 18 single shots. Requires either 20 P.P.E. or 40 I.S.P. to charge the weapon with nine blasts (three pulse blasts); 40 P.P.E. or 80 I.S.P. to completely recharge.

Cost: 56,000 credits.

## MP-6 “Firebolt” Pistol

The MP-6 “Firebolt” pistol is a unique innovation. It shoots miniature fire balls encased in Telekinetic Force Fields. When the weapon is fired, these red, glowing “bullets” strike the target



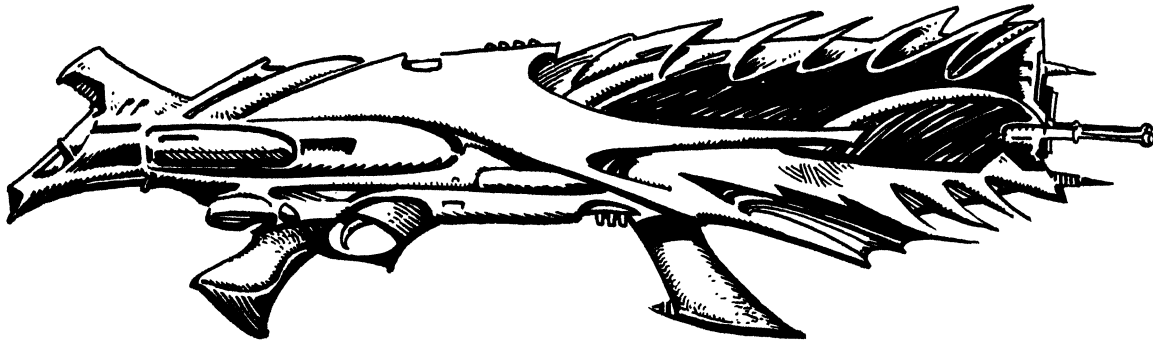

## MR-12 E-Mag Splinter Rifle

The MR-12 E-Mag Splinter rifle is basically the rifle version of the Electric Magnum pistol. It fires powerful electric bolts and has good range.

Weight: 11 lbs (5 kg).

Mega-Damage: 1D4x10+10 M.D. per single shot!

Rate of Fire: Each blast counts as one melee attack/action.

Effective Range: 1600 feet (488 m).

Payload: 25 blasts, but each payload of *five blasts* requires either 20 P.P.E. or 40 I.S.P. – that's 100 P.P.E. or 200 I.S.P. to completely recharge the weapon!

Cost: 88,000 credits.

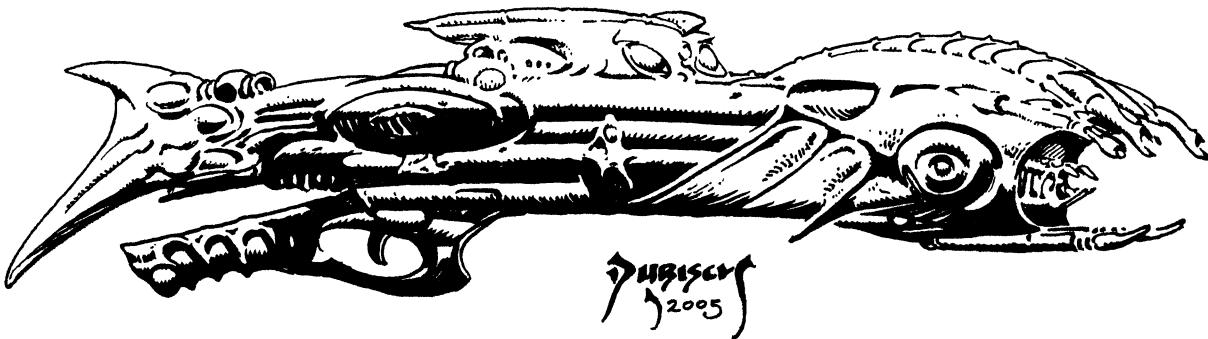

## MR-15 TW Particle Beam Rifle

Essentially the MR-15 is simply a TW converted particle beam rifle enchanted with the Sub-Particle Acceleration spell. The MR-15 is slightly more powerful than a conventional particle beam weapon, but suffers from a shorter range and smaller payload. Nonetheless, this weapon has been adopted by mercs and power armor troops looking for real punch.

Weight: 9 lbs (4 kg).

Mega-Damage: 1D6x10+10 per blast.

Rate of Fire: Each blast counts as one melee attack/action.

Effective Range: 1200 feet (366 m).

Payload: 7 blasts. Requires either 18 P.P.E. or 36 I.S.P. to fully charge the weapon.

Cost: 53,000 credits.



## MSR-1 "Vampire" Sniper Rifle

A long-range, precision marksmanship rifle that fires a light beam that is effectively sunlight and mystic energy. The weapon is specifically designed to kill vampires, Shadow Beasts and other Shadow creatures. It has become instantly popular among vampire hunters and Shifters alike.

Weight: 10 lbs (4.5 kg).

Damage: 6D6 Hit Point damage per shot to vampires or as a light laser, 5D6 M.D. per shot to Shadow Beasts and all crea-

tures of the Shadow Realm or for whom shadows and magical darkness are a part of their nature or being. Only 2D6 S.D.C. to all other targets.

Rate of Fire: Each blast counts as one melee attack/action.

Effective Range: 2000 feet (610 m).

Payload: 10 shots requires either 20 P.P.E. or 40 I.S.P. to completely recharge the weapon.

Bonus to Strike: +2 to strike on an aimed shot (magically guided).

Cost: 100,000 credits.



## ML-20 TK Grenade Launcher

The ML-20 is a semi-automatic grenade launcher which uses telekinetic force to propel the grenades. It can be loaded with *any* type of grenade from *any* manufacturer! The storage compartment and barrel magically conforms to accommodate the rounds and varying shapes, sizes and firepower (i.e., can use Northern Gun, Coalition Army, Wellington, etc., in any combination). The ML-20 is designed so that it can be employed on its own, or be mounted on a tripod or vehicle turret. This weapon was an instant hit and is hugely popular.

Weight: 10 lbs (4.5 kg).

Mega-Damage: Varies with the grenade type used.

Rate of Fire: Can fire single grenades or a controlled burst of two grenades (for double the damage).

Effective Range: 1200 feet (366 m).

Payload: 24 total. Grenades are loaded into a tubular style opening at the end of the rifle barrel, similar to a pump action shotgun only it doesn't have to break to load, just push into the opening. Requires either 12 P.P.E. or 24 I.S.P. to recharge the launcher.

Cost: 48,000 credits and in hot demand; fair to poor availability.

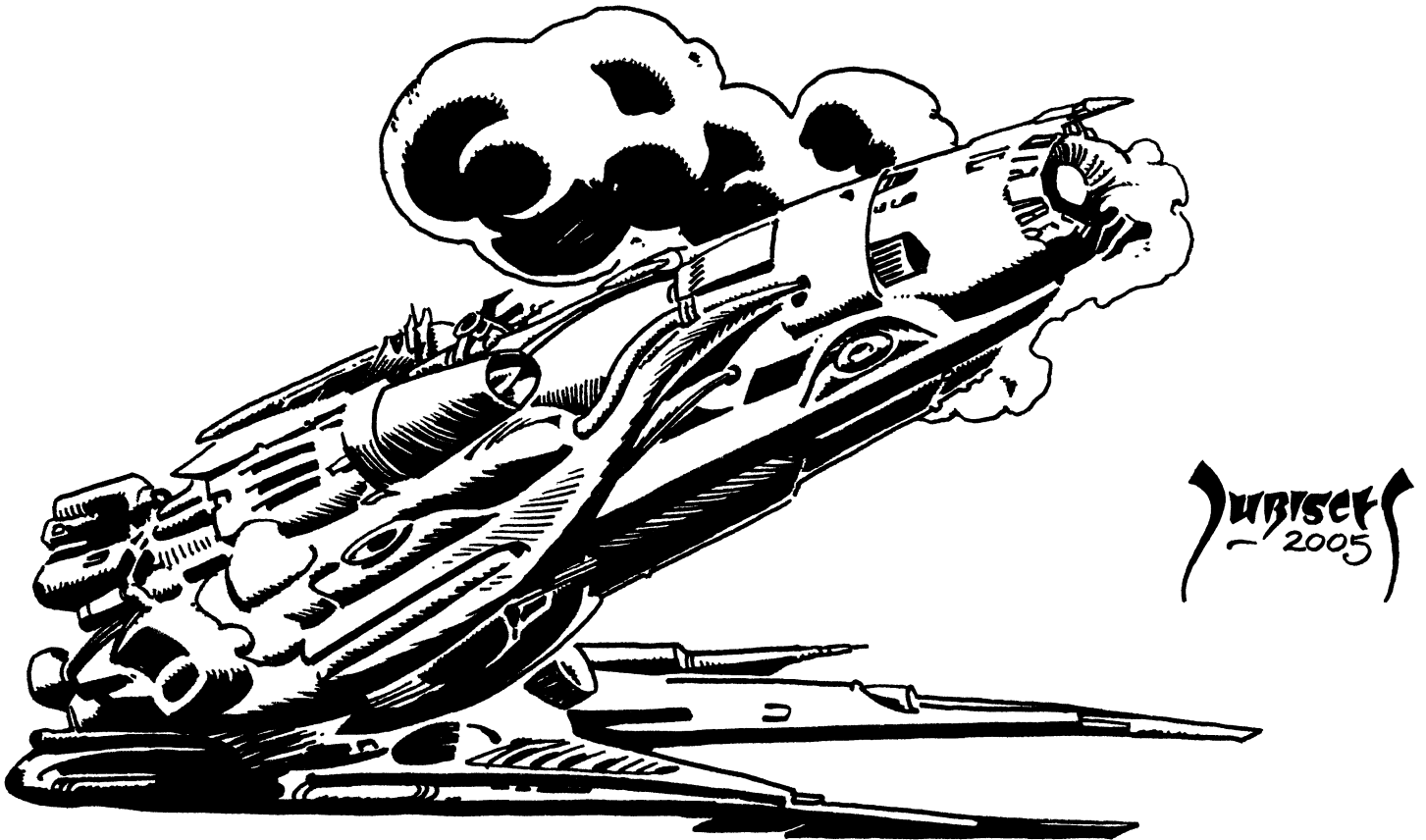

## TW EMP Cannon

This massive cannon more resembles a rocket than a gun. It is designed to knockout the instrumentation of power armor, aircraft ground vehicles and giant robots by hitting them with a powerful, magically generated electromagnetic pulse (EMP). When fired, a crackling blue ball of electricity hurtles at the target. Upon impact, the static electrical charge surges through the vehicle or machine, completely enveloping it. Unless the target (vehicle, robot, etc.) is equipped with hardened circuits or is a magical construct, it suffers a *major systems crash*.

**Small, light items** such as *hand portable* computers, radios, sensor systems, radar, civilian vehicles and *all* electronics are knocked offline and completely stop working for 4D6x10 minutes.

Similar electronic systems built into **body armor**, **power armor**, **light robots**, and **light combat vehicles** (anything with 290 M.D.C. or less) lose *ALL* sensors, communications, optics, guidance, targeting, computer, and H.U.D. systems, effectively rendering the pilot (and crew) electronically blind, deaf and

dumb! Response time is slow and the vehicle, power armor or robot's response is sluggish. The pilot/operator and crew must rely entirely on their human senses, NONE of the electronic systems.

**Penalties:** Reduce the number of attacks per melee by half, Spd and altitude are reduced by 30%, all combat bonuses are reduced to *zero* – unmodified dice rolls only on initiative, strike, parry, dodge, roll, etc., except for the pilot's natural P.P. (as applicable), and -40% to piloting skill when performing trick, combat or evasive maneuvers. In addition, *half* the built-in weapons go *offline* (don't work, no response); *missiles* (all types) are *ALWAYS* knocked offline for the duration.

**Duration of Systems Failure & Penalties:** 2D4x10 minutes. That's how long the systems are knocked offline, plus there is a 01-66% likelihood that *sensors*, *radar* and *targeting* combat systems are completely fried and will need to be replaced (roll for each).

**Heavy power armor, 'bots, and combat vehicles** with hardened circuitry or that are magical in nature get a saving throw vs EMP. **Saving Throw:** 12 or higher. If the saving throw *fails* they suffer the same penalties as above. If the saving throw is a *success*, all penalties are half and the duration is 5D6 minutes, with no chance of permanent damage.

**Bionic systems** also suffer from this attack, although the cannon is typically reserved for large targets (power armor and larger), not soldiers. **Saving Throw:** 13 or higher to save, but roll for *each* weapon system. Also roll for communications/radio, radar, targeting optics, camera and other recording systems (anything already recorded is wiped clean unless the save is good), all other sensors (as a package; roll once for all), bionic P.S. and bionic Spd. **Penalties:** A successful save means that particular system is still up and running with no significant problems except a bit sluggish (-1 attack per melee round, -1 on initiative, -1 on all bonuses and reduce bionic P.S. and Spd by 10%).

A failed roll to save means the bionic system is knocked out and unavailable for 2D4x10 minutes, plus the character sees his attacks per melee round reduced by two, initiative and all combat bonuses reduced by half and bionic P.S. and Spd by half!

**Weight:** 600 lbs (270 kg); portable via vehicle like a howitzer cannon, may be mounted on a large vehicle like a trunk, tank or giant robot (including the largest Magi Automatons), or transported via magic or along a ley line. (Floats 4-10 feet/1.2 to 3 m above the ground when on a ley line, and can be pushed or pulled like a balloon!)

**Mega-Damage:** Via EMP pulse described above.

**Rate of Fire:** Each blast counts as one of the gunner's melee attacks/actions.

**Effective Range:** 6000 feet (1828 m).

**Payload:** One blast per 30 P.P.E. or 55 I.S.P. pumped into it. Can hold enough P.P.E. or I.S.P. for a maximum of eight blasts before requiring recharging.

**Bonuses:** Laser targeting: +1 to strike. Considered a Heavy Weapon.

**Cost:** 320,000 credits. Poor availability; uncommon.



## MageFire TW Grenades

Like Stormspire, Tolkeen and other TW manufacturers on Rifts Earth, MageFire produces a series of Techno-Wizard grenades. However, the grenades manufactured by MageFire employ very different magic than those that originate on Earth, and thus produce vastly different effects. MageFire grenades are highly sought after and much more expensive than most TW grenades created by Earth-based Techno-Wizards.

Unless otherwise noted in the individual descriptions below, all MageFire grenades have the following basic statistics:

**Weight:** Half pound (0.23 kg).

**Rate of Fire:** One can be thrown per attack.

**Effective Range:** Thrown 100 feet (30.5 m); increase by 30% for augmented (Juicer/Crazy/Bionic) P.S. of 21 or greater, increase range 50% for Robotic P.S. and double the range for Supernatural P.S. (triple if Supernatural P.S. of 31 or greater).

**P.P.E. Cost to Use:** 5 P.P.E. or 10 I.S.P. to activate the explosive device.

**Cost:** High.

**Availability:** Rare, with poor availability of most types.

## Acid Grenade

This grenade erupts in a blast of concentrated acid that melts only *inorganic M.D.C.* materials, i.e., Mega-Damage metal, metal compounds, plastic, other materials. The only safe inorganic items are those enchanted with magic such as a rune sword, Techno-Wizard device and so on, or made of glass and silver.

Duration: Burns for 1D4+1 melee rounds before it becomes inert.

Mega-Damage: 4D6 M.D. for the first melee round and 2D6 M.D. per each additional round

Area of Effect: 3 foot (0.9 m) radius.

Cost: 5,000 credits; rare.

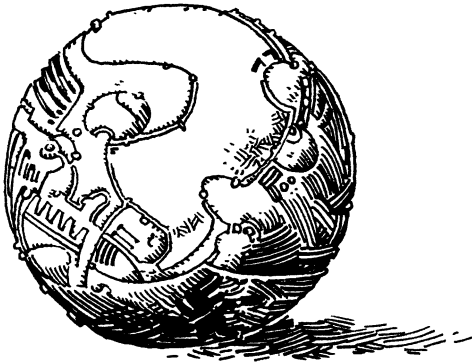

## Beehive Grenade

When it explodes the grenade releases a swarm of magic energy nodules that swarm and attack the nearest *living* being that radiates with magical energy. The attack will be divided against as many as four targets within a 20 foot (6.1 m) radius (40 foot/12.2 diameter), but a divided attack does less damage.

Mega-Damage: 5D6+6 M.D. to a single target or 2D6 M.D. each when the swarm divides to attack two or more.

Area of Effect: Finds 1D4 targets within a 20 feet (6.1 m) radius, but only damages living beings that are creatures of magic (dragons, Faerie Folk, etc.) or which currently have 30 P.P.E. or more.

Cost: 6,000 credits; rare and coveted by those opposing dragons and practitioners of magic.

## Darkness Grenade

Creates a sphere of impenetrable magic darkness 50 feet (15.2 m) in diameter (25 foot/7.6 m radius), effectively concealing everything within the area of effect. Those caught within the darkness cannot see and are -10 to strike, parry, dodge and all other combat moves.

Mega-Damage: None, see description above.

Area of Effect: 50 foot (15.2 m) diameter.

Duration: Darkness lasts for 1D4+2 melee rounds (45 to 90 seconds).

Cost: 5,000 credits; rare.

## Door Buster Grenade

An explosive device that is the size and shape of a hockey puck (only it is red in color) that delivers a concentrated blast to its target. Designed to slide across smooth surfaces, like a floor, or roll across carpet, and land in front of a door, explode and blast open ordinary and light M.D. doors, or make a man-sized hole in a wall.

Mega-Damage: 4D6 M.D.; blast goes up to create an entry space and blasts open doors.

Area of Effect: One foot (0.3 m); concentrated blast on one target.

Effective Range: 120 feet (36.6 m) sliding on a smooth surface (up to 300 feet/91.5 m). but -3 to strike), or 60 feet (18.3 m) on carpet.

Cost: 1,000 credits; uncommon, poor availability.

## Flashfire Grenade

More devastating than a standard plasma grenade, this magic pyrotechnic device releases a tightly focused, concentrated fire blast of incredibly bright, white fire that burns out in a matter of three or four seconds (one melee action) but delivers tremendous damage to the location it strikes.

Mega-Damage: 5D6 M.D. (double to creatures vulnerable to fire or heat).

Area of Effect: 2 foot (0.6 m) radius.

Cost: 700 credits; poor availability.

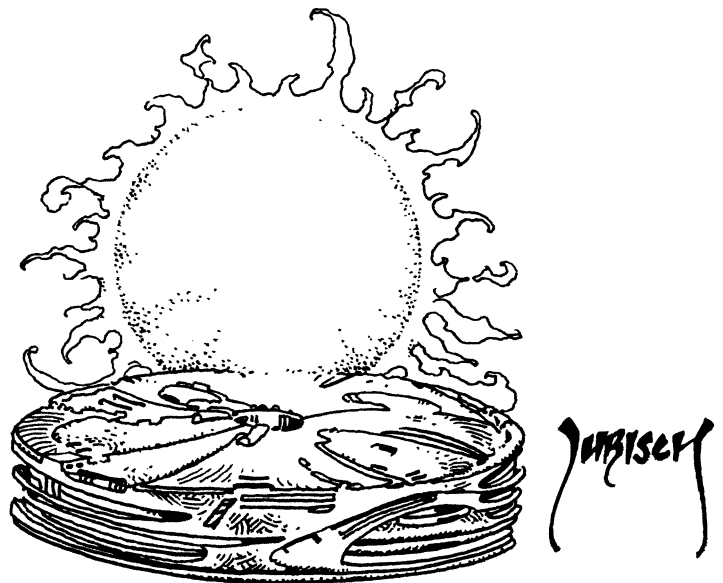

## Flare Grenade

A magical illumination round that fires a bright sphere of light that burns for 1D6x10+60 seconds. The light is so bright that one can easily read under its illumination. The flare inflicts no damage (and has NO effect on vampires), but lights up an area of the battlefield to better see approaching enemy forces or to mark an area for targeting or troop extraction.

Mega-Damage: None, see description above.

Area of Effect: Lights up a 600 foot (183 m) radius.

Cost: 1,000 credits; fair availability.

## Flying Explosive Disk

A disk-shaped explosive the size of a dessert plate or small Frisbee. It is designed for use against low altitude flying targets. It is thrown like a Frisbee and once launched, automatically zooms toward the nearest target at a speed of 100 mph (160 km).

Mega-Damage: 5D6 M.D. to a single target.

Area of Effect: 2 feet (0.6 m); concentrated blast on one target.

Extended Range: 300 feet (91.5 m) for a typical human.

Cost: 2,000 credits; uncommon, poor availability.

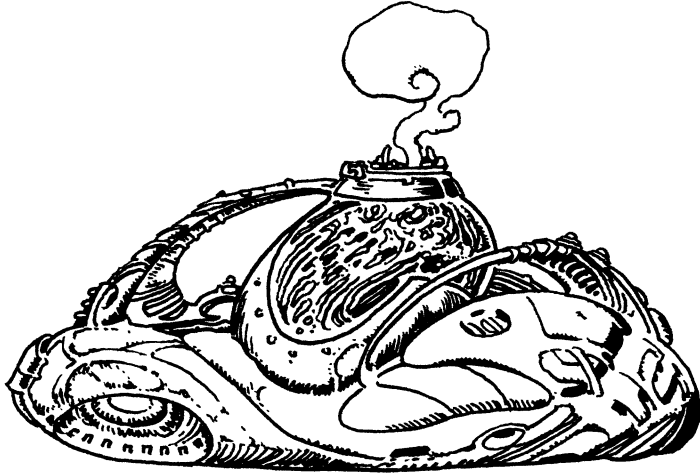

## Nexus Grenade

A magical device that disrupts the flow of energy at a ley line nexus. Available as a grenade or mine (a mine has a time delay of up to 30 minutes, a grenade goes off four seconds after it is thrown).

P.P.E. Cost to Use: 45 P.P.E. or 80 I.S.P. to activate the device.

Mega-Damage: Creates a disruptive force that has a 01-55% chance of closing a dimensional portal and does 1D6x10 M.D. to anything coming out of the Rift at the moment of detonation (does damage whether the Rift closes or not).

Also has the following effect on all TW devices and magic within its sizable blast radius: turns the invisible visible, knocks TW flying devices out of the air (4D6 S.D.C. crash damage plus the victim loses initiative and three melee attacks/actions), and has a 01-40% chance of negating any Ley Line Magic spell within its area of effect. **Note:** May also be used to *dispel magic barriers*, with a 01-50% chance of success.

Duration: 1D4+1 seconds.

Blast Radius: 500 feet (152 m) along the ley line.

**Note:** The device only works on or near (within 500 feet/152 m) a ley line nexus point.

Cost: 20,000 credits; rare.

## Seeker-Bat Grenade

After the grenade is thrown, a pair of green energy, bat-like wings deploy from the grenade, chasing the nearest target even if he tries to flee (individual soldier, robot or vehicle). The Seeker-Bat has a Speed of 58 (40 mph/64 km), is +2 to strike and keeps going for 300 feet (91.5 m). When the Seeker-Bat im-

age hits its intended target it sends a cold chill through him and does M.D.

Mega-Damage: 3D6+6 M.D.

Area of Effect: None; specific individual target.

Cost: 3,500 credits; rare.

## Sleep Grenade

Releases a 20 x 20 x 20 foot (6 m) cloud of gas which induces sleep instantly on everyone who fails to save vs spell magic (12 or higher is required; those inside environmental armor, power armor, or sealed vehicles are not affected).

Damage: None per se. The people affected by the spell fall into a deep sleep and cannot be roused for 1D6+1 minutes. The cloud itself dissipates after 1D4 melee rounds (15-60 seconds), but as long as the cloud is visible, it is an active agent and anyone entering it will fall to its enchantment unless they save vs magic.

Area of Effect: 20 x 20 x 20 foot (6 m) cloud of gas.

Cost: 3,500 credits; rare.

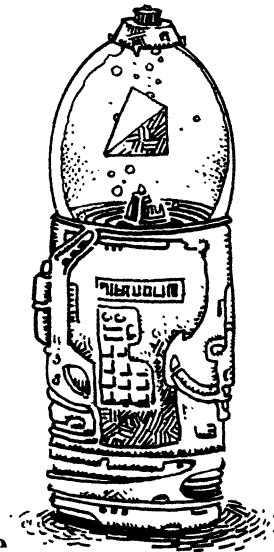

## TK Explosive

Available as a grenade and a land mine. Detonation of this device creates a Telekinetic blast or pulse that generates out from the device. The sound of an explosion is just part of the effect.

Damage: None per se, the *blast* picks up all objects weighing more than 50 lbs (22.5 kg) up to 250 lbs (112.5 kg) into the air and hurls them 30 feet (9.1 m)! Victims lose initiative and two melee attacks, but take 4D6 S.D.C. damage from the impact (a successful roll vs impact reduces damage by half).

Blast Radius: 15 foot (4.6 m) radius.

Cost: 3,000 credits; rare.

## Void Grenade

Detonation makes its victim(s) vanish into a temporary dimensional void for 1D4 melee rounds (15-60 seconds). While in the void the victims feel like they are falling through space in slow motion and are scared and disoriented (no sense of direction, not even up or down).

**Damage:** When the victim(s) reappear, they remain disoriented for 1D4+1 melee rounds. Reduce their number of attacks by one, and Spd, all combat bonuses and skill performance are reduced by *half*.

**Blast Radius:** 5 foot (1.5 m) radius.

**Cost:** 10,000 credits; rare.

## MageFire Specialty Equipment & Weapons

In addition to the usual range of common Techno-Wizard melee weapons and guns, MageFire also offers a few very unique items.



### Skorblades

Skorblades are edged melee weapons created through a process of Elemental Magic from another dimension. Designers at MageFire Weaponry, Inc. are privy to the secret process and create a variety of swords using Skorblade technology and enchantment (cannot be duplicated by Techno-Wizards).

Skorblades are unique creations in that these weapons, while created by a magical process, are not themselves magical in nature. They do not radiate any magical aura, and thus cannot be detected by the *Sense Magic* spell, psionic ability or the special powers of individuals like the Psi-Stalker and CS Dog Boys. The exact details of the creation process remain a mystery kept secret by those who manufacture these blades. What is known is that Skorblades are composed of a Mega-Damage ceramic compound shaped though Earth Elemental Magic used to temper and harden the blades. That also means they are invisible to metal detectors.

These weapons are incredibly durable, and are as difficult to break as many true magical weapons (200 M.D.C. and take damage only when an attacker is deliberately trying to damage or destroy the blade). The blades are honed to a very fine edge and are just as sharp and durable as any Vibro-Blade.

**Weight:** Generally 2-8 lbs (0.9 to 3.6 kg).

**Mega-Damage:** Skorblade Knife: 1D4 M.D. Skorblade Short

Sword: 1D6 or 1D8 M.D.; depending on the size of the blade.  
Skorblade Broadsword (or any large sword): 2D6 M.D.  
Skorblade Battle Axe: 2D6+2 M.D. Skorblade Pole Arm: 3D6 M.D.

**Range:** Hand to hand combat.

**Bonuses:** +1 to strike and parry due to the excellent balance and craftsmanship.

**Cost:** 5,000 to 20,000 credits (the larger and more M.D. the weapon delivers, the greater the cost).



### Mystic Assault Glove

The Mystic Assault Glove is a multi-weapon system built into a large, metallic gauntlet that covers the user's arm from the tips of the fingers to the elbow joint. Mystic Power Gloves are especially popular among combat-oriented practitioners of magic, including the Conjurer and Battle Magus. Availability is limited, as the device is more difficult and expensive to produce than many of MageFire's other weapons. As a result, they are even more rare and expensive than other coveted MageFire items.

**Enchantment:** When the glove is worn, it provides the wearer with Supernatural Strength equal to his original P.S. +6 (minimum of 20), allowing the individual to inflict Mega-Damage with punches (from the power glove fist only). Furthermore, the glove bestows the wearer with the following: Impervious to fire (including M.D. and magical fire), and the character can touch and handle (with the gloved hand only) burning hot, electrified, super-cold and radioactive materials without injury.

**Offensive Capability:** In addition to Supernatural P.S., the Assault Glove can fire electrical bolts from the hand, each doing 3D6 M.D. (Range: 300 feet/91.4 m, +1 to strike, each blast counts as one melee attack), or deliver electrified punches doing 3D6 M.D. plus the usual damage for Supernatural P.S.

**Weight:** 5 lbs (2.3 kg), feels like one pound (0.45 kg) when it is worn on the hand.

**Mega-Damage:** Punch damage varies with Supernatural P.S. Minimum damage (P.S. 20) is 3D6 S.D.C. on a restrained punch, 1D6 M.D. for a full strength punch and 2D6 M.D. for a power punch.

Lightning Blast: 3D6 M.D.

Rate of Fire: Two different types of magic can be activated per melee.

Effective Range: Hand to hand combat or 300 feet (91.5 m) with electrical blast.

P.P.E. Cost to Use: 15 P.P.E. or 30 I.S.P. to activate.

Payload/Duration: Five minutes per activation. Each electric blast counts as one of the user's melee attacks.

Cost: 1 to 2 million credits; rare.

## Death Ray Blaster

This weapon resembles a sawed-off shotgun with strange, Techno-Wizard doodads attached to it and a short, solid rod for a barrel. "The Death Ray," as the name suggests, is an extremely lethal device that can kill virtually any living being with a few blasts and has been outlawed in most places except the Federation of Magic and Atlantis.

The initial scandal caused by the release of the Death Ray was incredible. Laws were drafted by the governments of all the major powers in North America (so far, it is only available in North America) to make this weapon illegal and prevent it from being copied and mass-produced (not likely since each weapon has to be handmade, takes six months and 1000 P.P.E. to create). Death Rays were seized and destroyed by the authorities in Lazlo, New Lazlo, the Colorado Baronies and most magic communities. Most sentient beings of a good and even Unprincipled alignment consider the Death Ray to be an abhorrent weapon that should never have been invented, let alone used, and will not use such a weapon except under the most extreme circumstances (like taking on an evil, adult dragon, god or alien intelligence). In certain circles, however, especially among spell casting and psychic assassins, there is a hungry market for the Death Ray. The Splugorth of Atlantis can't get their hands on enough, satisfying only 2% of the overall demand in the Splynn Marketplace where there are standing orders for thousands of the weapons with customers willing to wait decades to get one.

The weapon fires a midnight black beam of death magic that does damage direct to Hit Points of mortal beings and considerable M.D. to Mega-Damage creatures (double damage to magical Creatures of Light and Air Elementals). It also penetrates non-environmental M.D.C. armor doing full damage to the wearer, and environmental M.D.C. body armor and power armor with less than 150 M.D. for a main body, but does *half* damage against such tough defenses.

Weight: 3 lbs (1.35 kg).

P.P.E. Cost: 40 P.P.E. or 80 I.S.P. per *each* Death Blast, so the shooter better have plenty of P.P.E. available.

Mega-Damage: *Mortal*, S.D.C. Beings: 5D6 damage direct to Hit Points (*half* damage to vampires and other undead).

Mega-Damage beings such as dragons, demons and gods: 1D6x10 M.D.C. Double damage (2D6x10 M.D.) to magical Creatures of Light and Air Elementals. **Note:** The Death Ray will affect most living creatures, including Entities, dragons, demons, Elementals, Demigods, Godlings and gods. The rod can also be used as an S.D.C. club in a pinch, doing 1D8 S.D.C. damage.

Rate of Fire: Single shot only, each blast counting as one melee attack and requires additional P.P.E. or I.S.P. from the shooter of each blast.

Effective Range: 300 feet (91.5 m).

Payload: One. Each death ray blast costs the shooter 30 P.P.E.

Cost: 3-4 million credits and up, it's a seller's market. Super-rare!

## MageFire Mystic Power Armor

Along with its diverse line of TW weapons MageFire produces a number of magical body armors and mystic power armor suits. Most of these suits are more or less identical to standard Three Galaxies body armor designs, but with a handful of magic TW enchantments placed on them. The types and costs of these enchantments are the same as listed in the **Rifts® RPG** in the Techno-Wizard description. Only a handful of the more exotic and/or unique armor suits produced by MageFire are described in the following section.

### MA-2 TW Combat Mage Armor

Intended for use by spell casting mercenaries and warriors. The Combat Mage Armor is a suit of *Huntsman* or *Peacekeeper* armor with the bonus of limited Armor of Ithan as a sort of magical force field for additional protection. It does not interfere with the casting of spell magic. Additionally, the armor is enchanted with a number of protective and defensive spells to keep the wearer alive in all environments, even on a modern battlefield.

**Class:** TW Medium Body Armor.

**Size:** Human equivalent is standard, larger sizes and custom configurations are available at additional cost.

**Weight:** 21 lbs (9.5 kg).

**Mobility:** Good mobility, -5% to Climb, Prowl, Swim, perform Acrobatics and similar physical skills/performance.

**M.D.C. by Location:**

Head/Helmet - 40

Arms - 45 each

Legs - 50 each

Main Body - 50

Armor of Ithan - 50

**Magic Features:** All of the following engage for the full duration of activation (or until used up in the case of armor). Armor of Ithan, Breathe Without Air, and Cleanse, all at 5th level equivalent.

**Duration:** 10 minutes per activation.

**P.P.E. Cost to Use:** 20 P.P.E. or 40 I.S.P.

**Cost:** 120,000 credits, poor availability.





**P.P.E. Cost to Use:** 30 P.P.E. or 60 I.S.P.

**Note:** Cannot be used with (worn) other armor.

**Cost:** 285,000 credits; rare.

## MA-7S Shining Swordsman TW Power Armor

Swordsman TW enhanced armor is specifically constructed to resemble the gleaming mail of a medieval knight. Similar to the knight of ancient times, this suit is intended for close combat. It is enchanted with a variety of spells to amplify the wearer's own hand to hand skills, increase the speed and number of his attacks and actually heighten his prowess with a sword. To enable the wearer to close with opponents who are armed with modern conventional weaponry the spell of Super-human Speed is part of the enchantment.

**Class:** TW Close Combat Body Armor.

**Size:** Human equivalent is standard, larger sizes and custom configurations are available at additional cost.

**Weight:** 32 lbs (14.4kg).

**Mobility:** Good mobility, -10% to Climb, Prowl, Swim, perform Acrobatics and similar physical skills/performance.

**M.D.C. by Location:**

Head/Helmet - 70

Arms - 50 each

Legs - 75 each

Main Body - 100

Armor of Ithan - 50

## MA-W1 TW Wraith Suit

Not exactly body armor, the Wraith Suit is a specialty infiltration suit designed for magic-using covert operatives. The fabric used in the creation of the suit is both lightweight and magically strengthened to provide minimal protection against Mega-Damage weaponry. Additionally, the suit is enchanted with several spells which allow the wearer to avoid detection, move unseen and to secretly observe surrounding events and individuals. The Wraith Suit is a highly sought after commodity by thieves, assassins, spies and espionage operatives.

**Class:** MA-W1 TW Wraith Suit.

**Size:** Human equivalent.

**Weight:** 3 lbs (1.35 kg).

**Mobility:** Excellent mobility; no penalties.

**M.D.C. Protection:** 50 (Armor of Ithan), covers entire body.

**Magical Features:** All of the following engage for the full duration of activation (or until used up in the case of armor). Armor of Ithan, Breathe Without Air, Chameleon, Escape, Float in Air (leaves no footprints, but reduces Spd by half), Invisibility: Superior, Levitation, See the Invisible, and Shadow Meld, all at 5th level equivalent power levels.

**Duration:** 10 minutes per activation.



**Magical Features:** All of the following engage for the full duration of activation (or until used up in the case of armor). Armor of Ithan, Breathe Without Air, Cleanse, Light Target, and Mystic Fulcrum, all at 5th level equivalent power levels. Duration: All are in effect for 10 minutes per activation. P.P.E. Cost to Use: 20 P.P.E. or 40 I.S.P.

**Bonus TW Features:** Each of the following must be engaged separately, as needed or desired, by expending the P.P.E. indicated in parentheses. Each lasts for three minutes. Superhuman Speed (10), Magic Shield (6), Impervious to Energy (20), Deflect (10), Frostblade (15), and Lightblade (20), all at fifth level equivalent.

**Cost:** 450,000 credits, poor availability.



## Atlas Enhanced Strength Power Armor

A suit of magically-powered exoskeleton armor, the Atlas is appropriately named for the legendary Greek Titan, a symbol of strength and endurance. MageFire's Atlas armor is permanently

enchanted with the Superhuman Strength spell, providing a Supernatural P.S. attribute of 30 and P.E. of 24, an enchantment which allows the wearer to carry and deploy heavy weapons,

like rail guns, missile launchers and energy cannons without penalty. The suit is also heavily armored with protection equal to the Triax Hopper and similar light power armor systems without activating any of its other TW enchantments.

Its most notable other TW spell features include Supernatural Endurance and its most potent feature, the Giant spell which transforms the Atlas suit and its wearer into a giant, fearsome killing machine that can take on the UAR-1 Enforcer, Titan robots and other giant robot combat vehicles. The Giant spell produces a similar effect on the Atlas armor (and its user, of course) as it does when cast upon a mortal creature. The unique magical composition of the armor plates allows it to grow and expand to double in size, and increase in density (i.e. Mega-Damage capacity); Supernatural P.S. is unchanged. Also, the wearer receives a bonus of one extra attack per melee, and +1D6 M.D. in hand to hand combat, but the Spd attribute is reduced by 20% and there is a penalty of -3 to dodge. This extreme transformation costs a mere 40 P.P.E. thanks to the special, magical design of the suit.

**Class:** Enhanced Strength TW Power Armor.

**Size:** Human equivalent is standard, larger sizes and custom configurations are available at additional cost.

**Weight:** 58 lbs (26 kg), increases to 1200 lbs (540 kg) when the Giant spell is activated.

**Mobility:** Poor mobility, -10% to Climb and -20% to Prowl, Swim, perform Acrobatics and similar physical skills/performance.

**M.D.C. by Location:**

Head/Helmet - 60 (140\*)

Arms - 80 (120\*) each

Legs - 90 (150\*) each

Main Body - 180 (260\*)

Armor of Ithan – 50

\* Numbers listed in parenthesis are used when the Giant spell is activated.

**Magical Features:** All of the following are on/engaged all the time and require no P.P.E. to activate or use: *Supernatural Strength* and *Mystic Fulcrum*.

**Bonus TW Features:** Each of the following must be engaged separately, as needed or desired, by expending the P.P.E. indicated in parenthesis. Each lasts for three minutes. Armor or Ithan (10), Breathe Without Air (5), Cleanse (6), Climb (3), Horror (10), Giant (40; special), Lantern Light (1), Magic Shield (6), Superhuman Endurance (12), and Swim as a Fish (6), all at fifth level equivalent.

**Color:** Typically available in black with red or gold accents and highlights, red with black highlights, or grey with gold or red highlights.

**Cost:** 1.6 million credits, very rare.

## Flying Dragon Power Armor

This armor looks just like the Atlas except it has wings on the helmet in place of horns and comes in white, silver, light blue and green colors. As the name suggests, it is designed to pack a wallop and fly.

**Class:** Enhanced Strength & Flying TW Power Armor.

**Size:** Human equivalent is standard, larger sizes and custom configurations are available at additional cost.

**Weight:** 58 lbs (26 kg).

**Mobility:** Poor mobility, -10% to climb and -20% to prowl, swim, perform acrobatics and similar physical skills/performance.

**M.D.C. by Location:**

Head/Helmet - 60

Arms - 80 each

Legs - 90 each

Main Body - 180

Armor of Ithan – 50

**Magical Features:** All of the following are on/engaged all the time and require no P.P.E. to activate or use: *Breathe Without Air*, *Supernatural Strength* and *Fly as the Eagle*.

**Bonus TW Features:** Each of the following must be engaged separately, as needed or desired, by expending the P.P.E. indicated in parentheses. Each lasts for three minutes. Armor of Ithan (10), Calling (8), Cleanse (6), Distant Voice (10), Levitation (5), Globe of Daylight (2), Lantern Light (1), and Magic Shield (6), all at fifth level equivalent.

**Color:** Typically available in white or silver with yellow or blue accents and highlights, green with white or gold highlights, or green with gold or silver highlights.

**Cost:** 900,000 million credits; rare.

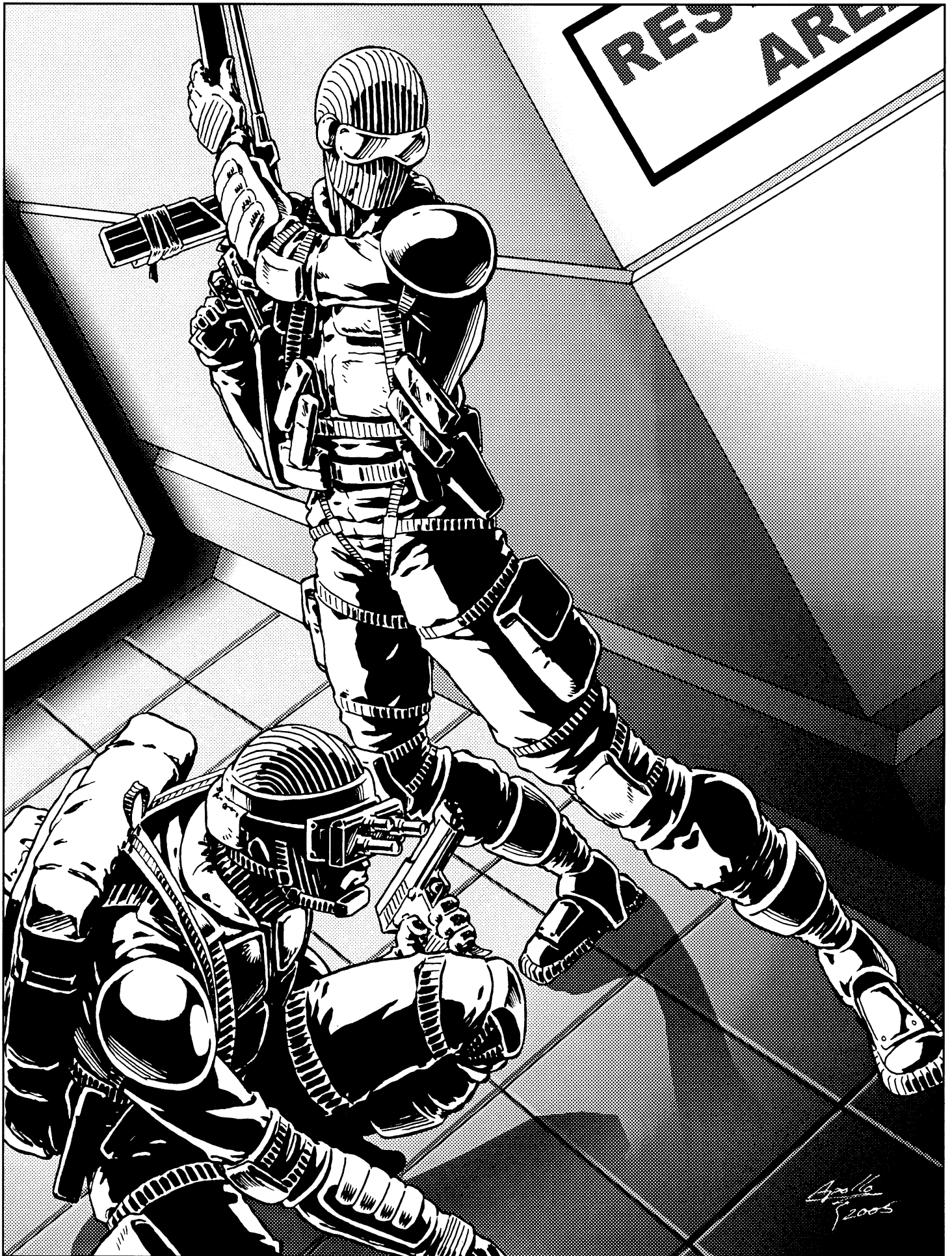

### Short Range Missiles

<u>Warhead</u>	<u>Mega-Damage</u>	<u>Speed</u>	<u>Maximum Range</u>	<u>Blast Radius</u>	<u>M.D.C.</u>
High Explosive (light)	2D4×10	500mph (804kmph)	5 miles (8km)	10ft (3m)	5
High Explosive (medium)	2D6×10	500mph (804kmph)	5 miles (8km)	15ft (4.6m)	5
Fragmentation (light)	2D4×10	450mph (724kmph)	3 miles (4.8km)	20ft (6.1m)	5
Armor Piercing (medium)	2D6×10	650mph (1045kmph)	5 miles (8km)	5ft (1.5m)	5
Plasma/Napalm (medium)	2D6×10	500mph (804kmph)	3 miles (4.8km)	15ft (4.6m)	5
Tear Gas	None	200mph (321kmph)	1/2 mile (.8km)	10ft (3m)	5
Knock-Out Gas	None	200mph (321kmph)	1/2 mile (.8km)	10ft (3m)	5
Smoke (colors available)	None	300mph (482.7kmph)	1 mile (1.6km)	20ft (6.1m)	5
Fire Retardent	None	200mph (321kmph)	1/2 mile (.8km)	20ft (6.1m)	5

### Medium Range Missiles

<u>Warhead</u>	<u>Mega-Damage</u>	<u>Speed</u>	<u>Maximum Range</u>	<u>Blast Radius</u>	<u>M.D.C.</u>
High Explosive (light)	2D4×10	1200mph (1929kmph)	50 miles (80.4km)	20ft (6.1m)	10
High Explosive (medium)	2D6×10	1200mph (1929kmph)	40 miles (64.3km)	20ft (6.1m)	10
High Explosive (heavy)	3D6×10	1200mph (1929kmph)	40 miles (64.3m)	30ft (9.1m)	10
Fragmentation (light)	2D6×10	1000mph (1608kmph)	40 miles (64.3km)	40ft (12.2m)	10
Armor Piercing (medium)	3D6×10	1600mph (2571kmph)	60 miles (96.5km)	20ft (6.1m)	10
Plasma/Napalm (medium)	4D6×10	1400mph (2251kmph)	40 miles (64.3km)	40ft (12.2m)	10
Multi-Warhead*	5D6×10	1200mph (1929kmph)	80 miles (128.7km)	20ft (6.1m)	10
Smoke (colors available)	None	1000mph (1608kmph)	40 miles (64.3km)	40ft (12.2m)	10

### Long Range Missiles

<u>Warhead</u>	<u>Mega-Damage</u>	<u>Speed</u>	<u>Maximum Range</u>	<u>Blast Radius</u>	<u>M.D.C.</u>
High Explosive (medium)	3D6×10	2010mph (Mach 3)	500 miles (804km)	30ft (9.1m)	20
High Explosive (heavy)	4D6×10	2010mph (Mach 3)	500 miles (804m)	40ft (12.2m)	20
Fragmentation (light)	2D6×10	1400mph (2251kmph)	400 miles (643km)	80ft (24.4m)	20
Armor Piercing (medium)	3D6×10	2010mph (Mach 3)	800 miles (1286km)	30ft (9.1m)	20
Plasma/Heat (medium)	4D6×10	1400mph (2251kmph)	500 miles (804km)	40ft (12.2m)	20
Plasma/Heat (medium)*	5D6×10	1400mph (2251kmph)	500 miles (804km)	50ft (15.2m)	20
Proton Torpedo (heavy)*	6D6×10	2010mph (Mach 3)	1200 miles (1928km)	50ft (15.2m)	25
Nuclear (medium)*	1D4×100	2010mph (Mach3)	1000 miles (1608km)	40ft (12.2m)	20
Nuclear (heavy)*	1D6×100	2010mph (Mach 3)	1000 miles (1608km)	50ft (15.2m)	20
Nuclear Multi-warhead*	2D4×100	2010mph (Mach3)	1800 miles (2893km)	50ft (15.2m)	25

### Mini Missiles and Special Armaments

<u>Warhead</u>	<u>Mega-Damage</u>	<u>Speed</u>	<u>Maximum Range</u>	<u>Blast Radius</u>	<u>M.D.C.</u>
High Explosive	5D6	500mph (804kmph)	1 mile (1.6km)	5ft (1.5m)	1
Fragmentation	5D6	500mph (804kmph)	1/2 mile (0.8km)	20ft (6.1m)	1
Armor Piercing	1D4×10	1400mph (2251kmph)	1 mile (1.6km)	3ft (0.9m)	2
Plasma/Napalm (medium)	1D6×10	1200mph (1929kmph)	1 mile (1.6km)	15ft (1.5m)	1
Smoke (colors available)	None	500mph (804kmph)	1/2 mile (0.8km)	20ft (6.1m)	1

\* Available as smart bombs, +5 to strike.

# Explore the Palladium Megaverse®

## The Palladium “Fantasy” Role-Playing Game®

A world of epic fantasy, incredible magic and amazing beings including the shape-changing Changeling, ferocious Wolfen, monstrous Melech, dragons, giants, trolls, dragons and creatures that defy description. Players can create scores of human and inhuman characters.

Combat is fast and fun.

Magic is different! There is spell casting wizardry, the wards of the Diabolist, the circles of the Summoner, and the powers of Druidism. Plus the mind-powers of the Mind Mage, elemental magic, the enchantments of the Alchemists, the blessings of the priest, the dark magic of the witch and magic items and creatures galore.

Sourcebooks define the world, offer new types of player characters, different player races and monsters, adventures and/or adventure ideas. This line is currently Palladium's second best seller (behind *Rifts*® and just edging out *Heroes Unlimited*™). • \$26.95 — 336 pages.

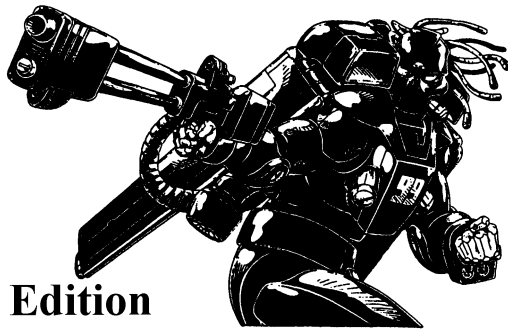

## Rifts® Ultimate Edition

Dimensional *Rifts* are tears in the very fabric of space and time. Portals to other worlds. Doorways that allow the incredible, monstrous and magical to invade our world. Reshaping it into an alien landscape that is both frightening and wondrous, alien and yet strangely familiar.

Super-science, bionics, power armor and robots collide with the forces of magic, Techno-Wizardry, dragons and demons from the Rifts. Humankind struggles on the brink of extinction, and the possibilities are endless.

Discover a world where anything is possible and you are limited only by your imagination. • \$39.95 – 376 page hardcover RPG.



## Heroes Unlimited™ RPG, 2nd Ed.

Create any type of superhuman hero you can imagine.

Aliens, mutants, robots, cyborgs, super-soldiers, psychics, super-sleuths, martial arts masters, gun-toting vigilantes, super-geniuses, masters of magic, demigods, Mega-Heroes and more!

Over 100 super abilities, plus scores of sub-powers and 40+ psionic powers. Over 100 magic spells, plus enchanted weapons and objects.

Everything one needs to play other than dice and friends are in this complete role-playing game. Cover by Jim Steranko. Written by Kevin Siembieda • \$26.95 — 352 pages.

## After the Bomb® RPG

Discover the world of mutant animals. Play it as a stand-alone game environment or combine it with *Heroes Unlimited*™, but check it out.

Mutant animal creation rules that make building your mutant characters fast, fun and challenging. Over 100 mutant animals presented. More than 40 animal powers and psionics; many more if you include weird abilities exclusive to certain animal species. • \$24.95 — 224 pages.

## Ninjas & Superspies™ RPG

Over 40 different types of martial arts, oriental mysticism, and superhuman abilities combined with spies, gizmos, super-vehicles, cybernetic implants and disguises, and more to create the ultimate spy and combat game. A complete role-playing game with everything you need to play. A complete game in itself as well as completely interchangeable with *Heroes Unlimited*™. Written by Erick Wujcik. • \$20.95 – 176 pages.

## Nightbane® RPG

The world has never been the same since Dark Day. Some say the world governments have been supplanted, taken over by ... god only knows what. That doppelgangers can steal one's identity and life, and that demons and monsters lurk in the shadows. Creatures of evil who serve the Nightlords.

But the lords of shadow are not unopposed. There are creatures of light as well as creatures born from darkness but champion the light. These are the Nightbane. Ordinary people, many teenagers, able to shed their human facade and assume a supernatural alter ego. A monstrous, inhuman visage imbued with superhuman power and the stuff of magic. Written by C.J. Carella. • \$24.95 – 240 pages.

## Beyond the Supernatural™ RPG

### A game of horror, mystery, & dark secrets

*BTS-2*™ is a stark, plausible reality where ghosts, demons, psychics, and magic are real, yet remain unknown to the world at large. Player characters are part of the secrets, part of the problems, and humanity's only true hope of dealing with the unexplained. Truly unique characters that will challenge and excite those who play them. New P.C.C.s include the Psychic Medium (and Spirit Guide), the Diviner and Autistic Psychic Savant, all with new and unique abilities. Characters like the Psychic Sensitive, Nega-Psychic and other original P.C.C.s get a face lift, new powers, and more details. The secrets of the supernatural, ESP, and magic revealed. • \$24.95 – 256 pages. Written by Kevin Siembieda and Randy McCall.

## Splicers® RPG

*Splicers*® is a new science fiction RPG set on a devastated world where machines rule, and human beings are vermin who are hunted and exterminated. The human struggle is complicated by a nano-virus that instantly turns metal objects touched by human flesh into killing machines. Consequently, humans have been forced to turn to organic technology to battle the world-dominating machines if they hope to reclaim any portion of their planet for themselves. Mega-Damage System – compatible with *Rifts*®, *Phase World*®, *Chaos Earth*™ and *Mechanoid Space*™. • \$23.95 – 224 pages. Written by Carmen Bellaire.

Palladium Books Inc.  
39074 Webb Court  
Westland, MI 48185

Free catalog upon request.  
[www.palladiumbooks.com](http://www.palladiumbooks.com)

Copyright 2014 Palladium Books Inc. All rights reserved, worldwide. Palladium Books®, Rifts®, Megaverse®, Nightbane®, The Mechanoids®, and After the Bomb® are registered trademarks of Palladium Books Inc. Heroes Unlimited, Ninjas & Superspies, Beyond the Supernatural, Splicers, and Rifts® Chaos Earth are trademarks owned and licensed by Palladium Books Inc.

# The Rifter® Subscription

**The Rifter®** is your doorway to unlimited imagination and numerous Palladium role-playing worlds. It offers new heroes, powers, weapons, magic and adventure for your games. It presents new villains, monsters and dangers to battle, and new ideas to consider.

It helps you unlock your imagination by showing you what gamers, just like *you*, have created. That's right, many of the articles and source material are written by ordinary gamers and fans like *you*. Other articles are by freelance writers and staff.

**The Rifter® is made for you, our fans.** Each issue presents unofficial (and sometimes official) source material, adventures, characters, monsters, villains, powers, weapons, equipment, ideas and fiction for **Rifts®**, **Chaos Earth®**, **Splicers®**, **Beyond the Supernatural™**, **Heroes Unlimited™**, **Ninjas & Superspies™**, **Palladium Fantasy RPG®**, **Nightbane®**, and/or any variety of other Palladium games and world settings. It's also a place where we test new ideas, and showcase new games, like *Dead Reign®* and the upcoming *Mechanoids® Space*.

It is also a way to get the latest news, coming attractions, and sneak previews of upcoming Palladium products, events and secret projects.

## Sourcebook

As a **sourcebook**, each issue of **The Rifter®** presents optional and/or official source material for a variety of Palladium's role-playing settings – **Rifts®**, **Phase World®**, **Palladium Fantasy RPG®**, **Heroes Unlimited™**, **Nightbane®**, **Beyond the Supernatural™**, and other titles such as **After the Bomb®**, **Ninjas & Superspies™**, **Rifts® Chaos Earth®**, **Splicers®**, and others. Every issue includes material for 3-6 different Palladium RPG lines.

## Magazine

As a **magazine**, each issue includes the latest news and goings on at Palladium Books, information on new product, our schedule of releases, convention appearances, special offers, and even sneak previews and extra “official” material for new Palladium games or sourcebooks.

## Talent Show

**The Rifter** is unlike anything on the market because it is a way for *you*, the fan, the unpublished writer and hopeful young artist to get published and break into the industry.

No other game company does that, so take advantage of the opportunity to see *your* work and *your* name in print! You'll get a small payment (about \$10 per printed page of text), four free copies of the issue your work appears in, and bragging rights to all your friends. Best of all, you get to share your ideas with thousands of other Palladium gamers.

Think it can't happen to you? Think again. Many of Palladium's artists and writers got started in **The Rifter®**, including *Apollo Okamura*, *Brian Manning*, *Mike Mumah*, *Carl Gleba*, *Todd Yoho*, *Brandon Aten*, *Taylor White*, *Jason Richards*, and *many others*.

Palladium is always looking for written material for **Rifts®**, **Chaos Earth®**, **Beyond the Supernatural™**, **Nightbane®**, **Palladium Fantasy RPG®**, **Heroes Unlimited™**, **Ninjas & Superspies™**, **After the Bomb®**, and all our game lines. We'd also like to see cartoons and comic strips.

Send your “article/source material” (5-30 pages) or art samples (photocopies, never original art), to *The Rifter® Submissions Dept*, 39074 Webb Court, Westland, MI 48185.

## Subscribe Today

### Lock in the current price and discount

The price of **The Rifter®** is \$13.95 retail (a steal for 96 pages of RPG source material and adventures), but a subscription saves you even more money, and you have the convenience of delivery right to your door. All prices are in U.S. dollars.

- **\$39.80 – that's only \$9.95 each**, a savings of \$16, and Palladium picks up the shipping cost. **Note:** This rate is *limited* to subscribers in the USA only.
- **\$61.80 – Canada.** Our apologies, but Palladium Books can no longer cover the increased cost of postage to other countries. We hope you understand.
- **\$75.80 – Overseas:** Overseas subscriptions *are* charged an additional fee for overseas shipping costs. Sorry. We are only passing along the additional postage costs, but it is hefty. Our apologies.
- **Free Shipping anywhere in the USA.**
- **Great Savings.**
- **A Megaverse® of adventure and fun.**
- **How to order.** *Send mail orders* with a check or money order (for \$39.80 in the USA) to:

**The Rifter® Subscription Dept.**  
**39074 Webb Court**  
**Westland, MI 48185**

Credit Card Orders: Can be made on our web site ([www.palladiumbooks.com](http://www.palladiumbooks.com)) or by telephone 734-271-2903 (this is an order line *only*).

Check or Money Orders: Send them to the address above with a note indicating which issue number you want your subscription to start.

**Please indicate what issue number you'd like your subscription to start** (i.e., last issue, current issue, next issue, or when your current subscription ends).

This offer is good till December 31, 2017.

© Copyright 2012 Palladium Books Inc.

[www.palladiumbooks.com](http://www.palladiumbooks.com)





# RIFTS®

- Imagine Earth transformed into an alien landscape.
- Humans exist – barely. And we are not alone.
- Aliens and monsters emerge from the Rifts – holes torn in the fabric of space and time, connected to countless worlds and realities.
- Ancient gods, demons and magic have returned.
- Magic and technology clash.
- Hundreds of character classes, many inhuman.
- *Rifts® Ultimate Edition* is the core RPG rule book.
- Expansive world setting with 90+ sourcebooks to draw upon.
- Rifts®, your portal to endless adventure.
- Limited only by your imagination.

[www.palladiumbooks.com](http://www.palladiumbooks.com)

© 2014 Palladium Books. Rifts®, Megaverse®, Nightbane® and other titles, slogans and likenesses are trademarks of Palladium Books, Inc. Palladium Books - 39074 Webb Court, Westland, MI 48185 USA - 734-271-2903 order line.

## Other RPG Worlds from Palladium Books®:

- *Rifts®* – the ultimate role-playing experience.
- *Rifts® Chaos Earth®* – Play the apocalypse as it happens.
- *Splicers®* – Weird science. Bio-tech battles insane robot legions.
- *Robotech® RPG* – All eras of the TV show brought to life.
- *Dead Reign™ RPG* – Can you survive the Zombie Apocalypse?
- *Palladium Fantasy RPG®* – Unique world, monsters as player characters, magic and more.
- *Heroes Unlimited™ RPG* – Play any hero; mutants, aliens, cyborgs, superhumans, mages, immortals and more.
- *Nightbane® RPG* – Conspiracy, magic, horror and monsters.
- *Beyond the Supernatural™ RPG* – Modern horror and suspense.
- *Ninjas and Superspies™*, and more.



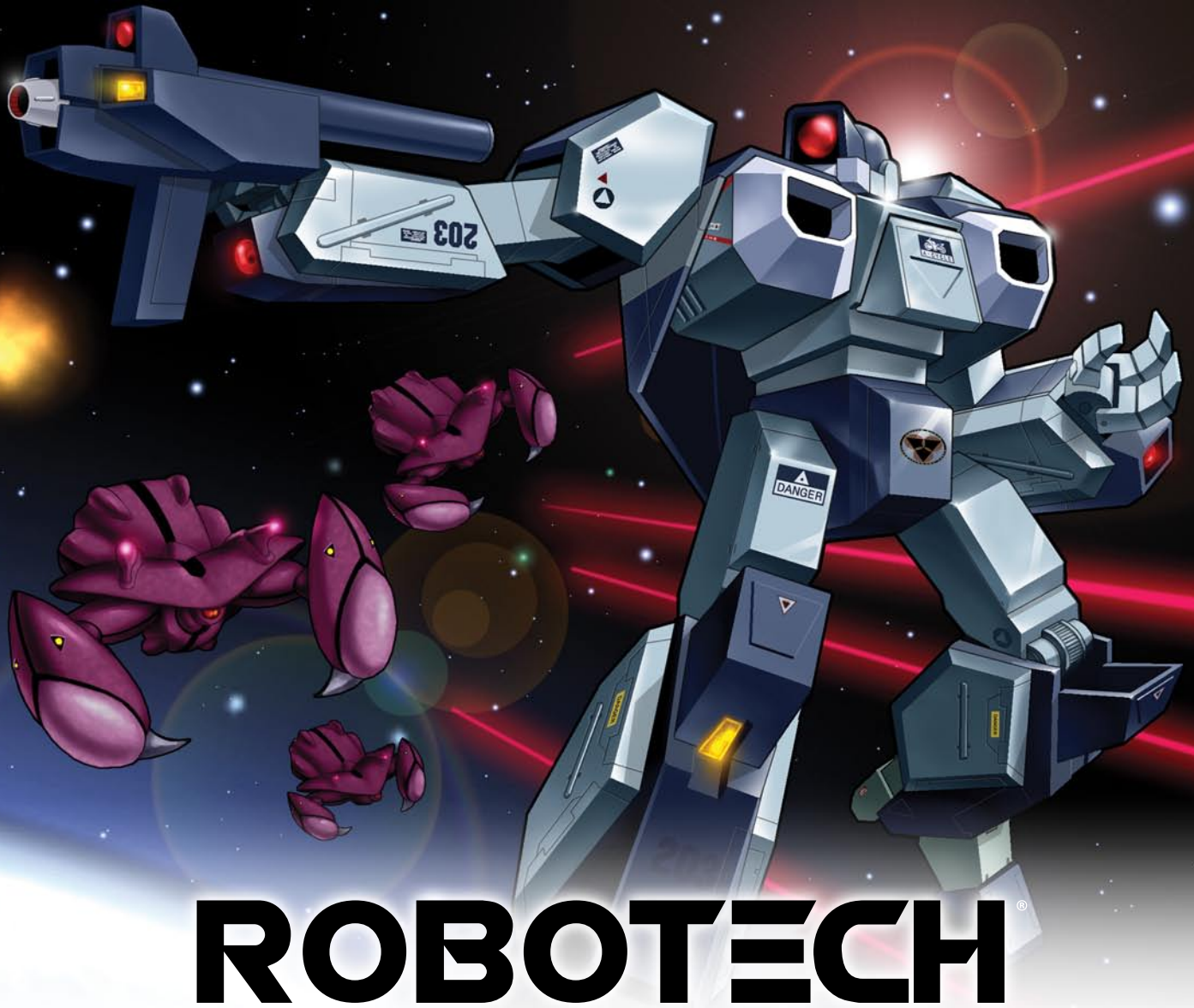

# ROBOTECH®

## Role-Playing Game and Sourcebooks

- **Four generations of heroes and mecha** • **Giant transformable robots** • **Alien invaders** • **Battle for control of the Earth** • **Combat takes to the stars** • **All presented in a core rule book and dynamic set of epic sourcebooks** • **Easy to learn** • **Fun to play** • **Quick character generation** • **Fast combat** • **Captures the action and adventure of the anime TV series** • **Isn't it time you joined the adventure?**

### Robotech® "Core Rules" – Shadow Chronicles® RPG Hardcover

All the rules and information a player needs to start a Robotech® role-playing campaign with Admiral Rick Hunter and the United Earth Expeditionary Force trekking across the galaxy.

- Human mecha: Alphas, Betas, Cyclones & much more.
- Five character classes. 25 different Military Specialties.
- Invid mecha, Haydonites, and alien enemies.
- Quick roll character tables. Make a character in 15 minutes.
- A complete, stand-alone RPG.
- 224 pages. Cat. No. 550HC. 8½ x 11 size, hardcover.

### Robotech®: The Macross® Saga Sourcebook – Cat. No. 551

A treasure chest packed with the iconic mecha, vehicles, weapons and characters that made Robotech® famous. Valkyries, Destroyers, ground vehicles, aircraft, spacecraft, weapons, Zentraedi soldiers, Zentraedi mecha, alien invaders, heroes, villains, and more.

- All the iconic Macross mecha, vehicles, weapons & characters.

[www.palladiumbooks.com](http://www.palladiumbooks.com)

### Robotech®: The Masters Saga™ Sourcebook – Cat. No. 552

Tons of never before seen stats and descriptions for the many weapons, armor, mecha and robots of the Army of the Southern Cross.

- The Army of the Southern Cross™ – all 15 branches and their mecha!

### Robotech®: New Generation™ Sourcebook – Cat. No. 554

The battle for the liberation of Earth starts here.

- Kit-bashed mecha combining parts from different mecha.
- Invid Hives, world overview, key characters and adventure ideas.

### Robotech®: Genesis Pits™ Sourcebook – Cat. No. 555

The Invid Genesis Pits, their purpose, function.

- Inorganics and other war machines of the Invid Regent.
- Genesis Pit mutations and monsters.

### Robotech®: Expeditionary Marines Sourcebook – Cat. No. 553

Join the UEEF (United Earth Expeditionary Force) led by Admiral Rick Hunter as they travel across the galaxy liberating planets from the bondage of the Invid Regent, the Robotech Masters and other tyrants.

- New mecha, weapons, and character classes of the UEEF Marines.
- New alien species and allies. Planet hopping and more.





# ROBOTECH

RPG TACTICS™

## Main Boxed Game – Cat. No. 55100 – Available Now!

A fast-paced, strategy battle game that captures the speed and action of Robotech®. Play Earth defenders or Zentraedi invaders.

- Scalable from small squad skirmishes to mass battles.
- Turn-based system of play and uses D6. Two or more players.
- 34 highly detailed game pieces. 6mm scale.
- 112 page color rule book with paint guide and index.
- 53 laminated, color game cards.
- 24 custom dice, two decal sheets and more.
- Assembly and painting required. Glue not included.
- \$99.95 retail – Cat. No. 55100 – shipping now!
- Available in North and South America, the EU, Australia & New Zealand.

**Note:** Each product contains plastic game pieces requiring assembly and painting. Glue not included. This is not a toy. Small parts, not suitable for children under the age of 13. Adult supervision advised. Images shown here are not to scale.



### UEDF Valkyrie Wing™ – Cat. No. 55201

Build your fleet of Earth defenders with the Valkyrie Veritech Fighter; six game pieces total. **\$36.95 retail.**

- 2 Valkyries in Fighter mode.
- 2 Valkyries in Guardian mode.
- 2 Valkyries in Battloid mode.
- Multiple heads for making the VF-1A, VF-1J, VF-1R & VF-1S.



### UEDF Tomahawk/Defender Destroids™ – Cat. No. 55202

Expand your Destroid squad with these formidable walking tanks; four game pieces total. **\$32.95 retail.**

- 2 Tomahawk Destroids – the main battle tank of Destroids, brimming with powerful particle beam cannons for arms, and wielding a battery of missiles and an array of other weapons.
- 2 Defender Destroids – a long-range, anti-aircraft juggernaut capable of shooting down incoming Zentraedi Battlepods and Gnerl Fighters.



### UEDF Spartan/Phalanx Destroids™ – Cat. No. 55203

Add some long-range power and up-close punch to your army with these valuable Destroids; four game pieces total. **\$32.95 retail.**

- 2 Spartan Destroids – civil defense, riot control and deadly in hand to hand combat.
- 2 Phalanx Destroids – a walking, long-range missile artillery unit.



### Zentraedi Regult Battlepods™ – Cat. No. 55401

Expand your Zentraedi forces with their main infantry battle mecha; six game pieces total. **\$36.95 retail.**

- 6 Regult Tactical Battlepods – the lightning quick Regults, armed with a pair of particle cannons and auto-cannons, attack in wave after wave.



### Zentraedi Artillery Battlepods™ – Cat. No. 55402

Give your Zentraedi legion greater firepower with these artillery and support Battlepods; four game pieces total. **\$36.95 retail.**

- 4 Zentraedi Support Battlepods, each of which can be made into:
    - Gluuhaug-Regult – Light Artillery Battlepod
    - Serauhaug-Regult – Heavy Artillery Battlepod
    - Telnesta-Regult – Experimental Particle Beam Battlepod
- Four game pieces total.**



### Zentraedi Glaug Command™ – Cat. No. 55403

This diverse pack provides your Zentraedi forces with greater tactical capabilities; three game pieces total. **\$36.95 retail.**

- 1 Glaug Officer's Battlepod – the fast and deadly mecha of Zentraedi field leaders.
- 1 Quel-Regult Scout Battlepod – the stealthy eyes and ears of your Zentraedi battle force; electronic warfare capabilities.
- 1 Quel-Gulnau Recovery Pod – enhances the Glaug's ability to bring in Battlepod reinforcements. **Note:** This figure has NEVER before been offered by any company.





# Can YOU survive the Zombie Apocalypse?



## Dead Reign™ RPG

It is the aftermath of the *zombie apocalypse*. Civilization is gone, the dead reign, and the living fight to survive against impossible odds. Tales of zombies, human survival and horror as a fast-paced, easy to learn game and sourcebooks.

- **Zombie combat rules, vehicles and equipment.**
- **Six iconic Apocalyptic Character Classes and Ordinary People with 40+ occupations to choose from.**
- **Seven types of zombies plus the Half-Living.**
- **Secrets of the Dead and tips on fighting zombies.**
- **Death Cults, their Priests, power over zombies and goals.**
- **101 Random Scenarios, Encounters and Settings.**
- **100 Random Corpse Searches and other tables.**
- **Quick Roll Character Creation tables (10 minutes).**
- **A complete role-playing game by Siembieda and others.**
- **\$22.95 retail – 224 pages – Cat. No. 230. Available now.**

## Civilization Gone™

### Dead Reign™ Sourcebook One

It has been months since the dead rose to attack the living. Civilization has crumbled. There is no army, no government, no help coming. You are on your own and things are only getting worse.

- **Madmen and Psychopaths including the *Zombie Master, Ghost Walker, Backstabber, Messianic Leader, Zombie Lover, Deathbringer* and others.**
- **Bandits and Raiders who prey upon other survivors.**
- **Street Gang Protectors and their mission to save lives.**
- **Phobia and Obsession tables. Many adventure ideas.**
- **House and home resource and encounter tables.**
- **Random encounter and survivor camp creation tables.**
- **Additional world information and survival advice.**
- **\$12.92 retail – 64 pages – Cat. No. 231. Available now.**

## Dark Places™

### Dead Reign™ Sourcebook Two

Secrets of survival, including using railroad tracks and the urban underground to travel unseen and undetected by zombies.

- **Worm Meat, Bug Boy, Sewer Crawler and Impersonator Zombies.**
- **“Live Bait” zombie lures with human beings as bait.**
- **Traveling the rails and boxcar encounter tables.**
- **Traveling sewer tunnels, steam tunnels & other dark places.**
- **The pitfalls and dangers of the urban underground.**
- **Diseases, infection and additional world information.**
- **Random encounter tables, boxcar content tables, and more.**
- **\$12.92 retail – 64 pages – Cat. No. 232. Available now.**

## Endless Dead™

### Dead Reign™ Sourcebook Three

The zombie hordes grow in number and strangeness. Can humankind survive? Where is the military?

- **New types of zombies like Fused Zombies and Walking Mass Grave.**
- **New O.C.C.s including Wheelman and Zombie Hunter.**
- **Info & tables for weaponizing vehicles and vehicle combat rules.**
- **Random encounter tables for military bases, police stations, gun stores, buildings, suburbs, industrial parks, small towns, farmland and wilderness.**
- **Tables to make Survivor caravans, hideouts, Safe Havens & more.**
- **Timetable for setting zombie campaigns & many adventure ideas.**
- **\$16.95 retail – 96 pages – Cat. No. 233. Available now.**



## Other horror titles from Palladium Books®

Fear the Reaper™

Graveyard Earth™

Beyond the Supernatural™ RPG

Nightbane® RPG series

© Copyright 2012 Palladium Books Inc. All rights reserved. Rifts®, Palladium Books®, Megaverse®, Nightbane®, Heroes Unlimited, Dead Reign and other published book titles, names, slogans and likenesses are trademarks of Palladium Books Inc.

[www.palladiumbooks.com](http://www.palladiumbooks.com)

# Palladium Books® Check List & Order Form

Dept. P-16, 39074 Webb Court, Westland, MI 48185

Name: \_\_\_\_\_ Address: \_\_\_\_\_

City: \_\_\_\_\_ State: \_\_\_\_\_ Zip/Postal Code: \_\_\_\_\_ Country: \_\_\_\_\_

Credit Card Number: \_\_\_\_\_ Expiration Date: \_\_\_\_\_  Visa  MasterCard

Telephone Number: \_\_\_\_\_ Signature: \_\_\_\_\_  AMEX  Other

## The Rifter® Series

- \_\_\_ 170 The Rifter® #70 – \$13.95
- \_\_\_ 171-172 The Rifter® #71 & 72 – \$24.95
- \_\_\_ 173 The Rifter® #73 – \$13.95
- \_\_\_ 174 The Rifter® #74 – \$13.95
- \_\_\_ 175 The Rifter® #75 – \$13.95
- \_\_\_ 176 The Rifter® #76 – \$13.95 (Fall)

## Splicers®

- \_\_\_ 200 Splicers® RPG – \$23.95
- Note: Sourcebooks coming soon.

## Dead Reign®

- \_\_\_ 230 Dead Reign® RPG – \$22.95
- \_\_\_ 231 SB 1: Civilization Gone™ – \$12.95
- \_\_\_ 232 SB 2: Dark Places™ – \$12.95
- \_\_\_ 233 SB 3: Endless Dead™ – \$16.95
- \_\_\_ 234 SB 4: Fear the Reaper™ – \$12.95
- \_\_\_ 235 SB 5: Graveyard Earth™ – \$12.95
- \_\_\_ 236 SB 6: Hell Followed™ – \$20.95 (coming)

## Rifts® Novels

- \_\_\_ 301 Sonic Boom™ – \$9.95
- \_\_\_ 302 Deception's Web™ – \$9.95
- \_\_\_ 303 Treacherous Awakenings™ – \$9.95
- \_\_\_ 304 Tales of the Chi-Town 'Burbs™ – \$12.95
- \_\_\_ 305 Rifts® Path of the Storm™ – Screen-play & Sourcebook – \$12.95

## Weapons Books

- \_\_\_ 401 Weapons and Armor™ – \$8.95
- \_\_\_ 402 Weapons and Castles™ – \$8.95
- \_\_\_ 403 Weapons and Assassins™ – \$8.95
- \_\_\_ 404 Weapons & Castles of the Orient™ – \$8.95

## Palladium Fantasy RPG®

- \_\_\_ 450 The Palladium Fantasy RPG® – \$26.95
- \_\_\_ 4500HC Palladium Fantasy RPG® 30th Anniversary Hardcover – \$50.00
- \_\_\_ 451 Dragons & Gods™ – \$24.95
- \_\_\_ 453 Old Ones™ 2nd Ed. – \$24.95
- \_\_\_ 454 Monsters & Animals™ 2nd Ed. – \$24.95
- \_\_\_ 455 Adventures on the High Seas™ – \$24.95
- \_\_\_ 458 Island at the Edge of the World™ – \$20.95
- \_\_\_ 459 Yin-Sloth Jungles™ – \$20.95
- \_\_\_ 462 Western Empire™ – \$24.95
- \_\_\_ 463 Baalgor Wastelands™ – \$24.95
- \_\_\_ 464 Mount Nimro™ – \$20.95
- \_\_\_ 465 Eastern Territory™ – \$24.95
- \_\_\_ 466 Library of Bletherad™ – \$20.95
- \_\_\_ 467 Northern Hinterlands™ – \$24.95
- \_\_\_ 468 Land/Damned 1: Chaos Lands™ – \$24.95
- \_\_\_ 469 LoD 2: Eternal Torment™ – \$24.95
- \_\_\_ 470 LoD 3: The Citadel – \$24.95 (coming)
- \_\_\_ 471 Wolfen Empire™ – \$20.95
- \_\_\_ 472 Mysteries of Magic™ One: Heart of Magic – \$16.95
- \_\_\_ 474 Bizantium/Northern Islands™ – \$20.95
- \_\_\_ 475 Garden of the Gods™ – \$12.95 (coming)

## Heroes Unlimited™ / After the Bomb®

- \_\_\_ 500-2 Heroes Unlimited™, 2nd Ed. – \$26.95
- \_\_\_ 5000HC Heroes Unlimited™ 30th Anniversary Hardcover – \$50.00
- \_\_\_ 501 Villains Unlimited™ Revised – \$24.95
- \_\_\_ 503 After the Bomb® RPG – \$24.95
- \_\_\_ 505 Road Hogs™ (After the Bomb® II) – \$9.95
- \_\_\_ 507 Mutants Down Under™ (AB III) – \$9.95
- \_\_\_ 511 Mutants of the Yucatan™ (AB IV) – \$9.95
- \_\_\_ 513 Mutants in Avalon™ (AB V) – \$16.95
- \_\_\_ 514 Mutants in Orbit™ (AB VI) – \$16.95
- \_\_\_ 515 Aliens Unlimited™ – \$24.95
- \_\_\_ 516 Heroes Unlimited™ G.M.'s Guide – \$24.95
- \_\_\_ 517 Century Station™ – \$24.95
- \_\_\_ 518 Gramercy Island™ – \$24.95
- \_\_\_ 519 Aliens Unlimited Galaxy Guide™ – \$24.95
- \_\_\_ 520 Mutant Underground™ – \$16.95
- \_\_\_ 521 Powers Unlimited® One – \$16.95
- \_\_\_ 522 Powers Unlimited® Two – \$16.95
- \_\_\_ 523 Powers Unlimited® Three – \$16.95
- \_\_\_ 525 Revised Ninjas & Superspies™ – \$20.95
- \_\_\_ 526 Mystic China™ – \$24.95
- \_\_\_ 527 Armageddon Unlimited™ – \$20.95

## Robotech® RPG

- \_\_\_ 550 Robotech® The Shadow Chronicles® RPG (manga size) – \$16.95
- \_\_\_ 550HC Robotech® The Shadow Chronicles® Deluxe Hardcover RPG – \$30.95
- \_\_\_ 5500HC Robotech® The Shadow Chronicles® Gold Ed. Hardcover RPG – \$70.00
- \_\_\_ 551 Robotech® Macross® Saga Sourcebook – \$16.95
- \_\_\_ 552 Robotech® The Masters Saga™ Sourcebook (NEW in 8½ x 11) – \$20.95
- \_\_\_ 553 Robotech®: Expeditionary Force Marines Sourcebook – \$20.95
- \_\_\_ 554 Robotech® The New Generation™ Sourcebook – \$16.95
- \_\_\_ 555 Robotech® Genesis Pits Sourcebook – \$16.95

## Robotech® RPG Tactics™ (New!)

- \_\_\_ 55100 Robotech® RPG Tactics™ – \$99.95
- \_\_\_ 55105 Robotech® RPG Tactics™ Rulebook – \$20.00
- \_\_\_ 55101 UEDF Dice Pack – \$12.00
- \_\_\_ 55102 Zentraedi Dice Pack – \$12.00
- \_\_\_ 55201 UEDF Valkyrie Wing – \$36.95
- \_\_\_ 55202 UEDF Destroid Pack – \$32.95
- \_\_\_ 55203 UEDF Spartan Pack – \$32.95
- \_\_\_ 55401 Zentraedi Regult Battlepods – \$36.95
- \_\_\_ 55402 Zentraedi Artillery Battlepods – \$36.95
- \_\_\_ 55403 Zentraedi Glaug Command – \$36.95

## Rifts® Chaos Earth®

- \_\_\_ 660 Rifts® Chaos Earth® RPG – \$20.95
- \_\_\_ 661 Rifts® CE Creatures of Chaos™ – \$12.95
- \_\_\_ 662 Rifts® CE The Rise of Magic™ – \$12.95
- \_\_\_ 665 Rifts® Chaos Earth® First Responders™ – \$16.95 (coming)
- \_\_\_ 666 Rifts® Chaos Earth® Resurrection™ – \$20.95

## Beyond the Supernatural™

- \_\_\_ 700 Beyond the Supernatural™, 2nd Ed. – \$24.95
- \_\_\_ 702 Tome Grotesque™ – \$20.95 (coming)
- \_\_\_ 703 Beyond Arcanum™ – \$24.95 (coming)

## Nightbane®

- \_\_\_ 730 Nightbane® RPG – \$24.95
- \_\_\_ 731 Nightbane®: Between the Shadows™ – \$20.95
- \_\_\_ 732 Nightbane®: Nighlands™ – \$20.95
- \_\_\_ 733 Nightbane®: Through the Glass Darkly™ – \$20.95
- \_\_\_ 735 Nightbane® Survival Guide™ – \$20.95

## Rifts®

- \_\_\_ 800HC Rifts® RPG Ultimate Edition – \$39.95
- \_\_\_ 801 Rifts® Sourcebook One Revised – \$20.95
- \_\_\_ 802-E Rifts® World Book 1: Vampire Kingdoms™, Revised – \$24.95
- \_\_\_ 803 Rifts® Conversion Book One™ – \$24.95
- \_\_\_ 804 Rifts® WB 2: Atlantis™ – \$20.95
- \_\_\_ 805 Rifts® Sourcebook 2: Mechanoids™ – \$16.95
- \_\_\_ 807 Rifts® WB 3: England™ – \$20.95
- \_\_\_ 808 Rifts® WB 4: Africa™ – \$20.95
- \_\_\_ 809 Rifts® Dimension Book 1: Wormwood™ – \$20.95
- \_\_\_ 810 Rifts® WB 5: Triax™ – \$24.95
- \_\_\_ 811 Rifts® Pantheons of the Megaverse® – \$24.95
- \_\_\_ 812 Rifts® Sourcebook 3: Mindwerks™ – \$16.95
- \_\_\_ 813 Rifts® Mercenaries™ – \$20.95
- \_\_\_ 814 Rifts® WB 6: South America™ – \$20.95
- \_\_\_ 815 Rifts® WB 7: Underseas™ – \$24.95
- \_\_\_ 816 Rifts® DB 2: Phase World® – \$24.95
- \_\_\_ 817 Rifts® DB 3: Phase World® Sourcebook – \$16.95
- \_\_\_ 818 Rifts® WB 8: Rifts® Japan™ – \$24.95
- \_\_\_ 819 Rifts® WB 9: South America Two™ – \$24.95
- \_\_\_ 820 Rifts® WB 10: Juicer Uprising™ – \$20.95
- \_\_\_ 821 Rifts® WB 11: Coalition War Campaign™ – \$24.95

- \_\_\_ 822 Rifts® WB 12: Psyscape™ – \$20.95  
 \_\_\_ 825 Rifts® WB 13: Lone Star™ – \$20.95  
 \_\_\_ 826 Rifts® WB 14: New West™ – \$24.95  
 \_\_\_ 827 Rifts® WB 15: Spirit West™ – \$24.95  
 \_\_\_ 828 Rifts® Sourcebook 4: Coalition Navy™ – \$16.95  
 \_\_\_ 829 Rifts® WB 16: Federation of Magic™ – \$20.95  
 \_\_\_ 830 Rifts® DB 4: Skraypers™ – \$20.95  
 \_\_\_ 831 Rifts® Index Volume Two™ – \$16.95  
 \_\_\_ 832 Rifts® WB 17: Warlords of Russia™ – \$24.95  
 \_\_\_ 833 Rifts® WB 18: Mystic Russia™ – \$20.95  
 \_\_\_ 834 Rifts® WB 19: Australia 1 – \$24.95  
 \_\_\_ 835 Rifts® WB 20: Canada™ – \$24.95  
 \_\_\_ 836 Rifts® WB 21: Splynn Dimensional Market™ – \$24.95  
 \_\_\_ 837 Rifts® WB 22: Free Quebec™ – \$24.95  
 \_\_\_ 838 Rifts® WB 23: Xiticix Invasion™ – \$20.95  
 \_\_\_ 839 Rifts® Coalition Wars®: Sedition™ – \$20.95  
 \_\_\_ 840 Rifts® Coalition Wars®: Coalition Overkill™ – \$16.95  
 \_\_\_ 841 Rifts® Coalition Wars®: Sorcerers' Revenge™ – \$16.95  
 \_\_\_ 842 Rifts® Coalition Wars®: Cyber-Knights™ – \$16.95  
 \_\_\_ 843 Rifts® Coalition Wars®: Shadows of Evil™ – \$16.95  
 \_\_\_ 844 Rifts® Coalition Wars®: Final Siege™ – \$24.95  
 \_\_\_ 845 Rifts® Game Master Guide™ – \$26.95  
 \_\_\_ 846 Rifts® Aftermath™ – \$24.95  
 \_\_\_ 847 Rifts® DB5: Anvil Galaxy™ – \$20.95  
 \_\_\_ 848 Rifts® Book of Magic™ – \$26.95  
 \_\_\_ 849 Rifts® Adventure Guide™ – \$24.95  
 \_\_\_ 850 Rifts® Bionics Sourcebook™ – \$16.95  
 \_\_\_ 851 Rifts® DB 6: Three Galaxies™ – \$20.95  
 \_\_\_ 852 Rifts® Dark Conversions™ – \$24.95  
 \_\_\_ 853 Rifts® Chi-Town 'Burbs™ – \$9.95  
 \_\_\_ 854 Rifts® The Tolkien Crisis™ – \$12.95  
 \_\_\_ 855 Rifts® The Black Vault™ – \$9.95  
 \_\_\_ 856 Rifts® The Vanguard™ – \$9.95  
 \_\_\_ 857 Rifts® WB 24: China One™ – \$20.95  
 \_\_\_ 858 Rifts® WB 25: China Two™ – \$20.95  
 \_\_\_ 859 Rifts® DB 7: Megaverse Builder™ – \$16.95  
 \_\_\_ 860 Rifts® DB 8: Naruni Wave Two™ – \$16.95  
 \_\_\_ 862 Rifts® WB 26: Dinosaur Swamp™ – \$20.95  
 \_\_\_ 863 Rifts® MercTown™ – \$20.95  
 \_\_\_ 865 Rifts® Merc Ops™ – \$20.95  
 \_\_\_ 866 Rifts® WB 27: Adventures in Dinosaur Swamp™ – \$20.95  
 \_\_\_ 867 Rifts® Mercenary Adventure Sourcebook – \$12.95  
 \_\_\_ 868 Rifts® WB 28: Arzno™ – \$20.95  
 \_\_\_ 869 Rifts® WB 29: Madhaven™ – \$16.95  
 \_\_\_ 870 Rifts® John Zeleznik Coloring Book – \$5.95  
 \_\_\_ 871 Rifts® Machinations of Doom™ – \$18.95  
 \_\_\_ 872 Rifts® DB 10: Hades™ – \$24.95  
 \_\_\_ 873 Rifts® DB 11: Dyval™ – \$24.95  
 \_\_\_ 874 Rifts® WB 30: D-Bees of North America™ – \$24.95  
 \_\_\_ 875 Rifts® DB12: Dimensional Outbreak – \$24.95  
 \_\_\_ 876 Rifts® Megaverse® in Flames™ – \$24.95  
 \_\_\_ 876HC Rifts® Megaverse® in Flames™ Gold Hardcover Edition – \$50.00  
 \_\_\_ 877 Rifts® Heroes of the Megaverse® – \$16.95  
 \_\_\_ 878 Rifts® Sourcebook: Shemarrian Nation™ – \$16.95  
 \_\_\_ 880 Phase World®: Fleets of the Three Galaxies™ – \$16.95  
 \_\_\_ 881 Rifts® WB 31: Triax™ Two – \$24.95  
 \_\_\_ 883 Rifts® DB 14: Thundercloud Galaxy™ – \$20.95  
 \_\_\_ 884 Rifts® Vampires Sourcebook™ – \$20.95  
 \_\_\_ 885 Rifts® WB 32: Lemuria™ – \$24.95  
 \_\_\_ 886 Rifts® Black Market™ – \$24.95  
 \_\_\_ 886HC Rifts® Black Market™ Hardcover Gold Edition – \$60.00  
 \_\_\_ 887 Rifts® WB 33: Northern Gun™ One – \$24.95  
 \_\_\_ 888 Rifts® WB 34: Northern Gun™ Two – \$26.95  
 \_\_\_ 889 Rifts® Sourcebook: Coalition States, Heroes of Humanity™ – \$20.95  
 \_\_\_ 890 Rifts® World Book: Secrets of the Atlanteans™ – \$24.95 (coming)  
 \_\_\_ 891 Rifts® World Book: Sovietski™ – \$24.95 (coming)  
 \_\_\_ 892 Rifts® Sourcebook: The Disavowed™ – \$16.95 (coming)  
 \_\_\_ 893 Rifts® CS: Heroes of Humanity™ Arsenal Sourcebook – \$16.95 (coming)  
 \_\_\_ 894 Rifts® Haunted Tech™ – \$16.95 (coming)  
 \_\_\_ 2510 Rifts® & The Megaverse® Art Book – \$22.95  
 \_\_\_ 2510-HC Rifts® & The Megaverse® Art Book, Hardcover – \$50.00  
 \_\_\_ 2510-CML Rifts® & The Megaverse® Art Book, Collector's Masterwork Edition – \$125.00
- Miscellaneous Products**  
 \_\_\_ 600 Deluxe Revised RECON® RPG – \$22.95  
 \_\_\_ 2537 Gamer Coffee Mug – \$10.00  
 \_\_\_ 2539 Rifts® Dice Bag – Black – \$8.00  
 \_\_\_ 2545 Dead Reign™ Coffee Mug – \$10.00  
 \_\_\_ 2554 Palladium Bookmarks, Set One – \$5.00  
 \_\_\_ 2555 Palladium Bookmarks, Set Two – \$5.00  
 \_\_\_ 2561 Property of Chi-Town Library Pencil – \$0.50 each  
 \_\_\_ 2562 Future Visions™ – The Artistry of Charles Walton II – \$13.95  
 \_\_\_ 2566 Glitter Boy Mouse Pad – \$9.95  
 \_\_\_ 2567 Old Ones Mouse Pad – \$9.95  
 \_\_\_ 2568 Zombie Graveyard Mouse Pad – \$9.95
- Note:** T-shirts and other products can be found online: [www.palladiumbooks.com](http://www.palladiumbooks.com)
- Rifts® Miniatures**  
 \_\_\_ MI8002 Xiticix Pack – \$18.00  
 \_\_\_ MI8004 Coalition Dog Pack – \$18.00  
 \_\_\_ MI8005 Men of Magic Pack #1 – \$18.00  
 \_\_\_ MI8006 Cyborgs Pack #1 – \$18.00  
 \_\_\_ MI8007 Simvan & Ostrosaurus Pack – \$18.00  
 \_\_\_ MI8008 Coalition Skelebots Pack #1 – \$18.00  
 \_\_\_ MI8009 Coalition SAMAS Pack #1 – \$22.00  
 \_\_\_ MI8010 Coalition Sky Cycle Pack – \$22.00  
 \_\_\_ MI8011 Coalition Dog Pack #2 – \$18.00  
 \_\_\_ MI8015 Damaged Skelebots Pack #1 – \$12.00  
 \_\_\_ MI8016 Cyber-Adventurers Pack – \$18.00  
 \_\_\_ MI8017 Rogues & Scout Pack #1 – \$18.00  
 \_\_\_ MI8018 Brodkil & Witchling Pack – \$18.00  
 \_\_\_ MI8019 Damaged Skelebots Pack #2 – \$18.00  
 \_\_\_ MI8020 Psi-Stalkers & Scouts Pack #1 – \$18.00  
 \_\_\_ MI8021 Shadow Beast – \$12.00  
 \_\_\_ MI8022 Mystic Knight – \$6.00  
 \_\_\_ MI8023 Lord Magus – \$6.00  
 \_\_\_ MI8024 High Magus – \$6.00  
 \_\_\_ MI8025 Coalition Psi-Stalker – \$6.00  
 \_\_\_ MI8026 Coalition Dog Boy in DPM-D1 Armor – \$6.00  
 \_\_\_ MI8027 Coalition Dog Boy #2 – \$6.00  
 \_\_\_ MI8028 Coalition Dog Boy #3 – \$6.00  
 \_\_\_ MI8029 Coalition Dog Boy #4 – \$6.00  
 \_\_\_ MI8030 Coalition Dog Boy #5 – \$6.00  
 \_\_\_ MI8031 Glitter Boy – \$20.00  
 \_\_\_ MI8032 Glitter Boy Pilot – \$6.00  
 \_\_\_ MI8033 Kydian Overlord – \$20.00  
 \_\_\_ MI8034 Dragonsaurus – \$10.00  
 \_\_\_ MI8035 Slaver and Slave (Atlantis) Set – \$10.00  
 \_\_\_ MI8036 Crazy – \$6.00  
 \_\_\_ MI8037 Juicer #1 – \$6.00  
 \_\_\_ MI8038 Juicer #2 – \$6.00  
 \_\_\_ MI8039 Cyborg #1 – \$12.00  
 \_\_\_ MI8040 Cyborg #2 – \$12.00  
 \_\_\_ MI8041 Cyborg #3 – \$6.00  
 \_\_\_ MI8042 Coalition Officer – \$6.00  
 \_\_\_ MI8043 Coalition Grunt #1 – \$6.00  
 \_\_\_ MI8044 Coalition Grunt #2 – \$6.00  
 \_\_\_ MI8045 Coalition Grunt #3 – \$6.00
- When placing an order by mail, please add money for shipping and handling.** Add \$5.00 for orders totaling \$1-\$50, \$10.00 for orders totaling \$51-\$95, and for orders totaling \$96-\$200 please add \$15.00 US. Double the amount for Canada, and *quadruple* it for overseas orders. For more shipping options, order online at [www.palladiumbooks.com](http://www.palladiumbooks.com). Allow 2-4 weeks for delivery. Make checks and money orders payable to: *Palladium Books*
- Check release dates for new products.** If the book you order has not been released yet, your order will be held as a backorder until the product is available. Please note that prices are subject to change without notice.
- Orders can also be placed by phone,** at (734) 721-2903 (order line only). Please have your credit card information when you call.
- [www.palladiumbooks.com](http://www.palladiumbooks.com)**



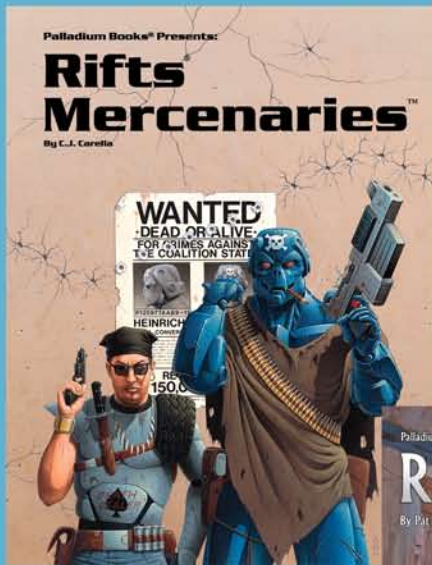

## Also from Palladium Books®

### Rifts® Mercenaries™

- Nine mercenary O.C.C.s; Thief, Spy, Bounty Hunter & more.
- Rules for creating mercenary companies.
- A half dozen merc companies and key characters.
- Tons of weapons and vehicles – Naruni, Iron Heart, Wellington, Northern Gun, Golden Age Weaponsmiths and others.
- 160 pages by C.J. Carella & Kevin Siembieda.

### Rifts® MercTown™

- 204 key locations – each an adventure idea.
- Street gangs, the Black Market, Thieves' Guild & more.
- Magic district and magic items.
- Adventure ideas by the hundreds, and more.
- 160 pages. Written by Nowak & Bellaire.

### Naruni Wave 2™

- Not even the Coalition could keep them away.
- New Naruni weapons, vehicles and equipment.
- New, wild Naruni power armor and drones.
- Molock Enforcers and background on the Naruni.
- 96 pages. Written by Nowak & Bellaire.

### Other Palladium RPGs

Beyond the Supernatural™ – horror  
Heroes Unlimited™ – super-heroes  
Ninjas & Superspies™, and more.  
Palladium Fantasy RPG®  
Nightbane® – horror and sci-fi  
Splicers® RPG – Mega-Damage setting  
Rifts® Chaos Earth® – how it all began

Join the adventure. Explore the Megaverse®

## Rifts® Merc Ops™

All the little extras a mercenary campaign might require: Job broker Merc Ops, bounties and how to collect on them, dealing with the Coalition States, preserving one's anonymity, merc missions, Techno-Wizard weapons, power armor, and scores of weapons and gear from Northern Gun, Golden Age Weaponsmiths, Wellington, MageFire and others.

- Mercenary Operations – missions and objectives.
- Job broker and middleman, Merc Ops, and its operations.
- Finding and collecting on bounties.
- Merc Ops' Ten Most Wanted and adventures to go with them.
- High-tech weapons and equipment from Northern Gun and others.
- S.D.C. weapons and gear from Golden Age Weaponsmiths.
- Techno-Wizard weapons and devices, and more.
- 160 pages written by Nowak, Bellaire and Siembieda.

Endless possibilities limited only by the imagination!™

\$20.95

Cat. No. 865

ISBN-10: 1-57457-109-5

ISBN-13: 978-1-57457-109-7

**Palladium  
Books Inc.®**

[www.palladiumbooks.com](http://www.palladiumbooks.com)