

Palladium Books® Presents:

RIFTS® BLACK MARKET™

By Matthew Clements, Kevin Siembieda & Carmen Bellaire



A Sourcebook for the Rifts® RPG

Warning!

Violence, War, Magic & the Supernatural

The fictional worlds of **Rifts**® are violent, deadly and filled with aliens, war and supernatural monsters. Other-dimensional beings often referred to as “demons,” torment, stalk and prey on humans. Alien life forms, monsters, vampires, ghosts, ancient gods and demigods, as well as magic, insanity, psychic powers and combat are all elements in this book. *All of it is fiction.*

Some parents may find the violence, magic and supernatural elements of the game inappropriate for young readers/players. We suggest parental discretion.

Please note that none of us at Palladium Books® condone or encourage the occult, the practice of magic, the use of drugs, or violence.



An epic sourcebook for the **Rifts**® series.

Compatible with the entire **Palladium Books**® **Megaverse**®.

Dedication from Matthew

To all the Palladium writers, artists and staff who came together to give us *Rifts® Black Market*. This book has grown and evolved into a huge resource full of incredible ideas and taken on a life of its own. And none of it would be possible without hard work from many different people. Everyone in the credits has my most sincere appreciation for the benefit of their unique perspective and experience. Without further ado, it is time for a visit to the wild and diverse criminal underground of Rifts Earth.

– Matthew Clements, 2012

Dedication from Kevin

To *Carmen Bellaire, Carl Gleba, Chuck Walton and Mark Dudley*, four friends of ours whose imaginations and energy are a constant source of inspiration to me.

– Kevin Siembieda

The cover, by *John Macdonnell*, depicts a Black Market Merchant selling weapons and contraband to a pair of mercenaries.

First Printing – August 2012

No part of this publication may be scanned, OCRed, reproduced or distributed in any way for electronic publication on the web/internet or any other medium.

Copyright 2012 Palladium Books Inc. & Kevin Siembieda

All rights reserved, worldwide, under the Universal Copyright Convention. No part of this book may be reproduced in part or whole, in any form or by any means, without permission from the publisher, except for brief quotes for use in reviews. All incidents, situations, institutions, governments and people are fictional and any similarity, without satiric intent, of characters or persons living or dead, is strictly coincidental.

Rifts®, The Rifter®, Megaverse®, The Mechanoids®, The Mechanoid Invasion®, Phase World®, Splicers®, Coalition Wars®, After the Bomb®, RECON®, Nightbane®, The Palladium Fantasy Role-Playing Game® and Palladium Books® are registered trademarks owned and licensed by Palladium Books Inc. and Kevin Siembieda.

Anti-Monster, Archie-Bot, Archie Three, Arzno, Baby Boom Gun, Boom Gun, Bandito Arms, BigBore, Bio-Armor, Biomancy, Biomancer, Bio-Constructs, Biomancer Gene-Mage, Bio-Wizard, Blind Warrior Women, 'Bot, 'Borg, 'Burb, Brodkil, Chaos Earth, Chicago Network, Chi-Town, City Rat, Coalition States, CS, Coalition State of El Dorado, Colorado Baronies, Combat Cyborg, Coming of the Rifts, Crazy, Cyber-Doc, Cyber-Knight, Dead Boy, Deluded Vampire, Doc Reid, Dog Boy, Dog Pack, Dinosaur Swamp, Dyna-Bot, E-Clip, Elementum, El Oculata, Emperor Prosek, Erin Tarn, Federation of Magic, Free Quebec, Gargoyle Empire, Glitter Boy, Great Cataclysm, Headhunter, Horune Pirates, Immaterial Hand, Ironmage, Juicer, Junk Crab, Lazlo, Lemurian, Le Marche Noir, Ley Line Walker, Lord Splynncryth, Madhaven, Magic Zone, Market Town, Master Vampire, Meran, Metztla, Mind Bleeder, Mind Melter, Naruni, Naruni Enterprises, Naut'Yll, NGR, New German Republic, New Navy, Northern Gun, Pecos Empire, Psi-Stalker, Psyscape, Psykes, Reid's Rangers, Rifts Earth, Rift Runner, Secondary Vampire, SAMAS, Shadow Boy, Shemarrian, Shifter, Simvan, Skelebot, Splynn Dimensional Market, Splugorth, Minions of Splugorth, Splugorth Slavers, Stone Magic, Stone Masters, Tattooed Man, Techno-Wizard, Tolkeen, Triax, True Atlantean, Undead Slayer, Vampire Kingdoms, Rifts® Game Master Guide, Rifts® Book of Magic, Rifts® Atlantis, Wild Vampires, Wilk's, Xiticix, Mega-Damage, M.D.C., S.D.C., I.S.P., P.P.E., and other names, titles, initials, characters, character likenesses, and slogans are trademarks owned and licensed by Kevin Siembieda and Palladium Books Inc.

Palladium Online: www.palladiumbooks.com – also visit us at [facebook.com/PalladiumBooks](https://www.facebook.com/PalladiumBooks)



Rifts® Black Market™ – A Rifts® Sourcebook is published by Palladium Books Inc., 39074 Webb Court, Westland, MI 48185-7606. Printed in the USA.

PALLADIUM BOOKS® PRESENTS:

RIFTS® BLACK MARKET™

A SOURCEBOOK FOR RIFTS®

Conceived by: **Matthew Clements**

Written by: **Matthew Clements**

Kevin Siembieda

Carmen Bellaire

Additional Writing & Ideas:

Taylor White

Julius Rosenstein

Alex Marciniszyn

Editors: **Alex Marciniszyn**

Wayne Smith

Kevin Siembieda

Proofreader: **Julius Rosenstein**

Cover Illustration: **John Macdonnell**

Interior Artists:

Amy L. Ashbaugh

Nicholas Bradshaw

Kevin Long

Allen Manning

Brian Manning

Michael Mumah

Benjamin Rodriguez

Charles "Chuck" Walton II

Art Direction: **Kevin Siembieda**

Typography and Layout: **Wayne Smith**

Based on the RPG rules, text, characters, settings, concepts and Megaverse® created by **Kevin Siembieda**.

Special Thanks to *Matthew Clements* for his efforts to expand upon the people and places of Rifts Earth; to *Carmen Bellaire* for unleashing his unparalleled imagination on a stockpile of new weapons, armor, vehicles and cool tech-designs including the Shadow Boy (what didn't make it in this book can be found in the *Northern Gun* books); to all of Palladium's incredible artists, *Chuck, Mike, Nick, Brian, Allen, Ben* and *Amy*, and to the Palladium crew, *Alex, Wayne, Kathy*, and *Julius* who work so hard to keep our organization going.

– *Kevin Siembieda, 2012*

Contents

The Black Market	8	El Oculta's Influence in Prisons	34
What is the Black Market?	8	Mercado, Market Town	34
Outlets	8	La Guarida	35
What does the Black Market do?	9	Adoncia Delafuente	36
The Black Market's Blueprint for Success	9	Carmen Delafuente	36
Contraband	9	Selena Delafuente	37
Criminal Enterprises	9	The Immaterial Hand	37
Smuggling Expertise	10	Immaterial Hand Contraband	37
Black Market Criminal Underbelly	10	The Market for Magic	39
Finding the Black Market	10	Specialists in the Art of Magic Smuggling	39
Market Towns	11	Spells used in smuggling	40
Random Black Market Contact Table	11	Dimensional Magic	41
Black Market Businesses	12	Nexus Hubs	41
Black Market Holdings in the West	12	Portal Overseers	41
Salvage and Scavenging	13	Contract Work	42
The Black Market's Relationships & Others	13	The Fist	42
The Atlantean Connection	13	Jacob Caine	42
Pirates of the Amazon	14	Ava Marcuse	42
The Verbrecher-Geschaeftsnetz	14	Yull Thundersworn	43
The Yakuza	15	Le Marche Noir	43
The Green Scarf Sect	15	Old Bones	45
The Black Market on Other Planets	15	Jean Robillard, Crime Boss	45
The Coalition States	15	Black Market Internal Structure	47
Smuggler Routes	15	Beware Favors	47
The Canadian Corridor and the Lake Route	16	D-Bees in the Black Market	48
The Texan Corridor	16	Black Market Etiquette	48
The Arkansas Corridor	17	Basic Rules of Etiquette	49
Other Smuggling Routes	17	Black Market Hierarchy	49
Magical Smuggling Methods	17	A Black Market Crew	50
Ships and Sea Traffic	18	Black Marketeers & Merchants	51
Black Market Factions	19	Security Within the Black Market	51
The Five Black Market Factions	19	Dealing with Authority	54
Bandito Arms	21	Passing Security Checkpoints	54
El Diablo and Area 51	21	Law Enforcement Encounter Table	54
Las Vegas	22	National Borders and Lawmen	55
"The Strip"	22	The Coalition States	56
The Jackpot	22	Encounters Within Coalition Territory	56
Old Las Vegas Suburbs	23	CS Frontiers & Remote Borders	56
Lake Mead & the Colorado River	23	CS Farmland & Lightly Populated Areas	58
Turner Collins	23	CS Cities, 'Burbs & Population Centers	58
Diablo Joe	24	CS Encounters Outside CS Territory	60
The Chicago Network	26	Black Market Activities Within the CS	61
Chi-Town Operations	26	Some Coalition Contraband	61
Contraband inside the fortress city	28	Books	61
Real Papers	29	Book Prices	62
Operations away from Chi-Town	29	Pre-Rifts Works of Art & Artifacts	63
Dealings with Large Corporations	30	Computer and Electronic Data	63
Chicago Network Executive Board	31	Knowledge Clubs	63
El Oculta	33	Coalition War Profiteering	64
Vampire Infiltration	33	Now Hiring	64
El Oculta & Human Trafficking	33	Job: Acquisitions Specialist	64
Feral Dog Boys	33	Job: Combat Medic	65
Simvan "Mule Trains"	34	Job: Courier	65

Job: Croupier	65	Black Market Banker	83
Job: Decoy	66	Case Man	85
Job: Defense Attorney/Representative	66	Con Artist	87
Job: Documentarian	66	Enforcer	89
Job: Drug Chemist	67	Expediter	91
Job: Entertainer	67	Information Broker	94
Job: Escort	67	Merchant	97
Job: Fence	68	Raider	99
Job: Hacker	68	Refurbisher	102
Job: Hit Man	68	Rift Runner	103
Job: Moonshiner	68	Black Market Sales Outlets	106
Job: Muscle, Bodyguard, Security	69	Optional: Merchant's Startup Investment	106
Job: Surveillance Specialist	69	Weapon Availability Table	107
Job: Slaver/Slave-Catcher	69	Selling to the Black Market	107
Job: Transporter	70	Market Value	108
Job: Weapon Tester	70	Black Market Traveling Merchant	108
Playing a Black Marketeer	70	Random Generation Tables	108
Creating a Black Marketeer Player Character	71	Black Market Retail Stores	111
Special Abilities of the Black Marketeer	72	Market Towns	114
Number of Black Market Special Abilities	72	Optional: Bar/Club Generation Tables	116
Note on Rank	72	Optional: Body-Chop-Shops Table	118
Existing characters becoming Black Marketeers	73	100 Random Black Market Contraband Finds	119
Quitting the Black Market	74	Traveling Shows	123
Black Market Benefits	74	Creating a Traveling Show	124
Professional Courtesy & Connections	74	Step One: Size & Orientation	124
Black Market Loans & Credit Lines	74	Step Two: Traveling Show Features	126
Available Funds	75	A. Sponsorship	126
The "Vig" – Interest Rate	75	B. Outfits	127
Black Market Enterprises	76	C. Equipment	127
Special Abilities of the Black Marketeer	79	D. Vehicles	128
Antiquities Trader	79	E. Communications	128
B&E Man	80	F. Internal Security	129
Bulletproof	80	G. Defenses/Military Power	130
Fence	80	H. Types of Acts	131
Friends in High Places	80	I. General Alignment of the Personnel	133
Friends in Low Places	80	J. Criminal Activity	133
Game Player	80	K. Reputation/Credentials	134
Home Turf Advantage	80	L. Typical Salary	135
Influential	81	Closing Thoughts for Adventure	135
Informant: Confidential	81	Bandito Arms Weapons	136
Informant: Corrupt Lawman	81	E-Clip Charging Stations	136
Informant: Street Snitch	81	BigBore Series Weapons	136
No Conscience	81	BigBore Revolver Rounds	137
Read Black Market Operations	81	BigBore Shotgun Shells	137
Read People	81	BigBore "Holdout" Derringer	137
Sincerity	82	BigBore "Big Boss" Magnum Revolver	138
Slippery	82	BigBore "Buccaneer" Breech-Lock Pistol	138
Steady Nerves	82	BigBore "Privateer" Breech-Lock Musket	138
Street Rep: Hardcase to be Feared	82	BigBore "Homesteader" Light Shotgun	139
Street Rep: Hero	82	BigBore "Last Stand" Scattergun	139
Street Rep: Trustworthy	82	BigBore "Lawman" Automatic Shotgun	140
Suave and Debonair	82	BigBore "Room Sweeper" Belt-Fed Shotgun	140
Wheelman	82	BigBore "Barking Dog" Submachine-Gun	140
Work the Law	82	BigBore "Fire Hose" Assault Weapon	141
Black Market Specialist O.C.C.s	83	BigBore "Universal" Assault Rifle	141

Bandit 5050 "Papa Bear" Rail Gun	142
Bandit 6000 "Big Dog" Sentry Gun	143
Bandito Arms Energy Weapons	144
IP-12 Ion Pistol	144
IP-15 Heavy Ion Pistol	145
LP2 Laser Pistol	145
LP3-D Dual-Shot Laser Pistol	145
LP5 Laser Pulse Pistol	145
IPR-16 Ion Pulse Rifle	146
LR7 Laser Rifle	146
LRP9 Laser Pulse Rifle	146
LR10-VLF Variable Laser Rifle	146
PE-33 Plasma Ejector	147
Bandito Arms Heavy Weapons	147
MM-16 "Coffin" Pepperbox Launcher	147
RG-14-LX "Baby Boom Gun" Rail Gun	148
RPM-6X Skyhammer Mortar	149
Notable Vehicles	150
All-Terrain Tumbler	150
Big Wheel Unicycle	151
Bushmaster Motorcycle	152
Overdrive Hovercycle	152
Road Hammer Transport	153
Romper Stomper	154
Rumble Wagon	155
Runabout	156
Skim Sled	157
Thunderhead VTOL	158
Walker Bike	159
Black Market Armors & Robots	160
Wrangler Riding Armor	160
Roadrunner Power Armor	162
Shadow Boy Power Armor	163
Mole Prospecting Robot	166
Robot Animals	168
Robot Animals with Hidden Compartments	168
Smugglers' Robot Cat	169
Smugglers' Robot Dog	170
Smugglers' Robot Horse	171
Smugglers' Robot Dinosaurs	171
Mega-Rex	172
Exotic Robot Steeds	174
Special Robot Steed Features	174
Unicorn Robot Steed	175
Pegasus Robot Steed	176
Monster Pegasus Robot Steed	178
Seahorse Robot Steed	179
Raptor Robot Steed	181
Magic Contraband	182
Magic Drugs	182
Elementum	182
Other Magic-Based Drugs	183
TW Wizard's Wine Machine	184
TW Power Armor	184
Mirage Power Armor	184

The Ironmage	187
Rift Hawk Power Armor	189
The Rifter®	192

Quick Find

Area 51	21
Atlantean Connection, The	13
Bandito Arms	21
Bandito Arms: Diablo Joe	24
Bandito Arms: Turner Collins	23
Bandito Arms: Weapons	136
Black Market, The	8
Black Market: Atlantis	13
Black Market: Abilities	79
Black Market: Armor & Robots	160
Black Market: Benefits	74
Black Market: Blueprint for Success	9
Black Market: Businesses	12
Black Market: China	15
Black Market: Coalition States	15 & 61
Black Market: Contraband	9
Black Market: Crew	50
Black Market: Criminal Enterprises	9
Black Market: Criminal Underbelly	10
Black Market: D-Bees	48
Black Market: Enterprises	76
Black Market: Etiquette	48
Black Market: Favors	47
Black Market: Family	51
Black Market: Germany	14
Black Market: Hierarchy	49
Black Market: Holdings in the West	12
Black Market: Internal Structure	47
Black Market: Japan	15
Black Market: Jobs	64
Black Market: Loans	74
Black Market: Magic	182
Black Market: Market Towns	11
Black Market: Outlets	8 & 106
Black Market: Quitting the Black Market	74
Black Market: Relationship with Others	13
Black Market: Sales Outlets	8 & 106
Black Market: Security	51
Black Market: Smuggling Expertise	10
Black Market: Smuggler Routes	15
Black Market: Special Abilities of Marketeers	79
Black Market: Traveling Merchant Tables	106
Black Market: Underground Railroad in Atlantis	13
Black Market: Vig, The	75
Black Market, What is it	8
Chicago Network, The	26
Chicago Network Executive Board	31
Chi-Town Operations	26
Chi-Town Contraband inside the fortress city	28
Chi-Town, dropping contraband	28

Common Black Market	10
CS Black Market Activities	61
CS Contraband	61
CS Holdings Outside of the States	30
CS Iron Heart	29
CS Knowledge Clubs	63
CS Lone Star	29
CS Missouri	30
CS War Profiteering	64
Delafuente, Adoncia	36
Delafuente, Carmen	36
Delafuente, Selena	37
Diablo Joe	24
Dragon (see Jean Robillard)	45
El Diablo (see El Diablo & Area 51)	21
El Diablo Joe	24
El Oculta	33
El Oculta Headquarters (see La Guarida)	35
El Oculta Leaders	36
El Oculta Human Trafficking	33
El Oculta Vampire Infiltration	33
Favors, Beware	47
Finding the Black Market	10
Faction: Bandito Arms	21
Faction: Chicago Network, The	26
Faction: El Oculta,	33
Faction: Immaterial Hand, The	37
Faction: Le Marche Noir	43
Five Black Market Factions, The	19
Five Factions, Summary of	19
Free Market	10
Haunted Las Vegas	22
Hidden One, The (see El Oculta)	33
Human Trafficking (see El Oculta)	33
Immaterial Hand, The	37
Immaterial Hand Contraband	37
Immaterial Hand Leaders (see The Fist)	42
Iron Heart (see Le Marche Noir)	45
Jackpot, The	22
Knowledge Clubs	63
Las Vegas	22
Le Marche Noir	43
Magic: Dimensional Magic (used in smuggling)	41
Magic: Drugs (see Elementum)	182
Magic: Immaterial Hand	37
Magic: Immaterial Hand Contraband	37
Magic: Spells (used in smuggling)	40
Magic: Nexus Hubs	41
Magic: Portal Overseers	41
Magic: Render Bag or Container Invisible	104
Magic: Rift Runner	103
Magic: Wine Making Drug/Powder	184
Magic: Wine Maker Machine	184
Market for Magic	39
Market Towns	11

Market Town, Mercado	34
Mercenary & Black Market Jobs	64
Now Hiring (Merc & Black Market Jobs)	64
O.C.C. Any	70
O.C.C. Black Market Banker	83
O.C.C. Case Man	85
O.C.C. Con Artist	87
O.C.C. Enforcer	89
O.C.C. Expediter	91
O.C.C. Information Broker	94
O.C.C. Merchant	97
O.C.C. Raider	99
O.C.C. Refurbisher	102
O.C.C. Rift Runner	103
Old Las Vegas	23
Playing a Black Marketeer	70
Real Papers	29
Simvan Mule Trains	34
Smuggler's Robots	168
Special Abilities of the Black Marketeer	79
Specialists in the Art of Smuggling	39
Sphinx (see Yull Thundersworn)	43
Strip, The	22
Traveling Shows	123
TW Power Armor	184
TW Power Armor: Glitter Boy (see The Ironmage)	187
TW Power Armor: Mirage (stealth)	184
TW Power Armor: SAMAS (see Rift Hawk)	189
TW Wizard's Wine Machine	184
Underground Railroad in Atlantis	13

Random Tables

Black Market Contact Table	11
CS Encounters at Cities, 'Burbs & Population Centers	58
CS Encounters at Farmland & Lightly Populated Areas	58
CS Encounters at Frontiers & Remote Borders	56
CS Encounters Outside CS Territory	60
Law Enforcement Encounter Table	54
Selling to the Black Market	107
Merchant: Black Market Traveling Merchant	106
Merchant: Random Generation Tables	108
Merchant: Retail Stores	111
Merchant: Market Town Tables	114
100 Random Black Market Contraband Finds	119
Passing Security Checkpoints	54
Optional: Bar/Club Generation Tables	116
Optional: Body-Chop-Shop Table	118
Optional: Merchant's Startup Investment	106
Traveling Shows Creation Tables (begin)	124
Weapon Availability Table	107



The Black Market

By Matthew Clements, Taylor White & Kevin Siembieda

What is the Black Market?

The Black Market is commonly referred to as if it were a single entity, but that is misleading. Instead, “the” Black Market is really a term for the endless variety of *less than legal* outlets for weapons, vehicles, contraband, drugs and anything else that can have a street value attached to it. To think that the entire Black Market operates under any single set of rulers, rules or principles oversimplifies the vast reach and overlapping spheres of influence within the sprawling criminal organization.

On Rifts Earth, most medium to large towns and small cities will have one, perhaps two principal *Black Market outlets*. This criminal cell can be overseen by anyone from a high-ranking crime lord or captain to a dedicated sales rep with entrepreneurial spirit

appointed by shadowy superiors. Underneath the head of the local cell are mid-level smugglers and “salesmen,” enforcers and other muscle. The big advantage this crew of crooks has going for it is the vast assortment of connections, intermediaries, thugs, spies, snitches, officials on the take, decoys, mules, “friends” and resources that are available to members of the organized crime network known as the Black Market. Larger cities and city-states may have one to a dozen Black Market outlets and cells. The exact number depends on the level of corruption, crime, commitment to law enforcement and hostilities in and around the community. Boomtowns and regions wracked with war or lawlessness may have many Black Market “outlets.” **Outlets** are often thinly dis-

guised dealerships, stores, garages, Body-Chop-Shops and bazaars (think farmers' market except it's an array of Black Market goods). That having been said, the majority of businesses that pander to vices (drugs, booze, gambling, women and contraband) are likely to be owned and operated by the Black Market.

What does the Black Market do?

In a way, the Black Market might be thought of as a network of scroungers, purveyors and facilitators in acquisitions, distribution and sales. In short, the Black Market specializes in the sale of whatever the customer wants but cannot get through normal or legal channels. Of course, such rare, dangerous and illegal contraband comes at a price. The greater the demand and unavailability of the item, the higher the price. And as criminals and opportunists, the Black Market takes advantage of circumstance and jacks the price up as high as the market will bear.

The Black Market's blueprint for success is built on the simple principle of selling contraband, weapons and vice to the disenfranchised. In the violent, ever changing environment of Rifts Earth, the ability to acquire weapons, vehicles, armor, medicine and supplies is, for many people, a matter of life and death. Thus, for a lot of communities, mercenary companies, adventurer groups, rebels, criminal bands and even heroes and refugees, the wares and services of the Black Market are their life's blood and only chance for survival.

The sale of illegal weapons and weapon systems such as power armor, robots, tanks and aircraft has always been the bread and butter of the modern Black Market's operations. And there has been no other time in history where the entire world has become a patchwork of tiny nation-states, kingdoms and city-states, all of which are under threat from the savage environment and hostile forces all around them. The Rifts regularly release new dangers from alien worlds, and then there is the threat from other, better-armed neighbors, raiders, bandits, monsters and magic. With these conditions in place, the Black Market has filled the void in providing "gear" quickly, quietly, and without regard to any possible legal red tape or moral ramifications. This has enabled the domestic and international arms trade to blossom into the world's leading industry, outstripping everything but food production and the collection of natural resources.

Every individual nation and fledgling community has to have its own weapons and defenses, and the Black Market is happy to provide them and everything else they might need or want. The Black Market specializes in the purchasing of weapons, vehicles and equipment often from less than legitimate sources, sanitizing and repackaging them (removing serial numbers and identifying marks and repainting and repackaging them), and selling them at a markup to anyone they can. Sometimes Black Marketeers steal shipments of weapons and other goods themselves, but more often they simply act as middlemen and distributors behind the scenes.

Though not a weapon in and of itself, the Black Market also provides methods of *human augmentation* that are outlawed in many "civilized" kingdoms and nations. This includes virtually all the services offered at Body-Chop-Shops, including Juicer and Crazy augmentation, cybernetic enhancements, cyber-disguises and bionic reconstruction. All are outlawed in the Coalition States, Free Quebec, and many other communities, but are available at

all these places via the criminal underground compliments of the Black Market.

Contraband. Simply put, contraband is any item that has been outlawed by the authorities. In the Coalition States, among others, contraband includes weapons and dangerous drugs, Juicer and Crazy augmentation, pre-Rifts artifacts and books, types of magic and magic items, and even types of people, animals and illegal services; even education. This market for contraband, as well as the Coalition's suppression of anyone who practices magic, is the central conflict in the life of the Black Market throughout North America. Black Market agents who work within the Coalition's borders must face this reality every day, while operators outside of the Coalition have other concerns. Despite the risks and pressure by the law, the CS markets are among the criminal organization's most lucrative. In fact, some argue that if it were not for the oppressive CS regime and its aggressive military, the Black Market would be insignificant. For example, for people living in the 'Burbs and even Coalition cities, the Black Market is the primary *available source* for weapons, body armor, cybernetics, vehicles, magic, books and other contraband on the market. They run the Body-Chop-Shops, Juicer clinics and cybernetics augmentation centers and provide things like books and magic that the CS strictly prohibits. Furthermore, if the surrounding mixed human-D-Bee communities and practitioners of magic did not feel threatened by the CS, there would be no arms escalation.

In places like *Northern Gun* where weapons and equipment are sold everywhere, the Black Market is forced to compete against other weapon wholesalers. Why go to an illegal merchant if there are perfectly safe, legal alternatives? In these circumstances, the Black Market cannot compete without offering steep discounts. Instead, it makes money through traditional criminal operations like robbery, jacking vehicles, gaming, prostitution, drug sales, and by selling contraband such as magic items, outlawed weapons and equipment hijacked from the Coalition Army and Naruni Enterprises.

Criminal enterprises. As purveyors of the illegal and difficult to obtain, the Black Market also deals in *vice* – a money-making enterprise as lucrative as the arms trade. Drugs, alcohol, the sex trade, gambling and other criminal operations are all part of the Black Market's business of providing immoral and/or illegal goods and services to whomever wants them. This is not a political or anarchist agenda by any stretch of the imagination, it is purely an entrepreneurial one. Put simply, sex, drugs and vice are big money. A moment after someone tells somebody they cannot own or do something, a new market is created for the Black Market to exploit. If there is money in it, the Black Market is there to capitalize on it, especially if it is illegal.

As a crime organization defying the law, the Black Market must also engage in its share of criminal activity, smuggling and the use of muscle to protect its "business" from lawmen, rivals and other enemies. These defense measures include soldiers, enforcers, spies, extortionists, and hit men/assassins, as well as thieves, con artists and a host of other outlaws. Moreover, the Black Market deals with all manner of criminals in the acquisition of its goods, services and information. They purchase stolen goods, encourage and support the drug and sex trade, gambling, racketeering, corruption and all sorts of activity that can be argued to be civil disobedience and immoral. Strong-arm tactics, threats, intimidation, extortion, bribery, smuggling, lies, bloody rivalries, and murder are all part of doing business for the Black Market. It just so happens that much of the dirty, ugly side of the business takes place

under the surface, out of sight of the *average customer*. But make no mistake, the Black Market is a high stakes business run by criminals who are quick to fight to hold on to what they have.

Structure and rules are important. It may seem counter-intuitive, but the Black Market thrives on rules, a sense of community and loyalty. Those who break the rules, betray the organization or are proven disloyal, are dealt with in a swift, decisive and permanent manner. Meanwhile, loyalty, ingenuity and ruthlessness are rewarded.

Smuggling expertise. All of this means the Black Market must excel in one area of expertise above all others: *smuggling*. Forgery, manufacturing fake I.D.s and other falsified documentation, all comes with the territory of smuggling. It is one thing to secure the illegal goods and services, it is quite another to get them into the hands of the customer under the vigilant eyes and ears of law enforcement and, as is the case at many communities, the military, militia, and/or beings with enhanced abilities such as Juicers, Cra-zies, psychics, mages, shape-shifters, dragons, and the supernatural. The Black Market excels at the arts of smuggling and forgery, and offers both as services to customers outside their criminal organization. While smuggling product is the Market's prime operation, smuggling outlaws and fugitives in and out of "hot zones" is another part of the Black Market's many charms and services.

The fluidity and cellular organization of the Black Market has helped it to survive and grow over the long years since the Great Cataclysm. Taking out even the largest criminal cell within the Black Market is only to cut off one of the hydra's many heads, and two more are sure to grow back in its place. The Coalition has fought for years to crush the Black Market, attempting in vain to enforce the sanctions it has laid down against arms shipments in North America. Their efforts have resulted in a massive, continent-wide arms race as groups hurry to equip themselves before the Coalition can interfere with their independence and survival. Most of the time, the CS threat is more psychological than real, as the majority of the Coalition's attention and resources are focused on the specific territory under their control, and resolving the aftermath of the war in Tolkeen. Other pressing concerns about the Federation of Magic, the Xiticix, and the Vampire Kingdoms also keep the Coalition's attention off the Black Market, which is one of the lesser evils. Still, the CS is making moves to close all three of the primary east-west smuggling corridors in North America, an exercise which, if successful, would deal a massive blow to the Black Market's profits.

Black Market holdings in the West provide natural resources and secure production facilities, and are far beyond the auspices of the Coalition. Most of the customers and population centers, however, are in the East or center of the continent. The Coalition is in between, and though there are enough customers within the CS to attract the Black Market, high volume shipments rarely go through Coalition territory, as security is just too tight. Caravans and truck convoys must stick to the open wilderness where they can avoid being discovered by CS armed forces. Due to geography and military superiority, the Coalition exerts a greater influence on the movement of Black Market goods than their actual territorial holdings might seem to indicate.

The majority of business on Rifts Earth is conducted through barter and trade. In most cases, "credits," a non-descript monetary unit, are used for business transactions. Occasionally, trade is also done in valuable items (weapons, medicine, food, other goods) or services (mercenary work, prostitution, labor, entertainment, religious reassurances) in exchange for other goods and services. Such

"trade" of services by local communities might include a concealed location for a Black Market convoy to hole up, safe houses and fronts for Black Market warehouses and manufacturing, as well as cover stories and other front operations. In return, the community, business or influential individual gets Black Market goods or services as well as favors and possibly, protection.

In North America and most other parts of the world, the business of barter and trade is done on three "levels." Each level is identical in its basic construction and operations. The differences are mainly in what items and services are traded, and who the traders are themselves.

First, there is the free market. The trade of common goods like food, animal pelts, cars and sometimes magic. Nothing on the free market is illegal, and very little of it is dangerous. It should be noted, however, that some weapons manufacturers and high-tech merchants do sell their wares on the free market. *Northern Gun, Wilk's Industries, the Manistique Imperium* and *Triax Industries* are the most notable examples. Free market items and services can be found almost everywhere there are societies doing business. Player characters interact with very little of the free market, as such transactions are not really the stuff of high adventure. Still, sometimes characters need to buy everyday goods like pigs, corn or blankets.

Second, there is the common black market. The trade of illegal, controlled, and dangerous items. The common black market operates out of nearly every shady nook and cranny on the continent. It has no leadership, direction, or unity. Anyone who trades in drugs, illegal and alien weaponry, slaves, illegal cybernetics, dangerous or outlawed magic, and in some places, books and informational material, is likely working in the black market. This is the most common market that player characters interact with, since it is one of the only ways to procure powerful weapons, armor and robots. It also allows characters to encounter the individuals who operate throughout the black market, such as wanted criminals, or those looking for work. The black market and mercenaries often go hand in hand, and such types can usually be hired for a variety of jobs via the black market.

Third, there is the criminal underbelly of the Black Market Network. The network is a vast, far-reaching criminal organization led by an elite cadre of five competing factions and their personal armies. They play against each other in elaborate games involving diplomacy, intrigue and violence, following their own code of ethics and etiquette. Sometimes two or three of the "Big Five" join forces for a brief period or in a certain area (usually to work together against a common enemy like the Coalition), but such alliances rarely last. Other than its enormous resources, the black market Network is made to appear identical to the common Black Market. This is done intentionally by the heads of the five Black Market Factions. By forgoing brand recognition for relative anonymity, they are able to hide from their enemies while growing steadily more powerful and influential.

Finding the Black Market

The Black Market inside Coalition territory and other powerful states is always balancing the need to advertise their presence to customers and the necessity of maintaining a low profile to avoid the authorities. Unlike legitimate businesses, illegal arms merchants and the like cannot simply put up signs and billboards, but are forced to use more subtle means to get the word out to custom-

ers. Many Black Market outlets and enterprises relocate frequently to avoid entanglement with the authorities, and sometimes would-be customers show up to the usual shady warehouse or back alley they know as a Black Market facility only to find the entire area has been taped off by the authorities or has been abandoned.

The most common means of “advertising” is by informing the people who might be asked about their whereabouts. Bartenders, especially in joints that cater to mercenaries and adventurers, and City Rats are particularly helpful, and often get a few credits on the side for referring customers to the local Black Market representative or enterprise. Shop owners who sell legal items like food and supplies that adventurers might need may also be in the know, as well as mechanics, hotel owners and other service providers.

In permissive kingdoms, no subtlety or subterfuge is necessary. Black Market outlets often fulfill the role of legitimate arms merchants and businesses in places that allow it. Official Northern Gun, Wilk’s or Triax outlets are unusual outside of their home countries, but Black Market suppliers make their home *everywhere*. Far from hiding in the shadows, the Black Market will have billboards and fliers posted if they are allowed to operate openly, and the market area may even take on a bit of a carnival atmosphere with food and entertainment trying to cater to the same customer base all hours of the day.

Market Towns

Even more open than outlets in permissive kingdoms, Market Towns are usually lawless ‘Burbs, MercTowns, boom towns and small communities off the beaten path that are either completely controlled by the Black Market or dominated by Black Market enterprises. Market Towns are the ultimate in capitalism, providing anything that one could want for a price. As a result, there will be many, many businesses such as gambling casinos, brothels, drug dens, and dealers in weapons, robots, magic, contraband and vice all out in the open. The majority of which are owned and operated by the Black Market.

Sometimes Market Towns are deliberately built by arms merchants looking for an outlet for their wares. Other times, they are happy accidents that accidentally spring up around a mining camp, logging camp, refugee camp, Black Market outlet or town that grows fast for any number of reasons. Many Market Towns start out as a temporary site and when the boom that got the town started goes bust, the Black Market is the first to close up shop and leave for greener pastures. This happens all the time, with the average life of a Market Town being 1D4 years before it turns into a ghost town or just vanishes.

Their location away from the authorities means that Market Towns can openly sell anything to anyone – D-Bees, mages, monsters – and offer a superior selection of weapons, equipment and contraband, while supplies last. It can be difficult to smuggle thirty-foot (9.1 m) tall combat robots and fifty-ton tanks inside the borders of the Coalition States or within other highly organized kingdoms, but out in the badlands and wilderness areas, caravans and convoys that stretch for miles can go completely unnoticed and the Market Town can sell anything to its heart’s content.

Market Towns are likely to include one to several arms dealers, Body-Chop-Shops/Cyber-Docs with bionics available, Juicer and Crazy augmentation centers, bars, gambling places, brothels, a mercenary contract office and/or recruiting center and can support semi-permanent camps for various groups and merc companies, not all of whom necessarily get along.

Random Black Market Contact Table

01-10% Cab Driver: Cab drivers tend to work with tourists, foreigners and out-of-towners. They also know the local area, and there is a 01-80% likelihood that one can drive a patron to 1D6+1 Black Market outlets even if he isn’t being paid by the market to do so. However, like bartenders, many get paid to send customers their way. Of course, a savvy taxi driver also requires a few credits (5-50 credits) from the customer for that information as well.

11-20% Prostitute: At least half of the ladies of the night are part of a Black Market enterprise. Like bartenders, even if they don’t have direct contacts, they hear and know things from their clients and odds are (01-70% chance) they can point a character to 1D6 Black Market operations or known Black Marketeers. These workers are expected to help their employer and do not get any extra money from the Black Market, though they may try to charge their customer or the person inquiring 5-20 credits for the information. (“What’s it worth to you, handsome?”)

21-30% Bartender/Barmaid/Exotic Dancer: Probably the most common Black Market contacts, bartenders work in gathering places and social hubs where they meet a large variety of people and hear all kinds of information. Odds are, even an honest bartender at a legitimate tavern will have heard enough to point an adventurer or hero to finding 1D6 Black Market operations or known Black Marketeers (probably a sales rep). Moreover, the Black Market is always looking for bartenders and hotel concierges they can trust to direct business their way. These helpful “friends” get a small to generous weekly payment for their help, depending on how many customers they provide, and the best might even get a small commission on sales or a 20% discount on goods and services. Twenty percent of drinking establishments and half the gambling halls are owned by the Black Market and have Black Marketeers the bartender can direct them to. (“Talk to that guy.”) Authorities know this as well, and some bartenders make money by feeding information to both the criminal underworld and the police.

31-35% Entertainer: Only the biggest names on Rifts Earth can afford to feed themselves through their art alone. Most performers are eager to find a way to augment their income, and working at casinos and nightclubs gives them that income and a good idea of the local players in the Black Market. However, these guys are not likely to know about low level operators, they know the middle and upper level Lieutenants, Captains and Bosses.

36-45% Black Market Relay (or City Rat in the position): Relays have one serious job: direct potential customers to the Black Market. While they may have a day job or cover, a Relay makes most of his money working for the Black Market. A Relay may not be knowledgeable about crime or the inner workings of the Black Market, but he knows about the 1D4 criminal enterprises and 2D4 Black Marketeers who pay him to send them potential customers.

46-50% Peddler/Street Merchant: Street vendors and retailers who sell weapons and contraband themselves, or who cater to adventurers, mercenaries and criminals, are likely to have connections and knowledge of the local Black Market. This is especially true of businesses in the ‘Burbs on the outskirts of the CS and other kingdoms, as well as towns that cater to mercenaries and bandits. Half of these guys probably buy some of their wares from the Black Market. (01-70% chance they can point a character to 1D4 Black Market operations or known Black Marketeers.)

51-55% Beggar: Beggars, including orphans, and the homeless are out on the street at all hours, and know to place themselves

in high-traffic areas to receive more handouts. They too see and hear things on the street and some make a few extra credits by picking out likely customers and directing them to market zones. Law enforcement and people in general tend to ignore and avoid the homeless, making them invisible amongst the urban landscape until they step out of the shadows with a bit of information to sell. (01-70% chance they can point a character to 2D4 Black Market operations or known Black Marketeers.)

56-65% City Rats/Street Urchins: City Rats and, to a lesser degree, homeless orphans make it their business to know what goes down on their streets. They know EVERY Black Market operation or most (95%) of the Black Marketeers from the top to the lowliest thug and snitch. Some will have done work for the Black Market as runners and lookouts. Others may be paid to spot adventurers, mercenaries, criminals and other potential customers and direct them to Black Market facilities and service providers.

66-75% Mercenary: Mercenaries are among the Black Market's most frequent and desirable customers. A local merc or one who has been in town for several weeks is likely (01-85% chance) to be someone who can point an adventurer to 1D6 Black Market outlets/fronts and 2D4 Black Marketeers. They are also likely to know criminals by their reputation. Convincing a merc to share that information might be a little tricky, however.

76-85% Criminal: Criminals know other criminals, and they certainly use the services of the Black Market (fences, forgers, chop-shops, etc.). Some may also work for the Black Market doing freelance jobs when they need money. As a result, most criminals (01-90% chance) can point a character to 2D4 Black Market operations and 2D4 known Black Marketeers.

86-90% Cyber-Doc: Most Cyber-Docs work at, own or run Body-Chop-Shops that are Black Market enterprises. Most others (90%) may not be owned by the Black Market, but are less-than-legal establishments, or turn to the Black Market for exotic military cybernetics and weapons. Black Marketeers also keep tabs on Cyber-Docs within their territory, even if they are not under their employ. Such specialized services are often needed on an emergency basis and large payments are handed out to insure quality work. As a result, most Cyber-Docs and underground Body Fixers (01-80%) can point a character to 1D6 Black Market operations and known Black Marketeers.

91-95% The Law: While law enforcement is often a bit behind on the current word on the street and Black Market activities, they're informed about "known" criminals and Black Marketeers, hear plenty through the grapevine and have their suspicions about people and places. A result, 01-70% of *clean police officers* can point a character to 1D6 Black Market operations and know 1D4 known Black Marketeers, by reputation if nothing else. 01-95% of detectives and undercover officers know of 1D4+3 Black Market operations and 3D4 Black Marketeers. **Dirty Lawmen:** Law officers and government officials are bribed all the time to turn a blind eye, keep quiet or help the criminal organization in some small way (sell information, threaten someone, not to be someplace, keep prying eyes away, cover up or lose evidence, etc.). 01-99% of dirty cops and corrupt government officials know about 3D4 Black Market operations, 3D6 Black Marketeers, and at least one Captain or Boss. Some (1D6%) are card carrying members of the Black Market themselves and know EVERYONE and every place.

96-100% A Black Marketeer: You don't find the Black Market, it finds you. A Black Marketeer with his ear to the ground hears about an individual or group that could use the help of the Black Market (supplies, weapons, magic, protection, smuggled to

safety, etc.) and *he* reaches out to make contact. If the meeting works out, he takes the new client wherever they have to go to get things done. If the adventurer(s) need a special criminal service, this individual knows where it can be found, provided it's available from his faction in a 100 mile (160 km) radius.

Black Market Businesses

The following businesses are typical Black Market dominated enterprises. The percentage indicates how heavily the Black Market dominates that particular type of business and the likelihood that it is run by them.

80% of all Body-Chop-Shops and Juicer and M.O.M. augmentation.

75% of all smuggling operations of every variety.

70% of all "underground" dealers in contraband.

65% of all fence operations (buying and reselling stolen goods).

60% of all houses of ill-repute/sex trade.

60% of all forgery/fake I.D.s and document enterprises.

56% of all sports betting.

54% of all gambling establishments.

52% of all drug manufacturing and drug dealing.

50% of all traveling shows.

50% of all used arms dealers: weapons, power armor, combat vehicles, robots and military grade equipment. And 50% of "legitimate" resellers knowingly or unknowingly purchase at least one third of their inventory from the Black Market. That number is 75% to mercenaries and the criminal underworld: bandits, raiders, pirates, outlaws, and other criminal groups/organizations.

45% of all pawnshops.

40% of all used vehicle, robot and adventure gear suppliers. Another 40% of "legitimate" resellers purchase at least one third of their inventory from the Black Market. That number is 60% to the criminal underworld: bandits, raiders, pirates, and other criminal organizations.

40% of all job brokering for mercenaries and adventurers.

30% of all nightclubs.

25% of all taverns/saloons/bars.

20% of organizing and running all high profile sporting events and 40% of all "blood sports" (gladiatorial games, duels, boxing/fighting competitions, animal fights, and similar violent sports).

10% of magic shops.

2% Slavery/Slave trafficking. The Black Market tends to avoid the slave business and considers Slavers to be despicable scum. There is a big difference between "slavery" and smuggling refugees, wanted fugitive, spies and agents in and out of a particular location. The former is avoided, the later is one of the Black Market's specialties.

35% of all other "criminal" enterprises.

Black Market Holdings in the West

In the American West, far from the prying eyes of the Coalition and other civilized nations, the Black Market has several secret production centers, as well as dozens of sales outlets, Market Towns, mines and supply caches. Bandito Arms is the market faction with the largest presence in the West, and has laid claim to old, abandoned military bases, established factories and even occupied the top-secret Golden Age military research facility at Area 51/Groom Lake. It is here that many of the products that the Black Market actually manufactures originate, usually sold under

the Bandito Arms brand name but sometimes destined for other market factions.

The New West is also a huge and mostly unmonitored frontier, allowing mobility to large Black Market caravans and a good place to “hide” Market Towns and supply caches. The number of Simvan Monster Riders in the West also helps the Black Market, as *El Oculata* and many other groups have spent years cultivating relationships with Simvan tribes and employ them to move goods in “mule trains” of giant pack animals.

Salvaging & Scavenging

If there is money to be made then the Black Market needs to set up near areas of employment, active warfare and commercial activity. In war zones, the Black Market sends out teams and agents to act like vultures, robbing the dead of weapons, armor and any other valuables. If someone is found wounded, an anonymous radio request is sometimes made giving out the coordinates. On occasion, a field dressing is applied but that is reserved mainly for those with whom the Black Market is on good terms. If someone is found alive but wounded, and has a bounty on his head, the Black Market agent is likely to treat the subject as a living paycheck. Trusted Bounty Hunters are called in to retrieve the individual with the Black Market receiving a *finder's fee* in return.

The Black Market and Others

The Black Market's Relationship with Weapons Manufacturers

The Black Market has always had a strange “love-hate” relationship with the companies who manufacture many of the weapons it sells. Arms giants like Triax, Northern Gun and Wilk's fully realize that in the unstable world of Rifts Earth, the Black Market fills the role of a huge sales and distribution network that they could never afford to maintain. Most of their small-scale transactions involve the Black Market in some way, and ruthless competitors like the Naruni and Splugorth have no qualms about dealing with the Black Market directly. However, doing business with the Black Market also has its downsides. It attracts attention from the Coalition, brings violence and occasional instability to a region and creates a healthy resale market that cuts into the large corporations' profit margins.

With the Coalition exerting more influence every year on the list of acceptable clients for arms shipments, the Black Market is also vital for its willingness to violate CS law. Big, high-profile companies can sidestep the Coalition's wrath by moving their products *through* Black Market intermediaries and claiming innocence if caught. (“We had no idea *Gleba Wholesale* was a Black Market front.”) Once most items have left the factory or sales floor, they disappear and are virtually impossible to track or locate.

Many employees of the large weapons manufacturers also have some history with the Black Market. The Market's recruiting policies are much more lenient than those in the corporate world and their back alley operations and secret warehouses can be a valuable place to gain experience. The openness and universal presence of the Black Market has led to an arms race on Rifts Earth the likes of which the planet has never seen.

The Atlantean Connection

Many of the more exotic and alien weapons and magic devices that find their way onto the Black Market have a single source: the *Splugorth's Atlantis*. Dumping old surplus weapons onto the Black Market is an easy way to make a few bucks, clear up space and frustrate the Coalition or the Germans. There is no real Black Market within Atlantis itself, where the most nefarious goods can be acquired without shame in open shops and public venues. The few things that are banned by Splugorth law, such as live Xiticix and vampire paraphernalia, are illegal for very convincing reasons.

Over time, the Atlantean trade in armaments and slaves has spurred the development of a series of Black Market trade ports in Florida and along the Gulf Coast. These “ports” are essentially pirate camps where Splugorth ships stop to unload cargo and caravans organize for trips inland. The atmosphere at these ports can sometimes be tense, with Black Market enforcers and Splugorth minions coming face to face surrounded by shipments of weapons, millions of credits and attractive slave girls. But considering it is usually only the most despicable and amoral Black Marketeers who work with the Splugorth, they usually get along fairly well. **Note:** The majority of Black Marketeers steer clear of the slave trade, but have no qualms dealing in Splugorth magic, symbiotes and other dangerous contraband.

Black Market Atlantis. The Black Market in Atlantis is forced to operate differently than elsewhere. The entire realm of Lord Splynncryth operates with few of the typical restrictions common to human kingdoms. Weapons and slaves are traded openly and there are outlets for drugs, the sex trade and all sorts of dark magic. This limits the Black Market to only a few key market areas.

First, they trade in goods from Naruni Enterprises and other groups whose products have been outlawed by Lord Splynncryth. Most of these decrees are political in nature, not restrictions based on some type of moral objection. Traders in such goods are often politically motivated as well; rebels or dissidents trying to upset Lord Splynncryth and stir up trouble. The presence of outlawed items is embarrassing for both the Lord of Atlantis and his security experts, and prestige is something Splynncryth takes very seriously.

The Black Market Underground Railroad in Atlantis. The other main source of income for Atlantean-based Black Marketeers is to exploit the slave trade. Not the procurement and selling of slaves, mind you, but the *underground railroad* that spirits them away to safety. Slaves represent a huge quantity of Splugorth wealth and investment. And unlike inanimate objects, they are usually eager to be liberated from those who have purchased them. Slaves, however, have little or no resources of their own, and are often unfamiliar with their surroundings outside of the immediate area where they live and work. Under such conditions, hiring a local smuggler is the safest and surest means to escape. And who specializes in smuggling? The Black Market. Black Market smugglers experienced with dealings in Atlantis have an in-depth understanding of the Atlantean slave system, methods of transportation, trade routes, Atlantean enforcers, checkpoints and slave catchers, and know how to avoid them.

Sometimes Black Market smugglers are hired by groups of slaves who pool their meager cash or steal the necessary funds. Most often, however, it is a slave's relatives or friends “on the outside” who hire a Black Market rep (or mercs or heroes) to retrieve their loved ones. The slave(s) to be rescued are, as a rule, unaware that they are to be rescued and smuggled out of the country until

they have been abducted and stashed away inside a secret compartment or given a new identity. From there the journey may take many routes, and is likely to be uncomfortable and dangerous.

The illegal abduction/freeing of slaves from Atlantis is also not always a pure-hearted act. Sometimes a wealthy slave owner's enemies or rivals will seek to deprive them of their most valuable property. Slaves don't ask why when they are set free, and releasing them is the only "destruction of property" crime that has a habit of covering itself up from the authorities. Slaves often count for more than brute labor, and freeing a specialist or highly trained individual can have disastrous effects on the owner or his holdings. Freeing valuable slaves is a type of *sabotage* not found in most other places on Rifts Earth, but Atlantis and the Vampire Kingdoms are two such locales.

In order to facilitate the trade of freeing slaves, the Black Market and a few abolitionist resistance groups have established a handful of secret camps, docks and relay stations. They are kept tightly under wraps and well concealed from vengeful Splugorth Slavers and their henchmen who are eager to recapture their escaped living bounty.

The coast of the **Preserves** along western Atlantis is the epicenter of the underground railroad. It is closest to the East Coast of North America and the secret staging points that human traffickers use to get slaves out. The lengthy coastline is impossible to completely secure, and a number of bays and rivers allow access to the Atlantean interior. Once a slave has reached the safety of a waiting boat in the Preserves, they must still pass through the threat of the Bermuda Triangle and avoid the underwater habitats and patrols around the island continent. Many Coyotes only take slaves east to Europe or north around the Bermuda Triangle, eager to avoid its supernatural horrors. Spain and Portugal are also known as drop-off points for rescued slaves departing Atlantis.

As one of the largest slave-holding societies on Rifts Earth, the Splugorth Kingdom of Atlantis is home to more than its share of runaway slaves, slave-catchers, freedmen and sympathizers. And while most of its "citizens" are monsters or supernatural creatures of some sort, a massive *underclass of human and D-Bee slaves* exists to serve their varied masters. Some of these beings turn out to have a soft spot for the suffering of others, and are willing to assist slaves in escaping their predicament. Normal humans and D-Bees who have somehow come to live in Atlantis also sometimes offer aid and shelter to runaway slaves.

The vast majority of slaves who are freed, however, are helped by one of three different "Underground Railroads." The first, as noted above, is the **Black Market**. Another is made up of dissenters and magically-empowered abolitionists who work from within Atlantis itself. Primarily hailing from Lazlo, the original core of magic users who started the group has expanded over the years and systematically works to undermine Lord Splynncryth by freeing slaves and disrupting the slave trade. They smuggle virtually every slave they free to safety using Rifts, teleportation and other magical means, and are especially hard to track because of this. The entire network, sometimes known as the **Lazlo Mission**, numbers less than one hundred members within all of Atlantis. When things go wrong or they need help, they often turn to the Black Market to assist in the smuggling of slaves and, as necessary, members of the Lazlo Mission who need rescuing and extraction themselves.

The third is the **Euro-Underground Railroad**. East of Atlantis are the Azores, a handful of pre-Rifts islands that used to be fairly isolated in the middle of the Atlantic. Now, they are a staging point for the European arm of the Atlantean Underground

Railroad. Based out of mainland Portugal and Spain, this network of freedom fighters includes Cyber-Knights, True Atlanteans, and Lemurians, as well as pirates-turned-good and normal people who have become obsessed with revenge since losing family members to Splugorth slave raids. They attack slave ships, raid slave stockades and infiltrate groups of Splugorth-hired pirates and mercs to disrupt slave-taking operations. They also have a number of ship captains who conduct "normal" business (weapons, plunder, raw materials, etc.) with the Splugorth but who are also willing to smuggle slaves to safety for a price.

The Pirates of the Amazon – Black Market South America

The vampire states of Mexico provide a significant obstacle to the integration of the North and South American Black Market networks. While some of the activities of **El Oculta** help to bridge this gap, for the most part, the two continents' criminal markets are separate entities. There are ships that travel to South America, and Northern Gun products in particular can sometimes be found there, but there is little in the way of traffic from south to north. Groups like the **Arknon Freehold** and others are careful not to let their equipment fall into the hands of criminals, and do not manufacture and sell arms to outsiders. Pirate kingdoms, the nation of Lagarto, and others get most of their weapons from local sources, Atlantis or interdimensional arms merchants like the Naruni.

There are regional Black Markets in Colombia and other pockets of civilization. Wherever there are laws to be broken, the Black Market will exist in some form, surviving on the profit margin created by artificial scarcity. The pirates of the Amazon's countless islands and secretive bays often double as Black Marketeers, selling off their hauls of captured goods and sometimes even working under contract.

The Verbrecher-Geschaeftsnetz – Black Market Europe

Over in Europe, the government of the New German Republic wages a similar battle against the Black Market as the Coalition does in North America. The dynamics are a bit different, what with Triax's market dominance, but the Germans are just as averse to letting shipments of weapons fall into the hands of potential enemies as the CS.

The main goal of Black Marketeers in Europe is to get their hands on superior Triax technology. There are many kingdoms, cities and mercenary groups that are legitimate Triax clients looking for weapons to resist the Gargoyle threat. These secondary customers are much easier to negotiate with or steal from than the German government, and market agents are sure to keep an eye out for arms shipments heading out of the country. Triax produces a massive volume of weapons and equipment every year, and older versions are constantly filtering down from the NGR military to reserve units, to other kingdoms and then onto the open market. Black Market con artists and smugglers are always impersonating agents from outside kingdoms, subcontractors and even NGR military supply officers to attempt to walk away with shipments of new Triax weapons, even if they might have to actually pay for them. Smaller manufacturers may sell directly to Black Market agents without needing to be deceived.

The Yakuza

– Black Market Japan

In the time before the Rifts, the Yakuza were arguably the most entrenched criminal system in the world. A long-time part of Japanese culture and industry, the Yakuza are most certainly criminals, bandits and murderers, but with a code of honor and discipline that is all their own. The Yakuza have a complex hierarchy of command and control, as well as a tradition of ritual body-tattoos that mark them specifically as fearless criminals and as Yakuza members in general.

Products from Ichto Robotics, H-Brand and in particular, Golden Age tech from the Republic of Japan, are all highly desired by the Japanese Black Market. The war against the Oni and other demons of Japan requires plenty of weapons, and certain governments' restrictions on weapon ownership means the Black Market is the only place to go. The state of constant terror and oppression found on mainland China also provides a consistent market for the Yakuza to unload surplus military gear.

The Green Scarf Sect

– Black Market China

Rifts China is a nightmarish place, and its local Black Market is certainly a reflection of that. While there are more traditional Black Market groups within the Geofront and in some of the coastal cities that see more trade and technological visitors, the *Green Scarf Sect* (GSS) is probably the largest single market organization. The Sect sells high-tech weapons, drugs and contraband, to be sure, but their main specialty is in the trafficking of *enslaved demons* and *magic*.

The main difference between the Green Scarf Sect's products and other enchanted goods is the duration of usability. GSS magic items will begin to lose power slowly, and will see the rate at which they decay increase if they are removed from China. This forces customers to use their purchases quickly and come back for more, or be forced to return and pay for their goods to be recharged or replaced. Green Scarf Sect agents are also skilled in the Snake Style Mystic Martial Art power and their namesake scarves are supposed to represent a green viper.

The Black Market on Other Planets

The presence of a Black Market varies wildly depending on the planet in question. Hubs like Rifts Earth and Phase World are too attractive for the market to pass up, and almost inevitably end up with some kind of Black Market presence. Fringe worlds and distant colonies are also good candidates as consistent government is often far removed. Sometimes a powerful market faction will take hold of an entire planet or moon, turning it into a giant shopping mall for mercenaries, smugglers, pirates and rebels.

On worlds dominated by permissive rulers like the Splugorth, there are usually only two outcomes. The Black Market is either a huge part of the economy with nothing to hold it back, or completely absent, unable to compete with legitimate companies that provide the same services. Which result comes about depends on the attitudes of the planet's leaders and the strength of preexisting competition.

The Coalition States

The relationship between the Coalition States and the Black Market is a long and complicated one. Politics aside, the Coalition is also the largest manufacturer of weapons, vehicles and military equipment in North America. While Northern Gun may dominate the open market, the CS churns out guns, ammo and war machines at a rate with which nobody else can compete. So while it may be risky to steal from the Coalition, or even to trade in their wares secondhand, the CS produces so much gear that a percentage of it will fall into the hands of eager Black Marketeers and resalers of weapons.

Not only does the CS manufacture a massive volume of desirable military weapons, they also have the highest level of technology in North America (with a few exceptions like *ARCHIE Three* and the *Naruni* aliens). Mercenaries, bandits and adventurers looking for the best equipment are eager to snatch up Coalition products that find their way to the market, and are often willing to pay inflated prices for them. The Coalition's infantry armor and personal weapons are good and desired, but comparable equipment can be found elsewhere. It is CS vehicles, power armor, (especially SAMAS suits), robots and aircraft that receive the highest mark-ups. Not only are adventurers and soldiers for hire looking for rare Coalition finds, but manufacturers like *Northern Gun*, *Wilk's* and even *Titan Robotics* are willing to pay good money to acquire CS tech that they can attempt to analyze and reverse engineer.

Smuggling Routes through CS Territory. While the Coalition may control every inch of their states on a map, in reality, their grip is not nearly as complete. Major cities are extremely well protected, monitored both by the military and the ISS, and population centers, factory complexes and resources like mines and power plants are under careful watch. Farmland and outlying areas are regularly patrolled, but unless ley lines, nexuses or hostile borders are nearby, the level of priority is low and small-scale Black Market smuggling activity can often go unnoticed. In more remote areas and wilderness, patrols will be almost completely airborne in nature and most ground forces consist primarily of Skelebots. Hot zones like nexus points are swept regularly by sizable military units, but experienced smugglers are sure to avoid such places. Forces out on training maneuvers, however, are a complete wild card, and can and do catch smugglers trying to sneak through the countryside.

Smuggler Routes

The Three Corridors

The dominance of the Coalition States is obvious to anyone on Rifts Earth with access to a map of North America. The continent is practically cut in half by the CS, from Iron Heart in the North to Lone Star in the South. Arkansas, formerly the last independent link in the chain, is becoming more of a Coalition State and less of a free kingdom every day and represents the most active front line between Coalition border security and Black Market smugglers. To move goods between the Black Market's holdings in the West and the population centers and markets of the Northeast, the Coalition's territory must be crossed or circumvented. This means either moving through the Coalition using traditional smuggling methods

or having undisguised convoys follow one of the three infamous east/west corridors that avoid CS holdings.

The Canadian Corridor and the “Lake Route”

The Canadian Corridor, also known as the Northern Corridor, is the least well defined of all the North American smuggling lanes. Contraband travels from Ohio and Indiana, often originating in the *Magic Zone* and the *Federation of Magic*, and travels west via routes through Coalition territory. The goods may be intended for use by the Tolkeen resistance, or the process may be reversed and Bandito Arms or other western Black Market groups may send their wares or raw materials across Lake Michigan, headed for Pyscape, Lazlo, New Lazlo or the Federation of Magic.

Another popular *east/west route* is to use the **Great Lakes** to avoid CS turf altogether, traveling from the coast of Indiana or western Michigan over to Illinois or Wisconsin. The biggest problem with this route is the necessity of transferring goods between ground and water transport, often a difficult issue on Rifts Earth. And Lake Michigan, particularly the southern portion, is thoroughly patrolled by the *Coalition Navy* as well as pirates. The lake, within easy reach of Chi-Town, has been a proving ground for the young naval branch, and its sailors are extremely familiar with Lake Michigan and the larger rivers that lead to it. Stopping and inspecting vessels suspected of carrying contraband makes up a large part of the Coalition Navy’s day-to-day activities, and the “Lake Route” has become a risky run for smugglers, forcing the activity to move further north each year. **Green Bay**, in particular, is developing a reputation for hiding suspicious vessels within its many inlets and miles of sheltered coastline.

Ohio, Indiana and Michigan. The eastern half of the Lake Route includes New York, Pennsylvania, Ohio, Indiana, Michigan and southeast and central Canada. Any area with access to the Great Lakes that is east of Chi-Town will do. Contraband follows the lakes and limited land routes, some of it continuing west to Wisconsin and northern Illinois, some of it being sold off at the resale markets of **Northern Gun** and the **Manistique Imperium**. There are also hundreds of tiny communities, settlements, logging operations and pirate camps ringing the shores of the Great Lakes, most of which make good customers for weapons and equipment. Some smugglers who make the trip up into Lake Superior, destined for Iron Heart and the surrounding cities and villages. A few, however, head west for the shores of Wisconsin or Minnesota in defiance of the danger represented by the *Xiticix Hivelands*. Though the giant insectoids are a serious threat to even the best prepared and equipped smugglers, they also ensure that nosy authorities stay far away. Some smugglers have learned to move slowly through Xiticix territory in small groups, leaving the hostile bugs undisturbed. Few other people are willing to go to such extremes, but smugglers are known for their daring and ingenuity and are always trying out unexpected routes and techniques.

Illinois and Wisconsin. The western end of the Lake Route is the coast of Wisconsin and northern Illinois. Smugglers move their wares down into Coalition territory or skirt north around it. The markup on goods that the Coalition’s grip creates is a tempting opportunity, but the Internal Security Service (I.S.S.) is also a threat not to be trifled with. This dynamic has created many secret docks and landing sites along Wisconsin’s coast, and **Green Bay** in particular has become a regular off-loading point for smugglers

and a haven for pirates, sheltering all inside from the full fury of Lake Michigan’s storms and currents.

The Texan Corridor

Politically, the Coalition States claims control over all of what was once the State of Texas. In real life, CS Lone Star is limited to the northernmost reaches of Texas, and while Coalition patrols range far and wide, the southern portions of the state are the territory of the barbarous **Pecos Empire**, a loose federation of bandits, aliens and monsters. Squeezed in between the two is the *Texan Corridor*.

For anyone trying to travel from the eastern US down into Mexico, the Texan Corridor is a necessary leg of the journey. Those who are permitted by the Coalition State or the Pecos Empire to pass through their lands may avoid it, but all others are channeled into the center of the state.

The Texan Corridor is a rough trip, especially its western leg, which cuts through **The Bend**, one of the most forbidding areas of the state. Herds of dinosaurs and Simvan Monster Riders frequent the area, some following the Corridor themselves. Coalition patrols and Pecos Raiders are also threats, though most Pecos Warlords have learned that allowing the Black Market free passage through their territory is beneficial, especially if they can squeeze bribes or “tribute” out of those seeking to cross.

The Texan Corridor seems to end abruptly at the **Rio Grande**, along with most signs of human civilization. In truth, boats and ferries wait at specific river crossings to take arms shipments and other goods into northern Mexico. The Vampire Hunters who are a constant presence in the region all need to be armed and equipped, and the Black Market is often the only game in town. Operating in Mexico is dangerous, but the high profits and constant turnover of much needed goods make it a worthwhile proposition for those bold enough to take it. Though there are some treacherous smugglers willing to sell shipments to the vampires or their agents, the Black Market is not one of them. Any Black Marketeer caught selling to the undead is summarily executed. Traitors of humanity are not tolerated.

New Mexico and West Texas. The western side of the Texan Corridor is where many of the weapons and goods sold by **Bandito Arms** and **El Oculta** begin their journey east. From the remote manufacturing sites and stockpiles of New Mexico, Arizona, Nevada, Utah and Colorado, caravans swing south to avoid CS Lone Star and enter **the Bend** of west Texas. From there they travel through central Texas before emerging in Louisiana, Arkansas or Oklahoma.

The Coalition State of Lone Star threatens this route from the north just as the Pecos Empire does from the south. Each has their own risk and reward. The Coalition military’s aggressive patrols seek to stop goods that might benefit the Pecos Empire from entering the territory. The Pecos Empire, on the other hand, represents a welcoming market, but customers can turn into hijackers or raiders in the blink of an eye. Whether a caravan follows a more northern or southern course is up to those guiding it and where their sympathies stand.

Arkansas and East Texas. The eastern portion of the Texan Corridor is southwest Arkansas and east Texas. Once clear of Lone Star, caravans can head north towards the **Federation of Magic** or continue east into the **Deep South** and ultimately, **Dinosaur Swamp**. The *State of El Dorado* pays less attention to this route

than the *Arkansas Corridor*, and it has become a major artery for contraband moving east.

Louisiana. The Texan Corridor also leads towards Louisiana and its swampy coastline. Made up of islands, bays and bayous, the Louisiana Gulf Coast is rife with pirates, smugglers and Splugorth Slavers. Aquatic dinosaurs and interdimensional creatures fill the swamps, making travel through them treacherous. The entire area is remote, wild and almost impossible for the Coalition's 2nd Fleet to monitor. A large percentage of the weapons and subversive magic that Atlantis unloads onto the American market enters somewhere in Louisiana.

The Arkansas Corridor

The gap between the CS State of Lone Star and the southern borders of CS Missouri and CS Chi-Town has always been a wide-open avenue for smugglers moving from east to west. In recent years, as Fort El Dorado has developed and grown closer and closer to becoming the Coalition State of Arkansas, the passageway for illegal travel has narrowed down into a third corridor. Fort El Dorado tries to monitor who is coming and going, but for the most part, Arkansas and Oklahoma are both wild lands where law and order are hard to find.

The Arkansas Corridor is usually the most active of the three main smuggling lanes. While the war in Tolkeen raged on, the Canadian Corridor and the Lake Route were both extremely active, but traffic has slowed down since large-scale resistance has come to an end. As overall sales patterns have gradually returned to normal, the *Arkansas Corridor* has once again become the busiest smuggling route. It allows Black Market smugglers to travel from east to west while avoiding official CS territory, is centrally located in the middle of the country, and avoids the complexities of tolls and tribute that one often encounters when using the Texan Corridor and passing through lands claimed by the Pecos Empire. In fact, many believe the CS proclaimed Arkansas to be the newly formed State of El Dorado simply so it could exercise more influence and military effort in the region. However, so far it has made not difference.

The presence of the Coalition to the north and south and the well-organized kingdom of El Dorado may put smugglers at risk of being caught and arrested, but these CS settlements and outposts also make the area unattractive to raiding Simvan, bandits and other threats that could just as easily interfere with Black Market traffic. The region is a wide-open space, and while there are plenty of Rifts, monsters and highwaymen, the Arkansas Corridor is safer and more reliable than the northern or southern alternatives.

Oklahoma. Oklahoma marks the western entrance to the Arkansas Corridor. Goods from the Black Market's western holdings and the Colorado Baronies must pass through here before making the crossover to Mississippi. Bands of righteous Plains Indians, marauding Simvan and packs of carnivorous dinosaurs sometimes make this a difficult prospect, but Oklahoma is remote and desolate enough for relatively safe travel.

Mississippi and southeastern Arkansas are the other half of the Arkansas Corridor. Once goods have reached this point, they are clear to head north to the *Federation of Magic* and *Psyscape*. The Mississippi River also intersects with the Arkansas Corridor's eastern portion and provides an easy transportation method for shipments coming or going. Coalition patrols during the Siege on Tolkeen had bottled up the Mississippi at several key junctions, but since Tolkeen's collapse, CS patrols are spotty at best.

Other Smuggling Routes

There are smaller corridors throughout North America as well, local "hot spots" for Black Market smuggling. **Le Marché Noir** has most of its weapons caches and outlets in and around **Free Quebec**, and consistently follows land routes between Free Quebec and **Iron Heart**. There are also trails that lead to **Lazlo**, but a large amount of the traffic intended for the magic state travels by water, down the St. Lawrence and through Lake Ontario. **New Lazlo's** contact with Le Marché Noir is almost exclusively by water, using Lake Erie as a conduit.

Most normal trade routes also see a steady percentage of Black Market activity. This includes Northern Gun's trade links to its neighbor, the **Manistique Imperium**, as well as to other customers on the Great Lakes, even the Coalition States of Chi-Town and Iron Heart. Sault Ste. Marie, the main land bridge between Manistique and Iron Heart, is a routine smuggling channel. **Pirate havens** like Green Bay, the Chesapeake Bay, the Gulf of Mexico (especially New Havana and the islands of Florida), the barrier islands off the coast of Dinosaur Swamp, Black Bay in Lake Superior, Queenston Harbor near the ruins of Cleveland and others, are also default hubs for Black Marketeers who sell weapons to the pirates and employ them to deliver their goods by water.

Tunnels. In some extreme cases, smugglers use secret tunnels to penetrate the most heavily defended borders. Tunnels are expensive and difficult to construct and conceal. They require careful planning and engineering in order to avoid cave-ins, and the most sophisticated will feature lighting, ventilation and tracks for powered carts.

The prohibitive cost of tunnel-digging ensures that most tunnels only run for short stretches. There are many guarded walls and fences, however, especially along the Coalition's borders, that are critical enough to warrant tunneling under. Tunnels that connect to the extensive sewers and subways beneath Coalition and NGR cities are particularly difficult for the authorities to locate and provide a way in and out for those willing to get a little dirty. And while cramped sewer tunnels are not a reliable method for moving large cargo, their use by fugitives and insurgents is particularly troubling to the CS.

Even more troubling are tunnel-diggers such as Elemental beings, practitioners of magic and D-Bee monsters with natural earth-moving abilities. Such capabilities allow for the construction of tunnels without significant noise or sustained activity, and at virtually no cost. Coalition border security has begun to use seismometers and ground-penetrating radar to attempt to prevent outsiders from tunneling under border defenses, but the equipment is not yet widespread and an organized national policy is not in place for its use.

Magical Smuggling Methods. Of course, for practitioners of magic, physical borders and boundaries are not the same obstacle as they are for normal smugglers. Portals between locations, dimensions and planets are all beyond the jurisdiction of the Coalition States and other regional powers, and direct teleportation is even more straightforward. It is literally impossible to even begin to estimate the amount of goods that pass across borders using these methods. Likewise, ley lines, which often serve as highways for magic users, are difficult for those not versed in magic to patrol.

Enemies of the Coalition States, like the Federation of Magic, Lazlo and former Tolkeen resistance fighters, often use their mystical abilities to undermine the Coalition. This kind of guerilla

resistance can be very profitable, making money by arming and equipping those who seek to do battle with the CS directly. The Black Market supplies such forces and uses people versed in magic in the smuggling of goods and people, as well as undermining mutual enemies like the CS.

Ships and Sea Traffic

In a world without superhighways or regular air travel, seas, lakes and rivers have regained their place as the main thoroughfares of commerce and travel. The mighty Mississippi cuts North America in half, its channels wider and deeper than ever. To the north, the Great Lakes are mighty inland seas that connect many trade partners and surround the kingdoms of northern Michigan, industrial powers whose products can be found even on other continents. And for those willing to face the dangers of the high seas, risen ocean levels have created new ports and shipping channels and submerged obstacles to sea trade like reefs and wrecks and even the entire isthmus of Panama.

The main attraction of sea trade is its efficiency and capacity to move vast volumes of goods. A single merchant ship can carry as much cargo as the longest conceivable caravan of trucks or pack animals. Sea routes avoid dangers on land, aggressive creatures, warlike locals and city-states seeking to protect their borders. There are few authorities that have the power to patrol the waves and even nations like Free Quebec and the Coalition Navy find it impossible to secure their territorial waters. Smugglers and pirate captains find the least guarded sea routes and waterways, and often use magic spells, illusions and high-technology to avoid being intercepted. Submarines complicate the chase even further, and Atlantean Shark submarines, Horune Pirates and unidentified seafarers have been reported in the Great Lakes, the Mississippi River, St. Lawrence Seaway and other bodies of water thought to be safe within the North American continent. Coalition patrols in particular have made such missions more dangerous over the last few years, but Atlantean ships, smugglers and pirates still make their way past the sensor buoys and sonar nets undetected.

The nature of waves and water confuses radar scanners and makes it difficult for authorities to monitor lakes, rivers and coastlines. Many smugglers choose to use small, fast boats and other vessels to outrun pursuers and blaze past blockades and patrols.

The Great Lakes are an especially active zone for trading and smuggling. The ports of Northern Gun and the Manistique Imperium are busy year-round, sending out goods for delivery throughout North America and sometimes beyond. Records and tracking information are kept for most vessels while they are in port, but once they leave the docks there is no telling what their actual destination might be. Port authorities are more concerned with protecting the Upper Peninsula from raiders, pirates and Xiticix than clamping down on smugglers, many of whom work with unofficial approval from the government or corporate higher-ups anyway.

Southern Lake Michigan, the most active part of the Black Market "Lake Route," sees constant activity on the part of smugglers. The Coalition Navy does its best to intercept shipments, but they only control a portion of the Illinois coast. The Mississippi River is another hot-spot and a vast commercial highway that winds through territory controlled by the Coalition, Federation of Magic and several other powers.

One of the most notorious runs in North America, however, are the **Straits of Mackinac**. Connecting Lake Michigan and Lake Huron, the straits are a narrow passage, less than five miles (8 km)

wide, and are carefully monitored and controlled by the **Manistique Imperium**. The island of Mackinac (pronounced Mack-in-naw), once a tourist resort, has been rebuilt as a fortress just as it was in colonial times. The other islands in the Straits, **Round Island** and **Bois Blanc**, have been converted into a prison camp and a naval base, respectively. And while daring smugglers and pirates may attempt to run the Straits, there is a secret alternative known to a handful of local fishermen and guides.

The secret Lake Run, also known simply as "the Detour," leads from Little Traverse Bay in northwest Michigan through Crooked Lake, Burt Lake and Mullet Lake, finally ending at the confluence of the Cheboygan and Black Rivers, where sailors can either head north to emerge at the eastern side of the Straits, or south to Black Lake and northeast Michigan. The increased water levels since the Coming of the Rifts help make this route passable, but the Great Lakes were not affected anywhere near as much as the open ocean, and in several places, magic or construction equipment have been used to expand the watercourse. A few illusions of sand bars and opposing banks have even been cast upon the area by magic users to make certain tributaries and shortcuts seem blocked or impassable. Those in the know, however, can sail right through, losing any pursuers who cannot control or see through the illusion.

The Mississippi River. For centuries, the Mississippi River has been one of the major transportation routes across North America, and with few roads and airborne routes as alternatives, its strategic importance has been magnified after the Coming of the Rifts. Running from its headwaters near the Xiticix Hivelands in Minnesota, it passes through both the Coalition States and the Federation of Magic before emptying out into the Gulf of Mexico in Louisiana. Many stretches of the wide river flow through completely unmonitored wilderness, and countless unmapped towns and small settlements adorn its banks. For the Black Market, the river is a highway of legitimate goods that illegal cargo can be hidden amongst. Ships with false documentation or secret compartments slip into the flow of traffic and hope to go unmolested by the authorities. They often stop to unload their haul at discreet bays and inlets, or slip up tributaries of the river to other hidden sites.

Black Market trading posts are not uncommon in the less regulated reaches of the river. Far from the authorities, the main problems are monstrous creatures and raiders looking for an easy target. Such facilities are usually well guarded and heavily armed, and relocate frequently to avoid being found out.

The Gulf of Mexico also sees its share of speedboat runs as smugglers try to outpace the Coalition fleet and supply the Pecos Empire or even the dreaded Vampire Kingdoms. The Gulf is quite open, though, and the presence of Splugorth Slavers and Horune Pirates complicates matters and provides a threat even to other pirates.

The Atlantic Ocean. High-quality and high-tech Triax imports are a hot seller in North America, but getting them from Germany across the sea to their eventual market is a difficult prospect. A rag-tag collection of merchant vessels are responsible for making the dangerous run, and even though many of them disappear at sea, the potential profits motivate newcomers to attempt the trip all the time. With the resurgence of **Atlantis**, vessels must detour northward to avoid the land mass, but Splugorth naval forces usually ignore anything not flying the flag of the Coalition States or New German Republic. Pirates, on the other hand, are a different story, and typically gun for helpless merchant ships while avoiding CS and NGR military vessels.

For pirates and smugglers with connections to Atlantis, the Atlantic Ocean is a giant water highway that can take them to many ports of call on Rifts Earth. With its central location, smugglers, pirates, slavers and raiding parties from Atlantis can strike out for the eastern coasts of North and South America, western Europe, Africa's western coast and even Antarctica. Unsavory characters who would be refused docking privileges anywhere else in the world can enjoy fine docks and well-made harbors in the kingdom of monsters that is Lord Splynncryth's Atlantis. There are risks, to be sure, but by and large, Atlantis caters to the needs of pirates and smugglers with no questions asked.

Black Market Factions

By Matthew Clements and Kevin Siembieda

The Five Black Market Factions

- **Bandito Arms** – A major manufacturer and smuggler operating out of the New West.

- **The Chicago Network** – The mob – they are who most people think of when they think of the Black Market.

- **The Immaterial Hand** – Black Marketeers who use magic and Rifts to smuggle goods and who specialize in magic contraband.

- **El Oculta** – The Black Market of the American Southwest and supplier to the Pecos Empire, Northern Mexico, Raiders, Bandits, and other unsavory types. Also deals in drugs and criminal enterprises.

- **Le Marche Noir** – The Black Market of Free Quebec and Southern Canada, and the main Supplier of Glitter Boys and Triax products on the Black Market.

The head of the “official” Black Market is a group of five criminal organizations, each roughly as powerful and influential as any of the others, with the possible exception of the Chicago Network. Thus, a balance has been struck between the Five Factions who, more or less, accept each other as the true powers within the American Black Market. So far, no other group has been able to gain a significant upper hand to topple any of the Five Factions. It is not for lack of trying, however, requiring the Five to be on the constant lookout for upstarts who might someday challenge them. In fact, the Big Five constantly work to undermine and destroy their competitors, as well as compete and mess with each other. Though the Five Factions are all too equally matched in raw power or strategic importance to truly destroy one another, some do possess more criminal enterprises and connections. For example, the **Chicago Network** is easily two or three times the size of any of the others, but because its Network is so sprawling in both scope and geography, they are more vulnerable to isolated attacks and must be careful. Theoretically, if any three of the Five Factions ganged up on the remaining two, they could wipe them out, but so far, no one has been able to create such an alliance. For one thing, there

is too much *distrust* between the factions for any two or three of them to ally for more than a short time on anything. For another, they are all so successful in their own areas of specialty that, at least for now, there is no reason to go to war or try to usurp another Faction's power base. As it stands, all five prosper, so they tolerate each other. Few serious conflicts have erupted between them in decades.

The number of Black Market organizations has fluctuated rapidly through post-Rifts history, and even today, many small and medium-sized groups, operating under each the Five Factions, come and go. It is only within the last 50 years or so that the current structural incarnation of the American Black Market has really come into being. Since that time, the five major Black Market Factions dominate and control almost everything having to do with large-scale criminal endeavors in the Americas. The names and faces have changed, but the business is always the same. Of course there are many smaller, independent Black Market groups and subgroups that operate in loose association with the Big Five, but none of them approach the size or level of power to compete with them. In fact, when a medium-sized to large Black Market organization or crime family shows weakness or vulnerability, it is often devoured by one of its similar-sized competitors, or absorbed by one of the Five Factions. Likewise, when an independent group of Black Marketeers show impressive growth and capability, they are often absorbed into one of the Five Factions long *before* they can challenge their dominance in the market. For example, several Rio Grande border gangs that showed great promise over the years have been absorbed by **El Oculta**. The Palazzo crime family in Chi-Town were once a major player before they fell apart due to internal rivalries and were taken over by the **Chicago Network**. The current roster of Black Market Factions has been in place for the last 50 years. They are all firmly entrenched, though each has its foibles and weaknesses that may, someday, be exploited by an ambitious up-and-comer or rival faction.



01 DÍAS DESDE NUESTRO ÚLTIMO ACCIDENTE.

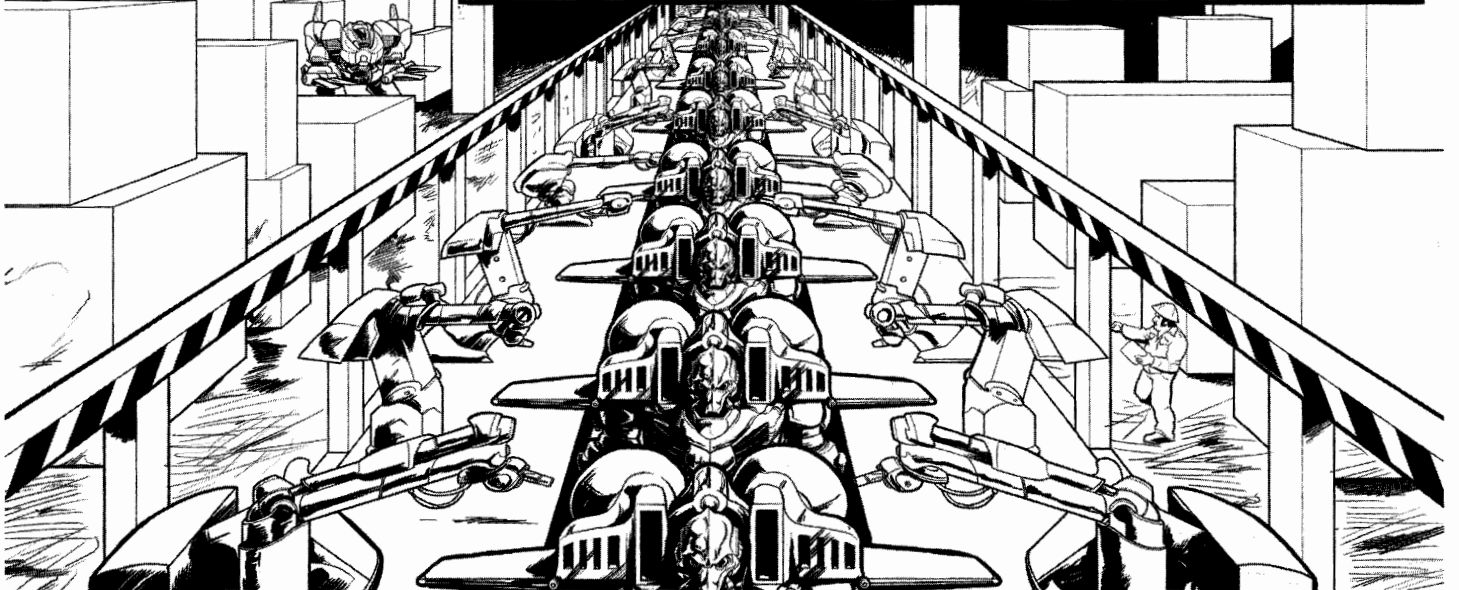

Bandito Arms

Bandito Arms is unique amongst the major Factions of the Black Market. Unlike their rivals, Bandito Arms actually *manufactures* a large percentage of the goods that it sells, and maintains its own mines, factories and production sites for raw materials. Granted, they do steal, smuggle and sell anything they can get their hands on, but products of Bandito Arms design are becoming more and more popular, threatening to turn this market faction into a major manufacturer and actual corporation.

Since the discovery of an old American Air Force base called *Area 51* hidden deep in the Nevada desert, Bandito has had a top secret headquarters and research and development center. They have pulled numerous prototypes and plans for Golden Age weapons, armor and aircraft from the ruins, putting them years ahead of the rest of the Black Market when it comes to technology.

All of this has changed what was once just a group of scavengers and smugglers into a giant market force. Bandito Arms is quickly gaining a reputation as the Northern Gun of the West (the “Western Gun,” to some), and their willingness to knock-off and manufacture competitors’ products means they take a larger slice of the market share than one might assume simply judging by the percentage of “name brand” Bandito Arms goods that are sold.

The Coalition States are particularly worried about Bandito Arms due to the SAMAS type power armor suits that have been attributed to their manufacture. As more of the suits are encountered in the East, Coalition troops and agents willing to report to the CS have sent in photographs and even recovered parts and electronics. Coalition Intelligence is currently trying to determine where and how the Black Market is producing such high quality weapon systems in order to put a halt to their activities. (Note: See page 171 of *Rifts® New West™* for more information on Bandito Arms and their original product line.)

El Diablo and Area 51

The main feature that separates Bandito Arms from other Black Market groups is their mysterious development and manufacturing center, known as **El Diablo**. El Diablo is located at the site of what was once *Groom Lake Air Force Base*, more famously known as “Area 51,” one of the old American Empire’s most secretive high-tech research centers.

The base itself is well hidden and defended. Knowledge of its existence and location is restricted on a “need to know” basis, and most of Bandito Arms’ employees and personnel are not kept in the loop. The small number of scientists, engineers, smugglers and supervisors who work at Area 51 live in an isolated, well-defended village over one hundred miles (160 km) from the actual underground base and commute back and forth every few days to work in shifts. To avoid attracting attention to Groom Lake, they do not actually drive out to the base, but rather to a secret access point several miles away that leads to an offshoot of the base’s underground facilities. From there, a lengthy tunnel and an improvised electric subway system carry the base staff where they need to go. Anyone looking aboveground will find no evidence of the tunnel, the concealed access point or even the base itself. All surface structures were lost to the Great Cataclysm or have been intentionally bulldozed by Bandito Arms to prevent the base from being located.

Underground is Bandito Arms’ crown jewel, and one of the Black Market’s luckiest discoveries of all time. The state-of-the-art manufacturing, research and development complex once known as Area 51 saw some of the old American Empire’s most sophisticated tests in the fields of aircraft and flying power armor. The dry lake bed known as Groom Lake stretches for miles in all directions, providing a massive natural runway should any of the experimental vehicles go wrong. And the isolation and remoteness that helped the American military keep the base a secret for so long is used for the same purpose by Bandito Arms.

The old underground hangars, labs and test ranges have all been refitted and repaired over the last few decades. Prototypes and computer schematics for pre-Rifts technology lost for centuries are processed by Bandito Arms’ scientists and eventually reworked into usable weapons and military products. The prize of the lot were several experimental SAMAS suits, the designs for which have served as the basis for the *Sidewinder* and *Wild Weasel* SAMAS units.

Area 51 is the most valuable possession of Bandito Arms. They have gone to great lengths to sweep the area above clean of any trace of human presence. The old runways connected to the experimental hangars were already well hidden, built into the lake-bed and concealed from detection from anyone flying overhead. A handful of scouts with binoculars, long-range rifles and mini-missile launchers are deployed up above at all times, watching the area from vantage points, hidden in camouflage hides and in ghillie suits. They report any activity to base security, which calls in the emergency response team if the activity is judged to be a threat. Often the security forces remain still and silent, hoping that the interloper simply moves on. If the threat must be eliminated, 4D4 RPA Pilots (Robot Power Armor Pilots) in a mix of flying power armor arrive in 1D4 minutes. They do not use any Bandito SAMAS suits or weapons, instead sticking to plainly painted *Triax Predators*, *NG Red Hawks* and *Flying Titan* units to remain anonymous. In other cases, a Mega-Rex robot dinosaur or several robot dinosaurs disguised in real looking animal hide coverings lumber out of nowhere to “encourage” intruders to leave the area. If that gentle nudge doesn’t work, the robots unleash their concealed weapon systems upon them and the aforementioned 4D4 RPA Pilots fly in to make sure there are no survivors, or any evidence of their presence or demise.

The RPA Emergency Response Team will assess the threat and neutralize it if they think they have sufficient firepower. If not, they can call for backup in the form of three squads of ten Bandito SAMAS suits (all types). If this second force is called in, the intruders are in real trouble, and will be wiped out completely to prevent them from talking about what they saw or where they saw it. As an extra precaution to cover their tracks, these SAMAS are painted Black to resemble Coalition troops and led by at least three (1D4+2) actual CS SAMAS (“acquired” by Bandito Arms). This way the CS takes the blame for any reports that might get out about people being slaughtered. The Emergency Response Team and the backup force are both sheltered in a concealed facility on the other side of the dry lake bed. Anyone who should notice either force leaving the facility will not be tipped off as to the location of the actual base, and intruders who are not accidentally looking right at the secret exit have no idea where these “marauders” came from. Most will assume they rocketed down from the mountains or had been lying in wait someplace. Of course, it doesn’t really matter, as most (99%) do not live to tell the tale of their encounter.

Las Vegas

Las Vegas, the legendary den of sin and vice from ages past, has been partially adopted by the Black Market of Rifts Earth. The ruins of the glamorous gambling mecca were discovered by surveyors working for Bandito Arms, an expanse of strange decorations and casino relics sticking up out of the sand. Below ground, the huge infrastructure that used to keep the city alive was preserved in many places, entombed by the sand dunes. Inside were dusty basements that spoke of the ancient city's wealth. Gambling halls, hotels, aquariums, exhibits and endless vaults were found, packed with pre-Rifts cash, coins, chips, and machines – all worthless now that centuries have passed. The scouts and explorers were excited by what they found, until night fell. For night is when Las Vegas has always come to life.

With the setting of the sun, the old ruins begin to glow with an unearthly radiance. Huge neon displays, elaborate fountains and streams of automobiles appear and disappear at random. Crowds of tourists and revelers are there one moment and gone the next. It's all a psychic disturbance that causes images and ghosts (literally) to appear at random intervals. And amongst the ethereal images of the past, real Haunting Entities, Poltergeists, and all manner of other Entities.

Bandito Arms and other Black Market groups who work out west have learned to treat Las Vegas with respect. They mostly stay out of the city, especially at night, and try to stick to the suburbs and outlying areas. The location of Las Vegas is too strategically important to abandon the city altogether, however. Located near Lake Mead and with access to the Colorado River, as well as within arm's reach of established *Bandito Arms* and *El Oculita* smuggling routes, Vegas is the doorway to Bandito Arms' western possessions and their hidden headquarters.

The Haunted City and "The Strip"

Since its discovery by Bandito Arms, the Black Market has slowly explored Las Vegas and developed the city into a kind of "free zone" and decoy for their main base in Henderson. With its reputation as a haunted, neon "fun house of death," most travelers steer well clear of Las Vegas. The city is also distant from the Coalition and others who may wish to interfere with the Black Market, and its ruins are a constant source of interesting ancient artifacts and historic items.

Those familiar with the city know the cyclical nature of its hauntings and have learned to avoid most of its horrors. The rules are simple: During the day, most of the city is safe. Of course, safe is a relative term on Rifts Earth, and monsters, vampires, dinosaurs, alien animals and scavengers roam through the ruins at any time of day. Even they are more prevalent in the outlying area of the city ruins, as animals can sense magic and the supernatural, and avoid the Strip with fear and apprehension.

"The Strip" is a famous 4.2 mile (6.7 km) stretch of old Las Vegas Boulevard that used to be the heart of the city, lined with expensive casinos and attractions. Today, it is a dead zone, avoided by not just monsters and mutants, but all animals, great and small. During the day, there is some wildlife and a few ghosts.

At night, the Strip lights up majestically as the epicenter of Las Vegas' ghostly illusions. While the suburbs and much of the rest of the city remain dark and silent, the Strip reflects its ancient character with a million mirages of bright lights, revelers and vehicles. The sounds of alarms and buzzers, chatter and honking horns, mu-

sic and the sounds of slot machines ring out through the air. Laughter and celebration can be heard for miles. Those hunkering down in the rest of the city must listen to the auditory hallucinations and resist the urge to walk off and join the endless party occurring on the Strip. Spotlights, blimps and sometimes even fireworks fill the night sky, adding to the allure.

Those who try to cross the Strip at night will be swept up in the joyous illusion all around them, and must roll to save vs mind control. For those who fail to save vs psionic attack/mind control, the illusion of the Strip becomes much more real, and they can lose themselves for 1D6 hours in the mirage, interacting with it as if it were real. They think they are partying and really gambling, or just walking around enjoying the sights and sounds. And for people of Rifts Earth, just walking around and seeing the wonders of pre-Rifts Las Vegas is a wonder all by itself. It's as if they have been transported to the past. To the Golden Age of Humanity. And hours fly by as if they were minutes. Such individuals forget about what they were doing in the real world and either wander around transfixed or behave like one of the illusory people, interacting with the mirages as if they were real. They may engage in conversations, dance, join celebrations, play slot machines and engage in all sorts of gambling. In short, they join the activities of people who perished hundreds of years ago as if they were with them in the past. Victims transfixed by the Strip are, for the most part, left alone by Entities who feel and feed upon the emotions, psychic energy and P.P.E. of the transfixed without any resistance. As a result, the living "victim" may be drained of psychic or magic energy over the hours interacting with the mirage, but is left otherwise unmolested. It is only the people who keep their senses and try to drag away their transfixed buddies who are attacked. The Entities don't want the living source of "food" to leave until they've had their fill, so they try to frighten away or fight those who try to take their food away. Worse, there is a 01-50% chance that these Entities' attacks will cause a Tectonic Entity to arrive on the scene and also attack. The entire city is plagued by such beings, but most of them are psychically linked to the Strip and remain close to it at all times. Leave the area that is the Strip and most Entities do not pursue. The exception is the malevolent Possessing Entity, but they seem comparatively rare in Las Vegas.

The Jackpot

It is rumored that somewhere within the haunted expanse of the Las Vegas Strip lies the remains of one or two pre-Rifts casino vaults, loaded with hundreds of millions of credits worth of gold, jewelry, ancient artifacts, computers and even weapons. The old tale is that during the Great Cataclysm, the various casinos and high-rollers of Vegas collected all of their wealth together in one or two secret, Mega-Damage vaults, and brought in every security officer, sentry 'bot and weapon system in the city to protect it/them. Of course, these people all perished during the Great Cataclysm, so the treasure is fair game to whoever can find it. There may be other, smaller vaults, but the Jackpot, as the legendary vault has become known, is the mother lode of them all. As the story goes, the last security personnel to flee sealed up the vault behind them forever. Whatever automated security systems and defenses are all that may be left to protect it, and they may no longer be operating after all these years. Now, centuries later, there is nobody who knows the exact location of the Jackpot. The casinos above have crumbled and decayed into ruins, replaced at night by haunted visions of their former grandeur. One such vision is not an

illusion, however, but a projected image of the forgotten vault and *the Jackpot*, the fabled treasure trove within. Radiating gold and white light, the Jackpot appears randomly throughout the Strip, intermixed with the other illusions that come and go. Unlike the other images, the Jackpot is not a ghostly impression of the city in its pre-Rifts glory days, but an actual projection of the incredible wealth contained inside the vault. Those who have seen the vision are given a tantalizing glimpse of the vault's treasures: an entire city's worth of coins, jewelry, diamonds and gems, pre-Rifts currency, casino chips, documents, computers, collectibles, and even luxury vehicles, survival gear and unauthorized heavy weapon systems. Or so the story goes.

As far as the local people living in the Las Vegas area are concerned, the Jackpot is just one of the city's illusions and nothing more than a myth. A fairy tale that attracts treasure hunters and adventurers to their doom at the hands of Entities, monsters or bandits. Thousands of people have searched for the Jackpot over the years – including Black Marketeers – but nobody has found it yet. The earthquakes of the Great Cataclysm smashed Las Vegas' sewers together with the Golden Age subway system, the casino infrastructure and the elaborate basements and underground parking garages of the city. Las Vegas below the surface, below the buried ruins, is a network of subterranean tunnels that have collapsed, flooded and become inhabited by animals, monsters, human and D-Bee squatters, Entities and some say, demons. Searching through the tunnel system is a dangerous and bewildering process, and should one actually find an old casino vault they will have to find a way around (or through) numerous Mega-Damage doors and walls, along with whatever may have crawled inside over the centuries and any robots and security systems that may have survived and remain activated. Even then, there is no guarantee that the vault is actually the site of the Jackpot or that it wasn't found and looted back in the Dark Age after the Great Cataclysm.

Old Las Vegas Suburbs

While the city of Las Vegas itself is haunted and unpredictable, the suburbs around it are all "normal" ruins, just like those found anywhere else on Rifts Earth. Spring Valley, Paradise and Sunrise Manor have all been well swept by Black Market scavengers, and the ruins of **Nellis Air Force Base** are staffed by Black Market guards and Enforcers tasked with watching the northeast approach to the city (the ruins themselves have long ago been picked through by opportunists looking for Golden Age military gear). It is the suburbs of Winchester, Whitney and Henderson in particular, however, that have become outposts for Bandito Arms.

Winchester and **Whitney** both shelter concealed listening posts, stations where Bandito Arms deploys scouts and has people monitoring radio scanners and even a few passive radar systems. The goal is to protect the ruins of the city and the Bandito Arms caravans and shipments that pass through on their way to Henderson.

In the suburb of **Henderson** is Bandito Arms' primary depot for moving goods to Lake Mead and the Colorado River. Countless tons of weapons, E-Clips and manufactured goods wait in secret storage facilities hidden underground and amongst the ruins, ready to be loaded onto vehicles or pack animals and relayed out to Las Vegas Bay and the concealed docks along Lake Mead. To cover their activities, Henderson appears to be a Merchant Town in the middle of nowhere. As one might expect, the people who live there are all Black Marketeers and their families. Even those who appear

to be visiting mercenaries are likely (01-75% chance) to be Black Marketeers, as are the small farms and cattle ranches around it.

Lake Mead and the Colorado River

Lake Mead is an enormous reservoir, a man-made lake created when the Hoover Dam was constructed. Spreading out from the course of the Colorado River, Lake Mead and the dam that gives it life have both survived the Coming of the Rifts. While Hoover Dam is inactive now and most of its machinery is hopelessly buried and clogged with debris, the dam structure is intact, creating a giant concrete waterfall when the river runs high. And while it does prohibit easy travel south towards Mexico on the Colorado River, the dam does not block the lake itself, which has become a well-used supply route for *Bandito Arms* as well as *El Oculata*.

Lake Mead is deep enough that large ships can use it for travel. The only restriction is the rapids and shallower sections of the Colorado River on its eastern approach, both of which can be dealt with using magic, technology, ingenuity or superhuman strength. The river runs through the Grand Canyon, past the roosts of the **Lyn-Srial Sky Knights**, but more importantly, past **Arzno**, city of mercenaries and Vampire Hunters. Boats from Bandito Arms are stopping at Arzno all the time, off-loading all manner of Black Market wares to sell and trade.

From there, the river runs up into Utah and Colorado, right to the doorstep of the **Colorado Baronies**, and is an important natural trade route. It is one of the reasons why Bandito Arms is spreading so effectively throughout the New West, relying on low-tech, low-cost supply chains like river travel. The Coalition has virtually no presence anywhere along the Colorado River, which is good for merchants selling power armor suspiciously similar to CS designs.

Turner Collins

CEO of Bandito Arms

Turner Collins is the "chief executive officer" of Bandito Arms and official head of the organization's corporate facade. Collins is an ambitious Black Market Entrepreneur who has been working inside the market since he was a teenager. He was just rising up the ranks when he was hired along with a group of other up and coming smugglers to head west to work at the Area 51 base out in the desert of Nevada.

Much more than the motley collection of criminals and smugglers who had discovered the base decades before, Bandito Arms was growing at an incredible rate. The micro-factories at Area 51 gave them manufacturing capabilities years beyond any other Black Market faction, and the plans, designs and prototypes they found in the base's hangars and vaults would provide a range of weapons and armor for Bandito Arms' initial product line.

Collins quickly became the unofficial overseer of Bandito's operations out west, reporting back to the bosses in more civilized eastern cities. Even supervisors and crime lords in comparatively nearby states like the Colorado Baronies or Arzno are still hundreds of miles from the Diablo complex, and Collins has a surprising amount of leeway in running the show there.

He has pushed production and design into high gear, recruiting scientists and weapons technicians to come in and reverse engineer the amazing technology from the Golden Age of Man left behind at the base. Old American infantry weapons are retooled with Western styling and other looks. Meanwhile, he's expanded their

successful BigBore line of weapons and the SAMAS suits they produce are painted in distinctly non-Coalition colors and sold to the highest bidder. After several years of increasing sales, the corporate and manufacturing side of Bandito Arms now threatens to eclipse the smuggling and organized crime that are the organization's roots. Turner Collins has declared himself CEO, and as long as his off-the-books profits keep going to the crime bosses and gangsters that support Bandito Arms, he will be allowed to run things his way.

Bandito Arms is the ONLY independent manufacturer able to produce and sell SAMAS power armors. A fact that has earned the organization the enmity of the Coalition States. The CS has been slow to take action against this arm of the Black Market. For one, they do not yet realize that Bandito Arms has full manufacturing capabilities. The CS thinks these are modifications made to SAMAS stolen or captured in the field. Second, nobody knows where any Black Market manufacturing is done. However, as more Bandito SAMAS hit the market, the Coalition's concerns increase, and they are likely to try to locate and destroy such a facility if they can.

Turner Collins Stats

Real Name: Collin Turner.

Rank Within the Black Market: Boss, and second only to the family heads who started the Bandito Arms faction. A position Collins is certain to one day share.

Race: Human.

Alignment: Anarchist.

Attributes: I.Q. 19, M.E. 15, M.A. 22, P.S. 13, P.P. 14, P.E. 17, P.B. 12, Spd 14.

Age: 45

Experience: 9th level Black Marketeer and Faction Boss.

Skills of Note: Speaks American at 98% and Spanish at 76%, Detect Concealment 70%, Find Contraband 78%, Hand to Hand: Basic, I.D. Undercover Agent 72%, Land Navigation 68%, Pilot: Hovercycle 98%, Pilot: Robots and Power Armor 85%, Radio: Basic 90%, Recognize Weapon Quality 70%, Salvage 80%, W.P. Energy Pistol and W.P. Energy Rifle at 9th level and W.P. Heavy M.D. Weapons at 5th level proficiency.

Black Market Benefits: Collins is the man to whom the lower Black Marketeers of Bandito Arms turn for Loans and Lines of Credit.

Loans and Lines of Credit: He has 750 million available at any given moment for loans to others.

Enterprises: In addition to running the manufacturing, R&D, and distribution of Bandito Arms products, Turner Collins owns many, many smuggling, criminal operations and legitimate retail and entertainment enterprises within the Faction. As CEO of Bandito Arms, Collins has a cool, one billion credits of his own socked away for a rainy day, and he runs a business worth billions of credits a year.

Special Abilities of Black Marketeers: Bulletproof, Fence, Friends in High Places (7 within the Bandito Arms Faction), Home Turf Advantage (Area 51, Las Vegas, the Pecos Empire), Influential, Informant: Confidential (three within the Pecos Empire, two at Arzno, one among the vampires of Ciudad Juarez, and one within Northern Gun), Informant: Corrupt Lawman (four in the Coalition State of El Dorado, two in Lone Star, and one in Chi-Town), Informant: Street Snitch (hundreds inform

his Captains and they inform him), Game Player, Read Black Market Operations, Read People, Steady Nerves, Street Rep: Trustworthy and Suave and Debonair.

Psionics: None.

Magic Knowledge: None.

Weapons of Note: Anything manufactured by Bandito Arms is at his disposal. Always carries a Bandito Arms *LP3-D Dual-Shot Laser Pistol*, but a *PE-33 Plasma Ejector* and *BigBore shotgun* are always close at hand.

Body Armor: Anything manufactured by Bandito Arms is at his disposal. Wears a Bandito M.D.C. duster/long-coat (28 M.D.C.) and always has a Naruni Enterprises personal force field on him for real protection.

Vehicles: Anything manufactured by Bandito Arms is at his disposal, but has a luxury hover limousine (240 M.D.C.) as his VIP transport.

Cybernetics: Internal radio antenna that he uses to communicate with security and the supply chain, plus clock calender and gyro-compass.

Diablo Joe

Bandito Arms has been excavating collapsed tunnels and levels, and exploring the opened levels of Area 51 for decades now. They have found that many of the deeper layers had been buried by earthquakes, which is to be expected, but at least 17% has been effected by *dimensional shifting*. In the D-Shifted areas, strips of rock and sand have been embedded in each other, and every inch of certain labs and storage hangars are completely merged with the underground strata around them. In these cases, tables, computers and items are trapped in rock and earth as if they had been filled with concrete; very weird. There are also a few areas that appear to be gone. Just gone. Replaced by rock and earth. The theory is they may have been Rifted, in chunks, to an entirely different dimension. Clearing out the twisted mess of collapsed and debris filled tunnels and elevators is the worst job, and most time consuming. Even the large sections that are free of debris, however, have their challenges, as any number of unearthly animals and sometimes D-Bees, demons and monsters may have moved in. Exploring, excavating and claiming the underground ruins of Area 51 has been a long, ongoing process. It is estimated that 25% of the secret complex is completely destroyed, buried or missing; 65% has been cleared out and is up and running under Bandito Arms control; and the rest is still being excavated.

It was during one of the excavations that a unique discovery was made. After punching through a collapsed length of tunnel, they found another sealed-off section that was still running under its own power. Everything was running at its lowest level of operation, but it had power and two-thirds of the machines were functional, including an experimental cybernetics lab. Inside the lab they found several prototype cyborg units. The volunteers who had been used as the subjects for the bionic experiments had died, presumably during the Coming of the Rifts, as they were long dead and mummified. One, however, was miraculously still alive! His preservation pod still connected to the weakly pulsing nuclear power unit located below the base. Bandito Arms technicians carefully revived the cyborg and reactivated him.

After the shock of waking up hundreds of years in the future to the a post-apocalyptic Earth reshaped by alien energy, Rifts and alien invaders wore off, the cyborg agreed to join his rescuers and

help in any way he can. Though he has provided Turner Collins and others at the Area 51 compound with some useful information, the cyborg can not remember his own name and retains only flashes of memory from his life prior to the Great Cataclysm. He is a relic from the Golden Age of Man and has many stories to tell, but he cannot remember his own past. Not his family, not his life before becoming a cyborg, nothing about himself. The Bandito Arms techs have no idea why this may be. It is almost as if his own history has somehow been erased. The last thing he remembers is going in for full bionic reconstruction to become, in effect, a Combat Cyborg. Indeed, the corrupted, partial surgical log indicates he was test subject J-10013. The bionic construction was near the final stages of completion when the Great Cataclysm struck the base. Panic ensued, and his surgeons chose to place him inside an experimental preservation/stasis pod to keep him safe until the crisis blew over. Apparently, this section of the base was cut off from the rest and the personnel never had the time or capabilities to come back for him. The preservation pod was designed for astronauts to use on long space journeys. The technicians at the base had no time to finish the augmentation, but didn't want to kill or abandon their patient on the operating table three-quarters of the way through the procedure. Instead, they put him in the stasis pod and unwittingly consigned him to the future. Almost three hundred years later, the Black Market Cyber-Docs finished the procedure and woke their subject to a new life.

Since the Black Market operation started out of the town **El-Diablo S-4**, the techs dubbed this strange time traveler "Diablo Joe." He rather liked the idea that he has "beaten the devil" to survive what should have been certain death, and has accepted the name as his own. Diablo Joe has decided he must have been fated to end up in the time of the Rifts and tries to make the best of his life in a world that seems alien and surreal. Earth seems more like an alien planet or weird dream, than reality. Though Diablo Joe has come to terms with what the Earth has become, he is a living relic from the past who is afraid to make a new life in the present. He has only seen isolated glimpses of Rifts Earth in and around Area 51 and the ruins of Las Vegas. He has never traveled more than 100 miles (160 km) from the secret base, which is mostly scrub, desert and dinosaurs. He has encountered mercenaries, other cyborgs, and a handful of D-Bees and mages, but always in a hostile situation. As a result, his image of the world is one of violence and the bizarre.

Diablo Joe can't shake the feeling he has survived 300+ years for an important reason. That he is fated to be in this world for a reason yet unknown. However, he is reticent to figure out what that something might be. He prefers to stay underground in the old base that represents the world he once knew. He feels uncomfortable and out of place whenever he sets foot above ground, so he avoids it. Worse, Joe only knows what his "handlers" at Area 51 have decided to tell and show him about the world. They have convinced him that Bandito Arms is part of a heroic underground that provides the downtrodden and disenfranchised people of the continent with the means to defend themselves, prosper and fight tyranny. The worst of those tyrants is the Coalition States, who have, unfairly, branded them as criminals. Joe's not an idiot, so he realizes Bandito Arms and the Black Market are all about making money, but he also believes they do plenty of good. Ultimately, however, Diablo Joe has been unable to bring himself to leave the safe haven of Area 51 and make his way in the world outside its doors.

Diablo Joe had been an invaluable source of information on pre-Rifts North America, and would be considered an incredible asset (and threat) by the Coalition States if they were to ever be-

come aware of his existence. Of course, others like Erin Tam and the scholars of Lazlo would love to pick his brain. CEO Collins has explained this reality to Diablo Joe, and it is one of the reasons Joe is happy to stay hidden amongst his friends at Bandito Arms, and far away from the politics of the outside world.

His work at Bandito Arms falls into three main areas. One, he functions as a pre-Rifts consultant and advisor about Area 51 and what may be located where. Joe seldom realizes how much he knows until put the test with very specific questions. Two, as a base defender. With his superior, ancient and modern bionic systems, and obvious combat experience, Diablo Joe makes a good soldier. He is also honest and loyal to his new friends, including the D-Bees among them, making him a reliable protector. Last, he is a source of entertainment and knowledge about the nearly forgotten past before the Coming of the Rifts. Turner Collins, himself, has dinner with Joe at least three times a week, during which they chat about everything under the sun about days past: the people, society, buildings, machines, life, entertainment, and much more. Of course, Joe's memory is spotty, and everything he relates is done from a third person, observer's point of view, seldom his own. That having been said, there is music and images that touch Diablo Joe deeply and must have some personal meaning to him. Oddly enough, Joe doesn't seem to mind not remembering his past or being a full conversion cyborg. Still, he is a man lost and set adrift. Killing time and hiding under the ground until . . . something moves him to find his fate.

Diablo Joe Stats

Real Name: Unknown, but he answers to Joe, Diablo Joe and el Diablo. His real name is Howard Mercer, but whether he ever remembers that or any part of his old life is yet to be seen.

Race: Human.

Alignment: Unprincipled with leanings toward good.

Attributes: I.Q. 11, M.E. 17, M.A. 13, P.S. 26 (Robotic), P.P. 24, P.E. 19, P.B. 10, Spd 132 (90 mph/144 km).

Age: 34 and 293 years in stasis. Joe has been active for four years.

Experience: 6th level Combat Cyborg.

Skills of Note: Basic Mechanics 75%, Camouflage 55%, Computer Operation 98%, History: Pre-Rifts 95%, Land Navigation 61%, Language: American at 98%, Literacy: American 98%, Philosophy 75%, Pilot: Automobile 98%, Pilot: Tanks and APCs 66%, Pilot: Truck 75%, Radio: Basic 85%, Read Sensory Equipment 70%, Weapon Systems 74%, and W.P. Knife, W.P. Energy Rifle, W.P. Heavy M.D. Weapons and Hand to Hand: Expert, all at 6th level.

Black Market Benefits: Joe has not taken advantage of any Black Market benefits, but lives at the secret, underground complex that is Area 51 where ALL of his needs are taken care of. On top of that, he draws a modest annual salary (for what he knows and does) of 120,000 credits as a defender and consultant. Most of it (437,000 credits) is in a Black Market bank account. He could command much more, but doesn't realize it, and doesn't have many needs or wants.

Enterprises: None.

Special Abilities of Black Marketeers: Friends in High Places (namely Turner Collins and several others at Area 51), Home Turf Advantage (Area 51, Las Vegas area only), Steady Nerves and Street Rep: Trustworthy.

Psionics: None.

Magic Knowledge: None.

Weapons of Note: Likes to use rail guns, BigBore weapons, and other heavy weapons.

Bionic Body: Full Conversion Combat Cyborg. Some of Joe's bionics are superior to what is available on Rifts Earth.

M.D.C. by Location: Body is of pre-Rifts manufacture and is an experimental unit.

Head – 120

Hands (2) – 60 each

Forearms (2) – 70 each

Upper Arms (2) – 90 each

Feet (2) – 35 each

Legs (2) – 125 each

Main Body – 368 (pre-Rifts body)

Bionic Body Armor: Has access to anything available to Bandito Arms, but tends to prefer Medium Infantry Armor (+230 M.D.C.), or Heavy (+360 M.D.C.) when he knows he's going into serious combat.

Bionics: Amplified Hearing, Bionic Booster Jet, Bionic Lung with Gas Filter and Oxygen Cell (one hour), Built-In Loudspeaker, Built-In Radio Receiver and Transmitter Headjack, Climb Cord, Clock Calender, Computer and Calculator, Cyber-Nano-Robot Repair System (pre-Cataclysm; advanced), Fingerjack, Forearm Heavy Laser (4D6 M.D.; 1,600 feet/488 m), Forearm Particle Beam (6D6+6 M.D.; 1,000 feet/305 m), Multi-Optic Eye, Radiation Sensor, Sound Filtration System, Universal Headjack and extendible/retractable Vibro-Blade Short Sword (2D4 M.D.) in his left forearm. **Note:** The built-in energy weapons are pre-Rifts and draw upon the power supply of the cyborg, providing an effectively unlimited payload.

Special Feature: The Nano-Bots in Joe's body are superior to anything available on Rifts Earth, and were an experimental, advanced system even for the Golden Age of Pre-Rifts Science. Unless Joe is atomized, or suffers more than 150 M.D. below his normal Main Body M.D.C. of his bionic body, his organic parts will be repaired and kept alive.

Furthermore, there is an even more revolutionary nano-bot repair system that repairs his M.D.C. mechanical body (one M.D.C. per hour), provided it doesn't suffer more than 150 M.D. below zero. This applies only to bionic body parts (arms, legs, lungs, body, implants, etc.), NOT bionic body armor that is worn nor weapon systems even though they are built-in. **Note:** Neither Joe nor the Bandito Arms techs are even aware these features exist. They have never been required to come online.

Vehicles: Joe likes all-terrain vehicles and military vehicles such as tanks and APCs. Has a Big Boss ATV he uses as his personal vehicle.

The Chicago Network

The "heart" of the North American Black Market will always be within the Domain of Man – including the Coalition States, CS territories and southern Canada. The population density alone makes it the premier marketplace where weapons and armor are traded alongside illegal cybernetics, drugs, vice, magic items and pre-Rifts artifacts, like books. There are numerous Black Market Factions and subgroups within this region. Generally, there is one main Boss or sub-faction and several smaller ones for every Coalition city and 'Burb. But all answer to the Faction known as the **Chicago Network**. Outside groups like *El Oculata* or *the Immaterial Hand* may also have a Black Market outlet in these territories, and/or work with or sponsor one of the small local factions, but they usually do so only after getting permission from one or more of the families that run the Chicago Network.

The real Black Market power within the CS is a shadowy criminal organization known as the Chicago Network. It is the oldest and arguably most powerful of the Five Factions. The Network grew up with the Coalition States themselves, and has evolved many times as different crime families and aggressive Bosses have come and gone, and the Coalition itself has expanded and matured. Born out of the bloody infighting that spelled the end of the infamous Staverone crime family, the modern day Chicago Network learned its lesson from that savage turf war, a conflict which forced the ISS and CS military to put more pressure on the Black Market than it had ever done before. The Chicago Network has proven to be an extremely organized and elusive opponent impossible for the Coalition authorities to pin down or stamp out. In fact, the Chicago Network almost always seems to be one step ahead of the Coalition authorities, leading some to believe that a high-ranking CS officer or political figure must be in their pocket.

Just like any Black Market group, the Chicago Network makes the majority of its profits from the sale of weapons, contraband and vice. Though inside CS territory, they also profit from smuggling D-Bees, free thinkers, rebels and fugitives of all kinds, in and out without their being captured by CS authorities. As for contraband such as books, movies, pre-Rifts artifacts, magic and alien wares, there is no other market that has such a steady supply of customers, even if most of them are looking for an illegal book or fake I.D. instead of a ten-million credit weapon system.

Chi-Town Operations

The city of Chi-Town is the home base of the Chicago Network, with most of the crime families living in the well established Old Town 'Burbs. However, the Chicago Network controls Black Market operations at all the Coalition States, particularly in the 'Burbs, where the Network does the majority (70%) of its business. They have agents and salespeople throughout the States' less reputable areas, while most of the organization's higher-ups live safely within the oldest 'Burbs. It is also rumored that one or two Chicago Network crime families live within the actual fortress city of Chi-Town itself. While many dismiss such rumors as lies and urban myths, there are others who insist it is true. If so, this might explain



why the Chicago Network often seems to be a step or two ahead of the efficient Coalition authorities; or that may be why some people assume there must be a crime family within the CS itself.

The Chicago Network's highest ranking bosses pretend to be upstanding members of society, with cover jobs and fine homes amongst the oldest and safest city 'Burbs. They use bribery and their near limitless supply of credits and luxury goods to sweeten the deal with CS police and even politicians who are willing to play ball with them under the table. In the highly monitored and regulated world of the Coalition States, "off-the-books" cash, gold, gems and Universal Credits are the only way to make certain transactions.

Outside the fortress city, the Chicago Network is nearly as powerful and elusive. It is said they have eyes and ears everywhere within the Domain of Man. Their web of informants, bribed sentries, corrupt law officers and observant low-life snitches keeps the Chicago Network well aware of actions undertaken on the part of the authorities, other Black Market Factions, their underlings and independent operators (the latter includes other criminals, mercenaries, rebel forces, heroes and adventurers). By staying one step ahead and offering up token "busts" to the police, the Chicago Network artfully plays the game of convincing CS citizens that the authorities' war on crime is working. The Chicago Network often gets rid of old or broken merchandise during these staged raids and captures, as well as getting rid of rivals, upstart competitors and loose cannons within the organization. Using their intimate knowledge and close connections with the Coalition States criminal system, the Chicago Network remains unchallenged within the CS and may be the oldest criminal organization in North America. They are certainly the slickest and one of the oldest in the entire world. The organization can actually trace its roots to a group of rough and cagey Dark Age smugglers and scavengers who grew up (and maybe even infiltrated polite society) within the Coalition States as it grew into a world power.

Contraband inside the fortress city. As things stand, the Chicago Network has exclusive control of the flow of illegal goods into the fortress city of Chi-Town itself, and is even reputed to be able to smuggle people in and out of the city. A feat that is supposed to be impossible. Of course, the Chicago Network is very careful about who they offer this service to, and the cost is great – millions – to sneak outsiders into Chi-Town. The Network doesn't want to lose this capability, so they are careful NOT to smuggle in rebels and freedom fighters who might engage in acts of assassination or terrorism. No matter how the Black Market may paint themselves, they are not patriots. They are a criminal underground that is not going to sacrifice a valuable avenue of income to high ideals or a noble cause like the assassination of the Emperor. Not for any amount of money. The Coalition States and their tyrannical policies are a gold mine for the Black Market. If anything, the Chicago Network secretly helps the authorities to preserve the CS and keep the Emperor and other CS officials safe. Thus, most of the Chicago Network's smuggling operations inside Chi-Town involve secretly smuggling wealthy city dwellers *out* to enjoy the vices of the 'Burbs (also controlled by the Black Market Faction) without the authorities knowing about it. They also smuggle millions of credits worth of contraband such as drugs, books, pre-Rifts artifacts and alien doodads (half of which are forgeries) into the city where wealthy citizens of Chi-Town – and remember, they are some of the wealthiest people in all of North America – are willing to pay top dollar for them.

Getting goods in, let alone people out and back in, is not an easy prospect. Chi-Town is not known as a fortress city for nothing, and while many of its defenses and security precautions are designed to detect and intercept magic users, psychics, monsters and the supernatural, everything and everyone that tries to enter the city is thoroughly scanned and documented. In order to bypass security, there are only a few methods.

1. Right in the Front Door: For bold smugglers with small shipments, sometimes the quickest, easiest way to fool security is to go right through it. Concealing the package on one's own body and walking through the guards and metal detectors is a risky proposition, but as long as the contraband is not metallic, magical in nature or particularly fragrant, it should not arouse the suspicion of the Dog Packs and Psi-Stalkers posted at each entrance. The flow of traffic in and out of the city can be quite heavy, especially during the morning and evening rush hour when people come and go from their jobs or homes out in the 'Burbs. In this press of humanity, a single smuggler can often go unnoticed as long as his appearance does not arouse suspicion and he avoids being selected for a *random* pat-down or strip-search. Those who are picked out of the crowd will be checked out in guarded, security isolation chambers nearby and are either released or whisked off to a real ISS interrogation cell depending on what they may be hiding.

2. Service and Maintenance Entrances: In addition to the pedestrian checkpoints that lead into Chi-Town, there are a number of cargo clearance gates that allow vehicles to enter with bulk shipments of food, trade goods and raw materials. The security procedures are different for those areas, as many of the drivers, loaders and deliverymen are not cleared for access into the Chi-Town interior and some are not even CS citizens. With this in mind, the cargo delivery areas are locked off from the rest of the city and anyone who wishes to go inside must pass similar clearance procedures to those in place at the pedestrian checkpoints outside.

Hiding Black Market shipments within perfectly legal deliveries is an age-old smuggling trick. Coalition security is very good, especially at fortress cities like Chi-Town and Iron Heart, and that includes the cargo scanners and customs agents in the delivery areas. Many of them are civilians, however, and not military or ISS, and can often be easier to bribe than government employees. Moreover, vast amounts of goods enter the city every day, and it is simply impossible to check every individual crate or box. As long as the magic detectors do not go off and the psychics remain undisturbed, a shipment is unlikely to receive much attention. Packages marked for VIPs also receive preferential treatment, and while they are sure to pass through customs more quickly, they will also get a more thorough inspection from security.

3. Window Drops/Window Grabs: The most daring way to get items into the city is to fly by one of Chi-Town's windows or verandas. This is dangerous for many reasons and is often considered a last resort or technique only fit to be employed in heavy fog, harsh weather or during dark, moonless nights.

A smuggler using a hovercycle, rocket bike, jet pack, magic or other means of flight zips by a prearranged location and simply drops a package to be picked up by a waiting courier. Private windows and balconies are the ideal choices for drop-sites, as public areas are typically well monitored by guards. And though the "concrete mountain" of Chi-Town is riddled with private windows and vent shafts that can be used for drop-off purchases, ISS Sky-cycle patrols, and SAMAS in pairs and wings of six, circle the city and the surrounding 'Burbs twenty-four hours a day. All CS

patrols are notably aggressive in policing the “no-fly zone” that extends around the fortress city of Chi-Town, and reinforcements can join the pursuit within 1D4 minutes. It is important to note that when an unauthorized flyer is spotted, the authorities zoom in like screeching eagles ready to tear the perpetrator to pieces. Capture and interrogation is optional. Death is the most common outcome. Moreover, the Coalition patrols will pursue the intruder to the ends of the Earth if necessary. This means unless the Black Marketeer can somehow evade and lose his CS pursuers, the chase will end with his destruction. Deadly force is always used in such chases. Some Coalition patrolmen even mark their vehicles or helmets to indicate the number of “kills” they’ve made. On average, that number is 40, but the best of the best may have 150 or more kills.

All of the above makes a “drop-off” dangerous enough, but a “pick-up” is even worse. The best pick-ups involve zooming in, grabbing the package while on the fly, and zooming away. Having to stop and hover, or worse, stop and get out of the vehicle, is extremely dangerous. The rule of thumb is: if a pickup takes more than one minute, abort and get out. If you were reported by someone a CS patrol is likely to arrive to investigate, guns blazing, in 1-4 minutes, with two or three minutes being the average. Get out before two minutes have elapsed and you can probably make a clean getaway. Linger longer than three, and you are probably dead meat.

Sometimes the goal is not to get contraband or passengers into the city, but to sneak them out. Daring hovercycle pilots have, a mere handful of times in the past, been able to pick up a passenger or a package from a window or balcony and rocket away before the ISS can give an effective chase. In order to counter “window grabbers,” many of the windows and balconies on the lower, poorer levels of the city have been enclosed or shrouded by gates, bars or fencing. Wealthier citizens on the higher levels are hesitant to accept such eye-sores, even if they mean better safety for the city overall. Still, the CS perimeter patrols and flybys are so frequent and so skilled, it is extremely hard to avoid them. Likewise, Coalition citizens are very conscientious and report intruders and suspicious behavior immediately, which brings the authorities zooming in to investigate.

Real Papers. The Chicago Network employs more Forgers than any other Black Market Faction. Their job is to provide all of the fake documents that the Network sells and uses for its own criminal purposes. In addition to convincing fakes and forgeries, however, the Chicago Network also has the connections and the know-how to get the real thing.

Real papers are just as good as any official citizen documentation. They require paying off or otherwise coercing a ranking Coalition civil official or getting hackers and inside agents into just the right places. Real papers are extremely expensive (10,000-100,000 credits depending on what it is), and the Chicago Network offers no guarantees they will work in every situation. Thorough investigation of the individual’s citizenship records is likely to reveal inconsistencies that are not found in normal citizens’ files. This investigation process is an extreme step, however, not seldom undertaken even if the person in question is being charged with a crime.

Operations away from Chi-Town

The Coalition State of Chi-Town, encompassing Iowa and parts of Illinois, is the Chicago Network’s back yard. And while Chi-Town and the ‘Burbs are the Network’s mainstay and primary marketplace, it takes a complex criminal infrastructure to keep the flow of contraband moving at all times, and much of this infrastructure is based in Illinois and Iowa.

There are numerous other population centers throughout the State of Chi-Town that, unlike Chi-Town itself, are designed along normal lines with no highly secure central fortress city. This makes them easier targets and simpler operating grounds for the Black Market, and a large amount of the contraband going into Chi-Town begins its journey at one of these outlying cities.

CS Lone Star. The establishment of CS Lone Star was an important CS military maneuver to protect the Lone Star Complex and to undermine the activities of the Black Market and Pecos Empire. While it has secured the former, the Coalition’s presence in the northern tip of Texas has done little to curtail the operations of the Black Market or damage the Pecos Empire. CS military operations are handily sidestepped, and if anything, the increased CS presence has only provoked the Pecos Empire to be more openly hostile toward the States. Meanwhile, *El Oculata* has long established connections with the Pecos Empire and other local bandits and independents in the Southwest and Deep South, as does *Bandito Arms*, who services the entire New West territory, including Texas and the southwest. This has left the Chicago Network only the Coalition NW quadrant as a potential sales zone.

When Lone Star was nothing but soldiers and CS engineers, the Black Market had a tough time finding a place for itself. Populations have grown in the last twenty years, however, as well as the number of soldiers deployed to protect them. Along with more people come greater opportunities for enterprising criminals, and more Coalition credits to be had.

The line of demarcation between territory claimed by *El Oculata* and *Bandito Arms*, and the Chicago Network is actually quite clear. The former service the Pecos Empire and the distant frontiers, and have a very limited presence within Coalition-claimed territory. The Chicago Network, on the other hand, is mostly made up of “city-boys” from elsewhere in the Coalition, and normally confines their activities to Lone Star City and other settlements in northern Texas. When the Chicago Network has a shipment they think is better slated for the Pecos Bandits or New West, they most often sell it directly to *El Oculata* or *Bandito Arms*, respectively. Unlike the simmering state of near-war between the Chicago Network and *Le Marché Noir*, the relationship between it, *El Oculata* and *Bandito Arms* is much more cordial. With *El Oculata* it is an uneasy truce and friendly rivalry. With *Bandito Arms* it is as a friendly business partner happy to exchange goods and services and help each other out. It is rare that agents of any of these Factions try to rip each other off, and never with permission from their superiors. At this point, the Network still believes it is easier to unload goods to *El Oculata* and *Bandito Arms* than for them to cultivate a relationship with the “Pecos Barbarians,” and it is unlikely for the Chicago Network to attempt any southward expansion.

CS Iron Heart. The Coalition State of Iron Heart has become a *contested zone* over the last few years. Since the secession of Free Quebec, **Le Marché Noir** has expanded greatly and increased their presence in CS Iron Heart. The Chicago Network has been in Iron Heart for decades, and the appearance of unwelcome competition has complicated matters between these two factions. There have been several assassinations, bombings and gun battles between enforcers of the two organizations. The prospect of a full-scale gang war is becoming more likely every day.

Ever since Iron Heart was inducted into the CS, it has been an irresistible target for the Chicago Network. Among the first planes and ships carrying Coalition ambassadors and military advisors were agents of the Black Market looking to extend their reach. And

as ties have developed between the States, so have the Chicago Network's holdings in Iron Heart.

Centered at the City of Iron, the Iron Heart branch of the Chicago Network attempts to insinuate itself into the large manufacturing and mining efforts in the region. They provide illicit entertainment to the industrial workers within the urban centers and the miners, and to the farmers and lumberjacks outside of town. With *Northern Gun* and the *Manistique Imperium* so close at hand, the Black Market has the opportunity to steal military equipment before it has even been delivered and placed on the open market. This includes secret shipments of cutting-edge Coalition hardware, which can disappear in the vast amount of commercial traffic that comes and goes from Manistique and Ishpeming's ports to Iron Heart and Chi-Town. It is a dangerous game stealing from the CS, Northern Gun (Ishpeming) and Manistique, but far less dangerous than stealing from military bases and active duty units' supply depots. Unknown to many people, both manufacturing empires secretly build parts, weapons and additional combat vehicles for the Coalition Army, which means CS gear can be acquired in the same fashion. The Chicago Network is also the Number One purchaser of "questionable merchandise" from pirates operating in the Great Lakes and along the Saint Lawrence River.

Plagued by long, fierce winters and proximity to the Xiticix Hiveland, regional Iron Heart military commanders are often happy to skip patrols during bad weather or periods of intense Xiticix activity. The local Black Market and the Chicago Network both use this to their advantage, hiding caravans and weapons caches in remote regions. During the worst months of winter, even the Xiticix often prefer to stay inside, and their partially dormant status means smugglers in warm clothes have the run of the place. When Free Quebec was still a member state, Quebecois scouts were brought in to help police the Great Lakes and trade zones around them, but the local replacements who have taken over since Quebec's secession are not quite as skilled or professional.

CS Missouri. Coalition Missouri is a state dominated by farms, slaughterhouses and agriculture. Even so, the Chicago Network has enterprises and Black Marketeers within the rural communities and the handful of urbanized cities like *New Chillicothe*.

Missouri is a fairly low priority for the ISS, and the Chicago Network takes advantage of this by hiding weapons caches and moving supply caravans through the mostly unwatched forests and remote reaches between stretches of farmland.

The state of Whykin, on the list to join the Coalition States, is an important base of operations for the CS and the Chicago Network. For one, it is another predominantly human nation. For another, while it is relatively secure, the ISS and Coalition Army have yet to set up shop in Whykin, and the Chicago Network currently runs circles around the local cops and military. Whykin even maintains a significant number of D-Bee slaves, and while Coalition representatives discourage the practice, the Black Market is happy to help out, with its more sinister members providing the slaves and others making a profit off of smuggling slaves out.

The city-state of Kingsdale, on the other hand, is an independent kingdom that is politically distant from the Coalition. It has become the unofficial headquarters of the Chicago Network's operations in the Missouri region. From Kingsdale, smuggling shipments are sent to Whykin where they blend in with the significant amount of trade conducted between Whykin and the CS, and between Kingsdale, Lazlo and the now destroyed Kingdom of Tolkeen.

Holdings Outside the CS. One of the ways the Chicago Network stays ahead of the Coalition military, ISS and other authorities is by constantly moving goods in and out of the Coalition's borders. While enemy military deployments and supernatural menaces in the vicinity are immediately noted and dealt with by Coalition forces, unobtrusive convoys and caravans can sometimes slip through unnoticed, or ignored, through the forests and farmlands. Using Lake Michigan and other water routes is a regular solution, but traffic must approach Chi-Town by a roundabout method as Old Chicago is heavily patrolled and monitored.

The farms and outlying communities around the Coalition are a kind of gray zone of which the Chicago Network takes full advantage. Many villages, towns and clusters of farmhouses are not technically part of the CS, but are still protected by Coalition military forces and far-ranging patrols. They do not receive much attention from the ISS, however, and are outside normal spheres of jurisdiction. This is the perfect situation for smugglers, as the Coalition military keeps watch for demons, D-Bee raiders and monsters, but the ISS coverage of the area is half-hearted at best. Smugglers, Black Marketeers and mercenaries masquerading as farmers and simple tradesmen can move about invisibly, blending into the populace and playing dumb if they are asked any questions. If their cargo is discovered, they can claim to be naive farmers or passers-by who were paid to deliver "secret cargo" with no questions asked. As long as they are human, the ISS tends to show considerable lenience, depending on the cargo, of course.

Dealings with Large Corporations

More so than any of the other Black Market factions, the Chicago Network has a long history of working with large corporations like Wilk's, Wellington, Northern Gun and the Manistique Imperium. Over the years, they have infiltrated agents into the headquarters and executive boards of such companies, and always have people placed throughout the rank and file. Insiders provide shipment information to the Chicago Network's thieves and hijackers, and even arrange for cargo to be intentionally rerouted or "misplaced."

The best corporate espionage agents do their jobs, stay in the shadows and remain undetected. They never actually steal goods themselves, preserving their anonymity and their place within the corporate system. Some Black Market agents even abandon the crime organization to "go legit," devoting themselves fully to what used to be only a cover job. Cutting one's ties to the Black Market is a risky proposition, though, especially considering that other Black Market sleeper agents are sure to be placed inside the company.

The Chicago Network, with its vast wealth and scores of civilized and educated gangsters, has had better luck infiltrating North American corporations than other Black Market Factions. The one notable exception is *Titan Robotics*. Despite their best efforts, the Chicago Network has never been able to get a sleeper agent promoted to a position of power within the mysterious robot manufacturer. A few robot detailers and low-level salesmen have been hired who secretly work for the Chicago Network, but they have found management positions, and even jobs in the repairs department, beyond their grasp to attain. The various leaders of the Black Market attribute this to a close-knit corporate culture, and continue their fruitless efforts to plant people inside the company.

Chicago Network Executive Board

“The Executive Board” is the insider term for the council of crime lords that runs the Chicago Network. Each is the head of a powerful crime family within the Chicago Network Faction. They are assembled from all walks of life, with some Board members raised inside the Coalition States and a few being ambitious outsiders. They each control a certain territory and have access to third parties who can provide the Black Market with weapons, contraband and resources.

James Coville, Chi-Town Crime Boss and Head of the Board: 11th level Smuggler and criminal mastermind (I.Q. 23, M.E. 21, M.A. 24). Coville is an extremely wealthy individual who lives within the fortress city of Chi-Town. He has used his Black Market profits to purchase several legitimate businesses – companies he uses to cover his smuggling operations. He lives the life of an upstanding CS citizen, and has even dined with the Emperor at a handful of public events. Coville is driven first and foremost by greed, cares little for the politics, and has no desire to undermine the Emperor or the Coalition States. He loves the Coalition and happily sings their praises as the greatest bastion of humanity in the world. Coville’s goal is to make lots and lots of money, and he is perfectly positioned to do so for the rest of his luxury-filled life. His alignment is Aberrant.

Trent Agon, Expediter (and secret Northern Gun Representative): 8th level Merchant Black Marketeer, Trent is a “former” mid-level executive from Northern Gun. Agon packed up his family and everything they owned, and moved to Chi-Town six years ago with his young family. “Officially” he has cut all ties with *Northern Gun* and the *Republic of Ishpeming*, and works as a consultant for a large manufacturing firm in the Coalition State of Chi-Town, but outside the fortress city. In reality, he is a Black Marketeer working for the Chicago Network as the middleman between the Black Market and Northern Gun. This means Agon is also still on Northern Gun’s payroll.

When Emperor Prosek declared war on the “enemies of the Coalition States” in his famous Campaign of Unity speech in 105 P.A., it was also announced that Northern Gun had become an “official” ally of the CS. That deal required Northern Gun to agree not to supply those deemed enemies of the CS (Tolkeen, the Federation of Magic, Lazlo, the Pecos Empire, numerous groups of resistance fighters, criminals, etc.). In return, the Coalition States agreed to respect the sovereignty of Northern Gun and their right to manufacture and sell arms. Agon’s job is to sidestep this treaty. He does so by secretly directing certain Northern Gun shipments into the hands of the Black Market for resale. This is done via fake raids, hijackings and other incidents that sound convincing to CS government officials, but which really place NG product into the hands of the Chicago Network. This deal enables NG to circumvent the restrictions of their treaty with the Coalition, puts money in the pockets of Northern Gun and the Black Market, and has catapulted young Trent Agon into the ranks of Major Players in the Black Market. His alignment is Aberrant.

Charles Macon, CS Lone Star Crime Boss: 9th level Bounty Hunter, Raider and Black Marketeer. Macon is a crime figure who lives a double life as a Black Marketeer and as a trusted Bounty Hunter for the Coalition Army. As a subcontractor for the CS Army, Macon travels constantly back and forth between Lone Star, the Pecos Empire, Chi-Town and the State of El Dorado, bringing “Criminals of the State” to justice. Most of the bounties he brings in have been sold out by their own comrades, and Macon maintains

close ties to both *El Oculata* and the various warlords of the *Pecos Empire*. He uses his trips out into the bush to disguise his secret meetings with Pecos Bandits, smugglers from Bandito Arms, independent raiders and members of El Oculata. Macon made his name and fortune as a Raider, attacking towns throughout the middle-Americas, Southwest and Deep South, but his favorite targets were CS military bases and patrols, as well as Splugorth traders and coastal pirates along the Gulf Coast. He still maintains connections with several disreputable bands of raiders, bandits and mercenary companies. His alignment is Diabolic.

John Millsly, CS Missouri Crime Boss: 10th level Smuggler. A high-ranking member of the CS Agriculture Committee, Millsly’s day job is to oversee all of the agricultural supply depots and granaries of CS Missouri. He uses his power and oversight to hide stashes of Black Market goods and contraband, and slips them past CS authorities. He, his family and his crew of Black Marketeers make a handsome profit smuggling an array of goods and people in and out of the Chi-Town ‘Burbs and Coalition Territories across the country. He pads his coffers even more by using his office and authority selling corn, grain and animal products that he has personally had marked “contaminated” and removed from normal distribution. Rather than the tainted product being destroyed, it is funneled by his Black Market enterprises for resale by the Black Market. His alignment is Miscreant.

Dominic Palazzo, New Town ‘Burb Crime Boss: 7th level Master Assassin. Dominic Palazzo is the last surviving member of the Palazzo crime family that used to be a major player in the Chicago Network. The family, led by the legendary Augusto Palazzo, became greedy and power hungry, and spawned the fratricidal gang war that brought about the destruction of the Palazzo empire. Dominic was only six years old at the time and was spared the family’s destruction. As he grew up, Dominic gathered together anyone he could find who was still loyal to his family, and over time, has managed to take control of Black Market operations within *Firetown* and a few other New Town Burbs. He has collected hundreds of stories about the glory days when the Palazzo family was on top and has plans to restore the family to its rightful place of power within the Chicago Network. To do so, he is willing to consider almost anything to supplant the rest of the Executive Board. Until that becomes a realistic option, however, he bides his time, plays at politics with the other Crime Bosses of the Chicago Network and appears to be a loyal member the Faction. His alignment is Miscreant.

June Sydell, Old Town ‘Burb Crime Boss: 13th level Banker/Fence. The prominent criminal figure in the Old Town ‘Burbs, June Sydell is a sharp-minded, charismatic predator who seeks profits and enjoys outwitting the authorities. She has kept things moving quietly in Old Town for the last 49 years, and sees more contraband go through her territory than any other member of the Executive Board. Her alignment is Anarchist.

Cassy Taylor, Federation of Magic Agent: 9th level Con Artist. Cassy Taylor was born within the Federation of Magic. Though she is not a practitioner of magic, she is nonetheless a Federation patriot and fiercely loyal to her homeland. Since she has no magical abilities, she was selected to infiltrate Chi-Town many years ago. Her mission is going better than planned, and her superiors from the Federation have turned her over from intercepting information to funneling weapons and magic items into the hands of dissidents and rebels within the CS via the Black Market. This “connection” to the Federation and magic items, albeit on a limited basis, has helped her rise through the ranks of the Chicago Network and onto the Board of Directors. Her alignment is Aberrant.



El Oculta

In the American Southwest and northern Mexico, much of the Black Market trade is dominated by a single cartel known as **El Oculta**, “the Hidden One.” True to its name, the command structure of El Oculta has remained outside the reach of Coalition authorities and vengeful competitors for years, melding into the shadows whenever their true identities and vital operations are at risk.

Descended from the drug cartels of ages past, El Oculta is arguably the most violent Faction of the Black Market in the Americas. They use torture, intimidation, kidnaping and gangland murder to maintain their share of the market and keep competitors away. And with clientele like the Pecos Empire, numerous bandit groups and raiders, rebels, terrorists, the Federation of Magic, and some say, even the *Vampire Kingdoms*, it pays to maintain a tough image. Those who try to cross El Oculta often end up buried in mass graves out in the desert.

Ever since the establishment of CS Lone Star in 68 P.A., Black Market activity in Texas has been forced to circumvent the northwest portion of the state. The motley collection of gangs, bandits and D-Bees that would evolve into the Pecos Empire were already excellent customers for weapons and the local Black Market, but sales only increased due to the presence of the Coalition Army. Routes were developed that cut south through “the Bend,” an inhospitable region of west Texas, connecting the Pecos Bandits and the marketeers who supply them to the American West.

As the Black Market developed holdings in Nevada and other areas, the trade routes became increasingly valuable. The appearance of more and more Coalition troops made it harder for the Black Market to supply the growing Pecos Empire and other southwestern customers, and competition for the Texan Corridor became fierce.

El Oculta is the product of that forty-year struggle for the Texan Corridor and the arms traffic into Mexico. There are many other Black Market groups in the area, but they are all small potatoes compared to El Oculta, and many exist essentially as “subcontractors” for the larger organization, working in specific zones like the Louisiana Gulf Coast or Rio Grande border and specializing in particular goods or clientele. It has been years since El Oculta has had to really go to war with a Black Market competitor, though occasionally, a Pecos Warlord will capture a caravan or market outlet and violence will flare up for a time between their troops and the cartel’s enforcers.

Vampire Infiltration

The question regarding vampires is not *if* they have infiltrated El Oculta, but to what extent. Vampires are regularly uncovered within the cartel’s ranks, and as they operate extensively in Mexico and often work at night, El Oculta is highly exposed to the undead. The somewhat careless nature of cartel security also makes a full sweep very unlikely. Sometimes new recruits are “tested” by being placed in sunlight or exposed to garlic, but there are always ways around such eventualities, especially for highly motivated vampire agents.

The main way the Vampire Kingdoms procure weapons from the Black Market is to use intermediaries to disguise their involvement. It is ironic that the vampires have to lie to do business even with the Black Market, but many Black Marketeers absolutely re-

fuse to sell their products to vampires and prefer to outfit Vampire Hunters. Vampires sometimes try to use loyal human and D-Bee servants to infiltrate El Oculta to get a way around this problem. Such a vampire pawn can clear shipments for travel south of the Rio Grande, divert weapons meant for Vampire Hunters or mercenaries, and act as an inside man when vampires decide to steal Black Market property. However, whenever such an individual is discovered he is either killed straight out, or used as lure to kill both slave and master.

El Oculta & Human Trafficking

Besides guns, drugs and the flow of CS contraband into Lone Star, El Oculta also does a tidy business in the trafficking of human beings. Beyond the usual Black Market trade in women and fugitives on the run from the authorities, the El Oculta cartel also makes good money smuggling people north and south of the Rio Grande.

The Vampire Kingdoms are always looking for new “cattle people” for consumption. For Black Marketeers who are desperate for cash or devoid of morals, abducting helpless villagers or travelers, and delivering them in lots to the vampires is always a reliable way to make a quick buck. The temporary camps *El Oculta* builds in the desert north of the Rio Grande are usually host to groups of desperate souls in some stage of their journey south. But just as the most ruthless elements of the Black Market are beyond the pleas for help from the victims they deliver, they are also no friend to the vampires. Cattle people already imprisoned are desperate to get away, willing to trade everything they have to a Black Market smuggler for a chance to escape to the north. There are several secret outposts that El Oculta operatives have in *Ciudad Juarez* and other parts of northern Mexico that form a kind of “underground railroad” that exists for the sole purpose of smuggling people *out* of the Vampire Kingdoms. This includes adventurers and Vampire Hunters who have gotten in over their heads and need to be secretly removed from Mexico before the undead can sink their teeth into them. And as the secret shipments of people go out, garlic, holy water and weapons and bullets made of silver come in to be marked up and sold to eager Vampire Hunters and people in need of protection against the undead. It is important to note that no Black Marketeer has ever been known to help or become one of the denizens who work for vampires and track down and slay Vampire Hunters. Such villains are regarded as beyond despicable and traitors to humanity.

Feral Dog Boys

El Oculta employs more mutants and D-Bees than any other Black Market Faction. The Coalition Lone Star Complex, located in Texas, is the primary genetic engineering facility of the CS. Millions of Dog Boys and other mutant animals have been created there. As a side-effect, the American Southwest has the highest population of rogue or “feral” Dog Boys living outside of the Coalition States. El Oculta is quick to recruit runaway and rogue mutants and bring them into their fold where they can find work as Enforcers, scouts and Black Marketeers. This means El Oculta has more Feral Dog Boys and runaway Coalition mutants than any other organization outside of the CS itself. Only the Pecos Empire even begins to come close, as many of these runaways end up as part of the Pecos Empire, or living in the Deep South, far from the CS. Those mutants who feel they have a bone to pick with the system that created them are recruited by El Oculta and Pecos

Warlords, and used to raid Coalition bases, supply convoys and even armored patrols.

Dog Boys have mutant psychic powers that also make them useful for detecting magic users, vampires and monsters from the Rifts, all threats that El Oculita smugglers have to deal with on a regular basis. Beyond that, their sense of smell lets them act like intelligent bloodhounds able to follow trails, detect intruders and generally maintain a superior sense of what is going on upwind. Most El Oculita (and other Black Market and Pecos) caravans and convoys traveling through the desert will have at least one or two Dog Boys amongst their numbers and using their superior senses to keep the smugglers out of trouble. All Dog Boys dislike Simvan and absolutely loathe vampires and the supernatural, and are not big fans of practitioners of magic either.

In addition to their use as runners, messengers, trackers, detectors, and fighters, many feral Dog Boys are born within Lone Star itself, making them familiar with the *Pecos Empire* and the operations of bandits, raiders and warlords. Runaways trained by the *Coalition Army* understand CS military operations, strategies and tactics. Some may even know current deployments in the field. The boldest Dog Boys may be willing to go into CS Lone Star cities, 'Burbs and military camps by donning their old military uniform or body armor. Most Coalition officers and security pay little attention to the underclass of Dog Boys and are unlikely to distinguish between one mutant dog and another. The big exceptions to that are Psi-Stalkers and Pack Leaders, and of course other Dog Boys.

Simvan “Mule Trains”

Following the westernmost leg of the Texan Corridor takes one perilously close to the Coalition-held northern quadrant of the state. While outsiders mock the feeble attempts to colonize and establish human settlements in this small corner of Texas, the fact is the Lone Star Complex is a sprawling CS military base. While the creation of genetically engineered Dog Boys is Lone Star's primary function, it is a full, functioning army base. As such, it fields thousands of Coalition troops, power armor, giant robots and combat vehicles. In fact, many outsiders have speculated that the pacification of the Pecos Empire is the Coalition Army's next target in its Campaign of Unity. While the surrounding country is mostly a rugged mix of canyons, scrub, prairie and mountain ranges, CS radar stations, air patrols and reconnaissance flights often spy merchant caravans, smugglers' vehicles and suspicious activity. When this happens, any nearby Coalition ground patrol or SAMAS or Skycycle wing is radioed the coordinates for interception and investigation. If no patrols or aerial wings are in the area, such a complement of troops, or a Death's Head Transport full of troops, will be dispatched from the Lone Star military base. Such CS patrols or transports usually arrive on the scene within the hour.

El Oculita has found a number of ways to avoid the Coalition's electronic surveillance and flybys. One simple, low-tech way is the use of mule trains. Groups of Simvan warriors are hired to transport shipments using Rhino-Buffalos, dinosaurs and other massive beasts of burden. Such mountains of meat may be large, but they barely register on Coalition radar and produce no radio traffic or other electronic signals that can be intercepted. Moreover, Simvan caravans are a common sight in Lone Star and the New West, and attract much less attention than any other method of cargo hauling. The Black Market employs other means of deception, including the use of magic and robots disguised to appear like an ordinary

herd of dinosaurs. Inside the bellies of the disguised robots is contraband.

Thanks to their usefulness in the Bend, the Simvan of the Pecos Empire have developed a relatively close relationship with El Oculita and Simvan warriors are present amongst the cartel's ranks. Migratory tribes and war parties of Simvan are frequently contracted to make runs throughout the Pecos Empire as well as out on the Great Plains and across the New West. The Black Market also uses Simvan and disguised robot dinosaurs to travel unobtrusively through Dinosaur Swamp and the Deep South.

El Oculita's Influence in Prisons

As a large, criminal organization in the American Southwest, El Oculita is well represented amongst the prison population of CS Lone Star. If a gang needs something smuggled into a prison, they need El Oculita – “the Hidden One” – and the amount of influence, information and favors owed that the cartel has accumulated behind bars makes it, by default, the most powerful group within the prison-gang system in the States of Lone Star and El Dorado (Arkansas). The Faction has some influence in other CS prisons, but it's nothing compared to the clout it wields in Lone Star and El Dorado.

El Oculita members enjoy a kind of protected status in jail; potential enemies know that attacking a cartel agent is an easy way to end up being unable to procure weapons, ammunition or even such prison essentials as cigarettes and junk food. As the number one payer of bribes to prison officials, it is also El Oculita who may be able to free a convict or arrange for circumstances that could lead to an easy escape.

In order to circumvent the influence that El Oculita's leaders have within the prison system, many high-ranking criminals are sent back to Chi-Town for incarceration. The wardens there have no contact with cartel money-men behind the scenes, and even the most powerful El Oculita smugglers are treated like common street trash by the guards in the North. For an El Oculita member, serving time in Chi-Town (or even worse, Iron Heart) is a very different punishment than the same stretch in Texas. As long as one's prison sentence is in Lone Star or El Dorado, life can remain comparatively comfortable.

Mercado, Market Town

Deep in the back-country of southwest Texas, within the territory claimed by the Pecos Empire, is the **Market Town of Mercado**. This dusty, muddy little city is the commercial headquarters of El Oculita, a giant, open-air marketplace where Pecos warlords, Simvan tribal chieftains and infamous outlaws come from hundreds of miles to do their shopping. Mercado is a one-stop shop for all El Oculita has to offer. Goons and enforcers hang around providing security, while others are ready to accept contracts from potential employers. Weapons and ammunition are everywhere and robots, power armor and vehicles are wrapped in tarps to protect them from the dust. Numerous saloons, gambling halls, drug dens, brothels, and other places of “entertainment” are set up around the town's perimeter. In fact, travelers can get a stiff drink and find something to spend their money on just about anywhere in town.

The secret of Mercado, and the main reason why a Coalition strike force has not already leveled the city, is that it is always moving, relocating itself to stay ahead of the authorities. Almost all of the buildings and market-stalls are temporary structures and

many of Mercado's products are sold out of the backs of trucks or right off of the giant pack animals that deliver them.

When word comes that there is good reason to relocate, the entire town is packed up and carted off to a new site. The cause could be anything: seasonal storms, severe ley line activity, or a tip that the Coalition plans to hit the mobile town. Maybe tensions have been mounting with the regional warlord. Whatever the justification, Mercado seems to move every three or four months, setting up shop somewhere else within the Pecos Empire, Arizona or northern Mexico. The new site might be hidden away in a canyon or deep within a forest. It could be up in the mountains or in an out-of-the-way valley where no one unwanted is likely to check. Negotiations with the local warlord have hopefully already secured military protection, usually not a difficult task for someone who can offer discounts on guns and power armor. Riders are sent out to the various faction leaders within the empire to inform them of Mercado's new location, and from there the information filters down to mercenaries, bounty hunters, outlaws and other interested parties who could be potential customers. This system works remarkably well, and the traveling town has avoided a CS attack for years now.

Groundwork is relatively minimal, with specialized engineers and practitioners of magic creating a few dirt roads, earthworks, flat areas for shops, and maybe a basic sewer system if there is time. Trucks and caravans of exotic beasts converge on the area, unloading their haul as tents and shops are erected. Merchants begin selling things almost immediately, and sometimes customers who are "in the know" are already waiting, eager to burn through some hard earned credits.

El Oculta keeps their traveling weapons bonanza well-stocked and supplied, as it is often the preferred outlet for Pecos Warlords looking to gear up before launching a military campaign or large-scale raid. Mercado is also well-guarded, especially when on the move. Roughly 400 El Oculta enforcers make up the city's normal defensive complement, at least one quarter of whom are psychics and magic users, another quarter cyborgs and troops in power armor. When the town relocates, the enforcers are especially organized and alert for trouble, moving about in aggressive patrols and sweeping a wide area in front of the vulnerable caravan.

Inside the market there are no weapons restrictions. Customers are free to walk around with the guns they came to town with as well as their new acquisitions, fully loaded and ready. With everyone in the area heavily armed and weapons literally everywhere, a kind of honor system is in place. Anyone who starts shooting will be gunned down by the enforcers immediately, no questions asked. The sales staff are also armed to the teeth and have an eye out for suspicious activity. Members of Don Marco's Silver Dagger Gang are carefully watched and sometimes banned from the town entirely as thieves and troublemakers.

Thanks to El Oculta's relationship with *Chief Zimchex* and the **Pervic Simvan** of the Grande Range, Mercado often sets up shop within their territory. El Oculta is always hiring Simvan to move their shipments (one of the few ways the nomadic D-Bees can come across Universal Credits without having to kill for them), and when Mercado relocates, there are usually hundreds of Simvan and their giant animals involved in the process or standing about happy to assist for the right trade goods.

When not sited in the Grande Range, Mercado may be hidden anywhere in the rough terrain of **the Bend**. In west Texas, the Bend is located closest to the Texan Corridor and Bandito Arms' holdings in Nevada, and minimizes the amount of time it takes

to resupply the Market Town or escape into the openness of the New West. El Oculta is wary of overusing the Bend, however, and is sure to choose a more easterly locale for Mercado if Coalition patrols seem to be increasing in regularity.

La Guarida

The headquarters of El Oculta is not a Market Town or a way-point like *Crossroads* or another of the Pecos Empire's "cities." Instead, it is the well concealed stronghold of the Delafuente sisters; the "hidden" in El Oculta's "the hidden one."

The location of La Guarida is not advertised to El Oculta's clients nor business partners, not even to Pecos Warlords who may be protecting or assisting the organization. It is sited east of *Edward's Plateau*, near the Colorado River (not the major Colorado River that runs through the Grand Canyon, but another river with the same name that is completely confined to Texas), but far enough from the water that river traffic will not notice the town. It is here that the cartel's enforcers rest and assemble, and where higher-ups can reside safely without need to worry about the Coalition or retribution from rivals, raiders or enemies.

Bulk product almost never goes through La Guarida, and what is sent through the secret HQ is sure to be the rarest and most expensive items that El Oculta can get its hands on. Enforcers come and go using the nearby river, stopping at one of three departure points where boats can dock and let off passengers. From there, they follow trails with camouflaged entrances through the rough country into the actual base camp. VIPs are transferred back and forth in hover vehicles.

La Guarida itself is a collection of large tents, rustic cabins and fairly elaborate wooden haciendas that the Delafuentes and their highest-ranking Bosses and Captains have built for themselves. They live like queens and kings off of their illicit profits and import all manner of pleasures for their amusement. In addition to stately homes for the three sisters and a dozen El Oculta big-wigs, La Guarida features swimming pools, several restaurants, taverns, drug dens and an exclusive market just for El Oculta members and their personal, special guests. And guests are truly special. Most luxury goods that pass through the cartel's hands are first offered to and picked through by La Guarida Market and higher-ups before being offered elsewhere or shipped out to normal customers. This includes things like Triax and Naruni weapons, new Coalition gear in good condition, exotic alien drugs, nuclear power packs and powerful magic items. The cartel's leaders and higher-ups get first crack at rare and special goods before the public ever sees them. Prices are fair and straightforward, usually at 60-70% of list price. Anyone who is allowed to visit La Guarida may shop at the market, though strangers not escorted by El Oculta members will stand out and are regarded with suspicion throughout the entire town.

2D4x100+150 El Oculta personnel of various types can normally be found at La Guarida at any given time – from the Delafuente sisters and their personal entourages and bodyguards to visiting smugglers, high-ranking Black Marketeers, "dignitaries" and "special guests." The latter two categories may include colorful adventurers, mercs, Cyber-Knights, Reid's Rangers, heroes and anyone who has impressed the heads of the cartel and who has been invited to enjoy the town's luxuries and exclusive market. Security is tight, and the atmosphere is close-knit enough that the guards tend to know every resident and guest's face. They spot intruders instantly and take immediate action to neutralize intruders. Wilderness Scouts, Simvan and Psi-Stalkers also roam a perimeter

of about 30 miles (48 km) around La Guarida in all directions, and are quick to report bands of Pecos Raiders or, God forbid, a Coalition patrol. In such instances, the Delafuente sisters and other non-combat VIPs are immediately rushed to high-speed vehicles or ships waiting concealed near the river while the town's defensive complement decides whether to stand and fight or attempt to melt into the countryside.

Adoncia Delafuente

The Black Widow, Head of El Oculta

El Oculta has a reputation for being the most bloodthirsty and vindictive of North America's Black Market Factions, a reputation that emanates from their leader, **Adoncia Delafuente**. Adoncia, known to outsiders as *la Viuda Negra*, "the Black Widow," is fond of chopping off arms and legs as a form of revenge, and is also infamous for sending the severed heads of her enemies to their comrades, families and friends. This notoriety gives low-life criminals and rivals pause before they decide to rip off El Oculta, and no one intentionally crosses Adoncia herself unless they have a serious death wish.

Adoncia Delafuente was born in the gutters of Ciudad Juarez. She knew only hardship and poverty growing up, and was working as a prostitute to support herself and her two younger sisters while still only a teenager. After a series of black eyes and beatings, Adoncia killed the abusive pimp she worked for in a particularly grisly fashion, and took over the business as madam and overseer.

Within a few years, she had murdered and seduced her way to the top and was one of the most powerful underworld figures within Ciudad Juarez. Anyone who crossed Adoncia ended up hacked to pieces and dumped out in the desert, their heads delivered in neat packages to their next of kin, boss, partner or associate. Her two younger sisters joined her in the expanding criminal enterprise, and the trio and their enforcers gradually became known throughout the region as *Beso de la Muerte*, "the Kiss of Death." Anyone deceived by their flirtatious demeanor and innocent appearance is said to be already doomed to die under the sisters' spell.

Beso de la Muerte soon expanded into a true Black Market powerhouse. Their only major competition came from El Oculta, a sprawling cartel that had already come to dominate the old highways, the desert watering holes and mountain passes of northern Mexico and the American Southwest. And despite repeated efforts, El Oculta refused to sacrifice market share or negotiate for territory. The Delafuente sisters had to try something else, so they fell back on their old, tried and true methods of seduction and murder.

Selena Delafuente, youngest of the three, fled to an El Oculta camp, injured and in tattered clothing. When it was found out who she was, she was taken to the current crime boss of El Oculta, an ambitious Pecos Warlord. She told him that her sisters had forced her out of the group and tried to have her killed. Selena offered inside information and the help of the *Beso de la Muerte* enforcers still loyal to her as insiders to destroy her sisters. Her only condition, she would rule over El Oculta as queen. The crime boss accepted, won over by her charms and her radiant beauty. By the morning after he declared her his second in command, he was dead, but it would take Adoncia and her sisters another two years before they killed off enough of El Oculta's leadership to take complete control of the cartel and make it their own. They have kept the name, however, as it is already known to many of their best customers within the Pecos Empire and northern Mexico. Besides, keeping the name, the Hidden One, seemed to feel right

and it also served as something of a trophy to their cunning and ruthlessness. The three sisters rule the El Oculta Faction with iron fists inside velvet gloves. All are ruthless, criminal masterminds steadfast in their loyalty to each other. But even the younger sisters fear Adoncia.

Adoncia Delafuente Stats

Real Name: Adoncia Delafuente.

Race: Human.

Alignment: Miscreant.

Attributes: I.Q. 21, M.E. 22, M.A. 25, P.S. 11, P.P. 13, P.E. 14, P.B. 19, Spd 12.

Experience: 9th level Black Marketeer Assassin.

Skills of Note: Speaks Spanish at 98% and American at 90%, Concealment 66%, Detect Concealment 80%, Escape Artist 85%, Find Contraband 75%, Hand to Hand: Expert, I.D. Undercover Agent 70%, Intelligence 82%, Interrogation Techniques 85%, Land Navigation 85%, Pick Locks 75%, Pick Pockets 70%, Pilot: Hovercycle 98%, Prowl 80%, Radio: Basic 95%, Recognize Weapon Quality 80%, Salvage 85%, Seduction 67%, Streetwise 67%, and W.P. Energy Pistol, W.P. Knife and W.P. Sword, all at 9th level.

Special Abilities of the Black Marketeer: Fence, Friends in Low Places (many throughout the American Southwest and Northern Mexico), Home Turf Advantage (Pecos Empire and Ciudad Juarez), Influential, Informant: Confidential (Ciudad Juarez, Lone Star), Informant: Street Snitch (many throughout the Southwest and Northern Mexico), Game Player, No Conscience, Steady Nerves and Street Rep: Hardcase to be Feared.

Psionics: Minor Psychic with the abilities of Intuitive Combat (10) and Telepathy (4). 61 I.S.P.

Magic Knowledge: None.

Weapons of Note: Has a penchant for Vibro-Blades and loves machetes and bowie knives.

Body Armor: Wears light body armor whenever going out into the public or when expecting violence.

Vehicles: Personally enjoys hovercycles, but is normally escorted around in a black, armored hover car (220 M.D.C.).

Cybernetics: Has a cybernetic computer implanted in her forearm that allows her to instantly check El Oculta's inventory and other information on shipments, schedules, payments and payrolls.

Carmen Delafuente

Carmen is an 8th level Black Market Entrepreneur and is the logistical brains behind El Oculta. While her two sisters run the cartel and mastermind acts of revenge and displays of violence to intimidate and maintain the cartel's reputation of fear amongst the Pecos Warlords and all rivals, it is Carmen who makes sure that supply caravans are moving and outlets stocked. She pays Simvan contractors, calculates losses from raids and Coalition interference, arranges bribes and bonuses and keeps an eye on the organization's day to day affairs. Carmen is usually flanked by a pair of 6th level full conversion cyborg bodyguards, a *Triax Marauder* and a *Triax Stopper* – elite Headhunters who have served the cartel for years and were sent to Europe at great risk and expense to be rebuilt into cutting-edge war machines.

Alignment: Miscreant.

Attributes: I.Q. 22, M.E. 19, M.A. 18, P.S. 9, P.P. 14, P.E. 13, P.B. 18, Spd 10.

Psionics: None.

Special Abilities of the Black Marketeer: Fence, Friends in High Places (many in the Pecos Empire and Northern Mexico, a few in CS Lone Star, CS El Dorado, and the Magic Zone; one in Triax), Friends in Low Places (many throughout the American Southwest and Northern Mexico), Home Turf Advantage (Pecos Empire and Ciudad Juarez), Influential, Informant: Corrupt Lawman (several at Ciudad Juarez, a few at CS Lone Star and CS El Dorado), Informant: Street Snitch (many throughout the American Southwest and Northern Mexico), Steady Nerves, Street Rep: Trustworthy and Work the Law.

Selena Delafuente

Selena is a 6th level Black Marketeer Master Assassin. She is the youngest of the sisters, only 24, and is known to take personal satisfaction in carrying out El Oculita's acts of intimidation and revenge. Selena uses her youth, her beauty and her innocent demeanor to get close to targets who would never expect that she is Black Market royalty and an elite cartel assassin. She prefers small

weapons like the NG Holdout, Wilk's derringer, poison darts and Vibro-Knives, and never appears overtly armed.

Alignment: Miscreant with sadistic tendencies.

Attributes: I.Q. 20, M.E. 20, M.A. 23, P.S. 14, P.P. 20, P.E. 15, P.B. 24, Spd 17.

Psionics: Major Physical Psychic with the abilities of Alter Aura (2), Deaden Senses (4), Impervious to Poison (4), Mind Block (4), Nightvision (4), Telekinesis (varies), Telekinetic Punch (6) and Telekinetic Push (4). 68 I.S.P.

Special Abilities of the Black Marketeer: Bulletproof, Friends in Low Places (many throughout the American Southwest, Northern Mexico and CS El Dorado), Home Turf Advantage (Pecos Empire and Ciudad Juarez), Informant: Street Snitch (many throughout the American Southwest and Northern Mexico), No Conscience, Read Black Market Operations, Read People, Sincerity, Steady Nerves, Street Rep: Hardcase to be Feared, and Suave and Debonair.

The Immaterial Hand

The most worrisome segment of the Black Market in the eyes of the Coalition States is the **Immaterial Hand**, Black Marketeers who use Rifts, ley lines and magic to circumvent the authorities (and their competitors) as well as traffic in magic items. The activities of the Immaterial Hand are almost impossible for the Coalition to trace. Based extensively within the Federation of Magic, but selling Techno-Wizard (TW) and magic items across the continent, the Immaterial Hand is located right on the Coalition's doorstep, albeit on the other side of a well-defended border.

The Immaterial Hand traces its roots back to the original conflict between Chi-Town/the Coalition States and the *Federation of Magic*. After the Federation's defeat, their subsequent retreat into the Magic Zone, and the onslaught of the *Bloody Campaign*, the fledgling Coalition States outlawed all magic and its practitioners. In so doing, they instantly created a market for illegal magic goods and the Immaterial Hand was born.

The group started as an outlaw corps of freedom fighters, a third of whom had been magic-using citizens of Chi-Town. Cast out of the CS and branded as untrustworthy criminals, they vowed to keep the flow of magic and free thinking alive in CS territory, but evolved over time into magic arms merchants and magic smugglers. Canny outlaws who made their living defying the will of the Coalition Army and selling wares and services in the same region as the Chicago Network, without directly competing with them. Furthermore, the Immaterial Hand's use of magic, Teleportation, ley lines and Rifts to transport cargo and contraband to foil Coalition intervention, made them a valuable ally to the Network. As a result, the Chicago Network and other Factions, large and small, would often hire the Immaterial Hand to smuggle contraband in and out of places via magic and Rifts.

However, while the Immaterial Hand did okay for itself, it didn't begin to grow in prominence until many years later, when TW items became more commonplace. Even then, the Black Market Faction was comparatively insignificant. Some felt they were little more than the wheelmen and porters for the rest of the Black Market. It has only been within the last twenty years that the Immaterial Hand started to become a significant commercial force

in the Black Market by increasing their trade in magic. The Chicago Network and other Factions didn't mind, because magic was a commodity that seemed to have a very limited clientele and was a product none of them carried. As a result, the Immaterial Hand could coexist because they were not direct competition. They had carved out their own niche in the market. Even then, the organization functioned primarily as an elite smuggling operation using magic and Rifts lines to smuggle goods and people into hostile areas.

The Coalition-Tolkeen War was a boon to the Immaterial Hand, helping it to explode onto the scene and rise to become one of the top Five Factions of the Black Market in a few short years. A Faction that is growing more powerful and influential every year. It is ironic that the Faction started out as idealistic freethinkers and advocates of freedom against the nascent Coalition States, because today, the members of the Immaterial Hand, even its most dedicated practitioners of magic, care nothing about such lofty ideals. These Black Marketeers may pretend to care about people, freedom and the right to use magic, but in truth, all they care about is profits and influence in the Black Market. And even influence and power take a back seat to money. Less than one percent of the practitioners of magic within the Faction care about revenge against the Coalition States. And none want to see the CS Empire toppled. Like many of their Black Market brethren, they jokingly thank to the CS for opening the door of opportunity to them, and laugh about how they'd be nobodies if it were not for the actions of the CS. Yes, the fall of Tolkeen was a tragedy, but for the Immaterial Hand, it was an incredible boon that catapulted them to landmark profits, prominence and power within the criminal underworld.

Immaterial Hand Contraband

The Immaterial Hand sells a wide range of the standard weapons, gear, vehicles and vices offered by the Black Market, but their area of specialty is magic. Whenever they can, this Faction will sell or trade magic potions, magic-based drugs and services, magic

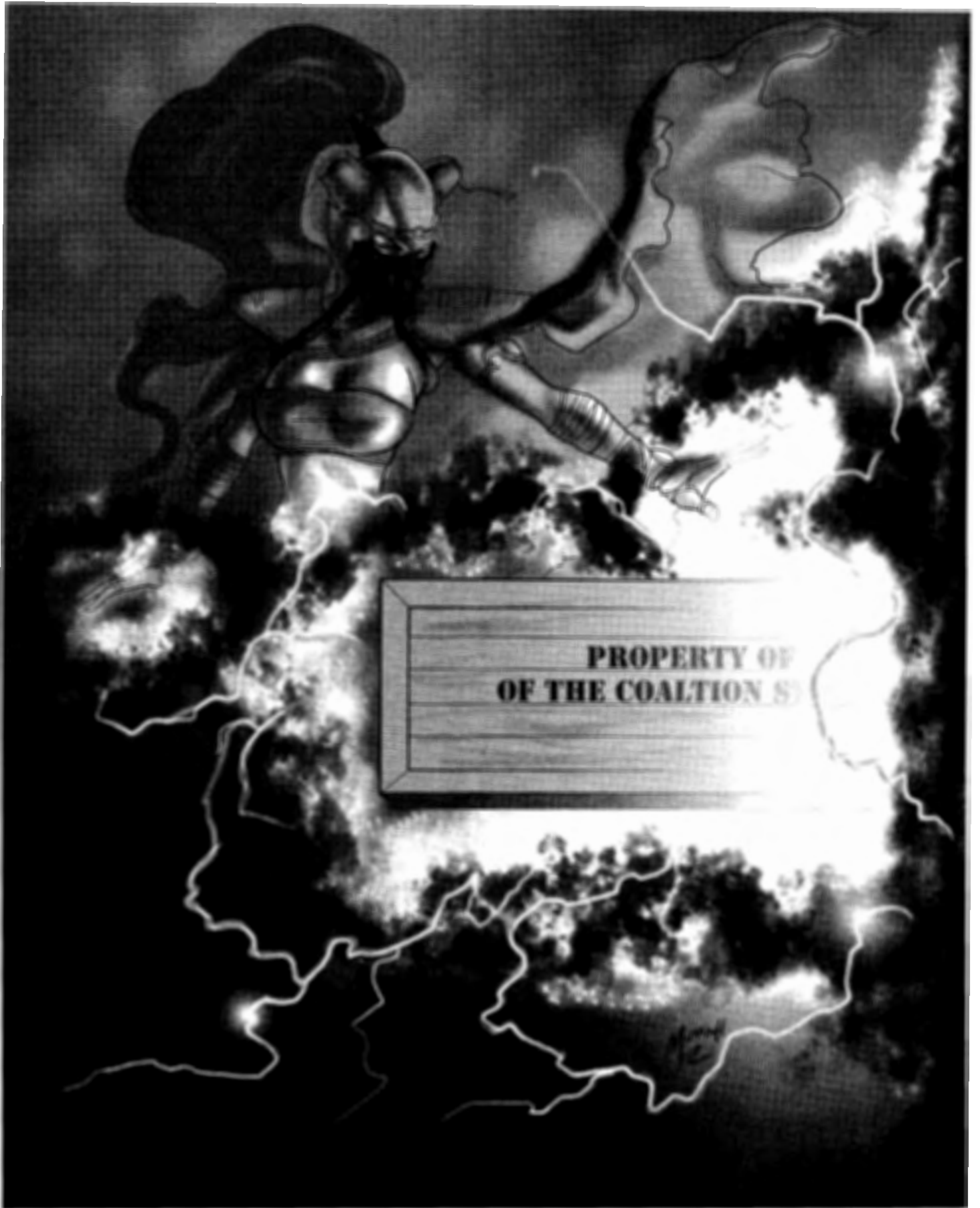

scrolls, TW weapons and devices, and even some TW body armor, power armor and vehicles.

The organization had always dabbled in the sale of magic and magical contraband, including gems and components for magic, but they did not become a major player until the Coalition States declared war on Tolkeen. War is often a boon to Black Marketeers, and the Immaterial Hand took full advantage of their expanding connections with the denizens of the Magic Zone to provide magic components, weapons and armor to the fighting forces in Tolkeen. The Faction's increased connections to the mages of the Magic Zone and Tolkeen opened doors to other communities of magic users and rebels. In the process, it enabled them to exponentially increase their entire magic business as countless others worried about the war spilling over to effect them.

While one might think the fall of Tolkeen and the razing of every one of that Kingdom's major cities would cause a dramatic decline in sales, it has not. Sales of magic have remained just as steady as when the war was going at full tilt. The very display of Techno-Wizard war machines and weaponry during the four-year-long war served to increase people's awareness of, and desire for, magic weapons and devices. Nobody outside of the Federation of Magic had ever seen such a display of magic or such an array of Techno-Wizard power. Indeed, many of the TW combat vehicles and weaponry were new or seldom seen creations. Creations that had stymied and held the Coalition Army at bay for years longer than anyone had imagined possible. Magic was put on display like no one in North America had ever seen, and it impressed.

Techno-Wizard items and all forms of magic are more alluring than ever before, and the Immaterial Hand has been able to exploit that like nobody else. It is a turn of events the Coalition States (and, honestly, most observers, including scholars and mages of Lazlo and the Federation of Magic) had not seen coming. For the CS, this is a nightmare, as the entire purpose of destroying Tolkeen so utterly was to show how the Coalition would not tolerate the use of magic and would destroy all who did so. While that message was received loud and clear, many people now see magic as a valuable, even vital, deterrent to the technological superiority of the Coalition States. The many types of magic and magic weaponry introduced to an unsuspecting world during the war has impressed everyone, and many want some of it for themselves.

(See the **Magic Contraband Section** of this book for full descriptions of some of the most notable magic and Techno-Wizard (TW) items sold on a regular basis by the Immaterial Hand, as well as some other Black Market outlets.)

The Market for Magic

The Immaterial Hand use their mystic knowledge and understanding of ley lines and Rifts to transport magical contraband and explore distant, new markets. To move cargo in ways that defy the laws of physics gives the faction a tremendous leg up, especially against enemies like the Coalition who know little about the workings of magic.

Their presence in the Federation of Magic is encouraged by the Federation's leaders, who see the Immaterial Hand as both a valuable ally and a face to the outside world that is not, strictly speaking, that of the Federation of Magic. Let's face it, the Federation of Magic has a colorful and bloody history that is off-putting even to other practitioners of magic. Many outsiders are quite simply afraid to have dealings with the Federation. Not just because of the Federation's own dangerous reputation, but because of the Coali-

tion States' unrelenting campaign to destroy them and anyone who has had even passing contact with them.

Enter the Immaterial Hand, who acquires 65% of its magic items from the Federation of Magic, 20% from non-affiliated mages within the Magic Zone and the rest from various other sources, including the Colorado Baronies and purchases from individuals, salvage operators, adventurers and others. They, in turn, sell magic items direct to the consumer as well as wholesale to other Black Market Factions. The Immaterial Hand provides 87% of all magic goods sold by the other four factions. And with practitioners of magic being distrustful of people they don't know – and the Federation being crazy-paranoid – few “outsiders” are allowed to establish new lines of trade. This gives the Immaterial Hand, who have proven themselves trustworthy and reliable for generations, complete dominance of magic within the Black Market. Of course, there are many practitioners of magic who are entrepreneurs and sell direct to consumers and others, but they tend to be located in faraway communities of magic, like Lazlo, New Lazlo, the City of Brass, and Dweomer, among others. And with the obliteration of the Kingdom of Tolkeen, arguably the most powerful kingdom of magic outside of the Federation, and the CS keeping up the pressure on user of magic and magic items, a great many people are giving such communities a wide berth.

As the established and time proven middleman, members of the magic community have turned to the Immaterial Hand to sell their wares and broker deals with other Black Market Factions and outside groups. Yet even with all these connections and years of trust, the flow of magic via the Black Market remains limited. This is due, in part, to the fact that magic items are all *one-of-a-kind items made by hand*, and cannot be mass-produced. This, alone, limits the number of items that can be put on the open market. Moreover, many items such as scrolls can only be used by other practitioners of magic. Even most Techno-Wizard items can only be used by magic users and psychics. To complicate matters further, many communities of practitioners of magic are hoarding and stockpiling magic items in case they are the next target of the Coalition's war on magic. Other mages do not like to see magic in the hands of those who do not truly understand or appreciate it. (Most mages tend to be elitist snobs who do not trust magic in the hands of those not initiated in the mystic arts. Many deny it, but it's a fact.) And while it may sound crazy, the Coalition's decades of propaganda against magic has worked like a charm. Many people, especially ordinary hardworking people, are convinced magic is dangerous or evil, or both. There is a massive number of people, including experienced warriors, bandits and adventurers, who will not use magic items under any circumstances. Most people look upon Ley Line Walkers, Mystics and other mages with a certain amount of suspicion and fear. They are quick to blame mages for everything that goes wrong or seems unnatural. As a result, the market for magic, at least in the Americas, is a tricky one that is very limited and scattered at best. All that said, when it comes to items available on the Black Market, odds are the Immaterial Hand made it possible.

Specialists in the Art of Magic Smuggling

Most Black Marketeers in the Immaterial Hand use magic and magic items, but only about one quarter of the Faction's members are practitioners of magic, with another 10% possessing Major Psionics and 5% Master Psionics. Before they exploded onto the scene as purveyors of magic items, the Hand became experts at

using magic for smuggling, concealing and transporting cargo and contraband. In fact, they are so expert, that even members of the Federation of Magic may turn to the Immaterial Hand and hire them to smuggle people and products. Any good Ley Line Rifter or Temporal Wizard can open a Rift so that a caravan from point "A" can travel to point "B" a thousand miles apart in a matter of a minute, but that's not smuggling and it definitely isn't stealthy. A Rift tearing open at a ley line nexus creates a magical vortex that rises a mile (1.6 km) or more into the sky. Such a stunt is useless if hostile forces are waiting on the other side or zoom in minutes later, weapons blazing. The Coalition, Raiders, Splugorth Slavers and Minions, dragons, evil mages and others either claim and use many nexuses themselves, or lie in wait to ambush unsuspecting travelers using magic and Rifts. The Immaterial Hand knows which nexus points, ley lines and places are safe and which are not. They know when and where the CS and Raiders lie in wait or make regular patrols. They have paid some of those who have claimed a particular nexus as their own and keep it by force, to allow them safe passage. They know to send scouts ahead, and may have armed escorts waiting at the rendezvous point and switch to conventional means of transportation when it is appropriate or less expensive.

Magic is also used to cover the trail of conventional vehicles and to hide cargo and personnel. Though some think of the Immaterial Hand as little more than "truckers" and package haulers, the Faction is much, much more. They have perfected the art of smuggling and transporting goods via magic, especially in and out of hot zones and secured areas.

A wide range of magic spells are used to help in the smuggling of all manner of goods, magical and non-magical. Using magic on ordinary people/Black Marketeers can get cargo loaded and unloaded at an impressive speed without heavy machines. Turning cargo *Featherlight* can enable ordinary people with normal strength to unload crates that weigh hundreds of pounds. Enhance their capabilities further by casting *Superhuman Strength* and *Superhuman Speed* on them, and workers can get a truck loaded and unloaded in record time. *Superhuman Endurance* and *Mystic Fulcrum* can also come in handy. All these spells are effective on ordinary humans, but are more effective when cast upon large, strong D-Bees. The use of *Levitation*, *Telekinesis*, and other spells can also be of help. In some cases, *Animate and Control Dead* is a fantastic way to load, unload, or carry and haul cargo on foot. Summoning forth Lesser Elementals, demons or other creatures with Supernatural Strength is sometimes employed as well, but they are a lot more tricky to handle than animated corpses or enchanted mortals.

While some of the magic used by the Immaterial Hand mages is high level spells, such as Open Dimensional Portals and Teleportation, the vast majority of spells used for concealment, cargo hauling and smuggling are Eighth Level or lower. **Elemental Magic** may be used to cover one's trail, conceal passage (fog, etc.), cross water, ice and so on, and to slow down or lose pursuers (storms of all kinds, etc.). **Temporal Magic** is great for opening and closing Rifts and using Dimensional Pockets and other dimensional magic to hide contraband.

The following spells are excellent for moving cargo, loading and unloading.

- Circle of Travel (600)
- Dimensional Envelope (60 or 380)
- Dimensional Pockets (20 or 140)

- Dimensional Portal (1000)
 - Dimensional Teleport (800)
 - Featherlight (10)
 - Float in Air (5)
 - Influence the Beast (12)
 - Invulnerability (25)
 - Levitation (5)
 - Giant (80)
 - Metamorphosis: Animal (25)
 - Mystic Fulcrum(5)
 - Mystic Portal (60)
 - Re-Open Gateway (180)
 - Rift Teleportation (200)
 - Superhuman Endurance (12)
 - Superhuman Strength (10)
 - Superhuman Speed (10)
 - Tame Beast (60)
 - Telekinesis (8)
 - Teleport: Lesser (15)
 - Teleport: Superior (600)
- As well as the use of Elementals and controlled animals and supernatural beings, Temporal Magic, and other spells.

The following spells are excellent for concealing and protecting cargo.

- Chameleon (6)
- Cloud of Smoke (2)
- Cloak of Darkness (6)
- Concealment (6)
- Detect Concealment (6)
- Energy Disruption (12)
- Extinguish Fire (4)
- Frequency Jamming (15)
- Globe of Silence (20)
- Impervious to Fire (5)
- Invisibility (any; 6 or 20)
- Multiple Image (7)
- Mystic Alarm (5)
- Shadow Meld (10)
- Sheltering Force (20)
- Watchguard (10)
- Words of Truth (15)

And all manner of illusions are used to conceal cargo and hiding places, as well as others.

The following spells are excellent for scouting, mystic communication and checking out travel routes.

- Calling (8)
- Chameleon (6)
- Climb (3)
- Commune with Spirits (25)
- Compulsion (20)
- Distant Voice (10)
- Eyes of the Wolf (25)
- Fly as the Eagle (25)
- Invisibility (any; 6 or 20)
- Locate (30)
- Magic Pigeon (20)
- Memory Bank (12)
- Metamorphosis: Animal (25)
- Metamorphosis: Insect (60)
- Phantom Mount (45)

Oracle (30)
Reduce Self (20)
Second Sight (20)
See the Invisible (4)
See Wards (20)
Sense Evil (2)
Tongues (12)

The following spells are excellent for preventing an alarm from being sounded or to get past checkpoints without incident or without harming anyone. With a little luck and proper execution, the smugglers can pass without being discovered or anyone being the wiser.

Aura of Death (12)
Aura of Doom (40)
Aura of Power (4)
Befuddle (6)
Blind (6)
Blinding Flash (1)
Calm Storms (200)
Charm (12)
Charismatic Aura (10)
Domination (10)
Fool's Gold (to distract and bribe; 10)
Force Bonds (25)
Frequency Jamming (15)
Horror (10)
Mask of Deceit (15)
Mute (50)
Negate Mechanics (20)
Seal (door, gate, etc.; 7)
Sleep (10)
And all manner of illusions.

The following spells are ideal for stopping or slowing pursuers without killing anyone.

Befuddle (6)
Carpet of Adhesion (10)
Circle of Flame (10)
Cloud of Smoke (2) and other magic clouds.
Light Target (6)
Magic Net (7)
Sleep (10)
Speed of the Snail (50)
Wall of Wind (40) and other magic walls.
Wind Rush (20)
And all manner of illusions, storms and obstacles created by magic.

Dimensional Magic

One of the Immaterial Hand's primary smuggling techniques is the placing the package or cargo outside our own dimension. This means the use of *Dimensional Pockets* and *Envelopes* to transport goods, and hide and deceive the authorities. The ability to bend the laws of physics makes magic smugglers a particular concern for those monitoring borders using traditional methods.

Dimensional Pockets are small Pocket Dimensions that have been created and affixed inside an enchanted container such as a jacket pocket, purse, backpack, or luggage. A Dimensional Pocket is generally compact and can only accommodate objects small enough to fit through the actual, physical entrance point. Dimensional Pock-

ets inside pockets can only fit objects smaller than the pocket itself, making them suitable only for smuggling handheld items, ammo, letters, and small pieces of contraband. Backpacks, duffel bags and sacks may be large enough to fit bigger objects, even people, but riding along as a passenger inside a Dimensional Envelope can be an uncomfortable, disorienting and frightening experience.

Even the largest Dimensional Envelopes are only the size of a closet or small room and their constrictive entrances limit their use even further. Experiments with larger envelopes and even full-fledged Pocket Dimensions have been attempted, but the magic used to create them is unstable and such tests have led to lost cargos, missing personnel and D-Envelopes that access unwanted realms such as Hades or Dyval.

Nexus Hubs

The Immaterial Hand's primary facilities are known as Nexus Hubs. Built around a ley line nexus, they are fortified camps that serve as launching points for magic-powered smuggling vehicles, portal jumps, opening Rifts, transporting cargo and so on. Convoys and individual blockade runners depart, following the ley lines off into the distance, and get to a location that can be thousands of miles away in the time it takes to open and go through a Rift. The energy of the central nexus is also drawn upon to cast magic spells necessary to expedite loading, unloading, concealment, protection or transportation.

At established Black Market Nexus Hubs, the area around the nexus is heavily guarded and locked down in case something unwanted should emerge from the Rift. Soldiers, Techno-Wizards, Ley Line Walkers, Rifters and Shifters are always present and available to work whatever magic is necessary to send smugglers and cargo on their way.

Nexus Hubs can be found in random locations in the Magic Zone and a few other places, including the ruins of the City of Tolkeen, the ruins of Old Chicago, the ruins of Old Detroit and Windsor, northern Mexico, Madhaven and Dinosaur Swamp. They also have arrangements to use one or more nexus points that are under the jurisdiction of the Federation of Magic at the City of Brass, Dweomer, Stormspire and other locations, as well as the Colorado Baronies, Lazlo, New Lazlo, Mexico, and the Splynn Dimensional Market. There may be others, but all are closely guarded secrets of the Immaterial Hand Faction. Of course, the organization may use any nexus point or ley line network without asking the permission of local governments or inhabitants. When this happens, the Black Marketeers do not linger. They use the nexus or lines and keep moving. Wherever there is a relatively stable ley line nexus not already in use, there is a chance of finding the Immaterial Hand.

Portal Overseers

The most powerful and highest-ranking spell casters within the Immaterial Hand are known as Overseers. The rank of Overseer is unique to this Faction and refers to a mage who specializes in magic involving the use of ley lines, nexus points, Rifts, and dimensional magic. They are roughly equal in rank to a Lieutenant in the Black Market, but regarded as elite specialists and are given much respect and protection. It is the Overseers who handle the most complicated rituals to control Rifts and open portals to desired locations. The typical Overseer is a Ley Line Walker, Ley Line Rifter, or Shifter, and usually 7-12th level of experience. They will have good amounts of personal P.P.E. and often use Techno-Wizard batteries and magic items to provide more energy. Overseers are generally accompanied by 1D4+1 bodyguards who

escort them to and from different locations, and sometimes assist in the magic ceremonies and Rift openings. Overseers are the ultimate VIPs of the Immaterial Hand, and without them the entire operation would be unsustainable.

Ley Line Drops. A favorite tactic is to travel along ley lines to a drop-off point or supplier. Coalition forces like to avoid ley lines unless they are engaged in an active search and destroy mission, and the speed and power granted to practitioners of magic and TW vehicles by the ley line is always to the Immaterial Hand's advantage. Sometimes promised shipments are delivered to a meeting place along a ley line and then chrono-shifted so that the shipment only appears at a designated time. Other deliveries are shielded by illusions to look like ruins, trash or open ground, concealed in shadows, and so on. It is "outside-the-box" thinking like this that makes the Immaterial Hand's shipments so well protected.

Contract Work

As noted, the Immaterial Hand uses magic to deliver all types of Black Market goods and contraband, most of it *non-magical*, and are hired by all Black Market Factions. However, the other Factions and smaller local organizations usually hire the Immaterial Hand only when they need a shipment delivered fast, or delivered to a place where conventional delivery is difficult, impractical or virtually impossible. The Hand's expertise is often used to circumvent military forces and disaster areas, and to transport valuable cargo a great distance. The "cargo" may be a small package or letter that can be carried by one mage or courier, or it may be a skid of merchandise to a convoy of vehicles. Other times the cargo is not goods at all, but a person or people.

The Immaterial Hand makes good money offering their expertise to fellow Black Marketeers and practitioners of magic, but enjoys other advantages as well. For one, they can spy on their comrades and clients in the course of doing normal business with them. All the Black Marketeers of the Immaterial Hand need to do is keep their eyes and ears open. If more information is desired, spy techniques and the utilization of magic and psionic abilities can garner even more valuable data. Information they can sell or use themselves to gain an upper hand in the market or against rivals and enemies.

The Fist

Unlike the other Black Market Factions, the Immaterial Hand is not run by a single crime boss, family or shadowy board of directors. Rather, a trio of powerful, unrelated individuals have managed to work their way to the top. While there are powerful crime families within the Faction, they defer to the proven cunning, skill and power of the Fist. While the name "Fist" suggests one leader, there are actually three, each a practitioner of magic and notorious smuggler/wholesaler in his or her own right. Each worked his or her way up the ladder within the organization and is highly respected. It has been the insight and coordinated effort of these three, working together, that has turned the Immaterial Hand from a mid-sized and notable Faction into one of the Top Five Factions in the Black Market.

In their capable hands, the Immaterial Hand threatens to become even more rich and powerful, so the rest of the Bosses, families and crews in the organization have all agreed to step back and let the Fist run the show. At least for now. After a century of being a second-string player in the Black Market, everyone loves being a powerhouse, and they don't want to do anything to change that. It is interesting to note that with such dramatic leadership,

growth and prosperity, nobody has challenged nor resents the Fist. All three are valued and celebrated by their comrades within the Faction. Their reign has likely only just begun.

All three are known and trusted by myriad members and Factions of the Black Market and Federation of Magic. They are also known to many individual practitioners of magic, magic communities and smugglers. Black Marketeers from the Immaterial Hand enjoy a reputation for getting the job done right and being reliable and honest in all their "business dealings." This means the Fist demands a lot from their crews, and anyone found cheating the Faction or its customers will pay for their crimes in a severe manner.

Jacob Caine

Caine is a powerful Ley Line Walker (10th level) with a mysterious past and a long history with the Federation of Magic as well as the defunct Kingdom of Tolkeen. The level of trust shown to him by Lord Dunscon and many others within the paranoid and evil Federation is nothing short of astounding. The other two in the Fist are accepted and trusted, but not to the same degree as Caine. As a result, Jacob Caine is the go-to guy in all dealings with Lord Dunscon and elite members of the Federation of Magic, a role in which he excels. He is also happy to handle other evil sources of magic. The various warlords, factions and cities within the Federation are the Immaterial Hand's largest suppliers of magic items for resale. That said, he also has excellent relations and many ties to the Black Market, mercenary companies, bandits, pirates and places like MercTown, Arzno, the Pecos Empire, and Calgary, the Kingdom of Monsters.

Jacob Caine is a handsome and charming forty-something human with a calm, relaxed manner that elicits trust and confidence. However, behind his smile and warm eyes is a ruthless predator quick to seize opportunity and quietly destroy his enemies, rivals and those who disappoint or fail him one time too often. He and Ava Marcuse are lovers and outstanding business partners. Together they can accomplish anything.

Alignment: Aberrant.

Attributes: I.Q. 21, M.E. 21, M.A. 24, P.S. 15, P.P. 12, P.E. 14, P.B. 22, Spd 11.

P.P.E.: 167

Experience Level: 10th level Ley Line Walker Black Marketeer.

Psionics: None.

Special Abilities of the Black Marketeer: Bulletproof, Friends in High Places (several in the Black Market, Federation of Magic and Magic Zone, two survivors in the aftermath of Tolkeen, one in the City of Chi-Town and one in New Lazlo), Friends in Low Places (many throughout the American Southwest, Magic Zone, Federation of Magic and Chi-Town 'Burbs), Home Turf Advantage (Magic Zone and Federation of Magic), Influential, Informant: Street Snitch (many throughout the Magic Zone, Federation of Magic, Black Market, and Chi-Town 'Burbs, a few in Lazlo, New Lazlo and Old Bones in Free Quebec), Read Black Market Operations, Read People, Sincerity, Steady Nerves, Street Rep: Trustworthy, and Suave and Debonair.

Ava Marcuse

Ava is an Elf trader born in Lazlo but whose parents emigrated from another world. She is a 9th level *Rift Runner* with a head for numbers, logistics and organization. She is a player in the criminal underworld of the Black Market and loves the success they have

enjoyed within the Immaterial Hand. Without her connections, the Immaterial Hand would have had a much more difficult time purchasing magic from honest and upstanding mages. She has no love for the Coalition, the Federation of Magic and the Splugorth, and thinks of them all as monsters and narrow-minded brutes consumed with a lust for power and revenge. As a result, she enjoys using the Federation to her own ends and stealing from the Coalition States and the Splugorth and their allies (e.g. Horune Pirates, Slavers, etc.). Ava is an Elven beauty who looks to be twenty-something, but is really 40 years old.

Alignment: Anarchist, through and through.

Attributes: I.Q. 20, M.E. 19, M.A. 19, P.S. 14, P.P. 20, P.E. 13, P.B. 26, Spd 12.

P.P.E.: 152

Experience Level: 9th Level Rift Runner Black Marketeer.

Psionics: Major Psychic with the abilities of Detect Psionics (2), Mind Block (4), Object Read (6), Read Dimensional Portal (6), See the Invisible (4) and Sixth Sense (2). 71 I.S.P.

Special Abilities of the Black Marketeer: Bulletproof, Fence, Friends in Low Places (many throughout the New West, Magic Zone, Black Market and criminal circles), Home Turf Advantage (Lazlo and Chi-Town 'Burbs), Informant: Street Snitch (many throughout Chi-Town 'Burbs, Lazlo and the American Southwest; a few in the Federation of Magic and Magic Zone), Read Black Market Operations, Read People, Steady Nerves, Street Rep: Trustworthy, and Suave and Debonair.

Yull Thundersworn

One of the most powerful spellcasters within the entire Immaterial Hand (14th level Ley Line Rifter), Yull Thundersworn is an expert in opening portals, controlling Rifts, using Ley Line Magic and traveling across dimensions. Though few know it, Yull is a Sphinx hailing from a far-off world. He has a vast knowledge of magic, dimensions and planes of existence. He comes and goes at times, searching for rare magic artifacts and other items not found on Earth that catch his interest. Yull is often willing to send adventurers to exotic and dangerous realms simply because it entertains him, though he is almost always arrogant and condescending towards non-magic humans and other "lower species" and is more likely to honor a request from a dragon, Elf or other higher life form. When meeting with humanoids or making a public appearance, Yull Thundersworn takes the form of a handsome human male 25 years of age, but is really 450 years old. Yull often uses metamorphosis magic to take other forms, including the human form, and only his two partners and a tiny handful of other trusted people know he is really a Sphinx.

Alignment: Aberrant.

Attributes: I.Q. 21, M.E. 22, M.A. 12, P.S. 23 (Supernatural), P.P. 18, P.E. 23, P.B. 22, Spd 20 running (14 mph/22.4 km), but 100 flying (72 mph/115 km).

P.P.E.: 258

Experience Level: 14th level Ley Line Rifter Black Marketeer.

Bonuses of Note: +3 on Perception Rolls, +4 on initiative, +7 to strike, +8 to parry, +6 to dodge, +7 to dodge in flight, +3 to disarm, +6 to pull punch, +4 to roll with impact, and +2 on all saving throws.

Natural Abilities of Note: As a Sphinx, he magically understands and speaks all languages at 98%, literate in Dragonese/Elven, American, Spanish, Euro and Demongogian at 98%, Math 98%, Prowl 60%, Swim 40%, never tires when flying, Nightvi-

sion 120 feet (36.6 m), leap 30 feet (9.1 m) high and 200 feet (61 m) across, bite does 3D6 M.D., claw strike does 4D6 M.D., power strike 6D6+10 M.D.

Psionics: Major Psionic with the abilities of Empathy (4), Mask I.S.P. & Psionics (7), Mask P.P.E. (4), Meditation (0), Read Dimensional Portal (6), Sense Dimensional Anomaly (4), Sense Time (2), and Total Recall. 98 I.S.P.

Special Abilities of the Black Marketeer: Antiquities Trader, Bulletproof, Friends in High Places (Federation of Magic and Atlantis), Friends in Low Places (many throughout the American Southwest, Magic Zone, and Atlantis), Game Player, Influential, Informant: Corrupt Lawman (one in the Federation of Magic, two in Atlantis and one in the Chi-Town 'Burbs), Read Black Market Operations, Read People and Street Rep: Hardcase to be Feared.

Le Marché Noir

Throughout the Coalition States, the Black Market has set up countless operations and small syndicates, taking advantage of the Coalition States' prohibition of magic, books and weapons. There are subgroups within each Coalition State, normally taking their orders from or competing with the *Chicago Network*. **Free Quebec**, however, has always stood apart from the rest of the Coalition, and their native Black Market is a reflection of their desire for sovereignty. **Le Marché Noir** has never really integrated with other Black Market groups, and since Free Quebec's declaration of independence, it has become even more aloof.

Le Marché Noir has been around for decades, catering to the needs of the Quebecois underworld and Canada at large. In addition to their grip on most of Free Quebec's Black Market activity, they also service Lazlo, New Lazlo and eastern Canada, and are increasing their presence every year in the Coalition State of Iron Heart. They control vast portions of Old Bones, the semi-lawless "gray zone" that is left somewhat undisturbed by the police, and deal with pirates operating in the Atlantic, the Great Lakes and St. Lawrence Seaway. There have even been rumors of collusion between Le Marché Noir's higher-ups and the more shadowy elements of Free Quebec's government, and there is a potential turf war brewing between Le Marché Noir and the Chicago Network over dominance of Iron Heart. Both think of it as their own.

Since Free Quebec's break with the other Coalition States, Le Marché Noir has enjoyed a boost in sales and access to new market shares. As part of the Coalition States, Free Quebec had partially integrated its own security apparatus with the Internal Security Service (ISS) based out of Chi-Town. Smugglers and market thugs had to deal with the Coalition's large database of wanted criminals, as well as pressure from Chi-Town for Free Quebec to meet certain quotas and investigate specific activities like Juicer augmentation or anti-Prosek sentiments. Now that Quebec is independent, it has to deal with the Black Market underworld on its own, and the Quebecois government is much more willing to turn a blind eye to certain crimes, especially if the perpetrators confine their activities to Old Bones and locations outside Free Quebec.



Part of the difference is also accessibility. The Black Market bosses who lead Le Marché Noir have never had the kind of power or reach needed to buy off the authorities in Chi-Town, especially when the local Chicago Network crime faction had already beaten them to the punch. Now that Chi-Town is out of the picture, Le Marché Noir has extended its influence within the Quebecois bureaucracy, with many powerful officials on the payroll and even some of its own people infiltrated within the government. Le Marché Noir is enjoying a kind of renaissance as the organization expands and reinvents itself, directing its attention and energies towards new markets in Iron Heart, the Lazlos, and America's East Coast, whose growing fishing villages and pirate coves are in need of protection from Splugorth slavers and Shemarrian war parties.

Old Bones

Old Bones is an interesting place for Le Marché Noir. On one hand, it is a bonanza of crime and illegal arms sales that is impossible for the Black Market to avoid. On the other hand, Le Marché Noir is somewhat suspicious of Old Bones after several of their larger outlets simply disappeared overnight. The leadership of Le Marché Noir is not sure of the cause for their misfortune. Monsters from the Rifts or Atlantis, hijackers, vengeful competitors from the Chicago Network or Horune Pirates, and even le Surete du Quebec are all suspect, but Le Marché Noir has no evidence to point to any of them. All they know is that three times, a well-planned and established operation has vanished into thin air, with none of the goods ever recovered and none of the smugglers and salespeople ever seen again. Granted, Old Bones is a dangerous place, but Le Marché Noir never expected to be targeted as a whole and is still somewhat perplexed that any other criminal element would dare cross them, even pirates or the Splugorth of Atlantis.

What Le Marché Noir does not know is that Old Bones is essentially run by the Quebecois government. Old Bones is a highly secretive project, and even Le Marché Noir's contacts within the government have been unable to access the necessary information to prove the case to their superiors. All the higher-ups within Le Marché Noir know is that there is some other force at work within Old Bones, and suspect that it is some kind of conspiracy of mages or powerful interdimensional creatures.

Le Marché Noir and Iron Heart

Iron Heart is quickly becoming the front line between Le Marché Noir and the Chicago Network. Just as the CS and Quebec have their difficulties, so do Le Marché Noir and the Chicago Network. Though they both operate within human supremacist countries, the two factions have found little other common ground. The Chicago Network cannot believe that Le Marché Noir has the audacity to trade within Iron Heart, still an important CS member state and relatively fresh territory that has been earmarked to serve as a base for Chicago Network expansion.

Le Marché Noir sees nothing stopping it from taking advantage of demand for their product in Iron Heart, and is quickly solidifying the trade connections that link it and their holdings within Free Quebec. The two nations are not all that far, geographically, and Quebecois smugglers are always on the move traveling back and forth. Quebec's secession has made their job slightly more difficult, but most of Le Marché Noir's more seasoned personnel already have connections within Iron Heart left over from when FQ was considered a vital part of the CS. They also have dealings

with Northern Gun, the Manistique Imperium and pirates active in the Great Lakes, all of which are near Iron Heart.

The Iron Heart division of the ISS takes particular offense at this upstart group of Quebecois criminals. They are notably ruthless and relentless in their pursuit of the organization, and the Chicago Network is always happy to lend a hand by selling out the competition to the authorities whenever possible. A number of busts made on Le Marché Noir smugglers attribute their success to "anonymous tips," many of which no doubt come from Chicago Network agents.

Le Marché Noir trafficks in all the things the rest of the Black Market offers, except magic; they avoid it as much as possible. There are two things they have, however, that few others can offer. One is *Glitter Boy* related items. The Marché Noir sells parts and repair services for Glitter Boys (they have for generations), as well as Glitter Boy ammunition (the famous Boom Gun shells) and even the occasional hijacked Glitter Boy power armor from the Quebec military. Two, Free Quebec has more open and regular trade with the New German Republic, which means le Marché Noir is North America's primary source for *Triax* weapons, gear, and power armor. Since they deal with pirates, they are sometimes able to get items from Atlantis, England, Europe and Africa, but not on a consistent or regular basis.

Jean Robillard

Crime Boss of Le Marché Noir

Jean Robillard is the unchallenged head and overseer of Le Marché Noir. He is a shadowy figure, a legend in the Quebecois underground even before he took the reins of power over Le Marché Noir itself. His background is part of the legend. Jean started out as an orphan in the streets of Free Quebec, working as a pickpocket just to stay alive. From such humble beginnings, he has risen up through the ranks of the Black Market to become one of its most powerful crime bosses.

What his closest associates know that others do not, is that this backstory is all a fabrication. There are no records of Jean Robillard before 79 P.A., and even the most veteran criminals in Free Quebec do not remember him from their youth. The reason for this is simple: Robillard is actually a *Royal Frilled Dragon*, an obsessive hoarder who insinuated himself into the Black Market a few decades ago in order to chase down some exotic items, and eventually fell into the habit of living in human form. He does not intend to stay with Le Marché Noir and is actually beginning to tire of Rifts Earth. He plans on casually moving on in another decade or two once he has filled out his collection a bit more.

Robillard runs Le Marché Noir for several reasons. He enjoys organizing and leading humanoids, hates the Coalition States and sees the leadership of Free Quebec as naive. The main reason he maintains his elaborate cover and position of responsibility, however, is to help add to his hoard. Dragons are famous for their treasure troves and secret caches of gold and jewels, but Robillard is known as a pack-rat and collector even amongst his own kind. His hoard is hidden in a massive cave he constructed that can only be accessed from a remote valley up in Quebec's Laurentian Highlands. Inside, hidden from thieves, competitors and even his own people at Le Marché Noir, is Robillard's meticulously organized and maintained collection. Priceless pre-Rifts artifacts, several ancient Glitter Boy suits, new weapons and vehicles from the Coalition, Triax, the Naruni, exotic pieces from Japan, the Arkhon Freehold, Atlantis and others, are all included in the collection.

There are rare and expensive Techno-Wizard devices, powerful magic objects, Golems in storage, mountains of gold, silver and jewels and a number of strange creatures and beings kept in suspended animation. Jean Robillard has active Golems and a handful of other supernatural servants that guard his treasure trove, but they, too, are actually part of his "collection." After decades of careful collecting and storage, Jean likes to think his treasure trove might be the largest dragon hoard on Rifts Earth. (Unlikely, though it may be one of the most eclectic.) Of course, anything that moves through the warehouses of Le Marché Noir that strikes his fancy, he takes for his own.

Sometimes other smugglers who are part of Le Marché Noir wonder where the best items have gone, but Robillard assures them that he has personally found well-paying clients, and dumps enough credits (basically worthless to him in the long haul) into the organization's accounts and coffers to discourage suspicion.

In addition to his obsessive hoarding habits, Robillard also likes to use his shape-changing abilities to keep his people on their toes. Only his inner circle know that he is not human, and only a few amongst even them are aware of his true dragon identity. When he wishes to test his salespeople or security, he simply assumes a different form and uses it to pass unnoticed. This practice is extremely unnerving for those who work for him, who never know if the new customer or smuggler they are working with is actually their boss. To help cover his dual identity, it is common knowledge that there are at least two dragons and a handful of shape-changers under his employment.

Jean Robillard likes to lay his plans out carefully, sometimes taking months or years to procure a particular item, or waiting patiently until he can manipulate things to come his way. This is true of collectibles, treasure and building Le Marché Noir to be a force of influence and power. For the truly impossible finds and elaborate schemes, Robillard may spend weeks away from the organization, using his magic and psionics to infiltrate rival and enemy groups and impersonating others. He constructs elaborate plans for these situations, and such schemes and chess-like games are his greatest personal joy and the best part of his "hobby." With his vast range of magical and psionic powers, as well as his ability to shock and impress as a dragon (or smash right through walls and vault-doors), there is almost nothing out of reach for Robillard, and his reptilian patience assures that he always gets what he wants.

Robillard's standard human form is a thin, mustachioed, middle-aged man who tends to dress in black and has expensive tastes in clothes, jewelry and works of art. His position of power in Le Marché Noir has made him extremely rich, and none of the other Faction Bosses suspect he is anything other than a human smuggler with psionic abilities. Spells like Lightblade and Magic Shield, two of his favorites, are often mistaken for Psi-Sword and Psi-Shield, as are other magic abilities and insight gleaned from magic rather than psionics. Of course, as a dragon, he also has genuine psychic abilities.

Jean Robillard Stats

True Name: Gennerabarde (a carefully guarded secret).

Aliases: Francois Robitaille, Adrien Robespierre, and Benedict Black the Dragon.

Race: Royal Frilled Dragon.

Alignment: Anarchist.

Horror Factor: 14 as a dragon. No Horror/Awe Factor in human form, thanks to Jean's convincing disguise and human impersonation.

Attributes: I.Q. 25, M.E. 19, M.A. 26, P.S. 30 (Supernatural), P.P. 18, P.E. 23, P.B. 28, Spd 17 running, 70 flying.

Height: (human) 5 feet, 11 inches (1.8 m). **Weight:** (dragon) 17 tons.

M.D.C.: 3,700.

Age: Appears to be in his mid-50s, but is actually 819 years old. He is still considered a Hatchling Dragon as dragons do not reach adulthood until 1,000 years of age.

P.P.E.: 314. **I.S.P.:** 272.

Experience: 10th level Smuggler/Dragon.

Disposition: For a dragon, Robillard is warm and open, at least to those who work for him within Le Marché Noir. To outsiders, he is much more likely to forget about his "human act" and let his natural dragon arrogance and callousness take hold. He loves to scheme and plan and trick others as much as he does accumulating treasure.

Skills of Note: Literate in Dragonese/Elven and American at 98%, French, German and Spanish at 90%, Appraise Goods 90%, Archaeology 90%, Animal Husbandry 95%, Camouflage 80%, Computer Operation 98%, Detect Concealment 90%, Field Armorer & Munitions Expert 98%, Find Contraband 64%, History: Post-Apocalypse 95%, Impersonation 78%, Lore: Demons & Monsters 85%, Lore: Faeries & Creatures of Magic 85%, Lore: Magic 85%, Pick Locks 90%, Pick Pockets 85%, Pilot: Airplane 98%, Pilot: Boat: Ships 98%, Pilot: Truck 88%, Recognize Weapon Quality 85%, Salvage 95%, Streetwise 68%, Tailing 90% and Undercover Ops 90%.

Special Abilities of the Black Marketeer: Antiquities Trader, Fence, Friends in Low Places (many throughout Southeastern Canada, Free Quebec, Iron Heart, and amongst pirates operating in the region), Game Player, Home Turf Advantage (Free Quebec), Influential, Informant: Corrupt Lawman (several in Free Quebec and Iron Heart, one in Lazlo), Read Black Market Operations, Sincerity, Slippery, and Work the Law.

Natural Abilities: Understands and speaks all languages, Nightvision, Bio-Regeneration and others as per page 162 of **Rifts® Ultimate Edition** under the *Royal Frilled Dragon* and its natural abilities.

Psionics: Master Psychic with 221 I.S.P. and the following abilities: Alter Aura (2), Astral Projection (8), Clairvoyance (4), Detect Psionics (6), Machine Ghost (12), Mask I.S.P. and Psionics (7), Mask P.P.E. (4), Mentally Possess Others (30), Mind Block (4), Object Read (6), Read Dimensional Portal (6), Remote Viewing (10), Restore P.P.E. (4+), Psychic Omni-Sight (15), Sense Dimensional Anomaly (4), Speed Reading (2), Telekinesis, Telemechanics (10), Telemechanic Possession (50), Telepathy (4), and Total Recall (2).

Magic Knowledge: Armor of Ithan (10), Aura of Power (4), Blind (6), Carpet of Adhesion (10), Call Lightning (15), Chameleon (6), Concealment (6), Death Curse (special), Death Trance (1), Detect Concealment (6), Dispel Magic Barriers (20), Distant Voice (10), Electric Arc (8), Energy Disruption (12), Energy Bolt (5), Escape (8), Eyes of Thoth (8), Familiar Link (55), Fool's Gold (10), Frostblade (15), Globe of Daylight (2), Greater Healing (30), Heal Wounds (10), Ley Line Transmission (30), Lightblade (20), Light Target (6), Locate (30), Magic Pigeon (30), Magic Shield (6), Manipulate Objects (2+), Mask of Deceit (15), Memory Bank (12), Metamorphosis: Mist (250), Mystic Alarm (5), Mystic Portal (60), Mute (50), Negate Magic (30), Orb of Cold (6), Reduce Self (20), Re-Open Gateway (180), Rift Teleportation (200), See Aura (6), Sense Evil (2),

Sense Magic (4), Sleep (10), Transferral (50), and Wall of Defense (55).

Weapons of Note: Robillard is rarely armed, preferring to rely on his natural abilities if he gets into trouble.

Body Armor: None.

Vehicles: Robillard's personal vehicle is an imported, Triax Z-Type Luxury Hover Sedan. It has been up-armored for a total of 160 M.D.C.

Cybernetics: None.

Black Market Internal Structure

By Matthew Clements, Kevin Siembieda & Alex Marciniszyn

The Black Market has become a formidable force on Rifts Earth. Since their inception, they have spread their tentacles across the width and breadth of North America. Their influence even reaches into places where they are officially outlawed, such as the Coalition States. To the many adventurers who travel throughout the continent risking life and limb in the quest for freedom, fame, wealth, or glory, the Black Market can be their best friend or worst nightmare.

Overall, the Black Market operates very much like organized crime of the pre-Cataclysm era. Much like their pre-Rifts counterparts, the Black Market often becomes involved with *legitimate businesses*, in addition to their less than legal activities. This is not done for altruistic reasons. Whenever the Black Market does business, they expect to get some type of "payoff" to make their time and effort worthwhile. This means big profit, insider information, the illusion of respectability, a front for criminality, and/or some other benefit. Not only will many legitimate Black Market businesses serve as outlets for their products and services, but by aiding honest people or other companies, the Black Market establishes ties to the local community. This results in a more positive and friendly public image, so that the Black Market is less likely to be perceived as a danger or bad influence by the local people and the political powers that be. It can also garner much needed local support if the Black Market is called to account for its less reputable enterprises. It also creates a strong network of friends, allies, contacts and ears to the ground that can warn of brewing trouble or opportunity. Thus, for these reasons and others, the Black Market realizes that though legitimate businesses are less given to earning the "big score," they can prove to be far more valuable on a long-term basis on a strategic level.

Most dealings with the Black Market are akin to gambling at an honest casino. The odds – and the rules – favor the house winning in the long run, but every now and then, some lucky gambler will hit it big. This is usually okay with the casino because any payout is offset by the huge profit made from the losers, who are many, many times more numerous. Moreover, it allows the casino to demonstrate that they run an honest operation and to point to the winners as examples to encourage the other gamblers to keep gambling as "their time will eventually come." While the example is that of a gaming and gambling enterprise, this business practice is used throughout many Black Market operations to keep old and new customers coming to the Black Market over and over again. As result, the Black Market will sometimes do things that benefit a loyal customer, a local community, group, company, or individual for what seems to be nothing more than a token fee or, in some cases, *at no charge at all*.

Do not be fooled, the Black Market seldom does anything that does not benefit it in the long run. They are in business to make a profit and are very good at doing their job. Sometimes, what seems to be, on the surface, a random act of kindness is actually a component of a deeper Black Market plan. Often, in lieu of money, the Black Market will accept (or demand) some information or a service. Something that may seem rather harmless and trivial to the person doing it, but may turn out to be a vital component in an elaborate scheme or operation of the Black Market to turn a sizable profit, or to get the upper hand on a rival, or to win over a new client.

Beware Favors

It is important to understand that a "favor" from the Black Market is not the same as doing an act of charity or kindness. A favor is a *debt*.

When you receive anything the Black Market identifies as "a favor," it means if you take it, you owe them *a favor in return*. Black Marketeers are like elephants, they NEVER forget. And though it may be tomorrow or two decades later, at some point the Black Market will *call in* that favor.

Failure to return the favor, *quid pro quo*, always has dire consequences. Such consequences seldom involve physical injury, but it will definitely have adverse results. For example, one's account with the Black Market may be suddenly closed or short of funds, a loan may be called in, the person may find himself blacklisted from Black Market services and/or that the price of everything he wants to purchase is 50% to 200% more expensive, or, for him, never in stock. Really anger the Black Market and you might find yourself implicated in wrongdoings or framed to be the scapegoat for a crime or act of treachery you had nothing to do with. From a Black Market business viewpoint, *favors are another type of currency*. And they are skilled at collecting interest and turning big profits on all of their investments.

Despite their proclivity to sometimes earn an honest buck, so to speak, there is one thing that still holds true and should not be lost sight of: The Black Market is a *criminal organization*. Granted, sometimes legitimate businesses may engage in questionable practices at times, but these businesses are still, ostensibly, trying to operate within the confines of the law. The same can not be said for the Black Market. The Black Market is not a legitimate company. They are not like Wilk's, Triax or Northern Gun. Even *Titan Robotics*, which is essentially a front corporation for A.R.C.H.I.E. Three in his plans for global domination, still adheres to local laws in its operations. The Black Market, on the other hand, violates

with impunity any rules, regulations and laws that stand in its way. At the end of the day, the Black Market is a pack of crooks. They may be better equipped and far more organized than a local street gang, and may have excellent public relations and sales people, but the bottom line is, they are criminals who defy the law and do as they please to turn a profit.



D-Bees in the Black Market

Unlike many of the human-dominated kingdoms of America, the Black Market does not harbor any official prejudices against non-humans. They are willing to deal with D-Bees and other inhuman beings as readily as with humans. To the Black Market, everyone is a potential customer, and a person's financial status and their willingness to share their wealth with the Black Market far transcend minor matters such as religion, political allegiances, or species.

The Black Market is well known for providing goods, services, and information that would be more expensive or unobtainable if going through normal channels. Sometimes, due to various reasons – usually economic, social and/or political “concerns” (i.e. prejudice) – some retailers and even manufacturers may jack up their prices to certain customers or outright refuse to sell them their products. These disenfranchised people are the bread-and-butter customers who keep the Black Market in business. Moreover, this “open-mindedness” allows many Black Marketeers to convince themselves that they are providing a valuable service, not only in assisting people in getting things that they would not otherwise be able to obtain, but in promoting the spread of free trade and freedom.

This accepting attitude toward all people extends beyond the Black Market's role as seller. The organization is, more or less,

an *equal opportunity employer* who would rather hire competent D-Bees than stay with humans who are incapable of doing the job. Also, having D-Bees on the payroll is good public relations and encourages other D-Bees to support the Black Market. In fact, an estimated 40% of low- to mid-ranking Black Marketeers are not human. In a world where D-Bees are treated like second-class citizens, or worse, D-Bees flock to the Black Market, where they are treated with respect and equality.

Black Market Etiquette

The Black Market's secretive and distrustful nature keeps their operations unseen by most outsiders. It exists in the underbelly of society (or what passes for it anyway), and is reasonably subtle and well concealed. The Five Factions do not keep large standing armies like many nations and mercenary companies. They have soldiers, to be sure, but large armies require many resources that Black Marketeers would rather keep for profit. Food, housing, weapons, training and medicine all drain the bottom line. Armies are also highly visible. They can be seen easily from the air or by the marks of their passing. It would be simple for rivals to track the path of a large group of soldiers, tanks, and robots. Not only that, but large armies can produce traitors and stool pigeons, and can be infiltrated by spies. The Black Market prefers to defend itself and its holdings by flying under the radar. By making their most important leaders and resources difficult to recognize and locate, they stay safe from enemies.

This clandestine, shadowy nature means that interaction between the Five Factions and other outside groups is usually quite personal and often face-to-face. Similar to the way the gods of ancient myth politicked and bickered and made deals amongst each other, the Black Market leaders operate the same way. If they do not meet with outsiders (like the player characters) personally, they will send a direct representative.

For this purpose there are rules and ways of doing business that all Black Marketeers are expected to live by. This not only fosters a culture of professionalism and mutual respect (most of the time), it creates a sense of family, and alienates outsiders who try to squeeze their way into the Five Factions.

The etiquette is never discussed or written down, or intentionally altered in any way. It is simply how business is done, and something everyone in the organization is supposed to know, whether they practice it or not. Likewise, outsiders who show respect and courtesy, or an understanding of Black Market etiquette, are likely to win their respect and an audience with Black Marketeer Lieutenants, Captains and Bosses. Over time, such etiquette may earn outsiders favor and connections with Black Marketeers. Being introduced as a “friend of ours” (as in a friend of the Black Market) is the highest honor an outsider can get. It tells everyone who understands how the Black Market works, that this is a “friend of the Black Market” and someone who can be trusted and relied upon. Someone who would never do anything to hurt, betray or rat out any Black Market operation. A “friend of mine” is someone trusted by a specific Black Marketeer, but who has yet to be proven a friend of the entire Black Market. As a result, the individual is viewed with suspicion by all who do not know him, and he is accepted by others only because a Black Marketeer has “vouched” for him. Because no one ever really talks about what the rules are, it is difficult to understand every nuance in any particular interaction, as noted above.

Basic Rules of Black Market Etiquette:

1. Be respectful in all business dealings and public affairs, and be worthy of respect. Respect is everything to Black Marketeers, especially when dealing with the Five Factions and other Bosses, leaders and criminals. Respect gets you the right kind of attention. It will make important people listen to you. It can build trust, which can lead to opportunities in the various criminal enterprises. Although the Five Factions can be heated rivals, and even deadly enemies, they are still respectful of each other most of the time.

2. If you're going to "hit" someone (take their holdings, assets, or lives), hit them directly and as hard as possible. This shows respect for one's rivals, keeps from disrupting business too much, and keeps aggressive actions quick and quiet. Black Marketeers do not generally fight their enemies with prolonged battles or armed forces. Better to use intimidation and extortion, and when necessary, send in an assassin or saboteur where you need him. It is also important to not be cruel, especially with Black Market rivals. It's an unspoken rule to not let your rivals suffer. Also, it is good form to finish what you start and never let your enemy escape your wrath, unless there is some advantage in it for you. A vengeful enemy on the loose can only complicate matters and come back to haunt you.

3. Deal with whomever you want, but never with demons, and only with the Coalition when exceptionally advantageous. This rule is broken probably more than any others. Many Black Marketeers trade with, if not outright work with, demons and other supernatural beings, as well as various types of monsters, aliens, dragons and creatures of magic. Dealing with the Coalition is generally considered to be less desirable than dealing with demons, but it is done more than anyone is willing to admit. Of course, blackmailing or corrupting a CS lawman and using him to your own advantage, or having a Coalition goon "in your pocket" (bribed to betray the CS and help you), is not only acceptable, but a feather in the Black Marketeer's cap, provided it doesn't backfire on him. Coalition snitches and agents are NEVER to be trusted completely. Never. Dealing with the CS and demons are both considered bad form, so it is done behind closed doors and usually handled by high-ranking members, such as Captains and Bosses within the Black Market. Furthermore, such disreputable and dangerous "contacts" are seldom identified by name even to the lower members of the Black Marketeer's own "crew."

4. Honor tradition. Tradition lets others know what to expect. It also lets you know what you're supposed to be doing. It discourages radical changes to due process and etiquette. Many traditions practiced by Black Marketeers have been passed down from *before the Coming of the Rifts*. Many more are interpretations based on discovered pre-Rifts documentaries, historical files and pure fiction based on organized crime.

5. Leave weapons at the door. This is many times a hard rule to honor and enforce. Many Black Market operations, especially those that are open to the public, like bars, casinos, and brothels, require patrons to disarm before entering. "In matters of etiquette," it is generally assumed that *no one* has weapons on them during the business transaction, meeting, or public function.

As a rule of thumb, the presence of a weapon generally means someone intends to *do harm*. This doesn't always mean that *everyone* is completely unarmed, they just have to be discreet about it. Hidden compartments and cybernetics are popular for this. Naturally, psychics and mages have little to fear, because they possess

natural abilities, and because of this they are sometimes treated with extra caution, or declined from participating.

6. Respect and fear magic. Some Black Marketeers do not trust magic at all. They either avoid dealing in it and the people who practice it, or use extreme caution when dealing with mages and magic. On the other hand, some love it, welcome its practitioners, and may actively participate in magic themselves. There are even some Black Market crews and the Immaterial Hand Faction, that embrace magic and use it all the time with impressive results. Some of the small groups within the Black Market are barely discernable from a cult or brotherhood of wizards, especially in CS territory. Generally, the use of magic is discreet. The accidental unleashing of destructive forces is always a possibility, and bad for business.

7. Never sell out. Nothing will lose you respect in the Black Market more than going straight or ratting out your old comrades to the law. This is always a possibility. The Coalition States, authorities and rival Black Market groups are willing to pay big for information that could compromise any large operation of the Five Factions. A traitorous Black Marketeer snitch might think he is getting over by taking the money and putting away a bunch of criminals, but in reality, he just made himself a target and proved he cannot be trusted. Once someone is connected to the Black Market, he can leave the organization, but is never again trusted, and may be monitored in case it looks like he might want to sell out. Sell-outs are dealt with harshly and seldom live to tell the tale of their motives for betraying their brethren.

Black Market Hierarchy

Friend of Mine
Friend of Ours
Runner
Black Marketeer
Soldier
Merchant/Sales/Business
Enforcer
Lieutenant
Advisor/Counselor
Captain
Boss
Top Boss/Crime Lord/Director/Crime Family Leader/Godfather

A Friend of Mine: This is someone a Black Marketeer of any rank is willing to vouch for. He is known to that one or a few Black Marketeers. This character is not a Black Marketeer, but an associate or friend of one or a few members in the organization. The individual may be a criminal, mercenary, adventurer, hero or just a friend.

A Friend of Ours: This is someone known to several Black Marketeers and who has proven himself over time to be a loyal, trustworthy friend of the Black Market (or at least that particular Faction). He still needs a Black Marketeer to vouch for him, and this character is *not* a Black Marketeer, but an associate or friend of numerous people in the organization, including a few higher-ups. This individual will be someone who has regular dealings with the Black Market, be he a fellow criminal, mercenary, adventurer or hero, and may be a politician, business person, scholar or ordinary citizen.

Runner: This character is likely to be a *City Rat*, *Bandit*, *Vagabond* or small-time criminal who does work for the organization, or at least one of the low ranking Black Marketeers. Runners are often Black Marketeers in training and do not need previous training or an established O.C.C.; can be any occupation or unskilled and looking to develop a life of crime.

Black Marketeer: This is a full-fledged member of the Black Market. Joe Average Black Marketeer is typically a low ranking, ground level member of the organization who answers to those above him. May also be considered a “Grunt.” Has no authority over others. Can be any O.C.C./R.C.C. whatsoever.

Soldier: This is the nuts and bolts “muscle” and “doer” of the Black Market. A Soldier is always 100% loyal, dedicated to the organization and does its dirty work without question or a reason. A soldier is a notch higher than a Grunt/Black Marketeer and may have authority above them. A Soldier may work alone or with other Soldiers, Enforcers and members of the Black Market. Soldiers are willing to do anything asked of them by their superiors, and usually perform the task with brutal efficiency. Many are, or start out as, thugs, tough guys and roughnecks who enjoy fighting and physical combat on any level and in any field of battle. All carry “heat” (weapons), use threats and intimidation tactics, and can be any *Men-at-Arms O.C.C.* as well as many *Adventurer O.C.C.s* like *City Rat*, *Wilderness Scout*, *Hunter*, *Professional Thief*, and *Vagabond*, and may even be any *psychic* or *practitioner of magic* who likes violence and combat. The *Case Man*, *Refurbisher* and *Expediter* fall under this category, though the most cunning and ambitious of them can rise to higher ranks in the organization.

Merchant/Sales/Business: *Merchants*, *Bankers*, *Con Artists*, *Fences*, *Information Brokers*, *Smugglers*, and *Traders* all fall into this category, as do most other “gentleman” criminals. These Black Marketeers deal in cunning, smarts and manipulating businesses or people. Black Market Merchants and the other Black Market O.C.C.s that fall under this category may function as part of a crew, as independent operators or specialists called in as needed. Black Market Merchants enjoy the benefits and protection of that organization, and pay a 10-20% tithing, based on their profit, on everything they make to the Faction. Each Crew Boss gets 1-2% of that tithing for keeping everything running smoothly and the rest goes to the Top Boss.

Enforcer: This is the heavy hitter of the Black Market when it comes to defense, protection and murder. They might be considered elite “special forces.” Most Enforcers are skilled killers, assassins and man-hunters. They can be any *Men-at-Arms O.C.C.* but tend to be the more elite and deadly classes of warrior, including *Assassin*, *Bounty Hunter*, *Commando*, *Crazies*, *Headhunter*, *Juicer*, *Fallen Cyber-Knight*, *Military Specialist*, *Ninja*, *Special Forces* and similar. And, of course, the *Black Market Enforcer O.C.C.* described elsewhere in this book. May also include psychics and practitioners of magic.

Lieutenant: This Black Marketeer leader equates very well to the military rank of the same name. He or she is the right-hand man of his Captain and leads and manages the lower ranking members, Soldiers, Merchants and underlings of his Captain’s “crew.” A Lieutenant can be absolutely any O.C.C., but many tend to be *Men-at-Arms* and *psychics*. A Lieutenant answers only to his Captain, Boss, and Crime Lord, and has a fair amount of autonomy regarding getting “the job” done. Most Captains and Boss don’t care how a job/mission/assignment gets done or by whom, as it is done correctly and expediently.

Advisor/Counselor: A Black Market advisor can be any O.C.C. but tends toward Adventurers and Scholars, practitioners of magic and psychic O.C.C.s. Most are versed in the area of law and/or commerce, can see the big picture, and have a head for strategy and tactics. An Advisor answers only to the Captain and Boss of the Crew he works for. Though a high ranking Black Marketeer, a Counselor can NOT lead a crew or command men. He is an *advisor* to the leadership only, not a field agent. As such, they are never completely trusted by Soldiers, Enforcers, Lieutenants and higher-ups, and most Black Marketeers resent that the Counselor has the ear of their Boss and makes more money than they do. Black Market Advisors/Counselors are often respected attorneys at law, business people and politicians with *no criminal record*, just criminal associations.

Captain: This is the crew leader and the man who calls the shots on the street and in the trenches. The Captain can be male or female, and handles most of the day to day responsibilities of his or her Boss’ criminal enterprises, and perhaps legitimate businesses as well. He can be equated to the rank of Colonel or Major-General in the Army and is the leader of the troops. Like a real army, there can be few or many Captains in the Boss’ army. The Lieutenants are the Captain’s right hand, and everyone of lesser rank answers to the Captain.

Boss or Crew Boss: This is the head of an established Black Market gang/crew, smuggling ring or criminal organization within the Black Market. He may be thought of as the General. There can be more than one Boss in a crime family or criminal network, but each runs his own, independent crew, and his crew – his men/ troops – answer only to him, not any other Boss. In fact, the various Bosses in a crime family are often rivals. Some are friendly rivals, others hate each other with a passion. Each Boss runs his own crew/network of Black Marketeers and criminal operations. The Captains and Lieutenants answer to the Boss and jump at his every command. Some Bosses are very hands on, while other Bosses may have little contact with the lower ranking Black Marketeers. However, all know, respect and fear their Boss, and do whatever he says when he does appear. There is never any question among Black Market crews who the Boss is or that it is he whom they ultimately serve. A Boss may be any O.C.C., but is likely to have years of experience in crime and the Black Market. He’ll also have a strong reputation and carry considerable clout even with other Factions. A Boss is responsible for everyone in his organization, but he answers only to the Crime Lord/Top Boss.

Crime Lord/Top Boss/Faction Boss. Also known as Criminal Mastermind, Director, Head of the Crime Family and Godfather. This is the big boss. The person everyone within a particular Faction or segment of a very large Faction answers to. He is the Five Star General who runs the show. Everyone, including the Bosses, answers to him/her, the head of the syndicate or family. Many, though not all, Top Bosses are members of crime families that have been members of the Black Market for generations. Some can trace their heritage back into the Dark Age, and at least one third inherit their position from a retiring parent or other family member. A Crime Lord can be any O.C.C.

A Black Market Crew

The term “crew” refers to the gang of Black Marketeers, Soldiers, Enforcers, Lieutenants, Captains, and Counselor who work for a specific Boss. In military terms this might be equated to a military *company*. Within that company or Boss’s crew, are smaller

“crews” or *platoons* led by a Black Market Captain. Only a Boss can have two or more Captains and crews working for him.

A Captain can only have one crew. All who rank beneath him serve the Captain, the Boss and, ultimately, the Top Boss/Faction Boss. However, most lower ranking crew NEVER interact with or even meet the Top Boss. Only the Boss and, sometimes, a Captain, Counselor or Enforcer ever meets the Top Boss. A crew led by a Captain functions like a *platoon*, with the Captain as the platoon leader. He answers to the Boss (General) who answers to the Top Boss/Crime Lord (Five Star General).

Others who are not Black Marketeers may be hired to do work or favors for a Black Market crew, Lieutenant, Captain, or Boss, but they are freelance, third party subcontractors, or runners, friends, or stooges (dupes tricked into doing Black Market business, usually for free).

Black Market Family

The Family is generally all of the Black Marketeers and crews who work under the auspices of a particular Black Market Crime Lord within a Faction. He is a Top Boss and holds the highest

position within the Faction, though that position may be shared by several Top Bosses. His own family members, including siblings, uncles, aunts, nephews, nieces and cousins are likely to hold positions of power under him, such as Boss and Captain, or Merchant with a criminal enterprise to run, though many start at the bottom as ordinary Black Marketeers and work their way up.

Black Marketeers & Merchants

Though the Black Marketeer and Merchant rank toward the bottom of the criminal organization’s hierarchy when it comes to power and authority within the Black Market, there is no disrespect in being either one. The less ambitious Black Marketeers may be grunts, but they make good money, have respect and connections, and some wield a considerable amount of influence. Many Black Market Merchants who run business enterprises within the organization are wealthy and powerful in their own right. They may have influence and power within the civilian community, as well as influence within the organization. The ranks above Black Marketeer and Merchant only represent levels of authority and power within the leadership of the organization.



Security Within the Black Market

Transport Security. Shipments of goods from one location to another often include a security contingent which is generally proportional to the size and value of the goods being shipped. In addition to security escorts, the route along the way is cleared

by advance scouts and enforcers who stay in regular contact via encrypted radio links or magic with the primary carrier group. Encrypted communications, burst transmissions and magic communication ensure a difficult time for anyone trying to eavesdrop.

Escape plans and alternative routes are planned in advance to avoid ambushes, washed out roads and other “obstacles” that may come up. Likewise, if a convoy comes under fire from bandits or needs to avoid the authorities, these detours and alternate routes will come in handy. As a rule, supply caravans fight only long enough to get away and use another route. In some cases, the Black Marketeers will have several security teams establish positions along the travel route in advance of the caravan. The idea is to prevent would-be attackers and hijackers from setting up at likely ambush junctions in the first place. By remaining at these likely strike points, they can get the drop on suspicious characters and deter them until the caravan passes. If the suspicious characters are obvious/known bandits, raiders or law enforcement, the advance team can warn the convoy to take an alternate route or try to take them down before the caravan arrives to that point. In most cases, a warning suffices and the advance team may stay there to keep an eye on the enemy force or slip away to join the caravan and provide additional back-up. Most of the time, there is no problem at these danger zones or ambush spots, so when the transport caravan passed that junction, the security team (2-8 Black Market scouts and fighters) waits till the caravan passes, and moves out to follow from behind as a rear guard for the shipment. In this capacity they can warn the caravan if enemies show up from behind, and they can provide reinforcements if the caravan is attacked up ahead. There are usually 2-4 such advance security teams placed at strategic points along the route; more if the route is especially long.

Savvy Black Market Bosses also enlist the help of locals along their travel route to protect their property. This is usually accomplished by offering steep discounts and bulk prices on items the locals need, or paying out small amounts of credits or goods for their help. As above, the locals warn the caravan about the presence of suspicious outsiders, lawmen or known enemies and rivals so the transport team can take an alternate route. Locals can also help by providing Black Market enemies false information and doing any number of things to create confusion and delays to help the caravan slip past undetected. Local leaders know that helping the Black Market can be highly profitable and it always pays to stay in the Market’s good graces. Sometimes Coalition troops even unknowingly protect Black Market shipments, assigned to the duty by commanders who have been corrupted and paid off in advance.

Magic-reliant groups like the Immaterial Hand may have slightly different security techniques that compensate for their heavy use of Rifts, dimensional portals, ley lines, illusions and magic. Generally, Rift and portal guards are stationed at appropriate points and work to prevent supernatural monsters and demons from interfering with the operation.

Supply caravans and regular shipments are not always carefully protected, however. Sometimes, circumstances, bad luck and enemies/law enforcement force Black Marketeers to move their goods without adequate protection, ahead of schedule or through unsavory territory. The Black Market is always making such snap decisions and compromises, and taking calculated risks to do their job. Smuggling contraband has its challenges.

Primary Location Security. This would include security for top Black Market personnel and their residences. Main depots for aircraft, vehicles, military equipment, contraband and other expensive goods also fall under this security umbrella. Only the most trusted operatives will draw this duty and often live in or near such locations. Remote surveillance of these locations by key members of Black Market security teams will be ongoing 24/7 and magic surveillance and protection may also be deployed. A loss of con-

tact brings about an automatic response even if mechanical faults are suspected. There is a triple redundancy built into the system so if one communication link fails, a second comes online, and a third link is available in that rare event that the first two malfunction. Elaborate levels of encryption, code words and magic alarms and barriers are all used to keep the odds of discovery and invasion very low, and the odds of a successful defense or escape in their favor.

Secondary Location Security. Secondary Locations are defined as small caches of contraband, weapons and other goods the Black Market sells or uses itself. Defenders and users of the caches are only given information that is basic to them and “need to know,” so, if captured and questioned, they can tell the authorities little and know nothing of similar locations or about higher-ups in the organization. They are partially expendable should the authorities find them and count as “necessary losses” in doing business. Those captured may even have been given disinformation by their immediate superior to feed to and confound the authorities/enemies and throw them off the trail.

Supply Location Security. Warehouses and caches of large quantities of contraband are usually stored far from a Black Market seller’s location. Secret facilities built and used by the Black Market are usually well guarded at some remote or unlikely location.

However, two thirds of Black Market goods are kept at legitimate businesses. For example, a truck yard, warehouse district, or factory, may be paid or blackmailed into hiding Black Market goods on their premises. In other cases, a Black Market front man may rent the warehouses, store fronts or offices of a struggling business owner or landlord who has no idea he’s dealing with a member of the Black Market. Similarly, businesses that have closed down and even homes may be rented or purchased by Black Marketeers and used to store good or function as a front for criminal enterprises. Black Marketeers like to appear legitimate and innocent whenever possible. Similarly, the Black Market posing as a legitimate business may hire a legitimate trucking company, transport company, shipper, mercenary group or adventurers to transport or store goods that are, unknown to them, illegal contraband. Those crates or boxcars designated as containing “farm equipment” or “blankets” may actually contain drugs, weapons or any number of illegal goods.

Legitimate companies who find themselves in financial difficulty or are just plain greedy or stupid may agree to hide Black Market contraband among their own legitimate goods at their legal place of business. Other times, a business owner who is in debt to the Black Market, or owes them a “favor,” may be leveraged into fronting for the criminals or into hiding their contraband. The same is done with manufacturing. At least half of the goods sold by the Black Market are manufactured by legitimate companies paid off or leveraged to do the work for the Black Market, or to skim goods from their own inventory, or to have it fall off one of their trucks and into the hands of the Black Market.

Bulk purchasers from a buyer who is not part of the Black Market can arrange to buy goods at a retail front for the organization that appears legitimate, at a Market Town, or at a predetermined location of his or the Black Market’s choosing. Depending on the merchandise, sometimes the Black Marketeers are flexible about the location of the delivery and sometimes they are not. How things often work is, an encrypted order is placed for goods stored there by a Black Market seller to a code-named contact who delivers the goods at a pre-arranged time and location to the buyer. If the buyer fails to show up or tries to negotiate a lower price at the

agreed upon delivery place, they usually receive no sale and are blacklisted by that local Black Market seller or all Black Market sellers in the area. After all, the potential buyer may be working for the authorities and trying to determine if a potential Black Market enterprise is a big enough fish to be taken down.

Anyone who stumbles upon a Black Market storage facility and is not immediately spotted by site security (i.e. an Enforcer, guard or guy with some binoculars or watching live surveillance camera footage) should get out fast and keep his mouth shut to avoid trouble. Anyone who shoots his mouth off to the authorities, a rival, or otherwise makes his discovery known in town, will end up being threatened and beaten, disappear (discreetly silenced/killed) or killed in a way to make a public statement to others to stay out of Black Market business. Such an incident is never left unpunished. It also causes the Black Market to reassess their other secret holdings and whether or not they need to move their other established operations.

Contraband and resources that fall into the hands of the authorities or rivals, may be abandoned as a loss. However, if there is a way, they'll try to steal it back. This is done, if for no other reason, to show the persons responsible they cannot pull one over on the Black Market. In some cases, the criminals would rather see it destroyed or fall into the hands of ordinary people or heroes than a rival, enemy or lawmen. This is considered just part of the cost of doing business.

Booby Traps. Hideouts and storage facilities may be booby trapped with high explosive surprises and/or magic to kill interlopers even if it means losing the goods stored there. In some cases, the Black Marketeers rig it so that the entire cache is blown up and/or catches fire. They have found that fire is an excellent method to create confusion, fear and time to escape. The smoke obscures other activities like grabbing the most valuable loot and making an escape, the heat and flames can hold intruders at bay in one part of the building while they flee or do more in another part, and it destroys evidence better than an explosion. However, using small amounts of explosives in booby traps at doors and other entry places is an excellent method of killing or harming invaders as well as unmistakably announcing their presence. In the end, what is most important is that high level contraband and any evidence of who might have been involved is destroyed, while buying time for any Black Marketeers inside to get away. Again, any losses are considered part of the cost of doing business.

Blind Alleys and Decoys. Misinformation, clues and red herrings that lead the authorities, rivals and enemies on a wild goose chase or to dead ends are a favorite tactic of some Black Market outfits. They love to leave authorities and rivals chasing their tail and spending time trying to make a case on a small-time Black Market outlet or setup, while they go about their business free of legal involvement. Some use this tactic to implicate and take down a troublemaker or rival within the organization, as well as criminal and legitimate competitors in their way. Other times, they'll use decoys and blind alleys to lure the attention of authorities and rivals away from their real objective or true money making activity. It's a simple matter of sleight of hand trickery to make your audience/enemies look in one direction while the real magic/crime is happening unseen elsewhere. Of course, some Black Marketeers are better with such "games" than others, and some don't use these tactics at all.

Dealing with Infiltrators. Spies and undercover agents sometimes try to infiltrate the Black Market. They can be government agents, lawmen, competitors or enemies, but they are all out to

gather damaging intelligence and evidence to undermine, shut-down or destroy that particular Black Market crew or operation. This may involve all types of sabotage and surveillance, from destroying supply caches and taking down key agents within the organization, to wire taps/bugs and moles transmitting important and damaging information to their partners on the outside. When an infiltrator is discovered inside a Black Market operation, the Captain or Boss may use him to turn the tables by feeding him false information to mislead his people or hurt a rival. However, in most cases, the infiltrator is not killed unless absolutely necessary. The spy is taken prisoner, thoroughly interrogated, probably roughed up and held for ransom. Ransom can include a trade for an imprisoned Black Market operative, certain confiscated goods, or Universal Credits. The exception is when such an agent is found targeting a high level Black Marketeer for assassination, in which case, he is savagely interrogated, tortured and killed, or shot immediately.

Internal Black Market Investigations and Security. There are Black Market Enforcers and operatives assigned to police the Black Market and its members. This is especially true of Black Market merchants and sales reps. The concern is that such sellers might decide to charge a little more and keep it for themselves or skim off the top. Skimming and cheating your Black Market employer or partner is frowned upon. To make sure everyone is operating on the up and up, occasionally a Black Marketeer will pose as a new customer or employee to make sure everything is run on the level. These Black Market undercover operations are usually handled by one or two Professional Spies, Enforcers, Con Artists or psychics, but can be anyone the crew Boss trusts. The Black Market is strict about reporting income and getting its share of the enterprises it helps fund and support. Just as bad is an outfit of yahoos or brutes that regularly cheats or harasses its clientele or creates an atmosphere of fear that damages the Black Market's benevolent reputation. Once such infractions are uncovered by an investigator, action is taken to correct the problem. The individual(s) involved may be reprimanded, warned and given a second chance, or beaten, warned, and forced to make recompense based on what the Boss decides is fair and given a second chance; or the infraction may result in his disappearance and replacement. Disappearance usually means the perpetrator is quietly removed, killed and disposed of in such a way that he is never found. In other cases, the perp may be killed and left for all to see as a warning not to let this happen to you.

Serious External Security Breaches. Sometimes, someone stumbles upon a Black Market operation and decides to go to the authorities or lets the Black Market know that they will keep quiet for a price. The Black Marketeers fingered may try to pay off the individual to keep quiet, or for the authorities to turn a blind eye or forget about what they uncovered. This can be a large single payment, especially in the case of a citizen, or a regular monthly, quarterly or annual payment, especially when it involves the authorities or government officials. However, more often than not, the average Joe or do-gooder adventurers disappear or suffer a deadly accident or are found murdered, and word on the street is that nobody should cross or threaten the Black Market.

The Coalition military, ISS police and other lawmen and heroes are a bigger problem, requiring more sophisticated solutions. There may be threats and "near-accidents" to intimidate the person or group to back off, but there is seldom outright murder. The Black Market may also try to pay such authorities off, or use blackmail or trickery (decoys and misinformation) to get them off

their tail. If the law officers prove to be honest and unshakeable, refusing bribes or threats, murder *may* be considered, but in most cases, the Black Market crew shuts down its operation and moves to a new location in the community and starts up again, but more quietly and subtly than before. If the harassment and loss of business continues, the crew and criminal enterprise packs its bags for good and moves to a completely different community, sometimes a great distance away.

Dealing with Competitors and Troublemakers. This is the job of Enforcers, though any member of the Black Market crew may join in for the fun or to make a point.

Minor Competitors. The average competitor is usually a guy who sets up shop offering competing services, goods or contraband. He is generally not considered a true competitor, just a guy trying to earn a few credits on the side. If his business has no impact on the Black Market's own, he is ignored. If he plans to close up shop after he sells what he has, or is just passing through for a week or two, he is ignored. This includes adventurers, bandits and independent criminals selling off loot and artifacts, traveling merchants and shows, and minstrels and entertainers. Such individuals are ignored by the Black Market unless they cause them grief somehow, deliberately or accidentally. In the latter case, troublemakers and annoyances are chased off with threats, damage to their business or supply stock, and, when deemed necessary, physical intimidation. Fight back too hard and someone might end up seriously hurt or dead, and it won't be a Black Marketeer. And if it is a Black Marketeer, the people responsible had better run for their lives and never come back. And even that may not be enough to save their lives.

Serious Competitors. As suicidal as it sounds, some hustlers move in to a known Black Market area and either try to steal from them, figuring the Black Marketeers cannot go to the authorities, or make it a point to offer goods and services in direct competition at superior prices. Both are asking for trouble and border on suicidal behavior. Once they've caught the Black Marketeers' attention, they are given one warning to get out. That warning may be friendly or come with a show of force. Failure to heed the warning invites an unending string of trouble and violence. The business is targeted with unrelenting harassment, sabotage and "incidents" like destructive vandalism, a string of robberies, muggings, fire, customers being chased away, and even trouble with the authorities and local government. ("Where's your permit?") If the competitor doesn't move on within 1D4 weeks, the business will find ALL its goods stolen or the place burnt to the ground, or one or more key people in the competing business are blackmailed to close up or move out, or kidnaped and ransomed. The terms of the ransom always require at least a token payment and a solemn promise to close up and get out within 48 hours, or die. Failure to do as agreed results in the murder of the owner and anyone else who gets in the way, which may include a spouse and children.

Tit for tat. The Black Market tends to be an eye for an eye type organization. Kill one of theirs, and the person or persons responsible will be hunted down and slain. Likewise, any offense, especially those that embarrass or hurt the Black Marketeers, will feel the heat of retribution. And retribution is usually 2-10 times more severe than the offense. Be warned.

Dealing with Authority

The enemy of the Black Market, by its very nature, are the authorities that try to prohibit and police their products and activities. Whether this is Coalition ISS Peacekeepers, Atlantean Overlords or Federation Magus Guards, the game of cat-and-mouse that smugglers and law enforcement play is the same. The rules and the risks may vary dramatically, but it is safe to say that no Black Marketeer takes the possibility of arrest or execution lightly.

Passing Security Checkpoints

When there is no other way, smuggling often boils down to simply walking or driving contraband through security checkpoints and hoping for the best. Well organized systems like those found in the Coalition States and Free Quebec are difficult to bypass, and almost impossible if one is carrying Techno-Wizard devices or other magic items. Less wealthy states and communities enforce their laws and protect their borders as best they can, but it is impossible to fully search everyone who passes through. What follows is a table of the basic chances of passing through security undetected with contraband.

Chance of Passing Through Security with Contraband

Maximum Security: 01-10%. Coalition fortress city or other ultra-secure, high-tech or heavily secured facility.

Secured Checkpoint: 01-15%. Coalition or other professional military/police security checkpoint, Black Market meet-up, military inspection/pat-down or prison inmate processing.

Standard Security: 01-35%. City gate, non-military checkpoint, guarded entrance, or basic pat-down.

Lax Security: 01-50%. Rushed or non-professional pat-down, hurried inspection.

Visual Check: 01-85%. Visual "once over" or passing within a few feet of law enforcement officials who eye the character/vehicle.

Sloppy/Careless/Distracted Security: 01-90%. It doesn't matter where or who, if the security force is unhappy, distracted and doesn't care about their job, odds are they'll miss contraband and shady characters. Heck, they may barely look at the person or his I.D., let alone pat down or look inside the vehicle, crates or bags.

Note: All practitioners of magic and supernatural creatures suffer a penalty of -25% to pass through any type of Coalition State or similar security. Those carrying magic items or under the effect of a magic spell are also -25%. Psychics are -5%. In short, the CS and those like them have systems and people (Dog Boys and psychics) in place to sense/detect the presence of magic and the supernatural, and such people and items are almost certain to be discovered, even by careless security.

Law Enforcement Encounter Table

"Law enforcement" can mean many different things on Rifts Earth. In some communities, the "police" are just soldiers assigned to the streets or mercenaries hired to intimidate ruffians and keep things quiet. Other places have well trained police forces, sheriffs, city guards, border patrols and other organized forces. Whatever the case, law enforcement is always on the lookout for criminals and is often a bit overbearing in its authority.

01-20% No Reaction. The police patrol or town guardsmen could be distracted, intimidated or might be rushing to respond to a serious crime or call for help, or fun. Maybe the player characters are not seen as a threat or have concealed their weapons/items well. The police let them walk right on by without a second glance. They might even respond with a polite greeting or tip of their hats.

21-40% Visual Inspection. As the law enforcement agents pass by, they give the characters a quick once-over just like any other pedestrian or member of a crowd. As long as there are no obvious illegal weapons or contraband visible, outlawed magic or other reason to investigate further, the player characters walk past without incident. Should something suspicious be seen or overheard, roll again on this Law Enforcement Encounter Table. If something is indeed amiss, a small bribe or “civic donation” may likely clear up the situation, or the characters may be in trouble.

41-60% Stop and Search. The law enforcement or security members stop and question the characters, asking simple things like where they are going/coming from, what their business is and the names of everyone in their group. Identity cards/papers are likely to be requested and the player characters receive a basic pat-down. Unless some piece of contraband or outlawed weapon is found, or something else suspicious happens, they are allowed to continue on their way. Often the goal of such simple searches is not actually to find anything, but to impress/harass passers-by and make the citizens feel like the police are active on the streets. Should something illegal actual be turned up it may only require a few credits or a good explanation and apology to convince the law officer to ignore the infraction and let them continue. **Note:** Of course, a serious infraction of the law is likely to get the item confiscated, the infringer arrested and his “associates” taken into custody for further questioning. Trying to bribe an honest cop only makes matters worse. Resisting arrest, running or fighting opens up a whole other can of worms. Let the role-playing ensue.

61-80% Precautionary Detainment. While not officially under arrest, security or law enforcement detains the player characters to question them and inspect their possessions much more thoroughly. If everything checks out they’ll be allowed to continue on. Any concealed weapons or contraband are almost certain to be discovered (01-95%) and likely to make matters worse. Particularly suspicious and dangerous individuals may be kept inside police vehicles or handcuffed for this procedure. Bribes are still a possible solution at this point, but might cost a hefty sum. Trying to bribe an honest cop only makes matters much worse. Resisting arrest, running or fighting opens up a whole other can of worms. Let the role-playing ensue.

81-95% Arrested on the Spot. Whether the player characters smart-off to law enforcement, behave or say something suspicious, or illegal weapons or contraband are noticed, the law officers/security move to arrest one or more of the player characters. Even if not originally targeted, any “friend” who tries to intervene with an explanation or cover story is arrested for questioning. For that matter, anyone associated with the person(s) being arrested is likely to be taken into custody for further questioning and a thorough inspection of his possessions. Any vehicles will be impounded and searched as well. If they come up clean or are guilty of a minor infraction, they’ll be given a fine, may have to make bail, and may be given a court date. Carrying illegal weapons or contraband, trespassing, drunk and disorderly conduct, brawling, minor crimes, being disrespectful, making a threat, hitting an officer of the law, and possibly a trumped-up charge because the lawman took a dislike to a character (hates D-Bees or that type of D-Bee, mages,

etc.) are all things that can get a person arrested. If things have come to this, the time for a bribe has likely come and gone. Trying to bribe an honest cop only makes matters much worse. Resisting arrest, running or fighting opens up a whole other can of worms. Let the role-playing ensue.

96-00% Weapons Drawn! For whatever reason, the authorities perceive the player characters as an immediate and serious threat. They may be mistaken for other criminals, or recognized as wanted criminals/fugitives, have a bounty on their heads, or the law enforcement agents may simply be acting out of fear or a misplaced sense of responsibility or revenge. There is no way the player characters can charm or bribe their way out of this one. The law has weapons drawn. They are shouting that the group is under arrest and to get on the ground. There are only three possible responses: Allow themselves to be arrested and hope for the best, make a run for it, or fight. Resisting arrest will bring gunfire, reinforcements and hot pursuit.

National Borders and Lawmen

All communities will have their borders and area of jurisdiction. At most independent towns, ‘Burbs and cities, it ends at where the community ends, or a short distance beyond. Only big nations may claim more land and have military, police or security forces patrolling those borders.

Atlantis: Being an island, Atlantis’ “border security” consists of ships, submarines, magic and aquatic minions. The military and slave-catching apparatuses do a good job of patrolling the sea lanes, above and below the waves, and traditional smugglers and blockade-runners are not much of a problem for the Splugorth Minions. Few people try to infiltrate the continent of Atlantis, and the border guards are mostly preoccupied with trying to seal off escape routes to keep runaway slaves from leaving the island. In addition to monstrous animals, Conservators, in particular, patrol the frontiers and wildernesses, making travel through them a risky proposition. Unknown to most outsiders, the waters around Atlantis are inhabited by Splugorth Slavers in their natural form, Conservators and the giant monsters known as Metztlains. All of whom keep a sharp eye from below the waves for trouble from outsiders and surface dwellers.

Federation of Magic: The borders of the Federation are not well defined and the level of security varies dramatically between different cities and regions. The City of Brass, Dweomer, Stormspire and other major settlements will have good security, relying on mages, Golems, Elementals, creatures of magic and supernatural beings. Gates, bridges and entrances are also sometimes enchanted to detect tech-based enemies, demons and other monsters and to record those who pass by.

Free Quebec: Free Quebec’s border security is quite different than the Coalition States. The Quebecois are even more extreme human supremacists than the CS, to the point that they refuse to use Psi-Stalkers, Dog Packs and psychics to detect practitioners of magic and supernatural beings. They consider all those troops to be “inhuman” monsters and mutants. Instead, they rely on isolation, experienced human troops and brute force, such as their Glitter Boy legions and other technological deterrents. M.D. walls and guard towers stand at the most critical junctions and at least a pair or quartet of Glitter Boys (often 6-12 G.B.s) stand guard at such locations. Perimeter patrols of Rangers and Wilderness Scout contractors familiar with the Canadian wilds patrol the woodlands that surround most Quebec cities and towns. It is their job to take

note of smugglers, raiders and pirates long before they reach the walls of a Free Quebec city. Mages, mutants, monsters and suspicious characters are reported by the patrol and a squad of SAMAS and/or Glitter Boys are dispatched to chase them off or destroy them on the spot. The Quebec Army is filled with thousands of Glitter Boys, and Free Quebec has its own version of the SAMAS and other fighting units to guard checkpoints and entrances and to respond to potential trouble from non-humans and villainy.

Lazlo and New Lazlo: Lazlo and New Lazlo both have similar magically-monitored borders. Golems, enchanted watching devices and mystic border guards using magically enhanced senses are all part of the nations' territorial limits. Books, devices of magic and other Coalition contraband are freely traded, but one must take care if they are transporting dark magicks and stolen goods, and will be in serious trouble if caught trafficking in slaves; human, D-Bee or supernatural.

New German Republic: Unlike in the Coalition, the NGR's borders are less geared towards detecting infiltrators and D-Bees and more akin to military defenses and anti-aircraft sites. While D-Bees are still a threat, they are tolerated and sometimes permitted to live within the NGR. Gargoyles, on the other hand, are huge, powerful and surround Germany on several fronts. There is no mistaking them for humans or smaller D-Bees, and German troops do not have to develop the same discerning eye that CS border guards and the ISS depend on. While tight military patrols may make it impossible for certain smugglers to operate, those with good cover stories and well-disguised cargoes may deceive the soldiers more easily than they would trained Border Patrol Agents.

Pecos Empire: This is the Wild West where one has to worry more about bandits and Simvan raiders than the law. All borders are in dispute, and there may be several factions (the CS, the Pecos Empire, Native Americans, Simvan and others) who claim the same land areas. What passes for the law at most places are local Sheriffs and Gunfighters. In the northern corner, the Coalition Army and their Dog Boys, as well as experimental mutants, patrol the area around Lone Star with an iron fist. CS patrols sometimes push into the south and southwest and may chase those they believe are Black Marketeers or bandits halfway across the New West when provoked to do so, but most stay close to home base.

The Coalition States

The Coalition is a large police state wedged right into the middle of the utter chaos that is Rifts North America. Their efforts to keep magic and high-tech weapons out of the hands of their own people have created a lucrative market for the continent's criminals. The location of the various Coalition States also creates several natural channels through which the majority of North America's contraband flows.

For most people in North America, the Coalition and "the authorities" are one and the same. Even for populations that do not live within its borders, the Coalition's mandates, its economic might and its occupying armies all have a profound effect on the geopolitical landscape. One day the Coalition States may be a distant threat, the next day, Death's Head Transports have deployed an entire battalion of Dead Boys to patrol the area. Many small kingdoms near the Coalition go through this experience once or twice a year, and with all the resources at its disposal there is nowhere within the Midwest that is outside the reach of the CS.

Coalition Border Security. In the Coalition States, providing border security is a responsibility shared by the military and Internal Security Service (ISS). The military has specific units stationed along every major border, especially those near areas of magic or trouble zones like the Federation of Magic and the Tolkeen occupation zone. These soldiers provide a flexible defense as well as the first eyes and ears to detect incoming threats and attacks. Military patrols are constant, but may only include SAMAS units, Sky-cycles or other aircraft in remote areas. Likewise, Skelebot patrols (robot drones) are most active out in the country, away from major cities and urban areas, and unprepared smugglers may wind up the target of a fully automated CS robot attack. In areas with concentrations of ley lines and heavy activity by monsters and demons, Dog Packs and CS Psi-Stalkers are a common sight, tracking down and destroying their supernatural prey. Intercepting Black Market shipments is *not* their first priority, but they will certainly arrest or eliminate smugglers who they come across.

Once one enters the cities, suburbs and even the more populous stretches of farmland, the presence of the Internal Security Service greatly increases. ISS agents may man roadblocks and checkpoints in areas known for the trafficking of contraband, and use Psi-Stalkers and Dog Boys extensively as living sensor systems to sniff out magic and the supernatural. Locals are instructed to report suspicious activity, and most are happy to do so, as they see the ISS, Dead Boys and Dog Boys as "the good guys." Except in parts of the 'Burbs and some outlying communities, practitioners of magic, D-Bees, the Black Market and outsiders with dangerous ideas are the "bad guys."

Encounters Within Coalition Territory

CS Frontiers & Remote Borders

The loosely monitored frontiers and unpopulated regions are the first layer of defense for the Coalition States. Most of the time this area includes the outer border or frontier of the "State," but can overlap with areas that the CS monitors but has not politically claimed. Most of the time this area is lightly populated, is patrolled by the CS military and may be used for military exercises and training maneuvers.

01-05% Coalition Power Armor Unit. This is probably a training exercise or there has been a report of a heavy hitting enemy force such as a gang of Brodkil or other demons, one or more dragons, heavily armed raiders or mercenary group, and so on. The military unit includes a SAMAS or Super SAMAS and 1D4+2 Maulers, Terror Troopers, or Glitter Boy Killers, or a mixed group of them all.

06-10% Coalition Rangers. Trained to operate in the vast wilderness, CS Rangers are usually deployed far from urban centers. They work in pairs or small groups (1D4+2) and can be extremely stealthy and difficult to detect. A single Ranger will observe and pursue, while units of them may try to set ambushes or attack the suspicious characters or apparent enemies. May be on foot or equipped with hovercycles, rocket cycles or jet packs.

11-15% Coalition RCSI Scientists. A team of 1D4+1 Coalition field scientists are conducting experiments or investigating a ley line or some other natural or unnatural occurrence. They will be escorted and protected by one CS Ranger or CS Psi-Stalker, two Dog Boys and two Grunts.



16-20% Coalition Juicers or Cyborgs. These are special operations forces, so they are either on exercises or deployed in search of something dangerous. They work in pairs or small groups (1D4+2) and can be extremely quick and deadly. A single Juicer or CS Cyborg will observe and pursue, while a unit of them may try to set ambushes or attack the suspicious characters and apparent enemies directly. May be on foot or equipped with hovercycles, rocket cycles or jet packs.

21-30% Light SAMAS/Sky Cycle Patrol. Monitoring its long borders is much easier from the air than the ground, and the Coalition has numerous light airborne systems that are perfect for the job. Smiling Jack SAMAS units and Sky Cycle patrols are the most common, but jet pack equipped infantry and helicopters are also used for aerial patrols. The average patrol consists of 1D4+1 SAMAS units (any style), 1D4+1 Sky Cyclists, one or two helicopters, or a helicopter and a pair of SAMAS, or 1D4+2 Grunts with jet packs.

31-45% Skelebot Patrol. Coalition Skelebots deployed everywhere, especially in remote areas. They are somewhat indiscriminate killing machines that are typically deployed away from CS citizens and property. Units led by human supervisors work nearer to habitation, while totally automated patrols are often sent out into remote areas and regions known for or suspected of danger. A standard Skelebot patrol is 2D4+2 Skelebots, one armed with a C-27 plasma cannon or CR-1 rocket launcher and the others equipped with C-200 rail guns or CS-213 variable frequency laser rifles. A medium-sized squad is 2D4+8. A large patrol is platoon-sized with

3D6+20 Skelebots. All are programmed to kill hostile forces, non-humans and practitioners of magic. This patrol is always on foot.

46-60% Military Dog Pack. Dog Packs are used by both the ISS and the military for normal patrols, tracking fugitives, sniffing out mages and monster hunting. Military Dog Packs will be more heavily armed and armored than those on urban patrols, but may have a mission that precludes their investigation of outsiders or criminal activity. Dog Packs on wilderness patrols are led or accompanied by a CS Psi-Stalker or CS Ranger and include 1D4+2 Dog Boys. This patrol is always on foot.

61-70% Dead Boy Patrol. A squad of 1D4+3 soldiers accompanied by two Dog Boys or two CS Psi-Stalkers. This is a basic perimeter patrol or reconnaissance patrol.

71-76% Super SAMAS Strike Force. Two or three Super SAMAS and a Windjammer Sky Cycle or Warbird Rocket Cycle.

77-82% Special Forces/Commando Squad. Special Forces units are experts at urban warfare, hostage rescue and breaching assaults. When neither the army nor the ISS feel comfortable about dealing with an enemy target or facing a particularly well equipped or powerful enemy, they may request Special Forces troops or Commandos to complete the job. Better armed and better trained, they can handle situations that require both firepower and finesse. Normally, Special Forces and Commando units operate in small squads of 1D4+4 individuals. Sometimes, one or two of them will be equipped with a Striker SAMAS or ground power armor, or robot like a Hellraiser or Hellfire. Or one or two of the members of the Commando Squad may be a Coalition Cyborg or Juicer.

83-89% Death's Head Transport Reaction Force. Most Coalition cities and military outposts maintain a reaction force. A unit of soldiers kept on alert and standing by, ready to pile into a transport and head out to wherever they may be needed. If you spot one of these coming in for a landing – run! Standard complement includes two Mark V APCs capable of carrying 20 CS troops each, two UAR-1 Enforcers or other giant robots, one Spider-Skull Walker and 96 infantry soldiers.

90-96% Training Maneuvers: Less organized than war games or military exercises, training maneuvers are conducted simply to test a unit's organization and discipline. Troops out on training maneuvers are less heavily armed than normal soldiers, but will be moving about in large units. One is likely to encounter squads (6-10 soldiers), platoons (20-40 soldiers) and companies (120-180 soldiers) while out on maneuvers.

97-00% Military Exercises/War Games. Full-scale military exercises are rare, but impressive. Tank and robot units churn up the terrain while thousands of infantrymen hustle from one position to another. Soldiers in these kinds of war games are fully equipped and planning on expending a lot of ammunition, and will have no problem gunning down Black Market smugglers, wizards, non-humans or insurgents who they may stumble across. Tank and robot platoons of 2D4 vehicles, and power armor squads of 2D6 units are common war game elements, as well as all types of combat squads, platoons and companies of infantry.

CS Farmland & Lightly Populated Areas

More populated border regions and the periphery around large cities is where the defenses really thicken. The ISS mounts regular sweeps and patrols within this range, and units of soldiers are constantly moving around between deployments and exercises. Civilian traffic is heavier, and the chances of being reported by a normal citizen increase dramatically.

01-15% Skelebot Patrol. Coalition Skelebots are deployed everywhere, especially in remote areas. Closer to civilization, they are dispatched in smaller numbers and carefully programmed not to hurt civilian citizens. A standard Skelebot patrol is 2D4+2 Skelebots, one armed with a C-27 plasma cannon or CR-1 rocket launcher and the others equipped with C-200 rail guns or CS-213 variable frequency laser rifles. A medium-sized squad is 2D4+8. A large patrol is never let loose in lightly populated areas. All are programmed to kill hostile forces, non-humans and practitioners of magic. This patrol is always on foot. While outsiders may be terrified of Skelebot patrols, Coalition citizens breathe a sigh of relief and feel safer when they see one shamble past them.

16-25% CS Militia/Reserves. The various Coalition States each have their own military forces, in addition to an emergency militia that can be called out in case of invasion or emergency. The militia is composed of veterans, off-duty ISS and volunteers. They are armed with old-style Coalition equipment and/or weapons and armor from the Northern Gun or the Manistique Imperium (no contraband like Naruni weapons or magic items). Militia units are most common in remote communities that are somewhat cut off from military support. This patrol may be on foot or in vehicles; probably commercial vehicles or light military fare.

26-35% ISS Dog Pack with Military Equipment. ISS Dog Packs working away from ISS stations and military bases are more heavily equipped and better armed than urban police units. Old-style Coalition weapons, grenades and rifles are all available for

these Dog Packs. Coalition citizens love Dog Boys and always feel safer when they see a squad on patrol. A standard Dog Pack squad is a CS Psi-Stalker leading 1D4+3 Dog Boys. This patrol is always on foot.

36-45% ISS SAMAS/Sky Cycle Patrol. Death's Head SAMAS units and old-style Sky Cycles are pieces of equipment that the Coalition has stockpiled by the thousand. ISS stations, reserve units and specially trained patrollers all use these power armor and light aircraft to monitor and patrol Coalition territory. 1D4+2 old-style SAMAS or Sky Cycles.

46-55% Long-Range ISS Patrol. As the Coalition's anti-crime specialists, the ISS sometimes chases smugglers and bandits out of city limits or looks for them in known havens and hideouts. While soldiers can also be used for this task, the ISS is trained and equipped to bring at least one person back alive for questioning. This patrol is always on foot.

56-65% Military Ground Patrol. Dead Boy Infantry Troops. Infantry and power armor units are the most common in the Coalition military. Millions of Dead Boys serve the CS and infantry units are always in various stages of training and deployment. This is a standard patrol of 1D4+2 infantry soldiers/Grunts and two Psi-Stalkers and/or two Dog Boys, and is always on foot.

66-75% Dead Boy Skelebot Patrol. Two Grunts, one CS Psi-Stalker and 1D4+2 Skelebots under the command of the human squad leader.

76-85% Military "Armored" Ground Patrol: Infantry. Millions of CS power armor are a standard part of CS military operations and "armored units" are always in various stages of training and deployment. This is a standard patrol of 1D4+1 Maulers or Terror Troopers, or one Hellraiser, Hellfire or Scout Spider-Skull Walker and two Maulers or Terror Troopers. (G.M.s may substitute with 1D4+1 CS Cyborgs or a Terror Trooper or Hellraiser or Scout Spider-Skull Walker and two CS Cyborgs.) This patrol is always on foot.

86-92% Military Ground Patrol: Mechanized. Mechanized units rely on larger numbers of APCs, tanks and giant robots. They will be faster on the move and pack more firepower than groups of infantry or power armor, though their overall numbers are less. 1D4 APCs and/or tanks, or one or two giant robots or spider-Skull Walkers.

93-00% Military Ground Armored Unit. Armored units are made up completely of troops in vehicles and robots. They will have more important orders than to search for criminals and trespassers, but good luck to any who get in their way. Armored troops will not be in a hurry to dismount, and fleeing into ruins, thick forests and other impassable terrain can provide an escape for Black Marketeers and enemies of the State who are not on the unit's list to destroy or seem to represent a minimal threat. Of course, the unit is likely to report the sighting and a small patrol, like those above, is likely to be dispatched to investigate or exterminate. A standard Armored Unit includes two Spider-Skull Walkers, 1D4 giant robots, 1D4+1 light robots such as the Hellraiser, Hellfire and Scout Spider-Skull Walker, 1D6+1 ground power armor units, 1D4 tanks, and one APC with 1D6+6 Dead Boys riding inside.

CS Cities, 'Burbs & Population Centers

Within twenty miles (32 km) of cities and important possessions, security becomes an even tighter grid. Military units are less present, but the ISS watches every corner and every alley. Urban

zones mean more people are around and there are more eyes on outsiders and suspicious visitors (the player characters?). Coalition citizens are trained to spot magic and supernatural activity and are eager for the acclaim (or bonus credits) that comes when they report suspicious activity. Neighborhood watch-style organizations may not pose a direct threat, but they can direct ISS Peacekeepers or soldiers right to the criminal or outsider's location.

Remember, while people outside the Coalition States consider it to be an oppressive, fascist regime built around fear, lies and tyranny, most CS citizens – as in 95% – trust and believe their government, their leaders and the authorities. They cheer when soldiers march or drive by, and they quickly and happily report crime, wrongdoing and suspicious activity to the police. This is not as often the case in the 'Burbs, where there is much more tolerance and openness to other ideas, non-humans and magic, but it is in the cities, towns and communities of 100% *human citizens* of the Coalition States.

01-15% Dutiful CS Citizens. Coalition citizens are always on the lookout for D-Bees, supernatural phenomena, and the presence of magic and suspicious outsiders. Since grade school, they have been conditioned to report such people and incidents to the State authorities. A few unarmed citizens may not be much of a threat, and they seldom take direct physical action themselves, but they make a quick call to the ISS. And ISS Peacekeepers (CS police) are quick to respond, arriving to investigate reports, on average, within 1D6+1 minutes, half that time if people are in immediate danger. Note: Most CS citizens have telephones and State Internet with which to report trouble via audio reports or selecting various icons. The CS internet is all based on images, video and audio, not written words.

16-25% CS Neighborhood Watch. Neighborhood Watch groups are not found in all CS communities. They are most commonplace in outlying rural communities, small towns, and communities that border the 'Burbs with their uncouth inhabitants and the poor. They are also found at places where the ISS and military cannot afford to patrol constantly, as well as communities with a history of crime, civil unrest or trouble from outsiders (D-Bees, Raiders, bandits, practitioners of magic, monsters, refugees, nomads, and the disenfranchised populace from the 'Burbs or neighboring non-CS communities, and so on). Still there is an ISS Peacekeeper force that tries to respond within 2D4+3 minutes to most calls for help or reports of trouble. All members of CS Citizens Watches are unarmed, but carry flashlights and radios. Only the most aggressive and paranoid members may also carry clubs/bludgeons or things like shovels, axe handles, hammers and butcher knives for protection in case they need it. They shouldn't need it such items because the authorities tell them NOT to take action themselves, but to report, observe from a distance and wait till help arrives. Help, by the way, is likely to be 2-4 old-style SAMAS flying in or 1D4 hover patrol cars arriving with sirens blaring, with two ISS Peacekeepers inside each. Reinforcements consist of more ISS law enforcement officers, Dog Boys and Psi-Stalkers all working under the auspices of the ISS. And when necessary, the Coalition military.

Most communities can receive help, in an emergency, from a nearby base or mobile Death's Head Transport within 1D6+4 minutes, half that time in many cases. However, the military only becomes involved when the ISS calls for such intervention, and that usually happens only when under attack by heavily armed forces, practitioners of magic or monsters.

Note: It is illegal for the human *citizens* living in an urban area to own firearms of any kind. Those in rural areas are allowed to bear arms for their own protection. Being caught in the possession of a firearm, especially M.D. weapons, results in steep fines, criminal charges on one's permanent record, and repeat offenders or those who use a weapon in the commission of a crime or violence, face loss of citizenship or imprisonment, or both. Losing one's citizenship means being stripped of all rights and the individual is removed from his family and community, loses his job, and is exiled from the CS. At best, such "criminals" can live in a nearby 'Burb, but will always be branded as a criminal, dissident and non-citizen, and NEVER allowed to live in any official CS community. Once citizenship is lost, it is almost impossible to regain.

26-35% ISS Dog Pack – Urban Equipment. Standard ISS Dog Packs will be armed only with Vibro-Blades, Neural Maces and pistols, but are on the hunt night and day and can always summon reinforcements. Each Dog Pack is led by a Psi-Stalker, and if they cannot handle the job themselves they will call for backup from military forces.

36-45% ISS Peacekeeper on Patrol. ISS Peacekeepers always work in pairs; either a pair of ISS officers, or an ISS Peacekeeper and a Dog Boy or Psi-Stalker. Each pair is assigned a hover police car and a pair of hovercycles and jet packs to use as the situation dictates. When backup is requested, two additional squad cars arrive on the scene. If armed combat is involved, 1D4+4 police cars arrive, and so might 1D4 ISS old-style SAMAS or Psi-Net agents. Military support can be requested at any time. The first to respond from the military is usually 2D4 SAMAS or Sky Cycles as part of the quick response. They are followed by whatever forces are deemed necessary to quell the disturbance or threat.

46-60% ISS Peacekeeper Squad. Squads of 1D6+6 human Peacekeepers work together to quell all manner of serious disturbances and investigation of organized crime and trouble from small, outside groups. The ISS very much function in the role of police, but tend to have much more flexibility and latitude in their investigations and interrogations of non-humans, outsiders and known or suspected criminals. Strong-arm tactics, threats and lies are permissible, and outsiders/non-citizens, whether they are human or not, have NO RIGHTS whatsoever.

61-68% ISS Specters. 1D4 Coalition ISS Specters are on the job. Specters are well-trained detectives backed up by all the resources of the ISS and the Coalition Army. Specters are only deployed for serious crimes such as murder, terrorism, extortion, kidnappings, and all matters involving magic and the supernatural. Their presence alone is enough for most criminals to worry and cease whatever they were doing to lie low or get out of town for a while. Specters are feared and respected.

69-77% ISS SAMAS Patrol. Peacekeepers equipped with old-style SAMAS suits are the primary airborne units of the ISS. Their exoskeletons allow them to chase down flying threats, make quick responses to critical situations and provide fast backup, and their superior firepower makes short work of most criminals, raiders, D-Bees and invaders. Like most ISS operations, a standard patrol is two old-style SAMAS, but can be as many as four or six if circumstances or the threat level warrant it. ISS patrols are a common sight above the streets, back alleys and borders of CS cities, towns and communities.

78-83% ISS UAR-1 Enforcer on Patrol or Standing Guard. Originally intended for use in urban settings, the CS Enforcer robots that have been retired from front-line duty have been eagerly

snatched up by the ISS. Enforcers are the heavy-hitters of ISS raids and defense. The giant robots are used as bulldozers, riot control, overwatch towers, walking shields and heavy weapons platforms for assaults and defense. When large monsters and gangs of bandits, Raiders or D-Bees strike, the UAR-1s are called in. One or two UAR-1s usually stand ready at every ISS Peacekeeper station, main city gates, hospitals, and other strategic locations.

84-88% CS Army Infantry Squad. Even in cities and areas with high populations and established ISS forces, the military is an intrinsic part of maintaining peace and order. Troops patrol city streets and rough districts all the time, and often without the familiarity or restraint of ISS Peacekeepers. Infantry units are as likely to gun down criminals as arrest them, making them an excellent deterrent to crime. This is a standard patrol of 1D4+2 Grunts and two Psi-Stalkers and/or two Dog Boys, and is always on foot.

89-92% Dead Boy Skelebot Patrol. Two Grunts, one CS Psi-Stalker or Dog Boy and 2-4 Skelebots under the command of the human squad leader patrol the streets. This patrol is always on foot.

93-95% CS Army Power Armor Patrol. Power armor units are perfect for urban operations. They possess heavy armor and firepower, all while staying small enough to fit down streets and into most doorways. Power armored troops are typically deployed for a specific purpose, however, not simply out conducting patrols. Probably 2-4 Maulers or Terror Troopers or Smiling Jack SAMAS, occasionally Glitter Boy Killers.

96-98% Urban Military Commando/Special Forces Squad. One of the most dangerous encounters in a CS city is with a Coalition Special Forces/Commando team. Special Forces teams are only called in for the most critical tactical strikes, and to see one inside a CS community is a sure sign that something big is about to happen. Such teams usually consist of four CS Special Forces or Commandos, two CS Juicers, one EOD Specialist, one CS Cyborg, and one Dog Boy or Psi-Stalker (or sometimes a Master Psychic).

99-00% Military Armored or Mechanized Squad. Mechanized units are 1D4+4 CS military APCs and tanks or giant robots accompanied by 4D6+20 Dead Boys plus one Spider-Skull Walker. They are usually called in as a show of force, to protect a particular border area or strategic location, or to deal with a possible invasion force, Raiders, wizards or monsters.

Coalition Encounters Outside CS Territory

01-15% Long-Range Reconnaissance Squad. Patrols outside of Coalition territory are typically made up of CS Rangers, Coalition Expeditionary Force squads, CS Psi-Stalkers and Dog Boys, or mercenary contractors, or some combination of them. Special Forces, Commando units and Juicer squads also frequently work outside the territories claimed by the Coalition States. Most scouting, search and rescue, seek and destroy, and missions of sabotage, are assigned to small squads (6-10 troops), but some may be carried out by a whole platoon (20-40 troops). Typically travel on foot or in light, fast vehicles.

16-30% RCSG Team. Rift Control Study Group teams are part science, part military lock-down. They are most commonly found around Rifts and along ley lines, as well as other locations of magical, supernatural, or unexplained activity. They study the flow of mystic energy and the supernatural creatures that are drawn to it, as well as engage in other scientific operations. Encounters with

Black Marketeers, criminals or adventurers will be an unwelcome surprise to the researchers, but the security element of the team should have no problem figuring out how to respond. 2D4 RCSG, 1D4+1 Grunts, two Psi-Stalkers, two Dog Boys, and two SAMAS (any type) or other power armor is a typical security team for long-range ops in hostile territory.

31-45% Coalition Expeditionary Force (CEF). The Coalition Expeditionary Force works outside official borders and often disguises its identity. CEF troops sometimes use foreign equipment, armor and uniforms while carrying out the will of the Coalition States. The player characters might not even know who they have encountered, and assume they are a mercenary squad or company, or military unit from a small kingdom, or adventurers like them. Size varies from squad to company in size, depending on the objective of the mission.

46-60% Coalition Probe. Probes are military units sent out into regions adjacent to Coalition borders. Their mission is simply to map and chart areas and seek out pockets of resistance. Probes may have orders to avoid damaging civilian property or instructions to burn down any villages and unlicensed settlements in their path, especially if infested by D-Bees or practitioners of magic.

61-70% Skelebot Seek and Destroy Squad. Coalition Skel-bots are deployed everywhere, especially in remote areas. This patrol is likely programmed to destroy all D-Bees, monsters and practitioners of magic they encounter. A Skelebot Squad of this nature will range from 10-40 (platoon-size). It keeps pressing forward and follows trails, slaughtering targets until they are themselves destroyed or completely run out of ammunition and return to a mobile or established CS base. This patrol is always on foot.

71-80% SAMAS Patrol. SAMAS are sent out to on long-range patrols with various mission goals. 01-25% Reconnaissance/Intelligence gathering. 26-50% Search and destroy smuggler caravans. 51-75% Search and destroy known and identifiable hostile enemy forces. 76-00% Troop support or flyby to intimidate enemies. Such a patrol consists of 1D4+2 Smiling Jack SAMAS units (any style) and one Super-SAMAS.

81-90% Undercover Operation. A squad of CS troops, probably a mixed group of 1D4 infantry soldiers, 1-2 Psi-Stalkers, 1-2 Special Forces or psychics, a CS Juicer or CS Cyborg, a CS Ranger and a CS Robot Pilot in power armor or an NG combat robot, all dressed and disguised as a band of adventurers, mercenaries, heroes or refugees. They have NOTHING to give them away as military or soldiers of the Coalition Army. Their purpose is likely to gather information about enemy and criminal operations that could threaten the CS, and they fight only when threatened.

91-00% Coalition Strike Force. A CS strike force is out on a direct mission. Its most likely mission is to seek out and destroy enemy or criminal camps, smuggler caravans and related targets that have been designated as threats by military high command. Strike forces are fast, effective and ruthless, leaving few alive to report their actions or organize a counter-attack. They will be a mixed force of Coalition soldiers and range from platoon to company size (40-160 troops).

Black Market Activities Within the Coalition States

Nowhere else is the Black Market under as much pressure as within the Coalition States. Nowhere else are the profit margins and demand for product as high, especially in the 'Burbs. The Coalition is a security state, highly committed to keeping magic, D-Bees and demons outside its borders. Citizens are not allowed to own modern weapons, body armor, war machines, magic, books or pre-Rifts relics, and the Coalition military and the Internal Security Service (ISS) see to it that this law is strictly enforced, which includes keeping careful watch over the cities and trade links of the CS. It is interesting to note that with the possible exception of books and pre-Rifts artifacts, most Coalition citizens have no interest in any of those items. Most are fiercely law-abiding citizens who trust their leaders, obey the law and respect the military and police who protect and serve. It is a different story in the 'Burbs.

One must remember that the 'Burbs are a sort of political no-man's land. According to CS law, the 'Burbs themselves are unofficial and illegal habitats. Every inhabitant is a squatter and non-citizen who lives there at his or her own risk. They have no rights under CS law, and even long-established 'Burbs are unofficial and could be bulldozed by the CS anytime it chooses to do so. This non-existence means Coalition authorities can do whatever they please to whomever they please without serious ramifications. They can beat-up and kill "suspects" without fear of charges against them, and innocent people are injured all the time in raids, but are simply collateral damage of no consequence. So why do people flock to the 'Burbs? The answer is simple, the rest of the continent is so hostile and frightening that millions of people, including D-Bees who are routinely hunted, dragged out and killed in the street by CS authorities, would prefer to take their chances with the CS than live elsewhere.

The 'Burbs are where the hopeful (and desperate) gather. At least two-thirds are people who dream of becoming *Citizens of the Coalition States* or to at least find work and live in the relative safety of the 'Burbs. When the innocent and hopeful gather, it attracts opportunists, criminals and bad guys. It is in the 'Burbs where the Black Market thrives like a weed. The Coalition's strict laws and long list of contraband have created a rich market and thriving income for the Black Market. The Black Market offers every luxury and every illegal item and service one can imagine: drugs, vice, magic, items, guns, body armor, vehicles, illegal bionics, books, education, pre-Rifts artifacts, historical documents, magic items, all things alien, and so much more. To add to the fun, Black Marketeers make money thumbing their nose at the Coalition.

If the denizens of the 'Burbs are the Black Market's biggest market, their customers inside the fortress cities are the elite. Coalition citizens in the big cities and fortress cities pay a premium to purchase contraband that has been smuggled past the checkpoints and security patrols. Black Market goods are more expensive within the Coalition fortress cities and all CS cities, towns and secured urban districts. Even in the 'Burbs, half of which are cast in poverty, prices are higher than many other places outside the CS, but the range of Black Market goods and services available at the 'Burbs is unsurpassed.

The Black Market faces intense pursuit and constant investigation by the ISS and Coalition military, both of which work to shut down the most serious criminal offenders even in the 'Burbs. Among the most serious offenses is selling weapons, power armor, robots, magic and magic items, as well as establishments that cater

to D-Bees. As far as the Coalition is concerned, Black Marketeers who traffic in magic items are just as bad as the practitioners of magic who make them. Death sentences and long prison terms are common for such offenders, even if the smuggler or seller knows nothing about magic or how the item works. Just possessing a magic item, especially a weapon, is a capital offense. As a rule, the military and police authorities in the 'Burbs will seize magic items in the hands of adventurers, mercs and people who don't seem to be a serious threat to the security of the CS, followed by a severe beating and threats. However, sellers and practitioners of magic are often killed on the spot (before they can use their inventory against the lawmen), no questions asked, and the magic seized. Magic items are taken to the legendary Black Vault where they are locked away at a secret, secured location in the CS. Any practitioner or seller of magic taken into custody for interrogation is likely to wish he had been killed. After a period of brutal interrogation, the criminal faces mandatory public execution. A serious punishment that somehow fails to deter the endless number of eager Black Marketeers. (See page 29 of **Coalition War Campaign** for more information on the Coalition legal system.)

Some Coalition Contraband

There are many types of goods that are considered contraband within the Coalition States that are perfectly legal in most places in North America. This ranges from military grade weaponry and magic items to simple things like books and video discs. Items that can be acquired legally and cheaply outside the Coalition States and then sold within its borders for a significant markup. This is a thriving industry, especially with the Black Market.

Books

Smuggling books and other printed materials is a consistent source of income for the Black Market. Setting up printing presses outside the Coalition is cheap and easy, and low-quality copies of *the Bible*, the works of *Erin Tarn*, various classic authors, history books, picture books showing pre-Rifts Earth, graphic novels, and pornography are churned out on pulp paper. The Bible is a big seller, as are the plays of Shakespeare, but many works considered trivial in their time have also made a surprising comeback with the resurgence of civilization after the Great Cataclysm. The vast majority of books did not survive the ravages of nature, the sweeping purges of the Coalition or the effects of time upon them over the centuries, and whatever random bits and pieces have survived all carry the same pre-Rifts mystique, whether they are famous novels or poorly written garbage. Digital data storage devices often break down faster than paper, and few of the digital libraries from the Golden Age of Man have been preserved and recopied. In this information blackout, a pulp romance novel, a cookbook, role-playing game, comic book or a collection of nursery rhymes may be the only window on a specific piece of forgotten human culture and history.

While punishment for selling or distributing printed materials is harsh, the operation is essentially risk-free for those on the production end, and the smugglers who do the dirty work face the same risks whether they are transporting a shipment of weapons or novels. For the vastly illiterate CS populace, however, simple political cartoons, picture books, comic books, cartoons, and collections of



photographs or works of art from the past and from the modern, outside world are the most popular printed contraband.

Small “pirate presses” using efficient printers have begun popping up in communities away from the Coalition States, further exasperating the efforts of the authorities to suppress the flow of information to the people. The cheap, stapled-together, instantly recognizable “pirate pamphlets” produced are often the only format in which a book is available. Pirate pamphlets generally don’t last long and fall apart after being passed around between readers long enough. Still, in a world without libraries, copiers/printers or the internet (as we know it), pirate presses are one of the only methods of manufacturing and distributing books.

The illiteracy rate and lack of books and formal education in most parts of the country have kept the book market small. This has created an environment for bard-like characters: Traveling scholars who come to a town and read from a book or use oral tradition, song and storytelling to inform the largely illiterate masses. Most are greeted with great excitement and treated like VIPs. With the exception of communities like Tolkeen, Lazlo and the Federation of Magic, the average person cannot read or write. That includes 95% of the CS population. Of course, such bards and scholars are criminals outlawed in the Coalition States, the ‘Burbs and CS controlled territory. Hence their being branded as “Rogue” Scholars. **Erin Tarn** is such a Rogue Scholar. She has spent the better part of her life wandering the Americas, teaching, reading and telling stories so that people could have a better understanding of the world, their past and ideas other than those taught by the Coalition States and other self-serving governments. Her crimes against the CS were compounded when she began writing books of her own and others began to memorialize and publish everything the woman said. Today, the caring humanitarian is the Coalition States’ “Enemy Number One.”

Book Prices

New books are recent publications printed for the CS literate elite (not meant for others) or publications produced and distributed by various scholastic and criminal undergrounds, including the Black Market. A typical novel, paperback book, magazine, comic book, or basic video disk costs 20 credits. Educational books, disks and digital files of instructional manuals and books dealing with subjects of history, science, medicine, social studies, philosophy, how to do it yourself, and similar, cost about 30-60 credits. Forbidden books blacklisted by the CS, such as *Erin Tarn’s Traversing Our Modern World*, can cost anywhere from 50 to 800 credits (on average, 2D4x100), depending on the seller.

Old, Pre-Rifts books vary greatly in price depending on the condition of the book itself, its subject matter, rarity and the state of the current collectors’ market. Technological journals of all kinds tend to get top dollar. Here are some typical prices:

Periodicals: Including comic books, newspapers, and magazines. 200-1,200 credits each.

Paperback Books: Novels, children’s books and other types of trade paperbacks command 300-1,200 credits each.

Hardcover Works of Fiction: 400-1,600 credits each.

Hardcover History Books: Includes art books and photo-books. 1,000-4,000 credits each; 5-10x more if truly ancient, rare and coveted.

Hardcover and Softbound Natural Science Books: Includes school, mass market, and reference books. 1,000-6,000 credits each; 5-10x more if truly ancient, rare and coveted.

Hardcover and Softbound Science Manuals and Instructional Books: Includes cookbooks, sheet music, scientific data or methodology, and books with construction plans, experiments, elaborate data, how-to instructions, and data with practical applications. 10,000-60,000 credits each; 5-10x more if truly ancient, rare and coveted.

Valuable Technical Journals: Books with step-by-step instructions, construction diagrams, how-to-build instructions, blueprints, schematics, formulas, etc. 40,000-240,000 credits each; 2-5x more if truly valuable, ancient, rare and coveted. Some high-tech journals/instruction manuals can be worth millions and all are highly illegal in the CS.

Electronic Data: The same prices and CS restrictions apply to audio, videos and digital files of the same nature. Add 50% to excellent instructional films, including microfilm and videotapes and disks.

Note: All Pre-Rifts books and recordings (film, audio and digital files) are outlawed in the Coalition States. If a book is found, it is to be given to the authorities without being read. There are also new books that the CS has found to be dangerous and are *forbidden*. They are usually books that speak against the Coalition, like the Erin Tarn series of history and geography books, or are deemed to be anarchist or subversive in content and/or ideas. Included are true history (the CS has rewritten history) and ideas like freedom of speech, equality to all, literacy, philosophy, magic (even magic in a fairy tale context!), religion (because of its mystical/magic aspects), and similar ideas. Any citizen or visitor found to read, collect, distribute or sell such contraband anywhere in CS territory is severely punished. As a result, books and other recordings are hot items on the Black Market and sold in carefully guarded, secret, transactions.

Pre-Rifts Works of Art and Artifacts

Pre-Rifts relics and artifacts have great value to some people – typically historians, scholars, scientists, collectors and the educated. As pieces of Earth History, even things we might consider junk, have value.

Mementoes of the Past: Old soda pop cans, bottles, bottle caps, cell phones, knickknacks, children’s toys, costume jewelry, glasses, cups, containers, etc., sell for anywhere from 50-600 credits each.

Old Melee Weapons: Knives, swords, spears, etc., sell for 200-1,200 credits each; 10-20x more if truly ancient, rare, unique and coveted (i.e. is 1,000+ years old).

Old guns (S.D.C. weapons): Any type of handgun, rifle, etc. sells for 300-1,800 credits each; 10-20x more if truly ancient, rare and coveted).

Pre-Rifts Advanced Weaponry: Military grade M.D. energy weapons, explosives, etc., sell for 3D6x10,000 credits each; 2-5x more if truly powerful, unusual, rare and coveted.

Pre-Rifts Advanced Electronics: Cameras, computers, recorders, radios, household appliances, etc., sell for 2D6x1,000 credits; 2-3x more if truly unusual, rare and coveted; 3-5x more if it still works!

Pre-Rifts Commercial Vehicles: Any. 2D6x10,000 credits; 2-3x more if truly unusual, rare and coveted; 5-10x more if it still works!

Pre-Rifts Military Vehicles: Any military grade vehicle sell for 1D6x100,000 credits each; 2-3x more if it is truly unusual, rare and coveted; 4-6x more if it still works!

Pre-Rifts Glitter Boy or SAMAS: Ancient versions of these power armors are practically considered to be sacred relics and worth 2x the cost of a modern day version/knock-off; 3-5x more if it still works!

Pre-Rifts Unknown Military Grade Technology: This could be a vehicle, power armor, robot or heavy weapon. Super-Rare. 5D6 million credits; double if it still works.

Pre-Rifts Jewelry: This is anything made of real precious metals and gemstones. Modern value x2 for its historical value; 4-10x more if truly ancient, unique, rare or coveted (i.e. is 1,000+ years old).

Pre-Rifts Art: This can be anything from a drawing, painting, print or sculpture to anything someone might consider to be “art.” Modern pre-Rifts works can sell anywhere from 50 credits to 50,000 credits. A genuine old master work of art (i.e. the art depicted in art books and once hung in the museums of the world) can sell for millions to tens of millions.

Computer and Electronic Data

A smaller niche market exists for those looking for computerized information within and outside the Coalition States. Few people in the CS have access to unregulated computers and know how to use them. Those who do are the Coalition elite such as academics, scientists, political and military leaders, and Rogue Scholars and political dissidents who read and study in secret. While most citizens have computers and the internet, there are few written words, no typed data exchanges and file-sharing (as we know it) is basically a thing of the past. Everything is audio-visual (the spoken word and video) and icon-based. The computers respond to the spoken word and key icons. Communication is an audio or video feed. Furthermore, there are few forums and message boards, and it is ALL monitored 24/7 by the *Department of Propaganda*.

Most of the material and services “online” are all provided by the government, and include CS approved (and created) games, public service announcements, government news, government education, government entertainment shows, State provided services, and similar. Again, only the CS elite, military and the privileged classes have “private” computers and access to restricted databases and sharing.

Among CS citizens, digital files and video disc sales are a tiny and discreet part of the Black Market’s operations, and often represent the only interaction between the Black Market and the upper crust of Coalition society. Beyond the Coalition’s borders, the Black Market must compete with legitimate publishers and sees its profit margins greatly reduced. Still, there are the ‘Burbs and other kingdoms where certain discs, books, entertainment and knowledge are forbidden, or the level of technology is too low to produce them locally, and the Black Market finds demand for their products.

Knowledge Clubs

Under the restrictive and repressive Prosek regime, “the truth” is oftentimes a rare and valuable commodity. In this environment, underground “knowledge clubs” have sprung up; groups of free-thinkers, academics and dissidents who celebrate and spread illegal knowledge, information and truth. They engage in rogue studies, read forbidden books, engage in philosophical debate, and find and stockpile pre-Rifts books, films, documents, etc., preserve them, copy them and do their best to piece together the incomplete historical record left behind by the Dark Age that followed the Great Cataclysm. They also produce and distribute writings and videos that raise forbidden ideas and ideals, question CS statements and policies, reveal the real truth about history and behind current events, and generally encourage freethinking, personal freedom and open debate. Of course, such Rogue Scholars, Rogue Scientists and freethinkers are dismissed and labeled by the Coalition as terrorists and subversives, and ranked as a higher priority for the ISS than murderers and practitioners of magic.

The Black Market has long ago learned about the profits to be made from providing members of knowledge clubs not only with books, disks and artifacts, but with *secret meeting places*, *protection* and *escape routes* if raided. Most Knowledge Clubs feature a number of Rogue Scholars, one or more Rogue Scientists and sometimes include surprisingly wealthy, powerful individuals from across the country, and sometimes even from the Coalition’s upper class. All of these people value *secrecy* and have the resources and necessity *to pay* for a safe, secure place to gather without Coalition intervention. To be caught is a death sentence, but it can also destroy entire generations of families if such subversive activity becomes public. And the CS always makes the exposure and execution of such a criminal public. This can destroy the reputation and business for the dissident’s family members, business associates and friends, all of whom will be assumed to have known and kept quiet, or worse, also involved in anti-government activity. They are usually shunned, their businesses and livelihoods ruined, and they, their children and children’s children forever live under the shadow of suspicion. Who is better suited to provide such secrecy and than the *Black Market*?

Secret Schools and Underground Libraries. Many of these Knowledge Clubs also double as *schools* and *mobile libraries* that meet at secret locations to teach youngsters and adults reading, writing and arithmetic. More advanced classes may include sci-

ence, history, creative writing, art and other advanced instruction and education. Knowledge Clubs that have been in place for many years grow and develop into Secret Schools or Underground Libraries. Inside the CS cities and 'Burbs, such institutions take a long time to mature, and often have a connection with some outside supporting group like a circle of Lazlo scholars or agents provocateur from the Federation of Magic. And whether their intention is the noble pursuit of truth and education, or to destabilize the Coalition, such groups are the beginning of the chain for getting contraband books and information to the citizens of the CS. Secret Schools have a mission to spread the truth and educate everyone they can. It is this altruistic quest, and the Coalition's violent suppression of it, that fuels their shadowy war of ideas.

Coalition War Profiteering

As the Coalition is years ahead of any other (known) technological power in North America, CS equipment has a reputation for quality and commands a high markup. There are numerous Black Market manufacturers who sell knock-off versions of CS guns and armor, but there is no substitute for the real thing. And no knock-off artist on Earth has the skill to recreate large units like Coalition power armor, robots and vehicles.

Quartermasters, supply officers and thieves within the Coalition military are aware of the credits to be made, and war profiteering has always been a problem for the Coalition. While large, expensive pieces of military hardware are carefully catalogued and protected, the Coalition States manufactures millions of infantry weapons, Vibro-Blades, E-Clips, field kits and ration packs. The CS military consumes vast amounts of food and fuel, and has a constant need for everything from extended E-Clips to officers' dress shoes. These lesser items are far easier to steal, misplace, or "fall off the back of a truck," and they represent the vast majority of the goods that disappear from CS supply depots every year.

Since the CS military's expansion and modernization prior to the war on Tolkeen, a huge amount of military equipment has been shifted from front-line units to reserves, the ISS Peacekeepers and long-term storage. Everything from old SAMAS suits and Dead Boy body armor to tanks, aircraft and even UAR-1 Enforcers have been moth-balled in case of some unforeseen emergency. Millions of personal weapons alone are kept in regional storage depots. This equipment, while kept under lock and key, remains vulnerable to some degree of theft and improper allocation. This, and the improving quality of knock-offs, has led to a marked increase in the amount of old-style Coalition gear on the Black Market. New-style Coalition equipment still sells for a premium, but older CS armor and weapons do not have quite the same forbidden appeal that they once did. Realistic customers do not care, however; they are simply happy to purchase superior equipment at a more reasonable rate.

Major military bases and cities are prime targets for profiteers, as well as occupation zones. The Tolkeen front has been a rich source of stolen goods for the Black Market and the Chicago Network in particular. So was the standoff between the CS and Free Quebec. Before these two powers came to an understanding, pirates and Black Marketeers stole what they could. It was a fraction of what occurred at Tolkeen, but there was theft and losses. All intense and large-scale conflicts consume a huge amount of ammunition, supplies and gear, and a measurable, if small, percentage disappears into the hands of eager smugglers and thieves every year.

Now Hiring

By Taylor White

Additional jobs and text by Kevin Siembieda

There are numerous different jobs and tasks for the Black Market that do not necessarily require specialized Occupational Character Classes (O.C.C.s). The following jobs are routinely sought out by Black Market operations for specific missions and short-term operations. Similar work and salaries are also offered by other criminal organizations, mercenary companies, well-funded adventurer groups, foreign agents, governments, some businesses and even wealthy individuals. Taking a job from the Black Market (or merc company) can be a source of quick cash or even regular work. Being employed by the Black Market does not make the character a Black Marketeer.

A Note about Pay: Most Jobs list a range in pay by dice roll, e.g. 2D6x100 credits. This is a tool for the Game Master for a quick, random determination. However, the G.M. may set a specific fee, such as 200 credits or 1,200 credits, etc., as he deems fit for his players. Moreover, the money listed is a guideline. Depending on the situation, the employer doing the hiring, and the experience and reputation of the characters being hired for the job, pay for the job could be 50% lower than the lowest suggested range or 200% higher than the highest, and everything in between.

In many situations, a savvy business person will try to get the best people for the job at the best price – meaning the lowest price. When it is important that the job is done right, the employer may be willing to pay top dollar or a premium price (more than the going rate), and does so by hiring the best, most experienced person/people for the job. In game terms, that means the higher the experience level, the better the pay. The same holds true for a good *reputation*. Fame and renown is a double-edged sword, but can come in handy when haggling a price. Whether the acclaim is deserved or not, characters of repute can often demand top or premium pay. Though not always.

A character or group can be the best of the best, but sometimes the potential employer just does NOT have the money they want or are normally paid. This is when a character must decide whether he'll take the job anyway at the lower price or not, even if it's the lowest pay possible. In some instances, and for a good cause, the characters may find themselves taking a job for peanuts or even doing it for free. An alternative when dealing with mercs, bandits, pirates, the Black Market and some business people, may be what is referred to as getting paid on the "back end," by agreeing to take a cut of the sales or value of the merchandise. A typical cut is 5-20%, but this is risky on many levels. The job has to be a success and you have to trust that your business partner/employer won't cheat you.

Job: Acquisitions Specialist

Description: This is for characters who are skilled at tracking down and "acquiring" (this usually means *stealing*) contraband, weapons, medicine or whatever the client wants "acquired." Most of the time, an Acquisitions Specialist is a con artist, thief, smuggler or other criminal type, but not always.

Pay: Typically a set price for the goods to be "acquired." Low-end items may only be 1D6x100 credits while high-end pay could be in the thousands. Vital, rare and dangerous/powerful acquisi-

tions could pay out hundreds or even millions of credits, but it is typically in the 3D6x1,000 credits range.

Job: Combat Medic

Description: Smuggling and other criminal enterprises are a risky business, and discreet doctors, nurses and paramedics are always in demand. Moreover, there are skirmishes, wars, rebellions, and gang wars going on all the time. For the more warlike situations, a combat medic will be needed to patch up the injured. A qualified field medic – let alone a Medical Doctor and surgeon – is a treasured rarity on the battlefields of Rifts Earth. When Mega-Damage weapons, explosives and magic start going off, a medic will be necessary to tend to the wounded. Not only that, but soldiers, mercs, tribal warriors and gang members suffer from other ailments, disease, dehydration, malnutrition, broken bones, infection, parasites, pregnancy, and insect bites, poison and so on, all of which require a trained physician.

Combat Medics are expected to work under intense pressure, even in the middle of a heated battle. They usually try to pull the wounded to cover before working on them, even though moving the wounded individual may be harmful to their patient. There are few rules to warfare in the world of Rifts, and many evil and selfish-aligned characters will fire at a Body Doc or field medic the same as they would any other enemy.

The best Combat Medics are Body Fixers and Cyber-Docs, because their training covers a wide variety of afflictions. Spell casters and psychics with healing powers are equally efficient and qualified, and in some cases, may be even better at getting the fallen back up and back into the fight than a conventional doctor.

Minimum Attribute Requirements: As per medical O.C.C. and skill requirements.

Skill Requirements: Medical Doctor and Field Surgery, but additional Medical skills are all applicable and useful; the more, the better.

Pay: Low-end pay is 1D6x100 credits per day of work. High-end pay is 1D6x1,000 credits per day. The Body Fixer gets paid the per day rate whether he has no patients, 5 patients or 50 a day. He is, in effect, on retainer when there is no work/patients. Treating a single, high-profile customer on the quiet, gets the highest of the high-end pay rate and sometimes 2-5x more, especially if the doctor's work is excellent and there are no complications.

Job: Courier

Description: Couriers in the world of Rifts are more than just delivery boys. They must be able to travel through any territory, through any kind of weather, day or night, and handle any type of threat that comes their way. When a Courier accepts a package, he or she is taking full responsibility for it (even though the contents are likely a mystery) and agrees to protect it with his life until it is delivered. This is serious business. He must survive in harsh environments, avoid the authorities, probably hide and protect the package, and contend with all dangers and impediments that come his way. And he must do all of this with no help at all from his employer or the recipient of the package. No one hires a Courier when the job is easy.

The best Couriers are fast. Fast on their feet, fast with their tongues, fast with their wits, and when necessary, fast with their weapons. Though a good percentage of Couriers are Juicers, Traveling Merchants, smugglers and spies, the only real requirement is being able to get the package delivered quickly and quietly, and

without compromising the employer or the recipient in any way. Couriers usually travel alone, in pairs or among small groups of travelers, mercenaries, and adventurers. Their delivery destination and target can be a specific person, a specific place of business, organization, dwelling or a drop point.

Couriers are entrusted with a package and promise to deliver it to the designated person or location without fanfare or damage to the item. Such packages are almost always one, relatively small item, such as an envelope containing important information or documents, a letter meant for one specific person's eyes only, a briefcase of guns/gems/valuables, a duffle bag of drugs, a magic item, ancient artifact, and on and on. In most cases, the "package" to be delivered is in a sealed container not to be opened by the Courier for any reason. Thus, the Courier has no idea what it contains. It could contain incriminating photos, jewelry, a birthday card, or a bomb. For a professional Courier, it doesn't matter what the package contains, it's all about getting it to its destination.

Minimum Attribute Requirements: I.Q. 10, M.E. 12, and P.E. 10.

Skill Requirements: Land Navigation, and at least two Pilot skills (Horsemanship can count as one of the piloting skills). Concealment, Detect Ambush, Palming, Streetwise, Roadwise and other *Rogue* and *Espionage skills* can be very handy, but are not required.

Pay: Varies with the level of danger and complexity. A simple delivery or drop is 1D6x100 credits. Moderately dangerous or complex delivery is 3D6x100 credits. A dangerous, complex or long-range delivery is 2D6x1,000 credits. A highly dangerous or complicated delivery that involves dodging the Coalition authorities, Federation of Magic, Minions of Atlantis, demons, murderous criminals, and similar, can range from 1D4x10,000 to 5D6x10,000 credits. **Note:** Employers of Couriers typically pay 10-20% up-front to cover expenses, and the balance after delivery. Employers always follow up with their destinations to make sure that the delivery was a success. Couriers who run off with the package, lose or destroy it, or get their employer or the recipient arrested, injured or killed, make enemies very quickly and have short careers (and probably a short life). Some employers pay a 10-20% bonus if the delivery was made much faster than they expected and without incident.

Job: Croupier

Description: The character works in a casino or gambling den. He must be knowledgeable regarding the rules of games of chance and must be able to handle drunk, obnoxious and frustrated gamblers. Most importantly, he must know how to spot a cheater and discreetly alert security to the presence of anyone trying to rip off the house. They must also be trusted enough to handle large amounts of money and have references that can vouch for their integrity. Some, but not all, Croupiers are trained to nudge the games in the favor of the casino as well. The work is generally pretty safe. Most casinos are in cities and towns with a standing defense force, and the casino will have its own security team. Professional Gamblers, Con Artists and City Rats can make some of the best Croupiers.

Minimum Attribute Requirements: I.Q. 10, M.A. 10, P.P. 11 and P.B. 9.

Skill Requirements: Gambling. Of course skills such as Gambling (Dirty Tricks), Palming, Pick Pockets, and Concealment are all helpful, but not required.

Pay: 3D4x100 credits for a week.

Job: Decoy

Description: The character's task is to keep the eyes of the authorities, rivals and enemies away from his employer. This is a very dangerous job, as the position of Decoy involves causing distractions, and deliberately stepping into harm's way to draw attackers and enemies away while his employer makes his escape, slips by unnoticed or continues his own task without interference. The pay can be very good, and just about anyone with daredevil courage and quick wits can do it. At the very least, it shows initiative, which can be great if the character is trying to get better work. Of course, the real trick is for the Decoy to be able to elude his attackers/pursuers and get away himself.

Minimum Attribute Requirements: None, though a high I.Q., M.A. and Spd are a plus. A high Perception Roll bonus and/or initiative are beneficial, but not required.

Skill Requirements: None, though skills such as Detect Ambush, Detect Concealment, Escape Artist, I.D. Undercover Agent, Running, Streetwise, and Horsemanship or various Pilot skills are a big plus.

Pay: Low-end pay is 2D4x100 credits a week; high-end pay for skilled and experienced Decoys is 2D6x100+1,000 credits a week, or per job. The latter can boil down to one day or even a few hours of work.

Job: Defense Attorney/Representative

Description: Sooner or later, a Black Marketeer is likely to run afoul of the law. Whether they are accused of a crime or arrested, they'll need someone who knows the law and can argue their innocence in a court of law. Or at least get them released so they can jump bail and make a run for it. A Defense Attorney or similar representative is needed. Though in most civilizations of Rifts Earth, anyone, including the accused, can plead his own case, it is often best if a respected member of the community or an attorney serves as his "mouthpiece" – legal representative. When an actual lawyer is not available, preachers, politicians, community leaders, business leaders, Rogue Scholars, Cyber-Knights and other heroes, or those with a gift for gab, including con artists and anyone with a high M.A., P.B. and good to excellent speaking skills, make some of the best legal representatives.

Black Market Defense Attorneys are NPCs (Non-Player Characters) who are on the payroll and in the pocket of a Black Market Faction. Actually, many medium and large Black Market "crews" are likely to have their own Defense Attorney on retainer. Such individuals are usually corrupt, self-serving individuals, who care nothing about justice, only about getting their criminal clients off scott-free or with the lightest charges, fines and punishments possible. Defense Attorneys working for the Five Black Market Factions are some of the best in the world. As such, they command great respect, money, and power within their Factions and among their peers.

Minimum Attribute Requirements: I.Q. 14, M.A. 14 and P.B. 12 or higher.

Skill Requirements: None for a well-meaning representative with no professional training as an attorney.

Professional attorneys must have at least Law (General or Specific), Research and Literacy. Skills such as History, Interrogation, Lore (various), Performance, Philosophy, Public Speaking, Seduction and Streetwise are helpful and all are common amongst professional Defense Attorneys employed by the Black Market.

Note: Black Market Defense Attorneys are Black Marketeers and are likely to have all (or most) of the following *Special Abilities of the Black Marketeer*: Friends in High Places, Friends in Low Places, Home Turf Advantage, Informant: Confidential, Read People, Sincerity, Slippery, Street Rep: Trustworthy, and Work the Law.

Pay: Professional Defense Attorneys get the big bucks. Getting a low bail set is 1D6x1,000 credits.

Getting minor charges dropped completely without going to trial: 3D4x1,000.

Getting major charges dropped completely without going to trial: 2D4x10,000 credits.

Going to trial and getting an acquittal (chance of getting an acquittal at trial is 50% chance +5% per level of experience, +10% for an M.A. greater than 20, +5% for a P.B. greater than 20): 4D6x1,000 credits for minor offenses; 3D6x10,000 credits for a major offense. Double for high profile crimes, quadruple for mass murder, terrorism, attempted assassination of a powerful political figure, and similar grievous crimes.

Defense Attorneys on retainer with the Black Market only takes clients the Black Market tells them to take, which means they only defend the Black Marketeers who work for their employer, the employer himself and his friends and associates. (This could be a "favor" from a Black Marketeer.) Retainers are 2D6x1,000 credits a week on average, but the best attorneys may get paid 2D6x1,000+12,000 credits a week.

Job: Documentarian

Description: Rifts Earth is a strange place. The landscape is peppered with alien beings, demonic creatures, undead aberrations, anomalies of magic and other weirdness. The ley lines and nexus points continue to be a mystery to many; erratic doorways to other worlds that seem to follow few patterns and defy conventional science. The wilderness is dangerous, full of deadly beasts and raiders. There are many scientists, scholars, and artists who work in capturing the world of Rifts on video. They observe supernatural creatures, D-Bees, and chaotic ley line events in the wild, usually trying not to be noticed. They feel it is important to record life's events for future generations and/or profit. Idealists want to capture such events for posterity so that others can study and learn from it, and so knowledge and history can be passed on to future generations. Others are in it for the money. They like to produce film pieces that shock, terrify and entertain a paying audience.

Documentary films can cover just about anything, from the territorial habits of dragons, to a year spent with the Noli Bushmen, to a portrait of a CS war hero, to a charming love story between a Blind Warrior Woman and an enslaved cyborg, gladiatorial fights, war, and an endless array of subjects. Depending on the funding of the documentary, it could be done for a variety of purposes and subjects, and shown to different audiences. Some films are shot just for select groups, and some more altruistic filmmakers make hundreds of small documentaries which are mass-produced and sold. The Black Market is big into purchasing, distributing and selling sensational, violent and bloody films, making them one of the major patrons of filmmakers of all kinds. Since many of these films contradict official Coalition Propaganda, they are, of course, banned in CS territories, which makes some of these films more desirable and pricey.

Other Documentarians work for an employer to capture and memorialize a specific event on film/video. This can be for any number of reasons. Black Marketeers, Bounty Hunters, Mercenar-

ies, adventurers and others sometimes need *proof* of a kill or the successful completion of a job; be it murder, sabotage, a raid, etc. Employers of these individuals and groups seldom trust video or documentation from the people they've hired for the job, but they trust Documentarians they have hired themselves. In fact, many Documentarians make big bucks working for the Black Market, Bounty Hunters, mercenaries, governments and even the authorities. Trustworthy, reliable, professional Documentarians are in big demand by these employers.

Characters who engage in such documentary work for underground organizations and independent operatives find that they need to be much more than filmmakers. They have to be able to keep up with the critical action, stay out of the way, get the "money shots" and take care of themselves. That means they may have to talk or fight their way out of trouble and most important, they cannot be a burden or annoyance to the people they are traveling with, and possibly documenting. These film makers must work on staying unbiased and need strong stomachs, as they are likely to be documenting murder, beheadings, combat, death and brutality. Some of the best documentary-makers are Rogue Scholars, Rogue Scientists, Wilderness Scouts, and City Rats. Although really, just about anyone can make themselves useful on a documentary shoot.

Minimum Attribute Requirements: I.Q. 9, M.E. 10 and P.E. 10. A high Spd may also be beneficial.

Skill Requirements: TV/Video and Photography are a must. Research, Public Speaking, Lore skills, and certain Physical skills such as Climbing, Prowl, Running and Swimming all come in very handy and are recommended, but are not necessities.

Pay: Depends largely on the funding of the documentary and the whims of the producers or employer. Low-end payment is 2D6x10 credits per day of work. High-end shoots and jobs with the Black Market, mercs and other groups pay 1D4x1,000 credits per day and maybe a bonus of a few thousand to 1D6x10,000 credits for outstanding work or something captured on film that is of tremendous benefit to the employer, above and beyond what the filmmaker was hired to do.

Job: Drug Chemist

Description: Drug Chemists are highly trained individuals who create or cut batches of drugs for resale. While the workers in drug labs may be simple laborers, the specialists who actually perform the delicate chemistry must know exactly what they are doing or else they could ruin the product or even kill users. Certain alien and magical substances require individuals with experience in magic, alchemy, and/or the alien substance. In addition to Drug Chemists who specialize in recreational drugs, there is also a valuable market for those who are familiar with the drugs used in the Juicer augmentation process. The process itself is well documented throughout the criminal underworld, but that knowledge and augmentation is useless without the special chemicals necessary to maintain the enhancements after the process. Chemists with Juicer experience can often name their own price when negotiating with criminals interested in setting up a conversion shop.

The best Drug Chemists are Rogue Scientists, Body Fixers, Cyber-Docs, other doctors and alchemists, but many are not doctors or scientists, but chemists who specialize in the drug trade.

Minimum Attribute Requirements: I.Q. 10 or higher.

Skill Requirements: Brewing: Medicinal, Chemistry, Chemistry: Pharmaceutical and Mathematics: Basic. And Chemistry: Analytical, Medical Doctor and Juicer Technology if working with

Juicer chemicals. As one might suspect, the more Medical and Science skills, the wider the range of the Drug Chemist's abilities.

Pay: Varies depending on the difficulty of processing the drug and its rarity. Typically 2D6x1,000 credits per week, but can be double or triple that in areas where drug demand is high or if a Juicer chemist.

Job: Entertainer

Description: The character is expected to hold the attention of a crowd of people by providing entertainment. Entertainment can be just about anything, but is typically music shows, comedy acts, feats of acrobatics or strength, gladiatorial contests, rodeo feats, and similar. Entertainers can find work just about anywhere, but typical venues are bars, saloons, nightclubs, casinos, festivals, traveling shows, fundraising events, parties, and private functions. Some Black Marketeers are well known for hosting parties with outstanding entertainment, as well as acts for those who run entertainment establishments.

Entertainment is big business in some parts of the world. The New German Republic has entertainment corporations, producing television shows which require actors, and cover major music acts, sporting events, and other events. While there are Entertainers such as athletes, race car drivers, and gladiators on Rifts Earth, others are traditional entertainers with no combat training or special powers.

Minimum Attribute Requirements: M.A. 14 or higher. A good I.Q., P.E. and P.B. are always a plus.

Skill Requirements: Performance and/or Public Speaking and at least one entertainment-type skill such as Dance, Play Musical Instrument, Sing, Acrobatics, Boxing, Wrestling, and/or others suitable to entertaining an audience in the character's chosen field of entertainment. For example, a stage magician could use various Rogue skills such as Palming and Pick Pockets to great effect, a rodeo performer would need Cowboy skills, and so on.

Pay: 2D6x100 credits for one night's work, sometimes less, but rarely more unless the individual is a "name act" with a well known reputation.

Job: Escort

Description: Considered more high-class than a mere prostitute, there are Escorts who do not have sex with their clients, but specialize in being enchanting companions who know how to make the client look good. Escorts attend parties, business events and social functions with their clients. Many people think an Escort's only real requirement is to look good and keep good manners, but that's not true. A professional Escort is intelligent, charming and able to impress and engage in conversation on a wide range of subjects. An Escort is never the life of the party, but is usually one of its gems. As a result, good-looking Rogue Scholars, Con Artists, and characters with a flair for entertainment, song, dance and a suave and debonaire demeanor are ideal. Shape-changers can also excel in this line of work. They can maintain an attractive appearance and even tailor their appearance to their client's whims and desires. An Escort must also be able to deal with snide remarks, insults and awkward situations without getting emotional. Only one third of these types of Escorts regularly agree to performing sexual favors for their client.

Minimum Attribute Requirements: M.A. 14 and P.B. 14. In both cases, the higher these attributes, the better. A good to excellent I.Q. is also a plus.

Skill Requirements: Dance and Wardrobe & Grooming are a must. Public Speaking, Art, Lore and/or History skills and Seduction can prove to be valuable assets. The more versatile the individual, the better.

Pay: 1D6x1,000 credits for one night's work.

Job: Fence

Description: Fences deal in the buying and selling of stolen goods and contraband. They have underground contacts who know how to work around the authorities and connecting with discreet purchasers, be they a collector or underground retail outlet such as the Black Market. Fences require a delicate touch and a certain amount of street know-how. Often Fences are legitimate businessmen during their "day jobs" and move illegal products around under the cover of normal commerce and special contacts.

Minimum Attribute Requirements: I.Q. and M.A. of 9 or higher.

Skill Requirements: Appraise Goods, Barter, Find Contraband, and the right connections and a good mind for business are all it takes. Skills such as Recognize Weapon Quality, Research and Streetwise are also valuable, as is connections with the Black Market.

Pay: Most Fences take a cut or commission from the goods they move, usually between 10-25 percent. Some Fences under long-term employment by groups of smugglers or Black Market Factions are paid a regular salary, ranging from 10,000-40,000 credits per week depending on their effectiveness and the volume of material they unload, plus a 10-15% cut.

Job: Hacker

Description: Hackers are people with computer experience who use their skills to penetrate computer databases, break code protection and passwords and design viruses. The intention may be to steal information, acquire blueprints and security system layouts, classified intelligence, and other useful data for heists, blackmail, framing others for crime, creating distractions, and sometimes to erase incriminating information and criminal records. Hacking can be a subtle way to empty a bank account of credits, monitor the authorities, circumvent security systems and so on. Many Hackers prefer to keep their identities unknown – ghosts in the machine – and use a go-between or other representatives. That means even the Hacker's employer may not know his real identity. Many Hackers lead secret lives. City Rats, Professional Thieves, Freelance Spies, and some psychics make the best Hackers.

Minimum Attribute Requirements: I.Q. of 12 or better.

Skill Requirements: Computer Hacking, Computer Operation and Computer Programming. Cryptography may be necessary for certain jobs and Computer Repair, Surveillance, Sensory Equipment, TV/Video and Electronics skills are all helpful.

Pay: Varies with the level of danger and complexity. A simple hack is 2D4x100 credits. Moderately dangerous or complex hacking is 3D6x100 credits. A dangerous or complex hack is 2D6x1,000 credits. A highly dangerous or complicated hack that involves the authorities, government, the Coalition States, Triax, Northern Gun, Federation of Magic, the Black Market, other dangerous criminals, and similar, can range from 5D6x1,000 to 3D6x10,000 credits. **Note:** Employers of Hackers typically pay 30% up-front and the balance after success is shown and the information or de-

sired results delivered. Hackers who hack their employers, betray their clients, or get their employer arrested, injured or killed, make enemies very quickly and have short careers (and probably a short life). Some employers pay a 10-30% bonus if the hacker provides valuable data or service above and beyond what he was paid to do.

Job: Hit Man

Description: A Hit Man is a hired killer, however, anyone willing to kill can be hired as a Hit Man. The average person hired to make a hit is not a professional assassin. Men-at-Arms O.C.C.s make the best Hit Men, but many classes and R.C.C.s may engage in murder for hire. The idea behind hiring a Hit Man, however, is that the individual will make a successful "hit" and not get caught. If he does get caught, the Hit Man is expected to take the rap and not reveal the identity of his employer.

The kill can be for any reason: revenge, hate, to eliminate a competitor or enemy, to intimidate others, a show of force, politics and so on. Most Hit Men do not need to know the reason, nor do they care.

Minimum Attribute Requirements: P.E. of 9. A high M.E. and I.Q. are also helpful.

Skill Requirements: At least Hand to Hand: Basic and one Weapon Proficiency.

Pay: Depends on the client and the target. Killing a nobody, Joe Citizen, or petty crook costs 1D6x1,000 credits. Killing someone with a moderate reputation or notoriety costs 3D6x1,000 credits. Killing someone with notoriety, money or clout costs 5D6x1,000 credits. Taking down a person in a position of power such as a lawman, business leader, political figure, mage, Master Psychic, Lieutenant or Captain in the Black Market or high-profile target costs 2D4x10,000 credits, sometimes more. Bonuses are possible but a rarity. Most Hit Men insist on the payment being paid half up-front and half upon successful completion of the job.

Job: Moonshiner

Description: Like the Drug Chemist, the Moonshiner creates intoxicating substances for sale to the Black Market and/or other customers. Unlike the Drug Chemist, most Moonshiners do not enjoy much of a traditional education and typically come from backgrounds where a person has to fend for oneself. Many frontier folk could be considered Moonshiners by default simply because they convert their excess crops into alcohol to trade, to make a few extra credits or for personal enjoyment. They become Moonshiners when they sell their services and stock to retailers, traveling shows, and the Black Market who are eager to score cheap liquor for bars and saloons.

Minimum Attribute Requirements: None.

Skill Requirements: Brewing. Holistic Medicine is helpful in making a quality, smooth and tasty moonshine, but is not a necessity (+200 credits a week for a Moonshiner with that skill).

Pay: Moonshining is not terribly dangerous work, and normally only pays 3D6x10+80 credits per week to make the booze for a customer like the Black Market. Under such a deal, someone else picks up the brew to transport, distribute, sell and profit from it.

Otherwise, a typical bottle of moonshine gets 4-5 credits when sold wholesale, 8-10 credits retail and double for high quality shine, sometimes triple. A typical, small-time moonshine operation can distill 1D4x10 bottles a week. More for larger operations.

Job: Muscle, Bodyguard, Security

Description: Hired Muscle is just that, a thug who is tough, strong and enjoys using his physical strength (and usually size) to intimidate, protect and coerce. Anyone who is big, strong and not afraid to fight or hurt people, even innocent people, can be hired Muscle. Most are also adept in at least two different types of weapons, many are familiar with several. The Black Market, other criminals, some businesses, mercs, and others, hire Muscle to provide security, guard people and locations, act as a bouncer and to break legs, exact revenge, interrogate, and intimidate. Muscle may be hired for a specific task, but most often the job is a position to be filled, and those on duty may be required to take action at a moment's notice. As a bodyguard, the Muscle is expected to put himself in harm's way to protect and defend whatever or whomever he's been hired to protect.

Minimum Attribute Requirements: P.S. 15 or greater (the stronger the better). A high P.P. and P.E. attribute are always helpful, but not required. Any large, muscular, dangerous or intimidating character can get work as Muscle, but most are Men-at-Arms O.C.C.s.

Skill Requirements: Two or more W.P. skills and at least Hand to Hand: Expert. Magic, psionics, natural ability and additional fighting skills are all a bonus in this line of work.

Pay: Varies with the level of danger and difficulty of the job. Simple work like standing guard at a fixed location (e.g. door) or work as a "bouncer" is 1D4x100 credits a day. Moderately dangerous or complex jobs, such as a bodyguard who escorts a specified person or cargo, are 2D4x100 credits a day. High-profile or very dangerous or complex situations are 1D4x1,000 credits per day. **Note:** Employers of guards and security details typically pay 25% up-front and the balance after the job is complete. A day's work is often 12-24 hours. A bonus of 10-50% more than the usual pay may be awarded for outstanding service, protection, heroism and professionalism. Sadly, muscle is not highly respected and considered easy to find. Still, those with an outstanding reputation and experience (7th level or greater) can command 50% above the high end of the pay scale.

Job: Surveillance Specialist

Description: This is someone who is skilled at following others, observing, recording and gathering intelligence on a specified target, individual or location. This usually involves following the target without being seen or recognized, to get information on the subject's routine, habits, and/or incriminating evidence. While cameras, video and listening devices/bugs may all be used, sometimes surveillance is simply tailing the individual and taking the right notes. The authorities use surveillance on criminals, but the Black Market and other criminals and organizations may use the same techniques to keep tabs on their own employees and operatives, rivals, enemies, targets of extortion, lawmen and juries. Oftentimes, the Surveillance Specialist has no idea why he's been hired to spy on a person or place, nor how his information will be used, as it could be used to help, hurt or blackmail someone. He just gathers the intel, passes the information on and walks away.

Minimum Attribute Requirements: I.Q. 10, P.P. 10 or greater. High M.A., M.E. and P.E. attributes are also helpful, but not required. Any character with good skills of observation and a knack for not being noticed is the man or woman for the job. Most Surveillance Specialists are Men-at-Arms, spies, psychics and criminal O.C.C.s, but can be anyone.

Skill Requirements: Intelligence, Prowl and Tailing or Surveillance Systems are a must. Other Espionage and Rogue Skills are a plus, as are magic, psionics, and certain natural abilities, especially invisibility and shape-changing.

Pay: Varies with the level of danger and difficulty of the job. Simple jobs like domestic situations is 2D6x10 credits an hour. Moderately dangerous or complex jobs get 3D6x10 credits an hour. Dangerous surveillance work such as following a lawman, ranking official in the Black Market, a high-profile or very dangerous individual or monster is 2D4x100 credits per hour. **Note:** Employers may typically pay 25% up-front and part of the balance every week until the job is done or cancelled. ALL notes and surveillance data, photos, film, etc., are given to the client at the end of the job or as requested. Nothing is kept by the Surveillance Specialist. A day's work can be 8-24 hours, though the high-end of the pay scale is given for 24 hour surveillance. A bonus for outstanding service, evidence or valuable information is entirely at the employer's whim, and can range from one thousand to 10,000 credits.

Job: Slaver/Slave-Catcher

Description: The practice of forcing other intelligent beings into servitude resurfaced sometime during the Two Hundred Years Dark Age. It was stomped out in most civilized lands about the same time as the Coalition came to power. For the most part, slavery is practiced only by demons and monsters, including demon kingdoms such as Calgary, the Vampire Kingdoms and Atlantis, but there are small pockets where slavery is also practiced by humans and D-Bees. With some exceptions, the Five Black Market Factions do not engage in the purchase or selling of intelligent life forms.

Nevertheless, there are markets for slaves, with the Slave Markets of Atlantis being the biggest customer. Likewise, Horune Pirates who sell to Atlantis, and if you go far enough into the wilderness, or deep enough into the criminal underbellies of some cities, towns and nations, you can find small-time slavery rings. These groups are always looking for skilled hunters and trappers to round up defenseless people for sale. These slaves are usually sold to wealthy, private landowners, living far away from civilization, or monstrous and alien beings.

The same types willing to work as Slavers often accept work as Slave-Catchers. Slave-Catchers are similar to Bounty Hunters, only they specialize in tracking down and returning escaped slaves to their owners. Slave-Catchers may find employment within slave-owning societies.

The best Slavers and Slave-Catchers are characters with hunting and trap-setting skills; Bounty Hunters, Highwaymen, Cowboys, Wilderness Scouts, Psi-Stalkers and Professional Raiders amongst them. They also need to be able to handle large groups, usually in tandem with 2D4 other Slavers. Mind Bleeders, Mind Melters and Smugglers also make good slavers.

Minimum Attribute Requirements: As per the requirements of the related O.C.C.

Skill Requirements: To be a Slaver or Slave-Catcher, the villain needs to have Wilderness Survival, Hunting, Prowl, and Tracking (People). Other Espionage, Rogue and Wilderness skills are also handy, are psionic abilities and magic. Only the truly desperate, morally corrupt, or cruel engage in slavery.

Pay: Varies. 1D4x100 credits per head for most slaves; half for the sick and elderly. 2D4x100 credits for exotic and attractive

specimens, or strong workers and attractive children. 1D4x1,000 credits for the truly rare, exotic, and magical, such as Faeries and Zenith Moon Warpers. The same holds true for *collection contracts* per runaway slave. However, on occasion, that amount can be as high as 3D6x10,000 credits depending on how badly the buyer/slave owner wants his escaped prize.

Job: Transporter

Description: Transporters deal in moving large amounts of cargo from one place to the next. These shipments of cargo could be just about anything, but there is a whole lot of it. Most of the time, Transporters know what it is they are carrying, and whether they need to look out for authorities. While there are many shipping companies around, they can get expensive. Hiring a mercenary or group of adventurers to carry and deliver cargo can be much more equitable.

Just about any O.C.C. that travels can find work in transportation. All that is required is one or more vehicles capable of hauling the designated cargo. Smugglers, Mercenaries, Traveling Merchants, and traveling shows tend to be most attracted to such jobs, but heroes and others are always considered.

Minimum Attribute Requirements: None.

Skill Requirements: None other than an appropriate piloting skill. That having been said, skills such as Camouflage, Detect Ambush, Land Navigation, Roadwise, and some W.P. skills are a big help.

Pay: Varies with the amount and type of cargo, distance and danger of the route. 2D6x100 credits per truckload of legal goods. 1D6x1,000 credits per truckload of illegal goods and contraband. Double pay if delivery requires going through or into hostile territory (bandits, monsters, the CS, and so on).

Job: Weapon Tester

Description: There are many weapons manufacturers out there, and most of them are not willing to risk their highly-paid scientists and engineers by blowing them to smithereens during a faulty weapons test. For this reason, weapon makers look for people outside the company to do extensive testing. "Testing" is defined, in this case, by taking a *weapon prototype* or *experimental knock-off* into different combat scenarios. Any scientist can point the weapon at a wall or bottle and fire off a round. For thorough testing, however, the weapon must function well in a wide range of environments and under all sorts of unfavorable conditions. Technically, anyone can be a Weapon Tester, but most makers look to hire Men-at-Arms and adventurers out in the field facing enemy combatants or monsters. The best Weapon Testers should know a lot about weapons in order to give the research and design team a detailed report on the weapon's performance, problems and possible improvements.

Minimum Attribute Requirements: None, unless a heavy weapon, then usually a high P.S. (21 or greater) is likely to be required.

Skill Requirements: Modern Weapon Proficiencies that fit the weapon to be tested. Recognize Weapon Quality, Literacy, and T.V./Video may also be helpful.

Pay: 2D6x1,000 credits for at least three major battles or three months in the field with the weapon to be tested as the primary weapon of choice. A known and trusted Weapon Tester who provides detailed notes and video in the field is likely to command 25-50% higher pay.

Playing a Black Marketeer

By Kevin Siembieda

Some additional ideas and text
by Matthew Clements & Taylor White



Creating a new character in the Black Market is simple

He or she can be almost any O.C.C. or R.C.C. That means a Combat Cyborg, Operator or mage (and countless others) can be a Black Marketeer.

A Black Marketeer character starts as an established member of the criminal organization. As such, it is already built into the character's back story that he has made all the requisite contacts and gone through everything necessary to be accepted as a trusted, card-carrying member of the Black Market. Of course, in the eyes of the law and many heroes, he or she is *an outlaw*.

With the exception of a few heroic O.C.C.s, the Black Market recruits people from all walks of life and has a need for most O.C.C.s (Occupational Character Classes) in their organization. In addition to obvious criminal occupations such as Assassins, Bandits, Forgers, Smugglers, Thieves and others, the Black Market needs men-at-arms, Body Docs, City Rats, Cyber-Docs, Operators, Psychics, Rogue Scientists, Vagabonds, practitioners of magic, lookouts, runners, laborers and most other character classes.

For most people, becoming a Black Marketeer means turning to a *life of crime*. For others it means working under the radar of the law or against the established authorities. In the latter case, this may mean the Black Marketeer *considers* himself to be an anarchist or a simple opportunist. Others may see themselves as rebels, freedom fighters, patriots, or even heroes. Of course, "the law" (and perhaps other heroes!) may consider such "rogues" to be criminals, dissidents or terrorists. Speaking of "rogues and outlaws," the very nature of a person's race or occupation may brand him as a "criminal" in some places and a hero at others. **For example**, in territories under the thumb of the Coalition States, practitioners of magic, Rogue Scholars, Rogue Scientists, D-Bees and freethinkers are all branded as "Enemies of the State" and "criminals." For that matter, anyone caught with a *book* is likely to be charged as a subversive, criminal, smuggler or malcontent. As a result, a tiny percentage of people and groups within the Black Market may actually be "good guys," at least early in their Black Market careers. It is, however, quite difficult to hold onto one's high ideals and moral compass when you associate with criminals and engage in lawlessness.

It is important to note that there is a big difference between being a *Professional Black Marketeer* and a free agent or subcontractor who does odd jobs for the Black Market, or fences his loot through them, or buys Black Market equipment. Everyone outside of the Coalition States has purchased items from the Black Market. Without arms dealers like **Northern Gun** and underground organizations like the **Black Market**, many a fledgling town and kingdom would never have had a chance to rise from their humble beginnings or survive against raiders, monsters and hostile forces. The same is true of adventurers, mercenaries and heroes.

Creating a Black Marketeer Player Character

1. Pick an O.C.C.; almost any O.C.C. or R.C.C. can become a Black Marketeer. Select any O.C.C. (or R.C.C.) except heroic ones like *Cyber-Knight*, *Reid's Ranger*, *Vampire Hunter*, *Tundra Ranger*, and similar, and then join the Black Market Faction that seems most appropriate for your character. Congratulations, your

character is now a career criminal or carpetbagger-type opportunist in a criminal organization.

Note: D-Bees are welcomed. There are few human communities and groups where D-Bees are treated with respect and are able to earn a great amount of money. *The Black Market is one such place*. A D-Bee can reach the rank of Lieutenant, own one or more small Black Market enterprises, and hold a position of power in which he leads or commands humans as well as other D-Bee underlings. In Rifts North America, that is a rarity to be treasured, so many D-Bees are attracted to the Black Market and it is a big employer of D-Bees.

An estimated 40% of low- and mid-ranking Black Marketeers are D-Bees. *D'norr Devilmen, Elves, Fennodi (especially out west), Larmacs, Grackle Tooth, Quick Flex Aliens, N'mbyr Gorilla Men, Nuhr Dwarves, Tirrvol Sword Fists, Vanguard Brawlers, and Yeno* are all common faces in the underground organization. Big, nasty and aggressive D-Bees like the *Bruutasaur, Greot Hunter, Lanotaur Hunter, Lyvorrk, Malvoren, Mastadonoid, Vernulian, and Vintex Warrior* find easy positions as bodyguards, leg-breakers, enforcers, and hit men within the Black Market; shape-changers and psychics get work as spies and extortionists; and fast talkers like *Fingertooth Carpetbaggers, Kraks, and Phlebus* find easy employment as sales reps, merchants and con artists. That being said, 90% of the top positions are held by humans.

2. Alignment Check. Characters with a good alignment are not likely to join the Black Market. True heroes of *Principled* and *Scrupulous* alignments may have dealings with the Black Market and work with Black Marketeers as necessary, but NEVER become Black Marketeers themselves. Even *Unprincipled* characters have trouble reconciling the notion of becoming a Black Marketeer criminal. Cyber-Knights and other O.C.C.s and R.C.C.s that appeal predominantly to heroes and people of good alignment seldom join the Black Market, though a *Fallen Cyber-Knight* and other rogues and outcasts can become Black Marketeers.

While some people who join the Black Market may try to justify the good done by the organization to soothe their own conscience or justify their choice, the Black Market is a criminal enterprise and Black Marketeers are outlaws. The crime organization and its "operatives" ignore the laws, treaties and trade agreements of communities and nations, and sell illegal weapons, contraband, drugs and vice to anyone who wants them. Intimidation, extortion and racketeering are common "business tactics" and the Black Market is structured as a Mafia-like organization. While some good aligned characters can find a place as Black Marketeers, most good characters will NOT do so.

As a general rule of thumb, *selfish* and *evil aligned* characters are most attracted to positions within the Black Market. However, *some* self-styled revolutionaries, underground activists and political criminals, as well as Bounty Hunters, Mercenaries and enemies of the Coalition States, may find becoming a Black Marketeer to be a means to a well-intentioned end. However, while such characters may start out with a good alignment and noble intentions, their close association with the shady criminal elements of the Black Market is likely to lead them down an eventual path of crime. Players running such characters must be prepared to see the G.M. drop their characters' alignment to selfish or evil. Many Black Marketeers are simply *opportunists* of Anarchist and evil alignments who see working within the Black Market as a way to make a small fortune or rise to a position of power and respect in an already dangerous and difficult existence. Others see it as a way to exact revenge upon the likes of the Coalition States.

3. Pick one of the Five Factions. All Black Marketeers are allied to and affiliated with one of the Five Factions. Even if the character is a member of a small, independent Black Market group, he and that group will be at least loosely affiliated with one of the Five Factions. Without such an affiliation, Black Market Benefits and Special Abilities of the Black Marketeer are not possible. Pick one:

- Bandito Arms
- The Chicago Network
- The Immaterial Hand
- El Oculata
- Le Marche Noir

Which Faction a character is directly affiliated with is usually decided by a person's geographic location and base of operations; e.g. someone living in the Chi-Town 'Burbs is likely to join the *Chicago Network*. Sometimes an occupation or special ability (e.g. mage or psychic) has better prospects with a particular Faction that specializes in his particular area of ability such as magic, and has need for a person with his "special" skill set. Thus a mage operating in the Coalition States may elect to join *The Immaterial Hand* rather than the Chicago Network.

4. Black Market Benefits.

- Black Market Professional Courtesy and Connections.
- Black Market Line of Credit.
- Black Market Business Enterprises (one or more).

All Black Marketeer O.C.C.s automatically get the three Black Market Benefits, described below. The character's position and reputation within the crime organization provides him with influence and resources that the average adventurer and free enterprise business person does not have. All Black Marketeers are members of an *organized crime family*, and that membership has its benefits. Whether the character takes advantage of them or not is up to him.

5. Special Abilities of the Black Marketeer. The character keeps all the skills of his primary O.C.C. (Robot Pilot, Juicer, Operator, Ley Line Walker, or whatever), but also gets a few *Special Abilities of the Black Marketeer*. He is not just an ordinary Operator or Juicer, he is a "Black Marketeer Operator" or "Juicer," or whatever O.C.C. Regardless of the O.C.C., the Black Marketeer character gets at least a few *Special Abilities of the Black Marketeer*. Abilities, skill bonuses and resources developed as a direct result of his membership and connection in, and work for, the Black Market.

List of Special Abilities of the Black Marketeer:

- Antiquities Trader
- B&E Man
- Bulletproof
- Fence
- Friends in High Places (counts as two Special Abilities)
- Friends in Low Places
- Game Player
- Home Turf Advantage
- Influential
- Informant: Confidential (counts as two Special Abilities)
- Informant: Corrupt Lawman (counts as two Special Abilities)
- Informant: Street Snitch
- No Conscience
- Read Black Market Operations (counts as two Special Abilities)
- Read People (counts as two Special Abilities)
- Sincerity

- Slippery
- Steady Nerves
- Street Rep: Hardcase to be Feared
- Street Rep: Hero
- Street Rep: Trustworthy
- Suave and Debonair
- Wheelman
- Work the Law

The number of Black Market Special Abilities available:

- **Criminal O.C.C.s:** Unless stated otherwise under a specific O.C.C., all *criminal O.C.C.s* (Bandit, Cyber-Snatcher, Forger, Highway Man, Smuggler, Pirate, Professional Thief, and similar) who become a Black Marketeer get **four Special Abilities of the Black Marketeer** of choice.
- **Non-Criminal O.C.C.s:** Adventurers, Men-at-Arms, Practitioners of Magic, Psychics, Scholars and all other O.C.C.s who become a *Black Marketeer* start with **three Special Abilities of the Black Marketeer** of their choice. **Note:** O.C.C.s such as Assassin, Bounty Hunter, Gunslinger, Mercenary, Privateer, Slaver, Spy and similar may have disreputable reputations and may associate with criminals, but they are *not* criminal O.C.C.s. In fact, most of the ones listed above fall under the category of *Men-at-Arms*.

6. Getting additional Special Abilities of the Black Marketeer: All abilities are cumulative.

- +1 ability upon reaching the rank of Lieutenant.
- +2 abilities upon reaching the rank of Captain.
- +2 abilities upon reaching the rank of Boss.

More if O.C.C. Related skills are traded. As a *Black Marketeer* the *Special Abilities of the Black Marketeer* may be regarded as more important than *O.C.C. Related Skills*. When that is the case, the player can trade **two O.C.C. Related Skills** for **one Special Ability of the Black Marketeer**. If so desired, the character can trade as many O.C.C. Related Skills as he has available to acquire several additional **Special Abilities of the Black Marketeer**. This should be done when the Black Marketeer character is first created.

Furthermore, the character can refrain from taking a new *O.C.C. Related Skill(s)* when he advances in experience. Instead, every time he has accumulated *two* such skill choices, he can trade them in for *one* new *Special Ability of the Black Marketeer*. Any Special Ability acquired later starts at level one proficiency and increases with experience starting after the level of experience when the ability was acquired. **Note:** Most Special Abilities are not skills and do not increase with level advancement.

Secondary Skills can **not** be traded for Special Abilities of the Black Marketeer.

Note on Rank: A when a character attains a *rank* within a crew, such as Lieutenant or Captain, it is a layer of additional responsibility. The character can not run off adventuring with his buddies any time he feels like. He now helps to manage and run a specific Black Market crew. He has people under him to direct and control, and answers to one or more superiors (Boss and Top Boss, for example). This also means a ranking Black Marketeer is assigned tasks and jobs he is obligated to fulfill. If the men under him make a mess of things, he pays the price for it, so he needs to make sure it all goes well.

Optional: Existing characters becoming Black Marketeers

An existing character of any level can also become a Black Marketeer – provided your Game Master allows it – but it will not be as easy as starting a Black Marketeer character from scratch. It will require role-playing, time and commitment. Assuming the G.M. even allows it.

First, the character needs to find and connect with an active Black Market operation.

Second, the character must earn the Black Market's trust and approval. This requires a lot more than buying and trading goods with the Black Market or saving a Black Marketeer's life. It requires building an ongoing, long-term relationship and exhibiting loyalty and value to the Black Market, or at least its local operatives. This is likely to entail doing work for the Black Market, proving oneself capable and dependable, and exhibiting skills and loyalty that appeals to a Black Market boss. And the character who wants in will have to prove himself repeatedly, time and time again.

Third, the character needs a compelling and convincing reason why he wants to join a particular Black Marketeer crew.

Fourth, the character must find someone who is trusted and has some level of authority within the Black Market to "vouch" for him. Without a sponsor to vouch for his trustworthiness, no one is allowed to join the Black Market. And should that trust be a mistake, the one who vouched for him will pay for that mistake along with the new recruit.

Fifth, the character asking to join must be willing to make a *lifetime commitment* to the organization and be willing to take orders from his Black Market superiors, even if he doesn't agree with them or finds what they ask to be distasteful or horrible. This isn't a college fraternity or fan club. Joining the Black Market is like joining the military as a career. It has military structure, rules and protocols you are expected to follow, a hierarchy you are expected to obey, and you need to accept that you are a small cog that serves a much larger organization where you will answer to superiors/bosses.

A Black Marketeer can make plenty of money for himself, but ultimately, he has responsibilities to the Black Market organization, and its continued existence. He has to answer to his immediate superiors above him, take care of the crew he belongs to or leads, and accept his new life of crime.

Sixth, the character must work his way up the organization to gain freedom, power and respect. All new Black Marketeers must join an existing crew and take orders from the boss of that crew, until the Black Market superiors believe they have proven themselves trustworthy. A process that usually takes years!

Seventh, outsiders, who join the Black Market later in life, will always suffer the stigma of suspicion. No matter what they do, or how many times they prove themselves loyal, they will NEVER be trusted one hundred percent. That also means they will never have the full level of respect enjoyed by those who start their careers as Black Marketeers at level one, and will never earn a top position in the organization. Lieutenant or Counselor or Consiglierie, is the best they can ever expect to achieve. Captain (an upper-level "boss" who leads his own crew) and Boss (top command) are never a possibility. Furthermore, even after decades of loyal service, there will always be some question as to where their hearts and loyalties truly lie. These are people with a *past outside* the Black Market. As criminals know all too well, the past has a nasty way

of coming back to haunt you. Will the outsider turned Black Marketeer disobey when asked to betray, rob or kill an "old friend" from his life before joining Black Market? Will those old loyalties and emotions make him do something stupid, or worse, something that hurts the organization? Can his past be used to leverage him to betray the Black Market? The answer, more often than one might think, is *yes*. And that's something other Black Marketeers never forget and always have to worry about. It also means, when an outsider who is embraced and allowed to join, *betrays* the Black Market, the repercussions are always bloody and extreme. The Black Market feels ashamed and angry for letting an outsider fool them into taking him in. Thus, retribution is brutal for that individual and everyone around him.

Joining the Organization and Becoming a Black Marketeer

If the player character accomplishes all of the above, follow *Steps 1-4* under **Creating a Black Marketeer Player Character**, except the character's O.C.C. remains unchanged. Do not pick a new one; it is the same as it was and continues to improve with experience as a Black Marketeer.

#5 and #6 are different.

5. Special Abilities of the Black Marketeer: An experienced character who becomes a Black Marketeer later in life only selects *ONE* Special Ability. This is in addition to his pre-existing O.C.C. skill set.

6. Additional Special Abilities of the Black Marketeer. An experienced character who becomes a Black Marketeer late in life (such as a 5th level character), may choose to trade *half* of his *O.C.C. Related Skills* for additional Special Abilities of the Black Marketeer. When this happens, the old skills he traded away become so rusty from lack of practice that they can only be performed at *half their base level* and without benefit of any bonuses whatsoever. Subtract the O.C.C. bonus and improvements gained through experience and level advancement and cut the base skill level in half. The traded away skills revert to half their bottom level starting base and NEVER improve. Not even if the character quits the Black Market. Once traded away, skill proficiencies in those areas are gone.

The character's new focus is on his career in the Black Market and his new Special Abilities of the Black Marketeer. They take precedence over the skills he gave up. Of course, the Special Abilities of the Black Market start at first level proficiency and only advance from the character's level at the point in which he became a Black Marketeer. So a sixth level character who becomes a Black Marketeer gets Special Abilities that are level one proficiency and do not advance (if applicable) till 7th level. Furthermore, while the character gets these Special Abilities when he becomes a Black Marketeer, he does not get the bonuses many of these abilities provide until he reaches his next level of experience. (If 6th level, that would be at 7th.) Note that most Special Abilities do not advance with experience to begin with, but provide contacts and bonuses for other skills. **Note:** *Special Abilities of the Black Marketeer* develop as a direct result of one's membership, experience and connections in the Black Market.

The character can refrain from taking a new *O.C.C. Related Skill(s)* when he advances in experience. Instead, every time he has accumulated *two* such skill choices, he can trade them in for *one* new Special Ability of the Black Market. Any Special Ability acquired later starts at level one proficiency and increases with

experience starting after the level of experience when the ability was acquired.

Secondary Skills can not be traded for Special Abilities of the Black Marketeer.

As usual, the character keeps all the skills of his primary O.C.C. (Robot Pilot, Juicer, Operator, Ley Line Walker, whatever) except as noted above.

Quitting the Black Market

WARNING: Once you join Black Market, you *can* get out – but you cannot come back

When a character forsakes the Black Market, whether he retires or quits (the reason for quitting doesn't matter), it is *nearly impossible* for him to get back into the organization. Once you leave "the organization," you are NEVER trusted again. While a member of the Black Market is allowed to quit and leave the organization at any time, for any reason, he is not allowed to change his mind and rejoin.

Benefits Revoked. Upon quitting – usually referred to as "retiring" – all of the ex-Black Marketeer's Benefits are revoked, and other Black Marketeers treat him the same as any *customer*, not as an insider or friend. He loses ALL his contacts within the organization and the bank is closed to him; no loans or lines of credit. Go live your new life.

No criminal enterprises. The character must also give up ALL his illegal Black Market business enterprises, but is allowed to keep one or two of his *legitimate business enterprises*, provided he had any.

Diminished Special Abilities. Bonuses from Special Abilities of the Black Marketeer are reduced by half.

When you quit the Black Market, they quit you. Your Black Market "friends," associates and contacts are gone. Period. The ex-Marketeer needs to start a new life without the Black Market and his old criminal pals in it. The ex-Black Marketeer may have a few "favors" he can call in, but that's it, and such favors should be held onto until absolutely necessary.

A shroud of suspicion will forever hang over those who choose to quit the organization. And it is astonishing how quickly word and rumors spread about those who quit, so every Black Marketeer seems to know about it in a matter of days. Since the Black Market Boss seldom pries into the reason for "retiring," one of the following is *assumed*: **1.** That the individual "lost his nerve and couldn't take it anymore." **2.** "Found God," a euphemism referring to any Marketeer who decides to quit his criminal ways and turn over a new leaf. **3.** Was quietly "forced out" by his superiors for a serious wrongdoing or costly mistake. **4.** Turned "snitch" and has become a spy and informant for the authorities or other enemy of the Black Market. Don't trust him.

On the rare occasion that a "retired" Black Marketeer manages to get accepted back into the fold, he is not likely to ever be completely trusted. Not ever. Worse, many Marketeers, especially the young up-and-comers, will treat him like a second-class member of the organization who is weak and not worthy of their respect.

Black Market Benefits

Joining the Black Market has its benefits. You are part of a massive, criminal organization and enjoy special perks and benefits of being a Black Marketeer regardless of your occupation (O.C.C.) or position within the organization. All Black Marketeers enjoy the following *benefits* thanks to their membership in the Black Market.

- Black Market Professional Courtesy and Connections
- Black Market Line of Credit
- Black Market Business Enterprises (one or more).

Professional Courtesy & Connections

Black Marketeers tend to see each other as brothers and sisters in the same, big, underground organization. As a **courtesy**, even members of rival factions are, as a general practice, regarded as comrades-in-arms rather than enemies, and treated with respect and courtesy. Sure, competition and rivalries can get heated at times, but the Five Factions have each carved out their place in the market and, for the most part, support each other. This means a fellow Black Marketeer will generally take the word of his brother over that of an outsider or "mark" (customer), and certainly over that of the authorities.

This trust and camaraderie demands a degree of loyalty and trust in return. As a result, Black Marketeers make it a rule to be honest, fair and sincere with each other, to the point of admitting accidents, wrongdoings and mistakes. It is better to admit to, and pay the price for, a stupid mistake or misstep than lie to a fellow Black Marketeer within the same Faction, and NEVER to a Boss.

Another benefit of being a member of an organized crime syndicate is **connections**. A fellow member of the Black Market always gets a small discount on anything purchased from the Black Market. A better deal *may* be possible if the character is a regular customer, a Boss, a big spender or friend. This includes discounts at Body-Chop-Shops and other professional services. The Black Market is a *network* of criminal operations and services, and fellow Black Marketeers are insiders who are part of that network. As such, they are expected to bring the Black Market opportunities and profit, and the organization reciprocates by providing work, services and information in return.

A Black Marketeer can also count on truthful (though possibly incomplete or withheld) information, provided it doesn't require giving up trade secrets that could hurt a brother's business. Fellow Black Marketeers are happy to share rumors and word on the street, offer warnings of trouble from the law and outsiders (but not necessarily from within the Black Market itself), and offer up the location of Black Market Body-Chop-Shops, dealers, fences and other Black Market facilities and services. They *may* even be willing to make an introduction to a Lieutenant or Captain of a local crime crew.

Bonuses: +10% to the skill Find Contraband when it is through the Black Market. Most Black Market Fences pay 5% more to fellow Marketeers than they do to outsiders, and most sell goods and services to fellow Black Marketeers at a 10% discount.

Black Market Loans & Credit Lines

A Black Marketeer has one advantage over most other player characters. If he needs a quick influx of money for a deal, he can usually get it with no problem through the Black Market. Loans and lines of credit are made by going to an NPC Black Market

Banker, Captain or Boss at a local Black Market facility that *knows him* personally or by reputation (even if he's just starting out). Otherwise, he'll need a known and trusted Black Market "associate" (again, probably an NPC/Non-Player Character) willing to vouch for him to a higher up, or willing to lend him the money himself.

The money lent doesn't just magically appear, the character must have access to his account at a Black Market bank and he'll be given a Black Market debit card with the available funds. Once approved, a Black Market bank can have the funds ready within 30 minutes.

Available Funds for a Black Market Loan or Credit:

How much a Black Marketeer can borrow depends on the character's experience, reputation and clout within the organization, as well as on his personal assets: house, criminal enterprises, drug stash, etc.

25,000 credits per level of experience; double if he has plenty of known personal assets worth at least 10 times the amount he wants to borrow.

+50,000 additional credits per level of experience for a character with a sterling reputation in the Black Market for reliability, making money or having repaid past loans and vig without incident. Must be at least second level and a rising star.

+200,000 additional credits per level of experience if a high ranking NPC (Non-Player Character), such as a Black Market Captain, Boss, Family or Faction, endorses the character for whom the line of credit is being secured. This is likely to require some role-playing to attain.

All these amounts are cumulative, provided the character meets the requirements.

Note: A line of credit works just like a loan. The full amount requested is made available in the character's account, and interest begins to accrue immediately on the *entire amount*, whether the character has spent it or it sits in his Black Market bank account.

Collateral: In all cases, it is understood by the borrower that everything he owns is automatically put up as *collateral* for the loan. Failure to pay the loan and the vig in full, when due, means seizure of the necessary assets owned by the borrower to cover the loan, or worse.

Alternative Black Market Loans: In all cases, loans and lines of credit made via the Black Market are expected to be repaid within 90-180 days, with interest compounded weekly. There are only two exceptions:

1. Money lent to a character by a friend who agrees to much more reasonable terms and time to pay, but such terms are dictated by the lender, and while more fair, they may remain odious, especially if that friend is a fellow Black Marketeer.

2. When a Black Marketeer player character calls in a "favor" to get a loan, it is usually he who dictates the terms. If the favor is coming from a friend, business or anyone with whom the Black Marketeer wishes to maintain a good business relationship, the terms will be fair for both parties. (Something like 10% interest compounded monthly and payment in full expected at the end of one or two years.) If the "favor" is being demanded from someone the character has no need or desire to maintain a good relationship with, the borrower can make any demand he wants (1% interest compounded annually and due in 20 years). However, unfair favors are likely to create a new enemy, so even then it is wise to make a fair deal. (Something like 5% interest compounded monthly or annually, and payment in full expected at the end of 2-5 years.)

Note: Borrowing money via the Black Market and calling in favors are effective when handled with tact and diplomacy, and for enterprises that have a very high likelihood of a quick return and handsome profit. They are not long-term and are costly even in the short term. A Black Marketeer getting a loan through the Black Market organization had better know what he is doing or he could find himself in a world of hurt.

This is why most Black Marketeers would rather get money the good old-fashioned ways: robbery and extortion. Both can be dangerous during the initial acquisition of funds, but once acquired, there is no vig nor requirement to repay the money. Of course, Black Marketeers with business savvy can also earn a nice, steady income and save piles of credits via criminal and legitimate Black Market enterprises. However, owning and overseeing a business is not for everyone, and business has its own perils.

The "Vig" – Interest Rate:

The "vig" on personal loans is an interest rate of 20% compounded weekly. No questions asked.

Payment in full, plus interest, is expected no later than 90 days later. Some lenders may demand a weekly payment with interest, while others are willing to wait for the entire amount, plus interest, at the end of the 90 days. In the latter case, interest accrues the entire time and weekly interest is applied to the original loan amount plus the increasing interest that grows weekly. The longer it takes to repay the loan, the more money is owed when it is repaid. A 90 day extension of the loan *may* be negotiated at a retroactive 30% interest rate that starts from the initial date of the loan.

A loan for a one-time opportunity, such as a heist, purchase for resale, etc., requires a 30 day repayment of the loan and no extension is likely. In this case, the lender gets a 25% cut from the transaction off the top instead of the usual 20% vig. So if the "opportunity" yields a return greater than what a personal loan would have been, the lender gets that greater amount; 25% of the take. If the opportunity fails to yield a profit, the lender expects to get his loan repaid in full, without any additional vig. It is a risk he took for a bigger slice of the pie, and he's okay with that. Black Marketeers are risk takers. However, that's only if the deal really is a dud. If the lender finds out that the borrower is holding out on him and made back his own investment or a secret profit, the lender is likely to extract payment by "messing up" the borrower – a brutal beating and breaking both legs or severing a limb (a couple fingers, hand or foot) and/or seizure of assets up to double the loan amount. All of which is allowed by the Black Market for such an infraction.

If the loan is for a business enterprise, the "vig" is 25% compounded weekly, with repayment of the loan in full plus interest due in 180 days. In the alternative, no vig and no repayment is required *if* the lender gets a permanent 10% "buy in" to the business. However, the lender is a permanent partner and gets weekly or monthly payments from the profit of the business. The more the lender makes, the happier he is and things go well. If there is no profit after three years from the date of his initial investment, or if the profit is less than the money lent plus vig, the full amount of the loan plus the usual vig, compounded weekly over that three year period, is expected to be paid, *or else*. Any profit sharing paid to the lender during that time period is not applicable to the return of the loan plus vig, even if it was almost the full amount.

If the borrower does not have the money, but the lender believes the business has genuine profit making potential "under new management" – his own – the lender has the right to seize the business

and all assets in that business, but the borrower is released from his debt whether the business goes on to make money or fails.

If the business is worthless and the borrower cannot repay the loan plus vig, the Black Market lender can seize the borrower's assets until the loan and the vig are paid in full. If that is not enough, the lender may insist the borrower perform one or more services sufficient to cover his debt. In the alternative, the lender has the right to extract penalties that can include forfeiture of the borrower's life and/or the lives of the borrower's family, business partners and teammates. Of course, a benevolent lender will not take such extreme measures as a "favor" or reward for some other service or benefit rendered to him by the borrower. If a favor, it means the borrower owes the lender a BIG debt and can expect that favor to reflect that whenever it may be called in.

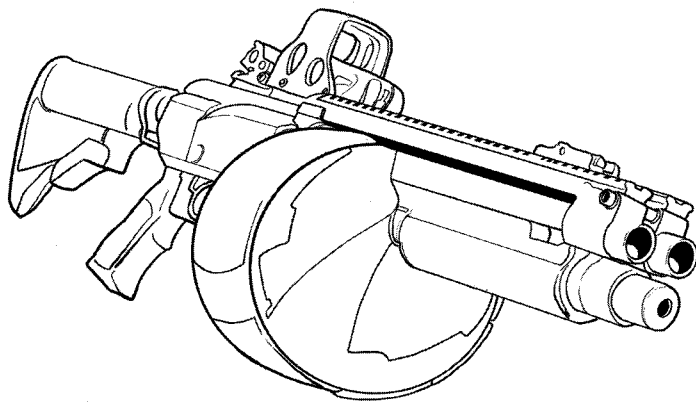

Black Market Enterprises

Unless noted otherwise under a specific Black Market O.C.C., a Black Marketeer character can start with *one* criminal enterprise of choice, from the list below. This represents his personal business within the Black Market.

Each of these enterprises has both an **operating cost** and an **average profit every week**. These figures are fluid, changing constantly depending on the circumstances. If the character conducts business well – through successful skill rolls and role-playing – the profit should always outpace the cost. The character must remember to keep tabs on his enterprises, however, because things can change every week. If the costs grow higher than the profits, the character needs to make some changes, such as firing people, beefing up security, scaling back activity, hiring a new manager, liquidating rivals, moving to a new location or liquidating the entire enterprise.

As the Black Market character gains experience levels, he can *choose* to do nothing, *invest more* into this initial enterprise and expand that operation, or *diversify* his criminal portfolio by gaining *new holdings*. If the character chooses to **invest more** into an enterprise, it doubles both the profit and the operating cost. If, at a later level, he invests again, the profit and cost are triple the initial amount, and so on. The opportunity to expand or add a new enterprise happens at levels 3, 5, 7, 9, 11 and 13. **New holdings** can be gained through forcibly taking them from others, winning them in gambling, buying them (from an NPC or player character), or starting them from the ground up. Such a business enterprise may be illegal or legitimate.

As noted elsewhere, not everyone is cut out to own and operate a business, so the player character (and NPCs) is not required to start one. If a player elects not to start a Black Market Enterprise,

he can hold that right in reserve and start one up (as per level of experience) at a later point in time; or never.

Common Criminal Enterprises of Black Marketeers

The following are the types of businesses Black Marketeers tend to gravitate toward. Pick one of the following, provided the character has the money to cover at least one month's expenses to get started and the funds to cover any possible loss every week. Starting a business is a Benefit and a potential means of making money, but a Marketeer player character does not have to run a business enterprise.

Business Note: In most cases, the main disadvantage of these enterprises, especially illegal ones, is the Black Marketeer may be a target of robbers, rivals and the authorities. Some portion of the goods or services are, as a rule, stolen or contraband, and most, if not all, are probably procured from the Black Market. Measures must be taken to protect the character's place of business, inventory and employees, and restock to replace items sold.

The amount listed under **Operating Cost** and **Average Sales** is always on a per week basis.

1. Arms Dealer: Weapon Sales. The Black Marketeer buys and sells weapons, weapon accessories, ammunition and possibly related items. This "business" may be conducted from the back of a truck, a hidden location, traveling *show* (not just a traveling merchant) or a legitimate looking storefront, probably at a frontier town, Market Town or a 'Burb. This does not include the cost of continuing to acquire and purchase stolen or wholesale wares for resale, their manufacture, repair, or the sanitizing of weapons (filing off serial numbers and repainting stolen items, etc.). The advantage here is that weapons are usually in ready supply and are always in demand. Adventurers and mercs are always turning to Black Marketeers to sell and purchase weapons and ammo. **Operating Cost:** 50,000 credits per week. **Average Sales:** 3D6x10,000 credits per week.

2. Arms Dealer: Armor and Vehicles. Same as above, only the Black Marketeer deals in M.D.C. body armor, power armor, vehicles and possibly robots. The costs and risk of dealing in such high profile items are much higher, but the monetary rewards are better. **Operating Cost:** 1 million credits per week. **Average Sales:** 1D6 million credits per week.

3. Contraband Books/Movies/Media Dealer. The illegal media market is a reliable one, and downright "hot" in the Coalition States and other communities where such items are outlawed and banned. Books, digital files, video discs, writing tools, and such sell outside the CS, but at a fraction (30%) of the CS market, and almost never with the kind of profit margin necessary to build the market. The numbers listed here are for operating only where *the media market (or items offered) is outlawed*. Otherwise, it becomes a legitimate business. Digital files are among the hottest selling format, but physical books, especially pre-Rifts books, magazines and disks, are even hotter to customers who see them as "collectible, pre-Rifts relics and artifacts" or that a purchase is an act of defiance in the face of the authorities. Some Black Marketeers enjoy the bonus of sticking it to the Coalition. **Operating Cost:** 20,000 credits. **Average Sales:** 1D6x10,000 credits.

4. Contraband Magic Dealer. The sale of contraband magic – Techno-Wizard devices, potions, scrolls and other types of magic items – is a hot market in Coalition held territories, especially the 'Burb and other communities where magic is outlawed

and banded. Some Black Marketeers enjoy the bonus of sticking it to the Coalition. The numbers listed here are for operating only where *magic is illegal*. Otherwise, it becomes a legitimate business. Magic items, potions, scrolls, TW devices and magical services (healing, empowerment, etc.) always seem to be in high demand, especially at CS 'Burbs and locations rife with civil unrest and war. The disadvantage is that dealing in magic is likely to require the employment of a reliable practitioner of magic to make or purchase new inventory, and run the shop. Magic shops are a high profile operation, making them a target of robbers, rival mages, the authorities, and possibly, members of the Federation of Magic. Likewise, unless the Black Marketeer is an experienced mage himself, he'll need one to accurately identify and purchase magic items for inventory. Extra precautions, including defenses against sorcerers and creatures of magic, may be in order to protect the sales location, inventory and employees. **Operating Cost:** 2D6x100,000 credits. **Average Sales:** 4D6x100,000 credits.

5. Drugs. Bigger than your average street dealer, the character manufactures, refines, sells and distributes illegal narcotics and performance-enhancing drugs. The major costs here involve hiring people to do the actual work and procuring raw materials for making the drug(s) or acquiring the finished, processed drug (probably stolen). The Black Marketeer needs chemists, package-handlers, dealers and street pushers. He will also need a discreet or hidden workshop and security. **Operating Cost:** 50,000 credits. **Average Sales:** 3D6x10,000 credits.

6. Fence Operation. The Black Marketeer is in the business of purchasing stolen goods for pennies on the dollar and reselling them to pawnshops, wholesalers and merchants for a profit (typically 2-3 times what he paid for it). May or may not have his own retail outlet; many do not. **Operating Cost:** 1D6x10,000 credits. **Average Sales:** 4D4x10,000 credits per week. Plus an additional 4D6x1,000 credits from a "big sale" once a month.

Common items: Adventuring gear, binoculars, cameras, computers, and electronics to common tools, vehicles and alleged pre-Rifts artifacts and unknown alien/D-Bee items are purchased for 10% of the common market value and resold for 30% wholesale. **Note:** Clothing, toys, household goods and food seldom have any market value, except under unusual circumstances such as famine and war, and are not generally purchased.

Gems, Jewelry and Collectible Art: Are purchased for 15% of the common market value and resold to wholesalers and merchants for 30-50% wholesale. Obviously very valuable and rare jewels may be purchased for as much as 30% of their value and resold for 60-120%.

Magic Items: Purchased for 25% of the common market value and resold to wholesalers and merchants for 50% wholesale. Obviously valuable and rare magic items may be purchased for 40% of their market value and resold for 80-300% of their value.

Medicine, Illegal Drugs and Other Contraband: Are purchased for 20-30% of the common market value and resold to wholesalers and merchants for 50-90% wholesale. High demand and rare drugs (for whatever reason) may be purchased at 40-60% of their market value and resold for 150-400% of their normal market value.

Used Weapons, Body Armor and Power Armor: Are purchased for 10-15% of the common market value and resold for 30-40% wholesale. Coalition weapons and Dead Boy armor are purchased for 15-20% of their market value and resold at 40-90% of their value. Heavy and rare CS weapons, armor and gear are purchased for 25-30% of their market value and resold for 60-200% of their market value.

Giant CS robots and armored vehicles: Such items are often too hot to handle for most Black Market Fences and are usually turned away or directed to larger Black Market Merchant establishments. One is lucky to get 5% from a sale.

New Weapons, Body Armor and Power Armor: Same as above plus and extra 5-10%, but is sold for 5-10% more.

7. Forgery: Artwork and Artifacts. The Black Marketeer owns a small counterfeit operation that makes fake collectibles, including pre-Rifts artifacts, jewelry, books and artwork. Forgers who specialize in making fake artifacts and relics are good at making new items and materials appear aged and authentic. These Forgers are also likely to be able to create false identity cards, travel papers, permits, bills of sale, and similar documents, but are not as good at it as the ones who specialize in such articles (see #8, below). Fake I.D.s and documents made by these Forgers will easily pass without scrutiny, but often be revealed as fakes (15% chance) upon close and careful inspection, but remain hard to trace to the source that made them (3%). However, fake artwork and artifacts look like the genuine article (only a 10% chance of detection by a trained eye, 2% by someone untrained). Makers and sellers of forged artifacts and art may claim innocence when caught trying to pawn off a fake, and are likely to refund the customer's money (if he has the funds available) or offer to exchange it for a different, better fake, he claims is the real deal. Of course, word of sloppy forgeries that get people angry spreads like wildfire and gets the business shut down and the seller/forgery branded as unreliable or a crook. **Operating Cost:** 20,000 credits (with most of that going to pay the forger and the rest for materials). **Average Sales:** 1D8x10,000 credits.

8. Forgery: Counterfeit Documents. The character owns a small counterfeit operation. Most Forgers specialize in creating official documents such as false identity cards/I.D.s, travel papers, permits, bills of sale, and similar. As usual, Coalition States I.D.s, travel documents and other "papers" (actually they are often readable I.D. cards with digital data) are hot sellers in the Coalition States and CS controlled territories. The major advantage here is that especially skilled Forgers create documents that are nearly impossible to detect (only a 2% chance) and even harder to trace to the source who made them (1%). Furthermore, forged documents and I.D.s are sold to clients who know full well that they are taking a risk and that the forgery *may not* pass close scrutiny. As such, there is little danger of the Black Marketeer providing the forgeries of being caught, and there are no refunds. Of course, word of sloppy forgeries that get people in trouble with the authorities or killed, spreads like wildfire and gets the business shut down and the provider/forgery killed by friends of those who fall victim to his shoddy handiwork. This keeps all sides square and the Black Marketeer providing the best forgeries possible. **Operating Cost:** 130,000 credits (with most of that going to pay the forger and the rest for materials). **Average Sales:** 1D6x100,000 credits.

9. Forgery: Sanitization of Stolen Goods. The Black Marketeer owns a small counterfeit operation that specializes in "sanitizing" stolen goods/weapons/vehicles. "Sanitizing" means removing or replacing serial numbers and manufacturer I.D.s, other identifying marks, and repainting or customizing the item to change its appearance. A fake bill of sale and/or ownership history may also be provided. When the sanitization is finished, there is no remaining evidence of it being a stolen item or of its previous owner or manufacturing lineage. Skilled "sanitizers" refurbish stolen items and create convincing bills of sale that are nearly impossible to *prove* stolen, fake or traceable to a previous owner (only a 1%

chance). It is even harder to trace back to the source of the forgery (1%). Sanitized items are expected to pass even intense inspection. There may be evidence of tampering, but nothing left to implicate the current owner in any illegal activity or indication of previous ownership. As such, there is little danger of the Black Marketeer providing the service or goods being caught selling stolen items. Besides, anyone buying goods from a known Black Market business should know to not ask questions and to assume they are getting a deal because the item is stolen or illegal. There are no refunds. Of course, word of sloppy work that gets people in trouble with the authorities, jailed or killed, spreads like wildfire and gets the business shut down and the provider/forgery killed by friends of those who fall victim to his shoddy work. This keeps all sides square and the Black Marketeer providing the best forgeries possible. **Operating Cost:** 225,000 credits (with half of that going to pay the forgers and sanitizers and the rest to the purchase of stolen goods for sanitizing and resale). **Average Sales:** 2D4x100,000 credits.

10. Gambling Establishment or Betting Parlor. The Black Marketeer owns and operates his own gambling den, betting parlor, small back alley casino or engages in numbers running. Although gambling is legal in most places, it is also tightly regulated and taxed by whatever government the business is located in. A Black Market gambling establishment is an illegal, underground operation where the house offers a much wider range of betting and games, and takes all profits. Such illegal gambling places will, as a rule, offer and take bets on anything, from the winners of races and gladiatorial games to political elections and the outcome of a war, and everything in between. Many also offer unconventional games such as animal fights, gladiator battles, and “lady or the tiger” games. Black Market gambling establishments are likely to sell plenty of alcohol, drugs, and illegal services (prostitution, etc.) as well as provide free entertainment attractions such as live music and dancers to keep patrons happy and distracted from all the money they are losing. In the alternative, there may be illegal “backdoor” Black Market gambling behind the scenes at legitimate places of business such as drinking establishments, nightclubs, dance halls, bingo parlors, restaurants, and even storefronts. **Operating Cost:** 60,000 credits. **Average Sales:** 3D8x10,000 credits.

11. Lascivious Enterprise. The Black Marketeer runs a strip club, escort service, brothel or similar enterprise involving the sex trade. The cost of doing business is likely to include renting or purchasing a location for the girls (or guys) to conduct business, clothing, paying bribes to local government and law enforcement officials, protection and management. **Operating Cost:** Small Time Operation: 2D6x1,000 credits. Medium-Size Operation: 4D6x1,000 credits. High-Class or Expansive Operation: 4D6x1,000 credits. **Average Sales:** Small Time Operation: 4D6x1,000 credits. Medium-Size Operation: 1D6x10,000 credits. High-Class or Expansive Operation: 3D6x10,000 credits.

12. Mercenary Services Broker. Though the Black Marketeer is not a mercenary himself, his own business specializes in finding and selling information and finding work for military personnel, hired guns, and muscle. A broker, he sniffs out data about jobs, war, bounties and conflicts where combat personnel are wanted. A Black Market enterprise that offers “mercenary services” then brokers freelance jobs for adventurers and mercenary companies. Such work can range from bodyguards and armed escorts to work as a sheriff, bounty hunting, and military service in a full-scale war. The Black Marketeer, in effect, acts as the warriors’ “agent,” negotiating deals with prospective clients in exchange for combat

personnel and their services. He handles the exchange of money, makes sure each participating member of the mercenary company or adventuring group is paid according to the contract, and takes a percentage (typically 10-20%) as his cut. He also vets the client, meaning he makes sure the client is capable of paying, and may try to have a portion of the pay made up-front or put in an escrow account. The Black Marketeer does not “lead” the mercenary company in to the field, he only arranges the work and pay. If the client fails to pay on the mercenary contract, the Black Marketeer steps into try to leverage payment using the strength of his connections in the Black Market, intimidation and threats. **Operating Cost:** 50,000 credits (mostly procuring accurate information). **Average Profit:** 3D4x10,000 credits.

13. Protection Racket. The character sells “protection” to other businesses, entrepreneurs and even other Black Market enterprises. Protection may also extend to fugitives, outlaws and others who need protection from their enemies, rivals or the law. This could translate to actual protection, such as bodyguard services, but also includes intimidating other businesses into giving the Black Marketeer a cut of their revenue to insure their safe operations. Those who refuse to pay up usually run into a string of bad luck and accidents, suffer vandalism and arson, and/or have their employees go missing or materials stolen or damaged. “Protection” by the Black Marketeer makes sure these “problems” come to an end. Profits can be high, but the Black Marketeer gains little respect for this kind of operation. In fact, he usually just ends up making a lot of enemies. **Operating Cost:** 2D6x1,000 credits (spent mostly on hired thugs and his own protection). **Average Profit:** 4D6x1,000 credits.

14. Raiding/Hijacking/Banditry/Piracy. The Black Marketeer handles the appraisal and fencing (reselling) of stolen goods taken by raiders, bandits, highway-men and pirates. While similar to #6 *Fence Operation*, this character goes a step farther by suggesting targets to hit and procuring schedules, routes and locations of cargo ships, trucks, convoys and storage facilities for his thieving clients. He may even help devise plans and strategies for an attack and pay-off inside men to leave a door unlocked, call when a delivery arrives, and so on, at no extra charge. He gets his cut from the profit made fencing the stolen goods. That being said, he typically offers the lowest purchase price for stolen goods (see #6 above for prices paid). This can be a highly profitable enterprise, as long as the Black Marketeer can keep the thieves from implicating his involvement. Furthermore, there is the risk of an unhappy client. Raiders and pirates, in particular, tend to be the worst of cutthroats, and have a reputation for leaving their former business partners a bloody corpse or pile of ashes. It is always best to deal honestly with them and as fairly as possible. This operation of bold raids, bribing insiders and more high-profile robberies is likely to get lawmen and private detectives (player characters?) searching hard for the fence or mastermind of these attacks. And when they are on the Black Marketeer’s trail, he may very well have to close up shop, move and start again in another town elsewhere. Big profits and bold moves mean big risks. **Operating Cost:** 1D6x10,000 credits. **Average Sales:** 3D6x10,000 credits.

15. Smuggling People. The Black Marketeer has a small-time smuggling operation going on, usually involving some City Rats, trade caravans, bandits, adventurers, Smugglers and possibly some Slavers. The character leaves most of the actual smuggling work to his hired experts, but is likely to be very hands-on managing the business, picking clients and jobs, and working behind the scenes to make sure everyone gets paid and things run smoothly. In this

case, the smuggling operation involves getting people in and/or out of specific places. This can include getting D-Bees and mages in and out of places they don't belong (like CS territory), getting assassins, spies, outlaws and fugitives out of "hot zones" where they are being hunted by the authorities, or into places where they can do their business, and similar. This service is likely to include safe houses and contacts for getting necessary supplies and medical care (one safe house per level of experience). As with the #14 *Raiding* enterprise, this is a high risk business, and when the authorities are on the Black Marketeer's trail, he may very well have to close up shop, move and start again in another town. Big profits and bold moves mean big risks. **Operating Cost:** 60,000 credits. **Average Profit:** 3D6x10,000 credits, but high-risk. **Note:** Smaller operations are possible for about one third the weekly cost and profits listed here.

16. Traveling Merchant. Think trading post on wheels or horse and wagon. The items sold are probably a mix of common necessities, adventurer supplies, a small selection of weapons, booze, and a bit of contraband. Or he may specialize in one area, selling a large selection of alcohol or weapons, or whatever, and little else. The Black Marketeer buys and sells these items as a traveling merchant, riding from town to town, 'Burb to 'Burb, hawking his wares. Operating costs do not include the continuing acquisition of (stolen or wholesale purchased) goods, their manufacture, repair, or the sanitizing of weapons (filing off serial numbers and repainting stolen items, etc.). The real danger is being robbed oneself. **Operating Cost:** 2D6x1,000 credits per week; 1D6x1,000 for a one- or two-man operation. **Average Sales:** 5D6x1,000 credits per week; 2D8x1,000 for a one-or two-man operation.

17. Legitimate Business. Probably something in retail or entertainment. Bars/taverns, dance halls, nightclubs, pawnshops, tattoo parlors, theaters, restaurants, barbershops and storefronts tend to appeal to Black Marketeers. The operating costs vary greatly depending on the business. **Note:** G.M.s, use your discretion. FYI: A successful business should be making twice what it spends on operating expenses. A very successful business should be making 3-4 times its operating expenses.

G.M. Note: Feel free to allow any commercial enterprise that makes sense and with which you, as G.M., feel comfortable. Just because a Black Marketeer player wants to start a particular enterprise, doesn't mean you have to let it happen. There are a lot of reasons (insufficient funds or customers, lack of supplies or supply routes, pressure and violence by rivals, enemies and/or the law, too much competition, bad location, etc.) to not allow any given enterprise. Ultimately, it is your choice, and the player(s) doesn't have to agree with your decision or reasons.

Body-Chop-Shop Note: This business is usually out of the range of most startup enterprises. **Operating Cost:** 2D6 million credits per week. **Average Profit:** 4D6 million credits per week, but high-risk and expensive to start. **Note:** Smaller operations are possible, for about one third the weekly cost and profits listed here, if half or more of the bionics are procured from Cyber-Snatchers. However, this is the sleaziest and most disreputable of Body-Chop-Shops.

Special Abilities of the Black Marketeer

All "official" members of the Black Market get to select at least one or two Special Abilities that provide additional resources, connections, extra bonuses and sometimes, skills developed while building a career as a Black Marketeer. Most are, of course, based in criminality and may only apply to crime and/or the Black Market.

As noted under **Creating a Black Marketeer Player Character**, *Criminal O.C.C.s* (unless stated otherwise under a specific O.C.C.) turned Black Marketeer start with *three* Special Abilities of choice.

Non-Criminal O.C.C.s turned Black Marketeer start with *two*.

Additional Special Abilities of the Black Marketeer may be acquired by trading O.C.C. Related Skills; see #6 under **Creating a Black Marketeer Player Character** earlier in this section.

Note: In all cases, the bonuses for the skills listed only apply to skills the character actually possesses in the first place. If he doesn't have one or more of the skills listed, the bonus has no meaning. Skills gained from a Special Ability can not be traded away.

Special Abilities of Black Marketeers

Alphabetical List

Antiquities Trader
 B&E Man
 Bulletproof
 Fence
 Friends in High Places (counts as two Special Abilities)
 Friends in Low Places
 Game Player
 Home Turf Advantage
 Influential
 Informant: Confidential (counts as two Special Abilities)
 Informant: Corrupt Lawman (counts as two Special Abilities)
 Informant: Street Snitch
 No Conscience
 Read Black Market Operations (counts as two Special Abilities)
 Read People (counts as two Special Abilities)
 Sincerity
 Slippery
 Steady Nerves
 Street Rep: Hardcase to be Feared
 Street Rep: Hero
 Street Rep: Trustworthy
 Suave and Debonair
 Wheelman
 Work the Law

Descriptions

Antiquities Trader. The allure of pre-Rifts artifacts seems to have no end to it. Such artifacts are junk and scraps to some people – the leftovers of a long-gone civilization dug up in a farmer's field. But to many others, pre-Rifts artifacts are valuable pieces of history and collectibles marking humanity's lost past. To such

individuals, including this Black Marketeer, ancient artifacts represent humanity's history and its golden age, and are just cool and fun to have. As a result, there is *always* a market for them, especially among the educated, freethinkers, historians and mages. Antiquities Traders can supplement their income or even make a nice living tracking down, acquiring, restoring and selling *pre-Rifts artifacts* (i.e. "old junk"). Every once in a while, they come upon a true rare find or a significant piece of lost technology, but most of the time, the Antiquities Trader is up to his elbows in old newspapers, books, video disks, broken appliances, bottles, tarnished jewelry, old toys, and other assorted relics from the past. Antiquities Traders recognize the monetary value in what they dig up and possess a fair knowledge of Earth history even if it's only based on the writings of Erin Tarn. Many tell sweeping, epic stories and make big, dramatic speeches to help sell their goods; some are true and accurate, others pure fiction to make the sale. Even though he may have nothing but a box of soda bottles or aluminum cans, a character with this ability knows how to work the angles to make the items appeal to potential buyers.

Bonuses: Automatically gets the skill History: Pre-Rifts (+20%). A character with this ability knows the difference between genuine artifacts and counterfeit items. He can look at all the details and see the little intricacies that make the difference between an authentic item and a cheap knock-off or fake, and gets a +5% bonus at levels 2, 4, 8, and 12 to skill rolls identifying, appraising, buying, or selling Pre-Rifts artifacts, including art, jewels, weapons and high technology. And +5% bonus to the skills Appraise Goods, Barter and Forgery (making or identifying fake artifacts), when they apply to ancient Earth/pre-Rifts artifacts only.

B&E Man. The Black Marketeer got his start with breaking and entering (B&E) robberies and he remains a skilled burglar. **Bonuses:** Automatically gets the skills *Basic Electronics* and *Locksmith* (+20% for both), and gets a +5% bonus on the skills Computer Operation, Prowl, Pick Locks and Surveillance.

Bulletproof. The Black Marketeer has a highly placed, secret admirer, friend, or someone of influence who can get him out of any minor offenses and criminal charges on his home turf or main base of operations. This includes disorderly conduct, drunkenness, and petty crimes as well as serious crimes in which the character has a reasonably good alibi or convincing story as to why it is all a terrible misunderstanding. **Bonus:** This secret ally also owes him one "favor" so big that he can get the charges of any crime, even murder or a terrorist act, dropped *one time*, but one time only. Furthermore, after the big favor is used up, the "friend" owes the Black Marketeer nothing else, and he is *no longer* Bulletproof even from an offense as minor as jaywalking. As a consequence, this big favor should be kept in reserve until the character needs it the most. In all cases, the dropping of charges applies only to the Black Marketeer, not his associates.

Fence. The character has a background in recognizing the value in items and knowledge of what they sell for on the open market. **Bonuses:** Automatically gets the skills *Appraise Goods* and *Gemology* (+10% for both, or a +15% bonus if he already has those skills), and enjoys a +5% bonus to the skills Barter, Forgery, and Recognize Weapon Quality.

Friends in High Places (counts as two special abilities). The Black Marketeer has connections with 1D4 lieutenants and perhaps 1D4 other higher ups (business operators, smugglers, fences, etc.) and even one Boss within his Faction of the Black Market.

In addition, he has a total of 1D4+1 well placed "friends" in the local community spread out among the government, influential

business owners, media and/or the local authorities/police. These civilian friends in high places already owe the Black Marketeer a "favor" or are corrupt, so when *properly motivated* with bribe money or enticed with the right opportunity or means to their own goal, or in exchange for a favor from the Black Marketeer, they can pull strings to get criminal investigations or charges dropped, provide insider information, and otherwise assist the Black Marketeer in subtle and even direct ways, provided their help does not get them entangled in public controversy or cost them their career or fortune. Likewise, having these "friends" enables the Black Marketeer to get 50% more money from Black Market loans and lines of credit. **Note:** These power brokers like to flex their muscle to help "friends" but are likely to expect a favor in return when asked, and show no leniency if a loan they endorsed is not repaid or comes up short. Additional friends in high places are possible through role-playing.

Friends in Low Places. This Black Marketeer knows his share of 3D4 thugs, thieves, drug dealers, pimps, streetwalkers, beggars, snitches, gamblers, gang-bangers, Cyber-Snatchers, City Rats, cut-throats and lower echelon criminals and lowlifes within the Black Market and outside of it. He has cultivated a network of reasonably reliable friends, associates and contacts within the local Black Market Faction and groups of other criminals, mercenaries, bounty hunters, bandits, and saloon owners in the community where he lives or does business. All of these "friends" are unsavory sorts of low character. Still, they have their ears and eyes on the street and may be able to provide information, warnings, rumors, inside information, suggest jobs and criminal opportunities, or come to the Black Marketeer with loot to fence, targets to rob, and provide temporary places for him to hole-up and hide out when he needs to lie low. **Bonus:** The Black Marketeer gets an additional 10% discount on most Black Market purchases and transactions from these lowlifes only. Additional friend in low places are possible through role-playing.

Game Player. Whether the Black Marketeer is a criminal or heroic freedom fighter working at odds with the law, the individual knows how to "work the system," go through channels and get what he wants out of the Black Market, including acquiring forged documents, smuggling refugees in and out of territories, fencing stolen property, and acquisition of stolen property at an additional 10% discount or 5% better rate, even if they are from a rival Faction. He is also likely to finagle special services and assistance not readily available to everyone. **Bonuses:** +5 to *save* vs charm, impress, intimidation and Seduction at the hands of fellow Black Marketeers, +5% to Find Contraband through Black Market channels, and can get 10% more from Black Market loans and lines of credit plus an extra 60 days to pay them.

Home Turf Advantage. The character has become extremely familiar with his home turf and, after a few years of operation there, knows virtually every nightspot, watering hole, hideout, criminal enterprise, back alley, road, trail, tunnel, safe house, and operation run and owned by the Black Market in town. This gives the character a huge advantage when moving about his home turf, intercepting contacts, tailing rivals and enemies, setting up, avoiding ambushes, looking for information and contraband, and so on. **Bonuses:** +5% to all skills that apply to familiarity with his home territory or base of operations, including *all Rogue skills*, Barter, Detect Ambush, Detect Concealment and Intelligence on his home turf only. He can secure a loan within 12 hours and borrow 10% more than usual on familiar turf where he is known. +2 on all Perception Rolls within his Home Turf, particularly when it comes to

avoiding trouble, recognizing spies, rivals and enemies, finding the best deals and contraband, and so on.

Influential. The Black Marketeer enjoys a position of clout or holds a position or level of trust and influence within his specific Faction of the Black Market or within his local community. In the latter case, the Black Marketeer may be a business person, adventurer, mercenary or hero of renown whose voice has influence among the local community or law enforcement or government. In some cases, the character may actually represent the law or work as a law enforcement officer, or as a town defender, militia leader or town councilman. People of lower positions or unsure of themselves will always defer to the Black Marketeer. The character *may* even be in a position to issue orders or take charge of a situation, request police assistance, or have access to people and places that the average person in the community, or Black Market, does not. **Bonuses:** +5% to all matters of etiquette and +5% to Public Speaking and Law (General).

Informant: Confidential. The Black Marketeer has ONE confidential informant – well placed mole, spy or snitch within an existing group, organization or business. This may include a soldier or police officer in the Coalition, a member of the government or media, or even someone within a rival or friendly Black Market group or Faction. The well placed confidential informant feeds the character information about that particular group, opportunities he may be able to exploit, warnings of attacks leveled at him by said group or at his friends and business interests, and other *inside information* that may benefit the Black Marketeer. The identity of this “mole” is a highly valued and protected secret asset that should never be shared even with trusted friends. **Bonus:** Add one additional confidential informant to his network at levels 5, 10 and 15. Others *may* be acquired through role-playing at the G.M.’s discretion.

Informant: Corrupt Lawman (counts as two special abilities). The Black Marketeer has one corrupt law enforcement officer (police officer, detective, sheriff, deputy, ISS agent, CS soldier, or similar) on the take and feeding him information for regular, weekly cash payments. This information includes letting the Black Marketeer know about investigations or the possibility of a bust on him or his business enterprises, members of his crew/friends or associates being investigated, as well as warnings about raids and sting operations, the schedule of police patrols, and similar beneficial data about police operations. Such corrupt police also look the other way whenever their Black Marketeer is involved in a crime. Weekly cash payments are typically in the range of 500-1,500 credits. However, the bad cop is likely to sell big information and do other things for 5,000-15,000 credits or a 5-10% cut of the profit from a crime job he helps to pull off. This includes covering up and losing or stealing evidence of the Black Marketeer’s involvement in a crime, helping him “hit” and rob a rival criminal or underground operation (i.e. crooks, mercs, adventurers or heroes who are not members of the Black Market or a crew from a rival Black Market Faction), misleading the authorities on an investigation, or creating a diversion while the Black Marketeer’s crew pulls off a robbery elsewhere, helping them getaway, or provides information that leads to a big score for the Black Marketeer, or finding the location of a hated rival or enemy. **Bonus:** Add one additional corrupt police informant to his network at levels 4, 8 and 12. Others *may* be acquired through role-playing at the G.M.’s discretion.

Informant: Street Snitch. The Black Marketeer has 1D4+1 Street Snitches in his pocket. These are usually petty criminal,

low-life scoundrels and underworld figures. Prostitutes, drug dealers, junkies, drunks, shady bartenders or pawnshop managers, City Rats, Cyber-Snatchers, bandits, and low-ranking muscle can all be informants who trade information for small amounts of cash, booze and small favors. Such informants and snitches tell the Black Marketeer about the activities of his rivals and enemies, offer juicy secrets they might stumble across, share the word on the street, and are happy to keep an eye open and an ear cocked for anything or anybody the Black Marketeer might ask them to find or watch out for. This includes the whereabouts of specific individuals, schedules for deliveries and patrols, and just about any data that can be learned from someone willing to carefully ask a few questions, listen in on conversations and do a little tailing. **Bonus:** Add one additional Street Snitch to his crime network at levels 2, 4, 6, 7, 8, 9, 11, 13 and 15. Others *may* also be acquired through role-playing at the G.M.’s discretion.

No Conscience. This Black Marketeer is a ruthless cutthroat whose primary concern is himself. He is always looking for an angle to get the most out of any situation and strategic sacrifices. In the end, nothing and nobody matters more than his own best interests and whims. He won’t hesitate at tricking, cheating or killing an enemy, rival or sucker, and probably engages in strong-arm tactics, threats and blackmail. This guy enjoys getting over on others and making people squirm. No appeal to his basic human goodness is likely to move this character, unless he can figure out some way to make it work to his advantage, even if it makes him look good or someone else look bad. **Bonuses:** +1 on Perception Rolls pertaining to his best interests and self-preservation, +1 on initiative, and +4% bonus on the skills Gambling Dirty Tricks, Recognize Weapon Quality and Streetwise.

Read Black Market Operations (counts as two special abilities). The character is good at recognizing and assessing Black Market operations of all sizes. He can tell which Faction the group belongs to and guess at what kinds of criminal enterprises the group/crew is engaged in, the strategies and tactics they are most likely to use, and estimate the group’s strength, level of aggression, penchant toward violence, and level of success (struggling, doing adequate, successful, etc.). He looks for indicators and details such as gang/faction/group affiliation, identifying tattoos and marks, word on the street, style of dress, indication of drug use, attitudes, behavior, the level of tension (if any) and other telling observations. This also gives the character a pretty good chance to spot a spy, double agent, or undercover officer. **Note:** This ability does not apply to law-abiding citizens, legitimate businesses and organizations, but it *may* help to spot a criminal in the organization or regular person about to commit a crime. **Base Skill to Read Black Market Operations:** 60% +3% per level of experience. **Bonuses:** Adds a bonus of +5% to the skills I.D. Undercover Agent, Intelligence, Streetwise, Research (by talking to people as well as reviewing data), and Tailing.

Read People (counts as two special abilities). After years dealing with customers, criminals, the authorities and fellow Black Marketeers, as well as engaging in confidence games and crime himself, the character has a knack for judging people and gauging what they are capable of doing. He is astute at recognizing tells and judging body language, and noticing other subtle cues, such as clothing, shifting eyes, shaking hands, tone of voice, overall demeanor and other signs. He can often tell if the person is a cop, criminal or something more than he seems, and is able to read desperation, lust, hate, hunger for revenge, criminal intent, lying or holding something back, sincerity, goodness and evil/untrustwor-

thiness/suspicion like others read street signs. To do so in game terms, both he and the person he is trying to assess roll 1D20. If the Black Marketeer's roll is higher, he can make a good guess. If they roll the same number, the Black Marketeer isn't sure. If the other roll is higher, he can't make a read . . . yet. Skilled liars such as con artists, smugglers, spies, assassins/hit men and evil supernatural beings get a +2 bonus to their roll. Innocent and good people not used to lying suffer a -2 penalty on their roll. **Note:** While the character may not be deceived by an individual, or know the suspect is hiding something, lying or is suspicious, the Black Marketeer cannot be sure of what that might be, nor can he make him tell the truth or reveal a secret. Role-playing is necessary for that. **Bonuses:** +1 on all Perception Rolls, +1 to dodge, and enjoys a +10% bonus on the skills Interrogation, I.D. Undercover Agent and Streetwise.

Sincerity. Many Black Marketeers have become skilled at appearing honest, truthful, friendly and sincere. This is ideal for Black Marketeers involved in con games, sales, smuggling, espionage and undercover operations. It also helps Enforcers appear more intimidating when they issue warnings and threats, and helps the character seem convincing when he lies under interrogation. **Bonuses:** +1 to M.A. attribute, +5% to the skills Barter, Impersonation, Interrogation (and resist interrogation), Public Speaking, Seduction and Undercover Operations.

Slippery. The Black Marketeer is a slippery character who has developed an awareness, skills and techniques to avoid and escape trouble. **Bonuses:** +1 on Perception Rolls, +1 to dodge, automatically gets the *Escape Artist* skill with a +15% bonus, and a +5% bonus to the skills Detect Ambush, Disguise, Impersonation, I.D. Undercover Agents, Law (General) and Undercover Operations.

Steady Nerves. Many Black Marketeers are accustomed to keeping their heads under fire, bluffing authorities and walking past security and checkpoints with a smile on their faces even when packing heat or transporting a trunk full of contraband. This practiced skill at remaining calm during stressful and even terrifying moments provides the character with nerves of steel and calm resolve. **Bonuses:** No Perception Roll penalties apply under duress, +2 to save vs Horror Factor and insanity, driving penalties for trick/evasive maneuvers are half, +6% to all Demolitions skills and +5% to the skills Disguise, Impersonation and Undercover Ops, and +1 to M.A. attribute.

Street Rep: Hardcase to be Feared. This character has a rep for being a ruthless, unsympathetic tough guy who takes no guff and is quick to punish, hurt and kill anyone who gets on his wrong side. If especially violent, he may have a reputation for being a mad dog killer. **Bonuses:** +10% bonus on Interrogation skill, +10% to intimidate and evoke fear (not trust), and has a base intimidation of 50% even if the character's M.A. isn't high enough to normally be intimidating. When angry or threatening, this guy exudes a Horror Factor of 14. Anyone who fails to save vs H.F. suffers the usual penalties or has the option to back down and immediately leave without further incident. **Note:** This is the character's rep "on the street," and is not necessarily what the Black Market or the authorities may think of him.

Street Rep: Hero. This Black Marketeer has earned the love and respect of City Rats and the poor and downtrodden of his home turf or someplace he frequents and does business at. It doesn't matter that he is an outlaw and a criminal. On one hand, the Black Marketeer may rob and cheat people, sell drugs or services that are harmful to others or even to his own customers (e.g. drugs), but he

has also done something big, or continues to do things, that greatly benefit the disenfranchised people in his local community, home turf or place of business. He may give out gifts to the children, support schools or has built a hospital. He may throw community parties, support local businesses, and help the needy, especially good people and hard workers who have fallen on hard times (not junkies and lazy lowlifes). He may also be a hero because he defies an unjust authority/ruler and/or protects the locals from them, or defends the locals from raiders, bandits, the Coalition, evil mages, monsters and other threats. He may also be a sort of an avenger. Hurt or kill an innocent on his turf, and he and his crew will hunt down those responsible and make them pay in kind. Any one or all of the above has made him a hero on the streets where he is known. **Note:** Best suited to characters with an Aberrant, Anarchist or Unprincipled alignment. This is the character's rep "on the street," and is not necessarily what the Black Market or the authorities may think of him. **Bonuses:** +5% to Find Contraband, Intelligence, Streetwise and Roadwise wherever he's a considered a hero. He is also protected by the people who think of him as a hero. They will warn him of any trouble coming his way, will lie for him, hide him and the members of his crew, share rumors and information to benefit him, and show other acts of good will and affection.

Street Rep: Trustworthy. Word on the street is this guy is fair and honest in his business dealings and can be trusted by fellow Black Marketeers, crooks and outlaws. He is in good standing with his clientele and he may have a rep for being the "go to guy" when looking for "X" – whatever that may be. "X" probably ties into one of the character's criminal enterprises or a particular Black Market service with which he is affiliated or run by a friend or crime boss. **Note:** This is the character's rep "on the street," and is not necessarily what the Black Market or the authorities may think of him. **Bonuses:** +5% bonus to the skills Barter, Gambling, Gambling Dirty Tricks and Pick Pockets.

Suave and Debonair. The character comes across as charming, smooth, confident, likeable and a gentleman with manners, even if he is really a brutal killer. **Bonuses:** +1 on initiative, +15% to Seduction, Public Speaking, and Wardrobe and Grooming, +5% bonus to Undercover Ops, and +2 to M.A. attribute.

Wheelman. The character has a love for fast vehicles and an expertise in piloting them. **Bonuses:** +10% to Roadwise, +5% to Land Navigation, +10% to the Piloting skill of his favorite type of vehicle, and he gets to select 1D4 additional Piloting skills allowed by his O.C.C. of choice (+10% bonus for each).

Work the Law. The character understands the law and knows how to work it to his advantage. On his own turf he knows the reputations of the lawmen, criminal prosecutors and judges, and who is lenient, who is tough as nails, and rumors of who can be bribed and bought-off. **Bonuses:** Automatically gets the skill *Law: General* (+10%), and a +5% bonus to the skills I.D. Undercover Agent, Research, Seduction, and Streetwise. He is also likely to recognize lawmen and heroes of great renown and hear about their presence in town 10 minutes after their arrival.

Black Market Specialist O.C.C.s

By Kevin Siembieda, Julius Rosenstein and Taylor White

Black Market Banker
Case Man
Con Artist
Enforcer
Expediter
Information Broker
Merchant
Raider
Refurbisher
Rift Runner

Note: The character types and O.C.C.s that follow can be allowed as player characters as well as used by Game Masters to create Non-Player Characters (NPCs).

When most people think of Black Marketeers, they generally think of the entrepreneurs and free traders, or criminals. Although it is true that these Jack-of-all-trades, rank-and-file operatives are the face of the Black Market seen by the public, they are supported (frequently behind the scenes) by a network of *specialists*.

Although it is uncommon for these specialists to rise to the very top levels of power and authority in the Black Market, enough of them manage to achieve positions equivalent to upper-middle management and the lower rungs of upper management to entice talented people to join the ranks of the Black Market.

Black Market Banker

Banker. Sounds boring, right? Not if you're a Black Market Banker.

The Black Market has its hands in a lot of different pies, but the one thing that is always of paramount importance is making money. The bottom line is: "If the Black Market doesn't make a profit, they won't stay in business." For this reason, the organization needs people with business and financial expertise. People who know how to handle money and how to make money. Such individuals are called Bankers, Financiers and "Fixers" within the organization.

However, unlike the stereotypical bean counters who never stray from the security of their air-conditioned offices, Black Market Bankers often find themselves on the front lines and in the thick of things. A lot of Black Market Bankers make it a point of being very hands-on and present wherever financial transactions are taking place. They have to be able to take care of themselves in complicated and volatile situations in back alleys as well as in the boardroom. As a result, most Black Market Bankers are part high-stakes financiers and part "James Bond" – cool, calm and looking dapper and professional while packing heat and unafraid to cheat, con, blackmail, threaten, fight and kill to make a deal happen or to preserve the assets of the Black Market. This makes the Black Market Banker a team player who helps his fellow Black Marketeers and others whom he believes can advance his position and his personal bank account.

As a money man and team player, the Banker is always looking for ways to optimize the upside of every situation for all members



AL
AS
PB
AU
GT
12

of his Black Marketeer team. This has earned the Banker the nickname of “Fixer,” because he’s always trying to fix finances, fix problems, cut the best deals and make all of his fellow Black Marketeers a profit. This makes the character fiercely loyal to his Black Market Faction first, his Top Boss second, and his Crew Boss and members of the crew next. Other Black Marketeers come last in his list of priorities, but a Banker will never cheat or con a fellow member of the same Faction. Other Factions and rivals are another story. It also means that, with a few exceptions, *everyone else* are marks, suckers and dupes to be taken to the cleaners. When “the fix is in,” it means someone is about to get burned while the Black Market is about to reap a handsome profit.

“Fixing” is a way of life for Black Market Bankers, and that includes setting up people and businesses, especially rivals and enemies, to take a fall so that the Black Market benefits in some way. The typical Fixer never offers someone outside the Black Market more money or a fair deal if he’s confident the sucker will take less. Bankers always play hardball with outsiders, rivals and enemies.

Many Black Market Financiers, especially when young, are hungry sharks who like to go out in the world to cut deals, rip people off, and help fellow Black Marketeers make money. Many go so far as to join adventurer groups, mercenaries, and bands of outlaws to acquire contraband and valuables for resale via the Black Market, or to scout locations and prospects for Black Market/criminal business enterprises. Protection services, mercenary companies, trading companies, smuggling rings, and outlaws fighting for liberty and the overthrow of a ruling power are always potential opportunities. Of course, helping freedom fighters and rebels is not done out of any sense of charity or justice, but rather the simple fact that patriots are very passionate about their causes. Passion is wonderful and powerful, but it can also blind rebels and freedom fighters to the risks they take and inspire them to take brash action and high-stake chances that can benefit the Black Market. Moreover, play your cards right and those freedom fighters will consider the Black Market to be a friend and ally. A friend and ally who sends more customers their way. And should the upstarts triumph, the Black Market has an instant “in” with the new ruling party. If the rebels lose, well, it was good business while it lasted.

It is later in life, when a Fixer retires from field duty, that he is likely to become one of the fat cats who is a keeper of the purse strings for a Black Market crew or Faction. Every Boss has at least one Banker in his crew. In this role, the Banker functions as accountant, financial planner, investment adviser, loan maker, and advisor to anything that involves keeping the money flowing and increasing profits. Their earlier experience makes older Black Market Bankers equally at home dealing with adventurers and mercenaries as they are business people and other bankers.

Special Abilities of the Black Market Banker O.C.C.

1. Black Market Benefits: All three Benefits are available to this character, plus the Banker can get 30% more money for any loan, and he has twice as long to pay his vig (interest rate). However, given his specific background and circumstances, Bankers are not allowed to exploit their position (i.e. make too much of a profit at the expense of their colleagues).

2. Special Abilities of the Black Marketeer: The Fixer starts with *Game Player* and *Read People*. In addition pick one of choice at level one and one additional at levels 4, 8 and 12.

3. Market Trends: The Banker is not just someone who counts the money when (and if) it comes in, he is the catalyst that brings it in. Whether through study or by natural instinct, Bankers can spot opportunities and economic trends, and formulate fiscal strategies to best take advantage of them. These strategies may entail legitimate or illicit action, or a combination of both. Bankers also keep abreast of local laws and politics. If the local kingdom has upcoming legislation affecting health care, then setting up some type of insurance scam may be an opportunity. +2 on Perception Rolls about things that could have an impact on sales, business operations and money matters.

4. Banker O.C.C. Bonuses: +1 to M.A., +2 to M.E. attributes, and +1 save vs Horror Factor and mind control.

Black Market Banker O.C.C. Stats

Also Known As: Fixer and Financier.

Alignment Restrictions: Usually a selfish or evil alignment, though many gravitate toward Anarchist and Aberrant.

Attribute Requirement: I.Q. 12 or higher.

Race Restrictions: None.

O.C.C. Skills:

Appraise Goods (+20%)

Barter (+20%)

Cardsharp (+14%)

Computer Operation (+10%)

Find Contraband (+14%)

Gambling (+15%)

I.D. Undercover Agent (+20%)

Language: Native Tongue at 98%.

Language: One of choice (+20%).

Literacy: Native Language (+25%)

Law (General, +10%)

Mathematics: Basic (+40%)

Pilot Hovercraft or Hovercycle (+10%); pick one.

Radio: Basic (+10%)

Research (+10%)

Wardrobe & Grooming (+20%)

W.P. Energy Pistol

W.P.: One of choice (any).

Hand to Hand: Basic; can be changed to Hand to Hand: Expert at the cost of two O.C.C. Related Skills, or Martial Arts for three.

O.C.C. Related Skills: Select six other skills at level one, and two additional skills at levels 3, 7, 9 and 11. All new skills start at level one proficiency. These selections get the benefit of any bonuses that may be noted below. **Note:** O.C.C. Related Skills may be traded at a rate of two skills for one *Black Market Special Ability*, described earlier in the Black Marketeer O.C.C. section.

Communications: Any (+5%).

Cowboy: None.

Domestic: Any.

Electrical: None.

Espionage: None.

Horsemanship: General only.

Mechanical: None.

Medical: First Aid only.

Military: Recognize Weapon Quality only (+5%).

Physical: Any.

Pilot: Any.

Pilot Related: Sensory Equipment only.

Rogue: Any (+5%).

Science: Anthropology and Mathematics: Advanced only (+15%).

Technical: Any (+5%).

W.P.: Any.

Wilderness: Carpentry and Wilderness Survival (+5%) only.

Secondary Skills: The character also gets to select four Secondary Skills from the Secondary Skills list in **Rifts Ultimate Edition**, page 300. These are additional areas of knowledge that do not get any bonuses, other than any possible bonus from having a high I.Q. Skills start at the base skill level.

Standard Equipment: One weapon for each W.P., 1D6 extra clips of ammunition for each, PC-3000 hand-held computer, a full-sized portable computer, PDD pocket audio recorder, portable language translator, pocket flashlight, pen flashlight, pocket notepad, 1D4 legal pads, 1D4+1 pens, 1D6+2 pencils, two spare sets of traveling clothes, one set of dress clothes, business suit, trench coat, briefcase, knapsack, backpack, satchel, canteen, a high quality forgery of a Coalition Citizen's I.D. card along with a weapons permit (for the same identity), and some personal items.

Money: 4D6x1,000 in credits to start, plus 2D6x1,000 in Black Market contraband/tradeable goods.

Cybernetics: None to start. Few Black Market Bankers get anything more than a handful of implants. The Cyber-Camera Eye and Cyber-Disguises are both popular. They have found preserving their humanity and humanoid appearance is important, as people are generally less trusting and open to machines and partial machines. Bankers want to inspire their clients with confidence and sincerity, so they tend to wear formal dress such as dark suits for men, pantsuits or below-knee length dresses for women. Even when the occasion calls for casual wear, Bankers will still dress in a conservative manner.

Case Man

The Black Marketeer known as the Case Man is an expert in security and surveillance. More importantly, it is his job to identify whether or not he and his bosses, associates, Black Market enterprises, etc., are being observed, followed, bugged, recorded, photographed or under surveillance. The Case Man knows where to look for surveillance systems, bugs and tails, can assess the quality of locks and the level of security systems, and how to counter or bypass them.

The Case Man has another area of expertise: he knows how to case the locations of rivals and targets for hits and robberies by assessing their security and the best way to break in, achieve his objective, and get out without getting caught. Whether it be Coalition Dead Boys, Federation Magus Guards or mercenaries hired for the job, *every* security force has its own standards and protocols. They also develop almost unavoidable patterns and habits. A skilled Black Market Case Man knows all the common patterns and practices of police, military and criminals, but he can pick up on and determine those of specific groups, guards and patrols after a period of careful observation. This gives the Case Man an excellent sense of timing and knowledge to determine the exact moment to attempt to pass through security unseen, when and where a target is at its most vulnerable, finding holes in security and defenses, and finding a window of opportunity and knowing how long that

window should remain open, and whether that window can be used to get out or another exit route is necessary.

On a personal level, the typical Case Man has an excellent poker-face, holds his cards close to the vest in all matters, and tends to be secretive and suspicious of all outsiders, rivals and those who



want to get close to him, his boss or teammates. He is cautious, careful and always aware of his surroundings. A master at hiding in plain sight, he is constantly surveying his surroundings in a subtle manner, taking note of the people and things around him to see if he or his group is being watched or tailed or in jeopardy of being ambushed. The entire time he is working out in his head alternative escape routes, ways to lose a tail or attacker, and how best to protect and get those he may be charged with protecting, in and out without being seen or caught on surveillance devices. Every Case Man wants to know everything he can about those with whom he has to work or have business dealings. As a consequence, many have a thing about *picking pockets* to take a quick look at wallets, I.D.s and possessions to confirm a person's claimed identity and glean things about him. The Case Man then slips the wallet/I.D./items back before the target realizes they were ever missing or puts it someplace where the target might have dropped or left them. A Case Man is also likely to tail and investigate people of whom he is suspicious, and he is suspicious of just about everyone he doesn't know well, and sometimes he's suspicious of those he knows.

Special Abilities of the Case Man O.C.C.

1. Black Market Benefits: All three Benefits are available to this character.

2. Special Abilities of the Black Marketeer: The Case Man starts with *B&E Man* and *Slippery*. Pick two others of choice at level one and one more at levels 4, 8 and 12.

3. Counter-Surveillance: A Case Man always tries to be aware of his surroundings and of the possibility of being observed. The Case Man has learned to turn his head and body, cock his hat, wear the right apparel and to position himself in such a way (cloaked in shadow, standing just outside the range of a security camera or at an angle that conceals his face, showing no identifying marks, etc.) that he can not be clearly seen, identified or photographed unless he gets careless. Furthermore, he is always looking to see if he is being followed and, as a precaution, always takes evasive action to lose himself in a crowd or in traffic, takes indirect routes to meetings and uses other countermeasures to make sure he is not being tailed or recorded. His *Surveillance* and *Tracking* skills are used in conjunction with this special ability for covering his own trail and leaving no incriminating evidence that can lead back to him or his associates. **Bonus:** Anyone trying to follow/tail, surveil or photograph this character does so with a penalty of -20%. **Base Skill:** 72% +2% per level of experience.

4. Master of the Heist: The hallmark of the Case Man is his ability to "case" a location for robbery, raid or other access without being identified or captured. This makes him good at pulling off heists and improvising when things go wrong, including having two or more alternative escape routes and a hideout planned. When directly involved in a heist, raid or infiltration/breaking and entry operation, the character will forgo other projects, responsibilities, and social contacts to focus intently on the job. Prior to the heist he gathers the necessary research and resources, assembles a team (if needed), plans the entry and escape, makes sure all the bases are covered, and tries to leave as little room for error as possible.

Bonus: When working on a heist or infiltration, the character gets a +5% to all skill rolls pertaining to the heist, but suffers a penalty of -10% on all skill rolls NOT pertaining to the job. The +5% bonus increases by 1% per every level of experience. All bonuses and penalties are cumulative.

5. O.C.C. Bonuses: +2 on Perception Rolls involving security, surveillance and being watched, followed or bugged, +10% to find

a surveillance device when looking for them; +2D6 to S.D.C., +1 to disarm, +1 to dodge, +2 to save vs Horror Factor, and +1 to save vs mind control and possession.

Case Man O.C.C. Stats

Also Known As: Breaker and A Pair of Eyes.

Alignment: Any, but typically a selfish or evil alignment.

Attribute Requirements: I.Q. and M.E. 11 or higher.

Race Restrictions: None.

O.C.C. Skills:

Basic Electronics (+15%)

Basic Mechanics (+10%)

Camouflage (+30%)

Computer Operation (+10%)

Electronic Countermeasures (+20%)

Find Contraband (+5%)

I.D. Undercover Agent (+15%)

Language: Native Tongue at 98%.

Literacy: Native Language (+10%)

Locksmith (+20%)

Mathematics: Basic (+20%)

Palming (+10%)

Pick Locks (+10%)

Pick Pockets (+20%)

Pilot: One of choice (+10%).

Research (+10%)

Sensory Equipment (+10%)

Streetwise (+10%)

Surveillance (+20% to tail, +10% to all other aspects of this skill).

Tracking (people; +10% to track, +20% to cover his tracks).

T.V./Video (+10%)

W.P. Handguns

W.P. Modern: One of choice, but usually Energy Pistol.

Hand to Hand: Basic can be changed to Expert at the cost of two O.C.C. Related Skills or Martial Arts (or Assassin if evil) for the cost of three skill selections.

O.C.C. Related Skills: Select four other skills at level one, plus one additional skill at levels 3, 6, 9 and 12. All new skills start at level one proficiency. These selections get the benefit of any bonuses that may be noted below. **Note:** O.C.C. Related Skills may be traded at a rate of two skills for one *Black Market Special Ability*, described earlier in the Black Marketeer O.C.C. section.

Communications: Any (+5%).

Cowboy: None.

Domestic: Any.

Electrical: None.

Espionage: Any.

Horsemanship: Any.

Mechanical: Automotive only.

Medical: First Aid only.

Military: Recognize Weapon Quality (+5%) only.

Physical: Any.

Pilot: Any (+5%), except Military Pilot skills.

Pilot Related: Any.

Rogue: Any (+10%).

Science: Mathematics: Advanced (+5%) only.

Technical: Any.

W.P.: Any.

Wilderness: Land Navigation (+10%) only.

Secondary Skills: Four Secondary Skills of choice at first level, +1 at levels 4, 8 and 12. Selections are made from the Secondary Skill list on page 300 of **Rifts Ultimate Edition**. These are additional areas of knowledge that do not get any bonuses, aside from any possible bonus from having a high I.Q. attribute. All Secondary Skills start at the base skill level.

Standard Equipment: One weapon for each W.P. plus two additional E-Clips/ammo magazine, Vibro-Knife (1D6 M.D.), pocket knife (1D4 S.D.C.), suit of light M.D.C. body armor, suit of medium or heavy body armor, several different sets of clothes, traveling clothes, black or dark business suit, trench coat, baseball cap, one wide-brimmed hat (probably a Fedora), one pullover cap, one ski mask, a pair of thin leather gloves, a box of 100 surgical gloves (plastic and disposable), 1D4 handkerchiefs, lock picking kit, tool kit, large crowbar (2D6 S.D.C.), bolt cutters, Wilk's Laser Torch, Wilk's Laser Scalpel, pocket laser distancer, binoculars, Multi-Optics Helmet, Language Translator, handheld portable computer, communicator, digital camera, large flashlight, pen flashlight, 1D4 Tracer Bugs, Pocket Scrambler, M.D.C. briefcase, small duffel bag, large duffel bag, backpack, large suitcase, wallet, tinted goggles, sunglasses, air filter, gas mask, and some personal items. **Note:** Has access to surveillance equipment when doing a specific job for a Black Market Boss, otherwise must buy his own gear.

Money: Starts with 2D6x1,000 credits and 1D6x1,000 credits in Black Market goods.

Cybernetics: None to start. Hidden compartments, concealed weapons, cybernetic disguises and voice modulators are all popular.

Con Artist

The Con Artist or "confidence artist" is a common feature of the Black Market and its sales operations. Con Artists prowl the marketplace like sharks in the shallows, always looking for a new "mark" – an individual or group who can somehow be exploited. The tools of the confidence artist – better known as a "con artist" or "con man" – are sincerity, deception and trickery. First, he or she works to gain a target's *confidence* (hence the name), before setting them up, leading them into trouble or ripping them off. The Con Artist's greatest gift, however, is the ability to convincingly pretend to be something or someone he is not, and to sell lies as truth. By the time the "mark" realizes he has been "had" – robbed, deceived or tricked, the Con Artist is long gone.

A Con Artist can work alone, in pairs or with a group of other people. Most have a gift for gab and can find easy work as a sales person, entertainer, guide or public speaker. Within the Black Market and military operations, a Con Artist can make an excellent thief, decoy, undercover operative and espionage agent for the purpose of gathering intelligence, stealing documents, planting evidence and similar, non-combat missions. They can be an essential part of pulling off a heist and/or throwing the authorities/pursuers off the trail.

A master of improvisation and quick thinking, a Con Artist can spin lies and react to any given situation without missing a beat. They may pose as a customer, innocent bystander, victim of a crime, or masquerade as a store clerk, the authorities or, well, just about anybody. Their number one scam is to con someone out of money and valuables that are paid up-front for a particular item or service, then vanish with the money before the victim realizes he's



not going to get what he paid for. They are also good at switching a package or documents, evidence, valuables, etc., with fakes or a package that contains junk or nothing at all. Selling real estate and property that is not actually theirs, is another popular con game, as is framing someone for a crime that person didn't commit. A fast and loose frame job may be used to create a distraction by causing a commotion while the Con Artist or his associates make good their escape or go about something criminal. A well planned frame job may be done to incriminate someone other than those really responsible, eliminate a rival or enemy and for the purpose of blackmail. Stealing evidence to use against someone is another ploy. Con Artists are often employed by Black Marketeers, mercs and espionage operatives to help them gain access to secure locations, cheat big customers and pull off elaborate schemes. Not all "con men" are men, either. There are plenty of female Con Artists. Men tend to be a sucker for a pretty face or a damsel in distress. Male or female, Con Artists are accustomed to deception and mind games, and the most clever and daring always seem to find new people and opportunities to exploit.

Special Abilities of the Con Artist O.C.C.

1. Black Market Benefits: All three Benefits are available to this character.

2. Special Abilities of the Black Marketeer: The Con Artist starts with *Read People* and *Sincerity*. In addition, pick one of choice at level one and one additional at levels 4, 8 and 12.

3. Plausible Believability: The Con Artist is an experienced and sincere actor, making it extremely difficult to determine when he is telling the truth or lying, even for psychics and magic users. A Con Artist can lie right to your face and is expert in creating those little details that make a lie seem truthful/genuine. A Con Artist can make someone believe his story or identity just like another character might roll to charm or impress.

In fact, use the Trust and Impress percentage number under the **M.A. attribute** to determine Plausible Believability. The player still has to role-play his explanations, lies and deceptions, and the lie must seem plausible or it doesn't work. For example, the Con Artist cannot make an outrageous or obvious lie such as, "Stand aside, fool, I'm Emperor Prosek!" and have any hope for it to be accepted by anybody. This is *not* magic nor mind control. The lie or deception must be *convincing* and *plausible* for the situation. While claiming to be Emperor Prosek won't fool anyone, pretending to be a terrified and innocent bystander in need of protection or comfort when a gunfight is taking place across the street should work like a charm. However, Plausible Believability only gets the Con Artist accepted or through the front door, the rest has to be role-played. Fumbling for words, making mistakes and contradictions will completely shatter the lies or con he is trying to pull. Worse, people hate liars and strongly react and even overreact when they realize someone is lying to them or trying to trick, rob or cheat them. **Bonus:** If the character's **M.A.** attribute number is 15 or less, increase it to 16 and roll 1D6 and the result to the character's **M.A.** attribute number. If it was 17 or higher to begin with just add the 1D6 bonus. Furthermore, regardless of the Con Artist's **M.A.**, he enjoys a +2% Believability bonus per level of experience; maximum possible is 97% even with bonuses.

4. O.C.C. Bonuses: +2 on Perception Rolls to recognize when others are trying to pull a con, pass off a forgery or pull a fast one, +1D4+2 +1 to save vs psionic and magical mind control and illusions, and Interrogators suffer a penalty of -3% per level of the

Con Artist. Also see #3 Plausible Believability, for **M.A.** attribute bonus.

Con Artist O.C.C. Stats

Also Known As: Con Man, Confidence Artist and Scammer.

Alignment: Any, but most Black Marketeers are selfish or evil.

Attribute Requirements: **M.A.** of 12 or higher.

Racial Requirements: None.

O.C.C. Skills:

Begging (+15%)

Concealment (+10%)

Disguise (+10%)

Gambling (Dirty Tricks) or Cardsharp (+15%).

I.D. Undercover Agent (+12%)

Imitate Voices & Sounds (+10%)

Impersonation (+12%)

Language: Native Tongue at 98%.

Language: Other: One of choice (+20%)

Mathematics: Basic (+15%)

Palming (+5%)

Performance (+20%)

Pick Pockets (+10%)

Prowl (+5%)

Seduction (+10%)

Streetwise (+15%)

Undercover Ops (+20%)

Hand to Hand: Basic; can be changed to Expert at the cost of two O.C.C. Related skills or Martial Arts (or Assassin if evil) for the cost of three skill selections.

O.C.C. Related Skills: Select four other skills at level one. Add one additional skill at levels 3, 6, 9 and 12. All new skills start at level one proficiency. These selections get the benefit of any bonuses that may be noted below. **Note:** O.C.C. Related Skills may be traded at a rate of two skills for one *Black Market Special Ability*, described earlier in the Black Marketeer O.C.C. section.

Communications: Any (+5%; +10% to all Language skills).

Cowboy: None.

Domestic: Any (+5%).

Electrical: Basic Electronics only.

Espionage: Any (+10%).

Horsemanship: Any.

Mechanical: Automotive and Basic Mechanics only.

Medical: First Aid only.

Military: Military Etiquette and Recognize Weapon Quality only (+5%).

Physical: Any, except Boxing.

Pilot: Any (+5%), except Military Pilot skills.

Pilot Related: Any.

Rogue: Any (+10%).

Science: Mathematics: Advanced (+5%) only.

Technical: Any (+10% to History, Law, Lore, and Research skills only).

W.P.: Any.

Wilderness: Land Navigation (+10%) only.

Secondary Skills: Four Secondary Skills of choice at first level, +1 at levels 3, 6 and 9. Selections are made from the Secondary Skill list on page 300 of **Rifts Ultimate Edition**. These are additional areas of knowledge that do not get any bonuses, aside from any possible bonus from having a high I.Q. attribute. All Secondary Skills start at the base skill level.

Standard Equipment: One weapon for each W.P., 1D6 extra clips of ammunition for each, one suit of light or medium M.D.C. body armor, several different sets of clothes for assuming different identities, traveling clothes, backpack, satchel, sleeping bag, 1D4 sacks, pocket computer, digital camera, pen flashlight, pocket notepad, 1D4 pens or markers, canteen, a high quality forgery of two different names and identities along with weapons permits for the same identities, wallet or purse, pocket mirror, cigarette lighter, small bottle of whiskey or rum, and some personal items.

Money: Starts with 2D6x1,000 credits and 2D6x1,000 credits in Black Market goods.

Cybernetics: None to start. Hidden compartments, stun guns, cybernetic disguises and voice modulators are all popular. They have found preserving their humanity and humanoid appearance is important, as people are generally less trusting and open to machines and partial machines such as cyborgs.

Enforcer

Despite their pretense to be legitimate business people, the Black Market is a *criminal* organization. As such, they are hardly in a position to go running to the authorities when trouble occurs. Whenever the Black Market is faced with such problems, the task of resolving them falls to the Boss and his crew. When that resolve requires putting someone in line or “eliminating a problem,” the Enforcer is called in.

One of the most common problems for the Black Market is dealing with deadbeats – people who owe money or interest on a loan, a gambling debt, and so on. Among their many dealings, the Black Market does a good deal of loan sharking (lending money and/or other capital at high interest rates). Sometimes, the borrower is poor at conducting his business or just plain unlucky. In either case, he needs to pay up, or else. The Enforcer is the “or else.” The Black Market often employs the carrot-and-stick method of motivating their clients; i.e. rewarding good conduct and punishing bad behavior. The Enforcer’s role is definitely that of the stick. They are there to make sure that any problems are dealt with quickly and efficiently through threats and violence.

Despite their stereotypical reputation, a good Enforcer is more than just a brawny goon who is willing to smack around or kill anyone who creates trouble for the Black Market. A skilled Enforcer is a combination of clinical psychologist, motivational speaker and father confessor. Other than to serve as an example and warning to others, and exacting revenge, killing a client is not likely to result in payment, so a good Enforcer is one who knows how to get results. Killing is a last resort unless it so decreed by his Boss. The other secret to being an effective Enforcer is saying and doing the right things to get the desired reaction. A lot of deadbeats are willing to take a beating themselves, so it is often more effective to figure out what they love or value more than themselves and threaten it. That can be a beloved vehicle, work of art, house, business, or, of course, friends and loved ones. Threatening a man’s spouse, sibling, parent or child has a way of getting amazing results. And you’d be surprised how many people will do almost anything to save a favorite pet. The trick to this tactic is to be serious and go through with the threat if the deadbeat doesn’t come through. An effective Enforcer never makes threats he’s not willing to make happen. Simply knowing that an Enforcer is willing to use violence inspires many people to avoid it at all costs.



AL
AS
HB
AM
GT
12

Also, Enforcers often have to deal with clients who are more than willing to honor their commitments to the Black Market but are simply unable to do so. In situations like these, Enforcers may actually take on the role of “good cop” and intercede with their superiors on the client’s behalf. By calling in an *Expediter* or *In-*

formation Broker to work out some type of alternative payment, the problem *may* be resolved to the benefit of all parties concerned. However, if no alternative solution can be found, and if the Boss or Captain of a crew designates someone for a hit, the Enforcer makes the hit. And don't think Enforcers are nice guys who "care." They aren't and they don't. They try to do what's best for business, and if murder is what's best, they do it without hesitation. Anyone who gets in the way goes down too. If no witnesses can be left behind, they die too.

Of course, there are just some people who need killing, and that's the Enforcer's speciality. Killing. Killing without leaving evidence that can lead back to him or implicate his Boss or Faction. An Enforcer is not a thug, soldier or hired gun off the street. Enforcers are professional killers, and that means doing the job right. As noted, most of the time, doing the job "right" means killing the target quietly and leaving the body to be found many hours after the murder, and without any trace of who might be responsible. One-third of professional "hits" requires the victim to simply vanish without a trace or hint of violence. In that instance, the Enforcer (an Enforcer or two and his crew) will lure or abduct the target, take him someplace quiet, removed from witnesses – usually out in the wilderness – and kill him and bury him there. This is done as much as an intimidation tactic or an act of revenge as it is an efficient way to make a kill. *Not knowing* what happened to a friend, loved one or associate – but suspecting and always wondering – is harder to bear for most people than knowing he or she was murdered.

There are times that a message needs to be sent, and these murders are usually brutal, ugly, filled with blood or multiple body counts. The Enforcer might even stage the murder scene to get the point across or deliver the right message to the appropriate individuals. If a really loud message needs to be sent, the building might be set on fire afterward, or blown up, or multiple hits made in the same night. Such tactics are, as a rule, reserved for hated enemies and despicable rivals.

Anyone can draw a gun or knife and take a life. Self-proclaimed "hit men" and would-be assassins are a dime a dozen. Most are loud, sloppy, and full of bravado. Not so the Enforcer. He is a cousin to the Master Assassin and that makes him a consummate pro. An artist in the methods of killing. If a hit needs to look like an accident, it does. If the person needs to disappear, he does. If a statement needs to be made, it's made. While amateur hit men may take out their targets with a barrage of missiles or flashy magic spells, those methods produce untold collateral damage. That in turn, draws unwanted attention to the death of their target, and possibly, back to the client or Boss. The Enforcer never leaves anything to implicate his Boss or client, and if necessary, takes the rap himself.

Enforcers are Black Market hit men. Their loyalty and most of their work is for the Black Market. While there are some independent Enforcers who work for any Black Market Boss or Captain on a job-by-job basis, and may even do work for two or more Factions, most Enforcers belong to a specific Faction and crew. However, one of the "services" offered by some Black Market enterprises is professional hits. Meaning, an outside client can "put a hit" on someone and the Black Market will send one of its Enforcers to take care of it. This requires a minimum payment of half upon placing the hit, and the balance paid within 24 hours of the hit. Failure to pay up means the client is killed, usually within 48 hours. Run, and you'll be tracked down, or your family or business will be targeted for retribution. If the client is a complete unknown,

payment in full may be insisted upon. Since the Black Market has a reputation for living up to its contracts, there is zero risk of the money being stolen. That said, children targets are usually off limits, and the hit man has the right to refuse the job for any reason, in which case the money is returned (or the Boss finds a different Enforcer to do the job).

The cost of a hit. Cost for a hit on Joe Nobody or Bob Average Citizen is 10,000-20,000 credits for a professional hit by an Enforcer (half by amateurs). Targets with a reputation or moderate local fame or importance cost 25,000-40,000 credits. Killing Joe Average Police Officer or military personnel costs 40,000-60,000 credits. Killing a person with enhanced abilities, including sorcerers and psychics, costs 100,000-200,000 credits. Killing a famous local cop, military officer, hero or politician is 200,000-400,000 credits. Taking down a beloved famous individual, superstar, head of a major corporation, or head of state costs 1-6 million credits. As a professional courtesy, Black Marketeers will NOT take a contract on another member of the Black Market, not even if that target is a hated rival or enemy in a different Faction. Extenuating circumstances, conditions, security, risk and danger can see any of these prices doubled, tripled or quadrupled.

Special Abilities of the Enforcer O.C.C.

1. Black Market Benefits: All three Benefits are available to this character, however, most Enforcers do not have other businesses, and if they do, it is only one.

2. Special Abilities of the Black Marketeer: The Enforcer starts with *Steady Nerves* and *Street Rep: Hardcase to be Feared*. Pick two others of choice at level one and one more at levels 4, 7 and 11.

3. Intimidation (special): First and foremost, an Enforcer is there to provide an incentive to the victim (oops, I meant client) to cooperate. This usually takes the form of avoiding unpleasant consequences for a lack of cooperation. When violence can be avoided, everybody wins (or, at least, hopefully, the Black Market wins). In the carrot-and-stick method of motivation, the Enforcer represents the stick. The Enforcer is a master at looking fierce, stern, scary and threatening. This is done through facial expression, body language, tone of voice, words and a bit of theatrics. **Base Skill:** 56% +2% per level of experience, and an M.A. bonus of +2% per M.A. point above 15.

4. Sanitizing a Crime Scene (special): Enforcers wear gloves and know all the ins and outs to avoid leaving forensic evidence at a crime scene. They may even pick up shell casings and cigarette butts, wipe down anything that might have fingerprints or identifying fluids, use certain cleansers, and similar methods and techniques. **Base Skill:** 50% +5% per level of experience.

5. O.C.C. Bonuses: +3D6+4 to S.D.C., +3 on Perception Rolls pertaining to possibly incriminating evidence, +1 on initiative at levels 2, 6 and 12, +1 attack per melee, +1 to strike on Called Shots/Aimed Shots, +1 to disarm, +2 to pull punch, and +2 to save vs Horror Factor.

Black Market Enforcer O.C.C. Stats

Also Known As: Hit Man, Mechanic and Contractor.

Alignment Restrictions: Any, but most Black Market Enforcers are Anarchist, Aberrant or other evil alignment.

Attribute Requirements: P.S. and P.E. of 12 or higher. Magic and psionics are always a plus.

Race Restrictions: Any. Intimidating looking D-Bees are often hired as hit men. The Black Market has found that having members of a different race can be effective since the target is less likely to identify with them and will react with greater fear and apprehension. D'norr Devilmen, Quick-Flex Aliens, Grackle Tooth, Lanotaur Hunters, Lyvorrr, Malvoren, Vanguard Brawlers and various shape-shifters are among the most commonly encountered D-Bees who opt for this O.C.C.

O.C.C. Skills:

Basic Mechanics (+5%)
Detect Ambush (+10%)
Find Contraband (+8%)
Intelligence (+10%)
Interrogation (+25%)
Language: Native Tongue at 94%
Physical: Two of choice, any.
Pilot: Two of choice, any.
Prowl (+15%)
Radio: Basic (+10%)
Streetwise (+10%)
Surveillance (+10%)
Tracking (people; +10%)
W.P. Blunt
W.P. Knife
W.P. Energy Pistol
W.P. Modern, three of choice (any).
Hand to Hand: Assassin or Martial Arts (if preferred or not evil).

O.C.C. Related Skills: Select five other skills, of which at least two must be from Espionage or Rogue. Add one skill at levels 3, 6, 9 and 12. All new skills start at level one proficiency. These selections get the benefit of any bonuses that may be noted below. **Note:** O.C.C. Related Skills may be traded at a rate of two skills for one *Black Market Special Ability*, described earlier in the Black Marketeer O.C.C. section.

Communications: Any (+5%).
Cowboy: None.
Domestic: Any (+10% to Wardrobe only).
Electrical: None.
Espionage: Any (+10%).
Horsemanship: General only.
Mechanical: Basic Mechanics only.
Medical: First Aid only.
Military: Camouflage and Recognize Weapon Quality only (+10%).
Physical: Any, except Acrobatics.
Pilot: Any.
Pilot Related: Weapon Systems only.
Rogue: Any (+5%).
Science: Mathematics: Basic (+15%) only.
Technical: Any (+5%).
W.P.: Any.
Wilderness: Carpentry, Hunting, Land Navigation and Wilderness Survival only.

Secondary Skills: The character also gets to select four Secondary Skills from the Secondary Skills list in **Rifts Ultimate Edition**, page 300. These are additional areas of knowledge that do not get any bonuses, other than any possible bonus from having a high I.Q. Skills start at the base skill level.

Standard Equipment: Two suits of M.D.C. body armor (usually one light and one heavy), two weapons for each W.P., +1D4+3

E-Clips or equivalent clips of ammunition for each, Vibro-Knife (1D6 M.D.), Wilk's Laser Scalpel (1D6 S.D.C.), a survival knife (1D6+1 S.D.C.), brass knuckles (1D4 + punch damage and P.S. damage bonus), garrote (strangle cord, 1D6 S.D.C. +P.S. damage bonus), 60 feet (18.3 m) of lightweight climbing cord, military fatigues, pair of black leather gloves, two black jump suits and ski masks, one set of traveling clothes, one set of dress clothes, small wardrobe of clothing, language translator, laser distancer, pen flashlight, box of plastic surgical gloves (100 pair), gas mask and air filter, tinted goggles, knapsack, backpack, canteen, a high quality forgery of one different name and identity along with a weapons Permit for the same identity, and some personal items.

Cybernetics: Starts with Clock Calendar and Gyro-Compass implants. Due to the nature of their work, Enforcers tend to utilize cybernetic implants more than actual bionic reconstruction. Still, partial 'Borgs and Headhunters as Enforcers are acceptable. Most Enforcers try to obtain cyber-ware overtime but always in the form of weaponry, cyber disguises and combat-oriented enhancements. Enforcers have little use for any cybernetics that do not improve their combat and assassination capabilities.

Money: 4D6x1,000 in credits, and 1D6x1,000 in Black Market items.

Appearance: Enforcers primarily rely on two things: intimidation and force. To achieve this, Enforcers dress to scare and/or fight. Enforcer clothing is usually loose enough to allow freedom of movement. Many Enforcers favor the City Rat look (leather jackets or long trench coats, mirrored sunglasses, spiked objects in the clothes, etc.). For formal occasions, some Enforcers have their suits altered so that weapon bulges are apparent (and hopefully, intimidating) to anyone nearby.

Expediter

Expediters are procurement specialists. These are the guys who make things happen and get things done.

An Expediter is part troubleshooter, part scrounger, part deal-maker and part talent agent. He keeps his ear to the ground, ever alert for new opportunities or trouble brewing, and lets the right people know about it. If the Information Broker is an expert at *gathering* information, the Expediter is an expert at using it – at putting information together, drawing connections and using it to his benefit and the benefit of others. For example, an Expediter might contact a Case Man about an opportunity for a heist, or a Con Artist about a scam with a big payoff. He may also warn a Black Market Merchant, Lieutenant or Captain about the activities or plans of a rival or enemy, and pass along rumors (or hard facts) about a police raid coming their way sometime soon.

Some of this helpfulness is a service the Expediter does as a gesture to ingratiate himself with the higher-ups in a Black Market Faction as well as business people and buddies. Expediters love to have people owe them *favors*, big and small, and use favors as currency better than any other Black Marketeer. Other data he sells for a fair price or he may use to “squeeze” or leverage someone to do what he wants. Blackmail is such an ugly word, and one that an Expediter never uses, even though it is *what he does* all the time. The thing is, he does it so smoothly and in such a friendly, matter of fact way, many people don't even think of it as blackmail. That's because the Expediter rarely blackmails for money.



per month. This seems like a small price for the restaurant owner to pay to keep the Expediter happy, and he now has an excellent new employee. The new waiter owes the Expediter because he has a much needed job, so both of them are happy with the Expediter. And are also beholden to him. The Expediter then tells the waiter to listen in on any adventurer-types or Coalition officers, local law enforcement, etc. who dine at the restaurant, and pass what he hears on to the Expediter. Again, that may seem like a small favor to the waiter, but it may lead to giving the Black Market insight and information they would not otherwise possess, and who knows where that might lead.

If done with enough subtlety, many people who would not normally assist an organization such as the Black Market will do so unwittingly or unknowingly, especially if the Expediter is not publicly known to be connected to the Black Market or crime. Expeditors often pass themselves off as benevolent business people, concerned citizens, scholars and helpful Good Samaritans.

The middle name of all Expeditors should be "Networker" or "Can Do." They listen to everything, seem to know everyone (or at least know about them) and have a knack for being able to put their knowledge, connections and skills together to make things happen. Need to cover up a murder or get rid of a dead body before the authorities find it? The Expediter can handle it. Need to sell some hot stolen goods? He can arrange it. Need the help of a Black Market Con Artist, Enforcer, mercenary or hero? The Expediter will get right on it. Need to acquire something that's hard to find? Need drugs, medical supplies, machine parts, weapons, contraband? The Expediter is the guy to find it. He'll add 10-20% to the price as his "finder's fee" and the item may have a steep price tag, but nine out of ten times, if the item is available in his area of influence, the Expediter can find it. For a heist, he'll find the opportunity, put together the right team, get schedules, timetables and other vital data, put it in the hands of the right people on the team, and then arrange for the hot goods to be fenced or smuggled to wherever they have to go afterward. This makes the *Case Man*, *Information Broker*, *Professional Thief*, *Rift Runners*, *fences* and *smugglers* the Expediter's best friends. *Black Market Merchants*, too.

An Expediter's network of connections doesn't end there. He makes friends and contacts with everyone, from bartenders and bouncers, to the local City Rats, merchants, mercs, adventurers and even heroes and lawmen. In fact, Expeditors love to broker jobs for mercenaries and adventurers. In many cases, those he has befriended or chatted up have no idea he is a Black Marketeer. Making the Expediter arguably the most street savvy of all the Black Market specialists, even more so than the Information Broker.

Special Abilities of the Expediter O.C.C.

1. Black Market Benefits: All three Benefits are available to this character, but most Expeditors do not own their own business. Instead, most have a 10% stake in many businesses as a silent partner for helping to put the business together and get it started. When it comes to a money-making venture the Expediter helps to line up or put into motion, he gets a cut. Typically 5-10%, even if he was not actually involved in pulling off the deed. He's also the go to guy for putting together "teams" for robberies, raids, and any criminal operation, as well as helping to put together and start or fix a business enterprise. Again, his cut for helping a business get off the ground is 10% of the profit as a silent partner.

2. Special Abilities of the Black Marketeer: The Expediter starts with *Street Rep: Trustworthy* and *Friends in Low Places*;

It's usually *calling in a favor*. When a person who owes him a favor hesitates, he reminds them of the favor (or many favors) he's done for them and says, "You owe me. I need this. Make it right." If there is more resistance, the iron fist in the velvet glove tightens with, "I'm sorry. You need to do this. Or else . . ." And or else is never good.

Expeditors frequently try to couch their services in the form of casual favors to preferred clients. Some of these "favors" may seem innocuous or trivial to the performers of the service, but could ultimately prove invaluable to the Expediter or his Black Market Boss. For example, an honest restaurant owner may be short on his wait staff. An Expediter provides him with a hardworking waiter in exchange for a token favor, say, a 50% discount on one meal

AL
AS
#B
-AH
GH
!Z

especially within the Black Market. Pick two others of choice at level one and one additional at levels 3, 6, 9, 12 and 15.

3. Art of the Deal: This is an area of expertise rather than an actual skill, per se. Using information, forging alliances (often temporary) and cutting deals is what this character does for a living. Good Expeditors are able to see the big picture, the risks and the potential of a given deal or situation. It is not surprising that Expeditors are often good at games such as Go or Chess that require strategy. Talented Expeditors can size up a situation and look ahead several moves.

As many Expeditors explain, "the Art of the Deal" is not just knowing what you want, but also what the other participants want as well. Once you know those facts, you are in a stronger bargaining position. Next, you have to figure out what you actually need and what you are willing to accept. This puts the deal-maker in an even stronger position. Then, it all comes down to trying to get the most you can for the lowest cost. If you can come up with a deal that you are happy with, that's good! However, if you can work out a deal that the other guy is happy with as well (so that he'll talk you up to his friends and be willing to deal with you in the future), that's even better.

Sometimes, Expeditors will seem to lose the negotiations and get what seems to be a bum deal. However, this is usually not the case. Experienced Expeditors sometimes take a short-term loss to set up a greater reward later on or a bigger, better deal next time; much like a chess master sacrificing a piece to improve his position on the board.

4. Charm and Impress: As per the P.B. attribute, but regardless of the character's P.B., he gets an additional +15% bonus to charm and impress and an extra +5% bonus to the Seduction skill. **Note:** Expeditors are expected to share any inside information and use their skills to aid their Black Market colleagues. Many do this as a means of staying on good terms with their colleagues and working up some favors that may be called in if needed later. Expeditors are big on currying favor.

5. O.C.C. Bonuses: +2 on Perception Rolls indicating trouble and opportunity as well as recognizing clues and windows of opportunity, +1D4 to M.A. and +2 to P.B. attributes, +2D6 S.D.C., +1 on initiative, and +1 to save vs magic and psionic charms and mind control.

Black Market Expediter O.C.C. Stats

Alignment Restrictions: Any, but most Black Market Expeditors are Anarchist, Aberrant or other evil alignment.

Attribute Requirements: I.Q. 10 and M.A. 11 or higher.

Race Restrictions: None, per se. However, certain races that have a low Mental Affinity (M.A.) may not be suited to this position. Also, the Black Market generally prefers an Expediter to be attractive, as most people (human and otherwise) are more relaxed and amenable to dealing with good-looking and/or charismatic people. Thus, most are human beings or human-like.

O.C.C. Skills:

Language: Native Tongue at 96%.

Language: Other: Two of choice (+15%).

Barter (+15%)

Computer Operation (+10%)

Dance (+15%)

Find Contraband (+20%)

Intelligence (+10%)

Mathematics: Basic (+20%)

Photography or T.V./Video (+10%).

Pilot: Two vehicles of choice (+10%), any, except Military.

Prowl (+5%)

Radio: Basic (+10%)

Salvage (+10%)

Seduction (+12%)

Streetwise (+20%)

Surveillance Systems (+10%)

Wardrobe & Grooming (+12%)

W.P. Any, two of choice.

Hand to Hand: Basic

O.C.C. Related Skills: Select four other skills at level one. Select one additional skill at levels 2, 4, 6, 10 and 15. All new skills start at level one proficiency. These selections get the benefit of any bonuses that may be noted below. **Note:** O.C.C. Related Skills may be traded at a rate of two skills for one *Black Market Special Ability*, described earlier in the Black Marketeer O.C.C. section.

Communications: Any (+10%).

Cowboy: None.

Domestic: Any, but +10% to Brewing, Cooking, Fishing, and Recycling only.

Electrical: Basic Mechanics and Computer Repair only (+5%).

Espionage: Intelligence and Undercover Ops only (+5%).

Horsemanship: Any.

Mechanical: Basic Mechanics and Automotive only (+5%).

Medical: First Aid only.

Military: Field Armorer & Munitions and Recognize Weapon Quality only (+10%).

Physical: Any.

Pilot: Any.

Pilot Related: Any.

Rogue: Any (+10%).

Science: Any.

Technical: Any (+10%).

W.P.: Any.

Wilderness: Any.

Secondary Skills: The character also gets to select three Secondary Skills from the Secondary Skills list in *Rifts Ultimate Edition*, page 300. These are additional areas of knowledge that do not get any bonuses, other than any possible bonus from having a high I.Q. Skills start at the base skill level.

Standard Equipment: A suit of light or medium M.D.C. body armor, one weapons for each W.P., +1D4+2 E-Clips or equivalent clips of ammunition for each, a Vibro-Knife (1D6 M.D.), pocket knife (1D4 S.D.C.), pair of black leather gloves, a black jump suit and ski mask, one set of traveling clothes, one set of dress clothes, a small wardrobe of clothing, language translator, a PC-3000 hand-held computer, a full-sized portable computer, language translator, PDD pocket audio recorder, pocket flashlight, notepad, 1D4+3 pens or markers, gas mask, air filter, sunglasses, cigarette lighter, tinted goggles, backpack, satchel, briefcase, canteen, three high quality forgeries of different names and identities along with weapon permits for the same identities, and some personal items.

Cybernetics: The Black Market's view of cybernetics is mixed. Although not opposed to cybernetics, per se, they realize that augmentation can make an individual more recognizable and therefore easier to hunt down. However, due to the nature of their work, Expeditors tend to utilize cybernetics more than some of their fellow Black Market brethren. Black Market Expeditors start out with only one cybernetic augmentation, with

the most common choices being either the Fingerjack or the Language Translator. Much like the Information Brokers, Expeditors favor implants that lend themselves to dealing with information. However, Expeditors are more concerned with communication as opposed to information gathering. As they progress in experience, most Expeditors attempt to acquire more cyber-ware that will enhance their senses (auditory and visual) and their awareness of their nearby surroundings, such as motion detectors.

Money: 3D6x1,000 in credits, and 1D6x1,000 in Black Market items.

Appearance: Expeditors try to present themselves as being capable professionals who just happened to be fortunate enough to be on hand to assist the client in getting a great bargain. To this end, Expeditors have become social chameleons who dress and act like the people with whom they associate. Many dress somewhat flashy and flamboyantly – think in terms of publicists, Hollywood agents – to try to talk up the deal or benefits the client will receive. A good Expeditor sizes up what approach is required and tailors himself to fit the bill.

Information Broker

Information Brokers live by the old adage: knowledge is power. They are experts in gathering intelligence and it is their job to know what's going on all the time, as well as finding specific info when assigned to the task.

Information Brokers are always street savvy individuals who know how to keep a secret when called for, handle themselves in a scrap when it comes to that, and keep their cool in a crisis. They have a range of duties that one might associate with investigative reporters and detectives. Which means they don't just collect information, they analyze it, cross-reference it, recognize important clues, and assess the importance and value of the data in their hands.

Trained Information Brokers are spies who engage in espionage to collect information. They know where to find information, how to identify fact from fiction and have a network of sources they can trust to obtain and pass on information. These sources are a diverse gamut of people ranging from friends, associates and snitches to government officials, members of the scientific and academic community, and law enforcement. Some are friends and associates, some are looking for favors and some are paid informants. Among friends, associates and those looking for favors, City Rats are at the top of the list. They run the streets and one City Rat or another is likely to catch word of anything going on in the 'Burbs and cities. Such friends tend to work on the premise of "you scratch my back, and I'll scratch yours." This can mean easy access to cybernetics or contraband or something as simple as a good word to the Crew Boss or admission to the hot new nightclub in town. And you might be surprised how loyalty and information can be bought with small acts of kindness and little luxuries like candy, cigarettes, video disks, food, wine and other alcohol.

Some of these "sources" may not even be aware that they are providing the Information Broker with any data of value. Like the Expeditor, the Information Broker seems to have an endless network of contacts and friends. However, unlike the Expeditor, Info Brokers tend to be less flashy and more sneaky. They are masters at eavesdropping and most have incredible memories. Minor and Major Psychics with the psionic powers of *Empathy*, *Speed Read-*



ing, *Telepathy*, and *Total Recall* find easy work as Black Market Information Brokers. Even those with any one or two of those abilities can find work.

Empathy helps the Broker to "read people" and gauge a potential source of information's emotions. For someone like the Information Broker who is already skilled at reading people and assessing information, Empathy can be used as a sort of psychic Geiger-counter letting the snoop know when the individual is nervous, happy, sad, concerned, and a range of other emotions. Knowing how the other person feels can provide helpful "tells" and confirm the validity of information. A happy chap shooting off his mouth about making a big score tomorrow is probably telling the truth. A suspicious or concerned individual may be hiding something or holding back. An angry man who has just gotten fired or treated unfairly by his boss is probably a reliable source of information about that boss, his business, schedules, security, and so on. And if the offended individual seeks revenge, he may be willing to provide even more damaging information or serve as the inside man for a heist. Similarly, Empathy helps the Information Broker know when he is pushing an information source too

far and he needs to change tack or walk away. **Speed Reading** has its obvious advantages. **Telepathy** enables the Information Broker to hear surface thoughts, which can provide more tells and bits of unspoken information such as a time, date or name of a particular person, maybe even an address. However, what most people don't realize is that humans and D-Bees are visual beings, so rather than the address number or the full name of a person, Telepathy may show the psychic what the building looks like, or an image of the room that contains the safe or documents desired, or a man or woman's face, and so on. Still, all of this is useful information, especially when compared to other bits of info. And that's where **Total Recall** comes in handy. Additional psionic abilities such as Clairvoyance, Object Read, Sense Evil, Sense Magic, Sixth Sense, and any of the Telemechanic abilities are all a plus, but the four described above, especially *Telepathy* and *Total Recall*, are enough to give an Information Broker a huge advantage.

Information is a commodity many people underestimate or overlook. But not the Black Market. For it, information can be worth more than gold.

What would you pay to know when and where to be to take advantage of an opportunity, or where not to be to avoid a trap? How much is it worth to know you can trust this person but not that one? That kind of knowledge is the stock in trade of the Black Market Information Brokers. It is their job to tap into the flow of information and know which info is legitimate and which is baloney. Information that the Black Market can utilize directly, indirectly or as leverage for favors.

The Black Market found long ago it was best to keep well informed of the activities and schedules of local law enforcement, rivals, enemies and friends. It pays to know who is in charge of which patrols and how amenable someone might be to cooperating with the Black Market, or how willing they are to accept a bribe. Such details can mean the difference between failure and success. Making a profit or going to prison. With so much happening, especially in the 'Burbs and large cities, it pays to know what's going on. In the case of the Black Market and criminal enterprises, there are almost always opportunities for those aware of them. Competition can be fierce and have deadly outcomes, so again, information is extremely valuable. The Black Market is not about to let any opportunity slip through its fingers or let competitors or the authorities get the upper hand on them.

Information is worthless if you don't know where to find it or how to use it. That's where the expertise of Information Brokers come in. **a)** They are masters at gathering information. **b)** They are gifted at sifting through data, and comparing, compiling and seeing, not only the meaning, but the value and opportunities that it provides. They then use that information themselves or turn it over to their Boss, teammates or other associates.

Part spy, part detective and part "broker," the character knows how to package and sell the information he uncovers. Though an Information Broker may use information to leverage someone into doing something or win favor, most are more interested in making a buck with their skills. Many are willing and able to perform detective-style investigations, tail and surveil targets, gather dirt on them, or engage in industrial espionage. On their own they may steal and sell such secrets, and often the first person they call is the one they stole it from. "I assume you don't want this information to fall into the wrong hands (or go public)."

Their spy and investigative detective sensibilities make many Information Brokers clever extortionists who make a nice living at blackmail. They rarely engage in actual kidnaping. They don't

have to. They deal in information and secrets. And the best secrets are usually the ugliest or most dangerous, so people are willing to pay a great deal of money or do crazy and criminal things to keep them secret.

As a broker of secrets and valuable information, the character is always happy to *purchase* or *trade* for more secrets. Of course, he or she always downplays the true value or validity of the information being offered for sale, and most Information Brokers have wonderful poker faces that belie the truth. They do this so they can purchase the info for as little as possible.

Depending on what the information is and how savvy the seller is about its value, it may be purchased for the price of a dinner, a bottle of booze, or thousands of credits. It may surprise some people to learn that the average piece of information is purchased for 1D6x100 credits. Much more valuable secrets – those potentially worth tens of thousands or hundreds of thousands of credits – are often purchased for as little as 1D6x1,000 credits and rarely more than 4D6x1,000 credits. Even big ticket info worth a million or several million seldom garners more than 2D6x10,000 credits. The reasons for these low-ball prices are many, but here are the main ones. **1.** How does the Information Broker know the info is genuine and accurate? **2.** Who else knows this info? How many other people has the seller or his associates sold this to, or shot their mouths off to? **3.** How does the purchaser know the seller won't tell it to someone else as soon as he leaves? **4.** The buyer is the one taking all the risk. He's willing to only pay so much, because he may not be able to profit from it. **5.** How many people actually have a use for this information and are willing to pay for it? Not many. In fact, one of the advantages of selling info to an Information Broker is that they have a long-standing reputation of paying for it rather than beating or torturing it out of the seller. A claim other criminals, mercenaries, and the authorities cannot make.

As a result, the negotiation usually ends with the Information Broker saying, "I'll give you X. Take it or leave it." It is only when a seller of something truly valuable gets up to walk away that an interested Broker *may* make a better offer or engage in haggling. If the price is too steep, or the Information Broker is honestly not interested, instead of buying the info himself, he may offer to "broker a deal" between the seller and one of the Broker's many contacts. For this, he usually gets a broker's fee of 10-20% of the amount that is paid to the seller. Only sellers who really know what they have and what it is worth will get top dollar or better than usual.

Information Brokers are also masters of providing *disinformation*. The Black Market has found that for certain transactions, it can be very useful to have one's adversaries and rivals (and even one's partners) operating with inaccurate or less than complete knowledge of the true situation. Information Brokers know how to seed false leads and information, clues and red herrings that send people on wild goose chases and lead to dead ends, as well as planting misleading evidence and subtly encouraging wrong assumptions and bad ideas to misdirect, confuse and distract.

Special Abilities of the Information Broker O.C.C.

1. Black Market Benefits: All three Benefits are available to this character, but most Information Brokers stay focused on their information business, supplemented by extortion rackets and detective and espionage work. Any formal business is likely to be related to these, such as a detective agency. For most, buying and selling information is their business, and they do very well at it.

2. Special Abilities of the Black Marketeer: The Information Broker starts with *Informant: Confidential*, *Informant: Street*

Snitch, Street Rep: Trustworthy and *Friends in Low Places*, especially within the Black Market. Pick one other of choice at level one and one additional at levels 2, 4, 8, 12 and 15.

Speaking of contacts, put an Information Broker together with an Expediter, a Con Artist and a Case Man and watch out. In fact, these Black Marketeers often gravitate toward one another. The right combination of these personalities can create a force to be reckoned with, especially when part of a larger crew with muscle and other skills. But the wrong personalities can turn these complementary O.C.C.s into cutthroat rivals or bitter enemies.

3. Information Grapevine: The Information Broker's stock in trade is information and he cannot afford to be too fussy about where or how he gets his information. Brokers do not wait for information to drop into their laps, they are proactive and set up networks for gathering (and disseminating) information. These networks or "grapevines" may consist of a number of different things, but rely on operatives, contacts and snitches. **Note:** Part of that grapevine is a street reputation that the Information Broker pays for reliable information on many subjects.

An Information Broker's grapevine network may come from all walks of life, ranging from strategically placed personnel in various media, law enforcement, military offices, researchers at universities, to workers and clerks at businesses, bartenders, prostitutes (they can learn a lot from their customers in the sack!), City Rats, crooks and homeless street people. The motives of operatives in the grapevine also vary. Some do their tasks just for profit of some type – cash, status, power (real or imagined), trade goods, a paying job, etc. – while others may be paying off a debt or favor, or have an ulterior reason (wants to become a Black Marketeer, likes having connections to the Black Market, seeks revenge against the government, law or business, is a spy or undercover agent himself and is spying on the Information Broker or the Black Market, or feeding them information for his own purposes, and so on). What positions these contacts hold and what information they can gather (or spread) is dependant on the role-playing skills of the player and the discretion of the G.M.

4. Spyware: Information Brokers do whatever it takes to gather information, and that includes expert use of bugs, listening devices, cameras and surveillance equipment. Both high-tech spyware and mystical devices can provide a Broker with invaluable (and very profitable) information. Starts with 1D4 of each type of bugs and surveillance devices; see the equipment section of **Rifts® Ultimate Edition**.

5. Psionics: Two-thirds of Black Market Information Brokers are at least Minor Psychics who possess abilities suited for spying and gathering information and intelligence. Roll percentile dice for a random determination or pick one, provided the G.M. allows this.

01-33% No psionic abilities, but a bonus of +1D4+1 to the character's M.A. and M.E. attributes and +1 to Perception Rolls regarding information and recognizing clues and opportunities.

34-43% Minor Psychic with the psionic abilities of *Empathy* and *Telepathy*. I.S.P. is M.E. attribute number +2D6 to start and +1D6 per level of experience.

44-53% Minor Psychic with the psionic abilities of *Speed Reading* and *Total Recall*. I.S.P. is M.E. attribute number +2D6 to start and +1D6 per level of experience.

54-63% Minor Psychic with the psionic abilities of *Telepathy* and *Total Recall*. I.S.P. is M.E. attribute number +2D6 to start and +1D6 per level of experience.

64-73% Minor Psychic with the psionic abilities of *Empathy* or *Telepathy*, and *one Sensitive ability of choice*. I.S.P. is M.E. attribute number +2D6 to start and +1D6 per level of experience.

74-83% Minor Psychic with the psionic abilities of *Speed Reading* or *Total Recall*, and *one Sensitive ability of choice*. I.S.P. is M.E. attribute number +2D6 to start and +1D6 per level of experience.

84-88% Major Psychic with the psionic abilities of *Empathy*, *Telepathy*, *Speed Reading* and *Total Recall* plus *four other Sensitive abilities of choice*. I.S.P. is M.E. attribute number +4D6 to start and +1D6+1 per level of experience. Reduce the number of starting O.C.C. Related Skills in half.

89-93% Major Psychic with the *eight Sensitive abilities of choice*. I.S.P. is M.E. attribute number +4D6 to start and +1D6+1 per level of experience. Reduce the number of starting O.C.C. Related Skills in half.

94-98% Master Psychic such as a Mind Melter, Mind Bleeder (rare), Psi-Ghost, or Psi-Tech. I.S.P. as per the appropriate Psychic O.C.C. Do NOT select ANY O.C.C. Related Skills at first level.

99-00% Mystic with psionic and magical abilities suitable for an Information Broker. I.S.P. and P.P.E. as per the Mystic O.C.C. Do NOT select ANY O.C.C. Related Skills at first level.

6. O.C.C. Bonuses: +1 on all Perception Rolls, +1 to M.A. attribute, +2D6 S.D.C. and +1 to save vs psionic and magic illusions.

Information Broker O.C.C. Stats

Alignment Restrictions: Any, but most lean toward Anarchist and Aberrant.

Attribute Requirements: I.Q. 12 or higher, a high M.A. and M.E. are also recommended, but not required.

Race Restrictions: None.

O.C.C. Bonuses: Tends to be methodical, +3 on Perception Rolls.

O.C.C. Skills:

Computer Operation (+20%)

Computer Programming (+5%)

Computer Hacking (+12%)

Intelligence (+25%)

Language: Native Tongue at 98%.

Language: Two others of choice (+20%).

Literacy: Native Language (+20%)

Lore: Three of choice (+10%).

Mathematics: Basic (+20%)

Prowl (+15%)

Pilot: One of choice (+5%).

Radio: Basic (+10%)

Research (+20%)

Streetwise (+15%)

Surveillance Systems (+12%)

W.P.: Any two of choice.

Hand to Hand: Basic; can be changed to Expert at the cost of two O.C.C. Related skills.

O.C.C. Related Skills: Select four other skills of choice plus one additional skill at levels 2, 4, 8 and 12. All new skills start at level one proficiency. These selections get the benefit of any bonuses that may be noted below. **Note:** O.C.C. Related Skills may be traded at a rate of two skills for one *Black Market Special Ability*, described earlier in the Black Marketeer O.C.C. section.

Communications: Any (+15%).

Cowboy: None.

Domestic: Any, but +10% to Play Musical Instrument and Sing only.

Electrical: Basic Mechanics and Computer Repair only (+5%).

Espionage: Disguise, Escape Artist, Forgery, Impersonation and Undercover Ops only (+10%).

Horsemanship: Any.

Mechanical: Basic Mechanics only.

Medical: First Aid only.

Military: Military Etiquette only.

Physical: Any, except Gymnastics and Boxing.

Pilot: Any.

Pilot Related: Any.

Rogue: Any (+10%).

Science: Any.

Technical: Any (+5%; +10% to History, Law and Lore skills only).

W.P.: Any.

Wilderness: Identify Plants and Fruit and Wilderness Survival only.

Secondary Skills: The character also gets three Secondary Skills at level one and one additional at levels 4, 8 and 12, from the Secondary Skills list in **Rifts Ultimate Edition**, page 300. These are additional areas of knowledge that do not get any bonuses, other than any possible bonus from having a high I.Q. Skills start at the base skill level.

Standard Equipment: One weapon for each W.P., +4 extra clips of ammunition for each weapon, top-of-the-line computers including two handheld computers, a portable computer, a full-size desktop computer and monitor with all necessary peripherals and heavy filters (A.R.: 17, S.D.C.: 75), portable electronics tool kit, pocket recorder, language translator, digital camera, flashlight, pen flashlight, pocket-size notepad, 1D4 pens, two spare sets of traveling clothes, one set of dress clothes, two high quality forgeries of different names and identities along with weapons permits for the same identities, and some personal items.

Cybernetics: None to start. Psychics tend to avoid them. Non-psychics may get cybernetic implants suitable for gathering and recording information, including sensory enhancements and cyber-disguises.

Money: 4D6x1,000 in credits, and 1D6x1,000 in Black Market contraband.

Merchant

Black Market Merchants are independent freebooters who buck the CS and the authorities. Many see themselves as rebels who may even work outside the Five Factions in order to strike out on their own. Many get a rush defying the authorities. They answer to no one, except their clients, customers, and Black Market Boss. That's all fine to the Black Market Merchant because he's out to make money, not save the world or strike down evil. He doesn't care about magic powers or battling demons or ancient secrets. He cares about making a buck.

Black Market Merchants, also known as Traders, often have two or more business enterprises going at once. That way, if one gets taken down by the authorities, a rival, or random monster from the Rifts, he still has income flowing in. What types of business and criminal activities he's into will depend on the interests of the Merchant and opportunity. Some have their hands in just about

everything illegal. Some focus on smuggling and selling goods wholesale. Many open storefronts, bars, or merchant caravans to sell retail where there is a bigger profit to be made. Others invest everything into one or two holdings and milk them for all they are worth. And some go adventuring to scout out territory, acquire relics or magic, and make connections. Along the way, they sell whatever loot they get, and work as go-betweens for their adventurous associates and the Black Market.

While starting a business and improving cash flow is first priority to most Black Market Merchants, there is more to them than just signing papers and counting inventory. The Merchants who own their own businesses set goals and procedures, but then often hire staff to handle the day to day grind while they seek new opportunities or satisfy cravings for adventure.

Merchants tend to be risk-takers who think quickly on their feet and try to adapt to changing situations, or at least that's the M.O. of the most successful ones. If they have a disadvantage in the field, it is that most are not fighters and may find themselves in over their heads in combat, especially large battles. Many are also city folk



who take a while to get adjusted to traveling through the wilderness or going off on exploratory campaigns. That said, adventure and travel are second-nature to most Merchants as they desire to see the world and to find new merchandise to sell and areas to exploit.

A Black Market Merchant can set up an enterprise almost anywhere. While a storefront, tavern, restaurant, hotel or office seems logical, those with limited resources selling contraband or running criminal enterprises may *start out* from a back room, street corner or out of the trunk of a car. Some of the more daring just takeover an abandoned building or house and work there until the authorities or the owner catch wind of the operation and come to arrest them or force them out. This works out fine for many illegal businesses, as it may be best to “move around” to keep the law off their backs anyway. And using a building without paying for rent or having to worry about its upkeep is a profitable move that pays off more often than not.

Traveling Black Market Merchants are some of the boldest, most inventive and creative of merchant entrepreneurs. They risk life, limb and product to make their sales, but they get to see the world, forge new ground and enjoy a certain amount of adventure, for those who crave it. And the person wouldn't be a Traveling Merchant if he didn't seek adventure. It is the Traveling Black Market Merchant who is at the forefront of carving out new territory. They are also much more likely to find or be approached with exotic, alien and magic weapons, devices and artifacts. And they're also the ones who will have face to face contact with infamous outlaws, mercenary companies, rebels, monsters, and resistance fighters, as well as Cyber-Knights, Reid's Rangers (vampire hunters), and other heroes.

Over time, many Traveling Merchants establish a specific route and traverse the same circuit, making regular stops. This enables them to form business and personal relationships with the people they meet in towns and trading posts along the way. **Low-level (1-4) Traveling Merchants** tend to target small towns and trading posts in remote regions or make the rounds to the newer 'Burbs and refugee camps, hitting 6-10 settlements at least twice in a year, often 4-6 times. They expand from their humble beginnings by slowly building their route, adding new stops, taking different routes, and establishing a few permanent or semi-permanent sales outlets or trading posts of their own. Some small and mid-sized Traveling Black Market Merchants become part of a mercenary company or traveling show. **Mid-level (5-8) Traveling Merchants** expand from a small mobile operation to a larger traveling caravan or a couple of merchant caravans and/or traveling shows, carnivals or a circus. While some prefer life on the road, others quit traveling to establish permanent Black Market stores and criminal enterprises at one or more established trading posts, towns or 'Burbs where they have enjoyed their best sales when on the road. Or the merchant might set up a few permanent locations and continue running one or two Traveling Merchant operations. **High-level (9+) Traveling Merchants** take extended trips across the country in large merchant caravans or may establish one or two expansive operations at one or more towns, cities and/or 'Burbs. The most successful may start his own Merchant Town and/or establish one or more permanent enterprises at someone else's Merchant Town, provided he's allowed to do so by the group who started it, or takes it over for himself.

Traveling Merchants are usually willing to buy and trade for just about anything. They keep tons of gear, some of it useful, some not. Some believe that everything is useful to somebody, at

some point, so they may trade you that rusty shovel for a microwave dinner. Many merchants are willing to take a loss on a deal in the short term, if they think they can get something rare, quirky, or interesting to sell later and make a nice profit then. Some also create their own unique folk art, knickknacks, herbal medicines, moonshine, elixirs (often moonshine), and micro-brewed beer to sell. Others sell a small selection of booze or moonshine but also offer entertainment and put on shows, which is always a big hit in communities in remote areas.

Game Note: A Traveling Merchant or any Black Market Merchant can be a fun player character in the right player's hands. They also make great NPCs (Non-Player Characters) for Game Masters. As an NPC, the merchant can offer a player group information, jobs, clues, warnings and instigate trouble and adventure. They can also be a life-saver if encountered when the player characters are short on supplies or in need of help. There will be a charge for “help” (and most everything else, for that matter), but it can also lead to adventure.

Special Abilities of the Merchant O.C.C.

1. Black Market Benefits: All three Benefits are available to this character.

2. Special Abilities of the Black Marketeer: The Merchant starts with *Fence* and *Friends in Low Places*. Pick two additional of choice at level one and one more at levels 3, 7, 10 and 13.

3. Travel Information & Tips: Traveling Merchants are not usually a front for Bandits or Raiders. Nor are they aggressive or combative. When away from home and friends, Traveling Merchants need to be on their friendliest behavior, especially when trying to sell something. Spending so much time out on the road, most Traveling Merchants form a loose network for buying, selling and information gathering. The information end of things means being tapped into a rumor mill, but with a lot more truth and accuracy. Traveling Merchants have a code of honor among their peers. They may lie to their customers, but rarely to each other. Those who do lie are never trusted again and no longer given professional courtesy, and fall into all sorts of trouble.

The usual trade-off is one important bit of information for another. Important information would be about recent bandit or monster attacks, strange activity at local ley lines, demon and monster sightings, CS troop movements in the area, mercenary operations, natural disasters, strange anomalies, warnings of trouble, politics and gossip at local towns, sales leads, good rest stops, watering holes, a safe place to hole up, customers who can or cannot be trusted, and any other information that might have value. If it is an *unsubstantiated rumor*, it will be represented as such, but may still be a possible lead. When none of these things are going on, Traveling Merchants talk shop, discuss their vehicles, the weather, their families, deals gone wrong, and other small talk. And sometimes, they just like to gossip about one another. **Base Skill:** 52% +4% per level of experience. A successful roll means the character learns something important, interesting, or mysterious from a colleague. NPC merchants will reveal a rumor or clue.

4. O.C.C. Bonuses: +1 on Perception Rolls pertaining to a good deal, +3D6 S.D.C., +1 to M.A. and +2 to P.E. attributes.

Black Market Merchant O.C.C. Stats

Also Known As: Trader and Traveling Merchant.

Alignment: Any, but most Black Marketeers are selfish or evil alignments.

Attribute Requirements: M.A. of 9, P.E. of 10.

Racial Restrictions: None; D-Bees are common for this occupation.

O.C.C. Skills:

- Appraise Goods (+20%)
- Barter (+20%)
- Detect Ambush (+5%)
- General Repair & Maintenance (+10%)
- Horsemanship: General or Horsemanship Exotic (+10%), pick one.
- Land Navigation (+5%, but +12% along his usual route).
- Language: Native Tongue at 90%.
- Language: Two of choice (+15%).
- Law: General (+5%)
- Mathematics: Basic (+25%)
- Pilot: Hovercraft (+10%)
- Pilot: Truck (+16%)
- Public Speaking (+5%)
- Recognize Weapon Quality (+10%)
- Roadwise (+10%, but +20% for Traveling Merchants).
- W.P. Rifles or Shotgun, pick one.
- W.P. Energy Pistol or Energy Rifle, pick one.
- Hand to Hand: Basic; can be changed to Expert at the cost of two O.C.C. Related Skills or Martial Arts (or Assassin if evil) for the cost of three skill selections.

O.C.C. Related Skills: Select five skills at level one and one additional skill at levels 3, 6, 9 and 12. All new skills start at level one proficiency. These selections get the benefit of any bonuses that may be noted below. **Note:** O.C.C. Related Skills may be traded at a rate of two skills for one *Black Market Special Ability*, described earlier in the Black Marketeer O.C.C. section.

- Communications: Any (+5%).
- Cowboy: Lore: Indians (+10%) only.
- Domestic: Any (+10% to Brewing and Wardrobe & Grooming only).
- Electrical: Basic Electronics only.
- Espionage: None.
- Horsemanship: Exotic Animals (+10%) only.
- Mechanical: Basic Mechanics and Automotive only.
- Medical: Brewing: Medicinal and First Aid only (+5%).
- Military: None.
- Physical: Any, except Acrobatics, Gymnastics, Boxing and Kick Boxing.
- Pilot: Any (+2%), including military vehicles.
- Pilot Related: Any.
- Rogue: Any (+10%).
- Science: Mathematics: Advanced only (+10%).
- Technical: Any (+10%).
- W.P.: Any.
- Wilderness: Wilderness Survival (+5%) only.

Secondary Skills: Four Secondary Skills at first level. Select one additional skill at levels 3, 6, 9 and 12. Selections are made from the Secondary Skill list on page 300 of *Rifts Ultimate Edition*. These are additional areas of knowledge that do not get any bonuses, aside from any possible bonus from having a high I.Q. attribute. All Secondary Skills start at the base skill level.

Standard Equipment: One weapon for each W.P. plus 1D4+4 E-Clips for each or equivalent ammunition. (**Note:** Many Merchants prefer light weapons with larger payloads and good range, mostly just to scare away animals and lightly-armed bandits.) Body Armor is typically light or medium, but may

also have some heavy armor for when traveling through hostile territory. Of course, they can use anything in their inventory, provided they know how to operate it.

Merchants tend to be pack rats, and have a smattering of personal effects, including a decent-sized wardrobe of clothing for all occasions, photographs, souvenirs, pre-Rifts artifacts and other oddities. In addition, most have a large folding tent, sleeping bag, 100 feet (30.5 m) of rope, binoculars, language translator, a canteen and water filtration device, sunglasses and/or tinted goggles, a map of several trade routes, compass, air filter, gas mask, a couple of backpacks, a satchel, several sacks of various sizes, and 1D4 large and small wooden crates to store cargo.

Business gear includes a large sign printed on a tarp or vinyl material that can be rolled up and unrolled with ease, though some have lighted neon signs or painted signs. Some also paint the sides of their trucks and vehicles, though this can be an open invitation to bandits and raiders when traveling through hostile territories. Other gear includes a small safe, shelving and display materials, a portable electric generator, a portable electronic credit transfer device, a portable computer with software to help in business transactions and to keep track of inventory, one or more timepieces, a dozen pens, markers and pencils, a dozen notepads and other odds and ends.

The character starts with a small, inexpensive vehicle with better than average cargo space, such as a robot horse with a hitch to pull a cart, or a beat-up old hover jeep, pickup truck, van or mini-van. If a *Traveling Merchant*, the vehicle should be capable of managing rough terrain and wilderness conditions. The character will want to invest in better transportation as soon as he can.

Money: 2D6x1,000 credits to start and 4D4x1,000 in tradeable goods.

Cybernetics: None to start, but may acquire cybernetic systems as they desire. Exactly how much cybernetics a Merchant may acquire depends entirely on the individual and his success. However, merchants have found preserving their humanity and humanoid appearance is important, as people are generally less trusting and open to machines and partial machines such as cyborgs.

Raider

An Independent Operative – not a Black Market O.C.C.

The term “raider” is used loosely by the people of Rifts Earth to describe any individuals or groups who stick mostly to the fringes of civilization and rely on sacking and looting as a means of survival. Raiders attack small towns and villages, caravans, and traveling adventurers. They steal food, weapons, armor, magic items, vehicles, livestock and occasionally take captives. Raiders may also pillage and rape, though the smart ones refrain from devastating damage so they may return to raid the people repeatedly. They vary in degrees of ruthlessness and cunning, but most Raiders are violent bandits who enjoy fighting and taking what they want. In many cases, Raiders have no other means of support, or at least no honest work they are willing to accept. For many wilderness people, these armed bullies and cutthroats are a part of daily life, and they are constantly alert in defense against them. However, un-



consist of D-Bees and monsters with unnatural powers. Beings such as Brodkil, Psi-Goblins, Worm Wraiths, Simvan Monster Riders, Horune Pirates and various mutants, barbaric D-Bees, evil psychics and practitioners of magic, especially outcasts, take to preying on others, as do a wide variety of sub-demons such as Gargoyles, Lesser Demons and other monsters. Very few raiders have any level of formal education though they may possess psychic or magic abilities, and all are well trained in combat. They use hit-and-run tactics, striking from ambush or at night, taking as much as they can grab before running off. Anyone who dares to stand against them becomes a target and is taken down. Many Raiders are vicious and cruel cutthroats who murder anyone who raises a fist against them, and some engage in wanton pillaging, the burning of towns, rape, and slavery. Some of the worst engage in the practice of Necromancy, human sacrifice, and cannibalism, and other dark arts or demon worship. While the average raiding party is 7-12 (1D6+6) strong, larger groups have 2D6+14 members and the largest may have 2D4x10+12 members. The boldest Raiders of any size are known to even attack Coalition patrols, mobile bases and supply convoys. Again, using hit and run, grab and snatch tactics.

Raider attacks are more organized than many people give them credit for, though they are often undisciplined, wild, and sloppy. Moreover, when they get caught up in rage and bloodletting, Raiders may fight till their last dying breath or until everyone else is slaughtered. When Raiders launch an attack, it is often without warning and involves whooping, hollering, war-cries and gunfire as well as lobbing grenades, setting fires and doing whatever they can to scare the hell out of their victims. But these tactics are more than acts of malicious destruction and violence. They are designed to catch people off-guard, create confusion, draw out town defenders and keep them busy in one part of town while the majority of the Raider's snatch whatever valuables they can in another part of town, before taking off in every direction. This practice usually involves many injuries, casualties and property damage for the victims, and minimal casualties for the Raiders, who have a plan of attack and rendezvous point. Conducting raids, however, is always a gamble, and Raiders can take a considerable losses, especially when they lose the elements of surprise and terror, or face combat veterans defending a community.

Professional Raiders are individuals who have been members of a raiding party for a long time, often their entire lives. Some were born into it, some were taken as children and indoctrinated into the life of a Raider, and some just ended up that way after leaving civilization behind for whatever reason. The difference is that while most raiders are poorly educated barbarians who prey on others like animals, the Professional Raider is exceptionally talented at this sort of lifestyle. And uneducated is not that same as stupid. Many Raiders are cunning, ruthless and experienced fighters. Their leaders are always smart, charismatic and capable of using military-style strategies and tactics in their attacks. Raider leaders know how to use terrain features, psychology, and tactics to get what they want. Many also have sense enough to conduct raids with a minimum expenditure of resources and casualties. If a targeted community quickly proves to be too tough, a smart leader will cut his losses, take what they can and ride off. However, Raiders tend to pride themselves on being the toughest and deadliest, and do not take defeat well. Odds are, they'll be back, only next time they'll bring more men and/or firepower and plan better. Not only will they seek to prove themselves, but they automatically believe the communities with the best defenses and fighters must

less a wilderness community has one or more powerful defenders, they are at the mercy of Raiders. Some communities even strike a bargain with the villains, agreeing to leave a designated amount of food, livestock or supplies on the edge of town at specified dates and times, or upon demand. Many communities consider this distasteful deal as a sort of tax or levy they must pay to survive.

Most Raider bands consist of 4D6 individuals, armed with medium to heavy Mega-Damage weaponry. Many of these gangs

also have something valuable worth protecting and they want it. Many leaders of Raiders are so personable, intelligent and admired by other cutthroats, that they can attract members from rival raiding parties or bandits to join them on big raids and attacks where everyone can share in the loot. Many a merchant caravan or adventuring group may seek to negotiate if they learn a particular Raider has his people set on attacking them. The well-known Raider may often show mercy to his victims, if for no other reason than to plunder them again, and to let stories of his power and influence spread further so he does not have to put his own people in danger.

If left unchecked, Raiders can grow into upstart warlords, leading armies of hundreds or even thousands of Bandits and Raiders. These large-scale operations can absolutely decimate small towns they run through, and have been known to attack cities as large as Kingsdale and El Paso. Once they get this large, however, they tend to leave the truly powerful groups alone. No Professional Raider wants to ruin all he has worked for by bringing down the full force of the CS Army, Cyber-Knights, mercenary companies, the Five Black Market Factions, or the Pecos Empire upon his head.

Raiders are involved the Black Market primarily as a seller of stolen goods and purchaser of weapons and supplies. Small black market groups are the biggest buyers of ill-gotten gains from Raiders, buying up new and used weapons, armor, vehicles and magic items for barter and trade. The Black Market sometimes employs Raiders and mercenaries as escorts and defenders of large merchant caravans and sometimes to attack and raid the caravans of rivals and enemies. Some will also pay Raiders "protection money" to insure that their cargo and operations are not sacked and carried off, especially if the fee is not steep.

Special Abilities of the Raider O.C.C.

1. Black Market Benefits: None. Not a member of the Black Market and Raiders are never admitted to the Black Market, unless retired and taking on a new career (rare). Raiders never have their own business. Raiding is their career.

2. Special Abilities of the Black Marketeer: Though not a member of the Black Market, these criminals get the equivalent of the Black Market Abilities of *Home Turf Advantage*, *Street Rep: Hardcase to be Feared* and either *No Conscience* or *Steady Nerves*. Does not get any others with experience.

3. O.C.C. Bonuses: +2D6+6 S.D.C., +2 on initiative, +3 to pull punch, +2 to roll with impact, and +1 to save vs Horror Factor at levels 2, 4, 7, 9, 12 and 15.

Raider O.C.C. Stats

Alignment: Selfish or evil, though most tend to be Anarchist (30%), Miscreant (30%), Diabolic (20%) and Aberrant (15%).

Attribute Requirements: I.Q. 9 and P.E. 11.

Racial Requirements: None. Anywhere from one-third to two-thirds of a Raider group can be D-Bees or even more monstrous beings, as well as humans.

O.C.C. Skills:

Speak Native Language at 86%.

Language: One of choice (+20%).

Radio: Basic (+10%)

Camouflage (+20%)

Detect Ambush (+20%)

Find Contraband (+5%)

Horsemanship: General or Exotic Animals (+20%).

Intelligence (+10%)

Pilot: Any except water vessels, one of choice (+10%).

Land Navigation (+20%)

Recognize Weapon Quality (+15%)

Streetwise or Roadwise (+10%).

Wilderness Survival (+15%)

W.P. Ancient: Two of choice.

W.P. Modern: Two of choice.

Hand to Hand: Expert; can be changed to Martial Arts (or Assassin if evil) for the cost of two O.C.C. Related Skill selections.

O.C.C. Related Skills: Select six skills at level one, and one additional skill at levels 3, 5, 7, 9, 12, and 15. All new skills start at level one proficiency. These selections get the benefit of any bonuses that may be noted below.

Communications: Any (+10%).

Cowboy: Any.

Domestic: Any.

Electrical: Basic only.

Espionage: None.

Horsemanship: Any (+5%).

Mechanical: Basic only.

Medical: None.

Military: Any (+5%).

Physical: Any.

Pilot: Any (+5%).

Pilot Related: Any.

Rogue: Any (+10%).

Science: Mathematics only.

Technical: Any (+5%).

W.P.: Any.

Wilderness: Any (+10%).

Secondary Skills: Three Secondary Skills at first level and one additional at levels 4, 8 and 12. Selections are made from the Secondary Skill list on page 300 of **Rifts® Ultimate Edition**. These are additional areas of knowledge that do not get any bonuses, aside from any possible bonus from having a high I.Q. attribute. All Secondary Skills start at the base skill level.

Standard Equipment: One weapon for each W.P., 1D4+2 additional E-Clips/ammo clips for each, a Vibro-Blade, large survival knife (does 1D6+1 S.D.C.) or machete (2D4 S.D.C. damage), medium to heavy M.D.C. body armor (including Bandito Arms types or Northern Gun and modified Coalition and Dog Boy armor), holster and belt for pistols and revolvers, wide-brimmed hat or baseball cap, poncho, spurs, set of riding/traveling clothes, a set or two of additional clothing, leather gloves, bandana/large handkerchief, 1D4 disposable cigarette lighters, flashlight, passive nightvision goggles, binoculars, tinted goggles or sunglasses, small folding tent, bedroll, backpack, two saddlebags or satchels, two large sacks, two small sacks, 20 feet (6.1 m) of rope, utility belt, air filter, two canteens or water skins, and some personal items.

Starts with a good quality horse or other riding animal; if the G.M. allows it, this could be a robot animal. In the alternative, it can be a slightly battered hover vehicle, or all-terrain ground vehicle that fits the character's Piloting skill.

Money: Starts with 2D4x1,000 in credits and 1D6x1,000 in Black Market items.

Cybernetics: None to start, but many acquire cybernetic systems and bionic limbs and weapons over the course of their lives. Exactly how much cybernetics a Raider may acquire depends entirely on the individual and what he can afford.



Refurbisher

One of the major sources of income for the Black Market is the sale of “used” and “stolen” weapons, armor and equipment. This requires someone to inspect, clean and make sure the items are in good working order. That’s where the Black Market Refurbisher comes in.

Refurbishers are sometimes likened to the “poor man’s Operator” as they are not thought to be as well-rounded or adept as the more famous and respected Operator. However, this is not quite the case. It is a matter of unique specialization and the fact is that the Black Market requires Refurbishers to have a different set of priorities and skills.

Although Refurbishers service, modify, adapt, and repair a whole gamut of technological hardware, their focus is on getting such items up and running in “good enough” condition. Since the customer usually expects secondhand equipment to malfunction or break down sooner than if they had purchased the item new from the dealer showroom, Refurbishers clean them up to look like new

and make only the most necessary repairs and modifications. Their Black Market employers want Refurbishers to gear repairs toward a shortened lifetime and good enough performance, because then the customer has to return to the Black Market sooner to buy a replacement or get it repaired.

Of course, a Refurbisher can do quality work, but that takes more work and time, and this mechanical whiz-kid doesn’t do that for free. A Refurbisher is happy to offer a full weapon inspection, cleaning and calibration for 500-1,000 credits, and return the weapon in like-new working condition. Vehicle inspections to find problems and potential trouble cost 150 credits, and robot and power armor inspections cost 250 credits. Each repair is an additional charge of 150 credits per hour of labor plus parts.

The odd thing about Refurbishers is most fancy themselves not as grease monkeys, but as swashbuckling artists who work in weapons and machine parts. To get the best work out of these prima donnas, one needs to pay them whatever they ask without complaint and heap compliments on their work and craftsmanship. Even the most friendly Refurbisher tends to be a bit full of himself and haughty toward others. They are also short-tempered with negative comments about the quality of their work. Customers who don’t treat a Refurbisher with respect and high praise can expect shoddy, second-rate work or deliberate sabotage that doesn’t become apparent until the customer is in the field of battle.

Special Abilities of the Refurbisher O.C.C.

1. Black Market Benefits: All three Benefits are available to this character, but few Refurbishers get involved in owning or running a business themselves. It is too demanding and no fun. They would rather focus on their “art” and let someone else worry about the business details. Instead, a Refurbisher may work for one or more Black Market enterprises owned by another Black Marketeer, or work on a freelance basis with whomever he pleases.

2. Special Abilities of the Black Marketeer: The Refurbisher starts with *Game Player* and *Influential*. Pick one other of choice at level one and one more at levels 4, 8 and 12.

3. Sanitize Stolen Goods: When it comes to sanitizing weapons, armor and vehicles, nobody is better. As you may know, the “sanitizing” of used and stolen goods refers to the art of removing serial numbers and identifying marks of “hot” equipment so they cannot be traced to the commission of a crime or identified as stolen. A Refurbisher will also clean, paint and customize equipment (and vehicles) to either look new or completely different than when they were first placed in his capable hands. When a Refurbisher is done, not even the manufacturer will be able to identify it. If he has the time, he’ll often replace old serial numbers and identifications with new false ones. None of this is in the Operator’s set of skills, and most honest mechanics wouldn’t even consider doing it. Refurbishers are also skilled salvagers and experts at recognizing and removing parts from “hot” or junked weapons, vehicles and equipment as spare parts for future usage or resale. When a more well-rounded and skilled mechanic is needed to rebuild an engine or perform complex repairs, a Refurbisher might be able to do it, but even he would rather call in an Operator. If you need something dirty made clean and untracable, the Refurbisher is an artist. **Base Skill:** 74% +2% per level of experience.

4. Improvisational Jury-Rigging Skill: In the Technical skills category, there is a skill called *Jury-Rig* that enables its user to repair almost anything and even build something out of salvaged components. The Improvisation ability of the Refurbisher is essentially the *Jury-Rig skill on steroids*.

Even though most of their assignments call for the finished quality of their work to be less than ideal due to the “planned obsolescence” factor of the Black Market, Refurbishers are expected to be problem-solvers and make things work. Often, their materials are sub-standard, their working conditions are dismal, and they are not allowed the proper time or resources to do what most people would consider necessary for the tasks at hand. Yet, Refurbishers are still able to repair or produce gear of an acceptable “good enough for a while” level of quality from what they have to work with. This is what has led many Refurbishers to develop their *prima donna* complex and the notion that they are “artists” not mere journeyman Operators or mechanics. With the right parts, a Refurbisher could jury-rig almost any repair. **Skill Note:** Improvisational Jury-Rigging is the same as the Jury-Rig skill as described in **Rifts® Ultimate Edition**, but repairs are made in half the time and last for twice as long. The character also starts with a much higher base skill. **Base Skill (for the Refurbisher only):** 60% +3% per level of experience.

5. O.C.C. Bonuses: +3 on Perception Rolls involving weapons, their quality, value and “sanitization” (removing identifying marks and recognizing when something has already been sanitized by someone else. Can even tell if it was likely to have been done by a Refurbisher), +1 to I.Q. and P.P. attributes, +2D6 S.D.C., and +1 to save vs fatigue and disease.

Refurbisher O.C.C. Stats

Alignment: Any, but most Black Marketeers are Selfish or Evil.

Attribute Requirements: I.Q. 12 and P.P. 12.

Race Restrictions: None. An aptitude with machines is all that is required. Among D-Bees, Kremin Cyborgs, Malvoren and Techno-Faeries are especially prized by the Black Market as Refurbishers.

O.C.C. Skills:

Appraise Goods, but limited to weapons, ammunition, armor and power armor only (+20%).

Art (+10%)

Automotive Mechanic (+5%)

Basic Electronics (+5%)

Computer Repair (+5%)

* Field Armorer & Munitions Expert (+20%)

General Repair & Maintenance (+15%)

Language: Native Tongue at 92%.

Optic Systems (+4%)

Pilot Hovercraft (+10%)

Pilot: Two of choice (+5%).

Radio: Basic (+10%)

Recognize Weapon Quality (+30%)

Salvage (+15%)

Sensory Equipment (+8%)

Vehicle Armorer (+10%)

Weapon Systems (+10%)

W.P.: Modern: Two of choice.

Hand to Hand: Basic; can be changed to Expert at the cost of two O.C.C. Related Skills.

* Includes the *Basic Mechanics* skill at 30% +5% per level. Also see the Improvisational Jury-Rigging skill under *Special Abilities*, above.

O.C.C. Related Skills: Select four other skills at level one and one additional skill at levels 3, 5, 7, 9 and 12. All new skills start at level one proficiency. These selections get the benefit of any bonuses that may be noted below. **Note:** O.C.C. Related

Skills may be traded at a rate of two skills for one *Black Market Special Ability*, described earlier in the Black Marketeer O.C.C. section.

Communications: Any (+5%).

Cowboy: None.

Domestic: Any.

Electrical: None.

Espionage: None.

Horsemanship: Any (+5%).

Mechanical: Locksmith (+5%) only.

Medical: First Aid only.

Military: Any (+5%).

Physical: Any, except Acrobatics or Gymnastics.

Pilot: Any (+5%), except Robots and Military vehicles.

Pilot Related: Any.

Rogue: Any (+5%).

Science: Any, except Astrophysics, Biology, Botany, Xenology and Zoology only (+10% to Math skills only).

Technical: Any (+5%).

W.P.: Any, but prefers modern weapons.

Wilderness: None.

Secondary Skills: Three Secondary Skills at first level and one additional at levels 4, 8 and 12. Selections are made from the Secondary Skill list on page 300 of **Rifts® Ultimate Edition**. These are additional areas of knowledge that do not get any bonuses, aside from any possible bonus from having a high I.Q. attribute. All Secondary Skills start at the base skill level.

Standard Equipment: A suit of light or medium M.D.C. body armor, two weapons for each W.P. plus 1D6 extra ammo clips for each, a portable tool kit with an electric screwdriver and additional interchangeable heads, wrenches, etc., large tool kit, soldering iron, a roll of duct tape, and a roll of electrical tape. Additional equipment includes a Wilk’s Portable Laser Torch (for welding), a large crowbar (does 2D6 S.D.C. damage as a weapon), a large flashlight, pen flashlight, 50 feet (15.2 m) of lightweight rope or cord, two four foot (1.2 m) lengths of chain, a couple knives, notebook, portable disc recorder, protective goggles, work gloves, utility belt, pocket notepad and two pens, magnifying glass, micro-scale, backpack, satchel, large sack, canteen, spare set of traveling clothes, one set of dress clothes, one high quality forgery of a different name and identity along with a weapons permit for himself and one for the fake identity, and some personal items.

Cybernetics: None to start (unless a Kremin Cyborg), but Refurbishers usually acquire cybernetic implants and light bionic enhancements that help in their work.

Money: 1D4x1,000 in credits, and 5D6x1,000 in E-Clips and ammunition, and/or weapons.

Rift Runner

The Rift Runner is part Ley Line Walker and part Smuggler. He uses both conventional and magical methods and techniques in the concealment and smuggling of contraband and people. A good number of the Immaterial Hand’s ranks are made up of Rift Runners, as well as Ley Line Rifiers, Ley Line Walkers, Mystics and other practitioners of magic who use their unique knowledge and abilities to smuggle and transport people and contraband. However, while many mages do work for the Immaterial Hand, only



half are members of the Black Market, but ALL Rift Runners are official members of the organization.

The difference between the Rift Runners and other mages is that they have attuned their magic, skills and focus to the purpose of smuggling. The vast majority of spells they use, if not all, have to do with concealment, smuggling and transportation. (See the Immaterial Hand for more ideas about using magic for smuggling.) Furthermore, most Rift Runners come from a long tradition of families who learn to tailor their magic and skills to smuggling, so there are families of Rift Runners who pass on the trade to generation after generation, rather than a broader discipline or guilds. These families rose from within the Black Market and are almost exclusive to them. There are, of course, always a few who break from tradition or the criminal life and use their skills and magic knowledge for good, but they are the minority.

Most Rift Runners pride themselves on their blend of magic, their wits and resourcefulness. They tend to be bold, daring and charismatic rascals who get a thrill from sneaking contraband past the authorities and enemies and outwitting rivals. They especially love defying the odds and pulling off the impossible. As smugglers and Black Marketeers, Rift Runners are professional criminals who know how to hold their cards close to the vest, be discreet and keep secrets. Most are decent in a fight with a gun too. To help conceal their cargo, many learn a nice range of magic illusions and other spells useful in deception. In addition to the Immaterial Hand where most Rift Runners originate, other Black Market Factions, criminals and fugitives are often eager to hire such specialists to move goods and to slip in and out of hostile territories without anyone being the wiser.

Rift Runner O.C.C. Abilities

1. Black Market Benefits: All three Benefits are available to this character, though they are having so much fun and make so much money as smugglers, they seldom start up a business at a permanent site until after they retire; and most don't retire until late in life.

2. Special Abilities of the Black Marketeer: The Rift Runner starts with *Street Rep: Trustworthy* and *Wheelman* or *Slippery*. Pick one additional of choice at level one and one more at levels 4, 8 and 12.

3. Sense Ley Line and Magic Energy: Same as a Ley Line Walker.

4. Read Ley Lines: Same as the Ley Line Walker.

5. Render Bag or Container Invisible: A subtype of the *Invisibility: Simple* spell exclusive to Rift Runners and a closely guarded secret, the Render Bag/Container Invisible spell conceals a single container such as a pouch, backpack, bag, purse, briefcase or small-sized suitcase and *everything* inside of it! As long as the bag/case remains within 3 feet (0.9 m) of the spell caster, it remains invisible. Maximum weight that can be contained is 10 lbs (4.5 kg) per level of experience. If the weight is exceeded, the bag/container becomes visible and the container/bag cannot have any dimension (length, height, width) greater than two feet (0.6 m). The invisible container remains a solid object with physical mass, and the weight of the container will register on scales. It can be seen on infrared and ultraviolet optic systems, and anything warm contained inside will register on thermal imaging and heat sensing devices. Likewise, anything making noise inside may be detected by normal hearing, let alone sensors. **Range:** The container is enchanted by touch or line of sight up to three feet (0.9 m) away. **Duration:** 3 minutes per level of experience provided the container is in the Rift Runner's possession or within three feet (0.9 m) of him. **Saving Throw:** None for inanimate objects, standard for any liv-

ing being inside the container. **P.P.E. Cost:** 9. **Note:** Considered a Fourth Level spell invocation.

6. Initial Spell Knowledge (Specialized): Select 8 spells from the list below. These are part of the Rift Runner's permanent spell-casting capabilities. Once selected, they cannot be changed.

- Blinding Flash (1)
- Chameleon (6)
- Cleanse (6)
- Cloak of Darkness (6)
- Concealment (6)
- Detect Concealment (6)
- Dimensional Envelope (60 or 380)
- Dimensional Pockets (20 or 140)
- Featherlight (10)
- Float in Air (5)
- Lantern Light (1)
- Locate (30)
- Invisibility: Simple (6)
- Manipulate Objects (2+)
- Mystic Alarm (5)
- Mystic Portal (60)
- Plane Skip (65)
- Re-Open Gateway (180)
- Rift Teleportation (200)
- Seal (7)
- See the Invisible (4)
- Teleport: Lesser (15)
- Teleport: Superior (600)
- Watchguard (10)

7. Learning New Spells: At level 2, select eight more spells from the list above.

At level 3, select the remaining eight spells from the list above. That should include ALL of them.

At level 4, select two new spells from any of those listed under the Immaterial Hand, starting on page 40, and useful for transporting goods and smuggling.

At level 5, select two new spells from any of those listed under the Immaterial Hand, starting on page 40, and useful for transporting goods and smuggling.

At level 6, select 1D4 spells of choice. They can be selected from invocation levels 1-6 only. They can be ANY spell invocation, but are still likely to be the types helpful in smuggling, hiding and transporting contraband.

At level 7, select 1D4 spells of illusion equal to or below the character's own experience level.

At level 8, select two new spells from any of those listed under the Immaterial Hand, starting on page 40, and useful for transporting goods and smuggling.

At level 9, select 1D4+1 spells of choice. They can be selected from invocation levels 1-9 only. They can be ANY spell invocation, but are still likely to be the types helpful in smuggling, hiding and transporting contraband, which includes illusionary magic.

From level 10 on, the character can learn 1D4 new spells per each new level of experience.

8. P.P.E.: Like all men of magic, the Rift Runner is a living battery of mystic energy. **Permanent P.P.E. Base:** 2D6x10+35 plus P.E. attribute number. Add 2D6 P.P.E. per additional level of experience. The Rift Runner can also draw P.P.E. from ley lines (10 points per melee round), nexus points (20 points per melee round - 40 points when a Rift is actually present, opening or closing!), and other people through blood sacrifice and when freely given.

See the **Pursuit of Magic** section of **Rifts® Ultimate Edition** for more details.

9. P.P.E. Recovery: For the Rift Runner, spent P.P.E. recovers at a rate of five points per hour of sleep or rest. Meditation restores P.P.E. at 10 per hour and is equal to two hours of sleep when it comes to recovery from fatigue and physical rest.

10. O.C.C. Magic Related Bonuses: +3 on Perception Rolls involving Rifts, magical illusions and concealment, +4 to save vs Horror Factor, +2 to save vs possession, +1 to save vs magic at levels 1, 3, 6, 9 and 12, and +1 to Spell Strength at levels 2, 4, 8 and 12.

Rift Runner O.C.C. Stats

Alignment: Any, but Anarchist (40%), Aberrant (20%), Miscreant (20%), and Diabolic (10%) are common. Fewer than 5% are good alignments.

Attribute Requirements: A high I.Q. and M.A. are helpful.

Racial Requirements: None.

O.C.C. Skills:

- Camouflage (+20%)
- Concealment (+10%)
- Detect Concealment (+10%)
- Find Contraband (+14%)
- Language: Native at 94%.
- Languages: Two of choice (+20%).
- Literacy: One of choice (+15%).
- Lore: Magic (+15%)
- Mathematics: Basic (+25%)
- Palming (+15%)
- Pick Locks (+15%)
- Streetwise (+14%)
- Surveillance (+10%)
- W.P. Energy Pistol or Energy Rifle, pick one.
- W.P. One of choice.

Hand to Hand: Basic; can be changed to Expert at the cost of two O.C.C. Related Skills.

O.C.C. Related Skills: Select four other skills at level one. Add one additional skill at levels 3, 6, 9 and 12. All new skills start at level one proficiency. These selections get the benefit of any bonuses that may be noted below. **Note:** O.C.C. Related Skills may be traded at a rate of two skills for one *Black Market Special Ability*, described earlier in the Black Marketeer O.C.C. section.

- Communications: Any (+10%).
- Cowboy: None.
- Domestic: Brewing, Cook, Dance and Wardrobe only.
- Electrical: Basic Electronic only.
- Espionage: Escape Artist, Impersonation, Intelligence, and Wilderness Survival only (+5%).
- Horsemanship: Any.
- Mechanical: Basic Mechanics only.
- Medical: First Aid and Holistic Medicine only.
- Military: Recognize Weapon Quality (+5%) only.
- Pilot: Any, except Robot piloting skills and military vehicles.
- Pilot Related: Any (+5%).
- Rogue: Any (+10%).
- Science: Any (+5%).
- Technical: Any (+5%, but +10% to Research and any History and Lore skills).
- W.P.: Any.
- Wilderness: None.

Secondary Skills: Two Secondary Skills at levels 1, 5 and 10. Selections are made from the Secondary Skill list on page 300 of **Rifts® Ultimate Edition**. These are additional areas of knowledge that do not get any bonuses, aside from any possible bonus from having a high I.Q. attribute. All Secondary Skills start at the base skill level.

Standard Equipment: One weapon for each W.P., plus 1D6 ammo/E-Clips, for each, light M.D.C. fabric armor or partial M.D.C. body armor, notepad, sketch pad, 1D4 markers or pens, 1D6 pencils, 1D4 pieces of charcoal, cigarette lighter, a small wardrobe, traveling clothes, two hooded cloaks, shoulder pouch, satchel, knapsack, backpack, bedroll, 1D4 small sacks, one large sack, six wooden stakes and mallet, small silver cross, canteen, binoculars, tinted goggles, sunglasses, air filter and gas mask, and some personal items. Loves magic items of all varieties and will try to acquire some throughout his career.

May also have a vehicle of some kind, usually a horse, robot horse, TW vehicle, hovercycle or ATV.

Money: 2D4x1,000 credits and 3D6x1,000 credits in Black Market goods.

Cybernetics: None, and avoids them because they interfere with spell casting.

Black Market Sales Outlets

Traveling Black Market Merchants

Sometimes the best way to make a sale is to take the product to the customers. Moving from town to town, Traveling Black Market Merchants are often the only available source of weapons, high-tech equipment and supplies in frontiers and remote areas.

In the more civilized reaches and within cities themselves, traveling merchants fill a different function, usually providing highly specialized goods and contraband that is too hot or too dangerous to keep at a permanent store location. Furthermore, they have found sales to be much more brisk when limited, rare and exotic items are made available for the short period of time the traveling merchant is in town. Within Coalition territory, such merchandise offered by Traveling Black Market Merchants includes books, video disks, pre-Rifts artifacts, alien items, and magic goods. Traveling merchants and traveling shows, many of which front for the Black Market and smuggle contraband, tend to travel the outer edge of town or set up camp a short distance away from town, but may also pitch a tent or camp in the seedier parts of town where they are least likely to be noticed, monitored, investigated or pestered by the authorities. Purveyors of books, computer disks, drugs and other lightweight, high-value items may also choose to store their goods in a backpack or the trunk of a vehicle instead of leaving them at a fixed location. Others commandeer an abandoned

building to use as a temporary storefront, or set up a temporary tent store or street corner kiosk.

Large and organized groups of Traveling Black Market Merchants often base their operations out of a large vehicle, a small convoy of vehicles, a caravan of large pack animals, or as part of a large traveling show. The ever popular traveling circus, carnival, medicine show and freak show are often (at least half of the time) fronts for Black Market smugglers and Traveling Merchants. In the most isolated parts of Rifts Earth, they represent the only "stores" available to wilderness people, settlers in distant lands and warriors in the field. As a result, they tend to be light on luxury items and heavy on a wide range of dry goods, foods, booze, survival and hunting gear, ammunition, E-Clips, repair kits, basic weapons and armor, adventuring gear, and other sundries that may not be normally considered Black Market goods.

Not all traveling merchants are Black Market operations, but the majority are. An estimated 70% of traveling merchants are Black Market operations, and at least half of them are open about it. The rest are fronts for the Black Market who deny any criminal affiliations. Of Traveling Shows, it is estimated that half of the circuses and carnivals, 60% of Freak Shows, and 65% of Medicine Shows are fronts for Black Market Traveling Merchants.

Optional: Merchant's Start-Up Investment

If the Game Master allows it, a Black Market Merchant can get a windfall of goods and/or credits to start a retail enterprise. This could have been an inheritance from a relative, winnings from gambling, a repossession, profitable purchase from someone going out of business, a gift from a Boss or grateful client, a bribe, or an accidental discovery. This is considered "seed money" or "wholesale goods" for the character to get his business rolling. Choose one from below or roll percentile dice for a random determination.

01-25% Weapons and Ammo: 5D6 fully-charged E-Clips, 2D6x1,000 rounds of rail gun ammunition, 4D6x100 rounds of various conventional ammunition, 3D6x100 special rounds (silver, hollow point, armor-piercing, etc.), 2D6 grenades, 1D4 mini-missiles, 2D4 low-powered energy rifles OR two high-powered energy weapons, 1D4 energy pistols, 1D6 various other melee and S.D.C. weapons, and an additional 1D6x1,000 in Universal Credits.

26-50% Food and Water: 1D6x100 gallons of clean drinking water, 244 plastic bottles, 3D6 large plastic jugs, 4D6 large sacks of grain, corn or wheat. 4D6 crates of fresh vegetables. 1D4 freshly-slaughtered pigs or cows (will need refrigeration, salting, or chemical preservatives), 2D6x10 cases (24 cans or boxes to a case) of processed food suitable for humans and D-Bees, plus an additional 1D4x10,000 in Universal Credits.

51-75% Pre-Rifts Artifacts: 3D4x10 old books, 4D6x10 plastic discs with digital information (music, video, software), 1D4x10 pieces of Pre-Rifts art (could be any style or time period), 1D6 Pre-Rifts firearms (ballistic or energy, functional or not), 1D4x20,000 in various other Black Market goods, and an additional 10,000 in credits.

76-00% Just Straight Cash: 4D6x10,000 in Black Market credits to spend on the acquisition of wholesale goods for the purpose of resale only. The character is free to spend it on whatever he wishes, provided it is for *resale*, but should invest wisely.

Weapon Availability Table

This is the likelihood of having a particular item in stock. A Weapon Availability bonus increases the likelihood of having the item in stock. So if the chance was 01-50% and the bonus is +10%, the odds are increased to 01-60%. Of course, Weapon Availability penalties reduce the odds.

01-75% S.D.C. melee weapons such as knives, swords, maces, and similar.

01-35% Large and exotic S.D.C. melee weapons such as battle axes, claymores, samurai swords, and pole arms. Staves fall into this category only because there isn't much of a market for them.

01-60% Small S.D.C. firearms such as revolvers and pistols.

01-50% Large S.D.C. firearms such as rifles and shotguns of all types, including military grade weapons.

01-30% Heavy S.D.C. and exotic military grade weapons such as grenade launchers, rocket launchers, hand grenades, explosives, machine-guns and flamethrowers.

01-60% Common Vibro-Blades. Knife, short sword and sword.

01-70% Common M.D. energy pistols.

01-40% Coalition M.D. energy pistols.

01-75% Common M.D. energy rifles.

01-45% Coalition M.D. energy rifles.

01-50% Common Heavy M.D. Weapons.

01-75% BigBore weapons and ammo.

01-60% Black Market knock-offs of brand weapons.

01-60% Wilk's weapons and tools.

01-55% Northern Gun weapons and gear.

01-45% Manistique Imperium weapons and gear.

01-30% Triax Weapons; limited selection (double the likelihood for le Marche Noir Faction).

01-35% Glitter Boy Boom Gun and ammo and G.B. repair capabilities (double the likelihood for le Marche Noir Faction).

01-30% Vampire slaying weapons and ammo (double the likelihood for El Oculata and Bandito Arms).

01-10% Naruni Weapons (double the likelihood for the Immaterial Hand).

01-15% Atlantis Kittani weapons.

01-10% * Atlantis magic weapons or Rune Weapons.

01-25% * Magic or TW Melee Weapons.

01-25% * Magic or TW pistols.

01-20% * Magic or TW rifles and long-range weapons.

01-10% * Magic potions or scrolls.

01-15% * Magic body armor and/or power armor.

01-20% * Alien/otherworldly weapon or magic item.

01-65% Body armor of Bandito Arms.

01-60% Common M.D.C. body armor.

01-45% Large to full range of body armor; excluding magic armor.

01-65% Power armor of Bandito Arms.

01-50% Power armor of Northern Gun manufacture.

01-20% Power armor of the Coalition States.

01-20% Power armor of Triax (double for le Marche Noir Faction).

01-10% Glitter Boy power armor (triple for le Marche Noir Faction).

01-60% Robots and vehicles of Bandito Arms.

01-40% Robots and vehicles of Northern Gun.

01-20% Robots and vehicles of other manufacturers.

01-05% Robots of the Coalition States.

01-15% Military vehicles of the Coalition States.

Note: * Triple the likelihood for merchants of the *Immaterial Hand*.

Selling to the Black Market

Black Market Merchants and opportunists are always looking to purchase contraband, used and stolen weapons and valuables, magic items and pre-Rifts artifacts, for *resale*. Their best clients for selling them such goods, as well as purchasing them, are bandits, thieves, raiders, pirates, mercenaries and adventurers. Unfortunately, the *wholesale purchase price* is never anywhere near the selling price. This is basic marketing. The retail price is always much more expensive than the raw cost to produce or purchase an item. The cost is increased by overhead expenses and other people who get a cut of the sale price for their involvement, like a mechanic who makes a used or damaged gun or vehicle look like new and run smoothly, or the forger who has to make false bills of sale or registration, and the city official who must be bribed, and so on.

The following is a list of the prices Black Market Merchants and Fences are usually willing to pay for different categories of items slated for resale. All numbers are the percentages of the average retail market price. A few odd items list current prices in credits. **Note:** When it lists a "resold for X% wholesale," that's the price a Fence or Merchant resells the item to a buyer for resale. The buyer then typically marks it up to the current retail market price, which is usually 2-3 times greater than what he paid for the item. *Black Market Merchants*, of course, try to pay as little as possible (as noted below) and sell the item in their own retail outlet at the current retail price or some attractive discount. Buying stolen and used goods on the cheap enables Black Market Merchants to undercut their legitimate business rivals, often selling the same goods for 10-30% less. If not *resold for wholesale price* is listed, assume it is usually 30-40% of the normal retail price.

Common Items: Adventuring gear, binoculars, cameras, computers, and electronics to common tools, vehicles and alleged pre-Rifts artifacts and unknown alien/D-Bee items are purchased for 10% of the common market value and resold for 30% wholesale. **Note:** Clothing, toys, household goods and food seldom have any market value, except under unusual circumstances such as famine and war, and are not generally purchased by a Fence, but may be desired by a Merchant.

Gems, Jewelry and Collectible Art: Are purchased for 15% of the common market value and resold to wholesalers and merchants for 30-50% wholesale. Obviously very valuable and rare jewels may be purchased for as much as 30% of their value and resold for 60-120%.

Magic Items: Purchased for 25% of the common market value and resold to wholesalers and merchants for 50% wholesale. Obviously valuable and rare magic items may be purchased for 40% of their market value and resold for 80-300% of their value.

Medicine, Illegal Drugs and Other Contraband: Are purchased for 20-30% of the common market value and resold to wholesalers and merchants for 50-90% wholesale. High demand and rare drugs (for whatever reason) may be purchased at 40-60% of their market value and resold for 150-400% of their normal market value.

Weapons, Body Armor and Power Armor: Are purchased for 10-15% of the common market value and resold for 30-40% wholesale. Coalition weapons and Dead Boy armor are purchased for 15-20% of their market value and resold at 40-90% of their

value. Heavy and rare CS weapons, armor and gear are purchased for 25-30% of their market value and resold for 60-200% of their market value.

Weapon Energy Clip: Fully charged E-Clips will get 10% to 20%.

Weapon Energy Clip: Used and empty 10%.

Vibro-Weapons: Once high-priced items, they are currently bought at 10-25% of their market value and resold for 40%.

Used Weapons, Body Armor and Power Armor: Are purchased for 10-15% of the common market value and resold for 30-40% wholesale. Coalition weapons and Dead Boy armor are purchased for 15-20% of their market value and resold at 40-90% of their value. Heavy and rare CS weapons, armor and gear are purchased for 25-30% of their market value and resold for 60-200% of their market value.

New Weapons, Body Armor and Power Armor: Same as above plus an extra 5-10%, but are also sold for 10-20% more.

Giant CS Robots and Armored Vehicles: Such items are often too hot to handle for most Black Market Fences and are usually turned away or directed to larger Black Market Merchant establishments. One is lucky to get 5% from a sale to a Fence, if he'll take it at all. An established merchant of such goods will moan and groan about costs, overhead, risk and liability to keep the selling price low, but is usually happy to pay as much as 20% of the market price, though he'll always start at 10%.

Robot Weapons and Vehicle Parts: 10-15% of retail price.

Commercial Vehicles: 10-20% of retail price.

Cybernetic Parts: 15-30% of retail price.

Bionic Parts & Cybernetic Components: Always in demand and purchased for 20-30% of their market value.

Complete Crazies M.O.M. System: 70,000 credits.

Complete Juicer Bio-Comp and Drug System: 100,000 credits.

Electronic Equipment: 10-20%.

Modern-Day Forbidden Books: 10-30%.

Pre-Rifts Trinkets: 10-20%.

Pre-Rifts Books, Comics, Magazines: 15-25%.

Pre-Rifts High-Tech Technical Manuals: 20-40%.

Pre-Rifts Jewelry: 20-30%.

Pre-Rifts Coins/Precious Metals: 20-40%.

Pre-Rifts Clothing and Miscellaneous: 15-25%.

Wilderness Items: Furs, 15-30%.

Wilderness Items: Herbs and drugs, 10-20%.

Wilderness Items: Horses and exotic animals, 15-20% untamed, 25-30% tamed/trained.

Note: Specialists, such as Antiquities Dealers, Body-Chop-Shops and others may be willing to pay 5-20% more for certain items.

Market Value

What a Black Marketeer is willing to pay and sell product for depends greatly on supply and demand.

As opportunists and criminals, the Black Market has no qualms or hesitation to corner a market on a particular item or category of items and resell them for 2-10 times the normal market cost. If medicine is desperately needed in a plague or war zone, some Black Marketeer/Merchant is happy to supply it for many times the usual price. Selling a bottle of water 10-20 credits to people suffering in drought is the kind of thing they love to do. Desperation makes an excellent short-term gain. Sometimes a huge gain. This is especially true of carpetbagger types who flock in like hungry

locusts to capitalize on a crisis or boom situation and then vanish when it is over and they've made a huge profit. It is not so true of local Black Market enterprises and Traveling Black Market Merchants who have a regular route of stops and customers. Local operations have to live with these people after the crisis or boom time ends. If they rip people off without mercy in the bad times, they'll be despised and run out of business during the good times. As a result, local Black Market operations will either use front-men or more likely, only jack prices up two or three times normal. Experience has shown that is about the limit of people's acceptance for being gouged. Anything more creates lasting animosity, which is bad for long-term business.

Market demand will also have an impact on what the Black Market Merchant is willing to pay for goods. If he can get two or three times the normal market price, or more, the merchant is likely to be willing to pay 50-75% of its full retail price, maybe even full retail. Of course, such *speculation* is risky, because as soon as the inflated demand drops back to normal, the Black Marketeer could be stuck with trucks of merchandise he way overpaid for.

Black Market Traveling Merchant Random Generation Tables

Step One: Size

The actual number of merchants and vehicles or pack animals that make up the group. Larger merchant groups are more common in less-developed and lightly inhabited areas as they have less competition with fixed-location stores and need to haul a wide range of goods.

01-20% One-Man Operation: A single traveling salesperson who roams across the wilderness or urban jungle in search of customers. The sales rep may use a mule, horse, dinosaur or other pack animal to carry his goods or to pull a wagon of supplies. Some types of D-Bees or beings with Supernatural P.S. and capable of carrying much greater weights than humans may work as their own pack animal, and pull a cart or wagon by hand. Most, however, will drive a truck of some sort. Large and expensive Black Market goods like robots and heavy power armor are not going to be part of this merchant's inventory.

21-40% Business Partners: Twice the size of the One-Man Operation, this dynamic duo may be two Black Market Merchants or one may be a dedicated salesperson and the other something else: warrior, con artist, thief, smuggler, Operator, entertainer, craftsman or other specialist. While the two-man operation is likely to carry a similar selection to the One-Man Operation, they tend to provide a greater range or degree of goods and services and can handle more customers at any given time. They'll share a much larger truck or drive two separate cargo vehicles. Large and expensive Black Market goods like robots and heavy power armor are not going to be part of these merchants' inventory.

41-60% Small Setup: A small setup is 1D4+2 trucks, small mule train or other modest Black Market mobile operation. A few smugglers, salespeople, defenders and other Black Marketeers are part of this enterprise. Stumbling across such an outfit can be a real boon to a small mercenary company or other force looking to re-equip. Such an operation is likely to have a Body-Fixer or

healer to offer medical services and will have a much larger range of weapons and goods, maybe even a few suits of body armor and/or power armor, but probably just one or two types.

61-80% Medium Setup: A medium-sized Traveling Black Market Merchant setup has 1D6+4 cargo vehicles or a very large truck, and often incorporates a small supply caravan along with the actual core sales outlet/vehicles. A merchant outfit of this size is likely to have a few different types of body armor and power armor, a few light vehicles (motorcycles or hovercycles), and may well have one or two military vehicles. It is much better stocked than smaller operations and is likely to offer medical services, drugs, weapon repair, E-Clip recharging, Juicer replacement chemicals, and possibly even a couple of dancing girls or prostitutes.

81-00% Large Traveling Black Market Outlet: This is a veritable traveling bazaar or shopping center. A dozen or more large trucks (1D6+10) or giant pack animals carry a nice selection of goods from wilderness supplies, weapons and ammo to light vehicles and a few military or special vehicles, maybe even 1-6 different types of robot vehicles (probably Northern Gun; one of each). A large range of alcohol, food, clothing, tobacco, drugs, food, supplies, medical care, a place to bathe and clean up, and other goods and services will be offered. Secondary services include field armorers, Operators for vehicle repair and painting, drug den, bar, prostitutes, entertainers, tattoo artists, barbers and the like. +5% to all Weapon Availability Table rolls and there are numerous salesmen and security staff.

Step Two: Type of Goods of the Traveling Merchant

Even within the same Black Market territories and amongst the same sponsors, different types of merchants can be encountered. Most smugglers and Black Market types have no regular product or set schedule and buy and sell whatever they can acquire cheap, for a good marked-up price. That means they'll buy goods from mercs, adventurers and communities along the way, but a Traveling Merchant has one of the following areas of specialty. This is his biggest and best selection of goods or services.

01-10% Supplies and Legal Items: The merchant is trying to unload a surplus of legal and/or "local" goods. That probably means food, grains, animal pelts, articles of clothing, as well as common supplies and items that fit the broadest needs of the people in the area. This always includes a small selection of popular and common Black Market weapons, ammo, drugs, alcohol and other odds and ends.

11-20% Commercial Service Provider: Rather than a true wholesale enterprise, these traveling merchants offer two or more of the following services and basic materials and goods necessary to perform those services: Armor repair, medical/Body Fixers/healers, bionics and cybernetics/Cyber-Docs, Juicer augmentation and chemical replenishment, vehicle and machine repair Operators, food preparation/restaurant, tailor, entertainment, appraisers of artifacts/pawnshop, and other services. Plus they offer at least a basic selection of vice such as gambling, prostitution, alcohol and drugs. These merchants may not have much in the way of goods for sale, but could have services to offer that are hard to find in the region or vital to a group's survival. Such Service Providers often travel from one Black Market town or mercenary camp to another, plying their various trades. In remote frontiers, doctors, barbers and entertainers may be specialized enough to form a traveling show or merchant group.

21-30% Criminal Service Provider: These Black Marketeers offer criminal and mercenary services such as assassination, blackmail, bounty hunting, forgery, providing false documents and I.D.s, smuggling, confidence games, theft, raiding, intimidation/threats, revenge, sabotage, spying/surveillance, protection and murder. These kinds of merchants are a necessary fixture of life under Coalition rule and may include forgers, hired thugs and spies amongst their ranks.

31-40% Contraband: These merchants sell goods that are illegal and outlawed in the area. +5% to Weapons Availability Table rolls involving CS, Triax, Glitter Boy and magic items, provided the merchant sells such things in the first place.

41-50% Arms Dealer: The Traveling Merchant specializes in the sale of weapons and ammunition. May include a small selection of body armor and power armor. +20% to all Weapon Availability Table rolls.

51-60% Entertainment. This will be a traveling show: Medicine Show, Freak Show, Carnival or Circus. However, there is a 01-50% chance the show is a front for a Black Market operation. Whether independent or a Black Market front, the entertainment merchant is likely to offer 1D4 of the following: booze, drugs, gambling, prostitution, strip shows, animal fights, or gladiatorial contests. They also sell playing cards, dice, darts, and a selection of board games.

61-70% Robots. Traveling Merchants specializing in the sale of robot horses and other animals, robot vehicles (limited selection) and may include a small selection of power armor. +5% to all Weapons Availability Table rolls as they apply to robots only.

71-80% Vehicles. The Traveling Merchant specializes in the sale of vehicles. May be low-end conventional fuel vehicles or high-end nuclear powered vehicles, including a selection of hovercycles, rocket bikes, hover cars, hover trucks, jet packs, canoes, rafts, small boats and other vehicles. May include a small selection of hopping or flying power armor and 1D4 giant robots. +5% to all Weapons Availability Table rolls as they apply to vehicles only.

81-90% Full Black Market Store Operation: This traveling depot offers weapons, ammunition, normal supplies and a myriad of other goods, both legal and illegal. However, they stock only the most common and popular items, as well as items that are slow sellers and hard to move. The latter is at a 20-40% discount. May also have a small selection of body armor, and they likely have a few pieces of serious military hardware for sale. +5% to all Weapon Availability Table rolls.

91-00% Mercenary and Adventurer Outfitters: These merchants make their living selling to mercenaries, private armies and regional defenders. Ammunition is plentiful, the variety of weapons is good to outstanding, and body armor, power armor, combat vehicles and maybe even a few giant robots are part of their inventory. +10% to all Weapon Availability Table rolls.

Step Three: Sponsorship or Allegiance of the Traveling Merchant

With such fierce competition for clients amongst the Black Market on Rifts Earth, even Traveling Shows and Merchants are often sponsored by a well-equipped backer or a larger organization. There are definitely lone wolves and small groups of merchants and speculators who make money competing with the larger market factions, but "independents" are losing ground every year to the slow creep of organized crime.

01-24% None. Independent: A large portion of Traveling Merchants are independent operators who owe no allegiance to any particular Black Market Faction. Independent Traveling Merchants are most common in more remote and uncivilized areas, as they sometimes become targets for intimidation or outright attack when entering a market zone that has already been claimed by the Black Market, criminal elements or business monopolies.

25-38% Bandito Arms: Most often encountered in the American Southwest, the New West, and the border of northern Mexico, Bandito Arms merchants travel between small cities, towns, camps of Tolkeen refugees, farm towns, new frontier settlements, mining camps and bands of bandits, raiders, pirates, mercenaries, adventurers and vampire hunters. Such traveling merchants sell predominantly (90%) Bandito Arms merchandise.

39-52% El Oculta: Prevalent in Texas and throughout the American South and northern Mexico, El Oculta sponsored merchants tend to deal in weapons, drugs and the sex trade. Rogue and morally deprived Traveling Merchants and Oculta operatives willing to work and deal with the Vampire Kingdoms sell slaves to the undead, as well as weapons, body armor and other supplies and information.

53-66% The Chicago Network: Most prevalent in middle and northern America and southern Canada. Merchants sponsored by them sell a wide range of weapons and armor (including CS and Northern Gun weapons and gear), contraband, services and vice.

67-80% Le Marché Noir: Agents of the Quebecois Black Market may be encountered in the eastern half of Canada and the American Northeast. Merchants sponsored by them sell a wide range of weapons and ammo (including Triax gear and Glitter Boy ammo, parts, Boom Guns and even the occasional Glitter Boy), as well as other goods, services and vice.

81-94% The Immaterial Hand: Traveling Merchants allied to the Immaterial Hand can be found anywhere in North America, and traffic in magic items, TW weapons and devices and magic services, as well as ley line and Rift traveling and cargo hauling services.

95-00% Other: While not as large or infamous, there are other Black Market criminal syndicates that have significant market shares and Traveling Merchants. There are also manufacturers and sellers such as Northern Gun, the Manistique Imperium, Wilk's, Naruni Enterprises, Golden Age Weaponsmiths, and many others who send out or sponsor Traveling Merchants in and outside of the Black Market.

Step Four: Security Personnel & Defenses

Black Market agents sell expensive, dangerous and desirable items and often to well-armed and/or well-trained clients. Keeping guards and security forces on hand is almost always a necessity, especially in a criminal market known for theft and dishonesty.

01-20% None: The only security comes from the salespeople themselves. While they may be heavily armed or wield magic or psionics, they are not dedicated enforcers or protectors, and may be caught off-guard during a sales transaction.

21-30% Bodyguard/Security Specialist: A single specialist is tasked specifically with providing security. He may be an augmented trooper like a Combat Cyborg, Crazy or Juicer, a psychic, a magic user, powerful D-Bee or other type of "muscle." Probably low or mid-level experience (1D6 level).

31-40% Security Team: 1D4+2 protectors are tasked specifically with providing security. They can be any Men-at-Arms or criminal O.C.C. but tend to be basic fighters, mercenaries, bandits and the like. There won't be more than one "heavy hitter," if any, in the group. That one can be an assassin, augmented trooper like a Combat Cyborg, Crazy or Juicer, a psychic, a magic user, powerful D-Bee or other type of "muscle." Probably low or mid-level experience (1D6 level each).

41-60% Medium Security: 1D6+4 guards of any Men-at-Arms or criminal O.C.C. but tend to be basic fighters, mercenaries, bandits and the like. Each is 1D6 level in experience. All armed with military grade weapons. Plus two "heavy hitters," such as an assassin, Combat Cyborg, Crazy, Juicer, a Master Psychic, a practitioner of magic, or a powerful D-Bee or other type of "muscle;" 1D6+2 level.

61-70% Heavy Security: A full squad (1D6+6) of experienced (1D4+2 levels of experience) "heavy hitters." They can be any one or combination of the following: Augmented trooper like a Combat Cyborg, Crazy, Juicer or power armor troops, and/or Master Psychic, practitioners of magic, powerful D-Bees, Sub-Demons or Lesser Demons, or creatures of magic. May include one or two giant robots or Greater Demons or a Dragon Hatchling. These forces are usually experienced (1D4+2 level each) and led by an overseer or security chief that is 1D4+4 level.

71-81% Armored Security: A full squad (1D6+7) of experienced (1D4+2 levels of experience each) "heavy hitters." Half are cyborgs or power armor troops and half pilot robot combat vehicles or tanks. If more magically oriented, the "power armor" troops will be clad in TW body armor or TW power armor, and the giant robots will be Iron Juggernauts or Automaton, Golems or something similar. Or the 'bots may be replaced by one adult dragon or two or three creatures of magic or young dragon hatchlings or two Greater Demons. The squad leader will be a practitioner of magic or powerful Master Psychic with 1D4+4 levels of experience.

82-95% Paranoid: A company of 3D6+10 protectors of mixed Men-at-Arms O.C.C.s, 1D4+4 "heavy hitters," 1-2 practitioners of magic, 2 Master Psychics and 1D4 giant robots. Each truck, pack animal or salesperson may have their own individual guard and all personnel carry a gun and a knife. Average level of the security force is 1D4+3. Specialists like mages and psychics, as well as 1D4 squad leaders, are 1D4+5 level experience. Stealing from or trying to stick-up such an operation is not recommended.

96-00% Small Army: Same as Paranoid, above, but double the number of defenders/fighters. Stealing from or trying to stick-up such an operation is suicide.

Step Five: Willingness to Sell

Without the luxury of conducting business under normal conditions, Black Market salesmen often sell out of popular items with no way to restock them quickly. In addition, they may be on the run from the authorities and not have time to exchange goods and credits. And unlike certain retail stores, the Black Market always reserves the right to refuse service, sometimes at gunpoint. Other times, the Traveling Black Market Merchant may be in a hurry to meet schedules or stay ahead of pursuers, and unwilling to stop and sell their wares, or must do so quickly.

01-20% Closed Doors/Out of Stock: The merchant is nearly out of stock and almost everything he carried is sold out. Even if the merchant can be persuaded to open his doors he has little to sell or trade. -60% on Weapon Availability Table rolls.

21-40% Picked Clean: The merchant has had a run on product that has reduced his normal level of supplies by 2D4x10%! Small arms and common goods may be available but large, expensive items, vehicles and magic items are long gone. -30% on Weapon Availability Table rolls.

41-60% No Hurry to Sell: The merchant is open to customers and has a decent selection of common goods, but nothing rare, exotic or expensive. He is in no hurry to unload his wares, so there are no discounts or specials.

61-80% Let's Deal: The Traveling Merchant is an aggressive sales person willing to offer deals and discounts on select items, bulk purchases (10% discount), BigBore weapons (25% discount), BigBore ammo (10% discount), big ticket items like power armor, robots and vehicles (10-20% discount), and there may be some "special sale items" (20-40% discounts). However, some of these sale items may be stolen and "hot." +10% on Weapon Availability Table rolls.

81-00% Everything Must Go! Not only is the traveling merchant set up and ready to do business, but he has been suffering through a terrible sales slump, so he is eager to sell. EVERYTHING, except the most exotic and rare items, is being offered at a 10-20% discount, including weapons, armor and vehicles. Big-Bore weapons (not the ammo), used weapons and gear, knock-off weapons (if available), and most common goods are at a 40% discount. +5% on Weapon Availability Table rolls. Salespeople may even be open to further haggling and provide deals up to 50% off other select items.

Black Market Retail Stores

In the larger towns, 'Burbs, and cities, as well as trading posts along travel routes, the Black Market is likely to have a few to several permanent business operations. Most will be retail outlets, others service providers and places of entertainment. Some will be legitimate, some legitimate businesses that front for criminal enterprises, and others criminal enterprises that may be secret or completely out in the open depending on the town and how the locals and the law regard the Black Market, drugs and vice.

Step One: Store Size

01-20% Hole in the Wall: There are just 1-2 people onsite at any given time running the place and there is a very limited supply of goods or a singular service. This might be an E-Clip charging station and small gun shop (sells a small selection of weapons, ammo and E-Clips), a small Black Market book shop, liquor store, small bar, drug paraphernalia shop (sells drugs behind the counter), drug den, tobacco shop, tiny pawnshop or resale shop (the "good stuff," i.e. contraband or weapons, is sold in the back or in the basement), small jewelry store (probably a front for something illegal), tiny magic shop, appraiser (may also be a fence and/or smuggler), forger (sells fake I.D.s), tattoo parlor, massage parlor (may be a front for prostitution, drugs or gambling), fortune-teller/psychic, barbershop, blind pig (illegal gambling), or other small operation. -30% on Weapon Availability Table rolls.

21-40% Retail Store: A storefront of small to medium size. If in a community where the sale of weapons is not illegal, the store may be an arms dealer, seller of body armor, seller of power armor

and/or robots, a vehicle store, etc. In a town where the Black Market is not viewed as a criminal enterprise, or where contraband and vice is acceptable, legal and illegal Black Market business enterprises will be out in the open. Their goods, from books, weapons and magic, to drugs, gambling and women, all proudly displayed for all to see.

Some Black Market "stores," especially those in remote areas away from civilization are, in effect, a "general store" that has a good selection of weapons, body armor, power armor, combat and wilderness/outdoors gear, hunting gear, electronics (which in this case may include communications, surveillance, camera, sensory and computer gear), and tools, as well as some clothing and common goods everyone can use, including clothes, fabric and sewing gear for making clothes, grain and dry goods, candy, a selection of alcohol, and perhaps even some produce, especially local fruits, vegetables, honey, jam and similar. The same store may also have an area where they offer drugs and contraband.

Large and expensive items, such as vehicles larger than a car, power armor suits, robots and magic are not available at small to medium-sized stores, but almost any other goods or service may be. -10% on Weapon Availability Table rolls.

41-60% Service Enterprise: This can be a small, medium or large facility. Services include hotels, boarding houses, restaurants, live theaters, film theaters, garages for vehicle repair, garage for armor and robot repair, taxicab services, car and truck rental service, courier service, Body-Chop-Shops, medical clinic, bars/saloons, comedy clubs, nightclubs, strip clubs, dance halls, gambling halls, small casino, other types of gambling, animal fights (and betting), boxing and duels (and betting), small-scale gladiatorial games (and betting), and tattoo parlors, as well as criminal operations such as protection/guard service, escort, forgery, fencing, smuggling, hit man, drugs, and so on. Many service-based



enterprises also offer a small selection of products or other services that might appeal to their clientele. For example, a bar may offer a small selection of something to eat and/or sell drugs, or have gambling upstairs, or a small selection of weapons or power armor in the basement, and so on. -40% on Weapon Availability Table rolls.

Warehousing is also a service that the Black Market offers to other Black Marketeers, traveling merchants, mercenaries and adventurers. Many towns and most cities do NOT allow mercs and adventurers to waltz into town inside power armor or driving giant robots, tanks and other military vehicles. A convoy of trucks and caravans of pack animals will need a safe place to park their vehicles and store their wares, especially if they are only stopping for the night or few days. The Black Market (and other business people) have short- and long-term rentals of warehouse space. A 30x30x30 foot (9x9x9 m) space costs a meager 20-40 credits per 24 hour period. The storage space can be increased in increments of 30 feet (9.1 m). Add 50 credits per day for a storage area that has an alarm and video surveillance, or 150 per day for one armed guard. Of course, these options can be combined, and a customer can hire as many guards as he'd like. It is common knowledge that customers who hire even one armed guard at a known Black Market storage warehouse have some of the best security in town, because few thieves and raiders are foolish enough to cross the Black Market. That is not the case if the warehouse operation is in a community where the Black Market is underground. The Black Market (and others) offer similar boarding and care for pack animals, including dinosaurs.

61-80% Large Retail Enterprise: This is either a large department store-style outlet, shopping mall, or strip mall with numerous different types of goods and services available. It is the large Black Market stores where shoppers can find new and used commercial vehicles, combat vehicles, power armor, giant robots, and riding animals and pack animals, including dinosaurs and alien beasts of burden. A large Black Market enterprise may also include gambling casinos, race track, sports arenas and gladiatorial arenas. +5% on Weapon Availability Table rolls.

81-00% Black Market Expo: A rare sight outside of permissive kingdoms, market expos are concentrations of different Black Market vendors, suppliers and traveling merchants. A small percentage (2D6+4%) may allow local and non-Black Market vendors to set up small and medium shopping areas/stores and kiosks. Mountains of weapons, ammo, E-Clips, body armor, power armor and gear abound, and large military items like combat robots, tanks and long-range missiles are likely to be available. There will be plenty of service people around and competition may well drive prices down by 3D6 percent. There may also be sales and auctions of select items (G.M.'s discretion) with discounts of 20-40%. +10% on Weapon Availability Table rolls.

Step Two: Retail Store Types

Different market zones and different parts of town often require specific market outlets to serve their customers. Arms merchants, forgery shops, brothels and other facets of the Black Market often occupy different buildings or sites, catering to different customers and under a varying level of pressure by local police forces.

01-20% Legitimate Business: The store offers legitimate goods or services. It may be a front for another type of Black Market operation or be involved in laundering money, or is simply a legitimate business. Whatever it is that the business offers, it is in good supply/availability.

21-40% Criminal Service Provider: These Black Marketeers offer criminal and mercenary services such as assassination, blackmail, bounty hunting, forgery, provide false documents and I.D.s, courier service, smuggling, confidence games, theft, raiding, intimidation/threats, revenge, sabotage, spying/surveillance, protection and murder for hire. These kinds of merchants are a necessary fixture of life under Coalition rule and may include forgers, hired thugs and spies amongst their ranks.

41-60% Arms Dealer: The retailer sells combat gear. This could be a general weapons store that sells a little bit of all kinds of weapons and combat gear, body armor, etc. Or the store may specialize in one or two lines or types of weapons and combat gear, such as Black Market guns and knock-offs, guns and body armor, heavy weapons and power armor, used weapons and armor, Bandito Arms weapons and hovercycles, body armor and power armor only, robots only, combat vehicles only, armor and vehicles, Bandito Arms and CS weapons only, magic and TW weapons only, and so on. +10% to all Weapon Availability Table rolls for the item or items the store specializes in.

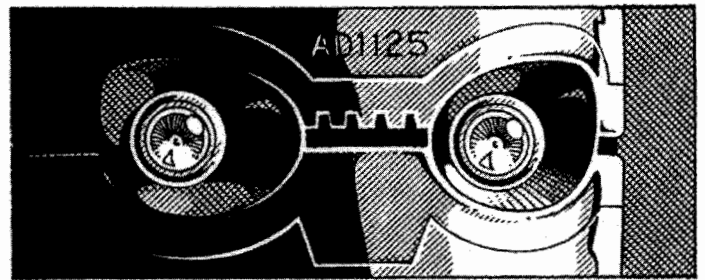

61-70% Robots: The merchant specializes in the sale of robot horses and other animals, or robot vehicles (limited or huge selection) and may include power armor (some types or a wide range). +10% to all Weapon Availability Table rolls when it comes to robots and power armor only.

71-80% Vehicles: The merchant specializes in the sale of vehicles. May be low-end conventional fuel vehicles, or high-end nuclear powered vehicles, including a selection of hovercycles, rocket bikes, hovercars, hover trucks, jet packs, canoes, rafts, small boats and other vehicles. May include a small selection of hopping or flying power armor and 1D4 giant robots. +15% to all Weapon Availability Table rolls when it comes to vehicles and robot vehicles only (does not include power armor).

81-90% Full Black Market Store Operation: The store offers common and popular weapons, ammunition, E-Clips, body armor, and adventuring gear as well as a wide range of legal and conventional supplies that fill the needs of the local community. It may also offer a myriad of other goods and services, both legal and illegal. They are likely to have a few pieces of serious military hardware for sale or something exotic. +5% to all Weapon Availability Table rolls.

91-00% Mercenary and Military Outfitter: These merchants make their living selling to mercenaries, private armies and regional defenders. Ammunition is plentiful, the variety of weapons is good to outstanding, and body armor, power armor, combat vehicles and maybe even a few giant robots are part of their inventory. +12% to all Weapon Availability Table rolls.

Step Three: Black Market Ties

Most Black Market business enterprises are established by one of the Five Factions which is able to purchase, run and protect a permanent facility. Keeping any Black Market enterprise running

and safe may require secrecy, regular bribes and a measure of influence over the authorities and/or ruling body.

01-20% None/Independent: This is an independent merchant with no allegiance to any particular Black Market Faction. Independent storefronts are allowed to exist by the Black Market to help keep the authorities off their backs and to blend in with other legitimate businesses.

21-30% Common Black Market: This storefront is operated by the common black market or other criminal or questionable group without official ties to any of the Five Factions. They are good scapegoats for the operations associated with the Five Factions, and are often “set-up” to take the fall for the Black Market.

31-40% Bandito Arms: Though most prevalent in the American Southwest, the New West, and the border of northern Mexico, Bandito Arms products and merchant outlets are spreading across North America. In other cases, other Black Market Factions sell Bandito wares because it is a Black Market brethren, offers excellent discounts and the Bandito Arms brand is growing in popularity.

41-50% The Chicago Network: As the largest and arguably most influential of the Five Factions, a Black Market retailer found anywhere in North America may be sponsored and have ties with the Chicago mob.

51-60% The Immaterial Hand: As a distributor of contraband and cargo for itself and ALL Factions of the Black Market, common black market, other criminals, mercenaries, the Federation of Magic and others, the Immaterial Hand has retail and service outlets, especially when it comes to Black Market owned magic shops, warehouses and cargo transport services, all across North America.

61-00% The Dominating Faction of that Region: In most cases, a Black Market store will be sponsored or affiliated with the dominant Faction for that part of the country. With the exception of the Immaterial Hand, the Five Factions tend to dominate and control one or more geographic regions. There may be some overlap and some friendly rivalry, but for the most part, the dominating Faction for that region runs most of the Black Market operations for that location. Thus, *Bandito Arms* and *El Oculita* dominate the New West, the American Southwest and northern Mexico. The *Chicago Network* dominates the Domain of Man/CS territory with some overlap and unfriendly rivalry from *Le Marche Noir*. *Le Marche Noir* dominates the southern Canadian landscape and Free Quebec. Even the *Immaterial Hand*, who provides its services everywhere to the other four Factions, outlaw groups, mercenaries, and businesses, has its main base of operations in the Magic Zone and greatest influence in communities of practitioners of magic.

Step Four: Store Security

Market retail operations represent a significant investment of resources and are well protected. Physical defenses and security staff are one of the benefits of setting up shop in a fixed location. In most cases, the establishment is owned by one of the Five Factions, or a lesser faction. In the ‘Burbs, cities and towns, this means there is a Boss and his crew of Black Marketeers running and protecting their personal criminal operations and their Faction’s holdings. There are likely to be a few Bosses and crews in towns and several in cities, large and small. Mess with one of the Boss’s personal business enterprises or a holding of the Faction he belongs

to, and he and his crew will respond, and mob justice is usually much more immediate, brutal and deadly than the law.

01-20% None: The only security comes from the salespeople themselves and their reputation. The knowledge that a business is a Black Market enterprise is enough to send most would-be crooks and troublemakers on their way without incident. Most people are smart enough to avoid messing with a business owned by the Black Market. While there is no tangible or immediate security at this store, odds are that if any of the Black Market Bosses or a member of their crew finds out who was responsible for theft or trouble at one of the Faction’s business holdings, there will be contact made with those responsible for recompense and amends, or bloody retribution.

21-40% Basic Security or Guards: One or two Soldiers or hired muscle guard the premises, the people and property inside during business hours only. When the business is closed there is an alarm and security camera in place. Muscle can be any Men-at-Arms O.C.C. from mercenary to Combat Cyborg or Juicer, or a practitioner of magic, psychic or powerful D-Bee or creature of magic. In most cases (60%), the “muscle” are members of the Black Market. **Note:** There is typically a day shift and a night shift.

41-60% Around the Clock Security: 1D4+2 Soldiers and one Enforcer, or hired muscle, watch over the premises, the people and property inside during business hours. When the business is closed, there are security cameras and an alarm in place. Half of the security team remains on duty inside and half stand guard outside at the main entrance and back entrance. All respond to any trouble at the facility within 1D6 melee rounds. Muscle can be any Men-at-Arms O.C.C.s or practitioners of magic, psychics, powerful D-Bees or a combination of some or all. In most cases (65%), the “muscle” are members of the Black Market. **Note:** There is typically a day shift and a night shift.

61-80% Heavy, Full-Time Security: 1D4+2 Soldiers, 1D4+1 Enforcers or other “heavy hitters” (Juicers, Crazies, power armor units, Master Psychic, mage or monster), and security specialists who often consist of 1-2 psychics and/or 1-2 practitioners of magic, guard the premises during business hours. When the business is closed, there are security cameras and an alarm in place, and the Soldiers patrol and guard the outside. Half of the Enforcers/heavy hitters and security specialists remain on duty inside. The other half go home but are on call. Those on-site respond to any trouble at the facility within 1D6+1 melee rounds. Those off-site respond as backup within 1D4+3 minutes. Members of the Heavy Security Force can be any Men-at-Arms O.C.C., practitioner of magic, psychic, powerful D-Bee or a combination of some or all. In most cases (75%), the “muscle” are members of the Black Market. **Note:** There is typically a day shift and a night shift.

81-00% Paranoid: Same as Heavy Security above, except the entire force stays on-site when the shop closes and the day security team is on call and will come running as reinforcements to the location within 1D4+1 minutes. Furthermore, each salesperson has access to a weapon kept unseen under various counters and secret locations, Black Marketeers working at the location carry concealed weapons, and there are, of course, silent and blaring alarms and security cameras in place. There may even be a high-level (1D4+5) practitioner of magic, Master Psychic, Dragon Hatchling or a giant combat robot assigned as one of the guards or responders to trouble. **Note:** There is a day shift and a night shift of defenders.

Step Five: Store Selling Attitude & Supply Level

Market outlets are built to do business and are almost always better supplied than traveling merchants. Most have long hours and some are open around the clock, 24 hours a day.

01-25% Low Inventory: There isn't much left on the shelves. The merchant had a run on product that has reduced his normal level of supplies by 2D4x10% and he's waiting for one or more shipments of product. Small arms and ordinary goods *may* be available, but even common goods may be sold out or few in number. Large, expensive items, vehicles and magic items are probably sold out. At the G.M.'s discretion, there may be a few special items that were overlooked or held in reserve for a specific customer who has yet to pick them up. Or maybe the store recently purchased a small amount of weapons or goods from adventurers or mercs, but hasn't had time to inspect or inventory it yet; purchase at your own risk. Until a new shipment arrives, there is only what's on the shelf. There is nothing else the store can do for the customers except maybe direct them to another Black Market retail location, if there is one. **Note:** If the shipment is late, it could mean trouble; it may have been hijacked or delayed due to unusual circumstances, being held ransom, etc., and it could be an adventures hook. -40% on Weapon Availability Table rolls.

26-65% Well Stocked and Open for Business: It is a normal day for this particular market outlet. The site is well stocked and there may be special deals on certain items. The store has 1D6+2 of everything they normally sell. Exotic and expensive items can be special ordered, but it will take 1D6+6 days to arrive. Special orders require a payment of half up-front for the order to even be placed, and the balance when the item(s) arrives. Business is good so there are no sale items. +10% on Weapon Availability Table rolls.

66-85% Let's Deal: The merchant is an aggressive salesperson or has a bunch of new inventory on its way and he needs to make shelf-space for it. As a result, he is willing to offer deals and discounts on select items (20%), bulk purchases (10% discount, 20% for those willing to haggle), BigBore weapons are on sale at a 25% discount (+5% more for bulk orders of 6 or more weapons), BigBore ammo is on sale at a 10% discount, big ticket items like power armor, robots and vehicles (if available) are on sale for 15-20% discounts, and used weapons and gear along with some "special sales items" are on sale for 30-40% discounts. However, some of these sale items may be stolen and "hot." +15% on Weapon Availability Table rolls.

85-00% Everything Must Go! Pick one of the following or roll 1D4.

1. Only sells used items and knock-offs (half of which are stolen and "hot") – EVERYTHING IS HALF OFF!

2. The merchant has a ton of new inventory on its way and he needs to make shelf-space for it – EVERYTHING in the store is marked down 30%.

3. The merchant has been suffering through a terrible sales slump, so he is eager to get business going with a sale: EVERYTHING, including all goods and services except the most exotic and rare of items, are being offered at a 20% discount! But there are other sales going on! Hunting and camping gear is marked down 30%, weapons, armor, vehicles, BigBore weapons (not the ammo) and knock-off weapons are all marked down 30%, any used weapons, power armor, gear and vehicles (if available) are marked down 40%. +10% on Weapon Availability Table rolls.

4. Big Season or Holiday Blow-Out Sale! EVERYTHING 50% OFF!! No lay away. Nothing put aside and held for a customer for any reason, even if it is only a few minutes.

As customers make purchases, the owner and his security team and/or most trusted workers and friends are loading up one or more trucks with the most valuable and rarest product, money and personal effects. *They have 4D6+12 minutes before this business is raided or attacked!* The owner has gotten word from his Crew Boss or a Friend in High Places that the authorities or a powerful enemy are coming to close him down and seize his goods, or kill him and burn him out! He plans to be gone in 20 minutes. And he plans to sell as much as he can and get out before that happens. The situation is such that the Black Market's hands are tied and they cannot help him avoid the inevitable. Heck, maybe he crossed the wrong Faction Top Boss, stole from the wrong person, or has gotten the Coalition, Federation of Magic, a dragon, a Demon Lord or other powerful force looking for revenge.

Market Towns

Market Towns are what serious Black Market customers are looking for. Why? Because two-thirds of the towns' businesses are owned and run by the Black Market and offer the most complete and wide range of Black Market products, contraband, stolen goods, vehicles, weapons and combat gear anywhere shy of MercTown or the Splynn Dimensional Market. They are rare settlements established by one or two Black Market Factions and dedicated to moving the kinds of serious hardware mercenary companies, rebels, bandits, raiders, criminals, adventurers, D-Bees and monsters are hungry for. Market Towns are always well defended, armed camps and may include the headquarters for one or more local Black Market Bosses and his/their crew. Market Towns only develop outside of the sphere of influence of nations and cities, or near nations and cities that allow it. Most of the really big ones are almost always deep within the wilderness or secretly protected by the local government.

Step One: Town Size

The actual number of merchants, buildings and vehicles that make up the site will vary with type, age and traffic. Game Master discretion.

01-20% Black Market Mobile Trade Camp: This is a mobile Market Town comprised of scores of trucks, giant tents and easy to put up and tear down or abandon buildings. Others sell from the back of their trucks and boxcars, or set up open-air market areas that resemble flea markets and car lots. Mobile Trade Camps usually spring up in remote areas along trade routes, and the outskirts of war zones. They are mobile to avoid the authorities, military forces and other dangers, or to take advantage of conflicts at numerous locations.

21-50% New Market Town: A recent development, this is an Old West-style (or New West, for that matter) "boom town." It can seem to appear overnight and grows and grows. A New Market Town may crop up near a war zone or mercenary camp, but more often than not, it appears at the crossroads or supply route of a growing town or settlement where it can offer the locals, visitors and travelers a wider range of products, services and vice. It may also crop up in areas where bandits, mercenaries and raiders go to hide from the authorities and their enemies. A New Market Town

is usually half the size of an established one, but still offers a huge selection of goods. +10% on Weapon Availability Table rolls.

51-80% Established Market Town: A developed hub of Black Market activity, established Market Towns have had some time to garner a reputation and attract various merchants, as well as to stockpile numerous items. +15% on Weapon Availability Table rolls.

81-00% Veritable Market Town: A notorious haven for mercenaries, bandits, criminals, rebels and roughnecks. The largest of Market Towns are often set up deep within areas controlled by a Black Market Faction or allowed by a permissive government. Virtually anything the Black Market has to offer is available, and there are a full range of goods and services. +20% on Weapon Availability Table rolls.

Step Two: Town Area of Specialty

ALL Market Towns generally carry a wide range of Black Market goods and services, but most also grow and develop their own individual atmosphere and area of specialization. Some Market Towns are open-air weapons markets that cater to mercenaries, adventurers and armies. Others may be Las Vegas-style dens of sin and entertainment, with prostitutes, gambling, lone sharks and other such accommodations.

01-10% Drugs: There is a sizeable portion of town that caters to drug users and Juicers. There are drug dens and taverns everywhere. Most drugs and Juicer chemicals can be purchased at a 10-20% discount, booze for 30% less and moonshine for a few credits above cost. Ironically, there are also drug rehab and Juicer detox clinics and half-way houses.

11-20% Magic: In addition to the usual Black Market products and services, this Market Town specializes in the sale of magic items and magic services, such as healing, transportation, Rifting, magic cargo hauling, illusions for entertainment, etc. The town caters to practitioners of magic and creatures of magic, as well as psychics and scholars on all levels, from weapons to entertainment. This means there will be many bookstores and stationary shops, magic shops, shops that sell magical/TW components, nice hotels and bed and breakfast places, restaurants, gentlemen's clubs, pubs, at least one public library, at least one large park for Warlocks and Druids, possibly a zoo, and other places that appeal to mages and intellectuals.

21-30% Augmentation: In addition to the usual Black Market products and services, this is the place to go to get turned into Juicers, Crazies, Headhunters and Cyborgs. Cybernetics and bionics of all kinds are available, and usually at prices 10-20% below market. Body-Chop-Shops seem to be on every block, and the town caters to augmented customers such as 'Borgs, Juicers, Crazies and others on all levels, from weapons to entertainment.

31-40% Service Provider: Medical. In addition to the usual Black Market products and services, this Market Town specializes in advanced medical care and the types of grievous wounds suffered in combat. Includes Body-Chop-Shops and cybernetic implants and bionic augmentation, enhancements and cybernetic Bio-Systems. It is also likely to offer psychic and magic healing.

41-50% Service Provider: Entertainment: In addition to the usual Black Market products and services, this Market Town caters to giving its visitors a place to relax and spend their money on entertainment. It is filled with hotels, boarding houses, brothels, casinos (at least 1D6+6), gambling halls, dance halls, nightclubs, taverns, restaurants, movie theaters, theaters for live acts (plays,

concerts, etc.), videogame parlors, pawnshops, shooting ranges, a race track and either a sports arena or gladiatorial arena.

51-60% Service Provider: Vice: This Market Town is a den of sin and vice. Drugs, prostitution, gambling, blood sports and contraband. Of course it offers the usual Black Market products and services.

61-65% Criminal Service Provider: Muscle and Death: Looking for Raiders, Master Assassins, Bounty Hunters, Juicers, Crazies, Gunslingers, Gunfighters, mercenaries, armed escorts, guards, and other Men-at-Arms to take a town, kill an enemy, mess up a rival, exact revenge, provide protection, etc.? This Market Town is crawling with them. This is also the place to find mercenary jobs, bounties and other work that involves hired guns and dangerous missions. Of course, it also offers the usual Black Market products and services.

66-70% Criminal Service Provider: Vehicle Repair: In addition to the usual Black Market products and services, this Market Town is packed with garages to fix vehicles, robots and power armor.

71-75% Criminal Service Provider: New and False Identities: In addition to the usual Black Market products and services, this Market Town specializes in forged documents and I.D.s, cyber-disguises, and magic to change one's identity and sometimes appearance.

76-80% Criminal Service Provider: Smuggling: In addition to the usual Black Market products and services, this Market Town is packed with retail outlets that cater to smugglers, sell robot animals that look real and have secret cargo containers and holds inside of them, as well as a wide range of smuggler services.

81-90% Weapons: Melee weapons, guns, heavy weapons, more guns, power armor, more guns, combat robots, more guns, bionic weapons, Juicer weapons and gear, combat vehicles, and more guns, and possibly a small selection of magic weapons. If any Black Market Faction offers the weapon, this Market Town is likely to have it. That includes BigBore, Triax, Northern Gun, Wilk's and the weapons of most other manufacturers. +20% on Weapon Availability Table rolls.

91-95% Robots: In addition to the usual Black Market products and services, this Market Town specializes in the sale of robot vehicles, robot animals, robot horses and companions, drones and other robot vehicles. Huge selection, many brand name manufacturers, including Bandito Arms and Northern Gun. +20% to all Weapon Availability Table rolls when it comes to robots and power armor only.

96-00% Vehicles: In addition to the usual Black Market products and services, this Market Town specializes in the sale of vehicles, but NOT robot vehicles or robot animals. Includes a wide range of hovercycles, rocket bikes, cars, motorcycles, jeeps, ATVs, hover vehicles, hover trucks, jet packs, canoes, rafts, small boats and other vehicles. +15% to all Weapon Availability Table rolls when it comes to vehicles only (does not include robots or power armor).

Step Three: Town Faction Affiliation

Market Towns rarely spring up on their own, and almost always in remote wilderness areas. Most of the time, better sited and connected Market Towns are the result of planning and preparation made by one of the big Market Factions. As immobile and very appealing targets, Market Towns unable to call on a larger organization for defense and supply rarely last long.

01-05% None/Independent: There are few independent Market Towns in North America, and those that exist usually have the support of a regional warlord, local government or powerful criminal figure.

06-23% Bandito Arms: Bandito Arms has a pair of Market Towns in southern Nevada, situated a good distance away from Area 51 so as not to attract attention to the secret facility. They are also setting up a Market Town near Carlsbad, New Mexico to help move more goods to the warlords of the Pecos Empire and into Mexico.

24-40% El Oculita: In addition to Mercado, El Oculita has a permanent Market Town located along the Texan coast outside of the ruins of *Odem*, near the site of pre-Rifts *Corpus Christi*. There are also rumors of El Oculita-controlled Market Towns in northern Mexico and somewhere along the Louisiana Gulf Coast.

41-58% The Chicago Network: The Chicago Network is so large and has such an influence in the 'Burbs of all the Coalition States, it rarely finds the opportunity or necessity to set up actual Market Towns. Such an endeavor requires a lot of room and trustworthy, bribed officials, a difficult set of circumstances to arrange inside Coalition territory. However, the Chicago Network has a Market Town not far from *Kingsdale* as well as having a considerable number of holdings in that small nation and another in Michigan along the lake, near the ruins of *South Haven*. The Network had two Market Towns in southern Minnesota and one in Wisconsin, but shut them both down a couple years into the Coalition's war on Tolkeen.

Twice a year, once in May or June and once in the fall, the Chicago Network holds a massive "Market Expo." The expo is a secret affair that is announced through Black Market and mercenary channels a month in advance so people start to keep an eye out for it, then it just springs up somewhere within the Coalition State of Illinois or Missouri, or sometimes Oklahoma or Kansas. It is a sprawling temporary town that lasts for only 1D4 weeks before packing up its wares and melting back into the criminal underground. The event is short to avoid CS intervention. As soon as word has it that the CS has uncovered the location, the Market Expo shuts down and vanishes before CS troops arrive. And somehow, the Chicago Network always knows when that is. Information on the expo's location is very valuable, both to interested customers and to the authorities, and every year the ISS ramps up their efforts for a month or two in an effort to locate the expo, shut it down and arrest as many shoppers as possible. So far, that scenario has never happened.

59-76% Le Marché Noir: Le Marché Noir operates a Market Town to the east of Iron Heart that occasionally relocates, and another located near the ruins of *Wingham* to service clientele from Lazlo and the communities around it, as well as pirates and privateers operating in the Great Lakes. The Faction does not have a single such facility in Free Quebec, but has numerous enterprises in the 'Burbs and many of the towns and cities.

77-94% The Immaterial Hand: The Immaterial Hand maintains a single large Market Town within the Magic Zone, southwest of the ruins of *Cincinnati*. It is a hub of magic items and Techno-Wizard gear, as well as conventional weapons and supplies. Of course, the Faction also has enterprises and influence at all the major cities of the Federation of Magic, as well as Lazlo and New Lazlo.

95-00% Other: Other Black Marketeers, mercenaries and business people may establish Market Towns when and where they can, but a third are often bought out and taken over by the Black Market or also include Black Market goods and businesses. *Pecos*

Warlord Don Marco of the Silver Dagger Gang, for example, has a Market Town of his own in *New San Antonio*, a bone of contention between his war band and the El Oculita cartel.

Step Four: Town Security

Market Towns are the jewels in the crown of the various Black Market syndicates. They are the preferred shopping outlets for mercenary companies, agents of local militaries, large criminal groups and adventurers seeking hard-to-find items. Many of whom are quick to join defenders of the Market Town should it fall under attack. As such, most thieves, bandits, raiders and even enemy nations consider such places hornets' nests best left alone.

Security is left to each *individual retail outlet*. See **Step Four: Store Security**, in the previous set of tables for Black Market retail stores.

Peacekeeping Force. That having been said, there is a **Sheriff** and 2D6 Deputies charged with keeping the peace. They are a mix of Men-at-Arms O.C.C.s with a couple psychics and mages tossed in for good measure.

Black Market Crew Offers Additional Security. There is likely to be 1D4+1 local Bosses and their crews of 6D6x10+6 Black Market operatives (Soldiers, Enforcers, etc.) in addition to the security of each retail outlet, who keep an eye on their Top Boss's assets and operations.

In short, only the most daring, stupid, or heavily armed combat force will consider hitting a Market Town.

Step Five: Store Selling Attitude & Supply Level

Again, roll per each individual retail outlet as described under **Step Five: Store Selling Attitude & Supply Level**, in the previous set of tables for Black Market retail stores.

Optional: Bar/Club Generation Tables

The most common types of "legitimate" businesses operated by the Black Market are bars and nightclubs. As both social gathering places and dens of vice, such establishments provide the perfect outlet for meeting contacts, dealing drugs, providing prostitutes and laundering money. Even from the inside there is often no way of telling who really runs a particular joint, and with frontmen and intermediaries, the real owners never even have to set foot in the place.

The most traditional arrangement is a kind of partnership between the establishment's owner and the Black Market. The owner comes to the Black Market for startup money to build or open the club and possibly, muscle to protect it. In return, the Market receives a share of the profits, (an amount that varies wildly by circumstance) and normally retains the rights to use the bar or club as a platform for their nefarious activities. This arrangement puts a legitimate name on the business while fulfilling all of the Black Market's needs. It is one of the very few ways that the Black Market is known to be helpful to the small businessman.

Step One: Type of Bar

There are many different types of establishments, from restaurants with a beer and wine list to full-fledged nightclubs to drug dens. The type of establishment is the primary factor for determining the clientele and type of business that comes and goes through the building's doors.

01-30% Bar: This place is a pretty standard tavern/saloon, and may range from a neighborhood bar or watering hole, to a rough and tumble tavern that caters to thugs and men-at-arms, to a classy microbrewery or large beer hall.

31-50% Nightclub/Lounge: With dimmed lights and a cool and casual atmosphere, nightclubs and lounges are the place to go to see musicians and live acts, meet people and enjoy a more sophisticated (and expensive) experience than what's found at a normal bar.

51-60% Restaurant that Serves Alcohol: A sit-down establishment that has numerous booths and tables as well as a large kitchen and refrigerator or pantry area. A fine restaurant may have a large selection of libations that are uncommon, such as a large selection of fine wine, champagne, brandy, flavored drinks and exotic beverages imported from other countries, perhaps even other worlds! Low-class eateries may serve only beer and hard liquor or moonshine.

61-70% Dance Club: Equipped with a large dance floor, fancy lighting and a bar, dance clubs are congregations that mainly cater to the young and energetic. The building may also have a stage for concerts and live bands, and definitely has a DJ booth and speaker system or magically-generated music.

71-80% Pub or Gentleman's Club: This club has a refined atmosphere that appeals to scholars, mages, business people, politicians and gentlemen. It is likely to have a lively but restrained and more polite clientele, and may offer games of darts, pool, gambling, a library and/or private sitting rooms (costs 50-100 credits an hour), as well as other services behind closed doors for their wealthy customers, such as high-class call girls, animal fights, high-stakes card games, and so on.

81-87% Strip Club: Sex appeal and booze are the attractions that draw customers into this club. Topless girls (human and D-Bee), stripteases and lap dances are available in addition to stiff drinks. The site may be a thinly-veiled front for actual prostitution and escort services.

88-95% Gambling Hall or Casino: All sorts of games of chance are made more fun with all kinds of alcoholic beverages, from wine and beer to flavored drinks and hard liquor.

96-00% Drug Den: This place is similar to a bar, only it serves Earthly intoxicants such as hashish, opium and cocaine. Some may also offer alien or magical drugs. Many drug dens are run-down dives, though there are upscale drug dens for sophisticated clientele. Drug dens are often dangerous places and are rarely advertised publicly like bars or clubs.

Step Two: Club Size

Any type of establishment can grow to almost any size. Even classic "dive bars" can sometimes expand into a large, popular place.

01-09% Hole-in-the-Wall: A small, easily passed-by location, probably acquired because it was cheap and available. Whichever type of bar or club occupies this spot, it is going to be limited in its facilities and likely a bit dirty and distasteful. Drug dens of this

scale may not be organized at all, simply groups of users clustered together in alleyways or squatting in abandoned apartments.

10-59% Small/Modest: While limited in space, this site is a true bar or club with all the amenities. It may represent small business owners who are just starting out or a location which exists solely as a front for the Black Market and only keeps up the bar to maintain its cover.

60-89% Medium-Sized: A good-sized bar or club with no cramped or congested feel. Has all the necessary touches in place, including bathrooms for each gender and likely a porch, veranda or upper floor. May feature extras like karaoke, darts, billiards, etc.

90-97% Large Establishment: A true beer hall, dance hall, casino or other large establishment which features multiple bars, stages for performers and acts, dance floors, games and side activities. On Rifts Earth, these entertainments could include almost anything, from bands, to magicians (real magic, most likely), to comedians, to alien dancing girls, to Juicer sports or gladiator death matches.

98-00% Mega-Club: Few and far between, Mega-Clubs are super-successful establishments that are likely located along trade routes or in popular sections of large towns and cities. No matter what type of club, bar, or entertainment spot of this size, it has taken years to develop and garnered a reputation as the only place to be on the weekends and at night. It has all the features of a Large Establishment only with greater variety and may be several different clubs and entertainment rolled into one big venue. The biggest traveling acts on Rifts Earth are likely to stop by and several thousands of guests will be in attendance on busy nights. In addition, the bouncers at a Mega-Club are well trained and organized superhuman (augmented, super-powered, psionic or magically endowed) individuals to keep the peace. Juicers are frequently employed as bouncers as their reflexes and advanced perception are extremely useful in a crowded, noisy club environment, and they can do their job without need for bulky weapons or armor.

Step Three: Criminal Activity

Even bars and clubs not owned by the Black Market are magnets for criminal activity. They make most of their money on the sale of alcohol and turn a blind eye to vice, so selling to, or working for, the Black Market is not a difficult step to take.

01-20% Clean/Legitimate: Whether it is a legitimate front for the Black Market or however it happened, the establishment is clean and safe. Well, as safe as a bar or nightclub can be.

21-40% Disorganized Crime: Pickpockets, prostitutes, drug dealers, con artists and other small-time criminals use the bar or club to find new marks/customers. There is no organized criminal presence and the owners may shoo away unsavory characters from time to time.

41-60% Criminal Activity: The Black Market and the bar or club's owners have come to an arrangement, and the Black Market (or other criminals) are allowed to ply their trade inside with few or no consequences. While not really run by the Black Market, they have a substantial presence here.

61-70% Black Market Backdoor Establishment: The bar or club may not advertise the fact, but it is owned and run by the Black Market, which means there is likely to be gambling, prostitution, drugs and/or contraband available at the place. Ask the right questions of the right person and the criminal products or services are made available.

71-80% Black Market Front: Though it is always denied, the Black Market owns and operates this establishment. While the bar or nightclub is the front, and is always busy, the real money is the secret criminal enterprise going on in secret rooms, a hidden basement, the upper floors or the “closed” part of the building.

Likely crime businesses behind the scenes are, *01-10% Brothel. 11-20% Gambling. 21-30% Body-Chop-Shop. 31-40% Arms dealer. 41-50% Seller of contraband (books, magic, drugs, etc.). 51-60% Fence. 61-70% Forgery. 71-80% Fight club (humanoids, animals, robots, or all). 81-90% Automobile/robot chop-shop (stolen vehicles are either chopped and sold off for parts or the vehicles are “sanitized,” repainted and shipped off for resale). 91-00% Criminal service or services.* And if one knows who and how to ask, they may be referred up the food chain to the regional Black Market Boss or Crime Lord.

81-90% Black Market Hub: This joint is known throughout town as a Black Market enterprise and a place to make contact with the mob, fences, smugglers, arms dealers, mercenaries, hit men, forgers, Safecrackers and other criminal specialists.

91-00% Criminal Headquarters: The site is the personal hangout and headquarters for the local Black Market Bosses or Top Boss and his “family.” They may hang out anywhere in the establishment and brush shoulders with the ordinary patrons, but there is always an area of the place reserved for Bosses and their crew. This could be a quieter area away from the day-to-day business activity, a private floor, basement or back rooms where the Bosses and the members of their crew meet to relax, drink, eat and talk business. There will also be a secured room for private meetings with clients, and a private, secured lounge with a private bar, bathroom and a bedroom for the Boss to sleep it off when necessary or engage in extracurricular activities. There may also be secret weapon caches, a hidden safe for valuables and even concealed escape tunnels. Only the Boss, his or her goons and escorted guests are allowed in the private areas.

Armed thugs are present and scattered throughout the establishment, many of whom look like patrons. The head bartender and his second, as well as other members of management or select workers are all Black Marketeers and armed, or have weapons within easy grasp (under the bar, in the kitchen), for additional security.

Optional: Body-Chop-Shops

The term “Body-Chop-Shop” has come to refer to any illegal, substandard or less than legitimate cybernetics conversion center. There are few places where someone who isn’t connected to a large military or corporation can receive legal cybernetic conversion, so the majority of independent adventurer and mercenary cyborgs receive their augmentation from a Body-Chop-Shop.

Body-Chop-Shops are so named for their habit of recklessly swapping out parts and accepting still-attached bionics for “trade-in value” or in lieu of payment. Most Cyber-Docs who run such establishments are “morally flexible,” and unlikely to ask where a certain piece of bionics came from before removing it, sometimes with a meat cleaver or a hacksaw.

The Body-Chop-Shop is the place to be for cyborgs looking for an upgrade. In the worst areas of the Coalition ‘Burbs and impoverished cities, Body Chop-Shops are often crude, improvised facilities set-up and dismantled in a hurry. In cities where cyber-

netic augmentation is legal, such as MercTown and most of the Northern Gun, “Body Chop-Shops” may be well-stocked medical clinics with attached showrooms that have their wares on display. Normally they exist somewhere in between both extremes, and the best may be booked for weeks or even months in advance.

Optional: Body Chop-Shop Generation Table

There are several different types of cybernetics and bionics outlets, each with a different focus and specialty. Most can handle basic procedures, but more complex and specific tasks should be relegated to the necessary specialists.

01-20% Prosthetics Clinic: Equipped for replacing limbs and organs, this facility is oriented towards repairing injuries rather than building war machines. Weapons, cybernetic armor and most gadgets are not available, but for those looking to replace a lost arm, leg, eye or even a kidney or other internal organ, this is the place to be. 01-50% chance they offer life-like Bio-System prosthetics.

21-40% Augmentation Center: This is a standard Body Chop-Shop that takes customers and turns them into Headhunters or Full Conversion ‘Borgs. They will be less capable of dealing with strictly medical implants and emergency transplants like the Prosthetics Clinic, but can handle the entire augmentation process from beginning to end. Weapons, armor and gadgets will be on hand.

41-60% Military Cybernetics Specialists: This is an arms merchant who specifically caters to cybernetic soldiers as customers. Built-in weapons, armor, gadgets for combat or spying and cyborg systems intended for military use are all in stock, as well as parts and ammo.

61-80% Cybernetics Complex: The largest and best equipped “Body Chop-Shops” are like a cross between a gun store and a small hospital. Medical cybernetics (artificial eyes, lungs, organs, etc.), Bio-Systems, and prosthetics are available, along with cybernetic implants, weapons, gadgets and armor. This is a one-stop-shop for all of a character’s cybernetics needs.

81-90% Medical Facility: This the place you go to when you don’t want a hospital or the police to know about your injuries. Discretion and privacy are par for the course. This facility also specializes in all forms of plastic surgery, cybernetic disguises and can provide the new identity card and papers that come with the new or changing face.

91-00% One-Stop Shopping: This facility provides all of the above.

Organ Trafficking and Chop-Shops

Even in the high-tech world of Rifts Earth, the majority of kingdoms and population centers do not have unlimited access to the amazing genetic and cybernetic technology that could prolong and improve their lives. The alternative is old-fashioned organ replacement, sometimes assisted by magic or improved surgical procedures. The high cost that many are willing to pay to continue living in good health has created a market for harvested organs. And in a world where poverty and desperation are commonplace, there are plenty of people willing to sell their organs.

Body-Chop-Shops are one of the places to come to sell organs and have them harvested as well as installed. Not all Body-Chop-Shops are willing or able to engage in this business, but many can,

and some specialize in it, particularly the ones that are medical facilities. Such shops buy organs for 2D6x1,000 each, double if the donor is already known to be a match for a specified recipient or when purchased from an Organ Trafficker. They resell and surgically implant the organ for 2D6x10,000 credits, sometimes more.

Similar to Cyber-Snatchers, there are **Organ Traffickers** – the worst scum that of the Black Market associates with. These butchers are disreputable M.D.s and surgeons willing to kill and maim innocent people to turn a profit. They have few personal morals and beliefs, or at least none that stand in the way of their sinister practices. Organ Traffickers may harvest the organ of a prisoner after interrogation when there is no need to keep him alive, or kidnap victims pulled of the street. The latter can be drunks, junkies, street people, refugees, travelers and others not likely to be missed. Some Organ Traffickers are careful to keep the victim alive during the process, others simply chop up their helpless victims and leave them for dead.



100 Random Black Market Contraband Finds

The following table presents Common Black Market items that might be found at a Black Market supply cache, depot, backroom, small warehouse, truck or hidden away inside a secret compartment. At the Game Master's discretion, he can increase the amount for large shipments, or roll on this table to include additional items or add things of his own design. We encourage Game Masters to use such tables as a guideline and source of ideas for their own story elements. As always, please adjust and modify the items as you deem fit.

01% Atlantean – Faeries or D-Bee Slaves: 2D6+10 Faerie Folk of various kinds in containers, cages and magical cells, or a mixed group of D-Bees. See **Rifts® World Book 2: Atlantis** and **WB 21: Splynn Dimensional Market** for exotic D-Bees or the slaves can be any D-Bees found in North America.

02% Atlantean – Kittani Power Armor: 1D4 suits of Kittani power armor, likely K-Universal Light or Manling models. Could be a single Flying Fox, Raptor or Equestrian.

03% Atlantean – Kittani Small Arms: 3D6 Kittani pistols and 2D6 Kittani rifles along with 1D4x10 E-Clips.

04% Atlantean – Market Goods: Alien spices, strange metals, exotic foods, technology and other trade goods. Value is 3D6x10,000 credits.

05% Atlantean – Symbiotes and Parasites: 1D6 Atlantean Symbiotes and 2D4 Parasites.

06% Bandito Arms Power Armor: A single flying suit like the Sidewinder or Wild Weasel or a pair of ground power armor suits.

07% Bandito Arms Small Arms: 2D6 Bandito pistols and 1D6+2 rifles or shotguns, along with 2D6 E-Clips and 1D4x100 BigBore revolver shells and 4D6x10 heavy BigBore rounds.

08% Coalition – Basic Military Supplies: 2D6+4 walkie-talkies or communicators, one field radio, 3D6 pairs of combat boots, 2D4 Coalition field uniforms, 1D6x10 CS ration kits and small, portable field kitchen.

09% Coalition – Body Armor – New-Style: 1D6 suits of new-style "Dead Boy" body armor, light or heavy.

10% Coalition – Body Armor – Old-Style: 2D4 suits of old-style "Dead Boy" body armor, light or heavy.

11% Coalition – Citizen's Papers: 1D6+1 citizen's I.D.s with valid computer chips installed in them. These are actual, stolen identification papers and will work – but have the name, description and photo of the original holder linked to their I.D. number.

12% Coalition – Infantry Weapons – New-Style: 2D6 various new-style CS pistols and 2D4 various new-style CS rifles and/or plasma cannons.

13% Coalition – Infantry Weapons – Old-Style: 2D6+2 old-style C-18 laser pistols and 2D6 various old-style rifles and/or plasma cannons.

14% Coalition – ISS Equipment: Two suits of old-style Dead Boy armor, 2D4 Neural Maces, 1D6 Vibro-Knives, 1D6 tear gas grenades, 1D6 sets of handcuffs and a pair of riot shields.

15% Coalition – Robot – Abolisher: A single Abolisher robot with 1D4x10+45% of its M.D.C. and the majority of its weapon systems intact. May be disassembled for smuggling purposes and is unlikely to include much ammunition for the auto-cannons. May substitute for an older-style Northern Gun Robot or two old-style CS Sky Cycles.

16% Coalition – Robot – UAR-1 Enforcer: A single Enforcer robot with 1D4x10+40% of its M.D.C. and the majority of its weapon systems intact. May be disassembled and may or may not include any ammunition for its rail guns and missile launchers. May substitute with a CS Hellfire robot or Scout Spider-Skull Walker!

17% Coalition – SAMAS: Two old-style Coalition SAMAS suits with 75% of their total M.D.C. Each has a single drum of rail gun ammunition and two mini-missiles.

18% Coalition – Sky Cycles: 1D4 old-style Coalition Sky Cycles. May or may not have ammunition for their missile launchers. May be substituted with two new-style CS Sky Cycles or two CS Death Wings.

19% Coalition – Visitor's Visas: 2D4+2 Coalition Visitor's Visas, good for 48 hours of clearance inside any Coalition city!

20% Fugitives: 1D4 fugitives on the run from the local authorities. They could be political prisoners guilty of offending the state, heroes, rebels, Federation of Magic mages (and bad guys), or

really nasty criminals wanted for murder or worse. They won't be happy to get intercepted before reaching their intended destination.

21% Refugees: 2D6+2 refugees are being smuggled in or out of someplace. They are likely to be displaced by war or fleeing an oppressive regime such as the CS, Federation of Magic, Vampire Kingdoms, Atlantis, Calgary or elsewhere. They have few or no possessions and there may be 1D4 small, melee weapons or M.D. pistols among them. They are frightened and have skills equivalent to 1st or 2nd level farmers, Cowboys or Vagabonds.

22% V.I.P.: A single important individual is being smuggled in or out of someplace by the Black Market. He or she could be a political leader or rebel, a high-ranking Black Market criminal, assassin, spy, whistle blower, Rogue Scholar, hero, D-Bee, and so on. Odds are, the player characters will have no idea who this individual is or that he is important unless the V.I.P. says or does something to indicate otherwise. The person is not happy to get intercepted before reaching his intended destination.

23% Free Quebec – Body Armor: 1D4 suits of Quebecois body armor.

24% Free Quebec – Infantry Weapons: 2D6 various Quebecois pistols and 2D4 Quebecois rifles.

25% Free Quebec – Power Armor: A single suit of Violator SAMAS or Power Trooper armor. May substitute with a suit of Glitter Boy armor and one full ammo drum.

26% Livestock – Cattle: 3D6+2 cows of various ages and genders.

27% Livestock – Chickens: 2D4x10 egg-laying chickens and 1 rooster.

28% Livestock – Horses: 2D6 adult horses in good health.

29% Livestock – Nodosaurus or Other Medium-Sized Dinosaur: 1-2 Nodosaurus or other medium-sized dinosaurs like Triceratops (Tri-Tops) or Hadrosaurs (Duckbilled Honkers). Could be a mother and 1D4+1 babies.

30% Livestock – Pigs: 3D6 adult pigs of various sizes.

31% Livestock – Rhino-Buffalo or Large Dinosaur: A single Rhino-Buffalo, Fury Beetle, sauropod (Brachiosaurus or other long-neck dinosaur) or other giant, alien pack animal.

32% Livestock – Silonar or Ostrosaurus: 1D6+2 Silonar or 1D6+1 Ostrosaurus.

33% Luxury Goods – Clothing: Fashionable, well-made clothing, including outdoor gear, shoes, undergarments, pants, skirts and shirts. Value of 4D6x1,000 credits.

34% Luxury Goods – Consumer Electronics: Mini-computers, video disc players, radios, speakers, light bulbs, circuits and assorted wires and switches. Value of 3D6x1,000 credits.

35% Luxury Goods – Food and Drink: Dried food stores, frozen meat, salted fish, jerky, pressed cider, juice, spring water or almost any other consumable is included. Value of 1D6x1,000 credits.

36% Luxury Goods – Gold and Jewelry: A small shipment of frontier gold and silver coins, alien ingots, mixed jewelry, pearls or other precious metal, stones or jewels. Value of 2D6x10,000 credits.

37% Luxury Goods – Tobacco and Alcohol: Bales of tobacco, cartons of cigarettes, boxes of cigars, barrels of beer and bottles of liquor. Value is 1D6x10,000 credits.

38% Magic Artifact – Supportive: A magical artifact that can cast a single supportive or non-damaging magic spell from levels 1-4. May be used once every 12 hours. May substitute with a TW device.

39% Magic Artifact – Weapon: A magical artifact that can cast a single damaging or offensive spell from levels 1-4. May be used once every 12 hours. May substitute with a TW weapon or other type of magic weapon.

40% Naruni Body Armor: 1D4 suits of various Naruni body armor.

41% Naruni Infantry Weapons: 2D4 various Naruni rifles and shotguns with 1D6 E-Clips and 1D4x10 plasma cartridges.

42% Naruni Pistols: 2D6 various Naruni pistols along with 1D6+2 E-Clips and 1D4x10+10 plasma cartridges.

43% Naruni Power Armor: A single suit of Naruni Mecha-Knight power armor or Earth Angel power armor, or 1D4+1 NE-BA-40 Infantry body armor suits or one Stealth Armor (see **Rifts® Dimension Book 8: Naruni Wave 2**).

44% Northern Gun Body Armor: 2D4 suits of various types of Northern Gun body armor.

45% Northern Gun Hovercycles: 1D6+1 Northern Gun hovercycles.

46% Northern Gun Labor Drones: 4 Northern Gun Light Labor Drones or a single Heavy Labor Drone.

47% Northern Gun Pistols: 2D6+4 various Northern Gun pistols and 3D6+4 E-Clips.

48% Northern Gun Power Armor: 1D4 suits of Samson, Red Hawk or other power armor suits, or a mix of different types.

49% Northern Gun Rail Guns: 1D4 NG-101 light rail guns and 1D6 NG-202 heavy rail guns, along with 1D6x10,000 rounds of rail gun ammo.

50% Northern Gun Rifles: 2D4+2 various Northern Gun rifles/plasma ejectors and 3D6+2 E-Clips.

51% Northern Gun Hunter Mobile Gun: A single Hunter Mobile Gun robot. May be disassembled for smuggling purposes. Comes with 1D6x1,000 rounds of rail gun ammo and no missiles. May substitute with a different NG Robot. (See **Rifts® World Book 33: Northern Gun One** for a variety of robots.)

52% Northern Gun Sky King: A single NG Sky King hovercraft. Comes with 2D4x1,000 rounds of rail gun ammo and one load of missiles. May substitute with some other NG or Black Market flying vehicle.

53% Raw Materials – Coal: Sacks, crates or open containers of coal. Value of 2D6x1,000 credits.

54% Raw Materials – Credits/Gold: A payment or cash shipment. Gold, pelts or 2D6+6 Universal Credits worth a total of 1D6x10,000 credits!

55% Raw Materials – Lumber: Felled trees destined for the lumberyard or finished boards and planks. Value of 1D6x1,000 credits.

56% Raw Materials – Ore: Ore containing iron, copper or some other valuable metal. Value of 1D6x10,000 credits.

57% Raw Materials – Salt: Sacks of salt. Value of 1D6x1,000 credits.

58% Raw Materials – Precious Stones: Gems and other stones useful to Techno-Wizards and valued for jewelry. Value of 1D6x10,000 credits.

59% Raw Materials – Steel: Sheet steel, I-beams, poles or other steel items; weighs a ton. Value of 2D6x1,000 credits.

60% Raw Materials – Sugar/Honey: Sacks of sugar or jars of honey. Value of 1D4x1,000 credits.

61% Slaves – D-Bee: 3D6 slaves of various D-Bee races. May include children.

62% Slaves – Feedstock: 4D4 human captives intended as food or slave stock for vampires, demons or other monsters. They are tired, dehydrated and frightened; possibly includes children.

63% Special Equipment: 4D6 language translators and/or 4D6 first aid kits and 1D6 RMK Robot Medical Kits or a box with 2D4x10 doses of antibiotics.

64% Spare Parts – Commercial Vehicles: Spare parts for ATVs, motorcycles, automobiles, hovercycles and hovercars. Value of 2D6x10,000 credits.

65% Spare Parts – Engines: Engines and electric motors. Value of 2D6x10,000 credits.

66% Spare Parts – Farm Equipment: Parts for tractors, threshers and other agricultural machines. Value of 3D6x10,000 credits.

67% Spare Parts – Generators: Generators and parts for generators. Value of 2D6x10,000 credits.

68% Spare Parts – Military Vehicles: Extra armor, vital spare parts and electronic systems. Value of 4D6x10,000 credits.

69% Spare Parts – Nuclear Power Cores: Nuclear power cores and secondary equipment. Value of 1D6x100,000 credits.

70% Spare Parts – Tools and Construction Equipment: Spare parts for power tools, industrial equipment and construction systems. Value of 2D4x10,000 credits.

71% Supplies – Munitions: 4D6 E-Clips, 2D6x1,000 rounds of rail gun ammunition, 288 rounds of heavy BigBore shells, and 3D6 mini-missiles or 4D6 hand grenades.

72% Supplies – Basic Military Equipment: 2D4 walkie-talkies, 1 field radio, 2D6 pairs of combat boots, 2D4 field uniforms, 1D4x10 ration kits and a small, portable field kitchen.

73% Supplies – E-Clips: 1D6x10 normal E-Clips, 5D6 Long E-Clips and 2D6 Forward Sliding E-Clips.

74% Supplies – Full-Sized Missiles: One of the following: 2D6+2 short-range missiles, 2D4 medium-range missiles or 1D4 non-nuclear long-range missiles.

75% Supplies – Gasoline/Diesel Fuel: 1D6x1,000 gallons of gasoline, diesel or ethanol.

76% Supplies – Scientific/Medical: 1D6 Micro-Scales, 1D6 Bio-Comp Monitors, one Compu-Drug Dispenser, one Computer Portable Field Unit, one Portable Bio-Scan & Bio-Lab, one portable Laboratory, one Multi-Optics Helmet, and a case of 1D6x100 disposable, plastic surgical gloves.

77% Supplies – Mini-Missiles: 1D4x10+40 mini-missiles of various types.

78% Supplies – Radar System: A single, short-range radar system including a radar dish and monitoring terminal. Range of 50 miles (80 km). Capable of tracking up to 50 individual targets.

79% Supplies – Rail Gun Rounds: 4D6x1,000 rounds of rail gun ammunition. May be substituted with BigBore rounds.

80% Supplies – Vibro-Blades: 3D6 Vibro-Knives, 1D6 Vibro-Swords and 1D6 pairs of Vibro-Claws.

81% Supplies – Wilderness Gear: 2D6 pairs of binoculars, 1D6 field stoves, 4D6 canteens, 100 water purification tablets, 1D6x10 ration packs, 1D6 backpacks, 1D6 sleeping bags, and 2D6 sets of wilderness survival clothing. May substitute with fishing gear.

82% Techno-Wizard Gadgets: 3D6 various Goblin Bombs or 1D4 Techno-Wizard gadgets like Eyes of Thoth reading glasses, Shadow Cloaks, Language Translators, Thieves' Gloves or Super Swimmer Diver's Suits.

83% Techno-Wizard Small Arms: 2D6+2 Techno-Wizard pistols and 1D6 Techno-Wizard rifles along with one charged P.P.E.-Clip in each weapon and 3D6 additional.

84% Titan Robotics – Combat Titan: A single Titan Combat Robot, possibly disassembled for smuggling purposes. Comes with 4D4x1,000 rounds for the rail gun and one load of missiles. May substitute with a Bandito Arms or Northern Gun Robot.

85% Titan Robotics – Recon Robot: A single Titan Reconnaissance Robot with full weapons and armor. May substitute with a Bandito Arms or Northern Gun Robot.

86% Titan Robotics – Titan Power Armor: 2 suits of Flying Titan or Footman power armor. May substitute with a Bandito Arms or Northern Gun power armor.

87% Triax Body Armor: 1D6 suits of Triax body armor such as the Explorer or Commando Scout, or 1D4 suits of Cyclops battle armor. May substitute with Bandito Arms or Northern Gun body armor.

88% Triax Power Armor: 2 suits of Terrain Hopper power armor or a single Ulti-Max robot or Predator X-10A. May substitute with a Bandito Arms or Northern Gun power armor.

89% Triax Small Arms: 2D6 various Triax pistols, 2D4 various Triax rifles and 1D4x10 Forward Sliding E-Clips.

90% Vehicles – ATV: A single, large ATV like the Big Boss or Mountaineer. May substitute with a Bandito Arms or other Northern Gun vehicle.

91% Vehicles – Automobiles/Hovercars: 1D6 personal automobiles or hovercars intended for road use.

92% Vehicles – Farm Tractors and Harvesters: 1D4 farm tractors and one large piece of equipment like a harvester or thresher.

93% Vehicles – Hovercycles: a total of 2D4 Northern Gun and Manistique Imperium hovercycles of various types.

94% Vehicles – Jet Packs: 2D4 jet packs and two Juicer Icarus Flight Systems (see **Rifts® World 10: Juicer Uprising** for the latter).

95% Vehicles – Light Armored Vehicle: One or two ATVs outfitted with extra armor (+100 to main body M.D.C.) or 1D4 Juicer vehicles such as the Tarantula, Road Boss, Rolling Thunder or rocket bikes (see **Rifts® World 10: Juicer Uprising** for the first three listed).

96% Vehicles – Motorcycles: 2D6 motorcycles or hovercycles of various types. May substitute with Bandito Arms bikes and hovercycles or with robot riding animals.

97% Wellington Industries Small Arms: 2D4 submachine-guns, 1D4x100 rounds of heavy ramjet ammo, 1D6 grenade launchers and 1D4 mini-missile launchers along with 3D6+2 grenades and 2D6+1 mini-missiles.

98% Wilk's Electronics: Circuit boards, computer processors, disc-reading lasers, mini-computers, computer memory and other electronic components. Value of 2D6x10,000 credits.

99% Wilk's Pistols: 3D6 various Wilk's pistols, along with 5D6 E-Clips.

00% Wilk's Rifles: 2D6 various Wilk's rifles, along with 5D6 E-Clips.



Traveling Shows

By Kevin Siembieda

Freak Shows, Circuses, and Traveling Shows

Entertainment in the big cities is as varied in the world of Rifts as it is in our own modern world of today. The typical big city like Lone Star, Chi-Town, and Free Quebec, offers a hundred or more television and radio channels, movie theaters, live theaters, comedy clubs, taverns, bars, bowling alleys, casinos, parks, sports stadiums, etc. A few, like the Coalition States, even offer local, state owned and government operated Internet and computer capabilities. However, even in these cities, a traveling show, especially a circus or carnival, is something special that brings out the crowds. For towns, villages, and small kingdoms located in remote areas, and even the 'Burbs spread around cities, it is a different matter. There, life is hard, entertainment is minimal and traveling shows are an exciting diversion from a gloomy, laborious routine.

Freak shows are, as a rule, small operations run by unscrupulous individuals. Such shows deliver on shock value rather than real performing arts. They present shrunken heads, wild men, monsters, mutants, and the exotic. In many cases, the living attractions are prisoners, D-Bees and animals locked up in cages. The exhibition of oddities is likely to present strange weapons, the bones of monsters, man-eating plants, fossils, magic items, and alien or pre-Rifts artifacts. Each and every item has a wondrous yarn spun around it, none of which are likely to be true. In fact, many of the items themselves are fakes, created by the show's staff or commissioned from artists. Freak shows may also sell souvenirs such as small statues, pottery, blankets, animal claws, rattlesnake tails, trinkets and animal teeth, which may be passed off as the fangs of vampires, werebeasts or other monsters. Some also sell live pets such as birds, snakes, turtles, lizards and the occasional exotic animal, and many sell elixirs of all kinds (usually with a narcotic or alcohol for a little zing), beer, moonshine, candy and exotic foods. Some freak shows sell decadent and illegal goods and services. These may include genuine pre-Rifts artifacts, though mostly common items, as well as weapons, E-Clips, batteries, body armor, healing potions, and the services of psychic healers and mages, as well as the services of prostitutes, tattoo artists and fortune-tellers.

The circus is much larger than other traveling shows and it is the most professional. A traveling circus will have its own museum of oddities, freak show, and merchants hawking their wares, but the main distinction is its emphasis on *performance*. Circuses are full of live acts. Something is going on all the time at a circus, with a dozen different attractions and small shows going on throughout the day. They include animal rides, mechanical rides, fortune-tellers, mind readers, minstrels, singers and sing-alongs, dancers and dancing, games of skill like knife-throwing, archery and shooting, and carnival games. There is often a 1-2 hour variety show in the afternoon, but the main event is a 3-4 hour blockbuster show in the big tent in the evening. Entertainment includes clowns, comedians,

jugglers, dance acts, musicians and singers, sing-alongs, acrobats, tightrope acts, magicians (often the real McCoy), animal acts, and feats of daring and wonder. Some even show movies, and those with pre-Rifts movies attract the largest crowds. Other attractions may include a petting zoo or a traveling zoo of exotic, beautiful and dangerous animals. **Crime:** At least half to two-thirds of circuses are honest, legitimate businesses, but even honest shows will attract their share of con artists, pick pockets and crooks, or have a few dishonest members of the show. And those run by the Black Market are a great way to smuggle contraband, scope out potential merchant routes, spy on local towns and authorities, and even sell weapons and contraband out in the open where it's not illegal.

Carnivals are part small circus, part freak show and part medicine show. They'll have a few acts, some clowns and jugglers, but nothing like a circus, plus a freak show area, a medicine show area where booze, drugs and contraband are sold, and other attractions you'd expect. The big difference between a carnival and other shows is there are few live acts and theater, and more rides and games. Rides always include old favorites such as the merry-go-round and the ferris wheel, and may include 2D4 others such as bumper cars, swings, spinning swings, and spinning rides of all kinds. Games include all kinds of amusement park/boardwalk type games of skill such as knocking down bottles with a ball, pitching coins, throwing darts, shooting moving targets with a pellet gun, racing remote control cars, and even outright gambling with slot machines, card games, dice games and other games of chance. **Crime:** Only one third of carnivals are honest, legitimate businesses. Most are fronts for Black Market operations and other criminals. Those run by the Black Market sell or smuggle contraband and vice, spy on local towns and authorities, and sell weapons, contraband and vice out in the open where it's not illegal.

Traveling shows and medicine shows are usually 1-6 wagon shows run by 3-30 individuals. Like the freak show, the scam is usually selling something shocking or frightening, tasty or fun but illegal. The smallest shows will have one main attraction and one or two other points of interest, from spectacle to material goods. Most sell moonshine and a vast variety of potions to fix what ails you; many of which are heavy on alcohol, narcotics, or hallucinogens. The larger shows will have 6-8 wagons and offer 2-3 main attractions, as well as sell many more potions, tonics, charms, booze, candy, and exotic services. Services often include fortune-telling, tattoo artists, barbers, psychic or magical healing and doctoring, veterinary doctoring, and the selling of herbs, books, tools, weapons, E-Clips, artifacts and news; traveling shows are a great way to learn about rumors and events taking place in the region. Vice includes gambling, drugs, drink and women. **Crime:** Only 10-20% of traveling shows and medicine shows are honest businesses. Most are Black Market operations or run by other criminals. Many 1-3 wagon shows are run by con artists, thieves, petty criminals and small-time Traveling Merchants, any of whom may, or may not, have ties to the Black Market. Those run by the Black Market sell and smuggle contraband and vice, spy on local towns and authorities, and sell weapons, contraband and vice out in the open where it's not illegal.

The success of any traveling show varies from town to town and time to time. Thus, the price of admission, at least for the smaller shows, can range from 1-10 credits and may include all attractions, but not rides or special shows. Sometimes each individual attraction has a price of admittance, and other times, admission may be free if the show is a con-game designed to trick people into buying goods, especially worthless goods like fake potions

and medicine that are really alcohol or placebos. Most shows will accept items in trade rather than credits as many wilderness communities do not deal in credits. Items accepted as trade include silver, gold, precious and semiprecious gems, artifacts, quality magic or high-tech weapons and equipment, animal pelts/furs, alcohol/moonshine, common supplies, fresh fruit and vegetables, jams and honey, grain, other foods, fresh drinking water, fuel, trinkets that can be resold, and other supplies.

During the worst of times, even the best and most reputable shows may offer a spectacular performance or services, including manual labor, in exchange for a hot meal, feed for the animals and/or gasoline for the vehicles and a warm bed to spend the night.

A Source of Evil and Adventure

Traveling shows have the opportunity to use their unique situation to earn a profit above and beyond mere showmanship. The shows are wonderful sources for gathering information and making contacts with a large variety of people. As they travel from town to town, the performers can make road maps and map a town accurately, noting places and people of importance. They can inconspicuously study the people, their philosophies, laws, defenses, armies, leaders and defenders. They can make note of the community's wealth or poverty, its racial mixture, the people's loyalties, and their leanings toward magic and other activities.

This information has many, many applications. It can be sold to the highest bidder, criminals or other interested parties (like the Coalition States), and used for blackmail and wrongdoing. The least scrupulous not only spy on unsuspecting towns, but may act as agents, performing reconnaissance for the Black Market, bandits or mercenaries (or the CS and other groups), or may be bandits or criminals themselves, and work as con artists, thieves, smugglers, extortionists, terrorists and scoundrels of all sorts. This is less true of the circuses, especially the larger and older circuses, but all too commonplace among freak shows, carnivals and other small traveling shows. In many cases, the owner and his performers are con men, criminals or hardened mercenaries to begin with, and the traveling show is just a front for the brigands. The opportunity for easy money can't be resisted. Such evil and illicit deeds have given medicine men, in particular, a bad reputation, with freak shows not far behind them.

Game Master's Note About Traveling Shows

Traveling shows operated by unscrupulous opportunists and brigands can lead to many fun and strange encounters, as well as clashes with unique enemies. The freak show, circus, carnival or medicine show can be much more than a bunch of run-of-the-mill crooks, which can go a long way to adding color, suspense and action to a story. On the down side, to really make a sideshow work, a fair amount of thought and character development is required on the part of the G.M., but it can pay off big if done right and if used as continuing characters and villains. Remember, these scoundrels travel all over the country.

Of course, not all are operated by evil villains, but even the most honest and friendliest traveling show can be a source of information, news, rumors and help. Many can provide medical treatment and/or sell food and supplies, including weapons (it depends on the specific show). If nothing else, the show can provide some amusing entertainment.

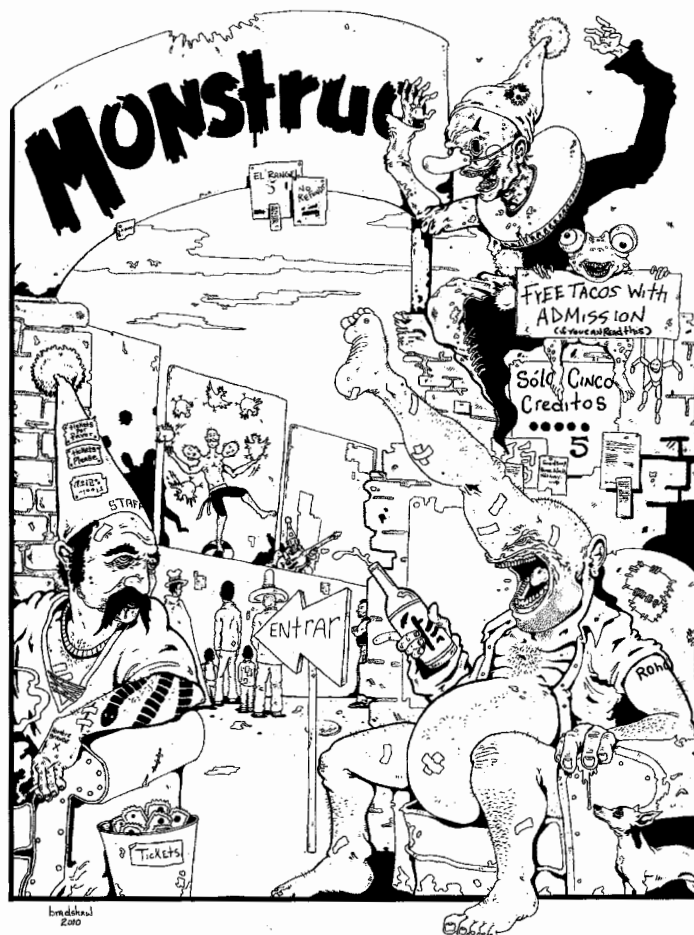

Creating a Traveling Show

Step One: The Size and Orientation

- Sideshow
- Freak Show
- Medicine Show
- Traveling Troubadours
- Small Circus or Carnival
- Large Circus

Traveling shows come in all sizes and varieties. There are six basic types of shows presented here along with the *total available points* one can spend on show features. The smaller the show, fewer the less features available. G.M.s with specific needs, ideas and requirements may bend these rules, because the design rules for the traveling shows are meant to serve as a *guideline*, not consistent rules and data for all shows. Also, while the emphasis is in the design of unscrupulous and crime-based operations, the same features can be used to create honest and good traveling shows; just skip the Criminal Sponsors, Criminal Activity and select Anarchist or better for the alignment.

Each basic type of show lists the initial number of points one can spend on the *features* of the show. The sponsoring force behind the show can also add points that can be spent on features, though some of these may have to be spent on a specific feature.

Obviously, the smaller shows have fewer all-around features and resources, which is as it should be. Specific, individual characters in the show may add to the overall power and dangerousness of the performers.

Note: For random determination of size and type of show, roll 1D6. When “X points” are listed in addition to the main number, those bonus points must go to that *specified feature* only.

1. Sideshow. This is a very small show, usually consisting of 6-12 people, including the show’s owner, performers, and operatives. The typical sideshow offers a combination of entertainment such as minstrels, tumblers, acrobats, jugglers, magic, fortune-tellers (a must, whether the fortune-teller is a real psychic or a charlatan), and an array of oddities. The oddities are mostly inanimate objects, including *supposedly* alien devices and pre-Rifts artifacts, stuffed animals, strange or monstrous skulls or skeletons, and usually one “live” freak, which is the main attraction (and often a fake). Most sideshows run on a shoestring budget and have very few resources and even less political power (virtually none; considered to be second rate and charlatans by most). Often return to the same towns and places where they have done well in the past.

110 POINTS. +10 bonus points for Vehicles and +30 points for Acts.

2. Freak Show. Most freak shows are about twice the size of a sideshow and have 6-36 personnel, but are frequently just as poorly funded as a sideshow. The show’s owner, performers, workers and the freaks, are usually willing participants of the show, even if some of the “freaks” or “monsters” are caged when an audience is around. The emphasis of a freak show is the bizarre, horrific and the frightening. Other than the show’s barker (announcer/host) and the possible inclusion of a juggler, tumbler, fortune-teller, minstrel or magician, there are no performers. The freaks *are* the show,

There will be at least 6-10 living freaks, which may include rare and unusual D-Bees, mutants, shape-changers, aliens, creatures of magic and monsters; some of whom may be fakes, but at least half will be genuine and truly impressive, and at least one or two will be a show stopper. As rule, few of these freaks or monsters are as disgusting or dangerous as they appear. A great deal of hype and theatrics are involved in the best traveling shows and that means putting on a show for the “customers.”

In addition to the living freaks, a freak show always has a display of the strange and exotic. Much like the sideshow, these include alleged pre-Rifts and alien artifacts, demon and monster skulls and/or skeletons, taxidermy animals, the occasional strange or cute live D-Bee animal(s), supposed magic items, castings of footprints, mummies, a corpse with a stake in its chest that is supposedly a slain vampire, and other oddities, many of which are fake, but fun to see. All will have a convincing and funny or scary story delivered by a guide to the attractions or one of the barkers.

Freak shows are seen as a bit off-color and potentially dangerous, both of which are part of the attraction. They are usually run on a shoestring budget and have few resources and even less political power (virtually none; considered to be rogues and charlatans by most), but some are very popular and successful. Freak shows often return to the same towns and places where they have done well in the past.

150 POINTS. +20 bonus points for Freaks (Acts) and +10 points for Equipment.

3. Medicine Show. The infamous medicine show can be as small as 2-5 people or as many as 10-30 people with entertainers and sideshow freaks, but the emphasis is always **SELLING**

product. Medicine shows are almost always a vehicle for flim-flam men, con artists and charlatans. The typical show will offer a number of potions, tonics, salves, herbs, alcohol and charms to cure whatever ails you. Often the selection of brews is staggering and can number over a hundred! Some also sell illegal drugs, narcotics and hallucinogens.

In most cases, the vast majority of the potions, tonics and elixirs are useless fakes, sugared or spiced water or fruit juices spiked with alcohol or narcotics. Only the herbs and illegal drugs are mostly authentic and even then it is best if one knows exactly what he’s buying rather than trusting the salesperson. Generally, S.D.C. poisons, herbs for holistic medicine, garlic, wolf’s bay/wolfsbane, mushrooms, spices, candy, salt, pepper, fruit juices, beer, wine and moonshine are available in abundance. Some medicine shows offer a small selection of Faerie Food or magic potions, amulets, talismans, scrolls and similar items (usually kept behind the closed doors of a special wagon for that special customer), though it is rare that more than 1D4x10% of these magic items are genuine. **ANYTHING** offered for sale at a medicine show should be viewed with great suspicion!

Entertainment is likely to include stage magic focusing on sleight of hand (palming, escaping from handcuffs, etc.) and a minstrel/singer or tumbler (great distractions while another member or two of the show slips through the crowd picking the richest pockets). A fortune-teller (psychic or not) and healer or doctor (may only know first aid!) are also typical members of a medicine show. The rest of the show’s members are salespeople, workers, con men, pick-pockets, guards and assistants. The show may return to the same places where they have done well, but will avoid places where they ran afoul of the law or were accused of fraud or other illicit activity.

140 POINTS. +10 points for Internal Security and +30 points for Criminal Activity.

4. Traveling Troubadours. Unlike the previous three traveling shows, troubadours or minstrel shows are all entertainment. Generally, the troupe will put on a half dozen to a dozen short performances, each about a half hour long, throughout the day, ending in a big, two hour nighttime show. The big show can be 01-30% a musical, 31-50% a comedy play, 51-60% drama, 61-70% stand-up comedy, 71-80% a pre-Rifts movie (always fascinating), 81-90% music or 91-00% music and dance for everyone. The pre-Rifts movie, musicals, comedy plays, and music and dance, especially if the townsfolk can dance along, are the most popular attractions and pack them in every time. The shorter daytime shows can include musicians playing instruments, singers, sing-alongs, short comedy plays, story-telling, puppet shows, comedy skits, comedic juggling, and similar types of fun. Minstrel shows often return to the same places where they have done well in the past.

160 POINTS. +10 points for Equipment and +20 points for Outfits.

5. Small Circus or Carnival. *The small circus* has all the usual elements already discussed, but on a smaller scale and less variety of acts. Entertainment includes a main nightly show that lasts 2-3 hours, preceded by several smaller acts during the day involving acrobats, tumblers, jugglers, clowns, comedic skits, magicians, fortune-tellers, animal tamers, some games of chance and souvenir and concession stands. They may or may not have a freak show, though most do. Some show modern or pre-Rifts movies. A small circus will employ 200-400 people.

Carnivals are similar to circuses except that there is less emphasis on performances (no long show) and more emphasis on

rides, sideshows, freak shows, medicine shows, and a lot of games. The typical traveling carnival has 100-400 workers and performers and offers at least a dozen different rides, a house of illusion (using real illusory magic as well as mirrors and holograms), two or three performances with showgirls, one magic show, a freak show, museum or library, concessions area and a couple dozen games of chance, as well as fortune-tellers, tattoo artists, etc. Some of the larger and/or more wild carnivals offer gambling an possibly and arena area for boxing matches, wrestling, animal fights or even gladiatorial matches with a cash prize. The fights often allow challengers from the audience to fight one of several champions, for a price, of course. Rides and experiences can include traditional carnival rides like the ferris wheel and less traditional rides like zooming along on a Sky Cycle or TW Tree Trimmer, riding giant robots, riding tame dinosaurs or monsters or exotic animals, and so on. Entertainment may include wandering clowns, jugglers, minstrels, and similar. Carnivals also sell a larger array of alcohol, elixirs, trinkets, toys, and candy.

240 POINTS are available to small circuses and carnivals, +50 points on Acts and +10 on Reputation.

6. Large Circus. The circus is still the favorite of all the traveling shows, consequently, there are a number of large traveling circuses throughout the world. Circuses are especially popular among frontier and rural communities that don't have access to technology, television and other types of entertainment. A typical circus employs 300-800 people, including performers and workers, but the largest may have more than 1,000. A circus offers a huge venue of diverse acts and entertainment as previously discussed.

300 POINTS are available, +90 points on Acts and +20 on Reputation.

Note: The points listed are the total available points for all the different show features. Even with 410 points, selecting features can be difficult. Remember that if no points are spent on a particular feature, say Security, then the traveling show automatically has the worst level, #1-NONE, in that feature. Bonus points for specific Features like Acts and Reputation **MUST** be spent on that feature. The points cannot be spent on some other area.

Step Two: Traveling Show Features

A. Sponsorship

Exactly who is controlling the traveling show, providing them with their leadership, goals, and their real source of funds? Select one. There is no cost for this necessary feature.

1. NONE. Independent Enterprise. The show is owned and operated by an entrepreneur or group of owners who like the business and run the show. Sometimes funded by a larger private business. The ultimate goal of the Independent Operator is to make enough money for the owners and employees to live well while doing work they enjoy. The owner(s) are responsible for the upkeep of the show, the selection of its attractions, paying employees and performers, food, supplies and virtually everything else. The owner(s) answer to no one and go where they please. **Note:** If owned by a Black Marketeer, the business is one of his legitimate businesses.

Add +20 points to Acts and +20 points wherever desired.

Show Cost: None.

2. Secret Benefactor. The performers and staff have no idea who is really behind the organization or what hidden motives there

might be in their assignments to stay alert and gather information. For the moment, they are their own bosses, given a free hand at what they want to do, provided they stay within the framework of the organization. The features and equipment of the show are paid for by this mysterious benefactor.

Add +10 points for the purchase of additional Acts, +10 points to Defense, and +30 points wherever desired, but remember, they don't know who they are working for or toward what purpose. Player characters may find themselves working on assignments they do not want, or told to do things that may compromise their morals (if the sponsoring agency is corrupt). G.M.s should take advantage of this as a continuing story subplot. **Note:** If owned by a Black Marketeer, a mercenary company or other notorious group, the business may be, 01-60% a legitimate business, or 61-00% a front for smuggling, spying or any number of criminal enterprises or nefarious purposes.

Show Cost: None.

3. Criminal. Small-Time Operation. The traveling show is run by a gang or band of smugglers, thieves, con artists or crooks NOT affiliated with the Black Market. They mainly use the show as a means to cheat and rob the people in the local communities they visit (e.g., sell snake oil, worthless trinkets, offer shows and services that cater to vices, as well as rob and pick pocket customers who look like they have money, and may even break into homes while people are at the show!). The group may also sell and trade with locals, but some of the goods (1D4x10%) traded to the people may be stolen. As a rule, common folk are given a show and offered variety of "opportunities" and merchandise.

Illicit shows include dancing girls, striptease acts and cabaret shows that are likely to include audience participation and are much more risqué than anything the community is likely to offer. The show may also offer illicit services such as prostitution, drug dens, gambling (01-50% the games are fair, 51-00% the games are fixed in the show's favor, but even fair and legitimate gambling is always tipped heavily in management's favor. For example, blackjack offers some of the best odds for the player, with a 42% chance of winning.), and sell a variety of contraband, alcohol, drugs, books, medicine, weapons and equipment of which 2D4x10% is certain to be stolen goods.

Add +30 points for Criminal Activity and +10 points wherever desired.

Show Cost: None.

4. Criminal: Black Market Front. The show is a big-time crime outfit used by the Black Market as a means to covertly smuggle and sell Black Market and stolen weapons, gear, criminal services, and contraband. This is likely to include weapons, drugs, CS outlawed items, a mobile Body-Chop-Shop for cybernetics and bionics, M.O.M. conversions, Juicer augmentation and supplies and EVERYTHING from #3 but on a larger and more covert scale.

Add +10 points to Internal Security, +10 points to Defense, and +50 points to Criminal Activity.

Show Cost: None.

5. Government. This kind of show is secretly sponsored by a local government, usually one of the smaller kingdoms, and may follow the government's moral viewpoint and legal framework. The group's covert agenda may be crime-busting and defending the innocent, or smuggling and aiding rebels/fighting injustice, scientific research/field investigation, spying on enemies and rivals to get useful intelligence (or other types of espionage), establishing trade or trade routes, or engaging in criminal enterprises, ferreting out moles/spies from other governments or criminal operations,

finding and stopping terrorists, covertly investigating and eliminating supernatural monsters and dangers without frightening the public, and so on. **Note:** Not necessarily an evil force, may be good or Anarchist in nature.

Add +10 points to Internal Security and +50 points wherever desired.

Show Cost: None.

6. Coalition Front (or other Big Nasty). Sponsored, controlled and secretly owned by the Coalition States – or other powerful force such as Free Quebec, the Federation of Magic, the Vampire Kingdoms, the Kingdom of Monsters in Calgary, Pecos Empire, the Splugorth of Atlantis, and so on. A whopping 80% of the management, 75% of the show defenders, and 33% of the workers and performers are operatives of the Coalition (or whatever government/agency is fronting the show). The show is a front for a traveling espionage network used to spy on enemies and rivals and identify rebels, dissidents, spies and criminals, and to gather other intelligence. It is also used for terrorism, sabotage, blackmail and assassination. The traveling organization is free to set its own policies and to wage war against enemies of the Coalition States (or whatever sponsoring agency) as it sees fit; this can include burning a town to the ground and slaughtering hundreds if it can be accomplished without blowing the show's cover or implicating the sponsoring government/organization. Either way, the characters represent a special team of operatives who utilize robots, cyborgs, high technology, psychic powers and other combat and espionage technology, magic, and personnel. The organization should be predominately evil.

Add +10 points to Internal Security, +20 points to Defenses, +10 points to Equipment and +40 points to wherever desired.

Show Cost: None.

B. Outfits

The quality and flamboyancy of the clothing worn by performers and workers. Replacement of any show outfit is automatic.

1. None. The characters are responsible for their own clothing. Costumes tend to be plain and simple. No replacements of any kind are available.

Show Cost: None.

2. Utility Outfits. The show has standard uniforms for all its employees and colorful costumes for its performers. Quality is good and designs are nice, but nothing spectacular.

Show Cost: 5 points.

3. Open Wardrobe. A complete range of clothes, uniforms, and costumes of superior quality. Bright colors, spectacular designs, rhinestones, sequins, feathers, capes, hats, and masks are available to all employees and performers. Quality is excellent; replacements and new designs are regularly available.

Show Cost: 10 points.

4. Specialty Clothing. The absolute BEST in uniforms and costumes. A similar array as described in number three are available, only more dynamic, imaginative and colorful. Includes stage armor, fluorescent colors, glow in the dark fabric, wigs, masks, hats, and props, as well as standard uniforms, clothing and special gear. Even civilian clothing is fairly classy, equivalent to what's available in expensive clothing stores.

Show Cost: 20 points.

5. Gimmick Clothing. A full range of quality clothes and costumes equal to Number Three (+10 points to be equal to #4), but also includes an array of colorful wigs, fright wigs, masks, complete make-up kits, disguises, and grease paint; plus "gimmick"

costumes like clothes with hidden pockets, body armor, concealed items (flowers, coins, tools, weapons, etc.), wings that are functioning gliders, jet packs, concealed optical systems built into helmets/hats/goggles, etc. The quality is high, very fashionable and believable.

Show Cost: 30 points.

6. Unlimited Clothing. All the quality costumes, uniforms, specialty outfits, and gimmick clothing one could ever want. All quality levels are available and the top designers are on call to specially make appropriate outfits for any need. Replacements and new designs are frequently available.

Show Cost: 50 points.

C. Equipment

This describes the general equipment and supplies provided free of charge by the management of the traveling show. Replacement of any lost or damaged, equipment is usually automatic and at the expense of the management. **Note:** Unlike other categories, it is possible to pay points to purchase more than one of the following equipment features. For example, by spending 15 points, a show would provide both Electronic (#3) and Medical (#4) equipment as described below.

1. None. The characters are responsible for buying and replacing their own equipment.

Show Cost: FREE.

2. Cheap Gear. Each performer has the basic equipment, props, and materials for his craft and up to 7,000 credits of additional equipment available to him. Damage or lost items may not be easily replaced, especially expensive things like cybernetic implants, weapons and vehicles.

Show Cost: 2 points.

3. Electronic Supplies and Good Gear. Good quality gear is provided, along with up to 40,000 credits' worth of common sensory, recording, video camera, communication, computer, surveillance, and miscellaneous equipment (like language translators, electro-adhesive pads, etc.) are available for each major performer and 10,000 credits worth for secondary performers. This selection is limited to electronic items only.

Show Cost: 5 points.

4. Medical Equipment. First-aid and paramedic type equipment and pharmaceuticals are available. Includes antibiotics, pain-killers, anesthetic, protein healing salve, sodium pentothal (truth serum), dosimeter, E.K.G. and E.E.G. machines, portable lab, bio-scan, oxygen, all commonly available robot medical kits (RMK, IRMSS, Compu-drug dispenser, etc.) and two basic life support units. Plus a budget of 750,000 for emergencies requiring hospitalization and cybernetic organs or prosthetics.

Show Cost: 10 points.

5. Medical Clinic. The traveling show is equipped with full medical facilities equal to a small medical clinic. There are 1D4 full-time doctors (M.D. or Holistic), 2D4 nurses and one or two psychic healers (or mages with healing magic), two paramedics and 1D4+1 assistants. In addition, the show has an emergency medical budget of 1D4x2 million credits for cybernetics and hospitalization. There is also a small veterinary facility for any circus animals. Replacement of lost or damaged equipment is automatic, but the total amount of medical equipment can never exceed 10 million credits.

Show Cost: 20 points.

6. Unlimited Equipment. The traveling show is a high-tech operation equipped with high quality equipment, electronics, com-

puters, communication systems, props, and all the materials and equipment needed for the acts and to run the show. In addition, there is a superb *mobile mini-hospital* that can accommodate as many as 40 patients, has six life support systems, three surgery rooms and one cybernetic surgery unit (cybernetics can be repaired and replaced safely). 1D6+3 medical doctors, 1D4+1 psychic healers (or mages with healing magic), 1D4 Cyber-Docs, six paramedics and eighteen nurses, plus administrative and other staff, man this operation. Plus 1D4 million credits' worth of common cybernetic and bionic items are in stock and there is an emergency medical fund of 2D6+20 million credits. There is also a comparable, state-of-the-art veterinary clinic to care for all circus animals.

Show Cost: 50 points.

D. Vehicles

Transportation provided by the management of the show to the characters. Also includes information on the show's fleet of vehicles.

1. None. Can you run? Fly? Swim? We sure hope so, because you're not going to get any kind of ride from the traveling show. The owner has two horse-drawn wagons: his personal wagon and living quarters and the supply wagon. Both are so filled with equipment that there is no space for others. Characters must provide their own transportation and tents.

Show Cost: None.

2. Basic Transportation. The traveling show has just enough vehicles to accommodate their needs. A third are horse (or exotic animal/dinosaur)-drawn wagons, a third are trucks and motor-home trailers, and the remaining third are old hover trucks pulling trailers. Living quarters are cramped and must be maintained by the people living in them. Performers may purchase their own vehicles but maintenance is their responsibility and cost.

Show Cost: 3 points.

3. Company Fleet of Vehicles. The management of the show maintains a fleet of trucks, trailers, motor-homes, and wagons. All are fairly new and well maintained hover vehicles. 1D4+2 construction vehicles such as cranes and bulldozers, and two giant NG-V10 robot labor vehicles complete the standard fleet. In addition, the performers may be assigned their own personal hovercar, hovercycle, or minivan. Living accommodations are pleasant, spacious personal trailers for top performers and their families and reasonably spacious accommodations shared by two to six laborers or minor performers. Special traveling arrangements and expenses for commercial airline flights are available upon authorization, with about 500,000 credits in the expense account.

Show Cost: 10 points.

4. Deluxe Fleet of Vehicles. The fleet of vehicles includes new and constantly maintained hover trucks, trailers, motor-homes, wagons, construction vehicles (8), four NG-V10 robot labor vehicles, six mountaineer ATVs, and a small fleet of personal luxury vehicles for the show's star performers (their choice). An expense account for vehicle maintenance, fuel, and rentals, including chartered aircraft and boats, is also maintained at a level of four million credits. All vehicles are high quality, with special vehicles being the top in luxury and performance. Living accommodations for the stars are spacious and luxurious, equipped with video and music disc stereo systems, rich furnishings and attractive in design. Personal trailers for minor performers and workers are also spacious and attractive though shared by families or two to six individuals.

Show Cost: 20 points.

5. Specialty Vehicles. This fleet contains a number of specially designed vehicles, especially large trucks, trailers, animal trailers, vans, motor-homes and construction vehicles (12). Includes six NG-V10 robot labor vehicles, a dozen NG-W10 heavy labor robots, six NG-W9 light labor robots, and two dozen T-21 Terrain Hopper power armor suits or other light Northern Gun, Bandito Arms or Triax power armor. Twenty percent of the vehicles are outfitted with additional armor (+20% the normal M.D.C.), special sensors (radar, etc.), electrical (computers and short-range communications), surveillance (camera and bugs), and security systems (locks and alarms) worth about 100,000 credits; 25% are outfitted with long-range radios (6 mile range/9.6 km). Also, a variety of conventional vehicles and luxury vehicles for star performers, hover vehicles and a few light aircraft or helicopters are available on a limited basis. All vehicles are of top quality, heavy-duty construction, and constantly maintained; ten million credits budget. A team of four Operators, one or two Techno-Wizards and 12 assistant mechanics are employed full time. Living accommodations are luxurious (identical to #4).

Show Cost: 30 points.

6. Unlimited Vehicles. Most commercial vehicles are available to this traveling show, including rare and expensive pre-Rifts models used in the show, jet packs, aircraft, and all the specialty vehicles and robots listed in number five. Half of the vehicles are outfitted with additional armor (+40% more than normal armor), and all have the same security systems and features described in #5, above. Half also have light to medium weapon systems, if allowed by the Military/Defense feature), and some may be modified with Techno-Wizard systems. Up to 500,000 credits may be spent on a vehicle that is important to the show. All are outfitted with short-range radios (6 mile range/9.6 km) and 35% have long-range radios. Living quarters are the most luxurious. The full-time staff of Operators and assistants is double that of #5.

Show Cost: 50 points.

E. Communications

This is a measure of how good the communications network and devices are in the traveling show.

1. None. Characters must buy their own and/or relate messages by word of mouth.

Show Cost: None.

2. Basic Service. The traveling show has one long-range, wide-band radio (500 mile/800 km range), one portable language translator and a walkie-talkie (3 mile/4.8 km range) in each vehicle. No scramblers or bug detectors available.

Show Cost: 2 points.

3. Secured Service. Two long-range radios, all personnel have a walkie-talkie or other short-range type radio, all with scramblers, six language translators, two mini-radar systems, one PC-3000 pocket computer, and a portable video camera and player.

Show Cost: 5 points.

4. Full Range System. Every tent and major vehicle is equipped with a short-range (6 mile/9.6 km range) radio and language translator, plus there are four long-range radios on line, and all personnel have a short-range walkie-talkie available to them. All radios have scrambler capabilities and one of the long-range radios has a laser booster system that doubles its range (1,000 miles/1,600 km). All key administrators have a full computer as well as the PC-3000 and a language translator, lesser administrative personnel have only the PC-3000. Employees have reasonable access to a variety of commercial audio and video recorders and players. A

public announcement system is wired throughout the show and a full sound and video recording studio trailer monitors and controls the music and announcements piped through the PA system. It is also used to mix and prepare music, sound effects and videos for the show. Two full-time communication specialists, two electrical engineers and five assistants are on staff. All equipment is good quality and well maintained.

Show Cost: 15 points.

5. Deluxe Communication Network. Identical to #4 except that all the equipment is of the highest quality, the communications staff is twice as big, equipment is more plentiful and readily available, there are two recording studios, and a small video theater tent or vehicle.

Show Cost: 25 points.

6. Theater and Superior Communications. Not only does this show have everything provided in #5, but it also has two large-screen video theaters, and a massive full-screen theater with a complete pre-Rifts film projection system with the best surround sound system. This package also provides computerized lighting, emergency generators, and a laser light show system. The two audio, video and film studios have state of the art editing, production and duplicating facilities. Plus a communications command center monitors, regulates and controls the PA system, lighting, surveillance/security cameras, sensor systems, and communications. All administrators have full-size and pocket-size computers and language translators. Two dozen or more sets of video cameras, lenses, filters, and other portable recording equipment are available to personnel for business and personal use.

Show Cost: 50 points.

F. Internal Security

This is the level of internal infiltration to which the traveling show is, itself, vulnerable. Internal Security is the only thing that prevents spies, enemies and intruders from being placed within the organization. Enemy agents, moles, "turned" employees and supernatural interlopers can only be prevented with high levels of Internal Security.

1. None. No security, anyone can walk in or out, and employees are not screened or given background checks. No supernatural safeguards other than the characters' own awareness and powers.

Show Cost: None.

2. Lax. A pair of security guards or muscular thugs stand at the main entrance and another pair walk the show with an eye out for thieves and troublemakers. The guards may be any O.C.C. of 1D4 level experience, but are most likely to be men-at-arms and psychics. No special identification cards or codes are necessary, everybody knows who is an employee and who is not. Only the owner's property and the most important vehicles and attractions have locks and alarms. There is a 01-25% chance that one out of every ten employees has a criminal, Coalition or suspicious background, or is an infiltrator secretly working for himself (skimming off the top) or for another organization. No mystic safeguards other than the player characters' own awareness and powers.

Show Cost: 2 points.

3. Tight. Alert security guards and circus personnel keep one eye open for intruders and troublemakers at all times. Everybody works as a team. One out of every 20 employees is a man-at-arms whose job is security, plus two security guards protect the main trailer (office/money) and the main attraction, another two watch the entrance, and 1D4+1 psychic O.C.C.s, D-Bees with keen senses or practitioners of magic (or combination of them all), 1D6

Psi-Stalkers or Feral Dog Boys, and 1D6+3 men-at-arms walk the grounds alert for supernatural trouble and serious danger. Average experience level of the security team is 1D4+1, with a couple of leaders who are 1D4+3. All show vehicles and living quarters have good, solid locks and electronic alarms.

Larger shows have the performer and living areas guarded by an additional security force of 1D6+4 protectors (same as above), and may require employees to wear electronic picture I.D. cards and have surveillance cameras filming and monitoring the most important areas. A rigid check of prospective employees reduces the chance of infiltration by nefarious individuals working for an enemy or rival. 01-15% chance of one infiltrator among every 20 employees. The members of the traveling show are fairly close-knit and protective of each other and of the show.

Supernatural safeguards include a security staff familiar with common supernatural and magic occurrences and how to handle them (items such as silver crosses, garlic, and holy water are available). In addition to the security force, psychic sensitives and magic trained members of the show assist in the event that there is trouble. Most large shows have at least one practitioner of magic, 1D4 psychics (healers or fortune-tellers), and 1D4 people with Minor or Major psionic abilities among their performers and staff who can assist in ferreting out and fighting magical, psychic and supernatural forces out to harm the show.

Show Cost: 10 points.

4. Iron-Clad. Every entrance, exit, attraction and area of importance is under constant video monitoring and guarded by one or two members of the security force. The security force represents a quarter of the overall staff (they also assist in tearing the show down, putting it up, and other chores). As a general rule, 5% are Robot Pilots in combat robots, 10% are power armor troops, 10% of the force are partial reconstruction cyborgs or Combat Cyborgs, 10% are Juicers and/or Crazies or other augmented humanoid/D-Bee/mutant, 10% are Psi-Stalkers or Dog Boys, 20% are Men-at-Arms O.C.C.s, 5% are psychics of one sort or another even if a Minor Psychic, and 5% are practitioners of magic. The rest possess some level of combat or street experience such as Black Marketeers, City Rats, Wilderness Scouts, Vagabonds and so on. All are 1D4+2 level, the head of security will be 1D4+5 level. Common M.D. and S.D.C. weapons, body armor, optical enhancements, and sensors are provided by the management with good availability. All have M.D.C. body armor and M.D. weapons.

Other security measures include high quality locks and alarms on all show vehicles and attractions, hidden compartments/safes, floodlights, emergency generators, motion detectors, heat sensors, mini-radar, and camera surveillance of areas of importance, including the personnel's living area, and magic alarms and defenses at strategic locations off-limits to the public. Patrons attending the show are asked to check weapons at the door and a metal detector is used to scan those entering (01-15% chance of slipping by or around the scanner). Robots are not permitted on the show grounds.

Supernatural safeguards include the previously mentioned mage and psychic characters on the force, as well as psychic and magic performers, and the occasional protection circle, amulet, and talisman. The security staff is familiar with common supernatural and magic beings, powers and dangers, and how to handle them (items such as silver crosses, garlic, and holy water are available). The members of the show are a tight-knit family that watches out for each other and the show. A rigid check of prospective employees reduces the chance of unwanted enemy and criminal infiltrators to

01-10%. A criminal past is okay if the character is up-front about it.

Show Cost: 20 points.

5. Paranoid. Top security and then some. This show, regardless of size, has all the measures taken in #4, above and more. Suspicious characters may be strip-searched or denied entrance, and no one can so much as enter a bathroom without surveillance. Multiple checkpoints and constant personnel checking prevent intruders from entering the restricted areas of the show. Several Master Psychics such as Mind Melters, Bursters, Zappers, Psi-Slayers, Psi-Warriors and Major Psychic Sensitives, as well as mages, are employed as part of the security force. The average level of the security force is 1D4+3 (1D6+4 for the head of security and his second). In addition to the human security force, eight NG-W9 Light Labor Robots with illegal military/defense programs and two Triax Dyna-Bots patrol the area, plus one Triax Ulti-Max or Glitter Boy, or two Shadow Boys or two Bandito Arms SAMAS are deployed at all times.

Supernatural safeguards include a dozen protection circles, amulets and scrolls (including Negate Magic, Dispel Magic Barrier, Turn Dead, Exorcism, Constrain Being, Remove Curse, Globe of Silence, Globe of Daylight, Locate, Negate Poison, Purification, and Apparition; 1D4 of each). The rooms of the show manager and chief of security are protected by a Sanctum spell and several Mystic Alarms. Superior protection circles, wards, and similar safeguards are scattered throughout the compound. The members of the show are an extremely tight-knit family that watches out for each other and the show. There is only a 01-05% chance of enemy infiltration. A criminal past is okay if the character is up-front about it, and may even be expected if the show is a Black Market operation.

Show Cost: 40 points.

6. Impregnable! A vast amount of time and resources have gone into this security system. Similar to #5, above, only with the absolute best locks, alarms, equipment and experienced personnel; add one experience level to each member of the security forces and double the number of psychics and mages. The security force has developed a system of secret verbal signals and hand signs and counter-signs to warn each other of danger and trouble. Reaction to trouble is swift and discreet. Surveillance cameras, motion detectors, heat sensors, and other measures protect the attractions and property of the show. The personnel's living area is protected by a microwave fence, in addition to the other safeguards, and a full radar and ground sensor system is also in place. The members of the show are fanatically protective of their people and property. There is only a 2% chance of an infiltrator making his way anywhere in the organization.

Show Cost: 60 points.

G. Defenses/Military Power

The amount of military force that the show can command directly. This is the number of defenders and special defensive weapons, giant robots and equipment available to security and personnel in the event of attack.

1. None. Everyone must provide their own weapons and equipment and fend for themselves or rely on the internal security force, if any.

Show Cost: None.

2. Basic Defenses. A small number of basic arms have been distributed to the members of the show. These include basic, inexpensive body armor like the Urban Warrior, the Bandito, and

Plastic Man, and common weapons, including Black Market knock-offs and used M.D. pistols and rifles. BigBore weapons are probably as close as one gets to "heavy weapons." Anti-vampire weaponry includes wooden crucifixes, garlic, wooden stakes and mallets, spears, and the occasional (about one in eight) crossbow with wood bolts. The management also provides six Highwayman motorcycles with machine-gun mounts, four ATV or hover cycles with laser mounts, two suits of low-end or used power armor (no Glitter Boys, Shadow Boys, SAMAS or other powerful and expensive units) and two giant robot combat vehicles of the more common and basic variety like Titan products or NG-V7 Hunter.

Show Cost: 5 points.

3. Weapons & Armor. A more deadly selection of arms and armor has been distributed to the members of the show. Any type of body armor is available, with the majority being medium and heavy armor such as Wrangler Riding Armor, Branaghan Armor, Crusader, Bushman, Explorer, and similar armors. 10% of the personnel have Northern Gun Samson, Titan, TX-Hopper and similar power armor. 40% of the vehicles have been fitted with light to medium vehicular energy weapons and rail guns. In addition, the organization has a special rescue team of ex-military and combat personnel who comprise a 12 man force. At least two have psionic powers and two are practitioners of magic. All have the best weapons and equipment, four wear power armor of choice (excluding Glitter Boy and Ulti-Max), two pilot giant robot combat vehicles, and all are 1D4+2 level in experience.

Show Cost: 10 points.

4. Militia. The traveling show has a 32 man force of warriors; all are 1D4+1 level, and have excellent quality weapons, medium to heavy body armor, field communications capabilities and other standard combat gear. Six wear power armor, six are cyborgs or augmented warriors like Juicers and Crazies, six pilot giant robots, four are Major or Master Psychics, and four are practitioners of magic. The remaining are experienced fighters, and may include D-Bees, Psi-Stalkers, and mutants. All have their own vehicle, probably a hovercycle, other hover vehicle, jet pack, jeep, etc.

All show personnel have the same type of equipment listed in number three, as well as performers who may know magic or possess psionics or other powers. 50% of the commercial vehicles are fitted with weapons, sensory systems like radar and 30% more M.D.C. armor. Weapons and equipment are of good quality and damaged or lost items are immediately repaired or replaced. 20 million credit budget for weapons and defense.

Show Cost: 20 points.

5. Private Army. A small unit of 2D6+40 combat veterans comprise this elite force, all of whom are 1D4+3 level. One is a Glitter Boy, Shadow Boy, or a giant robot of choice, six pilot giant robots (probably Black Market or Northern Gun), 12 pilot power armors (probably Black Market or Northern Gun), four are Master Psychics, four are practitioners of magic, and the rest are experienced fighters from the Men-at-Arms, criminal and adventurer categories; may include mutants and D-Bees of any kind. All are equipped with excellent quality weapons including heavy weapons such as rail guns, particle beam weapons, plasma ejectors, mini-missiles, and so on. Anti-vampire weapons, explosives, jet packs, and body armor of all variety are available to the private army. Half of the private army is on duty at any given time, and all are ready to mobilize at a moment's notice! In addition to the human troops, there are 12 NG-W10 drones with black market military programs, armed with pulse rifles or light rail guns, on constant patrol. As usual, light to medium weapons and basic body armor

have been issued to all personnel, and 60% of the vehicles have an extra 3D4x10 M.D.C. armor and may have light, vehicular weapons added to them. Weapons and equipment are new and excellent quality. Any damaged or lost items are immediately repaired or replaced. 35 million credit budget for weapons and defense.

Show Cost: 40 points.

6. Strike Force. Identical to #5, above, plus the following additions to personnel and equipment: Seven Triax Dyna-Bots, four more psychics or mages, four Psi-Stalkers, mutant animals or D-Bees with heightened senses or sensitivity to the supernatural, two Combat Cyborgs or Juicers, two men of magic, two Body Fixers or other healers, one additional Glitter Boy or two other power armor such as a Bandito Arms SAMAS or Shadow Boy, two additional combat robots (probably Northern Gun or Bandito Arms) or one other type of heavy hitter such as a Dragon Hatchling or other creature of magic or supernatural being (Lesser or Greater Demon or Sub-Demon?), and twelve additional men-at-arms or other fighting specialists. All members of the Strike Force are 1D4+5 level in experience.

As usual, weapons and armor have been issued to all personnel and 60% of the vehicles have an extra 4D4x10 M.D.C. armor and weapons added to them. Ammunition is plentiful. Weapons and equipment are new and excellent quality. Any damaged or lost items are immediately repaired or replaced. 50 million credit budget.

Show Cost: 60 points.

H. Types of Acts

There are no limits to the number of acts or combinations of acts that one can purchase from this feature. The same act can be selected as often as three times – although the same basic routine, each is different from the others. The more spectacular shows are the most costly but also the biggest money-makers. Game Masters, please feel free to add your own ideas for acts.

1. Average Clowns. Six clowns, all are first and second level Vagabonds who have a knack for comedy and any one or two of the following skills: Dance, Juggling, Gymnastics, Performance and Sing or Play Musical Instrument. All paint their faces and wear funny, colorful costumes. A typical clown can make funny voices and faces, tell jokes, dance, sing, tumble, juggle and perform short, silly pantomime and stories with a lot of sight gags and slapstick.

Show Cost: 1 point per group of four.

2. Expert Clowns. Four clowns, all are excellent comedians and experienced clowns; 1D4+2 level, can be any O.C.C., retired, turned to clowning, provided they have the right skills (see #1 above). These men and women can usually sing, dance, play a musical instrument, do backflips, cartwheels, tumble, and balance (Gymnastics skill), as well as the usual funny clown antics.

Show Cost: 3 points per group of four.

3. Jugglers. Four jugglers, all first or second level Vagabonds with high physical prowess and a knack for juggling and comedy. Can usually dance and tell funny stories too, nothing more.

Show Cost: 1 point per four jugglers.

4. Expert Jugglers. Four jugglers, all are experienced performers (1D4+1 levels, any O.C.C. turned performer). These fellows can dance, juggle and throw knives (W.P. Targeting), and perform sleight of hand (Concealment, Palming, and Pick Pockets) and may be tumblers as well (Gymnastics).

Show Cost: 5 points four jugglers.

5. Expert Tumblers. Four people skilled in tumbling, falling, rolling, pulling punches, backflips, cartwheels, balance and other

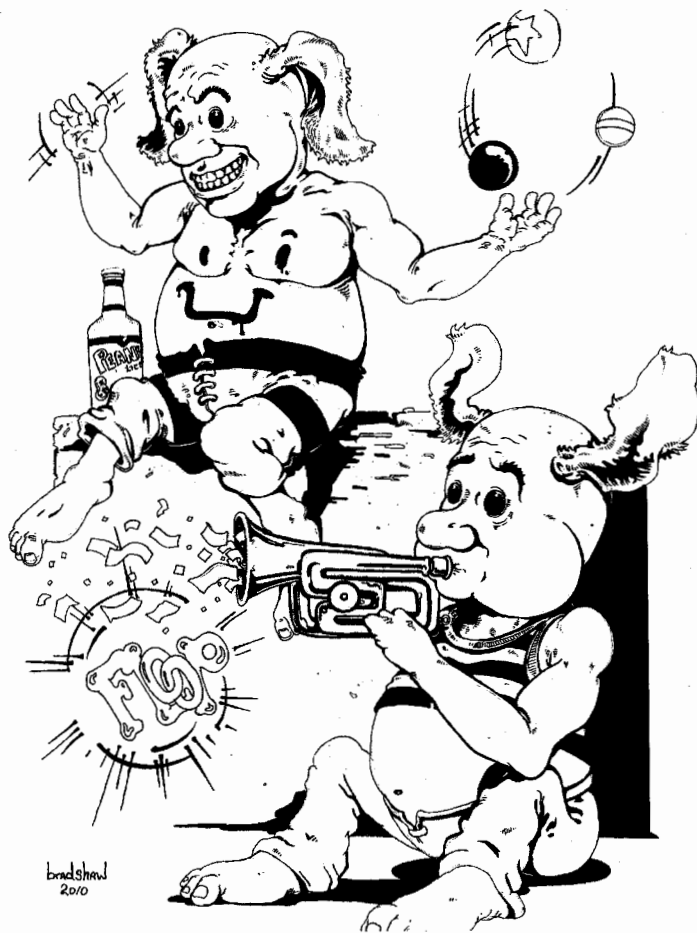

feats of physical prowess on the ground; requires the Gymnastics skill and good physical condition.

Show Cost: 5 points per group of four.

6. Average Minstrels. Four performers (P.B. 10+) that can sing, dance and play at least two different musical instruments each and speak at least two languages. Reasonably good quality.

Show Cost: 2 points per group of four.

7. Expert Minstrels. Four attractive and charismatic performers (M.A. 13+ and P.B. 14+) who sing, dance, can play at least three different musical instruments, tell stories, and speak at least three different languages (50% are literate in one).

Show Cost: 5 points per group of four.

8. Expert Sideshow Barker (1). This is the charismatic individual who stands outside the tent or wagon and shouts out descriptions about the wonders of the show or exhibit that awaits within. Barkers also serve as announcers and guides to attractions that require descriptions and have stories around them. Barkers are consummate salespeople and often Bartenders, Con Artists, Expeditors, Rogue Scholars and others who possess knowledge and like to talk and meet people are the best for the job. Barkers speak loudly, quickly, clearly, and have a knack for exciting people with their words.

Typical attributes required: I.Q. and M.A. of 11 or better. A high P.E. and P.B. are nice assets but not a requirement. Typical skills: Radio: Basic, T.V./Video, First Aid (is always there for the public), Performance or Public Speaking, and skills such as Anthropology, Archaeology, History, Lore, Mathematics, Mythology and the ability to speak two or more languages are always helpful.

Show Cost: 5 points per each Barker.

9. Fortune-Teller (Non-Psychic). This your classic reader of tarot cards, tea leaves, crystals, palms, lumps on the head and crys-

tal balls. They tend to create a lot of atmosphere and suspense but their predictions and intuition are just showmanship; none of it is real. Actors, Con Artists and others with a knack for performance and the ability to “read people” are perfect for the job. A typical fortune reading is 10-20 minutes long and costs 30-60 credits depending on the skill of the reader, the length and the complexity of the reading.

Show Cost: 2 points per each Fortune-Teller.

10. Psychic or Mystic Fortune-Teller. These are the real McCoy. True psychics or sorcerers with the ability to see into the future and/or sense emotions and thoughts. These guys can pull in the big bucks, 2D4x100 credits per individual reading, and are always amazingly accurate. Psychic Sensitives and Mystics with three or more of the following abilities are most suited for the position: *Clairvoyance*, *Commune With Spirits*, *Empathy*, *Object Read*, *Telepathy*, and *See Aura* are the very best! They can see the future and use Empathy and Telepathy to read the customers’s emotions and thoughts to tell the person exactly what he wants to hear. Object Read is great for locating people or telling whether a lost person is alive or dead. Many magic spells can produce similar results.

Show Cost: 6 points per each Psychic or Mystic Fortune-Teller.

11. Expert Stage Magician. The stage magician knows no real magic but is a master of tricks, performance and sleight of hand. They are frequently Con Artists, City Rats, Vagabonds and thieves who have turned their unconventional skills toward entertainment. However, they may be encouraged to continue their criminal ways by the management of the less scrupulous traveling shows to pick pockets and fleece the public. Common skills of Stage Magicians include Concealment, Escape Artist, Juggling, Palming, Performance, Pick Pockets, Pick Locks, and Streetwise, and even a couple psionic abilities like Ectoplasm, Levitation, Object Read or Telepathy can come in handy. (“Think of a number” and “Look at your playing card, remember it . . .”) 1D4+4 levels of experience.

Show Cost: 6 points.

12. Pickpocket and Skill. This can be an act, or a criminal activity, or both. In the latter case, the individual pretends to be an ordinary member of the audience, a fellow spectator. As a skill, the person helps work the crowd by being amazed by performances and claims or statements of fact with loud oohs, ahhs, excited exclamations, fear, fainting, applause, etc., or to provide a supposedly independent verification of facts (“I’ve been a trapper in these hills for years an’ I kin say that thing is real. An’ I ain’t never seen nothing like it.”). Similarly, the skill may volunteer to drink potions and tonics with immediate and wonderful effect, and so on. As a pickpocket and a skill, the individual helps to focus the attention of the audience on the performers, while he carefully picks pockets, or slips away to break into vehicles. Con Artists and thieves are best for the job.

Show Cost: 6 points.

13. Expert Acrobats. A group or family (01-80% likelihood of being a family) of 6-8 individuals of varying ages; two are attractive females. These performers have learned the art of acrobatic performance from an early age and are professionals. The two oldest members will be 30+3D6 years old and have 1D6+6 levels of experience, the youngest will be 6+2D6 years old and have 1D4 levels of experience, and the other four will be 18+1D6 years old and have 1D4+3 levels of experience as acrobats. Skills include Acrobatics, Body Building, Climbing, Dance, Gymnastics, General Athletics and Running. Juggling and other performance skills may be included.

Show Cost: 15 points per group.

14. Expert Animal Tamer. One star animal tamer (1D6+5 levels of experience), two secondary tamers (1D6+2 levels of experience) and six assistants, two of whom are Psi-Stalkers or Simvan Monster Riders (1D4 levels).

Show Cost for Performers: 15 points.

Show Cost per Animal Act: Each specific animal act must be purchased separately. Select as many acts as desired.

12 trained dogs of all kinds; dance and do tricks. One point.

24 snakes for snake act. One point.

Four bears; dance and do tricks. Three points.

Six horses; dance, leap and do tricks. Four points.

Six elephants; dance and do tricks. Five points.

Four lions; leap through flaming hoops and do tricks. Five points.

Two tigers; same tricks as lions. Five points.

Two leopards or other felines; same tricks as lions. Five points.

Small dinosaur; tame, does tricks and can be ridden. Five points.

Larger herbivore dinosaur; same tricks as small. 10 points.

Common monster; tame, does tricks, can be ridden. Five points.

Exotic monster (like Gryphon, Pegasus, Rhino-Buffalo, etc.: 20 points wild, 30 points tamed).

15. Real Magic Act! An experienced 1D4+3 level Wizard – probably a Ley Line Walker or Mystic, but can be any practitioner of magic – and one or two assistants perform an exciting, but safe, magic show using real magic. Illusionary magic is ideal as are spells like Concealment, Escape, Fly, Fool’s Gold, Levitate, Ignite Flames, Impervious to Fire, Invisibility, Trance, Superhuman Strength, and many, many others.

Show Cost: 12 points.

16. Healer (Psychic or Magic). This is a service oriented performer of any level of experience, who provides conventional doctoring along with magic or psychic healing. The more complex the ailment the more costly the service. This can be a very lucrative feature, especially in areas where medical treatment is costly, poor or not available at all.

Show Cost: 12 points.

17. Showgirls! Eight voluptuous and attractive women usually 1D4+1 level of just about any O.C.C., but must have the Dance skill. The skills Performance, Seduction, Sing, Wardrobe & Grooming, and the ability to speak two or more languages are always a plus.

Show Cost: 10 points per group.

18. Live Freaks. Two strange, alien, D-Bee, frightening looking mutant, or disfigured intelligent life forms (not necessarily humanoid). Or 6 fake freaks (make-up and an act; look very convincing).

Show Cost: 12 points per pair.

19. Sideshow Attractions. 12 inanimate oddities. Can include alleged magic items, pre-Rifts artifacts, the skulls or skeletons of aliens or monsters, inanimate mummies, strange plants and similar.

Show Cost: 10 points per dozen oddities.

20. Pre-Rifts Movie! The showing of pre-Rifts movies is always an incredible draw. People are fascinated about life before the time of the Great Cataclysm and will watch bad movies with utter fascination. 10-40 credits is the typical price for average to terrible movies. Horror and monster movies are too close to reality and are among the least popular. Some comedies also miss the mark as they are often not humorous in this future world. Otherwise, people want it all: love stories, dramas, slapstick comedies,

action-adventure, super-hero movies (which they often believe are real) and others. They sit glued to their seats, just to see what the world was like. A world they have never known. Color movies about city life are among the most popular. High quality, blockbuster action/adventure movies, historical, and science fiction movies are also extremely popular and can command 50 to 100 credits a person! Some movies can get even more.

One of the most famous movies is called **The Day of Destruction**, which claims to show the Great Cataclysm caused by the arrival of the Rifts. What this clever entrepreneur did was acquire a cache of super-rare disaster movies, made copies, spliced, edited and redubbed them together to show the destruction of the Earth. The three hour movie spectacle includes scenes from numerous classic pre-Rifts movies, including Independence Day and many others.

Other shows have exhibited unedited copies of The Wizard of Oz, 2001: A Space Odyssey, the Star Wars trilogy, Terminator and Taxi Driver to standing room only crowds for years. The films are under exclusive ownership and NOT reproduced or sold to others; too lucrative to flood the market.

Show Cost: 15 for projector/theater system (FREE if Communications #6 has been selected). Plus the cost of the film.

Lousy film of any kind: 5 points (3 if black and white).

Good film drama, gangster, adventure: 10 points.

Great film drama, gangster, adventure, and urban settings: 15 points.

Great science fiction and Superhero movies! 20 points.

21. Rides.

Pony ride, six animals: 1 point.

Horse ride, six animals: 2 points.

Elephant ride, four animals: 4 points.

Exotic animals, two animals, Pegasus and similar fantastic creatures: 10 points.

Unusual animals, two animals such as camels, llamas, buffalo, ostriches, etc.: 5 points.

Tamed Dinosaurs, two animals, typically the big, lumbering herbivores common to the American New West, Southwest and Mexico, but may also be robot dinosaurs disguised as the genuine animal (two animals). 8 points.

Carnival rides like those typically found in modern traveling carnivals (ferris wheel, spinning rides of all kinds, etc.). Note that big rides like roller coasters require too much construction, materials, time and labor for a traveling show. Cost 3 points each.

22. Games of Chance. These are all types of simple games of skill and chance, like throwing knives or darts, tossing a hoop over a target, target shooting, and similar arcade games.

Show Cost: 1 point per each game.

23. Gladiatorial Arena. Patrons may challenge the show's champions. Credits or prizes may or may not be offered as a reward to the participants. Taking bets is usually allowed. The typical arena is a large tent with a roped off area indicating the combat zone. Fights are usually limited to fisticuffs and ancient style weapons (swords, maces, etc.). Fights are rarely to the death. Set-up comes with one 1D4+7 level warriors, typically a Crazy, Juicer, Assassin, or other powerful or skilled fighter. The animal tamer may allow one of his bears or other animals to fight as well.

Show Cost: 15 points

24. Dancing Dinosaur Rider! One large dinosaur medium-sized or large carnivorous dinos. This is often a deception in which one of Bandito Arm's riding robot dinosaurs or giant robot vehicles, with fake skin and all the cosmetic features to appear real, is

used to perform amazing stunts and tricks. Of course, get a Simvan Monster Rider or someone else who can really control dinosaurs and monsters, and you have the real deal, but increased danger if the monster spins out of control. **Note:** May be substituted for some other type of "daredevil" or death-defying act.

Show Cost: 15 points.

I. General Alignment of the Personnel

The majority of the workers and performers (80%) fall into one of these categories:

1. Evil: Miscreant and Diabolic. Show Cost: None.
2. Evil: Miscreant and Aberrant. Show Cost: None.
3. Anarchist. Show Cost: 2 points.
4. Anarchist and Unprincipled. Show Cost: 4 points.
5. Unprincipled and Scrupulous. Show Cost: 6 points.
6. Scrupulous and Principled. Show Cost: 8 points.

J. Criminal Activity

In addition to petty crime, con jobs, theft and brutality, the traveling show has some very developed areas of criminal expertise. The following are special personnel skilled in the criminal arts, offering illegal services like assassination, blackmail and coercion (beat people up, break legs). Like the *Acts* and some other features, several Criminal Activities can be purchased and the same one can be purchased as often as four times to increase the number of people involved in that criminal pursuit.

1. One Medicine Man. This is a Con Artist and barker who pitches and sells fake, stolen, dangerous, illegal and mostly worthless medicines and other goods. He's called a Medicine Man or "Snake Oil Salesman" because the focus of his business is to sell elixirs, tonics, booze, herbs and components that are supposed to possess medicinal properties to help fix what ails you. Also fills in as an announcer and guide to attractions that require descriptions and have stories around them. Barkers are consummate salespeople and usually a Con Artist or Expediter, but can be any silver-tongued crook. They speak loudly, quickly, clearly, and have a knack for exciting people with their words.

Show Cost: 5 points.

2. Three Prostitutes. Ladies of the night who sell sexual favors for money or trade of goods or service. The ladies may also be used to put customers in compromising situations and blackmail schemes, as well as gathering information and spying. P.B. attribute is 2D6+12. A high M.A. is helpful but not required.

Show Cost: 5 points.

3. One Expert Forger. Typically a 1D4+4 level Scholar, Scientist or Military Specialist turned to crime. Skills of note: Forgery, literacy in at least three languages, Basic Math, Art, Photography, and Computer Operation.

Show Cost: 10 points.

4. Three Expert Worms. Two warriors trained in espionage (Military Specialist, Spy, Special Forces, Commando, Ranger, Wilderness Scout, etc.) and a City Rat, Case Man or Expediter; all are 1D6+2 level. Their job is to "case" the area around the traveling show making note of people, homes and businesses to rob or blackmail, mapping the streets and layout, assessing the capabilities of the community's police and defenders, taking note of possible spies and undercover agents and suspicious visitors, and mapping escape routes. They are called worms because they worm their way in unnoticed, or at least unnoticed for the threat they are or that they are casing the place.

Show Cost: 10 points.

5. One Cyber-Doc. A Cyber-Doc and one assistant and one nurse who are happy to engage in the sale and installation of illegal cybernetics, bionics and other types of human augmentation.

Show Cost: 10 points.

6. Pickpocket team. A pair of 1D4+4 level pickpockets whose job is to remain unnoticed and work their way through the crowd stealing currency cards (work like debit cards), valuables, weapons, illegal contraband (the victim can't call the authorities) and information. A favorite ploy is to steal only one third to half of the money in a wallet or on a currency card. That way the victim isn't sure that he was robbed, and is likely to think he spent more than he realized. Special bonus of +10% to Pick Pockets and Palming skills, and +5% to Prowl.

Show Cost: 8 points.

7. Gang of Robbers. While the show is going on, a gang of 2D4+2 thieves and thugs rob the empty houses and target select businesses (the ones easy to rob and which offer a good haul), and some may even mug people in the alleys and dark places. The robbers can be Bandits, Highwaymen, Professional Thieves, City Rats, Vagabonds, and anyone tough enough and brave enough to break-in, enter and rob. These are thieves, not killers, so they try hard not to seriously injure or kill anybody, but will restrain and beat up victims as necessary. No member of the gang is officially affiliated with the traveling show and they keep a low profile around the show. However, an observant individual will notice these shady characters hanging around the circus and they do have a secret hideout in the show's living area.

Show Cost: 10 points.

8. Smugglers and Sellers of Contraband. 1D6+2 specialists in smuggling; each has 1D4+3 levels of experience. They buy, sell and transport scarce, illegal, or dangerous goods and contraband, as well as carry and deliver secret packages, contraband and information for clients.

Show Cost: 15 points.

9. One Master Assassin. An evil, 1D4+4 level Master Assassin, Black Market Enforcer or any warrior who specializes in murder for hire and is good at it.

Show Cost: 15 points.

10. One Psychic Enforcer. A powerful, 1D4+2 level Master Psychic – Mind Melter, Psi-Slayer, Burster or other, whose job is to enforce the wishes of his boss and defend the traveling show.

Show Cost: 15 points.

11. One Fence. This 1D6+3 level criminal is an expert in the appraisal, barter, buying and selling of goods, especially illegal contraband. May be a Black Market Banker, Merchant or Expediter, provided he has the Special Ability: Fence, and other appropriate skills.

Show Cost: 15 points.

12. Special Operatives. A pair of super warriors used for special missions such as jail breaks, assaults/raids, and murder. Typically a pair of 1D4+3 level Crazies, Juicers, or a Dragon Hatchling or powerful, inhuman being, creature of magic or supernatural being, mage or Master Psychic.

Show Cost: 20 points.

K. Traveling Show's Reputation/Credentials

Just what is the reputation of the show? The credentials determine just how well known and respected the traveling show is and the reputation of the people and performers associated with it. Reputation may also indicate how likely the authorities are to cut

them a little slack or look away at minor infractions of the law, and how much the traveling show can charge for its attractions.

1. Hunted. The traveling show and/or its owner has a "bad" reputation. It may even be rumored to be a front for criminals or harbor troublemakers and bad sorts. As a consequence, anyone associated with the traveling show is viewed with great suspicion by everybody who encounters them. Moreover, the authorities of several towns and/or one or more bands of heroes are hunting them for questioning concerning one or more "incidents" in their community, or for smuggling, robbery, murder or other crimes, or for damage they caused to the town of the people hunting them. There is a 01-40% chance that one of these hunting parties will find them whenever the show stays in or near a community more than three days from the townspeople they have victimized (roll for each day). Due to their reputation, the show personnel finds cooperation from the authorities, particularly police and militia, to be slow and reluctant, if at all, and anything they claim is not trusted. Still, the show will draw a crowd. **Note:** This show gets the typical level of pay for its employees.

Show Cost: None.

2. Scoundrels. The traveling show and its personnel are viewed with suspicion. The public assumes them to be a group of criminals, outlaws, flim-flam men, quacks, freaks or fanatics. Word is they are to be feared and not trusted, but they still draw a decent crowd. Cooperation from authorities, particularly police and militia, will be slow and reluctant to non-existent. It is immediately assumed they are responsible for any wrongdoings, and this group might be run out of town for crimes they did or did not commit. **Note:** Decrease the typical level of pay for this show by 10%.

Show Cost: 1 point.

3. Unknown. No one has even heard of the traveling show. They get no special cooperation and receive no overt attention from the town or the authorities. The event draws good crowds, but is probably considered new or second-rate. Communities will try to be fair and give the visitors the benefit of the doubt on most matters, and do not immediately assume they are responsible for wrongdoings, but the authorities will tend to side with fellow citizens and other authorities over the word of the show and its performers. **Note:** This show gets the typical level of pay for its employees.

Show Cost: 5 points.

4. Known. The show is known to have been around for years or is seen as a source of good entertainment and good products. There are no rumors about the show having ever been involved in criminal or negative activities, regardless of whether the show is a criminal operation or not. It draws large and excited crowds. The local authorities will help with matters that are in their jurisdiction and the show is looked upon in good favor. **Note:** Increase the typical level of pay by 25%.

Show Cost: 10 points.

5. Excellent Reputation. The traveling show has a reputation for providing high quality entertainment and goods. Even if there are rumors of trouble or crimes, nobody holds it against the show. After all, hooligans follow such popular shows to prey on the attendees and the innocent show gets blamed! Or the show is so spectacular that people are willing to overlook any bad press. The management are known as "good guys" who deserve all the help they can get. The show draws excellent, big and excited crowds. Police overlook minor infractions such as brawls and drunkenness, and gladly dismiss minor criminal charges like petty larceny if the show's management makes restitution to the victim, pays a big

fine (double the usual amount) and promises to keep out of further trouble. Authorities give the traveling show their full cooperation, treat them like celebrities, and tend to give the show the benefit of the doubt when accusations are made against it. **Note:** Increase the typical level of pay by 50%.

Show Cost: 25 points.

6. Famous or Infamous! The traveling show either has a sparkling reputation or one of villainy and trouble. Regardless, it is also known to be sensational, with must-see attractions, spectacular acts and amazing performances. The performers are bigger-than-life stars displaying incomparable skill, death-defying courage and the best entertainment around! Any authority or citizen would jump at the chance to have the show visit their community, even if it means risking trouble that may come with it. The show always receives favorable press, gets lots of free advertising, is swamped with adoring fans, and draws huge crowds.

Shows with sterling reputations, and which are not known to be evil or a front for a criminal enterprise, receive the same level of cooperation and adulation as visiting dignitaries, perhaps better. The show and especially its star performers are always given benefit of the doubt and the authorities always side with the show unless there is concrete evidence to the contrary. Even then, most charges are dismissed and the punishment for even serious crimes often turns into a slap on the hand and a request for an autograph.

Traveling shows with infamous reputations, notorious for bringing or causing trouble and controversy (and crime) wherever they go (it may even be known to serve as a front for a smuggling operation or other serious accusations), are still accepted with open arms because they are known for spectacular entertainment. These performers have the same star status and are adored by thousands, but the difference is that a cloud of controversy and trouble puts the authorities on edge. The law and government leaders regard the show as trouble and would rather not have it in their community, but cannot ignore its popularity, so they put up with it. They do their utmost to prevent trouble and may increase police patrols or call in the militia just in case there is trouble. Authorities may suspect otherwise, but will always give the show and most of its star performers the benefit of the doubt unless there is hard evidence of wrongdoing. Brawls, drunkenness, larceny, and petty theft are completely ignored. Even major crimes may be ignored (especially if the show is leaving soon) out of fear of retribution by the show's dark forces.

Note: Double the typical level of pay for famous and infamous shows.

Show Cost: 50 points.

L. Typical Salary

The amount of money received weekly by the employees varies depending on the size of the show, its reputation and the amount of money made.

1. None. The performers pass the hat and hope for the generosity of the spectators. Criminal groups make their real money fleecing the crowds and selling alcohol, drugs and contraband. The take is generally small and varies dramatically from crowd to crowd. The performers' accommodations, food and costumes may be provided on loan from the management of the show or may be the responsibility of the performers. **A Typical Week's Pay:** 3D6x10 credits for workers and 5D6x10 credits for performers.

Show Cost: None.

2. Freelance. The performers and workers are paid a small commission based on the profit of each show. No profit means

no additional pay, but they receive free living quarters, food and the use of the show's other resources (costumes, props, housing, vehicles, etc., but it is all owned by management). Performers and workers have no binding contract and can be fired or quit with a moment's notice. **Typical Week's Pay:** 4D6x10 credits for laborers, thugs and lesser performers. 4D6x10+150 credits for experienced and headline performers as well as criminal specialists.

Show Cost: 2 points.

3. Pittance Salary. The show employs the characters on a full-time basis, but always seems to be strapped for money. The show provides living quarters, food, supplies, costumes, transportation, and access to other facilities and benefits at no charge. Performers are likely to be signed to 1-4 year contracts. **Typical Week's Pay:** 2D6x10+160 credits for laborers, thugs and lesser performers. 6D6x10+300 credits for experienced and headline performers as well as criminal specialists.

Show Cost: 5 points.

4. Good Salary. In addition to room, board, transportation and access to the show's resources, the employees receive a good salary. All performers and important laborers sign a 2-4 year contract. **Typical Week's Pay:** 2D6x10+200 credits for laborers and minor performers, 3D6x10+300 credits for most performers, and 1D4x100+800 credits for star performers and expert criminal specialists. Bonuses of 1D6x1,000 credits are paid to star performers every quarter and 1D4x100 to all others.

Show Cost: 10 points.

5. Excellent Salary. In addition to room, board, transportation and access to the show's resources, the employees receive an excellent salary. All performers and important laborers sign 3-6 year contracts. Performers and key people may get additional perks in the way of special accommodations, a private vehicle, star billing, and so on. **Typical Week's Pay:** 3D6x10+350 credits for laborers and minor performers, 5D6x10+400 credits for the average performer, and 3D6x100+1,200 credits for star performers and expert criminal specialists. Bonuses of 2D6x1,000 are paid to star performers every quarter and 2D4x100 to all others.

Show Cost: 20 points.

6. Outrageous Salary. All of the usual, plus additional perks in the way of special accommodations, a private vehicle, star billing, and so on. **Typical Week's Pay:** 1D6x100+240 credits for laborers and minor performers, 1D6x100+700 credits for the average performer, and 1D6x1,000+4,000 credits for star performers and expert criminal specialists. Bonuses of 1D6x10,000 are paid to star performers and expert criminals every quarter and 1D4x1,000 to all others.

Show Cost: 40 points.

Closing Thoughts for Adventure

Each traveling show should have a name, logo/insignia, and banners. It's a good idea to come up with an owner/manager, an executive officer, a couple of star performers, and a few other key characters. Remember that interesting guards, performers and scoundrels can make a traveling show much more memorable. The more colorful the details, the greater the atmosphere. Game Masters, think of a traveling show as a mobile source of random fun and large shows as traveling towns. All of which offer avenues of adventure and opportunities for trouble and employment. A show may be looking to hire one, a few or all of the player characters as laborers, armed escorts/protectors or as performers.

Bandito Arms Weapons

By Carmen Bellaire. Some additional ideas & text by Matthew Clements & Kevin Siembieda. Art by Brian & Allen Manning.

E-Clip Charging Stations

A necessary supporting industry for the arms market is ammunition sales. Without ammunition, all the weapons in the world are useless. On Rifts Earth, the majority of weapons use E-Clips (energy clips), simplifying the process of replenishing their ammunition. Whereas in previous eras, the manufacture of ammo required giant factories and shifts of workers, now those times are gone, replaced with simple **E-Clip Charging Stations**. Though the Black Market maintains facilities for manufacturing ammunition, especially the simple iron and lead slugs that rail guns use and BigBore rounds, E-Clip charging makes up the majority of ammunition sales and is fast and easy. Every Black Market arms dealer, including their traveling merchants, will have one, a few or even a bank of E-Clip Charging Stations tucked away behind the storefront.

New E-Clip Costs: All are new and fully charged.

Standard and Short E-Clips: 5,000-6,000 credits.

Long E-Clip: 7,000-9,000 credits.

Triax Forward Sliding E-Clip: 7,500-10,000 credits.

Coalition CE Canisters: 10,000-15,000 credits.

Electric Vehicles and Power Armor Batteries: 11,000-14,000 credits.

NG Power Packs/Batteries for Powered Robots and Large Vehicles: 75,000-100,000 credits.

Note on Used E-Clips: Previously owned clips are only slightly less, reduce price by 10%; 20-30% when on sale.

E-Clip Recharging Rates:

Standard and Short E-Clips: 1,500 credits.

Long E-Clip: 2,000 credits.

Triax Forward Sliding E-Clip: 2,200 credits.

Coalition CE Canisters: 2,300 credits.

Charging Electric Vehicles and Power Armor Batteries: 3,500 credits.

Charging NG Power Packs/Battery-Powered Robots and Large Vehicles: 25,000 credits.

Note: The prices above are the “standard market price” charged by most arms dealers, the Black Market amongst them. During sales, the price may be reduced, but not by much, typically 10-25%. Some retailers charge more, with prices 20-40% higher than those listed above.

E-Clip Charging Stations: Maintaining an E-Clip charger is one of the simplest ways to make money on Rifts Earth. Anyone who has access to one of the machines is equipped to dispense a high-demand product: energy ammunition. E-Clip chargers can be powered by gas/diesel generators, solar panels or nuclear cores. Each type has its own advantages and drawbacks.

Gasoline/Diesel: Gas/diesel models are small and portable, but require a reliable source of fuel. Since only a few kingdoms and states have sizable oil refining capabilities, gasoline is somewhat rare, quite a contrast to the pre-Rifts days of plenty.

Weight: 85 lbs (38.3 kg).

Charging Time: 20 minutes.

Charging Capacity: 1D4+6 E-Clips per 40 gallons (151 liters) of fuel.

Cost: 1.5 million credits, plus the cost of fuel which can range from 50-400 credits a gallon (3.8 liters), when you can find it. Pays for itself within 6-10 months when utilized to its full potential.

Solar Powered: Solar E-Clip chargers draw power right from the sun; unfortunately, they have a very limited capacity compared to gas or nuclear versions.

Weight: 240 lbs (108 kg).

Charging Time: 30 minutes.

Charging Capacity: 1D4+1 E-Clips per 6 hours of sunlight; holds a maximum of 48 hours of sunlight based energy, but that takes several days to capture.

Cost: 1.7 million credits, pays for itself within 8-12 months when utilized to its full potential.

Note: Double charging time in cloudy weather. Cannot draw power at night or indoors.

Nuclear Reactor: Miniature nuclear reactors are the ultimate in power generation, and due to their use in vehicles, robots and power armor are relatively common on Rifts Earth. They are expensive, however, and more dangerous than the alternatives.

Weight: 100 lbs (45 kg).

Charging Time: 5 minutes.

Charging Capacity: 12 E-Clips per hour and has a 1D4+5 year life!

Cost: 65 million credits, pays for itself within 6-8 months when utilized to its full potential.

Note: Reactor casing has 50 M.D.C. Rupturing the casing will spill radiation throughout a 50 foot (15 m) radius, contaminating anyone or anything within the area. When the nuclear core has been compromised, the charger no longer functions and is dangerous to be around.

BigBore Series Weapons

Bandito Arms' line of BigBore weapons has proven to be a huge success for the Black Market, as eager consumers all around Rifts North America have snatched them up. So much so, that the Coalition States has considered adding all “BB” weapons to their blacklist of illegal weapons and technology. Only their relatively low damage output (compared to most CS energy weapons) and the limited ammunition supply of the BigBore weapons has prevented them from being blacklisted to this point. The popularity of BB weapons has prompted Bandito Arms to find new ways to expand their BigBore weapons line with new western patterned arms for their customers in the New West, a new line of combat grade BigBore weapons for the hardcore mercenary and adventurer market, and even a few designs patterned after 18th century flintlock muskets and pistols for the pirates and privateers of the Great Lakes and Gulf of Mexico. All in all, it is quite an impressive lineup of new guns.

A common selling points for BigBore weapons has to do with them firing *projectiles* instead of energy blasts. The marketing goes as follows, “Since sooo many types of power armor, monsters, psychics and men of magic have some form of immunity to

energy weapons – Zappers, Psi-Slingers, Mystic Knights, a mage’s Impervious to Energy spell, the Glitter Boy’s laser resistant armor, etc. – it is *better* to have a weapon that fires a good old physical projectile that is ‘guaranteed’ to do (at least some) damage to your target. When you add in the BigBore’s unprecedented knockdown feature, you more than make up for the fact that some energy weapons might do more damage than a BigBore weapon. So why take chances?”

It’s surprising just how often this little sales pitch clinches the deal and sells the BigBore to new customers. In reality, many energy weapons do more damage, are more lightweight and have a larger payload, but the Black Market’s sales pitch and weapon line are a runaway hit.

From the manufacturing and sales perspective of Bandito Arms, the real advantage of BigBore weapons is not the sale of the guns themselves, but the repeat business generated by the need for replacement BigBore *ammunition*. Bandito Arms makes truckloads of credits on the sale of BB ammunition. Bandito Arms researchers have concluded that for any given BigBore weapon sold – or given away as a promotional item, for that matter – Bandito Arms makes approximately thousands of credits in ammunition sales over the functional life of the BigBore weapon, sometimes much more. For rapid-fire BB weapons, the figure is well over a million credits, and at least two million for the BigBore rail guns. These figures represent the revenue from ammunition sales alone and do not include replacement parts, maintenance and repair fees, which tend to be higher for BigBore weapons than comparable energy weapons due to the BigBore’s moving parts and higher levels of stress when firing projectiles. This has led to a real marketing and engineering push of BigBore weapons by Bandito Arms.

BigBore rounds. There are two basic types of BigBore rounds **the small BB** – known as the “BigBore revolver round” as they were first used in the BB-6 revolvers, and **the large BB rounds** – dubbed the “BigBore shotgun shell” as they are roughly the same size and shape as a large gauge S.D.C. shotgun shell. But if you break open either sized shell, you will find pretty much the same thing, a metallic ball (large or small), that resembles a steel ball bearing or marble. This “marble” is an *impact explosive* sealed in a light M.D. ferro-carbon, compression casing. When the BigBore casing undergoes a catastrophic impact, like when striking a target, the casing implodes around the explosive, detonating in a powerful blast of concussive force and shrapnel. The rest of the round/shell is a solid propellant similar to that used in the *Wellington Industries* caseless S.D.C. ammunition and is completely consumed in the combustion when the BB shell is fired.

Whether a BigBore projectile is called a bullet, round or shell is mostly a matter of style since they all pretty much mean the same thing. It is important to note, however, that most guns in the **BigBore “Shotgun Series”** that use the BB shotgun shells can *also* fire *conventional S.D.C. shotgun shells* (the damage is 4D6 S.D.C. for buckshot or 5D6 S.D.C. for solid slugs) as well as wooden or silver shells designed for *fighting vampires* and certain other supernatural beings. When loaded with silver or wooden rounds, the projectile does double its listed M.D. shotgun damage straight to the Hit Points of the creatures, such as vampires, vulnerable to such things. **Note:** Other BigBore weapons cannot fire conventional shotgun shells even if they use the BigBore shotgun shells, due to their firing mechanism or other factors that would cause these rounds to shred inside the weapon’s internal components during firing, jamming it. While the damage of a BB bullet/round/shell can vary based on how many rounds are fired or how it is de-

ployed, the *knockdown effects* of the two types of BigBore rounds/shells tend to remain consistent regardless of the firing mechanism.

BigBore “Revolver” Rounds

Mega-Damage: 1D6 M.D. per single BB revolver round/bullet fired, plus knockdown.

Knockdown Effect (Revolver): Human and human-sized D-Bees who are shot must roll a 20 sided die to maintain their footing. This balance roll must equal or surpass the attacker’s natural roll to strike.

A *successful save vs knockdown* means the character feels like he’s been kicked, but remains standing and suffers no penalties, except he *loses initiative* if he had it.

A *failed roll means the victim is knocked off his feet*, and falls back onto the ground (falls back 1D4 feet/0.3 to 1.2 m), loses initiative (if he had it) and loses one melee attack/action! Even characters in M.D.C. body armor will be knocked down, however, those in power armor, full conversion cyborgs, robots, giants, supernatural beings (demons) and creatures of magic (metamorphed dragons, etc.) are not.

Cost of BB Revolver Rounds: 80 credits per round or 10,000 credits for a gross (box of 144 rounds).

BigBore “Shotgun” Shells

Mega-Damage: 2D4 M.D. per single BB shotgun shell fired, plus knockdown.

Knockdown Effect (Shotgun): Human and human-sized D-Bees must roll a 20 sided die with a -6 penalty to stay standing. The roll must equal or surpass the attacker’s natural roll to strike.

A *successful save vs knockdown* means the character is staggered, feels like he was kicked by a mule and loses the initiative.

A *failed roll means the victim is knocked off of his feet* and flung 8-10 feet (2.4 to 3 m) before hitting the ground! The victim loses initiative, is momentarily dazed (reduce all combat bonuses by half for one melee round per each blast endured), and loses one melee attack/action!

Knockdown Note: Even characters in M.D.C. body armor are knocked down and suffer the penalties above. Those in power armor or who are full conversion cyborgs, man-sized robots (11 feet/3.3 m or smaller), lesser supernatural beings and lesser creatures of magic (including Dragon Hatchlings) are +6 to save vs knockdown. If knocked down they are staggered with each shot and lose initiative. **True Giants** (20 feet/6.1 m and larger), giant robots (12 feet/3.7 or larger), Demon Lords, deific level supernatural beings and powerful, giant creatures of magic such as adult and ancient dragons and Greater Elementals take damage only. They do not lose initiative, nor do they suffer knockdown or related penalties.

Cost of BB Shotgun Rounds: 120 credits per BB shotgun shell or 16,000 credits for a gross (box of 144 shells).

BigBore “Holdout” Derringer

Also known as the “BB-2” (for two-shot)

The BigBore “Holdout” is a large, western-style derringer using the same high explosive shells, small grenades really, as the classic *BB-6 Bandit Revolver*. The weapon is roughly the size of a light automatic pistol. The BigBore derringer packs all the man stopping power of the revolver, but only has two rounds, meaning that the outlaw using a Holdout had better be damn sure of his aim.



The weapon's weight (for its size) and gas venting means the gun is very stable when fired, negating its recoil and providing a steady aim for the shooter. The Holdout is a favorite among gamblers, card sharks, saloon girls, shopkeepers, bartenders, con artists, City Rats and bankers throughout North America, but especially in the New West.

Weight: 3 lbs (1.4 kg).

Range: 50 feet (15.2 m).

Mega-Damage: 1D6 M.D. per revolver round/bullet. See the BigBore Revolver Rounds above for the knockdown effect.

Rate of Fire: Single shot only. Each shot counts as a melee attack.

Payload: Two rounds; breech loaded.

Bonus: Steady aim; +1 to strike on Aimed Shots; no bonus when shooting wild due to its weight and gas venting.

Cost: 4,500 credits for the gun, 80 credits per revolver round or 10,000 credits for a box of 144 rounds.

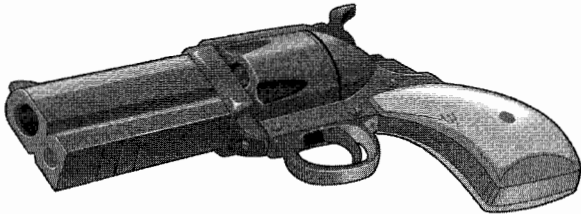

BigBore "Big Boss" Magnum Revolver

Also known as the "BB-4" (for four-shot revolver)

Using the same rounds/shells as the BigBore Sawed-Off Shotgun, the BB-4 is a "Magnum" revolver designed for use by *augmented humans* such as cyborgs, Juicers, Crazies, and others with *Augmented or better Physical Strength (P.S.)*, including fighters clad in suits of power armor. The "Big Boss" has quickly become the symbol of male machismo in the New West, and every desperado, bandito and two-bit crook in the West thinks owning one makes him a man. Of course, this is great for Bandito Arms sales, and they milk it for all it's worth! The BB Magnum revolver is a monster of a weapon that is intimidating even to the bravest opponents, with a Horror Factor of 11 when pointed in someone's face.

Note: A P.S. of 22 or an Augmented P.S. of 16 or better is required to fire the BB-4 without the shooter suffering ill effects himself. Those with lower P.S. are -2 to strike, are knocked on their butts each time they fire the weapon, take 1D4 S.D.C. damage and lose one melee attack/action. An Augmented P.S. of 20 or greater is required to fire it one-handed.

Weight: 4 lbs (1.8 kg).

Range: 200 feet (61 m).

Mega-Damage: 2D4 M.D. per single BB "shotgun" shell. See the BigBore Shotgun Shells above for the knockdown effects.

Rate of Fire: Single shot only. Each shot counts as a melee attack.

Payload: Four shells; revolver-style cylinder weapon.

Cost: 12,000 credits for the gun, 120 credits per shotgun shell or 16,000 credits for a box of 144 shells.

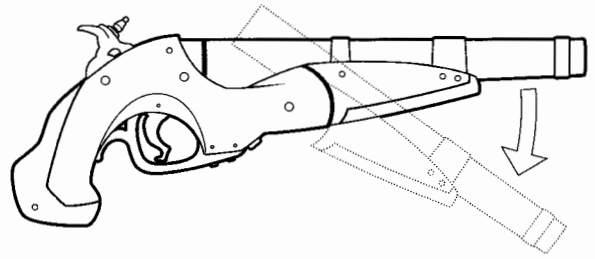

BigBore "Buccaneer" Breech-Lock Pistol

In order to capture a piece of the arms market among the pirates and privateers of the Great Lakes and Gulf Coast, Bandito Arms has designed a simple breech-lock pistol that looks and feels like an 18th Century flintlock pistol. The firing mechanism of the "Buccaneer" is incredibly simple, nothing more than a striking hammer that looks like an antique flintlock hammer, but is aligned with the rear of the weapon, not the side (functions like a revolver's hammer). The Buccaneer has to break open at the breech to reload in the same manner as a conventional double-barreled shotgun. The loose tolerances of the pistol's construction means that it vents a lot of smoke and gas when fired, reducing its range. The venting gas also limits the kick/recoil generated by the weapon and allows it to be fired by even mortal pirates single-handed.

The handle and body of the pistol is made of wood which is hand carved by locals living near Bandito's facilities. Only the barrel and firing mechanism are made of M.D.C. materials, which makes the Buccaneer extremely cheap to produce; approximately 100 credits, about 50-60 credits for the M.D.C. components, 10-30 credits for the handle and another 10 credits or so in miscellaneous parts. In fact, the Buccaneer is so cheap to produce that Bandito Arms has decided to give out a free Buccaneer with the purchase of each box of BigBore rounds in the Great Lakes and Gulf Coast target markets in an attempt to dominate the pirate market. Once Bandito has saturated the market, they plan on ending the free Buccaneer promotion and increase the price of the gun to 4,000 credits to maximize their profits.

Weight: 3 lbs (1.35 kg).

Range: 120 feet (36.6 m).

Mega-Damage: 1D6 M.D. per round/bullet. See the BigBore Revolver Rounds above for the knockdown effects of the BigBore rounds.

Rate of Fire: Single shot only. Each shot counts as a melee attack.

Payload: One round; breech loaded.

Cost: Current price for the gun alone is 2,500 credits; free in the Great Lakes, Gulf Coast regions when purchased with a box of ammo. 80 credits per round or 10,000 credits for a box of 144 rounds.

BigBore "Privateer" Breech-Lock Musket

The "Privateer" is patterned on the 18th century *Brown Bess flintlock musket* and looks similar to the *T.W. Firebolt Musket* favored by many pirates, but the weapon's hammer is rear-aligned like that of the Buccaneer, and the Privateer's barrel is thicker and

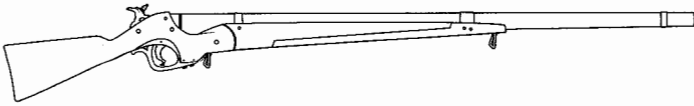

larger than a normal musket's barrel. With the Privateer's long barrel and the use of the BigBore shotgun shell, the weapon has impressive range and minimal kick for a BigBore weapon. It is quickly becoming a favorite weapon among those pirates who would rather murder their enemies at a distance than wait for the up-close swordplay. A normal strength of 14 or better is required to fire the Privateer as a two-handed weapon. Those with a weaker P.S. are -2 to strike even with an Aimed Shot, and -6 when shooting wild. The musket can not be fired single-handed, unless the shooter has an Augmented P.S. of 16 or greater (normal P.S. of 22), it is simply too long and awkward otherwise.

The construction of the Privateer is similar to that of the Buccaneer, including using local help to carve the wooden body and stock of the weapon. As such, Bandito Arms has included the weapon in its sales pitches to the pirate communities. One of which is a special offer of a Privateer musket for only 1,000 credits with each box of BigBore shells purchased by a pirate customer. (The 1,000 credits, the Black Market sellers insist, is the cost to make the weapon. The real cost is only 500 credits, so they are making a bit of a profit.) Once Bandito Arms begins to dominate the pirate weaponry market, this promotion will be discontinued and the Black Market price of the weapon will jump to 6,500 credits, which is still a very fair price. Money is money, after all.

Weight: 8 lbs (3.6 kg).

Range: 600 feet (183 m).

Mega-Damage: 2D4 M.D. per single shell/bullet. See the BigBore Shotgun Shells above for the knockdown effects. If loaded with silver or wooden rounds a round does double its listed M.D. to vampires and creatures vulnerable to such things.

Rate of Fire: Single shot only. Each shot counts as a melee attack.

Payload: One shell; breech loaded. **Note:** The Privateer can also fire conventional S.D.C. shells and wooden or silver shells designed for fighting vampires, making it a terrifying weapon against the undead.

Cost: Current price for the gun alone is 3,500 credits; 120 credits per shell or 16,000 credits for a box of 144 shells.

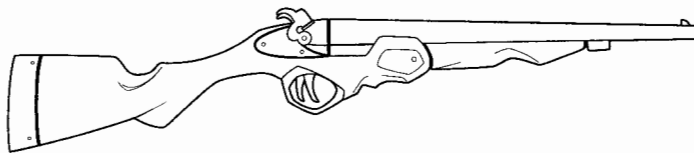

BigBore "Homesteader" Light Shotgun

The BB Homesteader is a simple breech-loading "shotgun" but it uses the *BigBore revolver rounds*. It is marketed to adventurers, bandits, ranchers, farmers and homesteaders all across the New West and wildlands everywhere. Its simple, durable construction means that the Homesteader shotgun is going to fire when it is needed and that the weapon is easy to clean and maintain. Using the lighter shells of the *BB revolver* means that the Homesteader's heavier frame and long barrels absorbs almost all of the weapon's recoil/kick, allowing this light shotgun to be handled by the average person, even women, without penalty. However, the weapon's length is enough that it is too awkward to be fired single-handed with a P.S. less than 22 (or an Augmented P.S. of 16 or better). Unfortunately, because the Homesteader uses the lighter revolver

rounds, the weapon can not be loaded with conventional shotgun shells like the other guns in the BigBore shotgun series.

Weight: 8 lbs (3.6 kg).

Range: 400 feet (122 m).

Mega-Damage: 1D6 M.D. per round/bullet, or 2D6 per double-barreled blast. **Note:** There is NO knockdown effect with this weapon.

Rate of Fire: Each shot, single or double-barreled blast, counts as one melee attack.

Payload: Two rounds; breech loaded. Takes three melee actions for most people to reload, twice as long for those not familiar with weapons.

Cost: 9,000 credits for the gun, 80 credits per round or 10,000 credits for a box of 144 rounds.

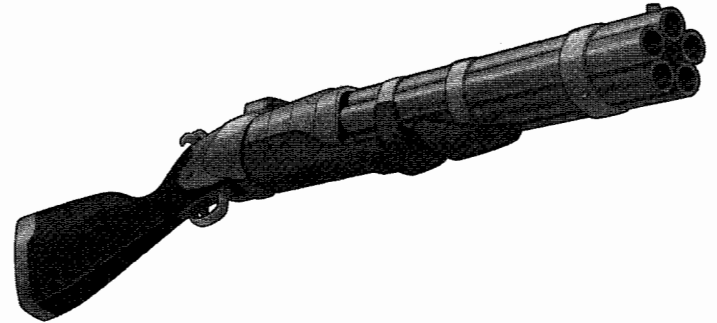

BigBore "Last Stand" Scattergun

When Bandito wanted to expand its range of BigBore shotguns, a member of the design team brought up the idea of making a "scattergun." Unfortunately, the BigBore rounds don't actually scatter that much. So what they came up with was a five barreled weapon whose individual rounds converge at the point of impact to detonate and spray an area in lethal M.D. shrapnel and concussion force. While the idea worked flawlessly, the final weapon design was heavy and the firing mechanism dictated that it had to be a breech-loader, limiting it to just one shot before reloading. But even with these problems the "Last Stand" has still proved to be a sales success. Buyers, especially physically strong D-Bees, as well as cyborgs, Juicers, Crazies and even bandits in the New West, love the western styling with the Last Stand's real wood stock and multiple barrels. The weapon's gatling gun appearance and massive bore also make it an intimidating looking weapon and even the bravest opponent suffers a Horror Factor of 12 when this monster is pointed in his face.

Note: A P.S. of 22 or an Augmented P.S. of 16 or better is required to fire the scattergun as a *two-handed weapon* without the shooter suffering ill effects himself. Those with a lower P.S. shoot with a -2 penalty to strike, are knocked on their rear each time they fire the weapon, take 1D6 S.D.C. damage and lose one melee attack/action. An Augmented P.S. of 26 or greater is required to fire it one-handed.

Weight: 20 lbs (9 kg).

Range: 150 feet (46 m).

Mega-Damage: 3D6 M.D. per simultaneous five shell blast to *everything* within a six foot (1.8 m) blast radius.

4D6+6 M.D. when leveled against a man-sized target at point-blank or *close range* (within 20 feet/6.1 m), and he alone takes most of the blast damage and full knockdown effect (reduce the usual bonus to save vs knockdown for large and supernatural beings by half). Anything or anyone else within the six foot (1.8 m) blast radius only takes 2D4 M.D. without risk of knockdown.

5D6+10 M.D. when fired upon a giant target, such as the side of a wall, giant combat robot, tank, large vehicle, dragon and giant (beings 15 feet/4.6 m or taller). No knockdown effect on these targets.

Rate of Fire: Each five shell blast counts as one melee attack.

Payload: Five shells, breech loaded, but that is only enough shells to fire the scattergun once. **Note:** The Last Stand can not fire with fewer than five shells, and only fires BigBore shotgun ammunition. Its firing mechanism will tear normal S.D.C. shotgun shells apart, jamming the weapon and rendering it unable to fire if anything but BB shotgun rounds are used.

Cost: 20,500 credits for the gun, 120 credits per shell or 16,000 credits for a box of 144 shells.

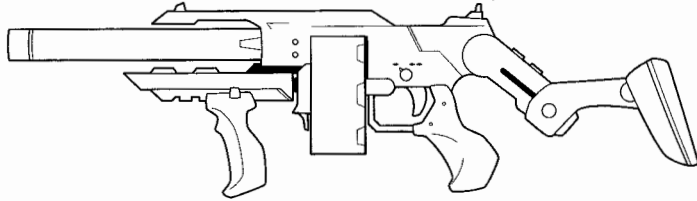

BigBore "Lawman" Automatic Shotgun

This new weapon in Bandito's BigBore shotgun series is popular among bartenders, shopkeepers, the Tundra Rangers, CyberKnights and lawmen of all types, earning the weapon the nickname of the "Lawman," an odd moniker for a weapon produced by the Black Market, but a fitting one. The Lawman Auto-Shotgun is a sturdy weapon that can be handled by most ordinary people with reasonable effectiveness. The gun uses a pair of alternating side-by-side barrels to maintain a high rate of fire and give it that intimidating double-barrel shotgun look. Its low recoil is achieved with "floating" barrels that partially retract into the gun when fired to absorb some of the impact. Of course the big advantage is a significant payload, making it unnecessary to stop and reload, every one or two blasts.

Note: A normal P.S. of 18 or an Augmented P.S. of 14 (or better) is required to shoot the Lawman Automatic Shotgun. Those with lower P.S. shoot with a -3 penalty to strike, double when shooting wild. An Augmented P.S. of 22 or greater is required to fire it one-handed.

Weight: 12 lbs (5.4 kg).

Range: 300 feet (91.5 m).

Mega-Damage: 2D4 M.D. per single shell/bullet, 4D4 per double-barreled blast, plus knockdown effect. If loaded with silver or wooden rounds the Lawman will do double its listed M.D. shotgun damage straight to the Hit Points of vampires and other beings vulnerable to such rounds.

Rate of Fire: Each single shot or double-barreled blast counts as one melee attack.

Payload: 18 round drum magazine. **Note:** The Lawman can also fire conventional S.D.C. shells and wooden or silver shells designed for fighting vampires, werebeasts, and certain demons, making it a popular weapon among Vampire Hunters and people throughout Mexico and the American Southwest.

Cost: 24,000 credits for the gun, 120 credits per shell or 16,000 credits for a box of 144 shells. An extra empty drum magazine (hold 19 rounds) costs 500 credits each.

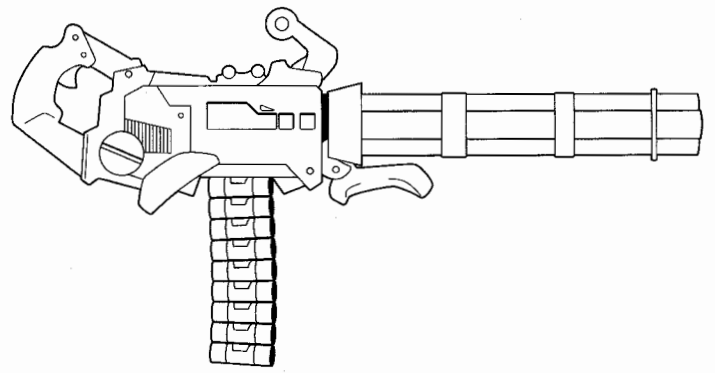

BigBore "Room Sweeper" Belt-Fed Shotgun

The Room Sweeper could be the definitive use of BigBore shotgun technology. Also known as the "Cantina Clearer" and "Bandito Broom," it is a heavy support weapon meant to be used at point blank-range for clearing out rooms, caves, trenches and other close-quarters environments. The shotgun system has three rotating barrels and connects to an ammo belt that allows an unbelievable amount of firepower to be unleashed within a very small area. The Room Sweeper can also fire conventional S.D.C. shells and wooden or silver shells designed for fighting vampires, making it a terrifying weapon against the undead. Its chief advantage is its large payload and multi-round firepower.

Note: A P.S. of 24 or an Augmented P.S. of 17 or better is required to operate the Room Sweeper as a *two-handed weapon* without the shooter suffering ill effects himself. Those with a lower P.S. shoot with a -4 penalty to strike, are knocked on their butts each time they fire the weapon, take 1D6 S.D.C. damage and lose one melee attack/action. An Augmented P.S. of 26 or greater is required to fire it one-handed (or a Robot P.S. of 20, or a Supernatural P.S. of 15).

Weight: 20 lbs (9 kg) plus the ammo pack worn on the shooter's back weighs 42 lbs (19 kg).

Range: 200 feet (61 m).

Mega-Damage: 2D4 M.D. for a single shell, 4D4 M.D. per short burst of three shells or 5D6 M.D. for a long burst of six shells, plus knockdown effects. (**Note:** When loaded with silver or wooden rounds, the Room Sweeper does double damage to those vulnerable to such material, but half damage to all others.)

Rate of Fire: Each shot or burst counts as one melee attack.

Payload: Ammo pack carries 180 shells.

Cost: 30,500 credits for the gun, including the ammo pack, 120 credits per shell or 16,000 credits for a box of 144 shells. An additional empty ammo pack costs 2,000 credits.

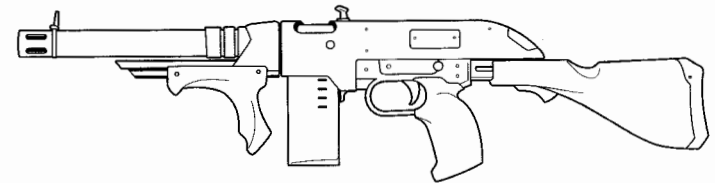

BigBore "Barking Dog" Submachine-Gun

Bandito has introduced a bulky looking, rapid-firing submachine-gun using their BigBore revolver rounds. The weapon somewhat resembles the famous Pre-Rifts Thompson submachine-gun (better known as the "Tommy Gun") and was dubbed the "Bark-

ing Dog.” The name is earned, because the weapon’s loose fittings absorb some of the SMG’s recoil, but cause the weapon to report so loudly that it can be heard from miles away when fired. In the hands of the military or a law enforcement agency, this is of little concern, but for someone relying on stealth to get away, this is an insurmountable handicap.

The chattering, noisy and jumpy BigBore SMG has met with mixed reviews. Cyborgs, Crazies and mercenaries looking for a heavy short-range weapon favor the BigBore SAW (described next) or rail guns, but many adventurers, mercs, warriors, town militias and bandits love the Barking Dog submachine-gun. Many Gunfighters and Gunslingers, on the other hand, tend to feel that submachine-guns, SAWS and rail guns are weapons for barbarians and raiders who lack skill and any sense of elegance or style, and won’t touch them.

Note: A normal P.S. of 18 or an Augmented P.S. of 14 (or better) is required to fire a burst from the Barking Dog SMG without penalty. Those with lower P.S. shoot with a -2 penalty to strike (double when firing long bursts and shooting wild). They are also knocked on their rears each time they fire the weapon, whether it’s a single shot or burst, suffer 1D4 S.D.C. damage and lose one melee attack. An Augmented P.S. of 22 or greater is required to fire it one-handed with any accuracy.

Weight: 12 lbs (5 kg).

Range: 300 feet (91.5 m).

Mega-Damage: 1D6 M.D. per single round, 2D6 M.D. per short burst of three rounds or 4D6 M.D. for a long burst of six rounds. See the BigBore Revolver Rounds for the knockdown effect.

Rate of Fire: Each shot or burst counts as one melee attack.

Payload: 18 round short magazine or a 45 round “banana” style long magazine.

Bonus: Laser targeting optional (costs extra) for +1 to strike on Aimed shots only.

Cost: 25,500 credits for the gun, 80 credits per round or 10,000 credits for a box of 144 shells. Extra empty magazines cost 100 credits each (regardless of size). The Barking Dog SMG can also be equipped with an optional under-barrel laser targeting sight for an additional 1,500 credits (+1 bonus to Aimed shots only).

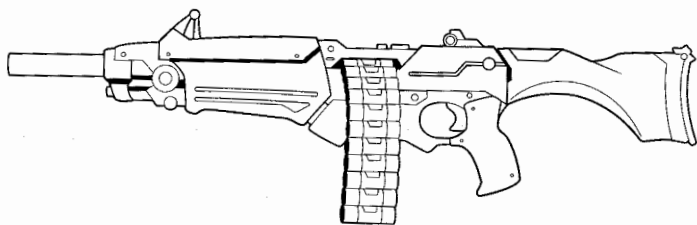

BigBore “Fire Hose” SAW – Squad Assault Weapon

Another rapid-fire weapon added to Bandito Arms’ new weapon lineup is the BigBore Squad Assault Weapon (SAW). This weapon is favored by mercenaries, adventurers and heavy hitters looking for firepower. It fires BB shotgun shells, has a smoother firing mechanism and higher rate of fire than the Barking Dog SMG, and offers a lot more firepower. In fact, the “Fire Hose” can take the place of a light rail gun or heavy energy weapon, though with much shorter range. Like its namesake, the Fire Hose can unleash a stream of destruction or spray an area in a hail of BigBore shells, covering an ally’s retreat or leading an assault.

Though the Fire Hose SAW cuts into on the Black Market’s sales of light rail guns to a small extent, Bandito believes that the prodigious rate of fire will lead to even greater BigBore munition sales, so in the long run, the BigBore SAW means a higher level of profit, not less.

Note: A P.S. of 24 or an Augmented P.S. of 17 or better is required to fire the BB SAW as a *two-handed weapon* without the shooter suffering ill effects himself. Those with a lower P.S. shoot with a -4 penalty to strike with bursts, are knocked on their rear each time they fire the weapon, take 1D6 S.D.C. damage and lose one melee attack/action. An Augmented P.S. of 26 or greater is required to fire it one-handed (or a Robot P.S. of 20, or a Supernatural P.S. of 15).

Weight: 25 lbs (11 kg) plus the ammo pack worn on the shooter’s back. Standard ammo pack (180 rounds) weighs 42 lbs (19 kg). The Cyborg ammo pack (240 round) weighs 64 lbs (28.8 kg).

Range: 600 feet (183 m).

Mega-Damage: 2D4 M.D. for a single shotgun shell, 4D4 M.D. per short burst of three shells, 5D6 M.D. for a medium burst of six shells, and 1D6x10 M.D. for a long burst of 12 shells, plus full knockdown effect. Knockdown is without benefit of any bonuses to stay standing when 12 shells are fired. (**Note:** When loaded with silver or wooden rounds, the Room Sweeper does double damage to those vulnerable to such material, but half damage to all others.)

Rate of Fire: Each shot or burst counts as one melee attack.

Payload: A 46 rounds “banana” style magazine or standard ammo pack with 180 rounds or cyborg ammo pack with 240 rounds.

Cost: 46,500 credits for the gun, 120 credits per shell or 16,000 credits for a box of 144 shells. Extra empty magazines cost 100 credits each, an empty standard ammo drum costs 2,000 credits and a heavy, cyborg drum costs 3,500 credits.

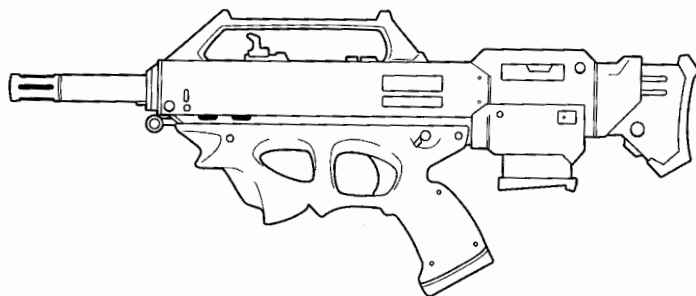

BigBore “Universal” Variable Assault Rifle

This weapon is intended to be the foundation of Bandito’s new military line of BigBore weapons: a large, dependable and versatile *assault rifle*. While Bandito Arms could have simply used the BigBore shotgun shells in a fairly standard rifle, they wanted something more. Around the same time, Bandito was researching ways to increase the range of BigBore weapons, and as part of this testing the lab boys used a variable breech and barrel system that allowed them to test different rounds and tolerances without having to make a new test weapon every time. This testing rig was seen in action by one of Bandito Arms’ head honchos. Impressed with the rig, he demanded that it be incorporated into their new assault rifle design and the researchers were left to figure out how to make that possible.

The final design of the variable breech assault rifle allows it to use BigBore revolver rounds, BigBore shotgun rounds, conventional S.D.C. shotgun shells, Triax pump rounds and even con-

ventional S.D.C. rifle rounds of various caliber sizes, as well as wooden and silver shotgun shells designed for fighting vampires and the supernatural.

An added benefit of the variable breech is tighter control of the weapon's gas venting properties, thereby reducing the rifle's overall recoil and increasing the muzzle velocity of the weapon. In fact, the Universal rifle is currently the longest ranged BigBore weapon that doesn't fall under the category of rail gun. And the gas venting means that the rifle may be used normally by humans without penalty, although a P.S. of 22 or higher (16 for Augmented P.S.) is necessary to fire the weapon one-handed (it's simply impossible for weaker shooters) and even then, the one-handed shooter is -3 to strike with the big gun.

The exceptional flexibility of the variable assault rifle allows it to be used in most combat roles, including close assault, squad fire support, jump infantry, pilot sidearm, etc., while its fold down stock, short barrel length (it has a bull-pup configuration) and very robust construction allow the weapon to be used in combat situations where a larger weapon is impractical. Even the folding rifle stock was designed to hold three spare short magazines in a top-down storage slot and to be completely removable in order to increase the flexibility of the stock. The weapon's flexibility is only improved by the availability of an optional laser targeter and scope package, as well as an optional under-barrel grenade launcher. Overall, Bandito Arms has produced one of the best modern firearms on the market, even at ten times its bottom barrel price!

Weight: 20 lbs (9 kg), plus another 2 lbs (0.9 kg) for the optional laser targeting scope package.

Range: 1,000 feet (305 m) firing BB and Triax rounds and shotgun shells of any kind. 2,000 feet (610 m) for S.D.C. rifle rounds.

Mega-Damage via Rifle & Shotgun Rounds: Varies with the type of rounds used:

BigBore Revolver Rounds: 1D6 M.D. per single round/bullet, 2D6 M.D. per short burst of three rounds or 4D6 M.D. for a long burst of six rounds plus knockdown effect.

BigBore Shotgun Shells: 2D4 M.D. per single shell, 4D4 M.D. per short burst of three shells or 5D6 M.D. for a long burst of six shells plus the knockdown effect.

Triax Pump Rounds: 4D6 M.D. per single round or 1D4x10+10 M.D. per short burst of three rounds. Longer bursts are not possible as they generate an excessive amount of heat that will cause the Universal assault rifle to explode (does 2D4x10+20 M.D. to the shooter).

S.D.C. Rifle Rounds: Conventional S.D.C. rifle rounds vary in damage based on their caliber: from 3D6 S.D.C. damage per single round to 6D6 S.D.C. damage per single round. A three round burst will do double the damage and a six round burst will do double the damage of a single rifle round. Cost and availability of S.D.C. rifle rounds varies widely.

Rate of Fire: Each single shot or burst counts as one melee attack.

Payload: 15 round short magazine, 36 round long magazine, or a 45 round, "banana" style long magazine. **Note:** Only a single type of round may be loaded into a single magazine, no mixing of ammunition types, and this includes conventional S.D.C. shells, or wooden or silver shells designed for fighting the supernatural.

Bonus: Laser targeting and scope package optional (costs extra): +1 to strike on Aimed shots. The package includes a scope with both telescopic and nightvision capabilities out to a range of 3,000 feet (914 m).

Cost: 45,000 credits for the gun. Extra empty magazines cost 100 credits each regardless of size. The optional laser targeter and scope package costs another 5,000 credits.

Ammunition Cost: Varies in cost based on type.

BigBore Revolver Rounds: 80 credits per round or 10,000 credits for a box of 144 rounds.

BigBore Shotgun Shells: 120 credits per shell or 16,000 credits for a box of 144 shells.

Triax Pump Rounds: 400 credits per round with poor availability of the genuine shells, but fair availability for Black Market knock-offs, but the cost can vary by as much as 300%.

Optional Second Weapon System for the Universal:

An Under-Barrel Grenade Launcher: The assault rifle can be fitted with a six-round grenade launcher for an additional fee. The grenade launcher is mounted under the barrel just in front of the rifle's ammo magazine.

Weight: Adds another 8 lbs (3.6 kg) to the weight of the rifle.

Range: 500 feet (152 m).

Mega-Damage: 2D6 M.D. per single round/grenade. Damage is inflicted to everything in a 12 foot (3.6 m) radius.

Rate of Fire: Each single grenade fired counts as one melee attack.

Payload: Six hand-loaded grenades. It takes one melee round (15 seconds) to reload the launcher by hand with six grenades (or one melee action to load two grenades); takes three times as long for those not familiar with military grade weapons. A reusable speed loader will load all six grenades in just one melee action.

Cost: An additional 10,000 credits for the grenade launcher, 2,000 credits for a speed loader and 500 credits per each grenade. These are the same grenades used in the *Bandit 6000 "Big Bang" Grenade Launcher* (see **Rifts® World Book 14: New West** for details) and are interchangeable with it.

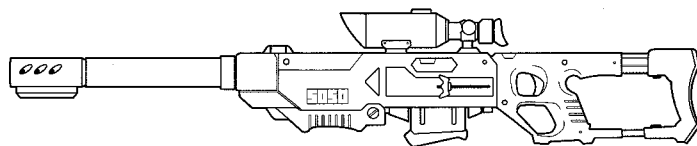

Bandit 5050 "Papa Bear" Enhanced BigBore Medium Rail Gun

In 105 P.A., Bandito Arms began its expansion of the BigBore line of weapons. A lot of emphasis was placed on BigBore weapons that could fire in longer bursts and at extended ranges. The development would result in such weapons as the Room Sweeper, Barking Dog SMG and the BigBore Squad Assault Weapon, Universal Assault Rifle and with the "Big Bear" Light Rail Gun, its longest ranged weapon. This item continues to be a popular weapon among mercenaries, adventurers, bandits and raiders, as well as for the defense of towns and merchant caravans. (See **Rifts® World Book 14: New West** for details about this weapon. **Note:** Stat correction: Fires BB revolver rounds that do 2D6 M.D. per short, three round burst, and 4D6 M.D. per six round, long burst).

With advancements in technology and a push to sell BigBore weapons, the Bandit 5000 "Big Bear" became the blueprint for the new 5050 "Papa Bear" with internal components designed to handle the larger BigBore "shotgun" shells without sacrificing range or payload. The Papa Bear can fire single shots (each pull of the trigger is one melee attack) or in bursts, including sweeping an area in a hail of BigBore shells.

Note: A P.S. of 24 or an Augmented P.S. of 17 or better is required to operate the Papa Bear as a *two-handed weapon* without the shooter suffering ill effects himself. Those with a lower P.S. shoot with a -3 penalty to strike, are knocked on their rear each time they fire the weapon, take 1D6 S.D.C. damage and lose one melee attack/action. An Augmented P.S. of 26 or greater is required to fire it one-handed (or a Robot P.S. of 20, or a Supernatural P.S. of 15).

Weight: Gun 27 lbs (12 kg), including the weight of the E-Clip. Standard ammo pack (180 rounds) weighs 42 lbs (19 kg). The cyborg ammo pack (240 rounds) weighs 64 lbs (28.8 kg).

Range: 2,000 feet (610 m); the E-Clip provides the extra “zip” for range.

Mega-Damage: 2D4 M.D. per single shell, 4D4 M.D. per short burst of three shells or 5D6 M.D. for a long burst of six shells.

Rate of Fire: Each shot or burst counts as one melee attack, but the bursts are less controlled and less accurate (so all shells fired do not hit the intended target).

Payload: 180 BigBore shotgun shells for a standard ammo drum backpack. A cyborg ammo drum with 240 rounds can be substituted provided he has the P.S. to handle one. The E-Clip can fire 240 bursts before needing to be replaced.

Bonus: Laser targeting standard; +1 to strike on Aimed shots.

Cost: 65,500 credits for the gun, 120 credits per shell or 16,000 credits for a box of 144 shells. Extra empty magazines cost 100 credits each, an empty standard ammo drum costs 2,000 credits and a heavy, cyborg drum costs 3,500 credits.

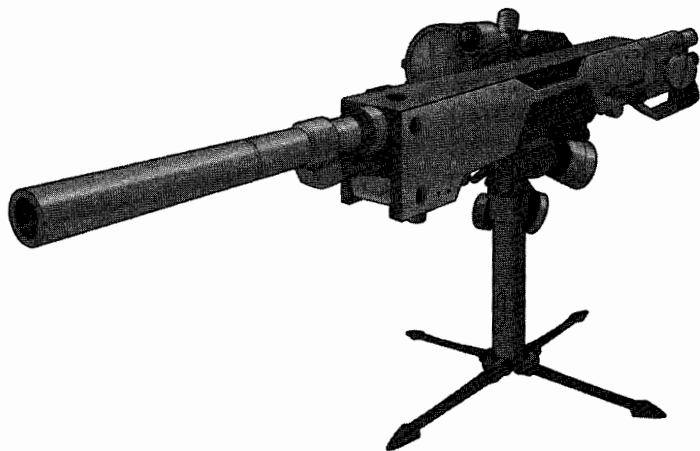

Bandit 6000 BigBore “Big Dog” Automated Sentry Gun

Simple but effective, the “Big Dog” is a modified *Big Bear* light rail gun (see **Rifts® World Book 14: New West** for details about this weapon) mated to an extendable mounting stalk containing an anchoring pylon which was inspired by the USA-G10 Glitter Boy anti-sway pylons. Once the owner of the Big Dog Sentry Gun has chosen a place to mount the weapon, four small, clawed feet drop from the sides of the mounting stalk to hold the weapon in place while the anchoring pylon activates. Once firmly in anchored, the gun can be raised as high as eight feet (2.4 m) on the mounting stalk before being armed, allowing for the best possible lines of fire.

The Big Dog has a simple computer and sensor array that includes a short-range radar, motion sensors, heat detector and camera eye. When placed on automatic, the sensor module detects the presence of human-size or larger targets and fires – the internal

computer and targeting system picks the target, typically the nearest or largest – and plots the line of fire to engage the target. Once it has locked onto a target within range, the sentry gun continues to fire until the target stops moving, retreats beyond its range, or is blown into multiple small pieces. This is repeated every time a new target comes within range, with the closest taking the fire until it stops moving or a new, closer target becomes available (e.g. a new target passes the original and gets closer to the gun, at which point the gun trains on it and fires).

The automatic nature and programming of the Big Dog Sentry Gun enables it to cover its full field of fire even against multiple targets. However, the Big Dog is not intelligent and cannot make arbitrary selections of targets or focus on any one specific target (unless it is the nearest, largest or the sentry gun is signaled to do so by a human operator a safe distance away). The sentry gun can be preprogrammed or controlled remotely via radio (observed from a distance via binoculars or remote cameras).

The Big Dog is not recommended for civilian defense, as the sentry gun cannot distinguish between friend and foe (FoF) without a more advanced and expensive FoF targeting computer system (costs 25,000 credits), and attacks anyone who enters its proximity. The Sentry Gun does come standard with six Friend or Foe identification “tags.” Wearing one of these “tags” tells the Big Dog that the person is a *friend* and not a foe/target. The sentry gun will not fire on anyone wearing a *Friend I.D. Tag*. Likewise, it can be programmed to exclude a given area or path from its field of fire, allowing the Big Dog’s owner to create safe zones within the weapon’s line of fire.

Weight: 75 lbs (33.7 kg), including the weight of the entire unit, E-Clip, mounting stalk, pylons and ammunition drum.

Range: 2,000 feet (610 m); the E-Clip provides the extra “zip” and distance.

Mega-Damage: Fires BB revolver rounds, inflicting 2D6 M.D. per three round burst or 4D6 M.D. per burst of six rounds, plus knock-down. Can be programmed to fire short or long bursts.

Rate of Fire: Four attacks/bursts per melee round.

Payload: A large ammo drum that holds 600 BigBore revolver rounds (100 long bursts) comes standard with the Big Dog Sentry Gun. The E-Clip can fire the Big Dog’s full 600 rounds before needing to be replaced.

Notable Features: The computerized sensor suite and targeting module has a detection range of 2,500 feet (762 m) with an equivalent Sensory Equipment skill of 88%. Its targeting computer provides the equivalent of +2 to strike on a burst and has four attacks per melee round. The sentry gun can turn 180 degrees on its mounting stalk and point up and down in a 180 degree arc of fire, enabling it to fire directly above and below it and anywhere in between.

M.D.C. by Location:

Control Pad (1) – 15 M.D.C. (tiny target; attackers are -9 to strike)

Mounting Stalk (1) – 80 M.D.C. (narrow target; attackers are -4 to strike)

Sentry Gun (main body) – 200 M.D.C.

Cost: 150,000 credits for the entire Big Dog Sentry Gun, control pad, mounting stalk and six Friend or Foe I.D. tags, and an empty ammo drum. An extra, empty ammo drum costs 5,000 credits. 80 credits per individual BB revolver rounds or 10,000 credits for a box of 144 rounds. Additional Friend or Foe I.D. tags may be purchased for 3,000 credits each.

Bandito Energy Weapons

With Bandito's current push toward expanding their marketing opportunities in North America with BigBore weapons, their line of energy weapons is comparatively small. The old **IP-10 ion pistol** and the **LP1 laser pistol** are still available, but mainly on the second-hand market and sale specials. These two older weapons have been "unofficially" phased out to make room for Bandito Arms' line of new energy weapons with superior damage and range, and BigBore items. All but a few of the facilities that used to produce the old weapons have been completely retooled for the new line of guns.

Bandito Arms has carefully studied the weapons market throughout North America through its own Black Market shops and its network of spies, thieves and informants among other manufacturers. This led the company to concentrate their new production on the dozen most popular energy weapon designs. More revealing was the purchasing trends of buyers, which broke down into five major *geographical regions* and weapon types: **1.** The New West with their fascination for Old West patterned revolvers, rifles and shotguns. **2.** The Domain of Man or Civilized Region, including the *Coalition States* and their territories, who favor the sleek, high-tech weapons produced by companies like Wilk's Laser Technologies, Triax and Naruni Enterprises, as well as Northern Gun. **3.** Mercenaries and militias who want no nonsense, rugged, military grade weapons with a hardware or Northern Gun/Manistique Imperium styling. **4.** The pirates and privateers of the Great Lakes and Gulf of Mexico with their love of 18th century style, mock flintlock muskets and pistols. **5.** The Magic Zone – actually all the various practitioners of magic across the continent.

It was noted that many, many buyers in these markets will pass over a superior weapon to the one they want based on little more than the styling and outward appearance of the weapon.

To sell their energy weapons to as many customers as possible, the Black Market, in general, led by Bandito Arms, have devised a *modular system* whereby they build the "guts" (internal components) of every weapon exactly the same, or close to it, and then simply encase the guts of the weapon in the different exterior casings that appeal most to the particular buyers in that region or group.

Each energy weapon has a group designation added to its model name as follows: "**W**" for customers in the New West, who prefer the weapon styles of the American Old West for a variety of western revolvers, rifles and shotguns made of M.D.C. gray or silver brushed steel with carved bone, pearl or wood handles and stocks, and are often sold with a leather belt and holster. "**D**" for customers in the Domain of Man, in which the casing for the weapon is designed along the lines of a Wilk's or Triax product with sleek lines, and a hard, light M.D. plastic exterior, but the finish is a shiny chrome plating or brushed steel. "**M**" for buyers who prefer mercenary/military hardware, for which the casing is made out of rugged M.D.C. composites and materials in a similar fashion to Northern Gun or Coalition weapons. "**P**" for customers who liken themselves to pirates, privateers and buccaneers. The casings for these "pirate" weapons are designed to look like 18th Century style flintlocks, blunderbuss, muskets and weapons with ornate, hand-carved wooden stocks and grips. And "**E**" standing for exotic, with a fanciful or steam-punk styling that appeals to many mages and resembles Techno-Wizard or Splugorhian Bio-Wizard weapons in appearance. **Note:** Bandito Arms and the Black Market, in general, does not manufacture Techno-Wizard weapons for

resale. Any TW and magic items sold by the Black Market tend to be things they acquired by other means (trade, stole, etc.).

Such designations are simply added to the end of the alphanumeric name of the weapon (e.g.: an IP-12M Ion Pistol is the Merc/Military version of the IP-12 ion pistol).

Cheap imitations. There is one final designation that is never discussed with potential customers: "K" series weapons. "K" for *knock-off*. The Black Market has been dealing in "knock-offs" – cheap imitations of other manufacturers' most popular *brand weapons*. The most common Black Market "knock-offs" are the weapons of *Northern Gun*, *Wilk's*, *Triax* and the *Coalition Army*. For each of the weapons, the Black Market will produce a number of different, standard knock-off casings (see the "K" Series entries below) for all of the most popular weapons (NG, CS, Triax, Wilk's, etc.) on the market. However, the Black Market, Bandito Arms included, makes no effort to make their knock-offs actually function as well as the weapon being imitated. That would take time, work and money the organization would rather not spend. As a result, Black Market "**K**" series imitations always do one or two dice less in damage and the range is 1D4x10% shorter. Only the outward appearance of the weapon is copied, as well as any features that simply cannot be faked, like the adding or removing of a scope or the inclusion of an under-barrel grenade launcher (same stats as the actual grenade launcher) or similar features.

The actual guts of the knock-offs are, as a rule, the same or modifications of existing Black Market weapons. New knock-offs are added to the various K series weapons all the time, within just a few months of a competitor's release of a new design. Some people would think this is stupid and that the Black Market would get caught in the fraud, but who is going to take apart their new energy rifle just to see if its components are of genuine Triax or CS manufacture? Besides, even the average adventurer and even soldier doesn't know the internal workings of his weapons that well and rarely pays attention to manufacturer markings and stylings. (Remember, we're talking about high-tech energy weapons, not bolt-action.) Furthermore, "K" series knock-offs are sold on the secondhand market as "stolen" and "used" weapons at discount prices (compared to the new, genuine article), so most buyers expect the "used" item may not be up to perfect specifications. Even if caught in the act, the Black Market reps and agents swear it's the real McCoy and deny with their last dying breath the existence of "K" series knock-offs. They are criminals, after all! **Note:** Many arms dealers and merchants who acquire portions of their stock from the Black Market are innocent dupes who have no clue any of the items they've purchased are knock-offs. With their new production setup, Bandito Arms is quickly becoming the leader in **K series** weapons. Regardless of the manufacturer or location of manufacture, the weapons described in the pages that follow are sold by ALL Black Market outlets.

IP-12 Ion Pistol

The new IP-12 is the replacement for the old Eye-Pie Ten ion pistol, with a slightly higher damage output and much better range. This simple ion pistol design is the cheapest model that Bandito Arms has to offer and is reliable and dependable. Even though the IP-12 does superior damage to the TX-25, the Triax knock-off model of the IP-12 constantly outsells the other variants of the weapon, proving sales requires more than just a good weapon.

Weight: 3 lbs (1.4 kg).

"K" Series: Q1-02 "Stopper" Ion Pistol, TX-25 Ion Pistol.

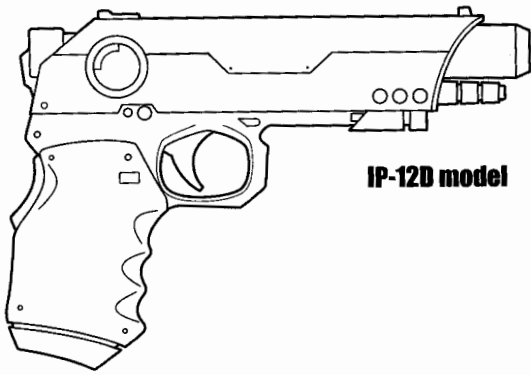

IP-12D model

Range: 500 feet (152 m).

Mega-Damage: 3D6 M.D. per blast.

Rate of Fire: Single shot only. Each shot counts as a melee attack.

Payload: 10 shots from a standard short E-Clip, 20 shots with a long E-Clip.

Bonus: +1 to strike, due to the weapon's light weight and balance.

Cost: 10,000 credits.

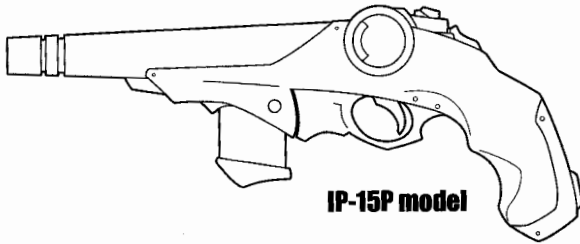

IP-15P model

IP-15 Heavy Ion Pistol

The IP-15 sacrifices range for higher damage output, but suffers from a quicker depletion of the weapon's energy reserves as a result. Even with these drawbacks, arms buyers seem to favor the increased damage. Models of the IP-15 are quickly outstripping the IP-12 models in overall sales.

Weight: 4 lbs (1.8 kg).

"K" Series: NG-57 Heavy-Duty Ion Blaster, TX-24 Ion Pulse Pistol (made to appear to pulse).

Range: 400 feet (122 m).

Mega-Damage: 4D6 M.D. per blast.

Rate of Fire: Single shot only. Each shot counts as a melee attack.

Payload: 8 shots from a standard short E-Clip, 16 shots with a long E-Clip.

Cost: 15,000 credits.

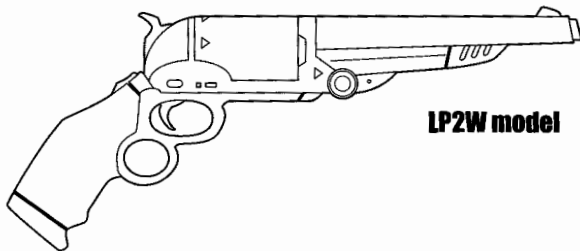

LP2W model

LP2 Laser Pistol

The new LP2 is the replacement for the old No Lip laser pistol, with a slightly higher damage output and the same superior laser focusing optics. The LP2 laser pistol has nearly the same large payload as the old LP1 and for that reason more than any other, many owners of the older weapon have been trading up to the new

gun. This gives them better stopping power with the same excellent accuracy and reliability they have come to depend on.

Weight: 2 lbs (0.9 kg).

"K" Series: C-18 and C-20 Laser Pistols, Q1-01 Laser Pistol, NG-45LP Long Pistol, TX-20 Short Laser Pistol, TX-22 Precision Laser Pistol, Wilk's 320 Laser Pistol, Wilk's-Remi 130 "Six-Shooter" and 136 "Big Man", and WI-LP24 Laser Pistol.

Range: 800 feet (244 m).

Mega-Damage: 2D6 M.D. per blast.

Rate of Fire: Single shot only. Each shot counts as a melee attack.

Payload: 18 shots from a standard short E-Clip, 36 shots with a long E-Clip.

Bonus: +1 to strike due to this weapon's laser focusing optics and light weight.

Cost: 17,000 credits.

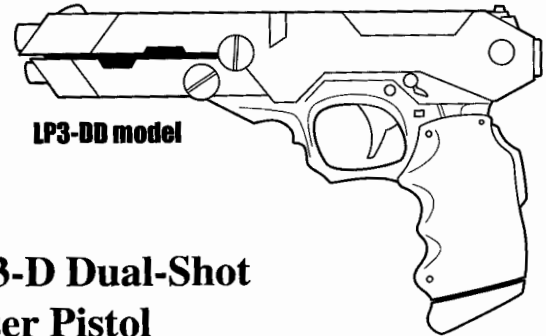

LP3-DD model

LP3-D Dual-Shot Laser Pistol

Much like the Wilk's weapons that inspired the new "Dual-Shot" laser pistol, this weapon uses two individual sets of focusing lenses to produce a double laser blast capable of inflicting twice the damage. The only problem with the LP3-D is that with two barrels firing, the weapon runs out of energy twice as fast as the LP2. The range is also diminished slightly due to photon interference between the two beams. But all and all, the Dual-Shot is an effective weapon.

Weight: 5 lbs (2.25 kg).

"K" Series: Wilk's 227, 237, 247 and 330 Laser Pistols, Wilk's-Remi 137 "Kingdom Come."

Range: 700 feet (213 m).

Mega-Damage: 2D6 M.D. per single blast or 4D6 per double blast.

Rate of Fire: Each single shot or double blast counts as a melee attack.

Payload: 18 shots from a standard short E-Clip, 36 shots with a long E-Clip. A double blast uses up two shots.

Cost: 25,000 credits.

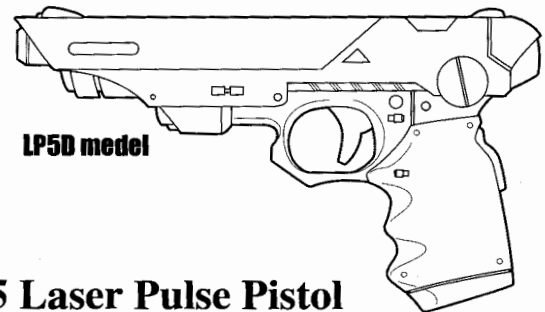

LP5D model

LP5 Laser Pulse Pistol

Pulse lasers are able to deliver significantly more damage than conventional single beam lasers for only a modest increase in energy consumption. Of course, the three pulse bursts are not quite as accurate as a single shot laser, but when you want to riddle your opponent with blasts of coherent light, nothing beats a pulse laser.

Weight: 5 lbs (2.25 kg).

“K” Series: C-30 Laser Pulse Pistol, TX-23 Laser Assault Pistol.

Range: 700 feet (213 m).

Mega-Damage: 1D6 M.D. per single shot, or 3D6 M.D. per three shot pulse.

Rate of Fire: Each shot or three shot pulse burst counts as a melee attack.

Payload: 18 single shots from a standard short E-Clip, 36 with a long E-Clip. A pulse burst uses up three shots.

Cost: 24,000 credits.

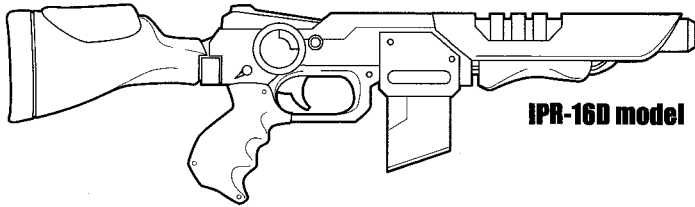

IPR-16D model

IPR-16 Ion Pulse Rifle

Ion pulse rifles are a favorite of anyone who prefers damage potential over range. Bandito's new IPR-16 ion pulse rifle incorporates all the features a rugged adventurer needs in a great energy rifle; excellent damage output, good energy reserves, accurate pulse bursts and respectable range for an ion pulse rifle.

Weight: 8 lbs (3.6 kg).

“K” Series: NG-IP7 Ion Pulse Rifle, TX-30 Ion Pulse Rifle.

Range: 1,100 feet (335 m).

Mega-Damage: 3D6 M.D. per single shot, or 6D6+3 M.D. per three shot pulse burst.

Rate of Fire: Each shot or pulse burst counts as a melee attack.

Payload: 15 shots from a standard short E-Clip, 30 shots with a long E-Clip. A pulse burst uses up three shots.

Cost: 24,000 credits.

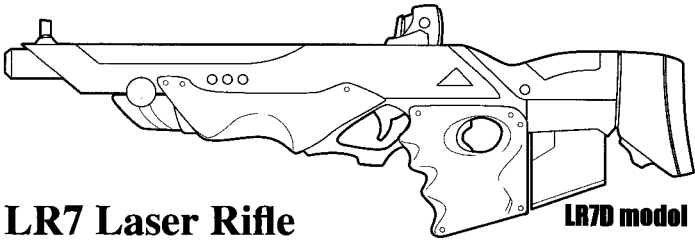

LR7D model

LR7 Laser Rifle

The LR7 is a precision, heavy laser rifle used as the basis for more knock-off designs than any of the other Bandito Arms energy weapons. Reliable, with great range and good damage, the LR7 is also becoming a hot seller on its own, especially in the wilderness communities and outposts, where the LR7's range can be put to its best use in hunting and defending the rural settlements from monstrous Mega-Damage creatures, hostile D-Bees and marauding bandits.

Weight: 6 lbs (2.7 kg).

“K” Series: C-10, C-12 and C-14 Laser Rifles, NG-L5 and NG-LG6 Laser Rifles, NG-SR3 and NG-SSL20 Sniper Laser Rifles, TX-11 and TX-43 Laser Rifles, TX-SL12 Sharpshooter Laser Rifle, Wilk's 447, 547 and 587 Laser Rifles, Wilk's-Remi 147 “Sharp Shooter” and 150 “Volcanic,” WI-SL13 Gunfighter Laser Rifle.

Range: 2,000 feet (610 m).

Mega-Damage: 3D6 M.D. per blast.

Rate of Fire: Single shot only. Each shot counts as a melee attack.

Payload: 18 shots from a standard short E-Clip, 36 shots with a long E-Clip.

Bonus: Precision laser targeting standard; +2 to strike with single Aimed shot!

Cost: 21,500 credits.

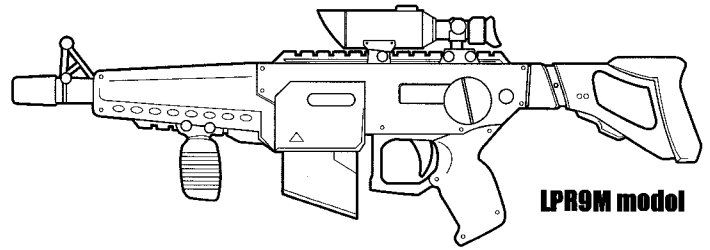

LPR9M model

LPR9 Laser Pulse Rifle

The LPR9-P laser pulse rifle does a little less damage than the standard laser rifle on a shot per shot basis, but is able to do significantly more damage through the use of a triple pulse burst. The LPR9-P is Bandito's assault rifle designed for serious consumers, and most of the LPR9-Ps are sold as “D,” “M” and “W” models to various mercenary groups, adventurers and small militaries.

Weight: 7 lbs (3 kg).

“K” Series: CP-40 and CP-50 Pulse Laser Rifles, Q2-10 and Q2-20 Laser Pulse Rifles, NE-600 Pulse Laser, TX-42 Laser Pulse Rifle, Wilk's 457 and 567 Laser Pulse Rifles, Wilk's-Remi 157 “Judgment Day,” WI-AL18 Assault Laser Rifle.

Range: 1,800 feet (548.6 m).

Mega-Damage: 2D6 M.D. per single shot, or 6D6 M.D. per three shot pulse burst.

Rate of Fire: Each shot or three shot pulse burst counts as a melee attack.

Payload: 15 single shots or 5 pulse blasts from a standard short E-Clip. 30 single shots or 10 pulse blasts from a long E-Clip. A pulse blast uses up three shots.

Bonus: Laser targeting standard; +1 to strike on Aimed shots or triple pulse.

Cost: 30,500 credits.

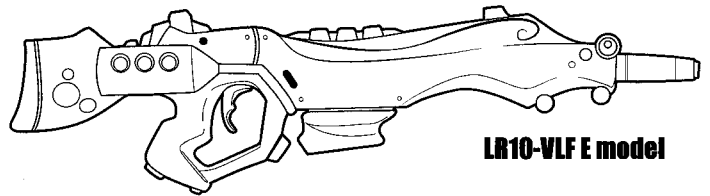

LR10-VLF E model

LR10-VLF Variable Light Frequency Laser Rifle

Designed based on stolen technology from Wilk's Laser Technologies, the new LR10-VLF variable laser rifle is intended to overcome laser resistant alloys such as the chromium armor of the Glitter Boy PA. The LR10-VLF is a marvel of weapons technology. The variable frequency laser has 12 different light frequencies (much fewer than the equivalent Wilk's weapon) in its memory and automatically resets itself after one attack if the target proves to be resistant to that frequency of light.

Weight: 8 lbs (3.6 kg).

“K” Series: CV-212 and CV-213 VLF Laser Rifles, Wilk's 557 VFALR “Chameleon.”

Range: 1,800 feet (548.6 m).

Mega-Damage: 2D6 M.D. per single shot, or 5D6+2 M.D. per three shot pulse.

Rate of Fire: Each single blast or three shot pulse burst counts as one melee attack.

Payload: 33 single shots or 11 pulse bursts from a standard short E-Clip, 51 single shots or 17 pulse bursts with a long E-Clip. A rapid-fire pulse uses up three shots.

Bonus: Laser targeting standard; +1 to strike on Aimed shots.

Cost: 28,500 credits.

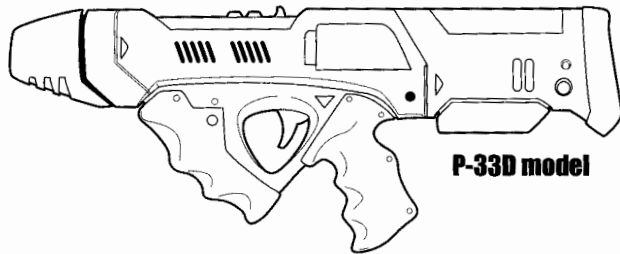

PE-33 Plasma Ejector

Bandito's new plasma ejector is on par with plasma rifles made by the other weapons manufacturers operating in North America. Though it does consume quite a bit of energy when fired, the only real drawback of the PE-33 is that Bandito Arms cannot manufacture them fast enough.

Weight: 15 lbs (6.75 kg).

"K" Series: C-27 and C-29 Plasma Cannons, NE-195 Assault Rifle, NE-1000 "Modified" Plasma Ejector Rifle, NG-E4 and NG-E12 Plasma Ejectors, NG-E15 Pulse Plasma Ejector (made to appear to pulse).

Range: 1,400 feet (426.7 m).

Mega-Damage: 1D4x10 M.D. per blast.

Rate of Fire: Single shot only. Each shot counts as a melee attack.

Payload: 6 single shots from a standard short E-Clip and 12 shots with a long E-Clip.

Cost: 33,000 credits.

Bandito Heavy Weapons

Bandito Arms wants to expand its range of heavy weapons in an attempt to drum up high volume sales among the various mercenary units and small independent militaries throughout North America. Up to this point, their sales of heavy weapons have been limited to various light rail guns and the Big Bang grenade launcher, but with their expanded range of products come the problems of safely smuggling the weapons to their new customers without running afoul of the CS. This has caused them to limit their range of new heavy weapons to just the most profitable designs, particularly those that rely on the use of ammunition and require the customer to return to the Black Market for more rounds, shells, missiles, etc.

MM-16 "Coffin" Pepperbox Man-Portable Multiple Mini-Missile Launcher

The new MM-16 multiple missile launcher was designed after careful study of battlefield tactics. From eye witness reports and battlefield footage, it is obvious that a mini-missile is not quite as effective as most soldiers believe. Beyond the obvious hazard of the mini-missile being shot down before it can strike its target, it has become clear that if a target is assaulted by one, two or even

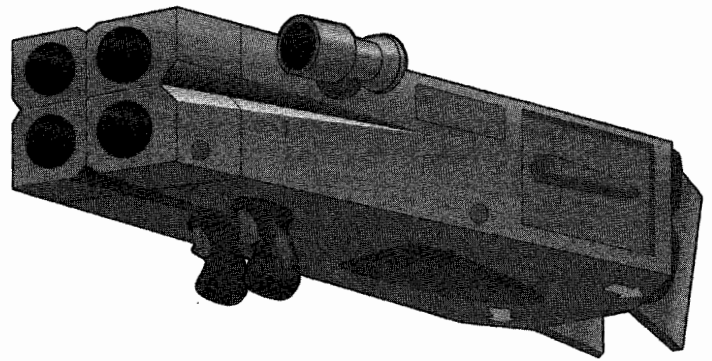

three mini-missiles, there is a chance that it can simply avoid or dodge the incoming warheads! While this may sound unbelievable, it's true. Bandito Arms has recovered pilot video after pilot video clearly showing the target simply sidestepping an incoming missile and letting it go sailing harmlessly past him. This has been witnessed being done by Juicers, Crazies and Cyber-Knights, as well as power armor, aircraft, dragons and monsters. But if the volley is comprised of four or more of mini-missiles, it appears the target is unable to avoid the volley. A four missile volley is the sweet spot, because five or more missiles don't seem to have any greater ratio of success. So Bandito Arms has created the *MM-16 pepperbox mini-missile launcher* that only fires in volleys of four mini-missiles.

The MM-16, often called the "Coffin" due to its shape, is approximately four feet (1.2 m) long, flaring slightly along its length so that the rear of the weapon is about three feet (0.9 m) wide, while the nose of the weapon is only two feet (0.6 m) wide and the whole launcher is about two feet (0.6 m) thick. This odd coffin wedge is due to the internal venting which is required to direct the rocket exhaust of the launching mini-missiles around the remainder of the payload to prevent a possible "cook-off" and explosion of the remaining mini-missiles. With its four launch tubes, targeting system and venting, the pepperbox launcher is quite hefty, but the overall design and a special sliding internal counterbalance makes the launcher able to be slung and fired from the shoulder of most Combat Cyborgs, power armors and others with sufficient strength. Even when the weapon is fired there is little recoil to speak of, but both hands are required to balance and aim the launcher on the shooter's shoulder and keep his eye aligned with the targeting system.

Note: A P.S. of 28, an Augmented P.S. of 22, or a Robot P.S. of 18 or better is required to handle the MM-16 Coffin as a *two-handed weapon*. Those with a lower P.S. shoot with a -3 penalty to strike. An Augmented P.S. of 36 or greater is required to fire it one-handed (or a Robot P.S. of 26, or a Supernatural P.S. of 22).

Weight: 85 lbs (38 kg), including the weight of the mini-missiles.

Range: One mile (1.6 km).

Mega-Damage: Varies with missile type. Any mini-missile can be used, but it comes standard with armor piercing (1D4x10 M.D.) or plasma (1D6x10 M.D.). Fragmentation (5D6 M.D.) may be used for anti-personnel operations.

Rate of Fire: One volley of four mini-missiles per melee attack. Can only fire in volleys of four missiles, not more nor less, each attack.

Payload: 12 mini-missiles (can fire three volleys of four missiles).

Bonus: Advanced targeting system provides a bonus of +3 to strike for the mini-missiles.

Cost: 62,000 credits for the mini-missile launcher, plus the cost of the mini-missiles loaded into it.

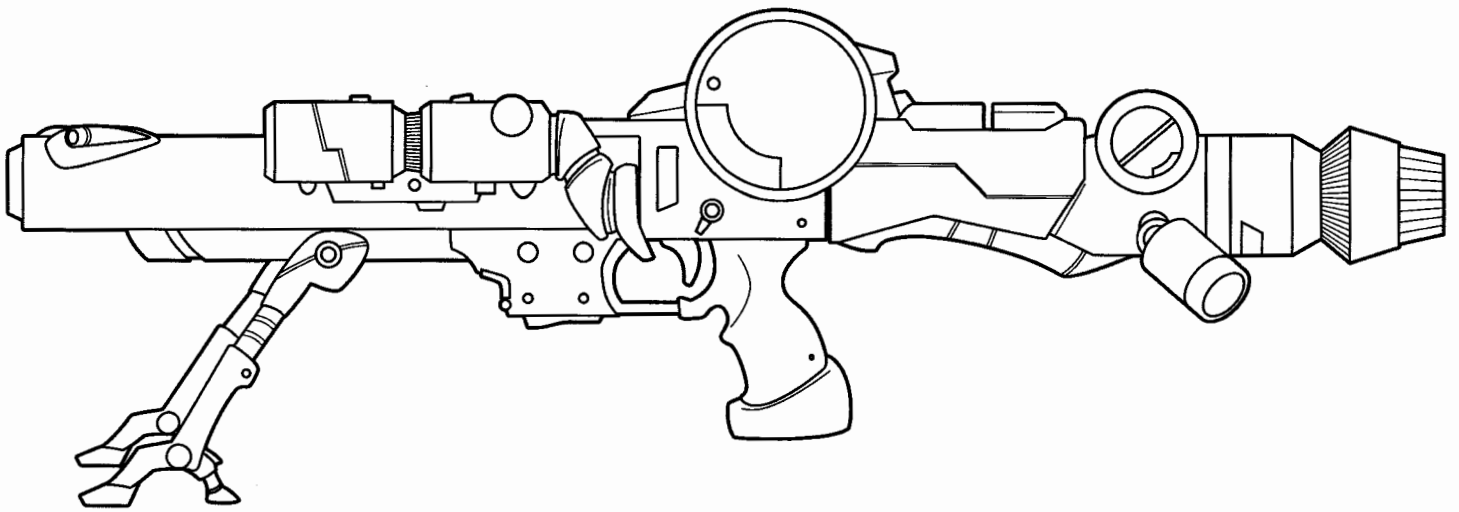

RG-14-LX “Baby Boom Gun” Light, Rapid Acceleration Electromagnetic Rail Gun

Area 51 held many secrets when it was unearthed. As a research and testing base for the U.S. Armed Forces, the secrets held there are among the most prized of the Golden Age knowledge, but prized among all others was the secret of how to create the mighty Glitter Boy and its infamous Boom Gun. Unfortunately for the Black Marketers who found the base, this secret was not among them. Though the USA-G10 Glitter Boy *was* tested at the base, the power armor itself was never constructed at the base, nor were the plans and schematics for its manufacture kept there. And while the Glitter Boys were tested and maintained at Area 51, it did not have the super-dense chromium armor forging facilities required to build a suit of Glitter Boy power armor, and so building their own Glitter Boys would be impossible.

Unable to build a full suit of USA-G10 armor the Black Market researchers turned their attention to building a working Boom Gun. Here too, they met with disappointment. It appears that the secret to building a Boom Gun lies, in part, in the ability to create the super-dense chromium armor. The forces generated in firing the RG-14 rail gun are so massive that only the chromium composite material, forged on a molecular level, can stand up to them. The Black Market has tried building copies of the Boom Gun out of lesser M.D.C. materials only to have gun after gun explode in their faces. The infamous Boom Gun accelerates its flechette style rounds to a speed of Mach 5 and actually creates a sonic boom when fired. It wasn't until the researchers tried scaling down the speed of the rail gun accelerators that they were able to create a test gun that didn't explode the first time it was fired.

The result is the *RG-14-LX Light Rapid Acceleration Electromagnetic Rail Gun*, dubbed the “Baby Boom Gun.” This new weapon is actually very different than the fabled Boom Gun, but has its uses as a heavy weapon. The Baby Boom Gun lacks the two mile (3.2 km) range of the original Boom Gun, does around a third of the damage, and it does not cause an ear-shattering sonic boom every time the weapon is fired. But the Black Market found these things to be an advantage, as they have, in effect, created an autocannon that has excellent range and destructive power without requiring the extensive system of rocket motors and support pylons in order to fire. Only a single reaction jet is needed to counter most of the recoil generated by the Baby Boom Gun.

Since the new weapon is still quite loud (cannon-shot loud) when fired, even if it does not create a sonic boom, it has been dubbed the “Baby Boom Gun” or “Baby Boom.” The RG-14-LX is more or less a smaller version of the classic *Glitter Boy Boom Gun* in both general appearance and basic design, but has many other differences. From a cosmetic point of view, the Baby Boom Gun is smaller, about 6 feet (1.8 m) from end to end, not nearly 10 feet (3 m) like the genuine article. Nor is it reflective chromium, but a medium-gray brushed metal, dark gray brushed metal or painted black. More important differences are that the weapon is not attached to a suit of power armor, but rather used like a giant sniper rifle with a built-in bipod to lay the weapon on the ground to fire, or to support it on some other sturdy surface (wall, boulder, the hood of a vehicle, etc.). It also has a recoil suppression jet built into the rear of the massive rail gun to keep it stable after each shot.

The Baby Boom Gun is far too heavy to be fired by a single individual while standing, even if that person is a *Combat Cyborg* or *power armor* clad soldier. For best results and accuracy, the Baby Boom Gun should be fired by a single shooter lying flat on the ground with the weapon supported in the front on its bipod, and the back of it angled over the shooter's shoulder and back. A standing shooter will be knocked off his feet and thrown 50 feet (15.2 m) by the weapon (he loses initiative and two melee attacks, and suffers 2D4 S.D.C. damage) even with the recoil suppression jet. Even full conversion cyborgs, dragons, Juicers, mutants and D-Bees with a Supernatural P.S. of 30 or more are incapable of using the weapon with any measure of accuracy while standing. (**Note:** -10 to strike if they can aim it at all. Beings with a Supernatural P.S. greater than 30 or a Robot P.S. greater than 50 can fire it as a two-handed weapon from a standing position with a -6 penalty to strike.) It takes 3-4 strong, normal humans, or one combat cyborg or power armor, to carry and set up the Baby Boom Gun for use. The additional men assist in carrying the weapon and ammo. After the weapon is in place on the ground or from a rooftop, they assist the shooter by spotting targets, defending the firing position, reloading the weapon and carrying extra ammunition canisters. **Note:** Even Combat Cyborgs and power armor troops must lie prone to use the Baby Boom with any measure of accuracy. The Baby Boom Gun can also be mounted on a heavy, armored vehicle such as an APC, tank, giant robot, or patrol boat.

Weight: Baby Boom Gun: 350 lbs (157.5 kg), plus ammo. Self-Feeding Ammo Canister: 55 lbs (24.7 kg).

Range: 5,000 feet (1,524 m).

Mega-Damage: One Boom Gun flechette round holds 200 slugs that inflict 1D6x10+10 M.D. when fired by this weapon. The rounds of the RG-14-LX are fired at lower speeds and do not cause a sonic boom when fired; no deafening boom nor collateral shock wave damage. It does have a very loud report (a pop like a big firework or small cannon going off) and can be heard for at least one mile (1.6 km) away; double or triple if carried by the wind and the ambient sound level is quiet.

Rate of Fire: Single shot. Each blast counts as one melee attack. Bursts and sprays are not possible.

Payload: 100 rounds (shots) loaded in a large, self-feeding ammunition canister. The ammo canister can be reloaded by hand, one round at a time, as necessary, but it takes 15 minutes to reload 20 rounds into an ammo canister. It takes only two melee rounds (30 seconds) for a two-man team to attach a new ammo canister onto the weapon. Note that these are the same Boom Gun rounds used by the Glitter Boy and are completely interchangeable with rounds from a standard Glitter Boy Boom Gun. The energy to fire the weapon is provided by six E-Clips, which can fire a full canister (100 rounds) before they need to be recharged, or can be linked to a vehicle's nuclear power supply for unlimited firing capacity.

Bonus: Laser targeting standard; +1 to strike on Aimed shots.

Cost: 550,500 credits for the Baby Boom Gun. An empty ammo canister costs 10,000 credits and the Boom Gun rounds cost 1,000 credits each, with fair to good availability through the Black Market. They have sold the ammo for decades, after all!

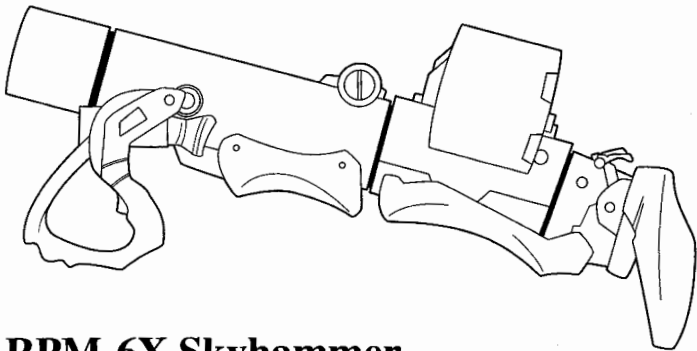

RPM-6X Skyhammer Rocket-Propelled Mortar

The Skyhammer Rocket-Propelled Mortar resembles a small mini-missile launcher more than a traditional mortar, and is fired from the shoulder like a missile launcher, not from the ground. The Skyhammer shells have warheads equal in strength to mini-missiles, but lack a mini-missile's propellant reserves and guidance systems, making the RPM shells much lighter and the overall weapon a lot easier to carry by the average human. Of course, these same factors also limit the weapon's range and make it much less accurate (-3 to strike a specific aerial target; -6 to strike targets moving faster than 15 mph/24 km), even when fired with care and taking time to aim. On the upside, when properly fired, these rocket-propelled mortars are launched on an upward arcing trajectory and are allowed to fall back onto a target on the ground. Striking from above may catch ground troops off-guard and make it hard for the target to simply dodge out of the way (-2 to dodge an incoming mortar shell). At close range, 200 feet (61 m) or less, the Skyhammer may be directly fired at its intended target, eliminating the need for arcing fire, but the penalties to strike (and dodge) remain in place; it is not a precision weapon. The Skyhammer's drum magazine can hold six mortar shells and a seventh shell can

be "hot-loaded" into the tube before the drum magazine is clipped into place.

Weight: 20 lbs (9 kg).

Range: 3,500 feet (1,067 m), but only 200 feet (61 m) when firing directly at an intended target.

Mega-Damage: Varies with the type of warhead used:

Armor Piercing: 6D6 M.D. to a blast radius of 3 feet (0.9 m).

Fragmentation: 3D6 M.D. to a blast radius of 12 feet (3.6 m).

High Explosive: 4D6 M.D. to a blast radius of 5 feet (1.5 m).

Plasma: 1D4x10 M.D. to a blast radius of 10 feet (3 m).

Flash-Bang Shell: Everyone in a 6 foot (1.8 m) radius must save vs being blinded for 1D4+1 melee rounds.

Fire Retardant: Extinguishes all fires in a 15 foot (4.6 m) radius.

Parachute Flares: Bursts into a glowing flare at 3,500 feet (1,067 m) and it slowly glides down and burns to illuminate a 60 foot (18 m) radius for 1D6 minutes.

Smoke: Creates a cloud of smoke that hangs over the ground in a 20 foot (6.1 m) radius. Smoke may be used as cover or to mark a target area. Colors of smoke: Black, white, blue, green, yellow or red. Duration of Smoke: 1D6 minutes, but reduce radius of effect and duration in winds stronger than 10 mph (16 km).

Tear Gas: Everyone in a 6 foot (1.8 m) radius must save vs non-lethal poison (16+) or suffer the effects of the tear gas for 1D4 minutes. Victims of the tear gas are -6 on initiative, -3 to strike, parry and dodge, and lose one melee attack for the duration. Reduce the radius of effect and duration by half of the gas in winds stronger than 10 mph (16 km).

Rate of Fire: Each shot counts as one melee attack.

Payload: 6 shells in the drum magazine, plus a single shell hand-loaded into the tube. A carrying case containing 12 shells is available; padded interior with individual compartments to hold the mortars. The case has 5 M.D.C.

Cost: 115,500 credits for the weapon, the mortar shells cost as follows: 170 credits for Fire Retardant, Parachute Flare and Smoke. 250 credits for Fragmentation. 300 credits for High Explosive and Armor Piercing. 350 credits for Plasma. 400 credits for Tear Gas or Knockout Gas.



Notable Vehicles

By Carmen Bellaire

Additional ideas and text by Kevin Siembieda

The following notable vehicles are available from many Black Market sellers and at most Merchant Towns.

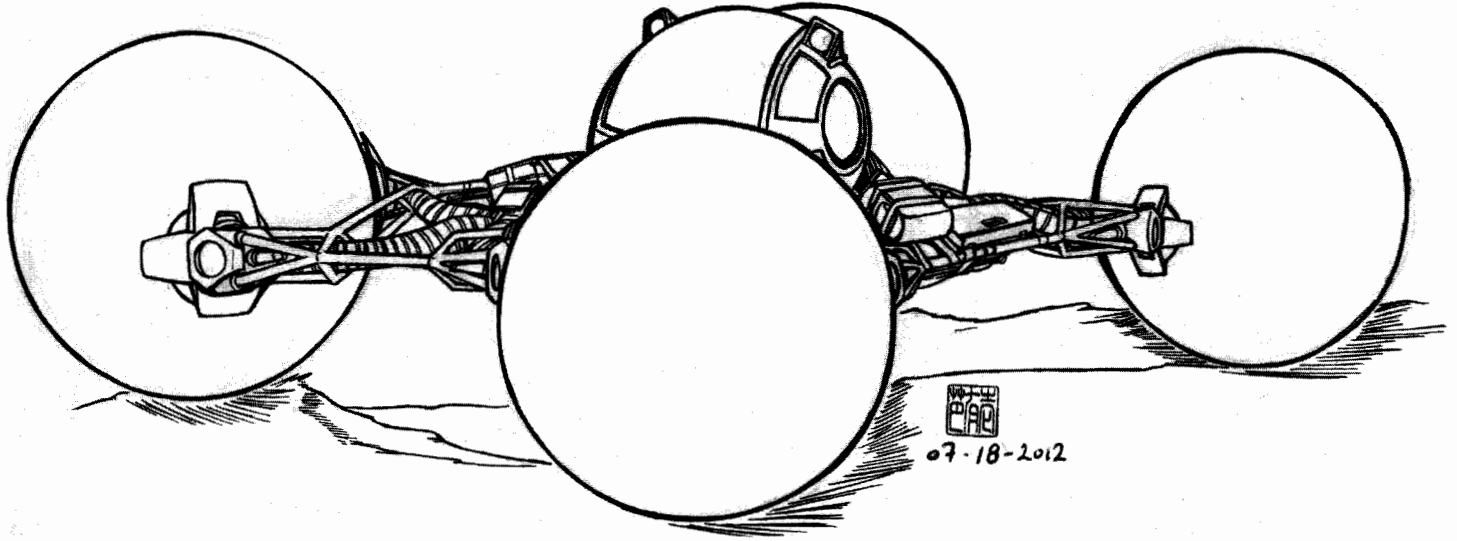

All-Terrain Tumbler

Among the various finds unburied at Area 51 by Bandito Arms was something labeled the “Mars Tumbler.” A vehicle being developed and tested for use on the planet Mars and other planets. It is unclear if the vehicle was ever used, or whether it was an improved, new generation Mars Tumbler slated for future use.

The Tumbler is an all-terrain ground vehicle, but instead of wheels or tracks, the Tumbler rolls on four large, metal spheres that are held to the hull of the vehicle via sets of crisscrossing magnetic rails. To turn the spheres, the sets of magnetic rails are activated, spinning the sphere up/down or left/right depending on which rails are used. By using a combination of rails and varying the speed of the accelerators in them, the spheres can be made to spin in any direction. Repeat this mechanism in all four spheres and you have a vehicle that can spin completely around in place, move in any direction at full speed and maneuver erratically. But this is just part of the Tumbler’s tricks.

The cockpit of the Tumbler is a sphere noticeably smaller than the road spheres and is free floating within its gyroscopic frame, allowing it to automatically right the cockpit if the Mars Tumbler rolls over. Moreover, it can rotate 360 degrees, enabling the pilot to stop and rotate to look in any direction, even upside down. Indeed, there is no real “up” for the Tumbler, and the top and bottom of the vehicle are essentially identical. With spheres for wheels, the Tumbler cannot find itself balanced on its side or nose because it automatically falls over on all fours. And that’s the beauty of this system, if the ATV Tumbler gets flipped over on its “back,” the cockpit rolls to accommodate the new position and the vehicle can continue to move at full speed. This makes the Tumbler incredibly fun to drive as long as the pilot’s stomach can take all the flipping and bouncing around. It also makes roll-over crashes nearly impossible in a Tumbler and the vehicle is perfect for rugged, uneven terrain, though not one with many trees.

The four hollow road spheres are made of a durable M.D.C. metal alloy and are dimpled like a golf ball. If one of the spheres

is damaged or dented, the performance of the vehicle remains unaffected since the magnetic fields that turn the spheres are unimpeded by such minor imperfections. Even the total loss of two spheres only slows down the Tumbler since the vehicle can drag itself along on the remaining two spheres, but it is a bumpy and miserable ride. But replacing a damaged sphere is as easy as shutting off the magnetic field, rolling away the damaged sphere, rolling up a new one, and engaging the magnetic field. With the new road sphere in place, the Tumbler can continue on as if nothing had happened.

This vehicle is extremely popular in the New West and locations with few trees. Smugglers, Vampire Hunters, Wilderness Scouts, non-Traditional Native Americans, Pecos Bandits, and traveling merchants have found this vehicle to be very attractive and fun to drive even though it does not have any weapon systems. Best of all for smugglers and merchants, any contraband not damaged by rolling around can fit within the hollow wheels/road spheres. The road spheres are designed to open by separating along their centerline. The normally hollow interior of the sphere can be filled with anything the smuggler desires, then the cargo is strapped in place and the sphere closed up. At pre-arranged Black Market locations, the smuggler can make a quick drop simply by driving up to the drop site where 1-4 empty, replacement wheels are waiting. He pulls up, releases the sphere or spheres filled with smuggled goods, has them rolled away and empty replacements rolled up, and he drives away. A prepared drop team can have the smuggler on his way in less than 30 seconds. His partner(s) at the drop site then simply rolls the cargo spheres away, unpacks it and has the sphere(s) ready for the next drop. It doesn’t get any faster.

Model Type: USAF-MEV-002

Manufacturer: Bandito Arms.

Class: Martian Exploration Vehicle.

Crew: One pilot.

M.D.C. by Location:

* Headlights (8, two in between each set of road spheres) – 2 each

Road Spheres (4) – 110 each

Reinforced Pilot's Compartment (cockpit) – 75

** Main Body/Frame and Pilot's Sphere (1, center) – 220

* A single asterisk indicates a small or difficult target to strike, requiring the attacker to make a "Called Shot," and even then the attacker is -4 to strike.

** Depleting the M.D.C. of the main body will shut the vehicle down completely, making it useless. It too is a difficult target to hit and is -2 to strike even with a "Called Shot."

Speed:

Maximum Speed: 130 mph (208 km).

Cruising Speed: 70 mph (112 km) or slower.

Range: 400 miles (640 km) per electric battery charge. Unlimited with a nuclear power supply, the preferred power source of smugglers.

Flying: Not possible.

Underwater Capabilities: Can drive along the bottom of the sea or lake bed at 35 mph (56 km). Maximum Ocean Depth is 800 feet (244 m).

Statistical Data:

Wheel Diameter: 5 feet (1.5 m).

Overall Height: 7 feet (2.1 m) tall.

Width: 16 feet (4.9 m).

Length: 20 feet (6.1 m).

Weight: 5,875 lbs (2,644 kg).

Cargo: Each of the four hollow "road wheels" is designed with hooks and straps inside to secure cargo storage, plus plenty of crates and packages can be attached to the vehicle frame, but with a maximum payload not exceeding a total of five tons. Can pull an additional five tons on a separate flatbed or trailer, but obviously, the trailer could not be flipped over. There is also a small area inside the cockpit for the pilot's personal items, as well as a weapon bin that has room for two rifles, two pistols, one light body armor, three canteens and food rations (4 week supply), plus a 10 gallon (37.8 liters) water cooler is built into the cockpit as well.

Power System: Electric engine and battery.

Cost: 245,000 credits for the electric version, 2.1 million for vehicles with a nuclear power source which has a 10 year life.

Weapon Systems: None.

Equipment of Note: The ATV Tumbler has a rebreather/CO2 scrubber that recycles the air inside the cockpit, keeping its air fresh and breathable indefinitely, as well as an eight hour backup oxygen supply if needed. There is also a set of two breathing masks in case the cockpit's environmental seal is breached.

Big Wheel Unicycle

Manufactured by Titan Industries, the Big Wheel Unicycle is a strange vehicle built for those who feel too exposed on a two-wheeler motorcycle or hovercycle. The Big Wheel is a unicycle (single wheeled), but a unicycle with a difference. The tire on the Big Wheel is huge (ten feet/3 m tall) and the pilot rides inside the wheel seated in a completely enclosed cockpit inside the giant wheel. The rider is protected by a pair of clamshell doors that close around the pilot and enclose all of the unicycle except for the bike's all-terrain tire. The rider sees the road/surroundings through a series of cameras set into the doors, and the bike's built-in gyroscope helps to stabilize the bike and prevent it from falling over. Visual images can also be linked and transmitted to any HUD display system in helmets, goggles or cybernetic eyes.

The Big Wheel can move at full speed moving forward or backward; since the pilot sees via cameras, moving in either direction is easy and not disorienting. Due to the design of the clamshell doors and gyroscopic balancing system, it's nearly impossible to fall over in the Big Wheel when the doors are buttoned up tight. If the vehicle does fall on its side, it will right itself without any aid from the driver at all. Even the steering is achieved through manipulating the gyroscope instead of the pilot leaning from side to side as he would on any type of bike. Only when the doors are open and the gyroscope is turned off can the Big Wheel be knocked over or fall on its side.

With the Big Wheel being so well protected and agile a ride, it was inevitable that various adventurers, criminals and mercenaries would try to arm the unicycle, but it cannot be done. The problem with arming the unicycle is that only two weapons of identical weight can be mounted on the doors, and even then it causes a problem with the gyroscope and balance, so this is an unarmed vehicle. Even without an available weapon system, the Big Wheel Unicycle is a very capable one-man transport vehicle. Its very narrow profile and wheeled shape make it difficult to shoot (-1) when it is coming straight at or away from someone and it can zoom down narrow alleyways, hallways, and around traffic the same as a motorcycle, and even along narrow ledges and what might be considered footpaths. It can handle the streets, alleyways and sidewalks of any urban setting like a dream, and does equally well on dirt and gravel roads, open grasslands and moderately rough terrain. Reduce speed by 25% in light scrub, but cannot navigate through trees and even very thin forests and heavy scrub are impossible for it to travel through. Wherever it goes it looks like a giant plate or disk rolling down the road on its edge.

Model Type: BAU-03

Manufacturer: Titan Industries.

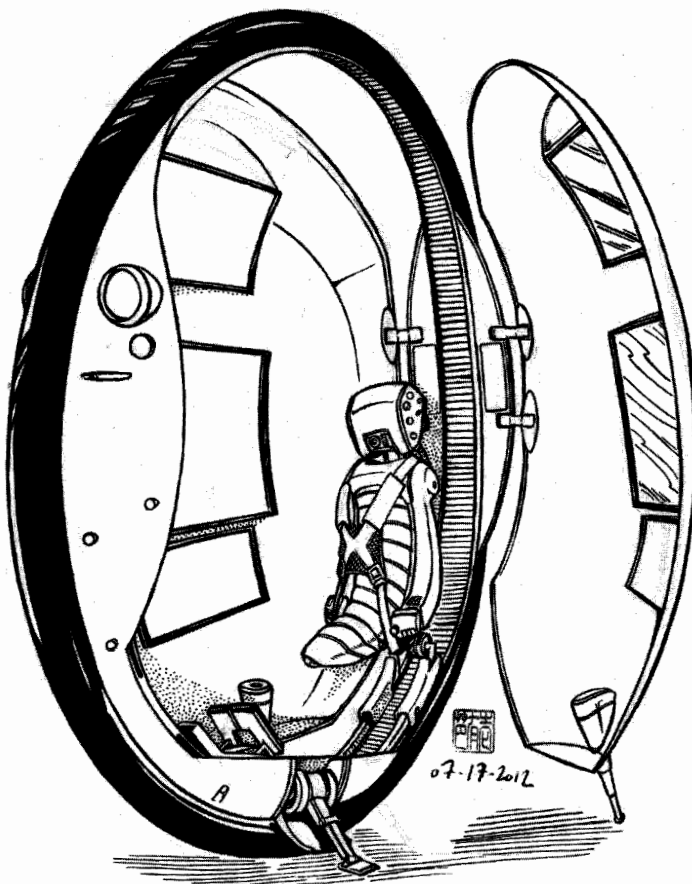

Class: Armored Enclosed Unicycle.

Crew: One pilot.

M.D.C. by Location:

- * Vision Cameras (2) – 2 each
- * Headlights (2) – 2 each
- Clamshell Doors (2) – 65 each
- All-Terrain Tire – 65
- ** Main Body – 130

* A single asterisk indicates a small and difficult target to strike, requiring the attacker to make a “Called Shot,” and even then the attacker is -4 to strike.

** Depleting the M.D.C. of the main body shuts the vehicle down completely, making it a useless wreck.

Speed:

Maximum Speed: 75 mph (120 km).

Cruising Speed: 50 mph (80 km) or slower.

Range: 800 miles (1,280 km) per electric charge. Unlimited with a nuclear power supply but increase cost by 500,000 credits (10 year life).

Flying: Not possible.

Underwater Capabilities: Not possible.

Statistical Data:

Height: 10 feet (3 m) tall.

Width: 4 feet, 1 inch (1.2 m).

Length: 10 feet (3 m).

Weight: 640 lbs (88 kg).

Cargo: Small storage area for extra supplies and personal weapons.

Cost: 80,000 credits.

Weapon Systems: None.

Bushmaster Motorcycle

The Bushmaster is a classic “enduro” style motorcycle designed for off-road and on-road driving. The motorcycle is powered by a simple flex-fuel engine allowing it to operate on a variety of fossil fuels, including gasoline, kerosene, jet fuel, diesel and distilled alcohols. Sensors in the engine management system automatically detect which fuel is being used and alter the engine’s burn rate to match. Anti-lock braking, traction control, solid rubber tires, a pair of saddlebags, active stabilization, and fully active and adjustable suspension are all standard features on the Bushmaster.

The Bushmaster also includes a set of jump jets patterned after those on the infamous Juicer Tarantula Jump Bike, but those on the Bushmaster are smaller and intended for non-augmented, normal human pilots. When the jump jets are engaged, the Bushmaster can jump up to a height of 15 feet (4.6 m) and/or a distance of 30 feet (9 m) on a single jump. The jump jets are fueled by the same compressed natural gas (CNG) used by the Tarantula, which is stored in a separate tank with a ten jump capacity. Great for hopping over wreckage and narrow ravines and chasms, and even over power armor and enemy vehicles, though landing can be a little tricky for the average pilot (-20% on piloting skill roll, but those with special driving skills and bonuses are likely to have a much reduced penalty or even no penalty at all).

The best features of the Bushmaster motorcycle are low cost (for what it can do), dependability and ease of repair. Popular with Wilderness Scouts, Rangers of many varieties, Cyber-Knights and City Rats everywhere, and with scouts, Native Americans, Sheriffs, lawmen and Pecos Bandits in the New West. The Bushmaster is just finding its market in the East and is selling well in the Magic

Zone, where Techno-Wizards love to soup it up with all kinds of TW gizmos.

Model Type: BAM-05

Manufacturer: Bandito Arms.

Class: Enduro All-Terrain Motorcycle.

Crew: One pilot with one additional rider possible in emergencies.

M.D.C. by Location:

- * Headlights (3) – 2 each
- * Wheels (2) – 12 each
- * Jump Jets (2; bottom and rear) – 25 each
- ** Main Body – 80

* A single asterisk indicates a small and difficult target to strike, requiring the attacker to make a “Called Shot,” and then the attacker is -3 to strike.

** Depleting the M.D.C. of the main body will shut the vehicle down completely, making it useless.

Speed:

Maximum Speed: 200 mph (320 km).

Cruising Speed: 100 mph (160 km).

Range: 900 miles (1,440 km) per tank of fuel.

Jump Jets: The maximum distance the bike can jump is 15 feet (4.6 m) high and 30 feet (9.1 m) long on a single jump. The bike can jump up to ten times before the jump tanks need to be refueled with more compressed natural gas (CNG).

Flying: Not possible.

Underwater Capabilities: Not possible.

Statistical Data:

Height: 4 feet, 1 inch (1.2 m).

Width: 3 feet, 10 inches (1.18 m).

Length: 6 feet (1.8 m).

Weight: 480 lbs (216 kg).

Cargo: Small storage area for extra supplies and personal weapons.

Power System: Flex-fuel internal combustion, with compressed natural gas (CNG) for the jump jets.

Cost: 30,000 credits.

Weapon Systems: None.

Overdrive Hovercycle

It is difficult to come up with a hovercycle that has features to set it apart from all the Northern Gun bikes flooding the market, but Bandito Arms has come up with something new using a turbo-thrust jet engine to provide an extra boost of raw power.

The Overdrive is built on a hovercycle frame around the turbo-thrust jet engine, making it a hybrid that falls somewhere between a hovercycle and a Coalition Rocket Bike. This becomes apparent when you look at the bike’s overall appearance and performance. The vehicle can take its rider from a stationary hover to its hovercycle speed of 200 mph (320 km) in just 7 seconds (two melee actions) and up to its maximum turbo-thruster speed of 300 mph (480 km) in one melee round (15 seconds), making it the fastest hovercycle on the market. The bike’s acceleration is so extreme that the pilot is held in place by a contoured seating arrangement and leg clamps that hold his feet on the foot pegs during high-speed take-offs.

The high performance hovercycle also has full VTOL (Vertical Take-Off and Landing) capabilities and in-flight stabilization to keep the ride smooth and the rider seated even during maximum acceleration. As the Overdrive was only intended as a high-speed

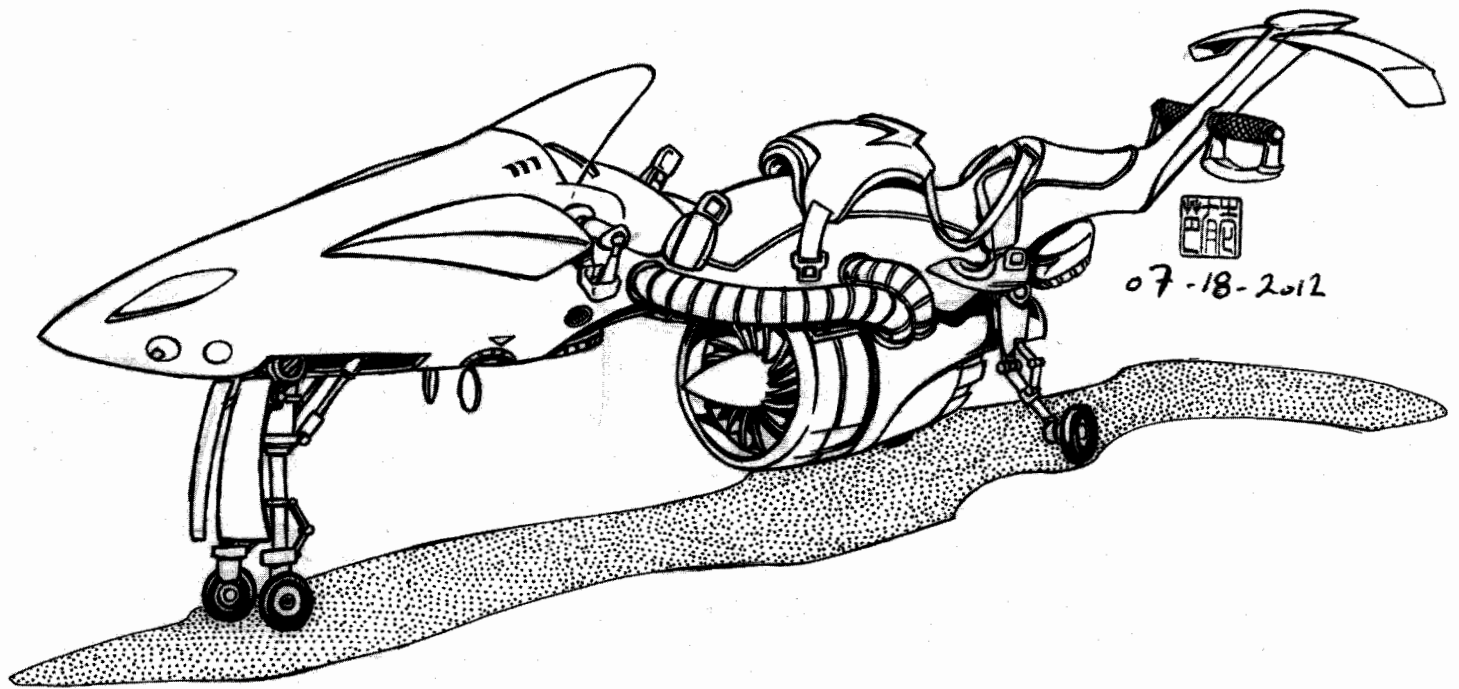

recreation and exploration vehicle, its heavy-duty frame and design is such that only one light energy weapon and a pair of mini-missiles can be added to the nose of the hovercycle without ruining the bike's aerodynamics and slowing it down. This has not hurt sales, as you buy the Overdrive when you have the need for speed.

Model Type: BAH-07

Manufacturer: Bandito Arms.

Class: High Performance Hovercycle.

Crew: One pilot.

M.D.C. by Location:

- * Headlights (3) – 2 each
- * Landing Struts (3, tricycle-style) – 8 each
- * Undercarriage Hover Jets (4, bottom) – 10 each
- * Rear Mounted Maneuvering Jets (3, small) – 20 each
- Main Turbo-Thruster Jet Engine – 75
- ** Main Body – 115

* A single asterisk indicates a small and difficult target to strike, requiring the attacker to make a "Called Shot," and even then the attacker is -3 to strike.

** Depleting the M.D.C. of the main body shuts down the vehicle completely, making it useless.

Speed:

Maximum Speed: Like most hovercycles, the Overdrive hovers 2-10 feet (0.6 to 3 m) above the ground, and it has a maximum speed of 300 mph (480 km).

Maximum Altitude: 750 feet (228.6 m) and can handle drops of up to 600 feet (183 m).

Maximum Range: 500 miles (800 km) with a fully charged electric engine; unlimited with a nuclear power supply.

Engine: Electric or nuclear.

Underwater Capabilities: The large turbo-thruster provides good mobility and control underwater and a speed of 40 mph (64 km); cannot ride on the surface of water. Maximum Ocean Depth: 800 feet (224 m).

Special Bonuses & Penalties: +1 to dodge for every 100 mph (160 km) of speed, and +10% bonus to piloting skill for handling leaps and dives, but -10% piloting penalty when driving faster than 250 mph (400 km).

Statistical Data:

Height: 5 feet (1.5 m).

Width: 4 feet, 6 inches (1.4 m).

Length: 8 feet, 6 inches (2.6 m).

Weight: 1,200 pounds (540 kg); lightweight frame.

Cargo: None.

Power System: Electric or nuclear.

Cost: 315,000 for electric, 985,000 for nuclear with a 10 year life.

Weapon Systems: None to start. A light laser (Range, 2,000 feet/610 m, 2D6 M.D., single shot, linked to the power supply for unlimited payload) is common and costs an additional 50,000 credits.

Road Hammer Transport

This big transport is currently the largest civilian cargo hauler that Bandito Arms produces. The Road Hammer is a heavy-duty, single-body transport designed to carry cargo within its enclosed frame or on its flatbed with the collapsible cargo frame removed. The truck also comes with a pintle hook for pulling various trailers and wagons. The transport can haul a total of 40 tons of freight, which is slightly more than what a pre-Rifts semi-tractor could haul. For hauling larger loads, the Black Market will generally steal (Why buy it after all?) one of Northern Gun's huge Big Berthas.

Unlike the more famous NG transport, the Road Hammer is a wheeled vehicle, riding on twelve, four foot (1.2 m) tall and three foot (0.9 m) wide, solid rubber and alloy wheels, four wheels in the front turning in tandem for steering and eight in the rear for carrying the load. The tires are heavy enough and wide enough that they leave a temporary pathway of packed earth behind them as they move (similar to a rolling earth compactor), allowing lesser wheeled vehicles to follow in their wake. This has earned them the nickname "Road Hammer" since they leave a temporary road behind them as they travel. Unfortunately, the wild environment of Rifts Earth means that these temporary packed earth roads return to their natural state in just a week or two due to the actions of wind, rain, wildlife and plant growth. Although a few towns

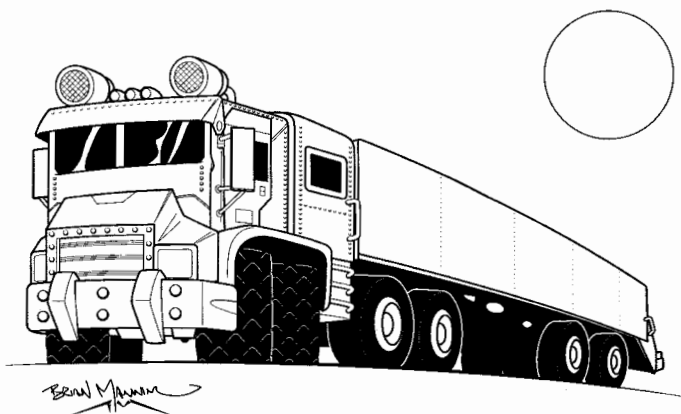

in the New West which are located very close together use these vehicles to keep a road open between their settlements. Of course, the vehicle cannot plow through even light forest and must find an alternate route.

The cab of the Road Hammer is designed for the comfort of the driver and a single passenger, and cab includes two long-haul seats, two bunks for sleeping, full climate control, entertainment suite, storage, refrigerator and cook top. Many drivers prefer staying in their Road Hammer rather than sleeping in an inn or boarding house when on the "road." They feel safe, tucked away inside and they can guard their truck and cargo. A simple alarm hooked onto the rear cargo doors goes off when the doors are opened unless a code is punched in. The Road Hammer Transports operate mainly in the prairies and the far-flung reaches of the New West, Southwest, and northern Mexico as the Coalition's vendetta against Bandito Arms makes it too dangerous to operate the large vehicles anywhere near CS territory.

Model Type: BA-AT-903 Transport

Manufacturer: Bandito Arms.

Class: All-Terrain Heavy Cargo Hauler.

Crew: One pilot with room for a single passenger, although 5-6 additional passengers can cram tight into the bunk area.

M.D.C. by Location:

* Driver's Mirrors (2) – 2 each

* Headlights (4) – 2 each

Rubber and Alloy Wheels (12) – 70 each

Cargo Box/Removable Cargo Frame – 100

Cargo Bay Doors (2, rear, open down the middle) – 40 M.D.C. each

Reinforced Pilot's Compartment (cab) – 75

** Main Body – 300

* A single asterisk indicates a small and difficult target to strike, requiring the attacker to make a "Called Shot," and even then the attacker is -3 to strike.

** Depleting the M.D.C. of the main body will shut the vehicle down completely, making it useless.

Speed:

Maximum Speed: 100 mph (160 km).

Cruising Speed: 75 mph (120 km).

Range: Varies with type. 1,000 miles (1,600 km) per fully charged electric battery. 500 miles (800 km) per fully charged, super-efficient solar cell system. The solar collector array is on the roof of the cargo bay and cannot be used when in flatbed mode. The system requires a full 10 hours of sunlight to recharge completely. It recharges at half rate while running/driving and one third during overcast days. Nuclear power supply costs more but has unlimited range and a 10 year life.

Flying: Not possible.

Underwater Capabilities: Not possible, but may ford through water up to 12 feet (3.6 m) deep.

Statistical Data:

Height: 22 feet (6.71 m) tall.

Width: 18 feet (5.5 m) wide.

Length: 52 feet (15.85 m).

Weight: 26.5 tons, plus cargo.

Cargo: The cargo box measures 12 feet x 12 feet x 40 feet long (3.6 m x 3.6 m x 12.2 m) and can hold 40 tons. The cargo box is removable for occasions when a flatbed hauler is required, but this feature is rarely used. The Road Hammer can also pull up to 120 tons with its pintle hook, but reduce speed by half. The cab is very roomy and comfortable, like a cross between a pre-Rifts semi-tractor cab and a recreational vehicle.

Power System: Electrically powered with electric motors in all 12 wheels, with super-efficient solar cells on the roof.

Cost: 550,000 credits for an electric engine. 850,000 for the solar cell engine. 1.6 million for a nuclear power supply.

Weapon Systems: None.

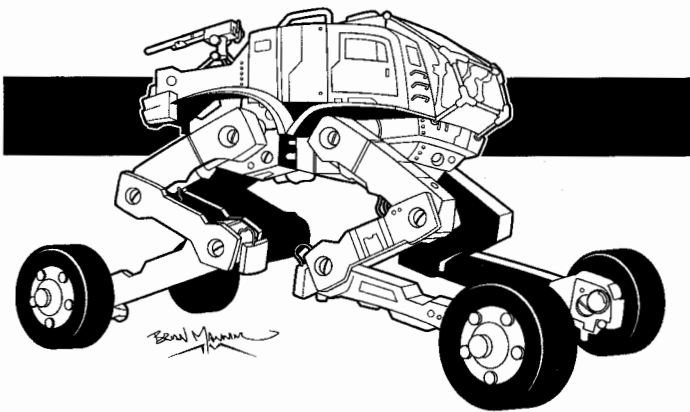

Romper Stomper

Without a huge Research and Development division like Northern Gun or the Coalition States, Bandito Arms makes a point to try to replicate any pre-Rifts technology they can find at Area 51 and elsewhere, and incorporate it into new designs they can mass produce and sell. The Wild Weasel SAMAS is one such example, as are the Baby Boom Gun and Shadow Boy. Inspired by a piece of farm equipment apparently designed to travel over a field of tall crops on long, wheeled legs, the Bandito research team came up with the Romper Stomper, an all-terrain vehicle which rides on a set of electrically driven wheels mounted on four long, extendable, robotic legs (maximum extension is twenty feet/6.1 m). Driven like any other automobile until the pilot encounters terrain unsuitable for a wheeled vehicle, the Romper Stomper can rise up on its legs and roll over an obstacle without fear of damaging the undercarriage or main vehicle itself. Furthermore, while the cab of the vehicle is elevated, the independent suspension and shock absorbers of the legs are such that the vehicle can bounce in and out of potholes and craters, drive across debris covered roads and shattered pavement, roll through tall underbrush, and drive through standing water up to 18 feet (5.5 m) deep. Skilled drivers can even drive over the wreckage of vehicles and even animals or people standing in the road (with some considerable risk that the animal will step into the wheels/legs of the moving vehicle and get hurt), and those truly familiar with the Romper Stomper make such

maneuvers at cruising speed! In order to reach its top speed, the Stomper must collapse its legs to a height no taller than 10 feet (3 m), but cruising speed (60 mph/96 km) is possible even at higher elevations.

The vehicle has room for the pilot and up to three passengers, one next to him and two riding behind him. There is ample room for the kind of gear carried by most adventurers and the cab is well armored. The Romper Stomper was built with Wilderness Scouts, Psi-Stalkers, hunters, explorers, adventurers, mercenaries and other wilderness people in mind, so the vehicle has plenty of hooks and clamps for attaching additional gear and cargo. There are also three hard points on the top, exterior of the vehicle where weapon systems can be integrated. The most common being a manned or unmanned gun or gun turret mounted on the back.

One of the most interesting modifications is the "Grand Theft Auto Package" in which a set of four winches are added to the undercarriage of the vehicle. With the Romper Stomper's wide chassis and each winch cable ending in a magnetic clamp, it is an easy proposition to raise the cab of the vehicle, drive over a smaller vehicle, hovercycle, motorcycle or even cargo crates or a pallet of supplies, release the cables or magnetic clamps, attach them to the vehicle or cargo below, and raise it off the ground and drive away with it! The design was originally intended to haul additional supplies and transport broken-down vehicles, but Black Marketeers quickly came up with the application for stealing cars and equipment. Of course, this opened up a whole new market among Raiders, Bandits, Black Marketeers, car thieves, smugglers, and criminals of all kinds, as well as merchants. Car thieves connected to the Black Market or other car stealing rings can hastily drive to the nearest Black Market vehicle chop-shop and drop it off within minutes. Or carry it off to a back alley, tear it down for parts, and drive off before the authorities have time to respond. The Coalition States have already outlawed the vehicle within the limits of their towns and cities, though the Romper Stomper is allowed in the no-man's lands that are the 'Burbs.

Model Type: RS-101-ATVV

Manufacturer: Bandito Arms.

Class: All-Terrain Variable Vehicle.

Crew: One pilot with up to three additional passengers inside. Two more can easily ride outside on the back of the vehicle.

M.D.C. by Location:

* Headlights (2) – 2 each

* Optional Weapon Turrets (1-3) – 50 each

Extendable Robotic Legs (4) – 115

* Wheels (4) – 50 each

Reinforced Pilot's Compartment (cockpit) – 75

** Main Body – 225

* A single asterisk indicates a small and difficult target to strike, requiring the attacker to make a "called shot," and even then the attacker is -3 to strike.

** Depleting the M.D.C. of the main body will shut the vehicle down completely, making it useless.

Speed:

Maximum Speed: 100 mph (160 km).

Cruising Speed: 60 mph (96 km).

Range: 500 miles (800 km) per electric charge; unlimited if nuclear.

Flying: Not possible.

Underwater Capabilities: Not possible.

Speed Note: Reduce to cruising speed when driving through underbrush and rugged terrain, as well as when carrying another vehicle or heavy load on the undercarriage. Reduce to 30 mph (48 km) or slower when driving through water deeper than 8 feet (2.4 m).

Statistical Data:

Height: 5 feet (1.5 m) with its legs at their shortest, to 25 feet (7.6 m) from the bottom of the wheels to the roof of the vehicle with the legs at their full 20 foot (6.1 m) extension.

Width: 11 feet (3.3 m) wide between the wheels/legs. Overall width is 14 feet (4.3 m).

Length: 18 feet (5.5 m).

Weight: 15,000 lbs (6,750 kg).

Cargo: Inside the vehicle is ample space for the pilot and passengers personal items behind the backseats, including a tent and bedrolls and similar bulky items, as well as a weapon bin that has room for two rifles, two pistols, a suit of light body armor, tool kit and a canteen.

Power System: Electric engine and battery or nuclear power system.

Cost: 400,000 for the electric version, 950,000 for the nuclear. The Grand Theft Auto Package costs an extra 120,000 credits, and most add-on light to medium weapon systems cost 50,000-150,000 credits each (three maximum). **Note:** Current production cannot keep up with demand, causing used Romper Stompers to sell for new vehicle prices and new ones to sell for 30-50% more than the standard list price, above. Current availability is poor.

Weapon Systems: None standard, however, it is common to have a manned rail gun or medium to heavy energy weapon mounted on the back of the vehicle (180 degree rotation, 90 degree arc of fire, range and damage vary per weapon), and a light laser (range 2,000 feet/610 m, 2D6 M.D., single shot or pulse, linked to the power supply for unlimited payload) on the top front or middle of the vehicle and typically fired by the pilot. A second weapon system, often a small mini-missile launcher (8 mini-missile payload), can be added on the roof. Cost varies per weapon system.

Combat Notes:

Physical Strength: The extendible legs have the equivalent of a Robotic P.S. of 24.

Bonuses: +1 to dodge when running or driving, reduce pilot skill penalties by half when driving across rough terrain and broken concrete, and can drive through tall weeds, standing water and debris strewn roads.

Equipment of Note: The Romper Stomper can be environmentally sealed but cannot travel underwater. It has a twelve hour oxygen supply if needed. There is also a set of three breathing masks in case the cockpit's environmental seal is breached.

Grand Theft Auto Package winches can lift a total of 5 tons (1.25 tons each) and the cables are 40 feet (12.2 m) long. Each winch and cable has an effective strength equal to a Robotic P.S. of 50. Cost to install is 120,000 credits.

Rumble Wagon

All through the backwoods and prairies of the New West, a single, ubiquitous light cargo vehicle can be seen pulling plows, hauling hay on old semi-trailers or hand-built farm carts, and performing a hundred other simple tasks. It is the Rumble Wagon, a durable, dependable, all-purpose work vehicle built for decades of service. While not the type of vehicle you would think for sale by the Black Market, demand for a reliable all-purpose truck is high

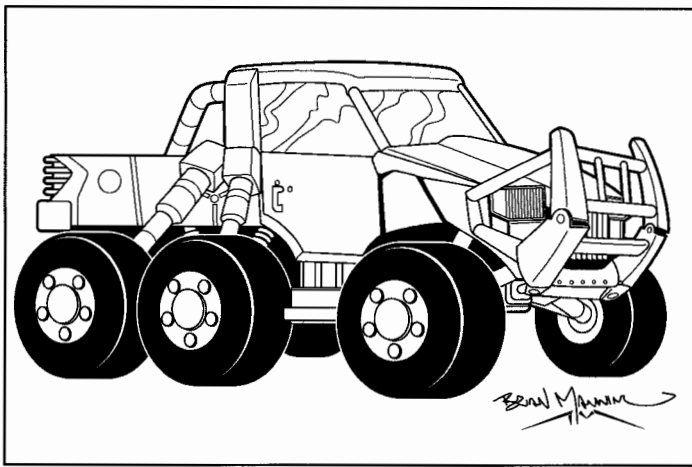

in the New West and other remote areas. This one, of apparent military design, as it was a common work vehicle at Area 51, can do it all, ride rough terrain, carry and pull cargo, plow fields and handles well on most surfaces. The Rumble Wagon has been a perennial moneymaker for Bandito Arms and has been knocked off and manufactured by *Titan Industries*. (Actually, both companies use the same pre-Rifts designs.) The Rumble Wagon has outsold all other Bandito Arms vehicles in that category.

The Rumble Wagon is powered by a flex-fuel power plant enabling it to operate on fossil fuels, propane, compressed natural gas (CNG) or distilled alcohol (very popular in the New West), depending on what is available. The vehicle has three different fuel tanks to prevent the needless mixing of fuels, and sensors in the engine's management system automatically detect which fuel is being administered and adjust the engine's burn rate to the fuel being used.

The Rumble Wagon is a six-wheeled, all-terrain truck with a reinforced frame and towing package to enable it to pull trailers, wagons, plows and other equipment. In fact, it can pull just about anything a farm tractor can handle. The bed of the Rumble Wagon is similar to a large pickup truck, but a fifth wheel hitch can be raised up out of the truck bed to pull semi-trailers and a standard pintle hook is mounted on the rear of the vehicle. Built for work, not comfort, the wagon's cramped cab only has room for a driver and a single passenger, but many a peasant farmer would sell their own soul for one of these tough, ugly trucks.

Model Type: BA-AT-601 Truck

Manufacturers: Bandito Arms and Titan Industries.

Class: All-Terrain Cargo Hauler.

Crew: One pilot with room for one passenger.

M.D.C. by Location:

- * Headlights (2) – 2 each
- * Tractor Fifth Wheel – 70
- * Wheels (6) – 40 each
- Push Bar/Ram (1) – 90
- ** Main Body – 190

* A single asterisk indicates a small and difficult target to strike, requiring the attacker to make a "Called Shot," and even then the attacker is -3 to strike.

** Depleting the M.D.C. of the main body will shut the vehicle down completely, making it useless.

Speed:

Maximum Speed: 100 mph (160 km).

Cruising Speed: 60 mph (96 km).

Range: 400 miles (640 km) per tank of fuel, with another 100 miles (160 km) for the backup electric charge.

Flying: Not possible.

Underwater Capabilities: Not possible.

Statistical Data:

Height: 6 feet, 8 inches (2.0 m).

Width: 10 feet (3 m) wide.

Length: 12 feet (3.6 m).

Weight: 4,152 lbs (1,868 kg).

Cargo: Small storage area for extra supplies and personal weapons in the truck and a large pickup bed for cargo, measuring 8 feet x 8 feet x 4 feet deep (2.4 m x 2.4 m x 1.2 m), with the tractor fifth wheel mounted in the middle. The Rumble Wagon can pull up to 40 tons with its fifth wheel or pintle hook.

Power System: Flex-fuel internal combustion, with an electric battery backup. Optional nuclear power system has a 20 year life.

Cost: Flex-fuel truck costs 89,000 credits and is the most common and popular. Nuclear costs 585,000 credits.

Weapon Systems: None.

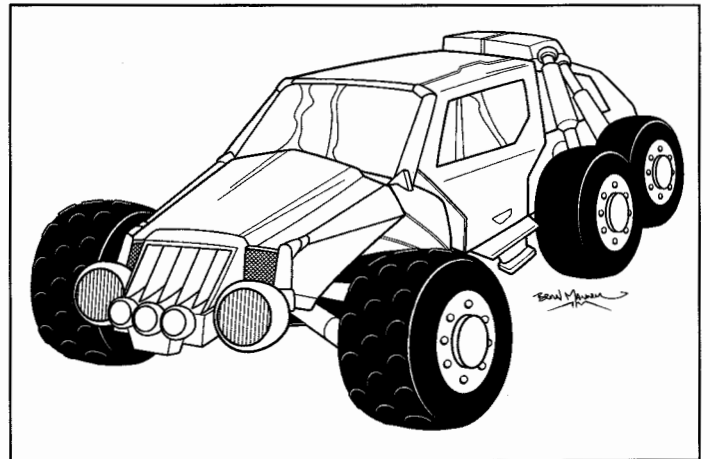

Runabout ATV

The Runabout All-Terrain Vehicle, sometimes called the "Backwoods Buggy," is a light, zippy, little, six-wheeled vehicle designed to bounce along at high speed on oversized, rubbery flex-tires. The ATV can carry up to four people and their baggage comfortably, or up to eight people if they squish in and leave their luggage behind or strap it to the roof. The Runabout is a dependable, comfortable design that has become nearly as ubiquitous as the Rumble Wagon out in the New West and Pecos Empire. Think of the Runabout is an off-road sedan or roadster.

The Runabout's active suspension allows it to adjust to road conditions and climb steep inclines garnering the ATV a reputation even in hilly and mountainous regions and Mexico. The buggy is powered by the same flex-fuel power plant as the Rumble Wagon, allowing it to use whatever fuel is available at hand. The flex-tires are made of a rubbery composite material that reacts like an air-filled tire when in motion but cannot be flattened or punctured by enemy fire or tire shredding obstacles. The vehicle package is rounded out with full six-wheeled steering (all six tires turn when the vehicle turns, not just the front two wheels), anti-lock braking on all six wheels, traction control, auto-compensating shock absorbing for a smooth ride and a full roll cage just in case the pilot manages to roll the buggy.

While the Runabout is sold as an unarmored vehicle, many mercenary companies and small militaries buy the Runabout ATV for use as a recon and sentry vehicle, often adding extra armor (can be increased 50%) and 2-3 weapons to the buggy to make it combat worthy. The buggy's speed and maneuverability make it perfect for the advance recon role, especially in desert and plains regions.

Model Type: BA-AT-602 Sedan.

Manufacturer: Bandito Arms.

Class: All-Terrain Passenger Vehicle.

Crew: One pilot with up to three additional passengers, or seven under cramped conditions.

M.D.C. by Location:

* Headlights (2) – 2 each

* Wheels (6) – 30 each

** Main Body – 155

* A single asterisk indicates a small and difficult target to strike, requiring the attacker to make a "Called shot," and even then the attacker is -3 to strike.

** Depleting the M.D.C. of the main body will shut the vehicle down completely, making it useless.

Speed:

Maximum Speed: 150 mph (240 km).

Range: 400 miles (640 km) per tank of fuel, with another 100 miles (160 km) for the backup electric charge.

Flying: Not possible.

Underwater Capabilities: Not possible.

Statistical Data:

Height: 5 feet (1.5 m).

Width: 10 feet (3 m) wide.

Length: 12 feet (3.6 m).

Weight: 2,975 lbs (1,339 kg).

Cargo: Average sized storage area for a commuter vehicle (a trunk) with room for extra supplies and personal weapons.

Power System: Flex-fuel internal combustion, with an electric battery backup. Optional nuclear power system has a 15 year life.

Cost: Flex-fuel version costs 68,000 credits and is the most common and popular. Nuclear costs 560,000 credits.

Weapon Systems: None.

Skim Sled

The Skim Sled is an unusual, low speed, ground hugging, stealth vehicle designed to penetrate guarded zones and high security perimeters undetected. Think hover surfboard with a wind-shield and aircraft-like steering mechanism for the hands. The pilot lies flat on his belly and the sled slides along the ground on a series of tiny, relatively quiet hover jets. The jets are much quieter than a hovercycle or vehicle and its black or camouflage color and low profile make it difficult to see. It can reach a height of four feet (1.2 m), but usually hugs the ground at about 6-12 inches (0.15 to 0.3 m). This allows the sled to avoid radar and most visual detection. Only when popping up to avoid an obstacle will the Skim Sled be easily detectable. Skimming just above the ground also prevents the sled from setting off most land mines or trip wires, and skims over dangers that would only harm someone on foot, like caltrops, punji-stakes, poisonous plants, insects or animals, etc.

Calling the Skim Sled a vehicle is a bit of a misnomer, as this is not something you would ride for transportation, but used to scout the perimeters of enemy positions and sneak onto bases,

camp and buildings. Designed for stealth and infiltration, the Skim Sled's cruising speed is only 15 mph (24 km), but it can achieve a maximum speed of 40 mph (64 km); enough to outrun a dog and most ordinary animals, as well as pursuers on foot. The hull of the skimmer is matte black, with a slim profile and coated in a radar absorbent layer to enhance its stealth properties (-15% penalty against those trying to spot the sled via Detect Ambush and Detect Concealment, and -30% to Sensory Equipment at cruising speed). The Skim Sled also has a couple of unique tricks to help with its mission profile. First, the sled can conceal itself by shooting out powerful jets of air, covering itself and its rider in sand, loose dirt, leaves and debris. This type of covering is not likely to blow off when traveling at cruising speed or slower. This increases the penalty to spot the Skim Sled by another -10%. This makes it ideal for use in the desert, dry forests and urban settings, but less effective in swamps, bogs or rocky terrain. The second feature is a low-power laser intended for cutting through wooden palisades, wire fencing, perimeter walls and other security barriers (S.D.C. or light M.D.C.). Designed to slowly, secretly and quietly cut a hole large enough for the sled and its rider to slide through, the laser is not a suitable offensive weapon. The preferred tactic is to float over to a fence or wall undetected, cut a hole through it and slip in and out of the hole. The pilot is usually a Case Man, criminal, scout, spy, saboteur or special forces, who then continues forward on the sled or on foot for the purpose of gathering intelligence, robbery, murder, sabotage, break someone out of a prison camp, and similar action. If the operative has remained unseen, once the deed is done, he can slip out the way he came in and vanish before anyone knows he was ever there.

Possession of the Skim Sled is strictly illegal in CS territory and owning one is an instant death sentence. As such, most Skim Sled sales are to criminals, mercenaries and other Black Marketeers with a need for such a limited and specialized vehicle. Of course, if you do need the sled, then the price is right even at twice the credits.

Model Type: BA-SS-01X

Class: One-Man Stealth Hovercraft.

Crew: One pilot.

M.D.C. by Location:

* Ultraviolet Headlight (2) – 2 each

* Concealed Low-Power Laser (1, nose) – 10

* Undercarriage Hover Jets (50, bottom) – 1 each

** Main Body – 50

* A single asterisk indicates a small and difficult target to strike, requiring the attacker to make a "Called Shot," and even then the attacker is -4 to strike.

** Depleting the M.D.C. of the main body will shut the vehicle down completely, making it useless.

Speed:

Ground Speed/Hovering: The hover propulsion system enables the Skim Sled to hover stationary up to four feet (1.2 m) high or skim across the surface of the ground. Maximum flying speed is 40 mph (64 km), but cruising speed is considered to be around 15 mph (24 km), slower while prowling along the ground. Maximum altitude is limited to four feet (1.2 m).

Flying: Not possible, this vehicle hovers above the ground.

Range: Electric is 500 miles (800 km), a nuclear power system gives the Skim Sled roughly five years of life under constant use, 10-20 years if not often used.

Underwater Capabilities: None. Cannot hover on the surface of water deeper than four feet (1.2 m).

Statistical Data:

Height: 2 feet, 6 inches (0.8 m).

Width: 3 feet, 6 inches (1.1 m).

Length: 7 feet (2.1 m) long.

Weight: 120 pounds (54 kg), built on a lightweight frame.

Cargo: None.

Power System: Nuclear; average energy life is only 5 years!

Cost: 575,000 credits.

Weapon Systems:

1. Concealed Low-Powered Laser: Concealed in the nose of the Skim Sled is a low-powered laser used to cut through wooden palisades, wire fencing, perimeter walls and other barriers. While not meant as a weapon, the laser can be fired as a normal laser but only does a limited amount of damage and it has a hard time hitting a target at range.

Primary Purpose: Cutting/Breaking and Entering.

Secondary Purpose: Defense.

Range: 10 feet (3 m) for cutting. 20 feet (6.1 m) as a weapon.

Mega-Damage: 3D4 M.D. per laser blast when used as a weapon. When used for slow cutting, the continuous beam laser will do 3D6 M.D. per melee round to fixed obstacles with fine precision, allowing the sled to cut an opening large enough for the vehicle to slip through perimeter barriers or for its pilot to crawl through.

Rate of Fire: Single shot only. Each blast counts as one melee attack.

Payload: Effectively unlimited.

Penalty: Not designed as a weapon, -3 to strike any moving target beyond a range of ten feet (0.3 m).

Thunderhead VTOL Flyer

The Thunderhead is a VTOL aircraft that resembles the Northern Gun Sky King in several design details, but is actually a pre-Rifts model, cargo hover-lifter with great strength and power. It is able to hoist up to 70 tons and suspend it from cables on short booms below the lifter. Those in the know suspect that the Sky King is also a pre-Rifts design, simply armed and armored for fighting. According to documents (owner's manuals) found in three Thunderheads unearthed near Las Vegas, the VTOL lifter was designed to replace the more mundane sky crane helicopters of the era.

While the overall appearance of the Thunderhead is similar to a Sky King, the VTOL lifter requires two crewmen, one is the pilot and the other the winch cable operator whose job it is to see that the load is properly hooked and lifted safely into the air. Once the load has been lifted up and held close to the Thunderhead's underbelly, the pilot flies the aircraft and its cargo to wherever it needs to go. The Thunderhead's hover jets are far larger than those of the Sky King and give the craft a bloated belly appearance which more than a few onlookers have compared to an oversized bumblebee, as its cable booms look a lot like insect legs.

The Thunderhead VTOL was designed to operate in and between pre-Rifts buildings on construction sites, in forests and other dense cover, in and around other aircraft, and on any job that required slow, but precision heavy lifting capabilities. These same

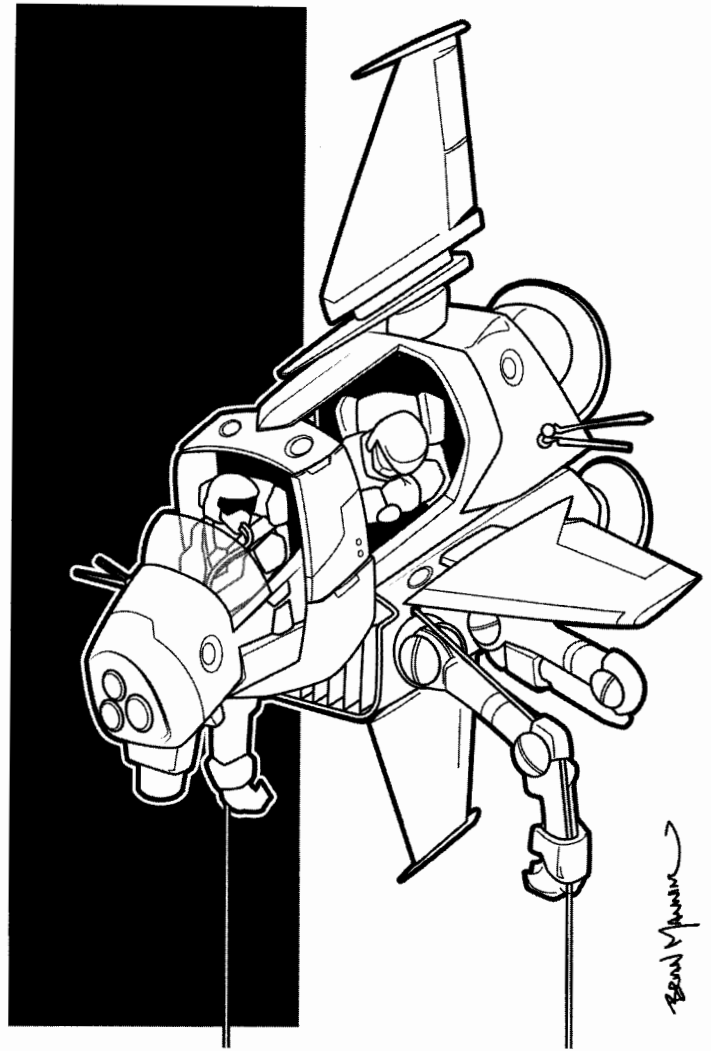

abilities have made it ideal for excavating pre-Rifts ruins or moving supplies and equipment.

While the Thunderhead is strictly a non-combat craft (it is sold without weapons), it is well armored for an aerial lifter to ensure that it can perform its job under dangerous conditions, like storms, hurricanes, forest fires, and even on a battlefield under-fire where it is used to evacuate damaged vehicles, field hospitals, insert and extract troops and giant robots, and other combat functions. The aircraft's powerful frame and enormous lifting capacity make it desirable by mercs and adventurers who have found adding a nose gun and wing missiles to be a simple matter without adverse effect on the performance of the aircraft.

Model Type: TH-VTOL-100L

Manufacturer: Bandito Arms.

Class: All-Purpose Heavy VTOL Lifter.

Crew: One pilot and one winch operator.

M.D.C. by Location:

* Headlights (6) – 2 each

* Landing Struts (3, tricycle-style) – 35 each

Concealed Winches (4) – 60 each, the cables have 5 M.D.C. per 1 foot (0.3 m) of length.

Control Vanes (1 top, 1 bottom) – 50 each

Extendable Cable Booms (4) – 50 each

* Small Maneuvering Jets (4 nose, 2 rear, 2 on each side) – 55 each

Main Lifting Jets (3, bottom) – 175

Main Propulsion Jets (2, rear) – 125
Reinforced Pilot's Compartment (cockpit) – 75
** Main Body – 250

* A single asterisk indicates a small and difficult target to strike, requiring the attacker to make a "Called Shot," and even then the attacker is -3 to strike.

** Depleting the M.D.C. of the main body will shut the vehicle down completely, making it useless.

Speed:

Ground Speed: Not possible. The Thunderhead has no ground wheels, just a set of landing struts.

Flying: The rocket propulsion system enables the VTOL Lifter to hover stationary up to 1,000 feet (305 m) or fly. Maximum flying speed is 570 mph (912 km), but cruising speed is considered to range between 100 and 200 mph (160 and 320 km). Can move no faster than cruising speed when lifting cargo over 10 tons. Maximum altitude is limited to 10,000 feet (3,048 m).

Flying Range: The nuclear power supply gives it decades of life, but the hover jets get hot and need to cool after a maximum of 12 hours of flight when traveling at speeds above cruising, and 48 hours with rest stops and/or at cruising speeds.

Underwater Capabilities: Not possible.

Statistical Data:

Height: 17 feet (5.2 m).

Width: 11 feet, 5 inches (3.5 m), not including the extendable winch booms which can reach out another 15 feet (4.6 m) to each side of the Thunderhead as needed.

Length: 22 feet, 10 inches (7 m) long.

Weight: 10,875 lbs (4,894 kg), not including cargo.

Cargo: Minimal storage space; about four feet (1.2 m) behind seats for extra clothing, weapons, and personal items. Of course the Thunderhead can hoist up to 70 tons suspended from its winch cables hanging below the lifter.

Power System: Nuclear; average energy life is only 15 years.

Cost: 1.8 million credits.

Weapon Systems: None.

Walker-Bike

Have you ever wanted to stomp around in a robot vehicle, but you're not a Robot Pilot? Or have you ever been racing through the back roads on your Highway-Man or Wastelander motorcycle and get bogged down in high grass or deep mud? Well, if you answered yes to either of these questions, Bandito Arms, has just the ride for you: the Walker-Bike!

So what does a Walker-Bike look like? Glad you asked. The Walker-Bike resembles your standard street bike, but this one appears to be fully kitted out with hard saddlebags and a touring trunk on the rear. On closer inspection, you notice that the saddlebags are actually a pair of humanoid robot legs folded tight at the knee and rolled back to the rear of the bike so that the foot and shin are pointing skyward. The foot too is folded down to form the final "saddlebag" arrangement. Likewise, the front forks are actually a pair of humanoid robot arms holding the front tire on either side by its center axle. The front tire suspension is provided by a subtle flexing of the arms.

At the flip of a switch, the legs rotate forward, unfolding to lift the rear wheel off the ground, while either one or both (rider's choice) of the hands let go of the front tire, readying them for use. In a standing position the legs remain connected to the bike's

frame and the bike's seat stays parallel to the ground with the rider perched on top. The arms hang down from the faring in a gorilla-like fashion, allowing them to assist in climbing and moving through rough terrain. The Walker-Bike's pilot remains in control of the Walker-Bike through the handlebars and foot controls, as well as specific verbal commands given through the radio receiver or high-gain microphone built into the vehicle.

In bike mode, the vehicle features anti-lock braking, traction control and an active suspension, which detects potholes and other dangers in the road surface and automatically adjusts the height and firmness of the front "suspension" arms, providing the best handling possible. The vehicle also features solid rubber tires, a bulletproof windshield (light M.D.C.) and a large touring trunk, with a set of external mechanical clamps for storing a weapon, tent, or other supplies.

While the Walker-Bike has no built-in weapons of its own, the pilot can use handheld weapons, or have it grab a weapon with the robot arms in walking mode. Even with a weapon, however, the Walker-Bike is really not a combat robot, it's just a vehicle (pilots only need the Pilot: Motorcycles skill to pilot the bike in either mode) that has the extra all-terrain feature of bipedal movement to walk through tall grass and underbrush, climb over debris and so on. It does not provide any augmented combat capabilities.

Model Type: BAW-09

Class: All-Terrain Robotic Motorcycle.

Crew: One pilot with one additional rider possible in emergencies.

M.D.C. by Location:

- * Headlights (3) – 2 each
- * Bulletproof Windshield – 5
- * Wheels (2) – 12 each
- Arms (2) – 80 each
- Legs (2) – 100 each
- ** Main Body – 150

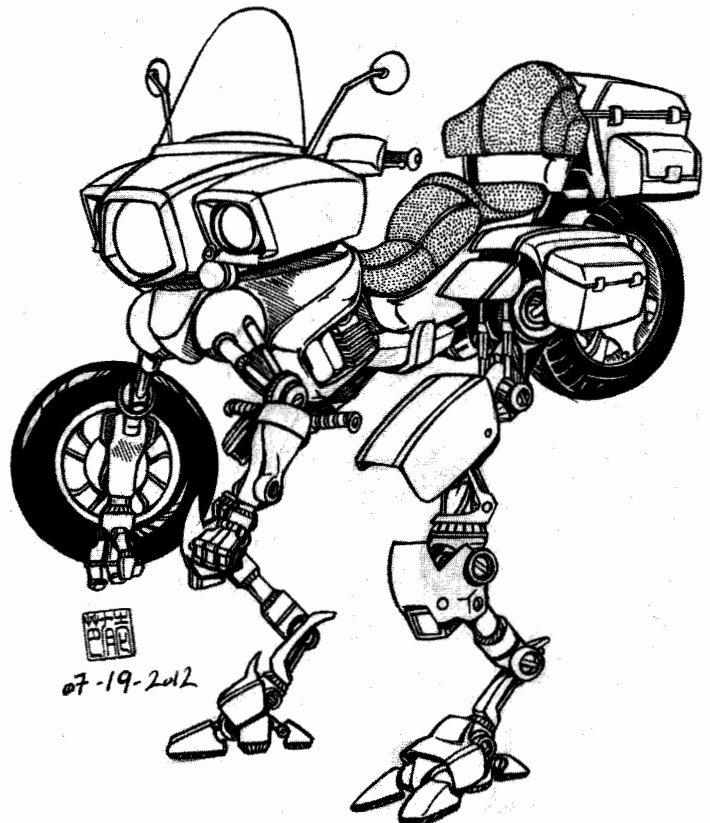

* A single asterisk indicates a small and difficult target to strike, requiring the attacker to make a "Called Shot," and even then the attacker is -4 to strike.

** Depleting the M.D.C. of the main body will shut the vehicle down completely, making it useless.

Speed:

Maximum Speed: 200 mph (320 km).

Cruising Speed: 100 mph (160 km).

Running: In addition to driving on its wheels, the Walker-Bike can run in walker mode at a speed of up to 75 mph (120 km).

Leaping: The robot legs can leap up to 15 feet (4.6 m) straight up or lengthwise.

Range: 900 miles (1,440 km) per electric charge.

Flying: Not possible.

Underwater Capabilities: Can walk or drive along the bottom of the sea or lake bed at about 25% of its normal running or cruising/maximum speed, or "swim" at a speed of 3 mph (4.8 km or 2.6 knots). Maximum Ocean Depth: 800 feet (244 m), but the rider will require some form of independent oxygen supply or full environmental body armor.

Statistical Data:

Height: 4 feet (1.2 m) in bike mode, but 7 feet, 6 inches (2.2 m) in walking mode.

Width: 4 feet, 4 inches (1.3 m), including saddlebags/legs.

Length: 10 feet (3 m) long.

Weight: 1,850 lbs (832.5 kg).

Cargo: A large touring trunk for personal items and small weapons, with a set of external mechanical clamps for storing a weapon, tent, bedroll, supplies or the front tire when the bike is in walker mode.

Power System: Electric engine and battery.

Cost: 645,000 credits.

Weapon Systems: None, but in walking mode the vehicle can use any human or cyborg-sized M.D. rifle, rail gun or melee weapon.

Combat Notes:

Physical Strength: In walker mode, the vehicle has the equivalent of a Robotic P.S. of 26.

Bonuses: +1 to dodge when running, +2 to dodge driving, and +1 to roll with impact.

Mega-Damage: May perform some limited hand to hand attacks. The number of attacks are the same as the driver's and each robot's action counts as one of the pilot's attacks.

Restrained Punch: 1D4 M.D.

Full Strength Punch: 1D6 M.D.

Power Punch: 2D6 M.D. (counts as two melee attacks).

Kick: 1D6 M.D. (it's not a fighting machine).

Leap Kicks and Stomp: Not possible.

Black Market Armors & Robots

By Carmen Bellaire, Kevin Siembieda
and Matthew Clements

Wrangler Riding Body Armor

Styled after Bandito's famous Branaghan armor, which the company has produced for years, the Wrangler Riding Armor is a heavier armor, but one that is specifically designed for riding in the saddle for long periods of time. The seat of the armor where the legs come together has more articulation than a normal suit of armor and padding. The inside seam is made from layers of enhanced Kevlar and mesh fabrics that keep the suit's environmental seal, but allow for comfort while seated on the saddle of a horse, robot steed, or other riding beast, as well as the seat of a motorcycle or hovercycle.

The body armor itself is pretty standard, but does have a definite Western flare to it. The top of the helmet resembles a cowboy hat, and has a flip-up visor/faceplate that can be sealed for full environmental protection when locked in a down position. The Wrangler has a pair of built-in holsters for side arms and several clips and clamps along the waist for ropes, bolas and similar cattle/herding gear. Its excellent mobility and ruggedness make the Wrangler perfect for riding, roping and handling ornery Mega-Damage dinosaurs and herd animals of the New West and Mexico (Duck-billed Honkers, Tri-Tops, Rhino-Buffer, etc.), protecting the wearer without impairing his actions. An optional M.D.C. long-coat is available for the Wrangler armor to keep the rain off and provide that little extra bit of style and protection, not to mention that Western cowboy look. Available in male and female models.

Weight: 16 lbs (7.2 kg), plus another 7 lbs (3 kg) for the optional long-coat.

Mobility: Excellent, no movement penalty, designed for horseback riding, but only good mobility when wearing the optional long-coat, -5% movement penalty.

M.D.C. By Location:

Helmet - 70

Arms - 32 each

Legs - 45 each

Main Body - 85 (+28 with M.D.C. long-coat).

Cargo: Standard attachment points for a hardened backpack, waist rope clips and a built-in pistol holster on each hip.

Cost: 47,000 credits, plus another 12,000 credits for the long-coat (or for the long-coat alone).

Special Features:

1. **All standard properties for Full Environmental Body Armor:** See the **Rifts® Ultimate Edition** rule book, page 267.

2. **Saddle Clamps:** The Wrangler allows even a novice rider to sit in the saddle like an old pro, with a set of integral clamps which can be used to securely hold the rider in the saddle, and even a sick or wounded rider can't fall from the saddle when these clamps

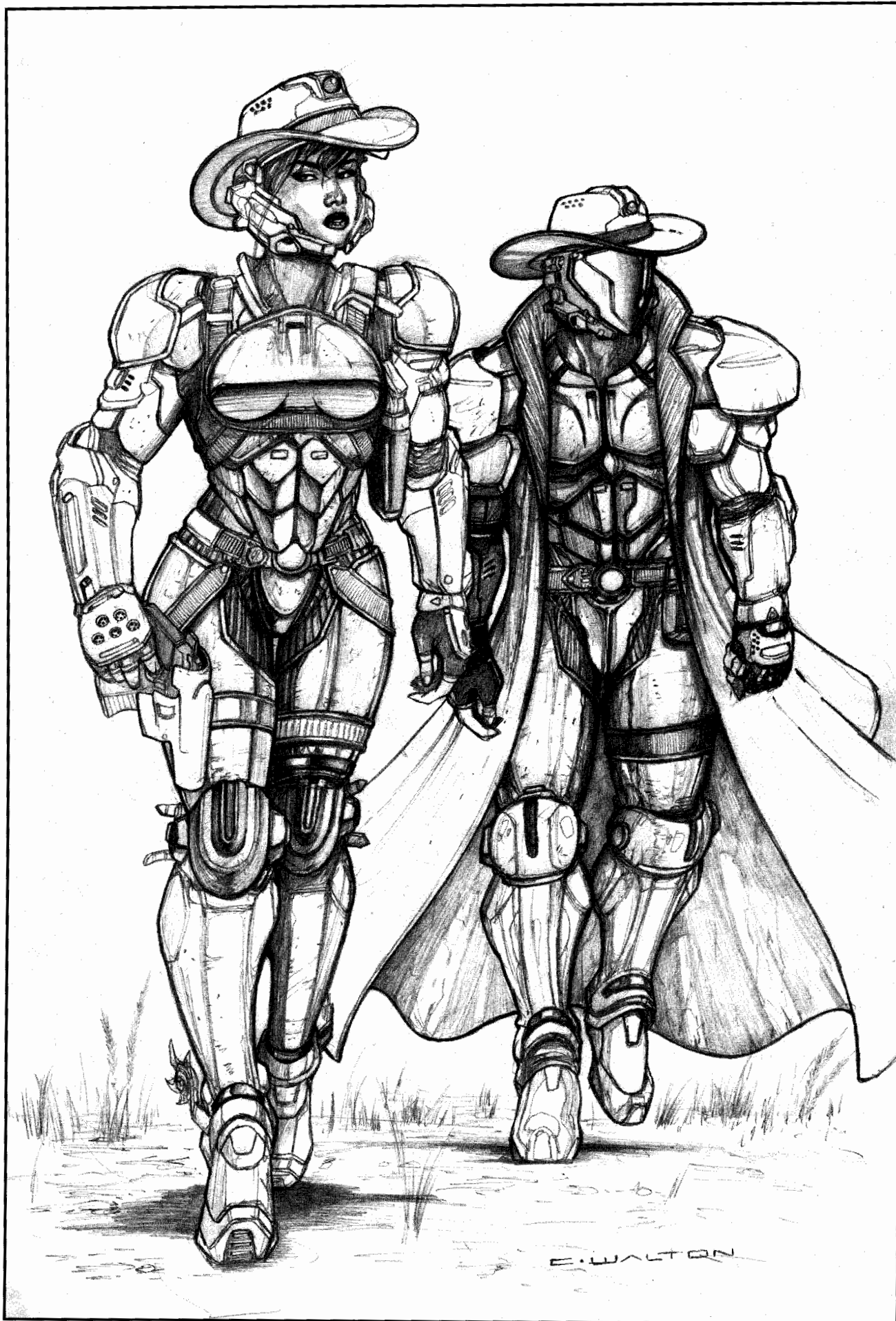

are engaged. One clamp is located at the rider's groin to hold the saddle horn or the front edge of a motorcycle's or hovercycle's seat and two clamps on the rear hips of the armor to hold the rear of the saddle or seat. Two additional clamps are located on the inside of the armor's knees to provide additional support if needed. With the clamps properly affixed it is nearly impossible to fall out of the saddle/seat, only a 01-05% chance, even if unconscious or dead!

3. Optional M.D.C. Armored Long-Coat: The long-coat or overcoat, also known as a "duster," is a favorite among Bandits, Cowboys, Gunfighters, Gunslingers, Saddle Tramps, and Sheriffs because it is both stylish and offers a surprising amount of protection, as well as providing pockets and serving as a raincoat – waterproof and a good article of clothing in which to hide a Big-Bore shotgun or rifle. The entire long-coat is lined with a type of Mega-Damage fabric similar to an enhanced form of Kevlar, with plates over the shoulders and chest for extra protection. Additional M.D.C. protection when worn: Main Body: 28, Arms: 12 each and Legs: 8 each. Cost: 12,000 credits from the Black Market, 13,000-15,000 credits from most other sellers.



Roadrunner Power Armor

The Roadrunner power armor is a light, inexpensive suit of basic power armor. Its simple design is to give the wearer enhanced speed, Robotic P.S. and jump capabilities. In fact, due to the jet pack thrusters that give the Roadrunner its ability to leap and bound, the armor is sometimes nicknamed the Grasshopper and Antelope.

A vectored thrust unit built into the back provides increased agility and mobility without actual flight capabilities. Brief applications of the thrusters enables the Roadrunner to engage in leap kicks, pouncing attacks, bounding dodges out of the way, and to close in on an opponent with a few quick leaps. The thrusters can

also be used to slow the descent of falls to land on its feet like a cat and suffer no or little damage from a height of 1,200 feet (366 m).

Model Type: PA-002G

Class: All-Terrain Power Armor.

Crew: One pilot.

M.D.C. by Location:

* Helmet – 75

Arms – 45 each

Legs – 80 each.

Thruster Jump Pack (1, back) – 60

Main body – 135

* A single asterisk indicates a small and difficult target to strike, requiring the attacker to make a "Called Shot," and even then he is -3 to strike.

** Depleting the M.D.C. of the main body will shut the armor down completely, making it useless. Until the wearer can remove it, he moves at one third his normal speed and all combat bonuses are -2 due to the dead weight of shredded armor.

Speed:

Running: Triple the usual speed of the wearer. For most people, that is in the range of Spd 35-50 or 24 mph (38.4 km) to 35 mph (56 km), and obviously faster for those with a Spd attribute of 20 or higher. The act of running does tire its operator, but only at 20% of the usual fatigue rate.

Leaping: The robot legs can leap up to 10 feet (3 m) high and 15 feet (4.6 m) across unassisted by the thrusters, and increase height and distance by 50% with a fast, running start. A jet thruster-assisted leap can propel the unit up to 60 feet (18.3 m) high and 120 feet (36.6 m) across without actually attaining flight.

Flying: Not possible. Hovering off the ground is possible, but only for 1D4+1 melee rounds before getting wobbly and shutting off. However, it can be used to slow the descent of falls and land on one's feet.

Underwater Capabilities: **Swimming:** The thrusters provide good mobility and control underwater and a speed of 15 mph (24 km); 22 mph (35.2 km) on the surface of the water. The Roadrunner can also walk along the bottom of the sea or lake bed at 25% of its normal walking/running speed. Maximum Ocean Depth: 1,000 feet (305 m).

Statistical Data:

Height: 7 feet (2.1 m).

Width: 3 feet (0.9 m).

Length: 2.8 feet (0.85 m).

Weight: 101 lbs (45.5 kg), including built-in thruster pack.

Physical Strength: Robot P.S. of 26.

Cargo: None. Only what the person can carry.

Power System: Nuclear; average energy life is 10 years.

Cost: 670,000 credits.

Weight: 101 lbs (45.5 kg), including VT pack.

Mobility: Excellent, no movement penalty.

Power Armor Features: Standard properties for Full Environmental Body Armor; see the **Rifts® Ultimate Edition** rule book, page 267.

Weapon Systems: There are no weapon systems built into this armor.

1. Handheld Weapons: Any hand-held weapon can be used by the Roadrunner, but large, bulky items, such as heavy energy weapons, grenade launchers and rail guns, will reduce running speed and jumping distance by 20%.

2. Hand to Hand Combat: Rather than use a weapon the pilot can engage in Mega-Damage hand to hand combat. See *Ground-Based Power Armor Training* on page 352 of **Rifts Ultimate Edition**. Damage as per Robot P.S. 26.

Restrained Punch: 1D4 M.D.

Full Strength Punch: 1D6 M.D.

Power Punch: 2D6 M.D. (counts as two melee attacks).

Kick: 2D4 M.D.

Short Leap Kick: 4D4 M.D., but counts as two attacks.

Flying/Thruster Launched Leap Kick: 4D6 M.D. and has a 01-50% chance of knocking down man-sized opponents weighing up to 500 pounds (225 kg), but counts as two attacks. Those knocked off their feet lose initiative and one melee attack.

Thrust-Assisted Body Block or Pounce Attack from Above: +2D6 S.D.C. damage on a restrained attack, 2D4 M.D. on a full weight attack, plus a 01-66% chance of knocking down man-sized opponents weighing up to 500 pounds (225 kg), but counts as two attacks. Those knocked off their feet lose initiative and one melee attack.

3. Bonuses: The body armor's augmentation, agility and jump capability give the pilot the following: +1 on initiative, +2 to automatic dodge (the act of dodging does not use up a melee attack), +2 to roll with impact, 01-66% chance of landing on his feet (no damage) from a fall at heights as great as 1,200 feet (366 m) and grants the user the ability to run along narrow ledges and trails as thin as five inches (12.7 cm) wide at full speed.

Shadow Boy Power Armor

With the limited success of the "Baby Boom Gun," the Bandito researchers turned their attention once more to the plans for the USA-G10 Chromium Guardsman, or *Glitter Boy* as it is known today. With its complete plans and schematics in their possession, they considered reproducing the Glitter Boy out of some other M.D.C. material, spraying it silver and pawning the resulting inferior armor off to would-be Glitter Boy Pilots, greenhorns and losers unable to tell the real thing from a fake. However, it was decided that such an inferior product and obvious deception would bring a terrible backlash on the Black Market, so the idea was scrapped. Furthermore, conventional armor cannot handle the boom of the Boom Gun, and the Black Market cannot make the dense, laser resistant armor, so they can't make a poor man's Glitter Boy that lasts more than a few minutes in combat; its own Boom Gun inflicting damage to the power armor and the pilot inside.

One day, one of the researchers came up with a simple, new idea. What if they made a Glitter Boy out of inferior material, gave it the *Baby Boom Gun* and some different weapons and features, painted it black so there could be no confusing it with "the" Glitter Boy, and sold it as something entirely new and different, under a different name. The fact that it still resembled a Glitter Boy would give the armor a sense of heroic history and the iconic Glitter Boy "vibe" that should appeal to power armor pilots, mercs and adventurers, and the Black Market could sell it for a fraction of the cost of a real Glitter Boy. After much debate, that's what Bandito Arms did, and it has been their hottest-selling new power armor since the release of the Bandito Arms SAMAS.

The marketing team thought the name "Shadow Boy" was appropriate and humorous, as its power level is a "shadow" of the

Glitter Boy's. The Shadow Boy is made from the exact same design and molds as the traditional Glitter Boy, but with a lighter, inferior M.D.C. armor. This armor can NOT reflect lasers (takes full damage from them), and in place of the big Boom Gun, it uses the *Baby Boom Gun* mounted on the exact shoulder housing as the traditional Boom Gun. With the extra support of the shoulder mounting, the power armor has sufficient strength to fire the Baby Boom Gun *without* the anti-sway pylons and recoil dampening thrusters. As a result, the anti-sway pylons were eliminated, clearing space in the design for something new. In the space left in the legs, the Bandito engineers installed a pair of powerful jump jet thrusters. On the back, they left the Glitter Boy *Recoil Suppression System*, which now functions as another jump jet system that propels the Shadow Boy a good distance, especially with a running start. The jets in the back augmented by the jump jets in the lower legs enable the Shadow Boy to perform jet-assisted leaps and bounding high-speed travel like that performed by the *Triax T-21 Terrain Hopper*. The Shadow Boy might be thought of as the faster, bounding cousin to the USA-G10 Glitter Boy, twice removed. It all works surprisingly well, though the Shadow Boy is a bit top and front heavy when leaping with the Baby Boom Gun extended forward in a firing position. The armor is much more balanced when the weapon is in its stowed position behind the right shoulder.

In addition to the Baby Boom Gun are a number of additional backup weapons to add some flexibility and versatility to the Shadow Boy. A compact variable laser is mounted on the right forearm, a forearm plasma ejector is built into the left forearm, and each arm has a retractable/extendable Vibro-Sword that slides out from a housing on the forearm.

The Shadow Boy operates on the battlefield in a very different way from a traditional Glitter Boy, running, jumping, bobbing and weaving as it goes. It can certainly stand its ground like a Glitter Boy too, but this is not an effective use of the power armor. As its name suggests, the Shadow Boy can hide in the shadows or use the darkness of night to mount its attacks or strike from an ambush point. It can also leap from rooftop to rooftop, sniping at the enemy or using hit and run tactics. The best Shadow Boy pilots are always on the move, sneaky and above all, fight smart.

Model Type: Bandito-G10-SX

Class: Stealth Infantry Personnel Assault Unit.

Crew: One pilot.

M.D.C. by Location:

Baby Boom Gun (1) – 100

Ammo-Drum (1, back) – 80

* Forearm Variable Laser (1, right) – 40

* Forearm Plasma Ejector (1, left) – 50

* Concealed Vibro-Swords (2) – 70 each

* Hands (2) – 35 each

Arms (2) – 100 each

Legs (2) – 170 each

* Leg Jump Jets (2, rear of legs) – 20 each

* Main Thruster/G.B. Recoil Suppressor System (1, back) – 90

** Head – 115

*** Main Body – 312

Reinforced Pilot's Compartment – 150

* A single asterisk indicates a small and difficult target to strike, requiring the attacker to make a "Called Shot," and even then the attacker is -4 to strike.

** Destroying the head will eliminate all forms of optical enhancement and sensory systems. The pilot must rely on his own



C. WALTON

vision and senses. In addition, all combat bonuses are lost. The head is a comparatively small, moving target and can only be hit when an opponent makes a Called Shot and even then, the attacker is -1 to strike.

*** Depleting the M.D.C. of the main body will shut the power armor down completely, making it useless.

Speed:

Running: 80 mph (128 km) maximum. Note that the act of running does tire its operator, but only at 10% of the usual fatigue rate thanks to the power armor's robotic exoskeleton.

Leaping Without Thrusters: The robot legs can leap up to 15 feet (4.6 m) straight up or lengthwise unassisted by the thrusters. Add 10 feet (3 m) with a running start.

Power Jumping and Travel: A jet thruster-assisted leap from a stationary position can propel the unit up to 80 feet (24.4 m) high and across. Double the distance with a running and leaping start.

The powerful jump jet thrusters enable the Shadow Boy to leap into the air and across distances in a bounding style of movement. Getting a running start and engaging the thruster in a forward direction, the Shadow Boy is propelled 160 feet (49 m) lengthwise. The height of the leap is controlled by the pilot and generally ranges between 20-50 feet (6 to 15.2 m). By leaping, landing, continuing to run a few dozen yards/meters, and power leaping again, the pilot can attain and maintain an impressive ground speed of 110 mph (176 km), even through scrub and light forest. Speed should be reduced to 40% when traveling through dense vegetation, water greater than hip deep, deep mud, deep snow, or other hazardous terrain. Failure to do so will result in jarring and potentially damaging collisions (2D6 M.D.), accidents (damaging or hurting others, 2D6 M.D.), and falling. (01-50% chance every landing under adverse conditions. A fall causes the power armor to lose momentum, lose one melee attack/action and the crash can alert enemies to the Shadow Boy's presence and position.) **Note:** Power Jumping Travel in a light to heavy forest makes a considerable amount of noise as this heavy power armor crashes through tree branches, makes a thundering landing and repeats. There is no chance of stealth leaping through trees and underbrush. It makes a lot of noise and alerts predators, enemies and others to one's position. It also reduces the pilot's vision and awareness: -3 on initiative and Perception Rolls, and -1 to strike, parry, and dodge due to obscured vision and rate of travel.

Directional control by the pilot is surprisingly good, but the pilot can NOT stop in mid-air, nor can he hover above the ground for more than a second or two. He can change direction/trajectory in mid-leap in as much as a 45 degree angle, and he can land softly when desired (makes a light thud). However, having to suddenly engage the jump jet thrusters in mid-flight to avoid a collision or bad landing will slow the pilot's speed, burns up one melee attack/action and is done with a penalty of -3 to dodge and strike.

Flight: Not possible.

Underwater Capabilities: The thruster system provides good mobility and control underwater but at a sluggish speed of 15 mph (24 km or 13 knots) swimming; same speed on the surface of water. The armor can also walk along the bottom of the sea or lake bed at about 25% of its normal walking/running speed. Maximum Ocean Depth: One mile (1.6 km).

Statistical Data:

Height: 10 feet, 5 inches (3.1 m).

Width: 4 feet, 4 inches (1.3 m).

Length: 4 feet (1.2 m).

Weight: A little less than one ton fully loaded.

Physical Strength: Equal to Robot P.S. of 30.

Cargo: Minimal storage space; a one foot (0.3 m) compartment and storage for a rifle, pistol, survival knife and first aid kit.

Power System: Nuclear; average energy life is 25 years.

Cost: 12 million credits.

Weapon Systems:

1. Baby Boom Gun (1): This main weapon is the *RG-14-LX Light Rapid Acceleration Electromagnetic Rail Gun*, based on the icon Boom Gun. The Baby Boom Gun has a range better than most rail guns, does good damage, and makes a loud "boom" when fired, but not so loud as to cause an ear-shattering sonic boom. The Baby Boom Gun is, in effect, an auto-cannon that has excellent range and destructive power without requiring the extensive system of rocket motors and support pylons in order to fire. Only a single reaction jet built into the weapon is required to counter most of the recoil generated by the Baby Boom Gun. And it still fires the Boom Gun flechette shells, just at a slower speed.

Weight: Baby Boom Gun: 350 lbs (157.5 kg): plus ammo. Uses the same ammo drum as the Glitter Boy with 1,000 rounds!

Range: 5,000 feet (1,524 m).

Mega-Damage: One Boom Gun flechette that inflict 1D6x10+10 M.D. when fired by this weapon. The rounds of the RG-14-LX are fired at much slower speeds and do not cause a sonic boom when fired; no deafening boom nor collateral shock wave damage. It does have a very loud report (a pop like a big firework or small cannon going off) and can be heard for at least one mile (1.6 km) away; double or triple if carried by the wind and the ambient sound level is quiet.

Rate of Fire: Single shot. Each blast counts as one melee attack. Bursts and sprays are not possible.

Payload: 1,000 rounds (shots) loaded in the standard Glitter Boy ammo drum mounted on the back of the power armor. The ammo canister can be reloaded by hand, one round at a time as necessary, but it takes 15 minutes to reload 100 rounds into the ammo drum. It takes only two melee rounds (30 seconds) for a two-man team to attach a new ammo drum onto the back. Note that these are the same Boom Gun rounds used by the Glitter Boy and are completely interchangeable with rounds from a standard Glitter Boy Boom Gun. The energy to fire weapon is provided by the power armor's nuclear power supply.

Bonus: Laser targeting standard, but on the Shadow Boy, the weapon has no bonus to strike even on aimed shots.

2. Variable Forearm Laser (1, right arm): A simple, compact variable laser is built into the forearm of the right arm. It is included to provide some additional ranged firepower. The variable frequency laser cannon is designed to overcome laser resistant armor and has 18 different light frequencies in its memory. It automatically resets itself after one attack if the target proves to be resistant to that frequency of light.

Primary Purpose: Anti-Aircraft/Anti-Missile.

Secondary Purpose: Anti-Personnel.

Range: 2,000 feet (610 m).

Mega-Damage: 3D6 M.D. per single blast.

Rate of Fire: Each single shot counts as one melee attack.

Payload: Effectively unlimited.

3. Arm-Mounted Short-Range Plasma Ejectors (1, left arm): Mounted on the left forearm is a powerful, but short-ranged plasma ejector for devastating short-range combat.

Primary Purpose: Assault.

Secondary Purpose: Defense.

Range: 800 feet (244 m).

Mega-Damage: 5D6 M.D. per single blast.

Rate of Fire: Each shot counts as one melee attack.

Payload: Effectively unlimited.

4. Concealed Vibro-Swords (2): An extendable Vibro-Sword is concealed in the underside of each forearm weapon housing.

Primary Purpose: Anti-Personnel/Close Combat.

Secondary Purpose: Defense.

Range: Melee combat only, with a two foot blade (0.6 m) length.

Mega-Damage: 2D6 M.D. per strike.

5. Handheld Weapons: Giant-sized M.D. rifles, giant melee weapons and rail guns may be used in addition to the built-in weapon systems, as desired. However, most Shadow Boy pilots stick to the weapons they have.

6. Hand to Hand Combat: Rather than use a weapon the pilot can engage in Mega-Damage hand to hand combat. See *Ground-Based Power Armor Training* on page 352 of **Rifts® Ultimate Edition**. Characters of the Glitter Boy O.C.C.s, ONLY, use their usual *Power Armor Combat Elite: Glitter Boy* (see pages 72-73 of **Rifts® Ultimate Edition**). However, the fighting styles of the Glitter Boy and Shadow Boy are completely different.

7. Sensor System Note: The Shadow Boy has all the normal sensors and features standard to environmental power armor (see the **Rifts® Ultimate Edition** rule book, page 271), plus the following:

1. Optical Systems: Full optical systems, including laser targeting, telescopic, passive nightvision (light amplification), thermal-imaging, infrared, ultraviolet, and polarization.
2. Other Features: Built-in language translator and depth gauge.

Mole Prospecting Robot

Not everyone who wishes to hunt for gold, silver and valuable ore wants to throw away their humanity and become a Mining 'Borg or risk life and limb without armor, though many do. For them, the best option is the Mole Prospecting Robot. Bandito Arms has put all its expertise in designing mining equipment for cyborgs into the Mole robot. The actual robot design is a prototype stolen by the Black Market from Northern Gun. The Mole is heavily built with powerful robotics and heavy armor in case of cave-ins. Should the armor get trapped underground for an extended period of time, it is equipped with a rebreather/CO2 scrubber, a water recycling system and a small refrigeration unit for holding food; enough to last two weeks. Due to the demands of mining, the pilot of the Mole sits at a small control console in the chest of the 'Bot. With the Mole's weight and purposeful design, the mining robot is short, squat, and ponderous, but then the Mole doesn't need to make a sneak attack on a vein of gold or to dig up coal.

While the Mole is not a combat power armor, most of its mining systems make impressive weapons if an enemy gets close enough to the Mole for them to be effective. One arm, either the right or the left, ends (no hand) in a powerful mining drill, which, in turn, is surrounded by four laser emitters. The Mole's laser cutters are used to cut through stone and steel and can fire individually, in pairs or all four. Mounted on the forearm of the mining drill arm is a hydraulic jackhammer that can extend far past the drill bit to batter stone and rock into powder. The opposite arm, left or right, from the mining drill has a modular forearm and modular hand

housings that allow either of them to be swapped out for a variety of mining attachments, the same type of tools used by the Mining Cyborg, only larger (see **Rifts® World Book 14: New West™**, page 187, for the Mining 'Borg Attachments and add 1D6 damage to the robot versions). And mounted on the back of this arm (just above the modular housing connection) is a ferro-concrete sprayer, which can be used to spray down streams of ferro-concrete foam which starts to instantly harden (in 1D4 melee rounds) into a strong, M.D.C. structural support for reinforcing the walls and ceiling of a mine to prevent cave-ins. The Mole has everything the prospector could want in a piece of mining equipment.

Model Type: R-050 – The Mole Prospecting Robot.

Class: Prospecting and Mining Powered Armor.

Crew: One.

M.D.C. by Location:

Mining Drill – 50

Hydraulic Jackhammer – 100

* Cutting Laser Emitters (4) – 15 each

* Ferro-Concrete Sprayer – 25

Ferro-Concrete Holding Tank (1; on back) – 80

Modular Forearm – 100

* Modular Hand – 45

Shoulders & Upper Arms – 150 each

Legs – 180 each

** Head (low profile) – 120

*** Main Body – 420

* A single asterisk indicates a small and difficult target to strike, requiring the attacker to make a "Called Shot," and even then the attacker is -4 to strike.

** Destroying the head will eliminate all forms of optical enhancement and sensory systems. The pilot must rely on his own vision and senses. In addition, all combat bonuses are lost. The head is a comparatively small, moving target and can only be hit when an opponent makes a Called Shot and even then, the attacker is -2 to strike.

*** Depleting the M.D.C. of the main body shuts the robot down completely, making it useless.

Speed:

Running: Only 30 mph (48 km) maximum. Cruising speed is a more cautious 15 mph (24 km). Note that the act of running does not tire out its operator.

Leaping: Not possible.

Flight: Not possible.

Underwater Capabilities: The Mole cannot swim, but can walk along the bottom of the sea or lake bed at about 25% of its normal walking/running speed. Maximum Ocean Depth: One mile (1.6 km).

Statistical Data:

Height: 15 feet, 9 inches (4.8 m) from head to toe.

Width: 10 feet (3 m).

Length: 8 feet, 6 inches (2.6 m).

Weight: 8.4 tons.

Physical Strength: Equal to a Robotic P.S. of 40.

Cargo: Small area for the pilot's personal items, as well as a weapon bin that has room for one rifle, one pistol, light body armor and a canteen. A four gallon (15 liters) water cooler and a compact refrigerator are built into the robot.

Power System: Nuclear; average life is 20 years.

Cost: 7.9 million credits, but interchangeable mining attachments cost extra.

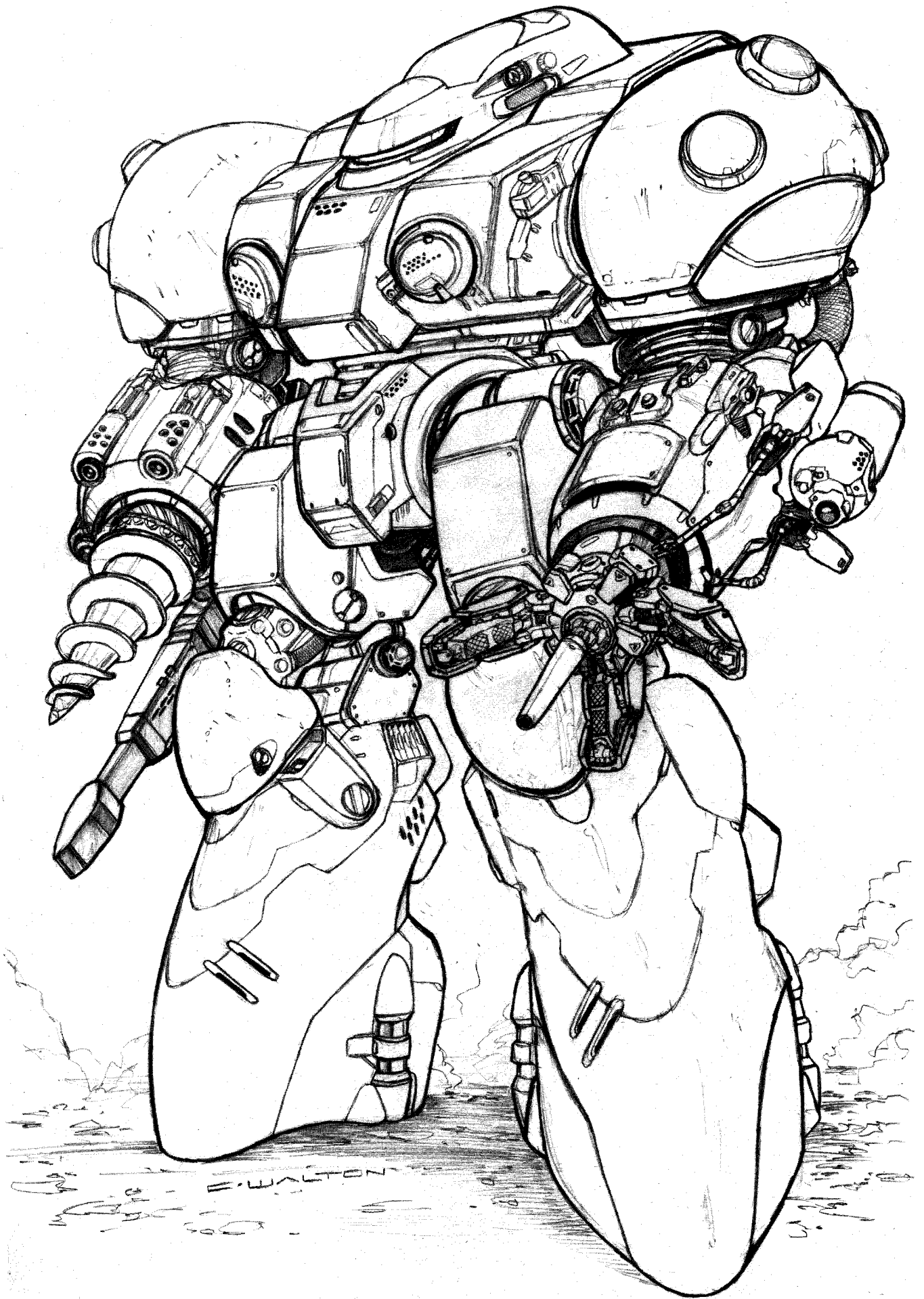

Weapon Systems:

1. Mining Drill: In place of one of the Mole's hands and forearm (buyer's choice as to which one) is a huge, powerful drill made for making large holes (a man can fit his head into one of these holes) in rock and metal and for drilling away rock.

Primary Purpose: Mining.

Secondary Purpose: Defense.

Range: Melee combat only, with an 8 foot (2.4 m) reach.

Mega-Damage: 6D6 M.D. per strike.

Attacks per Melee Round: Each attack counts as one melee attack.

2. Hydraulic Jackhammer: Mounted on the back of the mining drill is a heavy-duty Jackhammer designed to break rock into small pieces, typically used on rock that has already been drilled in order to clear rock during mining.

Primary Purpose: Mining.

Secondary Purpose: Assault.

Range: Melee combat only, with an 9.6 foot (2.9 m) reach.

Mega-Damage: 3D6 M.D. per strike. A full melee round of rapid-fire jack-hammering to a stationary target does 2D4x10+6 M.D. and may cause faults in rock and materials to crack and weaken. **Note:** Does half damage to M.D.C. hatches due to their armored design and locking mechanisms.

Attacks per Melee Round: Equal to the number of combined hand to hand attacks of the pilot and his Robot Piloting skill.

3. Cutting Lasers (4): There are four cutting lasers mounted equally spaced around the top and side of the mining drill. They are designed to cut through steel, roots, earth and rock. While not meant as a weapon, the cutting laser can do a lot of damage at short range.

Primary Purpose: Mining.

Secondary Purpose: Anti-Armor/Anti-Robot.

Range: Normal range as a tool is only 50 feet (15.2 m), and usually much closer. In a pinch, the lasers' range can be extended to 200 feet (61 m), but it takes two full melee rounds (30 seconds) to recalibrate them. Normally used at a range of just 10-20 feet (3-6.1 m), or less.

Mega-Damage: 2D6 M.D. per single laser, 4D6 M.D. per dual blast, 6D6 M.D. for a simultaneous triple blast and 1D4x10+4 M.D. for a quad blast. When each laser fires simultaneously at the same target it counts as one melee attack.

Rate of Fire: Single shot, but can fire simultaneously. When 2-4 lasers are fired simultaneously at the same target, it counts as one melee attack.

Payload: Effectively unlimited.

Penalty: Not designed as a weapon, -2 to strike any target beyond a range of 50 feet (15.2 m).

4. Ferro-Concrete Sprayer: The sprayer looks a lot like the nozzle of a fire hose, but sprays ferro-concrete foam from a large liquid storage tank on back of the Mole. Used for reinforcing the walls and ceiling of a mine to prevent cave-ins.

Primary Purpose: Mining.

Secondary Purpose: Defense.

Range: Only 30 feet (9.1 m)!

Mega-Damage: None, just immobilization of the target. A successful dodge means the target is not struck with the concrete. If the dodge is not successful, the victim is covered in ferro-concrete spray that hardens in four melee rounds. If allowed to harden, a single "spray" of the foam has 15 M.D.C., and can, in effect, freeze the joints of limbs, cover and block sensory arrays (they don't work), cover windows, and cover the barrel of a weapon, preventing the weapon from firing (the barrel explodes and the weapon is

knocked out of use if it is tried). Frozen joints can impair (reduce by half) movement and speed of legs, immobilize arms and legs, and knock out hover jets and thrusters. None of which work until the cement can be removed, usually by chipping it away; using M.D. energy weapons or fire works faster, but half the damage inflicted also damages the robot, power armor or vehicle it is being leveled against. Magic spells that turn stone to other materials are ideal, but the material will still have to be removed, which takes 2D6 minutes. **Note:** The best countermeasure is to *wash the concrete off* within the first minute (four melee rounds) before it starts to harden. Washing it off or diving into a body of water cleans the residue off in one melee round (15 seconds).

Rate of Fire: Each use counts as one melee attack.

Payload: The sprayer holds enough ferro-concrete foam for 20 "sprays" in total. Replacement liquid foam costs 5,000 credits for another tank of 20 sprays.

Penalty: Not designed as a weapon, -3 to strike any moving or dodging target. It is designed to spray on wooden support beams, arch supports, walls, ceilings and floors as necessary.

5. Handheld Weapons: Giant sized melee weapons and wooden or iron beams, or stone may be picked up and used as weapons, but typically, no ranged weapons.

6. Hand to Hand Combat: Rather than use a weapon the pilot can engage in Mega-Damage hand to hand combat. Due to its design, use *Heavy Vehicular Style Robots Training* on page 352 of **Rifts Ultimate Edition**, plus the following and as per Robot P.S. of 40.

Slow and ponderous: -3 to dodge all attacks, but no penalties to strike or parry.

Restrained Punch: 1D4 M.D.

Full Strength Punch: 2D6 M.D.

Power Punch: 4D6 M.D., but it counts as two attacks.

Kicks and Leap Kicks: Not possible.

7. Sensor System Note: The Mole Prospecting Robot has all the standard sensors of robot vehicles (see the **Rifts® Ultimate Edition** rulebook, page 273).

Robot Animals

Bandito Arms, Northern Gun, Titan Robotics, and the Manistique Imperium have found a surprisingly lucrative market making and selling robot animals. It started out with robot horses, but has expanded into other animals such as robot cat and dog companions, and more exotic fare. Bandito Arms leads the way in this area, and are the only ones to offer robot animals with compartments for smuggling..

Robot Animals with Hidden Compartments

"Here it is, your delivery." Zimov gestured towards the *Nodosaurus* that stood in front of them.

"What are you talking about? Inside the dino?"

"You could say that, yes."

"Wow, that's cold-blooded."

"What?"

"You just fed it all those guns? We're never gonna get 'em all out." Harold paced around the hulking creature. "We're gonna have to kill this thing and slice it open now. I thought you Simvan took care of your animals?"

Zimov smiled and produced a small remote from a satchel.

"I do not think you fully understand."

He pressed one of the buttons on the remote.

The Nodosaur shuddered and began to shake slightly. Its broad, armored back disconnected from the rest of the animal and began to rise up on hydraulic pistons. Under the facade were wires and mechanisms, along with flaps of leathery, artificial skin. Inside the body itself were dozens and dozens of rifles packed in straw and wrapped in bundles. Northern Gun models, mostly, but Harold could see a few Wilk's products too.

"Well I'll be damned."

"I know we Simvan don't really get along with machines, but I have to make an exception for this one." Zimov patted the robot-Nodosaur's head. The dim-witted robot didn't respond.

"That's a nice trick there, Zimov. What about the E-Clips?"

Zimov pressed another button on the remote. The Nodosaur's mouth opened and the creature began to cough up dozens and dozens of E-Clips, along with a few belts of rail gun ammo.

Harold laughed heartily and shook hands with Zimov.

"Very nice, my friend. Very nice."

In the New West, robotic horses, pack animals and canine companions have always been hot-selling items, sometimes designed to resemble actual flesh-and-blood animals. Such models can be expensive, but recreate the look and feel of a real creature while maintaining the abilities of a sophisticated robot.

Black Market Smugglers have expanded upon this concept, creating robot animals with hidden compartments for hiding and transporting contraband. As this is a big secret and used exclusively by Black Market Smugglers, animal robots with compartments are sold ONLY to trusted, fellow Black Marketeers who still marvel that nobody else has thought of this. The Black Market has been using fake animals, especially large creatures, for almost a decade, but it is such a closely held secret and handled with such discretion, that nobody else knows about this Black Market Smuggler's trick. Not even the majority of Black Marketeers. Unlike the example above, the Black Market Smugglers never unload merchandise in front of others, not even other Black Marketeers, and sometimes not even in front of other Black Market Smugglers. The effectiveness of these disguised cargo transports would be destroyed if a wide number of people knew about them or if the robots were offered on the open market.

Bandito Arms, Northern Gun and Titan Industries have been making robot cats and dogs to function as companions and wilderness scouts and selling them on the commercial market for years. But only Bandito Arms has a secret smugglers' line of such animals with a small internal space for storage. Such small animals are ideal for smuggling drugs, jewels, currency cards, E-Clips, pistols and other small items. Horses, mules and camels are all large enough to support big inner cavities for smuggling larger items and more contraband. They also make good riding animals, and all are sold as conventional robot steeds. As clever as this may be, Bandito Arms has taken the idea even farther by creating much larger robot animals for the sole purpose of smuggling.

The largest and most impressive artificial animals are robotic Rhino-Buffalos, Nodosaurs and other dinosaurs that can carry tons of cargo in concealed compartments in their bellies. And while such complex robots are expensive, it is easier to craft convincing fake dinosaur scales and thick Rhino-Buffalo hide than to actually build a realistic horse or dog, and the naturally unexpressive nature of such beasts helps preserve the deceptive illusion. The real trick

to making these smuggling operations a success is to cover the robots in fake skin. Since all of these creatures are herd animals, you can hide an entire convoy of contraband inside a disguised robot herd and nobody is the wiser. Since herds of the giant beasts are more deadly than a few animals, most people give them a wide berth. The plan is pure genius. The perfect cover, especially in the New West, Southwest, Deep South, Dinosaur Swamp and Mexico. Then a Black Marketeer R&D guy took it another step. To help keep the smuggler's herd protected, what about creating a few giant robot predators like the T-Rex? Tyrannosaurus Rex, Raptors and other big predators often trail and shadow such herds, attacking when one or two stray from the rest of the herd. In this case, the faux predator hangs back to protect the herd of fake robot beasts carrying cargo. If the herd is approached by Simvan, bandits or travelers, 2-3 Tyrannosaurus come charging out. Both scatter nomads and potential troublemakers in a heartbeat. Nobody hangs around to fight such monsters if they don't have to.

El Oculata have a special group of Simvan Monster Riders they use to haul actual, low value cargo such as grains, clothing and the like. A third of the animals the Simvan ride and use as cargo haulers are real, living creatures, the rest are cargo robot dinosaurs/animals made to look real. The robots also haul low-end cargo, and carry the valuable goods inside their bellies. This is perfect when traveling through areas controlled by the more opportunistic elements of the Pecos Bandits and other raiders. Loaded with harmless sacks of corn or beans, the animals are unlikely to draw enough attention for anyone to discover the secret treasure trove inside their life like bodies. And remember, NOBODY suspects the Black Market even has such disguised cargo hauling robots.

The following are the most popular versions of artificial animals with smuggling compartments. We start with small, common animals and work our way up to monster cargo haulers and robot steeds. Note that cargo haulers seldom have as much M.D.C. as a robot steed or animal companion for the consumer market.

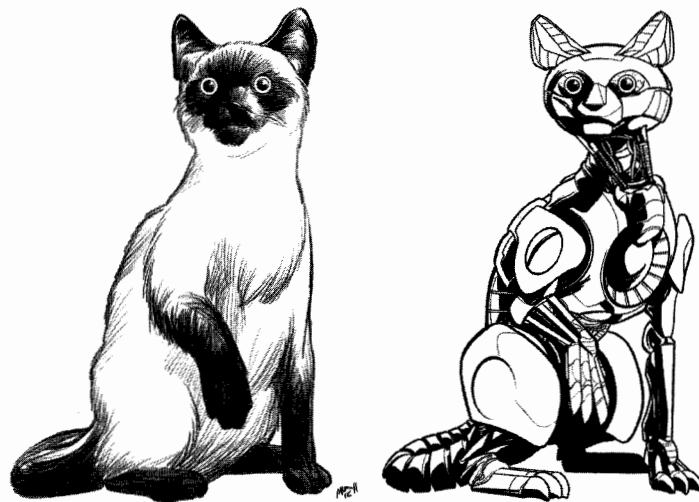

Smugglers' Robot Cat

Robot cats are small and can be effective for their ability to mimic a cat that is asleep or resting. They are quite convincing and virtually indistinguishable from the real thing, especially when carried in its owner's arms or purring as it is petted in his or her lap. Little does anyone know that there is a Vibro-Knife, energy pistol, magic item or a few million in gems inside.

M.D.C. by Location:

Head – 10

Legs (4) – 10 each

* Main Body – 25

* Destruction of the main body renders the robot useless. Destruction of the head shuts it down. Destroying one leg hobbles the robot and reduces speed and leaping distance and height by 30%.

Speed:

Running: 10 mph (16 km) maximum.

Leaping: 5 feet (1.5 m) high or across.

Flying: Not possible.

Underwater Capabilities: None; the robot's hollow insides allow it to float for a short while (2D6 minutes), but it is unable to swim or maneuver in the water.

Statistical Data:

Height: About 1 foot (0.3 m).

Width: About 0.5 feet (0.15 m).

Length: About 1.5 feet (0.45 m), plus a tail of a foot (0.3 m) long.

Weight: 10 pounds (4.5 kg) empty.

Color/Appearance: Available in black, gray, orange, brown, white and tabby.

Attributes of Note: Robot P.S. of 6, Spd 15.

Power System: Rechargeable battery or E-Clip. A single charge or E-Clip can power the animal for up to one week of walking and moving around, or up to a month if the drone can remain mostly still. A nuclear power supply (10 year life) is available but seldom used.

Cargo: The cat's internal compartment is roughly half the size of a shoebox and can hold up to 20 pounds (9 kg).

Cost: 290,000 credits.

Weapon Systems: None.

Combat Notes: The robot is designed to move and act just enough to make it seem real. Complex actions like combat are not included in the robot drone program, nor is the robot designed for much else other than walking.

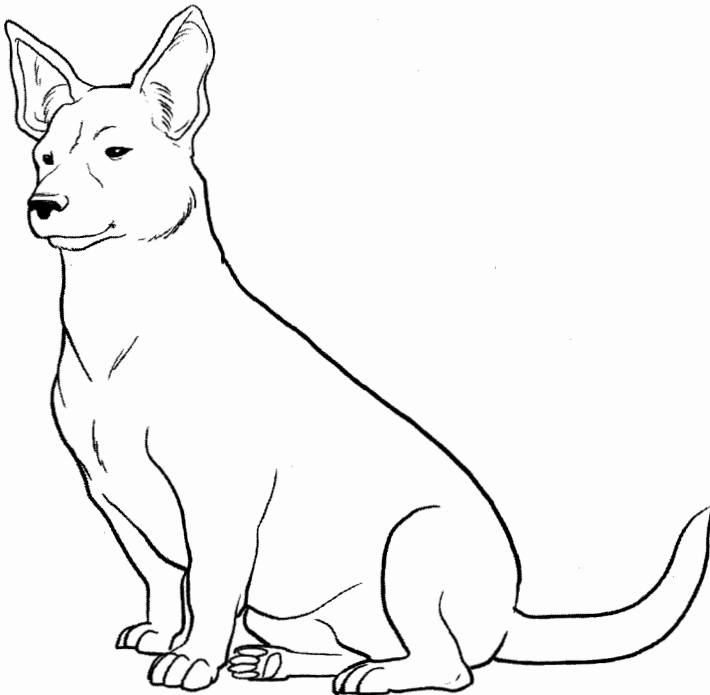

Smugglers' Robot Dog

Robot dogs are larger and sturdier than the cat model and designed for long periods of walking and prolonged activity. They are usually modeled after medium or large-sized dogs in order to

provide for a larger internal compartment. Unlike the Bandit K-9 companion, they are unarmed and possess a very rudimentary artificial intelligence programmed to behave like a loyal pet.

M.D.C. by Location:

Head – 30

Legs (4) – 20 each

* Main Body – 50

* Destruction of the main body renders the robot useless. Destruction of the head shuts it down. Destroying one leg hobbles the robot and reduces speed, leaping distance and height by 30%.

Speed:

Running: Up to 25 mph (40 km).

Leaping: Five feet (1.5 m) high and 10 feet (3 m) lengthwise.

Flying: None.

Underwater Capabilities: None; the robot's hollow insides allow it to float for a short time (2D6 minutes), but it is unable to swim or maneuver in the water.

Statistical Data:

Height: Usually about 3 feet (0.9 m) at the top of the head.

Width: 1.6 feet (0.5 m).

Length: Approximately 3-4 feet (0.9-1.2 m), plus a tail that varies with breed.

Weight: 24 pounds (11 kg) empty.

Color/Appearance: German Shepherds, Retrievers, Labs, Pit Bulls and a few other large dog breeds are available.

Attributes of Note: Robot P.S. 10, Spd 35.

Power System: Rechargeable battery or E-Clip. A single charge or pair of E-Clips can power the animal for up to one week walking and moving around, or up to a month if the drone can remain still. Nuclear power supply has a 15 year life.

Cargo: The dog's internal compartment is slightly larger than a shoebox and can hold up to 50 pounds (22.5 kg).

Cost: 620,000 credits for an electric powered version, 1.3 million for a nuclear powered one.

Weapon Systems: None to start.

Combat Notes: The robot is designed to move and act just enough to make it seem real. Complex actions like combat are simple like a real dog, with three attacks per melee; bite attack does 2D4 S.D.C. damage.



Smuggler's Robot Horse

Includes Mules, Camels, Cows & Oxen

Robot Animals such as workhorses, mules, cows, oxen and buffalo, as well as other work and riding animals, offer much more space to conceal contraband and cargo in their bellies. And, again, once they are covered in fake padding and fur, they look like the genuine, living animals. Smuggler robots intended to carry concealed goods inside them may be presented as livestock being taken to market (often mixed with live animals), ridden as a normal riding animal, or utilized as a work animal that hauls a load of little value, but carries the "good stuff" inside its robot body. Smugglers' robots have no combat capabilities and light M.D.C. compared to robot animals designed for actual riding, but are still quite sturdy and suitable for riding, work and hauling wagons and carts. On Rifts Earth, horses are not the only riding and work animals, so nobody thinks twice about camels, oxen or even elephants and dinosaurs being used. The fake skin and flesh coverings accurately replicate that of the particular real animal.

M.D.C. by Location:

Head – 50

Legs (4) – 45 each

* Main Body – 100

* Destruction of the main body destroys the robot. Destruction of the head shuts it down. Destroying one leg hobbles the robot and reduces speed, leaping distance and height by 30%.

Speed:

Running: Up to 35 mph (56 km).

Leaping: None.

Flying: None.

Underwater Capabilities: None; the robot's hollow insides allow it to float for a short time (1D6 minutes), but it is unable to swim or maneuver in the water.

Statistical Data:

Height: Varies by type of animal.

Width: Varies by type of animal.

Length: Varies by type of animal.

Weight: Varies by type of animal. Most robots of this class weigh between 400-700 pounds (180-315 kg) empty.

Color/Appearance: Horses are available in black, brown, chestnut and tan. Mules and camels are usually brown or sandy colored; designed to mimic the actual animal.

Attributes of Note: Robot P.S. 22, Spd 50.

Power System: Rechargeable battery or nuclear, average life 15 years. A single charge can power the animal for up to one week if it is forced to walk and move around, or up to a month if the drone can remain still.

Cargo: Internal compartments are roughly the size of a footlocker and can hold up to 200 pounds (90 kg) and the robot can pull an additional one ton.

Cost: 850,000 credits for the electric battery model, 1.5 million nuclear.

Weapon Systems: None to start.

Combat Notes: The robot is designed to move and act just enough to make it seem real. Complex actions like combat are not included in the robot drone program, nor is the robot designed for much else other than walking and basic riding.

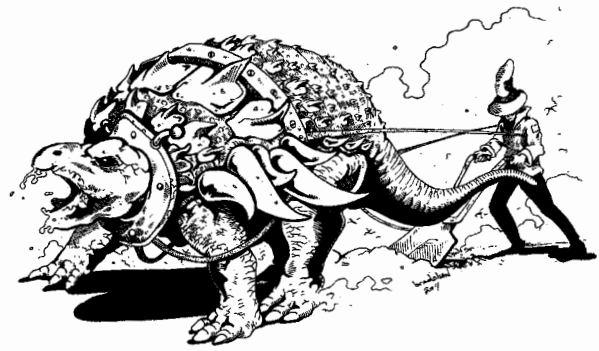

Smugglers' Robot Dinosaurs

Nodosaur, Tri-Tops or Other Medium-Sized Dinosaurs

Smugglers' Robot Dinosaurs are usually based on the four-legged herbivores that have large, round body shapes with lots of internal space. Nodosaurs, in particular, are commonly used as riding, work and livestock animals throughout the New West, South-west and Mexico, so again, nobody is likely to think twice about seeing people ride them or use them to pull wagons. Nor is anyone going to question a herd of (presumably) wild dinosaurs munching their way across the New West. Dinosaur skin is easier to simulate than mammalian fur and flesh, because it is hard, tough and cool to the touch and does not need convincing hair or fur.

M.D.C. by Location:

Head – 90

Legs (4) – 100 each

* Main Body – 200

* Destruction of the main body renders the robot useless. Destruction of the head shuts it down. Destroying one leg hobbles the robot and reduces speed, leaping distance and height by 30%.

Speed:

Running: Up to 35 mph (56 km).

Leaping: None.

Flying: None.

Underwater Capabilities: None; the robot's hollow insides allow it to float for a short time (1D6 minutes), but it is unable to swim or maneuver in the water.

Statistical Data:

Height: 6 feet (1.8 m) tall at the shoulders.

Width: 8 feet (2.4 m).

Length: 13-20 feet (4-6.1 m) long.

Weight: 2 tons empty.

Attributes of Note: Robot P.S. 28, Spd 50.

Power System: Rechargeable battery or nuclear, average life 15 years. A single battery charge can power the animal for up to one week if it is forced to walk and move around, or up to a month if the drone can remain still.

Cargo: Dinosaurs have much larger internal compartments, roughly the size of a large refrigerator, typical closet or large crate. A single robot can carry one ton of additional weight inside of it and pull an additional two tons.

Cost: 1.9 million credits with an electric battery, 3.2 million nuclear.

Weapon Systems: None to start.

Combat Notes: The robot is designed to move and act just enough to make it seem real. Complex actions like combat are not included in the robot drone program, nor is the robot designed for much else other than walking.

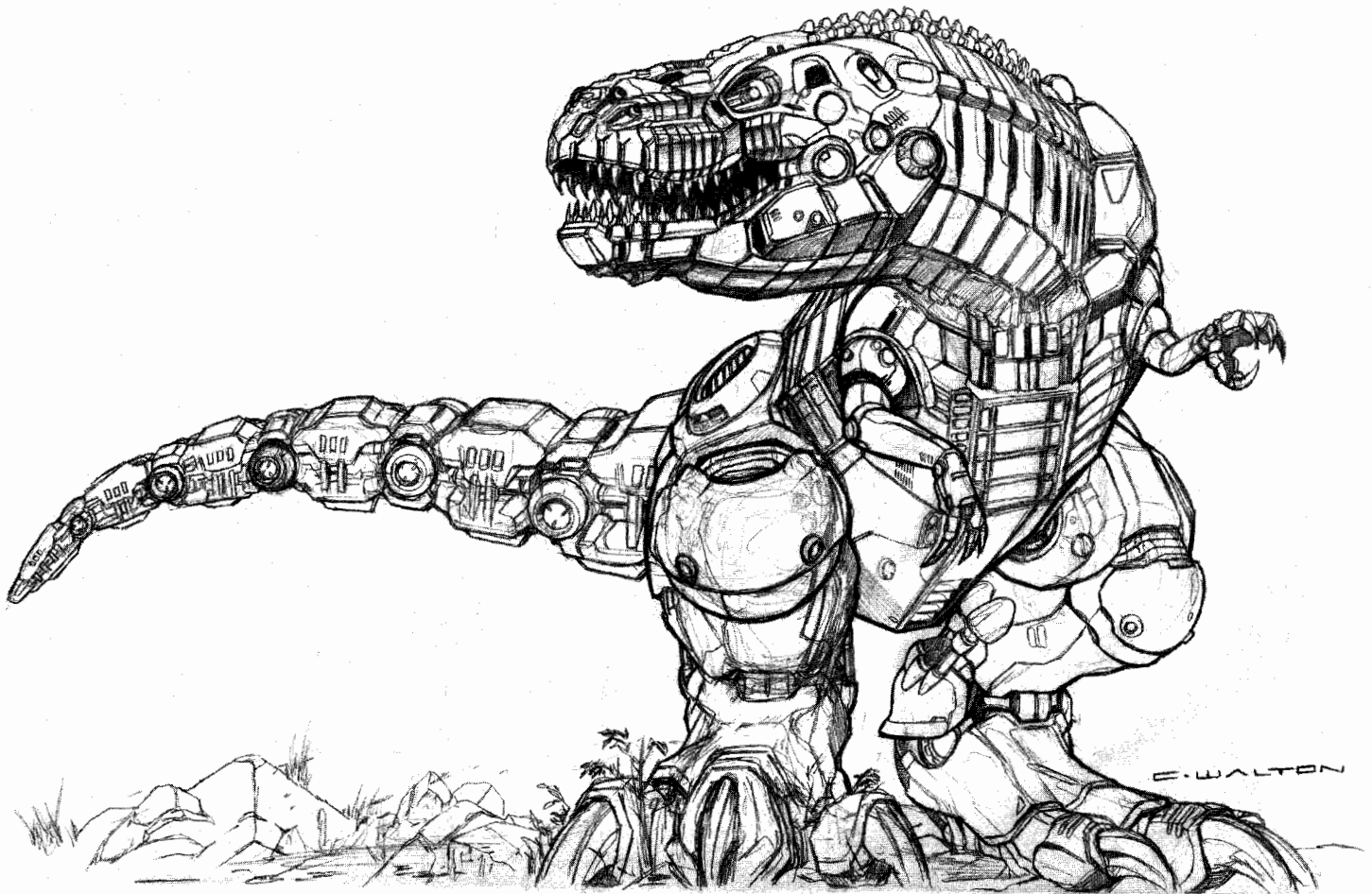

Mega-Rex

One of the best ways to smuggle Bandito Arms' products through the wild, especially the New West, and past any border is to place the goods inside an artificial animal robot. While this works out well with riding animals, when you want to move large loads in this manner, nothing beats a simulated *herd of wild dinosaurs*. The simulated herd can be set to rendezvous with the smugglers at a predetermined spot where the goods are to be intercepted and unloaded, and the herd turns around to get another load of goods, or new cargo going back the other way is loaded into them and sent back home.

So those are the secret Smugglers' Robot Dinosaurs whose purpose is to look and behave like real animals and *smuggle* concealed contraband inside of their bodies. This means they look like actual animals complete with skin coverings.

The problem then is, how do you keep an eye on your precious cargo inside the faux wild dinosaur herd? The answer: *You tail it in a fake dinosaur carnivore!*

The "Mega-series" of fake dinosaurs are built on a similar concept as the cargo robots, and may also have a few medium-sized storage bays inside of them, but they are disguised with an entirely different purpose: the defense of the cargo robots. Think manipulated, giant combat robots that look like predatory dinosaurs. These combat robot dinosaurs are also given a realistic, animal hide covering, but they also possess concealed weapon systems, lasers, and M.D. claws and fangs. **Note:** So far, these disguised cargo haulers are exclusive to the Black Market and are a well kept *secret!*

Here's just what every young boy has always wanted, a giant mechanical dinosaur – the Mega-Rex! But seriously, this oddball idea came out of a serious need, and it works.

The Mega-Rex is the preferred fake dinosaur robot defender. The robot body can be "dressed" in fake dinosaur flesh to make it look like a variety of big carnosaurus, like the *Alien Rex*, *Allosaurus*, *Devilsaurus*, and *Tyrannosaurus Rex*, just to name a few of the most fearsome and common in North America. With the fake dinosaur hide in place, the combat robot is indistinguishable from the real beast simulated to all but an expert dinosaur hunter, who might be able to spot the fake by its movements and other small details. Even then, the expert needs to carefully observe the fake for an extended period of time. (-35% penalty to Lore: Dinosaurs and related skills that might reveal the fake.)

The purpose of sending out these predator robots is to defend the cargo herd. Since predators tail and hunt such herds, no one passing by is likely to question a T-Rex or other large predator off in the distance waiting to make its move on a weak animal or one that strays from the herd. Moreover, long-range optic systems allow the pilot of the protector robot to tail the herd from as far away as a mile or two (1.6 to 3.2 km) and it may not even be noticed by people passing near the herd. This is especially true in the open plains, prairies and desert environments. Having a "manned" robot means there is a human mind determining when the cargo herd is in trouble and when to make a move.

To maintain the deception of ordinary animals, the pilot of the Mega-Rex is likely to charge onto the scene bellowing with great ferocity. This is enough to scare away most travelers all by itself, as few people, even heavily armed warriors, want to tangle with one or more Tyrannosaurus Rex if it can be avoided. As long as the

people run off, everything is cool and the faux T-Rex wanders off or chases the herd until they are all likely to be out of the sight of third party observers. Even then, just in case, the pilot will make it look as if the T-Rex got tired and gave up the chase. The disguised robot herd is programmed to run away when the fake T-Rex makes an appearance, so everything works out well, and nobody is the wiser.

If the travelers are not so easily frightened, the pilot may make threatening actions against them to motivate their retreat. This works 95% of the time just fine. Violence is not necessary as long as the unwanted observers/travelers do not follow the fleeing cargo herd. And, again, the T-Rex can go lumbering away. However, if the travelers attack the T-Rex robot or any of the members of the cargo herd, the pilot has a few options. *First*, there are usually 2-4 Mega-Rex defenders following a herd like this. If the other one or more have not made an appearance yet, this is the time. While some hunters and heroes are willing to face down a single T-Rex, few are willing to take on 2-4 of them. *The second option* is to attack like a T-Rex. Sometimes stubborn travelers need that extra push of feeling like their lives are in immediate danger before running off. Attacking with tooth and claw usually does the trick in this case. *The third option* is to attack with high-tech weapons blaring. This usually works out very well for the protectors in the Mega-Rex, as nobody is expecting energy blasts or rail gun rounds pouring out of a dinosaur. This gives the pilots inside the Mega-Rex(s) the element of surprise and initiative. The only downside is, once the pilot goes down this avenue, he (they) must *kill everyone* in order to keep the Black Market's dirty little secret about robot dinosaurs.

The Mega-Rex's primary weapons are arguably its teeth and Vibro-Claws, but the robot does come loaded with a number of concealed weapons. The main weapon system would be its chest mounted BMM-48 mini-missile launcher. To fire, the mini-missiles tear through the fake flesh on the chest between the Mega-Rex's tiny arms, with the back blast of the launching mini-missiles being vented through the robot and out the rear in a hellish dinosaur fart of smoke and sound. Silly, perhaps, but effective, and it prevents the fake flesh from taking more than cosmetic damage that can be fixed with a simple repair kit after the battle. The missile launcher is backed up by a pair of laser eyes and a plasma cannon located in the mouth. The weapons package is rounded out by a pair of belt-fed rail guns mounted in the nostrils of the Mega-Rex. When fired, the plastic disintegrating links of the rail gun rounds melt and come dribbling out of the nose like goopy plastic snot. Again odd, but effective, as the liquid plastic running from the nose prevents it clogging up the rail guns.

Model Type: Strategic Stealth Carnosaur Robot.

Class: MRR-01X

Crew: One pilot and one co-pilot or passenger; it helps to have a companion on long cargo runs.

M.D.C. by Location:

* Concealed BMM-48 Mini-Missile Launcher – 30

* Arms (2, small) – 80 each

* Clawed Hands (2) – 25 each

Legs (2) – 200 each

Clawed, Three-Toed Feet (2) – 130 each

** Tail – 200

*** Head – 200

Reinforced Pilot's Compartment – 100

**** Main Body – 400

* A single asterisk indicates a small and difficult target to strike, requiring the attacker to make a "Called Shot," and even then the attacker is -3 to strike.

** Destroying the tail will unbalance the robot, causing a -1 penalty to strikes and all other combat maneuvers; reduces running speed by one third and reduces leaps by half.

*** Destroying the head of the robot eliminates all forms of optical enhancement and sensory systems. The pilot must rely on his own vision and senses. In addition, all combat bonuses and weapons in the head are lost.

**** Depleting the M.D.C. of the main body shuts the robot down completely, rendering it useless scrap metal.

Speed:

Running: 80 mph (128 km) maximum; cruising speed is half.

Leaping: The robot legs can propel the armor 30 feet (9.1 m) high or across.

Flying: Not possible.

Underwater Capabilities: Cannot swim, but can walk along the bottom of the sea or lake bed at 20 mph (32 km). Maximum Ocean

Depth: 1,000 feet (305 m).

Statistical Data:

Height: 30 feet (9.1 m) standing fully erect.

Width: 14 feet (4.2m) at the hips, 7 foot (2.1 m) thick/wide body.

Length: 40 feet (12.2 m) from snout to tail tip.

Weight: 30 tons.

Physical Strength: Robotic P.S. of 42.

Cargo: Minimal storage space, enough for some extra clothing, weapons, and a few personal items. Plus, a weapons locker with room for two energy rifles, two energy pistols, two canteens and enough water and food rations for two weeks.

Power System: Nuclear; average energy life is 20 years.

Cost: 62 million credits.

Weapon Systems:

1. BMM-48 Concealed Mini-Missile Launcher: A concealed mini-missile launcher mounted in the dino-bot's chest. The launch tubes are covered in fake dinosaur scales.

Primary Purpose: Assault.

Secondary Purpose: Anti-Aircraft/Anti-Robot.

Range: One mile (1.6 km).

Mega-Damage: Varies with missile type. Any mini-missile can be used, but it comes standard with armor piercing (1D4x10 M.D.) or plasma (1D6x10 M.D.). Fragmentation (5D6 M.D.) may be used for anti-personnel operations.

Rate of Fire: One at a time or in volleys of 2, 3, 4 or 6.

Payload: 48 mini-missiles total.

2. Mouth Plasma Cannon (1): Concealed in the mouth of the Mega-Rex is a light plasma cannon.

Primary Purpose: Anti-Armor.

Secondary Purpose: Assault.

Range: 1,000 feet (305 m).

Mega-Damage: 6D6 M.D. per blast.

Rate of Fire: Single shot only. Each blast counts as one melee attack.

Payload: Effectively unlimited.

3. Eye Lasers (2): Each of the Mega-Rex's eyes sockets contains a laser for additional defense and offense capabilities.

Primary Purpose: Anti-Personnel.

Secondary Purpose: Defense.

Range: 1,200 feet (366 m).

Mega-Damage: 2D6 M.D. per blast, or 4D6 M.D. for a dual, linked blast.

Rate of Fire: Each single or linked blast counts as one melee attack.

Payload: Effectively unlimited.

- 4. Nose Rail Guns (2):** Mounted in the nose of the Mega-Rex are a pair of light rail guns that only fire in twin linked bursts. The nose rail guns are intended for self-defense and anti-personnel use.

Primary Purpose: Anti-Personnel.

Secondary Purpose: Defense.

Range: 2,000 feet (610 m).

Mega-Damage: A twin linked burst is 20 rounds from each rail gun and inflicts 1D4x10+6 M.D.; can only fire bursts.

Rate of Fire: Each burst counts as one melee attack.

Payload: 4,000 round drum, that's 100 twin linked bursts. Reloading a drum takes a trained Operator or Refurbisher about 10 minutes; double without the right equipment.

- 5. Handheld Weapons:** Not applicable, the arms cannot hold weapons.

- 6. Hand to Hand Combat:** Rather than use a weapon, the pilot can engage in Mega-Damage hand to hand combat. Each hand ends in Vibro-Claws, but the arms are tiny and ineffectual except in close combat, and even then are weak compared to the powerful legs and mouth. The small arms can be used for ripping and tearing; their reach is about four feet (1.2 m). The pilot uses the legs to kick and claw, the tail to slap and hit, and the giant maw to bite. See *Heavy Ground Robot Training* on page 352 of **Rifts® Ultimate Edition**, plus the following:

Restrained Punch/Claw Strike: 1D6 M.D.

Full Strength Claw/Tear/Rip: 3D6 M.D.; punch is not possible.

Power Punch/Claw Strike: Not possible.

Kick or Rake with Foot Claws: 5D6 M.D.; 12 foot (3.6 m) reach.

Leap Kick: Not possible.

Leaping Pounce: 1D4x10+10 M.D.; 30 foot (9.1 m) reach, effective only against targets/victims smaller than 20 feet (6.1 m) tall and counts as two melee attacks. 01-85% likelihood of knocking any opponent weighing less than 12 tons off its feet. Victims lose initiative and two melee attacks.

Tail Strike: 4D6 M.D.; 20 foot (6.1 m) reach, but requires turning and pivoting the entire body.

Head Butt: 3D6 M.D.

Bite: 1D4x10 M.D.

Body Block/Ram (short running start): 1D4x10 M.D. and has a 75% chance of knocking a truck-sized opponent over or down; 95% for man-size to 15 feet (4.6 m) tall opponents, motorcycles, and small cars. Victim loses initiative, one melee attack and is knocked back 2D6 yards/meters (x10 for human-sized targets, who also lose two melee attacks/actions unless they are supernatural beings, then they only lose one attack). A body block/ram counts as two melee attacks.

Stomp: 6D6 M.D. (only against opponents 10 feet/3 m tall or shorter).

- 7. Sensor Systems and Features of Note:** The Mega-Rex has all the standard sensors of the Coalition UAR-1 Enforcer (see the **Rifts® Ultimate Edition** rule book, page 250), plus loudspeaker and a magnified, terrifying roar and bellow that sounds like the real creature.

Exotic Robot Steeds

Since the huge success of the Bandito Arms line of robot horses, part of Bandito's new marketing plan is to expand as far as possible into every market area they can identify in North America, especially the few they dominate. Since they are one of the few manufacturers of robot horses, they have decided to expand the market for robot steeds. This has also opened inroads to the one region that always seemed to be elusive for them, the Magic Zone. Practitioners of magic seem to prefer Techno-Wizard weapons over the conventional M.D. weapons available from Bandito Arms. Even their normal line of robot horses has limited appeal to the citizens of the Magic Zone, though more so than conventional vehicles. It wasn't until Bandito Arms came up with the idea of doing Exotic Robot Steeds that they found a place in the markets of the Magic Zone.

Conventional and Exotic Robot Steeds also have a wide appeal to many other people, which has surprised the manufacturer. Another surprise is that many customers do not want the cosmetic features to make the robot steeds appear to look like the real animal. At least half of their customers like the idea of riding a "robot," and find its mechanical appearance to be exotic and desirable. Mages tend to be the exception, but Bandits, Cowboys, Cyborgs, Gunslingers, Raiders, Rangers and many others often like the robot appearance. And it trims off the comparatively minor expense of the cosmetics to make it look real.

In many cases, Bandito Arms has done nothing more than to tweak and modify its existing line of robot horses with new features to resemble fanciful creatures such as the Unicorn and Pegasus. All Exotic Robot Steeds use the same programming and features as the RH-1000 series robot horses. The RH-1000 series of robot horses from Bandito Arms (Northern Gun offers identical horses for 10% more) was originally developed with the adventurer, gunslinger and lawman in mind, but they have proven popular among a much wider demographic.

Not only are the robot horses and Exotic Robot Steeds stronger and faster than their living counterparts, but they can be programmed to be much more intelligent and tame. The average one can follow complex commands, recognize its owner and up to 96 of its owner's friends, associates and enemies, is programmed to warn the rider about the approach of enemies, as well as identify and warn the rider about 300 hostile life forms, including snakes, lions, alien predators, and others, without being afraid itself. The robot steed responds completely to the physical and voice commands of the rider, and can be programmed to respond to and obey six other people of the owner's choice. This means the robot will not allow unauthorized people to ride or command it. Most robot steeds are programmed to act like the genuine animal (without the fear response), but for an extra 100,000 credits, it can be given voice recognition and response (talks) capabilities!

Robot horses are a favorite of Cyber-Knights, Gunslingers, and heavy or oversized D-Bees and cyborgs because the robots can carry much more weight without fatigue or developing back problems. New, favorite robot steeds include the Unicorn, Pegasus and Raptor.

Special Robot Steed Features

Items listed below are "extras" that can be purchased for one's robot steed. All prices listed are for the "basic," robot-looking animal.

- Extra armor: Add 30% to all M.D.C. for the deluxe, armored model, but also add 30% to the cost.
- Life-like fur, scales or skin covering with padding and fake musculature, tail, mane and hoof coverings: 14,000 credits unless noted otherwise.
- Voice recognition and response (talks): 100,000 credits.
- Secret compartments can be built into the upper legs and body of the robot. The largest possible is approximately 12 inches (0.3 m) long and six inches (0.15 m) deep. As many as eight large compartments can be installed. Small compartments are half the size of a cigar box or roughly the size of a video-cassette box. Two small compartments can be installed in place of a large one. Cost: 1,200 for each small one, 4,000 for each large. Locks cost an additional 200 credits for each. Not applicable for 'Bots with fur. Excellent for holding small valuables, pistols, grenades, flares, an extra canteen, and so on.

Weapon Options: Weapon extras are *rarely* part of the basic package and always cost extra. Full price applies even during sales. All weapons tend to be small and unobtrusive to avoid obstructing the rider (or looking too obvious).

Chemical Spray: Built into the mouth. Basically the same as the cyborg unit, only with double the payload. Cost: 45,000 credits plus cost of the chemicals.

Concealed Weapon Rod (shoulder): Concealed in the robot's shoulder. Damage and range are the same as the light laser or ion blaster, depending on which is selected.

Ion Blaster (head): 3D6 M.D. or 6D6 from a dual system. Range is 800 feet (243.8 m), payload is effectively unlimited. Cost: 32,000 credits each. Typically built into the eyes (reduce range by 20%) or along the muzzle. As many as two, one on each side of the muzzle, can be installed.

Light Laser (head): 1D6 M.D. or 2D6 from a dual system. Range is 1,200 feet (366 m); payload is effectively unlimited. Cost: 15,000 credits each. Typically built into the eyes (reduce range by 20%) or along the muzzle. As many as two, one on each side of the muzzle (or in each eye socket), can be installed.

Heavy Laser (head): 2D6 M.D. or 4D6 from a dual system. Range is 2,000 feet (610 m), payload is effectively unlimited. Cost: 30,000 credits each. Typically built into the eyes (reduce range by 20%) or along the muzzle. As many as two, one on each side of the muzzle, can be installed. Depending on the robot, sometimes the weapon can be built into the mouth.

Double-Barrel Heavy Laser (shoulder): 2D6 M.D. per single shot or 4D6 damage per simultaneous double shot. Range is 2,000 feet (610 m), payload is effectively unlimited. Cost: 60,000 credits. A double-barrel unit can be built into each shoulder. They are low profile and can be fixed forward or have an arc of fire of 30 degrees in all directions.

Light Machine-Gun (head or shoulders): 1D4 M.D. per burst of 50 rounds, range: 2,000 feet (610 m), payload is 600 rounds (12 bursts). Cost: 10,000 credits. Typically built into the eyes (reduce range by 20%), or along the muzzle. As many as two, one on each side of the muzzle, can be installed. The feed runs up through the neck.

Mini-Missile Launchers (shoulders): As many as two small, dual system launchers can be added; one on each side, or sometimes in the chest. The small launchers fire two mini-missiles each; payload is two each with manual reloading (not possible while moving). Cost: 60,000 credits.

Note: Most of the new Exotic Robot Steeds incorporate a pair of small, vector thrust jump jets into their design. In the Unicorn they are used to provide its power jumping and travel ability, in the Seahorse they provide buoyancy to allow the robot to swim through the water using its shark tail, and for the Pegasus and Monster Pegasus, the jump jets carry the bulk of the robot and rider's weight, allowing the robot to seem to fly using beating wings like the real mythological animals. In reality, the wings are used to glide and change direction, but they look impressive.

In addition to the jump jets, each robot has at least one built-in weapon system that enhances its use as a combat mount. Mystic Knights, Cyber-Knights, Tundra Rangers, the 1st Calvary, a wide range of practitioners of magic and others with a whimsical bent or flair for theatrics, like the idea of riding a "mythological" beast. It is interesting to note that 80% of mages prefer their robot steed to look like the genuine animal and almost always acquire the cosmetic, life-like covering.

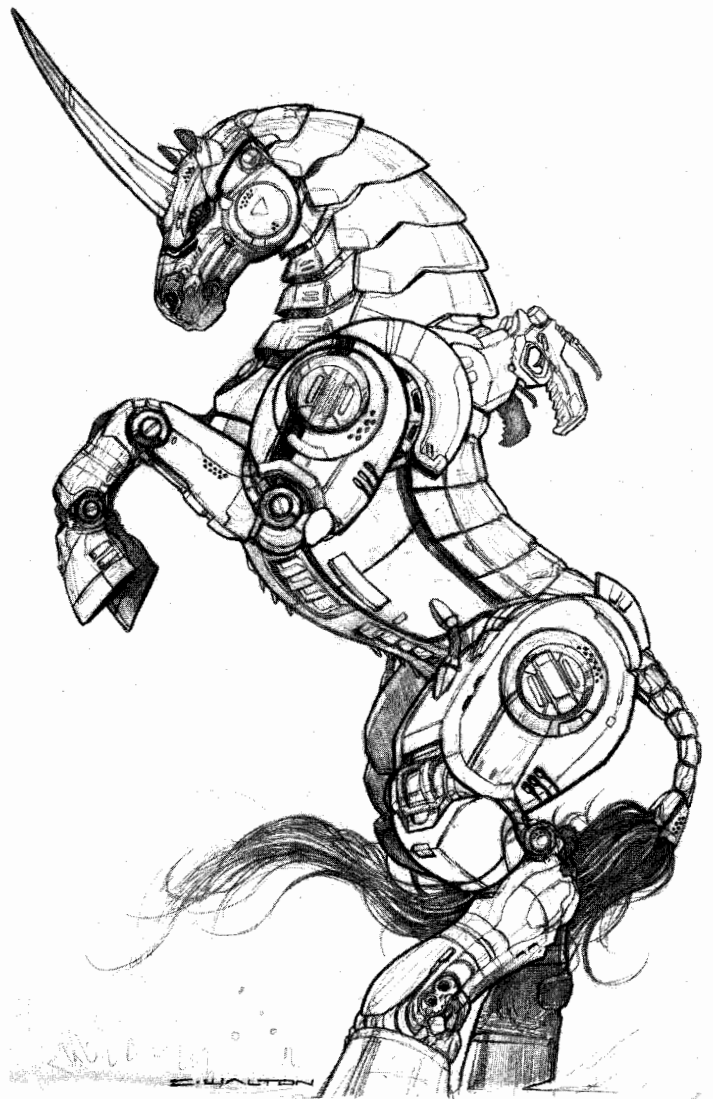

Unicorn Robot Steed

Based upon the Appaloosa robot horse chassis, the Unicorn is a bit tougher than the original pony, but it is still smaller than the other robot steeds. They are sturdy and reliable, with good speed and carrying capacity. The Unicorn's slight build is perfect for female riders and small D-Bees.

Model Type: MRH-1001E

Class: Light Robot Steed.

Crew: One humanoid rider with one additional rider possible in emergencies.

M.D.C. by Location:

* Concealed VT Hover Jets (2; on the underbelly) – 30 each

* Vibro-Horn – 50

Head – 100

** Legs (4) – 100 each

*** Main Body – 220

* A single asterisk indicates a small and difficult target to strike, requiring the attacker to make a “Called Shot,” and even then the attacker is -3 to strike.

** Destroying one leg hobbles the robot steed and reduce speed and leaping distance and height by 30%.

*** Depleting the M.D.C. of the main body shuts the robot down completely and renders it useless.

Speed:

Running: Maximum speed of 75 mph (120 km).

Leaping: 10 feet (3 m) high and 20 feet (6.1 m) lengthwise, with a running start. A vector thruster jet-assisted leap can propel the unit up to 60 feet (18.3 m) high and 200 feet (61 m) across without actually attaining flight.

Power Jumping and Travel: The powerful jump jet thrusters enable the Unicorn to leap great heights and distances. By leaping, landing, continuing to run a few dozen yards/meters, and power leaping again, the Unicorn can attain and maintain an impressive ground speed of 100 mph (160 km), even through desert scrub and light forests. Jump-travel is NOT possible traveling through dense forests and vegetation. The rider must keep a tight hold during each landing and leap to ensure he or she stays in the saddle, and body armor with saddle clamps is recommended when riding the Unicorn.

Directional control is excellent. The capabilities of the jump jet thrusters allow the pilot to slow down and change direction or trajectory, as well as slow descents so that the robot steed lands on its feet with minimal impact. It can NOT hover or fly. Moreover, having to suddenly engage the jump jet thrusters in mid-leap to avoid a collision or bad landing will slow one’s speed, causes the rider to lose one melee attack/action and makes the steed and its rider an easier target for attack. Likewise, crashing through the underbrush makes a lot of noise, alerting predators and the enemy to one’s presence, and reduces the rider’s vision and awareness (-3 on Perception Rolls and initiative, -1 to strike, parry, and dodge due to obscured vision and rate of travel).

Flying: Not possible. The vector thruster jets are there to aid in leaping and for power jumping travel.

Underwater Capabilities: The robot can function in/under water, able to walk along the bottom of the sea at about 20% its normal running speed, or swim at a speed of 3 mph (4.8 km or 2.6 knots). Maximum Depth is 500 feet (152.4 m).

Statistical Data:

Height: Usually about 13.2 hands (or 4 feet, 4 inches/1.34 m) at the shoulders.

Width: 2.6 feet (0.8 m).

Length: Approximately 6.6 feet (roughly 2 m).

Weight: 800 lbs (360 kg).

Color of Hide: The Unicorn generally comes in pure white or pure black, but other colors are available on demand, including an iridescent white-silver and gold. The mane can also range in color from red, yellow and gold, to blue, green, violet, black and white.

Attributes of Note: Robotic P.S. of 26, P.P. 20, P.B. 10 (15 with hide), Spd 110; equivalent I.Q. 9.

Power System: Nuclear, average life of 15 years.

Cargo: Can carry one rider and one companion (if both are roughly human-size, otherwise space may be tight for the companion rider, and this second seat is never comfortable for long periods; an hour or more), up to 1,000 pounds (450 kg). The robot horse can pull up to two tons!

Cost: 3 million; a fake fur hide costs an extra 25,000 credits.

Weapon Systems:

1. Silver-Coated Vibro-Horn: The primary melee combat weapon of the Unicorn, the silver-coating means that they are equally effective against werewolves, vampires and other creatures vulnerable to silver.

Primary Purpose: Assault.

Secondary Purpose: Defense.

Range: Melee combat only, with a 2½ to 3 foot blade (0.76 to 0.9 m) length.

Mega-Damage: 2D6 M.D. per strike.

Attacks per Melee Round: Equal to the number of attacks of the pilot.

2. Other Weapon Systems: Optional. The purchaser can acquire a couple of additional built-in weapons for his steed, but each has an additional cost.

3. Combat Notes:

Attacks per Melee Round: Three without a pilot controlling the steed.

Bonuses: +2 on initiative, +1 to strike and parry in melee combat, +3 to dodge when running (increase to +5 when jumping) and +2 to roll with impact.

Mega-Damage:

Restrained Hoof Strike: 1D4 M.D.

Full Hoof Strike: 1D6 M.D.

Kicks: 2D4 M.D.

Rear Kick/Power Kick: 2D6 M.D.

Stomp or Bite: 1D4 M.D.

Running Body Block: 1D4 M.D.

Pegasus Robot Steed

Designed to look like the regal, flying horse of myth, the Pegasus Robot Steed is as beautiful as the real breed; tall, sleek, and graceful, with long, thin (but powerful) legs. This robot steed is normally treated with synthetic fur, skin and musculature which gives it the look of the real creature. The Pegasus has the same upgraded skill program as the Arabian. The Pegasus is easily the fastest flier of the steeds.

Model Type: MRH-1003G

Class: Medium Robot Steed.

Crew: One humanoid rider with one additional rider possible in emergencies.

M.D.C. by Location:

* Concealed VT Hover Jets (4; on the underbelly) – 20 each

Head – 100

** Wings (2) – 120 each

*** Legs (4) – 90 each

**** Main Body – 240



* A single asterisk indicates a small and difficult target to strike, requiring the attacker to make a "Called Shot," and even then the attacker is -3 to strike.

** Destroying a wing or one of the vector thrust hover jets will force the robot to hover down to a clumsy landing, as forward flight is no longer possible. If the robot loses both wings or two jets (or one of each) it crashes to the ground immediately and takes 5D6 M.D.

*** Destroying one leg hobbles the robot steed and reduces speed and leaping distance and height by 30%.

**** Depleting the M.D.C. of the main body shut the robot down completely and renders it useless.

Speed:

Running: Maximum speed of 120 mph (192 km).

Leaping: 20 feet (9 m) high and 50 feet (15.2 m) lengthwise, with a running start. A vector thruster hover jet assisted leap can propel the unit up to 150 feet (45.7 m) high and 300 feet (91.5 m) across without actually attaining flight.

Flying: The vector thrust hover system and wings enable the robot-steed to hover stationary up to 400 feet (122 m) and fly. Maximum flying speed is 150 mph (240 km). Maximum altitude is 600 feet (183 m), double in a strong wind or when leaping into the air from a cliff or rooftop. Can dive from heights as great as 10,000 feet (3,048 m) and glide downward to a 1,200 foot (366 m) flight level or land safely!

Flying Range: The nuclear power system gives the unit 10 years of life, but the vector thrust hover jets that keep the robo-steed in the air do need to be cooled down after 24 hours of constant or near constant flight.

Underwater Capabilities: The robot does not function well in or under water. It is able to walk along the bottom of the sea at about 10% its normal running speed, or swim at a speed of 3 mph (4.8 km or 2.6 knots). Maximum Depth is 500 feet (152.4 m).

Statistical Data:

Height: Usually about 15 hands (or 5 feet/1.5 m) at the shoulders.

Width: 3 feet (0.9 m); with a wing span of 18 feet (5.5 m).

Length: Approximately 9 feet (2.7 m).

Weight: 1,800 lbs (810 kg).

Color of Hide: A solid body color, with dark brown, light brown/tan, white and black available, but the latter two are the most popular colors. Some prefer the steed to have "stockings," a different color, on the lower legs, and/or a color marking (usually white) on the top of the head, but other colors are available on demand. The realistic looking, feathered wings are normally the same color as the steed, but they may come in any natural color available in real bird wings, including red and blue.

Attributes of Note: Robot P.S. 28, P.P. 22, P.B. 11 (17 with hide), Spd 180; equivalent I.Q. 9.

Power System: Nuclear, average life of 10 years.

Cargo: Can carry one rider and one companion (if both are roughly human-size, otherwise space may be tight for the companion rider, and this second seat is never comfortable for long periods; an hour or more), up to 1,200 pounds (540 kg). The robot horse can pull up to four tons!

Cost: 8.2 million; a fake fur hide costs an extra 25,000 credits and wings, covered in real feathers cost an extra 50,000 credits.

Weapon Systems:

1. Eye Lasers (2): Each of the Pegasus's eyes is actually a light laser designed to be the robot's primary weapon system.

Primary Purpose: Assault.

Secondary Purpose: Defense.

Range: 1,200 feet (366 m).

Mega-Damage: 1D6 M.D. per single eye blast or 2D6 M.D. for a dual linked blast.

Rate of Fire: Each single or dual blast counts as one melee attack.

Payload: Effectively unlimited.

2. Other Weapon Systems: Optional. The purchaser can acquire a couple of additional built-in weapons for his steed, but each has an additional cost.

3. Combat Notes:

Attacks per Melee Round: Three without a pilot controlling the steed.

Bonuses: +3 on initiative, +2 to strike and parry in melee combat, +5 to dodge when running (increase to +7 when flying) and +2 to roll with impact.

Mega-Damage:

Restrained Hoof Strike: 1D4 M.D.

Full Hoof Strike: 1D6 M.D.

Kicks: 2D4 M.D.

Rear Kick/Power Kick: 2D6 M.D.

Stomp or Bite: 1D4 M.D.

Running or Flying Body Block: 1D6 M.D.



Monster Pegasus Robot Steed

This robot steed is black or charcoal gray with a flowing black mane, red eyes, large bat-like wings, a serpent's or dragon's tail that ends with a Vibro-Blade, and taloned feet like those of an eagle. A pair of horns sits atop its head. In fact, some might consider it a demonic version of a Pegasus. The Monster Pegasus can breathe "fire" (a plasma cannon), as well as slash with the Vibro-Claw talons on all four feet. This makes the Monster Pegasus a great combat mount. They are tough and reliable, with good speed and cargo capacity.

The Monster Pegasus and Pegasus robot steeds are able to fly because they have concealed vector thrust hover jets mounted on their underbellies, between the pairs of fore and rear legs. But the robots actually fly by flapping their wings just like the real creatures, the hover jets just hold up the weight of the robot and rider.

Also Known As: Dark Pegasus

Model Type: MRH-1002F

Class: Heavy Robot Steed.

Crew: One humanoid rider with one additional rider possible in emergencies.

M.D.C. by Location:

- * Concealed VT Hover Jets (4; on the underbelly) – 20 each
- Head – 120
- Serpent Tail – 90
- * Tail Vibro-Blade – 30
- ** Wings (2) – 120 each

*** Legs (4) – 120 each

**** Main Body – 300

* A single asterisk indicates a small and difficult target to strike, requiring the attacker to make a "Called Shot," and even then the attacker is -3 to strike.

** Destroying a wing or one of the vector thrust hover jets will force the robot to hover down to a clumsy landing, as forward flight is no longer possible. If the robot loses both wings or two jets (or one of each) it crashes to the ground immediately and takes 5D6 M.D.

*** Destroying one leg hobbles the robot steed and reduce speed and leaping distance and height by 30%.

**** Depleting the M.D.C. of the main body shuts the robot down completely and renders it useless.

Speed:

Running: Maximum speed of 100 mph (160 km).

Leaping: 15 feet (4.6 m) high and 40 feet (12.2 m) lengthwise, with a running start. A vector thruster hover jet-assisted leap can propel the unit up to 110 feet (33.5 m) high and 200 feet (61 m) across without actually attaining flight.

Flying: The vector thrust hover system and wings enable the robot-steed to hover stationary up to 400 feet (122 m) and fly. Maximum flying speed is 110 mph (176 km). Maximum altitude is 600 feet (183 m), double in a strong wind or when leaping into the air from a cliff or rooftop. Can dive from heights as great as 10,000 feet (3,048 m) and glide downward to a 1,200 foot (366 m) flight level or land safely!

Flying Range: The nuclear power system gives the unit 10 years of life, but the vector thrust hover jets that keep the robo-steed in the air do need to be cooled down after 24 hours of constant or near constant flight.

Underwater Capabilities: The robot does not function well in or under water. It is able to walk along the bottom of the sea at about 10% its normal running speed, or swim at a speed of 6 mph (9.6 km or 5.2 knots) using its serpent tail as a rudder and locomotion. Maximum Depth is 500 feet (152.4 m).

Statistical Data:

Height: Usually about 15 hands (or 5 feet/1.5 m) at the shoulders.

Width: 3 feet (0.9 m); with a wingspan of 16 feet (4.9 m).

Length: Approximately 8 feet (2.4 m) in length, with a 4 foot (1.2 m) long, serpentine tail.

Weight: 2,000 lbs (900 kg).

Color of Hide: The Monster Pegasus comes in various shades of black, deep red, and dark green; solid color with highlights on lower legs, and golden feet with silver claws. The realistic looking leathery wings are dark brown, dark grey, black, alizarin crimson or green.

Attributes of Note: Robot P.S. 28, P.P. 20, P.B. 9 (14 with hide), Spd 148; equivalent I.Q. 9.

Power System: Nuclear, average life of 10 years.

Cargo: Can carry one rider and one companion (if both are roughly human-size, otherwise space may be tight for the companion rider, and this second seat is never comfortable for long periods; an hour or more), up to 1,400 pounds (630 kg). The robot horse can pull up to four tons!

Cost: 9.6 million; a fake fur or leathery hide costs an extra 25,000 credits; comes with leathery-looking wings.

Weapon Systems:

1. Eye Lasers (2): Each of the Dark Pegasus's eyes is actually a laser designed to be the robot's primary weapon system.

Primary Purpose: Assault.

Secondary Purpose: Defense.

Range: 2,000 feet (610 m).

Mega-Damage: 2D6 M.D. per blast, or 4D6 M.D. for a dual, linked blast.

Rate of Fire: Each single or dual blast counts as one melee attack.

Payload: Effectively unlimited.

2. Mouth Plasma Cannon: Concealed in the mouth of the Monster Pegasus is a light plasma cannon that has been firmly throttled open so that plasma comes out in a weak, dribbling spray to simulate the dragon-like breath of the real animal.

Primary Purpose: Anti-Armor.

Secondary Purpose: Assault.

Range: 100 feet (30.5 m).

Mega-Damage: 4D6 M.D. per blast.

Rate of Fire: Single shot only. Each blast counts as one melee attack.

Payload: Effectively unlimited.

3. Vibro-Blade Tail: The tail of the Monster Pegasus is prehensile enough to slash up, down, and sideways to cut opponents.

Primary Purpose: Aerial Assault, slashing as it flies by.

Secondary Purpose: Defense.

Range: 10 feet (3 m).

Mega-Damage: 2D6 M.D. per strike.

4. Vibro-Blade Talons: Each foot ends in a wicked, four-toed talon.

Primary Purpose: Aerial and Ground Assault, slashing as it flies by or as it rears up or kicks.

Secondary Purpose: Defense.

Range: 6 feet (1.8 m).

Mega-Damage: 3D4+3 M.D. per strike.

5. Combat Notes:

Attacks per Melee Round: Four.

Bonuses: +2 on initiative, +2 to strike and parry in melee combat, +1 to strike with ranged weapons, +3 to dodge when running (increase to +5 when flying), and +2 to roll with impact.

Mega-Damage:

Restrained Hoof Strike: 1D4 M.D.

Full Hoof Strike: 1D6 M.D. + Vibro-Blade damage if so desired.

Headbutt with Horns: 2D6 M.D.

Kicks: 2D4 M.D. + Vibro-Blade damage if so desired.

Rear Kick/Power Kick: 2D6 M.D. + Vibro-Blade damage if so desired.

Stomp or Bite: 1D4 M.D.

Running or Flying Body Block: 1D6 M.D.

Seahorse Robot Steed

The Seahorse is Bandito Arms' most ambitious and unusual robot steed: a Seahorse with land and water capabilities. It has a stocky build, thick front and rear legs, extra armor and the basic shape of a Clydesdale, but with the addition of a large, shark-like tail. The rear legs of the Seahorse fold up and under its mechanical, shark-like tail for swimming, and on land the shark tail can stick back like the tail of a T-Rex, or can be held up and over the rider much like a scorpion holds its tail up and out of the way. It is designed for amphibious operations and aquatic use.

Model Type: MRH-1004H

Class: Heavy Robot Steed.

Crew: One humanoid rider with one additional rider possible in emergencies.

M.D.C. by Location:

* Concealed VT Hover Jets (4; on the underbelly) – 20 each

Head – 120

** Front Legs (2) – 180 each

** Rear Legs (2) – 150 each

*** Shark Tail – 250

**** Main Body – 380

* A single asterisk indicates a small and difficult target to strike, requiring the attacker to make a "Called Shot," and even then the attacker is -3 to strike.

** Destroying one leg hobbles the robot steed on land and reduces speed and leaping distance and height by 30%.

*** Eliminating the shark-like tail will reduce the Seahorse's swimming speed to just 3 mph (4.8 km or 2.6 knots).

**** Depleting the M.D.C. of the main body shuts the robot down completely and renders it useless.

Speed:

Running: Maximum speed of 75 mph (120 km).

Leaping: 15 feet (4.6 m) high and 40 feet (12.2 m) lengthwise, with a running start. A vector thruster jet-assisted leap can propel the unit up to 80 feet (24.3 m) high and 100 feet (30.5 m) across without actually attaining flight.

Flying: Not possible; the vector thrusters are there to aid in leaping and to help propel the Seahorse in the water.

Underwater Capabilities: The robot can function in and under water, able to walk along the bottom of the sea at about 25% its normal running speed, or swim at a speed of 45 mph (72 km) by using its shark-like tail as a rudder and means of locomotion augmented

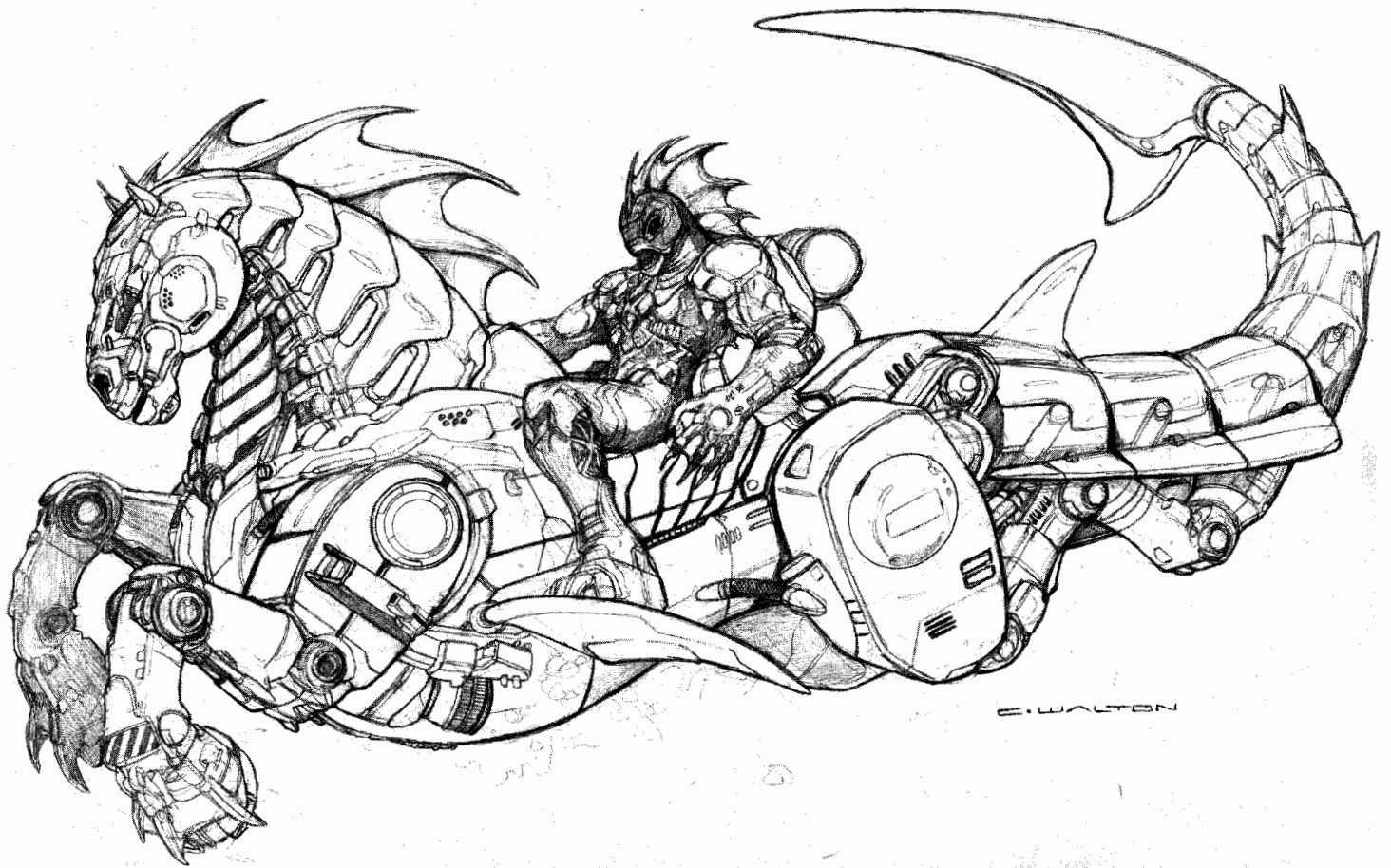

by the thrusters to propel it through the water; 35 mph (56 km) on the surface of the water. Maximum Ocean Depth: Two miles (3.2 km), but the rider will need power armor or other means to survive such depths. For emergencies, there is a rebreather apparatus and dive mask located at the base of the Seahorse's neck, and provides six hours of breathable air.

Statistical Data:

Height: Usually about 16 hands (or 5.4 feet/1.6 m) at the shoulders.

Width: 3.8 feet (1.1 m).

Length: Approximately 10 feet (3 m) in length, with a 6 foot (1.8 m) long, shark-like tail.

Weight: 3,000 lbs (1350 kg).

Color of Hide: Various shades of silver, grey and green; may be speckled or striped along the body and tail.

Attributes of Note: Robot P.S. 30, P.P. 20, P.B. 9 (14 with hide), Spd 110; equivalent I.Q. 9.

Power System: Nuclear, average life of 10 years.

Cargo: Can carry one rider and one companion (if both are roughly human-size, otherwise space may be tight for the companion rider, and this second seat is never comfortable for long periods; an hour or more), up to 2,000 pounds (900 kg). The robot horse can pull up to five tons on land, and eight tons on the surface of water.

Cost: 12.2 million; a fake hide with fish-like scales along the body and tail costs an extra 45,000 credits.

Weapon Systems:

1. Blue-Green Eye Lasers (2): Each of the Seahorse's eyes is actually a blue-green laser designed to be the robot's primary weapon system and is useable underwater, as well as on land.

Primary Purpose: Assault.

Secondary Purpose: Defense.

Range: 2,000 feet (610 m).

Mega-Damage: 2D6 M.D. per single blast or 4D6 M.D. for a dual, linked blast.

Rate of Fire: Each single or dual blast counts as one melee attack.

Payload: Effectively unlimited.

2. Tail Swat: The tail of the Seahorse is prehensile enough to slash up, down, and sideways to strike an opponent. The end of the tail is a long, wide M.D.C. plate.

Primary Purpose: Aquatic Assault, slashing as it swims by.

Secondary Purpose: Defense.

Range: 10 feet (3 m).

Mega-Damage: 3D6 M.D. per strike on land, 2D6 M.D. underwater.

3. Combat Notes:

Attacks per Melee Round: Four.

Bonuses: +2 on initiative, +2 to strike and parry in melee combat, +1 to strike with ranged weapons, +3 to dodge when running or swimming, and +2 to roll with impact.

Mega-Damage:

Restrained Hoof Strike: 1D4 M.D.

Full Hoof Strike: 2D6 M.D.

Rear Kick/Power Kick: 4D6 M.D.

Stomp or Bite: 1D6 M.D.

Running or Swimming Body Block: 2D4 M.D.

Raptor Robot Steed

This is another departure from the traditional horse and similar riding animals, and it has been a huge success. It seems to be especially popular in the Pecos Empire and the New West. The Raptor steed can be clothed in fake dinosaur musculature, skin and scales to make it look like a real dinosaur, but many (68%) prefer it in its robot form. Bandits and Raiders insist it is even scarier in robot appearance than as an animal. Really, no kidding. The Bandito Arms Velociraptor, depicted here, is given some additional plate covering for those who want to ride it robot-style (see illustration of the Grackle Tooth making a hasty getaway, on page one). Of course, with the fake dinosaur hide in place it is indistinguishable from the real thing to all but a trained paleontologist or an expert dinosaur hunter, who might be able to spot the fake by its movements and other small details.

The Raptor steed's main armaments are undoubtedly its scythe-like Vibro-Claws on its feet, and small Vibro-Claws on the hands of its forelimbs. A bite can inflict some hefty damage as well. Eye lasers provide additional firepower and long-range capabilities.

Model Type: MRH-5100D

Class: Heavy Combat Robot Steed.

Crew: One humanoid rider with one additional rider possible in emergencies.

M.D.C. by Location:

Head – 120

* Arms (2) – 40 each

** Legs (2) – 135 each

*** Tail – 90

**** Main Body – 290

* A single asterisk indicates a small and difficult target to strike, requiring the attacker to make a "Called Shot," and even then the attacker is -3 to strike.

** Destroying one leg hobbles the robot steed and reduces speed and leaping distance by 75%!

*** Destroying the tail makes the steed less balanced and impairs movement. Reduce running speed and leaping distances by one third, and reduce combat bonuses by half, round down.

**** Depleting the M.D.C. of the main body shuts the robot down completely and renders it useless.

Speed:

Running: Maximum speed of 75 mph (120 km).

Leaping: 15 feet (4.6 m) high and 20 feet (9 m) lengthwise, with a running start. Note: The Raptor steed does not have vector thruster jets.

Flying: Not possible.

Underwater Capabilities: The robot can function in/under water, able to walk along the bottom at 20% its normal running speed, or swim at a speed of 5 mph (8 km or 4 knots). Maximum Depth is 500 feet (152.4 m).

Statistical Data:

Height: Stands 10 feet (3.0 m) tall fully erect.

Width: 5 feet (1.5 m) at the hips.

Length: 10 feet (3 m) long from snout to rump; 20 feet (6.1 m) long from snout to tail tip.

Weight: One ton.

Physical Strength: Equal to a Robotic P.S. of 28.

Power System: Nuclear; average energy life is 10 years.

Cost: 15-20 million credits; varies with regional demand.

Weapon Systems:

1. **Eye Lasers (2):** Each of the Raptor's eyes has a light laser weapon for ranged attacks. For an additional 45,000 credits, the

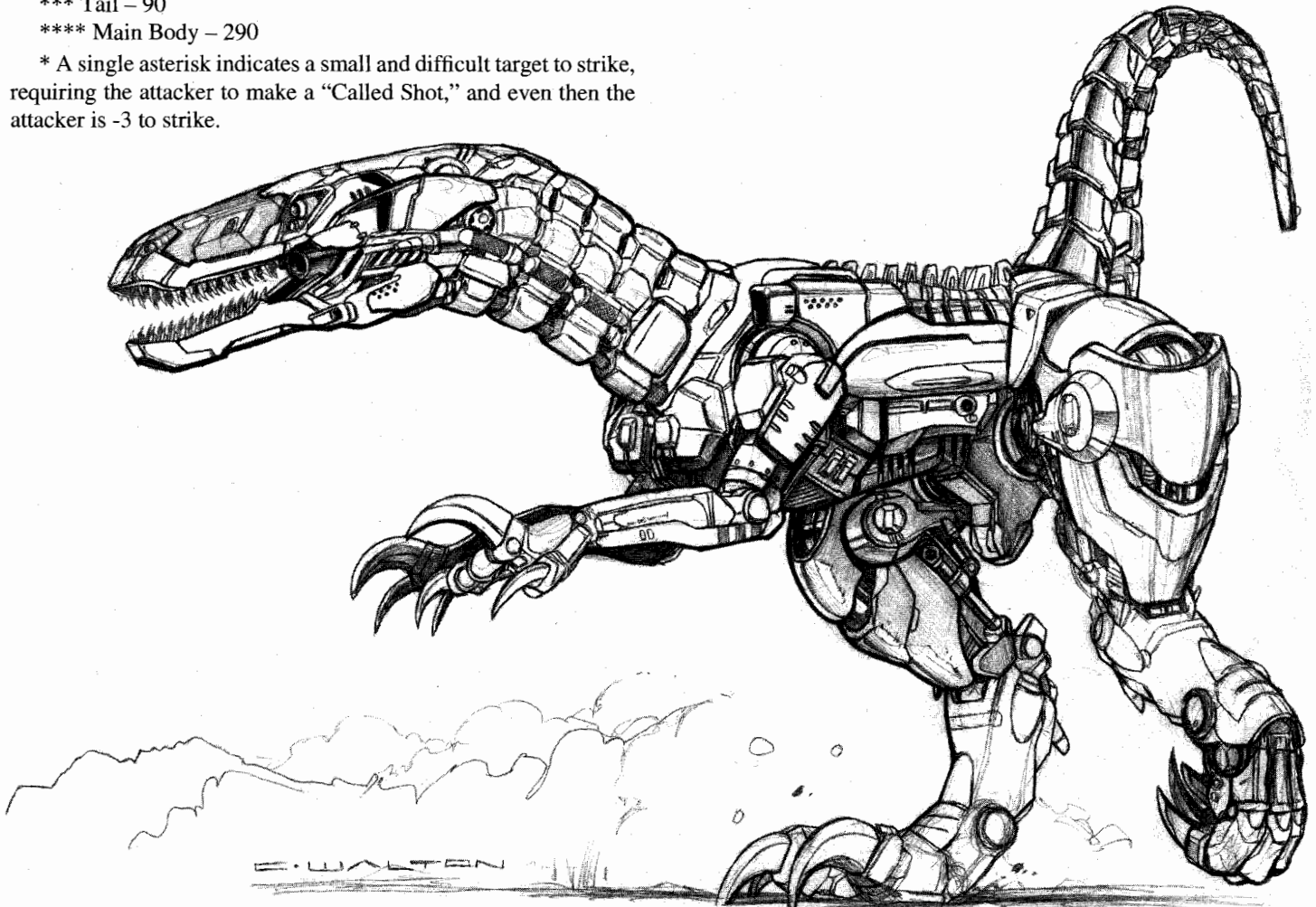

light lasers can be upgraded to do double the damage listed below with a range of 2,000 feet (610 m).

Primary Purpose: Defense.

Secondary Purpose: Anti-Personnel.

Range: 1,200 feet (366 m).

Mega-Damage: 1D6 M.D. per blast, or 2D6 M.D. for a dual, linked blast.

Rate of Fire: Each single or linked blast counts as one melee attack.

Payload: Effectively unlimited.

2. Vibro-Blade Talons, Feet (2): Each foot ends in a wicked, three-toed talon.

Primary Purpose: Assault, slashing and tearing at enemy armor and via kicks.

Secondary Purpose: Defense.

Range: 6 feet (1.8 m).

Mega-Damage: 3D6+6 M.D. per strike, which takes into consideration the Robot P.S.

3. Vibro-Blade Claw, Hands (2): Each arm ends in a wicked, three-fingered talon.

Primary Purpose: Assault, slashing and tearing at opponents and armor.

Secondary Purpose: Defense.

Range: 3 feet (0.9 m).

Mega-Damage: 2D4+6 M.D. per strike, which takes into consideration the Robot P.S.

4. Biting Jaws: The mouth is lined with small, sharp teeth, and when combined with Robot P.S., can do some serious damage.

Primary Purpose: Assault.

Secondary Purpose: Defense.

Range: Close Combat.

Mega-Damage: 2D6+3 M.D. per bite.

5. Mouth Ion Cannon (1), Option: A short-range, ion cannon can be built inside the mouth of the Raptor steed but impairs any vocal capabilities that might be desired (it cannot talk and growls and shrieks are a bit muffled). Costs 30,000 credits to install.

Primary Purpose: Anti-Armor/Anti-Robot.

Secondary Purpose: Defense.

Range: 500 feet (152 m).

Mega-Damage: 4D6+2 M.D. per blast.

Rate of Fire: Single shot; each blast counts as one melee attack.

Payload: Effectively unlimited.

6. Combat Notes:

Attacks per Melee Round: Four.

Bonuses: +3 on initiative, +3 to strike, +1 to parry in melee combat, +1 to strike with ranged weapons, +3 to dodge when running, and +1 to roll with impact.

Mega-Damage:

Restrained Punch, Head Butt or Kick: 1D6 M.D.

Full Strength Head Butt: 2D6 M.D.

Bite: 2D6+2 M.D.

Kicks: 2D4 M.D. without slashing Vibro-Blade claws.

Leap Kick: 2D6+2 M.D. without Vibro-Blades.

Leap Kick with Vibro-Blades: 3D6+6 M.D.; takes into consideration the Robot P.S. damage.

Stomp: 1D4 M.D.

Running Body Block: 1D6+2 M.D.

Tail Slash: Not possible.

Magic Contraband

By Matthew Clements.

Additional text & ideas by Kevin Siembieda

The following magic items, drugs, Techno-Wizard (TW) items and war machines are primarily offered by the *Immaterial Hand* Faction. Though other Black Market Factions and outlets may offer some of these and other magic items, the Immaterial Hand has a stranglehold on the magic sector of the underground market. A whopping 80% of magic items sold via the Black Market are provided by the Immaterial Hand.

Magic Drugs

Rifts Earth is a melting pot of different species, a crossroads of worlds and dimensions. Travelers bring with them an almost unlimited assortment of plants and animals, foodstuffs and medicines, some of which have very strange effects on other D-Bees and humans. Sometimes, especially with magic substances, the intended effect will be the same upon the user regardless of species. Other times, a simple medicine to one species may be a poison to another, or a potent hallucinogen, or a staple food. Over time, some of the most notorious effects have been discovered and isolated, and various alien drugs have become popular in Rifts North America.

Remember, the duration of the bonuses, penalties and emotions – good and bad – cannot be shortened or turned off. Once a drug is taken, the user is stuck with the effects and consequences for the full duration.

Elementum

Elementum is a series of four different magical drugs, each one tailored to a specific type of Elemental Magic. Each element has very different properties, and can produce random Warlock spells as a side effect. Elementum is sold as a brightly colored, powdery or leafy substance, yellow for air, green for earth, red for fire and blue for water. It is smoked like tobacco, and makes vivid clouds of the corresponding color when exhaled.

Each type of Elementum has a different range of magical side effects. For game purposes, consider each instance of the side effect as a single casting of the corresponding spell named, at first level strength and with no bonuses. Three spells are listed for each Elementum and they “go off” in the order they are listed or as indicated in the table. Roll 1D6 on the following table for each dose of Elementum consumed. +1 to the roll for fresh/strong batches, -1 for an old, stale or watered down batch. Unmodified roll for a typical drug off the shelf.

Here’s how the + or – works: If +1 is the case and a 3 was rolled, +1 makes it #4, and so on. If a #6 was rolled, +1 makes it 7, which means all the effects of #6 with all three magic spell side effects occurring, and the buzz/drug high lasts 50% longer.

If -1 is the case and a 3 was rolled, -1 makes it #2, and six is not possible. If #1 was rolled, -1 makes it 0, which means all the effects of #1, but reduce the sensation by two-thirds.

1. Weak buzz, reduce duration of the sensation by half and there is NO magic spell effect.

2. First magic spell effect only.

3. Second magic spell effect only.

4. Third magic spell effect only.

5. The first *two* of the three side effects occur, one a few minutes after the other. Both times the effect is likely to be stronger than level one (roll 1D4 to determine the level of potency).

6. All three side effects occur in random order 1D4 minutes apart at level 1D4+1 potency. The user does not know which side effect to expect next.

Duration of Magic Spells: As per the usual effect of the spell.

Duration of the Drug High (Bonuses and Penalties): 4D6+12 minutes unless stated otherwise.

Cost: Elementum typically sells for about 200-400 credits per "dose." The price can be up to twice as much for a well enchanted or particularly fresh and potent batch.

Elementum Air. Air creates an energetic, talkative condition in the user who feels alert, energetic and sharp. Bonuses: +1 to Perception Rolls, +1 on initiative, +1 to dodge, and +2% on skill performance. Penalties: Feels antsy, nervous and cannot sleep or remain still; becomes a bit claustrophobic when confined indoors in rooms that are smaller than 400 square feet (37 sq m), which makes him -2 on Perception Rolls and initiative, -2 to dodge, and -5% on skill performance while in confined areas, unless it involves an effort to leave. Penalties and bonuses last for the duration of the drug high. Spell Side Effects: Silence, Create Mild Wind, Cloak of Darkness.

Elementum Earth. Earth is calm and sleepy, but strong, producing a somewhat meditative state of introspective self-awareness. Users on Earth will find themselves drawn to nature, forests, and animals, and become lost in deep thought and conversation. They will seek respite from technology, bright lights and crowded areas and often have deeply reflective experiences. Bonuses: +5% on all nature related skills, +5 to P.S. attribute (temporary), +2 to save vs poison and disease, and +2 to save vs Horror Factor. Penalties: -2 to Perception Rolls unless it involves nature, then it's +2, -1 on initiative, -5% on skill performance and reduce Spd by 20%. Penalties and bonuses last for the duration of the drug high. Spell Side Effects: Chameleon, Dowsing, Grow Plants.

Elementum Fire. Fire Elementum creates an inner heat and burning desire. The character will want things with a deep yearning, and the drug is reputed to double a person's sexual prowess. The character is also given to hot emotions, instilling the drug user with a sense of physical power and aggression. Fire Elementum makes the user bold, short-tempered and quick to action. The character is likely to seek out action, adventure or physical contests like arm wrestling, boxing, racing and tests of strength and skill. Those high on Fire are much more likely to get involved in bar fights, resist arrest or attempt brazen acts. Bonuses: +5% on all skills used in a contest or display of prowess/ability. +1 on initiative, +1 to strike and disarm, +5 to Spd attribute (temporary). Bonuses last for the duration of the drug high. Penalties: -2 to Perception Rolls unless it involves winning a contest, -5% on skill performance, feels tired and worn out, and is -1 on all combat bonuses for 2D6x10 minutes after the drug high wears off. Spell Side Effects: Blinding Flash, Cloud of Smoke, Fuel Flames.

Elementum Water. Water produces a feeling of peace and serenity, but has the sensation that he is moving through water and his movements are slow and may mimic the kind of movement one would have under water. Water Elementum also distances the user from his own perceptions, making heat, cold, pain and other conditions seem far away. Users of Water Elementum are somewhat tranquilized and may have difficulty holding up a conversation or committing to a specific course of action. Bonuses: +3 to dodge

(the character just flows out of the way of danger), +2 to roll with impact, +1 to save vs mind control and possession, and +4 to save vs Horror Factor. Penalties: -2 to Perception Rolls and initiative, -1 attack per melee, -10% on skill performance and things take twice as long to do, and reduce Spd by 20%. Penalties and bonuses last for the duration of the drug high. Spell Side Effects: Color Water, Create Fog, Swim as a Fish.

Other Magic-Based Drugs

Note: Taking more than one dose does NOT increase the effects, bonuses, penalties or duration, but it will cause a severe headache and make the user feel sick to his stomach and vomit for the next 1D4 hours (reduce Spd and all combat bonuses by half).

Faerie Flight. Though reputed to be made from wings plucked from Faeries and Sprites, the actual drug is made from a variety of different herbs imbued with magic. The powder can be snorted through the nostrils, mixed with a cup of tea or other drinks or baked in cookies. It creates a euphoria in which the drug user feels calm, mellow, happy and positive. The world seems strangely beautiful and everything will be alright. At the same time, the affected person is sluggish and believes he can fly. It is not unusual to have a person under the influence of Faerie Wings to exclaim something like, "Don't worry, I'll go get him (or it)," close his eyes and strike a pose with arms out and standing on one leg as if he were flying, a big grin of delight etched on his face. Sometimes oohs and ahhs can be heard. In the drug-addled mind of the individual he imagines he is flying, and the magic makes him feel as if he is. This imagined flight lasts for 1D4 melee rounds unless the character is physically shaken or knocked to the ground. When told he was standing perched on one leg and not flying at all, the typical response is, "Really? Are you sure? Because . . . it was beautiful." Or simply, "That's weird." And odds are he strikes a pose and tries flying again.

Drug Bonuses: The individual feels happy, friendly, calm and at peace. It takes a great deal to provoke him to anger or wanting to fight even if the character is normally predisposed to rage and violence. +2 to save vs mind control and possession while under the influence, +3 to save vs aggression and fear-based magic and psionic attacks, and +3 to roll with impact.

Drug Penalties: -3 on Perception Rolls and initiative, -15% on skill performance and they take 50% longer to perform, -2 to save vs happy or beautiful illusions, reduce Spd by 20%, -1 attack per melee round and -1 on all combat bonuses.

Duration: 2D6+12 minutes and works on dragons and other creatures of magic, and Gargoyle and Brodkil Sub-Demons. Duration is twice as long for Horune Pirates, Lanotaur Hunters, Loaks, Grot Hunters and other reptilian D-Bees; triple duration for the naturally laid-back and lazy Larmac.

Cost: 50-100 credits per dose.

Powercide. The dangerous drug Powercide is a magical inebriant, a pill based on the Aura of Power spell. Instead of impressing the effect upon others, however, it works on the drug user, instilling him with a sense of overconfidence, strength and power.

Bonuses: +1 on initiative, +5% to all Physical skills, and +10% to charm, impress, intimidate and seduced while fueled by Powercide.

Penalties: People under the effects of Powercide become confident to the point of arrogance and foolishness. They dramatically overestimate their own abilities and are quick to challenge others to contests, brawls and duels, and think nothing of being outnum-

bered. The day after taking Powercide, users are -10% on all skills and -1 to save vs Horror Factor for 1D4+4 hours.

Duration: 3D6+15 minutes on humans, Dwarves, Elves and Ogres, but duration is 20% longer for most mammalian D-Bees, 20% shorter for reptilian D-Bees, and has no effect on plant and mineral based D-Bees, supernatural beings or creatures of magic.

Cost: 250 credits per dose.

Sorcerin. This substance was discovered in an attempt to create a drug that would allow the user to see auras. The experiment was a success, but the side effects are so powerful that Sorcerin is not very reliable for use in tense situations. Those under its effects can definitely see the auras of the people and creatures around them, but become extremely sensitive to the nature of the aural energy.

Bonuses: Gains the See Aura ability, is +1 to dodge, +1 to save vs magic and psionic attacks, and +1 to save vs possession, and can recognize supernatural beings, creatures of magic, evil and practitioners of magic by their aura.

Penalties: Reduce all bonuses and skill performance by half while bedazzled by the surreal experience of seeing the life auras of all living things. People under the effect of Sorcerin are impacted by the auras they see and sensations that come out of nowhere. Evil auras are terrifying and can cause the user to sweat profusely, suffer panic attacks or even black out. If forced to face the individual, the evil person has an increased Horror Factor (+3, or H.F. 13 if the character doesn't normally have an H.F.) and the drug user is -2 on all combat maneuvers leveled against him.

Conversely, good auras are mesmerizing and transfixing, and characters using Sorcerin feel extremely supportive and concerned towards characters of good alignment, becoming unusually attached and desiring to help or protect that person(s). (+1 on Perception Rolls and all bonuses when used to help or protect a good person.)

To see a demon or evil entity, or a sublime dragon or benevolent Godling while under the effects of Sorcerin is an overwhelming and indescribable thrill capable of overloading the human central nervous system, causing the character to faint for 1D4 melee rounds. If the source of the excitement is still present when the character awakens, he must roll to save against a 13 or he passes out again for 1D4 melee rounds. **Note:** Because the focus of this drug is the aura of living things, there is a 01-55% chance the character would not recognize the physical face and appearance of someone whose aura he'd know in an instant.

Duration: The See Aura ability, bonuses and penalties last for 1D4x10+12 minutes, but the things the person saw while under the influence, beautiful and terrifying, may last for a lifetime. Duration is half for most D-Bees.

Cost: 1,000 credits per dose.

Wizard's Wine. A pack of powder reminiscent of sugar, that when mixed with ordinary fruit juice, turns it into wine. One dose transforms 16 ounces (0.47 liters) into a good quality wine. Does not work on water or alcoholic beverages. (See TW Wine Machine, below.)

Duration: The wine must be consumed within 3D6+50 minutes or it turns back into a non-alcoholic beverage.

Cost: 40-50 credits per dose.

TW Wizard's Wine Machine

Wizard's Wine Machine is a Techno-Wizard device manufactured within the community of New Lazlo. It is not itself a beverage or a drug. Instead, *Wizard's Wine Machines* are similar to coffee-makers or beverage dispensers, except that they have been

enchanted with the Water to Wine spell. When filled and activated, the wine-maker transforms perfectly normal water into a fairly good quality wine. It's certainly not the best wine possible, but definitely enjoyable. There are different devices to make red wine, white wine and a bubbling champagne, and the Techno-Wizards and wine experts at Wizard's Wine are hard at work trying to synthesize more specific tastes. The machines are extremely popular in communities of magic like New Lazlo, Lazlo and the Federation of Magic, but have recently been the subject of an expose within the Coalition media and are being watched for by the ISS and cargo inspectors. **P.P.E. Cost to Activate:** Only six P.P.E. points are required to activate the enchanted mechanism to make enough for six glasses of wine (8 ounces/0.236 liters per glass). **Cost:** Average price is 10,000 credits per unit for wine-makers, and 15,000 credits for champagne-makers.

TW Power Armor

Mirage Power Armor

The Mirage is a light power armor designed for stealth, espionage and reconnaissance. It has no built-in weapon systems, but it is light and slim enough to use any man-sized weapons. Furthermore, the power armor does augment its wearer, provides M.D.C. protection and has a number of magic spells that can be activated through the armor to help it in its stealth role.

Mirage Espionage Power Armor

Model Type: TW Mirage

Class: Techno-Wizard Strategic Armored Military Stealth Suit.

Crew: One pilot.

M.D.C. by Location:

* Head – 70

Arms (2) – 45 each

Legs (2) – 65 each

Armor of Ithan – 50

** Main Body – 200

* A single asterisk indicates a small and difficult target to strike, requiring the attacker to make a "Called Shot," and even then the attacker is -3 to strike.

** Depleting the M.D.C. of the main body shuts the armor down completely, making it useless.

Speed:

Running: 30 mph (48 km) maximum, but only for 60 minute intervals, five times a day. Double speed and duration when on a ley line. Due to the magic infused into the Mirage, the act of running or fighting does not begin to tire its operator till after six hours of use. At that point the pilot begins to feel the effects of fatigue, but only at 10% of the usual rate.

Leaping: The robot legs and magic enable the wearer to leap up to 15 feet (4.6 m) high and 30 feet (9.1 m) across.

Silent Movement: When moving slower than, Spd attribute of 22 (15 mph/24 km!), the Mirage power armor makes NO NOISE. No footsteps, clicks, or clunks. +15% to Prowl skill.

Climb: Magic and built-in features enable the Mirage to climb any porous surface, including concrete walls, most steel beams, and similar, but he cannot hang upside down from a ceiling and he

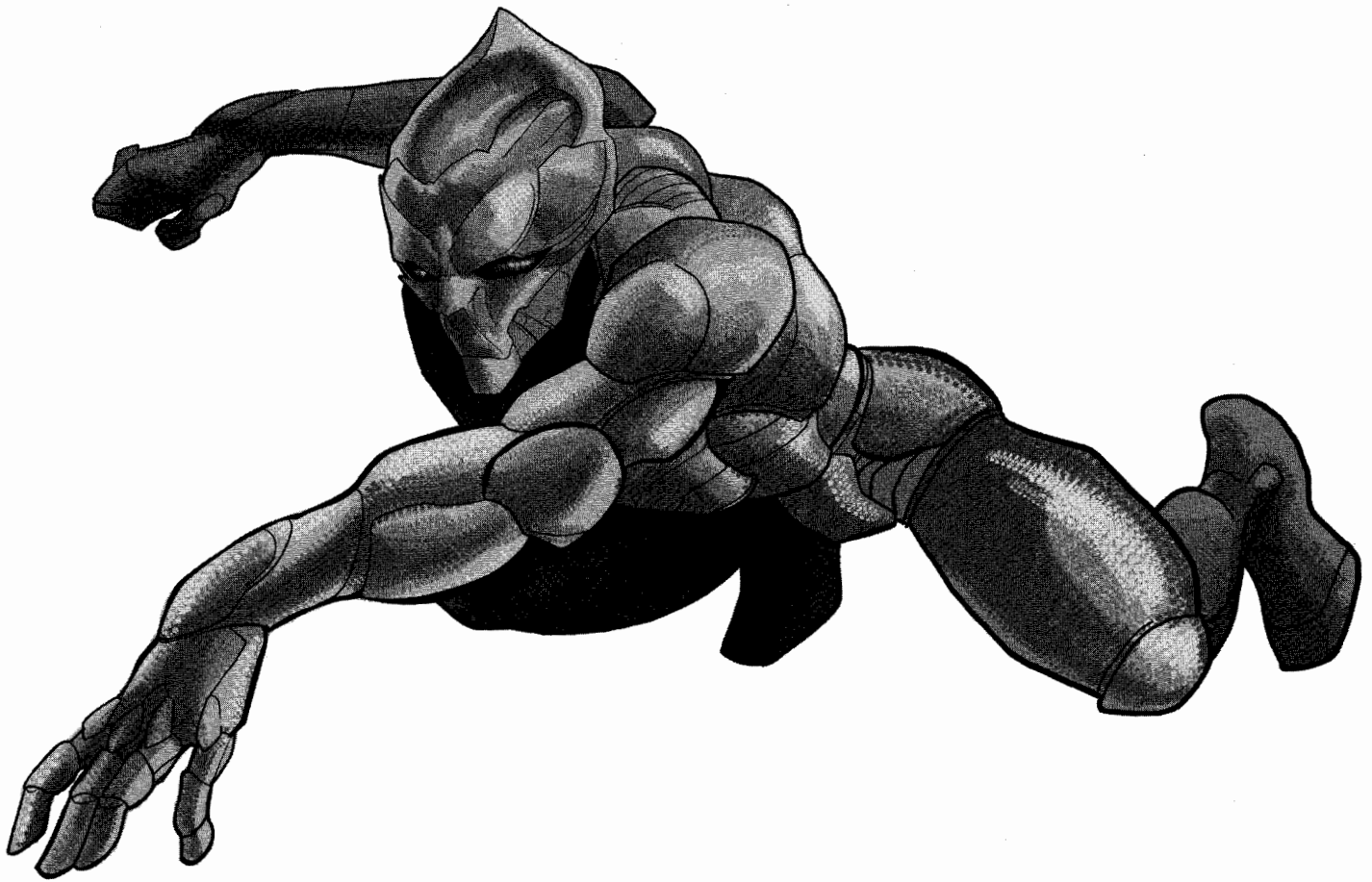

must continue to climb. Stopping for more than four melee rounds (one minute) causes the armor to lose its grip and fall. Climbing speed is at the character's normal running speed.

Flying: Not possible, under its own power, but can use a jet pack or pilot vehicles.

Underwater Capabilities: As per Swim as the Fish spell for 30 minute intervals, five times a day. Double speed and duration when on a ley line. Swimming speed is 30 mph (48 km) maximum at depths up to one mile (1.6 km). The act of swimming does NOT tire its operator.

Statistical Data:

Height: 7 feet (2.1 m).

Width: 2.5 feet (0.76 m).

Length: 2 feet (0.6 m).

Weight: 140 lbs (63 kg).

Physical Strength: Supernatural P.S. of 20.

Cargo: None, only what can be carried.

Power System: **P.P.E. battery.** Has a 100 P.P.E. point reserve to activate weapons and features. The pilot can also use his or her own P.P.E./I.S.P. to power the armor's TW equipment.

Cost: 1.3 to 2 million credits. Not normally available on the Black Market. The Immaterial Hand has only crafted a hundred or so, and so far, have sold most of them to fellow Black Marketeers.

Weapon Systems:

1. Handheld Weapons: Any man-sized and cyborg weapons are suitable for use by this power armor.

2. Armor of Ithan: A small device produces the Armor of Ithan enchantment to provide an additional 50 M.D.C. The effect

lasts for five minutes or until the M.D.C. is destroyed, whichever comes first. Requires 10 P.P.E. from the suit's battery.

3. Other Magic (P.P.E. cost in parentheses): The following spells can be cast by the pilot via the Mirage. The P.P.E. for them can be drawn from the power armor's P.P.E. battery or channeled from the pilot's own P.P.E. reserve (assuming he has sufficient P.P.E.). **Note:** Practitioners of Magic cannot cast their own spells while inside the Mirage as being enclosed by the power armor prevents their use of magic. They can only cast the spells imbued within the TW power armor when it was created.

Spells of the Mirage: In this case, all the spells are designed for stealth, espionage and reconnaissance. All are cast at 5th level potency. Armor of Ithan (10), Chameleon (6), Cloak of Darkness (6), Escape (8), Multiple Image (7), Shadow Meld (10) and Tongues (12).

4. Hand to Hand Combat: Rather than use a weapon, the pilot can engage in Mega-Damage hand to hand combat. See *Ground Based Power Armor Training* on page 352 of *Rifts® Ultimate Edition*.

Supernatural P.S. of 20 means the armor does M.D. damage in hand to hand combat.

Restrained Punch or Kick: 3D6 S.D.C.

Full Strength Punch: 1D6 M.D.

Power Punch: 2D6 M.D., but counts as two attacks.

Kick Attack: 2D4 M.D.

5. Sensor System Note: All the normal sensors and features standard to environmental power armor (see the *Rifts® Ultimate Edition* rule book, page 271), plus built-in language translator and depth gauge.



The Ironmage

Magically Resurrected TW Glitter Boy Power Armor

The most infamous power armor on all of Rifts Earth is the notorious Glitter Boy. It is the weapon of heroes and champions, a shining, laser-resistant symbol of freedom and defiance against both alien invaders and the overbearing Coalition States.

The GB-10 Glitter Boy's configuration is an ancient design created by the old American military to fill the role of walking tank. Its Boom Gun is so devastatingly powerful that the whole suit must be anchored temporarily to the ground and jet thrusters engaged to compensate when it fires. And to top it off, the exterior is coated with a reflective finish that cuts damage taken from laser weapons in half.

After being handed down through generations of constant warfare since the Great Cataclysm, the interior of a Glitter Boy suit is imprinted with the essences of many fallen champions, some of whom met their end inside the suit itself. Those who can read auras can see an ancient Glitter Boy armor almost as a living thing, a war-torn record of victories won from the Golden Age of Humanity, to the Dark Age that came after the Coming of the Rifts, to the modern day. The slain demons and wicked warriors who have perished under its gun all combine to charge the exoskeleton full of psychic resonance and latent P.P.E. energy. Recently manufactured suits do not share the same long and storied history, and register to psychics and other sensitives as nothing but spiritless hunks of metal.

The Techno-Wizard weaponsmiths of the Immaterial Hand have recently discovered that very old GB-10 suits (180-315 years old) are potent conductors of magic energy. A handful of the treasured artifacts were located, some damaged seemingly beyond repair, and ritually "resurrected" as enchanted war machines.

The most skilled TW technicians and sorcerers were called in for the solemn procedure. The Glitter Boys were lovingly restored and carefully hand-painted with magic symbols, runes and wards. Techno-Wizard devices were built-in and spell after spell was cast upon the venerated suits in order to give them abilities that they were never meant to have.

The end result is **the Ironmage**, one of the most sophisticated creations in the history of Techno-Wizardry. The Boom Gun has been rebuilt into the devastating Shriek Cannon, an overwhelming weapon that uses a magical shock wave of sound as its means of destruction, whereas the original rail gun's was just a sonic side effect. Its energies can also be redirected as a Starfire machine-gun, a weapon that compensates beautifully for the Shriek Cannon's slow rate of fire. The left forearm has been outfitted with a Goblin Bomb launcher capable of unleashing projectiles with a whole array of magical side effects. The launcher excels at neutralizing short-range opponents. Wards and runes replace the laser-resistant skin to imbue the armor with various protections and close-range, spell-like attacks and abilities such as See the Invisible and Sense Evil. Symbols on the hands can be activated to grant magic climbing ability, and the Chameleon spell makes the Ironmage disappear into the background where it stands, effectively concealed until it is ready to move or attack. The Heavy Breathing invocation is used for intimidation, making the menacing power armor seem to be a living, armored beast.

To increase the slow Glitter Boy's mobility, a Ley Line Booster is built into the back. Along ley lines, the Ironmage's speed and

magical invocations are enhanced and the Levitation spell that is normally only used to balance out the Shriek Cannon can raise the Ironmage into the air up to 150 feet (45.7 m) for attacks from an elevated position.

The human or D-Bee pilots of an Ironmage claim that piloting the power armor even for the first time, feels like putting on a comfortable set of clothes and completely natural. Many insist they feel more confident and heroic inside the Ironmage, especially when fighting the forces of evil, and some even claim they can hear the whispers of past heroes offering advice in their ears or sending them sudden flashes of insight or ideas for strategies and tactics to use in combat.

Ironmage TW Resurrected Glitter Boy

Model Type: TW Resurrected GB-10 Power Armor.

Class: Techno-Wizard power armor. Extremely rare.

Crew: One pilot.

Pilot Restrictions: The Ironmage is not believed to possess any sentience, awareness or alignment of its own, despite the claims of some who insist the armor is inhabited by the spirit of several to all of those heroes who ever piloted it. However, only the following O.C.C.s can get the power armor to function, and all must be of good alignment (Scrupulous or Principled only): *Glitter Boy Pilot (and variations like Free Quebec's "Descended" and Japan's Glitter Force Trooper)*, *Battle Magus*, *Controller Magus*, *High Magus*, *Ley Line Walker*, *Mystic*, *Mystic Kuznya*, or *anyone* who the armor accepts and *allows to pilot it!* As a general rule, characters of selfish alignments can pilot an Ironmage but get NO power armor bonuses, no additional attacks per melee, and the usual damage, range and the effects of spell magic are reduced by half. Evil pilots cannot get the power armor to function at all; it will not move an inch nor fire a weapon. For whatever reason, an Ironmage will not respond to Biomancers regardless of alignment.

M.D.C. by Location:

Shriek Cannon – 155

* Head – 26

* Hands (2) – 100 each

Arms (2) – 250 each

Legs (2) – 440 each

Reinforced Pilot's Compartment – 150

** Main Body – 676

* A single asterisk indicates a small and difficult target to strike, requiring the attacker to make a "Called Shot," and even then the attacker is -3 to strike.

** Depleting the M.D.C. of the main body will shut the armor down completely, making it useless. **SPECIAL: Magic Armor Regeneration:** Ironmage power armor and weapons "heal" from damage at a rate of 1D6x10 M.D.C. per hour when on a ley line (2D4x10 at a nexus) but this requires standing absolutely motionless like a statue. The moment the power armor is made to take any type of action whatsoever, the healing stops. No healing is possible when even just walking along a ley line or standing there and looking around. The Ironmage pilot himself heals at a rate of 1D4 per hour if he meditates or sleeps inside an Ironmage.

Speed:

Running: 60 mph (96 km) maximum, increase by 50% along ley lines. Note that the act of running does tire its operator, but only at 10% of the usual fatigue rate.

Leaping: The robot legs can leap up to 12 feet (3.6 m) high or across. Add 10 feet (3 m) with a running start, double height and

distance at ley lines. Also while on a ley line, the TW Levitation system enables the magic to lift the Ironmage (much heavier than the spell's normal capacity to handle) up to 150 feet (45.7 m) into the air for a better view or an elevated firing position; can rotate 360 degrees and height can be regulated as desired. Remember, Levitation is limited to up and down action. Horizontal movement is not possible.

Underwater Capabilities: Swimming: The suppressor thrusters in the back enable the Ironmage to propel itself underwater but at a sluggish speed of 15 mph (24 km); same speed on the surface of the water, double if traveling along a ley line. The Ironmage can also walk along the bottom of the sea or lake bed at about 25% of its normal walking/running speed. Maximum Ocean Depth: Two miles (3.2 km) and the pilot is magically protected.

Statistical Data:

Height: 10 feet, 5 inches (3.1 m).

Width: 4 feet, 4 inches (1.3 m).

Length: 4 feet (1.2 m).

Weight: 1.2 tons fully loaded.

Cargo: Minimal storage space; a one foot (0.3 m) compartment and storage for a rifle, handgun, survival knife and first-aid kit.

Power System: **P.P.E. battery.** Has a 350 P.P.E. point reserve to activate features. The pilot can also use his or her own P.P.E./I.S.P. to power the suit's TW weapons, equipment and the spells it can cast upon itself. The P.P.E. battery recovers spent P.P.E. at a rate of 10 P.P.E. per hour that the power armor is not using its weapons or casting magic. On a ley line, the Ironmage can draw upon 15 P.P.E. per melee round and 30 P.P.E. at a ley line nexus to power the weapon or cast magic.

Cost: Not normally available on the Black Market. The Immaterial Hand has only crafted a couple of dozen Ironmages, most of them for champions and rich clients who have provided the ancient GB-10 power armor themselves. When they are resold, they fetch 35-50 million credits.

Weapon Systems:

1. Shriek Cannon: When the original Boom Gun was fired, its recoil produced an actual sonic boom that emanated from the weapon. For the Shriek Cannon, the sonic boom *is* the weapon. Crafted to look like an open-beaked eagle, the Shriek Cannon screams a wave of sound energy at its targets. The magical sound blast strikes a specific target and does impressive damage, and those in close proximity suffer all the same effects as the *Sonic Blast* spell: Everyone within a 20 foot (6.1 m) radius of the Ironmage is temporarily deafened for 2D4 minutes and suffers the following penalties for the duration of that time: Lose two melee actions/attacks, are -8 on initiative, -3 to parry and dodge, and -25% on skill performance. Those caught in the blast will also be shaken by the shock wave of the boom, with a 01-40% chance of being knocked off their feet (lose another one melee action), while windows are rattled and livestock and children terrified. **Saving Throw:** Reduce penalties by half if a successful roll to save vs magic of 15 or better is made.

The weapon can also be "dry-fired" to cast the *Thunderclap* spell, useful for intimidation and fake-outs. As an intimidation device, it will momentarily startle and distract everyone other than the spell caster. This provides the creator of the thunder with a bonus of +5 on his initiative, +1 to strike, parry and dodge, and creates a Horror Factor of 8 (all characters within 30 feet/9.1 m must roll to save vs Horror Factor, except the pilot who made the thunder).

Primary Purpose: Assault.

Secondary Purpose: Anti-Aircraft.

Range: 5,000 feet (1,524 km).

Mega-Damage: 1D4x10 M.D., and increase to 1D6x10 M.D. when on a ley line and against creatures of magic and supernatural beings.

Rate of Fire: The Shriek Cannon takes a moment to charge up and may only be fired once per melee.

Payload: Each blast requires 12 P.P.E. from the suit's P.P.E. battery. "Dry-firing" requires 2 P.P.E.

2. Starfire Machine-Gun: The eagle shaped housing of the Shriek Cannon can activate its eyes to be used as a Starfire machine-gun. The weapon provides flexibility and allows the pilot an alternative to the devastating main gun.

Primary Purpose: Anti-Personnel.

Secondary Purpose: Anti-Aircraft.

Range: 1,500 feet (457 m).

Mega-Damage: 3D6 M.D. for a single blast, 6D6 M.D. for a dual blast from both eyes.

Rate of Fire: Each single or dual blast counts as one melee attack.

Payload: Each single blast requires 5 P.P.E. from the suit's P.P.E. battery, 10 P.P.E. for dual blasts.

3. Goblin Bomb Launcher: Goblin Bombs are compact, enchanted explosives that have a variety of different magical effects. Carpet of Adhesion, Fear, Lightning and Fire are all the most common types, but almost any low level enchantment can be turned into a Goblin Bomb by a Techno-Wizard.

Primary Purpose: Anti-Personnel.

Secondary Purpose: Defense.

Range: 800 feet (244 m).

Mega-Damage: Varies by grenade type. Fire is 4D6 M.D. to a 6 foot (1.8 m) radius, lightning 2D6+2 M.D. to a 3 foot (0.9 m) radius. See **Coalition Wars® Rifts®: Siege on Tolkeen™ – Chapter One** for complete details on Goblin Bombs. **Optional:** May substitute with *Fire Bolt* spell at the cost of 4 P.P.E. per bolt (range: 125 feet/38 m, 4D6 M.D. or 1D6x10 S.D.C. per blast as desired by the pilot).

Rate of Fire: Each grenade fired counts as one melee attack.

Payload: The suit has an ammo hopper that holds 8 Goblin Bombs and can select which one to fire next. A bandoleer or satchel/pouch slung over the shoulder or hung from a belt with 16 spare bombs is typically carried by Ironmage pilots.

4. Other Magic (P.P.E. cost in parentheses): The following spells can be cast by the pilot via the Ironmage. The P.P.E. for them can be drawn from the power armor's P.P.E. battery or channeled from the pilot's own P.P.E. reserve (assuming he has sufficient P.P.E.). Note: Practitioners of Magic cannot cast their own spells while inside the Ironmage, as being enclosed by the power armor prevents their use of magic. They can only cast the spells imbued within the Ironmage when it was created. All are cast as 7th level potency.

Spells of the Ironmage: Blinding Flash (1), Chameleon (6), Climb (3), Cleanse (6; in this case, the spell instantly cleanses the Ironmage only), Cloud of Smoke (2), Frostblade (15), Globe of Daylight (2), Heavy Breathing (5), Impervious to Fire (5), Levitation (5), Lightblade (20), Magic Shield (6), Mystic Fulcrum (5), See the Invisible (4), Sense Evil (2), Tongues (12), and one additional spell of choice from Invocation Levels 1, 2 and 3 as all Ironmages are a little different.

5. Handheld Weapons: Giant-sized M.D. rifles, giant melee weapons and rail guns suitable for use by power armor and cy-

borgs may be used in addition to the built-in weapon systems and magic, as desired.

- 6. Hand to Hand Combat:** Rather than use a weapon, the pilot can engage in Mega-Damage hand to hand combat. See *Ground-Based Power Armor Training* on page 352 of **Rifts® Ultimate Edition**. Characters of the Glitter Boy O.C.C. (and its variants), **ONLY**, use their usual *Power Armor Combat Elite: Glitter Boy* (see pages 72-73 of **Rifts® Ultimate Edition**).
- 7. Sensor System Note:** All the normal sensors and features standard to environmental power armor (see the **Rifts® Ultimate Edition** rule book, page 271), plus built-in language translator and depth gauge.

Rift Hawk Power Armor

Techno-Wizard SAMAS

Over the years in North America, the occasional SAMAS suit that hails back from the early days of the Coalition, or in some cases, even before, finds its way onto the Black Market. The venerable

SAMAS has been protecting the innocent against monsters from the Rifts for generations and though not as impressive or powerful as the Ironmage Glitter Boy, such experienced suits carry the psychic stain of war upon them. Fortunately for the Techno-Wizards of the Immaterial Hand, these SAMAS units turned out to be less averse to magic than the pilots who once flew them. With great care and ceremony, they can be reborn as enchanted exoskeletons, rearmed and renewed to fight on against the enemies of man.

The primary weapon of the Rift Hawk is the Ricochet Rifle. Enchanted with the *Ricochet Strike* spell, the dumb-dumb rounds fired by what is essentially a Techno-Wizard rail gun take on the enchantment as they leave the barrel and bounce around in an eerily intelligent pattern, impacting one target before ricocheting directly into the next and then a third.

The Rift Hawk also fires a *Barrage Beam* from the left hand, a Techno-Wizard spell-projector that casts a version of the *Barrage spell* that is effective both against large vehicles/monsters and groups of smaller targets. Its final trick is the *Armor of Ithan* spell that provides an additional, magic 50 M.D.C. that can be activated to provide additional protection during strafing runs, tense dog-fights and close escapes.



Otherwise, the power armor handles like a SAMAS and has all its usual standard features.

Rift Hawk Power Armor

Model Type: TW SAMAS.

Class: Techno-Wizard Strategic Armored Military Assault Suit.

Crew: One pilot.

M.D.C. by Location:

- * Ricochet Rifle – 50
- * Ammo Drum – 60
- Shoulder Wings (2) – 30 each
- TW Flight System (2) – 60 each
- Levitation Systems (3) – 25 each
- * Head – 70
- Arms (2) – 60 each
- Legs (2) – 100 each
- Armor of Ithan – 50
- ** Main Body – 250

* A single asterisk indicates a small and difficult target to strike, requiring the attacker to make a “Called Shot,” and even then the attacker is -3 to strike.

** Depleting the M.D.C. of the main body shuts the power armor down completely, making it useless.

Speed:

Running: 60 mph (96 km) maximum, increase by 10% on a ley line. Note that the act of running does tire its operator, but only at 10% of the usual fatigue rate.

Leaping: The robot legs can leap up to 15 feet (4.6 m) high or across unassisted by the thrusters. A jet thruster assisted leap can propel the unit up to 100 feet (30.5 m) high and 200 feet (61 m) across without actually attaining flight.

Flying: The rocket propulsion system enables the SAMAS to hover stationary up to 200 feet (61 m) or fly. Maximum flying speed is 300 mph (480 km), but cruising speed is considered to be 150 mph (240 km). Maximum altitude is limited to about 500 feet (152 m); increase speed and altitude by 30% when riding along a ley line.

Underwater Capabilities: Swimming: The thruster system provides good mobility and control underwater but at a sluggish speed of 15 mph (24 km); same speed on the surface of the water. The Rift Hawk can also walk along the bottom of the sea or lake bed at about 25% of its normal walking/running speed. Maximum Ocean Depth: One mile (1.6 km).

Statistical Data:

Height: 8 feet (2.4 m).

Width: Wings down: 3.5 feet (1.06 m). Wings extended: 10 feet (3 m).

Length: 4 feet, 6 inches (1.4 m).

Weight: 340 lbs (153 kg).

Physical Strength: Robotic P.S. of 30.

Cargo: None.

Power System: **P.P.E. battery.** Has a 200 P.P.E. point reserve to activate weapons and features. The pilot can also use his or her own P.P.E./I.S.P. to power the armor’s TW equipment.

Cost: Not normally available on the Black Market. The Immaterial Hand has only crafted twenty or thirty of the suits, mostly for champions and clients who have provided the SAMAS suits themselves. When they are resold, they fetch 4-6 million credits.

Weapon Systems:

1. Ricochet Rifle: The Ricochet Rifle looks and fires much like a conventional rail gun, and most targets do not realize they are taking fire from a magical weapon until they witness the effects of its enchanted ammunition. Roll to strike as normal for the first target, then use the same strike roll for up to two additional targets if they are within 30 feet (9 m) of the first. The projectile bounces off the first target (if it hit) to strike the second target and then bounces off it, to strike a third or the first target again. If the projectile is parried it will ricochet and strike another target as normal, but if it misses or is dodged, the ricochet effect ends and the attack misses everyone entirely.

Primary Purpose: Anti-Personnel.

Secondary Purpose: Anti-Aircraft.

Range: 3,000 feet (914 m).

Mega-Damage: Damage is progressively less per each target struck by the magical shell. The first target takes 3D6 M.D., the second 2D6 M.D. and the third/last 1D6 M.D.

Rate of Fire: Single shot only. Each shot counts as one melee action.

Payload: The Rift Hawk’s compact ammo drum holds 432 rounds. Any heavy rail gun ammunition may be used. Enchanting each round drains 1 P.P.E. from the energy reserve.

2. Barrage Beam: A heavy-duty version of the Barrage enchantment can be fired from the left hand.

This spell unleashes a succession of force blasts to batter its intended target like a swarm of tiny comets striking one after the other. Each energy blast is visible, about the size of a softball with a vapor trail, and is fast moving. Once unleashed against a target, the “barrage” continues until all blasts are used up. Even if the victim runs, flies up, or dives for cover, the barrage will follow him like tiny guided missiles. However, because the blast pulses are reasonably large and visible, the character can try to dodge or parry them with a weapon. A successful dodge means the magical blast misses and dispels. A successful parry means it is batted away and the blast dispels without damage on impact. Of course, the down side is that the barrage of magic force will either strike, injure or distract the targeted victim, and probably cause him to spend his time and combat actions trying to defend against the attack!

In addition to taking damage (each blast that hits does two M.D.), the victim is distracted from events and activity around him (focused on the pounding attack) and is -3 to defend against any other attack(s) leveled at him during the barrage. Worse, even if the character stands his ground and takes the pummeling of force, he loses two melee attacks/actions, because he can not take any offensive action (only parry and dodge) while being hammered by the barrage!

Primary Purpose: Anti-Personnel.

Secondary Purpose: Assault.

Range: 310 feet (95 m).

Mega-Damage: Two M.D. per force blast, blast radius of 20 feet (6.1 m). When used against a one man-sized target, he is barraged by 1D6+2 force blasts. When directed against a group of man-sized targets, 1D6+4 of them within the blast radius are struck by one of the barrage blasts. When leveled against one giant robot, large combat vehicle, dragon or similarly large monster, the target sustains 2D6+2 force blast impacts.

Rate of Fire: The Barrage Beam may be activated once per melee round.

Payload: Each Barrage requires 10 P.P.E. from the suit's battery.

3. **Armor of Ithan:** A small device produces the Armor of Ithan enchantment to provide an additional 50 M.D.C. The effect lasts for five minutes or until the M.D.C. is destroyed, whichever comes first. Requires 10 P.P.E. from the suit's battery.
4. **Other Magic (P.P.E. cost in parentheses):** The following spells can be cast by the pilot via the Rift Hawk. The P.P.E. for them can be drawn from the power armor's P.P.E. battery or channeled from the pilot's own P.P.E. reserve (assuming he has sufficient P.P.E.). **Note:** Practitioners of Magic cannot cast their own spells while inside the Rift Hawk, as being enclosed by the power armor prevents their use of magic. They can only cast the spells imbued within the TW SAMAS when it was created. Spells of the Rift Hawk: In this case, all the spells are designed to protect the pilot in the event the armor is severely damaged or on the verge of being destroyed. One or more can also be placed on the pilot when he exits or enters the power armor. All are cast at 5th level potency. Armor of Ithan (10), Breathe without Air (5), Climb (3), Death Trance (1; the pilot appears to be dead and an enemy is likely to leave him as such), Impervious to Fire (5), Light Healing (6), and Tongues (12).
5. **Handheld Weapons:** Large power armor and cyborg-sized M.D. rifles, rail guns, and similar, suitable for use by power armor, may be used in addition to the built-in weapon systems and magic, as desired.

6. **Hand to Hand Combat:** Rather than use a weapon, the pilot can engage in Mega-Damage hand to hand combat. See *Flying Power Armor Training* on page 352 of **Rifts® Ultimate Edition**.
7. **Sensor System Note:** All the normal sensors and features standard to environmental power armor (see the **Rifts® Ultimate Edition** rule book, page 271), plus built-in language translator and depth gauge.

Enchanting Other Antique Technology

Like the Glitter Boys used to create the Ironmage, other pieces of aged power armor or body armor can be potent conductors of psychic and magic energy. NEMA weapons that have been dug up or miraculously preserved are good candidates, as well as any "hand-me-downs" or armor that has been around for several generations. Age itself, however, is not a guarantee that the process will work. A suit of ancient power armor that has sat in a vault and never been used is as poorly conductive as a brand new version. In order to acquire its magic potential, the piece of technology must be used. It must have a history. It must be experienced.

The Rifter® Subscription

The Rifter® is your doorway to unlimited imagination and numerous Palladium role-playing worlds. It offers new heroes, powers, weapons, magic and adventure for your games. It presents new villains, monsters and dangers to battle, and new ideas to consider.

It helps you unlock your imagination by showing you what gamers, just like *you*, have created. That's right, many of the articles and source material are written by ordinary gamers and fans like *you*. Other articles are by freelance writers and staff.

The Rifter® is made for you, our fans. Each issue presents unofficial (and sometimes official) source material, adventures, characters, monsters, villains, powers, weapons, equipment, ideas and fiction for **Rifts®**, **Chaos Earth™**, **Splicers®**, **Beyond the Supernatural™**, **Heroes Unlimited™**, **Ninjas & Superspies™**, **Palladium Fantasy RPG®**, **Nightbane®**, and/or any variety of other Palladium games and world settings. It's also a place where we test new ideas, and showcase new games, like *Dead Reign* and the upcoming *Mechanoids® Space*.

It is also a way to get the latest news, coming attractions, and sneak previews of upcoming Palladium products, events and secret projects.

Sourcebook

As a sourcebook, each issue of **The Rifter®** presents optional and/or official source material for a variety of Palladium's role-playing settings – **Rifts®**, **Phase World®**, **Palladium Fantasy RPG®**, **Heroes Unlimited™**, **Nightbane®**, **Beyond the Supernatural™**, and other titles such as *After the Bomb®*, **Ninjas & Superspies™**, **Rifts® Chaos Earth™**, **Splicers®**, and others. Every issue includes material for 3-6 different Palladium RPG lines.

Magazine

As a magazine, each issue includes the latest news and goings on at Palladium Books, information on new product, our schedule of releases, convention appearances, special offers, and even sneak previews and extra "official" material for new Palladium games or sourcebooks.

Talent Show

The Rifter is unlike anything on the market because it is a way for *you*, the fan, the unpublished writer and hopeful young artist to get published and break into the industry.

No other game company does that, so take advantage of the opportunity to see *your* work and *your* name in print! You'll get a small payment (about \$10 per printed page of text), four free copies of the issue your work appears in, and bragging rights to all your friends. Best of all, you get to share your ideas with thousands of other Palladium gamers.

Think it can't happen to you? Think again. Many of Palladium's artists and writers got started in **The Rifter®**, including *Apollo Okamura*, *Brian Manning*, *Mike Mumah*, *Carl Gleba*, *Todd Yoho*, *Brandon Aten*, *Taylor White*, *Jason Richards*, and *many others*.

Palladium is always looking for written material for **Rifts®**, **Chaos Earth™**, **Beyond the Supernatural™**, **Nightbane®**, **Palladium Fantasy RPG®**, **Heroes Unlimited™**, **Ninjas & Superspies™**, **After the Bomb®**, and all our game lines. We'd also like to see cartoons and comic strips.

Send your "article/source material" (5-30 pages) or art samples (photocopies, never original art), to *The Rifter® Submissions Dept*, 39074 Webb Court, Westland, MI 48185.

Subscribe Today

Lock in the current price and discount

The price of **The Rifter®** is \$11.95 retail (a steal for 96 pages of RPG source material and adventures), but a subscription saves you even more money, and you have the convenience of delivery right to your door. All prices are in U.S. dollars.

- **\$39.80 – that's only \$9.95 each**, a savings of \$8, and Palladium picks up the shipping cost. **Note:** This rate is *limited* to subscribers in the USA only.
- **\$61.80 – Canada.** Our apologies, but Palladium Books can no longer cover the increased cost of postage to other countries. We hope you understand.
- **\$75.80 – Overseas:** Overseas subscriptions *are* charged an additional fee for overseas shipping costs. Sorry. We are only passing along the additional postage costs, but it is hefty. Our apologies.
- **Free Shipping anywhere in the USA.**
- **Great Savings.**
- **A Megaverse® of adventure and fun.**
- **How to order.** Send mail orders with a check or money order (for \$39.80 in the USA) to:

The Rifter® Subscription Dept.

39074 Webb Court

Westland, MI 48185

Credit Card Orders: Can be made on our web site (www.palladiumbooks.com) or by telephone 734-271-2903 (this is an order line *only*).

Check or Money Orders: Send them to the address above with a note indicating which issue number you want your subscription to start.

Please indicate what issue number you'd like your subscription to start (i.e., last issue, current issue, next issue, or when your current subscription ends).

This offer is good till October 31, 2013.

© Copyright 2012 Palladium Books Inc.

www.palladiumbooks.com

Also from Palladium Books®



Rifts® World Book One: Vampire Kingdoms™

- Everything you need to know about vampires.
- Vampire Hunters, vampire slaying weapons & undead combat tips.
- Weird creatures, dinosaurs, vampire slaves and more.
- Ciudad Juarez mapped and described, town creation and encounters.
- The Vampire Kingdoms, ideas for adventure and more. 224 pages.

Rifts® Sourcebook Five: Rifts® Vampires™

- Reid's Rangers, Fort Reid, desert survival & traveling shows.
- The villains who slay vampire hunters for the undead.
- Vampire Hunter Mages, Techno-Wizard weapons and vehicles.
- The Yucatan, Camazotz, Werebeasts and more. 128 pages.

Rifts® Northern Gun™ 1 and Rifts® Northern Gun™ 2

- Background on Northern Gun, the largest independent weapon, robot, vehicle and equipment manufacturer in North America.
- A new catalog of NG combat robots, drones and vehicles.
- A new catalog of NG power armor, weapons and gear.
- The Robot Gladiatorial Arena and much, much more.
- 160-192 pages each. Epic adventure. Tons of gear.

One game system – an endless Megaverse® of adventure

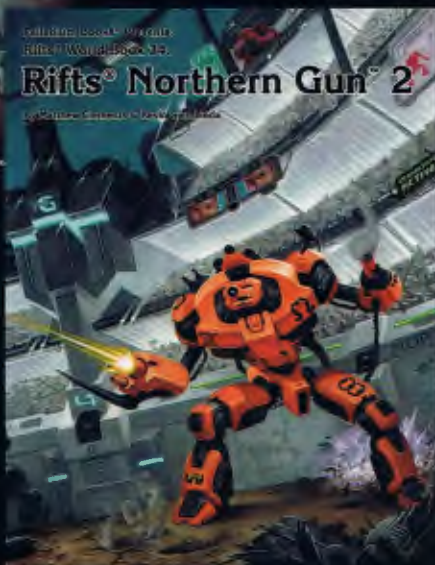

At stores
everywhere

Rifts® Black Market™

A Rifts® Sourcebook

Rifts® Black Market™ is an epic, 192 page sourcebook that contains a wealth of information about the inner workings of the Black Market, the Five Factions, new Bandito Arms/Black Market weapons and gear, how to make *any* O.C.C. a Black Marketeer, special abilities of the Black Marketeer, criminal enterprises, Black Market loans, merc and crime jobs, and much more. This book has it all. AND best of all, a lot of it can be easily adapted to just about any world setting, not just Rifts Earth.

- New Bandito Arms weapons, power armor and robot riding animals.
- New BigBore weapons and other weapons and gear.
- Black Market Techno-Wizard weapons and items.
- Major Black Market smuggling corridors and routes.
- Any O.C.C. (or R.C.C.) can become a Black Marketeer.
- Special abilities and benefits of the Black Marketeer.
- 10 Specialized O.C.C.s of the Black Market including Con Artist, Enforcer, Expediter and Rift Runner.
- The Five Black Market Factions that wield the greatest power in North America: Bandito Arms, The Chicago Network, The Immateral Hand, El Oculata and Le Marche Noir.
- Criminal enterprises and inner workings of the Black Market.
- Smuggling methods, both magical and conventional.
- Traveling Shows: Freak Shows, Medicine Shows, Circuses and more.
- 192 pages written by Matthew Clements, Kevin Siembieda and Carmen Bellaire. Additional material by Taylor White, Julius Rosenstein and Alex Marciniszyn.